



DESIGNED TO FIT  
OEM QUALITY & STANDARDS

# Westar has **better.**

Westar introduces 545 part numbers.

---

We're **manufacturers,**  
who became  
**distributors.**

WESTAR IS FOUNDED BY A TEAM OF  
MANUFACTURERS WHO FOCUSED ON  
OEM QUALITY ENGINEERING IN THE  
AUTOMOTIVE PARTS INDUSTRY.



#



***Thank you for choosing Westar Distribution, LLC for your Engine, Transmission, and Center Support Mount needs. Westar has been instilling customer confidence and satisfaction for over 30 years.***

**Our History:**

- 1986 - Westar incorporated in an initial warehouse 1,500 square feet, in Columbia, MD.
- 1989 - Westar moved into a 5,000 square foot facility in Jessup, MD
- 1992 – Westar expanded into a 19,000 square foot facility in Laurel, MD
- 2000 – Westar grew into a 60,000 square foot facility back in Jessup, MD
- 2011 – We relocated into our current 187,000 square foot facility in Columbia, MD

Westar incorporated a solid business model to ensure that any customer that aligns with Westar grows with us and becomes successful.

1. **Branding** – A whole new marketing effort was set up to allow Westar’s customers to be informed about what’s going on with our engine mounts and to make sure they are ahead of the game.
2. **Quality** – Amazing Product Quality reduces the customer’s returns and establishes a positive reputation in the market. All of our factories are required to obtain and adhere to the stringent requirements of such industry standards as ISO, QS, and TS.
3. **Coverage** – Great coverage and research allows Westar to ensure our customers have legitimate full line coverage of engine mounts along with the capability to make sure they are always stocking the right parts.
4. **Price** – Competitive Pricing allows Westar’s customers to grow and compete at the highest level.
5. **Performance** – Delivering amazing fill rate on all orders placed with Westar at amazing delivery time!

#

# TABLE OF CONTENTS

<b>New Part Numbers.....</b>	<b>v</b>
<b>Supersession / Consolidations.....</b>	<b>xi</b>
<b>Discontinued / Obsolete.....</b>	<b>xi</b>
<b>Abbreviations.....</b>	<b>xii</b>
<b>Body Mounts And Body Bushings.....</b>	<b>xiii</b>
<b>EM-5000 Universal.....</b>	<b>xiv</b>
<b>Engine, Transmission Mounts, &amp; Torque Struts.....</b>	<b>1</b>
ACURA PASSENGER CAR.....	1
ACURA SPORT UTILITY.....	4
AMERICAN MOTORS PASSENGER CAR.....	5
AUDI PASSENGER CAR.....	8
AUDI SPORTS UTILITY.....	14
BMW PASSENGER CAR.....	14
BMW SPORT UTILITY.....	22
BUICK PASSENGER CAR.....	22
BUICK SPORT UTILITY.....	36
BUICK VAN.....	36
CADILLAC PASSENGER CAR.....	37
CADILLAC SPORT UTILITY.....	42
CHEVROLET MEDIUM/HEAVY DUTY TRUCK.....	112
CHEVROLET PASSENGER CAR.....	43
CHEVROLET SPORT UTILITY.....	70
CHEVROLET TRUCK.....	82
CHEVROLET VAN.....	103
CHRYSLER PASSENGER CAR.....	112
CHRYSLER SUV.....	123
CHRYSLER VAN.....	124
DAEWOO PASSENGER CAR.....	126
DAIHATSU PASSENGER CAR.....	126
DAIHATSU SPORT UTILITY.....	126
DODGE MEDIUM/HEAVY DUTY.....	168
DODGE PASSENGER CAR.....	126
DODGE SPORT UTILITY.....	145
DODGE TRUCK.....	147
DODGE VAN.....	161
EAGLE PASSENGER CAR.....	169
FIAT.....	48
FIAT PASSENGER CAR.....	172
FORD MEDIUM/HEAVY DUTY.....	217
FORD PASSENGER CAR.....	172
FORD SPORT UTILITY.....	193
FORD TRUCK.....	198
FORD VAN.....	212
FREIGHTLINER.....	220
GEO PASSENGER CAR.....	221
GEO SPORT UTILITY.....	221
GMC SPORT UTILITY.....	222
GMC TRUCK.....	232
GMC VAN.....	251
HONDA PASSENGER CAR.....	258
HONDA SPORT UTILITY.....	266
HONDA TRUCK.....	268
HONDA VAN.....	268
HUMMER.....	269
HYUNDAI PASSENGER CAR.....	269
HYUNDAI SPORT UTILITY.....	276
HYUNDAI VAN.....	277
INFINITI PASSENGER CAR.....	277
INFINITI SPORT UTILITY.....	279

# TABLE OF CONTENTS

<b>Engine, Transmission Mounts, &amp; Torque Struts.....</b>	
ISUZU PASSENGER CAR.....	280
ISUZU SPORT UTILITY.....	281
ISUZU TRUCK.....	283
ISUZU VAN.....	284
JAGUAR.....	284
JEEP SPORT UTILITY.....	284
JEEP TRUCK.....	289
KIA PASSENGER CAR.....	290
KIA SPORT UTILITY.....	294
KIA VAN.....	295
LAND ROVER SPORT UTILITY.....	295
LEXUS PASSENGER CAR.....	295
LEXUS SPORT UTILITY.....	297
LINCOLN PASSENGER CAR.....	298
LINCOLN SPORT UTILITY.....	300
LINCOLN TRUCK.....	301
MAZDA PASSENGER CAR.....	301
MAZDA SPORT UTILITY.....	307
MAZDA TRUCK.....	308
MAZDA VAN.....	309
MERCEDES-BENZ PASSENGER CAR.....	310
MERCEDES-BENZ SPORT UTILITY.....	319
MERCEDES-BENZ VAN.....	320
MERCURY PASSENGER CAR.....	320
MERCURY SPORT UTILITY.....	333
MERCURY VAN.....	334
MG PASSENGER CAR.....	334
MINI.....	335
MITSUBISHI PASSENGER CAR.....	335
MITSUBISHI SPORT UTILITY.....	341
MITSUBISHI TRUCK.....	342
MITSUBISHI VAN.....	343
NISSAN PASSENGER CAR.....	343
NISSAN SPORT UTILITY.....	354
NISSAN TRUCK.....	356
NISSAN VAN.....	358
OLDSMOBILE PASSENGER CAR.....	360
OLDSMOBILE SPORT UTILITY.....	373
OLDSMOBILE VAN.....	373
PLYMOUTH PASSENGER CAR.....	374
PLYMOUTH SUV.....	395
PLYMOUTH TRUCK.....	395
PLYMOUTH VAN.....	395
PONTIAC PASSENGER CAR.....	399
PONTIAC SPORT UTILITY.....	419
PONTIAC VAN.....	419
PORSCHE.....	420
PORSCHE SUV.....	420
RAM MEDIUM/HEAVY DUTY TRUCK.....	420
RAM TRUCK.....	420
RAM VAN.....	420
RENAULT PASSENGER CAR.....	421
RENAULT SPORT UTILITY.....	421
RENAULT VAN.....	421
SAAB PASSENGER CAR.....	422
SAAB SUV.....	423
SATURN PASSENGER CAR.....	423
SATURN SUV.....	426
SATURN VAN.....	426
SCION PASSENGER CAR.....	427
SCION VAN.....	427
SEAT.....	130
SEAT PASSENGER CAR.....	427
SRT.....	428
STERLING MEDIUM/HEAVY DUTY TRUCK.....	428
SUBARU PASSENGER CAR.....	429



# TABLE OF CONTENTS

<b>Engine, Transmission Mounts, &amp; Torque Struts.....</b>	
SUBARU SPORT UTILITY.....	432
SUZUKI PASSENGER CAR.....	433
SUZUKI SPORT UTILITY.....	434
SUZUKI TRUCK.....	435
TOYOTA PASSENGER CAR.....	435
TOYOTA SPORT UTILITY.....	446
TOYOTA TRUCK.....	450
TOYOTA VAN.....	452
VOLKSWAGEN PASSENGER CAR.....	453
VOLKSWAGEN SPORT UTILITY.....	464
VOLKSWAGEN TRUCK.....	464
VOLKSWAGEN VAN.....	465
VOLVO PASSENGER CAR.....	466
VOLVO SPORT UTILITY.....	472
<b>Drive Shaft Center Supports.....</b>	<b>475</b>
AUDI SPORTS UTILITY.....	475
BMW PASSENGER CAR.....	475
BMW SPORT UTILITY.....	476
CADILLAC PASSENGER CAR.....	476
CADILLAC SPORT UTILITY.....	476
CHECKER PASSENGER CAR.....	476
CHEVROLET PASSENGER CAR.....	476
CHEVROLET SPORT UTILITY.....	476
CHEVROLET TRUCK.....	478
CHEVROLET VAN.....	481
CHRYSLER PASSENGER CAR.....	482
DODGE MEDIUM/HEAVY DUTY.....	485
DODGE PASSENGER CAR.....	482
DODGE TRUCK.....	482
DODGE VAN.....	485
FORD MEDIUM/HEAVY DUTY.....	487
FORD SPORT UTILITY.....	486
FORD TRUCK.....	486
FORD VAN.....	487
FREIGHTLINER.....	487
GMC MEDIUM/HEAVY DUTY TRUCK.....	492
GMC SPORT UTILITY.....	488
GMC TRUCK.....	489
GMC VAN.....	492
HONDA SPORT UTILITY.....	492
HYUNDAI SPORT UTILITY.....	492
INFINITI PASSENGER CAR.....	492
INFINITI SPORT UTILITY.....	493
INTERNATIONAL.....	396
INTERNATIONAL MEDIUM/HEAVY DUTY TRUCK.....	493
ISUZU SPORT UTILITY.....	494
ISUZU TRUCK.....	494
KIA SPORT UTILITY.....	494
LEXUS PASSENGER CAR.....	494
MAZDA PASSENGER CAR.....	494
MAZDA SPORT UTILITY.....	494
MAZDA TRUCK.....	494
MERCEDES-BENZ PASSENGER CAR.....	495
MERCEDES-BENZ VAN.....	495
MERCURY SPORT UTILITY.....	495
MINI TRUCK.....	495
NISSAN PASSENGER CAR.....	496
NISSAN SPORT UTILITY.....	496
NISSAN TRUCK.....	496
PLYMOUTH TRUCK.....	496
PONTIAC SPORT UTILITY.....	496
PORSCHE.....	448
PORSCHE SUV.....	496

# TABLE OF CONTENTS

<b>Drive Shaft Center Supports.....</b>	<b>499</b>
PORSCHE TRUCK.....	451
RAM TRUCK.....	496
SATURN SUV.....	496
TOYOTA PASSENGER CAR.....	496
TOYOTA SPORT UTILITY.....	497
TOYOTA TRUCK.....	497
TOYOTA VAN.....	497
VOLKSWAGEN SPORT UTILITY.....	497
<b>Suspension Strut Mounts.....</b>	<b>499</b>
ACURA PASSENGER CAR.....	499
ACURA SPORT UTILITY.....	500
AUDI PASSENGER CAR.....	500
AUDI SPORTS UTILITY.....	501
BMW PASSENGER CAR.....	501
BMW SPORT UTILITY.....	504
BUICK PASSENGER CAR.....	504
BUICK SPORT UTILITY.....	505
BUICK VAN.....	505
CADILLAC PASSENGER CAR.....	506
CADILLAC SPORT UTILITY.....	507
CHEVROLET PASSENGER CAR.....	507
CHEVROLET SPORT UTILITY.....	509
CHEVROLET TRUCK.....	509
CHEVROLET VAN.....	509
CHRYSLER PASSENGER CAR.....	509
CHRYSLER SUV.....	511
CHRYSLER VAN.....	511
DAIHATSU PASSENGER CAR.....	512
DODGE PASSENGER CAR.....	512
DODGE SPORT UTILITY.....	514
DODGE TRUCK.....	514
DODGE VAN.....	514
EAGLE PASSENGER CAR.....	515
FORD PASSENGER CAR.....	515
FORD SPORT UTILITY.....	518
FORD TRUCK.....	518
FORD VAN.....	518
GEO PASSENGER CAR.....	518
GEO SPORT UTILITY.....	518
GMC SPORT UTILITY.....	518
GMC TRUCK.....	519
HONDA PASSENGER CAR.....	519
HONDA SPORT UTILITY.....	520
HONDA TRUCK.....	521
HONDA VAN.....	521
HYUNDAI PASSENGER CAR.....	521
HYUNDAI SPORT UTILITY.....	522
HYUNDAI VAN.....	522
INFINITI PASSENGER CAR.....	522
INFINITI SPORT UTILITY.....	522
ISUZU PASSENGER CAR.....	523
ISUZU SPORT UTILITY.....	523
ISUZU VAN.....	523
JAGUAR.....	523
JEEP SPORT UTILITY.....	523
KIA PASSENGER CAR.....	523
KIA SPORT UTILITY.....	524
KIA VAN.....	524
LAND ROVER SPORT UTILITY.....	524
LEXUS PASSENGER CAR.....	524
LEXUS SPORT UTILITY.....	525
LINCOLN PASSENGER CAR.....	525
LINCOLN SPORT UTILITY.....	526

# TABLE OF CONTENTS

<b>Suspension Strut Mounts.....</b>	<b>.....</b>
LINCOLN TRUCK.....	526
MAZDA PASSENGER CAR.....	526
MAZDA SPORT UTILITY.....	527
MAZDA VAN.....	527
MERCEDES-BENZ PASSENGER CAR.....	527
MERCEDES-BENZ SPORT UTILITY.....	529
MERCURY PASSENGER CAR.....	529
MERCURY SPORT UTILITY.....	530
MERCURY VAN.....	530
MINI.....	530
MITSUBISHI PASSENGER CAR.....	531
MITSUBISHI SPORT UTILITY.....	532
MITSUBISHI VAN.....	532
NISSAN PASSENGER CAR.....	532
NISSAN SPORT UTILITY.....	534
NISSAN TRUCK.....	534
NISSAN VAN.....	534
OLDSMOBILE PASSENGER CAR.....	534
OLDSMOBILE SPORT UTILITY.....	536
OLDSMOBILE VAN.....	536
PLYMOUTH PASSENGER CAR.....	536
PLYMOUTH VAN.....	537
PONTIAC PASSENGER CAR.....	537
PONTIAC SPORT UTILITY.....	539
PONTIAC VAN.....	539
PORSCHE SUV.....	539
PORSCHE TRUCK.....	41
RAM TRUCK.....	539
RAM VAN.....	539
RENAULT PASSENGER CAR.....	540
RENAULT VAN.....	540
SAAB PASSENGER CAR.....	540
SAAB SUV.....	540
SATURN PASSENGER CAR.....	540
SATURN SUV.....	541
SATURN VAN.....	541
SCION PASSENGER CAR.....	541
SCION VAN.....	541
SEAT.....	43
SEAT PASSENGER CAR.....	541
SMART.....	541
SUBARU PASSENGER CAR.....	541
SUBARU SPORT UTILITY.....	542
SUZUKI PASSENGER CAR.....	542
SUZUKI SPORT UTILITY.....	542
SUZUKI TRUCK.....	543
TOYOTA PASSENGER CAR.....	543
TOYOTA SPORT UTILITY.....	545
TOYOTA TRUCK.....	545
TOYOTA VAN.....	546
VOLKSWAGEN PASSENGER CAR.....	546
VOLKSWAGEN TRUCK.....	547
VOLKSWAGEN VAN.....	547
VOLVO PASSENGER CAR.....	547
VOLVO SPORT UTILITY.....	548
<b>Buyer's Guide - Numerical Listing &amp; Illustrations.....</b>	<b>549</b>
<b>Interchange Guide.....</b>	<b>829</b>

# NEW PART NUMBERS

PART#	APPLICATION	YEAR	PART#	Application	Years
DS-6077	KIA SPORT UTILITY	2006-03	EM-4065	FORD PASSENGER CAR V6 Cyl 3.0	2007-05
DS-6078	DODGE VAN	2006-03		MERCURY PASSENGER CAR V6 Cyl 3.0	2007-05
DS-6092	CADILLAC SPORT UTILITY	2015-07	EM-4066	FORD PASSENGER CAR V6 Cyl 3.0	2007-05
	CHEVROLET TRUCK	2012-08		MERCURY PASSENGER CAR V6 Cyl 3.0	2007-05
	CHEVROLET VAN	2015-10	EM-4067	FORD PASSENGER CAR L4 Cyl 2.5	2012-10
	GMC TRUCK	2012-08		LINCOLN PASSENGER CAR L4 Cyl 2.5	2012-10
	GMC VAN	2015-10		MERCURY PASSENGER CAR L4 Cyl 2.5	2011-10
DS-6095	BMW SPORT UTILITY	2007-00	EM-4068	FORD PASSENGER CAR L4 Cyl 2.0	2015-13
DS-6099	CADILLAC SPORT UTILITY 2000-99	2000-99	EM-4069	FORD PASSENGER CAR L4 Cyl 2.0	2014-13
	CHEVROLET TRUCK	2015-97	EM-4072	CHEVROLET PASSENGER CAR L4 Cyl 2.2	2005-04
	CHEVROLET VAN	2009-97	EM-4074	FORD PASSENGER CAR L4 Cyl 1.5	2016-11
	GMC TRUCK	2007-99		MAZDA PASSENGER CAR L4 Cyl 1.5	2014-11
	GMC VAN	2009-97	EM-4076	BUICK PASSENGER CAR L4 Cyl 1.6	2017-16
DS-6501	FORD TRUCK	2004-99		CHEVROLET PASSENGER CAR L4 Cyl 1.4	2016-11
DS-6502	FORD TRUCK	2015-03	EM-4084	DODGE TRUCK V8 Cyl 5.7	2007-03
DS-6503	CADILLAC PASSENGER CAR	2011-03	EM-4085	DODGE TRUCK V8 Cyl 5.7	2007-03
DS-6510	CHEVROLET TRUCK	2007-99	EM-4086	DODGE TRUCK V8 Cyl 4.7	2005-02
	CHEVROLET VAN	2012-99	EM-4087	DODGE TRUCK V8 Cyl 4.7	2005-02
	GMC TRUCK	2007-99	EM-4088	DODGE TRUCK V6 Cyl 3.7	2005-02
	GMC VAN	2012-99	EM-4089	DODGE TRUCK V6 Cyl 3.7	2005-02
DS-6511	MITSUBISHI SPORT UTILITY	2006-03		DODGE MEDIUM/HEAVY DUTY L6 Cyl	2010-08
DS-6514	HYUNDAI SPORT UTILITY	2006-01		DODGE TRUCK L6 Cyl 5.9	2013-07
DS-6516	DODGE TRUCK	2012-07		RAM MEDIUM/HEAVY DUTY TRUCK L6 Cyl	2013-11
	RAM TRUCK	2012-10		RAM TRUCK L6 Cyl	2012-10
DS-6517	BMW PASSENGER CAR	2010-04	EM-4091	DODGE MEDIUM/HEAVY DUTY L6 Cyl	2010-08
DS-6519	LEXUS PASSENGER CAR	2015-06		DODGE TRUCK L6 Cyl 6.6	2013-07
DS-6520	MERCEDES-BENZ PASSENGER CAR	2010-02		RAM MEDIUM/HEAVY DUTY TRUCK L6 Cyl	2013-11
DS-6521	MERCEDES-BENZ VAN	2006-04		RAM TRUCK L6 Cyl	2012-10
DS-6524	KIA SPORT UTILITY	2006-03	EM-4098	FORD SPORT UTILITY V8 Cyl 5.4	2003
DS-6531	FORD TRUCK	2001-97		LINCOLN SPORT UTILITY V8 Cyl 5.4	2003
DS-6533	FORD TRUCK	2015-08	EM-4107	CHRYSLER PASSENGER CAR V6 Cyl 3.6	2014-11
DS-6534	FORD TRUCK	2015-08		DODGE PASSENGER CAR V6 Cyl 3.6	2018-09
DS-6535	FORD TRUCK	2015-08		DODGE SPORT UTILITY L4 Cyl 2.4	2010-09
DS-6536	FORD TRUCK	2015-08	EM-4109	DODGE SPORT UTILITY L4 Cyl 2.4	2010-09
EM-2818G	BUICK	2005-97	EM-4111	CHEVROLET SPORT UTILITY L4 Cyl 2.4	2017-10
	CHEVROLET	2005-97		GMC SPORT UTILITY L4 Cyl 2.4	2015-10
	OLDSMOBILE	2004-97	EM-4114	CHEVROLET PASSENGER CAR V6 Cyl 3.6	2016-12
	PONTIAC	2011-97	EM-4115	CHEVROLET PASSENGER CAR V6 Cyl 3.7	2017-12
	SATURN	2006-05	EM-4116	CHEVROLET PASSENGER CAR V6 Cyl 3.7	2016-12
EM-2866G	BUICK PASSENGER CAR V6 Cyl 3.1	2005-00	EM-4119	BUICK SPORT UTILITY V8 Cyl 5.3	2004
	CHEVROLET PASSENGER CAR V6 Cyl 3.4	2005-00		CHEVROLET TRUCK V8 Cyl 6.0	2006-05
	OLDSMOBILE PASSENGER CAR V6 Cyl 3.1	1997-94		GMC SPORT UTILITY V8 Cyl 5.3	2005
	PONTIAC PASSENGER CAR V6, L4, V8 Cyl 3.8	2009-94		SAAB SUV V8 Cyl 5.3	2009-05
EM-2897G	BUICK PASSENGER CAR V6 Cyl 3.8	2005-00	EM-4121	FORD PASSENGER CAR L4, L5 Cyl 2.0	2019-04
	OLDSMOBILE PASSENGER CAR V6 Cyl 3.5	2005-99		FORD SPORT UTILITY L4 Cyl 2.0	2019-13
	PONTIAC PASSENGER CAR V6 Cyl 3.8	2005-00		FORD VAN L4 Cyl 1.6	2016-14
EM-2909G	CADILLAC SPORT UTILITY V8 Cyl 6.0	2010-99		LINCOLN SPORT UTILITY L4 Cyl 2.0	2018-15
	CHEVROLET TRUCK V8 Cyl 4.8	2006-99	EM-4122	SATURN PASSENGER CAR L4 Cyl 1.8	2009-08
	GMC TRUCK V8 Cyl 4.8	2006-99	EM-4123	JEEP SPORT UTILITY V8 Cyl 5.7	2010-05
	HUMMER V8 Cyl 6.0	2007-03	EM-4124	FORD PASSENGER CAR V6, V8 Cyl 4.0	2014-05
EM-2939G	FORD PASSENGER CAR L4 Cyl 2.0	2007-00	EM-4125	FORD SPORT UTILITY L4 Cyl 2.0	2019-12
	FORD VAN L4 Cyl 2.0	2013-10	EM-4128	BUICK PASSENGER CAR L4 Cyl 2.4	2017-11
EM-2948G	CHRYSLER PASSENGER CAR L4 Cyl 2.4	2007-01		CHEVROLET PASSENGER CAR L4 Cyl 2.5	2015-12
	DODGE PASSENGER CAR L4 Cyl 2.0	2005-03	EM-4130	CHEVROLET PASSENGER CAR L4 Cyl 1.2	2015-13
	PLYMOUTH PASSENGER CAR L4 Cyl 2.0	2010-00	EM-4131	CHEVROLET PASSENGER CAR L4 Cyl 1.2	2015-13
EM-2949G	CHRYSLER PASSENGER CAR L4 Cyl 2.4	2007-01	EM-4132	CHRYSLER VAN V6 Cyl 3.6	2015-11
	DODGE PASSENGER CAR L4 Cyl 2.0	2005-03		DODGE PASSENGER CAR V6 Cyl 3.6	2016-11
	PLYMOUTH PASSENGER CAR L4 Cyl 2.0	2010-00		DODGE SPORT UTILITY V6 Cyl 3.6	2016-11
EM-2986G	FORD PASSENGER CAR L4 Cyl 2.0	2011-00		DODGE VAN V6 Cyl 3.6	2016-11
	FORD VAN L4 Cyl 2.0	2013-10		RAM VAN V6 Cyl 3.6	2015-12
EM-2987G	BUICK V6 Cyl	2011-01		VOLKSWAGEN VAN V6 Cyl	2014-11
	CHEVROLET V6 Cyl 3.4	2005-00	EM-4134	CHEVROLET PASSENGER CAR L4 Cyl 2.4	2010-09
	PONTIAC V6 Cyl	2008-01		PONTIAC PASSENGER CAR L4 Cyl 2.4	2010-09
	SATURN	2006-05		SATURN PASSENGER CAR L4 Cyl 2.4	2012-08
EM-4011	CHRYSLER VAN V6 Cyl 3.8	2010-08	EM-4135	CHEVROLET SPORT UTILITY L4, V6 Cyl 2.4	2017-10
	DODGE VAN V6 Cyl 3.3	2010-08		GMC SPORT UTILITY V6 Cyl 3.6	2016-13
	VOLKSWAGEN VAN V6 Cyl 3.8	2010-09	EM-4137	FORD TRUCK V8 Cyl 6.0	2007-05
EM-4021	FORD SPORT UTILITY V10 Cyl 6.8	2005-99	EM-4138	FORD SPORT UTILITY V6 Cyl 3.5	2015-11
EM-4023	FORD SPORT UTILITY V8 Cyl 6.0	2007-03	EM-4139	FORD SPORT UTILITY V6 Cyl 3.5	2019-13
EM-4024	FORD SPORT UTILITY V8 Cyl 6.0	2007-03	EM-4140	FORD SPORT UTILITY V6 Cyl 3.5	2017-11
EM-4025	FORD TRUCK V6, V8 Cyl 4.2	2008-05	EM-4141	FORD PASSENGER CAR V6 Cyl 3.0	2007-05
EM-4031	DODGE TRUCK L6 Cyl 5.9	2002-00		MERCURY PASSENGER CAR V6 Cyl 3.0	2007-05
EM-4053	CHEVROLET PASSENGER CAR L4 Cyl 1.4	2016-11	EM-4142	FORD SPORT UTILITY V8, V6 Cyl 5.4	2018-07
EM-4054	BUICK PASSENGER CAR L4 Cyl 2.5	2017-12		FORD TRUCK V8 Cyl 5.0	2014-11
	CHEVROLET PASSENGER CAR L4 Cyl 1.4	2016-11		LINCOLN SPORT UTILITY V8 Cyl 5.4	2013-07
EM-4061	CHEVROLET PASSENGER CAR V6 Cyl 3.6	2012-08		LINCOLN TRUCK V8 Cyl 5.0	2014-11
	PONTIAC PASSENGER CAR V6 Cyl 3.6	2009-07	EM-4143	FORD SPORT UTILITY V8, V6 Cyl 5.4	2018-07
	SATURN PASSENGER CAR V6 Cyl 3.6	2009-07		FORD TRUCK V6 Cyl 2.7	2017-15
EM-4062	CHEVROLET PASSENGER CAR V6 Cyl 3.6	2012-08		LINCOLN SPORT UTILITY V8 Cyl 5.4	2013-07
	PONTIAC PASSENGER CAR V6 Cyl 3.6	2009-07		LINCOLN TRUCK V8 Cyl 5.0	2014-11
	SATURN PASSENGER CAR V6 Cyl 3.6	2009-07	EM-4146	FORD PASSENGER CAR L4 Cyl 2.5	2012-10
				MERCURY PASSENGER CAR L4 Cyl 2.5	2011-10

## NEW PART NUMBERS

PART#	APPLICATION	YEAR	PART#	Application	Years
EM-4149	CHEVROLET PASSENGER CAR V6 Cyl 3.6	2015-10	EM-4190	FORD SPORT UTILITY L4 Cyl 1.5	2017-13
EM-4150	CHRYSLER PASSENGER CAR V8, V6 Cyl 5.7	2018-11	EM-4192	CHEVROLET SPORT UTILITY L4 Cyl 2.4	2017-10
	DODGE PASSENGER CAR V8 Cyl 5.7	2016-11		GMC SPORT UTILITY L4 Cyl 2.4	2015-10
EM-4151	DODGE TRUCK V8 Cyl 5.7	2005-03	EM-4193	CHRYSLER PASSENGER CAR L4, V6 Cyl 2.4	2016-15
EM-4152	FORD PASSENGER CAR L4 Cyl 2.0	2017-13		JEEP SPORT UTILITY V6 Cyl 3.2	2016-14
	FORD SPORT UTILITY L4 Cyl 2.5	2017-13	EM-4194	CHEVROLET PASSENGER CAR V6 Cyl 3.9	2007-06
	FORD VAN L4 Cyl 2.5	2017-14		PONTIAC PASSENGER CAR V6 Cyl 3.9	2009-06
EM-4153	JEEP SPORT UTILITY V6, V8 Cyl 3.7	2010-05	EM-4195	CHEVROLET PASSENGER CAR V6 Cyl 3.9	2007-06
EM-4154	FORD PASSENGER CAR L4, L3 Cyl 1.6	2016-11		PONTIAC PASSENGER CAR V6 Cyl 3.9	2009-06
EM-4155	CHEVROLET SPORT UTILITY V6 Cyl 3.0	2015-10	EM-4196	CHEVROLET TRUCK L4, V6 Cyl 2.5	2018-15
	GMC SPORT UTILITY V6 Cyl 3.6	2017-13		GMC TRUCK V6 Cyl 3.6	2018-15
	SATURN SUV V6 Cyl 3.6	2010-08	EM-4198	DODGE SPORT UTILITY L4 Cyl 2.4	2016-11
EM-4156	CHEVROLET TRUCK V8 Cyl 6.0	2016-07	EM-4199	FORD PASSENGER CAR L4 Cyl 2.0	2017-13
	GMC TRUCK V8 Cyl 6.6	2016-11	EM-4200	FORD SPORT UTILITY V6 Cyl 3.5	2016-15
EM-4157	CHEVROLET TRUCK V8 Cyl 6.0	2016-11		LINCOLN PASSENGER CAR V6 Cyl 3.7	2016-13
EM-4158	CHEVROLET PASSENGER CAR L4 Cyl 2.2	2011-05		LINCOLN SPORT UTILITY V6 Cyl 3.7	2016
	PONTIAC PASSENGER CAR L4 Cyl 2.2	2009-07	EM-4201	DODGE SPORT UTILITY V6 Cyl 3.6	2016-09
	SATURN PASSENGER CAR L4 Cyl 2.2	2007-05	EM-4202	FORD SPORT UTILITY V6 Cyl 3.5	2016-15
EM-4159	CHEVROLET TRUCK V8 Cyl 6.6	2016-11		LINCOLN PASSENGER CAR V6 Cyl 3.7	2016-13
	GMC TRUCK V8 Cyl 6.6	2016-11		LINCOLN SPORT UTILITY V6 Cyl 3.7	2016
EM-4160	FORD PASSENGER CAR V6 Cyl 3.0	2007-05	EM-4203	DODGE PASSENGER CAR L4 Cyl 1.4	2016-13
	MERCURY PASSENGER CAR V6 Cyl 3.0	2007-05	EM-4205	FORD PASSENGER CAR L4 Cyl 2.0	2018-13
EM-4161	CHEVROLET SPORT UTILITY L4 Cyl 2.5	2015-10		LINCOLN PASSENGER CAR L4 Cyl 2.0	2018-13
	GMC SPORT UTILITY L4 Cyl 2.5	2015-10	EM-4206	CHEVROLET PASSENGER CAR L4 Cyl 2.4	2010-09
EM-4163	CHEVROLET TRUCK V8 Cyl 6.0	2016-11		CHEVROLET PASSENGER CAR L4, V6 Cyl 2.4	2012-04
	GMC TRUCK V8 Cyl 6.0	2016-11		PONTIAC PASSENGER CAR L4 Cyl 2.4	2010-09
EM-4164	FORD PASSENGER CAR L4 Cyl 1.5	2014-11		PONTIAC PASSENGER CAR V6 Cyl 3.6	2009-07
EM-4166	CHRYSLER PASSENGER CAR L4, V6 Cyl 2.4	2010-07		SATURN PASSENGER CAR L4 Cyl 2.4	2008
	DODGE PASSENGER CAR V6 Cyl 3.5	2010-08		SATURN PASSENGER CAR V6 Cyl 3.6	2009-07
EM-4167	DODGE PASSENGER CAR V8 Cyl 5.7	2010-05	EM-4208	FORD PASSENGER CAR V6 Cyl 3.5	2012-09
EM-4168	CHRYSLER PASSENGER CAR V8, V6 Cyl 6.4	2016-11		LINCOLN PASSENGER CAR V6 Cyl 3.5	2008-07
	DODGE PASSENGER CAR V8 Cyl 6.4	2016-12	EM-4209	FORD PASSENGER CAR V6 Cyl 3.5	2017-13
	DODGE SPORT UTILITY V6 Cyl 3.6	2015-11		FORD SPORT UTILITY V6 Cyl 3.5	2017-10
	JEEP SPORT UTILITY V6 Cyl 3.0	2015-14		LINCOLN PASSENGER CAR V6 Cyl 3.5	2015-13
EM-4169	BUICK PASSENGER CAR V6, V8 Cyl 3.6	2011-94		LINCOLN SPORT UTILITY V6 Cyl 3.5	2015-10
	BUICK SPORT UTILITY V6 Cyl 3.4	2005-02	EM-4211	FORD VAN L5, V6 Cyl 3.2	2017-15
	BUICK VAN V6 Cyl 3.5	2006-05	EM-4212	BUICK PASSENGER CAR V8 Cyl 4.6	2011-06
	CHEVROLET PASSENGER CAR V6 Cyl 3.4	2005-00		CADILLAC PASSENGER CAR V8 Cyl 4.6	2011-06
	CHEVROLET VAN V6 Cyl 3.5	2006-05	EM-4213	JEEP SPORT UTILITY V6 Cyl 3.6	2017-12
	OLDSMOBILE PASSENGER CAR V6 Cyl 3.5	2002-99	EM-4214	JEEP SPORT UTILITY V6 Cyl 3.6	2017-12
EM-4171	CHEVROLET PASSENGER CAR L4 Cyl 2.4	2011-03	EM-4215	JEEP SPORT UTILITY V6 Cyl 3.6	2016-12
	CHEVROLET SPORT UTILITY L4 Cyl 2.4	2015-12	EM-4216	FORD PASSENGER CAR V8 Cyl 5.4	2014-07
	PONTIAC PASSENGER CAR L4 Cyl 2.2	2009-07	EM-4217	JEEP SPORT UTILITY V6 Cyl 3.7	2012-06
	SATURN PASSENGER CAR L4 Cyl 2.2	2007-05	EM-4218	CADILLAC PASSENGER CAR L4, V6 Cyl 2.0	2017-13
EM-4172	DODGE SPORT UTILITY V6, V8 Cyl 3.6	2017-11	EM-4220	CHEVROLET PASSENGER CAR V6 Cyl 3.6	2016-12
	JEEP SPORT UTILITY V6 Cyl 3.6	2013-11	EM-4221	FORD SPORT UTILITY L4 Cyl 2.0	2014-12
EM-4173	CADILLAC SPORT UTILITY V8, V6 Cyl 6.2	2016-14	EM-4223	BUICK PASSENGER CAR L4, V6 Cyl 2.0	2018-10
	CHEVROLET SPORT UTILITY V8 Cyl 5.3	2016-15		CADILLAC PASSENGER CAR V6 Cyl 3.6	2017-13
	CHEVROLET TRUCK V8 Cyl 6.2	2016-15		CHEVROLET PASSENGER CAR L4 Cyl 2.0	2015-13
	GMC SPORT UTILITY V8 Cyl 6.2	2016-15	EM-4224	CADILLAC PASSENGER CAR V6, V8 Cyl 3.6	2015-08
EM-4174	CADILLAC SPORT UTILITY V8, V6 Cyl 6.2	2016-14	EM-4225	CHEVROLET PASSENGER CAR V6, V8 Cyl 6.0	2017-10
	CHEVROLET SPORT UTILITY V8 Cyl 5.3	2016-15	EM-4226	CHEVROLET PASSENGER CAR V8 Cyl 6.2	2015-10
	CHEVROLET TRUCK V8 Cyl 6.2	2016-15	EM-4227	BUICK SPORT UTILITY L4 Cyl 1.4	2016-12
	GMC SPORT UTILITY V8 Cyl 6.2	2016-15		CHEVROLET PASSENGER CAR L4 Cyl 1.8	2016-12
EM-4175	CHEVROLET SPORT UTILITY V6 Cyl 3.0	2015-10		CHEVROLET SPORT UTILITY L4 Cyl 1.4	2016-15
	GMC SPORT UTILITY V6 Cyl 3.6	2016-13	EM-4228	DODGE SPORT UTILITY V6 Cyl 3.6	2017-15
EM-4176	FORD TRUCK V8, V10 Cyl 5.4	2010-08		JEEP SPORT UTILITY V6, V8 Cyl 3.6	2017-14
EM-4177	FORD TRUCK V8 Cyl 6.2	2016-11	EM-4229	FORD PASSENGER CAR L4 Cyl 2.0	2017-14
EM-4178	CHRYSLER PASSENGER CAR L4 Cyl 2.4	2014-11		FORD SPORT UTILITY L4 Cyl 2.0	2018-13
	DODGE PASSENGER CAR L4 Cyl 2.4	2014-13		FORD VAN L4 Cyl 2.5	2017-14
	DODGE SPORT UTILITY L4 Cyl 2.4	2016-11		LINCOLN SPORT UTILITY L4 Cyl 2.0	2018-15
EM-4179	CHRYSLER PASSENGER CAR L4 Cyl 2.4	2014-12	EM-4230	FORD PASSENGER CAR V6 Cyl 3.7	2016-11
	DODGE SPORT UTILITY L4 Cyl 2.4	2016-11	EM-4231	CHEVROLET TRUCK V8 Cyl 5.3	2012-09
EM-4180	CHEVROLET SPORT UTILITY V6 Cyl 3.0	2015-10		GMC TRUCK V8 Cyl 5.3	2012-09
	GMC SPORT UTILITY V6 Cyl 3.6	2016-13	EM-4232	CHEVROLET TRUCK V8 Cyl 5.3	2012-09
EM-4181	JEEP SPORT UTILITY V6 Cyl 3.8	2011-07		GMC TRUCK V8 Cyl 5.3	2012-09
EM-4182	JEEP SPORT UTILITY V6 Cyl 3.8	2011-07	EM-4234	CHEVROLET PASSENGER CAR L4 Cyl 1.8	2016-13
EM-4183	CADILLAC PASSENGER CAR L4 Cyl 1.4	2015-14	EM-4237	CHEVROLET TRUCK V6 Cyl 3.6	2018-15
	CHEVROLET PASSENGER CAR L4 Cyl 1.4	2015-11		GMC TRUCK V6 Cyl 3.6	2018-15
EM-4184	FORD PASSENGER CAR L4 Cyl 2.0	2018-13	EM-4238	CHEVROLET TRUCK V6 Cyl 3.6	2018-15
	FORD SPORT UTILITY L4 Cyl 2.0	2017-15		GMC TRUCK L4, V6 Cyl 2.5	2018-15
	LINCOLN PASSENGER CAR L4 Cyl 2.0	2018-13	EM-4239	DODGE PASSENGER CAR L4 Cyl 2.0	2016-13
EM-4185	JEEP SPORT UTILITY V8 Cyl 5.7	2010-05	EM-4240	DODGE PASSENGER CAR L4 Cyl 2.4	2016-13
EM-4186	CHRYSLER VAN V6 Cyl 3.6	2015-11	EM-4241	CHEVROLET PASSENGER CAR V6 Cyl 3.6	2015-10
	DODGE VAN V6 Cyl 3.6	2016-11	EM-4243	FIAT PASSENGER CAR L4 Cyl 1.4	2015-12
	RAM VAN V6 Cyl 3.6	2015-12	EM-4248	CADILLAC PASSENGER CAR V6 Cyl 3.0	2014-08
	VOLKSWAGEN VAN V6 Cyl	2014-11	EM-4249	CHEVROLET TRUCK V8 Cyl 6.6	2016-11
EM-4187	FORD TRUCK V8, V10 Cyl 5.4	2010-08		GMC TRUCK V8 Cyl 6.6	2016-11
EM-4189	CADILLAC PASSENGER CAR L4 Cyl 1.4	2015-14	EM-4250	CHRYSLER PASSENGER CAR V8 Cyl 5.7	2010-05
	CHEVROLET PASSENGER CAR L4 Cyl 1.4	2015-11		DODGE PASSENGER CAR V8 Cyl 6.1	2010-06

# NEW PART NUMBERS

PART#	APPLICATION	YEAR	PART#	Application	Years
EM-4251	FORD PASSENGER CAR L4 Cyl 2.0	2017-13	EM-7008	INFINITI PASSENGER CAR V6 Cyl 3.7	2013-09
	FORD SPORT UTILITY L4 Cyl 2.0	2017-15		INFINITI SPORT UTILITY V6 Cyl 3.5	2012-08
	LINCOLN PASSENGER CAR L4 Cyl 2.0	2017-13		NISSAN PASSENGER CAR V6 Cyl 3.7	2019-07
EM-4252	FORD PASSENGER CAR L4 Cyl 2.5	2017-13	EM-7009	NISSAN PASSENGER CAR L4 Cyl 1.8	2015-12
EM-4253	GMC SPORT UTILITY V6 Cyl 3.6	2008-07		NISSAN SPORT UTILITY L4 Cyl 1.6	2014-11
	SATURN SUV V6 Cyl 3.6	2008-07	EM-7012	HONDA PASSENGER CAR L4 Cyl 1.8	2015-12
EM-4254	FORD PASSENGER CAR L4 Cyl 1.6	2017-13	EM-7013	NISSAN SPORT UTILITY L4 Cyl 1.6	2014-11
EM-4255	FORD PASSENGER CAR V6 Cyl 3.0	2012-10	EM-7016	TOYOTA PASSENGER CAR L4 Cyl 2.5	2017-12
	LINCOLN PASSENGER CAR V6 Cyl 3.5	2012-07	EM-7018	MAZDA SPORT UTILITY L4 Cyl 2.3	2012-07
	MERCURY PASSENGER CAR V6 Cyl 3.0	2011-10	EM-7019	AUDI PASSENGER CAR L4 Cyl 1.8	2006-03
EM-4256	FORD SPORT UTILITY L4 Cyl 1.6	2017-13		VOLKSWAGEN PASSENGER CAR L4 Cyl 1.8	2005-00
	FORD VAN L4 Cyl 1.6	2016-14	EM-7020	MERCEDES-BENZ PASSENGER CAR V8 Cyl 6.2	2007
EM-4258	DODGE SPORT UTILITY V6 Cyl 3.7	2011-07		MERCEDES-BENZ SPORT UTILITY V6, V8 Cyl 3.5	2011-06
	JEEP SPORT UTILITY V6 Cyl 3.7	2012-08	EM-7022	MAZDA PASSENGER CAR L4 Cyl 1.5	2014-11
EM-4261	BUICK PASSENGER CAR L4 Cyl 2.0	2016-14	EM-7023	ACURA SPORT UTILITY L4 Cyl 2.3	2012-07
	CADILLAC PASSENGER CAR V6 Cyl 3.6	2017-13	EM-7024	NISSAN PASSENGER CAR L4 Cyl 1.8	2017-13
	CADILLAC SPORT UTILITY V6 Cyl 3.0	2016-10		NISSAN SPORT UTILITY L4 Cyl 1.6	2017-11
	SAAB PASSENGER CAR V6 Cyl 2.8	2011-10		NISSAN SPORT UTILITY L4 Cyl 2.0	2018-17
EM-4264	CHRYSLER PASSENGER CAR L4 Cyl 2.4	2017-15	EM-7025	BMW SPORT UTILITY L6 Cyl 3.0	2017-07
EM-4265	CHRYSLER PASSENGER CAR V6 Cyl 3.6	2017-15	EM-7027	TOYOTA SPORT UTILITY V6 Cyl 3.5	2013-08
	JEEP SPORT UTILITY V6 Cyl 3.2	2018-14	EM-7029	SUZUKI PASSENGER CAR L4 Cyl 2.0	2013-07
EM-4266	CHRYSLER PASSENGER CAR L4 Cyl 2.4	2017-15	EM-7031	PORSCHE SUV V8, V6 Cyl 4.5	2016-03
	JEEP SPORT UTILITY L4, V6 Cyl 2.4	2018-14		PORSCHE V6 Cyl 3.0	2016-14
EM-4267	CHEVROLET PASSENGER CAR L4 Cyl 1.2	2015-14	EM-7034	HYUNDAI PASSENGER CAR L4 Cyl 2.4	2014-11
EM-4268	FORD SPORT UTILITY V8 Cyl 6.0	2005-03	EM-7035	HYUNDAI PASSENGER CAR L4 Cyl 2.4	2012-11
	FORD TRUCK V8 Cyl 6.0	2004-03	EM-7036	HYUNDAI SPORT UTILITY V6 Cyl 3.5	2006-03
EM-4269	FORD SPORT UTILITY V8 Cyl 6.0	2005-03	EM-7037	KIA PASSENGER CAR L4 Cyl 2.4	2010-09
	FORD TRUCK V8 Cyl 6.0	2004-03	EM-7038	HONDA PASSENGER CAR V6 Cyl 3.5	2015-08
EM-4270	FORD SPORT UTILITY V6 Cyl 3.5	2018-15	EM-7041	TOYOTA SPORT UTILITY V6 Cyl 3.3	2010-08
	LINCOLN PASSENGER CAR V6 Cyl 3.7	2016-13	EM-7044	FORD PASSENGER CAR L4, V6 Cyl 2.5	2013-06
	LINCOLN SPORT UTILITY V6 Cyl 3.7	2018-16		MAZDA PASSENGER CAR L4 Cyl 2.5	2013-09
EM-4274	DODGE TRUCK V8 Cyl 4.7	2010-05		MERCURY PASSENGER CAR L4 Cyl 2.3	2009-06
EM-4275	DODGE TRUCK V6 Cyl 3.7	2010-08	EM-7046	MAZDA PASSENGER CAR L4 Cyl 1.5	2014-11
	RAM TRUCK V6 Cyl 3.7	2012-11	EM-7047	AUDI PASSENGER CAR V6 Cyl 3.0	2008-02
EM-4295	BUICK PASSENGER CAR L4 Cyl 2.0	2019-16	EM-7048	SCION VAN L4 Cyl 2.4	2015-08
	CHEVROLET PASSENGER CAR L4 Cyl 1.5	2018-16	EM-7049	KIA PASSENGER CAR L4 Cyl 2.0	2013-10
EM-4298	FORD SPORT UTILITY V6 Cyl 3.5	2019-13	EM-7053	LEXUS PASSENGER CAR L4 Cyl 2.5	2018-13
EM-5583	GMC SPORT UTILITY V8 Cyl 5.3	2012-07		TOYOTA PASSENGER CAR L4 Cyl 2.5	2017-12
EM-5583G	CADILLAC SPORT UTILITY V8 Cyl 6.0	2014-07	EM-7054	TOYOTA PASSENGER CAR L4 Cyl 2.5	2017-12
	CHEVROLET SPORT UTILITY V8 Cyl 5.3	2013-07	EM-7055	HONDA SPORT UTILITY L4 Cyl 2.4	2016-12
	CHEVROLET TRUCK V8 Cyl 6.0	2007	EM-7056	HYUNDAI SPORT UTILITY L4 Cyl 2.4	2013-10
EM-5790	ACURA PASSENGER CAR V6 Cyl 3.2	2008-04		KIA SPORT UTILITY L4 Cyl 2.4	2013-11
	HONDA PASSENGER CAR V6 Cyl 3.0	2007	EM-7057	HYUNDAI PASSENGER CAR L4 Cyl 1.6	2017-12
EM-5820	NISSAN PASSENGER CAR V6 Cyl 3.0	2004-00		HYUNDAI PASSENGER CAR L4 Cyl 1.8	2016-11
EM-5842	LEXUS PASSENGER CAR V6 Cyl 3.3	2006-04		KIA PASSENGER CAR L4 Cyl 1.6	2014-12
	TOYOTA PASSENGER CAR V6 Cyl 3.3	2006-04	EM-7058	INFINITI PASSENGER CAR V6 Cyl 3.7	2013-08
EM-5847	VOLVO PASSENGER CAR L4 Cyl 1.9	2003-99		INFINITI SPORT UTILITY V6, V8 Cyl 3.5	2015-06
	VOLVO PASSENGER CAR L4 Cyl 1.9	2004-01	EM-7060	HYUNDAI SPORT UTILITY L4, V6 Cyl 2.4	2012-10
EM-5848	VOLVO PASSENGER CAR L4 Cyl 1.9	2004-01		KIA SPORT UTILITY L4 Cyl 2.4	2013-11
EM-5851	TOYOTA PASSENGER CAR L4 Cyl 1.8	2002-98	EM-7061	HYUNDAI SPORT UTILITY L4 Cyl 2.4	2012-10
EM-5862	CHEVROLET PASSENGER CAR L4 Cyl 2.4	2008		KIA SPORT UTILITY L4 Cyl 2.4	2013-11
	PONTIAC PASSENGER CAR L4, V6 Cyl 2.4	2010-07	EM-7062	HYUNDAI PASSENGER CAR L4 Cyl 1.6	2016-12
	SATURN PASSENGER CAR L4 Cyl 2.4	2008		KIA PASSENGER CAR L4 Cyl 1.6	2014-12
EM-5868	CHEVROLET PASSENGER CAR L4 Cyl 2.0	2010-04	EM-7064	HYUNDAI PASSENGER CAR L4 Cyl 1.8	2019-11
	SUZUKI PASSENGER CAR L4 Cyl 2.0	2008-04	EM-7065	HYUNDAI PASSENGER CAR L4 Cyl 1.6	2014-12
EM-5880	KIA PASSENGER CAR L4 Cyl 1.6	2011-10		KIA PASSENGER CAR L4 Cyl 1.6	2016-12
EM-5883	HYUNDAI SPORT UTILITY L4, V6 Cyl 2.4	2013-10	EM-7066	HYUNDAI PASSENGER CAR L4 Cyl 1.8	2016-14
	KIA SPORT UTILITY L4 Cyl 2.4	2013-11		KIA PASSENGER CAR L4 Cyl 2.0	2016-10
EM-5891	HONDA PASSENGER CAR L4 Cyl 1.5	2012-09	EM-7069	BMW PASSENGER CAR V10, V8 Cyl 5.0	2010-04
EM-5898	TOYOTA PASSENGER CAR L4 Cyl 1.8	2013-09	EM-7070	NISSAN PASSENGER CAR L4 Cyl 1.8	2013
EM-5920	TOYOTA TRUCK V8 Cyl 4.7	2006-05		NISSAN SPORT UTILITY L4 Cyl 1.6	2014-11
EM-5948	INFINITI PASSENGER CAR V8 Cyl 4.5	1996-90	EM-7072	NISSAN PASSENGER CAR L4 Cyl 2.0	2012-07
EM-5956	ACURA SPORT UTILITY V6 Cyl 3.7	2013-10	EM-7073	HONDA SPORT UTILITY L4 Cyl 2.4	2014-12
	HONDA VAN V6 Cyl 3.5	2016-10	EM-7075	VOLKSWAGEN PASSENGER CAR V6, L4 Cyl 3.6	2015-06
EM-5957	ACURA PASSENGER CAR V6 Cyl 3.5	2008-04	EM-7076	VOLKSWAGEN PASSENGER CAR L4 Cyl 2.0	2015-09
EM-5961	NISSAN SPORT UTILITY V6 Cyl 3.5	2007-03	EM-7077	LEXUS PASSENGER CAR L4 Cyl 1.8	2016-11
EM-5966	AUDI PASSENGER CAR V6 Cyl 3.2	2010-08		TOYOTA PASSENGER CAR L4 Cyl 1.8	2016-10
EM-5972	MERCEDES-BENZ PASSENGER CAR V6 Cyl 3.5	2009-08	EM-7078	TOYOTA SPORT UTILITY V6 Cyl 3.5	2012-06
	MERCEDES-BENZ SPORT UTILITY V6, V8 Cyl 3.5	2012-06	EM-7079	TOYOTA TRUCK L4 Cyl 2.7	2015-11
EM-5974	ACURA PASSENGER CAR V6 Cyl 3.2	1998-97	EM-7080	NISSAN PASSENGER CAR L4 Cyl 2.5	2017-13
EM-5975	LEXUS PASSENGER CAR V6 Cyl 2.5	2012-06	EM-7081	NISSAN SPORT UTILITY L4 Cyl 1.6	2014-11
EM-5977	TOYOTA SPORT UTILITY L4 Cyl 2.5	2012-09	EM-7082	NISSAN PASSENGER CAR V6 Cyl 3.5	2012-08
EM-5979	TOYOTA SPORT UTILITY L4 Cyl 2.5	2012-09	EM-7083	LEXUS SPORT UTILITY V6 Cyl 3.5	2015-10
EM-5981	NISSAN SPORT UTILITY L4 Cyl 2.5	2007-02		TOYOTA SPORT UTILITY V6 Cyl 3.5	2015-11
EM-5985	ACURA SPORT UTILITY L4 Cyl 2.3	2012-07	EM-7084	LEXUS SPORT UTILITY V6 Cyl 3.5	2015-10
EM-5989	SCION PASSENGER CAR L4 Cyl 2.4	2010-05	EM-7085	HONDA TRUCK V6 Cyl 3.5	2014-06
EM-5991	LEXUS PASSENGER CAR V6 Cyl 3.0	2003-02	EM-7086	TOYOTA SPORT UTILITY V6 Cyl 3.5	2013-10
EM-5995	HONDA SPORT UTILITY L4 Cyl 2.0	2001-97	EM-7087	HYUNDAI PASSENGER CAR L4 Cyl 2.4	2014-11
EM-5997	KIA PASSENGER CAR L4 Cyl 2.4	2013-10	EM-7088	NISSAN PASSENGER CAR L4 Cyl 1.6	2015-12
EM-5999	KIA PASSENGER CAR L5, L4 Cyl 2.4	2013-10	EM-7090	HYUNDAI PASSENGER CAR L4 Cyl 1.6	2017-11
EM-7001	SUZUKI PASSENGER CAR L4 Cyl 2.0	2009-07		KIA PASSENGER CAR L4 Cyl 1.6	2016-14
			EM-7091	HYUNDAI PASSENGER CAR L4 Cyl 2.4	2014-11

# NEW PART NUMBERS

PART#	APPLICATION	YEAR	PART#	Application	Years
EM-7092	HYUNDAI PASSENGER CAR L4 Cyl 2.0	2014-11	EM-7175	INFINITI SPORT UTILITY V6 Cyl 3.5	2013
	KIA PASSENGER CAR L4, V6 Cyl 2.0	2017-11		NISSAN SPORT UTILITY V6 Cyl 3.5	2018-09
EM-7093	HYUNDAI PASSENGER CAR L4 Cyl 2.4	2014-11		NISSAN VAN V6 Cyl 3.5	2015-11
EM-7094	ACURA PASSENGER CAR V6 Cyl 3.0	1999-97	EM-7176	AUDI PASSENGER CAR L4 Cyl 2.0	2015-06
	HONDA PASSENGER CAR V6 Cyl 2.7	1997-95		VOLKSWAGEN PASSENGER CAR L4 Cyl 2.0	2012-09
EM-7096	TOYOTA PASSENGER CAR L4 Cyl 1.8	1997-94	EM-7177	ACURA PASSENGER CAR L4 Cyl 2.4	2015-13
EM-7099	KIA PASSENGER CAR L4 Cyl 1.6	2016-14		HONDA PASSENGER CAR L4 Cyl 2.4	2015-12
EM-7104	HYUNDAI SPORT UTILITY L4 Cyl 2.4	2013-10	EM-7178	HONDA PASSENGER CAR L4 Cyl 2.4	2017-13
	KIA SPORT UTILITY L4 Cyl 2.0	2013-11	EM-7179	HONDA PASSENGER CAR L4 Cyl 2.4	2017-13
EM-7105	HYUNDAI SPORT UTILITY L4 Cyl 2.0	2014-11	EM-7183	TOYOTA TRUCK V6 Cyl 4.0	2014-07
	KIA PASSENGER CAR L4 Cyl 2.4	2016-09	EM-7184	TOYOTA TRUCK V6 Cyl 4.0	2014-07
	KIA SPORT UTILITY L4 Cyl 2.0	2016-11	EM-7185	TOYOTA SPORT UTILITY V6 Cyl 3.5	2016-11
EM-7107	TOYOTA SPORT UTILITY V6 Cyl 3.5	2012-06	EM-7186	HONDA SPORT UTILITY V6 Cyl 3.5	2015-09
EM-7108	TOYOTA SPORT UTILITY V8 Cyl 4.7	2009-08	EM-7187	HONDA SPORT UTILITY V6 Cyl 3.5	2015-09
	TOYOTA TRUCK V8 Cyl 4.7	2009-07	EM-7188	LEXUS SPORT UTILITY V6 Cyl 3.5	2015-06
EM-7110	HYUNDAI SPORT UTILITY L4, V6 Cyl 2.4	2013-10		TOYOTA SPORT UTILITY V6 Cyl 3.5	2016-11
	KIA SPORT UTILITY L4 Cyl 2.4	2013-11	EM-7189	LEXUS SPORT UTILITY V6 Cyl 3.5	2015-10
EM-7111	HONDA SPORT UTILITY L4 Cyl 2.4	2016-12		TOYOTA SPORT UTILITY V6 Cyl 3.5	2018-11
EM-7112	HYUNDAI PASSENGER CAR V8, V6 Cyl 4.6	2016-09	EM-7191	AUDI PASSENGER CAR L4 Cyl 2.0	2016-13
EM-7113	HYUNDAI PASSENGER CAR L4 Cyl 2.0	2010-07		AUDI SPORTS UTILITY L4 Cyl 2.0	2016-13
EM-7114	NISSAN PASSENGER CAR L4 Cyl 1.6	1998-91	EM-7192	TOYOTA VAN V6 Cyl 3.5	2019-15
EM-7115	CHEVROLET VAN L4 Cyl 2.0	2017-15	EM-7193	INFINITI PASSENGER CAR V6 Cyl 3.7	2015-14
	NISSAN VAN L4 Cyl 2.0	2017-13		INFINITI SPORT UTILITY V6, V8 Cyl 3.5	2018-07
EM-7116	HONDA PASSENGER CAR L4 Cyl 1.8	2015-12	EM-7194	VOLVO PASSENGER CAR L5 Cyl 2.4	2008-01
EM-7118	INFINITI PASSENGER CAR L4 Cyl 2.0	2002-99	EM-7195	BMW PASSENGER CAR L6 Cyl 3.0	2011-04
	NISSAN PASSENGER CAR L4, V6 Cyl 1.8	2013-95	EM-7197	TOYOTA SPORT UTILITY V8 Cyl 4.7	2009-08
	NISSAN SPORT UTILITY L4 Cyl 2.5	2007-02		TOYOTA TRUCK V8 Cyl 4.7	2009-07
EM-7119	RENAULT PASSENGER CAR L4 Cyl 1.6	2013-11	EM-7198	TOYOTA SPORT UTILITY V8 Cyl 4.7	2009-08
	NISSAN PASSENGER CAR L4 Cyl 1.6	2013-91		TOYOTA TRUCK V8 Cyl 4.7	2009-07
EM-7120	MERCEDES-BENZ PASSENGER CAR L4 Cyl 2.0	2016-13	EM-7201	SCION PASSENGER CAR L4 Cyl 2.5	2016-11
	MERCEDES-BENZ SPORT UTILITY L4 Cyl 2.0	2016-15	EM-7202	AUDI PASSENGER CAR L4, V6 Cyl 2.0	2017-08
EM-7121	MERCEDES-BENZ PASSENGER CAR L4 Cyl 2.0	2016-13	EM-7204	NISSAN SPORT UTILITY L4 Cyl 2.5	2018-14
	MERCEDES-BENZ SPORT UTILITY L4 Cyl 2.0	2016-15	EM-7205	NISSAN SPORT UTILITY L4 Cyl 2.5	2018-14
EM-7122	MERCEDES-BENZ PASSENGER CAR L4 Cyl 2.0	2016-13	EM-7207	HYUNDAI PASSENGER CAR V6 Cyl 3.8	2011
	MERCEDES-BENZ SPORT UTILITY L4 Cyl 2.0	2016-15	EM-7214	HYUNDAI SPORT UTILITY L4 Cyl 2.0	2015-14
EM-7123	MERCEDES-BENZ PASSENGER CAR L4 Cyl 2.0	2016-13	EM-7221	KIA PASSENGER CAR L4 Cyl 1.6	2017-14
	MERCEDES-BENZ SPORT UTILITY L4 Cyl 2.0	2016-14	EM-7224	KIA SPORT UTILITY L4 Cyl 2.4	2016-14
EM-7124	MERCEDES-BENZ PASSENGER CAR V6 Cyl 3.0	2013-11	EM-7225	HYUNDAI PASSENGER CAR L4 Cyl 2.4	2005
EM-7125	MAZDA PASSENGER CAR V6 Cyl 3.0	2008-06	EM-7229	ACURA SPORT UTILITY V6 Cyl 3.7	2013-07
EM-7126	INFINITI SPORT UTILITY L4 Cyl 2.5	2015-14	EM-7230	MAZDA PASSENGER CAR L4 Cyl 2.5	2017-14
EM-7127	HONDA PASSENGER CAR L4 Cyl 1.5	2019-15		MAZDA SPORT UTILITY L4 Cyl 2.5	2017-14
	HONDA SPORT UTILITY L4 Cyl 1.8	2018-16	EM-7231	HONDA PASSENGER CAR V6 Cyl 3.5	2017-13
EM-7128	INFINITI PASSENGER CAR V6 Cyl 3.7	2015-14	EM-7232	TOYOTA SPORT UTILITY L4 Cyl 2.5	2018-13
	INFINITI SPORT UTILITY V6, V8 Cyl 3.5	2017-09	EM-7233	TOYOTA SPORT UTILITY L4 Cyl 2.5	2018-13
EM-7129	ACURA PASSENGER CAR L4 Cyl 2.4	2016-15	EM-7234	INFINITI SPORT UTILITY L4 Cyl 2.5	2015-14
	HONDA PASSENGER CAR L4 Cyl 2.4	2017-13		NISSAN SPORT UTILITY V6, L4 Cyl 3.5	2016-13
EM-7130	MERCEDES-BENZ PASSENGER CAR V6 Cyl 3.2	2005-01	EM-7235	MAZDA PASSENGER CAR L4 Cyl 2.0	2018-14
EM-7132	VOLVO PASSENGER CAR L5 Cyl 2.3	2004-98		MAZDA SPORT UTILITY L4 Cyl 2.0	2018-13
EM-7134	ACURA PASSENGER CAR L4 Cyl 2.4	2016-15	EM-7236	TOYOTA VAN V6 Cyl 3.5	2019-15
	HONDA PASSENGER CAR L4 Cyl 2.4	2017-13	EM-7238	TOYOTA SPORT UTILITY V8 Cyl 5.7	2017-11
EM-7138	VOLKSWAGEN PASSENGER CAR L4 Cyl 2.0	2012-06		TOYOTA TRUCK V8 Cyl 5.7	2017-11
EM-7139	AUDI PASSENGER CAR L4, V6, V8 Cyl 1.8	2011-02	EM-7239	MAZDA SPORT UTILITY L4 Cyl 2.0	2016-13
EM-7140	AUDI PASSENGER CAR V6 Cyl 3.0	2011-05	EM-7241	MAZDA PASSENGER CAR L4 Cyl 1.5	2014-11
EM-7145	HONDA PASSENGER CAR L4 Cyl 1.8	2015-12	EM-7242	VOLVO PASSENGER CAR L6 Cyl 3.0	2016-07
EM-7148	HONDA PASSENGER CAR L4 Cyl 1.8	2015-13		VOLVO SPORT UTILITY L6 Cyl 3.2	2015-10
EM-7151	KIA PASSENGER CAR L4 Cyl 1.6	2013-10	EM-7244	TOYOTA SPORT UTILITY V6 Cyl 3.0	2003-01
EM-7152	NISSAN SPORT UTILITY L4 Cyl 1.6	2017-11	EM-7246	SUBARU PASSENGER CAR 3.6	2014-10
EM-7153	HYUNDAI PASSENGER CAR L4 Cyl 2.0	2012-10		SUBARU SPORT UTILITY H6 Cyl 3.6	2014-10
EM-7154	NISSAN SPORT UTILITY L4 Cyl 1.6	2017-11	EM-7247	SUBARU PASSENGER CAR 3.6	2014-10
EM-7155	ACURA PASSENGER CAR L4 Cyl 2.4	2016-15		SUBARU SPORT UTILITY H6 Cyl 3.6	2014-10
	HONDA PASSENGER CAR L4 Cyl 2.4	2017-13	EM-7248	SUBARU PASSENGER CAR 3.6	2014-10
EM-7156	MERCEDES-BENZ PASSENGER CAR V6 Cyl 3.5	2014-08		SUBARU SPORT UTILITY H6, H4 Cyl 3.6	2014-10
EM-7159	DODGE VAN V6, L4 Cyl 3.0	2016-07	EM-7249	TOYOTA PASSENGER CAR L4 Cyl 1.5	2017-12
	FREIGHTLINER V6 Cyl 3.0	2016-07	EM-7250	TOYOTA PASSENGER CAR L4 Cyl 1.5	2017-12
	MERCEDES-BENZ VAN V6 Cyl 3.0	2016-10	EM-7251	TOYOTA PASSENGER CAR L4 Cyl 1.5	2013-12
EM-7160	HYUNDAI PASSENGER CAR L4 Cyl 1.8	2016-11	EM-7253	SUBARU PASSENGER CAR H4 Cyl 2.5	2012-10
	KIA PASSENGER CAR L4 Cyl 1.6	2017-15	EM-7254	SCION PASSENGER CAR H4 Cyl 2.0	2016-13
EM-7163	KIA PASSENGER CAR L4 Cyl 2.0	2013-12		SUBARU PASSENGER CAR H4 Cyl 2.0	2017-13
EM-7168	ACURA PASSENGER CAR L4 Cyl 2.4	2015-13		SUBARU SPORT UTILITY H4 Cyl 2.0	2016-14
	HONDA PASSENGER CAR L4 Cyl 2.4	2015-12		TOYOTA PASSENGER CAR H4 Cyl 2.0	2017
EM-7169	ACURA PASSENGER CAR L4 Cyl 2.4	2015-13	EM-7255	SCION PASSENGER CAR H4 Cyl 2.0	2016-13
	HONDA PASSENGER CAR L4 Cyl 2.4	2015-12		SUBARU PASSENGER CAR H4 Cyl 2.0	2017-13
EM-7170	ACURA PASSENGER CAR L4 Cyl 2.0	2015-13		SUBARU SPORT UTILITY H4 Cyl 2.0	2016-14
	HONDA PASSENGER CAR L4 Cyl 1.8	2015-12		TOYOTA PASSENGER CAR H4 Cyl 2.0	2017
EM-7171	INFINITI SPORT UTILITY V6 Cyl 3.5	2013	EM-7256	SUBARU PASSENGER CAR H4 Cyl 2.5	2004-00
	NISSAN PASSENGER CAR V6 Cyl 3.5	2017-13		SUBARU SPORT UTILITY H4 Cyl 2.5	2006-00
	NISSAN SPORT UTILITY V6 Cyl 3.5	2016-13	EM-7257	SUBARU PASSENGER CAR H4 Cyl 2.5	2004-00
EM-7172	MAZDA PASSENGER CAR L4 Cyl 2.0	2015-14		SUBARU SPORT UTILITY H4 Cyl 2.5	2006-00
	MAZDA SPORT UTILITY L4 Cyl 2.5	2015-14	EM-7258	ACURA PASSENGER CAR L4 Cyl 2.4	2015-13
EM-7174	MAZDA PASSENGER CAR L4, V6 Cyl 2.5	2013-09		HONDA PASSENGER CAR L4 Cyl 2.4	2015-13
			EM-7259	TOYOTA PASSENGER CAR L4 Cyl 1.5	2014-12
			EM-7260	AUDI PASSENGER CAR L4 Cyl 1.8	2017-15

# NEW PART NUMBERS

PART#	APPLICATION	YEAR	PART#	Application	Years
EM-7261	VOLKSWAGEN PASSENGER CAR L4 Cyl 1.8	2018-15	EM-90030	FORD PASSENGER CAR L4 Cyl 1.6	2012-03
EM-7262	VOLKSWAGEN PASSENGER CAR L4, L5 Cyl 2.0	2017-11		FORD SPORT UTILITY L4 Cyl 2.0	2008-07
EM-7263	ACURA PASSENGER CAR L4 Cyl 2.0	2015-13	EM-90031	NISSAN PASSENGER CAR L4 Cyl 1.6	2008-02
EM-7264	MAZDA PASSENGER CAR V6 Cyl 3.7	2013-09		RENAULT PASSENGER CAR L4 Cyl 1.6	2008-02
EM-7265	DODGE VAN V6, L4 Cyl 3.0	2016-07	EM-90032	NISSAN VAN L4 Cyl 2.4	2008-03
	FREIGHTLINER V6 Cyl 3.0	2016-07	EM-90033	DODGE PASSENGER CAR L4 Cyl 1.1	2010-05
	MERCEDES-BENZ VAN L4 Cyl 2.0	2016-14	EM-90035	TOYOTA VAN L4 Cyl 2.7	2005-01
EM-7266	TOYOTA PASSENGER CAR L4 Cyl 2.5	2017-12	EM-90036	NISSAN SPORT UTILITY L4 Cyl 2.5	2014-08
EM-7267	SUBARU PASSENGER CAR 3.6	2016-15		RENAULT SPORT UTILITY L4 Cyl 2.5	2014-09
	SUBARU SPORT UTILITY H6 Cyl 3.6	2016-15	EM-90037	DODGE PASSENGER CAR L4 Cyl 1.1	2010-01
EM-7268	BMW PASSENGER CAR L6 Cyl 3.0	2016	EM-90038	NISSAN VAN L4 Cyl 2.4	2008-00
	VOLKSWAGEN PASSENGER CAR L4 Cyl 2.0	2015-09	EM-90039	NISSAN SPORT UTILITY L4 Cyl 2.5	2007-02
EM-7270	VOLKSWAGEN PASSENGER CAR L4 Cyl 2.0	2015-13	EM-90040	DODGE PASSENGER CAR L4 Cyl 1.0	2010-01
EM-7271	VOLKSWAGEN PASSENGER CAR L4 Cyl 2.0	2014-09	EM-90071	TOYOTA VAN L4 Cyl 1.5	2018-07
EM-7272	AUDI PASSENGER CAR L4 Cyl 2.0	2014-09	EM-9190G	NISSAN PASSENGER CAR L4 Cyl 2.5	2006-02
	VOLKSWAGEN PASSENGER CAR V6, L4 Cyl 3.6	2016-09	EM-9590	LEXUS SPORT UTILITY V6 Cyl 3.3	2006-04
EM-7275	VOLKSWAGEN PASSENGER CAR L4 Cyl 2.0	2015		TOYOTA SPORT UTILITY V6 Cyl 3.5	2015-07
EM-7277	BMW PASSENGER CAR L4, L6 Cyl 2.0	2017-12	EM-9591	TOYOTA SPORT UTILITY L4, V6 Cyl 2.7	2016-01
	BMW SPORT UTILITY L4 Cyl 2.0	2017-13		TOYOTA VAN V6 Cyl 3.3	2006-04
EM-7278	BMW PASSENGER CAR L4, L6 Cyl 2.0	2017-12	ST-10000	BMW SPORT UTILITY	2014-07
	BMW SPORT UTILITY L4 Cyl 2.0	2017-13	ST-10002	MERCEDES-BENZ PASSENGER CAR	2009-03
EM-7279	BMW PASSENGER CAR L4, L6 Cyl 2.0	2017-12	ST-10003	AUDI PASSENGER CAR	2011-05
EM-7280	MERCEDES-BENZ PASSENGER CAR V6, V8, L4 Cyl	2017-07	ST-10004	BUICK PASSENGER CAR	2017-12
	MERCEDES-BENZ VAN L4 Cyl 2.0	2017-16		BUICK SPORT UTILITY	2019-13
EM-7281	BMW SPORT UTILITY L6, V8 Cyl 3.0	2017-07		CHEVROLET PASSENGER CAR	2019-11
EM-7284	SUBARU PASSENGER CAR H4 Cyl 2.5	2016-13		CHEVROLET SPORT UTILITY	2019-13
	SUBARU SPORT UTILITY H4 Cyl 2.5	2016-13	ST-10005	MERCEDES-BENZ PASSENGER CAR	2011-06
EM-7285	AUDI PASSENGER CAR V6 Cyl 3.2	2011-06	ST-10006	MERCEDES-BENZ PASSENGER CAR	2015-10
EM-7286	INFINITI PASSENGER CAR L4 Cyl 2.0	1996-91	ST-10007	MERCEDES-BENZ PASSENGER CAR	2015-08
EM-7287	TOYOTA PASSENGER CAR V6 Cyl 3.0	2003-97	ST-10008	AUDI PASSENGER CAR	2015-08
EM-7289	HYUNDAI SPORT UTILITY L4 Cyl 2.0	2015-14		AUDI SPORTS UTILITY	2015-09
EM-7290	BMW PASSENGER CAR L6, L4 Cyl 3.0	2018-10		BMW PASSENGER CAR	2003-99
EM-7294	NISSAN SPORT UTILITY L4 Cyl 2.5	2018-14		PORSCHE SUV	2015
EM-7296	HONDA PASSENGER CAR L4 Cyl 1.5	2019-15	ST-10009	BMW PASSENGER CAR	2003-99
EM-7300	ACURA SPORT UTILITY V6 Cyl 3.0	2018-14	ST-10010	MERCEDES-BENZ PASSENGER CAR	2018-08
	HONDA SPORT UTILITY V6 Cyl 3.5	2019-16		MERCEDES-BENZ SPORT UTILITY	2018-15
	HONDA TRUCK V6 Cyl 3.5	2018-17	ST-10011	SMART	2014-08
EM-7302	HONDA SPORT UTILITY L4 Cyl 2.4	2016-15	ST-10012	AUDI PASSENGER CAR	2015-08
EM-7303	LEXUS PASSENGER CAR V6 Cyl 3.0	2015-06		AUDI SPORTS UTILITY	2015-09
EM-7307	SCION PASSENGER CAR L4 Cyl 2.5	2016-11	ST-5968	CHRYSLER PASSENGER CAR	2014-05
EM-7316	NISSAN SPORT UTILITY V6 Cyl 3.5	2014-09		DODGE PASSENGER CAR	2010-07
EM-7325	MAZDA PASSENGER CAR L4 Cyl 2.5	2017-14	ST-6994	FORD VAN	2007-04
	MAZDA SPORT UTILITY L4 Cyl 2.5	2017-14	ST-7914	HONDA PASSENGER CAR	2011-01
EM-7333	INFINITI SPORT UTILITY V6 Cyl 3.5	2013		HONDA SPORT UTILITY	2006-02
	NISSAN SPORT UTILITY V6 Cyl 3.5	2018-09	ST-7917	HONDA PASSENGER CAR	2005-02
EM-7335	LEXUS SPORT UTILITY V6 Cyl 3.5	2015-13	ST-7919	HONDA VAN	2004-99
EM-8974G	ACURA PASSENGER CAR V6 Cyl 3.2	1999	ST-7927	TOYOTA TRUCK	2004-95
	HONDA PASSENGER CAR V6 Cyl 3.0	2003-98	ST-7973	BMW PASSENGER CAR	2006-01
	HONDA VAN V6 Cyl 3.5	2004-99	ST-7974	BMW PASSENGER CAR	2006-01
EM-90000	NISSAN PASSENGER CAR L4 Cyl 1.6	2008-02	ST-7975	BMW PASSENGER CAR	2006-01
	RENAULT PASSENGER CAR L4 Cyl 1.6	2010-03	ST-7979	INFINITI SPORT UTILITY	2001-99
EM-90001	NISSAN PASSENGER CAR L4 Cyl 1.6	2009-02		NISSAN SPORT UTILITY	2001-99
	RENAULT PASSENGER CAR L4 Cyl 1.6	2008-02	ST-7980	INFINITI SPORT UTILITY	2001-99
	RENAULT VAN L4 Cyl 2.0	2008		NISSAN SPORT UTILITY	2001-99
EM-90002	CHEVROLET PASSENGER CAR L4 Cyl 1.4	2012-97	ST-7981	PONTIAC PASSENGER CAR	2008-03
	CHEVROLET TRUCK L4 Cyl 1.8	2015-12		TOYOTA PASSENGER CAR	2008-03
EM-90003	CHEVROLET PASSENGER CAR L4 Cyl 1.8	2008-02	ST-7982	PONTIAC PASSENGER CAR	2008-03
	CHEVROLET TRUCK L4 Cyl 1.8	2011-04		TOYOTA PASSENGER CAR	2008-07
EM-90004	NISSAN PASSENGER CAR L4 Cyl 1.6	2010-02	ST-7984	BMW PASSENGER CAR	2013-07
	RENAULT PASSENGER CAR L4 Cyl 2.0	2006-03	ST-7987	BUICK PASSENGER CAR	2013-10
	RENAULT VAN L4 Cyl 2.0	2008		CHEVROLET PASSENGER CAR	2013
EM-90006	CHEVROLET PASSENGER CAR L4 Cyl 1.8	2008-02	ST-7995	DODGE SPORT UTILITY	2015-09
	CHEVROLET TRUCK L4 Cyl 1.8	2011-04	ST-7998	FORD PASSENGER CAR	2009-05
EM-90008	FORD PASSENGER CAR L4 Cyl 1.6	2010-03		MERCURY PASSENGER CAR	2008
EM-90009	FORD PASSENGER CAR L4 Cyl 1.6	2010-03	ST-7999	FORD PASSENGER CAR	2009-08
EM-90010	CHEVROLET PASSENGER CAR L4 Cyl 1.8	2008-00		LINCOLN PASSENGER CAR	2011-10
	CHEVROLET VAN L4 Cyl 2.2	2006-02		LINCOLN SPORT UTILITY	2011-10
EM-90011	CHEVROLET PASSENGER CAR L4 Cyl 2.2	2003-01		MERCURY PASSENGER CAR	2011-08
	CHEVROLET VAN L4 Cyl 2.2	2006-02	ST-8911	BMW SPORT UTILITY	2018-16
EM-90015	CHEVROLET PASSENGER CAR L4 Cyl 1.8	2008-02		MINI	2018-07
	CHEVROLET TRUCK L4 Cyl 1.8	2011-04	ST-8919	SUZUKI SPORT UTILITY	2013-06
EM-90019	FORD PASSENGER CAR L4 Cyl 1.6	2008-01	ST-8920	TOYOTA SPORT UTILITY	2013-08
EM-90021	CHEVROLET PASSENGER CAR L4 Cyl 1.6	2015-94	ST-8921	TOYOTA SPORT UTILITY	2013-08
	CHEVROLET TRUCK L4 Cyl 1.8	2011-04	ST-8927	CHRYSLER PASSENGER CAR	2004-98
EM-90022	NISSAN PASSENGER CAR L4 Cyl 1.6	2010-92		DODGE PASSENGER CAR	2004-98
EM-90027	FORD PASSENGER CAR 8 Cyl 1.3	2000-98	ST-8928	FORD VAN	2003-95
	FORD TRUCK L4 Cyl 1.6	2008-98	ST-8929	HYUNDAI PASSENGER CAR	2005-00
EM-90028	FORD PASSENGER CAR L4 Cyl 1.4	2000-98	ST-8930	HYUNDAI PASSENGER CAR	2005-00
	FORD TRUCK L4 Cyl 1.6	2008-98	ST-8931	HYUNDAI PASSENGER CAR	2006-97
EM-90029	FORD PASSENGER CAR L4 Cyl 1.3	2000-98		KIA PASSENGER CAR	2009-05
	FORD TRUCK L4 Cyl 1.6	2010-98	ST-8932	HYUNDAI PASSENGER CAR	2006-01
			ST-8933	MAZDA PASSENGER CAR	2003-99



# NEW PART NUMBERS

PART#	APPLICATION	YEAR	PART#	Application	Years
ST-8934	MAZDA PASSENGER CAR	2003-99	ST-9913	TOYOTA TRUCK	2013-05
ST-8937	HYUNDAI SPORT UTILITY	2010-05	ST-9914	FORD PASSENGER CAR	2011-08
	KIA SPORT UTILITY	2010-05		FORD SPORT UTILITY	2009
ST-8938	HYUNDAI SPORT UTILITY	2010-05		LINCOLN PASSENGER CAR	2011-10
	KIA SPORT UTILITY	2010-05		LINCOLN SPORT UTILITY	2011-10
ST-8941	VOLVO PASSENGER CAR	1997-93	ST-9915	FORD PASSENGER CAR	2012
	VOLVO SPORT UTILITY	2007-98		FORD SPORT UTILITY	2012
ST-8943	CHRYSLER PASSENGER CAR	2016-07		LINCOLN PASSENGER CAR	2012
	DODGE PASSENGER CAR	2014-08		LINCOLN SPORT UTILITY	2012
	DODGE SPORT UTILITY	2015-09	ST-9916	FORD PASSENGER CAR	2019-13
	JEEP SPORT UTILITY	2016-07		FORD SPORT UTILITY	2019-13
ST-8944	MITSUBISHI PASSENGER CAR	2012-04		LINCOLN PASSENGER CAR	2016-13
	MITSUBISHI SPORT UTILITY	2011-04		LINCOLN SPORT UTILITY	2015-13
ST-8947	SUZUKI PASSENGER CAR	2008-04	ST-9917	ACURA PASSENGER CAR	2014-09
ST-8950	HYUNDAI PASSENGER CAR	2006-96		HONDA PASSENGER CAR	2015-08
ST-8951	MAZDA PASSENGER CAR	2003-99	ST-9918	ACURA PASSENGER CAR	2014-09
ST-8952	SATURN PASSENGER CAR	2007-03		HONDA PASSENGER CAR	2015-08
ST-8955	INFINITI PASSENGER CAR	2004-00	ST-9920	HONDA SPORT UTILITY	2011-03
	NISSAN PASSENGER CAR	2003-00	ST-9921	CHEVROLET TRUCK	2012-04
ST-8956	INFINITI PASSENGER CAR	2004-02		GMC TRUCK	2012-04
	NISSAN PASSENGER CAR	2003-00	ST-9922	ACURA PASSENGER CAR	2015-09
ST-8957	INFINITI PASSENGER CAR	2004-00		HONDA PASSENGER CAR	2012-08
	NISSAN PASSENGER CAR	2003-00	ST-9923	BUICK SPORT UTILITY	2016-08
ST-8958	CHRYSLER SUV	2008-04		CHEVROLET SPORT UTILITY	2016-09
ST-8961	FORD PASSENGER CAR	2018-12		GMC SPORT UTILITY	2016-07
	FORD SPORT UTILITY	2018-13		SATURN SUV	2010-07
	FORD VAN	2019-14	ST-9924	BUICK SPORT UTILITY	2016-08
	LINCOLN SPORT UTILITY	2019-15		CHEVROLET SPORT UTILITY	2016-09
ST-8962	DODGE TRUCK	2018-09		GMC SPORT UTILITY	2016-07
	RAM TRUCK	2011-10		SATURN SUV	2010-07
ST-8969	DODGE PASSENGER CAR	2012-07	ST-9925	NISSAN PASSENGER CAR	2012-07
ST-8970	DODGE PASSENGER CAR	2012-07	ST-9927	HONDA SPORT UTILITY	2011-03
ST-8973	DODGE PASSENGER CAR	2012-07	ST-9929	FORD PASSENGER CAR	2012-06
ST-8977	HYUNDAI PASSENGER CAR	2005-00		LINCOLN PASSENGER CAR	2012-07
ST-8978	HYUNDAI PASSENGER CAR	2005-00		MAZDA PASSENGER CAR	2008-05
ST-8979	HYUNDAI SPORT UTILITY	2006-01		MERCURY PASSENGER CAR	2011-06
ST-8980	HYUNDAI SPORT UTILITY	2006-01	ST-9930	LINCOLN SPORT UTILITY	2011-03
ST-8981	HYUNDAI SPORT UTILITY	2006-01	ST-9931	LEXUS PASSENGER CAR	2015-10
ST-8982	DODGE VAN	2012-08		SCION PASSENGER CAR L4 Cyl 2.4	2010-05
ST-8983	DODGE SPORT UTILITY	2015-09		TOYOTA PASSENGER CAR	2015-10
ST-8984	DODGE SPORT UTILITY	2015-09		TOYOTA SPORT UTILITY	2012-09
ST-8990	TOYOTA PASSENGER CAR	2013-09	ST-9937	HYUNDAI PASSENGER CAR	2011-06
ST-8993	BUICK PASSENGER CAR	2019-11		KIA PASSENGER CAR	2011-06
	CADILLAC PASSENGER CAR	2016-14	ST-9938	HYUNDAI PASSENGER CAR	2011-06
	CHEVROLET PASSENGER CAR	2015-11		KIA PASSENGER CAR	2011-06
ST-8994	MAZDA PASSENGER CAR	2013-09	ST-9939	TOYOTA SPORT UTILITY	2005-96
ST-8997	HYUNDAI PASSENGER CAR	2017-11	ST-9940	TOYOTA SPORT UTILITY	2005-96
	KIA PASSENGER CAR	2017-11	ST-9942	LEXUS PASSENGER CAR	2015-04
ST-8998	NISSAN SPORT UTILITY	2014-09		LEXUS SPORT UTILITY	2008-06
	NISSAN VAN	2014-11		TOYOTA SPORT UTILITY	2013-08
ST-98000	FORD PASSENGER CAR	2007-98	ST-9943	LEXUS SPORT UTILITY	2015-10
ST-98001	FORD PASSENGER CAR	2010-03		TOYOTA SPORT UTILITY	2014-04
	FORD SPORT UTILITY	2012-04	ST-9945	HONDA PASSENGER CAR	2011-06
ST-98002	NISSAN PASSENGER CAR	2010-02	ST-9946	HONDA SPORT UTILITY	2011-07
	RENAULT PASSENGER CAR	2010-02	ST-9947	CHRYSLER PASSENGER CAR	2005-95
	RENAULT VAN	2009-07		DODGE PASSENGER CAR	2005-01
ST-98003	CHEVROLET PASSENGER CAR	2012-94		EAGLE PASSENGER CAR	1998-95
ST-98004	DODGE PASSENGER CAR	2010-05		MITSUBISHI PASSENGER CAR	2003-99
ST-98005	CHEVROLET PASSENGER CAR	2008-00	ST-9948	HYUNDAI PASSENGER CAR	2012-07
	CHEVROLET TRUCK L4 Cyl 1.8	2011-04	ST-9949	HYUNDAI PASSENGER CAR	2012-07
	CHEVROLET VAN	2006-02	ST-9955	TOYOTA PASSENGER CAR	2015-09
ST-9901	BUICK PASSENGER CAR	2011-06	ST-9956	TOYOTA PASSENGER CAR	2013-03
	CADILLAC PASSENGER CAR	2011-06	ST-9957	TOYOTA PASSENGER CAR	2013-09
ST-9902	HYUNDAI PASSENGER CAR V6 Cyl 3.8	2010-06	ST-9959	HONDA SPORT UTILITY	2011-07
ST-9903	MAZDA PASSENGER CAR	2004-03	ST-9962	SCION PASSENGER CAR L4 Cyl 2.4	2010-05
ST-9904	NISSAN PASSENGER CAR	2013-07		TOYOTA PASSENGER CAR	2009-03
ST-9905	FORD SPORT UTILITY	2013-11	ST-9969	CHRYSLER PASSENGER CAR	2005-99
ST-9906	FORD PASSENGER CAR	2014-11		DODGE PASSENGER CAR	2005-01
	FORD SPORT UTILITY	2015-11		MITSUBISHI PASSENGER CAR	2005-00
	LINCOLN SPORT UTILITY	2015-11	ST-9977	HONDA VAN	2007-05
ST-9907	AUDI PASSENGER CAR	2004-97	ST-9978	HONDA VAN	2007-05
ST-9908	BMW PASSENGER CAR	2017-04	ST-9988	DODGE PASSENGER CAR	2016-13
ST-9909	CADILLAC PASSENGER CAR	2016-13	ST-9989	DODGE PASSENGER CAR	2016-13
ST-9910	CADILLAC PASSENGER CAR	2016-13	ST-9998	KIA PASSENGER CAR	2011-06
ST-9911	CADILLAC PASSENGER CAR	2016-13	ST-9999	KIA PASSENGER CAR	2010-06
ST-9912	ACURA PASSENGER CAR	2017-15			
	HONDA PASSENGER CAR	2014-13			
ST-9913	TOYOTA TRUCK	2013-05			

## SUPERSESSIONS

Old Part#	Surviving Part#	Old Part#	Surviving Part#	Old Part#	Surviving Part#
DS-6097	..... DS-6078	DS-6117	..... DS-6517	EM-5704	..... EM-90029
DS-6100	..... DS-6500	DS-6118	..... DS-6518	EM-5708	..... EM-90008
DS-6101	..... DS-6501	DS-6119	..... DS-6519	EM-5709	..... EM-90009
DS-6102	..... DS-6502	DS-6120	..... DS-6520	EM-5712	..... EM-90012
DS-6103	..... DS-6503	DS-8534	..... DS-8474	EM-5719	..... EM-90000
DS-6104	..... DS-6504	EM-4032	..... EM-4018	EM-5721	..... EM-90001
DS-6105	..... DS-6505	EM-4083	..... EM-4117	EM-5722	..... EM-90031
DS-6106	..... DS-6506	EM-4246	..... EM-4142	EM-5724	..... EM-90054
DS-6107	..... DS-6507	EM-5444	..... EM-5612	EM-5727	..... EM-90037
DS-6108	..... DS-6508	EM-5674	..... EM-2993	EM-5728	..... EM-90040
DS-6109	..... DS-6509	EM-5676	..... EM-90003	EM-5730	..... EM-90012
DS-6110	..... DS-6510	EM-5677	..... EM-90006	EM-5784	..... EM-9459
DS-6111	..... DS-6511	EM-5678	..... EM-90025	EM-5998	..... EM-9360
DS-6112	..... DS-6512	EM-5679	..... EM-90014	EM-8486	..... EM-8163
DS-6113	..... DS-6513	EM-5685	..... EM-90021	ST-3925	..... ST-5911
DS-6114	..... DS-6514	EM-5702	..... EM-90056		
DS-6116	..... DS-5236	EM-5703	..... EM-90057		

## Discontinued Part Numbers

Part #	Year Discontinued	Part #	Year Discontinued	Part #	Year Discontinued
DS-6067	2014	EM-5199	2015	EM-5705	2014
<b>EM-2906</b>	<b>2019</b>	EM-5201	2015	<b>EM-5706</b>	<b>2016</b>
<b>EM-4014</b>	<b>2017</b>	EM-5203	2015	EM-5707	2014
<b>EM-4020</b>	<b>2017</b>	EM-5207	2015	EM-5711	2014
<b>EM-4148</b>	<b>2017</b>	EM-5211	2015	EM-5714	2014
<b>EM-4170</b>	<b>2017</b>	EM-5212	2014	EM-5715	2014
<b>EM-4191</b>	<b>2019</b>	EM-5220	2015	EM-5716	2014
<b>EM-4207</b>	<b>2017</b>	<b>EM-5322</b>	<b>2019</b>	EM-5717	2014
EM-5071	2014	EM-5331	2015	EM-5718	2014
EM-5088	2015	EM-5360	2015	EM-5720	2014
EM-5090	2015	EM-5361	2015	EM-5723	2014
EM-5095	2015	<b>EM-5391</b>	<b>2019</b>	EM-5725	2014
EM-5099	2015	<b>EM-5408</b>	<b>2019</b>	EM-5729	2014
EM-5115	2015	<b>EM-5412</b>	<b>2019</b>	EM-5811	2015
EM-5116	2015	EM-5415	2015	<b>EM-5816</b>	<b>2018</b>
EM-5122	2015	EM-5418	2015	EM-5833	2014
EM-5123	2015	EM-5419	2015	EM-5878	2014
<b>EM-5124</b>	<b>2019</b>	<b>EM-5421</b>	<b>2019</b>	EM-7005	2015
EM-5125	2015	EM-5431	2015	<b>EM-7063</b>	<b>2017</b>
<b>EM-5126</b>	<b>2019</b>	EM-5472	2014	<b>EM-7190</b>	<b>2018</b>
<b>EM-5127</b>	<b>2019</b>	EM-5508	2015	EM-8136	2014
<b>EM-5128</b>	<b>2019</b>	EM-5520	2015	<b>EM-8505</b>	<b>2019</b>
EM-5154	2015	EM-5532	2015	EM-8625	2015
EM-5164	2015	<b>EM-5589</b>	<b>2016</b>	EM-8634	2014
EM-5167	2015	EM-5680	2014	EM-8960S	2015
EM-5172	2015	EM-5681	2014	<b>EM-9321</b>	<b>2019</b>
EM-5183	2015	EM-5683	2014	<b>EM-9561</b>	<b>2019</b>
EM-5185	2015	EM-5684	2014	<b>ST-4959</b>	<b>2019</b>
<b>EM-5192</b>	<b>2019</b>	EM-5686	2014	<b>ST-4960</b>	<b>2019</b>
EM-5196	2015	<b>EM-5700</b>	<b>2017</b>	<b>ST-4978</b>	<b>2019</b>
EM-5197	2015	EM-5701	2014	ST-5541	2015

*5 Year Running List. All prior to 2015 have been removed from the catalog.*

*Discontinued Since the 2016 Catalog*

# ABBREVIATIONS

2WD ..... 2 Wheel Drive  
 4WD ..... 4 Wheel Drive  
 ABS..... Antilock Brake System  
 A/C ..... Air Conditioning  
 A/T ..... Automatic Transmission  
 AWD ..... All Wheel Drive  
 BBL ..... Barrel  
 BEF ..... Before  
 CC ..... Cubic Centimeters  
 CONV ..... Convertible  
 DSL ..... Diesel  
 EFI ..... Electronic Fuel Injection  
 ENG ..... Engine  
 EXC ..... Excluding  
 FI ..... Feul Injection  
 F/T ..... Full Time  
 FWD ..... Front Wheel Drive  
 GVWR ...Gross Vehicle Weight Rating  
 H ..... Hydraulic  
 HP ..... Horsepower  
 INC ..... Includes  
 L&R ..... Left and Right Hand

LH ..... Left Hand  
 LIMO ..... Limosine  
 LONG ..... Longitudinal  
 LOW ..... Lower  
 M/T ..... Manual Transmission  
 N/A ..... Not Applicable  
 PASS ..... Passanger  
 P/S ..... Power Steering  
 P/T ..... Part Time  
 PWR ..... Power  
 RH ..... Right Hand  
 SER ..... Series  
 STD ..... Standard  
 SUSP ..... Suspension  
 T/C ..... Turbo Charge  
 T/H ..... Turbo Hydromatic  
 T/M ..... Trans-O-Matic  
 TRANS ..... Transmission  
 UPR ..... Upper  
 W/ ..... With  
 W/O ..... Without

## **General Motors**

### **Automatic Transmission**

M29 ..... PA  
 M30 ..... 4L60E  
 M33 ..... Hybrid 4L60E  
 M38 ..... THM350C  
 M40 ..... THM400C  
 M74 ..... 5 Speed Allison  
 MD8 ..... 700R4  
 MT1 ..... THMF4  
 MV4 ..... THM350C  
 MW9 ..... THM2004R

### **Ford Automatic Tramnsmission**

AOD ..... Automatic Overdrive  
 C3 ..... 3 Speed Automatic  
 C4 ..... 3 Speed Automatic  
 C5 ..... Speed Automatic  
 C6 ..... speed Automatic  
 CM ..... Cruise-O-Matic

# BODY MOUNTS AND BODY BUSHINGS

## FORD / LINCOLN / MERCURY

### Body Mounts for Taurus and Sable 1986 thru 1995

#### FRONT KIT Part No. BB-5500

Includes:  
Mount, Washer, Bolt  
Plate Nut and Rubber Plug

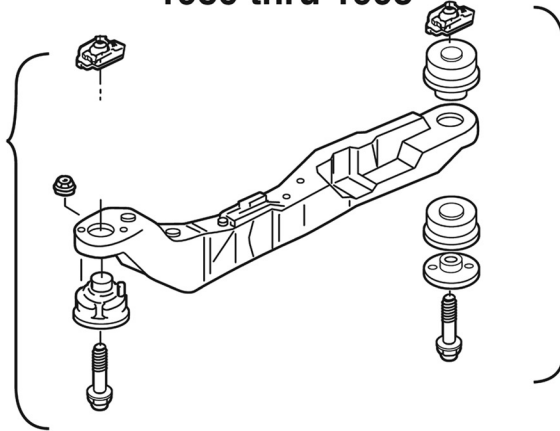

#### REAR KIT Part No. BB-5501

Includes:  
Upper Mount, Lower Mount  
Washers, Bolt  
Plate Nut and Rubber Plug

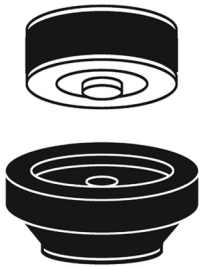

### Chassis Body Bushings for Crown Victoria, Town Car, Grand Marquis

Part No. BB-5502 – 1 Bushing Kit per box

## GENERAL MOTORS BODY MOUNT BUSHINGS

### Part No. BB-5503

Replaces O.E.M. No. 348080 - 4 required

Make	Model	Year	Position
<b>BUICK</b>	Estatewagon	1982 - 1996	3 & 4
	Regal	1985 - 1987	3 & 4
	Riviera	1982 - 1985	3 & 4
	Electra	1982 - 1984	1 & 3
Chevrolet	Caprice Sedan	1985 - 1996	1 & 3
	Stationwagon	1982 - 1996	3 & 4

Make	Model	Year	Position
<b>OLDSMOBILE</b>	Custom Cruiser	1982 - 1992	3 & 4
	Regency 98	1982 - 1984	1 & 3
	Toronado	1982 - 1985	3 & 4
<b>PONTIAC</b>	Bonneville	1982 - 1984	1 & 3
	Parisienne	1985 - 1986	1 & 3
	Safari	1982 - 1989	3 & 4

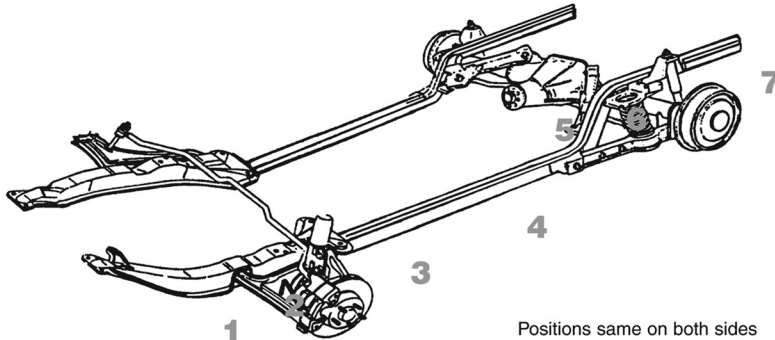
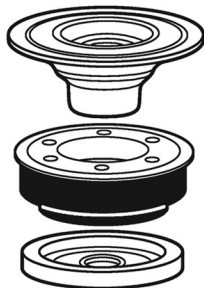

Positions same on both sides

# EM-5000 UNIVERSAL

## GENERAL MOTORS TRANSMISSION MOUNT



Replaces Most (85%) General Motors Rear Wheel Drive Single-Stud and Two-Hole Transmission Mounts on 4cyl., 6cyl. and 8 cyl. Engines (fits over 100 million vehicles now on the road)

### *Replaces these Westar parts*

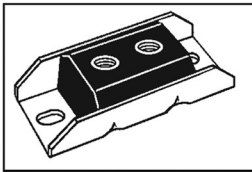

EM-2143

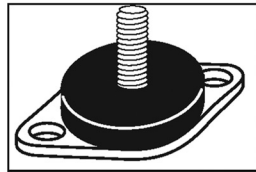

EM-2150

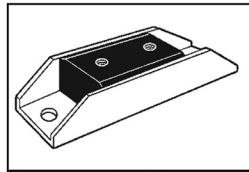

EM-2215

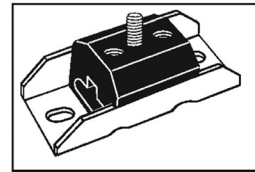

EM-2360

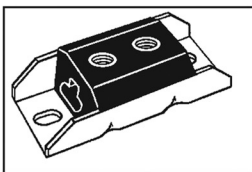

EM-2378

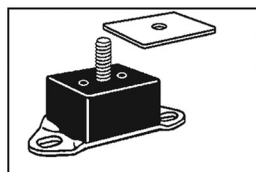

EM-2510

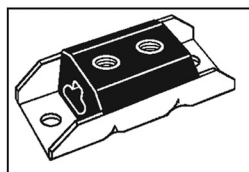

EM-2268

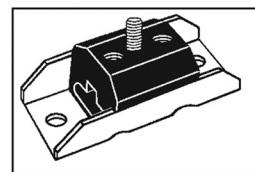

EM-2288

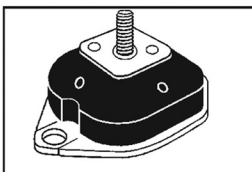

EM-2374

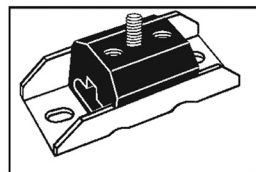

EM-2659

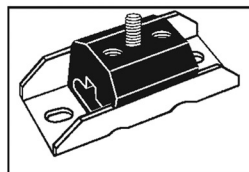

EM-2773

**Original Design or Universal—  
Westar has what you need!**



# Engine, Transmission, And Torque Strut Mounts

CYL	ENG. SIZE	YEAR	LOCATION	DESCRIPTION	QTY	ENGINE	TORQUE STRUT	TRANSMISSION
<b>ACURA PASSENGER CAR</b>								
<b>CL</b>								
L4	L4 2.2L 2156cc	1997	Front	Auto	1	EM-8026		
			Front	Manual	1	EM-8432		
			LH Front		1	EM-8404		
			Rear	Auto; w/ Solenoid	1	EM-8984		
			Rear	Auto; w/o Solenoid	1	EM-8011		
			Rear	Manual	1	EM-8009		
			Trans	Auto	1			EM-8002
	L4 2.3L 2254cc	1998-99	Front	Auto	1	EM-8026		
			Front	Manual	1	EM-8432		
			LH Front		1	EM-8404		
			Rear	Auto; w/ Solenoid	1	EM-8984		
			Rear	Auto; w/o Solenoid	1	EM-8011		
			Rear	Manual	1	EM-8009		
			Trans	Auto	1			EM-8002
V6	V6 3.0L 2997cc	1997-99	Front		1	EM-9178		
			Rear	w/o Vacuum Switch	1	EM-5471		
			Rear	With Vacuum Switch	1	EM-7094		
			Trans		1			EM-8896
	V6 3.2L 3210cc	2001-03	Front		1	EM-9441		
			Rear		1	EM-9149		
			Right		1	EM-8974#		
			Trans - Front		1			EM-8986
<b>CSX</b>								
L4	L4 2.0L 1998cc	2006-09	RH Front		1	EM-9282		
		2006-10	Torq Str - Lower		1		EM-9386	
			Torq Str - Upper		1		EM-9385	
<b>EL</b>								
L4	L4 1.7L 1668cc	2001-05	Front	Auto	1	EM-8988		
			Front	Manual	1	EM-8975		
			Left		1	EM-9016		
			Rear		1	EM-8973		
			Trans	Auto; Exc. CVT	1			EM-5794
			Trans	Manual	1			EM-9204
<b>ILX</b>								
L4	L4 2.0L 1997cc	2013-15	Torq Str - Lower		1		EM-7170	
			Torq Str - Upper		1		EM-5954	
			Trans		1			EM-7263
	L4 2.4L 2351cc	2013-15	Torq Str - Lower		1		EM-7168	
			Torq Str - Upper		1		EM-7169	
	L4 2.4L 2354cc	2013-15	RH Front		1	EM-7258		
			Trans	Auto	1			EM-7177
			Trans	Manual	1			EM-7177
<b>INTEGRA</b>								
L4	L4 1.6L 1590cc	1986-89	Rear	Auto; After Chassis #GS000960	1	EM-9084		
			Rear	Manual	1	EM-9084		
			Trans	Auto	1			EM-8018
			Trans	Manual	1			EM-8018
	L4 1.7L	1992-93	Trans	Manual	1			EM-5385
	L4 1.7L 1678cc	1992-93	Front		1	EM-8823		
			LH Front		1	EM-8981		
			Rear		1	EM-8895		
	L4 1.8L 1797cc	1997-01	Front	GS-R & Type-R	1	EM-8434		

\* = Hydraulic Mount, "S" suffix = solid replacement.

@ = Universal Mount EM-5000 also available.

# = Available in the Westar Gold Line

# Engine, Transmission, And Torque Strut Mounts

CYL	ENG. SIZE	YEAR	LOCATION	DESCRIPTION	QTY	ENGINE	TORQUE STRUT	TRANSMISSION
<b>ACURA PASSENGER CAR (continued)</b>								
<b>INTEGRA (continued)</b>								
L4	L4 1.8L 1797cc	1994-96	Front	GS-R	1	EM-8824		
		1997-01	LH Front	GS-R & Type-R	1	EM-8435		
		1994-96	LH Front Lower	GS-R	1	EM-8893		
		1997-01	LH Front Upper	GS-R & Type-R	1	EM-8894		
		1994-96	LH Front Upper	GS-R	1	EM-8894		
		1997-01	Rear	GS-R & Type-R	1	EM-8010		
		1994-96	Rear	GS-R	1	EM-8010		
		1997-01	Trans	GS-R & Type-R; Manual	1			EM-8329
		1994-96	Trans	GS-R; Manual	1			EM-8329
	L4 1.8L 1834cc	1997-01	Front	exc. GS-R & Type-R; Auto	1	EM-8575		
			Front	exc. GS-R & Type-R; Manual 5 Spd	1	EM-8824		
		1994-96	Front	exc. GS-R; Auto	1	EM-8575		
			Front	exc. GS-R; Manual	1	EM-8824		
		1992-93	Front	Auto	1	EM-8860		
			Front	Manual	1	EM-8823		
		1990-91	Front	Auto	1	EM-8860		
			Front	Manual	1	EM-8823		
		1992-93	LH Front		1	EM-9169		
		1990-91	LH Front		1	EM-8981		
		1997-01	LH Front Lower	exc. GS-R & Type-R; Auto	1	EM-8709		
			LH Front Lower	exc. GS-R & Type-R; Manual 5 Spd	1	EM-8893		
		1994-96	LH Front Lower	exc. GS-R; Auto	1	EM-8709		
			LH Front Lower	exc. GS-R; Manual	1	EM-8893		
		1997-01	LH Front Upper	exc. GS-R & Type-R	1	EM-8894		
		1994-96	LH Front Upper	exc. GS-R	1	EM-8894		
		1997-01	Rear	exc. GS-R & Type-R; Auto	1	EM-8897		
			Rear	exc. GS-R & Type-R; Manual 5 Spd	1	EM-8010		
		1994-96	Rear	exc. GS-R	1	EM-8010		
		1992-93	Rear	Auto	1	EM-8895		
			Rear	Manual	1	EM-8895		
		1990-91	Rear	Auto	1	EM-8895		
			Rear	Manual	1	EM-8895		
		1997-01	Trans	exc. GS-R & Type-R; Auto	1			EM-8330
Trans			exc. GS-R & Type-R; Manual	1			EM-8329	
1994-96		Trans	exc. GS-R & Type-R; Auto	1			EM-8330	
		Trans	exc. GS-R & Type-R; Manual	1			EM-8329	
1990-93	Trans		1			EM-8980		
		Trans	Manual	1			EM-5385	
<b>LEGEND</b>								
V6	V6 2.5L 2494cc	1986	Front		1	EM-9043		
		1987	Rear		1	EM-9110		
		1986-87	Torq Str - Front	Insert Only	1		EM-8614	
			Torq Str - Rear	Insert Only	1		EM-8615	
	V6 2.7L	1987-90	Trans		1			EM-5379
	V6 2.7L 2675cc	1989-90	Front	Vibration Damper	1	EM-5382		
		1987-88	Front	Vibration Damper	1	EM-5382		
		1989-90	RH Front		1	EM-9043		
		1987-88	RH Front		1	EM-9043		
			Rear		1	EM-9110		
		1987-90	Torq Str - Front	Insert Only	1		EM-8614	
	Torq Str - Rear		Insert Only	1		EM-8615		
	V6 3.2L 3206cc	1993-95	Front Lower		2	EM-9067		
			RH Front		2	EM-8992		
		1991-92	RH Front		1	EM-9083		



# Engine, Transmission, And Torque Strut Mounts

CYL	ENG. SIZE	YEAR	LOCATION	DESCRIPTION	QTY	ENGINE	TORQUE STRUT	TRANSMISSION		
<b>ACURA PASSENGER CAR (continued)</b>										
<b>LEGEND (continued)</b>										
V6	V6 3.2L 3206cc	1993-95	Rear		1	EM-8037				
			Trans	Manual	1			EM-9054		
		1991-92	Trans	Manual	1			EM-9054		
<b>NSX</b>										
V6	V6 3.0L 2977cc	1991-05	RH Front		1	EM-9030				
	V6 3.2L 3179cc	1997-05	RH Front		1	EM-9030				
<b>RL</b>										
V6	V6 3.5L 3471cc	2009-12	Rear		1	EM-9451				
		2005-08	Rear		1	EM-5984				
<b>RLX</b>										
V6	V6 3.5L 3471cc	2014-16	Front		1	EM-5793				
			Rear		1	EM-5875				
<b>RSX</b>										
L4	L4 2.0L 1998cc	2002-06	Front	Auto	1	EM-9066				
			Front	Manual	1	EM-9424				
			RH Front		1	EM-9413				
			Rear	Auto	1	EM-9175				
			Rear	Manual	1	EM-9396				
		2006	Trans	Auto	1			EM-9205		
			Trans	Manual	1			EM-9433		
		2002-05	Trans	Auto	1			EM-9205		
			Trans	Manual, Exc. Type S Trans.	1			EM-9433		
<b>TL</b>										
V6	V6 3.2L 3206cc	1997-98	Center Front Lower		1	EM-5974				
			Center Lower		2	EM-8037				
			L & R Front Lower		2	EM-8992				
	V6 3.2L 3210cc	2007-08	2007-08	Front	Auto	1	EM-9247			
				2004-06	Front	Auto	1	EM-9247		
				2004-06	Front	Manual	1	EM-5790		
		2000-03	1999	Front	Hydraulic Mount	1	EM-9441			
				Front		1	EM-9185			
		2007-08	2004-06	RH Front		1	EM-8974#			
				Rear		1	EM-5984			
		2007-08	2004-06	Rear		1	EM-5984			
				Rear		1	EM-9149			
		2000-03	1999	Rear		1	EM-9149			
				Right	Auto	1	EM-9297			
		2007-08	2004-06	Right	Auto	1	EM-9297			
				Right	Manual	1	EM-5787			
		2000-03	2004-06	Right		1	EM-8974#			
				Trans - Front	Auto	1			EM-5744	
		2000-03	1999	Trans - Front	Manual	1			EM-9458	
				Trans - Front		1			EM-8898	
		2007-08	2004-06	Trans - Front	Auto	1			EM-8898	
				Trans - Lower	Auto	1			EM-5994	
		2007-08	2004-06	Trans - Rear	Auto	1			EM-5957	
				Trans - Rear	Manual	1			EM-9220	
		2000-03	1999	Trans - Rear		1			EM-8986	
				Trans - Rear	Auto	1			EM-8986	
		2007-08	2004-06	Trans - Upper	Auto	1			EM-5978	
				Front	Auto	1	EM-9247			
		V6 3.5L 3471cc	2007-08	Front	Manual	1	EM-5790			
				Front		1				

# = Available in the Westar Gold Line

# Engine, Transmission, And Torque Strut Mounts

CYL	ENG. SIZE	YEAR	LOCATION	DESCRIPTION	QTY	ENGINE	TORQUE STRUT	TRANSMISSION	
<b>ACURA PASSENGER CAR (continued)</b>									
<b>TL (continued)</b>									
V6	V6 3.5L 3471cc	2007-08	Rear		1	EM-5984			
			Right	Auto	1	EM-9297			
			Right	Manual	1	EM-5787			
			Trans - Front	Manual	1			EM-5744	
		2009-14	Trans - Lower			1			EM-9459
		2007-08	Trans - Lower	Auto		1			EM-5994
			Trans - Rear	Manual		1			EM-5957
		2009-14	Trans - Upper			1			EM-9463
		2007-08	Trans - Upper	Auto		1			EM-5978
		V6 3.7L 3664cc	2009-14	Trans - Lower			1		
Trans - Upper					1			EM-9463	
<b>TLX</b>									
L4	L4 2.4L 2356cc	2015-16	Rear	Auto	1	EM-7155			
			Right		1	EM-7134			
			Trans - Upper	Auto	1			EM-7129	
V6	V6 3.5L 3471cc	2015-16	Front		1	EM-5793			
			Rear		1	EM-5875			
<b>TSX</b>									
L4	L4 2.4L 2354cc	2009-14	Front		1	EM-9488			
			2006-08	Front	Auto	1	EM-5789		
		2004-05	Front	Auto		1	EM-9247		
		2009-14	LH Rear	Auto		1	EM-9443		
			RH Front			1	EM-9457		
		2006-08	RH Front			1	EM-9297		
		2004-05	RH Front			1	EM-9297		
		2006-08	Rear	Hydraulic Mount		1	EM-9194		
		2004-05	Rear	Hydraulic Mount		1	EM-9194		
		2004-08	Trans - Front	Auto		1			EM-9426
			Trans - Front	Manual		1			EM-9152
		2009-12	Trans - Lower	Auto		1			EM-9428
			Trans - Lower	Manual		1			EM-9417
		2004-08	Trans - Rear	Auto		1			EM-9438
			Trans - Rear	Manual		1			EM-9440
		2009-12	Trans - Upper	Auto		1			EM-9459
			Trans - Upper	Auto; When Current Stock is Depleted, Re-order EM-9459		1			EM-5784
		V6	V6 3.5L 3471cc	2010-14	Rear		1	EM-9451	
Right					1	EM-9467			
2010-12	Trans - Lower					1			EM-9439
<b>ACURA SPORT UTILITY</b>									
<b>MDX</b>									
V6	V6 3.0L 2997cc V6 3.5L 3471cc	2017-18	Rear		1	EM-7300			
			2005-06	Front	Hydraulic Mount	1	EM-9441		
		2003-04	Front	Hydraulic Mount		1	EM-9441		
			2001-02	Front	Hydraulic Mount		1	EM-9441	
		2005-06	RH Front	w/o Counter Weight		1	EM-9299		
		2003-04	RH Front	w/o Counter Weight		1	EM-9299		
		2001-02	RH Front			1	EM-9389		
		2014-18	Rear			1	EM-7300		
		2005-06	Rear			1	EM-9300		
		2003-04	Rear			1	EM-9300		
		2001-02	Rear			1	EM-9300		
		2003-06	Trans - Front			1			EM-9301
		2001-02	Trans - Front	Auto		1			EM-8898
			Trans - LH Rear	Auto		1			EM-8986

## Engine, Transmission, And Torque Strut Mounts

CYL	ENG. SIZE	YEAR	LOCATION	DESCRIPTION	QTY	ENGINE	TORQUE STRUT	TRANSMISSION
<b>ACURA SPORT UTILITY (continued)</b>								
<b>MDX (continued)</b>								
V6	V6 3.5L 3471cc	2003-06	Trans - Rear		1			EM-9298
		2014-15	Trans		1			EM-5956
	V6 3.7L 3664cc	2007-13	Rear		1	EM-7229		
			Right		1	EM-5992		
		2010-13	Trans		1			EM-5956
		2007-09	Trans		1			EM-5994
<b>RDX</b>								
L4	L4 2.3L 2300cc	2007-12	Torq Str - Lower		1		EM-5985	
			Torq Str - Upper		1		EM-5913	
			Trans		1			EM-7023
V6	V6 3.5L 3471cc	2013-16	Front		1	EM-5793		
<b>SLX</b>								
V6	V6 3.2L 3165cc	1996-97	LH Front	4WD	1	EM-8351		
			RH Front	4WD	1	EM-8352		
			Trans	4WD	1			EM-9142
	V6 3.5L 3494cc	1998-99	LH Front	4WD	1	EM-8351		
			RH Front	4WD	1	EM-8352		
			Trans	4WD	1			EM-9142
<b>ZDX</b>								
V6	V6 3.7L 3664cc	2010-13	Rear		1	EM-7229		
			Trans		1			EM-5956
<b>AMERICAN MOTORS PASSENGER CAR</b>								
<b>AMBASSADOR</b>								
L6	L6 3.8L 232ci	1965-70	L & R Front		2	EM-2280		
		1967-70	Trans	Auto	1			EM-2317
			Trans	Manual	1			EM-2317
	L6 4.2L 258ci	1971	L & R Front		2	EM-2330		
			Trans	Auto	1			EM-2317
			Trans	Manual	1			EM-2317
V8	V8 4.7L 287ci	1966-67	L & R Front		2	EM-2351		
	V8 4.8L 290ci	1967-69	L & R Front		2	EM-2351		
	V8 5.0L 304ci	1974	L & R Front		2	EM-2351		
		1970-72	L & R Front		2	EM-2351		
			LH Front		1	EM-2722		
		1973	RH Front		1	EM-2351		
			1972-74	Trans	Auto	1		
				Trans	Manual	1		EM-2453
	V8 5.6L 343ci	1967-69	L & R Front		2	EM-2351		
	V8 5.9L 360ci	1974	L & R Front		2	EM-2351		
		1970-72	L & R Front		2	EM-2351		
			LH Front		1	EM-2722		
		1973	RH Front		1	EM-2351		
			1972-74	Trans	Auto	1		
				Trans	Manual	1		EM-2453
V8 6.4L 390ci	1968-70	L & R Front		2	EM-2351			
V8 6.6L 401ci	1974	L & R Front		2	EM-2351			
	1971-72	L & R Front		2	EM-2351			
		LH Front		1	EM-2722			
	1973	RH Front		1	EM-2351			
		1972-74	Trans	Auto	1			EM-2453
			Trans	Manual	1		EM-2453	

# Engine, Transmission, And Torque Strut Mounts

CYL	ENG. SIZE	YEAR	LOCATION	DESCRIPTION	QTY	ENGINE	TORQUE STRUT	TRANSMISSION		
<b>AMERICAN MOTORS PASSENGER CAR (continued)</b>										
<b>AMERICAN</b>										
L6	L6 3.2L 196ci	1960-63	L & R Front	OEM Design	2	EM-2150@				
			Trans - L & R	OEM Design	2		EM-2150 @			
	L6 3.3L 199ci	1966-68	L & R Front		2	EM-2280				
			Trans		1			EM-2310		
<b>AMX</b>										
L6	L6 4.2L 258ci	1978-80	L & R Front		2	EM-2330				
			Trans	Auto	1		EM-2454			
		1979-80	Trans	Manual	1		EM-2454			
			Trans	Auto	1		EM-2373			
			Trans	Manual	1		EM-2373			
<b>CLASSIC</b>										
L6	L6 3.8L 232ci	1964-65	L & R Front		2	EM-2280				
<b>CONCORD</b>										
L4	L4 2.5L 151ci	1980-82	L & R Front		2	EM-2446				
			Trans	Auto	1		EM-2453			
			Trans	Manual	1		EM-2453			
L6	L6 3.8L 232ci	1978-79	L & R Front		2	EM-2330				
			Trans	Auto	1		EM-2454			
			Trans	Manual	1		EM-2454			
	L6 4.2L 258ci	1978-83	L & R Front		2	EM-2330				
			Trans	Auto	1		EM-2454			
			Trans	Manual	1		EM-2454			
V8	V8 5.0L 304ci	1978-79	L & R Front		2	EM-2351				
			Trans	Auto	1		EM-2454			
			Trans	Manual	1		EM-2454			
<b>EAGLE</b>										
L4	L4 2.5L 151ci	1981-84	L & R Front		2	EM-2330				
L6	L6 4.2L 258ci	1980-88	L & R Front		2	EM-2330				
			Trans	Manual	1		EM-2921			
<b>GREMLIN</b>										
L6	L6 3.3L 199ci	1970	L & R Front		2	EM-2280				
			Trans	Auto	1		EM-2317			
			Trans	Manual	1		EM-2317			
			L6 3.8L 232ci	1973-78	L & R Front		2	EM-2330		
					L & R Front		2	EM-2280		
					Trans	Auto; w/ Calif. Emissions	1		EM-2454	
	1975-78	Trans	Auto; w/ Federal Emissions	1		EM-2373				
		Trans	Manual	1		EM-2454				
		1971-74	Trans	Auto; w/ Calif. Emissions	1		EM-2454			
	Trans		Auto; w/ Federal Emissions	1		EM-2373				
	Trans		Manual	1		EM-2317				
	1970	Trans	Auto	1		EM-2317				
		Trans	Manual	1		EM-2317				
	L6 4.2L 258ci	1973-78	L & R Front		2	EM-2330				
			L & R Front		2	EM-2280				
		1973-78	Trans	Auto; w/ Calif. Emissions	1		EM-2454			
			Trans	Auto; w/ Federal Emissions	1		EM-2373			
			Trans	Manual	1		EM-2454			
		1971-72	Trans	Auto	1		EM-2317			
			Trans	Manual	1		EM-2317			
V8			V8 5.0L 304ci	1972-76	L & R Front		2	EM-2351		
	1975-76	Trans		Auto	1		EM-2454			
Trans		Manual		1		EM-2454				
1972-74		Trans		Auto	1		EM-2317			

@ = Universal Mount EM-5000 also available.

# Engine, Transmission, And Torque Strut Mounts

CYL	ENG. SIZE	YEAR	LOCATION	DESCRIPTION	QTY	ENGINE	TORQUE STRUT	TRANS-MISSION
<b>AMERICAN MOTORS PASSENGER CAR (continued)</b>								
<b>GREMLIN (continued)</b>								
V8	V8 5.0L 304ci	1972-74	Trans	Manual	1			EM-2317
<b>HORNET</b>								
L6	L6 3.3L 199ci	1970	L & R Front		2	EM-2280		
			Trans	Auto	1		EM-2317	
			Trans	Manual	1		EM-2317	
	L6 3.8L 232ci	1973-77	L & R Front		2	EM-2330		
			1970-72	L & R Front		2	EM-2280	
			1975-77	Trans	Auto; w/ Calif. Emissions	1		EM-2454
		Trans		Auto; w/ Federal Emissions	1		EM-2373	
		Trans		Manual	1		EM-2454	
		1971-74	Trans	Auto; w/ Calif. Emissions	1		EM-2454	
			Trans	Auto; w/ Federal Emissions	1		EM-2373	
			Trans	Manual	1		EM-2317	
		1970	Trans	Auto	1		EM-2317	
	Trans		Manual	1		EM-2317		
	L6 4.2L 258ci		1973-77	L & R Front		2	EM-2330	
		1971-72		L & R Front		2	EM-2280	
		1973-77	Trans	w/ Calif. Emissions	1		EM-2454	
			Trans	w/ Federal Emissions	1		EM-2373	
			Trans	Manual	1		EM-2454	
		1971-72	Trans	Auto	1		EM-2317	
	Trans		Manual	1		EM-2317		
<b>JAVELIN</b>								
L6	L6 3.8L 232ci	1973-74	L & R Front		2	EM-2330		
			1968-72	L & R Front		2	EM-2280	
		1973-74	Trans	Auto	1		EM-2373	
			Trans	Manual	1		EM-2317	
		1968-72	Trans	Auto	1		EM-2373	
			Trans	Manual	1		EM-2317	
	L6 4.2L 258ci	1973-74	L & R Front		2	EM-2330		
			1971-72	L & R Front		2	EM-2280	
		1973-74	Trans		1		EM-2373	
			Trans	Manual	1		EM-2317	
		1972	Trans	Auto	1		EM-2373	
			Trans	Manual	1		EM-2317	
		1971	Trans	Auto	1		EM-2373	
Trans	Manual		1		EM-2317			
V8	V8 4.8L 290ci	1968-69	L & R Front		2	EM-2351		
<b>MARLIN</b>								
L6	L6 3.8L 232ci	1965-67	L & R Front		2	EM-2280		
			Trans	Auto	1		EM-2317	
			Trans	Manual	1		EM-2317	
V8	V8 4.8L 290ci	1967	L & R Front		2	EM-2351		
<b>MATADOR</b>								
L6	L6 3.8L 232ci	1973-74	L & R Front		2	EM-2330		
			1971-72	L & R Front		2	EM-2280	
		1973-74	Trans	Auto	1		EM-2453	
			Trans	Manual	1		EM-2453	
		1971-72	Trans	Auto	1		EM-2317	
			Trans	Manual	1		EM-2317	
	L6 4.2L 258ci	1973-78	L & R Front		2	EM-2330		
			1971-72	L & R Front		2	EM-2280	
		1973-78	Trans	Auto	1		EM-2373	
			Trans	Manual	1		EM-2373	
		1971-72	Trans	Auto	1		EM-2317	

# Engine, Transmission, And Torque Strut Mounts

CYL	ENG. SIZE	YEAR	LOCATION	DESCRIPTION	QTY	ENGINE	TORQUE STRUT	TRANSMISSION
<b>AMERICAN MOTORS PASSENGER CAR (continued)</b>								
<b>MATADOR (continued)</b>								
L6	L6 4.2L 258ci	1971-72	Trans	Manual	1			EM-2317
V8	V8 5.0L 304ci	1974	L & R Front		2	EM-2351		
			Trans	Auto	1		EM-2453	
			Trans	Manual	1		EM-2453	
	V8 5.9L 360ci	1974	L & R Front		2	EM-2351		
			Trans	Auto	1		EM-2453	
			Trans	Manual	1		EM-2453	
V8 6.6L 401ci	1974	L & R Front		2	EM-2351			
		Trans	Auto	1		EM-2453		
		Trans	Manual	1		EM-2453		
<b>PACER</b>								
L6	L6 3.8L 232ci	1975-78	L & R Front		2	EM-2330		
			Trans	Auto	1		EM-2373	
			Trans	Manual	1		EM-2373	
	L6 4.2L 258ci	1979-80	Trans	Auto	1		EM-2373	
			Trans	Manual	1		EM-2373	
V8	V8 5.0L 304ci	1979	L & R Front		2	EM-2351		
			Trans	Auto	1		EM-2453	
			Trans	Manual	1		EM-2453	
<b>REBEL</b>								
V8	V8 4.8L 290ci	1967-69	L & R Front		2	EM-2351		
			Trans	Auto	1		EM-2317	
			Trans	Manual	1		EM-2317	
<b>SPIRIT</b>								
L4	L4 2.5L 151ci	1980-82	L & R Front		2	EM-2446		
			Trans	Auto	1		EM-2453	
			Trans	Manual	1		EM-2454	
L6	L6 3.8L 232ci	1979	L & R Front		2	EM-2330		
			Trans	Auto	1		EM-2453	
			Trans	Manual	1		EM-2454	
	L6 4.2L 258ci	1979-83	L & R Front		2	EM-2330		
			Trans	Auto	1		EM-2454	
Trans	Manual	1		EM-2454				
<b>AUDI PASSENGER CAR</b>								
<b>80</b>								
L4	L4 2.0L 1983cc	1988-90	Center Front		1	EM-5485		
			L & R Front	Auto	2	EM-9109		
			L & R Front	Manual	2	EM-2421		
			Trans	Auto; 3 Spd	1		EM-8831	
L5	L5 2.3L 2309cc	1991-92	L & R Front		2	EM-8663		
			Trans		1		EM-9046	
<b>80 QUATTRO</b>								
L5	L5 2.3L 2309cc	1988-92	Center Front		1	EM-5485		
			L & R Front		2	EM-8663		
			Trans	Manual	1		EM-9046	
<b>90</b>								
L4	L4 2.0L 1983cc	1988	L & R Front	Auto	2	EM-2421		
			L & R Front	Manual	2	EM-9109		
			Trans	Auto; 3 Spd	1		EM-8831	
L5	L5 2.3L 2309cc	1988-91	Center Front		1	EM-5485		
			L & R Front		2	EM-8663		
			Trans		1		EM-8831	
V6	V6 2.8L	1993-95	Trans		1			EM-5432
	V6 2.8L 2771cc	1993-95	Center Front		1	EM-5485		

## Engine, Transmission, And Torque Strut Mounts

CYL	ENG. SIZE	YEAR	LOCATION	DESCRIPTION	QTY	ENGINE	TORQUE STRUT	TRANS-MISSION
<b>AUDI PASSENGER CAR (continued)</b>								
<b>90 (continued)</b>								
V6	V6 2.8L 2771cc	1993-95	LH Front		1	EM-8828		
			RH Front		1	EM-8829		
<b>90 QUATTRO</b>								
L5	L5 2.3L 2309cc	1988-91	Center Front		1	EM-5485		
			L & R Front		2	EM-8663		
			Trans	Manual	1			EM-9046
V6	V6 2.8L	1993-95	Trans		1			EM-5432
	V6 2.8L 2771cc	1993-95	Center Front		1	EM-5485		
			LH Front		1	EM-8828		
			RH Front		1	EM-8829		
<b>100</b>								
L5	L5 2.3L 2309cc	1989-91	L & R Front		2	EM-8663		
			Trans	Auto	1			EM-9046
			Trans	Manual	1			EM-9046
V6	V6 2.8L 2771cc	1992-94	Center Front		1	EM-5675		
			LH Front		1	EM-9004		
			RH Front		1	EM-9005		
			Trans	Auto	2			EM-9102
			Trans	Manual	2			EM-9102
<b>100 QUATTRO</b>								
L5	L5 2.3L 2309cc	1989-91	L & R Front		2	EM-8663		
			Trans	Manual	1			EM-9046
V6	V6 2.8L 2771cc	1992-94	Center Front		1	EM-5675		
			LH Front		1	EM-9004		
			RH Front		1	EM-9005		
			Trans - L & R		2			EM-9102
<b>200</b>								
L5	L5 2.2L 2226cc	1989-91	L & R Front		2	EM-8663		
			Trans	Auto	1			EM-9046
			Trans	Manual	1			EM-9046
<b>200 QUATTRO</b>								
L5	L5 2.2L 2226cc	1989-91	L & R Front		2	EM-8663		
			Trans	Manual	1			EM-9046
<b>4000</b>								
L4	L4 1.6L 1588cc	1980	L & R Front		2	EM-2421		
	L4 1.6L 1588cc Diesel	1982-83	Trans	Auto	1			EM-8221
			Trans	Manual	1			EM-9093
	L4 1.6L 1588cc	1980	Trans		1			EM-8623
	L4 1.7L 1715cc	1981-83	L & R Front		2	EM-2421		
			Trans	Auto	1			EM-8221
Trans			Manual	1			EM-9093	
<b>4000CS QUATTRO</b>								
L5	L5 2.2L 2226cc	1986-87	L & R Front		2	EM-8663		
			Trans	Manual	1			EM-9046
<b>4000S</b>								
L4	L4 1.8L 1780cc	1984-87	L & R Front		2	EM-2421		
			Trans	Auto	1			EM-8221
			Trans	Manual	1			EM-9093
L5	L5 2.2L 2226cc	1985-86	L & R Front		2	EM-8663		

# Engine, Transmission, And Torque Strut Mounts

CYL	ENG. SIZE	YEAR	LOCATION	DESCRIPTION	QTY	ENGINE	TORQUE STRUT	TRANSMISSION
<b>AUDI PASSENGER CAR (continued)</b>								
<b>4000S QUATTRO</b>								
L4	L4 1.8L 1780cc	1984-87	Trans	Manual	1			EM-9093
L5	L5 2.2L 2226cc	1985	L & R Front		2	EM-8663		
<b>5000</b>								
L5	L5 2.2L 2144cc	1978-88	L & R Front		2	EM-8663		
			Trans	Auto	1			EM-9046
			Trans	Manual	1			EM-9046
<b>5000 QUATTRO</b>								
L5	L5 2.2L 2226cc	1986-88	L & R Front		2	EM-8663		
			Trans		1			EM-9089
	L5 2.3L 2309cc	1987-88	L & R Front		2	EM-8663		
			Trans	Manual	1			EM-9046
<b>A3</b>								
L4	L4 1.8L 1781cc	1998-01	RH Front	Hydraulic Mount; Mexican Vehicle	1	EM-9092		
			Rear	Mexican Vehicle	1	EM-9208		
			Trans	Hydraulic Mount; Mexican Vehicle	1			EM-9101
	L4 1.8L 1798cc	2015-16	Trans		1			EM-7260
	L4 2.0L 1968cc Diesel	2010-11	Lower Rear		1	EM-9260		
		2015-16	RH Front		1	EM-9402		
		2010-11	RH Front		1	EM-9402		
		2015-16	Rear		1	EM-9283		
		2010-11	Rear		1	EM-9283		
		2015-16	Trans		1			EM-7260
	L4 2.0L 1984cc	2010-13	LH Front Upper	Gas	1	EM-9263		
		2006-09	LH Front Upper		1	EM-9263		
		2010-13	Lower Rear	Gas	1	EM-9260		
		2006-09	Lower Rear		1	EM-9260		
		2010-13	RH Front	Gas	1	EM-9092		
		2006-09	RH Front		1	EM-9092		
		2010-13	Rear	Gas	1	EM-9283		
		2006-09	Rear		1	EM-9283		
			Trans	Manual	1			EM-9262
<b>A3 QUATTRO</b>								
L4	L4 2.0L 1984cc	2015-17	Trans		1			EM-7260
V6	V6 3.2L 3189cc	2006-09	LH Front		1	EM-9259		
			LH Front Upper		1	EM-9263		
			RH Front		1	EM-9257		
			Right		1	EM-9405		
<b>A4</b>								
L4	L4 1.8L 1781cc	2002-06	Front	Buffer Assy.	1	EM-7139		
			LH Front		1	EM-8997		
		1997-01	LH Front		1	EM-8998		
		2002-06	RH Front		1	EM-7030		
		1997-01	RH Front		1	EM-8997		
		2005-06	Trans	Auto; CVT	1			EM-8999
		2003-04	Trans	Auto	1			EM-8999
		2002-05	Trans	Differential Mount	2			EM-5855
		2002	Trans	Auto	1			EM-8999
		1997-01	Trans	Auto	1			EM-8999
			Trans	Manual	1			EM-8999
	L4 2.0L 1984cc	2005-08	Front	Buffer Assy.	1	EM-7139		
		2013-16	L & R Front	Auto	2	EM-7191		
		2005-08	L & R Front	w/o Sensor	2	EM-7043		
			L & R Front	With Sensor	2	EM-9403		



# Engine, Transmission, And Torque Strut Mounts

CYL	ENG. SIZE	YEAR	LOCATION	DESCRIPTION	QTY	ENGINE	TORQUE STRUT	TRANSMISSION		
<b>AUDI PASSENGER CAR (continued)</b>										
<b>A4 (continued)</b>										
L4	L4 2.0L 1984cc	2017	Trans	Manual	1			EM-7202		
		2011-16	Trans	Auto; FWD	1			EM-7202		
		2010	Trans	Mexico; Auto	1			EM-7202		
		2009-10	Trans	US & Canada; Auto; CVT; US & Canada	1			EM-7202		
		2005-09	Trans	Differential Mount	2			EM-5855		
		2005-07	Trans	Manual	1			EM-9287		
V6	V6 2.8L 2771cc	2000-01	Center Front	Auto	1	EM-8830				
			L & R Front		2	EM-8997				
		1996-99	L & R Front		2	EM-8997				
		2000-01	Trans - L & R		2			EM-9258		
		1996-99	Trans	Auto	2			EM-8999		
			Trans	Manual	2			EM-8999		
	V6 3.0L 2976cc	2002-05	Front	Buffer Assy.	1	EM-7139				
			LH Front		1	EM-5517				
			RH Front		1	EM-7047				
		2003-05	Trans - L & R		2			EM-8999		
		2002	Trans - L & R		2			EM-9258		
		2002-05	Trans	Differential Mount	2			EM-5855		
	V6 3.1L 3123cc	2006-08	Trans	Differential Mount	2			EM-5855		
	V6 3.2L 3123cc	2006-08	Front	Buffer Assy.	1	EM-7139				
			LH Front		1	EM-5517				
			RH Front		1	EM-7047				
		2006-07	Trans - L & R		2			EM-9258		
		2008	Trans	Manual	1			EM-7202		
<b>A4 QUATTRO</b>										
L4	L4 1.8L 1781cc	2002-05	Front	Buffer Assy.	1	EM-7139				
			LH Front		1	EM-8997				
		1997-01	LH Front		1	EM-8998				
		2002-05	RH Front		1	EM-7030				
		1997-01	RH Front		1	EM-8997				
		2002	Trans - L & R		2			EM-9258		
		2002-05	Trans	Differential Mount	2			EM-5855		
		1997-01	Trans		1			EM-8999		
			Trans	Manual	1			EM-8999		
		L4 2.0L 1984cc	2007-08	Front	Buffer Assy.	1	EM-7139			
				2005-06	Front	Buffer Assy.	1	EM-7139		
				2013-16	L & R Front	Auto	2	EM-7191		
	2007-08		L & R Front	With Sensor	2	EM-9403				
	2005-06		L & R Front	w/o Sensor	2	EM-7043				
			Trans - LH	Auto	1			EM-9258		
			Trans - RH Rear	Auto	1			EM-9258		
	2008-10		Trans	US & Canada; Auto	1			EM-7202		
			Trans	US & Canada; Manual	1			EM-7202		
		Trans	Mexico; Auto	1			EM-7202			
	2007	Trans		1			EM-9287			
	2005-09	Trans	Differential Mount	2			EM-5855			
2005-06	Trans	Manual	1			EM-9287				
V6	V6 2.8L 2771cc	1996-01	Front Center		1	EM-8830				
			L & R Front		2	EM-8997				
		2000-01	Trans - L & R	Auto	2			EM-9258		
			Trans	Manual	2			EM-8999		
		1996-99	Trans	Manual	2			EM-8999		
	V6 3.0L 2976cc	2002-05	Front	Buffer Assy.	1	EM-7139				
			LH Front		1	EM-5517				
			RH Front		1	EM-8997				
2003-05	Trans - L & R		2			EM-8999				

# Engine, Transmission, And Torque Strut Mounts

CYL	ENG. SIZE	YEAR	LOCATION	DESCRIPTION	QTY	ENGINE	TORQUE STRUT	TRANSMISSION
<b>AUDI PASSENGER CAR (continued)</b>								
<b>A4 QUATTRO (continued)</b>								
V6	V6 3.0L 2976cc	2002	Trans - L & R		2			EM-9258
		2002-06	Trans	Differential Mount	2			EM-5855
	V6 3.2L 3123cc	2006-08	Front	Buffer Assy.	1	EM-7139		
			LH Front		1	EM-5517		
			RH Front		1	EM-8997		
	2005-07	Trans - L & R	Auto	2			EM-9258	
	2008-10	Trans	Mexico; Auto	1			EM-7202	
	2008-09	Trans	US & Canada; Auto	1			EM-7202	
		Trans	US & Canada; Manual	1			EM-7202	
2005-09	Trans	Differential Mount	2			EM-5855		
<b>A5</b>								
L4	L4 2.0L 1984cc	2013-16	L & R Front	Auto	2	EM-7191		
		2011-16	Trans	Mexico; Auto; FWD	1			EM-7202
		2010-14	Trans	US; Auto (CVT)	1			EM-7202
V6	V6 3.2L 3197cc	2008-10	L & R Front		1	EM-5966		
			Trans	Auto (CVT)	1			EM-7202
<b>A5 QUATTRO</b>								
L4	L4 2.0L 1984cc	2013-16	L & R Front	Auto	2	EM-7191		
		2010-16	Trans	Manual	1			EM-7202
V6	V6 3.2L 3123cc	2008-09	L & R Front		1	EM-5966		
			2008-10	Trans	Auto	1		EM-7202
		2008-10	Trans	Manual	1			EM-7202
<b>A6</b>								
V6	V6 2.8L 2771cc	1998-01	Center Front		1	EM-8830		
		1995-97	Center Front		1	EM-5675		
		1998-01	L & R Front		2	EM-8997		
		1995-97	LH Front		1	EM-9004		
			RH Front		1	EM-9005		
		2000-01	Trans - L & R		2			EM-9258
		1995-97	Trans	Auto	1			EM-9102
	V6 3.0L 2976cc	2002-04	L & R Front		2	EM-8998		
			Trans		1			EM-8999
	V6 3.0L 2995cc	2005-06	Front	Buffer Assy.	1	EM-7139		
			RH Front		1	EM-7140		
	V6 3.1L 3123cc	2006-11	Trans	Differential Mount	2			EM-5855
	V6 3.2L 3123cc	2006-11	Front	Buffer Assy.	1	EM-7139		
			LH Front	From VIN 4F5087151	1	EM-9406		
			RH Front	From VIN 4F5087151	1	EM-9407		
Trans			Auto (CVT); FWD	1			EM-7285	
<b>A6 QUATTRO</b>								
V6	V6 2.7L 2671cc	2000-04	L & R Front		2	EM-8997		
			Trans - L & R		2			EM-9258
	V6 2.8L 2771cc	1998-01	Center Front		1	EM-8830		
			Center Front		1	EM-5675		
			L & R Front		2	EM-8998		
			LH Front		1	EM-9004		
			RH Front		1	EM-9005		
			2000-01	Trans - L & R		2		
	1995-97	Trans	Auto	1			EM-9102	
	V6 3.0L 2976cc	2002-04	Front	Buffer Assy.	1	EM-7139		
			L & R Front		2	EM-8997		
			Trans		1			EM-8999
	V6 3.0L 2995cc	2009-11	Front	Buffer Assy.	1	EM-7139		
			RH Front		1	EM-7140		
			Trans	Differential Mount	2			EM-5855

# Engine, Transmission, And Torque Strut Mounts

CYL	ENG. SIZE	YEAR	LOCATION	DESCRIPTION	QTY	ENGINE	TORQUE STRUT	TRANS-MISSION
<b>AUDI PASSENGER CAR (continued)</b>								
<b>A6 QUATTRO (continued)</b>								
V6	V6 3.0L 2995cc	2009-11	Trans		1			EM-9558
	V6 3.2L 3123cc	2006-09	Front	Buffer Assy.	1	EM-7139		
		2005	Front	Buffer Assy.	1	EM-7139		
		2006-09	LH Front	From VIN 4F5087151	1	EM-9406		
			RH Front	From VIN 4F5087151	1	EM-9407		
		2005-09	Trans	Auto; AWD	1			EM-9558
2005-08	Trans	Differential Mount	2			EM-5855		
V8	V8 4.2L 4163cc	2005-11	Front	Buffer Assy.	1	EM-7139		
			Trans	Differential Mount	2		EM-5855	
	V8 4.2L 4172cc	2000-04	Center Front		1	EM-8999		
<b>ALLROAD</b>								
L4	L4 2.0L 1984cc	2013-16	L & R Front	Auto	2	EM-7191		
<b>ALLROAD QUATTRO</b>								
V6	V6 2.7L 2671cc	2001-05	Center Front Lower		1	EM-5485		
			L & R Front		2	EM-8997		
			Trans	Manual	2		EM-9258	
V8	V8 4.2L 4172cc	2003-05	Front	Buffer Assy.	1	EM-7139		
			Trans	Auto	1		EM-9258	
<b>CABRIOLET</b>								
V6	V6 2.8L 2771cc	1994-98	LH Front		1	EM-8828		
			RH Front		1	EM-8829		
			Trans		1		EM-5432	
<b>COUPE</b>								
L5	L5 2.2L 2144cc	1981-87	L & R Front		2	EM-8663		
	L5 2.3L 2309cc	1987	L & R Front		2	EM-8663		
			Trans		1		EM-9046	
<b>COUPE QUATTRO</b>								
L5	L5 2.3L 2309cc	1990-91	L & R Front		2	EM-8663		
			Trans		1		EM-9046	
<b>FOX</b>								
L4	L4 1.5L 1471cc	1973-74	L & R Front		2	EM-2421		
			Trans	Auto	1		EM-8221	
	L4 1.6L 1588cc	1975-79	L & R Front		2	EM-2421		
			Trans	Auto	1		EM-8221	
			Trans	Manual	1		EM-8623	
<b>RS4</b>								
V8	V8 4.2L 4172cc	2007-08	Trans	Differential Mount	2			EM-5855
<b>S3</b>								
L4	L4 2.0L 1984cc	2015-17	Trans		1			EM-7260
<b>S4</b>								
L5	L5 2.2L 2226cc	1992-94	L & R Front		2	EM-8663		
			Trans	Manual	1		EM-9089	
V6	V6 2.7L 2671cc	2000-02	L & R Front		2	EM-8997		
			Trans	Auto	2		EM-8999	
			Trans	Manual	2		EM-8999	
V8	V8 4.2L 4163cc	2004-09	Front	Buffer Assy.	1	EM-7139		
			Trans	Differential Mount	2		EM-5855	
<b>S6</b>								
L5	L5 2.2L 2226cc	1995-97	L & R Front		2	EM-8663		
			Trans	Manual	1		EM-9089	
V10	V10 5.2L 5204cc	2007-11	Trans	Differential Mount	2			EM-5855

# Engine, Transmission, And Torque Strut Mounts

CYL	ENG. SIZE	YEAR	LOCATION	DESCRIPTION	QTY	ENGINE	TORQUE STRUT	TRANSMISSION	
<b>AUDI PASSENGER CAR (continued)</b>									
<b>TT</b>									
L4	L4 1.8L 1781cc	2001-02	Rear		1	EM-9208			
		2003-06	Right		1	EM-7019			
		2001-02	Right		1	EM-7019			
		2000	Right		1	EM-7019			
	L4 2.0L 1984cc	2008-09	Front			1	EM-9092		
			Rear			1	EM-7176		
		2009-14	Trans		Mexico; Manual	1			EM-7272
		2009	Trans		US & Canada; Auto (Dual Clutch)	1			EM-7272
	Trans		US & Canada; Manual	1			EM-7272		
<b>TT QUATTRO</b>									
L4	L4 2.0L 1984cc	2009	Front		1	EM-9092			
		2010-14	Rear		1	EM-7176			
		2009	Rear		1	EM-7176			
		2015-17	Trans		1			EM-7260	
		2009-14	Trans		Auto (Dual Clutch)	1			EM-7272
V6	V6 3.2L 3189cc	2004-06	Rear		1	EM-9208			
		2008-09	Right		1	EM-9405			
		2004-06	Right		1	EM-9261			
<b>AUDI SPORTS UTILITY</b>									
<b>Q5</b>									
L4	L4 2.0L 1984cc	2013-16	L & R Front	Auto	2	EM-7191			
<b>Q7</b>									
V6	V6 3.0L 2967cc Diese				2	EM-5879			
	V6 3.0L 2995cc	2011-16	L & R Front	Gas	2	EM-5879			
	V6 3.6L 3597cc	2007-10	L & R Front		2	EM-5879			
V8	V8 4.2L 4163cc	2007-10	L & R Front		2	EM-5879			
<b>BMW PASSENGER CAR</b>									
<b>125I</b>									
L6	L6 3.0L 2996cc	2009-10	L & R Front	Mexico	2	EM-5886			
<b>130I</b>									
L6	L6 3.0L 2996cc	2006-10	L & R Front	Mexico	2	EM-5886			
<b>128I</b>									
L6	L6 3.0L 2996cc	2008-12	L & R Front		2	EM-5886			
		2008-10	Trans	Auto	1			EM-9096	
			Trans	Manual	1			EM-9096	
<b>135I</b>									
L6	L6 3.0L 2979cc	2008-13	L & R Front		2	EM-5886			
		2008-10	Trans	Auto	1			EM-9096	
			Trans	Manual	1			EM-9096	
<b>1 SERIES M</b>									
L6	L6 3.0L 2979cc	2011	L & R Front		2	EM-5886			
<b>228I</b>									
L4	L4 2.0L 1997cc	2014-16	LH Front	RWD	1	EM-7277			
			RH Front	RWD	1	EM-7278			
			Trans	RWD	2			EM-7279	
<b>230I</b>									
L4	L4 2.0L 1998cc	2017	LH Front	RWD	1	EM-7277			
			Trans	RWD	2			EM-7279	

# Engine, Transmission, And Torque Strut Mounts

CYL	ENG. SIZE	YEAR	LOCATION	DESCRIPTION	QTY	ENGINE	TORQUE STRUT	TRANSMISSION	
<b>BMW PASSENGER CAR (continued)</b>									
<b>3.0SI</b>									
L6	L6 3.0L 2985cc	1975-76	Trans	Manual	1			EM-8594	
		1971	Trans	Manual	1			EM-8594	
<b>318I</b>									
L4	L4 1.8L	1992-95	Trans	Auto	1			EM-9096	
	L4 1.8L 1766cc	1984-85	L & R Front		2	EM-9111			
	L4 1.8L 1796cc	1994-95	L & R Front	Hydraulic Mount	2	EM-9003			
	L4 1.9L 1796cc	1996-99	L & R Front	Hydraulic Mount	2	EM-9003			
<b>318IS</b>									
L4	L4 1.8L	1993-95	Trans		1			EM-9096	
	L4 1.8L 1796cc	1994-95	L & R Front	Hydraulic Mount	2	EM-9003			
	L4 1.9L	1996-97	Trans		1			EM-9096	
	L4 1.9L 1895cc	1996-99	L & R Front	Hydraulic Mount	2	EM-9003			
<b>318TI</b>									
L4	L4 1.8L	1995	Trans	Auto	1			EM-9096	
			Trans	Manual	1			EM-9096	
	L4 1.8L 1796cc	1995	L & R Front	Hydraulic Mount	2	EM-9003			
	L4 1.9L	1996-97	Trans	Auto	1			EM-9096	
			Trans	Manual	1			EM-9096	
	L4 1.9L 1895cc	1996-99	L & R Front	Hydraulic Mount	2	EM-9003			
<b>320I</b>									
L4	L4 1.8L	1980-83	Trans		1			EM-8592	
			Trans	Auto	1			EM-8592	
			Trans	Manual	1			EM-8592	
	L4 2.0L 1997cc	2015-16	LH Front	RWD	1	EM-7277			
			RH Front	RWD	1	EM-7278			
			2012-14	RH Front	RWD	1	EM-7278		
			2012-17	Trans	RWD	2			EM-7279
<b>323CI</b>									
L6	L6 2.5L 2494cc	2000	L & R Front	Hydraulic Mount; 2WD	2	EM-9003			
<b>323I</b>									
L6	L6 2.5L 2494cc	2001	L & R Front	Mexican Vehicle; Hydraulic Mount; RWD	2	EM-9003			
			L & R Front	Hydraulic Mount; RWD	2	EM-9003			
		1998-00	Trans	Auto	1			EM-9096	
			Trans	Manual	1			EM-9096	
	L6 2.5L 2497cc	2006-07	L & R Front	Hydraulic Mount; RWD	2	EM-9003			
			2006-11	Trans	Auto	1		EM-9096	
				Trans	Manual	1		EM-9096	
<b>323IS</b>									
L6	L6 2.5L 2494cc	1998-99	L & R Front	Hydraulic Mount; 2WD	2	EM-9003			
			Trans	Auto	1		EM-9096		
			Trans	Manual	1		EM-9096		
<b>325</b>									
L6	L6 2.7L	1986-88	L & R Front		2	EM-9404			
	L6 2.7L 2693cc	1986-87	Trans	Auto	1			EM-9107	
			Trans	Manual	1			EM-9098	
<b>325CI</b>									
L6	L6 2.5L 2494cc	2001-06	L & R Front	Hydraulic Mount; 2WD	2	EM-9003			
<b>325E</b>									
L6	L6 2.7L	1984-87	Front		1	EM-9094			
			Trans	Auto	1		EM-9107		
			Trans	Manual	1		EM-9098		

# Engine, Transmission, And Torque Strut Mounts

CYL	ENG. SIZE	YEAR	LOCATION	DESCRIPTION	QTY	ENGINE	TORQUE STRUT	TRANSMISSION
<b>BMW PASSENGER CAR (continued)</b>								
<b>325I</b>								
L6	L6 2.5L 2494cc	2001-05	L & R Front	Hydraulic Mount	2	EM-9003		
		1993-95	L & R Front		2	EM-9003		
		1987-92	L & R Front		2	EM-9404		
		1992-93	Trans - LH	Auto	1			EM-9104
			Trans - RH	Auto	1			EM-9100
		1994-95	Trans	Auto	1			EM-9096
			Trans	Manual	1			EM-9096
		1992-93	Trans	Manual	2			EM-9096
	1987-91	Trans	Auto	1			EM-9107	
		Trans	Manual	1			EM-9098	
L6 3.0L 2979cc	2011	L & R Front	Mexico	2	EM-5886			
L6 3.0L 2996cc	2006	L & R Front		2	EM-5886			
<b>325IC</b>								
L6	L6 2.5L	1991-95	L & R Front	Hydraulic Mount; After 10/91	2	EM-9003		
		1987-90	L & R Front		2	EM-9404		
<b>325IS</b>								
L6	L6 2.5L	1992-95	L & R Front		2	EM-9003		
		1991	L & R Front	after 10/91	2	EM-9003		
			L & R Front	before 10/91	2	EM-9404		
		1994-95	Trans	Auto	1			EM-9096
			Trans	Manual	1			EM-9096
		L6 2.5L 2494cc	1987-90	L & R Front		2	EM-9404	
	1992-93		Trans - LH	Auto	1		EM-9104	
			Trans - RH	Auto	1		EM-9100	
			Trans	Manual	2		EM-9096	
	1991		Trans	Auto	1		EM-9107	
			Trans	Manual	1		EM-9098	
	1987-90	Trans	Auto	1		EM-9107		
		Trans	Manual	1		EM-9098		
<b>325IX</b>								
L6	L6 2.5L	1988-91	Front	before 10/91	1	EM-5340		
			Trans	Auto	1		EM-9107	
			Trans	Manual	1		EM-9098	
<b>325XI</b>								
L6	L6 2.5L 2494cc	2001-05	LH Front	Hydraulic Mount; AWD	2	EM-9003		
<b>328CI</b>								
L6	L6 2.8L 2793cc	2000	Trans - LH	Auto	1			EM-9104
			Trans - RH	Auto	1			EM-9100
<b>328D</b>								
L4	L4 2.0L 1995cc	2014-17	LH Front		1	EM-7277		
			RH Front		1	EM-7278		
			Trans	RWD	2			EM-7279
<b>328I</b>								
L4	L4 2.0L 1997cc	2012-16	LH Front	RWD	1	EM-7277		
			RH Front	RWD	1	EM-7278		
			Trans	RWD	2			EM-7279
L6	L6 2.8L 2793cc	1996-00	Trans - LH	Auto	1			EM-9104
			Trans - RH	Auto	1			EM-9100
	L6 3.0L 2996cc	2007-13	L & R Front		2	EM-5886		
			Trans	RWD, Auto	1			EM-9096
			Trans	RWD, Manual	1			EM-9096

## Engine, Transmission, And Torque Strut Mounts

CYL	ENG. SIZE	YEAR	LOCATION	DESCRIPTION	QTY	ENGINE	TORQUE STRUT	TRANSMISSION
<b>BMW PASSENGER CAR (continued)</b>								
<b>328IC</b>								
L6	L6 2.8L 2793cc	1996-99	Trans - LH	Auto	1			EM-9104
			Trans - RH	Auto	1			EM-9100
<b>328IS</b>								
L6	L6 2.8L 2793cc	1996-99	Trans - LH	Auto	1			EM-9104
			Trans - RH	Auto	1			EM-9100
<b>330I</b>								
L6	L6 3.0L 2979cc	2001-06	L & R Front	Hydraulic Mount	2	EM-9003		
<b>330CI</b>								
L6	L6 3.0L 2979cc	2001-06	L & R Front	Hydraulic Mount	2	EM-9003		
<b>330E</b>								
L4	L4 2.0L 1998cc	2016-17	Trans	RWD	2			EM-7279
<b>335I</b>								
L6	L6 3.0L 2979cc	2007-11	L & R Front		2	EM-5886		
		2012-15	LH Front	RWD; exc. Sport Suspension	1	EM-7277		
<b>330XI</b>								
L6	L6 3.0L 2979cc	2001-05	LH Front	Hydraulic Mount; AWD	2	EM-9003		
<b>335I</b>								
L6	L6 3.0L 2979cc	2012-15	RH Front	RWD; exc. Sport Suspension	1	EM-7278		
		2007-12	Trans	RWD, Auto	1			EM-9096
			Trans	RWD, Manual	1			EM-9096
<b>335D</b>								
L6	L6 3.0L 2993cc	2009-11	Trans	Auto	1			EM-7195
<b>335IS</b>								
L6	L6 3.0L 2979cc	2011-13	Trans	RWD, Manual	1			EM-9096
			Trans	RWD; Auto (Dual Clutch)	1			EM-9096
<b>335XI</b>								
L6	L6 3.0L 2979cc	2007-08	L & R Front		2	EM-5886		
<b>340I</b>								
L6	L6 3.0L 2997cc	2016-17	Trans	RWD	2			EM-7279
	L6 3.0L 2998cc	2016	LH Front	RWD	1	EM-7277		
			RH Front	RWD	1	EM-7268		
<b>428I</b>								
L4	L4 2.0L 1997cc	2014-16	LH Front	RWD	1	EM-7277		
			RH Front	RWD	1	EM-7278		
<b>430I</b>								
L4	L4 2.0L 1997cc	2017	Trans	RWD	2			EM-7279
<b>428I</b>								
L4	L4 2.0L 1997cc	2014-16	Trans	RWD	2			EM-7279
<b>435I</b>								
L6	L6 3.0L 2979cc	2014-16	Trans	RWD	2			EM-7279
<b>440I</b>								
L6	L6 3.0L 2979cc	2017	Trans	RWD	2			EM-7279
<b>524TD</b>								
L6	L6 2.4L 2443cc Diesel	1985-86	Trans		1			EM-9095
<b>525I</b>								
L6	L6 2.5L 2494cc	2001-03	L & R Front	Hydraulic Mount	2	EM-9276		
		1989-95	L & R Front	Manual	2	EM-9099		
		2006-09	LH Front	Mexico	1	EM-5884		
		2004-05	LH Front		1	EM-5884		

# Engine, Transmission, And Torque Strut Mounts

CYL	ENG. SIZE	YEAR	LOCATION	DESCRIPTION	QTY	ENGINE	TORQUE STRUT	TRANSMISSION
<b>BMW PASSENGER CAR (continued)</b>								
<b>525I (continued)</b>								
L6	L6 2.5L 2494cc	2006-09	RH Front	Mexico	1	EM-5885		
		2004-05	RH Front		1	EM-5885		
		1991-95	Trans - LH	Auto	1			EM-9104
			Trans - RH	Auto	1			EM-9100
			Trans - RH	Manual	1			EM-9100
		1989-90	Trans - RH	Auto	1			EM-9100
		2004-05	Trans	Auto	1			EM-7195
			Trans	Manual	1			EM-7195
		2001-03	Trans	Auto	2			EM-9096
	Trans		Manual	2			EM-9096	
	1989-90	Trans	Manual	1			EM-9096	
	L6 3.0L 2996cc	2010	LH Front	Mexico	1	EM-5884		
		2006-07	LH Front		1	EM-5884		
		2010	RH Front	Mexico	1	EM-5885		
		2006-07	RH Front		1	EM-5885		
Trans			RWD, Auto	1			EM-9096	
Trans	RWD, Manual	1			EM-9096			
<b>525IT</b>								
L6	L6 2.5L	1993	Trans - LH	Auto	1			EM-9104
			Trans - RH		1		EM-9100	
	L6 2.5L 2494cc	1993	L & R Front		2	EM-9099		
<b>528E</b>								
L6	L6 2.7L 2693cc	1982-88	Trans	Manual	1			EM-9105
<b>528I</b>								
L4	L4 2.0L 1997cc	2012-16	LH Front		1	EM-7290		
L6	L6 2.8L 2793cc	1997-00	L & R Front	Hydraulic Mount	2	EM-9276		
			Trans	Manual	1			EM-9103
	L6 2.8L 2798cc	1979-81	L & R Front		2	EM-5491		
	L6 3.0L 2996cc	2008-11	LH Front		1	EM-5884		
			RH Front		1	EM-5885		
2009-10		Trans	Auto	1			EM-7195	
Trans	Manual	1				EM-7195		
<b>528I XDRIVE</b>								
L4	L4 2.0L 1997cc	2012-16	LH Front		1	EM-7290		
<b>530I</b>								
L6	L6 3.0L 2979cc	2001-03	L & R Front	Hydraulic Mount	2	EM-9276		
	L6 3.0L 2985cc	1975-78	Trans	Auto	1			EM-8594
			Trans	Manual	1			EM-8594
	L6 3.0L 2996cc	2008-10	LH Front	Mexico	1	EM-5884		
		2004-07	LH Front		1	EM-5884		
		2008-10	RH Front	Mexico	1	EM-5885		
		2004-07	RH Front		1	EM-5885		
		2004-05	Trans	Auto	1			EM-7195
			Trans	Manual	1			EM-7195
		2001-03	Trans	Auto	2			EM-9096
Trans	Manual		2			EM-9096		
V8	V8 3.0L 2997cc	1994-95	LH Front		1	EM-9274		
			RH Front		1	EM-9273		
<b>533I</b>								
L6	L6 3.2L 3210cc	1984	Trans	Auto	1			EM-9095
			Trans	Manual	1			EM-9096
		1983	Trans	Auto	1			EM-8594
			Trans	Manual	1			EM-9090



## Engine, Transmission, And Torque Strut Mounts

CYL	ENG. SIZE	YEAR	LOCATION	DESCRIPTION	QTY	ENGINE	TORQUE STRUT	TRANS-MISSION
<b>BMW PASSENGER CAR (continued)</b>								
<b>535I</b>								
L6	L6 3.0L 2979cc	2012-16	LH Front		1	EM-7290		
		2008-11	LH Front		1	EM-5884		
			RH Front		1	EM-5885		
	L6 3.5L 3430cc	2008-09	Trans	Auto		1		EM-7195
			Trans	Manual		1		EM-7195
		1989-93	L & R Front	Hydraulic Mount		2	EM-9275	
		1987-93	Trans	Auto		1		EM-9094
			Trans	Manual		1		EM-9096
1985-86	Trans	Auto		1		EM-9090		
<b>535I GT</b>								
L6	L6 3.0L 2979cc	2012-17	LH Front		1	EM-7290		
<b>535IS</b>								
L6	L6 3.5L 3430cc	1988	Trans	Auto	1			EM-9094
			Trans	Manual	1			EM-9096
<b>540I</b>								
V8	V8 4.0L 3982cc	1994-95	LH Front		1	EM-9274		
			RH Front		1	EM-9273		
	V8 4.4L 4398cc	1997-03	LH Front		1	EM-9271		
			RH Front		1	EM-9272		
			Trans	Manual	1		EM-9103	
<b>545I</b>								
V8	V8 4.4L 4398cc	2004-06	Right		1	EM-7069		
<b>550I</b>								
V8	V8 4.8L 4837cc	2006-10	Right		1	EM-7069		
<b>630CSI</b>								
L6	L6 3.0L	1978	Trans		2			EM-8594
<b>633CSI</b>								
L6	L6 3.2L	1978-82	L & R Front		2	EM-5491		
	L6 3.2L 3210cc	1984	Trans	Manual	1			EM-9096
		1983	Trans	Auto	1			EM-8594
<b>635CSI</b>								
L6	L6 3.5L 3430cc	1985-89	Trans	Manual	1			EM-9098
<b>640I Gran Coupe</b>								
L6	L6 3.0L 2979cc	2013-18	LH Front		1	EM-7290		
<b>640I</b>								
L6	L6 3.0L 2979cc	2012-18	LH Front		1	EM-7290		
<b>645CI</b>								
V8	V8 4.4L 4398cc	2004-05	Right		1	EM-7069		
<b>650I</b>								
V8	V8 4.8L 4837cc	2006-10	Right		1	EM-7069		
<b>733I</b>								
L6	L6 3.2L	1978-79	Rear		1	EM-5218		
		1980-84	Rear		1	EM-5218		
	1983-84		Trans	Auto		1		EM-9090
		Trans	Manual		1		EM-9096	
	1978-82	Trans	Auto		1		EM-9090	
		Trans	Manual		1		EM-9090	

# Engine, Transmission, And Torque Strut Mounts

CYL	ENG. SIZE	YEAR	LOCATION	DESCRIPTION	QTY	ENGINE	TORQUE STRUT	TRANSMISSION
<b>BMW PASSENGER CAR (continued)</b>								
<b>735I</b>								
L6	L6 3.5L	1985-87	LH Front		1	EM-5070		
			RH Front		1	EM-5069		
	L6 3.5L 3430cc	1988-92	L & R Front	Hydraulic Mount	2	EM-9275		
			Trans	Auto	1			EM-9094
			Trans	Manual	1			EM-9096
			1985-87	Trans	Auto	1		
		Trans	Manual	1			EM-9098	
<b>735IL</b>								
L6	L6 3.5L 3430cc	1988-92	L & R Front	Hydraulic Mount	2	EM-9275		
			Trans		1			EM-9096
			Trans	Auto	1			EM-9094
<b>740I</b>								
L6	L6 3.0L 2979cc	2010-15	LH Front		1	EM-7290		
V8	V8 4.0L 3982cc	1993-95	LH Front		1	EM-9274		
			RH Front		1	EM-9273		
			Trans		1			EM-9096
	V8 4.4L 4398cc	1997-01	LH Front		1	EM-9271		
			RH Front		1	EM-9272		
			Trans		1			EM-9096
<b>740IL</b>								
V8	V8 4.0L 3982cc	1993-95	LH Front		1	EM-9274		
			RH Front		1	EM-9273		
			Trans		1			EM-9096
	V8 4.4L 4398cc	1997-01	LH Front		1	EM-9271		
			RH Front		1	EM-9272		
			Trans		1			EM-9096
<b>740LI</b>								
L6	L6 3.0L 2979cc	2011-15	LH Front		1	EM-7290		
<b>740LI XDRIVE</b>								
L6	L6 3.0L 2979cc	2013-15	LH Front		1	EM-7290		
<b>750IL</b>								
V12	V12 5.0L 4988cc	1988-94	Trans	Auto	1			EM-9094
	V12 5.4L 5379cc	1995-01	Left		1	EM-9271		
			Right		1	EM-9272		
<b>840CI</b>								
V8	V8 4.4L	1996-97	LH Front		1	EM-9274		
			RH Front		1	EM-9273		
	W8 4.0L	1994-95	LH Front		1	EM-9274		
			RH Front		1	EM-9273		
		1994-97	Trans	Auto	1			EM-9094
<b>850CI</b>								
V12	V12 5.0L 4988cc	1993-94	Trans	Auto	1			EM-9094
	V12 5.4L	1995-97	Trans	Auto	1			EM-9094
<b>850CSI</b>								
V12	V12 5.6L 5576cc	1994-95	Trans	Manual	1			EM-9094
<b>850I</b>								
V12	V12 5.0L 4988cc	1991-92	Trans		1			EM-9094
<b>1600</b>								
L4	L4 1.6L 1573cc	1967-71	LH Front		1	EM-5067		
			RH Front		1	EM-5068		

# Engine, Transmission, And Torque Strut Mounts

CYL	ENG. SIZE	YEAR	LOCATION	DESCRIPTION	QTY	ENGINE	TORQUE STRUT	TRANSMISSION
<b>BMW PASSENGER CAR (continued)</b>								
<b>2000</b>								
L4	L4 2.0L	1970	LH Front		1	EM-5067		
			RH Front		1	EM-5068		
			Trans	Auto	1			EM-8593
			Trans	Manual	1			EM-8592
<b>2002</b>								
L4	L4 2.0L 1990cc	1966-76	LH Front		1	EM-5067		
			RH Front		1	EM-5068		
			Trans	Auto	1			EM-8593
			Trans	Manual	1			EM-8592
<b>L6</b>								
L6	L6 3.5L 3430cc	1987	Trans	Auto	1			EM-9096
<b>L7</b>								
L6	L6 3.5L 3430cc	1986-87	Trans	Auto	1			EM-9096
<b>M2</b>								
L6	L6 3.0L 2979cc	2016-17	Trans	RWD; exc. Sport Suspension	2			EM-7279
<b>M235i</b>								
L6	L6 3.0L 2979cc	2014-16	LH Front	RWD	1	EM-7277		
			Trans	RWD	2			EM-7279
<b>M240i</b>								
L6	L6 3.0L 2997cc	2017	Trans	RWD	2			EM-7279
<b>M3</b>								
L6	L6 3.0L	1994-95	L & R Front		2	EM-9003		
			Trans	Auto	1			EM-9096
			Trans	Manual	1			EM-9096
	L6 3.0L 2979cc	2016	LH Front	RWD	1	EM-7277		
		2015-17	Trans	RWD; exc. Sport Suspension	2			EM-7279
	L6 3.2L 3152cc	1996-99	L & R Front		2	EM-9003		
L6 3.2L 3246cc	2001-06	L & R Front		2	EM-9003			
V8	V8 4.0L 3999cc	2008-09	L & R Front		2	EM-9003		
<b>M4</b>								
L6	L6 3.0L 2979cc	2015-16	LH Front	RWD	1	EM-7277		
		2015-17	Trans	RWD; exc. Sport Suspension	1			EM-7279
<b>M5</b>								
L6	L6 3.5L 3453cc	1988	Trans	Manual	1			EM-9096
	L6 3.6L 3553cc	1991-93	L & R Front		2	EM-9275		
			Trans	Manual	1			EM-9096
V8	V8 5.0L 4941cc	2000-03	Trans	Manual	2			EM-9103
V10	V10 5.0L 4999cc	2006-10	Right		1	EM-7069		
<b>Z3</b>								
L4	L4 1.9L 1895cc	1999	L & R Front	Mexican Vehicle; Hydraulic Mount	2	EM-9003		
			L & R Front	Hydraulic Mount	2	EM-9003		
		1996-98	Trans	Mexican Vehicle	1			EM-9096
		1996-98	Trans		1			EM-9096
L6	L6 2.5L 2494cc	1999-02	L & R Front		2	EM-9003		
	L6 2.8L 2793cc	1999-00	L & R Front		2	EM-9003		
	L6 3.0L 2979cc	2001-02	L & R Front		2	EM-9003		
	L6 3.2L 3246cc	1999-02	L & R Front		2	EM-9003		

# Engine, Transmission, And Torque Strut Mounts

CYL	ENG. SIZE	YEAR	LOCATION	DESCRIPTION	QTY	ENGINE	TORQUE STRUT	TRANSMISSION
<b>BMW PASSENGER CAR (continued)</b>								
<b>Z4</b>								
L4	L4 2.0L 1997cc	2012-15	LH Front		1	EM-5888		
			RH Front		1	EM-5887		
L6	L6 3.0L 2979cc	2009-16	L & R Front		2	EM-5886		
<b>BMW SPORT UTILITY</b>								
<b>X1</b>								
L4	L4 2.0L 1997cc	2013	LH Front		1	EM-5888		
			RH Front		1	EM-5887		
<b>X3</b>								
L4	L4 2.0L 1997cc	2013-17	LH Front	Gas; RWD	1	EM-7277		
			RH Front	Gas; RWD	1	EM-7278		
L6	L6 2.5L 2494cc	2004-06	Left		1	EM-5889		
			Right		1	EM-5890		
			Trans		1		AS-7318	
	L6 3.0L 2979cc	2004-06	Trans		1		AS-7318	
	L6 3.0L 2996cc	2004-06	Left		1	EM-5889		
2007-10		Right		1	EM-5890			
		2004-06	Right		1	EM-5890		
<b>X5</b>								
L6	L6 3.0L 2979cc	2011-16	Front		2	EM-7025		
		2001-06	L & R Front		2	EM-5877		
		2011-17	Trans	Gas	1		EM-7281	
	L6 3.0L 2993cc Diesel	2009-10	Front		2	EM-7025		
		2009-17	Trans		1		EM-7281	
	L6 3.0L 2996cc	2007-10	Front		2	EM-7025		
Trans			Gas	1		EM-7281		
V8	V8 4.4L 4395cc	2010-17	Trans		1		EM-7281	
	V8 4.4L 4398cc	2000-06	L & R Front		2	EM-5877		
	V8 4.6L 4598cc	2002-03	L & R Front		2	EM-5877		
	V8 4.8L 4837cc	2004-06	L & R Front		2	EM-5877		
		2008-09	Trans		1		EM-7281	
<b>X6</b>								
L6	L6 3.0L 2979cc	2008-17	Front		2	EM-7025		
V8	V8 4.4L 4395cc	2009-17	Trans		1		EM-7281	
<b>BUICK PASSENGER CAR</b>								
<b>ALLURE</b>								
V6	V6 3.6L 217ci	2005-07	Right		1	EM-2987#		
			Torq Str - Front	Bracket to Radiator Support Complete Unit	2		EM-3088	
			Torq Str - Front	Bracket to Radiator Support Insert	2		EM-4169	
			Torq Str - Front	Complete Unit; LH & RH Front	2		EM-2866#	
			Torq Str - Front	Insert Only; LH & RH Front	2		EM-2716	
		2005-08	Trans		1		EM-2818 #	
	V6 3.8L 231ci	2005-07	Right		1	EM-2987#		
			Torq Str - Front	Bracket to Radiator Support Complete Unit	2		EM-3088	
			Torq Str - Front	Bracket to Radiator Support Insert	2		EM-4169	
			Torq Str - Front	Complete Unit; LH & RH Front	2		EM-2866#	
			Torq Str - Front	Insert Only; LH & RH Front	2		EM-2716	
	2005-09	Trans		1		EM-2818 #		
V8	V8 5.3L 325ci	2008-09	Front		1	EM-3093		
			Rear		1	EM-2990		

# = Available in the Westar Gold Line

# Engine, Transmission, And Torque Strut Mounts

CYL	ENG. SIZE	YEAR	LOCATION	DESCRIPTION	QTY	ENGINE	TORQUE STRUT	TRANS-MISSION			
<b>BUICK PASSENGER CAR (continued)</b>											
<b>ALLURE (continued)</b>											
V8	V8 5.3L 325ci	2008-09	Torq Str - Front	Bracket to Radiator Support Complete Unit	1		EM-3104				
			Torq Str - Front	Bracket to Radiator Support Insert	1		EM-4169				
			Torq Str - Front	Complete Unit	2		EM-2866#				
			Torq Str - Front	Insert Only; LH & RH Front	2		EM-2716				
			Trans - Rear		1			EM-2990			
<b>APOLLO</b>											
L6	L6 4.1L 250ci	1973-75	L & R Front		2	EM-2292					
		1975	Trans		1			EM-2360 @			
		1973-74	Trans		1			EM-2378 @			
V8	V8 4.3L 260ci	1975	L & R Front		2	EM-2328					
			Trans		1		EM-2288 @				
	V8 5.7L 350ci	1973-75	L & R Front		2	EM-2281					
			1975	Trans	Auto; THM350 (M38)	1		EM-2288 @			
			Trans	Manual	1		EM-2288 @				
			1973-74	Trans	Auto; THM350	1		EM-2378 @			
				Trans	Auto; THM400	1		EM-2360 @			
			Trans	Manual	1		EM-2378 @				
			<b>CASCADA</b>								
L4	L4 1.6L 98ci	2016-17	RH Front		1	EM-4076					
			Trans - Front		1		EM-4049				
			Trans - Rear	Complete Unit	1		EM-4080				
<b>CENTURION</b>											
V8	V8 5.7L 350ci	1973	L & R Front		2	EM-2281					
			Trans	Auto; THM350	1		EM-2288 @				
			Trans	Auto; THM400	1		EM-2268 @				
	V8 7.5L 455ci	1971-73	L & R Front		2	EM-2291					
			Trans		1		EM-2288 @				
<b>CENTURY</b>											
L4	L4 2.2L 134ci	1993-96	RH Front		1	EM-2548*					
		1995-96	Torq Str - Front	Complete Unit	1		EM-2866#				
			Torq Str - Front	Insert	1		EM-2716				
		1993-94	Torq Str - Front		1		EM-2609				
		1993-96	Trans		1			EM-2543			
	L4 2.5L 151ci	1985-92	RH Front		1	EM-2548*					
			RH Front		1	EM-2472					
			Torq Str - Front		1		EM-2396				
			1982-84	Trans - Front	Auto	1		EM-2467			
			1989-92	Trans		1		EM-2543			
			1985-88	Trans	Auto	1		EM-2543			
				Trans	Manual	1		EM-2543			
			V6	V6 2.8L 173ci	1985-89	RH Front		1	EM-2548*		
					1983-84	RH Front		1	EM-2472		
1986-89	Torq Str - Front				1		EM-2396				
1983-85	Torq Str - Front				1		EM-2490				
1989	Trans - Front	Auto			1		EM-2467				
1984-88	Trans - Front	Auto			1		EM-2466				
	Trans - Front	Manual			1		EM-2467				
Trans - Front	Mexico; Auto	1				EM-2467					
1983	Trans - Front	Auto			1		EM-2467				
1984-88	Trans - Rear	Auto			1		EM-2467				
V6 3.0L 181ci	1985	RH Front		1	EM-2548*						

\* = Hydraulic Mount, "S" suffix = solid replacement.

@ = Universal Mount EM-5000 also available.

# = Available in the Westar Gold Line

# Engine, Transmission, And Torque Strut Mounts

CYL	ENG. SIZE	YEAR	LOCATION	DESCRIPTION	QTY	ENGINE	TORQUE STRUT	TRANSMISSION	
<b>BUICK PASSENGER CAR (continued)</b>									
<b>CENTURY (continued)</b>									
V6	V6 3.0L 181ci	1982-84	RH Front		1	EM-2472			
		1982-85	Torq Str - Front		1		EM-2490		
			Trans - Front	Auto	1			EM-2467	
	V6 3.1L 189ci	1994-96	Front		1	EM-2548*			
		1997-05	RH Front		1	EM-2796*			
			Torq Str - Front	Bracket to Radiator Support Complete Unit	1		EM-2901		
			Torq Str - Front	Bracket to Radiator Support Insert	1		EM-4169		
			Torq Str - Front	Complete Unit	1		EM-2866#		
			Torq Str - Front	Insert Only	2		EM-2716		
		1995-96	Torq Str - Front	Insert	1		EM-2716		
		1994	Torq Str - Front		1		EM-2396		
		1994-96	Trans - LH Front		1			EM-2466	
			Trans - LH Rear		1			EM-2467	
	1997-05	Trans		1			EM-2818 #		
	V6 3.2L 196ci	1978-79	LH Front		1	EM-2382			
			RH Front		1	EM-2384			
			Trans	Auto	1			EM-2379	
			Trans	Manual	1			EM-2379	
	V6 3.3L 204ci	1989-93	RH Front		1	EM-2548*			
			Torq Str - Front		1		EM-2396		
			Trans - LH Front		1			EM-2466	
			Trans - LH Rear		1			EM-2467	
	V6 3.8L 231ci	1975-81	LH Front		1	EM-2382			
		1985-88	RH Front		1	EM-2548*			
		1984	RH Front		1	EM-2472			
		1975-81	RH Front		1	EM-2384			
		1987-88	Torq Str - Front		1		EM-2396		
		1984-86	Torq Str - Front		1		EM-2490		
		1984-88	Trans - Front	Auto	1			EM-2466	
			Trans - Front	Manual	1			EM-2467	
			Trans - Rear	Auto	1			EM-2467	
		1978-81	Trans	Auto	1			EM-2379	
			Trans	Manual	1			EM-2379	
		1975-77	Trans	Auto	1			EM-2379	
			Trans	Manual; OEM Design	1			EM-2360 @	
	V6 4.3L 260ci Diesel	1982-85	Front		1	EM-2472			
			Torq Str - Front		1		EM-2490		
			Torq Str - Front		1		EM-2396		
			Trans - Front	Auto	1			EM-2467	
	V8	V8 4.3L 265ci	1980-81	L & R Front		2	EM-2387		
				Trans	Auto	1			EM-2393
				Trans	Manual	1			EM-2393
V8 4.4L 267ci		1981	L & R Front		2	EM-2387			
			Trans	Auto	1			EM-2393	
			Trans	Manual	1			EM-2393	
V8 4.9L 301ci	1979-80	L & R Front		2	EM-2387				
		Trans	Auto	1			EM-2360 @		
		Trans	Manual	1			EM-2360 @		
V8 5.0L 305ci	1977-81	L & R Front		2	EM-2292				
		Trans	Auto	1			EM-2393		
	1979-81	Trans	Manual	1			EM-2393		
		1977-78	Trans	Auto	1			EM-2360 @	
		Trans	Manual	1			EM-2360 @		

\* = Hydraulic Mount, "S" suffix = solid replacement.

@ = Universal Mount EM-5000 also available.

# = Available in the Westar Gold Line

# Engine, Transmission, And Torque Strut Mounts

CYL	ENG. SIZE	YEAR	LOCATION	DESCRIPTION	QTY	ENGINE	TORQUE STRUT	TRANSMISSION	
<b>BUICK PASSENGER CAR (continued)</b>									
<b>CENTURY (continued)</b>									
V8	V8 5.7L 350ci	1978-79	L & R Front		2	EM-2292			
		1977	L & R Front	VIN R; VIN R	2	EM-2328			
			L & R Front	VIN H & VIN J; VIN H; VIN J	2	EM-2281			
			L & R Front		2	EM-2281			
		1979	Trans	Auto		1			EM-2393
			Trans	Manual		1			EM-2393
		1978	Trans	Auto		1			EM-2360 @
			Trans	Manual		1			EM-2360 @
		1977	Trans	VIN L; VIN L		1			EM-2360 @
			Trans	VIN R; Auto; THM200 (M29) THM350 (M38); VIN R		1			EM-2337
			Trans	VIN R; Auto; THM400-475 (M40); VIN R		1			EM-2360 @
			Trans	VIN H & VIN J; Auto; VIN H, VIN J		1			EM-2394
			Trans	VIN H & VIN J; Manual; VIN H, VIN J		1			EM-2394
		1976	Trans	Auto		1			EM-2394
			Trans	Manual		1			EM-2394
		1975	Trans	Auto		1			EM-2394
		1973-74	Trans	Auto		1			EM-2394
			Trans	Manual		1			EM-2394
		V8 5.7L 350ci Diesel	1981	Trans	Auto		1		
	Trans			Manual		1			EM-2360 @
	V8 6.6L 403ci	1977	L & R Front		2	EM-2328			
			Trans		1			EM-2337	
	V8 7.5L 455ci	1973-74	L & R Front		2	EM-2291			
Trans			OEM Design	1			EM-2288 @		
<b>ELECTRA</b>									
V6	V6 3.0L 181ci	1985	RH Front	1st Design	1	EM-2630			
			RH Front	Hydraulic Mount; 2nd Design	1	EM-2551*			
			Trans - LH Front		1			EM-2537	
			Trans - LH Rear		1			EM-2568	
			Trans - RH Rear	1st Design	1			EM-2663	
			Trans - RH Rear	2nd Design	1			EM-2664	
			Trans - RH Rear	Hydraulic Mount; 3rd Design	1			EM-2556 *	
	V6 3.8L 231ci	1986-90	RH Front	Hydraulic Mount; 2nd Design	1	EM-2551*			
			1985	RH Front	1st Design	1	EM-2630		
		1987-90	RH Front	Hydraulic Mount; 2nd Design	1	EM-2551*			
			Trans - LH Front		1			EM-2537	
		1985-86	Trans - LH Front		1			EM-2537	
		1987-90	Trans - LH Rear		1			EM-2568	
		1985-86	Trans - LH Rear		1			EM-2568	
		1987-90	Trans - RH Rear	Hydraulic Mount; 3rd Design	1			EM-2556 *	
		1985-86	Trans - RH Rear	1st Design	1			EM-2663	
			Trans - RH Rear	2nd Design	1			EM-2664	
	Trans - RH Rear		Hydraulic Mount; 3rd Design	1			EM-2556 *		
	V6 4.1L 252ci	1980-84	LH Front		1	EM-2382			
			RH Front		1	EM-2384			
			Trans		1			EM-2379	
	V6 4.3L 260ci Diesel	1985	Front	1st Design	1	EM-2630			
			Front	Hydraulic Mount; 2nd Design	1	EM-2551*			
			Trans - LH Front		1			EM-2537	
			Trans - LH Rear		1			EM-2568	
			Trans - RH Rear	Hydraulic Mount; 2nd Design	1			EM-2556 *	

\* = Hydraulic Mount, "S" suffix = solid replacement. @ = Universal Mount EM-5000 also available.

# Engine, Transmission, And Torque Strut Mounts

CYL	ENG. SIZE	YEAR	LOCATION	DESCRIPTION	QTY	ENGINE	TORQUE STRUT	TRANSMISSION
<b>BUICK PASSENGER CAR (continued)</b>								
<b>ELECTRA (continued)</b>								
V8	V8 4.9L 301ci	1980	L & R Front		2	EM-2387		
			Trans	OEM Design	1			EM-2360 @
	V8 5.0L 252ci	1981-87	L & R Front		2	EM-2328		
	V8 5.0L 307ci	1981-89	Trans	OEM Design	1			EM-2360 @
V8	5.7L 350 ci Gas	1981 1978-80	L & R Front		2	EM-2281		
			L & R Front	VIN R	2	EM-2328		
			L & R Front	VIN X	2	EM-2281		
V8	5.7L 350ci	1977	L & R Front	VIN R; VIN R	2	EM-2328		
			L & R Front	VIN H & VIN J; VIN H; VIN J	2	EM-2281		
		1978-80	Trans	Auto; THM350 (M38); VIN R	1			EM-2360 @
			Trans	Auto; THM350 (M38); VIN X,	1			EM-2394
			Trans	Auto; THM400-475 (M40); VIN X	1			EM-2360 @
		1977	Trans	VIN R; Auto; THM350 (M38)	1			EM-2360 @
			Trans	VIN R VIN H & VIN J; Auto THM400-475 (M40); VIN H VIN J	1			EM-2394
V8	5.7L 350ci Diesel	1980-85	L & R Front		2	EM-2328		
			Trans	VIN N; OEM Design	1			EM-2360 @
V8	6.6L 401ci	1961-66	L & R Front		2	EM-2219		
		1959-60	Trans		1			EM-2070
V8	6.6L 403ci	1977-79	L & R Front		2	EM-2328		
			Trans	OEM Design	1			EM-2360 @
	V8 7.0L 425ci	1965-66	L & R Front		2	EM-2219		
V8	7.0L 430ci	1967-69	L & R Front		2	EM-2291		
			Trans	OEM Design	1			EM-2378 @
V8	7.5L 455ci	1970-76	L & R Front		2	EM-2291		
		1976	Trans	OEM Design	1			EM-2360 @
		1973-75	Trans	OEM Design	1			EM-2374 @
		1970-72	Trans	OEM Design	1			EM-2378 @
<b>ESTATE WAGON</b>								
V8	V8 4.9L 301ci	1980	L & R Front		2	EM-2387		
	V8 5.0L 252ci	1981-83	L & R Front		2	EM-2328		
	V8 5.0L 307ci	1981-83	Trans	OEM Design	1			EM-2360 @
	V8 5.7L GAS	1978-80	L & R Front	VIN R	2	EM-2328		
V8	5.7L 350ci	1977	L & R Front	VIN X	2	EM-2281		
			L & R Front		2	EM-2328		
		1973	L & R Front		2	EM-2281		
		1970	L & R Front		2	EM-2328		
			Trans	Gas; Auto; THM350 (M38); VIN X,	1			EM-2394
			Trans	Gas; Auto; THM400-475 (M40); VIN R	1			EM-2360 @
			Trans	Gas; Auto; THM400-475 (M40); VIN X	1			EM-2360 @
		Trans	Gas; Auto; THM350 (M38); VIN R	1			EM-2288 @	
		1977	Trans	Auto; THM400 (M40)	1			EM-2360 @
		1973	Trans	VIN J	1			EM-2394
1970	Trans	OEM Design	1			EM-2360 @		
V8	5.7L 350ci Diesel	1980-83	L & R Front		2	EM-2328		
			Trans	VIN N; OEM Design	1			EM-2360 @
	V8 6.0L 364ci	1959-61	L & R Front		2	EM-2219		

@ = Universal Mount EM-5000 also available.



# Engine, Transmission, And Torque Strut Mounts

CYL	ENG. SIZE	YEAR	LOCATION	DESCRIPTION	QTY	ENGINE	TORQUE STRUT	TRANSMISSION
<b>BUICK PASSENGER CAR (continued)</b>								
<b>ESTATE WAGON (continued)</b>								
V8	V8 6.6L 401ci	1961-64	L & R Front		2	EM-2219		
		1959-60	Trans		1			EM-2070
	V8 6.6L 403ci	1977-79	L & R Front		2	EM-2328		
			Trans	OEM Design	1			EM-2360 @
	V8 7.5L 455ci	1970-76	L & R Front		2	EM-2291		
			Trans	OEM Design	1			EM-2360 @
		1973-75	Trans	OEM Design	1			EM-2374 @
1970-72		Trans	OEM Design	1			EM-2378 @	
<b>GRAN SPORT</b>								
V8	V8 6.6L 401ci	1965-67	L & R Front		2	EM-2219		
<b>GS</b>								
V8	V8 5.7L 350ci	1970-72	L & R Front		2	EM-2281		
			Trans		1			EM-2394
<b>GS 350</b>								
V8	V8 5.7L 350ci	1968-69	L & R Front		2	EM-2281		
			Trans	Auto	1			EM-2394
			Trans	Manual	1			EM-2394
<b>GS 400</b>								
V8	V8 6.6L 400ci	1968-69	L & R Front		2	EM-2291		
			Trans		1			EM-2378 @
<b>INVICTA</b>								
V8	V8 6.6L 401ci	1959-63	L & R Front		2	EM-2219		
			Trans		1			EM-2070
<b>LACROSSE</b>								
L4	L4 2.4L 145ci	2010-15	Right		1	EM-3198		
			Trans - Center		1			EM-4128
		2012-15	Trans - Front		1			EM-3194
			2010-11	Trans - Front		1		EM-3194
			2012-15	Trans - Rear	FWD	1		EM-3196
			2010-11	Trans - Rear	FWD	1		EM-3196
V6	V6 3.0L 182ci	2010	Right		1	EM-3200		
			Trans - Front		1			EM-3195
	V6 3.6L 217ci	2005-08	RH Front		1	EM-2987#		
			2016	Right		1	EM-3198	
		2010-15	Right		1	EM-3200		
			Torq Str - Front	Bracket to Radiator Support Complete Unit	2		EM-3088	
			Torq Str - Front	Bracket to Radiator Support Insert	2		EM-4169	
			Torq Str - Front	Complete Unit; LH & RH Front	2		EM-2866#	
			Torq Str - Front	Insert Only; LH & RH Front	2		EM-2716	
			2010-16	Trans - Center	Auto	1		
		Trans - Front			1			EM-3195
		Trans - Rear		AWD	1			EM-4261
	Trans - Rear	FWD		1			EM-3196	
	2005-08	Trans		1			EM-2818 #	
	V6 3.8L 231ci	2005-09	RH Front		1	EM-2987#		
Torq Str - Front			Bracket to Radiator Support Complete Unit	2		EM-3088		
Torq Str - Front			Bracket to Radiator Support Insert	2		EM-4169		
Torq Str - Front			Complete Unit; LH & RH Front	2		EM-2866#		
Torq Str - Front			Insert Only; LH & RH Front	2		EM-2716		

@ = Universal Mount EM-5000 also available. # = Available in the Westar Gold Line

# Engine, Transmission, And Torque Strut Mounts

CYL	ENG. SIZE	YEAR	LOCATION	DESCRIPTION	QTY	ENGINE	TORQUE STRUT	TRANSMISSION	
<b>BUICK PASSENGER CAR (continued)</b>									
<b>LACROSSE (continued)</b>									
V6	V6 3.8L 231ci	2005-09	Trans		1			EM-2818 #	
V8	V8 5.3L 325ci	2008-09	Front		1	EM-3093			
			Rear		1	EM-2990			
			Torq Str - Front	Bracket to Radiator Support Complete Unit	2		EM-3104		
			Torq Str - Front	Bracket to Radiator Support Insert	2		EM-4169		
			Torq Str - Front	Complete Unit; LH & RH Front	2		EM-2866#		
			Trans		1			EM-5661	
<b>LESABRE</b>									
V6	V6 3.0L 181ci	1986	Front	1st Design	1	EM-2630			
			Front	Hydraulic Mount; 2nd Design	1	EM-2551*			
			Trans - LH Front		1			EM-2537	
			Trans - LH Rear		1			EM-2568	
			Trans - RH Rear	1st Design	1			EM-2663	
			Trans - RH Rear	2nd Design	1			EM-2664	
			Trans - RH Rear	Hydraulic Mount; 3rd Design	1			EM-2556*	
	V6 3.8L 231ci	1976-85	LH Front		1	EM-2382			
			2000-05	RH Front		1	EM-2896*		
		1992-99	RH Front		1	EM-2801			
		1987-91	RH Front	Hydraulic Mount; 2nd Design	1	EM-2551*			
		1986	RH Front	1st Design	1	EM-2630			
			RH Front	Hydraulic Mount; 2nd Design	1	EM-2551*			
		1976-85	RH Front		1	EM-2384			
		1992-99	Torq Str - Front		1		EM-2662		
		2000-05	Trans - Center		1			EM-2895*	
			Trans - LH Front		1			EM-2897 #	
		1994-99	Trans - LH Front	Shock Mount	1			EM-2881	
		1992-93	Trans - LH Front		1			EM-2800	
		1987-91	Trans - LH Front		1			EM-2537	
		1986	Trans - LH Front		1			EM-2537	
		2000-05	Trans - LH Rear		1			EM-2898	
		1994-99	Trans - LH Rear		1			EM-2778	
		1992-93	Trans - LH Rear		1			EM-2823*	
		1987-91	Trans - LH Rear		1			EM-2568	
		1986	Trans - LH Rear		1			EM-2568	
		1987-91	Trans - RH Rear	Hydraulic Mount; 3rd Design	1			EM-2556*	
		1986	Trans - RH Rear	1st Design	1			EM-2663	
			Trans - RH Rear	2nd Design	1			EM-2664	
			Trans - RH Rear	Hydraulic Mount; 3rd Design	1			EM-2556*	
		1976-85	Trans		1			EM-2379	
		V6 4.1L 252ci	1980-84	LH Front		1	EM-2382		
				RH Front		1	EM-2384		
				Trans		1			EM-2379
		V8	V8 4.4L 267ci	1982	L & R Front		2	EM-2292	
	Trans					1			EM-2360 @
	V8 4.9L 300ci		1965	L & R Front		2	EM-2350		
	V8 4.9L 301ci		1977-80	L & R Front		2	EM-2387		
				Trans		1			EM-2360 @
	V8 5.0L 305ci		1978	L & R Front		2	EM-2292		
				Trans		1			EM-2360 @
V8 5.0L 307ci	1981-90		L & R Front		2	EM-2328			
			Trans		1			EM-2360 @	
V8 5.6L 340ci	1966-67		L & R Front		2	EM-2350			

\* = Hydraulic Mount, "S" suffix = solid replacement.

@ = Universal Mount EM-5000 also available.

# = Available in the Westar Gold Line

# Engine, Transmission, And Torque Strut Mounts

CYL	ENG. SIZE	YEAR	LOCATION	DESCRIPTION	QTY	ENGINE	TORQUE STRUT	TRANSMISSION
<b>BUICK PASSENGER CAR (continued)</b>								
<b>LESABRE (continued)</b>								
V8	V8 5.6L 340ci	1966-67	Trans	Auto	1			EM-2268 @
			Trans	Manual	1			EM-2378 @
	V8 5.7L	1968-70	Trans		1			EM-2534
	V8 5.7L 350 ci Gas	1978-80	L & R Front	VIN R	2	EM-2328		
			L & R Front	VIN X	2	EM-2281		
	V8 5.7L 350ci	1977	L & R Front	VIN R; VIN R	2	EM-2328		
			L & R Front	VIN H & VIN J; VIN H; VIN J	2	EM-2281		
		1972-76	L & R Front		2	EM-2281		
		1968-71	L & R Front		2	EM-2281		
		1978-80	Trans	Auto; THM350 (M38); VIN X,	1			EM-2394
			Trans	Auto; THM400-475 (M40); VIN X	1			EM-2360 @
			Trans	VIN R	1			EM-2360 @
		1977	Trans	VIN R; VIN R	1			EM-2360 @
			Trans	VIN H & VIN J; VIN J	1			EM-2394
		1975-76	Trans	Auto; THM350	1			EM-2394
	1972-74	Trans	VIN H	1			EM-2378 @	
	Trans	VIN J	1				EM-2394	
	V8 5.7L 350ci Diesel	1980-85	L & R Front		2	EM-2328		
			Trans		1			EM-2360 @
	V8 6.0L 364ci	1959-61	L & R Front		2	EM-2219		
	V8 6.6L 400ci	1975	L & R Front		2	EM-2291		
	V8 6.6L 401ci	1960-64	L & R Front		2	EM-2219		
	V8 6.6L 403ci	1977-78	L & R Front		2	EM-2328		
			Trans		1			EM-2360 @
	V8 7.0L 425ci	1964	L & R Front		2	EM-2219		
	V8 7.5L 455ci	1970-76	L & R Front		2	EM-2291		
			Trans		1			EM-2360 @
		1973-75	Trans		1			EM-2374 @
		1970-72	Trans		1			EM-2378 @
	<b>LUCERNE</b>							
V6	V6 3.8L 231ci	2006-08	Front		1	EM-3148		
			Rear		1	EM-3146		
			Torq Str - Front		1		EM-3139	
			Trans	Auto	1			EM-3153
	V6 3.9L 237ci	2009-11	Front		1	EM-3158		
			Rear		1	EM-3149		
			Torq Str - Front		1		EM-3139	
			Trans	Auto	1			EM-3153
V8	V8 4.6L 281ci	2006-11	Front		1	EM-3166		
			Rear		1	EM-4212		
			Torq Str - Right		1		EM-3140	
			Trans	Auto	1			EM-3153
<b>PARK AVENUE</b>								
V6	V6 3.8L	1999	Trans - LH Front		1			EM-2897 #
			Trans - LH Rear		1			EM-2898
	V6 3.8L 231ci	1997-99	LH Front		1	EM-3126		
			RH Front	Hydraulic Mount	1	EM-2896*		
		1997-99	RH Front	RH Front	1	EM-5074		
			RH Front		1	EM-2801		
		2000-05	Torq Str - Front		1		EM-2662	
			Trans - Center		1			EM-2895 *
		1994-96	Trans - LH Front		1			EM-2897 #
			Trans - LH Front	Shock Mount	1			EM-2881

\* = Hydraulic Mount, "S" suffix = solid replacement.

@ = Universal Mount EM-5000 also available.

# = Available in the Westar Gold Line

# Engine, Transmission, And Torque Strut Mounts

CYL	ENG. SIZE	YEAR	LOCATION	DESCRIPTION	QTY	ENGINE	TORQUE STRUT	TRANSMISSION	
<b>BUICK PASSENGER CAR (continued)</b>									
<b>PARK AVENUE (continued)</b>									
V6	V6 3.8L 231ci	1991-93	Trans - LH Front		1			EM-2800	
		2000-05	Trans - LH Rear		1			EM-2898	
		1994-96	Trans - LH Rear	VIN K; VIN L		1			EM-2778
		1991-93	Trans - LH Rear			1			EM-2823
		1997-98	Trans - Rear	Complete Unit		1			EM-5075
			Trans - Rear	Insert Only		1			EM-3065
<b>REATA</b>									
V6	V6 3.8L 231ci	1988-91	RH Front		1	EM-2943*			
			Torq Str - Front		1		EM-2662		
		1991	Trans - LH		1			EM-2779	
		1989-90	Trans - LH		1			EM-2779	
		1988	Trans - LH		1			EM-2779	
		1989-90	Trans - RH		1			EM-2691	
<b>REGAL</b>									
L4	L4 2.0L 122ci	2011-13	Trans - Center	Auto	1			EM-3201	
			Trans - Front		1			EM-3197	
			Trans - Rear		1			EM-3196	
	L4 2.0L 122ci	2011-17 2014-16	Right		1	EM-3198			
			Trans - Center	Auto	1			EM-4223	
			Trans - Front		1			EM-3195	
			Trans - Rear	AWD	1			EM-4261	
	L4 2.4L 145ci	2011-17	Trans - Rear	FWD	1			EM-3196	
			Right		1	EM-3198			
			Trans - Center		1			EM-4128	
	V6	V6 2.8L 173ci	1988-89	RH Front		1	EM-2660*		
				Torq Str - Front	LH & RH Front	2		EM-2609	
Trans					1		EM-2620		
V6 3.1L 189ci		1994-96 1989-93 1995-96	Front		1	EM-2796*			
			Front		1	EM-2660*			
			Torq Str - Front	Bracket to Radiator Support Complete Unit	2		EM-2901		
			Torq Str - Front	Bracket to Radiator Support Insert	2		EM-4169		
			Torq Str - Front	Complete Unit; LH & RH Front; 2nd Design	2		EM-2866#		
			Torq Str - Front	Insert; LH & RH Front; 2nd Design	2		EM-2716		
			Torq Str - Front	Bracket to Radiator Support Complete Unit	2		EM-2901		
			Torq Str - Front	Bracket to Radiator Support Insert	2		EM-4169		
			Torq Str - Front	Complete Unit; LH & RH Front; 2nd Design	2		EM-2866#		
	Torq Str - Front		Insert; LH & RH Front; 2nd Design	2		EM-2716			
V6 3.2L 196ci	1978-79	Torq Str - Left	1st Design	1		EM-2609			
		Torq Str - Left	1st Design	1		EM-2609			
		Torq Str - Right	1st Design	1		EM-2609			
		Torq Str - Right	1st Design	1		EM-2609			
		Trans	Auto	1			EM-2712		
		Trans		1			EM-2620		
V6 3.2L 196ci	1978-79	LH Front		1	EM-2382				
		RH Front		1	EM-2384				

\* = Hydraulic Mount, "S" suffix = solid replacement. # = Available in the Westar Gold Line

# Engine, Transmission, And Torque Strut Mounts

CYL	ENG. SIZE	YEAR	LOCATION	DESCRIPTION	QTY	ENGINE	TORQUE STRUT	TRANSMISSION	
<b>BUICK PASSENGER CAR (continued)</b>									
<b>REGAL (continued)</b>									
V6	V6 3.2L 196ci	1978-79	Trans	Auto	1			EM-2379	
			Trans	Manual	1			EM-2379	
	V6 3.8L 189ci	1996-04	RH Front		1	EM-2796*			
	V6 3.8L 231ci	1975-87 1993-95 1990-92 1975-87 1993-95 1990-92 1996-04 1996-04 1996-04 1996-04 1990-95 1997-04 1994-96 1990-93 1980-87 1976-79 1975	LH Front		1	EM-2382			
			RH Front		1	EM-2697*			
			RH Front		1	EM-2697*			
			RH Front		1	EM-2384			
			RH Rear		1	EM-2676			
			RH Rear		1	EM-2763			
			Torq Str - Front	Bracket to Radiator Support Complete Unit	2		EM-3088		
			Torq Str - Front	Bracket to Radiator Support Insert	2		EM-4169		
			Torq Str - Front	Complete Unit; LH & RH Front	2		EM-2866#		
			Torq Str - Front	Insert; LH & RH Front	2		EM-2716		
			Torq Str - Front		1		EM-2609		
			Trans		1			EM-2818 #	
			Trans		1			EM-2712 *	
			Trans		1			EM-2620	
			Trans		1			EM-2379	
	Trans	Auto	1			EM-2379			
	Trans	Manual	1			EM-2379			
	Trans		1			EM-2379			
	V6 4.1L 252ci	1982-84	LH Front		1	EM-2382			
			RH Front		1	EM-2384			
			Trans		1		EM-2360 @		
	V6 4.3L 260ci Diesel	1982-84 1983-84	L & R Front		2	EM-2292			
			Trans		1		EM-2360 @		
	V8	V8 4.3L 265ci	1980-81	L & R Front		2	EM-2387		
				Trans		1		EM-2391	
V8 4.4L 267ci		1981-82	L & R Front		2	EM-2387			
			Trans	Auto	1		EM-2393		
V8 4.9L 301ci		1979-80	L & R Front		2	EM-2387			
			Trans	Auto	1		EM-2393		
V8 5.0L 305ci		1982-87 1977-80 1982-87 1980 1977-79	L & R Front		2	EM-2292			
			L & R Front		2	EM-2292			
			Trans		1		EM-2360 @		
			Trans	Auto	1		EM-2360 @		
			Trans	Auto	1		EM-2360 @		
Trans		Manual	1		EM-2360 @				
V8 5.0L 307ci		1986-87	L & R Front		2	EM-2328			
V8 5.7L 350ci		1977	L & R Front	VIN L; VIN L	2	EM-2292			
			L & R Front	VIN R; VIN R	2	EM-2328			
			L & R Front	VIN H & VIN J; VIN H; VIN J	2	EM-2281			
		1973-76	1977	L & R Front	VIN H; VIN J	2	EM-2281		
				Trans	VIN L; Auto; VIN L	1		EM-2393	
				Trans	VIN L; Manual; VIN L	1		EM-2393	
				Trans	VIN H & VIN J; Auto; VIN H	1		EM-2394	
		Trans	VIN H & VIN J; Manual; VIN H	1		EM-2394			
		1975-76	Trans		1		EM-2394		
		1973-74	Trans	Auto	1		EM-2394		
Trans			Manual	1		EM-2394			
V8 5.7L 350ci Diesel		1985 1982-83 1985	L & R Front	VIN N	2	EM-2328			
			L & R Front	VIN N	2	EM-2328			
			Trans		1		EM-2360 @		

\* = Hydraulic Mount, "S" suffix = solid replacement.

@ = Universal Mount EM-5000 also available.

# = Available in the Westar Gold Line

# Engine, Transmission, And Torque Strut Mounts

CYL	ENG. SIZE	YEAR	LOCATION	DESCRIPTION	QTY	ENGINE	TORQUE STRUT	TRANSMISSION
<b>BUICK PASSENGER CAR (continued)</b>								
<b>REGAL (continued)</b>								
V8	V8 5.7L 350ci Diesel	1982-83	Trans		1			EM-2360 @
	V8 7.5L 455ci	1973-74	L & R Front		2	EM-2291		
			Trans		1		EM-2374 @	
<b>RIVIERA</b>								
V6	V6 3.8L 231ci	1979-85	L & R Front		2	EM-2777		
		1986-91	RH Front		1	EM-2943'		
		1988-93	Torq Str - Front		1		EM-2662	
		1995-98	Trans - Front		1			EM-3127
		1991	Trans - LH		1			EM-2779
		1989-90	Trans - LH		1			EM-2779
		1986-88	Trans - LH		1			EM-2671
		1982-85	Trans - LH		1			EM-2495
		1979-81	Trans - LH		1			EM-2497
		1989-90	Trans - RH		1			EM-2691
		1982-85	Trans - RH		1			EM-2494
		1979-81	Trans - RH		1			EM-2494
		1995-98	Trans - Rear	Complete Unit	1			EM-5075
		Trans - Rear	Insert Only	1			EM-3065	
	1999	Trans		1			EM-2898	
	V6 4.1L 252ci	1981-84	L & R Front		2	EM-2777		
		1982-84	Trans - LH		1			EM-2495
		1981	Trans - LH		1			EM-2497
		1982-84	Trans - RH		1			EM-2494
		1981	Trans - RH		1			EM-2494
V8	V8 5.0L 307ci	1980-85	L & R Front		2	EM-2629		
		1982-85	Trans - LH		1			EM-2495
		1980-81	Trans - LH		1			EM-2497
		1982-85	Trans - RH		1			EM-2494
		1980-81	Trans - RH		1			EM-2494
	V8 5.7L 350ci	1977-78	L & R Front		2	EM-2328		
	V8 5.7L 350ci Diesel	1981-85	L & R Front		2	EM-2629		
			Trans - LH		1		EM-2495	
			Trans - RH		1		EM-2494	
	V8 6.6L 401ci	1963-65	L & R Front		2	EM-2219		
	V8 6.6L 403ci	1977-78	L & R Front		2	EM-2328		
			L & R Rear		2	EM-5388		
			Trans		1		EM-2360 @	
	V8 7.0L 425ci	1963-66	L & R Front		2	EM-2219		
	V8 7.0L 430ci	1967-69	RH Front		1	EM-2291		
	V8 7.5L 455ci	1970-76	L & R Front		2	EM-2291		
			Trans		1		EM-2360 @	
1973-75		Trans		1		EM-2374 @		
1970-72		Trans		1		EM-2378 @		
<b>ROADMASTER</b>								
V8	V8 5.0L 305ci	1991	L & R Front		2	EM-2292		
			Trans		1		EM-2360 @	
	V8 5.7L 350ci	1992-96	L & R Front		2	EM-2292		
			Trans		1		EM-2394	
	1992-93	Trans		1		EM-2360 @		
<b>SKYHAWK</b>								
L4	L4 1.8L 112ci	1985-86	RH Front		1	EM-2538		
		1983-84	RH Front		1	EM-2496		
		1982	RH Front	Auto; 3 Spd; Vin G; w/ Air	1	EM-2474		
			RH Front	Auto; 3 Spd; VIN G; w/o Air	1	EM-2506		

\* = Hydraulic Mount, "S" suffix = solid replacement. @ = Universal Mount EM-5000 also available.

# Engine, Transmission, And Torque Strut Mounts

CYL	ENG. SIZE	YEAR	LOCATION	DESCRIPTION	QTY	ENGINE	TORQUE STRUT	TRANSMISSION	
<b>BUICK PASSENGER CAR (continued)</b>									
<b>SKYHAWK (continued)</b>									
L4	L4 1.8L 112ci	1982	RH Front	Auto; 4 Spd; VIN G; w/o Air	1	EM-2524			
			RH Front	Manual; 4 Spd; VIN G; w/ Air	1	EM-2473			
		1985-86	RH Rear		1	EM-2477			
			RH Rear		1	EM-2477			
		1982	RH Rear		1	EM-2477			
			Torq Str - Front	Lateral	1		EM-2492		
		Torq Str - Front	Longitudinal	1		EM-2528			
		1985-86	Trans	Complete Unit	1			EM-2601	
			Trans	Auto; Insert	1			EM-2720	
		1982-84	Trans	Manual; Insert	1			EM-2720	
		L4 2.0L 122ci	1985-89	RH Front		1	EM-2538		
				RH Front	Auto w/o Air	1	EM-2506		
			1983-84	RH Front	Auto; w/ Air	1	EM-2474		
	RH Front			Manual; w/ Air	1	EM-2473			
	RH Front		Manual; w/o Air	1	EM-2524				
	1985-89		RH Rear		1	EM-2477			
			RH Rear		1	EM-2477			
	1989		Torq Str - Rear	Longitudinal	1		EM-2528		
			Torq Str - Rear	Lateral	1		EM-2492		
	1983-88		Torq Str - Rear	Longitudinal	1		EM-2528		
			Trans	Auto	1			EM-2601	
	Trans		Manual	1			EM-2601		
	1983-84		Trans	Auto; Insert	1			EM-2720	
			Trans	Manual; Insert	1			EM-2720	
	V6	V6 3.8L 231ci	1975-80	LH Front		1	EM-2382		
				RH Front		1	EM-2384		
			1978	Trans	Auto; VIN 2	1			EM-2379
Trans				Manual	1			EM-2393	
1976-77			Trans	Auto	1			EM-2353	
			Trans	Manual	1			EM-2353	
1975			Trans	Auto	1			EM-2353	
			Trans	Auto	1			EM-2393	
V6 3.8L 3800cc			1978-80	Trans	Auto; VIN A	1			EM-2393
<b>SKYLARK</b>									
L4		L4 2.3L 138ci	1992-95	RH Front	Complete Unit	1	EM-5031*		
	RH Front			Insert	1	EM-2803*			
	1988-91		RH Front		1	EM-2859*			
			RH Rear		1	EM-2952			
	1995		Torq Str - Front		1		EM-2814		
	1992-94		Torq Str - Front		1		EM-2782		
	1992-95		Trans		1			EM-2715	
	L4 2.4L 146ci		1996-98	RH Front	Complete Unit	1	EM-5031*		
				RH Front	Insert	1	EM-2803*		
				Torq Str - Front		1		EM-2814	
		Trans			1			EM-2715	
	L4 2.5L 151ci	1986-91	RH Front		1	EM-2538			
			RH Front		1	EM-2548*			
		1982-84	RH Front		1	EM-2472			
			RH Front		1	EM-2505			
		1986-91	RH Rear		1	EM-2477			
			Torq Str - Front		1		EM-2396		
		1980-84	Torq Str - Front		1		EM-2396		
			Torq Str - Rear		1		EM-2528		
		1980-84	Trans - Front	Auto	1			EM-2466	
			Trans - Front	Manual	1			EM-2467	
	Trans - Rear		Auto	1			EM-2467		

\* = Hydraulic Mount, "S" suffix = solid replacement.

# Engine, Transmission, And Torque Strut Mounts

CYL	ENG. SIZE	YEAR	LOCATION	DESCRIPTION	QTY	ENGINE	TORQUE STRUT	TRANSMISSION	
<b>BUICK PASSENGER CAR (continued)</b>									
<b>SKYLARK (continued)</b>									
L4	L4 2.5L 151ci	1990-91	Trans	Auto	1			EM-2601	
		1986-89	Trans	Auto	1			EM-2601	
			Trans	Manual	1			EM-2601	
			Trans	Auto	1			EM-2543	
		1985	Trans	Manual	1			EM-2543	
L6	L6 4.1L 250ci	1968-71	L & R Front		2	EM-2292			
			Trans	Auto	1			EM-2378 @	
			Trans	Manual	1			EM-2378 @	
V6	V6 2.8L 173ci	1985	RH Front		1	EM-2548*			
		1982-84	RH Front		1	EM-2472			
			RH Front		1	EM-2505			
			Torq Str - Front		1		EM-2396		
		1980-85	Trans - Front	Auto	1			EM-2466	
			Trans - Front	Manual	1			EM-2467	
			Trans - Rear	Auto	1			EM-2467	
	V6 3.0L 181ci	1986-88	RH Front		1	EM-2626			
			RH Rear		1	EM-2477			
			Torq Str - Rear		1		EM-2528		
			Trans	Auto	1			EM-2601	
			Trans	Manual	1			EM-2601	
	V6 3.1L 189ci	1994-98	RH Front	Insert	1	EM-2803*			
			Torq Str - Front		1		EM-2814		
			1994	Torq Str - Front		1		EM-2782	
			1994-98	Trans		1			EM-2715
	V6 3.3L 204ci	1992-93	RH Front	Insert	1	EM-2803*			
			1989-91	RH Front		1	EM-2626		
				RH Rear		1	EM-2477		
				Torq Str - Front		1		EM-2782	
			1989-91	Torq Str - Rear		1		EM-2528	
			1992-93	Trans		1			EM-2715
	V6 3.8L 231ci	1975-79	LH Front		1	EM-2382			
			RH Front		1	EM-2384			
			1979	Trans	Auto	1			EM-2394
				Trans	Manual	1			EM-2394
1976-78			Trans	Auto	1			EM-2394	
1975			Trans	Auto; OEM Design	1			EM-2288 @	
V8	V8 3.5L 215ci	1961-63	L & R Front		2	EM-2219			
	V8 4.3L 260ci	1975-76	L & R Front		2	EM-2328			
			Trans	Auto	1			EM-2360 @	
	V8 4.9L 301ci	1977	L & R Front		2	EM-2387			
			Trans	Auto	1			EM-2360 @	
			Trans	Manual	1			EM-2360 @	
	V8 5.0L 305ci	1977-79	L & R Front		2	EM-2292			
			Trans	Auto	1			EM-2360 @	
			Trans	Manual	1			EM-2360 @	
	V8 5.6L 340ci	1966-67	L & R Front		2	EM-2350			
			Trans	Auto	1			EM-2378 @	
			Trans	Manual	1			EM-2378 @	
	V8 5.7L 350ci	1977-79	L & R Front		2	EM-2292			
			1975-76	L & R Front		2	EM-2281		
			1968-72	L & R Front		2	EM-2281		
1977-79			Trans	Auto	1			EM-2360 @	
			Trans	Manual	1			EM-2360 @	
1975-76	Trans	Auto; THM350 (M38); VIN H	1			EM-2288 @			

\* = Hydraulic Mount, "S" suffix = solid replacement. @ = Universal Mount EM-5000 also available.



# Engine, Transmission, And Torque Strut Mounts

CYL	ENG. SIZE	YEAR	LOCATION	DESCRIPTION	QTY	ENGINE	TORQUE STRUT	TRANSMISSION	
<b>BUICK PASSENGER CAR (continued)</b>									
<b>SKYLARK (continued)</b>									
V8	V8 5.7L 350ci	1975-76	Trans	Auto; THM350 (M38); VIN J	1			EM-2394	
			Trans	Manual; OEM Design	1			EM-2288 @	
		1971-72	Trans	Auto; THM350 (M38); OEM Design	1				EM-2378 @
			Trans	Auto; THM400-475 (M40) OEM Design	1				EM-2268 @
			Trans	Manual	1				EM-2378 @
		1968-70	Trans	Auto; THM350 (M38); OEM Design	1				EM-2378 @
	Trans		Manual	1				EM-2378 @	
	V8 6.6L 400ci	1968	L & R Front		2	EM-2291			
	V8 6.6L 401ci	1965-67	L & R Front		2	EM-2219			
	V8 7.5L 455ci	1970-71	L & R Front		2	EM-2291			
Trans	OEM Design		1			EM-2374 @			
<b>SOMERSET</b>									
L4	L4 2.5L 2474cc	1985-87	RH Front		1	EM-2538			
			RH Rear		1	EM-2477			
			Torq Str - Rear		1		EM-2528		
			Trans	Auto	1			EM-2601	
			Trans	Manual	1			EM-2601	
V6	V6 3.0L 181ci	1985-87	RH Front		1	EM-2626			
			RH Rear		1	EM-2477			
		1986-87	Torq Str - Rear		1		EM-2528		
			Torq Str - Rear		1		EM-2528		
		1985-87	Trans	Auto	1			EM-2601	
			Trans	Manual	1			EM-2601	
<b>SPECIAL</b>									
L6	L6 4.1L 250ci	1968-69	L & R Front		2	EM-2292			
			Trans		1			EM-2378 @	
V6	V6 3.2L 198ci	1962-63	L & R Front		2	EM-2218			
V8	V8 3.5L 215ci	1961-63	L & R Front		2	EM-2218			
	V8 5.7L 350ci	1968-69	L & R Front		2	EM-2281			
<b>SPORTWAGON</b>									
V8	V8 5.6L 340ci	1966-67	L & R Front		2	EM-2350			
			Trans	Manual	1			EM-2378 @	
	V8 5.7L 350ci	1968-72	L & R Front		2	EM-2281			
	V8 6.6L 400ci	1968	L & R Front		2	EM-2291			
<b>SUPER</b>									
V8	V8 5.3L 322ci	1953-56	Trans		1			EM-2070	
<b>VERANO</b>									
L4	L4 2.0L 122ci	2013-16	Trans - Front		1			EM-3194	
			Trans - Rear	Complete Unit	1			EM-4080	
	L4 2.4L 145ci	2012-17	Trans - Center		1			EM-3194	
			Trans - Front		1			EM-4080	
<b>WILDCAT</b>									
V8	V8 6.6L 401ci	1963-66	L & R Front		2	EM-2219			
	V8 7.0L 425ci	1964-66	L & R Front		2	EM-2219			
	V8 7.0L 430ci	1967-69	L & R Front		2	EM-2291			
			Trans	Auto	1			EM-2378 @	
			Trans	Manual	1			EM-2378 @	

@ = Universal Mount EM-5000 also available.

# Engine, Transmission, And Torque Strut Mounts

CYL	ENG. SIZE	YEAR	LOCATION	DESCRIPTION	QTY	ENGINE	TORQUE STRUT	TRANSMISSION
<b>BUICK SPORT UTILITY</b>								
<b>ENCLAVE</b>								
V6	V6 3.6L 217ci	2009-17	Front		1	EM-4037		
		2008	Front		1	EM-3192		
		2009-17	Rear		1	EM-4035		
		2008	Rear		1	EM-3192		
		2009-17	Torq Str - Right		1		EM-3141	
		2008	Torq Str - Right	Bracket Only	1		EM-3143	
			Torq Str - Right	Strut	1		EM-3133	
		2009-17	Trans		1			EM-4036
2008	Trans		1			EM-3192		
<b>ENCORE</b>								
L4	L4 1.4L 83cid	2013-16	Torq Str - Lower		1		EM-4227	
<b>RAINIER</b>								
L6	L6 4.2L 256ci	2004-07	L & R Front		2	EM-3021*		
			Trans		1		EM-3027	
V8	V8 5.3L 325ci	2005-07	LH Front		1	EM-5694		
			RH Front		1	EM-5693		
		2004	Trans	RWD	1			EM-4119
<b>RENDEZVOUS</b>								
V6	V6 3.4L 207ci	2002-05	RH Front		1	EM-2987#		
			Torq Str - Front	Bracket to Radiator Support Complete Unit	2		EM-2900	
			Torq Str - Front	Bracket to Radiator Support Insert	2		EM-4169	
			Torq Str - Front	Complete Unit; LH & RH Front	2		EM-2899	
			Torq Str - Front	Insert Only; LH & RH Front	2		EM-2716	
		Trans		1			EM-2818 #	
	V6 3.5L 213ci	2006-07	RH Front		1	EM-2987#		
			Torq Str - Front	Bracket to Radiator Support Complete Unit	2		EM-2900	
			Torq Str - Front	Bracket to Radiator Support Insert	2		EM-4169	
			Torq Str - Front	Complete Unit; LH & RH Front	2		EM-2899	
			Torq Str - Front	Insert Only; LH & RH Front	2		EM-2716	
		Trans		1			EM-2818 #	
	V6 3.6L 217ci	2004-06	RH Front		1	EM-2987#		
			Torq Str - Front	Bracket to Radiator Support Complete Unit	2		EM-2900	
			Torq Str - Front	Bracket to Radiator Support Insert	2		EM-4169	
Torq Str - Front			Complete Unit; LH & RH Front	2		EM-2899		
Torq Str - Front			Insert Only; LH & RH Front	2		EM-2716		
	Trans		1			EM-2818 #		
<b>BUICK VAN</b>								
<b>TERRAZA</b>								
V6	V6 3.5L 213ci	2005-06	RH Front		1	EM-2987#		
			Torq Str - Front	Bracket to Radiator Support Complete Unit	2		EM-2900	
			Torq Str - Front	Bracket to Radiator Support Insert	2		EM-4169	
			Torq Str - Front	Complete Unit; LH & RH Front	2		EM-2899	
			Torq Str - Front	Insert Only; LH & RH Front	2		EM-2716	
		Trans		1			EM-2818 #	
	V6 3.9L 237ci	2007	RH Front		1	EM-2987#		

\* = Hydraulic Mount, "S" suffix = solid replacement. # = Available in the Westar Gold Line

# Engine, Transmission, And Torque Strut Mounts

CYL	ENG. SIZE	YEAR	LOCATION	DESCRIPTION	QTY	ENGINE	TORQUE STRUT	TRANSMISSION	
<b>BUICK VAN (continued)</b>									
<b>TERRAZA (continued)</b>									
V6	V6 3.9L 237ci	2006-07	Torq Str - Front	Bracket to Radiator Support Complete Unit	2		EM-2900		
			Torq Str - Front	Bracket to Radiator Support Insert	2		EM-4169		
			Torq Str - Front	Complete Unit; LH & RH Front	2		EM-3090		
			Torq Str - Front	Insert Only; LH & RH Front	2		EM-2716		
	Trans		1			EM-2818 #			
	V6 3.9L 3880cc	2006	RH Front		1	EM-2987#			
<b>CADILLAC PASSENGER CAR</b>									
<b>60 SPECIAL</b>									
V8	V8 4.9L	1993	RH Front	Hydraulic Mount	1	EM-2551*			
<b>ALLANTE</b>									
V8	V8 4.1L 250ci	1987-88	RH Front		1	EM-2892'			
			Trans - Center		1		EM-2779		
			Trans - RH Rear		1		EM-2691		
	V8 4.5L 273ci	1989-92	RH Front		1	EM-2892'			
			Torq Str - Front		1		EM-2662		
			Trans - Center		1		EM-2779		
			Trans - LH		1		EM-2779		
	V8 4.6L 281ci	1990-92	Trans - RH Rear		1		EM-2691		
			V8 4.6L 281ci	1993	RH Front		1	EM-2838'	
					Torq Str - Front		1		EM-2781
Torq Str - Front		1				EM-2780			
Trans - LH		1				EM-2893 *			
Trans - RH		1		EM-2837 *					
<b>ATS</b>									
L4	L4 2.0L 122ci	2013-17	Trans	Auto; AWD	1			EM-4218	
			Trans	Auto; RWD	1			EM-4218	
			Trans	Manual; AWD	1			EM-4218	
			Trans	Manual; RWD	1			EM-4218	
V6	V6 3.6L 217ci	2013-16	Trans	Auto; AWD	1			EM-4218	
			Trans	Auto; RWD	1			EM-4218	
			Trans	Manual; AWD	1			EM-4218	
			Trans	Manual; RWD	1			EM-4218	
<b>BROUGHAM</b>									
V8	V8 5.0L	1987-90	L & R Front		2	EM-2387			
			Trans	Auto; THM200-R4 (MW9)	1			EM-2394	
			Trans	Auto; THM400 (M40)	1			EM-2374 @	
	V8 5.0L 305ci	1991-92	Trans	w/ Armored Body	1			EM-2374 @	
Trans	w/o Armored Body	1			EM-2394				
<b>CALAIS</b>									
V8	V8 7.0L 429ci	1965-67	L & R Front		2	EM-2296			
	V8 7.7L 472ci	1968-74	L & R Front		2	EM-2296			
			Trans		1			EM-2320	
	V8 8.2L 500ci	1975-76	L & R Front		2	EM-2470			
Trans				1			EM-2320		
<b>CTS</b>									
V6	V6 2.8L 170ci	2005-07	L & R Front		2	EM-3149			
			Trans		1			EM-3159	
	V6 3.0L 182ci	2011-13	L & R Front	Mexico; RWD	2	EM-4248			
		2010-14	L & R Front	AWD	2	EM-3149			
			L & R Front	RWD	2	EM-4248			

\* = Hydraulic Mount, "S" suffix = solid replacement.

@ = Universal Mount EM-5000 also available.

# = Available in the Westar Gold Line

# Engine, Transmission, And Torque Strut Mounts

CYL	ENG. SIZE	YEAR	LOCATION	DESCRIPTION	QTY	ENGINE	TORQUE STRUT	TRANSMISSION	
<b>CADILLAC PASSENGER CAR (continued)</b>									
<b>CTS (continued)</b>									
V6	V6 3.0L 182ci	2010-13	Trans	Insulator	2			EM-4224	
			Trans		2			EM-4224	
	V6 3.2L 197ci	2003-04	L & R Front		2	EM-3149			
			2004	Trans	Auto	1			EM-3123
			Trans	Manual	1				EM-3162
	V6 3.6L 217ci	2003	Trans	Auto	1				EM-3123
			2011-14	L & R Front	Mexico; RWD	2	EM-4248		
		2008-14	L & R Front	AWD; US & Canada	2	EM-3149			
	V6 3.6L 217ci	2005-07	L & R Front	RWD	2	EM-4248			
			2010-13	Trans	Auto; RWD; Insulator Only	2			EM-4224
			2008-09	Trans	Auto; RWD	2			EM-4224
		2004-07	Trans	Manual; RWD	2				EM-4224
			Trans	Auto	1				EM-3159
		V8 6.2L 376ci	2012-14	L & R Front	Mexico; RWD	2	EM-4248		
2009-14	L & R Front			RWD	2	EM-4248			
V8	V8 5.7L 346ci	2004-05	L & R Front		2	EM-3149			
	V8 6.0L 364ci	2006-07	L & R Front		2	EM-3149			
	V8 6.2L 376ci	2011-15	Trans	Insert	2			EM-4224	
			Trans	Insulator	2			EM-4224	
<b>CIMARRON</b>									
L4	L4 1.8L 112ci	1982	RH Front	Auto; w/ Air	1	EM-2474			
			RH Front	Auto; w/o Air	1	EM-2506			
			RH Front	Manual; w/ Air	1	EM-2473			
			RH Front	Manual; w/o Air	1	EM-2524			
			RH Rear		1	EM-2477			
			Torq Str - Rear	Lateral	1		EM-2492		
			Torq Str - Rear	Longitudinal	1		EM-2528		
			Trans	Auto; Insert	1			EM-2720	
	Trans	Manual; Insert	1			EM-2720			
	L4 2.0L 122ci	1985-86	RH Front		1	EM-2538			
			1983-84	RH Front	Auto	1	EM-2474		
		1985-86	RH Front	Manual	1	EM-2473			
			1983-84	RH Rear		1	EM-2477		
		1983-86	RH Rear		1	EM-2477			
			Torq Str - Rear	Lateral	1		EM-2492		
		1985-86	Torq Str - Rear	Longitudinal	1		EM-2528		
			Trans	Auto	1			EM-2601	
		1983-84	Trans	Manual	1			EM-2601	
			Trans	Auto; Insert	1			EM-2720	
		Trans	Manual; Insert	1			EM-2720		
V6		V6 2.8L 173ci	1985-88	RH Front		1	EM-2538		
	RH Rear			Auto	1	EM-2477			
	RH Rear			Manual	1	EM-2708			
	Torq Str - Rear			Lateral	1		EM-2492		
	Torq Str - Rear			Longitudinal	1		EM-2528		
	Trans			Auto	1			EM-2601	
	Trans			Manual	1			EM-2601	
<b>COMMERCIAL CHASSIS</b>									
V8	V8 7.0L 425ci	1977-79	L & R Front		2	EM-2387			
			Trans		1			EM-2374 @	
	V8 8.2L 500ci	1975-76	L & R Front		2	EM-2470			
			Trans		1			EM-2320	

@ = Universal Mount EM-5000 also available.

# Engine, Transmission, And Torque Strut Mounts

CYL	ENG. SIZE	YEAR	LOCATION	DESCRIPTION	QTY	ENGINE	TORQUE STRUT	TRANSMISSION
<b>CADILLAC PASSENGER CAR (continued)</b>								
<b>CONCOURS</b>								
V8	V8 4.6L 281ci	1994-99	RH Front		1	EM-2838*		
		1997-99	Trans - LH		1			EM-2932 *
		1994-96	Trans - LH		1			EM-2893 *
		1997-99	Trans - RH		1			EM-2837 *
		1994-96	Trans - RH		1			EM-2837 *
<b>DTS</b>								
V8	V8 4.6L 281ci	2006-11	Front		1	EM-3166		
			Rear		1	EM-4212		
			Torg Str - Right		1		EM-3140	
			Trans		1			EM-3153
<b>DEVILLE</b>								
V6	V6 4.1L 252ci	1980-82	LH Front	w/o Wires	1	EM-2382		
			RH Front		1	EM-2384		
			Trans		1			EM-2379
	V6 4.3L 260ci Diesel	1985	RH Front	1st Design	1	EM-2630		
			RH Front	Hydraulic Mount; 2nd Design	1	EM-2553*		
			Trans - LH Front		1		EM-2800	
			Trans - LH Rear		1		EM-2568	
V8	V8 4.1L 250ci	1982-84	L & R Front	RWD	2	EM-2387		
		1987	RH Front	Hydraulic Mount; 3rd Design	1	EM-2553*		
		1986	RH Front	1st Design, Non-Hyd	1	EM-2630		
			RH Front	Hydraulic Mount; 3rd Design	1	EM-2553*		
		1985	RH Front	Solid Mount; 1st. Design	1	EM-2630		
		1985-87	Trans - LH Front		1			EM-2537
			Trans - LH Rear		1			EM-2568
		1982-84	Trans	RWD	1			EM-2907
	V8 4.5L 273ci	1988-90	RH Front		1	EM-2551*		
			Trans - LH Front		1		EM-2537	
			Trans - LH Rear		1		EM-2568	
			Trans - RH Rear		1		EM-2556 *	
	V8 4.6L 281ci	2000-05	RH Front		1	EM-2896*		
			RH Front		1	EM-2838*		
			Torg Str - Front		1		EM-2781	
			Torg Str - Front		1		EM-2780	
			Trans - Center		1		EM-2895 *	
			Trans - LH		1		EM-2932 *	
			Trans - LH		1		EM-2893 *	
			Trans - LH Front		1		EM-3020 *	
			Trans - LH Rear		1		EM-2898	
			Trans - RH		1		EM-2837 *	
	1996	Trans - RH		1		EM-2837 *		
V8 4.9L 300ci	1994-95	RH Front		1	EM-2836*			
		RH Front		1	EM-2551*			
		Torg Str - Front		1		EM-2662		
		Trans - LH		1		EM-2620		
		Trans - LH Front		1		EM-2800		
		Trans - LH Rear		1		EM-2568		
		Trans - RH		1		EM-2951		
1991-93	Trans - RH Rear		1		EM-2821 *			
V8 5.7L 350ci Diesel	1979-84	L & R Front		2	EM-2387			
		Trans		1		EM-2773 @		
V8 6.0L 368ci	1980-81	L & R Front		2	EM-2387			
		1981	Trans		1		EM-2499	

\* = Hydraulic Mount, "S" suffix = solid replacement. @ = Universal Mount EM-5000 also available.

# Engine, Transmission, And Torque Strut Mounts

CYL	ENG. SIZE	YEAR	LOCATION	DESCRIPTION	QTY	ENGINE	TORQUE STRUT	TRANSMISSION
<b>CADILLAC PASSENGER CAR (continued)</b>								
<b>DEVILLE (continued)</b>								
V8	V8 6.0L 368ci	1980	Trans		1			EM-2374 @
	V8 6.4L 390ci	1959-63	L & R Front		2	EM-2238		
	V8 7.0L 425ci	1977-79	L & R Front		2	EM-2387		
			Trans		1		EM-2374 @	
	V8 7.0L 429ci	1965-67	L & R Front		2	EM-2274		
		1964	L & R Front		2	EM-2238		
	V8 7.7L 472ci	1968-74	L & R Front		2	EM-2296		
			Trans		1		EM-2320	
V8 8.2L 500ci	1975-76	L & R Front		2	EM-2470			
		Trans		1		EM-2320		
<b>ELDORADO</b>								
V6	V6 4.1L 252ci	1981-82	L & R Front		2	EM-2777		
			Trans - LH		1		EM-2495	
			Trans - RH		1		EM-2494	
V8	V8 4.1L 250ci	1982-85	L & R Front		2	EM-2629		
		1986-87	RH Front		1	EM-2892'		
		1987	Trans - LH		1			EM-2783
		1986	Trans - LH		1			EM-2783
		1982-85	Trans - LH		1			EM-2497
		1987	Trans - RH		1			EM-2691
		1982-85	Trans - RH		1			EM-2498
		V8 4.5L 273ci	1988-90	RH Front		1	EM-2892'	
	Torq Str - Front				1		EM-2662	
	Trans - LH				1			EM-2779
	Trans - RH				1			EM-2691
	V8 4.6L 281ci	1993-02	RH Front		1	EM-2838'		
			Torq Str - Front		1		EM-2781	
			Torq Str - Front		1		EM-2780	
		1997-02	Trans - LH		1			EM-2932 *
		1993-96	Trans - LH		1			EM-2893 *
		1997-02	Trans - RH		1			EM-2837 *
		1993-96	Trans - RH		1			EM-2837 *
	V8 4.9L 300ci	1992-93	RH Front		1	EM-2836'		
			RH Front		1	EM-2892'		
			Torq Str - Front		1		EM-2662	
			Trans - LH		1			EM-2620
			Trans - LH		1			EM-2779
Trans - RH				1			EM-2951	
V8 5.7L 350ci Diesel	1981-85	L & R Front		2	EM-2629			
		Trans - LH		1			EM-2497	
		Trans - LH		1			EM-2495	
		Trans - RH		1			EM-2498	
		Trans - RH		1			EM-2494	
V8 6.0L 365ci	1957-58	L & R Front		2	EM-2238			
V8 6.0L 368ci	1981	LH Front		1	EM-2629			
		Trans - LH		1			EM-2495	
		Trans - RH		1			EM-2494	
V8 6.4L 390ci	1959-63	L & R Front		2	EM-2238			
V8 7.0L 425ci	1977-78	L & R Front		2	EM-2296			
V8 7.0L 429ci	1964-66	L & R Front		2	EM-2274			
V8 8.2L 500ci	1973-76	L & R Front		2	EM-2296			

\* = Hydraulic Mount, "S" suffix = solid replacement. @ = Universal Mount EM-5000 also available.

# Engine, Transmission, And Torque Strut Mounts

CYL	ENG. SIZE	YEAR	LOCATION	DESCRIPTION	QTY	ENGINE	TORQUE STRUT	TRANSMISSION
<b>CADILLAC PASSENGER CAR (continued)</b>								
<b>ELR</b>								
L4	L4 1.4L 1398cc 85cid	2014-15	Right		1	EM-4189		
			Torq Str - Lower		1		EM-4183	
<b>FLEETWOOD</b>								
V6	V6 4.1L 252ci	1980-82	LH Front		1	EM-2382		
			RH Front		1	EM-2384		
			Trans		1			EM-2379
	V6 4.3L 260ci Diesel	1985	RH Front	1st Design	1	EM-2630		
			RH Front	Hydraulic Mount; 2nd Design	1	EM-2553*		
			Trans - LH Front		1			EM-2800
			Trans - LH Rear		1		EM-2568	
V8	V8 4.1L 250ci	1982-87	L & R Front		2	EM-2387		
			Trans		1			EM-2907
	V8 4.5L 273ci	1988-90	RH Front		1	EM-2551*		
			Trans - LH Front		1			EM-2537
			Trans - LH Rear		1			EM-2568
			Trans - RH Rear		1			EM-2556 *
	V8 4.9L 300ci	1991-92	RH Front		1	EM-2551*		
			Trans - LH Front		1			EM-2800
			Trans - LH Rear		1			EM-2568
			Trans - RH Rear		1			EM-2821 *
	V8 5.0L 307ci	1986	L & R Front		2	EM-2387		
			Trans	Auto	1			EM-2394
	V8 5.7L 350ci	1993-96	L & R Front		2	EM-2292		
		1990-96	Trans	w/ Armored Body	1			EM-2374 @
			Trans	w/o Armored Body	1			EM-2394
	V8 5.7L 350ci Diesel	1979-85	L & R Front		2	EM-2387		
			Trans		1			EM-2773 @
	V8 6.0L 368ci	1980-84	L & R Front		2	EM-2387		
		1982-84	Trans		1			EM-2374 @
		1981	Trans		1			EM-2499
1980		Trans		1			EM-2374 @	
V8 7.0L 425ci	1977-79	L & R Front		2	EM-2387			
		Trans		1			EM-2374 @	
V8 7.0L 429ci	1965-67	L & R Front		2	EM-2274			
V8 7.7L 472ci	1968-74	L & R Front		2	EM-2296			
		Trans		1			EM-2320	
V8 8.2L 500ci	1975-76	L & R Front		2	EM-2470			
		Trans		1			EM-2320	
<b>SEVILLE</b>								
V6	V6 4.1L 252ci	1981-82	L & R Front		2	EM-2777		
			Trans - LH		1			EM-2495
			Trans - RH		1			EM-2494
V8	V8 4.1L 250ci	1982-85	L & R Front		2	EM-2629		
		1986-87	RH Front		1	EM-2892*		
		1987	Trans - LH		1			EM-2783
		1986	Trans - LH		1			EM-2783
		1982-85	Trans - LH		1			EM-2497
		1987	Trans - RH		1			EM-2691
		1986	Trans - RH		1			EM-2498
		1982-85	Trans - RH		1			EM-2498
		V8 4.5L 273ci	1988-90	RH Front		1	EM-2892*	
Torq Str - Front				1		EM-2662		
Trans - LH				1			EM-2779	
Trans - RH				1			EM-2691	

\* = Hydraulic Mount, "S" suffix = solid replacement. @ = Universal Mount EM-5000 also available.

# Engine, Transmission, And Torque Strut Mounts

CYL	ENG. SIZE	YEAR	LOCATION	DESCRIPTION	QTY	ENGINE	TORQUE STRUT	TRANSMISSION
<b>CADILLAC PASSENGER CAR (continued)</b>								
<b>SEVILLE (continued)</b>								
V8	V8 4.6L 281ci	1998-04	RH Front		1	EM-2896*		
		1993-97	RH Front		1	EM-2838*		
		1993-99	Torq Str - Front		1		EM-2781	
			Torq Str - Front		1		EM-2780	
		1998-04	Trans - Center		1			EM-2895 *
		1997	Trans - LH		1			EM-2932 *
		1993-96	Trans - LH		1			EM-2893 *
		1998-04	Trans - LH Front		1			EM-3083 *
		1997	Trans - RH		1			EM-2837 *
		1993-96	Trans - RH		1			EM-2837 *
	1998-04	Trans - Rear		1			EM-3068	
	V8 4.9L 300ci	1992-93	RH Front		1	EM-2836*		
		1991	RH Front		1	EM-2892*		
		1991-93	Torq Str - Front		1		EM-2662	
		1992-93	Trans - LH		1			EM-2620
		1991	Trans - LH		1			EM-2779
	V8 5.7L GAS	1978-80	L & R Front		2	EM-2292		
			Trans	Gas	1			EM-2360 @
	V8 5.7L 350ci Diesel	1978-85	L & R Front		2	EM-2629		
			1982-85	Trans - LH		1		EM-2497
1981			Trans - LH		1		EM-2495	
1982-85			Trans - RH		1		EM-2498	
1981			Trans - RH		1		EM-2494	
1979-80			Trans		1		EM-2360 @	
V8 6.0L 368ci	1980-81	LH Front		1	EM-2629			
		Trans - LH		1		EM-2495		
		Trans - RH		1		EM-2494		
<b>SERIES 75 FLEETWOOD</b>								
V8	V8 6.0L 365ci	1957-58	L & R Front		2	EM-2238		
	V8 6.4L 390ci	1959-63	L & R Front		2	EM-2238		
<b>STS</b>								
V6	V6 3.6L 217ci	2005-11	L & R Front		2	EM-3149		
V8	V8 4.4L 267ci	2006-09	Trans		1			EM-5665
	V8 4.6L 281ci	2005-10	L & R Front		2	EM-3149		
<b>XTS</b>								
V6	V6 3.6L 217ci	2013-17	Right		1	EM-3200		
			Trans - Center	Auto	1		EM-4223	
			Trans - Front	FWD	1		EM-3195	
			Trans - Rear	AWD	1		EM-4261	
			Trans - Rear	FWD	1		EM-3196	
<b>XLR</b>								
V8	V8 4.4L 267ci	2006-09	Trans - L & R		2			EM-5660
	V8 4.6L 281ci	2004-09	L & R Front		2	EM-2993*		
			Trans - L & R		2			EM-5660
<b>CADILLAC SPORT UTILITY</b>								
<b>SRX</b>								
V6	V6 2.8L 170ci	2010-11	Trans - Center		1			EM-3201
			Trans - Front		1		EM-3197	
			Trans - Rear	FWD	1		EM-3196	
	V6 3.0L 182ci	2010-11	Trans - Front		1		EM-3195	
			Trans - Rear	AWD	1		EM-4261	

\* = Hydraulic Mount, "S" suffix = solid replacement. @ = Universal Mount EM-5000 also available.



# Engine, Transmission, And Torque Strut Mounts

CYL	ENG. SIZE	YEAR	LOCATION	DESCRIPTION	QTY	ENGINE	TORQUE STRUT	TRANS-MISSION	
<b>CADILLAC SPORT UTILITY (continued)</b>									
<b>SRX (continued)</b>									
V6	V6 3.0L 182ci	2010-11	Trans - Rear	FWD	1			EM-3196	
	V6 3.6L 217ci	2004-09	LH Front		1	EM-3149			
		2012-16	Trans - Front		1			EM-3195	
			Trans - Rear	AWD	1			EM-4261	
			Trans - Rear	FWD	1			EM-3196	
V8	V8 4.6L 281ci	2004-09	LH Front		1	EM-3149			
		2007-09	Trans	AWD	1			EM-5664	
			Trans	RWD	1			EM-5662	
		2004-06	Trans	RWD	1			EM-5662	
<b>ESCALADE</b>									
V8	V8 5.3L 325ci	2002-05	L & R Front		2	EM-2909#			
			Trans	AWD & 4WD	1			EM-2638	
			Trans	RWD	1			EM-2811	
	V8 5.7L 350ci	1999-00	2000	L & R Front		2	EM-2637		
				Trans	4WD	1			EM-2638
		1999	Trans	RWD	1			EM-2811	
	V8 6.0L 364ci	2009-13	2002-06	L & R Front		2	EM-5583#		
				L & R Front		2	EM-2909#		
		2009-10	2003-06	Trans	AWD	1			EM-2638
				Trans	RWD	1			EM-2811
				Trans	AWD	1			EM-2638
		2002	Trans	RWD	1			EM-2811	
			Trans	AWD	1			EM-2638	
	V8 6.2L 376ci	2007-14	L & R Front		2	EM-5583#			
			LH Front		1	EM-4173			
	V8 6.2L 378ci	2007-10	RH Front		1	EM-4174			
			Trans	AWD	1			EM-2638	
			Trans	RWD	1			EM-2811	
			Trans	Mexico; AWD	1			EM-2638	
	<b>ESCALADE ESV</b>								
V8	V8 6.0L 364ci	2003-06	L & R Front		2	EM-2909#			
			Trans	AWD	1			EM-2638	
	V8 6.2L 376ci	2007-14	2015-16	L & R Front		2	EM-5583#		
				LH Front		1	EM-4173		
		2008-14	2007	RH Front		1	EM-4174		
				Trans	AWD	1			EM-2638
	Trans	RWD	1			EM-2811			
	Trans	AWD	1			EM-2638			
V8 6.2L 378ci	2007-10	Trans	Mexico; AWD	1			EM-2638		
<b>ESCALADE EXT</b>									
V8	V8 6.0L 364ci	2003-06	L & R Front		2	EM-2909#			
			Trans	AWD	1			EM-2638	
	V8 6.2L 376ci	2007-13	L & R Front		2	EM-5583#			
			Trans	AWD	1			EM-2638	
<b>CHEVROLET PASSENGER CAR</b>									
<b>AVEO5</b>									
L4	L4 1.6L 98ci	2007-11	Front	Hydraulic Mount	1	EM-3113			
		2009-11	Torq Str - Front		1		EM-3114		
		2007-08	Torq Str - Front		1		EM-3114		
			Trans		1			EM-3115	

# = Available in the Westar Gold Line

# Engine, Transmission, And Torque Strut Mounts

CYL	ENG. SIZE	YEAR	LOCATION	DESCRIPTION	QTY	ENGINE	TORQUE STRUT	TRANSMISSION	
<b>CHEVROLET PASSENGER CAR (continued)</b>									
<b>AVEO</b>									
L4	L4 1.6L 98ci	2004-11	Front	Hydraulic Mount	1	EM-3113			
		2009-11	Torq Str - Front		1		EM-3114		
		2004-08	Torq Str - Front		1		EM-3114		
			Trans		1			EM-3115	
<b>ASTRA (MEXICO)</b>									
L4	L4 1.8L 1796cc	2006-08	Right		1	EM-9001			
		2000-03	Right		1	EM-9001			
	L4 2.0L 2000cc	2004-08	Right		1	EM-9001			
		L4 2.2L 2198cc	2001-03	Front	Auto	1	EM-9001		
Right				1	EM-9001				
<b>BEL AIR</b>									
L6	L6 3.6L 217ci	1950-51	L & R Front	Manual	2	EM-2053			
			1952	L & R Front Lower		2	EM-2092		
		1950-51	L & R Front Upper		2	EM-2091			
			Trans	Manual	2			EM-2057	
	L6 3.8L 230ci	1965	L & R Front		2	EM-2284			
			1963-64	L & R Front		2	EM-2231		
		1963-65	Trans	Auto	1			EM-2378 @	
			Trans	Manual	1			EM-2378 @	
	L6 3.9L 235ci	1958-62	L & R Front		2	EM-2231			
			1955-57	L & R Front	Large	2	EM-2123		
		1955-57	L & R Front	Small	2	EM-2122			
			Trans - LH	Auto	1			EM-2127	
			Trans - LH	Manual	1			EM-2124	
			Trans - RH	Auto	1			EM-2126	
			Trans - RH	Manual	1			EM-2125	
		1958-62	Trans	Auto	1			EM-2378 @	
			Trans	Manual	1			EM-2378 @	
	L6 3.9L 236ci	1950-54	L & R Front Lower		2	EM-2092			
			L & R Front Upper		2	EM-2091			
	L6 4.1L 250ci	1973	L & R Front		2	EM-2292			
			1965-72	L & R Front		2	EM-2284		
		1973	Trans	Auto	1			EM-2360 @	
			Trans	Manual	1			EM-2337	
		1965-72	Trans	Auto	1			EM-2360 @	
	Trans		Manual	1			EM-2378 @		
	V8	V8 4.3L 265ci	1955-57	L & R Front	Large	2	EM-2123		
				L & R Front	Small	2	EM-2122		
Trans - LH				Auto	1			EM-2127	
Trans - LH				Manual	1			EM-2124	
Trans - RH				Auto	1			EM-2126	
Trans - RH				Manual	1			EM-2125	
V8 4.4L 267ci		1981	L & R Front		2	EM-2292			
			Trans	Auto	1			EM-2360 @	
			Trans	Manual	1			EM-2360 @	
V8 4.6L 283ci		1965-67	L & R Front		2	EM-2142			
			1957-64	L & R Front		2	EM-2267		
		1965-67	LH Front	Power Steering Bracket	1	EM-2278			
			1958-67	Trans	Auto; Powerglide	1			EM-2143
V8 5.0L 305ci		1981	Trans	Manual	1			EM-2378 @	
			L & R Front		2	EM-2292			

@ = Universal Mount EM-5000 also available.

# Engine, Transmission, And Torque Strut Mounts

CYL	ENG. SIZE	YEAR	LOCATION	DESCRIPTION	QTY	ENGINE	TORQUE STRUT	TRANSMISSION
<b>CHEVROLET PASSENGER CAR (continued)</b>								
<b>BEL AIR (continued)</b>								
V8	V8 5.0L 305ci	1981	Trans	Auto	1			EM-2360 @
			Trans	Manual	1			EM-2360 @
	V8 5.0L 307ci	1968	L & R Front		2	EM-2142		
			Trans	Auto	1			EM-2378 @
			Trans	Manual	1			EM-2378 @
	V8 5.4L 327ci	1962-69	L & R Front		2	EM-2267		
			Trans	Auto	1			EM-2268 @
			Trans	Manual	1			EM-2378 @
	V8 5.7L 348ci	1958-60	L & R Front		2	EM-2267		
		1958-61	Trans	Auto; 3 Spd	1			EM-2378 @
			Trans	Auto; Powerglide	1			EM-2143
			Trans	Manual	1			EM-2378 @
	V8 5.7L 350ci	1973-75	L & R Front		2	EM-2292		
		1969-72	L & R Front		2	EM-2283		
		1975	Trans	Auto	1			EM-2337
		1974	Trans	Auto	1			EM-2294
			Trans	Manual	1			EM-2294
		1969-73	Trans	Auto; Powerglide	1			EM-2294
			Trans	Auto; THM400	1			EM-2337
		Trans	Manual	1			EM-2268 @	
	V8 6.5L 396ci	1966-69	L & R Front		2	EM-2283		
		1969	Trans		1			EM-2295
		1966-68	Trans	Auto	1			EM-2378 @
			Trans	Manual	1			EM-2378 @
	V8 6.6L 400ci	1974-75	L & R Front		2	EM-2292		
		1973	L & R Front		2	EM-2395		
		1972	L & R Front	VIN R	2	EM-2395		
		1970-71	L & R Front		2	EM-2283		
		1974-75	Trans	Auto	1			EM-2294
		1971-73	Trans	Auto	1			EM-2337
			Trans	Manual	1			EM-2294
		1970	Trans	Auto	1			EM-2268 @
			Trans	Manual	1			EM-2378 @
	V8 6.6L 402ci	1972	L & R Front	VIN S	2	EM-2283		
	V8 6.7L 409ci	1961-65	L & R Front		2	EM-2285		
			Trans	Auto, 3 Speed	1			EM-2378 @
			Trans	Auto; Powerglide	1			EM-2143
			Trans	Manual	1			EM-2378 @
	V8 7.0L 427ci	1966-69	L & R Front		2	EM-2283		
		1968-69	Trans		1			EM-2295
		1966-67	Trans	Auto	1			EM-2268 @
			Trans	Manual	1			EM-2378 @
V8 7.4L 454ci	1973-75	L & R Front		2	EM-2395			
	1970-72	L & R Front		2	EM-2283			
	1975	Trans	Auto	1			EM-2294	
	1971-74	Trans	Auto	1			EM-2294	
		Trans	Manual	1			EM-2294	
	1970	Trans	Auto	1			EM-2378 @	
		Trans	Manual	1			EM-2378 @	
<b>BERETTA</b>								
L4	L4 2.0L 122ci	1987-89	RH Front		1	EM-2538		
			RH Rear		1	EM-2477		
			Torq Str - Rear		1		EM-2528	
			Trans		1			EM-2601

@ = Universal Mount EM-5000 also available.

# Engine, Transmission, And Torque Strut Mounts

CYL	ENG. SIZE	YEAR	LOCATION	DESCRIPTION	QTY	ENGINE	TORQUE STRUT	TRANSMISSION
<b>CHEVROLET PASSENGER CAR (continued)</b>								
<b>BERETTA (continued)</b>								
L4	L4 2.0L 122ci	1987-89	Trans	Manual	1			EM-2601
		1992-96	RH Front	Complete Unit	1	EM-5031'		
			RH Front	Insert	1	EM-2803'		
		1990-91	RH Front		1	EM-2538		
			RH Rear		1	EM-2477		
		1995-96	Torq Str - Front	Auto	1		EM-2814	
			Torq Str - Front	Manual	1		EM-2782	
		1992-94	Torq Str - Front	Auto	1		EM-2782	
		1990-91	Torq Str - Rear		1		EM-2528	
	1992-96	Trans	Auto	1			EM-2715	
	1990-91	Trans		1			EM-2601	
		Trans	Manual	1			EM-2601	
		Trans	Manual	1			EM-2601	
	L4 2.3L 140ci	1992-94	RH Front	Complete Unit	1	EM-5031'		
			RH Front	Insert	1	EM-2803'		
		1990-91	RH Front		1	EM-2859'		
			RH Rear		1	EM-2952		
		1992-94	Torq Str - Front		1		EM-2782	
1990-91	Trans	Manual; Insert	1			EM-2766		
V6	V6 2.8L 173ci	1987-89	RH Front		1	EM-2538		
			RH Rear	Auto	1	EM-2477		
			RH Rear	Manual	1	EM-2708		
			Torq Str - Front	Lateral	1		EM-2492	
			Torq Str - Front	Longitudinal	1		EM-2528	
			Trans		1			EM-2601
			Trans	Manual	1			EM-2601
	V6 3.1L 189ci	1994-96	RH Front	Insert	1	EM-2803'		
			RH Front	Complete Unit	1	EM-5028'		
		1992-93	RH Front	Insert	1	EM-2803'		
			RH Front	Insert	1	EM-2803'		
		1990-91	RH Front		1	EM-2538		
			RH Rear	Auto	1	EM-2477		
		1995-96	RH Rear	Manual	1	EM-2708		
			Torq Str - Front	Auto	1		EM-2814	
		1992-94	Torq Str - Front		1		EM-2782	
		1990-91	Torq Str - Rear		1		EM-2528	
		1992-96	Trans - Front	Manual	1			EM-5033
			Trans - Rear	Manual	1			EM-5032
			Trans	Auto	1			EM-2715
			1990-91	Trans	Auto	1		EM-2601
Trans	Manual		1			EM-2601		
<b>BISCAYNE</b>								
L6	L6 3.8L 230ci	1965	L & R Front		2	EM-2284		
		1963-64	L & R Front		2	EM-2231		
		1963-65	Trans		1			EM-2378 @
	L6 3.9L 235ci	1958-62	L & R Front		2	EM-2231		
		1958-59	Trans		1			EM-2378 @
	L6 4.1L 250ci	1965-72	L & R Front		2	EM-2284		
			Trans	Auto	1		EM-2360 @	
			Trans	Manual	1		EM-2378 @	
	V8	V8 4.6L 283ci	1965-67	L & R Front		2	EM-2142	
1958-64			L & R Front		2	EM-2267		
1965-67			LH Front	Power Steering Bracket	1	EM-2278		
1958-67			Trans	Auto; Powerglide	1			EM-2143
			Trans	Manual	1			EM-2378 @
V8 5.0L 307ci		1968	L & R Front		2	EM-2142		
		Trans		1			EM-2378 @	

\* = Hydraulic Mount, "S" suffix = solid replacement. @ = Universal Mount EM-5000 also available.

# Engine, Transmission, And Torque Strut Mounts

CYL	ENG. SIZE	YEAR	LOCATION	DESCRIPTION	QTY	ENGINE	TORQUE STRUT	TRANSMISSION
<b>CHEVROLET PASSENGER CAR (continued)</b>								
<b>BISCAYNE (continued)</b>								
V8	V8 5.4L 327ci	1962-69	L & R Front		2	EM-2267		
			Trans	Auto	1		EM-2268 @	
			Trans	Manual	1		EM-2378 @	
	V8 5.7L 348ci	1958-61	L & R Front		2	EM-2267		
			Trans	Auto; 3 Spd	1		EM-2378 @	
			Trans	Auto; Powerglide	1		EM-2143	
			Trans	Manual	1		EM-2378 @	
	V8 5.7L 350ci	1969-72	L & R Front		2	EM-2283		
			Trans	Auto; Powerglide	1		EM-2294	
			Trans	Auto; THM400	1		EM-2337	
	V8 6.5L 396ci	1966-69	L & R Front		2	EM-2283		
		1969	Trans		1		EM-2295	
		1966-68	Trans		1		EM-2378 @	
	V8 6.6L 400ci	1972	L & R Front		2	EM-2395		
		1970-71	L & R Front		2	EM-2283		
		1971-72	Trans	Auto	1		EM-2337	
			Trans	Manual	1		EM-2294	
		1970	Trans	Auto	1		EM-2268 @	
	V8 6.6L 402ci	1971-72	L & R Front		2	EM-2283		
			Trans	Auto; THM350	1		EM-2378 @	
			Trans	Auto; THM400	1		EM-2268 @	
	V8 6.7L 409ci	1961-65	L & R Front		2	EM-2285		
			Trans	Auto; 3 Spd	1		EM-2378 @	
			Trans	Auto; Powerglide	1		EM-2143	
			Trans	Manual	1		EM-2378 @	
	V8 7.0L 427ci	1966-69	L & R Front		2	EM-2283		
		1968-69	Trans		1		EM-2295	
		1966-67	Trans	Auto	1		EM-2268 @	
Trans			Manual	1		EM-2378 @		
V8 7.4L 454ci	1970-72	L & R Front		2	EM-2283			
	1971-72	Trans		1		EM-2294		
	1970	Trans		1		EM-2378 @		
<b>BROOKWOOD</b>								
L6	L6 4.1L 250ci	1969	L & R Front		2	EM-2267		
			Trans		1		EM-2378 @	
V8	V8 5.7L 350ci	1969-72	L & R Front		2	EM-2283		
			Trans	Auto; Powerglide	1		EM-2294	
			Trans	Auto; Turbo-Hydramatic	1		EM-2337	
			Trans	Manual	1		EM-2268 @	
	V8 6.6L 400ci	1972	L & R Front	VIN R	1	EM-2395		
			L & R Front		2	EM-2283		
			Trans		1		EM-2337	
			Trans	Auto; THM350 (M38)	1		EM-2378 @	
			Trans	Auto; THM400 (M40)	1		EM-2268 @	
	V8 6.6L 402ci	1972	L & R Front	VIN S	2	EM-2283		
Trans	Auto; THM350 (M38)	1		EM-2378 @				
<b>CAMARO</b>								
L4	L4 2.5L 151ci	1982-86	LH Front		1	EM-2549		
			RH Front		1	EM-2550		
		1984-86	Trans	Auto	1		EM-2392	
			Trans	Manual; 5 Spd	1		EM-2393	

@ = Universal Mount EM-5000 also available.

# Engine, Transmission, And Torque Strut Mounts

CYL	ENG. SIZE	YEAR	LOCATION	DESCRIPTION	QTY	ENGINE	TORQUE STRUT	TRANSMISSION	
<b>CHEVROLET PASSENGER CAR (continued)</b>									
<b>CAMARO (continued)</b>									
L4	L4 2.5L 151ci	1983	Trans	Auto; 3 Spd	1			EM-2392	
			Trans	Manual; 4 Spd	1			EM-2392	
			Trans	Manual; 5 Spd	1			EM-2393	
		1982	Trans	Auto; 3 Spd	1			EM-2392	
			Trans	Manual; 4 Spd	1			EM-2392	
L6	L6 3.8L 230ci	1967-69	L & R Front		2	EM-2142			
			Trans	Auto	1			EM-2378 @	
			Trans	Manual	1			EM-2378 @	
	L6 4.1L 250ci	1973-79	L & R Front		2	EM-2292			
			1971-72	L & R Front		2	EM-2284		
			1967-70	L & R Front		2	EM-2267		
		1976-79	Trans	Auto	1			EM-2360 @	
			Trans	Manual	1			EM-2360 @	
		1975	Trans	Auto	1			EM-2378 @	
			Trans	Manual	1			EM-2337	
		1967-74	Trans	Auto	1			EM-2378 @	
	Trans		Manual	1			EM-2378 @		
	V6	V6 2.8L 173ci	1982-89	L & R Front		2	EM-2436		
Trans				Auto	1			EM-2394	
1982-87			Trans		1			EM-2394	
V6 3.1L 189ci		1990-92	L & R Front		2	EM-2436			
			Trans	Auto	1			EM-2394	
V6 3.4L 207ci		1993-95	L & R Front		2	EM-2436			
			Trans		1			EM-2880 *	
V6 3.6L 217ci		2010-15	L & R Front		2	EM-4149			
			Trans	Auto	1			EM-4241	
			Trans	Manual	1			EM-4225	
V6 3.8L 229ci		1980-81	L & R Front		2	EM-2436			
			Trans		1			EM-2360 @	
V6 3.8L 231ci		1995-02	LH Front		1	EM-2436			
			1980-81	LH Front		1	EM-2382		
			1995-02	RH Front		1	EM-2878		
			1980-81	RH Front		1	EM-2384		
			1995-02	Trans		1			EM-2880 *
	1980-81		Trans	Auto	1			EM-2379	
Trans	Manual	1			EM-2379				
V8	V8 4.4L 267ci	1980-81	L & R Front		2	EM-2292			
			Trans	Auto	1			EM-2360 @	
			Trans	Manual	1			EM-2360 @	
	V8 4.9L 302ci	1967-68	L & R Front		2	EM-2285			
			Trans	Manual	1			EM-2378 @	
	V8 5.0L 302ci	1969-73	L & R Front		2	EM-2267			
	V8 5.0L 305ci	1976-92	L & R Front		2	EM-2292			
			1982-92	Trans		1			EM-2394
			1976-81	Trans	Auto	1			EM-2360 @
	Trans	Manual		1			EM-2360 @		
	V8 5.0L 307 ci	1969-73	Trans	Auto	1			EM-2378 @	
			Trans	Manual	1			EM-2378 @	
	V8 5.4L 327ci	1967-69	L & R Front		2	EM-2267			
			Trans	Auto	1			EM-2378 @	
			Trans	Manual	1			EM-2378 @	
V8 5.7L 350ci	1998-02	L & R Front		2	EM-3064				
		1987-92	L & R Front		2	EM-2292			
		1972-81	L & R Front	Hi-Perf Engine	2	EM-2395			

\* = Hydraulic Mount, "S" suffix = solid replacement. @ = Universal Mount EM-5000 also available.

# Engine, Transmission, And Torque Strut Mounts

CYL	ENG. SIZE	YEAR	LOCATION	DESCRIPTION	QTY	ENGINE	TORQUE STRUT	TRANSMISSION	
<b>CHEVROLET PASSENGER CAR (continued)</b>									
<b>CAMARO (continued)</b>									
V8	V8 5.7L 350ci	1972-81	L & R Front	Std Engine	2	EM-2292			
		1970-71	L & R Front		2	EM-2267			
		1967-69	L & R Front		2	EM-2285			
		1993-97	LH Front		1	EM-3045			
			RH Front		1	EM-3046			
		1998-02	Trans	Manual		1		EM-3125	
		1994-97	Trans	Auto		1		EM-2811	
			Trans	Manual		1		EM-2394	
		1993	Trans			1		EM-2394	
		1987-92	Trans	Auto; 4 Spd		1		EM-2360 @	
			Trans	Manual; 5 Spd		1		EM-2360 @	
		1976-81	Trans	Auto		1		EM-2360 @	
			Trans	Manual		1		EM-2360 @	
		1975	Trans	Auto		1		EM-2268 @	
			Trans	Manual		1		EM-2378 @	
		1974	Trans	Auto		1		EM-2378 @	
			Trans	Manual		1		EM-2378 @	
		1973	Trans	Auto		1		EM-2378 @	
	Trans		Manual		1		EM-2378 @		
	1967-72	Trans	Auto; THM400		1		EM-2268 @		
		Trans	Manual		1		EM-2378 @		
	V8 6.2L 376ci	2010-15	Trans	Auto		1		EM-4226	
			Trans	Manual		1		EM-4226	
			Trans			1		EM-4225	
			Trans			1		EM-4226	
	V8 6.5L 396ci	1967-69	L & R Front			2	EM-2283		
			Trans	Auto; THM350		1		EM-2378 @	
			Trans	Manual		1		EM-2378 @	
V8 6.6L 402ci	1970-72	L & R Front			2	EM-2283			
		Trans	Auto; THM350		1		EM-2378 @		
		Trans	Manual		1		EM-2378 @		
V8 7.0L 427ci	2014-15	Trans	Manual		1		EM-4226		
<b>CAPRICE</b>									
L6	L6 4.1L 250ci	1977-79	L & R Front		2	EM-2292			
		1967-69	L & R Front		2	EM-2284			
		1977-79	Trans		1			EM-2360 @	
		1967-69	Trans	Auto		1		EM-2360 @	
			Trans	Manual		1		EM-2378 @	
V6	V6 3.8L 229ci	1980-84	L & R Front		2	EM-2436			
		1983-84	Trans		1			EM-2360 @	
		1980-82	Trans		1			EM-2379	
	V6 3.8L 231ci	1980-85	LH Front			1	EM-2382		
			RH Front			1	EM-2384		
			Trans			1			EM-2379
	V6 4.3L 262ci	1992-93	L & R Front			2	EM-2627		
			L & R Front			2	EM-2627		
			L & R Front			2	EM-2436		
			Trans			1			EM-2360 @
			Trans			1			EM-2360 @
	V8 6.0L 364ci	2011-17	Trans			1		EM-4225	
V8	V8 4.3L 265ci	1994-96	L & R Front		2	EM-2292			
		Trans			1			EM-2394	
V8 4.4L 267ci	1980-82	L & R Front			2	EM-2292			

@ = Universal Mount EM-5000 also available.

# Engine, Transmission, And Torque Strut Mounts

CYL	ENG. SIZE	YEAR	LOCATION	DESCRIPTION	QTY	ENGINE	TORQUE STRUT	TRANSMISSION
<b>CHEVROLET PASSENGER CAR (continued)</b>								
<b>CAPRICE (continued)</b>								
V8	V8 4.4L 267ci	1980-82	Trans		1			EM-2360 @
	V8 4.6L 283ci	1966-67	L & R Front		2	EM-2267		
			Trans	Auto; Powerglide	1		EM-2143	
	V8 5.0L 305ci	1977-93 1985-93 1979-84 1977-78	L & R Front		2	EM-2292		
			Trans	Auto	1		EM-2360 @	
			Trans	Auto	1		EM-2337	
			Trans		1		EM-2360 @	
	V8 5.0L 307ci	1986-90	L & R Front		2	EM-2328		
			Trans	Auto	1		EM-2360 @	
	V8 5.4L 327ci	1966-69	L & R Front		2	EM-2142		
			Trans		1		EM-2268 @	
	V8 5.7L 350 ci Gas	1980	L & R Front		2	EM-2292		
	V8 5.7L 350ci	1986-96 1975-79 1969-74 1994-96 1986-93 1975-80 1971-74 1969-70	L & R Front		2	EM-2292		
			L & R Front		2	EM-2292		
			L & R Front		2	EM-2283		
			Trans		1		EM-2394	
			Trans		1		EM-2360 @	
			Trans	Auto	1		EM-2337	
			Trans	Auto	1		EM-2294	
			Trans	Manual	1		EM-2294	
			Trans	Auto	1		EM-2295	
			Trans	Manual	1		EM-2295	
	V8 5.7L 350ci Diesel	1980-85	L & R Front	VIN N	2	EM-2328		
			Trans	Auto	1		EM-2360 @	
	V8 6.5L 396ci	1968-69 1966-67 1969 1966-68	L & R Front		2	EM-2283		
			L & R Front		2	EM-2283		
			Trans	Auto	1		EM-2295	
			Trans	Auto	1		EM-2378 @	
	V8 6.6L 400ci	1972-76 1970-71 1975-76 1971-74 1970	L & R Front		2	EM-2395		
			L & R Front		2	EM-2283		
			Trans	Auto	1		EM-2294	
			Trans	Auto	1		EM-2294	
			Trans	Manual	1		EM-2294	
	V8 6.6L 402ci	1971-72	L & R Front		2	EM-2283		
			Trans	Auto; THM350	1		EM-2378 @	
			Trans	Auto; THM400	1		EM-2268 @	
	V8 7.0L 427ci	1966-69 1968-69 1966-67	L & R Front		2	EM-2283		
			Trans		1		EM-2295	
			Trans	Auto	1		EM-2268 @	
			Trans	Manual	1		EM-2378 @	
	V8 7.4L 454ci	1973-76 1970-72 1975-76 1971-74 1970	L & R Front		2	EM-2395		
			L & R Front		2	EM-2283		
Trans			Auto	1		EM-2294		
Trans			Auto	1		EM-2294		
Trans			Manual	1		EM-2294		
Trans		1		EM-2378 @				
<b>CAVALIER</b>								
L4	L4 1.8L 112ci	1982	RH Front	Auto; w/ Air	1	EM-2474		
			RH Front	Auto; w/o Air	1	EM-2506		
			RH Front	Manual; w/ Air	1	EM-2473		
			RH Front	Manual; w/o Air	1	EM-2524		
			RH Rear		1	EM-2477		
			Torq Str - Rear	Lateral	1		EM-2492	
			Torq Str - Rear	Longitudinal	1		EM-2528	

@ = Universal Mount EM-5000 also available.



# Engine, Transmission, And Torque Strut Mounts

CYL	ENG. SIZE	YEAR	LOCATION	DESCRIPTION	QTY	ENGINE	TORQUE STRUT	TRANSMISSION	
<b>CHEVROLET PASSENGER CAR (continued)</b>									
<b>CAVALIER (continued)</b>									
L4	L4 1.8L 112ci	1982	Trans	Auto; Insert	1			EM-2720	
			Trans	Manual; Insert	1			EM-2720	
	L4 2.0L 122ci	1985-89	RH Front		1	EM-2538			
			1983-84	RH Front	Auto; w/ Air	1	EM-2474		
				RH Front	Auto; w/o Air	1	EM-2506		
				RH Front	Manual; w/ Air	1	EM-2473		
				RH Front	Manual; w/o Air	1	EM-2524		
		1985-89	RH Rear		1	EM-2477			
		1983-84	RH Rear		1	EM-2477			
		1987-89	Torq Str - Rear		1		EM-2528		
		1983-86	Torq Str - Rear	Lateral	1		EM-2492		
			Torq Str - Rear	Longitudinal	1		EM-2528		
		1985-89	Trans	Auto	1			EM-2601	
			Trans	Manual	1			EM-2601	
	1983-84		Trans	Auto; Insert	1			EM-2720	
			Trans	Manual; Insert	1			EM-2720	
	L4 2.2L 134ci	2002-05	RH Front	DOHC	1	EM-3128			
			1995-02	RH Front	OHV; Complete Unit	1	EM-5026*		
				RH Front	OHV; Insert	1	EM-2803*		
		1990-94	RH Front		1	EM-2538			
			RH Rear		1	EM-2477			
		1995-05	Torq Str - Front		1		EM-2798		
		1990-94	Torq Str - Rear		1		EM-2528		
		1995-05	Trans - Front	Manual; Insert	1			EM-2923	
			Trans - Rear	Manual; Insert	1			EM-2924	
			Trans	Auto	1			EM-2820	
			1990-94	Trans	Auto	1			EM-2601
		Trans		Manual	1			EM-2601	
	L4 2.3L 138ci	1995	RH Front	Insert	1	EM-2803*			
			Torq Str - Front		1		EM-2798		
			Trans - Front	Manual; Insert	1			EM-2923	
			Trans - Rear	Manual; Insert	1			EM-2924	
			Trans	Auto	1			EM-2820	
	L4 2.4L 146ci	1996-02	RH Front	Insert	1	EM-2803*			
			Torq Str - Front		1		EM-2798		
			Trans - Front	Manual; Insert	1			EM-2923	
			Trans - Rear	Manual; Insert	1			EM-2924	
			Trans	Auto	1			EM-2820	
	V6	V6 2.8L 173ci	1987-89	RH Front		1	EM-2538		
				1985-86	RH Front		1	EM-2538	
1987-89			RH Rear	Auto	1	EM-2477			
			RH Rear	Manual	1	EM-2708			
1985-86			RH Rear		1	EM-2477			
1985-89			Torq Str - Front	Lateral	1		EM-2492		
			Torq Str - Front	Longitudinal	1		EM-2528		
			Trans	Auto	1			EM-2601	
1985-89		Trans	Manual	1			EM-2601		
		V6 3.1L 189ci	1990-94	RH Front		1	EM-2538		
RH Rear				Auto	1	EM-2477			
RH Rear				Manual	1	EM-2708			
Torq Str - Rear					1		EM-2528		
Trans	Auto			1			EM-2601		
Trans	Manual	1			EM-2601				

\* = Hydraulic Mount, "S" suffix = solid replacement.

# Engine, Transmission, And Torque Strut Mounts

CYL	ENG. SIZE	YEAR	LOCATION	DESCRIPTION	QTY	ENGINE	TORQUE STRUT	TRANSMISSION	
<b>CHEVROLET PASSENGER CAR (continued)</b>									
<b>CELEBRITY</b>									
L4	L4 2.5L 2474cc	1985-90	RH Front		1	EM-2548*			
		1982-84	RH Front		1	EM-2472			
		1982-90	Torq Str - Front		1		EM-2396		
		1985-86	Trans - Front	Manual; 4 Spd	1			EM-2466	
		1982-84	Trans - Front	Auto	1			EM-2467	
		1985-86	Trans - Rear	Manual; 4 Spd	1			EM-2467	
		1987-90	Trans	Auto	1			EM-2543	
		1985-86	Trans	Auto; MD9	1			EM-2543	
V6	V6 2.8L 173ci	1985-89	Front		1	EM-2548*			
		1982-84	Front		1	EM-2472			
		1982-89	Torq Str - Front		1		EM-2396		
		1989	Trans - Front	Auto	1			EM-2466	
			Trans - Front	Manual	1			EM-2467	
		1984-86	Trans - Front	Auto	1			EM-2466	
			Trans - Front	Manual	1			EM-2467	
		1982-83	Trans - Front	Auto	1			EM-2467	
		1987-88	Trans - LH Front	Auto	1			EM-2466	
			Trans - LH Front	Manual	1			EM-2762	
			Trans - LH Rear	Auto	1			EM-2467	
			Trans - LH Rear	Manual	1			EM-2467	
		1989	Trans - Rear	Auto	1			EM-2467	
	1984-86	Trans - Rear	Auto	1			EM-2467		
	V6 3.1L 189ci	1990	RH Front		1	EM-2548*			
			Torq Str - Front		1		EM-2396		
			Trans - LH Front		1			EM-2466	
			Trans - LH Rear		1			EM-2467	
	V6 4.3L 260ci Diesel	1982-85	RH Front		1	EM-2472			
			Torq Str - Front		1		EM-2396		
Trans - Front			Auto	1			EM-2467		
<b>CHEVELLE</b>									
L6	L6 3.2L 194ci	1964-66	L & R Front		2	EM-2284			
			Trans		1			EM-2378 @	
	L6 3.8L 230ci	1965-69	L & R Front		2	EM-2284			
			1964	L & R Front		2	EM-2231		
			1964-69	Trans		1			EM-2378 @
	L6 4.1L 250ci	1973	L & R Front		2	EM-2292			
			1967-72	L & R Front		2	EM-2284		
			Trans	Auto	1			EM-2360 @	
			Trans	Manual; 3 Spd	1			EM-2337	
			Trans	Manual; 4 Spd	1			EM-2294	
			1967-72	Trans	Auto	1			EM-2360 @
		1967-72	Trans	Manual; 3 Spd	1			EM-2378 @	
V8	V8 4.6L 283ci	1964-67	L & R Front		2	EM-2142			
			Trans	Auto	1			EM-2268 @	
			Trans	Manual	1			EM-2378 @	
	V8 5.0L 307ci	1968-73	L & R Front		2	EM-2142			
			Trans	Manual	1			EM-2378 @	
	V8 5.4L 327ci	1964-68	L & R Front		2	EM-2142			
			Trans		1			EM-2378 @	
	V8 5.7L 350ci	1973	L & R Front		2	EM-2292			
			1969-72	L & R Front		2	EM-2283		
			Trans	Auto	1			EM-2360 @	
			Trans	Manual; 3 Spd	1			EM-2360 @	
Trans			Manual; 4 Spd	1			EM-2294		
1969-72	Trans		1			EM-2295			

\* = Hydraulic Mount, "S" suffix = solid replacement. @ = Universal Mount EM-5000 also available.

# Engine, Transmission, And Torque Strut Mounts

CYL	ENG. SIZE	YEAR	LOCATION	DESCRIPTION	QTY	ENGINE	TORQUE STRUT	TRANSMISSION
<b>CHEVROLET PASSENGER CAR (continued)</b>								
<b>CHEVELLE (continued)</b>								
V8	V8 6.5L 396ci	1968-69	L & R Front		2	EM-2283		
		1966-67	L & R Front		2	EM-2285		
		1966-69	Trans	Auto; THM350	1			EM-2378 @
			Trans	Auto; THM400	1			EM-2268 @
			Trans	Manual	1			EM-2378 @
	V8 6.6L 400ci	1970-71	L & R Front		2	EM-2283		
			Trans	Auto; THM350	1		EM-2378 @	
			Trans	Auto; THM400	1		EM-2295	
			Trans	Manual	1		EM-2378 @	
	V8 6.6L 402ci	1972	L & R Front		1	EM-2283		
			L & R Front		2	EM-2283		
			Trans		1		EM-2378 @	
			Trans	Auto; THM350	1		EM-2378 @	
		1970	Trans	Auto; THM400	1		EM-2268 @	
			Trans	Auto; THM350	1		EM-2378 @	
			Trans	Auto; THM400	1		EM-2268 @	
			Trans	Manual	1		EM-2378 @	
	V8 7.4L 454ci	1973	L & R Front		2	EM-2395		
L & R Front				2	EM-2283			
1970-72		Trans		1		EM-2360 @		
		Trans		1		EM-2294		
<b>CHEVETTE</b>								
L4	L4 1.4L 1393cc	1976-77	L & R Front		2	EM-2381		
			Trans		1		EM-2391	
	L4 1.6L 98ci	1976-87	L & R Front		2	EM-2381		
			Trans		1		EM-2391	
	L4 1.8L 1819cc Diesel	1981-86	L & R Front		2	EM-2381		
Trans				1		EM-2391		
<b>CHEVY (MEXICO)</b>								
L4	L4 1.4L 1389cc	1997-01	LH Front	Bushing	1	EM-9002		
			LH Front	Bushing	1	EM-9002		
		1997-01	RH Front	Bushing	1	EM-5682		
			RH Front	Complete Unit	1	EM-9000		
			Rear	Bushing	1	EM-2657		
	L4 1.6L 1588cc	1996	LH Front	Bushing	1	EM-9002		
	L4 1.6L 1597cc	1997-12	LH Front	Bushing	1	EM-9002		
			RH Front	Bushing	1	EM-5682		
			RH Front	Complete Unit	1	EM-9000		
			Rear	Bushing	1	EM-2657		
<b>CHEVY II / NOVA (PRE 1968)</b>								
L4	L4 2.5L 153ci	1968	Trans	Auto; THM400	1		EM-2268 @	
			Trans	Manual	1		EM-2378 @	
		1962-67	Trans	Auto	1		EM-2378 @	
			Trans	Manual	1		EM-2378 @	
L6	L6 3.2L 194ci	1962-67	L & R Front		2	EM-2231		
			Trans	Auto	1		EM-2378 @	
			Trans	Manual	1		EM-2378 @	
	L6 3.8L 230ci	1968	L & R Front		2	EM-2231		
			L & R Front		2	EM-2231		
			Trans	Auto; THM400	1		EM-2268 @	
			Trans	Auto	1		EM-2378 @	
			Trans	Manual	1		EM-2378 @	
L6 4.1L 250ci	1967-68	L & R Front		2	EM-2284			

@ = Universal Mount EM-5000 also available.

# Engine, Transmission, And Torque Strut Mounts

CYL	ENG. SIZE	YEAR	LOCATION	DESCRIPTION	QTY	ENGINE	TORQUE STRUT	TRANS-MISSION
<b>CHEVROLET PASSENGER CAR (continued)</b>								
<b>CHEVY II / NOVA (PRE 1968) (continued)</b>								
L6	L6 4.1L 250ci	1967-68	Trans	Auto	1			EM-2378 @
			Trans	Manual	1			EM-2378 @
V8	V8 4.6L 283ci	1963-67	L & R Front		2	EM-2267		
			Trans	Auto	1			EM-2378 @
			Trans	Manual	1			EM-2378 @
	V8 5.0L 307ci	1968	L & R Front		2	EM-2142		
			Trans	Auto	1			EM-2268 @
			Trans	Manual	1			EM-2378 @
	V8 5.4L 327ci	1965-68	L & R Front		2	EM-2142		
			Trans	Auto	1			EM-2378 @
			Trans	Manual	1			EM-2378 @
	V8 5.7L 350ci	1968	L & R Front		2	EM-2283		
Trans				1			EM-2295	
V8 6.5L 396ci	1968			1	EM-2285			
		Trans	Auto; THM350	1			EM-2378 @	
		Trans	Auto; THM400	1			EM-2268 @	
		Trans	Manual	1			EM-2378 @	
<b>CITATION</b>								
L4	L4 2.5L 2474cc	1982-83 1980-81 1980-83	RH Front		1	EM-2472		
			RH Front		1	EM-2505		
			Torq Str - Front		1		EM-2396	
			Trans - Front	Auto	1			EM-2466
			Trans - Front	Manual	1			EM-2467
			Trans - Rear	Auto	1			EM-2467
V6	V6 2.8L 173ci	1985 1982-84 1980-81 1980-85 1984-85 1980-83 1984-85 1980-83	RH Front		1	EM-2548*		
			RH Front		1	EM-2472		
			RH Front		1	EM-2505		
			Torq Str - Front		1		EM-2396	
			Trans - Front	Mexico; Manual	1			EM-2466
			Trans - Front	Auto	1			EM-2466
			Trans - Front	Manual	1			EM-2467
			Trans - Rear	Mexico; Manual	1			EM-2467
Trans - Rear	Auto	1			EM-2467			
<b>CITATION II</b>								
L4	L4 2.5L 151ci	1985 1984 1984-85	RH Front		1	EM-2548*		
			RH Front		1	EM-2472		
			Torq Str - Front		1		EM-2396	
			Trans - Front	Manual	1			EM-2466
			Trans - Rear	Manual	1			EM-2467
			Trans	Auto	1			EM-2543
V6	V6 2.8L 173ci	1984-85	Torq Str - Front		1		EM-2396	
			Trans - Front	Auto	1			EM-2466
			Trans - Front	Manual	1			EM-2467
			Trans - Rear	Auto	1			EM-2467
<b>CLASSIC</b>								
L4	L4 2.2L 134ci	2004-05	Right		1	EM-3129		
			Trans - Center		1			EM-2874
			Trans - LH Front	Complete Unit	1			EM-3070
			Trans - LH Front	Insert Only	1			EM-5422
			Trans - LH Rear	Complete Unit	1			EM-5078
			Trans - LH Rear	Insert Only	1			EM-2875

\* = Hydraulic Mount, "S" suffix = solid replacement. @ = Universal Mount EM-5000 also available.

# Engine, Transmission, And Torque Strut Mounts

CYL	ENG. SIZE	YEAR	LOCATION	DESCRIPTION	QTY	ENGINE	TORQUE STRUT	TRANSMISSION		
<b>CHEVROLET PASSENGER CAR (continued)</b>										
<b>COBALT</b>										
L4	L4 2.0L 122ci	2008-09	RH Front		1	EM-3108				
		2005-07	RH Front	Manual	1	EM-3108				
		2009-10	Trans - Upper		1			EM-3092		
		2008	Trans - Upper	Auto	1			EM-3092		
		2005-07	Trans - Upper		1			EM-3092		
	L4 2.2L 134ci	2005-10	RH Front	Auto	1	EM-3109				
			RH Front	Manual	1	EM-3108				
			Trans - Center		1			EM-4158		
			Trans - Front	Auto	1			EM-3086		
	L4 2.4L 145ci	2006-08	Trans - Front	Bushing Only; Auto	1			EM-3043		
			RH Front	Auto	1	EM-3109				
			RH Front	Manual	1	EM-3108				
			Trans - Front	Auto	1			EM-3086		
			Trans - Front	Bushing Only; Auto	1			EM-3043		
<b>CORSA (MEXICO)</b>										
L4	L4 1.8L 1796cc	2002-08	RH Rear	Complete Unit	1	EM-9000				
			Rear	Complete Unit	1	EM-9000				
			Trans - Front Lower	Complete Unit	1			EM-90015		
<b>CORSICA</b>										
L4	L4 2.0L 122ci	1987-89	RH Front		1	EM-2538				
			RH Rear		1	EM-2477				
		1987-88	Torq Str - Rear		1		EM-2528			
		1987-89	Trans	Auto	1			EM-2601		
			Trans	Manual	1			EM-2601		
	L4 2.2L 134ci	1992-96	RH Front	Insert	1	EM-2803*				
			RH Front		1	EM-2538				
		1995-96	RH Rear		1	EM-2477				
			Torq Str - Front	Auto	1		EM-2814			
		1992-94	Torq Str - Front	Manual	1		EM-2782			
			Torq Str - Front	Auto	1		EM-2782			
		1992-94	Torq Str - Front	Manual	1		EM-2782			
		1990-91	Torq Str - Rear		1		EM-2528			
		1992-96	Trans	Auto	1			EM-2715		
		1990-91	Trans	Auto	1			EM-2601		
		1990-91	Trans	Manual	1			EM-2601		
		V6	V6 2.8L 173ci	1987-89	RH Front		1	EM-2538		
RH Rear	Auto				1	EM-2477				
RH Rear	Manual				1	EM-2708				
Torq Str - Rear	Lateral				1		EM-2492			
Torq Str - Rear	Longitudinal				1		EM-2528			
Trans	Auto				1			EM-2601		
Trans	Manual				1			EM-2601		
V6 3.1L 189ci	1994-96				RH Front	Insert	1	EM-2803*		
					RH Front	Complete Unit	1	EM-5028*		
					RH Front	Insert	1	EM-2803*		
	1990-91		RH Front		1	EM-2538				
			RH Rear	Auto	1	EM-2477				
	1995-96		RH Rear	Manual	1	EM-2708				
			Torq Str - Front	Auto	1		EM-2814			
	1992-94		Torq Str - Front	Auto	1		EM-2782			
	1990-91		Torq Str - Rear		1		EM-2528			
	1992-96		Trans - Front	Manual	1			EM-5033		
	Trans - Rear		Manual	1			EM-5032			
	Trans		Auto	1			EM-2715			
1990-91	Trans		Auto	1			EM-2601			

\* = Hydraulic Mount, "S" suffix = solid replacement.

# Engine, Transmission, And Torque Strut Mounts

CYL	ENG. SIZE	YEAR	LOCATION	DESCRIPTION	QTY	ENGINE	TORQUE STRUT	TRANSMISSION
<b>CHEVROLET PASSENGER CAR (continued)</b>								
<b>CORSICA (continued)</b>								
V6	V6 3.1L 189ci	1990-91	Trans	Manual	1			EM-2601
<b>CORVETTE</b>								
L6	L6 3.9L 236ci	1953-55	L & R Front Lower		2	EM-2092		
V8	V8 4.3L 265ci	1955-56	L & R Front Lower		2	EM-2092		
	V8 4.6L 283ci	1957-60	L & R Front Lower		2	EM-2092		
	V8 5.0L 305ci	1980	L & R Front		2	EM-2292		
			Trans		1		EM-2360 @	
	V8 5.4L 327ci	1962-68	L & R Front		2	EM-2285		
			Trans	Auto	1		EM-2378 @	
			Trans	Manual	1		EM-2378 @	
	V8 5.7L 350ci	1997-04	L & R Front		2	EM-2993'		
			1992-96	L & R Front		2	EM-2902'	
		1984-91	L & R Front		2	EM-2713		
		1969-82	L & R Front		2	EM-2249		
		1982	Trans		1		EM-2268 @	
		1979-81	Trans	Auto	1		EM-2268 @	
			Trans	Manual	1		EM-2378 @	
		1969-78	Trans	Auto	1		EM-2378 @	
	1969-78	Trans	Manual	1		EM-2378 @		
	V8 6.0L 364ci	2005-07	L & R Front		2	EM-2993'		
			Trans		1		EM-5660	
	V8 6.2L 376ci	2009-10	L & R Front	w/ Supercharger	2	EM-5673		
			L & R Front	w/o Supercharger	2	EM-2993'		
2008		L & R Front		2	EM-2993'			
2008-12		Trans		1		EM-5660		
V8 7.0L 427ci	2009-10	L & R Front		2	EM-2993'			
	2006-08	L & R Front		2	EM-2993'			
	1966-69	L & R Front		2	EM-2283			
	2006-13	Trans		1		EM-5660		
	1968-69	Trans	Auto	1		EM-2295		
	1968-69	Trans	Manual	1		EM-2295		
	1966-67	Trans	Auto	1		EM-2268 @		
1966-67	Trans	Manual	1		EM-2378 @			
V8 7.4L 454ci	1970-74	L & R Front		2	EM-2249			
		Trans	Auto	1		EM-2268 @		
		Trans	Manual	1		EM-2378 @		
<b>CRUZE</b>								
L4	L4 1.4L 83cid	2011-16	Right		1	EM-4076		
		2011-15	Trans - Center	Auto	1		EM-4054	
			Trans - Center	Manual	1		EM-3202	
			Trans - Front	Auto	1		EM-4080	
	L4 1.8L 110ci	2011-16	Right		1	EM-4076		
			2013-15	Trans - Center	Auto	1		EM-4234
		2011-12	Trans - Center	Manual	1		EM-3202	
			Trans - Center	Auto	1		EM-4129	
		2013-15	Trans - Center	Manual	1		EM-3202	
			Trans - Front	Auto	1		EM-4080	
	2011-12	Trans - Front	Auto	1		EM-4080		
	L4 2.0L 119ci	2014-15	Trans - Rear		1		EM-4080	

\* = Hydraulic Mount, "S" suffix = solid replacement. @ = Universal Mount EM-5000 also available.

# Engine, Transmission, And Torque Strut Mounts

CYL	ENG. SIZE	YEAR	LOCATION	DESCRIPTION	QTY	ENGINE	TORQUE STRUT	TRANSMISSION
<b>CHEVROLET PASSENGER CAR (continued)</b>								
<b>CRUZE LIMITED</b>								
L4	L4 1.4L 83cid	2016	Right		1	EM-4076		
			Trans - Center	Auto	1		EM-4054	
			Trans - Center	Manual	1		EM-3202	
			Trans - Front	Auto	1		EM-4080	
	L4 1.8L 110ci	2016	Right		1	EM-4076		
			Trans - Center	Auto	1		EM-4234	
Trans - Center			Manual	1		EM-3202		
			Trans - Front	Auto	1		EM-4080	
<b>DEL RAY</b>								
L6	L6 3.9L 235ci	1958	L & R Front		2	EM-2231		
			Trans		1		EM-2378 @	
V8	V8 4.6L 283ci	1958	L & R Front		2	EM-2142		
			Trans	Auto; Powerglide	1		EM-2143	
			Trans	Manual	1		EM-2378 @	
	V8 5.7L 348ci	1958	L & R Front		2	EM-2267		
Trans			Auto; Powerglide	1		EM-2143		
Trans			Manual	1		EM-2378 @		
<b>HHR</b>								
L4	L4 2.0L 122ci	2008-10	RH Front	Auto	1	EM-3109		
			RH Front	Manual	1	EM-3108		
			Trans - Front	Auto	1		EM-3043	
			Trans - Front	Bushing Only; Auto	1		EM-3092	
	L4 2.2L 134ci	2006-11	RH Front	Auto	1	EM-3109		
			RH Front	Manual	1	EM-3108		
			Trans - Center		1		EM-4158	
			Trans - Front	Auto	1		EM-3086	
				Trans - Front	Bushing Only; Auto	1		EM-3043
	L4 2.4L 134ci	2006-11	RH Front	Auto	1	EM-3109		
			RH Front	Manual	1	EM-3108		
	L4 2.4L 145ci	2006-11	Trans - Center		1		EM-4158	
Trans - Front			Auto	1		EM-3086		
Trans - Front			Bushing Only; Auto	1		EM-3043		
<b>IMPALA</b>								
L4	L4 2.4L 145ci	2014	Trans - Center		1			EM-4128
			Trans - Front		1		EM-3194	
			Trans - Rear	FWD	1		EM-3196	
	L4 2.5L 153ci	2014-17	Right		1	EM-3198		
			Trans - Center		1		EM-3199	
			Trans - Front		1		EM-3194	
			Trans - Rear		1		EM-3196	
L6	L6 3.8L 230ci	1965	L & R Front		2	EM-2284		
		1963-64	L & R Front		2	EM-2231		
		1963-65	Trans		1		EM-2378 @	
	L6 3.9L 235ci	1961-62	L & R Front		2	EM-2231		
			1959	L & R Front		2	EM-2231	
		1961-62	Trans		1		EM-2378 @	
			1959	Trans		1		EM-2378 @
	L6 4.1L 250ci	1977-79	L & R Front		2	EM-2292		
			1973	L & R Front		2	EM-2292	
		1965-72	L & R Front		2	EM-2284		
1978-79			Trans		1		EM-2360 @	
1977		Trans		1		EM-2337		
1973		Trans	Auto		1		EM-2360 @	
		Trans	Manual; 3 Spd		1		EM-2337	
	Trans	Manual; 4 Spd		1		EM-2294		

@ = Universal Mount EM-5000 also available.

# Engine, Transmission, And Torque Strut Mounts

CYL	ENG. SIZE	YEAR	LOCATION	DESCRIPTION	QTY	ENGINE	TORQUE STRUT	TRANSMISSION
<b>CHEVROLET PASSENGER CAR (continued)</b>								
<b>IMPALA (continued)</b>								
L6	L6 4.1L 250ci	1965-72	Trans	Auto	1			EM-2360 @
			Trans	Manual	1			EM-2378 @
V6	V6 3.4L 207ci	2000-05	Right		1	EM-2987#		
			Torq Str - Front	Bracket to Radiator Support Complete Unit	2		EM-2901	
			Torq Str - Front	Bracket to Radiator Support Insert	2		EM-4169	
			Torq Str - Front	Complete Unit; LH & RH Front	2		EM-2866#	
			Torq Str - Front	Insert; LH & RH Front	2		EM-2716	
			Trans		1			EM-2818 #
	V6 3.5L 213ci	2006-11	Right		1	EM-2987#		
			Torq Str - Front	Bracket to Radiator Support Complete Unit	2		EM-3104	
			Torq Str - Front	Bracket to Radiator Support Insert	2		EM-4169	
			Torq Str - Front	Complete Unit	2		EM-3090	
			Trans		1			EM-2818 #
	V6 3.6L 217ci	2012-13	Front		1	EM-4114		
			Rear		1	EM-4220		
		2014-19	Right		1	EM-3200		
		2012-17	Torq Str - Rear		1		EM-4115	
		2014-18	Trans - Center	Auto	1			EM-4223
			Trans - Front		1			EM-3195
			Trans - Rear		1			EM-3196
	2012-13	Trans		1			EM-4116	
	V6 3.8L 229ci	1980-84	L & R Front		2	EM-2436		
			Trans		1			EM-2360 @
			Trans		1			EM-2379
	V6 3.8L 231ci	1980-85	LH Front		1	EM-2382		
			RH Front		1	EM-2796*		
2004-05		RH Front		1	EM-2384			
		Torq Str - Front	Bracket to Radiator Support Complete Unit	1			EM-3088	
		Torq Str - Front	Bracket to Radiator Support Insert	2		EM-4169		
		Torq Str - Front	Complete Unit	2		EM-2866#		
		Torq Str - Front	Insert; LH & RH Front	2		EM-2716		
		Torq Str - Front	Bracket to Radiator Support Complete Unit	2		EM-3088		
2000-03		Torq Str - Front	Bracket to Radiator Support Insert	2		EM-4169		
		Torq Str - Front	Complete Unit; LH & RH Front	2		EM-2866#		
		Torq Str - Front	Insert; LH & RH Front	2		EM-2716		
2000-05		Trans		1			EM-2712 *	
1980-85		Trans		1			EM-2379	
V6 3.9L 237ci	2006-11	Front		1	EM-2987#			
		Torq Str - Front	Bracket to Radiator Support Complete Unit	2		EM-3104		
		Torq Str - Front	Bracket to Radiator Support Insert	2		EM-4169		
		Torq Str - Front	Complete Unit; LH & RH Front	2		EM-3090		
	2008-09	Trans	exc. Police Cars	1			EM-2712 *	
		Trans	Police Cars	1			EM-5746	
	2006-07	Trans		1			EM-2712 *	
V6 4.3L 262ci	1985	L & R Front		2	EM-2436			

\* = Hydraulic Mount, "S" suffix = solid replacement.

@ = Universal Mount EM-5000 also available.

# = Available in the Westar Gold Line



# Engine, Transmission, And Torque Strut Mounts

CYL	ENG. SIZE	YEAR	LOCATION	DESCRIPTION	QTY	ENGINE	TORQUE STRUT	TRANSMISSION	
<b>CHEVROLET PASSENGER CAR (continued)</b>									
<b>IMPALA (continued)</b>									
V6	V6 4.3L 262ci	1985	Trans		1			EM-2360 @	
V8	V8 4.4L 267ci	1980-82	L & R Front		2	EM-2292			
			Trans		1			EM-2360 @	
V8	V8 4.6L 283ci	1965-67	L & R Front		2	EM-2142			
			1959-64	L & R Front		2	EM-2267		
		1959-67	Trans	Auto; Powerglide	1			EM-2143	
			Trans	Manual	1			EM-2378 @	
V8	V8 5.0L 305ci	1977-85	L & R Front		2	EM-2292			
		1985	Trans	Auto	1			EM-2360 @	
		1979-84	Trans	Auto	1			EM-2337	
		1977-78	Trans	Auto	1			EM-2360 @	
V8	V8 5.0L 307ci	1968	L & R Front		2	EM-2142			
V8	V8 5.3L 325ci	2006-09	Front		1	EM-3093			
			Rear		1	EM-2990			
			Torq Str - Front	Bracket to Radiator Support Complete Unit	2		EM-3104		
			Torq Str - Front	Bracket to Radiator Support Insert	2		EM-4169		
			Torq Str - Front	Complete Unit	2		EM-3090		
	Trans			1			EM-5661		
V8	V8 5.4L 327ci	1962-69	L & R Front		2	EM-2142			
			Trans	Auto	1			EM-2268 @	
			Trans	Manual	1			EM-2378 @	
V8	V8 5.7L 348ci	1959-61	L & R Front		2	EM-2267			
			Trans	Auto; Powerglide	1			EM-2143	
			Trans	Auto; Turbo-Hydramatic	1			EM-2378 @	
			Trans	Manual	1			EM-2378 @	
V8	V8 5.7L 350ci	1994-96	L & R Front		2	EM-2292			
		1980-85	L & R Front		2	EM-2292			
		1973-79	L & R Front		2	EM-2292			
		1969-72	L & R Front		2	EM-2283			
		1994-96	Trans		1			EM-2394	
		1980-85	Trans	Gas; Auto	1			EM-2360 @	
		1975-79	Trans		1			EM-2337	
		1974	Trans	Auto	1			EM-2294	
			Trans	Manual	1			EM-2294	
		1971-73	Trans	Auto; Powerglide	1			EM-2294	
			Trans	Auto; Turbo-Hydramatic	1			EM-2337	
			Trans	Manual	1			EM-2268 @	
		1969-70	Trans	Auto; Powerglide	1			EM-2294	
Trans	Manual		1			EM-2268 @			
V8	V8 5.7L 350ci Diesel	1980-85	L & R Front	VIN N	2	EM-2328			
			Trans	Auto	1			EM-2360 @	
V8	V8 6.5L 396ci	1968-69	L & R Front		2	EM-2283			
		1969	Trans		1			EM-2295	
		1968	Trans		1			EM-2378 @	
V8	V8 6.6L 400ci	1972-76	L & R Front		2	EM-2395			
		1971	L & R Front		2	EM-2283			
		1975-76	Trans	Auto	1			EM-2294	
		1971-74	Trans	Auto	1			EM-2294	
			Trans	Manual	1			EM-2294	
		1970	Trans	Auto	1			EM-2268 @	
V8	V8 6.6L 402ci	1971-72	L & R Front		2	EM-2283			
			1970-72	Trans	Auto; THM350 (M38)	1			EM-2378 @
				Trans	Auto; THM400 (M40)	1			EM-2268 @

@ = Universal Mount EM-5000 also available.

# Engine, Transmission, And Torque Strut Mounts

CYL	ENG. SIZE	YEAR	LOCATION	DESCRIPTION	QTY	ENGINE	TORQUE STRUT	TRANSMISSION	
<b>CHEVROLET PASSENGER CAR (continued)</b>									
<b>IMPALA (continued)</b>									
V8	V8 6.7L 409ci	1961-65	L & R Front		2	EM-2285			
			Trans	Auto; 3 Spd	1			EM-2378 @	
			Trans	Auto; Powerglide	1			EM-2143	
			Trans	Manual	1			EM-2378 @	
	V8 7.0L 427ci	1966-69	L & R Front		2	EM-2283			
			Trans		1			EM-2295	
			Trans	Auto	1			EM-2268 @	
			Trans	Manual	1			EM-2378 @	
	V8 7.4L 454ci	1973-76	L & R Front		2	EM-2395			
			Trans		1			EM-2294	
		1970-72	L & R Front		2	EM-2283			
			Trans	Auto	1			EM-2294	
		1971-74	Trans	Auto	1			EM-2294	
			Trans	Manual	1			EM-2294	
1970	Trans		1			EM-2378 @			
<b>IMPALA LIMITED</b>									
V6	V6 3.6L 217ci	2014-16	Front		1	EM-4114			
			Rear		1	EM-4220			
			Trans		1			EM-4116	
<b>IMPALA SS</b>									
V6	V8 3.8L	2004-05	Torq Str - Front	Bracket to Radiator Support Complete Unit	1		EM-3088		
			Torq Str - Front	Bracket to Radiator Support Insert	2		EM-4169		
			Torq Str - Front	Complete Unit	2		EM-2866#		
			Torq Str - Front	Insert; LH & RH Front	2		EM-2716		
V8	V8 5.7L 350ci	1994-96	L & R Front		2	EM-2292			
			Trans		1			EM-2394	
<b>KINGSWOOD</b>									
V8	V8 5.7L 350ci	1969-72	L & R Front		2	EM-2283			
			Trans	Auto	1			EM-2295	
			Trans	Manual	1			EM-2295	
	V8 6.6L 400ci	1972	L & R Front		2	EM-2395			
			1970-71	L & R Front		2	EM-2283		
				Trans	Auto	1			EM-2294
			1971-72	Trans	Manual	1			EM-2294
				Trans		1			EM-2268 @
	V8 6.6L 402ci	1971-72	L & R Front		2	EM-2283			
			Trans	Auto; THM350	1			EM-2378 @	
			Trans	Auto; THM400	1			EM-2268 @	
			Trans	Manual	1			EM-2378 @	
	V8 7.4L 454ci	1972	L & R Front		2	EM-2395			
			Trans	Auto	1			EM-2294	
		1970	L & R Front		2	EM-2283			
			Trans	Manual	1			EM-2294	
1970		Trans	Auto	1			EM-2378 @		
		Trans	Manual	1			EM-2378 @		
<b>LAGUNA</b>									
V8	V8 5.0L 305ci	1976	L & R Front		2	EM-2292			
			Trans	Auto	1			EM-2360 @	
			Trans	Manual	1			EM-2360 @	
	V8 5.7L 350ci	1973-76	L & R Front		2	EM-2292			
			Trans		1			EM-2337	
			Trans		1			EM-2294	

@ = Universal Mount EM-5000 also available. # = Available in the Westar Gold Line

# Engine, Transmission, And Torque Strut Mounts

CYL	ENG. SIZE	YEAR	LOCATION	DESCRIPTION	QTY	ENGINE	TORQUE STRUT	TRANSMISSION	
<b>CHEVROLET PASSENGER CAR (continued)</b>									
<b>LAGUNA (continued)</b>									
V8	V8 5.7L 350ci	1973	Trans		1			EM-2268 @	
	V8 6.6L 400ci	1974-76	L & R Front		2	EM-2292			
			Trans	Auto, M40 (THM400)	1			EM-2353	
			Trans	Auto; THM350 (M38)	1			EM-2360 @	
		1974-75	Trans	Manual	1			EM-2378 @	
			Trans	Auto; THM350 (M38)	1			EM-2360 @	
			Trans	Auto; THM400 (M40)	1			EM-2353	
	V8 7.4L 454ci	1973-74	L & R Front		2	EM-2395			
			Trans	Auto	1			EM-2360 @	
			Trans	Manual	1			EM-2360 @	
<b>LUMINA</b>									
L4	L4 2.2L 134ci	1993	RH Front	Insert	1	EM-2803*			
			Torq Str - Front		1		EM-2782		
	L4 2.2L 2180cc	1993	Trans	Auto	1			EM-2715	
	L4 2.5L 151ci	1990-92	Torq Str - Front		1		EM-2609		
Trans				1			EM-2620		
L4 2.5L 2474cc	1990-92	Front		1	EM-2660*				
V6	V6 3.1L 189ci	1995-01	RH Front		1	EM-2796*			
		1990-94	RH Front		1	EM-2660*			
		1995-01	Torq Str - Front	Bracket to Radiator Support Complete Unit	1		EM-2901		
			Torq Str - Front	Bracket to Radiator Support Insert	1		EM-4169		
			Torq Str - Front	Complete Unit	1		EM-2866#		
			Torq Str - Front	Insert Only	2		EM-2716		
		1990-94	Torq Str - Front		1		EM-2609		
		1991-93	Trans - Front	Manual	1				EM-2466
			Trans - Rear	Auto	1				EM-2620
		1995-01	Trans		1				EM-2712 *
	1994	Trans	Auto	1				EM-2620	
	1991-93	Trans	Manual	1				EM-2467	
	1990	Trans		1				EM-2620	
	V6 3.4L 189ci	1994-97	Trans	Auto	1			EM-2712 *	
	V6 3.4L 207ci	1991-97	RH Front		1	EM-2555*			
RH Rear				1	EM-2676				
Torq Str - Front			Auto	1		EM-2799			
1992-93		Trans	Auto	1			EM-2620		
1991		Trans	Auto	1			EM-2712 *		
V6 3.8L 231ci	1998-99	RH Front		1	EM-2796*				
		Torq Str - Front	Bracket to Radiator Support Complete Unit	1		EM-2901			
		Torq Str - Front	Bracket to Radiator Support Insert	1		EM-4169			
		Torq Str - Front	Complete Unit	1		EM-2866#			
		Torq Str - Front	Insert Only	2		EM-2716			
Trans		1				EM-2712 *			
<b>MALIBU</b>									
L4	L4 2.0L 122ci	2013-15	Right		1	EM-3198			
			Trans - Center	Auto	1			EM-4223	
			Trans - Front		1			EM-3195	
			Trans - Rear		1			EM-3196	
	L4 2.2L 134ci	2004-05	Front		1	EM-3129			

\* = Hydraulic Mount, "S" suffix = solid replacement.

@ = Universal Mount EM-5000 also available.

# = Available in the Westar Gold Line

# Engine, Transmission, And Torque Strut Mounts

CYL	ENG. SIZE	YEAR	LOCATION	DESCRIPTION	QTY	ENGINE	TORQUE STRUT	TRANSMISSION	
<b>CHEVROLET PASSENGER CAR (continued)</b>									
<b>MALIBU (continued)</b>									
L4	L4 2.2L 134ci	2006-08	Right		1	EM-3117			
		2004-05	Right		1	EM-4072			
		2008	Trans - Center		1			EM-4047	
		2006-07	Trans - Center		1			EM-4047	
		2004-05	Trans - Center		1			EM-4047	
		2008	Trans - LH Front	1st Design - Stamped Part	1		EM-3094		
			Trans - LH Front	Complete Unit	1		EM-5659		
			Trans - LH Front	Insert	1		EM-4206		
		2006-07	Trans - LH Front	Complete Unit	1		EM-5659		
			Trans - LH Front	Insert	1		EM-4206		
		2004-05	Trans - LH Front	Complete Unit	1		EM-5659		
			Trans - LH Front	Insert	1		EM-4206		
		2008	Trans - LH Rear	Insert	1		EM-4206		
			2006-07	Trans - LH Rear	Complete Unit	1		EM-3094	
			Trans - LH Rear	Insert	1		EM-4206		
			2004-05	Trans - LH Rear	Complete Unit	1		EM-3094	
		Trans - LH Rear		Insert	1		EM-4206		
		L4 2.4L 145ci	2009-12	RH Front	Exc. Hybrid	1	EM-3118		
	2013-14		Right		1	EM-3198			
	2008		Right		1	EM-3117			
	2011-12		Trans - Center		1			EM-4134	
	2009-10		Trans - Center	Auto; 4 Spd	1		EM-4047		
			Trans - Center	Auto; 6 Spd	1		EM-4134		
	2008		Trans - Center	Auto; 4 Spd	1		EM-4047		
	2013		Trans - Front		1		EM-3194		
	2011-12		Trans - Front		1		EM-4046		
	2009-10		Trans - Front	Auto; 4 Spd; Complete Unit	1		EM-4027		
			Trans - Front	Auto; 4 Spd; Insert	1		EM-4206		
			Trans - Front	Auto; 6 Spd	1		EM-4046		
	2008		Trans - Front	Auto; 4 Spd; Complete Unit	1		EM-4027		
			Trans - Front	Auto; 4 Spd; Insert	1		EM-4206		
			Trans - Front	Auto; 6 Spd	1		EM-4046		
	2011-12		Trans - Rear		1		EM-4045		
	2009-10		Trans - Rear	Auto; 4 Spd; Complete Unit	1		EM-5862		
			Trans - Rear	Auto; 4 Spd; Insert	1		EM-4206		
			Trans - Rear	Auto; 6 Spd	1		EM-4045		
	2008		Trans - Rear	Auto; 4 Spd; 1st Design Stamped Part	1		EM-3094		
			Trans - Rear	Auto; 4 Spd; 2nd Design; Cast Part	1		EM-5862		
			Trans - Rear	Auto; 4 Spd; Insert	1		EM-4206		
	Trans - Rear		Auto; 6 Spd	1		EM-4045			
	L4 2.4L 146ci		1997-99	RH Front		1	EM-2876		
			1999	Trans - Center	Auto	1			EM-2874
1997-98			Trans - Center	Auto	1			EM-2874	
1999			Trans - LH Front	Auto; Complete Unit	1		EM-5079		
			Trans - LH Rear	Auto; Complete Unit	1		EM-5078		
		Trans - LH Rear	Auto; Insert	1		EM-2875			
L4 2.5L 153ci	2013-15	Right		1	EM-3198				
		Trans - Center		1			EM-4128		
		Trans - Front		1			EM-3194		
		Trans - Rear		1			EM-3196		
L6	L6 3.2L 194ci	1964-66	L & R Front		2	EM-2284			
			Trans	Auto	1			EM-2378 @	
			Trans	Manual	1			EM-2378 @	
	L6 3.8L 230ci	1964-67	L & R Front		2	EM-2284			
			Trans	Auto	1			EM-2378 @	

\* = Hydraulic Mount, "S" suffix = solid replacement. @ = Universal Mount EM-5000 also available.

# Engine, Transmission, And Torque Strut Mounts

CYL	ENG. SIZE	YEAR	LOCATION	DESCRIPTION	QTY	ENGINE	TORQUE STRUT	TRANSMISSION
<b>CHEVROLET PASSENGER CAR (continued)</b>								
<b>MALIBU (continued)</b>								
L6	L6 3.8L 230ci	1964-67	Trans	Manual	1			EM-2378 @
	L6 4.1L 250ci	1973-77	L & R Front		2	EM-2292		
		1967	L & R Front		2	EM-2284		
		1976-77	Trans	Auto	1			EM-2337
			Trans	Manual; 3 Spd	1			EM-2337
		1973-75	Trans	Auto	1			EM-2360 @
			Trans	Manual	1			EM-2337
		1967	Trans	Auto	1			EM-2360 @
			Trans	Manual	1			EM-2378 @
V6	V6 3.1L 189ci	2002-03	Front	Made in Lansing, MI	1	EM-2933*		
		2001	Front	Made in Lansing, MI	1	EM-2933*		
			Front	Made in Oklahoma City	1	EM-2876*		
		1997-00	Front	Made in Oklahoma City	1	EM-2876*		
		1999-03	Trans - Center		1			EM-2874
		1997-98	Trans - Center	Auto	1			EM-2874
		1999-03	Trans - LH Front	Complete Unit	1			EM-5079
			Trans - LH Rear	Complete Unit	1			EM-5078
			Trans - LH Rear	Insert	1			EM-2875
	V6 3.3L 200ci	1978-79	LH Front		1	EM-2382		
			RH Front		1	EM-2384		
		1979	Trans	Notchback	1			EM-2393
			Trans	Coupe	1			EM-2353
			Trans		1			EM-2393
		1978	Trans	Auto	1			EM-2353
			Trans	Manual	1			EM-2353
		V6 3.5L 213ci	2004-10	RH Front	Hydraulic Mount	1	EM-3097	
	2008-10		Trans - Center		1			EM-3096
	2006-07		Trans - Center		1			EM-3096
	2004-05		Trans - Center		1			EM-3096
	2008-10		Trans - Front	Complete Unit	1			EM-4027
			Trans - Front	Insert	1			EM-4206
	2006-07		Trans - Front	Complete Unit	1			EM-5659
			Trans - Front	Insert	1			EM-4206
	2004-05		Trans - Front	Complete Unit	1			EM-5659
			Trans - Front	Insert	1			EM-4206
	2008-10		Trans - Rear	Insert	1			EM-4206
	2006-07		Trans - Rear	Complete Unit	1			EM-3094
			Trans - Rear	Insert	1			EM-4206
	2004-05		Trans - Rear	Complete Unit	1			EM-3094
			Trans - Rear	Insert	1			EM-4206
	V6 3.6L 217ci	2008-10	Front	Hydraulic Mount	1	EM-3097		
		2008-12	Trans - Center		1			EM-3135
			Trans - Front	Complete Unit	1			EM-4061
			Trans - Front	Insert	1			EM-4206
			Trans - Rear	Complete Unit	1			EM-4062
			Trans - Rear	Insert	1			EM-4206
	V6 3.8L 229ci	1980-83	L & R Front		2	EM-2436		
			Trans	Auto	1			EM-2379
	V6 3.8L 231ci	1978-83	LH Front		1	EM-2382		
			RH Front		1	EM-2384		
		1982-83	Trans	Auto	1			EM-2379
		1978-81	Trans	Auto	1			EM-2379
	V6 3.9L 237ci	2006-07	Trans	Manual	1			EM-2379
			Front	Hydraulic Mount	1	EM-3097		
			Trans - Center	Hydraulic Mount	1			EM-3112
				Trans - Front		1		EM-4195

\* = Hydraulic Mount, "S" suffix = solid replacement. @ = Universal Mount EM-5000 also available.

# Engine, Transmission, And Torque Strut Mounts

CYL	ENG. SIZE	YEAR	LOCATION	DESCRIPTION	QTY	ENGINE	TORQUE STRUT	TRANSMISSION
<b>CHEVROLET PASSENGER CAR (continued)</b>								
<b>MALIBU (continued)</b>								
V6	V6 3.9L 237ci	2006-07	Trans - Rear		1			EM-4194
	V6 4.3L 260ci	1982-83	L & R Front		2	EM-2292		
	V6 4.3L 260ci Diesel	1982-83	Trans		1			EM-2360 @
V8	V8 4.4L 267ci	1979-82	L & R Front		2	EM-2292		
		1982	Trans	Auto	1			EM-2360 @
		1979-81	Trans	Auto	1			EM-2360 @
			Trans	Manual	1			EM-2360 @
	V8 4.6L 283ci	1964-67	L & R Front		2	EM-2142		
			Trans	Auto; Powerglide	1		EM-2143	
			Trans	Manual	1		EM-2378 @	
	V8 5.0L 305ci	1976-83	L & R Front		2	EM-2292		
			Trans	Auto	1		EM-2337	
		1979-81	Trans	Auto	1		EM-2337	
			Trans	Manual	1		EM-2337	
		1976-78	Trans	Auto	1		EM-2360 @	
	Trans		Manual	1		EM-2360 @		
	V8 5.0L 307ci	1973	L & R Front		2	EM-2142		
			Trans	Auto	1		EM-2378 @	
			Trans	Manual	1		EM-2378 @	
	V8 5.4L 327ci	1964-67	L & R Front		2	EM-2142		
			Trans	Auto	1		EM-2378 @	
			Trans	Manual	1		EM-2378 @	
	V8 5.7L 350ci	1973-81	L & R Front		2	EM-2292		
			Trans	Auto	1		EM-2360 @	
Trans			Manual	1		EM-2360 @		
V8 5.7L 350ci Diesel	1982-83	L & R Front		2	EM-2328			
		Trans		1		EM-2360 @		
V8 6.5L 396ci	1966-67	L & R Front		2	EM-2285			
		Trans	Auto	1		EM-2378 @		
		Trans	Manual	1		EM-2378 @		
V8 6.6L 400ci	1974-76	L & R Front		2	EM-2292			
		Trans	Auto	1		EM-2353		
	1976	Trans	Manual	1		EM-2353		
		Trans	Auto; THM350 (M38)	1		EM-2360 @		
		Trans	Auto; THM400 (M40)	1		EM-2353		
1974-75	Trans	Manual	1		EM-2360 @			
	L & R Front		2	EM-2395				
V8 7.4L 454ci	1973-75	Trans	Auto	1		EM-2360 @		
		Trans	Manual	1		EM-2360 @		
		L & R Front		2	EM-2395			
<b>MALIBU LIMITED</b>								
L4	L4 2.5L 153ci	2016	Right		1	EM-3198		
<b>MERIVA (MEXICO)</b>								
L4	L4 1.8L 1796cc	2004-08	RH Rear		1	EM-9000		
			Rear	Complete Unit	1	EM-9000		
			Trans - Front Lower	Complete Unit	1			EM-90015
<b>METRO</b>								
L3	L3 1.0L 993cc	1998-00	Front		1	EM-5608		
			Rear		1	EM-8277		
			Torg Str - Rear		1		EM-8658	
			Trans		1			EM-8277
L4	L4 1.3L 1295cc	1998-01	Front		1	EM-5608		
			1992	Front		1	EM-8517	

@ = Universal Mount EM-5000 also available.

# Engine, Transmission, And Torque Strut Mounts

CYL	ENG. SIZE	YEAR	LOCATION	DESCRIPTION	QTY	ENGINE	TORQUE STRUT	TRANSMISSION	
<b>CHEVROLET PASSENGER CAR (continued)</b>									
<b>METRO (continued)</b>									
L4	L4 1.3L 1295cc	1992	Torq Str - Front	Auto	1		EM-8658		
		1998-01	Torq Str - Rear	Auto	1		EM-8658		
			Trans		1			EM-8277	
		1992	Trans			1			EM-8277
<b>MONTE CARLO</b>									
V6	V6 3.1L 189ci	1995-99	RH Front		1	EM-2796*			
			Torq Str - Front	Bracket to Radiator Support Complete Unit	1		EM-2901		
			Torq Str - Front	Bracket to Radiator Support Insert	1		EM-4169		
			Torq Str - Front	Complete Unit	1		EM-2866#		
			Torq Str - Front	Insert	2		EM-2716		
			Trans		1			EM-2712 *	
	V6 3.3L 200ci	1978-79	LH Front		1	EM-2382			
			RH Front		1	EM-2384			
			Trans	Auto	1			EM-2353	
			Trans	Manual	1			EM-2353	
	V6 3.4L 207ci	2000-05	RH Front		1	EM-2796*			
			1995-97	RH Front		1	EM-2555*		
				RH Rear		1	EM-2676		
		2000-05	Torq Str - Front	Bracket to Radiator Support Insert	2		EM-4169		
			Torq Str - Front		1		EM-2799		
			Torq Str - Front	Bracket to Radiator Support Complete Unit	1		EM-2901		
			Torq Str - Front	Complete Unit	1		EM-2866#		
			Torq Str - Front	Insert Only	1		EM-2716		
			Trans		1			EM-2712 *	
	1995-97	Trans		1			EM-2712 *		
		Trans		1			EM-2712 *		
	V6 3.5L 213ci	2006-07	Front		1	EM-2987#			
			Torq Str - Bushin	Bracket	2		EM-3104		
			Torq Str - Bushin	Strut	2		EM-3090		
			Trans		1			EM-2818 #	
	V6 3.8L 229ci	1980-84	L & R Front		2	EM-2436			
			Trans	Auto	1			EM-2379	
	V6 3.8L 231ci	1978-87	LH Front		1	EM-2382			
			1998-05	RH Front		1	EM-2796*		
			1978-87	RH Front		1	EM-2384		
		1998-05	Torq Str - Front	Bracket to Radiator Support Complete Unit	1		EM-3088		
			Torq Str - Front	Bracket to Radiator Support Insert	1		EM-4169		
			Torq Str - Front	Complete Unit	1		EM-2866#		
			Torq Str - Front	Insert Only	2		EM-2716		
			Trans		1			EM-2712 *	
			1982-87	Trans		1			EM-2379
	1978-81	Trans	Auto	1			EM-2379		
	V6 3.9L 237ci	2006	Front		1	EM-2987#			
			Torq Str - Bushin	Bracket	2		EM-3104		
			Torq Str - Front	Bracket	2		EM-3090		
			Trans	Hydraulic Mount	1			EM-2712 *	
			Trans	Solid Mount; Bushing	1			EM-2712S	
	V6 4.3L 260ci	1982-83	L & R Front		2	EM-2292			
	V6 4.3L 260ci Diesel	1982-83	Trans		1			EM-2360 @	

\* = Hydraulic Mount, "S" suffix = solid replacement.

@ = Universal Mount EM-5000 also available.

# = Available in the Westar Gold Line

# Engine, Transmission, And Torque Strut Mounts

CYL	ENG. SIZE	YEAR	LOCATION	DESCRIPTION	QTY	ENGINE	TORQUE STRUT	TRANSMISSION
<b>CHEVROLET PASSENGER CAR (continued)</b>								
<b>MONTE CARLO (continued)</b>								
V6	V6 4.3L 262ci	1985-88	L & R Front		2	EM-2436		
			Trans		1			EM-2379
V8	V8 4.4L 267ci	1979-82	L & R Front		2	EM-2292		
			Trans	Auto	1			EM-2360 @
	V8 5.0L 305ci	1976-88 1980-88 1976-79	L & R Front		2	EM-2292		
			Trans	Auto	1			EM-2360 @
			Trans	Auto	1			EM-2360 @
			Trans	Manual	1			EM-2360 @
	V8 5.3L 325ci	2006-07	Front		1	EM-3093		
			Rear		1	EM-2990		
			Torq Str - Bushin	Bracket	2			EM-3104
			Torq Str - Front	Bracket	2			EM-3090
			Trans		1			EM-5661
	V8 5.7L 350ci	1973-77 1970-72	L & R Front		2	EM-2292		
			L & R Front		2	EM-2283		
		1973-77	Trans	Auto	1			EM-2360 @
			Trans	Manual	1			EM-2360 @
			Trans		1			EM-2295
V8 5.7L 350ci Diesel	1982-84	L & R Front		2	EM-2328			
		Trans		1			EM-2360 @	
V8 6.6L 400ci	1974-76 1970-73	L & R Front		2	EM-2292			
		L & R Front		2	EM-2283			
	1976	Trans	Auto	1			EM-2360 @	
		Trans	Manual	1			EM-2360 @	
	1974-75	Trans	Auto, M40 (THM400)	1			EM-2353	
		Trans	Auto; THM350 (M38)	1			EM-2360 @	
	1970-73	Trans	Auto; THM350	1			EM-2378 @	
		Trans	Auto; THM400	1			EM-2295	
Trans	Manual	1			EM-2378 @			
V8 6.6L 402ci	1970-72	L & R Front		2	EM-2283			
		Trans	Auto; THM350	1			EM-2378 @	
		Trans	Auto; THM400	1			EM-2268 @	
		Trans	Manual	1			EM-2378 @	
V8 7.4L 454ci	1973-75 1970-72	L & R Front		2	EM-2395			
		L & R Front		2	EM-2283			
	1973-75	Trans	Auto	1			EM-2360 @	
		Trans	Manual	1			EM-2360 @	
		Trans		1			EM-2294	
<b>MONZA</b>								
L4	L4 2.3L 140ci	1975-77	LH Front		1	EM-2357		
			RH Front		1	EM-2356		
		1976-77	Trans	Auto	1			EM-2353
			Trans	Manual	1			EM-2288 @
		1975	Trans	Auto	1			EM-2353
			Trans	Manual	1			EM-2353
	L4 2.5L 151ci	1978-80	L & R Front		2	EM-2446		
			Trans	Auto	1			EM-2531
Trans			Manual	1			EM-2531	
V6	V6 3.2L 196ci	1978-79	L & R Front		2	EM-2436		
			Trans	Auto	1			EM-2379
			Trans	Manual	1			EM-2379
	V6 3.8L 231ci	1978-80	LH Front		1	EM-2382		
			RH Front		1	EM-2384		
		1980	Trans	Auto	1			EM-2353

@ = Universal Mount EM-5000 also available.



# Engine, Transmission, And Torque Strut Mounts

CYL	ENG. SIZE	YEAR	LOCATION	DESCRIPTION	QTY	ENGINE	TORQUE STRUT	TRANSMISSION
<b>CHEVROLET PASSENGER CAR (continued)</b>								
<b>MONZA (continued)</b>								
V6	V6 3.8L 231ci	1980	Trans	Manual	1			EM-2467
		1978-79	Trans	Auto	1			EM-2353
			Trans	Manual	1			EM-2353
V8	V8 4.3L 262ci	1975-76	Trans	Auto	1			EM-2353
			Trans	Manual	1			EM-2353
	1976-79	Trans	Auto	1			EM-2353	
		Trans	Manual	1			EM-2353	
		Trans	Manual	1			EM-2353	
<b>NOVA</b>								
L4	L4 1.6L 1588cc	1985-88	Front		1	EM-2674		
			RH Front		1	EM-8233		
			Rear	Auto	1	EM-2688		
			Trans	Manual	1			EM-8648
	L4 2.5L 153ci	1970	Trans		1			EM-2378 @
			Trans	Auto	1			EM-2378 @
		1969	Trans		1			EM-2378 @
			Trans		1			EM-2268 @
L6	L6 3.8L 230ci	1969-70	L & R Front		2	EM-2284		
			Trans		1			EM-2378 @
			Trans	Auto	1			EM-2378 @
	L6 4.1L 250ci	1973-79	L & R Front		2	EM-2292		
			L & R Front		2	EM-2284		
		1978-79	Trans	Auto	1			EM-2360 @
			Trans	Manual	1			EM-2360 @
		1976-77	Trans	Auto	1			EM-2337
			Trans	Manual	1			EM-2337
		1973-75	Trans	Auto	1			EM-2360 @
			Trans	Manual	1			EM-2337
		1969-72	Trans	Auto	1			EM-2360 @
			Trans	Manual	1			EM-2378 @
		V8	V8 4.3L 262ci	1975	L & R Front		2	EM-2292
Trans	Auto				1			EM-2360 @
Trans	Manual				1			EM-2360 @
V8 5.0L 305ci	1976-79		L & R Front		2	EM-2292		
			Trans	Auto	1			EM-2360 @
			Trans	Manual	1			EM-2360 @
V8 5.0L 307ci	1969-73		L & R Front		2	EM-2142		
			Trans	Auto; OEM Design	1			EM-2268 @
			Trans	Manual; OEM Design	1			EM-2378 @
V8 5.7L 350ci	1973-79		L & R Front		2	EM-2292		
	1972		L & R Front		2	EM-2283		
	1970-71		L & R Front		2	EM-2142		
	1969		L & R Front		1	EM-2283		
			Trans	Auto	1			EM-2360 @
	1976-79		Trans	Manual	1			EM-2360 @
			Trans		1			EM-2268 @
	1970-74		Trans		1			EM-2378 @
			Trans	Auto	1			EM-2378 @
	1969	Trans	Auto	1			EM-2295	
		Trans	Manual	1			EM-2295	
V8 6.5L 396ci	1970	L & R Front		2	EM-2283			
		Trans		1			EM-2378 @	
		Trans	Auto	1			EM-2378 @	
V8 6.6L 402ci	1970	L & R Front		2	EM-2283			

@ = Universal Mount EM-5000 also available.

# Engine, Transmission, And Torque Strut Mounts

CYL	ENG. SIZE	YEAR	LOCATION	DESCRIPTION	QTY	ENGINE	TORQUE STRUT	TRANSMISSION
<b>CHEVROLET PASSENGER CAR (continued)</b>								
<b>NOVA (continued)</b>								
V8	V8 6.6L 402ci	1970	Trans		1			EM-2378 @
			Trans	Auto; THM350	1			EM-2378 @
			Trans	Auto; THM400	1			EM-2268 @
<b>ONE-FIFTY SERIES</b>								
V8	V8 4.3L 265ci	1955-57	L & R Front	Large	2	EM-2123		
			L & R Front	Small	2	EM-2122		
			Trans - LH	Auto	1			EM-2127
			Trans - LH	Manual	1			EM-2124
			Trans - RH	Auto	1			EM-2126
			Trans - RH	Manual	1			EM-2125
	V8 4.6L 283ci	1957	L & R Front		2	EM-2142		
			Trans	Auto; Powerglide	1			EM-2143
			Trans	Manual	1			EM-2378 @
<b>OPTRA</b>								
L4	L4 2.0L 1998cc	2008-10 2004-07 2006-10 2004-07 2006-10 2004-07 2008-10 2004-07	Right	Mexican Vehicle	1	EM-5931		
			Right		1	EM-5931		
			Torq Str - Lower	Mexico	1		EM-5933	
			Torq Str - Lower		1		EM-5933	
			Torq Str - Right	Mexico	1		EM-5932	
			Torq Str - Right		1		EM-5932	
			Trans	Mexican Vehicle	1			EM-5868
			Trans		1			EM-5868
<b>PRIZM</b>								
L4	L4 1.8L 110ci	1998-02	Front	Auto	1	EM-8870		
			Front	Manual	1	EM-8966		
			RH Front		1	EM-8850		
			Rear	Auto	1	EM-8851		
			Trans	Auto; 3 Spd	1			EM-8872
			Trans	Auto; 4 Spd	1			EM-8873
			Trans	Manual	1			EM-9474
<b>SONIC</b>								
L4	L4 1.6L 98ci	2012-16	Torq Str - Lower		1		EM-4227	
	L4 1.8L 110ci	2012-16	Torq Str - Lower		1		EM-4227	
<b>SPARK</b>								
L4	L4 1.2L 76ci	2013-15 2014-15 2013	Torq Str - Lower		1		EM-4130	
			Trans - Upper	Auto (CVT)	1			EM-4267
			Trans - Upper	Auto	1			EM-4131
<b>SPARK EV</b>								
	Electric Vehicle	2014-15	Torq Str - Lower		1		EM-4130	
			Trans - Upper	Auto	1			EM-4267
<b>SPECTRUM</b>								
L4	L4 1.5L	1985-88	Torq Str - Front	Complete Unit	1		EM-8438	
			Torq Str - Front	Insert Only	1		EM-8539	
	L4 1.5L 1471cc	1985-88	Front	Manual; w/o Turbo	1	EM-8442		
			RH Front	w/o Turbo	1	EM-8439		
			Rear		1	EM-8826		
			Trans	Auto	1			EM-8439
			Trans	Manual	1			EM-8439
<b>SS</b>								
V8	V8 6.2L 376ci	2014-17	Trans		1			EM-4225

@ = Universal Mount EM-5000 also available.

# Engine, Transmission, And Torque Strut Mounts

CYL	ENG. SIZE	YEAR	LOCATION	DESCRIPTION	QTY	ENGINE	TORQUE STRUT	TRANSMISSION
<b>CHEVROLET PASSENGER CAR (continued)</b>								
<b>SPRINT</b>								
L3	L3 1.0L 61ci	1987-88	Front		1	EM-8283		
		1985-86	Front	Auto	1	EM-8162		
			Front	Manual	1	EM-8489		
		1991	LH Front	Auto	1	EM-5591		
			LH Front	Manual	1	EM-8517		
		1989-90	LH Front	Auto	1	EM-5591		
			LH Front	Manual	1	EM-8517		
		1991	RH Front	Auto; To 3-1-1991	1	EM-5733		
			RH Front	Manual	1	EM-8514		
		1989-90	RH Front	Auto	1	EM-5733		
			RH Front	Manual	1	EM-8514		
		1991	Rear	Manual	1	EM-8294		
		1989-90	Rear	Manual	1	EM-8294		
		1987-88	Rear	Manual	1	EM-8294		
		1985-86	Rear	Manual	1	EM-8294		
		1989-91	Torq Str - Front		1		EM-8521	
		1985-88	Torq Str - Front	Manual	1		EM-8521	
		1989-91	Torq Str - Rear	Auto	1		EM-8658	
			Torq Str - Rear	Manual	1		EM-8524	
		1985-88	Torq Str - Rear	Auto	1		EM-8658	
Torq Str - Rear	Manual		1		EM-8524			
1989-91	Trans		1			EM-8277		
1987-88	Trans	Manual	1			EM-8282		
1985-86	Trans	Manual; 5 Spd	1			EM-8282		
<b>TOWNSMAN</b>								
V8	V8 5.7L 350ci	1969-72	L & R Front		2	EM-2283		
		1971-72	Trans	Auto	1			EM-2294
			Trans	Manual	1			EM-2294
		1969-70	Trans	Auto	1			EM-2295
			Trans	Manual	1			EM-2295
	V8 6.6L 400ci	1972	L & R Front	VIN R	2	EM-2395		
		1970-71	L & R Front		2	EM-2283		
		1971	Trans	Auto	1			EM-2294
			Trans	Manual	1			EM-2294
	V8 6.6L 402ci	1972	L & R Front	VIN S	2	EM-2283		
			Trans	Auto; THM350	1			EM-2378 @
			Trans	Auto; THM400	1			EM-2268 @
		1970	Trans	Manual	1			EM-2378 @
			Trans	Auto; THM350	1			EM-2378 @
			Trans	Auto; THM400	1			EM-2268 @
			Trans	Manual	1			EM-2378 @
	V8 7.4L 454ci	1972	L & R Front		2	EM-2283		
		1970	L & R Front		2	EM-2283		
		1972	Trans	Auto	1			EM-2294
			Trans	Manual	1			EM-2294
1970		Trans		1			EM-2294	
<b>TWO-TEN SERIES</b>								
V8	V8 4.3L 265ci	1955-57	L & R Front	Large	2	EM-2123		
			L & R Front	Small	2	EM-2122		
			Trans - LH	Auto	1			EM-2127
			Trans - LH	Manual	1			EM-2124
			Trans - RH	Auto	1			EM-2126
			Trans - RH	Manual	1			EM-2125
	V8 4.6L 283ci	1957	L & R Front		2	EM-2142		

@ = Universal Mount EM-5000 also available.

# Engine, Transmission, And Torque Strut Mounts

CYL	ENG. SIZE	YEAR	LOCATION	DESCRIPTION	QTY	ENGINE	TORQUE STRUT	TRANSMISSION
<b>CHEVROLET PASSENGER CAR (continued)</b>								
<b>TWO-TEN SERIES (continued)</b>								
V8	V8 4.6L 283ci	1957	Trans	Auto; Powerglide	1			EM-2143
			Trans	Manual	1			EM-2378 @
<b>VEGA</b>								
L4	L4 2.0L 122ci	1975-76	LH Front		1	EM-2357		
			RH Front		1	EM-2356		
			Trans	Auto	1			EM-2353
			Trans	Manual	1			EM-2353
	L4 2.3L 140ci	1971-77	LH Front		1	EM-2357		
			RH Front		1	EM-2356		
		1976-77	Trans	Auto	1			EM-2353
			Trans	Manual	1			EM-2288 @
		1971-75	Trans	Auto	1			EM-2353
			Trans	Manual	1			EM-2353
<b>VOLT</b>								
L4	L4 1.4L 85ci	2011-15	Right		1	EM-4189		
			Torq Str - Lower		1		EM-4183	
<b>CHEVROLET SPORT UTILITY</b>								
<b>AVALANCHE</b>								
V8	V8 5.3L 325ci	2007-13	L & R Front		2	EM-5583#		
			Trans	Auto; 4WD	1			EM-2638
			Trans	Auto; RWD	1			EM-2811
	V8 6.0L 364ci	2007-09	L & R Front		2	EM-5583#		
			Trans	Auto; 4WD	1			EM-2638
			Trans	Auto; RWD	1			EM-2811
<b>AVALANCHE 1500</b>								
V8	V8 5.3L 325ci	2002-06	L & R Front	w/Heat Shield	2	EM-5423		
			L & R Front	w/o Heat Shield	2	EM-2909#		
			Trans	4WD	1			EM-2638
			Trans	RWD	1			EM-2811
<b>AVALANCHE 2500</b>								
V8	V8 8.1L 496ci	2002-06	L & R Front		2	EM-5353		
		2006	Trans	4WD	1			EM-2839
		2002-05	Trans		1			EM-2839
<b>CAPTIVA SPORT</b>								
L4	L4 2.4L 145ci	2012-15	Right		1	EM-4161		
			Trans - Center		1			EM-4192
			Trans - Front		1			EM-4111
			Trans - Front	Bushing Only; Auto	1			EM-4135
	L4 2.4L 2404cc	2008-11	Trans - Center	Mexico	1			EM-4064
V6	V6 3.0L 182ci	2012-15	Front		1	EM-4155		
			Trans - Rear		1			EM-4135
<b>EQUINOX</b>								
L4	L4 2.4L 145ci	2010-15	Right		1	EM-4161		
		2010-17	Trans - Center		1			EM-4192
			Trans - Front		1			EM-4111
			Trans - Rear		1			EM-4135
V6	V6 3.0L 182ci	2010-12	Front		1	EM-4155		
			Trans - Center		1			EM-4180
			Trans - Front		1			EM-4175
			Trans - Rear		1			EM-4135
	V6 3.4L 207ci	2005-09	RH Front		1	EM-3110		
2007-09		Trans - Front		1			EM-3082	
2005-06		Trans - Front		1			EM-3082	

@ = Universal Mount EM-5000 also available. # = Available in the Westar Gold Line

## Engine, Transmission, And Torque Strut Mounts

CYL	ENG. SIZE	YEAR	LOCATION	DESCRIPTION	QTY	ENGINE	TORQUE STRUT	TRANSMISSION	
<b>CHEVROLET SPORT UTILITY (continued)</b>									
<b>EQUINOX (continued)</b>									
V6	V6 3.4L 207ci	2007-09	Trans - Rear		1			EM-3069	
		2005-06	Trans - Rear		1			EM-3069	
			Trans - Upper		1			EM-5475	
	V6 3.6L 217ci	2013-15	Front		1	EM-4155			
		2008-09	Left		1	EM-3154			
			Right		1	EM-3154			
		2013-15	Trans - Center		1			EM-4180	
		2008-09	Trans - Center		1			EM-3154	
		2013-15	Trans - Front		1			EM-4175	
		2008-09	Trans - Front		1			EM-4079	
		2013-15	Trans - Rear		1			EM-4135	
2008-09	Trans - Rear		1			EM-4078			
<b>K5 BLAZER</b>									
L6	L6 4.1L 250ci	1982	Trans - Lower	Auto; 4WD	2			EM-2108	
			Trans - Lower	Manual; 4WD	2			EM-2108	
		1977-81	Trans - Lower	Auto; 4WD	2			EM-2108	
			Trans - Lower	Manual; 4WD	2			EM-2108	
		1975-76	Trans - Lower	Auto; 4WD	2			EM-2108	
			Trans - Lower	Manual; 4WD	2			EM-2108	
		1982	Trans - Upper	Auto; 4WD	2			EM-2107	
			Trans - Upper	Manual; 4WD	2			EM-2378 @	
		1977-81	Trans - Upper	Auto; 4WD	2			EM-2107	
			Trans - Upper	Manual; 4WD	2			EM-2378 @	
		1975-76	Trans - Upper	Auto; 4WD	2			EM-2107	
			Trans - Upper	Manual; 4WD	2			EM-2378 @	
		1982	Trans	Auto; THM350C (MV4)	1			EM-2268 @	
				THM700-R4/4L60 (MD8); RW					
		1977-81	Trans	Auto; THM400 (M40); RWD	1			EM-2378 @	
Auto; THM350 (M38); RWD	1					EM-2268 @			
1975-76	Trans	Auto; THM400 (M40); RWD	1			EM-2378 @			
		Auto; THM350 (M38); RWD	1			EM-2378 @			
V8	V8 5.7L 350ci	1983-84	Trans - Lower	Auto; 4WD	2			EM-2108	
			Trans - Lower	Manual; 4WD	2			EM-2108	
			Trans - Upper	Auto; 4WD	2			EM-2107	
			Trans - Upper	Manual; 4WD	2			EM-2392	
		1985-86	Trans	Auto	1			EM-2638	
			Trans	Manual	1			EM-2638	
		1983-84	Trans	Auto; RWD	1			EM-2392	
		V8 6.2L 379ci	1982-84	Trans - Lower	Auto; 4WD	2			EM-2108
				Trans - Lower	Manual; 4WD	2			EM-2108
	Trans - Upper			Auto; 4WD	2			EM-2107	
	1985-86		Trans	Auto	1			EM-2638	
			Trans	Manual	1			EM-2638	
	V8 6.6L 400ci	1975-79	Trans - Lower	Auto; 4WD	2			EM-2108	
			Trans - Lower	Manual; 4WD	2			EM-2108	
			Trans - Upper	Auto; 4WD	2			EM-2107	
	V8 7.4L 454ci	1976-78	Trans - Lower	Auto; 4WD	2			EM-2108	
			Trans - Lower	Manual; 4WD	2			EM-2108	
			Trans - Upper	Auto; 4WD	2			EM-2107	
	<b>BLAZER</b>								
	L6	L6 4.1L 250ci	1973-82	L & R Front		2	EM-2292		
			1969-72	L & R Front		2	EM-2282		
1973-74			Trans - L & R Lower	4WD 4WD	2			EM-2108	
1969-72			Trans - L & R Lower	4WD 4WD	2			EM-2108	

@ = Universal Mount EM-5000 also available.

# Engine, Transmission, And Torque Strut Mounts

CYL	ENG. SIZE	YEAR	LOCATION	DESCRIPTION	QTY	ENGINE	TORQUE STRUT	TRANSMISSION
<b>CHEVROLET SPORT UTILITY (continued)</b>								
<b>BLAZER (continued)</b>								
L6	L6 4.1L 250ci	1973-74	Trans - L & R Upper	4WD 4WD	2			EM-2107
		1969-72	Trans - L & R Upper	4WD 4WD	2			EM-2107
		1973-74	Trans	Auto; THM350 (M38) THM350C (MV4); RWD	1			EM-2378 @
			Trans	Auto; THM400 (M40); RWD	1			EM-2268 @
			Trans	Manual; RWD	1			EM-2378 @
		1969-72	Trans	Auto; THM350 (M38) THM350C (MV4); RWD	1			EM-2378 @
			Trans	Manual; RWD	1			EM-2378 @
		L6 4.8L 292ci	1973	L & R Front		2	EM-2292	
	1970		L & R Front		2	EM-2282		
	1973		Trans - L & R Lower	4WD 4WD	2			EM-2108
	1970		Trans - L & R Lower	4WD 4WD	2			EM-2108
	1973		Trans - L & R Upper	4WD 4WD	2			EM-2107
	1970		Trans - L & R Upper	4WD 4WD	2			EM-2107
	1973		Trans	Auto; THM350 (M38); RWD	1			EM-2378 @
			Trans	Auto; THM400 (M40); RWD	1			EM-2268 @
			Trans	Manual; RWD	1			EM-2378 @
	1970		Trans	Auto; THM350 (M38); RWD	1			EM-2378 @
			Trans	Auto; THM400 (M40); RWD	1			EM-2268 @
			Trans	Manual; RWD	1			EM-2378 @
	V6	V6 4.3L 262ci	1996-05	L & R Front		2	EM-2802	
1995			L & R Front	4WD	2	EM-2802		
			L & R Front	RWD	2	EM-2627		
			Trans	Auto; 4WD	1		EM-2638	
2002-05			Trans	Auto; RWD	1		EM-2394	
			Trans	Manual; 4WD	1		EM-2638	
			Trans	Manual; RWD	1		EM-2394	
			Trans	Auto; 4WD	1		EM-2839	
1995-01			Trans	Auto; RWD	1		EM-2394	
			Trans	Manual; 4WD	1		EM-2839	
	Trans	Manual; RWD	1		EM-2394			
V8	V8 5.0L 305ci	1977-87	L & R Front		2	EM-2292		
		1987	Trans - L & R Lower	4WD 4WD	2		EM-2108	
			Trans - L & R Upper	4WD 4WD	2		EM-2107	
			Trans	Auto; THM180C (MD2) THM400 (MD38); 4WD	1		EM-2638	
		V8 5.0L 307ci	1973	L & R Front		2	EM-2292	
	1969-72		L & R Front		2	EM-2282		
	1969-73		Trans - L & R Lower	4WD 4WD	2		EM-2108	
			Trans - L & R Upper	4WD 4WD	2		EM-2107	
	Trans		Auto; Powerglide	1		EM-2378 @		
	Trans		Auto; THM350 (M38) THM350C (MV4); RWD	1		EM-2378 @		
	Trans		Auto; THM400 (M40); RWD	1		EM-2268 @		

@ = Universal Mount EM-5000 also available.

# Engine, Transmission, And Torque Strut Mounts

CYL	ENG. SIZE	YEAR	LOCATION	DESCRIPTION	QTY	ENGINE	TORQUE STRUT	TRANSMISSION
<b>CHEVROLET SPORT UTILITY (continued)</b>								
<b>BLAZER (continued)</b>								
V8	V8 5.0L 307ci	1969-73	Trans	Manual; RWD	1			EM-2378 @
	V8 5.7L 350ci	1990-94	L & R Front	4WD	2	EM-2637		
		1988-89	L & R Front	4WD	2	EM-2637		
		1973-87	L & R Front		2	EM-2292		
		1969-72	L & R Front		2	EM-2282		
		1969-74	Trans - L & R Lower	4WD 4WD	2			EM-2108
			Trans - L & R Upper	4WD 4WD	2			EM-2107
		1990-94	Trans	Auto; 4WD	1			EM-2638
			Trans	Manual; 4WD	1			EM-2638
		1987-89	Trans	Auto; 4WD	1			EM-2638
			Trans	Manual; 4WD	1			EM-2638
		1969-74	Trans	Auto; THM350 (M38); RWD	1			EM-2378 @
			Trans	Auto; THM400 (M40); RWD	1			EM-2268 @
			Trans	Manual; RWD	1			EM-2378 @
	V8 6.2L 379ci Diesel	1988-91	L & R Front		2	EM-2637		
		1984-87	L & R Front		2	EM-2395		
		1982-83	L & R Front		2	EM-2292		
		1987-91	Trans	Auto; 4WD	1			EM-2638
	Trans		Manual; 4WD	1			EM-2638	
	V8 6.5L 395ci Diesel	1994	L & R Front	4WD	2	EM-2637		
			Trans	Auto; 4WD	1			EM-2638
			Trans	Manual; 4WD	1			EM-2638
	V8 6.6L 400ci	1975-79	L & R Front		2	EM-2292		
	V8 7.4L 454ci	1976-78	L & R Front		2	EM-2292		
		1973	L & R Front		2	EM-2395		
			Trans - L & R Lower		2			EM-2108
			Trans - L & R Upper		2			EM-2107
	<b>C10/C1500 SUBURBAN</b>							
L6	L6 4.1L 250ci	1973-80	L & R Front		2	EM-2292		
		1967-72	L & R Front		2	EM-2282		
		1976-80	Trans	Auto; THM350 (M38) THM350C (MV4); RWD	1			EM-2378 @
			Trans	Auto; THM400-475 (M40)	1			EM-2268 @
			Trans	Manual	1			EM-2378 @
			Trans	Manual	1			EM-2378 @
		1975	Trans	Auto; THM400-475 (M40)	1			EM-2268 @
			Trans	Manual	1			EM-2378 @
		1973-74	Trans	Auto; THM350 (M38) THM350C (MV4); RWD	1			EM-2378 @
			Trans	Auto; THM400-475 (M40)	1			EM-2268 @
			Trans	Manual	1			EM-2378 @
		1967-72	Trans		1			EM-2378 @
	L6 4.8L 292ci	1973-74	L & R Front		2	EM-2292		
		1967-71	L & R Front		2	EM-2282		
		1973-74	Trans	Auto; THM350 (M38)	1			EM-2378 @
			Trans	Auto; THM400-475 (M40)	1			EM-2268 @
			Trans	Manual	1			EM-2378 @
		1967-71	Trans	Auto	1			EM-2378 @
Trans	Manual		1			EM-2378 @		
V8	V8 5.0L 305ci	1977-86	L & R Front		2	EM-2292		
		1985-86	Trans	Auto; THM700R4 (MD8)	1			EM-2392

@ = Universal Mount EM-5000 also available.

# Engine, Transmission, And Torque Strut Mounts

CYL	ENG. SIZE	YEAR	LOCATION	DESCRIPTION	QTY	ENGINE	TORQUE STRUT	TRANSMISSION
<b>CHEVROLET SPORT UTILITY (continued)</b>								
<b>C10/C1500 SUBURBAN (continued)</b>								
V8	V8 5.0L 305ci	1982-84	Trans	Auto; THM400-475 (M40)	1			EM-2513
			Trans	Auto; THM700R4 (MD8)	1			EM-2392
			Trans	Manual	1			EM-2392
		1977-81	Trans	Auto; THM350 (M38)	1			EM-2378 @
				THM350C (MV4)				
			Trans	Auto; THM400-475 (M40)	1			EM-2268 @
	V8 5.0L 307ci	1973	L & R Front		2	EM-2292		
			1968-72	L & R Front		2	EM-2282	
			1968-73	Trans	Auto; Powerglide	1		
		Trans		Auto; THM350 (M38)	1			EM-2378 @
		Trans		Auto; THM400-475 (M40)	1			EM-2268 @
		Trans	Manual	1			EM-2378 @	
	V8 5.4L 327ci	1967-68	L & R Front		2	EM-2282		
			Trans	Auto; THM400-475 (M40)	1			EM-2268 @
			Trans	Manual	1			EM-2378 @
	V8 5.7L 350ci	1992-99	L & R Front		2	EM-2621		
			1973-86	L & R Front		2	EM-2292	
		1969-72	L & R Front		2	EM-2282		
		1994-99	Trans		1			EM-2817
		1992-93	Trans	Auto; RWD	1			EM-2659 @
		1985-86	Trans	Auto; THM350C (MV4) THM700R4 (MD8)	1			EM-2392
			1982-84	Trans	Auto; THM350C (MV4) THM700R4 (MD8)	1		EM-2392
			Trans	Auto; THM400 (M40)	1			EM-2513
			Trans	Manual	1			EM-2392
			1976-81	Trans	Auto; THM350 (M38)	1		
		Trans		Auto; THM400-475 (M40)	1			EM-2268 @
		1975	Trans	Manual	1			EM-2378 @
Trans			Auto; THM400-475 (M40)	1			EM-2268 @	
1969-74		Trans	Manual	1			EM-2378 @	
		Trans	Auto; THM350 (M38)	1			EM-2378 @	
		Trans	Auto; THM400-475 (M40)	1			EM-2268 @	
Trans		Manual	1			EM-2378 @		
V8 6.2L 379ci Diesel		1984-86	L & R Front		2	EM-2395		
	1982-83		L & R Front		2	EM-2292		
	1983-86	Trans	Auto; THM700R4 (MD8)	1			EM-2393	
	1982	Trans	Auto; THM700R4 (MD8)	1			EM-2392	
V8 6.5L 395ci Diesel	1995-99	L & R Front		2	EM-2621			
		Trans		1			EM-2817	
V8 6.6L 402ci	1970-72	L & R Front		2	EM-2283			
		Trans	Auto; THM350 (M38)	1			EM-2378 @	
		Trans	Auto; THM400-475 (M40)	1			EM-2268 @	
		Trans	Manual	1			EM-2378 @	
V8 7.4L 454ci	1973-80	L & R Front		2	EM-2395			
		1976-80	Trans	Auto; THM350 (M38)	1			EM-2378 @
	1975	Trans	Auto; THM400-475 (M40)	1			EM-2268 @	
		Trans	Manual	1			EM-2378 @	
		Trans	Auto; THM400-475 (M40)	1			EM-2268 @	
	1973-74	Trans	Manual	1			EM-2378 @	
		Trans	Auto; THM350 (M38)	1			EM-2378 @	
Trans	Auto; THM400-475 (M40)	1			EM-2268 @			

@ = Universal Mount EM-5000 also available.



# Engine, Transmission, And Torque Strut Mounts

CYL	ENG. SIZE	YEAR	LOCATION	DESCRIPTION	QTY	ENGINE	TORQUE STRUT	TRANSMISSION	
<b>CHEVROLET SPORT UTILITY (continued)</b>									
<b>C10/C1500 SUBURBAN (continued)</b>									
V8	V8 7.4L 454ci	1973-74	Trans	Manual	1			EM-2378 @	
<b>C20/C2500 SUBURBAN</b>									
L6	L6 4.1L 250ci	1973-74	L & R Front		2	EM-2292			
		1967-72	L & R Front		2	EM-2282			
		1973-74	Trans	Auto; THM350 (M38)	1			EM-2378 @	
				THM350C (MV4)					
			Trans	Auto; THM400-475 (M40)	1			EM-2268 @	
		1967-72	Trans	Manual	1			EM-2378 @	
			Trans	Auto	1			EM-2378 @	
	Trans		Manual	1			EM-2378 @		
	Trans		Manual	1			EM-2378 @		
	L6 4.8L 292ci	1973-82	L & R Front		2	EM-2292			
		1967-72	L & R Front		2	EM-2282			
		1982	Trans	Auto; THM350C (MV4)	1			EM-2378 @	
			Trans	Auto; THM400 (M40)	1			EM-2513	
			Trans	Auto; THM700-R4/4L60 (MD8)	1			EM-2268 @	
			Trans	Manual	1			EM-2378 @	
		1968-81	Trans	Auto; THM350 (M38)	1			EM-2378 @	
			Trans	Auto; THM400-475 (M40)	1			EM-2268 @	
			Trans	Manual	1			EM-2378 @	
		1967	Trans	Auto; THM400-475 (M40)	1			EM-2268 @	
			Trans	Manual	1			EM-2378 @	
V8		V8 5.0L 305ci	1977-86	L & R Front		2	EM-2292		
			1985-86	Trans	Auto; THM350C; THM400	1			EM-2513
	Trans			Auto; THM700-R4/4L60 (MD8)	1			EM-2392	
	1982-84		Trans	Auto; THM400-475 (M40)	1			EM-2513	
			Trans	Auto; THM700R4 (MD8)	1			EM-2392	
			Trans	Manual	1			EM-2392	
	1977-81		Trans	Auto; THM350 (M38)	1			EM-2378 @	
				THM350C (MV4); RWD					
			Trans	Auto; THM400-475 (M40)	1			EM-2268 @	
			Trans	Manual	1			EM-2378 @	
	V8 5.0L 307ci	1973	L & R Front		2	EM-2292			
		1968-72	L & R Front		2	EM-2282			
		1968-73	Trans	Auto; Powerglide	1			EM-2378 @	
			Trans	Auto; THM400-475 (M40)	1			EM-2268 @	
			Trans	Manual	1			EM-2378 @	
	V8 5.4L 327ci	1967-68	L & R Front		2	EM-2282			
		Trans	Auto; THM400-475 (M40)	1			EM-2268 @		
		Trans	Manual	1			EM-2378 @		
	V8 5.7L 350ci	1992-99	L & R Front		2	EM-2621			
		1973-86	L & R Front		2	EM-2292			
1969-72		L & R Front		2	EM-2282				
1994-99		Trans		1			EM-2817		
1992-93		Trans	Auto; RWD	1			EM-2659 @		
		Trans	Auto; THM350C (MV4)	1			EM-2392		
1985-86			THM700-R4/4L60 (MD8)						
		Trans	Auto; THM400 (M40)	1			EM-2513		
		Trans	Auto; THM350C (MV4)	1			EM-2392		
1982-84			THM700-R4/4L60 (MD8)						
		Trans	Auto; THM400 (M40)	1			EM-2513		
1969-81		Trans	Manual	1			EM-2392		
	Trans	Auto; THM350 (M38)	1			EM-2378 @			
	Trans	Auto; THM400-475 (M40)	1			EM-2268 @			

@ = Universal Mount EM-5000 also available.

# Engine, Transmission, And Torque Strut Mounts

CYL	ENG. SIZE	YEAR	LOCATION	DESCRIPTION	QTY	ENGINE	TORQUE STRUT	TRANSMISSION	
<b>CHEVROLET SPORT UTILITY (continued)</b>									
<b>C20/C2500 SUBURBAN (continued)</b>									
V8	V8 5.7L 350ci	1969-81	Trans	Manual	1			EM-2378 @	
	V8 6.2L 379ci Diesel	1984-86	L & R Front		2	EM-2395			
		1982-83	L & R Front		2	EM-2292			
		1983-86	Trans	Auto; THM400-475 (M40)	1			EM-2515	
			Trans	Auto; THM700R4 (MD8)	1			EM-2393	
	1982	Trans	Auto; THM700R4 (MD8)	1			EM-2392		
	V8 6.5L 395ci Diesel	1994-99	L & R Front		2	EM-2621			
			Trans		1			EM-2817	
	V8 6.6L 400ci	1976-80	L & R Front		2	EM-2292			
			Trans		1			EM-2378 @	
	V8 6.6L 402ci	1970-72	L & R Front		2	EM-2283			
			Trans	Auto; THM350 (M38)	1			EM-2378 @	
			Trans	Auto; THM400-475 (M40)	1			EM-2268 @	
			Trans	Manual	1			EM-2378 @	
	V8 7.4L 454ci	1973-86	L & R Front		2	EM-2395			
		1996-99	Trans		1			EM-2817	
		1992-95	Trans	Auto; RWD	1			EM-2659 @	
		1986	Trans	Auto; THM400 (M40)	1			EM-2513	
			Trans	Auto; THM700-R4/4L60 (MD8)	1			EM-2392	
		1985	Trans	Auto; THM400 (M40)	1			EM-2513	
			Trans	Auto; THM700-R4/4L60 (MD8)	1			EM-2392	
		1982-84	Trans	Auto; THM350C (MV4)	1			EM-2378 @	
			Trans	Auto; THM400 (M40)	1			EM-2513	
		Trans	Auto; THM700-R4/4L60 (MD8)	1			EM-2392		
		Trans	Manual	1			EM-2392		
		1973-81	Trans	Auto; THM350 (M38)	1			EM-2378 @	
	Trans		Auto; THM400-475 (M40)	1			EM-2268 @		
	Trans	Manual	1			EM-2378 @			
	<b>K10/K1500 SUBURBAN</b>								
	L6	L6 4.1L 250ci	1973-80	L & R Front		2	EM-2292		
			1967-72	L & R Front		2	EM-2282		
			1967-80	Trans - Lower	Auto	2			EM-2108
Trans - Lower				Manual	2			EM-2108	
Trans - Upper				Auto	2			EM-2107	
V8	V8 5.0L 250ci	1977-84	Trans - Lower	Auto	2		EM-2108		
			Trans - Lower	Manual	2		EM-2108		
			Trans - Upper	Auto	2		EM-2107		
	V8 5.0L 305ci	1977-86	L & R Front		2	EM-2292			
			1985-86	Trans	Auto	1		EM-2638	
	V8 5.0L 307ci	1973	L & R Front		2	EM-2292			
1968-72		L & R Front		2	EM-2282				
1968-73		Trans - L & R Lower		2			EM-2108		
	Trans - L & R Upper		2			EM-2107			
V8 5.4L 327ci	1967-68	L & R Front		2	EM-2282				
		Trans - L & R Lower		2		EM-2108			
		Trans - L & R Upper		2		EM-2107			
V8 5.7L 350ci	1992-99	L & R Front		2	EM-2637				
		L & R Front		2	EM-2292				
		L & R Front		2	EM-2282				
		Trans - Lower	Auto	2		EM-2108			
		Trans - Lower	Manual	2		EM-2108			

@ = Universal Mount EM-5000 also available.

# Engine, Transmission, And Torque Strut Mounts

CYL	ENG. SIZE	YEAR	LOCATION	DESCRIPTION	QTY	ENGINE	TORQUE STRUT	TRANSMISSION	
<b>CHEVROLET SPORT UTILITY (continued)</b>									
<b>K10/K1500 SUBURBAN (continued)</b>									
V8	V8 5.7L 350ci	1969-84	Trans - Upper	Auto	2			EM-2107	
		1992-99	Trans	Auto	1			EM-2638	
		1985-86	Trans	Auto	1			EM-2638	
	V8 6.2L 379ci Diesel	1984-86	L & R Front			2	EM-2395		
		1982-83	L & R Front			2	EM-2292		
		1982-84	Trans - Lower	Auto		2			EM-2108
			Trans - Lower	Manual		2			EM-2108
			Trans - Upper	Auto		2			EM-2107
		1985-86	Trans	Auto		1			EM-2638
	V8 6.5L 395ci Diesel	1995-99	L & R Front			2	EM-2637		
			Trans	Auto		1			EM-2638
	V8 6.5L 396ci	1968-69	L & R Front			2	EM-2283		
			Trans			1			EM-2378 @
	V8 6.6L 400ci	1975-79	L & R Front			2	EM-2292		
			Trans - Lower	Auto		2			EM-2108
			Trans - Lower	Manual		2			EM-2108
			Trans - Upper	Auto		2			EM-2107
	V8 6.6L 402ci	1970-72	L & R Front			2	EM-2283		
Trans					1			EM-2378 @	
<b>K20/K2500 SUBURBAN</b>									
L6	L6 4.1L 250ci	1973-74	L & R Front		2	EM-2292			
		1967-72	L & R Front		2	EM-2282			
		1967-74	Trans - Lower	Auto		2			EM-2108
			Trans - Lower	Manual		2			EM-2108
			Trans - Upper	Auto		2			EM-2107
	L6 4.8L 292ci	1973-82	L & R Front			2	EM-2292		
		1968-72	L & R Front			2	EM-2282		
		1967-82	Trans - Lower	Auto		2			EM-2108
			Trans - Lower	Manual		2			EM-2108
			Trans - Upper	Auto		2			EM-2107
V8	V8 5.0L 305ci	1985-86	L & R Front		2	EM-2292			
		1977-78	L & R Front		2	EM-2292			
			Trans - Lower	Auto		2		EM-2108	
			Trans - Lower	Manual		2		EM-2108	
			Trans - Upper	Auto		2		EM-2107	
		1985-86	Trans	Auto		1		EM-2638	
	V8 5.0L 307ci	1973	L & R Front			2	EM-2292		
		1968-72	L & R Front			2	EM-2282		
		1968-73	Trans - L & R Lower			2			EM-2108
			Trans - L & R Upper			2			EM-2107
	V8 5.7L 350ci	1992-99	L & R Front			2	EM-2637		
		1973-86	L & R Front			2	EM-2292		
		1969-72	L & R Front			2	EM-2282		
		1969-84	Trans - Lower	Auto		2			EM-2108
			Trans - Lower	Manual		2			EM-2108
			Trans - Upper	Auto		2			EM-2107
		1992-99	Trans	Auto		1		EM-2638	
		1985-86	Trans	Auto		1		EM-2638	
	V8 6.2L 379ci Diesel	1984-86	L & R Front			2	EM-2395		
		1982-83	L & R Front			2	EM-2292		
1982-84		Trans - Lower	Auto		2			EM-2108	
		Trans - Lower	Manual		2			EM-2108	
		Trans - Upper	Auto		2			EM-2107	
1985-86		Trans	Auto		1		EM-2638		

@ = Universal Mount EM-5000 also available.

# Engine, Transmission, And Torque Strut Mounts

CYL	ENG. SIZE	YEAR	LOCATION	DESCRIPTION	QTY	ENGINE	TORQUE STRUT	TRANSMISSION	
<b>CHEVROLET SPORT UTILITY (continued)</b>									
<b>K20/K2500 SUBURBAN (continued)</b>									
V8	V8 6.5L 395ci Diesel	1994-99	L & R Front		2	EM-2637			
			Trans	Auto	1		EM-2638		
	V8 6.6L 400ci	1975-80	L & R Front		2	EM-2292			
			Trans - Lower	Auto	2		EM-2108		
			Trans - Lower	Manual	2		EM-2108		
			Trans - Upper	Auto	2		EM-2107		
	V8 7.4L 454ci	1992-99	L & R Front		2	EM-2637			
			1985	L & R Front		2	EM-2395		
		1973	L & R Front		2	EM-2395			
			Trans - Lower	Auto	2		EM-2108		
			Trans - Lower	Manual	2		EM-2108		
			Trans - Upper	Auto	2		EM-2107		
		1992-99	Trans	Auto	1		EM-2638		
			1985	Trans	Auto	1		EM-2638	
<b>R10/R1500 SUBURBAN</b>									
V8	V8 5.0L 305ci	1987	L & R Front		2	EM-2292			
			Trans	Auto; THM700R4 (MD8)	1		EM-2392		
	V8 5.7L 350ci	1989-91	L & R Front		2	EM-2621			
			1987-88	L & R Front		2	EM-2621		
		1991	Trans	Auto; 4L80E (MT1)	1		EM-2513		
			Trans	Auto; THM700-R4/4L60 (MD8)	1		EM-2392		
		1989-90	Trans	Auto; THM700-R4/4L60 (MD8)	1		EM-2392		
		1987-88	Trans	Auto; THM700-R4/4L60 (MD8)	1		EM-2392		
	V8 6.2L 379ci Diesel	1989-91	L & R Front		2	EM-2395			
			1987-88	L & R Front		2	EM-2395		
		1991	Trans	Auto; 4L80E (MT1)	1		EM-2513		
			Trans	Auto; THM700-R4/4L60 (MD8)	1		EM-2392		
		1989-90	Trans	Auto; THM700-R4/4L60 (MD8)	1		EM-2392		
		1987-88	Trans	Auto; THM700R4 (MD8)	1		EM-2393		
<b>R20/R2500 SUBURBAN</b>									
V8	V8 5.7L 350ci	1989-91	L & R Front		2	EM-2621			
		1987-88	L & R Front		2	EM-2621			
		1991	Trans	Auto; 4L80E (MT1)	1		EM-2513		
			Trans	Auto; THM700-R4/4L60 (MD8)	1		EM-2392		
		1989-90	Trans	Auto; THM400 (M40)	1		EM-2513		
			Trans	Auto; THM700-R4/4L60 (MD8)	1		EM-2392		
		1987-88	Trans	Auto; THM400 (M40)	1		EM-2513		
			Trans	Auto; THM700-R4/4L60 (MD8)	1		EM-2392		
		V8 6.2L 379ci Diesel	1989-91	L & R Front		2	EM-2395		
				1987-88	L & R Front		2	EM-2395	
			1991	Trans	Auto; 4L80E (MT1)	1		EM-2513	
				Trans	Auto; THM700-R4/4L60 (MD8)	1		EM-2392	
	1989-90		Trans	Auto; THM400 (M40)	1		EM-2515		
			Trans	Auto; THM700-R4/4L60 (MD8)	1		EM-2393		
	1987-88	Trans	Auto; THM400 (M40)	1		EM-2515			
		Trans	Auto; THM700-R4/4L60 (MD8)	1		EM-2393			
		V8 7.4L 454ci	1989-91	L & R Front		2	EM-2395		
	1987-88		L & R Front		2	EM-2395			
	1989-91		Trans		1		EM-2515		
1987-88	Trans	Auto; THM700-R4/4L60 (MD8)	1		EM-2515				
<b>S10 BLAZER</b>									
L4	L4 1.9L	1984	Trans	Auto; 2WD	1			EM-2531	
			Trans	Auto; 4WD	1		EM-2638		
			Trans	Manual; 2WD	1		EM-2531		
			Trans	Manual; 4WD	1		EM-2638		
	L4 1.9L 119ci	1983-84	L & R Front		2	EM-2381			

# Engine, Transmission, And Torque Strut Mounts

CYL	ENG. SIZE	YEAR	LOCATION	DESCRIPTION	QTY	ENGINE	TORQUE STRUT	TRANSMISSION	
<b>CHEVROLET SPORT UTILITY (continued)</b>									
<b>S10 BLAZER (continued)</b>									
L4	L4 1.9L 119ci	1983	Trans	Auto; 2WD	1			EM-2771	
			Trans	Auto; 4WD	1			EM-2638	
			Trans	Manual; 2WD	1				EM-2771
			Trans	Manual; 4WD	1				EM-2638
	L4 2.0L	1984	Trans	Auto; 2WD	1				EM-2531
			Trans	Auto; 4WD	1				EM-2638
			Trans	Manual; 2WD	1				EM-2531
			Trans	Manual; 4WD	1				EM-2638
	L4 2.0L 122ci	1983-84	LH Front		1	EM-2755			
			RH Front		1	EM-2756			
		1983	Trans	Auto; 2WD	1				EM-2772
			Trans	Auto; 4WD	1				EM-2638
			Trans	Manual; 2WD	1				EM-2772
			Trans	Manual; 4WD	1				EM-2638
	L4 2.2L 134ci Diesel	1984	LH Front		1	EM-2549			
			RH Front		1	EM-2550			
			Trans	Auto; 2WD	1				EM-2531
			Trans	Manual; 2WD	1				EM-2531
	L4 2.5L 2474cc	1985-88	LH Front		1	EM-2549			
			RH Front		1	EM-2550			
		1988	Trans	2WD	1				EM-2508
			Trans	Auto; 4WD	1				EM-2638
			Trans	Manual; 4WD	1				EM-2638
		1985-87	Trans	Auto; 2WD	1				EM-2531
Trans			Auto; 4WD	1				EM-2638	
Trans			Manual; 2WD	1				EM-2531	
Trans			Manual; 4WD	1				EM-2638	
V6		V6 2.8L 173ci	1983-89	L & R Front		2	EM-2436		
	1988-89		Trans	Auto; 2WD	1			EM-2508	
			Trans	Manual; 2WD	1			EM-2508	
	1984-87		Trans	Auto; 2WD	1				EM-2531
			Trans	Auto; 4WD	1				EM-2638
			Trans	Manual; 2WD	1				EM-2531
			Trans	Manual; 4WD	1				EM-2638
	1983		Trans	Auto; 2WD	1				EM-2772
			Trans	Auto; 4WD	1				EM-2638
			Trans	Manual; 2WD	1				EM-2772
		Trans	Manual; 4WD	1				EM-2638	
	V6 4.3L 262ci	1988-94	L & R Front		2	EM-2627			
			Trans	Auto; 2WD	1			EM-2508	
			Trans	Auto; 4WD	1			EM-2638	
Trans			Manual; 2WD	1			EM-2508		
Trans			Manual; 4WD	1			EM-2638		
<b>SUBURBAN</b>									
L6	L6 4.1L 250ci	1966	L & R Front		2	EM-2282			
			Trans	Auto; THM350 (M38)	1			EM-2378 @	
				THM350C (MV4); RWD					
			Trans	Manual; 2WD	1			EM-2378 @	
V8	V8 5.3L 325ci	2015-16	LH Front		1	EM-4173			
			RH Front		1	EM-4174			
<b>SUBURBAN 1500</b>									
V8	V8 5.3L 325ci	2007-14	L & R Front		2	EM-5583#			
		2000-06	L & R Front		2	EM-2909#			
		2007-14	Trans	2WD	1			EM-2811	
			Trans	4WD	1			EM-2638	
		2006	Trans	RWD	1			EM-2811	

@ = Universal Mount EM-5000 also available. # = Available in the Westar Gold Line

# Engine, Transmission, And Torque Strut Mounts

CYL	ENG. SIZE	YEAR	LOCATION	DESCRIPTION	QTY	ENGINE	TORQUE STRUT	TRANSMISSION
<b>CHEVROLET SPORT UTILITY (continued)</b>								
<b>SUBURBAN 1500 (continued)</b>								
V8	V8 5.3L 325ci	2000-05	Trans	2WD	1			EM-2811
			Trans	4WD	1		EM-2638	
	V8 6.0L 364ci	2007-09	L & R Front		2	EM-5583#		
			Trans	4WD; Auto	1		EM-2638	
			Trans	Auto; 2WD	1		EM-2811	
<b>SUBURBAN 2500</b>								
V8	V8 6.0L 364ci	2007-13	L & R Front		2	EM-5583#		
		2000-06	L & R Front		2	EM-2909#		
		2007-13	Trans	4WD; Auto	1		EM-2638	
			Trans	Auto; 2WD	1		EM-2811	
		2004-06	Trans	RWD; Auto	1		EM-2811	
		2000-03	Trans	Auto; 2WD	1		EM-2811	
	Trans		Auto; 4WD	1		EM-2638		
	V8 8.1L 496ci	2001-06	L & R Front		2	EM-5353		
			Trans	Auto	1		EM-2839	
	<b>TAHOE</b>							
V8	V8 4.8L 294ci	2000-06	L & R Front		2	EM-2909#		
		2007-09	LH Front	2WD	1	EM-4000		
			RH Front		1	EM-4017		
		2000-09	Trans	2WD	1		EM-2811	
	Trans		4WD	1		EM-2638		
	V8 5.3L 325ci	2012-14	L & R Front	exc. Police (PPV) Vehicle	2	EM-5583#		
		2007-11	L & R Front		2	EM-5583#		
		2007	L & R Front		2	EM-5583#		
		2006	L & R Front		2	EM-2909#		
		2000-05	L & R Front		2	EM-2909#		
		2015-16	LH Front		1	EM-4173		
			RH Front		1	EM-4174		
		2007-17	Trans	2WD	1		EM-2811	
			Trans	4WD	1		EM-2638	
		2000-05	Trans		1		EM-2638	
	V8 5.7L 350ci	1995-00	L & R Front	4WD	2	EM-2637		
			L & R Front	RWD	2	EM-2621		
		1997-00	Trans	2WD	1		EM-2817	
			Trans	4WD	1		EM-2638	
		1995-96	Trans	Auto; 2WD	1		EM-2817	
			Trans	Auto; 4WD	1		EM-2638	
	Trans	Manual; 2WD	1		EM-2817			
	Trans	Manual; 4WD	1		EM-2638			
	V8 6.0L 364ci	2008-13	L & R Front		2	EM-5583#		
			Trans	2WD	1		EM-2811	
			Trans	4WD	1		EM-2638	
	V8 6.2L 378ci	2008-09	L & R Front		2	EM-5583#		
Trans			2WD	1		EM-2811		
Trans			4WD	1		EM-2638		
V8 6.5L 395ci Diesel	1995-99	L & R Front	4WD	2	EM-2637			
		L & R Front	RWD	2	EM-2621			
		Trans	Auto; 2WD	1		EM-2817		
		Trans	Auto; 4WD	1		EM-2638		
<b>TRACKER</b>								
L4	L4 1.6L 98ci	1999-00	L & R Front		2	EM-9240		
		1998	L & R Front		2	EM-8568		
		1999-00	Torq Str - Front	Auto; 4 Spd; 4WD	1		EM-8657	
			Torq Str - Front	Manual; 4WD	1		EM-8657	

# = Available in the Westar Gold Line

# Engine, Transmission, And Torque Strut Mounts

CYL	ENG. SIZE	YEAR	LOCATION	DESCRIPTION	QTY	ENGINE	TORQUE STRUT	TRANSMISSION	
<b>CHEVROLET SPORT UTILITY (continued)</b>									
<b>TRACKER (continued)</b>									
L4	L4 1.6L 98ci	1998	Torq Str - Front	Auto; 4 Spd	1		EM-8657		
			Torq Str - Front	Manual	1		EM-8657		
		1998-00	Trans		1			EM-8825	
	L4 2.0L 122ci	1999-03	L & R Front		2	EM-9240			
			Trans	Auto	1			EM-9241	
Trans			Manual	1			EM-8825		
V6	V6 2.5L 2500cc	2001-04	L & R Front		2	EM-9240			
			Trans		1			EM-8825	
<b>TRAILBLAZER</b>									
L6	L6 4.2L 256ci	2002-08	L & R Front		2	EM-3021*			
		2002-09	Trans	Auto	1			EM-3027	
V8	V8 5.3L 325ci	2006-08	LH Front		1	EM-5694			
			RH Front		1	EM-5693			
	V8 6.0L 364ci	2006-09	LH Front		1	EM-5694			
			RH Front		1	EM-5693			
<b>TRAILBLAZER EXT</b>									
L6	L6 4.2L 256ci	2002-06	L & R Front		2	EM-3021*			
			Trans	Auto	1			EM-3027	
V8	V8 5.3L 325ci	2005-06	LH Front		1	EM-5694			
			RH Front		1	EM-5693			
<b>TRAVERSE</b>									
V6	V6 3.6L 217ci	2009-17	Front		1	EM-4037			
			Rear		1	EM-4035			
			Torq Str - Right		1		EM-3141		
			Trans		1			EM-4036	
<b>TRAX</b>									
L4	L4 1.4L 83cid	2015-16	Torq Str - Lower		1		EM-4227		
<b>V10/V1500 SUBURBAN</b>									
V8	V8 5.7L 350ci	1989-91	L & R Front	4WD	2	EM-2637			
		1988	L & R Front	4WD	2	EM-2637			
		1987	L & R Front	4WD	2	EM-2292			
		1989-91	Trans	Auto	1			EM-2638	
		1987-88	Trans	Auto	1			EM-2638	
			Trans	Manual	1			EM-2638	
		V8 6.2L 379ci Diesel	1989-91	L & R Front	4WD	2	EM-2637		
	1988		L & R Front	4WD	2	EM-2637			
	1987		L & R Front	4WD	2	EM-2395			
	1989-91		Trans	Auto	1			EM-2638	
	1987-88		Trans	Auto	1			EM-2638	
			Trans	Manual	1			EM-2638	
	<b>V20/V2500 SUBURBAN</b>								
	V8	V8 5.7L 350ci	1989-91	L & R Front	4WD	2	EM-2637		
1988			L & R Front	4WD	2	EM-2637			
1987			L & R Front	4WD	2	EM-2292			
1989-91			Trans	Auto	1			EM-2638	
1987-88			Trans	Auto	1			EM-2638	
			Trans	Manual	1			EM-2638	
V8 6.2L 379ci Diesel			1989-91	L & R Front	4WD	2	EM-2637		
		1988	L & R Front	4WD	2	EM-2637			
		1987	L & R Front	4WD	2	EM-2395			
		1989-91	Trans	Auto	1			EM-2638	
		1987-88	Trans	Auto	1			EM-2638	
			Trans	Manual	1			EM-2638	
		V8 7.4L 454ci	1990	L & R Front	4WD	2	EM-2637		

\* = Hydraulic Mount, "S" suffix = solid replacement.

# Engine, Transmission, And Torque Strut Mounts

CYL	ENG. SIZE	YEAR	LOCATION	DESCRIPTION	QTY	ENGINE	TORQUE STRUT	TRANSMISSION
<b>CHEVROLET SPORT UTILITY (continued)</b>								
<b>V20/V2500 SUBURBAN (continued)</b>								
V8	V8 7.4L 454ci	1988	L & R Front	4WD	2	EM-2637		
		1987	L & R Front	4WD	2	EM-2395		
		1990	Trans	Auto	1			EM-2638
		1987-88	Trans	Auto	1			EM-2638
			Trans	Manual	1			EM-2638
<b>CHEVROLET TRUCK</b>								
<b>C10/C1500 P/U</b>								
L6	L6 3.8L 230ci	1963-66	L & R Front		2	EM-2282		
	L6 3.9L 235ci	1961-62	L & R Front		2	EM-2142		
			Trans		1			EM-2378 @
	L6 4.1L 250ci	1973-84	L & R Front		2	EM-2292		
		1966-72	L & R Front		2	EM-2282		
		1982-84	Trans		1			EM-2392
		1976-81	Trans	Mexico; Manual	1			EM-2378 @
		1973-81	Trans	Auto; THM350 (M38)	1			EM-2378 @
			Trans	Auto; THM400 (M40)	1			EM-2268 @
			Trans	Manual	1			EM-2378 @
		1966-72	Trans	Auto; THM350 (M38)	1			EM-2378 @
			THM350C (MV4)					
	Trans		Manual	1			EM-2378 @	
	L6 4.8L 292ci	1973-80	L & R Front		2	EM-2292		
		1963-71	L & R Front		2	EM-2282		
		1976-80	Trans	Mexico; Manual	1			EM-2378 @
			Trans	Auto; THM350 (M38)	1			EM-2378 @
			Trans	Auto; THM400 (M40)	1			EM-2268 @
		1963-71	Trans	Manual	1			EM-2378 @
			Trans	Auto; THM350 (M38)	1			EM-2378 @
	Trans	Manual	1			EM-2378 @		
V6	V6 4.3L 262ci	1988-95	L & R Front		2	EM-2436		
		1985-86	L & R Front		2	EM-2436		
		1996-98	LH Front		1	EM-3028		
			RH Front		1	EM-3044		
			Trans		1			EM-2811
		1991-95	Trans	Auto	1			EM-2394
			Trans	Manual	1			EM-2394
		1988-90	Trans	Auto, 3 Spd	1			EM-2510 @
			Trans	Auto, 4 Spd	1			EM-2394
			Trans	Manual	1			EM-2394
1985-86	Trans	Auto	1			EM-2394		
	Trans	Manual	1			EM-2394		
V8	V8 4.6L 283ci	1963-67	L & R Front		2	EM-2282		
		1961-62	L & R Front		2	EM-2267		
		1961-67	Trans - L & R Lower	Manual	2			EM-2108
			Trans - L & R Upper	Manual	2			EM-2107
			Trans	Auto	1			EM-2378 @
		V8 5.0L	1982-86	LH Front		1	EM-2292	
	V8 5.0L 305ci	1988-99	L & R Front		2	EM-2621		
		1977-81	L & R Front		2	EM-2292		
		1999	Trans	Auto; 2WD	1			EM-2817
		1996-98	Trans	Auto; 2WD	1			EM-2817
Trans	Manual; 2WD		1			EM-2817		
1992-95	Trans	Auto; RWD	1			EM-2659 @		

@ = Universal Mount EM-5000 also available.



## Engine, Transmission, And Torque Strut Mounts

CYL	ENG. SIZE	YEAR	LOCATION	DESCRIPTION	QTY	ENGINE	TORQUE STRUT	TRANS-MISSION
<b>CHEVROLET TRUCK (continued)</b>								
<b>C10/C1500 P/U (continued)</b>								
V8	V8 5.0L 305ci	1992-95	Trans	Manual; RWD	1			EM-2659 @
		1990-91	Trans	Auto; THM700R4 (MD8)	1			EM-2392
			Trans	Manual	1			EM-2392
		1988-89	Trans	Auto; THM400-475 (M40)	1			EM-2513
			Trans	Auto; THM700R4 (MD8)	1			EM-2392
			Trans	Manual	1			EM-2392
		1982-86	Trans	Auto; THM350C (MV4) THM700R4 (MD8)	1			EM-2392
			Trans	Auto; THM400-475 (M40)	1			EM-2513
			Trans	Manual	1			EM-2392
		1977-81	Trans	Auto; THM350 (M38) THM350C (MV4)	1			EM-2378 @
			Trans	Auto; THM400-475 (M40)	1			EM-2268 @
			Trans	Manual	1			EM-2378 @
	V8 5.0L 307ci	1973	L & R Front			2	EM-2292	
		1968-72	L & R Front			2	EM-2282	
		1968-73	Trans	Auto; THM350 (M38)	1			EM-2378 @
			Trans	Auto; THM400-475 (M40)	1			EM-2268 @
	V8 5.4L 327ci	1966-68	L & R Front			2	EM-2282	
			Trans	Auto; THM350 (M38)	1			EM-2378 @
			Trans	Auto; THM400-475 (M40)	1			EM-2268 @
			Trans	Manual	1			EM-2378 @
	V8 5.7L 350 ci Gas	1979-80	L & R Front			2	EM-2292	
		1979-81	Trans	Auto; THM350 (M33); THM350 (M38); OEM Design	1			EM-2378 @
			Trans	Auto; THM400 (M40)	1			EM-2268 @
			Trans	Manual	1			EM-2378 @
	V8 5.7L 350ci	1988-99	L & R Front			2	EM-2621	
		1973-78	L & R Front			2	EM-2292	
		1969-72	L & R Front			2	EM-2282	
		1982-86	LH Front			1	EM-2292	
		1999	Trans	Auto; 2WD	1			EM-2817
		1996-98	Trans	Auto; 2WD	1			EM-2817
			Trans	Manual; 2WD	1			EM-2817
		1995	Trans	Auto; 2WD	1			EM-2817
			Trans	Manual; 2WD	1			EM-2817
		1994	Trans	Auto; 2WD; 1st Design	1			EM-2360 @
			Trans	Auto; 2WD; 2nd Design	1			EM-2817
			Trans	Manual	1			EM-2360 @
1992-93		Trans	Auto; RWD	1			EM-2659 @	
1991		Trans	Auto; THM700R4 (MD8)	1			EM-2392	
		Trans	Manual	1			EM-2392	
1988-90		Trans	Auto; THM400 (M40); RWD	1			EM-2513	
		Trans	Auto; THM700-R4/4L60 (MD8) RWD	1			EM-2392	
		Trans	Manual; RWD	1			EM-2392	
1982-86		Trans	Auto; THM350 (M38) THM700R4 (MD8)	1			EM-2392	
		Trans	Auto; THM400-475 (M40)	1			EM-2513	
		Trans	Manual	1			EM-2392	
1975-78	Trans	Auto; THM350 (M33); THM350 (M38); OEM Design	1			EM-2378 @		
	Trans	Auto; THM400 (M40)	1			EM-2268 @		

@ = Universal Mount EM-5000 also available.

# Engine, Transmission, And Torque Strut Mounts

CYL	ENG. SIZE	YEAR	LOCATION	DESCRIPTION	QTY	ENGINE	TORQUE STRUT	TRANSMISSION
<b>CHEVROLET TRUCK (continued)</b>								
<b>C10/C1500 P/U (continued)</b>								
V8	V8 5.7L 350ci	1975-78	Trans	Manual	1			EM-2378 @
	V8 5.7L 350ci Diesel	1979-81	L & R Front		2	EM-2328		
			Trans	Auto, THM350 (M38)	1			EM-2378 @
			Trans	Auto; THM400-475 (M40)	1			EM-2268 @
			Trans	Manual	1			EM-2378 @
	V8 6.2L 379ci Diesel	1988-93	L & R Front		2	EM-2621		
			1984-86	L & R Front		2	EM-2395	
		1982-83	L & R Front		2	EM-2292		
		1992-93	Trans	Auto; RWD	1			EM-2659 @
		1991	Trans	Auto; THM700-R4/4L60 (MD8)	1			EM-2392
			Trans	Manual	1			EM-2392
		1989	Trans	Auto; THM400 (M40)	1			EM-2513
			Trans	Auto; THM700-R4/4L60 (MD8)	1			EM-2392
			Trans	Manual	1			EM-2392
		1988-90	Trans	Auto; THM400 (M40)	1			EM-2513
			Trans	Auto; THM700-R4/4L60 (MD8)	1			EM-2392
			Trans	Manual; 4 Spd	1			EM-2393
			Trans	Manual; 5 Spd	1			EM-2392
		1988	Trans	Auto; THM400 (M40)	1			EM-2513
			Trans	Auto; THM700-R4/4L60 (MD8)	1			EM-2392
			Trans	Manual; 4 Spd	1			EM-2393
			Trans	Manual; 5 Spd	1			EM-2392
		1983-86	Trans	Auto; THM400-475 (M40)	1			EM-2515
	Trans		Auto; THM700R4 (MD8)	1			EM-2393	
	Trans		Manual	1			EM-2393	
	1982	Trans	Auto	1			EM-2393	
		Trans	Manual	1			EM-2392	
	V8 6.5L 395ci Diesel	1994-98	L & R Front		2	EM-2621		
			Trans	Auto; 2WD	1			EM-2817
			Trans	Manual; 2WD	1			EM-2817
	V8 6.6L 400ci	1976-80	L & R Front		2	EM-2292		
			Trans	Auto; THM350 (M38)	1			EM-2378 @
			Trans	Auto; THM400-475 (M40)	1			EM-2268 @
			Trans	Manual	1			EM-2378 @
	V8 6.6L 402ci	1970-72	L & R Front		2	EM-2283		
			Trans	Auto; THM350 (M38)	1			EM-2378 @
			Trans	Auto; THM400-475 (M40)	1			EM-2268 @
			Trans	Manual	1			EM-2378 @
	V8 7.4L 454ci	1990-93	L & R Front		2	EM-2621		
		1973-80	L & R Front		2	EM-2395		
		1992-93	Trans	Auto; RWD	1			EM-2659 @
		1990-91	Trans		1			EM-2392
1973-80		Trans	Auto; THM350 (M38)	1			EM-2378 @	
		Trans	Auto; THM400-475 (M40)	1			EM-2268 @	
Trans	Manual	1			EM-2378 @			
<b>C20/C2500 P/U</b>								
L6	L6 3.8L 230ci	1963-65	L & R Front		2	EM-2282		
	L6 3.9L 235ci	1961-62	L & R Front		2	EM-2142		
			Trans		1			EM-2378 @
	L6 4.1L 250ci	1973-84	L & R Front		2	EM-2292		
		1966-72	L & R Front		2	EM-2282		
		1982-84	Trans		1			EM-2392
		1973-81	Trans	Auto; THM350 (M38)	1			EM-2378 @
			THM350C (MV4)					

@ = Universal Mount EM-5000 also available.

# Engine, Transmission, And Torque Strut Mounts

CYL	ENG. SIZE	YEAR	LOCATION	DESCRIPTION	QTY	ENGINE	TORQUE STRUT	TRANS-MISSION	
<b>CHEVROLET TRUCK (continued)</b>									
<b>C20/C2500 P/U (continued)</b>									
L6	L6 4.1L 250ci	1973-81	Trans	Auto; THM400-475 (M40)	1			EM-2268 @	
			Trans	Manual	1			EM-2378 @	
		1966-72	Trans	Auto; THM350 (M38)	1			EM-2378 @	
				THM350C (MV4)					
			Trans	Manual	1			EM-2378 @	
	L6 4.8L 292ci	1973-86	L & R Front			2	EM-2292		
			1963-72	L & R Front		2	EM-2282		
		1983-86	Trans	Auto; THM400-475 (M40)	1			EM-2513	
			Trans	Auto; THM700R4 (MD8)	1			EM-2392	
			Trans	Manual	1			EM-2392	
		1982	Trans	Auto; THM350C (MV4)	1			EM-2378 @	
			Trans	Auto; THM400 (M40)	1			EM-2513	
			Trans	Auto; THM700-R4/4L60 (MD8)	1			EM-2392	
			Trans	Manual	1			EM-2378 @	
		1973-81	Trans	Auto; THM350 (M38)	1			EM-2378 @	
			Trans	Auto; THM400-475 (M40)	1			EM-2268 @	
			Trans	Manual	1			EM-2378 @	
		1963-72	Trans	Auto; THM350 (M38)	1			EM-2378 @	
			Trans	Auto; THM400-475 (M40)	1			EM-2268 @	
		V6	V6 4.3L 262ci	1988-95	L & R Front		2	EM-2436	
1985-86	L & R Front				2	EM-2436			
1992-95	Trans				1			EM-2394	
1991	Trans			Auto; 4L80E THM700-R4/4L60 (MD8)	1			EM-2394	
	Trans			Manual	1			EM-2394	
1988-90	Trans			Auto; THM400 (M40)	1			EM-2510 @	
	Trans			Auto; THM700-R4/4L60 (MD8)	1			EM-2394	
	Trans			Manual	1			EM-2394	
1985-86	Trans				1			EM-2394	
V8	V8 4.6L 283ci			1963-67	L & R Front		2	EM-2282	
		1961-62	L & R Front		2	EM-2267			
		1961-67	Trans - L & R Lower	Manual Manual	2			EM-2108	
			Trans - L & R Upper	Manual Manual	2			EM-2107	
			Trans	Auto	1			EM-2378 @	
		V8 5.0L 305ci	1988-98	L & R Front		2	EM-2621		
	1977-86		L & R Front		2	EM-2292			
	1996-98		Trans	Auto; 2WD	1			EM-2817	
			Trans	Manual; 2WD	1			EM-2817	
	1992-95		Trans	Auto; RWD	1			EM-2659 @	
	1990-91		Trans		1			EM-2392	
	1988-89		Trans	Auto; THM400-475 (M40)	1			EM-2513	
			Trans	Auto; THM700R4 (MD8)	1			EM-2392	
			Trans	Manual	1			EM-2392	
	1982-86		Trans	Auto; THM350C (MV4) THM700R4 (MD8)	1			EM-2392	
			Trans	Auto; THM400-475 (M40)	1			EM-2513	
		Trans	Manual	1			EM-2392		
1977-81	Trans	Auto; THM350 (M38)	1			EM-2378 @			
	Trans	Auto; THM400 (M40)	1			EM-2268 @			
	Trans	Manual	1			EM-2378 @			
V8 5.0L 307ci	1973	L & R Front		2	EM-2292				
	1968-72	L & R Front		2	EM-2282				
	1968-73	Trans	Auto; THM350 (M38)	1			EM-2378 @		

@ = Universal Mount EM-5000 also available.

# Engine, Transmission, And Torque Strut Mounts

CYL	ENG. SIZE	YEAR	LOCATION	DESCRIPTION	QTY	ENGINE	TORQUE STRUT	TRANS-MISSION	
<b>CHEVROLET TRUCK (continued)</b>									
<b>C20/C2500 P/U (continued)</b>									
V8	V8 5.0L 307ci	1968-73	Trans	Auto; THM400-475 (M40)	1			EM-2268 @	
			Trans	Manual	1			EM-2378 @	
	V8 5.4L 327ci	1966-68	L & R Front		2	EM-2282			
			Trans	Auto; THM350 (M38)	1			EM-2378 @	
			Trans	Auto; THM400-475 (M40)	1			EM-2268 @	
			Trans	Manual	1			EM-2378 @	
	V8 5.7L	1985-86	LH Front		1	EM-2292			
	V8 5.7L 350ci	1988-00	L & R Front		2	EM-2621			
			1973-84	L & R Front		2	EM-2292		
		1969-72	L & R Front		2	EM-2282			
		1996-00	Trans	Auto; 2WD	1				EM-2817
			Trans	Manual; 2WD	1				EM-2817
		1995	Trans	Auto; 4L80E (MT1)	1				EM-2817
			Trans	Manual; RWD	1				EM-2659 @
		1994	Trans	Auto; 4L60E (M30)	1				EM-2659 @
			Trans	Auto; 4L80E (MT1)	1				EM-2817
			Trans	Manual	1				EM-2659 @
		1992-93	Trans	Auto; RWD	1				EM-2659 @
		1991	Trans	Auto; RWD	1				EM-2659 @
			Trans	Manual; RWD	1				EM-2659 @
		1988-90	Trans	Auto; THM400-475 (M40)	1				EM-2513
			Trans	Auto; THM700R4 (MD8)	1				EM-2392
			Trans	Manual	1				EM-2392
		1982-86	Trans	Auto; THM350C (MV4) THM700-R4/4L60 (MD8)	1				EM-2392
			Trans	Auto; THM400 (M40)	1				EM-2513
			Trans	Manual	1				EM-2392
		1975-81	Trans	Auto; THM350 (M38)	1				EM-2378 @
	Trans		Auto; THM400-475 (M40)	1				EM-2268 @	
	Trans		Manual	1				EM-2378 @	
	V8 6.2L 379ci Diesel	1988-93	L & R Front		2	EM-2621			
			1984-86	L & R Front		2	EM-2395		
		1982-83	L & R Front		2	EM-2292			
		1992-93	Trans	Auto; RWD	1				EM-2659 @
			Trans	Manual; RWD	1				EM-2659 @
		1991	Trans	Auto; THM700-R4/4L60 (MD8)	1				EM-2392
			Trans	Manual	1				EM-2392
		1989-90	Trans	Auto; 4L80E THM700-R4/4L60 (MD8)	1				EM-2392
			Trans	Auto; THM400 (M40)	1				EM-2513
			Trans	Manual	1				EM-2392
		1988	Trans	Auto; THM400 (M40)	1				EM-2513
			Trans	Auto; THM700-R4/4L60 (MD8)	1				EM-2392
			Trans	Manual; 4 Spd	1				EM-2393
			Trans	Manual; 5 Spd	1				EM-2392
		1983-86	Trans	Auto; THM400-475 (M40)	1				EM-2515
			Trans	Auto; THM700R4 (MD8)	1				EM-2393
	Trans		Manual	1				EM-2393	
	1982	Trans		1				EM-2392	
	V8 6.5L 395ci Diesel	1992-00	L & R Front		2	EM-2621			
			Trans	Auto; 2WD	1			EM-2817	
		1995-00	Trans	Manual; 2WD	1				EM-2817
Trans			Auto; RWD	1				EM-2659 @	
1992-94		Trans	Manual; RWD	1				EM-2659 @	

@ = Universal Mount EM-5000 also available.

# Engine, Transmission, And Torque Strut Mounts

CYL	ENG. SIZE	YEAR	LOCATION	DESCRIPTION	QTY	ENGINE	TORQUE STRUT	TRANSMISSION	
<b>CHEVROLET TRUCK (continued)</b>									
<b>C20/C2500 P/U (continued)</b>									
V8	V8 6.5L 396ci	1968-69	L & R Front		2	EM-2283			
	V8 6.6L 400ci	1976-80	L & R Front		2	EM-2292			
			Trans	Auto; THM350 (M38)	1			EM-2378 @	
			Trans	Auto; THM400-475 (M40)	1			EM-2268 @	
			Trans	Manual	1			EM-2378 @	
	V8 6.6L 402ci	1970-71	L & R Front		2	EM-2283			
			Trans		1			EM-2378 @	
	V8 7.4L 454ci	1991-00	L & R Front		2	EM-2621			
		1973-86	L & R Front		2	EM-2395			
		1996-00	Trans	Auto; 2WD	1			EM-2817	
			Trans	Manual; 2WD	1			EM-2817	
		1992-95	Trans	Auto; RWD	1			EM-2659 @	
			Trans	Manual; RWD	1			EM-2659 @	
		1991	Trans		1			EM-2392	
		1982-86	Trans	Auto; THM350C; THM400	1			EM-2513	
			Trans	Auto; THM700R4 (MD8)	1			EM-2392	
			Trans	Manual	1			EM-2392	
		1973-81	Trans	Auto; THM350 (M38)	1			EM-2378 @	
			Trans	Auto; THM400-475 (M40)	1			EM-2268 @	
	Trans		Manual	1			EM-2378 @		
<b>C30/C3500 P/U</b>									
L6	L6 3.8L 230ci	1964-65	L & R Front		2	EM-2282			
	L6 3.9L 235ci	1961-62	L & R Front		2	EM-2142			
			Trans		1			EM-2378 @	
	L6 4.1L 250ci	1978-80	L & R Front		2	EM-2292			
		1973-75	L & R Front		2	EM-2292			
		1966-72	L & R Front		2	EM-2282			
		1978-80	Trans	Auto; THM350 (M38)	1			EM-2378 @	
			Trans	Auto; THM400 (M40)	1			EM-2268 @	
			Trans	Manual	1			EM-2378 @	
			Trans	Mexico; Manual	1			EM-2378 @	
		1973-75	Trans	Auto; THM400 (M40)	1			EM-2268 @	
			Trans	Manual	1			EM-2378 @	
		1966-72	Trans		1			EM-2378 @	
		L6 4.8L 292ci	1973-86	L & R Front		2	EM-2292		
			1963-72	L & R Front		2	EM-2282		
	1983-86		Trans	Auto; THM400-475 (M40)	1			EM-2513	
			Trans	Auto; THM700R4 (MD8)	1			EM-2392	
			Trans	Manual	1			EM-2392	
	1982		Trans	Auto; THM350C (MV4)	1			EM-2378 @	
			Trans	Auto; THM400 (M40)	1			EM-2513	
			Trans	Auto; THM700-R4/4L60 (MD8)	1			EM-2392	
			Trans	Manual	1			EM-2378 @	
	1976-81		Trans	Auto; THM350 (M38)	1			EM-2378 @	
			Trans	Auto; THM400 (M40)	1			EM-2268 @	
			Trans	Manual	1			EM-2378 @	
			Trans	Mexico; Manual	1			EM-2378 @	
	1973-75		Trans	Auto; THM350 (M38)	1			EM-2378 @	
			Trans	Auto; THM400 (M40)	1			EM-2268 @	
		Trans	Manual	1			EM-2378 @		
	1963-72	Trans		1			EM-2378 @		
V8	V8 4.6L 283ci	1963-67	L & R Front		2	EM-2282			
		1961-62	L & R Front		2	EM-2267			

@ = Universal Mount EM-5000 also available.

# Engine, Transmission, And Torque Strut Mounts

CYL	ENG. SIZE	YEAR	LOCATION	DESCRIPTION	QTY	ENGINE	TORQUE STRUT	TRANSMISSION
<b>CHEVROLET TRUCK (continued)</b>								
<b>C30/C3500 P/U (continued)</b>								
V8	V8 4.6L 283ci	1961-67	Trans - L & R Lower	Manual Manual	2			EM-2108
			Trans - L & R Upper	Manual Manual	2			EM-2107
			Trans	Auto	1			EM-2378 @
V8	V8 5.0L 305ci	1978-79	L & R Front		2	EM-2292		
			Trans	Auto; THM350 (M38) THM350C (MV4)	1			EM-2378 @
			Trans	Auto; THM400-475 (M40)	1			EM-2268 @
			Trans	Manual	1			EM-2378 @
V8	V8 5.0L 307ci	1973	L & R Front		2	EM-2292		
		1968-72	L & R Front		2	EM-2282		
		1968-73	Trans	Auto; THM350 (M38)	1			EM-2378 @
			Trans	Auto; THM400-475 (M40)	1			EM-2268 @
V8	V8 5.4L 327ci	1966-68	L & R Front		2	EM-2282		
			Trans	Auto; THM350 (M38)	1			EM-2378 @
			Trans	Auto; THM400-475 (M40)	1			EM-2268 @
			Trans	Manual	1			EM-2378 @
V8	V8 5.7L GAS	1973-83	L & R Front		2	EM-2292		
		1969-72	L & R Front		2	EM-2282		
V8	V8 5.7L 350ci	1988-00	L & R Front		2	EM-2621		
		1984-86	LH Front		1	EM-2292		
		1995-00	Trans	Auto; 2WD	1			EM-2817
			Trans	Manual; 2WD	1			EM-2817
		1994	Trans	C309, 1st Design	1			EM-2659 @
			Trans	C309, 2nd Design	1			EM-2817
			Trans	C314 & C318, 15,000 GVW	1			EM-2638
		1991-93	Trans	Auto; RWD	1			EM-2659 @
			Trans	Manual; RWD	1			EM-2659 @
		1988-90	Trans	Auto; THM400 (M40)	1			EM-2513
			Trans	Auto; THM700-R4/4L60 (MD8)	1			EM-2392
			Trans	Manual; 131.5WB (C309)	1			EM-2392
			Trans	Manual; 155.5WB (C309) 159.5WB (C314)	1			EM-2638
		1982-86	Trans	Auto; THM350 (M38) THM700R4 (MD8)	1			EM-2392
			Trans	Auto; THM400-475 (M40)	1			EM-2513
			Trans	Manual	1			EM-2392
1975-81	Trans	Auto; THM350 (M38)	1			EM-2378 @		
	Trans	Auto; THM400-475 (M40)	1			EM-2268 @		
	Trans	Manual	1			EM-2378 @		
V8	V8 6.2L 379ci Diesel	1988-93	L & R Front		2	EM-2621		
		1984-86	L & R Front		2	EM-2395		
		1982-83	L & R Front		2	EM-2292		
		1992-93	Trans	Auto; RWD	1			EM-2659 @
			Trans	Manual; RWD	1			EM-2659 @
		1991	Trans	Auto; 4L80E THM700-R4/4L60 (MD8)	1			EM-2392
			Trans	Manual	1			EM-2392
		1989-90	Trans	Auto; THM400 (M40)	1			EM-2513
			Trans	Auto; THM700-R4/4L60 (MD8)	1			EM-2392
Trans	Manual		1			EM-2392		
1988	Trans	Auto; THM400-475 (M40)	1			EM-2513		

@ = Universal Mount EM-5000 also available.

# Engine, Transmission, And Torque Strut Mounts

CYL	ENG. SIZE	YEAR	LOCATION	DESCRIPTION	QTY	ENGINE	TORQUE STRUT	TRANSMISSION	
<b>CHEVROLET TRUCK (continued)</b>									
<b>C30/C3500 P/U (continued)</b>									
V8	V8 6.2L 379ci Diesel	1988	Trans	Auto; THM700R4 (MD8)	1			EM-2392	
			Trans	Manual; 4 Spd	1			EM-2393	
			Trans	Manual; 5 Spd	1			EM-2392	
		1983-86	Trans	Auto; THM400-475 (M40)	1			EM-2515	
			Trans	Auto; THM700R4 (MD8)	1			EM-2393	
			Trans	Manual	1			EM-2393	
		1982	Trans		1			EM-2393	
		V8 6.5L 395ci Diesel	1992-00	L & R Front		2	EM-2621		
				Trans	Auto; 2WD	1			EM-2817
	1995-00		Trans	Manual; 2WD	1			EM-2817	
			Trans	Auto; RWD	1			EM-2659 @	
			Trans	Manual; RWD	1			EM-2659 @	
	V8 6.5L 396ci	1968-69	L & R Front		2	EM-2283			
	V8 6.6L 400ci	1976-79	L & R Front		2	EM-2292			
			Trans	Auto; THM350 (M38)	1			EM-2378 @	
			Trans	Auto; THM400-475 (M40)	1			EM-2268 @	
	V8 6.6L 402ci	1970-71	Trans	Manual	1			EM-2378 @	
			L & R Front		2	EM-2283			
			Trans	Auto; THM350 (M38)	1			EM-2378 @	
	V8 7.4L 454ci	1988-00	L & R Front		2	EM-2621			
			L & R Front		2	EM-2395			
			Trans	Auto; 4L80-E 4 Spd	1			EM-2817	
		1996-00	Trans	Manual; FleetSide	1			EM-2817	
			Trans	Manual; 135.5WB (C310), 159.5WB (C314), 183.5WB (C318)	1			EM-2638	
		1992-95	Trans	Auto; RWD	1			EM-2659 @	
			Trans	Manual; RWD	1			EM-2659 @	
		1990-91	Trans		1			EM-2392	
		1988-89	Trans	Auto; THM400 (M40)	1			EM-2513	
			Trans	Auto; THM700R4 (MD8)	1			EM-2392	
			Trans	Manual	1			EM-2392	
		1982-86	Trans	Auto; THM400 (M40)	1			EM-2513	
	Trans		Auto; THM700R4 (MD8)	1			EM-2392		
	Trans		Manual	1			EM-2392		
1973-81	Trans	Auto; THM350 (M38)	1			EM-2378 @			
	Trans	Auto; THM400-475 (M40)	1			EM-2268 @			
	Trans	Manual	1			EM-2378 @			
V8 8.1L 496ci	2001-02	Trans	Mexican Vehicle; Manual; 2WD	1			EM-2817		
<b>COLORADO</b>									
L4	L4 2.5L 153ci	2015-18	Trans	Manual	1			EM-4196	
	L4 2.8L 169ci	2004-06	LH Front		1	EM-3121			
			RH Front		1	EM-3120			
			Trans	2WD w/ Z71	1			EM-2638	
			Trans	2WD w/o Z71	1			EM-3122	
			Trans	4WD	1			EM-2638	
	L4 2.8L 171 ci Diesel	2016-18	Right		1	EM-4238			
	L4 2.9L 178ci	2007-12	LH Front		1	EM-3121			
			RH Front		1	EM-3120			
			Trans	Auto; 2WD	1			EM-3122	
			Trans	Auto; 4WD	1			EM-2638	
			Trans	Manual; 2WD	1			EM-3122	
Trans	Manual; 4WD	1			EM-2638				

@ = Universal Mount EM-5000 also available.

# Engine, Transmission, And Torque Strut Mounts

CYL	ENG. SIZE	YEAR	LOCATION	DESCRIPTION	QTY	ENGINE	TORQUE STRUT	TRANSMISSION
<b>CHEVROLET TRUCK (continued)</b>								
<b>COLORADO (continued)</b>								
L5	L5 3.5L 211ci	2004-06	LH Front		1	EM-3121		
			RH Front		1	EM-3120		
		2004-05	Trans	Auto; 2WD	1			EM-3122
			Trans	Auto; 4WD	1			EM-2638
			Trans	Manual; 2WD	1			EM-3122
	L5 3.7L 223ci	2007-12	LH Front		1	EM-3121		
			RH Front		1	EM-3120		
			Trans	Auto; 2WD	1			EM-3122
			Trans	Auto; 4WD	1			EM-2638
			Trans	Manual; 2WD	1			EM-3122
V6	V6 3.6L 217ci	2015-18	Left		1	EM-4237		
			Right		1	EM-4238		
			Trans	RWD, Auto	1			EM-4196
V8	V8 5.3L 325ci	2009-12	LH Front		1	EM-4231		
			RH Front		1	EM-4232		
			Trans	Auto	1			EM-3172
<b>EL CAMINO</b>								
L6	L6 3.2L 194ci	1964-65	L & R Front		2	EM-2284		
			Trans		1			EM-2378 @
	L6 3.8L 230ci	1964-69	L & R Front		2	EM-2231		
	L6 4.1L 250ci	1975-77	L & R Front		2	EM-2292		
			1973	L & R Front		2	EM-2292	
		1967-72	L & R Front		2	EM-2284		
			1976-77	Trans	Auto	1		
		1973-75	Trans	Manual; 3 Spd	1			EM-2337
			Trans	Auto	1			EM-2360 @
			Trans	Manual; 3 Spd	1			EM-2337
			Trans	Manual; 4 Spd	1			EM-2294
	1967-72	Trans	Auto	1			EM-2360 @	
		Trans	Manual	1			EM-2378 @	
	V6	V6 3.3L 200ci	1978-79	LH Front		1	EM-2382	
RH Front					1	EM-2384		
Trans					1			EM-2353
V6 3.8L 229ci		1980-84	L & R Front		2	EM-2436		
			Trans	Auto	1			EM-2379
		1980-81	Trans	Auto	1			EM-2379
			Trans	Manual	1			EM-2379
V6 3.8L 231ci		1978-84	LH Front		1	EM-2382		
			RH Front		1	EM-2384		
		1982-84	Trans	Auto	1			EM-2379
			1978-81	Trans	Auto	1		EM-2379
V6 4.3L 262ci		1985-87	Trans	Manual	1		EM-2379	
			L & R Front		2	EM-2436		
				Trans	Auto	1		
V8	V8 4.4L 267ci	1979-82	L & R Front		2	EM-2292		
			1982	Trans	Auto	1		
		1979-81	Trans	Auto	1			EM-2360 @
			Trans	Manual	1			EM-2360 @
	V8 4.6L 283ci	1964-67	L & R Front		2	EM-2142		
			Trans	Auto	1			EM-2268 @
			Trans	Manual	1			EM-2378 @
	V8 5.0L 305ci	1976-87	L & R Front		2	EM-2292		
			1982-87	Trans	Auto	1		

@ = Universal Mount EM-5000 also available.



## Engine, Transmission, And Torque Strut Mounts

CYL	ENG. SIZE	YEAR	LOCATION	DESCRIPTION	QTY	ENGINE	TORQUE STRUT	TRANSMISSION	
<b>CHEVROLET TRUCK (continued)</b>									
<b>EL CAMINO (continued)</b>									
V8	V8 5.0L 305ci	1976-81	Trans	Auto	1			EM-2337	
			Trans	Manual	1			EM-2337	
	V8 5.0L 307ci	1968-73	L & R Front		2	EM-2142			
			Trans	Auto	1			EM-2378 @	
			Trans	Manual	1			EM-2378 @	
	V8 5.4L 327ci	1966-68	L & R Front		2	EM-2142			
			Trans	Auto	1			EM-2378 @	
	V8 5.7L 348ci	1959-60	L & R Front		2	EM-2267			
			Trans	Auto; Powerglide	1			EM-2268 @	
	V8 5.7L 350ci	1973-79 1969-72 1979  1976-78  1975  1969-74	L & R Front		2	EM-2292			
			L & R Front		2	EM-2282			
			Trans	Auto; THM200 (M29)	1			EM-2378 @	
			Trans	THM200C (MV9); THM350 (M38)					
			Trans	Manual	1			EM-2378 @	
			Trans	Auto; THM200 (M29); THM350 (M38)	1			EM-2378 @	
			Trans	Manual	1			EM-2378 @	
			Trans	Auto; THM350 (M38)	1			EM-2378 @	
			Trans	Auto; THM400 (M40)	1			EM-2268 @	
			Trans	Manual	1			EM-2378 @	
			Trans	Auto; THM350 (M38)	1			EM-2378 @	
			Trans	Auto; THM400 (M40)	1			EM-2268 @	
	V8 5.7L 350ci Diesel	1983-84	L & R Front		2	EM-2328			
			Trans		1			EM-2360 @	
	V8 6.5L 396ci	1968-70	L & R Front		2	EM-2283			
			L & R Front		2	EM-2285			
		1966-70	Trans	Auto; THM350 (M38)	1			EM-2378 @	
			Trans	Auto; THM400 (M40)	1			EM-2268 @	
	V8 6.6L 400ci	1974-76	L & R Front		2	EM-2292			
			L & R Front		2	EM-2283			
		1974-76	Trans	Auto	1			EM-2360 @	
			Trans	Manual	1			EM-2360 @	
		1970-72	Trans	Auto	1			EM-2378 @	
			Trans	Manual	1			EM-2378 @	
	V8 7.4L 454ci	1973-74	L & R Front		2	EM-2395			
			L & R Front		2	EM-2283			
		1973-74	Trans	Auto	1			EM-2360 @	
			Trans	Manual	1			EM-2360 @	
		1970-72	Trans		1			EM-2294	
	<b>K10/K1500 P/U</b>								
	L6	L6 3.8L 230ci	1964-65	L & R Front		2	EM-2282		
				L & R Rear Lower		2	EM-2108		
				L & R Rear Upper		2	EM-2107		
L6 3.9L 235ci		1961-62	L & R Front		2	EM-2142			
			L & R Rear Lower		2	EM-2108			

@ = Universal Mount EM-5000 also available.

# Engine, Transmission, And Torque Strut Mounts

CYL	ENG. SIZE	YEAR	LOCATION	DESCRIPTION	QTY	ENGINE	TORQUE STRUT	TRANSMISSION
<b>CHEVROLET TRUCK (continued)</b>								
<b>K10/K1500 P/U (continued)</b>								
L6	L6 3.9L 235ci	1961-62	L & R Rear Upper		2	EM-2107		
		L6 4.1L 250ci	1973-84	L & R Front		2	EM-2292	
	1970-72		L & R Front		2	EM-2282		
	1966-67		L & R Front		2	EM-2282		
			Trans - L & R Lower		2			EM-2108
			Trans - L & R Upper		2			EM-2107
	1970-84		Trans - Lower	Auto	2			EM-2108
		Trans - Lower	Manual	2			EM-2108	
		Trans - Upper	Auto	2			EM-2107	
	L6 4.8L 292ci	1979-80	L & R Front		2	EM-2292		
			1975-76	L & R Front		2	EM-2292	
		1964-66	L & R Front		2	EM-2282		
			Trans - L & R Lower		2			EM-2108
			Trans - L & R Upper		2			EM-2107
		1979-80	Trans - Lower	Auto	2			EM-2108
			Trans - Lower	Manual	2			EM-2108
		1975-76	Trans - Lower	Auto	2			EM-2108
			Trans - Lower	Manual	2			EM-2108
		1979-80	Trans - Upper	Auto	2			EM-2107
			1975-76	Trans - Upper	Auto	2		EM-2107
V6		V6 4.3L 262ci	1988-95	L & R Front		2	EM-2436	
	1985-86		L & R Front		2	EM-2436		
			Trans	Auto	1			EM-2638
	1998		Trans	Manual	1			EM-2638
			Trans	Auto	1			EM-2638
	1988-97		Trans	Manual	1			EM-2638
			Trans	Manual	1			EM-2638
	1985-86		Trans	Auto	1			EM-2638
			Trans	Manual	1			EM-2638
	V8		V8 4.6L 283ci	1963-67	L & R Front		2	EM-2282
1961-62		L & R Front			2	EM-2267		
1963-67		Trans - L & R Lower			2			EM-2108
		Trans - L & R Upper			2			EM-2107
V8 5.0L 305ci		1988-99	L & R Front		2	EM-2637		
		1981-86	L & R Front		2	EM-2292		
		1977-79	L & R Front		2	EM-2292		
		1981-84	Trans - Lower	Auto	2			EM-2108
			Trans - Lower	Manual	2			EM-2108
		1977-79	Trans - Lower	Auto	2			EM-2108
			Trans - Lower	Manual	2			EM-2108
		1981-84	Trans - Upper	Auto	2			EM-2107
			Trans - Upper	Auto	2			EM-2107
		1999	Trans	Auto	1			EM-2638
		1988-98	Trans	Auto	1			EM-2638
			Trans	Manual	1			EM-2638
		1985-86	Trans	Auto	1			EM-2638
			Trans	Manual	1			EM-2638
V8 5.0L 307ci		1968-69	L & R Front		2	EM-2282		
			Trans - L & R Lower		2			EM-2108
	Trans - L & R Upper			2			EM-2107	

## Engine, Transmission, And Torque Strut Mounts

CYL	ENG. SIZE	YEAR	LOCATION	DESCRIPTION	QTY	ENGINE	TORQUE STRUT	TRANSMISSION
<b>CHEVROLET TRUCK (continued)</b>								
<b>K10/K1500 P/U (continued)</b>								
V8	V8 5.4L 327ci	1966-68	L & R Front		2	EM-2282		
			Trans - L & R Lower		2			EM-2108
			Trans - L & R Upper		2			EM-2107
V8	V8 5.7L 350ci	1988-99	L & R Front		2	EM-2637		
		1973-86	L & R Front		2	EM-2292		
		1969-72	L & R Front		2	EM-2282		
		1969-84	Trans - Lower	Auto	2			EM-2108
			Trans - Lower	Manual	2			EM-2108
			Trans - Upper	Auto	2			EM-2107
		1999	Trans	Auto	1			EM-2638
		1988-98	Trans	Auto	1			EM-2638
			Trans	Manual	1			EM-2638
		1985-86	Trans	Auto	1			EM-2638
Trans	Manual		1			EM-2638		
V8	V8 6.2L 379ci Diesel	1988-93	L & R Front		2	EM-2637		
		1984-86	L & R Front		2	EM-2395		
		1982-83	L & R Front		2	EM-2292		
		1982-84	Trans - Lower	Auto	2			EM-2108
			Trans - Lower	Manual	2			EM-2108
			Trans - Upper	Auto	2			EM-2107
		1988-93	Trans	Auto	1			EM-2638
			Trans	Manual	1			EM-2638
		1985-86	Trans	Auto	1			EM-2638
			Trans	Manual	1			EM-2638
V8	V8 6.5L 395ci Diesel	1994-98	L & R Front		2	EM-2637		
			Trans	Auto	1			EM-2638
			Trans	Manual	1			EM-2638
V8	V8 6.6L 400ci	1975-80	L & R Front		2	EM-2292		
			Trans - Lower	Auto	2			EM-2108
			Trans - Lower	Manual	2			EM-2108
			Trans - Upper	Auto	2			EM-2107
V8	V8 7.4L 454ci	1979-80	L & R Front		2	EM-2395		
		1976	L & R Front		2	EM-2395		
		1974	L & R Front		2	EM-2395		
		1979-80	Trans - Lower	Auto	2			EM-2108
			Trans - Lower	Manual	2			EM-2108
		1976	Trans - Lower	Auto	2			EM-2108
			Trans - Lower	Manual	2			EM-2108
		1974	Trans - Lower	Auto	2			EM-2108
			Trans - Lower	Manual	2			EM-2108
		1979-80	Trans - Upper	Auto	2			EM-2107
1976	Trans - Upper	Auto	2			EM-2107		
1974	Trans - Upper	Auto	2			EM-2107		
<b>K20/K2500 P/U</b>								
L6	L6 3.8L 230ci	1964-65	L & R Front		2	EM-2282		
			L & R Rear Lower		2	EM-2108		
			L & R Rear Upper		2	EM-2107		
	L6 3.9L 235ci	1961-62	L & R Front		2	EM-2142		
			Trans - L & R Lower		2			EM-2108
			Trans - L & R Upper		2			EM-2107
L6 4.1L 250ci	1978-80	L & R Front		2	EM-2292			

# Engine, Transmission, And Torque Strut Mounts

CYL	ENG. SIZE	YEAR	LOCATION	DESCRIPTION	QTY	ENGINE	TORQUE STRUT	TRANSMISSION
<b>CHEVROLET TRUCK (continued)</b>								
<b>K20/K2500 P/U (continued)</b>								
L6	L6 4.1L 250ci	1973-76	L & R Front		2	EM-2292		
		1966-72	L & R Front		2	EM-2282		
		1978-80	Trans - L & R Lower		2			EM-2108
			Trans - L & R Upper		2			EM-2107
		1966-76	Trans - Lower	Auto	2			EM-2108
			Trans - Lower	Manual	2			EM-2108
	Trans - Upper		Auto	2			EM-2107	
	L6 4.8L 292ci	1973-86	L & R Front		2	EM-2292		
		1970-72	L & R Front		2	EM-2282		
		1964-67	L & R Front		2	EM-2282		
			Trans - L & R Lower		2			EM-2108
			Trans - L & R Upper		2			EM-2107
		1970-84	Trans - Lower	Auto	2			EM-2108
			Trans - Lower	Manual	2			EM-2108
			Trans - Upper	Auto	2			EM-2107
		1985-86	Trans	Auto	1			EM-2638
			Trans	Manual	1			EM-2638
V6		V6 4.3L 262ci	1988-95	L & R Front		2	EM-2436	
	1985		L & R Front		2	EM-2436		
	1988-95		Trans	Auto	1			EM-2638
			Trans	Manual	1			EM-2638
	1985		Trans	Auto	1			EM-2638
			Trans	Manual	1			EM-2638
V8	V8 4.6L 283ci	1963-67	L & R Front		2	EM-2282		
		1961-62	L & R Front		2	EM-2267		
		1963-67	Trans - L & R Lower		2			EM-2108
			Trans - L & R Lower		2			EM-2108
		1963-67	Trans - L & R Upper		2			EM-2107
		1961-62	Trans - L & R Upper		2			EM-2107
		V8 5.0L 305ci	1998	L & R Front		2	EM-2637	
	1988-95		L & R Front		2	EM-2637		
	1985		L & R Front		2	EM-2292		
	1980		L & R Front		2	EM-2292		
	1977-78		L & R Front		2	EM-2292		
			Trans - Lower	Auto	2			EM-2108
	1980		Trans - Lower	Manual	2			EM-2108
			Trans - Lower	Auto	2			EM-2108
	1977-78		Trans - Lower	Auto	2			EM-2108
			Trans - Lower	Manual	2			EM-2108
	1980		Trans - Upper	Auto	2			EM-2107
	1977-78		Trans - Upper	Auto	2			EM-2107
			Trans	Auto	1			EM-2638
	1988-95		Trans	Manual	1			EM-2638
			Trans	Auto	1			EM-2638
	1985		Trans	Manual	1			EM-2638
			Trans	Auto	1			EM-2638
	V8 5.0L 307ci	1968-69	L & R Front		2	EM-2282		
			Trans - L & R Lower		2			EM-2108

# Engine, Transmission, And Torque Strut Mounts

CYL	ENG. SIZE	YEAR	LOCATION	DESCRIPTION	QTY	ENGINE	TORQUE STRUT	TRANSMISSION	
<b>CHEVROLET TRUCK (continued)</b>									
<b>K20/K2500 P/U (continued)</b>									
V8	V8 5.0L 307ci	1968-69	Trans - L & R Upper		2			EM-2107	
	V8 5.4L 327ci	1966-68	L & R Front		2	EM-2282			
			Trans - L & R Lower		2			EM-2108	
			Trans - L & R Upper		2			EM-2107	
	V8 5.7L 348ci	1961	Trans	Auto; Powerglide	1				EM-2268 @
			Trans	Manual	1				EM-2378 @
	V8 5.7L 350ci	1988-00 1973-86 1969-72 1969-84 1988-00 1985-86	L & R Front		2	EM-2637			
			L & R Front		2	EM-2292			
			L & R Front		2	EM-2282			
			Trans - Lower	Auto	2				EM-2108
			Trans - Lower	Manual	2				EM-2108
			Trans	Auto	1				EM-2638
			Trans	Manual	1				EM-2638
			Trans	Auto	1				EM-2638
			Trans	Manual	1				EM-2638
	V8 6.2L 379ci Diesel	1988-93 1984-86 1982-83 1982-84 1988-93 1985-86	L & R Front		2	EM-2637			
			L & R Front		2	EM-2395			
			L & R Front		2	EM-2292			
			Trans - Lower	Auto	2				EM-2108
			Trans - Lower	Manual	2				EM-2108
			Trans	Auto	1				EM-2638
			Trans	Manual	1				EM-2638
			Trans	Auto	1				EM-2638
			Trans	Manual	1				EM-2638
	V8 6.5L 395ci Diesel	1992-00	L & R Front		2	EM-2637			
			Trans	Auto	1				EM-2638
			Trans	Manual	1				EM-2638
	V8 6.6L 400ci	1975-80	L & R Front		2	EM-2292			
	V8 7.4L 454ci	1991-00 1980 1976-78 1973-74 1980 1976-78 1973-74 1976-78 1973-74 1991-00	L & R Front		2	EM-2637			
			L & R Front		2	EM-2395			
			L & R Front		2	EM-2395			
			L & R Front		2	EM-2395			
			Trans - L & R Lower		2				EM-2108
			Trans - L & R Upper		2				EM-2107
			Trans - Lower	Auto	2				EM-2108
			Trans - Lower	Manual	2				EM-2108
			Trans - Lower	Auto	2				EM-2108
			Trans - Lower	Manual	2				EM-2108
			Trans - Upper	Auto	2				EM-2107
			Trans - Upper	Auto	2				EM-2107
			Trans	Auto	1				EM-2638
	Trans	Manual	1				EM-2638		
<b>K30/K3500 P/U</b>									
L6	L6 4.1L 250ci	1973-74	L & R Front		2	EM-2292			
			L & R Front		2	EM-2282			
		1968-74	Trans - Lower	Auto	2				EM-2108
			Trans - Lower	Manual	2				EM-2108
			Trans - Upper	Auto	2				EM-2107
	L6 4.8L 292ci	1977-86 1973-74 1968-72	L & R Front		2	EM-2292			
			L & R Front		2	EM-2292			
			L & R Front		2	EM-2282			

@ = Universal Mount EM-5000 also available.

# Engine, Transmission, And Torque Strut Mounts

CYL	ENG. SIZE	YEAR	LOCATION	DESCRIPTION	QTY	ENGINE	TORQUE STRUT	TRANS-MISSION	
<b>CHEVROLET TRUCK (continued)</b>									
<b>K30/K3500 P/U (continued)</b>									
L6	L6 4.8L 292ci	1977-84	Trans - Lower	Auto	2			EM-2108	
			Trans - Lower	Manual	2			EM-2108	
		1968-74	Trans - Lower	Auto	2				EM-2108
			Trans - Lower	Manual	2				EM-2108
		1977-84	Trans - Upper	Auto	2				EM-2107
		1968-74	Trans - Upper	Auto	2				EM-2107
		1985-86	Trans	Auto	1				
Trans	Manual		1					EM-2638	
V8	V8 5.0L 307ci	1973	L & R Front		2	EM-2292			
		1968-72	L & R Front		2	EM-2282			
		1968-73	Trans - Lower	Auto	2				EM-2108
			Trans - Lower	Manual	2				EM-2108
		Trans - Upper	Auto	2				EM-2107	
	V8 5.7L 350ci	1988-00	L & R Front		2	EM-2637			
		1977-86	L & R Front		2	EM-2292			
		1973-74	L & R Front		2	EM-2292			
		1969-72	L & R Front		2	EM-2282			
		1977-84	Trans - Lower	Auto	2				EM-2108
			Trans - Lower	Manual	2				EM-2108
		1969-74	Trans - Lower	Auto	2				EM-2108
			Trans - Lower	Manual	2				EM-2108
		1977-84	Trans - Upper	Auto	2				EM-2107
		1988-00	Trans	Auto	1				EM-2638
		1985-86	Trans	Manual	1				EM-2638
			Trans	Auto	1				EM-2638
		Trans	Manual	1				EM-2638	
	V8 6.2L 379ci Diesel	1988-93	L & R Front		2	EM-2637			
		1984-86	L & R Front		2	EM-2395			
		1982-83	L & R Front		2	EM-2292			
		1982-84	Trans - Lower	Auto	2				EM-2108
			Trans - Lower	Manual	2				EM-2108
			Trans - Upper	Auto	2				EM-2107
		1988-93	Trans	Auto	1				EM-2638
			Trans	Manual	1				EM-2638
		1985-86	Trans	Auto	1				EM-2638
	Trans		Manual	1				EM-2638	
	V8 6.5L 395ci Diesel	1992-00	L & R Front		2	EM-2637			
			Trans	Auto	1			EM-2638	
			Trans	Manual	1			EM-2638	
	V8 6.6L 400ci	1977-80	L & R Front		2	EM-2292			
			Trans - Lower	Auto	2			EM-2108	
Trans - Lower			Manual	2			EM-2108		
Trans - Upper			Auto	2			EM-2107		
V8 6.6L 402ci	1970-71	L & R Front		2	EM-2283				
		Trans - Lower	Auto	2			EM-2108		
		Trans - Lower	Manual	2			EM-2108		
		Trans - Upper	Auto	2			EM-2107		
V8 7.4L 454ci	1988-00	L & R Front		2	EM-2637				
	1980-86	L & R Front		2	EM-2395				
	1977	L & R Front		2	EM-2395				
	1973-74	L & R Front		2	EM-2395				
	1980-84	Trans - Lower	Auto	2				EM-2108	
		Trans - Lower	Manual	2				EM-2108	
	1977	Trans - Lower	Auto	2				EM-2108	
		Trans - Lower	Manual	2				EM-2108	
	1973-74	Trans - Lower	Auto	2				EM-2108	
		Trans - Lower	Manual	2				EM-2108	

# Engine, Transmission, And Torque Strut Mounts

CYL	ENG. SIZE	YEAR	LOCATION	DESCRIPTION	QTY	ENGINE	TORQUE STRUT	TRANSMISSION
<b>CHEVROLET TRUCK (continued)</b>								
<b>K30/K3500 P/U (continued)</b>								
V8	V8 7.4L 454ci	1980-84	Trans - Upper	Auto	2			EM-2107
		1977	Trans - Upper	Auto	2			EM-2107
		1973-74	Trans - Upper	Auto	2			EM-2107
		1988-00	Trans	Auto	1			EM-2638
			Trans	Manual	1			EM-2638
		1985-86	Trans	Auto	1			EM-2638
			Trans	Manual	1			EM-2638
<b>LLV (POSTAL VEHICLE)</b>								
L4	L4 2.2L 134ci	1994-95	L & R Front	Insert	2	EM-2819		
			Trans		1			EM-2508
	L4 2.5L 2474cc	1987-93	LH Front		1	EM-2549		
			RH Front		1	EM-2550		
			Trans		1			EM-2508
<b>LUV PICKUP</b>								
L4	L4 1.8L 111ci	1972-82	LH Front		1	EM-2563		
			RH Front		1	EM-2562		
			Trans	Auto	1			EM-2567
			Trans	Manual	1			EM-2567
	L4 2.2L 134ci Diesel	1982	LH Front		1	EM-8048		
			RH Front		1	EM-8049		
			Trans		1			EM-8586
<b>R10 PICKUP</b>								
V6	V6 4.3L 262ci	1987	L & R Front		2	EM-2436		
			Trans	Auto; THM700R4 (MD8)	1			EM-2394
			Trans	Manual	1			EM-2394
V8	V8 5.0L 305ci	1987	L & R Front		2	EM-2292		
			Trans	Auto	1			EM-2513
			Trans	Manual	1			EM-2392
	V8 5.7L 350ci	1987	L & R Front		2	EM-2292		
			Trans		1			EM-2392
	V8 6.2L 379ci Diesel	1987	L & R Front		2	EM-2395		
Trans			Auto; THM400-475 (M40)	1			EM-2515	
Trans			Auto; THM700R4 (MD8)	1			EM-2393	
			Trans	Manual	1			EM-2393
<b>R20/R2500 P/U</b>								
L6	L6 4.8L 292ci	1987-88	L & R Front		2	EM-2292		
			Trans	Auto	1			EM-2513
			Trans	Manual	1			EM-2392
V6	V6 4.3L 262ci	1987	L & R Front		2	EM-2436		
			Trans	Auto; THM700R4 (MD8)	1			EM-2394
			Trans	Manual	1			EM-2394
V8	V8 5.0L 305ci	1987	L & R Front		2	EM-2292		
			Trans	Auto	1			EM-2513
			Trans	Manual	1			EM-2392
	V8 5.7L 350ci	1987-88	L & R Front		2	EM-2292		
			Trans		1			EM-2392
	V8 6.2L 379ci Diesel	1989	L & R Front		2	EM-2395		
			L & R Front		2	EM-2395		
		1989	Trans	Auto; THM400-475 (M40)	1			EM-2515
			Trans	Auto; THM700R4 (MD8)	1			EM-2393
			Trans	Manual	1			EM-2393
		1987-88	Trans	Auto; THM400-475 (M40)	1			EM-2515
	Trans		Auto; THM700R4 (MD8)	1			EM-2393	
			Trans	Manual	1			EM-2393
	V8 7.4L 454ci	1989	L & R Front		2	EM-2395		

# Engine, Transmission, And Torque Strut Mounts

CYL	ENG. SIZE	YEAR	LOCATION	DESCRIPTION	QTY	ENGINE	TORQUE STRUT	TRANSMISSION	
<b>CHEVROLET TRUCK (continued)</b>									
<b>R20/R2500 P/U (continued)</b>									
V8	V8 7.4L 454ci	1987-88	L & R Front		2	EM-2395			
		1989	Trans	Auto; THM400 (M40)	1			EM-2513	
			Trans	Auto; THM700R4 (MD8)	1			EM-2392	
			Trans	Manual	1			EM-2392	
		1987-88	Trans	Auto; THM400-475 (M40)	1			EM-2513	
			Trans	Auto; THM700R4 (MD8)	1			EM-2392	
Trans	Manual		1			EM-2392			
<b>R30/R3500 P/U</b>									
L6	L6 4.8L 292ci	1987-88	L & R Front		2	EM-2292			
			Trans	Auto	1			EM-2513	
			Trans	Manual	1			EM-2392	
V8	V8 5.7L 350ci	1987-91	L & R Front		2	EM-2292			
		1989-91	Trans		1			EM-2392	
		1987-88	Trans		1			EM-2392	
	V8 6.2L 379ci Diesel	1989-91	L & R Front		2	EM-2395			
		1987-88	L & R Front		2	EM-2395			
			Trans	Auto; THM700-R4/4L60 (MD8)	1			EM-2393	
		Trans	Manual	1			EM-2393		
		1989-90	Trans	Auto; THM400 (M40)	1			EM-2515	
			Trans	Auto; THM700-R4/4L60 (MD8)	1			EM-2393	
			Trans	Manual	1			EM-2393	
		1987-88	Trans	Auto; THM400-475 (M40)	1			EM-2515	
			Trans	Auto; THM700R4 (MD8)	1			EM-2393	
	Trans		Manual	1			EM-2393		
	V8 7.4L 454ci	1989-91	L & R Front		2	EM-2395			
			Trans	Auto	1			EM-2513	
Trans		Manual	1			EM-2392			
1987-88		Trans	Auto	1			EM-2513		
		Trans	Manual	1			EM-2392		
<b>S10 PICKUP</b>									
L4	L4 1.9L 119ci	1982-85	L & R Front		2	EM-2381			
		1983-85	Trans	Auto; 2WD	1			EM-2531	
			Trans	Auto; 4WD	1			EM-2638	
			Trans	Manual; 2WD	1			EM-2531	
			Trans	Manual; 4WD	1			EM-2638	
		1982	Trans	Auto; 2WD	1			EM-2771	
			Trans	Manual; 2WD	1			EM-2771	
		L4 2.0L 122ci	1983-84	LH Front		1	EM-2755		
				RH Front		1	EM-2756		
	1984		Trans	Auto; 2WD	1			EM-2531	
			Trans	Auto; 4WD	1			EM-2638	
			Trans	Manual; 2WD	1			EM-2531	
			Trans	Manual; 4WD	1			EM-2638	
	1983		Trans	Auto; 2WD	1			EM-2772	
			Trans	Auto; 4WD	1			EM-2638	
			Trans	Manual; 2WD	1			EM-2772	
		Trans	Manual; 4WD	1			EM-2638		
	L4 2.2L 134ci	1994-03	L & R Front	Insert	2	EM-2819			
			LH Front	Complete Unit	1	EM-5426			
			RH Front	Complete Unit	1	EM-5350			
		1998-03	Trans	Auto	1			EM-2957	
			Trans	Manual	1			EM-2957	
		1994-97	Trans	Auto	1			EM-2957	
Trans	Manual		1			EM-2956			
L4 2.2L 134ci Diesel	1983-85	LH Front		1	EM-2549				
		RH Front		1	EM-2550				



# Engine, Transmission, And Torque Strut Mounts

CYL	ENG. SIZE	YEAR	LOCATION	DESCRIPTION	QTY	ENGINE	TORQUE STRUT	TRANSMISSION		
<b>CHEVROLET TRUCK (continued)</b>										
<b>S10 PICKUP (continued)</b>										
L4	L4 2.2L 134ci Diesel	1983-85	Trans	Auto; 2WD	1			EM-2531		
			Trans	Manual; 2WD	1		EM-2531			
	L4 2.5L 2474cc	1985-93	LH Front		1	EM-2549				
			RH Front		1	EM-2550				
		1988-93	Trans	Auto; 2WD	1			EM-2508		
			Trans	Manual; 2WD	1			EM-2508		
1985-87	Trans	Auto; 2WD	1			EM-2531				
	Trans	Manual; 2WD	1			EM-2531				
V6	V6 2.8L 173ci	1982-93	L & R Front		2	EM-2436				
		1988-93	Trans	Auto; 2WD	1			EM-2508		
			Trans	Auto; 4WD	1			EM-2638		
			Trans	Manual; 2WD	1			EM-2508		
			Trans	Manual; 4WD	1			EM-2638		
		1984-87	Trans	Auto; 2WD	1			EM-2531		
			Trans	Auto; 4WD	1			EM-2638		
			Trans	Manual; 2WD	1			EM-2531		
			Trans	Manual; 4WD	1			EM-2638		
		1983	Trans	Auto; 2WD	1			EM-2772		
			Trans	Auto; 4WD	1			EM-2638		
			Trans	Manual; 2WD	1			EM-2772		
			Trans	Manual; 4WD	1			EM-2638		
		1982	Trans	Auto; 2WD	1			EM-2771		
	Trans		Manual; 2WD	1			EM-2771			
	V6 4.3L 262ci	1996-04	L & R Front		2	EM-2802				
		1988-95	L & R Front		2	EM-2627				
		2004	Trans	Auto; 4WD	1			EM-2839		
		1995-03	Trans	Auto; 4WD	1			EM-2839		
			Trans	Auto; RWD	1			EM-2394		
			Trans	Manual; 4WD	1			EM-2839		
			Trans	Manual; RWD	1			EM-2394		
		1988-94	Trans	Auto; 2WD	1			EM-2508		
			Trans	Auto; 4WD	1			EM-2638		
			Trans	Manual; 2WD	1			EM-2508		
			Trans	Manual; 4WD	1			EM-2638		
		<b>SILVERADO 1500</b>								
		V6	V6 4.3L 262ci	2007-13	L & R Front		2	EM-4073		
1999-06				L & R Front		2	EM-2994			
2014-16	LH Front				1	EM-4173				
	RH Front				1	EM-4174				
2006-13	Trans			4WD	1			EM-2638		
	Trans			RWD	1			EM-2811		
1999-05	Trans			4WD	1			EM-2638		
	Trans			RWD	1			EM-2817		
V8	V8 4.8L 294ci	2007	L & R Front	Classic Body Style	2	EM-2909#				
		1999-06	L & R Front		2	EM-2909#				
		2008-13	LH Front		1	EM-4000				
		2007	LH Front	New Body Style	1	EM-4000				
		2008-13	RH Front		1	EM-4017				
		2007	RH Front	New Body Style	1	EM-4017				
		2007-12	Trans	4WD	1			EM-3172		
			Trans	RWD	1			EM-2817		
		1999-06	Trans	4WD	1			EM-2638		
			Trans	RWD	1			EM-2811		
	V8 5.3L 325ci	2010-13	L & R Front		2	EM-5583#				
		2008-09	L & R Front		2	EM-5583#				
2007		L & R Front	Gas; New Body Style	2	EM-5583#					

# = Available in the Westar Gold Line

# Engine, Transmission, And Torque Strut Mounts

CYL	ENG. SIZE	YEAR	LOCATION	DESCRIPTION	QTY	ENGINE	TORQUE STRUT	TRANSMISSION
<b>CHEVROLET TRUCK (continued)</b>								
<b>SILVERADO 1500 (continued)</b>								
V8	V8 5.3L 325ci	2007	L & R Front	Gas; Old Body Style	2	EM-2909#		
		2006	L & R Front	Hybrid; Hybrid	2	EM-5423		
			L & R Front	Gas; Exc. Hybrid; RWD	2	EM-2909#		
		2004-05	L & R Front	Complete Unit; Hybrid; RWD	2	EM-5423		
			L & R Front	Exc. Hybrid; RWD	2	EM-2909#		
		1999-03	L & R Front		2	EM-2909#		
		2014-16	LH Front		1	EM-4173		
			RH Front		1	EM-4174		
		2006-14	Trans	4WD	1			EM-2638
			Trans	RWD	1			EM-2811
		2005	Trans	Auto, 4WD, Hybrid	1			EM-2638
		1999-04	Trans	4WD	1			EM-2638
	Trans		RWD	1			EM-2811	
	V8 6.0L 364ci	2008-12	L & R Front		2	EM-5583#		
		2007	L & R Front	New Body Style	2	EM-5583#		
			L & R Front	Old Body Style	2	EM-2909#		
		2003-06	L & R Front		2	EM-2909#		
		2009-13	Trans	4WD	1			EM-2638
			Trans	RWD	1			EM-2811
		2006-08	Trans	4WD	1			EM-2638
			Trans	RWD	1			EM-2811
	2003-05	Trans		1			EM-2638	
	V8 6.2L 376ci	2009-13	L & R Front		2	EM-5583#		
		2015-16	LH Front		1	EM-4173		
RH Front				1	EM-4174			
2009-14		Trans	4WD	1			EM-2638	
	Trans	RWD	1			EM-2811		
<b>SILVERADO 1500 CLASSIC</b>								
V6	V6 4.3L 262ci	2007	L & R Front		2	EM-4073		
			Trans	4WD	1		EM-2638	
			Trans	RWD	1		EM-2817	
V8	V8 4.8L 294ci	2007	L & R Front	Classic Body Style	2	EM-2909#		
			LH Front	New Body Style	1	EM-4000		
			RH Front	New Body Style	1	EM-4017		
			Trans	4WD	1		EM-3172	
			Trans	RWD	1		EM-2817	
			V8 5.3L 325ci	2007	L & R Front	Gas; New Body Style	2	EM-5583#
	L & R Front	Gas; Old Body Style			2	EM-2909#		
	L & R Front	Hybrid; Hybrid			2	EM-5423		
	Trans	4WD			1		EM-2638	
	Trans	RWD			1		EM-2817	
	V8 6.0L 364ci	2007			L & R Front	New Body Style	2	EM-5583#
			L & R Front	Old Body Style	2	EM-2909#		
Trans			4WD	1		EM-2638		
Trans			RWD	1		EM-2817		
<b>SILVERADO 1500 HD</b>								
V8	V8 6.0L 364ci	2005-06	L & R Front		2	EM-2909#		
		2001-03	L & R Front		2	EM-2909#		
		2005-06	Trans	2WD	1		EM-2811	
			Trans	4WD	1		EM-2638	
		2001-03	Trans	2WD	1		EM-2811	
			Trans	4WD	1		EM-2638	

# = Available in the Westar Gold Line

# Engine, Transmission, And Torque Strut Mounts

CYL	ENG. SIZE	YEAR	LOCATION	DESCRIPTION	QTY	ENGINE	TORQUE STRUT	TRANSMISSION		
<b>CHEVROLET TRUCK (continued)</b>										
<b>SILVERADO 2500</b>										
V8	V8 5.3L 325ci	2006-08	L & R Front	Mexican Vehicle	2	EM-5074				
		2001-05	L & R Front	Mexican Vehicle	2	EM-2909#				
		1999-00	L & R Front		2	EM-2909#				
		2006-09	Trans	Mexican Vehicle	1			EM-2811		
		2001-05	Trans	Mexican Vehicle	1			EM-2811		
		1999-00	Trans	4WD	1			EM-2638		
	V8 6.0L 364ci	1999-04	L & R Front	w/Heat Shield	2	EM-5423				
			L & R Front	w/o Heat Shield	2	EM-2909#				
			Trans	2WD	1			EM-2811		
			Trans	4WD	1			EM-2638		
<b>SILVERADO 2500 HD</b>										
V8	V8 6.0L 364ci	2011-16	L & R Front		2	EM-4163				
		2008-10	L & R Front		2	EM-5583#				
		2001-07	L & R Front	w/Heat Shield	2	EM-5423				
			L & R Front	w/o Heat Shield	2	EM-2909#				
		2011-16	Trans	Auto; 4WD	1			EM-4157		
			Trans	Auto; RWD	1			EM-4156		
		2007-10	Trans	Auto; 4WD	1			EM-2638		
			Trans	Auto; RWD	1			EM-4156		
		2001-06	Trans	Auto; 4WD	1			EM-2638		
			Trans	Auto; RWD	1			EM-2811		
			Trans	Manual; 4WD	1			EM-2638		
		V8 6.6L 400ci Diesel	2011-16	LH Front		1	EM-4249			
	LH Front				1	EM-3102				
	RH Front				1	EM-4249				
	RH Front			Complete Unit	1	EM-5582				
	RH Front			w/o Heat Shield	1	EM-3102				
	Trans			Auto; 4WD	1			EM-4159		
	Trans			Auto; RWD	1			EM-4156		
	2007-10			Trans	GM Transmission	1			EM-2839	
	2001-06			Trans		1			EM-2839	
	V8 8.1L 496ci			2001-07	L & R Front		2	EM-5353		
					Trans		1			EM-2839
	<b>SILVERADO 3500</b>									
V8	V8 6.0L 364ci	2007-10	L & R Front	Old Body Style; w/ Heat Shield	2	EM-5423				
			L & R Front	Old Body Style; w/o Heat Shield	2	EM-2909#				
		2001-06	L & R Front	w/Heat Shield	2	EM-5423				
			L & R Front	w/o Heat Shield	2	EM-2909#				
		2008-10	Trans	RWD	1			EM-2811		
		2007	Trans	4WD	1			EM-2638		
	Trans		RWD	1			EM-2811			
	V8 6.6L 400ci Diesel	2001-07	Left	Complete Unit	1	EM-5582				
			Left	w/o Heat Shield	1	EM-3102				
			Right		1	EM-3102				
			Trans	2WD	1			EM-2839		
	V8 8.1L 496ci	2001-07	L & R Front		2	EM-5353				
Trans				1			EM-2839			
<b>SILVERADO 3500 HD</b>										
V8	V8 6.0L 364ci	2011-16	L & R Front		2	EM-4163				
		2008-10	L & R Front		2	EM-5583#				
		2007	L & R Front	New Body Style	2	EM-5583#				

# = Available in the Westar Gold Line

# Engine, Transmission, And Torque Strut Mounts

CYL	ENG. SIZE	YEAR	LOCATION	DESCRIPTION	QTY	ENGINE	TORQUE STRUT	TRANSMISSION	
<b>CHEVROLET TRUCK (continued)</b>									
<b>SILVERADO 3500 HD (continued)</b>									
V8	V8 6.0L 364ci	2011-16	Trans	Auto; RWD	1			EM-4156	
	V8 6.6L 400ci Diesel	2011-16	LH Front		1	EM-4249			
		2007-10	LH Front		1	EM-3102			
		2011-16	RH Front		1	EM-4249			
		2007-10	RH Front	Complete Unit	1	EM-5582			
			RH Front	w/o Heat Shield	1	EM-3102			
		2011-16	Trans	Auto; 4WD	1			EM-4159	
		Trans	Auto; RWD	1			EM-4156		
2007-10	Trans	GM Transmission	1			EM-2839			
<b>SSR</b>									
V8	V8 6.0L 364ci	2005-06	Trans		1			EM-4119	
<b>TORNADO (MEXICO)</b>									
L4	L4 1.8L 1796cc	2012-15	LH Front		1	EM-9002			
		2004-11	LH Front		1	EM-9002			
		2012-15	RH Front	Complete Unit	1	EM-9000			
		2004-11	RH Rear	Complete Unit	1	EM-9000			
			Rear	Complete Unit	1	EM-9000			
			Trans - Front Lower	Complete Unit	1			EM-90015	
<b>TRUCK</b>									
L6	L6 3.5L 216ci	1942-53	Center Front		1	EM-2007			
			Trans	Manual, 1st Design	2			EM-2060	
			Trans	Manual, 3rd Design	2			EM-2073	
	L6 3.9L 235ci	1960	L & R Front		2	EM-2142			
			Trans	Auto	1			EM-2378 @	
			1953-58	Trans	Large	1			EM-2123
				Trans	Small	1			EM-2122
<b>V10 PICKUP</b>									
V6	V6 4.3L 262ci	1987	L & R Front		2	EM-2436			
			Trans	Auto	1			EM-2638	
			Trans	Manual	1			EM-2638	
V8	V8 5.0L 305ci	1987	L & R Front		2	EM-2292			
			Trans	Auto	1			EM-2638	
			Trans	Manual	1			EM-2638	
	V8 5.7L 350ci	1987	L & R Front		2	EM-2292			
			Trans	Auto	1			EM-2638	
			Trans	Manual	1			EM-2638	
V8 6.2L 379ci Diesel	1987	L & R Front		2	EM-2395				
		Trans	Auto	1			EM-2638		
		Trans	Manual	1			EM-2638		
<b>V20 PICKUP</b>									
L6	L6 4.8L 292ci	1987	L & R Front		2	EM-2292			
			Trans	Auto	1			EM-2638	
			Trans	Manual	1			EM-2638	
V8	V8 5.7L 350ci	1987	L & R Front		2	EM-2292			
			Trans	Auto	1			EM-2638	
			Trans	Manual	1			EM-2638	
	V8 6.2L 379ci Diesel	1987	L & R Front		2	EM-2395			
			Trans	Auto	1			EM-2638	
			Trans	Manual	1			EM-2638	
<b>V30/V3500 P/U</b>									
V8	V8 5.7L 350ci	1989-91	L & R Front		2	EM-2292			
		1987-88	L & R Front		2	EM-2292			
		1989-91	Trans	Auto	1			EM-2638	

@ = Universal Mount EM-5000 also available.

# Engine, Transmission, And Torque Strut Mounts

CYL	ENG. SIZE	YEAR	LOCATION	DESCRIPTION	QTY	ENGINE	TORQUE STRUT	TRANSMISSION
<b>CHEVROLET TRUCK (continued)</b>								
<b>V30/V3500 P/U (continued)</b>								
V8	V8 5.7L 350ci	1989-91	Trans	Manual	1			EM-2638
		1987-88	Trans	Auto	1			EM-2638
			Trans	Manual	1			EM-2638
	V8 6.2L 379ci Diesel	1989-91	L & R Front		2	EM-2395		
			Trans	Auto	1			EM-2638
			Trans	Manual	1			EM-2638
	V8 7.4L 454ci	1989-91	L & R Front		2	EM-2395		
			Trans	Auto	1			EM-2513
		1987-91	Trans	Manual	1			EM-2392
<b>CHEVROLET VAN</b>								
<b>ASTRO</b>								
L4	L4 2.5L 2474cc	1985-90	LH Front		1	EM-2549		
			RH Front		1	EM-2550		
		1990 1985-89	Trans	Auto	1			EM-2508
			Trans	Auto	1			EM-2508
			Trans	Manual	1			EM-2508
V6	V6 4.3L 262ci	1985-05 1996-05	L & R Front		2	EM-2436		
			Trans	AWD	1			EM-2839
		1994-95	Trans	RWD	1			EM-2879
			Trans	Auto; RWD	1			EM-5392
			Trans	Auto; AWD	1			EM-2394
		1990-93	Trans	2WD	1			EM-2950
			Trans	AWD	1			EM-2508
		1985-89	Trans	Auto	1			EM-2508
			Trans	Manual	1			EM-2508
<b>CITY EXPRESS</b>								
L4	L4 2.0L 1997cc	2015-17	RH Front		1	EM-5656		
			Torq Str - Rear		1		EM-9228	
			Trans		1			EM-7115
<b>EXPRESS 1500</b>								
V6	V6 4.3L 262ci	2003-12	L & R Front		2	EM-3177		
		1999-02	L & R Front		2	EM-2621		
		1997-02	Trans		1			EM-2817
		1996	Trans		1			EM-2816
V8	V8 5.0L 305ci	1999-02	L & R Front		2	EM-2621		
			Trans		1			EM-2817
		1996-98	Trans		1			EM-2816
	V8 5.3L 325ci	2004-14	L & R Front	US & Canada; RWD	2	EM-5354		
			L & R Front	Mexico; RWD	2	EM-5354		
		2004-14	LH Front	US & Canada; AWD	1	EM-3175		
			RH Front	US & Canada; AWD	1	EM-5354		
		2003-14	Trans	AWD	1			EM-4108
	Trans	RWD	1			EM-3098		
	V8 5.7L 350ci	1999-02	L & R Front		2	EM-2621		
Trans				1			EM-2817	
<b>EXPRESS 2500</b>								
V6	V6 4.3L 262ci	2003-05	L & R Front		2	EM-5354		
		1996-02	L & R Front		2	EM-2621		
		1999-02	Trans		1			EM-2817
V8	V8 4.8L 294ci	2003-17	L & R Front		2	EM-5354		
		2003-16	Trans	2WD	1			EM-3098
	V8 5.0L 305ci	1999-02	L & R Front		2	EM-2621		
			Trans		1			EM-2816
	V8 5.3L 325ci	2003-05	L & R Front	RWD	2	EM-5354		

\* = Hydraulic Mount, "S" suffix = solid replacement.

# Engine, Transmission, And Torque Strut Mounts

CYL	ENG. SIZE	YEAR	LOCATION	DESCRIPTION	QTY	ENGINE	TORQUE STRUT	TRANSMISSION
<b>CHEVROLET VAN (continued)</b>								
<b>EXPRESS 2500 (continued)</b>								
V8	V8 5.3L 325ci	2003-05	LH Front	AWD	1	EM-3175		
			RH Front	AWD	1	EM-5354		
			Trans	RWD	1			EM-3098
			Trans	AWD	1			EM-4108
	V8 5.7L 350ci	1999-02	L & R Front		2	EM-2621		
			Trans		1			EM-2817
		1996-98	Trans		1			EM-2816
	V8 6.0L 364ci	2003-17	L & R Front	RWD	2	EM-5354		
			Trans	RWD	1			EM-3098
		2003-05	Trans	RWD	1			EM-3098
			Trans	AWD	1			EM-4108
	V8 6.5L 395ci Diesel	1999-02	L & R Front		2	EM-2621		
		1996-02	Trans		1			EM-2816
V8 6.6L 400ci Diesel	2006-09	Trans	Turbo	1			EM-5663	
<b>EXPRESS 3500</b>								
V8	V8 4.8L 294ci	2005-17	L & R Front		2	EM-5354		
		2005-16	Trans		1			EM-3098
	V8 5.7L 350ci	1999-02	L & R Front		2	EM-2621		
		1996-02	Trans	Auto; 4L80E (MT1)	1			EM-2817
	V8 6.0L 364ci	2003-17	L & R Front		2	EM-5354		
		2003-16	Trans - Front		1			EM-3098
	V8 6.5L 395ci Diesel	1999-02	L & R Front		2	EM-2621		
			Trans		1			EM-2816
	V8 6.6L 400ci Diesel	2006-09	Trans	Turbo	1			EM-5663
	V8 7.4L 454ci	1999-00	L & R Front		2	EM-2621		
		1996-00	Trans		1			EM-2816
	V8 8.1L 496ci	2001-02	L & R Front		2	EM-2621		
			Trans		1			EM-2816
<b>G10/G1500 VAN</b>								
L4	L4 2.5L 153ci	1964-65	L & R Front		2	EM-2282		
L6	L6 3.2L 194ci	1964-66	L & R Front		2	EM-2282		
			L & R Rear Lower	Manual Manual	2	EM-2108		
			L & R Rear Upper	Manual Manual	2	EM-2107		
	L6 4.1L 250ci	1971-84	L & R Front		2	EM-2292		
			1967-70	L & R Front		2	EM-2282	
		1983-84	Trans	Auto; THM400 (M40)	1			EM-2515
			Trans	Auto; THM700-R4/4L60 (MD8)	1			EM-2393
			Trans	Manual	1			EM-2393
		1982	Trans	Auto; THM350 (M38)	1			EM-2378 @
			Trans	THM350C (MV4)				
			Trans	Auto; THM400 (M40)	1			EM-2268 @
			Trans	Manual	1			EM-2378 @
		1977-81	Trans	Auto; THM350 (M38)	1			EM-2378 @
Trans	Auto; THM400 (M40)		1			EM-2268 @		
Trans	Manual		1			EM-2378 @		
1975-76	Trans	Auto; THM350 (M38)	1			EM-2378 @		
	Trans	Manual	1			EM-2378 @		
V6	V6 4.3L 262ci	1998	L & R Front		2	EM-2621		
		1997	L & R Front		2	EM-2621		
		1985-96	L & R Front		2	EM-2436		
		1991-95	Trans		1			EM-2811
		1990	Trans	Auto; THM400 (M40)	1			EM-2515
			Trans	Auto; THM700-R4/4L60 (MD8)	1			EM-2394

@ = Universal Mount EM-5000 also available.

# Engine, Transmission, And Torque Strut Mounts

CYL	ENG. SIZE	YEAR	LOCATION	DESCRIPTION	QTY	ENGINE	TORQUE STRUT	TRANSMISSION
<b>CHEVROLET VAN (continued)</b>								
<b>G10/G1500 VAN (continued)</b>								
V6	V6 4.3L 262ci	1985-89	Trans	Auto; THM400-475 (M40)	1			EM-2515
			Trans	Auto; THM700R4 (MD8)	1		EM-2508	
			Trans	Manual	1		EM-2508	
V8	V8 5.0L 305ci	1998	L & R Front		2	EM-2621		
		1996-97	L & R Front		2	EM-2621		
		1977-95	L & R Front		2	EM-2292		
		1991-95	Trans		1			EM-2816
		1983-90	Trans	Auto; 4 Spd	1		EM-2393	
			Trans	Auto; THM400-475 (M40)	1		EM-2515	
			Trans	Manual	1		EM-2393	
		1977-82	Trans	Auto, THM350 (M38), THM350C (MV4)	1		EM-2378 @	
			Trans	Auto; THM400-475 (M40)	1		EM-2268 @	
			Trans	Manual	1		EM-2378 @	
	V8 5.0L 307ci	1972-73	L & R Front		2	EM-2292		
			1968-71	L & R Front		2	EM-2282	
			1968-73	Trans	Auto, THM350 (M38)	1		EM-2378 @
				Trans	Auto; THM400-475 (M40)	1		EM-2268 @
				Trans	Manual	1		EM-2378 @
V8 5.7L 350ci	1998	L & R Front		2	EM-2621			
	1996-97	L & R Front		2	EM-2621			
	1970-93	L & R Front		2	EM-2292			
	1992-93	Trans	Auto	1		EM-2816		
	1991	Trans	Auto; THM700-R4/4L60 (MD8)	1		EM-2817		
	1990	Trans	Auto; THM400-475 (M40)	1		EM-2515		
		Trans	Auto; THM700R4 (MD8)	1		EM-2394		
	1983-89	Trans	Auto; THM400-475 (M40)	1		EM-2515		
		Trans	Auto; THM700R4 (MD8)	1		EM-2393		
		Trans	Manual	1		EM-2393		
		Trans	Auto; THM400-475 (M40)	1		EM-2515		
		Trans	Auto; THM700R4 (MD8)	1		EM-2393		
		Trans	Manual	1		EM-2393		
	1982	Trans	Auto; THM350C (MV4)	1		EM-2378 @		
		Trans	Auto; THM400 (M40)	1		EM-2268 @		
		Trans	Manual	1		EM-2378 @		
	1977-81	Trans	Auto, THM350 (M38)	1		EM-2378 @		
		Trans	Auto; THM400 (M40)	1		EM-2268 @		
		Trans	Manual	1		EM-2378 @		
	1975-76	Trans	Auto, THM350 (M38)	1		EM-2378 @		
Trans		Manual	1		EM-2378 @			
<b>G20/G2500 VAN</b>								
L6	L6 4.1L 250ci	1971-84	L & R Front		2	EM-2292		
		1968-70	L & R Front		2	EM-2282		
		1983-84	Trans	Auto, 4 Spd	1		EM-2393	
			Trans	Auto; THM400-475 (M40)	1		EM-2515	
			Trans	Manual	1		EM-2393	
		1982	Trans	Auto; THM350C (MV4)	1		EM-2378 @	
			Trans	Auto; THM400 (M40)	1		EM-2268 @	
			Trans	Manual	1		EM-2378 @	
		1975-81	Trans	Auto, THM350 (M38)	1		EM-2378 @	
			Trans	Auto; THM400 (M40)	1		EM-2268 @	
			Trans	Manual	1		EM-2378 @	
		1971-74	Trans	Auto, THM350 (M38)	1		EM-2378 @	
Trans	Auto; THM400 (M40)		1		EM-2268 @			

@ = Universal Mount EM-5000 also available.

# Engine, Transmission, And Torque Strut Mounts

CYL	ENG. SIZE	YEAR	LOCATION	DESCRIPTION	QTY	ENGINE	TORQUE STRUT	TRANSMISSION		
<b>CHEVROLET VAN (continued)</b>										
<b>G20/G2500 VAN (continued)</b>										
L6	L6 4.1L 250ci	1971-74	Trans	Manual	1			EM-2378 @		
		1968-70	Trans	Auto	1			EM-2378 @		
			Trans	Manual	1			EM-2378 @		
	L6 4.8L 292ci	1973-80	L & R Front			2	EM-2292			
		1971	L & R Front			2	EM-2282			
		1973-80	Trans	Auto		1			EM-2373	
			Trans	Manual		1			EM-2268 @	
		1971	Trans	Auto		1			EM-2378 @	
			Trans	Manual		1			EM-2268 @	
		V6	V6 4.3L 262ci	1997-98	L & R Front		2	EM-2621		
1985-95	L & R Front				2	EM-2436				
1996	Trans					1			EM-2816	
1991-95	Trans					1			EM-2811	
1990	Trans			Auto; THM400-475 (M40)		1			EM-2515	
	Trans			Auto; THM700R4 (MD8)		1			EM-2394	
1985-89	Trans			Auto; THM400-475 (M40)		1			EM-2515	
	Trans			Auto; THM700R4 (MD8)		1			EM-2508	
Trans	Manual				1			EM-2508		
V8	V8 5.0L 305ci			1998	L & R Front		2	EM-2621		
		1996-97	L & R Front		2	EM-2621				
		1977-95	L & R Front		2	EM-2292				
		1991-95	Trans			1			EM-2816	
		1983-90	Trans	Auto, 4 Spd		1			EM-2393	
			Trans	Auto; THM400-475 (M40)		1			EM-2515	
			Trans	Manual		1			EM-2393	
		1977-82	Trans	Auto, THM350 (M38), THM350C (MV4)		1			EM-2378 @	
			Trans	Auto; THM400-475 (M40)		1			EM-2268 @	
			Trans	Manual		1			EM-2378 @	
		V8 5.0L 307ci	1968-69	L & R Front			2	EM-2282		
			1968-73	Trans	Auto		1			EM-2378 @
	Trans			Manual		1			EM-2378 @	
	V8 5.7L 350ci	1998	L & R Front			2	EM-2621			
		1996-97	L & R Front			2	EM-2621			
		1970-95	L & R Front			2	EM-2292			
		1993-95	Trans	Auto; 4L60E (M30)		1			EM-2816	
		1992	Trans	Auto; THM700-R4/4L60 (MD8)		1			EM-2816	
		1991	Trans	Auto; THM700-R4/4L60 (MD8)		1			EM-2817	
		1990	Trans	Auto; THM400-475 (M40)		1			EM-2515	
			Trans	Auto; THM700R4 (MD8)		1			EM-2394	
		1987-89	Trans	Auto; THM400-475 (M40)		1			EM-2515	
			Trans	Auto; THM700R4 (MD8)		1			EM-2393	
		1983-86	Trans	Auto; THM400-475 (M40)		1			EM-2515	
			Trans	Auto; THM700R4 (MD8)		1			EM-2393	
			Trans	Manual		1			EM-2393	
		1982	Trans	Auto; THM350C (MV4)		1			EM-2378 @	
			Trans	Auto; THM400 (M40)		1			EM-2268 @	
			Trans	Manual		1			EM-2378 @	
		1979-81	Trans	Auto, THM350 (M38)		1			EM-2378 @	
			Trans	Auto; THM400 (M40)		1			EM-2268 @	
			Trans	Manual		1			EM-2378 @	
		1975-78	Trans			1			EM-2378 @	
		1971-74	Trans	Auto		1			EM-2378 @	
			Trans	Manual		1			EM-2378 @	

@ = Universal Mount EM-5000 also available.



## Engine, Transmission, And Torque Strut Mounts

CYL	ENG. SIZE	YEAR	LOCATION	DESCRIPTION	QTY	ENGINE	TORQUE STRUT	TRANSMISSION	
<b>CHEVROLET VAN (continued)</b>									
<b>G20/G2500 VAN (continued)</b>									
V8	V8 6.2L 379ci Diesel	1983-93	L & R Front		2	EM-2292			
		1992-93	Trans		1			EM-2817	
		1991	Trans	Auto; THM700-R4/4L60 (MD8)	1			EM-2394	
		1990	Trans	Auto; THM400 (M40)	1			EM-2515	
			Trans	Auto; THM700-R4/4L60 (MD8)	1			EM-2394	
		1983-89	Trans	Auto; THM400-475 (M40)	1			EM-2515	
			Trans	Auto; THM700R4 (MD8)	1			EM-2393	
			Trans	Manual	1			EM-2393	
		V8 6.5L 395ci Diesel	1998	L & R Front		2	EM-2621		
	1997		L & R Front		2	EM-2621			
	1994-96		L & R Front		2	EM-2292			
	1998		Trans		1			EM-2816	
	1994-95		Trans		1			EM-2816	
	V8 6.6L 400ci	1975-80	L & R Front		2	EM-2292			
			Trans	Auto, THM350 (M38)	1			EM-2378 @	
			Trans	Auto; THM400-475 (M40)	1			EM-2268 @	
			Trans	Manual	1			EM-2378 @	
	V8 7.4L 454ci	1976	L & R Front		2	EM-2395			
			Trans	Auto	1			EM-2268 @	
			Trans	Manual	1			EM-2378 @	
<b>G30/G3500 VAN</b>									
L6	L6 4.1L 250ci	1981-84	L & R Front		2	EM-2292			
		1978-79	L & R Front		2	EM-2292			
		1976	L & R Front		2	EM-2292			
		1971-74	L & R Front		2	EM-2292			
		1983-84	Trans	Auto, 4 Spd	1			EM-2393	
			Trans	Auto; THM400-475 (M40)	1			EM-2515	
			Trans	Manual	1			EM-2393	
		1981-82	Trans	Auto; THM400 (M40)	1			EM-2268 @	
			Trans	Manual	1			EM-2378 @	
		1978-79	Trans	Auto, THM350 (M38)	1			EM-2378 @	
			Trans	Auto; THM400 (M40)	1			EM-2268 @	
			Trans	Manual	1			EM-2378 @	
		1976	Trans	Auto, THM350 (M38)	1			EM-2378 @	
			Trans	Auto; THM400 (M40)	1			EM-2268 @	
			Trans	Manual	1			EM-2378 @	
		1971-74	Trans	Auto, THM350 (M38)	1			EM-2378 @	
			Trans	Auto; THM400-475 (M40)	1			EM-2268 @	
			Trans	Manual	1			EM-2378 @	
		L6 4.8L 292ci	1974-79	L & R Front		2	EM-2292		
	1971-72		L & R Front		2	EM-2282			
	1974-79		Trans	Auto	1			EM-2373	
			Trans	Manual	1			EM-2268 @	
	1971-72		Trans	Auto	1			EM-2378 @	
		Trans	Manual	1			EM-2268 @		
	V6	V6 4.3L 262ci	1985-95	L & R Front		2	EM-2436		
			1991-95	Trans		1			EM-2811
1990			Trans	Auto; THM400-475 (M40)	1			EM-2515	
			Trans	Auto; THM700R4 (MD8)	1			EM-2394	
1985-89			Trans	Auto; THM400-475 (M40)	1			EM-2515	
			Trans	Auto; THM700R4 (MD8)	1			EM-2508	
			Trans	Manual	1			EM-2508	
V8	V8 5.0L 305ci	1985	L & R Front		2	EM-2292			
		1982	L & R Front		2	EM-2292			

@ = Universal Mount EM-5000 also available.

# Engine, Transmission, And Torque Strut Mounts

CYL	ENG. SIZE	YEAR	LOCATION	DESCRIPTION	QTY	ENGINE	TORQUE STRUT	TRANSMISSION
<b>CHEVROLET VAN (continued)</b>								
<b>G30/G3500 VAN (continued)</b>								
V8	V8 5.0L 305ci	1978-79	L & R Front		2	EM-2292		
		1985	Trans	Auto, 4 Spd	1			EM-2393
			Trans	Auto; THM400-475 (M40)	1			EM-2515
			Trans	Manual	1			EM-2393
		1982	Trans	Auto, THM350 (M38), THM350C (MV4)	1			EM-2378 @
			Trans	Auto; THM400-475 (M40)	1			EM-2268 @
			Trans	Manual	1			EM-2378 @
		1978-79	Trans	Auto, THM350 (M38), THM350C (MV4)	1			EM-2378 @
			Trans	Auto; THM400-475 (M40)	1			EM-2268 @
	Trans		Manual	1			EM-2378 @	
	V8 5.7L 350ci	1998	L & R Front		2	EM-2621		
		1996-97	L & R Front		2	EM-2621		
		1971-95	L & R Front		2	EM-2292		
		1992-95	Trans		1			EM-2816
		1991	Trans	Auto, 4L60E (M30). THM-R2 (MT1)	1			EM-2816
			Trans	Auto; THM700R4 (MD8)	1			EM-2817
		1990	Trans	Auto; THM400-475 (M40)	1			EM-2515
			Trans	Auto; THM700R4 (MD8)	1			EM-2394
		1987-89	Trans	Auto; THM400-475 (M40)	1			EM-2515
			Trans	Auto; THM700R4 (MD8)	1			EM-2393
		1983-86	Trans	Auto; THM400 (M40)	1			EM-2515
			Trans	Auto; THM700R4 (MD8)	1			EM-2393
			Trans	Manual	1			EM-2393
		1982	Trans	Auto; THM350C (MV4)	1			EM-2378 @
			Trans	Auto; THM400 (M40)	1			EM-2268 @
			Trans	Manual	1			EM-2378 @
		1979-81	Trans	Auto, THM350 (M38)	1			EM-2378 @
			Trans	Auto; THM400 (M40)	1			EM-2268 @
	Trans		Manual	1			EM-2378 @	
	1971-78	Trans		1			EM-2378 @	
	V8 6.2L 379ci Diesel	1983-93	L & R Front		2	EM-2292		
		1992-93	Trans		1			EM-2816
		1991	Trans	Auto; THM-R2 (MT1) 4L80E	1			EM-2816
Trans			Auto; THM700R4 (MD8)	1			EM-2817	
1983-90		Trans	Auto; THM400-475 (M40)	1			EM-2515	
		Trans	Auto; THM700R4 (MD8)	1			EM-2393	
	Trans	Manual	1			EM-2393		
V8 6.5L 395ci Diesel	1998	L & R Front		2	EM-2621			
	1997	L & R Front		2	EM-2621			
	1996	L & R Front		2	EM-2621			
	1994-95	L & R Front		2	EM-2292			
	1998	Trans		1			EM-2816	
	1994-97	Trans		1			EM-2816	
V8 6.6L 400ci	1975-80	L & R Front		2	EM-2292			
		Trans	Auto, THM350 (M38)	1			EM-2378 @	
		Trans	Auto; THM400-475 (M40)	1			EM-2268 @	
		Trans	Manual	1			EM-2378 @	
V8 7.4L 454ci	1998	L & R Front		2	EM-2621			
	1997	L & R Front		2	EM-2621			
	1988-96	L & R Front		2	EM-2292			
	1973-76	L & R Front		2	EM-2395			
	1992-96	Trans		1			EM-2816	

@ = Universal Mount EM-5000 also available.

# Engine, Transmission, And Torque Strut Mounts

CYL	ENG. SIZE	YEAR	LOCATION	DESCRIPTION	QTY	ENGINE	TORQUE STRUT	TRANSMISSION
<b>CHEVROLET VAN (continued)</b>								
<b>G30/G3500 VAN (continued)</b>								
V8	V8 7.4L 454ci	1990	Trans		1			EM-2816
		1988-89	Trans	Auto; THM400 (M40)	1			EM-2515
		1973-76	Trans	Auto	1			EM-2268 @
			Trans	Manual	1			EM-2378 @
<b>LUMINA APV</b>								
V6	V6 3.1L 189ci	1990-95	RH Front		1	EM-2548'		
			Torq Str - Front		1		EM-2396	
			Trans - LH Front		1			EM-2466
			Trans - LH Rear		1			EM-2467
	V6 3.4L 207ci	1996	RH Front		1	EM-2548'		
			Torq Str - Front	Insert	1		EM-2716	
			Trans - LH Front		1			EM-2466
			Trans - LH Rear		1			EM-2467
	V6 3.8L 231ci	1992-95	RH Front		1	EM-2548'		
			Torq Str - Front		1		EM-2396	
			Trans - LH Front		1			EM-2466
			Trans - LH Rear		1			EM-2467
<b>ORLANDO</b>								
L4	L4 2.4L 145ci	2012-14	Trans - Center	Canada; Auto	1			EM-4054
			Trans - Front	Canada; Auto	1			EM-4080
			Trans - Rear	Canada; Auto	1			EM-4080
<b>P10 VAN</b>								
L4	L4 2.5L 153ci	1963-65	Trans - L & R Lower		2			EM-2108
			Trans - L & R Upper		2			EM-2107
L6	L6 4.1L 250ci	1973-74	L & R Front		2	EM-2292		
		1968-72	L & R Front		2	EM-2282		
		1968-74	Trans		1			EM-2378 @
	L6 4.8L 292ci	1975-80	L & R Front		2	EM-2292		
			Trans	Auto	1			EM-2378 @
			Trans	Manual	1			EM-2268 @
V8	V8 5.0L 305ci	1979	L & R Front		2	EM-2292		
			Trans	Auto	1			EM-2268 @
			Trans	Manual	1			EM-2378 @
	V8 5.7L 350ci	1977-78	L & R Front		2	EM-2292		
			L & R Front		2	EM-2292		
			L & R Front		2	EM-2292		
			Trans	Auto; THM400	1			EM-2268 @
			Trans	Manual	1			EM-2378 @
			Trans	Auto, M40	1			EM-2268 @
			Trans	Manual	1			EM-2378 @
			Trans	Auto; THM400	1			EM-2268 @
	Trans	Manual	1			EM-2378 @		
	V8 6.6L 400ci	1977	L & R Front		2	EM-2292		
			Trans	Auto	1			EM-2268 @
			Trans	Manual	1			EM-2378 @
V8 7.4L 454ci	1973	L & R Front		2	EM-2395			
		Trans	Auto; THM400	1			EM-2268 @	
		Trans	Manual	1			EM-2373	

\* = Hydraulic Mount, "S" suffix = solid replacement. @ = Universal Mount EM-5000 also available.

# Engine, Transmission, And Torque Strut Mounts

CYL	ENG. SIZE	YEAR	LOCATION	DESCRIPTION	QTY	ENGINE	TORQUE STRUT	TRANS-MISSION		
<b>CHEVROLET VAN (continued)</b>										
<b>P20 VAN</b>										
L6	L6 4.1L 250ci	1970-74	Trans		1			EM-2378 @		
	L6 4.8L 292ci	1973-89	L & R Front		2	EM-2292				
		1968-72	L & R Front		2	EM-2282				
		1985-89	Trans	Auto		1			EM-2513	
			Trans	Manual		1			EM-2392	
		1968-84	Trans	Auto		1			EM-2378 @	
Trans	Manual			1			EM-2268 @			
V8	V8 5.0L 307ci	1968-69	L & R Front		2	EM-2282				
			Trans	Auto	1			EM-2268 @		
			Trans	Manual	1			EM-2378 @		
	V8 5.7L 350ci	1973-89	1970-72	L & R Front		2	EM-2292			
				L & R Front		2	EM-2282			
			1985-89	Trans	Auto		1			EM-2513
				Trans	Manual		1			EM-2392
			1970-84	Trans	Auto		1			EM-2268 @
				Trans	Manual		1			EM-2378 @
	V8 6.2L 379ci Diesel	1982-89	L & R Front		2	EM-2292				
			Trans	Auto	1			EM-2513		
			Trans	Manual	1			EM-2392		
	V8 7.4L 454ci	1979	1970-71	L & R Front		2	EM-2395			
				L & R Front		2	EM-2395			
				L & R Front		2	EM-2395			
				L & R Front		2	EM-2395			
		1979	Trans	Auto		1			EM-2513	
			Trans	Manual		1			EM-2378 @	
		1976	Trans	Auto		1			EM-2268 @	
			Trans	Manual		1			EM-2378 @	
		1973	Trans	Auto		1			EM-2268 @	
Trans			Manual		1			EM-2378 @		
1970-71	Trans	Auto		1			EM-2268 @			
	Trans	Manual		1			EM-2378 @			
<b>P30 VAN</b>										
L4	L4 3.9L 239ci Diesel	1990-91	Trans		1			EM-2513		
L6	L6 4.1L 250ci	1979	L & R Front		2	EM-2292				
			L & R Front		2	EM-2292				
			L & R Front		2	EM-2292				
			L & R Front		2	EM-2282				
		Trans		1			EM-2378 @			
		Trans		1			EM-2378 @			
		Trans		1			EM-2378 @			
	L6 4.8L 292ci	1973-89	1968-72	L & R Front		2	EM-2292			
				L & R Front		2	EM-2282			
		1985-89	Trans	Auto		1			EM-2513	
			Trans	Manual		1			EM-2392	
		1983-84	Trans	Auto		1			EM-2513	
			Trans	Manual		1			EM-2268 @	
1968-82	Trans	Auto		1			EM-2378 @			
	Trans	Manual		1			EM-2268 @			
V6	V6 4.3L 262ci	1990-99	L & R Front		2	EM-2436				
		1992-99	Trans	Manual; 5 Spd	1			EM-2922		
		1991	Trans	Auto		1			EM-2510 @	
			Trans	Manual; 5 Spd		1			EM-2922	
		1990	Trans	Auto		1			EM-2510 @	

@ = Universal Mount EM-5000 also available.

# Engine, Transmission, And Torque Strut Mounts

CYL	ENG. SIZE	YEAR	LOCATION	DESCRIPTION	QTY	ENGINE	TORQUE STRUT	TRANSMISSION		
<b>CHEVROLET VAN (continued)</b>										
<b>P30 VAN (continued)</b>										
V6	V6 4.3L 262ci	1990	Trans	Manual; 4 Spd	1			EM-2515		
V8	V8 5.0L 307ci	1968-69	L & R Front		2	EM-2282				
			Trans	Auto	1			EM-2268 @		
V8	V8 5.7L 350ci	1973-99	L & R Front		2	EM-2292				
			1970-72	L & R Front		2	EM-2282			
			1992-99	Trans	Auto	1			EM-2392	
		1991	Trans	Manual	1			EM-2922		
			Trans	Auto	1			EM-2392		
		1985-90	Trans	Manual; 5 Spd	1			EM-2922		
			Trans	Auto	1			EM-2513		
		1970-84	Trans	Manual	1			EM-2392		
			Trans	Auto	1			EM-2268 @		
			Trans	Manual	1			EM-2378 @		
		V8	V8 6.2L 379ci Diesel	1982-93	L & R Front		2	EM-2292		
					Trans		1			EM-2922
				1982-90	Trans	Auto	1			EM-2513
					Trans	Manual	1			EM-2392
V8	V8 6.5L 395ci Diesel	1994-99	L & R Front		2	EM-2292				
			Trans		1			EM-2922		
V8	V8 6.6L 400ci	1976	L & R Front		2	EM-2292				
			Trans	Auto	1			EM-2268 @		
			Trans	Manual	1			EM-2378 @		
V8	V8 7.4L 454ci	1998-99	L & R Front		2	EM-2621				
			1973-97	L & R Front		2	EM-2395			
		1970-71	L & R Front		2	EM-2395				
			1991-99	Trans		1			EM-2922	
		1981-90	Trans	Auto	1			EM-2513		
			Trans	Manual	1			EM-2393		
		1979-80	Trans	Auto	1			EM-2513		
			Trans	Manual	1			EM-2373		
		1973-78	Trans	Auto	1			EM-2268 @		
			Trans	Manual	1			EM-2373		
<b>UPLANDER</b>										
V6	V6 3.5L 213ci	2005-06	RH Front		1	EM-2987#				
			Torq Str - Front	Bracket to Radiator Support Complete Unit	2		EM-2900			
			Torq Str - Front	Bracket to Radiator Support Insert	2		EM-4169			
			Torq Str - Front	Complete Unit; LH & RH Front	2		EM-2899			
			Torq Str - Front	Insert Only; LH & RH Front	2		EM-2716			
			Trans	Auto	1			EM-2818 #		
	V6	V6 3.9L 237ci	2006-07 2006-09	RH Front		1	EM-2987#			
				Torq Str - Front	Bracket to Radiator Support Complete Unit	2		EM-2900		
				Torq Str - Front	Bracket to Radiator Support Insert	2		EM-4169		
				Torq Str - Front	Complete Unit; LH & RH Front	2		EM-2899		
Torq Str - Front	Insert Only; LH & RH Front	2		EM-2716						
Trans	Auto	1			EM-2818 #					
<b>VENTURE</b>										
V6	V6 3.4L 207ci	2005	RH Front		1	EM-2796*				
			2003-04	RH Front	AWD	1	EM-2987#			
		2003-04	RH Front	FWD	1	EM-2796*				

\* = Hydraulic Mount, "S" suffix = solid replacement.

@ = Universal Mount EM-5000 also available.

# = Available in the Westar Gold Line

# Engine, Transmission, And Torque Strut Mounts

CYL	ENG. SIZE	YEAR	LOCATION	DESCRIPTION	QTY	ENGINE	TORQUE STRUT	TRANSMISSION
<b>CHEVROLET VAN (continued)</b>								
<b>VENTURE (continued)</b>								
V6	V6 3.4L 207ci	1997-02	RH Front	FWD	1	EM-2796*		
		1997-05	Torq Str - Front	Bracket to Radiator Support Complete Unit	2		EM-2900	
			Torq Str - Front	Bracket to Radiator Support Insert	2		EM-4169	
			Torq Str - Front	Complete Unit; LH & RH Front	2		EM-2899	
			Torq Str - Front	Insert; LH & RH Front	2		EM-2716	
			Trans		1			EM-2818 #
<b>ZAFIRA (MEXICAN VEHICLE)</b>								
L4	L4 2.2L 2198cc	2002-06	Front	Auto	1	EM-9001		
			Right		1	EM-9001		
<b>CHEVROLET MEDIUM/HEAVY DUTY TRUCK</b>								
<b>C50/5000 KODIAK</b>								
	V6 5.2L	1966-72	Center Front		1	EM-2041		
<b>C60/6500 KODIAK</b>								
	V6 5.2L	1966-72	Center Front		1	EM-2041		
<b>C70/7500 KODIAK</b>								
	V6 5.2L	1966-72	Center Front		1	EM-2041		
<b>C50/5000 KODIAK</b>								
	V6 5.2L	1966-72	Trans - L & R Lower	Manual Manual	2			EM-2163
<b>C60/6500 KODIAK</b>								
	V6 5.2L	1966-72	Trans - L & R Lower	Manual Manual	2			EM-2163
<b>C70/7500 KODIAK</b>								
	V6 5.2L	1966-72	Trans - L & R Lower	Manual Manual	2			EM-2163
<b>C50/5000 KODIAK</b>								
	V6 5.2L	1966-72	Trans - L & R Upper	Manual Manual	2			EM-2162
<b>C60/6500 KODIAK</b>								
	V6 5.2L	1966-72	Trans - L & R Upper	Manual Manual	2			EM-2162
<b>C70/7500 KODIAK</b>								
	V6 5.2L	1966-72	Trans - L & R Upper	Manual Manual	2			EM-2162
<b>CHRYSLER PASSENGER CAR</b>								
<b>200</b>								
L4	L4 2.4L 144ci	2012-14	Front	Auto; 4 Spd; Complete Unit	1	EM-3152		
			Front	Auto; 4 Spd; Insert	1	EM-4094		
		2011	Front	Complete Unit	1	EM-3152		
			Front	Insert	1	EM-4094		
		2015-17	RH Front		1	EM-4264		
		2012-14	RH Front	Auto; 4 Spd	1	EM-3167		
			RH Front	Auto; 6 Spd	1	EM-4179		
		2011	RH Front		1	EM-3167		
		2012-14	Rear	Auto; 4 Spd	1	EM-3168		
		2011	Rear		1	EM-3168		
		2015-16	Torq Str - Rear		1		EM-4193	
		2015-17	Trans	Auto	1			EM-4266
		2011-14	Trans	Auto; 4 Spd; Insert	1			EM-4127

\* = Hydraulic Mount, "S" suffix = solid replacement. # = Available in the Westar Gold Line

## Engine, Transmission, And Torque Strut Mounts

CYL	ENG. SIZE	YEAR	LOCATION	DESCRIPTION	QTY	ENGINE	TORQUE STRUT	TRANSMISSION		
<b>CHRYSLER PASSENGER CAR (continued)</b>										
<b>200 (continued)</b>										
L4	L4 2.4L 144ci	2011-14	Trans	Auto; 6 Spd	1			EM-4178		
V6	V6 3.6L 220ci	2011-14	Front		1	EM-4113				
		2015-17	RH Front		1	EM-4265				
		2011-14	Right		1	EM-4112				
		2015-16	Torq Str - Rear		1		EM-4193			
		2015-17	Trans	Auto	1			EM-4266		
		2011-14	Trans	Bushing	1			EM-4127		
			Trans	Complete Unit	1			EM-4107		
<b>300</b>										
V6	V6 2.7L 167ci	2005-10	L & R Front		2	EM-5588				
			Trans		1		EM-5587			
	V6 3.5L 215cc	2006-10	L & R Front	Mexican Vehicle; Mexican Vehicle	1	EM-5588				
			2005-10	L & R Front	RWD	2	EM-5588			
	V6 3.6L 220ci	2012-18	L & R Front	RWD	2	EM-4150				
			2011	L & R Front		2	EM-4150			
			2011-18	Trans		1			EM-5587	
	V8	V8 5.7L 345ci	2011-18	L & R Front		2	EM-4150			
				2005-10	L & R Front	RWD; exc. Police Pkg.	2	EM-3138		
				2011-18	L & R Front	RWD; Police Pkg.	2	EM-4250		
2011-18				Trans		1			EM-5587	
V8 6.1L 370cid		2005-10	Trans	RWD	1			EM-5587		
			L & R Front	RWD; exc. Police Pkg.	2	EM-3138				
			L & R Front	RWD; Police Pkg.	2	EM-4250				
V8 6.3L 383ci		1962-65	Trans	RWD	1			EM-5587		
			L & R Front		2	EM-2250				
			LH Front		1	EM-2228				
	Trans		Auto	1			EM-2272			
V8 6.4L 392ci	2012-14	L & R Front		2	EM-4168					
		Trans		1			EM-5587			
V8 6.8L 413ci	1959-65	LH Front		1	EM-2228					
		RH Front		1	EM-2227					
		Trans		1			EM-2272			
V8 7.2L 440ci	1966-71	L & R Front		2	EM-2250					
		Trans	Complete Unit	1			EM-2340			
		Trans	Insert	1			EM-2525			
		Trans		1			EM-2272			
<b>300M</b>										
V6	V6 3.5L 215cc	1999-04	L & R Front		2	EM-2903*				
			Trans		1			EM-2908		
<b>CIRRUS</b>										
L4	L4 2.0L 122ci	2000	Front		1	EM-2958				
			RH Front		1	EM-2841*				
			Rear		1	EM-3089				
			Trans - Center	Auto	1			EM-2842 *		
			Trans	Manual	1			EM-2842 *		
	L4 2.4L 148ci	1995-97	Bushing Kit	Cradle Insert Kit (2 pieces) Recommended	1	EM-5178				
			2000	Front		1	EM-2958			
			1995-97	Front	Cradle-Insert	1	EM-2980			
			2000	RH Front		1	EM-2841*			
			1995-97	RH Front		1	EM-2841*			
2000	Rear		1	EM-2945						

\* = Hydraulic Mount, "S" suffix = solid replacement.

# Engine, Transmission, And Torque Strut Mounts

CYL	ENG. SIZE	YEAR	LOCATION	DESCRIPTION	QTY	ENGINE	TORQUE STRUT	TRANSMISSION			
<b>CHRYSLER PASSENGER CAR (continued)</b>											
<b>CIRRUS (continued)</b>											
L4	L4 2.4L 148ci	1995-97	Rear	Cradle-Insert	1	EM-3011					
		2000	Trans	Auto	1			EM-2842 *			
			Trans	Manual	1			EM-2842 *			
		1995-97	Trans	Auto	1			EM-2842 *			
V6	V6 2.5L 152cid	1995-97	Bushing Kit	Cradle Insert Kit (2 pieces) Recommended	1	EM-5178					
		1998-00	Front		1	EM-2958					
		1995-97	Front	Cradle-Insert	1	EM-2980					
		1998-00	RH Front		1	EM-2841*					
		1995-97	RH Front		1	EM-2841*					
		1998-00	Rear		1	EM-2945					
		1995-97	Rear	Cradle-Insert	1	EM-3011					
		1999-00	Trans	Auto	1			EM-2842 *			
			Trans	Manual	1			EM-2842 *			
		1995-98	Trans	Auto	1			EM-2842 *			
<b>CONCORDE</b>											
V6	V6 2.7L 167ci	1998-04	LH Front		1	EM-2942*					
			RH Front		1	EM-2903*					
			Trans		1			EM-2908			
	V6 3.2L 197ci	1998-01	L & R Front		2	EM-2903*					
			Trans		1			EM-2908			
	V6 3.3L 201ci	1996	L & R Front		2	EM-5020*					
			L & R Front		2	EM-2795*					
			Trans		1			EM-2810			
	V6 3.5L 215cc	2002-04	L & R Front		2	EM-2903*					
			L & R Front		2	EM-5020*					
		1993-95	L & R Front		2	EM-2795*					
			Trans		1			EM-2908			
		1993-97	Trans		1			EM-2810			
<b>CONQUEST</b>											
L4	L4 2.6L 2555cc	1987-89	Trans	Manual	1			EM-2730			
<b>CORDOBA</b>											
L6	L6 3.7L 225ci	1980-83	Trans	Complete Unit	1			EM-2340			
			Trans	Complete Unit - HD	1			EM-2512			
			Trans	Insert Only	1			EM-2525			
	L6 3.7L 3687cc	1980-83	LH Front	Complete Unit	1	EM-2324					
			LH Front	Insert Only	1	EM-2376					
			RH Front	Complete Unit	1	EM-2323					
			RH Front	Insert Only	1	EM-2376					
			V8	V8 5.2L 318ci	1975-80	L & R Front	Insert Only	2	EM-2369		
					1981-83	LH Front	Complete Unit	1	EM-2326		
LH Front	Insert Only	1	EM-2369								
RH Front	Complete Unit	1	EM-2325								
RH Front	Insert Only	1	EM-2369								
Trans	Insert	1				EM-2525					
1975-80	Trans	Complete Unit	1				EM-2340				
Trans	Complete Unit - HD	1			EM-2512						
Trans	Insert Only	1			EM-2525						
V8	V8 5.9L 360ci	1975-79	LH Front	Complete Unit	1	EM-2326					
			LH Front	Insert Only	1	EM-2369					
			RH Front	Complete Unit	1	EM-2325					
			RH Front	Insert Only	1	EM-2369					
			Trans	Complete Unit	1			EM-2340			

\* = Hydraulic Mount, "S" suffix = solid replacement.



# Engine, Transmission, And Torque Strut Mounts

CYL	ENG. SIZE	YEAR	LOCATION	DESCRIPTION	QTY	ENGINE	TORQUE STRUT	TRANSMISSION
<b>CHRYSLER PASSENGER CAR (continued)</b>								
<b>CORDOBA (continued)</b>								
V8	V8 5.9L 360ci	1975-79	Trans	Complete Unit - HD	1			EM-2512
			Trans	Insert Only	1			EM-2525
	V8 6.6L 400ci	1975-78	L & R Front	Complete Unit	2	EM-5476		
			L & R Front	Insert Only	2	EM-2369		
			Trans	Complete Unit - HD	1			EM-2512
		Trans	Insert Only	1			EM-2525	
<b>CROSSFIRE</b>								
V6	V6 3.2L 195ci	2004-08	Trans		1			EM-9268
<b>DAYTONA</b>								
L4	L4 2.2L 135ci	1984-89	Front		1	EM-2493		
		1992-93	RH Front		1	EM-2600		
		1984-89	RH Front		1	EM-2600		
		1992-93	Trans		1			EM-2618
		1984-89	Trans		1			EM-2617
	L4 2.5L 2507cc	1992	Front		1	EM-2615		
		1990-91	Front		1	EM-2493		
		1987	Front		1	EM-2493		
		1992	RH Front		1	EM-2616		
		1990-91	RH Front		1	EM-2616		
		1987	RH Front		1	EM-2600		
		1990-92	Trans		1			EM-2618
		1989	Trans		1			EM-2617
V6	V6 3.0L 2972cc	1990-93	Front		1	EM-2615		
			RH Front	Hydraulic Mount	1	EM-2711		
			RH Front	Solid Mount; Bushing	1	EM-2616		
			Trans		1			EM-2618
<b>DYNASTY</b>								
V6	V6 3.0L 2972cc	1989-90	Front		1	EM-2615		
			RH Front	Hydraulic Mount	1	EM-2711		
			RH Front	Solid Mount; Bushing	1	EM-2616		
		1990	Trans		1			EM-2824 *
		1989	Trans		1			EM-2618
	V6 3.3L 201ci	1991-93	Front		1	EM-2615		
			RH Front	Hydraulic Mount	1	EM-2711		
			RH Front	Solid Mount; Bushing	1	EM-2616		
			Trans		1			EM-2824 *
<b>E CLASS</b>								
L4	L4 2.2L 135ci	1983-84	Front		1	EM-2447		
			RH Front		1	EM-2600		
			Torq Str - Front		1		EM-2491	
		1984	Trans	Auto	1			EM-2617
	1983	Trans	Auto	1			EM-2600	
	L4 2.6L 2555cc	1983-84	Front		1	EM-2493		
			RH Front		1	EM-2600		
1984			Trans	Auto	1			EM-2617
		1983	Trans	Auto	1			EM-2600
<b>EXECUTIVE LIMOUSINE</b>								
L4	L4 2.6L 2555cc	1985	Front		1	EM-2493		
			RH Front		1	EM-2600		
			Trans		1			EM-2617

\* = Hydraulic Mount, "S" suffix = solid replacement.

# Engine, Transmission, And Torque Strut Mounts

CYL	ENG. SIZE	YEAR	LOCATION	DESCRIPTION	QTY	ENGINE	TORQUE STRUT	TRANSMISSION	
<b>CHRYSLER PASSENGER CAR (continued)</b>									
<b>EXECUTIVE SEDAN</b>									
L4	L4 2.6L 2555cc	1983-84	Front		1	EM-2493			
			RH Front		1	EM-2600			
			Trans		1			EM-2617	
<b>FIFTH AVENUE</b>									
L6	L6 3.7L 225ci	1983	Trans	Complete Unit	1			EM-2340	
			Trans	Complete Unit - HD	1			EM-2512	
			Trans	Insert Only	1			EM-2525	
	L6 3.7L 3687cc	1983	LH Front	Complete Unit	1	EM-2324			
			LH Front	Insert Only	1	EM-2376			
			RH Front	Complete Unit	1	EM-2323			
			RH Front	Insert Only	1	EM-2376			
	V8	V8 5.2L 318ci	1983-89	LH Front	Complete Unit	1	EM-2326		
				LH Front	Insert Only	1	EM-2369		
RH Front				Complete Unit	1	EM-2325			
RH Front				Insert Only	1	EM-2369			
Trans				Complete Unit	1			EM-2340	
Trans				Complete Unit - HD	1			EM-2512	
Trans	Insert Only	1			EM-2525				
<b>IMPERIAL</b>									
V6	V6 3.3L 201ci	1990-91	Front		1	EM-2615			
			RH Front		1	EM-2711			
			Trans		1			EM-2824 *	
	V6 3.8L 230ci	1991-93	Front		1	EM-2615			
			RH Front		1	EM-2711			
			Trans		1			EM-2824 *	
V8	V8 5.2L 318ci	1981-83	LH Front	Complete Unit	1	EM-2326			
			LH Front	Insert Only	1	EM-2369			
			RH Front	Complete Unit	1	EM-2325			
			RH Front	Insert Only	1	EM-2369			
			Trans	Complete Unit	1			EM-2340	
			Trans	Complete Unit - HD	1			EM-2512	
	Trans	Insert Only	2			EM-2525			
	V8 6.8L 413ci	1959-65	LH Front		1	EM-2228			
			RH Front		1	EM-2227			
	V8 7.2L 440ci	1974-75	L & R Front	Complete Unit	2	EM-5476			
			L & R Front	Insert Only	2	EM-2369			
		1966-73	L & R Front		2	EM-2250			
			Trans	Complete Unit	1			EM-2340	
		1969-75	Trans	Insert Only	1			EM-2525	
			1966-68	Trans	Auto	1			EM-2272
Trans	Manual	1				EM-2272			
<b>INTREPID</b>									
V6	V6 2.7L 167ci	2002-04	LH Front		1	EM-2942'			
			1998-01	LH Front		1	EM-2942'		
		2002-04	RH Front		1	EM-2903'			
			1998-01	RH Front		1	EM-2903'		
		2002-04	Trans		1			EM-2908	
			1998-01	Trans		1		EM-2908	
	V6 3.2L 197ci	1998-01	L & R Front		2	EM-2903'			
			Trans		1			EM-2908	
	V6 3.3L 201ci	1993-96	L & R Front		2	EM-2795'			
		1993-97	Trans		1			EM-2810	
	V6 3.5L 215cc	2003-04	L & R Front		2	EM-2903'			
			1993-97	L & R Front		2	EM-2795'		

\* = Hydraulic Mount, "S" suffix = solid replacement.

# Engine, Transmission, And Torque Strut Mounts

CYL	ENG. SIZE	YEAR	LOCATION	DESCRIPTION	QTY	ENGINE	TORQUE STRUT	TRANSMISSION	
<b>CHRYSLER PASSENGER CAR (continued)</b>									
<b>INTREPID (continued)</b>									
V6	V6 3.5L 215cc	2003-04	Trans		1			EM-2905	
		1993-97	Trans		1			EM-2810	
<b>LASER</b>									
L4	L4 2.2L 135ci	1984-86	Front		1	EM-2493			
			RH Front		1	EM-2600			
			Torq Str - Front	Manual	1		EM-2491		
			Trans		1			EM-2617	
	L4 2.5L 2507cc	1986	Front		1	EM-2493			
			RH Front		1	EM-2600			
			Torq Str - Front		1		EM-2491		
			Trans		1			EM-2617	
<b>LEBARON</b>									
L4	L4 2.2L 135ci	1983-90	Front		1	EM-2493			
		1982	Front		1	EM-2447			
		1983-90	RH Front		1	EM-2600			
		1982	RH Front		1	EM-2600			
		1984-90	Trans	US & Canada; Auto	1			EM-2617	
			Trans	US & Canada; Manual	1			EM-2617	
		1984-87	Trans	Mexico; Auto	1			EM-2617	
		1982-83	Trans	Auto	1			EM-2600	
			Trans	Manual	1			EM-2600	
		L4 2.5L 2500cc	1991-93	Trans	Mexico; Auto	1			EM-2618
		L4 2.5L 2507cc	1990-93	Front		1	EM-2615		
				Front		1	EM-2493		
	RH Front			Hydraulic Mount	1	EM-2711			
	RH Front			Solid Mount; Bushing	1	EM-2616			
	1986-89			RH Front		1	EM-2600		
	1990-93			Trans	US & Canada; Auto	1			EM-2618
	Trans			US & Canada; Manual	1			EM-2618	
	1986-89			Trans	Auto	1			EM-2617
	Trans	Manual	1			EM-2617			
	L4 2.6L 2555cc	1982-85	Front		1	EM-2493			
			RH Front		1	EM-2600			
			1985	Trans	Auto	1			EM-2617
			1984	Trans	Auto	1			EM-2617
		1982-83	Trans	Manual	1			EM-2617	
			Trans	Auto	1			EM-2600	
			Trans	Manual	1			EM-2600	
			Trans	Manual	1			EM-2617	
	L6	L6 3.7L 225ci	1978-81	Trans	Auto; Complete Unit	1			EM-2512
Trans				Auto; Insert Only	1			EM-2525	
L6 3.7L 3687cc		1978-81	LH Front	Complete Unit	1	EM-2324			
			LH Front	Insert Only	1	EM-2376			
			RH Front	Complete Unit	1	EM-2323			
			RH Front	Insert Only	1	EM-2376			
V6	V6 3.0L 2972cc	1992-95	Front		1	EM-2615			
		1990-91	Front		1	EM-2615			
		1992-95	RH Front	Hydraulic Mount	1	EM-2711			
			RH Front	Solid Mount; Bushing	1	EM-2616			
		1990-91	RH Front	Solid Mount; Bushing	1	EM-2616			
		1994	Trans	Auto	1			EM-2618	
		1990-93	Trans	Auto	1			EM-2618	
		Trans	Manual	1			EM-2618		
V8	V8 5.2L 318ci	1977-81	LH Front	Complete Unit	1	EM-2326			
			LH Front	Insert Only	1	EM-2369			
			RH Front	Complete Unit	1	EM-2325			
			RH Front	Insert Only	1	EM-2369			

# Engine, Transmission, And Torque Strut Mounts

CYL	ENG. SIZE	YEAR	LOCATION	DESCRIPTION	QTY	ENGINE	TORQUE STRUT	TRANSMISSION
<b>CHRYSLER PASSENGER CAR (continued)</b>								
<b>LEBARON (continued)</b>								
V8	V8 5.2L 318ci	1977-81	Trans	Auto; Complete Unit	1			EM-2340
			Trans	Auto; Complete Unit; HD Pkg.	1			EM-2512
			Trans	Auto; Insert Only	1			EM-2525
	V8 5.9L 360ci	1978-79	LH Front	Complete Unit	1	EM-2326		
			LH Front	Insert Only	1	EM-2369		
			RH Front	Complete Unit	1	EM-2325		
			RH Front	Insert Only	1	EM-2369		
			Trans	Complete Unit	1			EM-2340
			Trans	Complete Unit - HD	1			EM-2339
Trans	Insert for EM-2512	1			EM-2525			
<b>LHS</b>								
V6	V6 3.5L 215cc	1999-01	L & R Front		2	EM-2903*		
		1996-97	L & R Front		2	EM-5020*		
		1994-95	L & R Front		2	EM-2795*		
		1999-01	Trans		1			EM-2908
		1994-97	Trans		1			EM-2810
<b>NEON</b>								
L4	L4 2.0L	2002	Trans	Auto	1			EM-3124
			Trans	Manual	1			EM-3050
		2000-01	Trans	Auto	1			EM-2975
			Trans	Manual	1			EM-3050
	L4 2.0L 1996cc	2000-02	LH Rear Upper		1	EM-2948#		
			RH Front Lower		1	EM-2949#		
		Rear		1	EM-2947			
<b>NEW YORKER</b>								
L4	L4 2.2L 135ci	1983-88	Front		1	EM-2493		
			RH Front		1	EM-2600		
		1983-84	Torq Str - Front	w/o Turbo	1		EM-2491	
		1984-88	Trans		1			EM-2617
		1983	Trans		1			EM-2600
		L4 2.5L 2507cc	1986-87	Front		1	EM-2493	
	RH Front				1	EM-2600		
	Torq Str - Front				1		EM-2491	
	Trans				1		EM-2617	
	L4 2.6L 2555cc	1983-85	Front		1	EM-2493		
			RH Front		1	EM-2600		
		1984-85	Trans		1			EM-2617
1983		Trans		1			EM-2600	
L6	L6 3.7L 225ci	1982	Trans	Complete Unit	1			EM-2340
			Trans	Complete Unit - HD	1			EM-2512
			Trans	Insert Only	1			EM-2525
	L6 3.7L 3687cc	1982	LH Front	Complete Unit	1	EM-2324		
			LH Front	Insert Only	1	EM-2376		
			RH Front	Complete Unit	1	EM-2323		
		RH Front	Insert Only	1	EM-2376			
V6	V6 3.0L 2972cc	1989	Front		1	EM-2615		
		1988	Front		1	EM-2615		
		1989	RH Front		1	EM-2711		
		1988	RH Front		1	EM-2600		
		1988-89	Trans		1			EM-2617
	V6 3.3L 201ci	1990-93	Front		1	EM-2615		
			RH Front		1	EM-2711		
			Trans		1			EM-2824*
	V6 3.5L 215cc	1994-96	Trans		1			EM-2810
	V6 3.5L 3497cc	1996	L & R Front		2	EM-5020*		

\* = Hydraulic Mount, "S" suffix = solid replacement. # = Available in the Westar Gold Line

# Engine, Transmission, And Torque Strut Mounts

CYL	ENG. SIZE	YEAR	LOCATION	DESCRIPTION	QTY	ENGINE	TORQUE STRUT	TRANSMISSION	
<b>CHRYSLER PASSENGER CAR (continued)</b>									
<b>NEW YORKER (continued)</b>									
V6	V6 3.5L 3497cc	1994-95	L & R Front		2	EM-2795*			
	V6 3.8L 230ci	1991-93	Front		1	EM-2615			
			RH Front		1	EM-2711			
			Trans		1			EM-2824	
V8	V8 5.2L 318ci	1979-82	LH Front	Complete Unit	1	EM-2326			
			LH Front	Insert Only	1	EM-2369			
			RH Front	Complete Unit	1	EM-2325			
			RH Front	Insert Only	1	EM-2369			
			Trans	Complete Unit	1			EM-2340	
			Trans	Complete Unit - HD	1			EM-2512	
			Trans	Insert Only	1			EM-2525	
	V8 5.9L 360ci	1977-80	LH Front	Complete Unit	1	EM-2326			
			LH Front	Insert Only	1	EM-2369			
			RH Front	Complete Unit	1	EM-2325			
			RH Front	Insert Only	1	EM-2369			
			Trans	Complete Unit	1			EM-2340	
			Trans	Complete Unit - HD	1			EM-2512	
	V8 6.6L 400ci	1975-78	L & R Front	Insert Only	2	EM-2369			
			Trans	Complete Unit	1			EM-2512	
			Trans	Insert Only	1			EM-2525	
	V8 6.8L 413ci	1959-65	LH Front		1	EM-2228			
			RH Front		1	EM-2227			
			Trans		1			EM-2272	
	V8 7.2L 440ci	1974-78	L & R Front	Complete Unit	2	EM-5476			
			L & R Front	Insert Only	2	EM-2369			
		1966-73	L & R Front		2	EM-2250			
			Trans	Complete Unit	1			EM-2340	
		1969-78	Trans	Insert Only	1			EM-2525	
			1966-68	Trans	Auto	1			EM-2272
	Trans	Manual	1				EM-2272		
	<b>NEWPORT</b>								
	L6	L6 3.7L 225ci	1979-81	Trans	Complete Unit	1			EM-2340
Trans				Complete Unit - HD	1			EM-2512	
Trans				Insert Only	1			EM-2525	
L6 3.7L 3687cc		1979-81	LH Front	Complete Unit	1	EM-2324			
			LH Front	Insert Only	1	EM-2376			
			RH Front	Complete Unit	1	EM-2323			
V8	V8 5.2L 318ci	1979-81	RH Front	Insert Only	1	EM-2376			
			LH Front	Complete Unit	1	EM-2326			
			LH Front	Insert Only	1	EM-2369			
			RH Front	Complete Unit	1	EM-2325			
			RH Front	Insert Only	1	EM-2369			
			Trans	Complete Unit	1			EM-2340	
			Trans	Complete Unit - HD	1			EM-2512	
	Trans	Insert Only	1			EM-2525			
	V8 5.9L 360ci	1971-72	L & R Front		2	EM-2250			
			1974-80	LH Front	Complete Unit	1	EM-2326		
		LH Front		Insert Only	1	EM-2369			
		RH Front		Complete Unit	1	EM-2325			
		RH Front		Insert Only	1	EM-2369			
		Trans		Complete Unit	1			EM-2340	
Trans		Complete Unit - HD	1			EM-2512			
Trans	Insert Only	1			EM-2525				
1971-72	Trans	Complete Unit	1			EM-2340			
Trans	Complete Unit - HD	1			EM-2512				

\* = Hydraulic Mount, "S" suffix = solid replacement.

# Engine, Transmission, And Torque Strut Mounts

CYL	ENG. SIZE	YEAR	LOCATION	DESCRIPTION	QTY	ENGINE	TORQUE STRUT	TRANSMISSION	
<b>CHRYSLER PASSENGER CAR (continued)</b>									
<b>NEWPORT (continued)</b>									
V8	V8 5.9L 360ci	1971-72	Trans	Insert Only	1			EM-2525	
	V8 5.9L 361ci	1961-64	Trans	Auto	1			EM-2272	
			Trans	Manual	1			EM-2272	
			V8 6.3L 383ci	1966-71	L & R Front		2	EM-2250	
	1965	LH Front			1	EM-2228			
		RH Front			1	EM-2227			
		1969-71	Trans	Auto; Complete Unit	1			EM-2512	
		Trans	Auto; Insert Only	1				EM-2525	
		Trans	Manual; Complete Unit	1				EM-2512	
		Trans	Manual; Insert Only	1				EM-2525	
		1965-68	Trans	Auto	1			EM-2272	
	Trans	Manual	1				EM-2272		
	V8 6.6L 400ci	1972-78	L & R Front	Insert Only	2	EM-2369			
			Trans	Complete Unit	1			EM-2512	
			Trans	Insert Only	1			EM-2525	
	V8 6.8L 413ci	1962-64	LH Front		1	EM-2228			
		1959-60	LH Front		1	EM-2228			
		1962-64	RH Front		1	EM-2227			
		1959-60	RH Front		1	EM-2227			
		1962-64	Trans	Auto	1			EM-2272	
		Trans	Manual	1				EM-2272	
		1959-60	Trans	Auto	1			EM-2272	
	Trans	Manual	1				EM-2272		
	V8 7.2L 440ci	1974-78	L & R Front	Complete Unit	2	EM-5476			
			L & R Front	Insert Only	2	EM-2369			
		1966-73	L & R Front		2	EM-2250			
			1972-78	Trans	Complete Unit	1			EM-2340
		Trans	Insert Only	1				EM-2525	
		1969-71	Trans	Auto; Complete Unit	1				EM-2340
			Trans	Auto; Insert Only	1				EM-2525
			Trans	Manual; Insert Only	1				EM-2525
		1966-68	Trans	Auto	1				EM-2272
			Trans	Manual	1				EM-2272
<b>PT CRUISER</b>									
L4	L4 2.4L 148ci	2010	RH Front Upper		1	EM-2948#			
		2008-09	RH Front Upper		1	EM-2948#			
		2001-07	RH Front Upper	Auto	1	EM-2948#			
			RH Front Upper	Manual	1	EM-5080			
		2010	Right		1	EM-2947			
		2008-09	Right		1	EM-2947			
		2001-07	Right		1	EM-2947			
		2010	Torq Str - Front		1		EM-2949#		
		2003-09	Torq Str - Front	Turbo	1		EM-5692		
			Torq Str - Front	w/o Turbo	1		EM-2949#		
		2001-02	Torq Str - Front		1		EM-2949#		
		2009-10	Trans	Non Turbo	1			EM-3026	
		2003-08	Trans	Non Turbo	1			EM-3026	
			Trans	Turbo	1			EM-3179	
<b>SEBRING</b>									
L4	L4 2.0L 122ci	1995-99	Front		1	EM-8670			
			RH Front		1	EM-5081			
			Rear	Auto	1	EM-9394			
			Rear	Manual, Complete Unit	1	EM-8798			
			Rear	Manual; Bushing	1	EM-5420			
			Trans	Auto	1			EM-9174	

# = Available in the Westar Gold Line

# Engine, Transmission, And Torque Strut Mounts

CYL	ENG. SIZE	YEAR	LOCATION	DESCRIPTION	QTY	ENGINE	TORQUE STRUT	TRANSMISSION	
<b>CHRYSLER PASSENGER CAR (continued)</b>									
<b>SEBRING (continued)</b>									
L4	L4 2.0L 122ci	1995-99	Trans	Manual	1			EM-8793	
	L4 2.4L 144ci	2007-10	Front	Complete Unit	1	EM-3152			
			Front	Insert	1	EM-4094			
			RH Front		1	EM-3167			
			Rear	Bushing	1	EM-4166			
			Rear	Complete Unit	1	EM-3155			
			Trans	Bushing	1		EM-4127		
			Trans	Complete Unit	1		EM-3168		
	L4 2.4L 148ci	1996-97	Bushing Kit	Cradle Insert Kit (2 pieces) Recommended	1	EM-5178			
			2001-06	Front	DOHC	1	EM-3034		
			1998	Front		1	EM-2958		
			1996-97	Front	Cradle Insert	1	EM-2980		
			2001-06	RH Front	DOHC	1	EM-2841*		
			1998	RH Front		1	EM-2841*		
			1996-97	RH Front		1	EM-2841*		
			2001-06	Rear	DOHC	1	EM-3049		
			1998	Rear		1	EM-2945		
			1996-97	Rear	Cradle Insert	1	EM-3011		
			2006	Trans	DOHC; Convertible & Sedan	1		EM-2842 *	
			2001-05	Trans	DOHC; Convertible & Sedan	1		EM-2842 *	
			2006	Trans	DOHC	1		EM-2842 *	
			2001-05	Trans	DOHC	1		EM-2842 *	
	L4 2.4L 2351cc SOH					1	EM-9160		
						1	EM-9160		
						1	EM-9160		
						1	EM-9184		
						1	EM-9184		
						1	EM-9184		
						1	EM-9184		
						1	EM-9161		
					Auto	1	EM-9161		
					Manual	1	EM-9485		
						1	EM-9161		
				Trans	Auto, Coupe	1		EM-9162	
				Trans	Auto, Coupe	1		EM-9162	
				Trans	Manual; Coupe	1		EM-5452	
			Trans	Auto, Coupe	1		EM-9162		
V6	V6 2.5L 152cid	1996-00	Bushing Kit	Convertible, Cradle Insert Kit (2 pcs) Recommended	1	EM-5178			
			Front	Convertible, Cradle Insert	1	EM-2980			
			Front	Coupe	1	EM-5089			
		1995	Front	Coupe	1	EM-5089			
			1996-00	RH Front	Convertible	1	EM-2841*		
		Rear		Convertible, Cradle Insert	1	EM-3011			
		Rear		Coupe	1	EM-9392			
		1996-97	Trans	Hydraulic Mount; JX; JXi	1		EM-2842 *		
		1998-00	Trans	LX; LXi	1		EM-9174		
		1996-97	Trans	Solid Mount; LX, LXi	1		EM-9174		
			Trans		1		EM-2842 *		
		1995	Trans	LX; LXi	1		EM-9174		
		V6 2.7L 167ci	2007-10	Front	Complete Unit	1	EM-3152		
				Front	Insert	1	EM-4094		
	2002-06			Front		1	EM-3034		
	2001			Front		1	EM-3034		
	2007-10			RH Front		1	EM-3167		
2002-06	RH Front				1	EM-2841*			

\* = Hydraulic Mount, "S" suffix = solid replacement.

# Engine, Transmission, And Torque Strut Mounts

CYL	ENG. SIZE	YEAR	LOCATION	DESCRIPTION	QTY	ENGINE	TORQUE STRUT	TRANSMISSION	
<b>CHRYSLER PASSENGER CAR (continued)</b>									
<b>SEBRING (continued)</b>									
V6	V6 2.7L 167ci	2007-10	Rear	Bushing	1	EM-4166			
			Rear	Complete Unit	1	EM-3155			
		2002-06	Rear			1	EM-3049		
		2001	Rear			1	EM-3049		
		2007-09	Trans	Bushing	1			EM-4127	
			Trans	Complete Unit	1			EM-3168	
		2005-06	Trans	Auto	1			EM-2842 *	
		2001-04	Trans	Auto	1			EM-2842 *	
	Trans		Manual	1			EM-2842 *		
	V6 3.0L 181ci	2001-05	LH Front		1	EM-5159			
			LH Rear		1	EM-5349			
			RH Front		1	EM-9187			
		2004-05	Trans - LH	Auto, Limited Coupe	1			EM-9384	
		2003	Trans	Auto, LX Coupe	1			EM-9384	
	2001-02	Trans	Auto, LXi Coupe	1			EM-9384		
	V6 3.5L 215cc	2007-10	Front	Complete Unit	1	EM-3152			
			Front	Insert	1	EM-4094			
			RH Front		1	EM-3167			
			Rear	Bushing	1	EM-4166			
			Rear	Complete Unit	1	EM-3155			
		2009-10	Trans - BUSHING	Bushing Bushing	1			EM-4107	
2007-08		Trans	Bushing	1			EM-4127		
		Trans	Complete Unit	1			EM-3168		
<b>TC MASERATI</b>									
L4	L4 2.2L 135ci	1990	RH Front		1	EM-2711			
		1989	RH Front		1	EM-5083			
		1989-90	Trans		1			EM-2617	
V6	V6 3.0L 2972cc	1990-91	Front		1	EM-2493			
			Trans		1			EM-2617	
<b>TOWN &amp; COUNTRY</b>									
L4	L4 2.2L 135ci	1982-88	Front		1	EM-2493			
			RH Front		1	EM-2600			
		1984-88	Trans		1			EM-2617	
		1982-83	Trans		1			EM-2600	
	L4 2.5L 2507cc	1986-88	Front		1	EM-2493			
			RH Front		1	EM-2600			
			Torq Str - Front		1		EM-2491		
			Trans		1			EM-2617	
	L4 2.6L 2555cc	1984-85	Front		1	EM-2493			
			1982	Front		1	EM-2493		
		1984-85	RH Front		1	EM-2600			
			1982	RH Front		1	EM-2600		
		1984-85	Trans		1			EM-2617	
			1982	Trans		1		EM-2600	
	L6	L6 3.7L 225ci	1978-81	Trans	Complete Unit	1			EM-2340
Trans				Complete Unit - HD	1			EM-2512	
Trans				Insert Only	1			EM-2525	
L6 3.7L 3687cc		1978-81	LH Front	Complete Unit	1	EM-2324			
			LH Front	Insert Only	1	EM-2376			
			RH Front	Complete Unit	1	EM-2323			
	RH Front		Insert Only	1	EM-2376				
V8	V8 5.2L 318ci	1978-81	LH Front	Complete Unit	1	EM-2326			
			LH Front	Insert Only	1	EM-2369			
			RH Front	Complete Unit	1	EM-2325			
			RH Front	Insert Only	1	EM-2369			

\* = Hydraulic Mount, "S" suffix = solid replacement.



# Engine, Transmission, And Torque Strut Mounts

CYL	ENG. SIZE	YEAR	LOCATION	DESCRIPTION	QTY	ENGINE	TORQUE STRUT	TRANSMISSION	
<b>CHRYSLER PASSENGER CAR (continued)</b>									
<b>TOWN &amp; COUNTRY (continued)</b>									
V8	V8 5.2L 318ci	1978-81	Trans	Complete Unit	1			EM-2340	
			Trans	Complete Unit - HD	1			EM-2512	
			Trans	Insert Only	1			EM-2525	
V8	V8 5.9L 360ci	1978-79	LH Front	Complete Unit	1	EM-2326			
			LH Front	Insert Only	1	EM-2369			
			RH Front	Complete Unit	1	EM-2325			
			RH Front	Insert Only	1	EM-2369			
			Trans	Complete Unit	1			EM-2340	
			Trans	Complete Unit - HD	1			EM-2512	
			Trans	Insert Only	1			EM-2525	
V8	V8 6.3L 383ci	1965-71	L & R Front		2	EM-2250			
			Trans	Complete Unit - HD	1			EM-2512	
		1969-71	Trans	Insert Only	1			EM-2525	
			1965-68	Trans		1			EM-2272
V8	V8 6.6L 400ci	1975-77	L & R Front	Complete Unit	2	EM-5476			
			L & R Front	Insert Only	2	EM-2369			
		1972	L & R Front		2	EM-2250			
		1975-77	Trans	Complete Unit - HD	1			EM-2512	
			Trans	Insert Only	1			EM-2525	
		1972	Trans	Complete Unit	1			EM-2340	
			Trans	Insert	1			EM-2525	
		V8	V8 6.8L 413ci	1959-65	LH Front		1	EM-2228	
RH Front					1	EM-2227			
Trans					1			EM-2272	
V8	V8 7.2L 440ci	1974-77	L & R Front	Complete Unit	2	EM-5476			
			L & R Front	Insert Only	2	EM-2369			
		1968-73	L & R Front		2	EM-2250			
		1969-77	Trans	Complete Unit	1			EM-2340	
			Trans	Insert	1			EM-2525	
		1968	Trans		1			EM-2272	
<b>CHRYSLER SUV</b>									
<b>ASPEN</b>									
V8	V8 4.7L 287ci	2007-09	Trans		1			EM-3066	
	V8 5.7L 345ci	2007-09	Trans		1			EM-3066	
<b>PACIFICA</b>									
V6	V6 3.5L 215cc		Front		1	EM-3084*			
			Rear		1	EM-3084*			
			Right		1	EM-5085			
			Torq Str - Front		1		EM-3095		
	V6 3.8L 230ci	2007-08	2005-06	Front		1	EM-3147		
				Front	AWD	1	EM-3084*		
			Front	FWD	1	EM-3084*			
			2007-08	Rear		1	EM-3147		
			2005-06	Rear	AWD	1	EM-3084*		
			2007-08	Right		1	EM-5085		
			2005-06	Right		1	EM-5085		
			2005-08	Torq Str - Front		1		EM-3095	
	V6 4.0L 241ci	2007-08	Front		1	EM-3147			
			Rear		1	EM-3147			
Right				1	EM-5085				

\* = Hydraulic Mount, "S" suffix = solid replacement.

# Engine, Transmission, And Torque Strut Mounts

CYL	ENG. SIZE	YEAR	LOCATION	DESCRIPTION	QTY	ENGINE	TORQUE STRUT	TRANS-MISSION
<b>CHRYSLER VAN</b>								
<b>GRAND VOYAGER</b>								
V6	V6 3.0L 181ci	2000	RH Front	Complete Unit	1	EM-2959		
			RH Front	Insert	1	EM-2844		
			Trans - Center	Complete Unit	1			EM-2984
			Trans - Center	Insert	1			EM-2845
			Trans - LH Front	Complete Unit	1			EM-2960
			Trans - LH Front	Insert	1			EM-2849
			Trans - LH Rear	Complete Unit	1			EM-3017
	Trans - LH Rear	Insert	1			EM-2849		
	V6 3.3L 201ci	2000	RH Front	Complete Unit	1	EM-2959		
			RH Front	Insert	1	EM-2844		
			Trans - Center	Complete Unit	1			EM-2984
			Trans - Center	Insert	1			EM-2845
			Trans - LH Front	Complete Unit	1			EM-2960
			Trans - LH Front	Insert	1			EM-2849
Trans - LH Rear			Complete Unit	1			EM-3017	
Trans - LH Rear	Insert	1			EM-2849			
<b>TOWN &amp; COUNTRY</b>								
V6	V6 3.3L 201ci	2008-10	Front	Complete Unit	1	EM-3156		
			Front	Insert	1	EM-4094		
		1990-93	Front		1	EM-2615		
		2005-07	RH Front	Hydraulic Mount; FWD	1	EM-2926*		
		2001-04	RH Front	Hydraulic Mount; FWD	1	EM-2926*		
		1996-00	RH Front	Complete Unit	1	EM-2959		
		1996-00	RH Front	Insert	1	EM-2844		
		1990-93	RH Front	Hydraulic Mount	1	EM-2711		
		1990-93	RH Front	Rubber Mount	1	EM-2616		
		2008-10	Rear	Complete Unit	1	EM-4042		
		2008-10	Right		1	EM-4012		
		2001-07	Trans - Center		1			EM-2925
		1996-00	Trans - Center	Complete Unit	1			EM-2984
		1996-00	Trans - Center	Insert Only	1			EM-2845
		2001-07	Trans - LH Front		1			EM-2928
		1996-00	Trans - LH Front	Complete Unit	1			EM-2960
		1996-00	Trans - LH Front	Insert Only	1			EM-2849
		2001-07	Trans - LH Rear		1			EM-2927
		1996-00	Trans - LH Rear	Complete Unit	1			EM-3017
	1996-00	Trans - LH Rear	Insert Only	1			EM-2849	
	2008-10	Trans	Bushing	1			EM-4127	
	2008-10	Trans	Complete Unit	1			EM-4013	
	1990-93	Trans		1			EM-2618	
	V6 3.6L 220ci	2011-15	Front	Complete Unit	1	EM-4050		
			Front	Insert	1	EM-4186		
			Rear		1	EM-4132		
			Right		1	EM-4012		
Trans				1			EM-4077	
V6 3.8L 230ci	2008-10	Front	Complete Unit	1	EM-3156			
		Front	Insert	1	EM-4094			
		Front	FWD	1	EM-2615			
	2005-07	RH Front	Hydraulic Mount; FWD	1	EM-2926*			
	2001-04	RH Front	Hydraulic Mount; FWD	1	EM-2926*			
	1996-00	RH Front	Complete Unit; FWD	1	EM-2959			
	1996-00	RH Front	Insert Only; FWD	1	EM-2844			
	1994-95	RH Front	FWD, Solid Mount	1	EM-2616			
	1994-95	RH Front	Hydraulic Mount; FWD	1	EM-2711			
	2008-10	Rear	Complete Unit	1	EM-4042			
	2008-10	Right		1	EM-4011			

\* = Hydraulic Mount, "S" suffix = solid replacement.

# Engine, Transmission, And Torque Strut Mounts

CYL	ENG. SIZE	YEAR	LOCATION	DESCRIPTION	QTY	ENGINE	TORQUE STRUT	TRANS-MISSION
<b>CHRYSLER VAN (continued)</b>								
<b>TOWN &amp; COUNTRY (continued)</b>								
V6	V6 3.8L 230ci	2001-07	Trans - Center		1			EM-2925
		1996-00	Trans - Center	Complete Unit	1			EM-2984
			Trans - Center	Insert Only	1			EM-2845
			Trans - LH Front		1			EM-2928
		1996-00	Trans - LH Front	Complete Unit	1			EM-2960
			Trans - LH Front	Insert Only	1			EM-2849
			Trans - LH Rear		1			EM-2927
		1996-00	Trans - LH Rear	Complete Unit	1			EM-3017
			Trans - LH Rear	Insert Only	1			EM-2849
			Trans	Bushing	1			EM-4127
		2008-10	Trans	Complete Unit	1			EM-4013
			1994-95	Trans		1		EM-2618
	V6 4.0L 241ci		2008-10	Front	Complete Unit	1	EM-3156	
		Front		Insert	1	EM-4094		
		Rear		Complete Unit	1	EM-4042		
		Right			1	EM-4012		
		Trans		Bushing	1			EM-4127
		Trans		Complete Unit	1			EM-4013
<b>VOYAGER</b>								
L4	L4 2.4L 148ci	2003	Front		1	EM-2928		
		2001-02	Front		1	EM-2928		
		2003	Right		1	EM-4004		
		2001-02	Right		1	EM-4003		
			Trans - Center		1			EM-2925
		2000	Trans - Center	Auto, Complete Unit	1			EM-2984
			Trans - Center	Auto; Insert	1			EM-2845
			Trans - LH Front	Auto, Complete Unit	1			EM-2960
			Trans - LH Front	Auto; Insert	1			EM-2849
			Trans - LH Rear	Auto, Complete Unit	1			EM-3017
			2003	Trans		1		
		2001-02	Trans		1			EM-2927
V6	V6 3.0L 181ci	2000	RH Front	Complete Unit	1	EM-2959		
			RH Front	Insert	1	EM-2844		
			Trans - Center	Complete Unit	1			EM-2984
			Trans - Center	Insert	1			EM-2845
			Trans - LH Front	Complete Unit	1			EM-2960
			Trans - LH Front	Insert	1			EM-2849
			Trans - LH Rear	Complete Unit	1			EM-3017
			Trans - LH Rear	Insert	1			EM-2849
	V6 3.3L 201ci	2001-03	RH Front		1	EM-2926*		
		2000	RH Front	Complete Unit	1	EM-2959		
			RH Front	Insert Only	1	EM-2844		
			Trans - Center		1			EM-2925
		2000	Trans - Center	Complete Unit	1			EM-2984
			Trans - Center	Insert	1			EM-2845
		2001-03	Trans - LH Front		1			EM-2928
		2000	Trans - LH Front	Complete Unit	1			EM-2960
			Trans - LH Front	Insert	1			EM-2849
			Trans - LH Rear		1			EM-2927
		2000	Trans - LH Rear	Complete Unit	1			EM-3017
			Trans - LH Rear	Insert	1			EM-2849

\* = Hydraulic Mount, "S" suffix = solid replacement.

# Engine, Transmission, And Torque Strut Mounts

CYL	ENG. SIZE	YEAR	LOCATION	DESCRIPTION	QTY	ENGINE	TORQUE STRUT	TRANSMISSION
<b>DAEWOO PASSENGER CAR</b>								
<b>LANOS</b>								
L4	L4 1.6L 1588cc	1999-02	Front	Auto	1	EM-8920		
			Front	Manual	1	EM-2658		
			Rear		1	EM-2657		
			Trans	Auto	1			EM-8915
			Trans	Manual	1			EM-2656
<b>LEGANZA</b>								
L4	L4 2.2L 2198cc	1999-02	Front		1	EM-8916		
			RH Front		1	EM-8918		
			Rear		1	EM-8917		
			Trans	Auto	1			EM-8923
			Trans	Manual	1			EM-8923
<b>NUBIRA</b>								
L4	L4 2.0L 1998cc	2000-02	Torq Str - Front		1		EM-8919	
			L4 2.0L 2000cc	2000-02	RH Front	Auto	1	EM-8928
	RH Front	Manual			1	EM-8929		
	1999	RH Front		Auto	1	EM-8928		
		RH Front		Manual	1	EM-8929		
	2000-02	Rear		1	EM-8921			
		1999	Rear		1	EM-8921		
	2000-02	Trans	Auto	1			EM-8926	
		Trans	Manual	1			EM-8925	
	1999	Trans	Auto	1			EM-8931	
		Trans	Manual	1			EM-8930	
<b>DAIHATSU PASSENGER CAR</b>								
<b>CHARADE</b>								
L3	L3 1.0L	1991-92	Trans	Auto	1			EM-8655
			Trans	Manual	1			EM-8653
	L3 1.0L 993cc	1991-92	Front		1	EM-8652		
			Rear		1	EM-8654		
L4	L4 1.3L 1295cc	1989-92	RH Front		1	EM-8652		
			Rear		1	EM-8654		
			Trans	Auto	1			EM-8655
			Trans	Manual	1			EM-8653
<b>DAIHATSU SPORT UTILITY</b>								
<b>ROCKY</b>								
L4	L4 1.6L 1589cc	1990-92	L & R Front		2	EM-8811		
			Trans	Manual	1			EM-8812
<b>DODGE PASSENGER CAR</b>								
<b>330</b>								
V8	V8 5.2L 318ci	1963-64	LH Front		1	EM-2228		
			RH Front		1	EM-2227		
			Trans		1			EM-2302
	V8 6.3L 383ci	1964	LH Front		1	EM-2227		
			RH Front		1	EM-2228		
			Trans		1			EM-2302
<b>400</b>								
L4	L4 2.2L 135ci	1982-83	Front		1	EM-2493		
			RH Front		1	EM-2600		
			Torq Str - Front	Manual	1		EM-2491	
			Trans	Auto	1			EM-2600
			Trans	Manual	1			EM-2600
	L4 2.6L 2555cc	1982-83	Front		1	EM-2493		
			RH Front		1	EM-2600		

## Engine, Transmission, And Torque Strut Mounts

CYL	ENG. SIZE	YEAR	LOCATION	DESCRIPTION	QTY	ENGINE	TORQUE STRUT	TRANSMISSION	
<b>DODGE PASSENGER CAR (continued)</b>									
<b>400 (continued)</b>									
L4	L4 2.6L 2555cc	1982-83	Trans	Auto	1			EM-2600	
			Trans	Manual	1			EM-2600	
<b>440</b>									
V8	V8 5.2L 318ci	1963-64	LH Front		1	EM-2227			
			RH Front		1	EM-2228			
	V8 6.3L 383ci	1964	LH Front		1	EM-2227			
			RH Front		1	EM-2228			
			Trans		1			EM-2302	
<b>600</b>									
L4	L4 2.2L 135ci	1983-88	Front		1	EM-2493			
			RH Front		1	EM-2600			
			Torq Str - Front	Manual	1		EM-2491		
		1984-88	Trans	Auto	1			EM-2617	
			Trans	Manual	1			EM-2617	
		1983	Trans	Auto	1			EM-2600	
			Trans	Manual	1			EM-2600	
		L4 2.5L 2507cc	1986-88	Front		1	EM-2493		
	RH Front				1	EM-2600			
	Trans			Auto	1			EM-2617	
	L4 2.6L 2555cc	1983-85	Trans	Manual	1			EM-2617	
			Front		1	EM-2493			
			RH Front		1	EM-2600			
			1984-85	Trans	Auto	1			EM-2617
			Trans	Manual	1			EM-2617	
	1983	Trans	Auto	1			EM-2600		
Trans		Manual	1			EM-2600			
<b>880</b>									
V8		V8 6.3L 383ci	1963-64	LH Front		1	EM-2227		
	RH Front				1	EM-2228			
	Trans				1			EM-2302	
	V8 6.8L 413ci	1963	LH Front		1	EM-2227			
			RH Front		1	EM-2228			
			Trans		1			EM-5087	
<b>ARIES</b>									
L4	L4 2.2L 135ci	1982-89	Front		1	EM-2493			
			1981	Front	Auto	1	EM-2493		
			Front	Manual; 4 Spd	1	EM-2493			
		1982-89	RH Front		1	EM-2600			
			1981	RH Front		1	EM-2600		
		1981-87	Torq Str - Front	Manual	1		EM-2491		
		1984-89	Trans	Auto	1			EM-2617	
			Trans	Manual	1			EM-2617	
		1981-83	Trans	Auto	1			EM-2600	
			Trans	Manual	1			EM-2600	
	L4 2.5L 2507cc	1986-89	Front		1	EM-2493			
			RH Front		1	EM-2600			
			Torq Str - Front	Manual	1		EM-2491		
			Trans	Auto	1			EM-2617	
	L4 2.6L 2555cc	1981-85	Trans	Manual	1			EM-2617	
			Front		1	EM-2493			
			RH Front		1	EM-2600			
			1984-85	Trans	Auto	1			EM-2617
Trans			Manual	1			EM-2617		
1981-83			Trans	Auto	1			EM-2600	
	Trans	Manual	1			EM-2600			

# Engine, Transmission, And Torque Strut Mounts

CYL	ENG. SIZE	YEAR	LOCATION	DESCRIPTION	QTY	ENGINE	TORQUE STRUT	TRANSMISSION			
<b>DODGE PASSENGER CAR (continued)</b>											
<b>ASPEN</b>											
L6	L6 3.7L 225ci	1976-80	Trans	Auto; Complete Unit	1			EM-2340			
			Trans	Auto; Complete Unit; HD Pkg.	1			EM-2512			
			Trans	Auto; Insert	1			EM-2525			
			Trans	Manual; Complete Unit	1			EM-2340			
			Trans	Manual; Complete Unit; HD Pkg.	1			EM-2512			
			Trans	Manual; Insert	1			EM-2525			
	L6 3.7L 3687cc	1976-80	LH Front	Complete Unit	1	EM-2324					
			LH Front	Insert Only	1	EM-2376					
			RH Front	Complete Unit	1	EM-2323					
			RH Front	Insert Only	1	EM-2376					
			LH Front	Complete Unit	1	EM-2326					
			LH Front	Insert Only	1	EM-2369					
V8	V8 5.2L 318ci	1976-80	RH Front	Complete Unit	1	EM-2325					
			RH Front	Insert Only	1	EM-2369					
			Trans	Auto; Complete Unit	1			EM-2340			
			Trans	Auto; Complete Unit; HD Pkg.	1			EM-2512			
			Trans	Auto; Insert	1			EM-2525			
			Trans	Manual; Complete Unit	1			EM-2340			
			Trans	Manual; Complete Unit; HD Pkg.	1			EM-2512			
			Trans	Manual; Insert	1			EM-2525			
			V8 5.9L 360ci	1976-80	LH Front	Complete Unit	1	EM-2326			
					LH Front	Insert Only	1	EM-2369			
					RH Front	Complete Unit	1	EM-2325			
					RH Front	Insert Only	1	EM-2369			
	Trans	Auto; Complete Unit			1			EM-2340			
	Trans	Auto; Complete Unit; HD Pkg.			1			EM-2512			
	Trans	Auto; Insert			1			EM-2525			
	Trans	Manual; Complete Unit			1			EM-2340			
	Trans	Manual; Complete Unit; HD Pkg.			1			EM-2512			
	Trans	Manual; Insert			1			EM-2525			
	<b>ATOS (MEXICAN VEHICLE)</b>										
	L4	L4 1.0L 999cc			2001-04	Rear	Insert Only	1	EM-9004		
			Trans	Insert Only		1			EM-90037		
		L4 1.1L 1086cc	2005-10	Rear	Insert Only	1	EM-9004				
				Trans	Complete Unit	1			EM-90037		
				Trans	Insert Only	1			EM-90037		
Trans					1			EM-90033			
Trans					1			EM-90033			
Trans					1			EM-90033			
<b>AVENGER</b>											
L4	L4 2.0L 122ci	1995-99	Front		1	EM-8670					
			RH Front		1	EM-5081					
			Rear		1	EM-9394					
			Trans	Auto	1			EM-9174			
			Trans	Manual	1			EM-8793			
	L4 2.4L 144ci	2008-10	Front	Complete Unit	1	EM-3152					
			Front	Insert	1	EM-4094					
		2011-13	RH Front		1	EM-3167					
			2008-10	RH Front		1	EM-3167				
		2011-13	Rear		1	EM-3168					
			2008-10	Rear	Bushing	1	EM-4166				
		Rear		Complete Unit	1	EM-3155					
		2013-14	Trans	Auto	1			EM-4178			
		2011-12	Trans	Bushing	1			EM-4127			

## Engine, Transmission, And Torque Strut Mounts

CYL	ENG. SIZE	YEAR	LOCATION	DESCRIPTION	QTY	ENGINE	TORQUE STRUT	TRANSMISSION
<b>DODGE PASSENGER CAR (continued)</b>								
<b>AVENGER (continued)</b>								
L4	L4 2.4L 144ci	2008-09	Trans	Bushing	1			EM-4127
			Trans	Complete Unit	1			EM-3168
V6	V6 2.5L 152cid	1995-00	Front		1	EM-5089		
			Rear	Complete Unit	1	EM-9392		
			Trans		1			EM-9174
	V6 2.7L 167ci	2008-10	Front	Complete Unit	1	EM-3152		
			Front	Insert	1	EM-4094		
			RH Front		1	EM-3167		
			Rear	Bushing	1	EM-4166		
			Rear	Complete Unit	1	EM-3155		
			2008-09	Trans	Bushing	1		
	V6 3.5L 215cc	2008-10	Front	Complete Unit	1	EM-3152		
			Front	Insert	1	EM-4094		
			RH Front		1	EM-3167		
			Rear	Bushing	1	EM-4166		
			Rear	Complete Unit	1	EM-3155		
			2009-10	Trans - BUSHING	Auto; Bushing Auto; Bushing	1		
	V6 3.6L 220ci	2011-14	Front		1	EM-4113		
Rear				1	EM-4132			
Right				1	EM-4112			
Trans			Bushing	1			EM-4127	
Trans			Complete Unit	1			EM-4107	
<b>CALIBER</b>								
L4	L4 1.8L 110ci	2007-09	Front		1	EM-3131		
			RH Front		1	EM-3130		
			Rear		1	EM-3132		
			Trans	Auto; CVT	1			EM-3134
			Trans	Manual	1			EM-3137
	L4 2.0L 122ci	2007-12	Front		1	EM-3131		
			RH Front		1	EM-3130		
			Rear		1	EM-3145		
			Trans	Auto; CVT	1			EM-3134
	L4 2.4L 144ci	2009	Front		1	EM-3131		
			2007-08	Front		1	EM-3131	
		2009	RH Front		1	EM-3130		
			2007-08	RH Front		1	EM-3130	
		2009	Rear	Auto; CVT	1	EM-3145		
			Rear	Manual	1	EM-3132		
2007-08		Rear	Auto (CVT); AWD	1	EM-3157			
		Rear	Auto (CVT); FWD	1	EM-3145			
2007-09		Rear	Manual	1	EM-3132			
	Trans	Auto; CVT	1			EM-3134		
Trans	Manual	1			EM-3137			
<b>CHALLENGER</b>								
L4	L4 1.6L 98ci	1978-79	L & R Front		2	EM-2731		
			Trans	Auto	1			EM-8544
			Trans	Manual	1			EM-8544
	L4 2.6L 156ci	1978-83	L & R Front		2	EM-2731		
Trans				1			EM-2730	
L6	L6 3.2L 198ci	1970-71	LH Front		1	EM-2275		
			RH Front		1	EM-2277		
			Trans	Auto; Complete Unit	1			EM-2340
			Trans	Auto; Insert	1			EM-2525
			Trans	Manual; Complete Unit	1			EM-2340

# Engine, Transmission, And Torque Strut Mounts

CYL	ENG. SIZE	YEAR	LOCATION	DESCRIPTION	QTY	ENGINE	TORQUE STRUT	TRANSMISSION
<b>DODGE PASSENGER CAR (continued)</b>								
<b>CHALLENGER (continued)</b>								
L6	L6 3.2L 198ci	1970-71	Trans	Manual; Insert	1			EM-2525
	L6 3.7L 225ci	1970-72	LH Front		1	EM-2275		
			RH Front		1	EM-2277		
			Trans	Auto; Complete Unit	1		EM-2512	
			Trans	Auto; Insert	1		EM-2525	
			Trans	Manual; Complete Unit	1		EM-2512	
Trans	Manual; Insert	1		EM-2525				
V6	V6 3.5L 215cc	2009-10	L & R Front		2	EM-5588		
	V6 3.6L 220ci	2011-17	L & R Front		2	EM-4150		
		2011-18	Trans	Auto	1		EM-5587	
			Trans	Manual	1		EM-5587	
V8	V8 5.2L 318ci	1970-74	L & R Front		2	EM-2250		
			Trans	Auto; Complete Unit	1		EM-2340	
			Trans	Auto; Complete Unit; HD Pkg.	1		EM-2512	
			Trans	Auto; Insert	1		EM-2525	
			Trans	Manual; Complete Unit	1		EM-2340	
			Trans	Manual; Complete Unit; HD Pkg.	1		EM-2512	
	V8 5.6L 340ci	1970-73	L & R Front		2	EM-2250		
			Trans	Auto; Complete Unit	1		EM-2340	
			Trans	Auto; Insert	1		EM-2525	
			Trans	Manual; Complete Unit	1		EM-2340	
			Trans	Manual; Insert	1		EM-2525	
	V8 5.7L 345ci	2011-16	L & R Front		2	EM-4150		
		2009-10	L & R Front		2	EM-3138		
		2011-18	Trans	Auto	1		EM-5587	
			Trans	Manual	1		EM-5587	
	2009-10	Trans		1		EM-5587		
	V8 5.9L 360ci	1974	L & R Front		2	EM-2250		
			Trans	Auto; Complete Unit	1		EM-2340	
			Trans	Auto; Complete Unit; HD Pkg.	1		EM-2512	
			Trans	Auto; Insert	1		EM-2525	
			Trans	Manual; Complete Unit	1		EM-2340	
			Trans	Manual; Complete Unit; HD Pkg.	1		EM-2512	
	V8 6.1L 370cid	2008-10	L & R Front		2	EM-3138		
			Trans		1		EM-5587	
	V8 6.2L 376ci	2015-18	Trans	Auto	1		EM-5587	
			Trans	Manual	1		EM-5587	
	V8 6.3L 383ci	1970-71	L & R Front		2	EM-2250		
			Trans	Auto	1		EM-2272	
			Trans	Manual	1		EM-2272	
	V8 6.4L 392ci	2012-16	L & R Front		2	EM-4168		
		2012-18	Trans	Auto	1		EM-5587	
			Trans	Manual	1		EM-5587	
	V8 7.0L 426ci	1970-71	LH Front		1	EM-2227		
			RH Front		1	EM-2228		
			Trans	Auto; Complete Unit	1		EM-2512	
			Trans	Auto; Insert	1		EM-2525	
			Trans	Manual; Complete Unit	1		EM-2512	
			Trans	Manual; Insert	1		EM-2525	
	V8 7.2L 440ci	1970-71	L & R Front		2	EM-2250		
			Trans		1		EM-2272	



# Engine, Transmission, And Torque Strut Mounts

CYL	ENG. SIZE	YEAR	LOCATION	DESCRIPTION	QTY	ENGINE	TORQUE STRUT	TRANSMISSION
<b>DODGE PASSENGER CAR (continued)</b>								
<b>CHARGER</b>								
L4	L4 1.6L 97ci	1984	Front		1	EM-2493		
			RH Front		1	EM-2600		
			Torq Str - Front	Manual	1		EM-2491	
			Trans	Auto	1			EM-2617
			Trans	Manual	1			EM-2617
	L4 2.2L 135ci	1985-87	Front	exc Shelby	1	EM-2493		
			Front	Shelby	1	EM-2447		
		1983-84	Front		1	EM-2493		
		1985-87	RH Front		1	EM-2600		
		1983-84	RH Front		1	EM-2600		
		1983-87	Torq Str - Front	Manual	1		EM-2491	
		1984-87	Trans	Auto	1			EM-2617
			Trans	Manual	1			EM-2617
		1983	Trans	Auto	1			EM-2600
			Trans	Manual	1			EM-2600
		L6	L6 3.7L 225ci	1976	LH Front	Complete Unit	1	EM-2324
LH Front	Insert Only				1	EM-2376		
1973-74	LH Front			Complete Unit	1	EM-2324		
	LH Front			Insert Only	1	EM-2376		
1968-72	LH Front				1	EM-2275		
1976	RH Front			Complete Unit	1	EM-2323		
	RH Front			Insert Only	1	EM-2376		
1973-74	RH Front			Complete Unit	1	EM-2323		
	RH Front			Insert Only	1	EM-2376		
1968-72	RH Front				1	EM-2277		
	Trans			Auto; Complete Unit	1			EM-2512
1976	Trans			Auto; Insert	1			EM-2525
	Trans			Auto; Complete Unit	1			EM-2512
1970-74	Trans			Auto; Insert	1			EM-2525
	Trans			Manual; Complete Unit	1			EM-2512
	Trans			Manual; Insert	1			EM-2525
1968-69	Trans			Auto	1			EM-2272
	Trans	Manual	1			EM-2272		
V6	V6 2.7L 167ci	2006-10	L & R Front		2	EM-5588		
			Trans		1		EM-5587	
	V6 3.5L 215cc	2006-10	L & R Front	RWD	2	EM-5588		
			Trans	US & Canada; US & Canada	1		EM-5587	
			Trans	Mexico; Mexican Vehicle	1		EM-5587	
	V6 3.6L 220ci	2012-17	L & R Front	RWD	2	EM-4150		
			L & R Front	RWD	2	EM-4150		
2011-18		Trans		1		EM-5587		
V8	V8 5.2L 318ci	1972	L & R Front		2	EM-2250		
			Trans		1		EM-5587	
		1973-78	LH Front	Complete Unit	1	EM-2326		
			LH Front	Insert Only	1	EM-2369		
			RH Front	Complete Unit	1	EM-2325		
			RH Front	Insert Only	1	EM-2369		
		1975-78	Trans	Auto; Complete Unit	1			EM-2340
			Trans	Auto; Complete Unit; HD Pkg.	1			EM-2512
			Trans	Auto; Insert	1			EM-2525
		1972-74	Trans	Auto; Complete Unit	1			EM-2340
			Trans	Auto; Complete Unit; HD Pkg.	1			EM-2512
			Trans	Auto; Insert	1			EM-2525
			Trans	Manual; Complete Unit	1			EM-2340
			Trans	Manual; Complete Unit; HD Pkg.	1			EM-2512
			Trans	Manual; Insert	1			EM-2525
1967-71	Trans		Auto	1		EM-2272		

# Engine, Transmission, And Torque Strut Mounts

CYL	ENG. SIZE	YEAR	LOCATION	DESCRIPTION	QTY	ENGINE	TORQUE STRUT	TRANSMISSION	
<b>DODGE PASSENGER CAR (continued)</b>									
<b>CHARGER (continued)</b>									
V8	V8 5.2L 318ci	1967-71	Trans	Manual	1			EM-2272	
	V8 5.6L 340ci	1971-72	L & R Front		2	EM-2250			
		1973	LH Front	Complete Unit	1	EM-2326			
			LH Front	Insert Only	1	EM-2369			
			RH Front	Complete Unit	1	EM-2325			
			RH Front	Insert Only	1	EM-2369			
			1971-73	Trans	Auto; Complete Unit	1			EM-2340
		Trans		Auto; Complete Unit; HD Pkg.	1			EM-2512	
		Trans		Auto; Insert	1			EM-2525	
		Trans		Manual; Complete Unit	1			EM-2340	
		Trans		Manual; Complete Unit; HD Pkg.	1			EM-2512	
	Trans	Manual; Insert		1			EM-2525		
	V8 5.7L 345ci	2007-10	L & R Front		2	EM-3138			
		2006	L & R Front		2	EM-3138			
		2007-10	LH Front	AWD	1	EM-4167			
		2011-18	Trans		1			EM-5587	
		2006-10	Trans		1			EM-5587	
	V8 5.9L 360ci	1974-78	LH Front	Complete Unit	1	EM-2326			
			LH Front	Insert Only	1	EM-2369			
			RH Front	Complete Unit	1	EM-2325			
			RH Front	Insert Only	1	EM-2369			
			Trans	Auto; Complete Unit	1			EM-2340	
			Trans	Auto; Complete Unit; HD Pkg.	1			EM-2512	
			Trans	Auto; Insert	1			EM-2525	
	V8 6.1L 370cid	2006-10	L & R Front	RWD; exc. Police Pkg.	2	EM-3138			
			L & R Front	RWD; Police Pkg.	2	EM-4250			
			Trans		1			EM-5587	
	V8 6.2L 376ci	2015-18	Trans	Auto	1			EM-5587	
	V8 6.3L 383ci	1967-71	L & R Front		2	EM-2250			
			Trans	Auto	1			EM-2272	
			Trans	Manual	1			EM-2272	
	V8 6.4L 392ci	2012-16	L & R Front		2	EM-4168			
		2012-18	Trans		1			EM-5587	
	V8 6.6L 400ci	1974-78	L & R Front	Complete Unit	1	EM-5476			
			L & R Front	Insert Only	2	EM-2369			
		1972-73	L & R Front		2	EM-2250			
			Trans	Auto; Complete Unit	1			EM-2340	
			Trans	Auto; Complete Unit; HD Pkg.	1			EM-2512	
		1975-78	Trans	Auto; Insert	1			EM-2525	
			1972-74	Trans	Auto; Complete Unit	1			EM-2340
				Trans	Auto; Complete Unit; HD Pkg.	1			EM-2512
Trans				Auto; Insert	1			EM-2525	
Trans			Manual; Complete Unit	1			EM-2340		
Trans	Manual; Complete Unit; HD Pkg.		1			EM-2512			
Trans	Manual; Insert	1			EM-2525				
V8 7.0L 426ci	1967-71	LH Front		1	EM-2227				
		RH Front		1	EM-2228				
		Trans	Auto; Complete Unit	1			EM-2512		
		Trans	Auto; Insert	1			EM-2525		
		Trans	Manual; Complete Unit	1			EM-2512		
		Trans	Manual; Insert	1			EM-2525		
V8 7.2L 440ci	1967-74	L & R Front		2	EM-2250				
		Trans	Auto; Complete Unit	1			EM-2340		
		Trans	Auto; Complete Unit; HD Pkg.	1			EM-2512		
		Trans	Auto; Insert	1			EM-2525		

## Engine, Transmission, And Torque Strut Mounts

CYL	ENG. SIZE	YEAR	LOCATION	DESCRIPTION	QTY	ENGINE	TORQUE STRUT	TRANS-MISSION
<b>DODGE PASSENGER CAR (continued)</b>								
<b>CHARGER (continued)</b>								
V8	V8 7.2L 440ci	1967-74	Trans	Manual; Complete Unit	1			EM-2340
			Trans	Manual; Complete Unit; HD Pkg.	1			EM-2512
			Trans	Manual; Insert	1			EM-2525
<b>COLT</b>								
L4	L4 1.4L 1410cc	1979-84	LH Front		1	EM-8205		
		1980-84	Trans	Auto	1			EM-8545
			Trans	Manual	1			EM-2730
		1979	Trans	Manual	1			EM-2730
	L4 1.5L 1468cc	1994	Front	Auto	1	EM-8097		
			Front	Manual	1	EM-8100		
		1993	Front	Auto	1	EM-8097		
			Front	Manual	1	EM-8100		
		1991-92	Front	Auto	1	EM-2673		
			Front	Manual	1	EM-8107		
		1989-90	Front	Auto	1	EM-2673		
			Front	Manual	1	EM-8107		
		1985-88	Front	Auto	1	EM-8235		
			Front	Manual	1	EM-8103		
		1994	RH Front	w/ Power Steering	1	EM-8238		
			RH Front	w/o Power Steering	1	EM-8206		
		1993	RH Front	w/ Power Steering	1	EM-8238		
			RH Front	w/o Power Steering	1	EM-8206		
		1991-92	RH Front		1	EM-8108		
		1989-90	RH Front	Hatchback	1	EM-8108		
			RH Front	Station Wagon	1	EM-8242		
		1985-88	RH Front		1	EM-8875		
		1994	Rear	Manual	1	EM-8818		
		1993	Rear	Manual	1	EM-8818		
		1991-92	Rear	Auto	1	EM-8796		
		1985-88	Rear		1	EM-8267		
		1993-94	Trans	Auto	1			EM-8582
			Trans	Manual	1			EM-8099
		1989-92	Trans	Auto	1			EM-8584
			Trans	Manual	1			EM-8669
		1987-88	Trans	Sedan	1			EM-8242
		1985-86	Trans	Auto	1			EM-8875
	Trans		Manual; Insert	1			EM-8552	
	L4 1.6L 1597cc	1989-90	Front	Auto	1	EM-2673		
			Front	Manual	1	EM-8107		
		1985-88	Front	Auto	1	EM-8253		
			Front	Manual	1	EM-8231		
		1971-84	L & R Front		2	EM-2731		
		1989-90	RH Front	Auto	1	EM-8584		
			RH Front	Manual	1	EM-8060		
		1985-88	RH Front	Auto	1	EM-8205		
			RH Front	Manual	1	EM-8242		
		1989-90	Rear	Auto	1	EM-8102		
			Rear	Manual	1	EM-8102		
		1985-88	Trans		1			EM-8108
			Trans	w/ Manual Steering	1			EM-8232
		1981-84	Trans		1			EM-8545
			Trans	w/ Power Steering	1			EM-8556
		1980	Trans	Auto	1			EM-8502
			Trans	Manual	1			EM-8503
1975-77		Trans	Auto	1			EM-8502	
1971-74		Trans	Auto	1			EM-8502	

# Engine, Transmission, And Torque Strut Mounts

CYL	ENG. SIZE	YEAR	LOCATION	DESCRIPTION	QTY	ENGINE	TORQUE STRUT	TRANSMISSION	
<b>DODGE PASSENGER CAR (continued)</b>									
<b>COLT (continued)</b>									
L4	L4 1.8L 1754cc	1989-90	Front	Auto	1	EM-8235			
			Front	Manual	1	EM-8231			
	L4 1.8L 1834cc	1994	Front	Auto	1	EM-8239			
			Front	Manual	1	EM-8098			
		1993	Front	Auto	1	EM-8097			
			Front	Manual	1	EM-8098			
		1992	Front	Auto	1	EM-8097			
			Front	Manual	1	EM-8098			
		1994	RH Front	Sedan	1	EM-8099			
		1993	RH Front	Sedan	1	EM-8099			
		1992	RH Front	Sedan	1	EM-8099			
		1994	Rear	Auto, Sedan	1	EM-8100			
			Rear	Manual, After 6/3/92	1	EM-9057			
			Rear	Manual, Before 6/3/92	1	EM-8100			
		1993	Rear	Auto, Sedan	1	EM-8100			
			Rear	Manual, After 6/3/92	1	EM-9057			
	Rear		Manual, Before 6/3/92	1	EM-8100				
	1992	Rear	Auto	1	EM-8100				
		Rear	Manual, After 6/3/92	1	EM-9057				
		Rear	Manual, Before 6/3/92	1	EM-8100				
	1993-94	Trans	Sedan; w/o Power Steering	1			EM-9147		
L4 2.0L 1995cc	1984-91	RH Front	Auto	1	EM-8807				
		Trans		1			EM-8502		
L4 2.4L 2351cc	1993-94	Rear	Auto	1	EM-8690				
		Rear	Manual	1	EM-8689				
		Trans	Sedan; w/o Power Steering	1			EM-8686		
<b>CONQUEST</b>									
L4	L4 2.6L 2555cc	1984-86	Trans	Manual	1			EM-2730	
<b>CORONET</b>									
L6	L6 3.7L 225ci	1973-76	LH Front	Complete Unit	1	EM-2324			
			LH Front	Insert Only	1	EM-2376			
		1967-72	LH Front		1	EM-2275			
			RH Front	Complete Unit	1	EM-2323			
		1973-76	RH Front	Insert Only	1	EM-2376			
			RH Front		1	EM-2277			
		1970-76	Trans	Auto; Complete Unit	1			EM-2512	
			Trans	Auto; Insert	1			EM-2525	
			Trans	Manual; Complete Unit	1			EM-2512	
			Trans	Manual; Insert	1			EM-2525	
		1967-69	Trans	Auto	1			EM-2272	
			Trans	Manual	1			EM-2272	
		L6 3.8L 230ci	1953-56	Center Front		1	EM-2018		
				Center Front		1	EM-2018		
L & R Rear				2	EM-2014				
V8	V8 4.5L 273ci	1966-68	L & R Front		2	EM-2250			
			1965	LH Front		1	EM-2227		
		1966-68	RH Front		1	EM-2228			
			Trans	Auto	1			EM-2272	
		Trans	Manual	1			EM-2272		
		V8 5.2L 318ci	1967-72	L & R Front		2	EM-2250		
1973-76	LH Front			Complete Unit	1	EM-2326			
1965-66	LH Front		Insert Only	1	EM-2369				
	LH Front			1	EM-2227				
1973-76	RH Front		Complete Unit	1	EM-2325				
	RH Front		Insert Only	1	EM-2369				
1965-66	RH Front		1	EM-2228					

## Engine, Transmission, And Torque Strut Mounts

CYL	ENG. SIZE	YEAR	LOCATION	DESCRIPTION	QTY	ENGINE	TORQUE STRUT	TRANSMISSION
<b>DODGE PASSENGER CAR (continued)</b>								
<b>CORONET (continued)</b>								
V8	V8 5.2L 318ci	1972-76	Trans	Auto; Complete Unit	1			EM-2340
			Trans	Auto; Complete Unit; HD Pkg.	1			EM-2512
			Trans	Auto; Insert	1			EM-2525
			Trans	Manual; Complete Unit	1			EM-2340
			Trans	Manual; Complete Unit; HD Pkg.	1			EM-2512
			Trans	Manual; Insert	1			EM-2525
		1965-71	Trans	Auto	1			EM-2272
			Trans	Manual	1			EM-2272
	V8 5.6L 340ci	1972-73	LH Front	Complete Unit	1	EM-2326		
			LH Front	Insert Only	1	EM-2369		
			RH Front	Complete Unit	1	EM-2325		
			RH Front	Insert Only	1	EM-2369		
			Trans	Auto; Complete Unit	1			EM-2340
			Trans	Auto; Insert	1			EM-2525
			Trans	Manual; Complete Unit	1			EM-2340
			Trans	Manual; Insert	1			EM-2525
	V8 5.9L 360ci	1973-76	L & R Front	Insert Only	2	EM-2369		
			LH Front	Complete Unit	1	EM-2326		
			RH Front	Complete Unit	1	EM-2325		
			Trans	Auto; Complete Unit	1			EM-2340
			Trans	Auto; Complete Unit; HD Pkg.	1			EM-2512
			Trans	Auto; Insert	1			EM-2525
			Trans	Manual; Complete Unit	1			EM-2340
			Trans	Manual; Complete Unit; HD Pkg.	1			EM-2512
	V8 6.3L 383ci	1967-71	L & R Front		2	EM-2250		
			Trans	Auto	1			EM-2272
			Trans	Manual	1			EM-2272
	V8 6.6L 400ci	1974-76	L & R Front	Complete Unit	2	EM-5476		
L & R Front			Insert	2	EM-2369			
1972-73 1972-76		L & R Front		2	EM-2250			
		Trans	Auto; Complete Unit	1			EM-2340	
		Trans	Auto; Complete Unit; HD Pkg.	1			EM-2512	
		Trans	Auto; Insert	1			EM-2525	
		Trans	Manual; Complete Unit	1			EM-2340	
		Trans	Manual; Complete Unit; HD Pkg.	1			EM-2512	
Trans	Manual; Insert	1			EM-2525			
V8 7.0L 426ci	1965-70	LH Front		1	EM-2227			
		RH Front		1	EM-2228			
		Trans	Auto; Complete Unit	1			EM-2512	
		Trans	Auto; Insert	1			EM-2525	
		Trans	Manual; Complete Unit	1			EM-2512	
		Trans	Manual; Insert	1			EM-2525	
V8 7.2L 440ci	1972-76	L & R Front		2	EM-2250			
	1967-70	L & R Front		2	EM-2250			
	1972-76	Trans	Auto	1			EM-2272	
		Trans	Manual	1			EM-2272	
	1967-70	Trans	Auto	1			EM-2272	
		Trans	Manual	1			EM-2272	
<b>DART</b>								
L4	L4 1.4L 83cid	2013-16	Torq Str - Rear		1		EM-4203	
	L4 2.0L 122ci	2013-16	Right		1	EM-4239		
			Torq Str - Rear		1		EM-4203	
			Trans	Auto	1			EM-4240

# Engine, Transmission, And Torque Strut Mounts

CYL	ENG. SIZE	YEAR	LOCATION	DESCRIPTION	QTY	ENGINE	TORQUE STRUT	TRANSMISSION
<b>DODGE PASSENGER CAR (continued)</b>								
<b>DART (continued)</b>								
L4	L4 2.4L 144ci	2013-16	Right		1	EM-4239		
			Torq Str - Rear		1		EM-4203	
			Trans	Auto	1			EM-4240
L6	L6 2.8L 170ci	1967-69	LH Front		1	EM-2265		
		1963-66	LH Front		1	EM-2303		
		1961	LH Front		1	EM-2303		
		1967-69	RH Front		1	EM-2264		
		1963-66	RH Front		1	EM-2304		
		1961	RH Front		1	EM-2304		
		1966-69	Trans	Auto	1			EM-2272
			Trans	Manual	1			EM-2272
	L6 3.2L 198ci	1973-74	LH Front	Complete Unit	1	EM-2324		
			LH Front	Insert Only	1	EM-2376		
		1970-72	LH Front		1	EM-2265		
		1973-74	RH Front	Complete Unit	1	EM-2323		
			RH Front	Insert Only	1	EM-2376		
		1970-72	RH Front		1	EM-2264		
		1973-74	Trans	Auto; Complete Unit	1			EM-2340
			Trans	Auto; Insert	1			EM-2525
			Trans	Manual; Complete Unit	1			EM-2340
			Trans	Manual; Insert	1			EM-2525
		1970-72	Trans	Auto	1			EM-2272
			Trans	Manual	1			EM-2272
	L6 3.7L 225ci	1973-76	LH Front	Complete Unit	1	EM-2324		
			LH Front	Insert Only	1	EM-2376		
		1967-72	LH Front		1	EM-2265		
		1960-66	LH Front		1	EM-2303		
		1973-76	RH Front	Complete Unit	1	EM-2323		
			RH Front	Insert Only	1	EM-2376		
		1967-72	RH Front		1	EM-2264		
		1960-66	RH Front		1	EM-2304		
		1973-76	Trans	Auto; Complete Unit	1			EM-2512
			Trans	Auto; Insert	1			EM-2525
Trans			Manual; Complete Unit	1			EM-2512	
Trans			Manual; Insert	1			EM-2525	
1962-72	Trans	Auto	1			EM-2272		
	Trans	Manual	1			EM-2272		
V8	V8 4.5L 273ci	1964-69	L & R Front		2	EM-2266		
		1969	Trans	Auto	1			EM-2272
			Trans	Manual	1			EM-2272
	V8 5.2L 318ci	1968-72	L & R Front		2	EM-2266		
			1973-76	LH Front	Complete Unit	1	EM-2326	
		LH Front		Insert Only	1	EM-2369		
		RH Front		Complete Unit	1	EM-2325		
		RH Front		Insert Only	1	EM-2369		
		1974-76	Trans	Auto; Complete Unit	1			EM-2340
			Trans	Auto; Complete Unit; HD Pkg.	1			EM-2512
			Trans	Auto; Insert	1			EM-2525
			Trans	Manual; Complete Unit	1			EM-2340
			Trans	Manual; Complete Unit; HD Pkg.	1			EM-2512
			Trans	Manual; Insert	1			EM-2525
		1968-73	Trans	Auto	1			EM-2272
	Trans		Manual	1			EM-2272	
	V8 5.6L 340ci	1968-73	L & R Front		2	EM-2266		
			Trans	Auto	1			EM-2272
Trans			Manual	1			EM-2272	

## Engine, Transmission, And Torque Strut Mounts

CYL	ENG. SIZE	YEAR	LOCATION	DESCRIPTION	QTY	ENGINE	TORQUE STRUT	TRANSMISSION
<b>DODGE PASSENGER CAR (continued)</b>								
<b>DART (continued)</b>								
V8	V8 5.9L 360ci	1974-76	LH Front	Complete Unit	1	EM-2326		
			LH Front	Insert Only	1	EM-2369		
			RH Front	Complete Unit	1	EM-2325		
			RH Front	Insert Only	1	EM-2369		
			Trans	Auto; Complete Unit	1		EM-2340	
			Trans	Auto; Complete Unit; HD Pkg.	1		EM-2512	
			Trans	Auto; Insert	1		EM-2525	
			Trans	Manual; Complete Unit	1		EM-2340	
			Trans	Manual; Complete Unit; HD Pkg.	1		EM-2512	
	V8 6.3L 383ci	1967-69	L & R Front		2	EM-2250		
			Trans	Auto	1		EM-2272	
			Trans	Manual	1		EM-2272	
	<b>DAYTONA</b>							
L4	L4 2.2L 135ci	1992-93 1990 1984-89 1992-93 1990 1984-89 1984-86 1992-93 1990 1984-89	Front		1	EM-2615		
			Front		1	EM-2493		
			Front		1	EM-2493		
			RH Front		1	EM-2616		
			RH Front		1	EM-2616		
			RH Front		1	EM-2600		
			Torq Str - Front	Manual	1		EM-2491	
			Trans	Manual	1		EM-2618	
			Trans	Auto	1		EM-2618	
			Trans	Manual	1		EM-2618	
			Trans	Auto	1		EM-2617	
			Trans	Manual	1		EM-2617	
	L4 2.5L 153ci	1992-93 1990-91 1986-89 1992-93 1990-91 1986-89	Front		1	EM-2615		
			Front		1	EM-2493		
			Front		1	EM-2493		
			RH Front		1	EM-2616		
			RH Front		1	EM-2616		
			RH Front		1	EM-2600		
	L4 2.5L 2507cc	1986 1990-93 1986-89	Torq Str - Front	Manual	1		EM-2491	
			Trans	Auto	1		EM-2618	
			Trans	Manual	1		EM-2618	
Trans			Auto	1		EM-2617		
Trans			Manual	1		EM-2617		
V6	V6 3.0L 181ci	1990-93	Front		1	EM-2615		
			RH Front	Hydraulic Mount	1	EM-2711		
			RH Front	Solid Mount; Bushing	1	EM-2616		
	V6 3.0L 2972cc	1990-93	Trans	Auto	1		EM-2618	
			Trans	Manual	1		EM-2618	
<b>DIPLOMAT</b>								
L6	L6 3.7L 225ci	1978-83	LH Front	Complete Unit	1	EM-2324		
			LH Front	Insert Only	1	EM-2376		
			RH Front	Complete Unit	1	EM-2323		
			RH Front	Insert Only	1	EM-2376		
			Trans	Complete Unit	1		EM-2340	
			Trans	Complete Unit - HD	1		EM-2512	
V8	V8 5.2L 318ci	1977-89	LH Front	Complete Unit	1	EM-2326		
			LH Front	Insert Only	1	EM-2369		
			RH Front	Complete Unit	1	EM-2325		
			RH Front	Insert Only	1	EM-2369		
		1979-89	Trans	Complete Unit	1		EM-2340	
			Trans	Complete Unit - HD	1		EM-2512	

# Engine, Transmission, And Torque Strut Mounts

CYL	ENG. SIZE	YEAR	LOCATION	DESCRIPTION	QTY	ENGINE	TORQUE STRUT	TRANSMISSION
<b>DODGE PASSENGER CAR (continued)</b>								
<b>DIPLOMAT (continued)</b>								
V8	V8 5.2L 318ci	1979-89	Trans	Insert	1			EM-2525
		1977-78	Trans	Auto; Complete Unit; HD Pkg.	1			EM-2512
			Trans	Auto; Complete Unit; w/o HD	1			EM-2340
			Trans	Auto; Insert	1			EM-2525
			Trans	Manual; Insert	1			EM-2525
	V8 5.9L 360ci	1978-79	LH Front	Complete Unit	1	EM-2326		
			LH Front	Insert Only	1	EM-2369		
			RH Front	Complete Unit	1	EM-2325		
			RH Front	Insert Only	1	EM-2369		
			Trans	Complete Unit	1			EM-2340
			Trans	Complete Unit - HD	1			EM-2512
		Trans	Insert	1			EM-2525	
<b>DYNASTY</b>								
L4	L4 2.5L 2507cc	1988-93	Front		1	EM-2615		
			RH Front		1	EM-2711		
		1990-93	Trans	Auto; 4 Spd	1			EM-2824 *
		1988-89	Trans	Auto	1			EM-2617
V6	V6 3.0L 2972cc	1988-93	Front		1	EM-2615		
			RH Front		1	EM-2711		
		1990-93	Trans		1			EM-2824 *
		1988-89	Trans		1			EM-2617
	V6 3.3L 201ci	1990-93	Front		1	EM-2615		
		RH Front		1	EM-2711			
		Trans		1			EM-2824 *	
<b>INTREPID</b>								
V6	V6 2.7L 167ci	1998-04	LH Front		1	EM-2942'		
			RH Front		1	EM-2903'		
			Trans		1			EM-2908
	V6 3.2L 197ci	1998-00	L & R Front		2	EM-2903'		
			Trans		1			EM-2908
	V6 3.3L 201ci	1996-97	L & R Front		2	EM-5020'		
			L & R Front		2	EM-2795'		
		1993-97	Trans		1			EM-2810
	V6 3.5L 215cc	2000-04	L & R Front		2	EM-2903'		
			L & R Front		2	EM-5020'		
		1993-95	L & R Front		2	EM-2795'		
			Trans		1			EM-2908
	1993-97	Trans		1			EM-2810	
<b>LANCER</b>								
L4	L4 2.2L 135ci	1985-89	Front		1	EM-2493		
			RH Front		1	EM-2600		
		1985-87	Torq Str - Front	Manual	1		EM-2491	
		1985-89	Trans	Auto	1			EM-2617
			Trans	Manual	1			EM-2617
	L4 2.5L 153ci	1986-89	Front		1	EM-2493		
			RH Front		1	EM-2600		
	L4 2.5L 2507cc	1986-89	Torq Str - Front	Manual	1		EM-2491	
			Trans	Auto	1			EM-2617
			Trans	Manual	1			EM-2617
L6	L6 2.8L 170ci	1962	LH Front		1	EM-2303		
	L6 3.7L 225ci	1962	LH Front		1	EM-2303		
Trans				1			EM-2272	

\* = Hydraulic Mount, "S" suffix = solid replacement.



## Engine, Transmission, And Torque Strut Mounts

CYL	ENG. SIZE	YEAR	LOCATION	DESCRIPTION	QTY	ENGINE	TORQUE STRUT	TRANSMISSION
<b>DODGE PASSENGER CAR (continued)</b>								
<b>MAGNUM</b>								
V6	V6 2.7L 167ci	2005-08	L & R Front		2	EM-5588		
			Trans	RWD	1		EM-5587	
	V6 3.5L 215cc	2005-08	L & R Front	RWD	2	EM-5588		
		2005-07	Trans	RWD	1		EM-5587	
V8	V8 5.2L 318ci	1978-79	LH Front	Complete Unit	1	EM-2326		
			LH Front	Insert Only	1	EM-2369		
			RH Front	Complete Unit	1	EM-2325		
			RH Front	Insert Only	1	EM-2369		
			Trans	Complete Unit	1		EM-2340	
			Trans	Complete Unit - HD	1		EM-2512	
			Trans	Insert	1		EM-2525	
	V8 5.7L 345ci	2005-08	L & R Front		2	EM-3138		
			LH Front	AWD	1	EM-4167		
			Trans	RWD	1		EM-5587	
	V8 5.9L 360ci	1978-79	LH Front	Complete Unit	1	EM-2326		
			LH Front	Insert Only	1	EM-2369		
			RH Front	Complete Unit	1	EM-2325		
			RH Front	Insert Only	1	EM-2369		
Trans			Complete Unit	1		EM-2340		
Trans			Complete Unit - HD	1		EM-2512		
V8 6.1L 370cid	2006-07	Trans	RWD	1		EM-5587		
		Trans	Insert	1		EM-2525		
V8 6.6L 400ci	1978	L & R Front	Insert Only	2	EM-2369			
		Trans	Complete Unit	1		EM-2340		
		Trans	Complete Unit - HD	1		EM-2512		
		Trans	Insert	1		EM-2525		
<b>MIRADA</b>								
L6	L6 3.7L 225ci	1980-83	LH Front	Complete Unit	1	EM-2324		
			LH Front	Insert Only	1	EM-2376		
			RH Front	Complete Unit	1	EM-2323		
			RH Front	Insert Only	1	EM-2376		
			Trans	Complete Unit	1		EM-2340	
			Trans	Complete Unit - HD	1		EM-2512	
			Trans	Insert	1		EM-2525	
V8	V8 5.2L 318ci	1980-83	LH Front	Complete Unit	1	EM-2326		
			LH Front	Insert Only	1	EM-2369		
			RH Front	Complete Unit	1	EM-2325		
			RH Front	Insert Only	1	EM-2369		
			Trans	Complete Unit	1		EM-2340	
			Trans	Complete Unit - HD	1		EM-2512	
	V8 5.9L 360ci	1980	Trans	Insert	1		EM-2525	
			LH Front	Complete Unit	1	EM-2326		
			LH Front	Insert Only	1	EM-2369		
			RH Front	Complete Unit	1	EM-2325		
			RH Front	Insert Only	1	EM-2369		
			Trans	Complete Unit	1		EM-2340	
			Trans	Complete Unit - HD	1		EM-2512	
Trans	Insert	1		EM-2525				
<b>MONACO</b>								
L6	L6 3.7L 225ci	1977-78	LH Front	Complete Unit	1	EM-2324		
			LH Front	Insert Only	1	EM-2376		
			RH Front	Complete Unit	1	EM-2323		
			RH Front	Insert Only	1	EM-2376		
			Trans	Auto; Complete Unit	1		EM-2340	
			Trans	Auto; Complete Unit; HD Pkg.	1		EM-2512	
			Trans	Auto; Insert	1		EM-2525	

# Engine, Transmission, And Torque Strut Mounts

CYL	ENG. SIZE	YEAR	LOCATION	DESCRIPTION	QTY	ENGINE	TORQUE STRUT	TRANSMISSION
<b>DODGE PASSENGER CAR (continued)</b>								
<b>MONACO (continued)</b>								
V8	V8 5.2L 318ci	1975-78	LH Front	Complete Unit	1	EM-2326		
			LH Front	Insert Only	1	EM-2369		
			RH Front	Complete Unit	1	EM-2325		
			RH Front	Insert Only	1	EM-2369		
			Trans	Auto; Complete Unit	1		EM-2340	
			Trans	Auto; Complete Unit; HD Pkg.	1		EM-2512	
			Trans	Auto; Insert	1		EM-2525	
	V8 5.9L 360ci	1971-73 1974-78	L & R Front		2	EM-2250		
			LH Front	Complete Unit	1	EM-2326		
			LH Front	Insert Only	1	EM-2369		
			RH Front	Complete Unit	1	EM-2325		
			RH Front	Insert Only	1	EM-2369		
			Trans	Auto; Complete Unit	1		EM-2340	
			Trans	Auto; Complete Unit; HD Pkg.	1		EM-2512	
		Trans	Auto; Insert	1		EM-2525		
		1971-73	Trans	Auto	1		EM-2272	
			Trans	Manual	1		EM-2272	
	V8 6.3L 383ci	1965-71	L & R Front		2	EM-2250		
		1966-71	Trans	Auto	1		EM-2272	
			Trans	Manual	1		EM-2272	
	V8 6.6L 400ci	1974-78	L & R Front	Complete Unit	1	EM-5476		
			L & R Front	Insert Only	2	EM-2369		
		1972-73	L & R Front		2	EM-2250		
			1975-78	Trans	Auto; Complete Unit	1		EM-2340
				Trans	Auto; Complete Unit; HD Pkg.	1		EM-2512
		Trans		Auto; Insert	1		EM-2525	
		1972-74	Trans	Auto; Complete Unit	1		EM-2340	
			Trans	Auto; Complete Unit; HD Pkg.	1		EM-2512	
			Trans	Auto; Insert	1		EM-2525	
			Trans	Manual; Complete Unit	1		EM-2340	
			Trans	Manual; Complete Unit; HD Pkg.	1		EM-2512	
	Trans		Manual; Insert	1		EM-2525		
V8 6.8L 413ci	1965	LH Front		1	EM-2227			
		RH Front		1	EM-2228			
V8 7.2L 440ci	1974-78	L & R Front	Insert Only	2	EM-2369			
	1966-73	L & R Front		2	EM-2250			
<b>NEON</b>								
L4	L4 2.0L 122ci	1995-99	Front	Complete Unit	1	EM-2867		
			Front	Insert	1	EM-2846		
			RH Front	Complete Unit	1	EM-2979		
			RH Front	Insert	1	EM-2847		
		2003-05	RH Front Lower	Auto	1	EM-2949#		
		2000-02	RH Front Lower		1	EM-2949#		
		2003-05	RH Front Upper	Auto	1	EM-2948#		
		2000-02	RH Front Upper		1	EM-2948#		
		2003-05	RH Rear	Auto	1	EM-2947		
		2000-02	RH Rear		1	EM-2947		
		2002-05	Trans	Auto	1		EM-3124	
			Trans	Manual	1		EM-3050	
		2000-01	Trans	Auto	1		EM-2975	
			Trans	Manual	1		EM-3050	
		1995-99	Trans	Auto; Complete Unit	1		EM-5052	
			Trans	Auto; Insert	1		EM-2848	
			Trans	Manual; Complete Unit	1		EM-5180	
Trans	Manual; Insert		1		EM-2848			

# = Available in the Westar Gold Line

## Engine, Transmission, And Torque Strut Mounts

CYL	ENG. SIZE	YEAR	LOCATION	DESCRIPTION	QTY	ENGINE	TORQUE STRUT	TRANSMISSION	
<b>DODGE PASSENGER CAR (continued)</b>									
<b>NEON (continued)</b>									
L4	L4 2.4L 148ci	2003-05	Front Lower		1	EM-5692			
			Rear		1	EM-2947			
<b>OMNI</b>									
L4	L4 1.6L 1595cc	1983-86	Front		1	EM-2493			
			RH Front		1	EM-2600			
			Torq Str - Front	Manual	1		EM-2491		
		1984-86	Trans	Auto	1			EM-2617	
			Trans	Manual	1			EM-2617	
		1983	Trans	Auto	1			EM-2600	
			Trans	Manual	1			EM-2600	
		L4 1.7L 105ci	1978-83	Front	Complete Unit	1	EM-2733		
				Front	Insert Only	1	EM-2447		
				RH Front		1	EM-2600		
	1981-83		Torq Str - Front	Manual	1		EM-2491		
			Trans	Auto	1			EM-2600	
	1978-80		Trans	Manual	1			EM-2600	
			Trans	Auto; Complete Unit	1			EM-2734	
			Trans	Auto; Insert Only	1			EM-2721	
			Trans	Manual; Complete Unit	1			EM-2734	
			Trans	Manual; Insert Only	1			EM-2721	
	L4 2.2L 135ci	1981-90	Front		1	EM-2493			
			RH Front		1	EM-2600			
			Torq Str - Front	Manual	1		EM-2491		
1984-90		Trans	Auto	1			EM-2617		
		Trans	Manual	1			EM-2617		
1981-83		Trans	Auto	1			EM-2600		
		Trans	Manual	1			EM-2600		
		Trans	Manual	1			EM-2600		
<b>POLARA</b>									
L6	L6 3.7L 225ci	1970-71	LH Front		1	EM-2275			
			RH Front		1	EM-2276			
			Trans	Auto; Complete Unit	1			EM-2512	
			Trans	Auto; Insert	1			EM-2525	
			Trans	Manual; Complete Unit	1			EM-2512	
			Trans	Manual; Insert	1			EM-2525	
V8	V8 5.2L 318ci	1967-72	L & R Front		2	EM-2250			
			1973	LH Front		1	EM-2326		
		1963-66	LH Front		1	EM-2228			
			1960-61	LH Front		1	EM-2228		
		1973	RH Front		1	EM-2325			
			1963-66	RH Front		1	EM-2227		
		1960-61	RH Front		1	EM-2227			
			1971-72	Trans	Auto; Complete Unit	1			EM-2340
		Trans		Auto; Insert	1			EM-2525	
		Trans		Manual; Complete Unit	1			EM-2340	
		Trans		Manual; Insert	1			EM-2525	
		1966-70	Trans	Auto	1			EM-2272	
			Trans	Manual	1			EM-2272	
		V8 5.9L 360ci	1971-73	L & R Front		2	EM-2250		
	Trans			Auto	1		EM-2272		
	Trans			Manual	1		EM-2272		
	V8 6.3L 383ci	1966-71	L & R Front		2	EM-2250			
			1962-65	LH Front		1	EM-2228		
		1963-71	RH Front		1	EM-2227			
			Trans	Auto	1			EM-2272	
Trans			Manual	1			EM-2272		
V8 6.6L 400ci	1972-73	L & R Front		2	EM-2250				

# Engine, Transmission, And Torque Strut Mounts

CYL	ENG. SIZE	YEAR	LOCATION	DESCRIPTION	QTY	ENGINE	TORQUE STRUT	TRANS-MISSION		
<b>DODGE PASSENGER CAR (continued)</b>										
<b>POLARA (continued)</b>										
V8	V8 6.6L 400ci	1972-73	Trans	Auto; Complete Unit	1			EM-2340		
			Trans	Auto; Complete Unit; HD Pkg.	1			EM-2512		
			Trans	Auto; Insert	1				EM-2525	
			Trans	Manual; Complete Unit	1				EM-2340	
			Trans	Manual; Complete Unit; HD Pkg.	1				EM-2512	
			Trans	Manual; Insert	1				EM-2525	
	V8 6.8L 413ci	1965	LH Front		1	EM-2227				
			RH Front		1	EM-2228				
	V8 7.0L 426ci	1964-65	LH Front		1	EM-2227				
			RH Front		1	EM-2228				
			Trans	Auto; Complete Unit	1				EM-2512	
			Trans	Auto; Insert	1				EM-2525	
			Trans	Manual; Complete Unit	1				EM-2512	
			Trans	Manual; Insert	1				EM-2525	
	V8 7.2L 440ci	1966-73	L & R Front		2	EM-2250				
			Trans	Auto; Complete Unit	1				EM-2340	
			Trans	Auto; Complete Unit; HD Pkg.	1				EM-2512	
			Trans	Auto; Insert	1				EM-2525	
			Trans	Manual; Complete Unit	1				EM-2340	
			Trans	Manual; Complete Unit; HD Pkg.	1				EM-2512	
			Trans	Manual; Insert	1				EM-2525	
<b>ROYAL MONACO</b>										
V8	V8 5.2L 318ci	1977	LH Front	Complete Unit	1	EM-2326				
			LH Front	Insert Only	1	EM-2369				
		1975	LH Front	Complete Unit	1	EM-2326				
			LH Front	Insert Only	1	EM-2369				
		1977	RH Front	Complete Unit	1	EM-2325				
			RH Front	Insert Only	1	EM-2369				
		1975	RH Front	Complete Unit	1	EM-2325				
			RH Front	Insert Only	1	EM-2369				
		1977	Trans	Complete Unit	1				EM-2340	
			Trans	Complete Unit - HD	1				EM-2512	
			Trans	Insert	1				EM-2525	
		1975	Trans	Complete Unit	1				EM-2340	
			Trans	Complete Unit - HD	1				EM-2512	
			Trans	Insert	1				EM-2525	
		V8 5.9L 360ci	1975-77	LH Front	Complete Unit	1	EM-2326			
				LH Front	Insert Only	1	EM-2369			
				RH Front	Complete Unit	1	EM-2325			
				RH Front	Insert Only	1	EM-2369			
	Trans			Complete Unit	1				EM-2340	
	Trans			Complete Unit - HD	1				EM-2512	
	Trans	Insert	1				EM-2525			
V8 6.6L 400ci	1975-77	L & R Front	Complete Unit	2	EM-5476					
		L & R Front	Insert Only	2	EM-2369					
		Trans	Complete Unit	1				EM-2340		
		Trans	Complete Unit - HD	1				EM-2512		
		Trans	Insert	1				EM-2525		
<b>SHADOW</b>										
L4	L4 2.2L 135ci	1991-94	Front		1	EM-2615				
		1987-90	Front		1	EM-2493				
		1991-94	RH Front		1	EM-2616				
		1987-90	RH Front		1	EM-2600				
		1987	Torq Str - Front	Manual	1			EM-2491		

## Engine, Transmission, And Torque Strut Mounts

CYL	ENG. SIZE	YEAR	LOCATION	DESCRIPTION	QTY	ENGINE	TORQUE STRUT	TRANSMISSION	
<b>DODGE PASSENGER CAR (continued)</b>									
<b>SHADOW (continued)</b>									
L4	L4 2.2L 135ci	1991-94	Trans	Auto	1			EM-2618	
			Trans	Manual	1			EM-2618	
		1987-90	Trans	Auto	1			EM-2617	
			Trans	Manual	1			EM-2617	
	L4 2.5L 2507cc	1991-94	Front		1	EM-2615			
			1988-90	Front		1	EM-2493		
		1991-94	RH Front		1	EM-2616			
			1988-90	RH Front		1	EM-2600		
		1990-94	Trans	Auto	1			EM-2618	
			Trans	Manual	1			EM-2618	
		1988-89	Trans	Auto	1			EM-2617	
			Trans	Manual	1			EM-2617	
	V6	V6 3.0L 2972cc	1992-94	Front		1	EM-2615		
RH Front					1	EM-2711			
1994			Trans	Auto	1			EM-2618	
			Trans	Manual	1			EM-2618	
<b>SPIRIT</b>									
L4	L4 2.2L 135ci	1991-92	Front		1	EM-2615			
			RH Front		1	EM-2616			
			Trans		1			EM-2618	
	L4 2.5L 2507cc	1990-95	Front		1	EM-2615			
			1989	Front		1	EM-2615		
		1990-95	RH Front		1	EM-2616			
			1989	RH Front		1	EM-2600		
		1990-95	Trans	Auto	1			EM-2618	
			Trans	Manual	1			EM-2618	
		1989	Trans	Auto	1			EM-2617	
			Trans	Manual	1			EM-2617	
	V6	V6 3.0L 2972cc	1992-95	Front		1	EM-2615		
			1990-91	Front		1	EM-2615		
1989			Front		1	EM-2615			
1992-95			RH Front	Hydraulic Mount; NOT INTERCHANABLE WITH NON HYDRAULIC	1	EM-2711			
1990-91			RH Front		1	EM-2616			
1989			RH Front		1	EM-2600			
1990-95			Trans	Auto	1			EM-2618	
			Trans	Manual	1			EM-2618	
1989			Trans	Auto	1			EM-2617	
			Trans	Manual	1			EM-2617	
<b>ST. REGIS</b>									
L6	L6 3.7L 225ci	1979-81	LH Front	Complete Unit	1	EM-2324			
			LH Front	Insert Only	1	EM-2376			
			RH Front	Complete Unit	1	EM-2323			
			RH Front	Insert Only	1	EM-2376			
			Trans	Complete Unit	1			EM-2340	
			Trans	Complete Unit - HD	1			EM-2512	
			Trans	Insert Only	1			EM-2525	
V8	V8 5.2L 318ci	1979-81	LH Front	Complete Unit	1	EM-2326			
			LH Front	Insert Only	1	EM-2369			
			RH Front	Complete Unit	1	EM-2325			
			RH Front	Insert Only	1	EM-2369			
			Trans	Complete Unit	1			EM-2340	
			Trans	Complete Unit - HD	1			EM-2512	
	Trans	Insert Only	1			EM-2525			
	V8 5.9L 360ci	1979-80	LH Front	Complete Unit	1	EM-2326			

# Engine, Transmission, And Torque Strut Mounts

CYL	ENG. SIZE	YEAR	LOCATION	DESCRIPTION	QTY	ENGINE	TORQUE STRUT	TRANSMISSION				
<b>DODGE PASSENGER CAR (continued)</b>												
<b>ST. REGIS (continued)</b>												
V8	V8 5.9L 360ci	1979-80	LH Front	Insert Only	1	EM-2369						
			RH Front	Complete Unit	1	EM-2325						
			RH Front	Insert Only	1	EM-2369						
			Trans	Complete Unit	1			EM-2340				
			Trans	Complete Unit - HD	1			EM-2512				
			Trans	Insert Only	1			EM-2525				
<b>STEALTH</b>												
V6	V6 3.0L	1991-96	Front	FWD	1	EM-9191						
<b>STRATUS</b>												
L4	L4 2.0L 122ci	1995-97	Bushing Kit	Cradle Insert Kit (2 pieces) Recommended	1	EM-5178						
			1998-00	Front		1	EM-2958					
			1995-97	Front	Cradle Insert	1	EM-2980					
			1998-00	RH Front		1	EM-2841*					
			1995-97	RH Front		1	EM-2841*					
			1998-00	Rear		1	EM-3089					
			1995-97	Rear	Cradle Insert	1	EM-3011					
			2001-06	Trans	Mexican Vehicle	1			EM-3124			
			1995-00	Trans	Auto	1			EM-2842 *			
	L4 2.4L 148ci	2005-06	2001-04	Front	DOHC	1	EM-3034					
				Front	DOHC	1	EM-3034					
				RH Front	DOHC	1	EM-2841*					
				RH Front	DOHC	1	EM-2841*					
				Rear	DOHC	1	EM-3049					
				Rear	DOHC	1	EM-3049					
				Trans	Auto	1			EM-2842 *			
				Trans	DOHC; Auto	1			EM-2842 *			
				Trans	DOHC; Manual	1			EM-2842 *			
				Trans	Auto	1			EM-2842 *			
				Trans	Manual	1			EM-2842 *			
				L4 2.4L 2351cc	2001-05	2001-05	Front	SOHC	1	EM-9160		
							RH Front	SOHC	1	EM-9184		
	Rear	SOHC; Auto	1				EM-9161					
	Rear	SOHC; Manual	1				EM-9485					
	Trans	SOHC; Auto, Coupe	1						EM-9162			
	Trans	SOHC; Manual; Coupe	1						EM-5452			
	L4 2.4L 2429cc	1995-99	2000	Bushing Kit	Cradle Insert Kit (2 pieces) Recommended	1	EM-5178					
				Front		1	EM-2958					
				Front	Cradle Insert	1	EM-2980					
				RH Front		1	EM-2841*					
				RH Front		1	EM-2841*					
				Rear		1	EM-2945					
				Rear	Cradle Insert	1	EM-3011					
				Trans	Auto	1			EM-2842 *			
	V6	V6 2.5L 2497cc	1995-97	Bushing Kit	Cradle Insert Kit (2 pieces) Recommended	1	EM-5178					
				1999-00	Front		1	EM-2958				
				1995-97	Front	Cradle Insert	1	EM-2980				
				1999-00	RH Front		1	EM-2841*				
				1995-97	RH Front		1	EM-2841*				
				1999-00	Rear		1	EM-2945				
				1995-97	Rear	Cradle Insert	1	EM-3011				
				1998-00	Trans	Auto	1			EM-2842 *		
				1996-00	Trans	Auto	1			EM-2842 *		

\* = Hydraulic Mount, "S" suffix = solid replacement.

# Engine, Transmission, And Torque Strut Mounts

CYL	ENG. SIZE	YEAR	LOCATION	DESCRIPTION	QTY	ENGINE	TORQUE STRUT	TRANSMISSION	
<b>DODGE PASSENGER CAR (continued)</b>									
<b>STRATUS (continued)</b>									
V6	V6 2.5L 2497cc	1996-00	Trans	Manual	1			EM-2842 *	
		1995	Trans	Auto	1			EM-2842 *	
	V6 2.7L 2700cc	2001-06	Front			1	EM-3034		
			RH Front			1	EM-2841 *		
			Rear			1	EM-3049		
		2006	Trans	Auto		1			EM-2842 *
		2001-05	Trans	Auto		1			EM-2842 *
	Trans		Manual		1			EM-2842 *	
	V6 3.0L	2003-05	Trans - LH	Auto, R/T Coupe		1			EM-9384
		2001-02	Trans	Auto, SE & R/T Coupe		1			EM-9384
	V6 3.0L 2972cc	2001-05	LH Front			1	EM-5159		
			LH Rear			1	EM-5349		
			RH Front			1	EM-9187		
<b>VIPER</b>									
V10	V10 8.4L 515cid	2015-17	Trans	Manual	1			EM-5587	
<b>VERNA (MEXICAN VEHICLE)</b>									
L4	L4 1.5L 1493cc	2005-06	Front	Auto	1	EM-9253			
			Front	Manual	1	EM-8938			
			RH Front	Manual	1	EM-9255			
			Rear	Manual	1	EM-9254			
			Trans - LH	Manual	1		EM-8253		
	L4 1.6L 1599cc	2006	Front	Auto	1	EM-9253			
			Front	Manual	1	EM-8938			
		2004-05	Front		1	EM-9253			
			RH Front	Manual	1	EM-9255			
		2006	Rear	Manual	1	EM-9254			
			Trans - LH		1		EM-8253		
		2004-05	Trans - LH	Auto	1		EM-8253		
		<b>DODGE SPORT UTILITY</b>							
<b>DURANGO</b>									
V6	V6 3.6L 220ci	2011-15	L & R Front		2	EM-4168			
		2015-17	Trans	Auto; RWD	1			EM-4172	
			Trans	AWD	1			EM-4228	
		2011-14	Trans		1			EM-4172	
		2004-09	Trans		1			EM-3066	
	V6 3.7L 226ci	1998-99	LH Front		1	EM-2963			
			RH Front		1	EM-2962			
			Trans		1		EM-2858		
	V8	V8 4.7L 287ci	2000-03	LH Front	4WD	1	EM-3005		
				LH Front	RWD	1	EM-3035		
RH Front				4WD	1	EM-3006			
RH Front				RWD	1	EM-3036			
2004-09			Trans	Auto; 4WD	1			EM-3066	
2000-03			Trans	Auto; 2WD	1			EM-2992	
			Trans	Auto; 4WD	1			EM-2858	
V8 5.2L 318ci		1999-00	LH Front	4WD	1	EM-2963			
			LH Front	RWD	1	EM-2917			
		1998	LH Front		1	EM-2963			
			RH Front	4WD	1	EM-2962			
		1999-00	RH Front	RWD	1	EM-3067			
			RH Front		1	EM-2962			
1999-00	Trans	Auto; 4WD	1			EM-2858			
	Trans	Auto; RWD	1			EM-2992			
1998	Trans	Auto; 4WD	1			EM-2858			

\* = Hydraulic Mount, "S" suffix = solid replacement.

# Engine, Transmission, And Torque Strut Mounts

CYL	ENG. SIZE	YEAR	LOCATION	DESCRIPTION	QTY	ENGINE	TORQUE STRUT	TRANSMISSION	
<b>DODGE SPORT UTILITY (continued)</b>									
<b>DURANGO (continued)</b>									
V8	V8 5.7L 345ci	2011-15	L & R Front		2	EM-4168			
		2014-17	Trans	AWD	1			EM-4228	
			Trans	RWD	1			EM-4172	
		2011-13	Trans	Auto	1			EM-4172	
		2004-09	Trans		1			EM-3066	
	V8 5.9L 360ci	2000-03	LH Front		1	EM-3005			
		1998-99	LH Front		1	EM-2963			
		2000-03	RH Front		1	EM-3006			
		1998-99	RH Front		1	EM-2962			
		Trans	4WD		1			EM-2858	
		Trans	RWD		1		EM-2991		
<b>JOURNEY</b>									
L4	L4 2.4L 144ci	2009-10	Front	Complete Unit	1	EM-3165			
		2011-16	Rear	FWD	1	EM-4198			
		2009-10	Rear		1	EM-4109			
		2011-16	Right		1	EM-4179			
		2009-10	Right		1	EM-3183			
			Trans - BUSHING	Bushing Bushing	1			EM-4107	
		2011-16	Trans	Auto	1			EM-4178	
V6	V6 3.5L 215cc	2009-10	Front	Complete Unit	1	EM-3165			
			Rear		1	EM-4201			
		2011-12	Right		1	EM-3183			
		2009-10	Right		1	EM-3183			
			Trans - BUSHING	Bushing Bushing	1			EM-4107	
	V6 3.6L 220ci	2011-16	Front	US & Canada	1	EM-4113			
			Front	Mexico	1	EM-4113			
			Rear	US & Canada; AWD; US & Canada	1	EM-4201			
			Rear	US & Canada; FWD	1	EM-4132			
		2011-18	Rear	Mexico; FWD	1	EM-4132			
		2011-18	Trans - BUSHING	Bushing Bushing	1			EM-4107	
<b>NITRO</b>									
V6	V6 3.7L 226ci	2007-11	LH Front		1	EM-4101			
			RH Front		1	EM-4258			
<b>RAIDER</b>									
L4	L4 2.6L 2555cc	1987-89	L & R Front		2	EM-2731			
			1987-88	Trans	Auto	1			EM-8096
				Trans	Manual	1			EM-8248
V6	V6 3.0L 2972cc	1989	L & R Front		2	EM-8235			
<b>RAMCHARGER</b>									
L6	L6 3.7L 225ci	1974-80	Trans - Lower	4WD	1			EM-2668	
			Trans - Upper	4WD	1			EM-2667	
			Trans	Auto; Complete Unit; 2WD	1			EM-2512	
			Trans	Auto; Insert; 2WD	1			EM-2525	
			Trans	Manual; Complete Unit; 2WD	1			EM-2512	
			Trans	Manual; Insert; 2WD	1			EM-2525	
	L6 3.7L 3687cc	1979-80	L & R Front		2	EM-2469			
			1974-78	L & R Front		2	EM-2265		
	V8	V8 5.2L 318ci	1979-93	L & R Front		2	EM-2469		
				1974-78	L & R Front		2	EM-2265	
			1990-93	Trans - Lower	Auto; 4WD	2			EM-2668
Trans - Lower				Manual; 4WD	2			EM-2668	



# Engine, Transmission, And Torque Strut Mounts

CYL	ENG. SIZE	YEAR	LOCATION	DESCRIPTION	QTY	ENGINE	TORQUE STRUT	TRANS-MISSION	
<b>DODGE SPORT UTILITY (continued)</b>									
<b>RAMCHARGER (continued)</b>									
V8	V8 5.2L 318ci	1974-89	Trans - Lower	Auto; 4WD	2			EM-2668	
			Trans - Lower	Manual; 4WD	2			EM-2668	
		1990-93	Trans - Upper	Auto; 4WD	2			EM-2667	
			Trans - Upper	Manual; 4WD	2			EM-2624	
		1974-89	Trans - Upper	Auto; 4WD	2			EM-2667	
			Trans - Upper	Manual; 4WD	2			EM-2512	
		1990-93	Trans	Auto; 2WD	1			EM-2624	
			1974-89	Trans	Auto; Complete Unit; 2WD	1			EM-2525
		Trans		Auto; Insert; 2WD	1			EM-2512	
		Trans		Manual; Complete Unit; 2WD	1			EM-2525	
		V8 5.9L 360ci	1984-93	L & R Front		2	EM-2469		
				1979-81	L & R Front		2	EM-2469	
	1974-78				L & R Front		2	EM-2265	
	1990-93		Trans - Lower	Auto; 4WD	2			EM-2668	
			Trans - Lower	Manual; 4WD	2			EM-2668	
	1984-89		Trans - Lower	Auto; 4WD	2			EM-2668	
			Trans - Lower	Manual; 4WD	2			EM-2668	
	1974-81		Trans - Lower	Auto; 4WD	2			EM-2668	
			Trans - Lower	Manual; 4WD	2			EM-2668	
	1990-93		Trans - Upper	Auto; 4WD	2			EM-2667	
			Trans - Upper	Manual; 4WD	2			EM-2624	
	1984-89		Trans - Upper	Auto; 4WD	2			EM-2667	
			Trans - Upper	Manual; 4WD	2			EM-2512	
	1974-81		Trans - Upper	Auto; 4WD	2			EM-2667	
			Trans - Upper	Manual; 4WD	2			EM-2512	
	1990-93		Trans	Auto; 2WD	1			EM-2624	
			1984-89	Trans	Auto; Complete Unit; 2WD	1			EM-2525
	Trans			Auto; Insert; 2WD	1			EM-2512	
	Trans			Manual; Complete Unit; 2WD	1			EM-2525	
	1974-81		Trans	Auto; Complete Unit; 2WD	1			EM-2525	
			Trans	Auto; Insert; 2WD	1			EM-2512	
			Trans	Manual; Complete Unit; 2WD	1			EM-2525	
	V8 6.6L 400ci		1977-78	L & R Front		2	EM-2265		
Trans				Auto; Complete Unit	1			EM-2512	
Trans		Auto; Insert Only		1			EM-2525		
Trans		Manual; Complete Unit		1			EM-2512		
Trans		Manual; Insert Only		1			EM-2525		
V8 7.2L 440ci	1974-78	L & R Front		2	EM-2265				
		Trans	Auto; Complete Unit	1			EM-2512		
		Trans	Auto; Insert Only	1			EM-2525		
		Trans	Manual; Complete Unit	1			EM-2512		
		Trans	Manual; Insert Only	1			EM-2525		
<b>DODGE TRUCK</b>									
<b>D50 PICKUP</b>									
L4	L4 2.0L 1995cc	1982	LH Front	RWD	1	EM-2731			
			1979-81	LH Front		1	EM-2731		
		1982	RH Front		1	EM-2731			
			1979-81	RH Front		1	EM-2731		
		1982	Trans	4WD	1			EM-8248	
			Trans	Auto; 2WD	1			EM-8111	
			Trans	Manual; 2WD	1			EM-8111	
		1979-81	Trans	Auto; 2WD	1			EM-8111	
			Trans	Manual; 2WD	1			EM-8111	
		L4 2.6L 2555cc	1982	LH Front	RWD	1	EM-2731		
				LH Front		1	EM-2731		
RH Front				1	EM-2731				

# Engine, Transmission, And Torque Strut Mounts

CYL	ENG. SIZE	YEAR	LOCATION	DESCRIPTION	QTY	ENGINE	TORQUE STRUT	TRANSMISSION	
<b>DODGE TRUCK (continued)</b>									
<b>D50 PICKUP (continued)</b>									
L4	L4 2.6L 2555cc	1979-81	RH Front		1	EM-2731			
		1982	Trans	4WD	1			EM-8248	
			Trans	RWD	1			EM-8111	
		1979-81	Trans			1			EM-8111
<b>D100 PICKUP</b>									
L6	L6 2.8L 170ci	1963-65	L & R Front		2	EM-2235			
	L6 3.2L 198ci	1970-71	L & R Front		2	EM-2266			
			Trans	Auto; Complete Unit	1			EM-2512	
			Trans	Auto; Insert Only	1			EM-2525	
			Trans	Manual; Complete Unit	1			EM-2512	
			Trans	Manual; Insert Only	1			EM-2525	
	L6 3.7L 225ci	1986-87	L & R Front		2	EM-2469			
			1972-79	L & R Front		2	EM-2265		
		1969-71	L & R Front		2	EM-2266			
		1968	L & R Front		2	EM-2235			
		1963-67	1969-79	L & R Front		2	EM-2235		
				Trans	Auto; Complete Unit	1			EM-2512
				Trans	Auto; Insert Only	1			EM-2525
				Trans	Manual; Complete Unit	1			EM-2512
	L6 3.7L 3687cc	1986-87	Trans	Manual; Insert Only	1			EM-2525	
			Trans	Auto; Complete Unit	1			EM-2512	
			Trans	Auto; Insert Only	1			EM-2525	
			Trans	Manual; Complete Unit	1			EM-2512	
	L6 4.0L 243ci Diesel	1979	Trans	Manual; Insert Only	1			EM-2525	
			L & R Front		2	EM-2469			
1978			L & R Front		2	EM-2265			
L & R Front				2	EM-2469				
V6	V6 3.9L 239ci	1988-89	L & R Front		2	EM-2469			
			Trans	Auto	1			EM-2624	
			Trans	Manual	1			EM-2624	
V8	V8 5.2L 318ci	1986-89	L & R Front		2	EM-2469			
			1979	L & R Front		2	EM-2469		
		1972-78	L & R Front		2	EM-2265			
		1968-71	L & R Front		2	EM-2235			
		1963-67	1988-89	L & R Front		2	EM-2235		
				Trans	Auto	1			EM-2624
		1986-87	1969-79	Trans	Manual	1			EM-2624
				Trans	Auto; Complete Unit	1			EM-2512
				Trans	Auto; Insert Only	1			EM-2525
				Trans	Manual; Complete Unit	1			EM-2512
		1969-79	1986-87	Trans	Manual; Insert Only	1			EM-2525
				Trans	Auto; Complete Unit	1			EM-2512
	Trans			Auto; Insert Only	1			EM-2525	
	Trans			Manual; Complete Unit	1			EM-2512	
	V8 5.9L 360ci	1986-88	1979	Trans	Manual; Insert Only	1			EM-2525
				L & R Front		2	EM-2469		
		1971-78	1988	L & R Front		2	EM-2265		
				Trans	Auto	1			EM-2624
		1986-87	1972-79	Trans	Manual	1			EM-2624
				Trans	Auto; Complete Unit	1			EM-2512
Trans				Auto; Insert Only	1			EM-2525	
Trans				Manual; Complete Unit	1			EM-2512	
1972-79	1986-87	Trans	Manual; Insert Only	1			EM-2525		
		Trans	Auto; Complete Unit	1			EM-2512		
		Trans	Auto; Insert Only	1			EM-2525		
		Trans	Manual; Complete Unit	1			EM-2512		

## Engine, Transmission, And Torque Strut Mounts

CYL	ENG. SIZE	YEAR	LOCATION	DESCRIPTION	QTY	ENGINE	TORQUE STRUT	TRANSMISSION	
<b>DODGE TRUCK (continued)</b>									
<b>D100 PICKUP (continued)</b>									
V8	V8 6.3L 383ci	1968-71	L & R Front		2	EM-2235			
		1967	L & R Front		2	EM-2235			
		1968	Trans - L & R		2			EM-2302	
		1967	Trans - L & R		2			EM-2302	
	V8 6.6L 400ci	1976-78	L & R Front		2	EM-2265			
		1972-74	L & R Front		2	EM-2265			
		1971	L & R Front		2	EM-2235			
		1976-78	Trans	Auto; Complete Unit		1			EM-2512
			Trans	Auto; Insert Only		1			EM-2525
			Trans	Manual; Complete Unit		1			EM-2512
			Trans	Manual; Insert Only		1			EM-2525
		1972-74	Trans	Auto; Complete Unit		1			EM-2512
	Trans		Auto; Insert Only		1			EM-2525	
	Trans		Manual; Complete Unit		1			EM-2512	
	Trans		Manual; Insert Only		1			EM-2525	
	V8 7.2L 440ci	1973-78	L & R Front		2	EM-2265			
			Trans	Auto; Complete Unit		1		EM-2512	
Trans			Auto; Insert Only		1		EM-2525		
Trans			Manual; Complete Unit		1		EM-2512		
Trans			Manual; Insert Only		1		EM-2525		
<b>D150 PICKUP</b>									
L6	L6 3.7L 225ci	1982-87	L & R Front		2	EM-2469			
		1977-81	L & R Front		2	EM-2265			
		1977-87	Trans	Auto; Complete Unit		1			EM-2512
			Trans	Auto; Insert Only		1			EM-2525
			Trans	Manual; Complete Unit		1			EM-2512
	Trans		Manual; Insert Only		1			EM-2525	
L6 4.0L 243ci Diesel	1979-80	L & R Front		2	EM-2469				
	1978	L & R Front		2	EM-2265				
V6	V6 3.9L 239ci	1988-93	L & R Front		2	EM-2469			
			Trans	Auto		1		EM-2624	
			Trans	Manual		1		EM-2624	
V8	V8 5.2L 318ci	1979-93	L & R Front		2	EM-2469			
		1977-78	L & R Front		2	EM-2265			
		1988-93	Trans	Auto		1			EM-2624
			Trans	Manual		1			EM-2624
		1977-87	Trans	Auto; Complete Unit		1			EM-2512
			Trans	Auto; Insert Only		1			EM-2525
			Trans	Manual; Complete Unit		1			EM-2512
			Trans	Manual; Insert Only		1			EM-2525
	Trans		Manual; Insert Only		1			EM-2525	
	V8 5.9L 360ci	1993	L & R Front		2	EM-2469			
		1984-91	L & R Front		2	EM-2469			
		1979-82	L & R Front		2	EM-2469			
		1977-78	L & R Front		2	EM-2265			
		1993	Trans	Auto		1			EM-2624
			Trans	Manual		1			EM-2624
		1988-91	Trans	Auto		1			EM-2624
			Trans	Manual		1			EM-2624
		1984-87	Trans	Auto; Complete Unit		1			EM-2512
			Trans	Auto; Insert Only		1			EM-2525
			Trans	Manual; Complete Unit		1			EM-2512
			Trans	Manual; Insert Only		1			EM-2525
	1977-82	Trans	Auto; Complete Unit		1			EM-2512	
		Trans	Auto; Insert Only		1			EM-2525	
Trans		Manual; Complete Unit		1			EM-2512		
Trans		Manual; Insert Only		1			EM-2525		
Trans		Manual; Insert Only		1			EM-2525		
V8 6.6L 400ci	1977-78	L & R Front		2	EM-2265				

# Engine, Transmission, And Torque Strut Mounts

CYL	ENG. SIZE	YEAR	LOCATION	DESCRIPTION	QTY	ENGINE	TORQUE STRUT	TRANSMISSION
<b>DODGE TRUCK (continued)</b>								
<b>D150 PICKUP (continued)</b>								
V8	V8 6.6L 400ci	1977-78	Trans	Auto; Complete Unit	1			EM-2512
			Trans	Auto; Insert Only	1			EM-2525
			Trans	Manual; Complete Unit	1			EM-2512
			Trans	Manual; Insert Only	1			EM-2525
	V8 7.2L 440ci	1978	L & R Front		2	EM-2265		
			Trans	Auto; Complete Unit	1			EM-2512
			Trans	Auto; Insert Only	1			EM-2525
			Trans	Manual; Complete Unit	1			EM-2512
			Trans	Manual; Insert Only	1			EM-2525
<b>D200 PICKUP</b>								
L6	L6 3.7L 225ci	1972-80	L & R Front		2	EM-2265		
		1969-71	L & R Front		2	EM-2266		
		1968	L & R Front		2	EM-2235		
		1963-67	L & R Front		2	EM-2235		
		1969-80	Trans	Auto; Complete Unit	1			EM-2512
			Trans	Auto; Insert Only	1			EM-2525
			Trans	Manual; Complete Unit	1			EM-2512
			Trans	Manual; Insert Only	1			EM-2525
	L6 4.0L 243ci Diesel	1980	L & R Front		2	EM-2469		
		1978	L & R Front		2	EM-2265		
V8	V8 5.2L 318ci	1979-80	L & R Front		2	EM-2469		
		1972-78	L & R Front		2	EM-2265		
		1968-71	L & R Front		2	EM-2235		
		1963-67	L & R Front		2	EM-2235		
		1969-80	Trans	Auto; Complete Unit	1			EM-2512
			Trans	Auto; Insert Only	1			EM-2525
			Trans	Manual; Complete Unit	1			EM-2512
			Trans	Manual; Insert Only	1			EM-2525
	V8 5.9L 360ci	1979-80	L & R Front		2	EM-2469		
		1971-78	L & R Front		2	EM-2265		
		1971-80	Trans	Auto; Complete Unit	1			EM-2512
			Trans	Auto; Insert Only	1			EM-2525
			Trans	Manual; Complete Unit	1			EM-2512
		Trans	Manual; Insert Only	1			EM-2525	
	V8 6.3L 383ci	1968-71	L & R Front		2	EM-2235		
		1967	L & R Front		2	EM-2235		
		1967-68	Trans - L & R		2			EM-2302
			Trans - L & R		2			EM-2302
	V8 6.6L 400ci	1972-78	L & R Front		2	EM-2265		
		1971	L & R Front		2	EM-2235		
		1972-78	Trans	Auto; Complete Unit	1			EM-2512
			Trans	Auto; Insert Only	1			EM-2525
Trans			Manual; Complete Unit	1			EM-2512	
Trans	Manual; Insert Only		1			EM-2525		
V8 7.2L 440ci	1973-78	L & R Front		2	EM-2265			
		Trans	Auto; Complete Unit	1			EM-2512	
		Trans	Auto; Insert Only	1			EM-2525	
		Trans	Manual; Complete Unit	1			EM-2512	
		Trans	Manual; Insert Only	1			EM-2525	
<b>D250 PICKUP</b>								
L6	L6 3.7L 3687cc	1982-87	L & R Front		2	EM-2469		
		1981	L & R Front		2	EM-2265		
		1981-87	Trans	Auto; Complete Unit	1			EM-2512
			Trans	Auto; Insert Only	1			EM-2525
			Trans	Manual; Complete Unit	1			EM-2512
			Trans	Manual; Insert Only	1			EM-2525

## Engine, Transmission, And Torque Strut Mounts

CYL	ENG. SIZE	YEAR	LOCATION	DESCRIPTION	QTY	ENGINE	TORQUE STRUT	TRANSMISSION	
<b>DODGE TRUCK (continued)</b>									
<b>D250 PICKUP (continued)</b>									
L6	L6 5.9L 359ci Diesel	1989-93	L & R Front		2	EM-2710			
			Trans	Auto	1			EM-2624	
			Trans	Manual	1			EM-2624	
V6	V6 3.9L 239ci	1988-93	L & R Front		2	EM-2469			
			Trans	Auto	1			EM-2624	
			Trans	Manual	1			EM-2624	
V8	V8 5.2L 318ci	1981-93	L & R Front		2	EM-2469			
		1988-93	Trans	Auto	1			EM-2624	
			Trans	Manual	1			EM-2624	
		1981-87	Trans	Auto; Complete Unit	1			EM-2512	
			Trans	Auto; Insert Only	1			EM-2525	
			Trans	Manual; Complete Unit	1			EM-2512	
			Trans	Manual; Insert Only	1			EM-2525	
		V8 5.9L 360ci	1984-93	L & R Front		2	EM-2469		
			1981-82	L & R Front		2	EM-2469		
	1988-93		Trans	Auto	1			EM-2624	
			Trans	Manual	1			EM-2624	
	1984-87		Trans	Auto; Complete Unit	1			EM-2512	
			Trans	Auto; Insert Only	1			EM-2525	
		Trans	Manual; Complete Unit	1			EM-2512		
	1981-82	Trans	Manual; Insert Only	1			EM-2525		
Trans		Auto; Complete Unit	1			EM-2512			
Trans		Auto; Insert Only	1			EM-2525			
		1981-82	Trans	Manual; Complete Unit	1			EM-2512	
		1981-82	Trans	Manual; Insert Only	1			EM-2525	
<b>D300 PICKUP</b>									
L6	L6 3.7L 225ci	1972-78	L & R Front		2	EM-2265			
		1969-71	L & R Front		2	EM-2266			
		1968	L & R Front		2	EM-2235			
			L & R Front		2	EM-2235			
		1963-67	L & R Front		2	EM-2235			
		1975-78	Trans	Auto; Complete Unit	1			EM-2512	
			Trans	Auto; Insert Only	1			EM-2525	
		1969-74	Trans	Auto; Complete Unit	1			EM-2512	
			Trans	Auto; Insert Only	1			EM-2525	
			Trans	Manual; Complete Unit	1			EM-2512	
			Trans	Manual; Insert Only	1			EM-2525	
		V8	V8 5.2L 318ci	1972-80	L & R Front		2	EM-2265	
1968-71	L & R Front				2	EM-2235			
1963-67	L & R Front				2	EM-2235			
1975-80	Trans			Auto; Complete Unit	1			EM-2512	
	Trans			Auto; Insert Only	1			EM-2525	
1969-74	Trans			Auto; Complete Unit	1			EM-2512	
	Trans			Auto; Insert Only	1			EM-2525	
	Trans			Manual; Complete Unit	1			EM-2512	
	Trans			Manual; Insert Only	1			EM-2525	
V8 5.9L 360ci	1979-80		L & R Front		2	EM-2469			
	1971-78		L & R Front		2	EM-2265			
	1975-80		Trans	Auto; Complete Unit	1			EM-2512	
			Trans	Auto; Insert Only	1			EM-2525	
	1971-74		Trans	Auto; Complete Unit	1			EM-2512	
			Trans	Auto; Insert Only	1			EM-2525	
Trans		Manual; Complete Unit	1			EM-2512			
		1971-74	Trans	Manual; Insert Only	1			EM-2525	
V8 6.3L 383ci	1968-71	L & R Front		2	EM-2235				
		L & R Front		2	EM-2235				
		Trans - L & R		2			EM-2302		

# Engine, Transmission, And Torque Strut Mounts

CYL	ENG. SIZE	YEAR	LOCATION	DESCRIPTION	QTY	ENGINE	TORQUE STRUT	TRANSMISSION	
<b>DODGE TRUCK (continued)</b>									
<b>D300 PICKUP (continued)</b>									
V8	V8 6.6L 400ci	1976-78	L & R Front		2	EM-2265			
		1972-74	L & R Front		2	EM-2265			
			L & R Front		2	EM-2265			
			L & R Front		2	EM-2235			
		1976-78	Trans	Auto; Complete Unit		1			EM-2512
			Trans	Auto; Insert Only		1			EM-2525
		1972-74	Trans	Auto; Complete Unit		1			EM-2512
			Trans	Auto; Insert Only		1			EM-2525
	Trans		Manual; Complete Unit		1			EM-2512	
	Trans		Manual; Insert Only		1			EM-2525	
	V8 7.2L 440ci	1973-78	L & R Front		2	EM-2265			
		1975-78	Trans	Auto; Complete Unit		1			EM-2512
			Trans	Auto; Insert Only		1			EM-2525
		1973-74	Trans	Auto; Complete Unit		1			EM-2512
Trans			Auto; Insert Only		1			EM-2525	
Trans			Manual; Complete Unit		1			EM-2512	
Trans	Manual; Insert Only		1			EM-2525			
<b>D350 PICKUP</b>									
L6	L6 5.9L 359ci Diesel	1989-93	L & R Front		2	EM-2710			
		1992-93	Trans - L & R Lower		1			EM-2667	
			Trans - L & R Upper		1			EM-2668	
V8	V8 5.2L 318ci	1981-83	L & R Front		2	EM-2469			
			Trans	Auto; Complete Unit		1		EM-2512	
			Trans	Auto; Insert Only		1		EM-2525	
			Trans	Manual; Complete Unit		1		EM-2512	
			Trans	Manual; Insert Only		1		EM-2525	
	V8 5.9L 360ci	1981-93	L & R Front		2	EM-2469			
			Trans	Auto		1		EM-2624	
		1988-93	Trans	Manual		1		EM-2624	
			Trans	Auto; Complete Unit		1		EM-2512	
			Trans	Auto; Insert Only		1		EM-2525	
			Trans	Manual; Complete Unit		1		EM-2512	
			Trans	Manual; Insert Only		1		EM-2525	
<b>DAKOTA</b>									
L4	L4 2.2L 135ci	1987-88	LH Front	Complete Unit	1	EM-2914			
			LH Front	Insert Only	1	EM-2981			
			RH Front	Complete Unit	1	EM-2913			
			RH Front	Insert Only	1	EM-2981			
			Trans	Auto; 2WD	1			EM-2624	
			Trans	Manual; 2WD	1			EM-2624	
	L4 2.5L 153ci	1989-96	LH Front	Complete Unit	1	EM-2914			
			LH Front	Insert Only	1	EM-2981			
			RH Front	Complete Unit	1	EM-2913			
			RH Front	Insert Only	1	EM-2981			
		1997-02	Trans	Auto; 2WD		1			EM-2624
			Trans	Manual; 2WD		1			EM-2624
		1989-96	Trans	Auto; 2WD		1			EM-2624
			Trans	Manual; 2WD		1			EM-2624
			Trans	Auto; 2WD		1			EM-2624
			Trans	Manual; 2WD		1			EM-2624
	V6	V6 3.7L 226ci	2004	LH Front	4WD	1	EM-2963		
RH Front				4WD	1	EM-2962			
Trans				4WD	1			EM-2858	
V6 3.9L 239ci		1991-96	L & R Front	RWD	2	EM-2652			
			L & R Front	RWD	2	EM-2652			
		1997-03	LH Front	4WD	1	EM-2963			

## Engine, Transmission, And Torque Strut Mounts

CYL	ENG. SIZE	YEAR	LOCATION	DESCRIPTION	QTY	ENGINE	TORQUE STRUT	TRANSMISSION		
<b>DODGE TRUCK (continued)</b>										
<b>DAKOTA (continued)</b>										
V6	V6 3.9L 239ci	1997-03	LH Front	RWD	1	EM-2918				
		1991-96	LH Front	4WD	1	EM-2955				
		1987-90	LH Front	4WD	1	EM-5092				
		1997-03	RH Front	4WD	1	EM-2962				
			RH Front	RWD	1	EM-3004				
		1991-96	RH Front	4WD	1	EM-2961				
		1987-90	RH Front	4WD	1	EM-2944				
		1994-96	Trans - L & R Lower	Manual; 4WD	Manual; 4WD	2			EM-2667	
		1992-93	Trans - L & R Lower	Manual; 4WD	Manual; 4WD	2			EM-2667	
		1987-91	Trans - L & R Lower	Auto; 4WD	Auto; 4WD	2			EM-2667	
		1994-96	Trans - L & R Upper	Manual; 4WD	Manual; 4WD	2			EM-2668	
		1992-93	Trans - L & R Upper	Manual; 4WD	Manual; 4WD	2			EM-2668	
		1987-91	Trans - L & R Upper	Auto; 4WD	Auto; 4WD	2			EM-2668	
		1997-03	Trans	Auto; 2WD		1			EM-2624	
			Trans	Auto; 4WD		1			EM-2858	
			Trans	Manual; 2WD		1			EM-2624	
			Trans	Manual; 4WD		1			EM-2858	
		1994-96	Trans	Auto; 2WD		1			EM-2624	
			Trans	Auto; 4WD		1			EM-2858	
			Trans	Manual; 2WD		1			EM-2954	
		1992-93	Trans	Auto; 2WD		1			EM-2624	
			Trans	Manual; 2WD		1			EM-2954	
		1987-91	Trans	Auto; 2WD		1			EM-2624	
			Trans	Manual; 2WD		1			EM-2624	
		V8	V8 4.7L 287ci	2002-04	LH Front	4WD	1	EM-3005		
					LH Front	RWD	1	EM-3035		
				2000-01	LH Front	4WD	1	EM-3005		
					LH Front	RWD	1	EM-3035		
2005-10	RH Front			2WD	1	EM-4274				
2002-04	RH Front			4WD	1	EM-3006				
	RH Front			RWD	1	EM-3036				
2000-01	RH Front			4WD	1	EM-3006				
	RH Front			RWD	1	EM-3036				
2002-04	Trans			Auto; 2WD		1			EM-2992	
	Trans			Auto; 4WD		1			EM-2858	
	Trans			Manual; 2WD		1			EM-2992	
	Trans			Manual; 4WD		1			EM-2858	
2000-01	Trans			Auto; 2WD		1			EM-2992	
	Trans			Auto; 4WD		1			EM-2858	
	Trans			Manual; 2WD		1			EM-2992	
	Trans		Manual; 4WD		1			EM-2858		
V8 5.2L 318ci	1990-96		L & R Front	RWD	2	EM-2652				
	1989		L & R Front	RWD	2	EM-2652				
	1997-99		LH Front	4WD	1	EM-2963				
		LH Front	RWD	1	EM-2917					
	1990-96	LH Front	4WD	1	EM-2953					
	1997-99	RH Front	4WD	1	EM-2962					
		RH Front	RWD	1	EM-3067					
	1990-96	RH Front	4WD	1	EM-2983					
1990-91	Trans - L & R Lower	4WD	4WD	2			EM-2667			

# Engine, Transmission, And Torque Strut Mounts

CYL	ENG. SIZE	YEAR	LOCATION	DESCRIPTION	QTY	ENGINE	TORQUE STRUT	TRANS-MISSION	
<b>DODGE TRUCK (continued)</b>									
<b>DAKOTA (continued)</b>									
V8	V8 5.2L 318ci	1990-91	Trans - L & R Upper	4WD 4WD	2			EM-2668	
		1994-96	Trans - Lower	Manual; 4WD	2			EM-2667	
		1992-93	Trans - Lower	Manual; 4WD	2			EM-2667	
		1994-96	Trans - Upper	2WD	1			EM-2954	
		1992-93	Trans - Upper	Manual; 4WD	2			EM-2624	
		1997-99	Trans	Auto; 2WD	1				EM-2991
			Trans	Auto; 4WD	1				EM-2858
			Trans	Manual; 2WD	1				EM-2991
			Trans	Manual; 4WD	1				EM-2858
		1994-96	Trans	Manual; 4WD	2			EM-2570	
		1992-93	Trans	Auto; 2WD	1			EM-2570	
			Trans	Auto; 4WD	1			EM-2624	
		1990-91	Trans	Auto; 2WD	1			EM-2624	
			Trans	Manual; 2WD	1			EM-2624	
	1989	Trans	Auto; 2WD	1			EM-2624		
	V8 5.9L 360ci	2001-03	LH Front	4WD	1	EM-3005			
			LH Front	RWD	1	EM-2917			
		2000	LH Front	4WD	1	EM-2963			
			LH Front	RWD	1	EM-2917			
		1998-99	LH Front	RWD	1	EM-2917			
		2001-03	RH Front	4WD	1	EM-3006			
			RH Front	RWD	1	EM-3067			
		2000	RH Front	4WD	1	EM-2962			
			RH Front	RWD	1	EM-3067			
		1998-99	RH Front	RWD	1	EM-3067			
		2003	Trans	2WD	1			EM-2991	
		2000-02	Trans	2WD	1			EM-2991	
			Trans	Auto; 4WD	1			EM-2858	
Trans			Manual; 4WD	1			EM-2858		
1998-99	Trans	2WD	1			EM-2991			
<b>POWER RAM 50</b>									
L4	L4 2.0L 1997cc	1983-84	RH Front		1	EM-2731			
		Trans	4WD	1			EM-8248		
	L4 2.3L 2346cc Diesel	1983-85	LH Front		1	EM-8205			
		Trans	4WD	1			EM-8096		
L4 2.6L 2555cc	1983-86	RH Front		1	EM-2731				
	Trans	4WD	1			EM-8248			
<b>RAM 50</b>									
L4	L4 2.0L 1995cc	1987-89	L & R Front	RWD	2	EM-2731			
		RH Front	4WD	1	EM-2731				
	L4 2.0L 1997cc	1983-86	L & R Front		2	EM-2731			
		1987-89	Trans	2WD	1			EM-8111	
			Trans	Auto; 4WD	1			EM-8248	
			Trans	Manual; 4WD	1			EM-8248	
	1983-86	Trans	2WD	1			EM-8111		
	L4 2.3L 2346cc Diesel	1983-85	LH Front		1	EM-8205			
			RH Front		1	EM-8205			
			Trans	2WD	1			EM-8556	
	L4 2.4L 2351cc	1990-93	L & R Front	RWD	2	EM-2731			
			LH Front	4WD	1	EM-8205			
			RH Front	4WD	1	EM-2731			
			Trans	Auto; 2WD	1			EM-9199	
Trans			Auto; 4WD	1			EM-9070		
Trans			Manual; 2WD	1			EM-8111		
Trans	Manual; 4WD	1			EM-8244				



## Engine, Transmission, And Torque Strut Mounts

CYL	ENG. SIZE	YEAR	LOCATION	DESCRIPTION	QTY	ENGINE	TORQUE STRUT	TRANSMISSION	
<b>DODGE TRUCK (continued)</b>									
<b>RAM 50 (continued)</b>									
L4	L4 2.6L 2555cc	1987-89	L & R Front	RWD	2	EM-2731			
		1983-86	L & R Front		2	EM-2731			
		1987-89	LH Front	4WD	1	EM-8205			
			RH Front	4WD	1	EM-2731			
			Trans	2WD	1			EM-8111	
		1983-86	Trans	4WD	1			EM-8096	
			Trans	Auto; 2WD	1			EM-8556	
1983-86	Trans	Manual; 2WD	1			EM-8556			
	Trans	Auto	1			EM-9070			
V6	V6 3.0L 2972cc	1990-91	Trans	Auto	1			EM-9070	
		1990-91	Trans	Manual	1			EM-8243	
<b>RAM 1500 PICKUP</b>									
V6	V6 3.7L 226ci	2008-10	LH Front		1	EM-4275			
		2002-05	LH Front		1	EM-4088			
			RH Front		1	EM-4089			
			Trans	Auto	1			EM-3066	
			Trans	Manual	1			EM-3066	
	V6 3.9L 239ci	1997-01	LH Front		1	EM-2829			
		1997-01	RH Front		1	EM-2830			
		1994-01	Trans		1			EM-2624	
	V8	V8 4.7L 287ci	2002-05	LH Front	2WD	1	EM-4086		
				LH Front	4WD	1	EM-3073		
RH Front				2WD	1	EM-4087			
RH Front				4WD	1	EM-3074			
2006-08			Trans	4WD	1			EM-4002	
2002-05			Trans	Auto; 4WD	1			EM-3066	
			Trans	Manual; 4WD	1			EM-3066	
V8 5.2L 318ci		1994-01	LH Front		1	EM-2829			
			RH Front		1	EM-2830			
			Trans	Auto	1			EM-2852	
			Trans	Manual	1			EM-2852	
V8 5.7L 345ci		2006-07	LH Front	Complete Unit; 2WD	1	EM-4084			
			LH Front	Insert; 2WD	1	EM-4006			
		2003-05	LH Front	4WD	1	EM-3073			
			LH Front	RWD	1	EM-4084			
		2006-07	RH Front	Complete Unit; 2WD	1	EM-4085			
			RH Front	Insert; 2WD	1	EM-4007			
		2003-05	RH Front	4WD	1	EM-3074			
			RH Front	RWD	1	EM-4085			
		2006-08	Trans	4WD; Auto	1			EM-4002	
		2003-05	Trans	Auto	1			EM-3066	
			Trans	Manual	1			EM-3066	
V8 5.9L 360ci	2002-03	LH Front	4WD	1	EM-3073				
		1996-01	LH Front		1	EM-2829			
	1994-95	LH Front		1	EM-2829				
	2002-03	RH Front	4WD	1	EM-3074				
	1996-01	RH Front		1	EM-2830				
	1994-95	RH Front		1	EM-2830				
	2002-03	Trans	Auto	1			EM-3066		
		Trans	Manual	1			EM-3066		
	1994-01	Trans	Auto	1			EM-2852		
		Trans	Manual	1			EM-2852		
<b>RAM 2500 PICKUP</b>									
L6	L6 5.9L 359ci Diesel	2006-07	L & R Front		2	EM-4018			
		2003-05	L & R Front		2	EM-4018			
		2008-10	Left		1	EM-4090			
		2000-02	Left		1	EM-4031			

# Engine, Transmission, And Torque Strut Mounts

CYL	ENG. SIZE	YEAR	LOCATION	DESCRIPTION	QTY	ENGINE	TORQUE STRUT	TRANSMISSION	
<b>DODGE TRUCK (continued)</b>									
<b>RAM 2500 PICKUP (continued)</b>									
L6	L6 5.9L 359ci Diesel	2007-10	Trans	Auto	1			EM-4060	
			Trans	Manual	1			EM-4060	
		2003-06	Trans	Auto	1			EM-3066	
			Trans	Manual	1			EM-3066	
		1994-02	Trans	Auto	1			EM-2852	
	Trans		Manual	1			EM-2852		
	L6 6.7L 408ci Diesel	2007-10	LH Front	4WD	1	EM-4090			
			RH Front		1	EM-4091			
	V8	V8 5.2L 318ci	1994-96	LH Front		1	EM-2829		
				RH Front		1	EM-2830		
1996			Trans	Auto	1			EM-2852	
			Trans	Manual	1			EM-2852	
V8 5.7L 345ci		2006-07	L & R Front	Exc. Extended Crew Cab	2	EM-4018			
			L & R Front	Exc. Extended Crew Cab	2	EM-4018			
		2006-10	Trans	Auto	1			EM-4060	
			Trans	Manual	1			EM-4060	
		2003-05	Trans	Auto	1			EM-4151	
			Trans	Manual	1			EM-4151	
V8 5.9L 360ci		2002	LH Front	4WD	1	EM-3073			
			LH Front		1	EM-2829			
		1994-01	RH Front	4WD	1	EM-3074			
			RH Front		1	EM-2830			
		2001-02	Trans	Auto	1			EM-2852	
			Trans	Manual	1			EM-2852	
		1994-00	Trans	Auto	1			EM-2852	
			Trans	Manual	1			EM-2852	
V10	V10 8.0L 488ci	2003	L & R Front		2	EM-4018			
			LH Front		1	EM-2829			
		1994-02	RH Front		1	EM-2830			
			Trans	Auto	1			EM-2852	
		1994-03	Trans	Manual	1			EM-2852	
			Trans	Manual	1			EM-2852	
<b>RAM 3500 PICKUP</b>									
L6	L6 5.9L 359ci Diesel	2006-07	L & R Front		2	EM-4018			
			L & R Front		2	EM-4018			
		2003-05	L & R Front		2	EM-4018			
			Left		1	EM-4031			
		2000-02	L & R Front		2	EM-4018			
			L & R Front		2	EM-4018			
		2007-10	Trans	Auto	1			EM-4060	
			Trans	Manual	1			EM-4060	
		2003-06	Trans	Auto	1			EM-3066	
			Trans	Manual	1			EM-3066	
	1994-02	Trans	Auto	1			EM-2852		
		Trans	Manual	1			EM-2852		
	L6 6.7L 408ci Diesel	2007-09	LH Front		1	EM-4090			
			RH Front		1	EM-4091			
2007-10		Trans	Auto	1			EM-4060		
		Trans	Manual	1			EM-4060		
V8	V8 5.7L 345ci	2006-07	L & R Front	Exc. Extended Crew Cab	2	EM-4018			
			L & R Front	Exc. Extended Crew Cab	2	EM-4018			
		2006-08	Trans	Auto	1			EM-4060	
			Trans	Manual	1			EM-4060	
		2003-05	Trans	Auto	1			EM-4151	
			Trans	Manual	1			EM-4151	
	V8 5.9L 360ci	2002	LH Front		1	EM-2829			
			LH Front	Gas	1	EM-2829			
		1994-01	RH Front	4WD	1	EM-3074			
			RH Front	Gas	1	EM-2830			
		2001-02	Trans	Auto	1			EM-2852	
			Trans	Manual	1			EM-2852	

## Engine, Transmission, And Torque Strut Mounts

CYL	ENG. SIZE	YEAR	LOCATION	DESCRIPTION	QTY	ENGINE	TORQUE STRUT	TRANS-MISSION	
<b>DODGE TRUCK (continued)</b>									
<b>RAM 3500 PICKUP (continued)</b>									
V8	V8 5.9L 360ci	1994-00	Trans	Auto	1			EM-2852	
			Trans	Manual	1			EM-2852	
V10	V10 8.0L 488ci	2003	L & R Front		2	EM-4018			
		1994-02	LH Front		1	EM-2829			
			RH Front		1	EM-2830			
		1994-03	Trans	Auto		1			EM-2852
			Trans	Manual		1			EM-2852
<b>RAMPAGE</b>									
L4	L4 2.2L 135ci	1982-84	Front		1	EM-2447			
			RH Front		1	EM-2600			
		1984	Trans		1			EM-2617	
		1982-83	Trans	Auto		1			EM-2600
<b>RD200 PICKUP</b>									
V8	V8 5.2L 318ci	1980	L & R Front		2	EM-2469			
		1979	L & R Front		2	EM-2469			
		1978	L & R Front		2	EM-2265			
		1980	Trans	Complete Unit		1			EM-2512
			Trans	Insert Only		1			EM-2525
		1978-79	Trans	Complete Unit		1			EM-2512
			Trans	Insert Only		1			EM-2525
		V8 5.9L 360ci	1980	L & R Front		2	EM-2469		
	1979		L & R Front		2	EM-2469			
	1978		L & R Front		2	EM-2265			
	1980		Trans	Complete Unit		1			EM-2512
			Trans	Insert Only		1			EM-2525
	1978-79		Trans	Complete Unit		1			EM-2512
	Trans	Insert Only		1				EM-2525	
<b>W100 PICKUP</b>									
L6	L6 3.7L 225ci	1986-87	L & R Front		2	EM-2469			
		1972-77	L & R Front		2	EM-2265			
		1969-71	L & R Front		2	EM-2266			
		1968	L & R Front		2	EM-2235			
		1986-87	Trans - Lower	Auto		2			EM-2668
			Trans - Lower	Manual		2			EM-2668
		1974-77	Trans - Lower	Auto		2			EM-2668
			Trans - Lower	Manual		2			EM-2668
		1986-87	Trans - Upper	Auto		2			EM-2667
		1974-77	Trans - Upper	Auto		2			EM-2667
		1969-73	Trans	Auto; Complete Unit		1			EM-2512
			Trans	Auto; Insert Only		1			EM-2525
			Trans	Manual; Complete Unit		1			EM-2512
			Trans	Manual; Insert Only		1			EM-2525
V6	V6 3.9L 239ci	1989	L & R Front		2	EM-2469			
			Trans - Lower	Auto		2		EM-2668	
			Trans - Lower	Manual		2		EM-2668	
			Trans - Upper	Auto		2		EM-2667	
V8	V8 5.2L 318ci	1986-89	L & R Front		2	EM-2469			
		1972-77	L & R Front		2	EM-2265			
		1969-71	L & R Front		2	EM-2266			
		1968	L & R Front		2	EM-2235			
		1963-67	L & R Front		2	EM-2235			
		1986-89	Trans - Lower	Auto		2			EM-2668
			Trans - Lower	Manual		2			EM-2668
		1974-77	Trans - Lower	Auto		2			EM-2668
			Trans - Lower	Manual		2			EM-2668
		1986-89	Trans - Upper	Auto		2			EM-2667

# Engine, Transmission, And Torque Strut Mounts

CYL	ENG. SIZE	YEAR	LOCATION	DESCRIPTION	QTY	ENGINE	TORQUE STRUT	TRANSMISSION	
<b>DODGE TRUCK (continued)</b>									
<b>W100 PICKUP (continued)</b>									
V8	V8 5.2L 318ci	1974-77	Trans - Upper	Auto	2			EM-2667	
		1972-73	Trans	Auto; Complete Unit	1			EM-2512	
			Trans	Auto; Insert Only	1			EM-2525	
			Trans	Manual; Complete Unit	1			EM-2512	
			Trans	Manual; Insert Only	1			EM-2525	
	V8 5.9L 360ci	1986-88	L & R Front			2	EM-2469		
		1972-77	L & R Front			2	EM-2265		
		1986-88	Trans - Lower	Auto		2			EM-2668
			Trans - Lower	Manual		2			EM-2668
		1972-77	Trans - Lower	Auto		2			EM-2668
			Trans - Lower	Manual		2			EM-2668
		1986-88	Trans - Upper	Auto		2			EM-2667
	1972-77	Trans - Upper	Auto		2			EM-2667	
	V8 6.3L 383ci	1969-71	L & R Front			2	EM-2235		
	V8 6.6L 400ci	1974-77	L & R Front			2	EM-2265		
		1971	L & R Front			2	EM-2235		
		1974-77	Trans	Auto; Complete Unit		1			EM-2512
			Trans	Auto; Insert Only		1			EM-2525
			Trans	Manual; Complete Unit		1			EM-2512
	1971	Trans	Manual; Insert Only		1			EM-2525	
1971	Trans			1			EM-2235		
V8 7.2L 440ci	1974-77	L & R Front			2	EM-2265			
		Trans	Auto; Complete Unit		1			EM-2512	
		Trans	Auto; Insert Only		1			EM-2525	
		Trans	Manual; Complete Unit		1			EM-2512	
		Trans	Manual; Insert Only		1			EM-2525	
<b>W150 PICKUP</b>									
L6	L6 3.7L 3687cc	1982-87	L & R Front		2	EM-2469			
		1978-81	L & R Front		2	EM-2265			
		1978-87	Trans - Lower	Auto		2			EM-2668
			Trans - Lower	Manual		2			EM-2668
			Trans - Upper	Auto		2			EM-2667
L6 4.0L 243ci Diesel	1979	L & R Front			2	EM-2469			
	1978	L & R Front			2	EM-2265			
V6	V6 3.9L 239ci	1989-93	L & R Front		2	EM-2469			
		Trans - Lower	Auto		2			EM-2668	
		Trans - Lower	Manual		2			EM-2668	
V8	V8 5.2L 318ci	1979-93	L & R Front		2	EM-2469			
		1977-78	L & R Front		2	EM-2265			
		1977-93	Trans - Lower	Auto		2			EM-2668
			Trans - Lower	Manual		2			EM-2668
			Trans - Upper	Auto		2			EM-2667
	V8 5.9L 360ci	1993	L & R Front			2	EM-2469		
		1984-91	L & R Front			2	EM-2469		
		1979-81	L & R Front			2	EM-2469		
		1977-78	L & R Front			2	EM-2265		
		1993	Trans - Lower	Auto		2			EM-2668
			Trans - Lower	Manual		2			EM-2668
		1977-91	Trans - Lower	Auto		2			EM-2668
			Trans - Lower	Manual		2			EM-2668
		1993	Trans - Upper	Auto		2			EM-2667
	1977-91	Trans - Upper	Auto		2			EM-2667	
V8 6.6L 400ci	1977-78	L & R Front			2	EM-2265			
		Trans	Auto; Complete Unit		1			EM-2512	
		Trans	Auto; Insert Only		1			EM-2525	
		Trans	Manual; Complete Unit		1			EM-2512	

## Engine, Transmission, And Torque Strut Mounts

CYL	ENG. SIZE	YEAR	LOCATION	DESCRIPTION	QTY	ENGINE	TORQUE STRUT	TRANSMISSION
<b>DODGE TRUCK (continued)</b>								
<b>W150 PICKUP (continued)</b>								
V8	V8 6.6L 400ci	1977-78	Trans	Manual; Insert Only	1			EM-2525
	V8 7.2L 440ci	1978	L & R Front		2	EM-2265		
			Trans	Auto; Complete Unit	1			EM-2512
			Trans	Auto; Insert Only	1			EM-2525
			Trans	Manual; Complete Unit	1			EM-2512
			Trans	Manual; Insert Only	1			EM-2525
<b>W200 PICKUP</b>								
L6	L6 3.7L 225ci	1972-80	L & R Front		2	EM-2265		
		1969-71	L & R Front		2	EM-2266		
		1974-80	Trans - Lower	Auto	2			EM-2668
			Trans - Lower	Manual	2			EM-2668
			Trans - Upper	Auto	2			EM-2667
		1972-73	Trans	Auto; Complete Unit	1			EM-2512
			Trans	Auto; Insert Only	1			EM-2525
			Trans	Manual; Complete Unit	1			EM-2512
			Trans	Manual; Insert Only	1			EM-2525
	L6 4.0L 243ci Diesel	1979	L & R Front		2	EM-2469		
		1978	L & R Front		2	EM-2265		
V8	V8 5.2L 318ci	1979-80	L & R Front		2	EM-2469		
		1972-78	L & R Front		2	EM-2265		
		1969-71	L & R Front		2	EM-2235		
		1963-67	L & R Front		2	EM-2235		
		1974-80	Trans - Lower	Auto	2			EM-2668
			Trans - Lower	Manual	2			EM-2668
			Trans - Upper	Auto	2			EM-2667
		1972-73	Trans	Auto; Complete Unit	1			EM-2512
			Trans	Auto; Insert Only	1			EM-2525
			Trans	Manual; Complete Unit	1			EM-2512
			Trans	Manual; Insert Only	1			EM-2525
		V8 5.9L 360ci	1979-80	L & R Front		2	EM-2469	
	1972-78		L & R Front		2	EM-2265		
	1971		L & R Front		2	EM-2235		
	1972-80		Trans - Lower	Auto	2			EM-2668
			Trans - Lower	Manual	2			EM-2668
	Trans - Upper	Auto	2			EM-2667		
	V8 6.3L 383ci	1969-71	L & R Front		2	EM-2235		
	V8 6.6L 400ci	1976-78	L & R Front		2	EM-2265		
		1974	L & R Front		2	EM-2265		
		1971	L & R Front		2	EM-2235		
		1976-78	Trans	Auto; Complete Unit	1			EM-2512
			Trans	Auto; Insert Only	1			EM-2525
			Trans	Manual; Complete Unit	1			EM-2512
			Trans	Manual; Insert Only	1			EM-2525
		1974	Trans	Auto; Complete Unit	1			EM-2512
			Trans	Auto; Insert Only	1			EM-2525
			Trans	Manual; Complete Unit	1			EM-2512
	Trans	Manual; Insert Only	1			EM-2525		
	V8 7.2L 440ci	1974-78	L & R Front		2	EM-2265		
Trans			Auto; Complete Unit	1			EM-2512	
Trans			Auto; Insert Only	1			EM-2525	
Trans			Manual; Complete Unit	1			EM-2512	
Trans			Manual; Insert Only	1			EM-2525	
<b>W250 PICKUP</b>								
L6	L6 5.9L 359ci Diesel	1989-93	L & R Front		2	EM-2710		
			Trans - Lower	Auto	2			EM-2668
			Trans - Lower	Manual	2			EM-2668

# Engine, Transmission, And Torque Strut Mounts

CYL	ENG. SIZE	YEAR	LOCATION	DESCRIPTION	QTY	ENGINE	TORQUE STRUT	TRANSMISSION	
<b>DODGE TRUCK (continued)</b>									
<b>W250 PICKUP (continued)</b>									
L6	L6 5.9L 359ci Diesel	1989-93	Trans - Upper	Auto	2			EM-2667	
V8	V8 5.2L 318ci	1981-93	L & R Front		2	EM-2469			
		1985-93	Trans - Lower	Auto	2			EM-2668	
			Trans - Lower	Manual	2			EM-2668	
		1981-84	Trans - Lower	Auto	2				EM-2668
			Trans - Lower	Manual	2				EM-2668
		1985-93	Trans - Upper	Auto	2				EM-2667
	1981-84	Trans - Upper	Auto	2				EM-2667	
	V8 5.9L 360ci	1984-93	L & R Front		2	EM-2469			
		1981-82	L & R Front		2	EM-2469			
		1984-93	Trans - Lower	Auto	2				EM-2668
			Trans - Lower	Manual	2				EM-2668
		1981-82	Trans - Lower	Auto	2				EM-2668
			Trans - Lower	Manual	2				EM-2668
		1984-93	Trans - Upper	Auto	2				EM-2667
1981-82		Trans - Upper	Auto	2				EM-2667	
<b>W300 PICKUP</b>									
L6	L6 3.7L 225ci	1972-78	L & R Front		2	EM-2265			
		1969-71	L & R Front		2	EM-2266			
		1968	L & R Front		2	EM-2235			
		1974-78	Trans - Lower	Auto	2				EM-2668
			Trans - Lower	Manual	2				EM-2668
			Trans - Upper	Auto	2				EM-2667
		1972-73	Trans	Auto; Complete Unit	1				EM-2512
			Trans	Auto; Insert Only	1				EM-2525
			Trans	Manual; Complete Unit	1				EM-2512
			Trans	Manual; Insert Only	1				EM-2525
V8	V8 5.2L 318ci	1980	L & R Front		2	EM-2469			
		1972-78	L & R Front		2	EM-2265			
		1969-71	L & R Front		2	EM-2266			
		1968	L & R Front		2	EM-2235			
		1963-67	L & R Front		2	EM-2235			
		1980	Trans - Lower	Auto	2				EM-2668
		1974-78	Trans - Lower	Auto	2				EM-2668
			Trans - Lower	Manual	2				EM-2668
		1980	Trans - Upper	Auto	2				EM-2667
		1974-78	Trans - Upper	Auto	2				EM-2667
		1972-73	Trans	Auto; Complete Unit	1				EM-2512
			Trans	Auto; Insert Only	1				EM-2525
			Trans	Manual; Complete Unit	1				EM-2512
			Trans	Manual; Insert Only	1				EM-2525
	V8 5.9L 360ci	1979-80	L & R Front		2	EM-2469			
		1972-78	L & R Front		2	EM-2265			
		1971	L & R Front		2	EM-2235			
		1980	Trans - Lower	Auto	2				EM-2668
		1972-79	Trans - Lower	Auto	2				EM-2668
			Trans - Lower	Manual	2				EM-2668
		1980	Trans - Upper	Auto	2				EM-2667
		1972-79	Trans - Upper	Auto	2				EM-2667
	V8 6.3L 383ci	1971	L & R Front		2	EM-2235			
		1968-69	L & R Front		2	EM-2235			
V8 6.6L 400ci	1976-78	L & R Front		2	EM-2265				
		Trans	Auto; Complete Unit	1				EM-2512	
		Trans	Auto; Insert Only	1				EM-2525	
		Trans	Manual; Complete Unit	1				EM-2512	
	Trans	Manual; Insert Only	1				EM-2525		
V8 7.2L 440ci	1975-78	L & R Front		2	EM-2265				

# Engine, Transmission, And Torque Strut Mounts

CYL	ENG. SIZE	YEAR	LOCATION	DESCRIPTION	QTY	ENGINE	TORQUE STRUT	TRANSMISSION
<b>DODGE TRUCK (continued)</b>								
<b>W300 PICKUP (continued)</b>								
V8	V8 7.2L 440ci	1975-78	Trans	Auto; Complete Unit	1			EM-2512
			Trans	Auto; Insert Only	1			EM-2525
			Trans	Manual; Complete Unit	1			EM-2512
			Trans	Manual; Insert Only	1			EM-2525
<b>W350 PICKUP</b>								
L6	L6 5.9L 359ci Diesel	1989-93	L & R Front		2	EM-2710		
			Trans - Lower	Auto	2			EM-2668
			Trans - Lower	Manual	2			EM-2668
			Trans - Upper	Auto	2			EM-2667
V8	V8 5.2L 318ci	1982-83	L & R Front		2	EM-2469		
			Trans - Lower	Auto	2			EM-2668
			Trans - Lower	Manual	2			EM-2668
			Trans - Upper	Auto	2			EM-2667
	V8 5.9L 360ci	1981-93	L & R Front		2	EM-2469		
			Trans - Lower	Auto	2			EM-2668
			Trans - Lower	Manual	2			EM-2668
			Trans - Upper	Auto	2			EM-2667
<b>DODGE VAN</b>								
<b>A100</b>								
L6	L6 2.8L 170ci	1964-66	LH Front		1	EM-2235		
			RH Front		1	EM-2234		
	L6 3.7L 3687cc	1964-66	LH Front		1	EM-2235		
			RH Front		1	EM-2234		
V8	V8 4.5L 273ci	1964-66	L & R Front		2	EM-2338		
	V8 5.2L 318ci	1970	L & R Front		2	EM-2338		
<b>A108 VAN</b>								
L6	L6 2.8L 170ci	1967-69	LH Front		1	EM-2235		
			RH Front		1	EM-2234		
	L6 3.2L 198ci	1970	LH Front		1	EM-2235		
			RH Front		1	EM-2234		
	L6 3.7L 225ci	1967-70	LH Front		1	EM-2235		
			RH Front		1	EM-2234		
<b>B100 VAN</b>								
L6	L6 3.2L 198ci	1971	LH Front		1	EM-2235		
			RH Front		1	EM-2234		
			Trans	Auto; Complete Unit	1			EM-2512
			Trans	Auto; Insert	1			EM-2525
			Trans	Manual; Complete Unit	1			EM-2512
			Trans	Manual; Insert	1			EM-2525
	L6 3.7L 225ci	1971-80	L & R Front		2	EM-2266		
			Trans	Auto; Complete Unit	1			EM-2512
			Trans	Auto; Insert	1			EM-2525
			Trans	Manual; Complete Unit	1			EM-2512
	L6 3.7L 3687cc	1979-80	L & R Front		2	EM-2469		
			L & R Front		2	EM-2265		
			L & R Front		2	EM-2469		
			L & R Front		2	EM-2265		
V8	V8 5.2L 318ci	1971-80	L & R Front		2	EM-2266		
			Trans	Auto; Complete Unit	1			EM-2512
			Trans	Auto; Insert	1			EM-2525
			Trans	Manual; Complete Unit	1			EM-2512
			Trans	Manual; Insert	1			EM-2525
			V8 5.9L 360ci	1976-78	L & R Front		2	EM-2265
L & R Front		2			EM-2265			

# Engine, Transmission, And Torque Strut Mounts

CYL	ENG. SIZE	YEAR	LOCATION	DESCRIPTION	QTY	ENGINE	TORQUE STRUT	TRANS-MISSION
<b>DODGE VAN (continued)</b>								
<b>B100 VAN (continued)</b>								
V8	V8 5.9L 360ci	1971	L & R Front		2	EM-2266		
			1976-78	Trans	Auto; Complete Unit	1		EM-2512
				Trans	Auto; Insert	1		EM-2525
				Trans	Manual; Complete Unit	1		EM-2512
		Trans		Manual; Insert	1		EM-2525	
		1971-74	Trans	Auto; Complete Unit	1		EM-2512	
			Trans	Auto; Insert	1		EM-2525	
			Trans	Manual; Complete Unit	1		EM-2512	
	Trans		Manual; Insert	1		EM-2525		
	V8 7.2L 440ci		1974	L & R Front		2	EM-2265	
		Trans		Auto; Complete Unit	1		EM-2512	
		Trans		Auto; Insert	1		EM-2525	
		Trans		Manual; Complete Unit	1		EM-2512	
Trans		Manual; Insert		1		EM-2525		
<b>B150 VAN</b>								
L6	L6 3.7L 3687cc	1981-87	L & R Front		2	EM-2469		
			Trans	Auto; Complete Unit	1		EM-2512	
			Trans	Auto; Insert	1		EM-2525	
			Trans	Manual; Complete Unit	1		EM-2512	
			Trans	Manual; Insert	1		EM-2525	
V6	V6 3.9L 239ci	1994	L & R Front		2	EM-2469		
			1992-93	L & R Front		2	EM-2652	
		1988-91	L & R Front		2	EM-2469		
			1994	Trans		1		EM-2624
		1992-93	Trans	Auto	1		EM-2624	
			Trans	Manual	1		EM-2982	
		1988-91	Trans	Auto	1		EM-2624	
			Trans	Manual	1		EM-2624	
V8	V8 5.2L 318ci	1981-94	L & R Front		2	EM-2469		
			1994	Trans	Auto	1		EM-2624
		1988-93	Trans	Auto	1		EM-2624	
			Trans	Manual	1		EM-2624	
		1981-87	Trans	Auto; Complete Unit	1		EM-2512	
			Trans	Auto; Insert	1		EM-2525	
			Trans	Manual; Complete Unit	1		EM-2512	
			Trans	Manual; Insert	1		EM-2525	
<b>B200 VAN</b>								
L6	L6 3.2L 198ci	1971	L & R Front		2	EM-2266		
			Trans	Auto; Complete Unit	1		EM-2512	
			Trans	Auto; Insert	1		EM-2525	
			Trans	Manual; Complete Unit	1		EM-2512	
			Trans	Manual; Insert	1		EM-2525	
	L6 3.7L 225ci	1979-80	L & R Front		2	EM-2469		
			1971	L & R Front		2	EM-2266	
		1971-80	Trans	Auto; Complete Unit	1		EM-2512	
			Trans	Auto; Insert	1		EM-2525	
			Trans	Manual; Complete Unit	1		EM-2512	
			Trans	Manual; Insert	1		EM-2525	
	L6 3.7L 3687cc	1972-78	L & R Front		2	EM-2265		
			V8	V8 5.2L 318ci	1979-80	L & R Front		2
1972-78	L & R Front		2		EM-2265			
1971	L & R Front		2		EM-2266			
1971-80	Trans	Auto; Complete Unit	1			EM-2512		
	Trans	Auto; Insert	1			EM-2525		
	Trans	Manual; Complete Unit	1			EM-2512		
Trans	Manual; Insert	1		EM-2525				



## Engine, Transmission, And Torque Strut Mounts

CYL	ENG. SIZE	YEAR	LOCATION	DESCRIPTION	QTY	ENGINE	TORQUE STRUT	TRANSMISSION
<b>DODGE VAN (continued)</b>								
<b>B200 VAN (continued)</b>								
V8	V8 5.9L 360ci	1979-80	L & R Front		2	EM-2469		
		1972-78	L & R Front		2	EM-2265		
		1971	L & R Front		2	EM-2266		
		1971-80	Trans	Auto; Complete Unit	1			EM-2512
			Trans	Auto; Insert	1			EM-2525
			Trans	Manual; Complete Unit	1			EM-2512
			Trans	Manual; Insert	1			EM-2525
	V8 6.6L 400ci	1976-78	L & R Front		2	EM-2265		
		1974	L & R Front		2	EM-2265		
		1976-78	Trans	Auto; Complete Unit	1			EM-2512
			Trans	Auto; Insert	1			EM-2525
			Trans	Manual; Complete Unit	1			EM-2512
			Trans	Manual; Insert	1			EM-2525
		1974	Trans	Auto; Complete Unit	1			EM-2512
			Trans	Auto; Insert	1			EM-2525
	Trans		Manual; Complete Unit	1			EM-2512	
	Trans		Manual; Insert	1			EM-2525	
V8 7.2L 440ci	1974-78	L & R Front		2	EM-2265			
<b>B250 VAN</b>								
L6	L6 3.7L 3687cc	1981-87	L & R Front		2	EM-2469		
			Trans	Complete Unit	1		EM-2512	
			Trans	Insert Only	1		EM-2525	
V6	V6 3.9L 239ci	1994	L & R Front		2	EM-2469		
		1992-93	L & R Front		2	EM-2652		
		1988-91	L & R Front		2	EM-2469		
		1994	Trans		1		EM-2624	
		1992-93	Trans		1		EM-2624	
		1988-91	Trans		1		EM-2624	
V8	V8 5.2L 318ci	1981-94	L & R Front		2	EM-2469		
		1988-94	Trans		1		EM-2624	
		1981-87	Trans	Complete Unit	1		EM-2512	
			Trans	Insert Only	1		EM-2525	
		V8 5.9L 360ci	1984-94	L & R Front		2	EM-2469	
	1981		L & R Front		2	EM-2469		
	1988-94		Trans		1		EM-2624	
	1984-87		Trans	Complete Unit	1		EM-2512	
			Trans	Insert Only	1		EM-2525	
	1981		Trans	Complete Unit	1		EM-2512	
	Trans	Insert Only	1		EM-2525			
<b>B300 VAN</b>								
L6	L6 3.7L 225ci	1971	L & R Front		2	EM-2266		
		1971-80	Trans	Auto; Complete Unit	1		EM-2512	
			Trans	Auto; Insert	1		EM-2525	
			Trans	Manual; Complete Unit	1		EM-2512	
			Trans	Manual; Insert	1		EM-2525	
	L6 3.7L 3687cc	1979-80	L & R Front		2	EM-2469		
		1972-78	L & R Front		2	EM-2265		
V8	V8 5.2L 318ci	1979-80	L & R Front		2	EM-2469		
		1972-78	L & R Front		2	EM-2265		
		1971	L & R Front		2	EM-2266		
		1971-80	Trans	Auto; Complete Unit	1		EM-2512	
			Trans	Auto; Insert	1		EM-2525	
			Trans	Manual; Complete Unit	1		EM-2512	
			Trans	Manual; Insert	1		EM-2525	
	V8 5.9L 360ci	1979-80	L & R Front		2	EM-2469		
		1972-78	L & R Front		2	EM-2265		

# Engine, Transmission, And Torque Strut Mounts

CYL	ENG. SIZE	YEAR	LOCATION	DESCRIPTION	QTY	ENGINE	TORQUE STRUT	TRANSMISSION
<b>DODGE VAN (continued)</b>								
<b>B300 VAN (continued)</b>								
V8	V8 5.9L 360ci	1971	L & R Front		2	EM-2266		
		1971-80	Trans	Auto; Complete Unit	1			EM-2512
			Trans	Auto; Insert	1			EM-2525
			Trans	Manual; Complete Unit	1			EM-2512
			Trans	Manual; Insert	1			EM-2525
	V8 6.6L 400ci	1976-78	L & R Front		2	EM-2265		
		Trans	Auto; Complete Unit	1			EM-2512	
		Trans	Auto; Insert	1			EM-2525	
		Trans	Manual; Complete Unit	1			EM-2512	
		Trans	Manual; Insert	1			EM-2525	
	V8 7.2L 440ci	1975-78	L & R Front		2	EM-2265		
	<b>B350 VAN</b>							
V8	V8 5.2L 318ci	1981-94	L & R Front		2	EM-2469		
		1988-94	Trans		1			EM-2624
		1981-87	Trans	Complete Unit	1			EM-2512
			Trans	Insert Only	1			EM-2525
	V8 5.9L 360ci	1981-94	L & R Front		2	EM-2469		
		1988-94	Trans		1			EM-2624
		1981-87	Trans	Complete Unit	1			EM-2512
			Trans	Insert Only	1			EM-2525
<b>B1500 VAN</b>								
V6	V6 3.9L 239ci	1995-98	L & R Front		2	EM-2469		
			Trans		1			EM-2624
V8	V8 5.2L 318ci	1995-98	L & R Front		2	EM-2469		
			Trans		1			EM-2624
	V8 5.9L 360ci	1998	L & R Front		2	EM-2469		
			Trans		1			EM-2624
<b>B2500 VAN</b>								
V6	V6 3.9L 239ci	1995-97	L & R Front		2	EM-2469		
			Trans		1			EM-2624
V8	V8 5.2L 318ci	1995-98	L & R Front		2	EM-2469		
			Trans		1			EM-2624
	V8 5.9L 360ci	1995-98	L & R Front		2	EM-2469		
			Trans		1			EM-2624
<b>B3500 VAN</b>								
V8	V8 5.2L 318ci	1995-98	L & R Front		2	EM-2469		
			Trans		1			EM-2624
	V8 5.9L 360ci	1995-98	L & R Front		2	EM-2469		
			Trans		1			EM-2624
<b>CARAVAN</b>								
L4	L4 2.2L 135ci	1984-87	Front		1	EM-2493		
			RH Front		1	EM-2600		
			Torq Str - Front	Manual	1		EM-2491	
			Trans		1			EM-2617
	L4 2.4L 148ci	2003-07 2001-02 2003-07 2001-02 1996-00 2003-07 2001-02 1996-00	Front		1	EM-2928		
			Front		1	EM-2928		
			RH Front		1	EM-4004		
			RH Front		1	EM-4003		
			RH Front	Complete Unit	1	EM-2959		
			RH Front	Insert	1	EM-2844		
			Trans - Center		1			EM-2925
			Trans - Center		1			EM-2925
			Trans - Center	Auto, Complete Unit	1			EM-2984
Trans - Center	Auto; Insert	1			EM-2845			
Trans - LH Front	Auto, Complete Unit	1			EM-2960			

# Engine, Transmission, And Torque Strut Mounts

CYL	ENG. SIZE	YEAR	LOCATION	DESCRIPTION	QTY	ENGINE	TORQUE STRUT	TRANS-MISSION
<b>DODGE VAN (continued)</b>								
<b>CARAVAN (continued)</b>								
L4	L4 2.4L 148ci	1996-00	Trans - LH Rear	Auto, Complete Unit	1			EM-3017
			Trans - LH Rear	Auto; Insert	1		EM-2849	
		2003-07	Trans - Rear		1		EM-2927	
		2001-02	Trans - Rear		1		EM-2927	
	L4 2.5L 153ci	1991-95	Front		1	EM-2615		
			1988-90	Front		1	EM-2493	
			1991-95	RH Front		1	EM-2616	
			1988-90	RH Front		1	EM-2600	
			1991-95	Trans		1		EM-2618
	L4 2.6L 156ci	1984-87	Front		1	EM-2493		
			RH Front		1	EM-2600		
			Trans		1		EM-2617	
	V6	V6 3.0L 181ci	1990-95	Front		1	EM-2615	
1987-89				Front		1	EM-2493	
1996-00			RH Front	Complete Unit	1	EM-2959		
			RH Front	Insert	1	EM-2844		
1990-95			RH Front	Hydraulic Mount	1	EM-2711		
			RH Front	Rubber Mount	1	EM-2616		
1987-89			RH Front		1	EM-2600		
1996-00			Trans - Center	Auto, Complete Unit	1		EM-2984	
			Trans - Center	Auto; Insert	1		EM-2845	
			Trans - LH Front	Auto, Complete Unit	1		EM-2960	
			Trans - LH Front	Auto; Insert	1		EM-2849	
			Trans - LH Rear	Auto, Complete Unit	1		EM-3017	
			Trans - LH Rear	Auto; Insert	1		EM-2849	
1990-95			Trans	Auto	1		EM-2618	
1987-89			Trans	Auto	1		EM-2617	
V6 3.3L 201ci			1990-95	Front	FWD	1	EM-2615	
				2001-06	RH Front		1	EM-2926*
			1996-00	RH Front	Complete Unit	1	EM-2959	
		RH Front		Insert	1	EM-2844		
		1990-95	RH Front	FWD, Solid Mount	1	EM-2616		
			RH Front	Hydraulic Mount; FWD	1	EM-2711		
		2001-07	Trans - Center		1		EM-2925	
		1996-00	Trans - Center	Auto, Complete Unit	1		EM-2984	
			Trans - Center	Auto; Insert	1		EM-2845	
		2001-07	Trans - LH Front		1		EM-2928	
		1996-00	Trans - LH Front	Auto, Complete Unit	1		EM-2960	
			Trans - LH Front	Auto; Insert	1		EM-2849	
		2001-07	Trans - LH Rear		1		EM-2927	
		1996-00	Trans - LH Rear	Auto, Complete Unit	1		EM-3017	
Trans - LH Rear			Auto; Insert	1		EM-2849		
1991-95		Trans		1		EM-2618		
1990		Trans	FWD	1		EM-2618		
V6 3.8L 230ci		1996-99	RH Front	Complete Unit	1	EM-2959		
			RH Front	Insert	1	EM-2844		
			Trans - Center	Auto, Complete Unit	1		EM-2984	
			Trans - Center	Auto; Insert	1		EM-2845	
			Trans - LH Front	Auto, Complete Unit	1		EM-2960	
			Trans - LH Front	Auto; Insert	1		EM-2849	
			Trans - LH Rear	Auto, Complete Unit	1		EM-3017	
			Trans - LH Rear	Auto; Insert	1		EM-2849	

\* = Hydraulic Mount, "S" suffix = solid replacement.

# Engine, Transmission, And Torque Strut Mounts

CYL	ENG. SIZE	YEAR	LOCATION	DESCRIPTION	QTY	ENGINE	TORQUE STRUT	TRANSMISSION	
<b>DODGE VAN (continued)</b>									
<b>GRAND CARAVAN</b>									
L4	L4 2.4L 148ci	1996-97	RH Front	Complete Unit	1	EM-2959			
			RH Front	Insert	1	EM-2844			
			Trans - Center	Auto, Complete Unit	1			EM-2984	
			Trans - Center	Auto; Insert	1			EM-2845	
			Trans - LH Front	Auto, Complete Unit	1			EM-2960	
			Trans - LH Front	Auto; Insert	1			EM-2849	
			Trans - LH Rear	Auto, Complete Unit	1			EM-3017	
			Trans - LH Rear	Auto; Insert	1			EM-2849	
	L4 2.5L 153ci	1988	Front		1	EM-2493			
			RH Front		1	EM-2600			
			Trans		1			EM-2617	
	V6	V6 3.0L 181ci	1992-95	Front		1	EM-2615		
			1988-89	Front		1	EM-2493		
			1996-00	RH Front	Complete Unit	1	EM-2959		
RH Front				Insert	1	EM-2844			
1992-95			RH Front	Hydraulic Mount	1	EM-2711			
			RH Front	Rubber Mount	1	EM-2616			
1988-89			RH Front		1	EM-2600			
1996-00			Trans - Center	Complete Unit	1			EM-2984	
			Trans - Center	Insert	1			EM-2845	
			Trans - LH Front	Complete Unit	1			EM-2960	
			Trans - LH Front	Insert	1			EM-2849	
			Trans - LH Rear	Complete Unit	1			EM-3017	
			Trans - LH Rear	Insert	1			EM-2849	
1992-95			Trans		1			EM-2618	
1988-89			Trans		1			EM-2617	
V6 3.3L 201ci			2008-10	Front	Complete Unit	1	EM-3156		
				Front	Insert	1	EM-4094		
			1990-95	Front		1	EM-2615		
		2005-07	RH Front	FWD	1	EM-2926*			
		2001-04	RH Front	Hydraulic Mount; FWD	1	EM-2926*			
		1996-00	RH Front	FWD, Complete Unit	1	EM-2959			
			RH Front	FWD, Insert Only	1	EM-2844			
		1990-95	RH Front	Hydraulic Mount	1	EM-2711			
			RH Front	Rubber Mount	1	EM-2616			
		2008-10	Rear	Complete Unit	1	EM-4042			
			Right		1	EM-4011			
		2005-07	Trans - Center	FWD	1			EM-2925	
		2004	Trans - Center		1			EM-2925	
		2001-03	Trans - Center	FWD	1			EM-2925	
		1996-00	Trans - Center	FWD, Auto, Complete Unit	1			EM-2984	
			Trans - Center	FWD, Auto, Insert Only	1			EM-2845	
		2005-07	Trans - LH Front	FWD	1			EM-2928	
		2004	Trans - LH Front		1			EM-2928	
		2001-03	Trans - LH Front	FWD	1			EM-2928	
		1996-00	Trans - LH Front	Auto, Complete Unit	1			EM-2960	
			Trans - LH Front	Auto; Insert	1			EM-2849	
		2005-07	Trans - LH Rear	FWD	1			EM-2927	
		2004	Trans - LH Rear		1			EM-2927	
		2001-03	Trans - LH Rear	FWD	1			EM-2927	
		1996-00	Trans - LH Rear	Auto, Complete Unit	1			EM-3017	
			Trans - LH Rear	Auto; Insert	1			EM-2849	
		2008-10	Trans	Bushing	1			EM-4127	
			Trans	Complete Unit	1			EM-4013	
		1991-95	Trans		1			EM-2618	
		1990	Trans	FWD	1			EM-2618	
V6 3.6L 220ci		2011-16	Front	Complete Unit	1	EM-4050			

\* = Hydraulic Mount, "S" suffix = solid replacement.

# Engine, Transmission, And Torque Strut Mounts

CYL	ENG. SIZE	YEAR	LOCATION	DESCRIPTION	QTY	ENGINE	TORQUE STRUT	TRANS-MISSION	
<b>DODGE VAN (continued)</b>									
<b>GRAND CARAVAN (continued)</b>									
V6	V6 3.6L 220ci	2011-16	Front	Insert	1	EM-4186			
			Rear		1	EM-4132			
			Right		1	EM-4012			
		2011-17	Trans		1			EM-4077	
	V6 3.8L 230ci	2008-10	Front	Complete Unit	1	EM-3156			
			Front	Insert	1	EM-4094			
		1994-95	Front	FWD	1	EM-2615			
		2005-07	RH Front	FWD	1	EM-2926*			
		2001-04	RH Front	Hydraulic Mount; FWD	1	EM-2926*			
		1996-00	RH Front	FWD, Complete Unit	1	EM-2959			
			RH Front	FWD, Insert Only	1	EM-2844			
		1994-95	RH Front	FWD, Solid Mount	1	EM-2616			
			RH Front	Hydraulic Mount; FWD	1	EM-2711			
		2008-10	Rear	Complete Unit	1	EM-4042			
			Right		1	EM-4011			
		2005-07	Trans - Center	Auto; FWD	1			EM-2925	
		2001-04	Trans - Center	Auto; FWD	1			EM-2925	
		1996-00	Trans - Center	FWD, Auto, Complete Unit	1			EM-2984	
			Trans - Center	FWD, Auto, Insert Only	1			EM-2845	
		2005-07	Trans - LH Front	Auto; FWD	1			EM-2928	
		2001-04	Trans - LH Front	Auto; Complete Unit; AWD	1			EM-2960	
			Trans - LH Front	Auto; FWD	1			EM-2928	
			Trans - LH Front	Auto; Insert; AWD	1			EM-2849	
		1996-00	Trans - LH Front	Auto, Complete Unit	1			EM-2960	
			Trans - LH Front	Auto; Insert	1			EM-2849	
		2005-07	Trans - LH Rear	Auto; FWD	1			EM-2927	
		2001-04	Trans - LH Rear	Auto; Complete Unit; AWD	1			EM-3017	
			Trans - LH Rear	Auto; FWD	1			EM-2927	
			Trans - LH Rear	Auto; Insert; AWD	1			EM-2849	
		1996-00	Trans - LH Rear	Auto, Complete Unit	1			EM-3017	
			Trans - LH Rear	Auto; Insert	1			EM-2849	
		2008-10	Trans	Bushing	1			EM-4127	
		Trans	Complete Unit	1			EM-4013		
	1994-95	Trans		1			EM-2618		
	V6 4.0L 241ci	2008-10	Front	Complete Unit	1	EM-3156			
			Front	Insert	1	EM-4094			
			Rear	Complete Unit	1	EM-4042			
			Right		1	EM-4012			
			Trans	Bushing	1			EM-4127	
			Trans	Complete Unit	1			EM-4013	
	<b>MINI RAM</b>								
	L4	L4 2.2L 135ci	1984-87	Front		1	EM-2493		
				RH Front		1	EM-2600		
Torq Str - Front				Manual	1		EM-2491		
Trans				Auto	1			EM-2617	
Trans				Manual	1			EM-2617	
L4 2.5L 2507cc		1987-88	Front		1	EM-2493			
			RH Front		1	EM-2600			
			Trans	Auto	1			EM-2617	
			Trans	Manual	1			EM-2617	
L4 2.6L 2555cc		1984-87	Front		1	EM-2493			
			RH Front		1	EM-2600			
			Trans	Auto	1			EM-2617	
			Trans	Manual	1			EM-2617	
V6	V6 3.0L 2972cc	1987-88	Front		1	EM-2493			
			RH Front		1	EM-2600			

\* = Hydraulic Mount, "S" suffix = solid replacement.

# Engine, Transmission, And Torque Strut Mounts

CYL	ENG. SIZE	YEAR	LOCATION	DESCRIPTION	QTY	ENGINE	TORQUE STRUT	TRANS-MISSION
<b>DODGE VAN (continued)</b>								
<b>MINI RAM (continued)</b>								
V6	V6 3.0L 2972cc	1987-88	Trans	Auto	1			EM-2617
			Trans	Manual	1			EM-2617
<b>RAM 1500 VAN</b>								
V6	V6 3.9L 239ci	1999-03	L & R Front		2	EM-2469		
			Trans		1			EM-2852
V8	V8 5.2L 318ci	1999-03	L & R Front		2	EM-2469		
			Trans		1			EM-2852
	V8 5.9L 360ci	1999-03	L & R Front		2	EM-2469		
			Trans		1			EM-2852
<b>RAM 2500 VAN</b>								
V8	V8 5.2L 318ci	1999-03	L & R Front		2	EM-2469		
			Trans		1			EM-2852
	V8 5.9L 360ci	1999-03	L & R Front		2	EM-2469		
			Trans		1			EM-2852
<b>RAM 3500 VAN</b>								
V8	V8 5.2L 318ci	1999-03	L & R Front		2	EM-2469		
			Trans		1			EM-2852
	V8 5.9L 360ci	1999-03	L & R Front		2	EM-2469		
			Trans		1			EM-2852
<b>SPRINTER 2500</b>								
L5	L5 2.7L 165ci	2003-06	L & R Front		2	EM-3190		
			Trans		1			EM-3189
V6	V6 3.0L 2987cc	2007-09	L & R Front		2	EM-7265		
			Trans	Auto	1			EM-7159
	V6 3.5L 3498cc	2007-08	L & R Front		2	EM-7265		
			Trans	Auto	1			EM-7159
<b>SPRINTER 3500</b>								
V6	V6 3.0L 2987cc	2007-09	L & R Front		2	EM-7265		
			Trans	Auto	1			EM-7159
	V6 3.5L 3498cc	2007-08	L & R Front		2	EM-7265		
			Trans	Auto	1			EM-7159
<b>DODGE MEDIUM/HEAVY DUTY</b>								
<b>D400 PICKUP</b>								
V8	V8 5.9L 360ci	1979-81	L & R Front		2	EM-2469		
		1978	L & R Front		2	EM-2265		
		1978-81	Trans	Auto; Complete Unit	1			EM-2512
			Trans	Auto; Insert Only	1			EM-2525
			Trans	Manual; Complete Unit	1			EM-2512
	V8 7.2L 440ci	1978	L & R Front		2	EM-2265		
			Trans	Auto; Complete Unit	1			EM-2512
			Trans	Auto; Insert Only	1			EM-2525
			Trans	Manual; Complete Unit	1			EM-2512
			Trans	Manual; Insert Only	1			EM-2525
<b>D450 PICKUP</b>								
V8	V8 5.9L 360ci	1979-81	L & R Front		2	EM-2469		
		1978	L & R Front		2	EM-2265		
		1978-81	Trans	Auto; Complete Unit	1			EM-2512
			Trans	Auto; Insert Only	1			EM-2525
			Trans	Manual; Complete Unit	1			EM-2512
	V8 7.2L 440ci	1978	L & R Front		2	EM-2265		
			Trans	Auto; Complete Unit	1			EM-2512

## Engine, Transmission, And Torque Strut Mounts

CYL	ENG. SIZE	YEAR	LOCATION	DESCRIPTION	QTY	ENGINE	TORQUE STRUT	TRANSMISSION
<b>DODGE MEDIUM/HEAVY DUTY (continued)</b>								
<b>D450 PICKUP (continued)</b>								
V8	V8 7.2L 440ci	1978	Trans	Auto; Insert Only	1			EM-2525
			Trans	Manual; Complete Unit	1			EM-2512
			Trans	Manual; Insert Only	1			EM-2525
<b>RAM 4000</b>								
L6	L6 5.9L 359ci Diesel	2007-09	Left		1	EM-4090		
			Trans	Auto	1			EM-4060
		2007-10	Trans	Manual	1			EM-4060
	L6 6.7L 408ci Diesel	2010	LH Front		1	EM-4090		
<b>RAM 4500</b>								
L6	L6 6.7L 408ci Diesel	2008-10	LH Front		1	EM-4090		
<b>RAM 5500</b>								
L6	L6 6.7L 408ci Diesel	2008-10	LH Front		1	EM-4090		
<b>RAM 4000</b>								
L6	L6 6.7L 408ci Diesel	2010	RH Front		1	EM-4091		
<b>RAM 4500</b>								
L6	L6 6.7L 408ci Diesel	2008-10	RH Front		1	EM-4091		
<b>RAM 5500</b>								
L6	L6 6.7L 408ci Diesel	2008-10	RH Front		1	EM-4091		
<b>RAM 4000</b>								
L6	L6 6.7L 408ci Diesel	2010	Trans	Auto	1			EM-4060
			Trans	Manual	1			EM-4060
<b>RAM 4500</b>								
L6	L6 6.7L 408ci Diesel	2008-10	Trans	Auto	1			EM-4060
			Trans	Manual	1			EM-4060
<b>RAM 5500</b>								
L6	L6 6.7L 408ci Diesel	2008-10	Trans	Auto	1			EM-4060
			Trans	Manual	1			EM-4060
<b>RAM 4000</b>								
V8	V8 5.7L 345ci	2007-10	Trans	Auto	1			EM-4060
			Trans	Manual	1			EM-4060
<b>EAGLE PASSENGER CAR</b>								
<b>SUMMIT</b>								
L4	L4 1.5L 1468cc	1996	Front	Auto	1	EM-8239		
			Front	Manual	1	EM-8098		
		1995	Front		1	EM-8239		
			Front	Auto	1	EM-8239		
		1994	Front	Manual	1	EM-8098		
			Front	Auto	1	EM-8097		
		1993	Front	Manual	1	EM-8098		
			Front	Auto	1	EM-2673		
		1989-92	Front	Manual	1	EM-8107		
			Front	Auto	1	EM-8238		
		1996	LH Front	Power Str	1	EM-8206		
			LH Front	w/o Power Streering	1	EM-8238		
		1995	LH Front	Power Str	1	EM-8206		
			LH Front	w/o Power Streering	1	EM-8238		
		1994	LH Front	Power Str	1	EM-8206		
			LH Front	w/o Power Streering	1	EM-8238		
		1993	LH Front	Power Str	1	EM-8108		
			LH Front	w/o Power Streering	1	EM-8100		
1989-92	LH Front		1					
1996	Rear		1					

# Engine, Transmission, And Torque Strut Mounts

CYL	ENG. SIZE	YEAR	LOCATION	DESCRIPTION	QTY	ENGINE	TORQUE STRUT	TRANSMISSION
<b>EAGLE PASSENGER CAR (continued)</b>								
<b>SUMMIT (continued)</b>								
L4	L4 1.5L 1468cc	1995	Rear		1	EM-8100		
		1994	Rear	Auto	1	EM-8100		
			Rear	Manual	1	EM-8100		
		1993	Rear	Auto	1	EM-8100		
			Rear	Manual	1	EM-8100		
		1989-92	Rear	Auto	1	EM-8102		
			Rear	Manual	1	EM-8102		
		1996	Trans	Auto; Coupe & Sedan	1			EM-8582
			Trans	Manual; Coupe & Sedan	1			EM-8099
		1995	Trans	Auto; Coupe & Sedan	1			EM-8582
		1993-94	Trans	Auto; Coupe & Sedan	1			EM-8582
			Trans	Manual; Coupe & Sedan	1			EM-8099
		1991-92	Trans	Auto; Sedan; Hatchback	1			EM-8584
			Trans	Manual; Sedan; Hatchback	1			EM-8669
	1989-90	Trans	Auto; Sedan	1			EM-8584	
		Trans	Manual; Sedan	1			EM-8669	
	L4 1.6L 1597cc	1989-90	Front	Auto	1	EM-2673		
			Front	Manual	1	EM-8107		
			LH Front		1	EM-8108		
			Rear	Auto	1	EM-8102		
			Rear	Manual	1	EM-8102		
			Trans	Auto	1			EM-8584
	L4 1.8L 1834cc	1989-90	Trans	Manual	1			EM-8669
			Trans	Auto	1			EM-8584
	L4 1.8L 1834cc	1996	Front	Auto	1	EM-8818		
			Front	Manual	1	EM-8098		
		1995	Front		1	EM-8818		
			Front		1	EM-8818		
		1994	Front	Auto	1	EM-8239		
			Front	Manual	1	EM-8098		
		1992-93	Front	Auto	1	EM-8097		
			Front	Manual	1	EM-8098		
		1996	LH Front	Auto	1	EM-8690		
LH Front			Manual	1	EM-8689			
1995		LH Front		1	EM-8690			
1994		LH Front	Auto	1	EM-8690			
		LH Front	Manual, Pwr Str	1	EM-9147			
1992-93		LH Front	Auto	1	EM-8690			
		LH Front	Manual, Pwr Str	1	EM-9147			
1996		Rear		1	EM-8100			
1995		Rear		1	EM-8100			
1994		Rear	Auto	1	EM-8100			
		Rear	Manual	1	EM-8100			
1992-93		Rear	Auto	1	EM-8100			
1996		Trans	Auto; Coupe & Sedan	1			EM-8619	
		Trans	Manual; Wagon; FWD	1			EM-8686	
1995		Trans	Auto; Coupe & Sedan	1			EM-8619	
1992-94		Trans	Auto; Sedan; Hatchback	1			EM-8619	
	Trans	Auto; Wagon; 2WD	1			EM-8881		
	Trans	Manual; Sedan; Hatchback	1			EM-8099		
	Trans	Manual; Wagon; 2WD	1			EM-8686		
L4 2.4L 2351cc	1996	Front	Auto	1	EM-8687			
		Front	Manual	1	EM-8688			
	1995	Front		1	EM-8687			
		Front		1	EM-8687			
	1992-94	Front	Auto	1	EM-8102			
		Front	Manual	1	EM-8821			
	1996	LH Front		1	EM-8820			
1995	LH Front		1	EM-8820				
1996	Rear	Auto	1	EM-8690				



## Engine, Transmission, And Torque Strut Mounts

CYL	ENG. SIZE	YEAR	LOCATION	DESCRIPTION	QTY	ENGINE	TORQUE STRUT	TRANSMISSION		
<b>EAGLE PASSENGER CAR (continued)</b>										
<b>SUMMIT (continued)</b>										
L4	L4 2.4L 2351cc	1996	Rear	Manual	1	EM-8689				
		1995	Rear		1	EM-8690				
		1996	Trans	Auto	1			EM-8881		
			Trans	Manual	1			EM-8686		
		1995	Trans	Auto	1			EM-8881		
		1992-94	Trans	Auto	1			EM-8881		
			Trans	Manual	1			EM-8686		
<b>TALON</b>										
L4	L4 1.8L 1755cc	1993-94	Front		1	EM-8103				
			LH Front		1	EM-9056				
			Rear	Auto	1	EM-8104				
			Rear	Manual	1	EM-5098				
			Trans	Auto	1			EM-8700		
			Trans	Manual	1			EM-8686		
	L4 2.0L 1997cc	1997-98	1997-98	Front		1	EM-8670			
				1995-96	Front		1	EM-8670		
				1993-94	Front	FWD	1	EM-8103		
					Front	TSi; Auto; AWD	1	EM-8559		
					Front	TSi; Manual; AWD	1	EM-9078		
				1991-92	Front	FWD	1	EM-8103		
					Front	TSi; Auto; AWD	1	EM-8559		
					Front	TSi; Manual; AWD	1	EM-9078		
				1990	Front	FWD	1	EM-8103		
					Front	TSi; Manual; AWD	1	EM-9078		
				1997-98	LH Front		1	EM-8792		
				1995-96	LH Front		1	EM-8792		
				1993-94	LH Front	TSi; Auto; AWD	1	EM-9206		
				1991-92	LH Front	TSi; Auto; AWD	1	EM-9206		
				1990	LH Front		1	EM-9206		
					RH Front		1	EM-5081		
				1995-96	RH Front		1	EM-9198		
				1997-98	Rear	Auto	1	EM-9039		
					Rear	Manual	1	EM-8798		
				1995-96	Rear	Auto	1	EM-9039		
				1993-94	Rear	Auto; FWD	1	EM-8104		
					Rear	Manual; FWD	1	EM-5098		
					Rear	TSi; Auto; AWD	1	EM-8104		
					Rear	TSi; Manual; AWD	1	EM-5101		
					Rear	Auto; AWD	1	EM-8104		
				1991-92	Rear	Manual; FWD	1	EM-5098		
					Rear	TSi; Auto; AWD	1	EM-8104		
					Rear	TSi; Manual; AWD	1	EM-5101		
				1990	Rear	Auto; FWD	1	EM-8104		
					Rear	Manual; FWD	1	EM-5098		
					Rear	TSi; Manual; AWD	1	EM-5101		
				1995-98	Trans	Exc.TSi Auto	1			EM-9174
					Trans	Auto; TSi	1			EM-9058
					Trans	Exc. TSi Manual	1			EM-9174
					Trans	Manual; TSi	1			EM-8793
				1990-94	Trans	Auto, w/ Spd Cntrl, w/o ABS	1			EM-8700
	Trans	AWD, Manual, w/o Spd Cntrl	1				EM-8686			
	Trans	Manual; AWD; w/ Std Brakes	1				EM-8686			
	<b>VISION</b>									
	V6	V6 3.3L 201ci	1993-97	L & R Front		2	EM-2795*			
				Trans		1			EM-2810	
		V6 3.5L 3497cc	1993-97	L & R Front		2	EM-2795*			

\* = Hydraulic Mount, "S" suffix = solid replacement.

# Engine, Transmission, And Torque Strut Mounts

CYL	ENG. SIZE	YEAR	LOCATION	DESCRIPTION	QTY	ENGINE	TORQUE STRUT	TRANSMISSION
<b>EAGLE PASSENGER CAR (continued)</b>								
<b>VISION (continued)</b>								
V6	V6 3.5L 3497cc	1993-97	Trans		1			EM-2810
<b>FIAT PASSENGER CAR</b>								
<b>500</b>								
L4	L4 1.4L 1368cc	2012-15	RH Front	Manual	1	EM-4243		
			RH Front	Turbo, Auto	1	EM-4243		
<b>FORD PASSENGER CAR</b>								
<b>ASPIRE</b>								
L4	L4 1.3L 1295cc	1994-97	Trans - Front	Manual	1			EM-5104
			Trans - Rear		1			EM-5103
<b>CLUB</b>								
V8	V8 4.5L 272ci	1955-57	L & R Front		2	EM-2110		
<b>CONTOUR</b>								
L4	L4 2.0L 121ci	1998-00	Front	Auto; Complete Unit	1	EM-5521		
			Front	Auto; Insert	1	EM-2885		
			Front	Manual; Insert	1	EM-2978		
		1995-97	Front	Auto; Complete Unit	1	EM-5596		
			Front	Auto; Insert	1	EM-2886		
			Front	Manual; Insert	1	EM-2978		
		1998-00	RH Front		1	EM-2890		
		1995-97	RH Front	Complete Unit	1	EM-2889		
			RH Front	Insert Only	1	EM-5105		
		1998-00	Trans - Front	Auto, Complete Unit	1			EM-2873
			Trans - Front	Auto; Insert	1			EM-5106
		1995-97	Trans - Front	Auto, Complete Unit	1			EM-2873
			Trans - Front	Auto; Insert	1			EM-5106
		1998-00	Trans - Rear	Auto; Insert	1			EM-2888
		1995-97	Trans - Rear	Auto, Complete Unit	1			EM-5107
			Trans - Rear	Auto; Insert	1			EM-2887
		1998-00	Trans	Manual; Complete Unit	2			EM-3119
		1995-97	Trans	Manual; Complete Unit	2			EM-3119
V6	V6 2.5L 155ci	1998-00	Front	Auto; Insert	1	EM-2885		
			Front	Manual; Insert	1	EM-2888		
		1995-97	Front	Auto; Complete Unit	1	EM-5596		
			Front	Auto; Insert	1	EM-2886		
			Front	Manual; Insert	1	EM-2978		
		1998-00	RH Front	Complete Unit	1	EM-5352		
		1995-97	RH Front	Complete Unit	1	EM-2889		
			RH Front	Insert Only	1	EM-5105		
		1998-00	Trans - Front	Auto; Complete Unit	1			EM-2873
			Trans - Front	Auto; Insert	1			EM-5106
		1995-97	Trans - Front	Auto; Complete Unit; Att. to Fender Apron	1			EM-2873
			Trans - Front	Auto; Insert; Att. to Fender Apron	1			EM-5106
			Trans - Front	Auto; Insert; Attached to Crossmember	1			EM-2887
		1998-00	Trans - Rear	Auto; Insert	1			EM-2888
		1995-97	Trans - Rear	Auto; Complete Unit; Att. to Crossmember	1			EM-5107
			Trans - Rear	Manual; Complete Unit	1			EM-3119
		1998-00	Trans	Manual; Complete Unit	2			EM-3119

\* = Hydraulic Mount, "S" suffix = solid replacement.

# Engine, Transmission, And Torque Strut Mounts

CYL	ENG. SIZE	YEAR	LOCATION	DESCRIPTION	QTY	ENGINE	TORQUE STRUT	TRANSMISSION	
<b>FORD PASSENGER CAR (continued)</b>									
<b>COUGAR (MEXICAN VEHICLE)</b>									
V6	V6 3.8L 232ci	1990-94	L & R Front	Hydraulic Mount	2	EM-2661*			
		1986-88	L & R Front	Hydraulic Mount	2	EM-2661*			
		1990-94	Trans	Hydraulic Mount	1			EM-2707 *	
		1986-88	Trans	Hydraulic Mount	1			EM-2707 *	
<b>COUNTRY SEDAN</b>									
V8	V8 4.5L 272ci	1955-57	L & R Front		2	EM-2110			
	V8 5.8L 351ci	1969-74	L & R Front		2	EM-2287			
			Trans	Auto	1			EM-2311	
			Trans	Manual	1			EM-2311	
			Trans		1			EM-2242	
	V8 5.8L 352ci	1963-65	Trans		1			EM-2242	
	V8 6.4L 390ci	1969-71	LH Front		1	EM-2271			
			LH Front		1	EM-2241			
			LH Front		1	EM-2223			
			RH Front		1	EM-2270			
			RH Front		1	EM-2240			
			RH Front		1	EM-2222			
			Trans	Auto	1			EM-2242	
			Trans	Manual	1			EM-2242	
	V8 6.6L 400ci	1971-74	LH Front		1	EM-2359			
			RH Front		1	EM-2358			
			Trans		1			EM-2345	
	V8 7.0L 428ci	1969-73	Trans	AOD	1			EM-2345	
			Trans	C-4/C-6 Transmission	1			EM-2311	
	V8 7.0L 429ci	1969-73	LH Front		1	EM-2368			
RH Front				1	EM-2367				
V8 7.5L 460ci	1972-74	LH Front		1	EM-2368				
		RH Front		1	EM-2367				
		Trans		1			EM-2345		
<b>COUNTRY SQUIRE</b>									
L6	L6 2.8L 170ci	1966-67	L & R Front		2	EM-2333			
		1965	LH Front		1	EM-2226			
			RH Front		1	EM-2225			
	1965-67	Trans		1			EM-2253		
	L6 3.3L 200ci	1966-67	L & R Front		2	EM-2333			
			Trans		1			EM-2253	
L6 3.9L 240ci	1965-67	Trans		1			EM-2242		
V8	V8 3.9L 239ci	1954	L & R Front		2	EM-2110			
	V8 4.3L 260ci	1963-64	LH Front		1	EM-2220			
			RH Front		1	EM-2221			
			Trans		1			EM-2242	
	V8 4.5L 272ci	1955-57	L & R Front		2	EM-2110			
	V8 4.7L 289ci	1965-67	L & R Front		2	EM-2287			
			1963-64	LH Front		1	EM-2220		
				RH Front		1	EM-2221		
	1963-67	Trans		1			EM-2242		
	V8 4.8L 292ci	1959-62	L & R Front		2	EM-2141			
		1958	L & R Front		2	EM-2110			
	V8 5.0L 302ci	1968-72	L & R Front		2	EM-2287			
			1987-91	LH Front		1	EM-2438		
				RH Front		1	EM-2437		
				Trans		1			EM-2464
			1969-72	Trans		1			EM-2311
	1968	Trans		1			EM-2242		
V8 5.8L 351ci	1969-74	L & R Front		2	EM-2287				
		Trans		1			EM-2311		
V8 5.8L 352ci	1965-67	LH Front		1	EM-2241				

\* = Hydraulic Mount, "S" suffix = solid replacement.

# Engine, Transmission, And Torque Strut Mounts

CYL	ENG. SIZE	YEAR	LOCATION	DESCRIPTION	QTY	ENGINE	TORQUE STRUT	TRANS-MISSION
<b>FORD PASSENGER CAR (continued)</b>								
<b>COUNTRY SQUIRE (continued)</b>								
V8	V8 5.8L 352ci	1958-64	LH Front		1	EM-2223		
		1965-67	RH Front		1	EM-2240		
		1958-64	RH Front		1	EM-2222		
		1963-67	Trans		1			EM-2242
	V8 6.4L 390ci	1969-71	LH Front		1	EM-2271		
		1968	LH Front		1	EM-2241		
		1963-64	LH Front		1	EM-2223		
		1969-71	RH Front		1	EM-2270		
		1968	RH Front		1	EM-2240		
		1963-64	RH Front		1	EM-2222		
		1968-71	Trans		1			EM-2242
	V8 6.6L 400ci	1971-74	LH Front		1	EM-2359		
			RH Front		1	EM-2358		
			Trans		1			EM-2345
	V8 7.0L	1964	LH Front		1	EM-2223		
			RH Front		1	EM-2222		
	V8 7.0L 427ci	1966	LH Front		1	EM-2241		
			RH Front		1	EM-2240		
			Trans		1			EM-2242
	V8 7.0L 428ci	1968-69	LH Front		1	EM-2241		
			RH Front		1	EM-2240		
			Trans		1			EM-2242
	V8 7.0L 429ci	1973	LH Front		1	EM-2368		
			LH Front		1	EM-2724		
			RH Front		1	EM-2367		
RH Front				1	EM-2723			
Trans			AOD	1			EM-2345	
Trans	C-4/C-6 Transmission	1			EM-2311			
V8 7.5L	1972-74	LH Front		1	EM-2368			
		RH Front		1	EM-2367			
V8 7.5L 460ci	1972-78	Trans		1			EM-2345	
<b>CROWN VICTORIA</b>								
V8	V8 4.6L 281ci	2003-09	LH Front		1	EM-3025		
		1998-02	LH Front		1	EM-2861		
		1992-97	LH Front		1	EM-2807		
		2003-09	RH Front		1	EM-3024		
		1998-02	RH Front		1	EM-2860		
		1992-97	RH Front		1	EM-2806		
		2003-09	Trans		1			EM-3038
		1998-02	Trans		1			EM-2822
		1994-97	Trans	exc. Police Cars	1			EM-2822
		1992-93	Trans	Police Cars	1			EM-2448
	1992-93	Trans		1			EM-4147	
	V8 5.0L 302ci	1987-91	LH Front		1	EM-2438		
			RH Front		1	EM-2437		
			Trans		1			EM-2464
	V8 5.8L 351ci	1987-91	LH Front		1	EM-2438		
			RH Front		1	EM-2437		
			Trans		1			EM-2464
<b>CUSTOM</b>								
L6	L6 3.7L	1949-51	Front		1	EM-5465		
V8	V8 3.9L	1949-52	Front		1	EM-5465		

# Engine, Transmission, And Torque Strut Mounts

CYL	ENG. SIZE	YEAR	LOCATION	DESCRIPTION	QTY	ENGINE	TORQUE STRUT	TRANSMISSION	
<b>FORD PASSENGER CAR (continued)</b>									
<b>CUSTOM 500</b>									
L6	L6 3.9L 240ci	1968-72	L & R Front		2	EM-2319			
		1969-72	Trans		1			EM-2311	
		1968	Trans	Auto		1			EM-2242
Trans	Manual			1			EM-2242		
V8	V8 4.7L 289ci	1965-67	L & R Front		2	EM-2287			
	V8 4.8L 292ci	1957	L & R Front		2	EM-2110			
	V8 5.0L 302ci	1968-72	L & R Front		2	EM-2287			
		1969-72	Trans		1			EM-2311	
		1968	Trans	Auto		1			EM-2242
	Trans		Manual		1			EM-2242	
	V8 5.8L 351ci	1969-77	L & R Front		2	EM-2287			
			Trans	Auto		1		EM-2311	
			Trans	Auto		1		EM-2311	
			Trans	Manual		1		EM-2242	
	V8 5.8L 352ci	1965-66	LH Front		1	EM-2241			
		1964	LH Front		1	EM-2223			
		1965-66	RH Front		1	EM-2240			
		1964	RH Front		1	EM-2222			
		1964-66	Trans	Auto		1			EM-2242
	Trans		Manual		1			EM-2242	
	V8 6.4L 390ci	1969-71	LH Front		1	EM-2271			
			LH Front		1	EM-2241			
		1964	LH Front		1	EM-2223			
			RH Front		1	EM-2270			
		1968	RH Front		1	EM-2240			
			RH Front		1	EM-2222			
		1969-71	Trans	Auto		1			EM-2242
			Trans	Manual		1			EM-2242
	V8 6.6L 400ci	1971-77	LH Front		1	EM-2359			
			RH Front		1	EM-2358			
		1974-77	Trans		1			EM-2345	
		1971-73	Trans	Auto		1			EM-2345
			Trans	Manual		1			EM-2345
	V8 7.0L 427ci	1968	Trans	Auto		1		EM-2242	
			Trans	Manual		1		EM-2242	
	V8 7.0L 428ci	1969-70	LH Front		1	EM-2241			
			LH Front		1	EM-2241			
1968		RH Front		1	EM-2240				
		RH Front		1	EM-2240				
1969-70		Trans	Auto		1			EM-2242	
	Trans	Manual		1			EM-2242		
V8 7.0L 429ci	1973	LH Front		1	EM-2368				
	1969-72	LH Front		1	EM-2723				
	1973	RH Front		1	EM-2367				
	1969-72	RH Front		1	EM-2724				
		Trans	AOD		1			EM-2345	
	Trans	C-4/C-6 Transmission		1			EM-2311		
V8 7.5L 460ci	1973-76	LH Front		1	EM-2368				
		RH Front		1	EM-2367				
	1974-76	Trans	Auto		1		EM-2345		
	1973	Trans	Auto		1			EM-2345	
		Trans	Manual		1			EM-2345	
<b>CUSTOMLINE</b>									
V8	V8 4.5L 272ci	1955-56	L & R Front		2	EM-2110			

# Engine, Transmission, And Torque Strut Mounts

CYL	ENG. SIZE	YEAR	LOCATION	DESCRIPTION	QTY	ENGINE	TORQUE STRUT	TRANSMISSION	
<b>FORD PASSENGER CAR (continued)</b>									
<b>C-MAX</b>									
L4	L4 2.0L 122ci	2013-15	RH Front		1	EM-4068			
		2013-17	Torg Str - Lower		1		EM-4199		
		2013-14	Trans - Lower		1			EM-4069	
			Trans - Upper		1			EM-4070	
<b>DELUXE</b>									
L6	L6 3.7L	1949-51	Front		1	EM-5465			
V8	V8 3.9L	1949-51	Front		1	EM-5465			
	V8 3.9L 239ci	1946-48	L & R Front Lower		2	EM-2010			
<b>ELITE</b>									
V8	V8 5.8L 351ci	1975-76	L & R Front		2	EM-2287			
			Trans		1		EM-2311		
	V8 6.6L 400ci	1975-76	LH Front		1	EM-2359			
			RH Front		1	EM-2358			
			Trans		1		EM-2345		
	V8 7.5L 460ci	1975-76	LH Front		1	EM-2368			
			RH Front		1	EM-2367			
			Trans		1		EM-2345		
<b>ESCORT</b>									
L4	L4 1.6L 98ci	1984-85	Front		1	EM-2559			
		1981-83	Front	Auto	1	EM-2461			
			Front	Manual	1	EM-2460			
		1984-85	RH Front		1	EM-2558			
		1981-83	RH Front		1	EM-2459			
		1984-85	Trans	Auto	1		EM-2632		
			Trans	Manual; 4 Spd	1		EM-2634		
			Trans	Manual; 5 Spd	1		EM-2665		
		1981-83	Trans	Auto	1		EM-2463		
			Trans	Manual	1		EM-2463		
		L4 1.8L 112ci	1994-96	Front	Auto	1	EM-2910*		
				Front	Manual	1	EM-2651		
			1991-93	Front		1	EM-2651		
			1994-96	LH Rear		1	EM-2650		
	1991-93		LH Rear		1	EM-2650			
	1994-96		RH Front		1	EM-2649			
	1991-93		RH Front		1	EM-2649			
	1991-96		Trans	Auto	1		EM-2815		
			Trans	Manual	1		EM-2815		
	L4 1.9L 116ci		1991-96	Front		1	EM-2651		
		1988-90	Front		1	EM-2559			
		1987	Front		1	EM-2559			
		1986	Front		1	EM-2559			
		1985	Front		1	EM-2559			
		1987	LH Front	Auto; w/ EFI	1	EM-5063			
		1986	LH Front	Auto; w/ EFI	1	EM-5063			
			LH Front	Auto; w/o EFI	1	EM-5064			
		1985	LH Front	Auto	1	EM-5063			
		1991-96	LH Rear		1	EM-2650			
			RH Front		1	EM-2649			
		1988-90	RH Front		1	EM-2558			
		1987	RH Front		1	EM-2558			
		1986	RH Front	Auto; w/o EFI	1	EM-2558			
		1985	RH Front		1	EM-2558			
		1991-96	Trans	Auto	1		EM-2815		
			Trans	Manual	1		EM-2815		
			1985-90	Trans	Auto	1		EM-2632	

\* = Hydraulic Mount, "S" suffix = solid replacement.

# Engine, Transmission, And Torque Strut Mounts

CYL	ENG. SIZE	YEAR	LOCATION	DESCRIPTION	QTY	ENGINE	TORQUE STRUT	TRANSMISSION	
<b>FORD PASSENGER CAR (continued)</b>									
<b>ESCORT (continued)</b>									
L4	L4 1.9L 116ci	1985-90	Trans	Manual; 4 Spd	1			EM-2634	
			Trans	Manual; 5 Spd	1			EM-2665	
	L4 2.0L 121ci	2001-02	2001-02	Front	Auto	1	EM-2910*		
				Front	Manual	1	EM-2651		
			2000	Front	LX, Manual	1	EM-2651		
				Front	LX; Auto	1	EM-2910*		
			1998-99	Front	Auto	1	EM-2910*		
				Front	Manual	1	EM-2651		
			1997	Front	Auto	1	EM-2910*		
				Front	Manual	1	EM-2651		
			1984-87	LH Front	Auto; Complete Unit	1	EM-5063		
				LH Front	Insert; All	1	EM-2559		
				LH Front	Manual, Complete Unit	1	EM-5065		
			2001-02	RH Front		1	EM-2649		
			2000	RH Front	LX	1	EM-2649		
			1998-99	RH Front		1	EM-2649		
			1997	RH Front		1	EM-2649		
			2001-02	Rear	Auto	1	EM-2911		
				Rear	Manual	1	EM-2912		
			2000	Rear	LX, Manual	1	EM-2912		
Rear	LX; Auto	1		EM-2911					
1998-99	Rear	Auto	1	EM-2911					
	Rear	Manual	1	EM-2912					
1997	Rear	Auto	1	EM-2911					
	Rear	Manual	1	EM-2912					
1997-02	Trans	Auto	1				EM-2843		
	Trans	Manual	1				EM-2843		
<b>EXP</b>									
L4	L4 1.6L 1598cc	1984-85	Front	Front	1	EM-2559			
			1982-83	Front	Auto	1	EM-2461		
		1984-85	Front	Manual	1	EM-2460			
			RH Front	RH Front	1	EM-2558			
		1982-83	RH Front	RH Front	1	EM-2459			
			Trans	Auto	1			EM-2632	
		1984-86	Trans	Manual; 4 Spd	1			EM-2634	
			Trans	Manual; 5 Spd	1			EM-2665	
			1982-83	Trans	Auto	1		EM-2463	
		1982-83	Trans	Manual	1			EM-2463	
	L4 1.9L 116ci		1986-88	Front		1	EM-2559		
		RH Front			1	EM-2558			
		Trans		Auto	1			EM-2632	
Trans		Manual		1			EM-2665		
<b>FAIRLANE</b>									
L6	L6 2.8L 170ci	1966	L & R Front		2	EM-2333			
			1963-65	LH Front		1	EM-2226		
		RH Front			1	EM-2225			
		1963-64	Trans	Auto	1			EM-2253	
			Trans	Manual	1			EM-2253	
	L6 3.3L 200ci	1966-68	L & R Front		2	EM-2333			
			Trans	Auto	1			EM-2253	
Trans	Manual	1			EM-2253				
V8	V8 4.5L 272ci	1955-57	L & R Front		2	EM-2110			
			V8 4.7L 289ci	1964-67	L & R Front		2	EM-2257	
	Trans	Auto			1			EM-2253	
	Trans	Manual			1			EM-2253	
	V8 5.0L 302ci	1968-70	L & R Front		2	EM-2257			

\* = Hydraulic Mount, "S" suffix = solid replacement.

# Engine, Transmission, And Torque Strut Mounts

CYL	ENG. SIZE	YEAR	LOCATION	DESCRIPTION	QTY	ENGINE	TORQUE STRUT	TRANSMISSION	
<b>FORD PASSENGER CAR (continued)</b>									
<b>FAIRLANE (continued)</b>									
V8	V8 5.0L 302ci	1968-70	Trans	Auto	1			EM-2253	
			Trans	Manual	1			EM-2253	
	V8 5.8L 351ci	1969-70	L & R Front		2	EM-2287			
			Trans	Auto	1			EM-2311	
			Trans	Manual	1			EM-2311	
	V8 6.4L 390ci	1968-69	LH Front		1	EM-2241			
			RH Front		1	EM-2240			
		1966-69	Trans	Auto	1			EM-2253	
			Trans	Manual	1			EM-2253	
	V8 7.0L 427ci	1966-68	LH Front		1	EM-2241			
			RH Front		1	EM-2240			
			Trans	Auto	1			EM-2253	
Trans			Manual	1			EM-2253		
<b>FAIRMONT</b>									
L4	L4 2.3L 140ci	1978-83	LH Front		1	EM-2458			
			RH Front		1	EM-2457			
			Trans	Auto	1			EM-2388	
			Trans	Manual	1			EM-2388	
L6	L6 3.3L 200ci	1978-83	L & R Front		2	EM-2385			
			Trans	Auto	1			EM-2388	
		1982-83	Trans	Manual	1			EM-2388	
			Trans	Auto, C3	1			EM-2389	
		1980-81	Trans	Auto, C4	1			EM-2388	
			Trans	Manual	1			EM-2389	
		1978-79	Trans		1			EM-2389	
			Trans	Manual	1			EM-2389	
V8	V8 4.2L 255ci	1980-82	LH Front		1	EM-2458			
			RH Front		1	EM-2457			
			Trans	Auto	1			EM-2388	
			Trans	Manual	1			EM-2388	
	V8 5.0L 302ci	1978-79	LH Front		1	EM-2458			
			RH Front		1	EM-2457			
			Trans	Auto	1			EM-2388	
			Trans	Manual	1			EM-2388	
<b>FALCON</b>									
L6	L6 2.4L 144ci	1962	L & R Front	Before 7/4/62	2	EM-2170			
		1960-61	L & R Front		2	EM-2170			
		1963-64	LH Front		1	EM-2226			
		1962	LH Front	After 7/4/62	1	EM-2226			
		1963-64	RH Front		1	EM-2225			
		1962	RH Front	After 7/4/62	1	EM-2225			
		1960-61	Trans	w/ Cantelever	1			EM-2172	
			Trans	w/o Cantelever	1			EM-2172	
		1962-64	Trans	Auto	1			EM-2253	
			Trans	Manual	1			EM-2253	
		1960-61	Trans		1			EM-2171	
			Trans		1			EM-2171	
		L6 2.8L 170ci	1966-69	L & R Front		2	EM-2333		
				1962	L & R Front	Before 7/4/62	2	EM-2170	
			1960-61	L & R Front		2	EM-2170		
			1963-65	LH Front		1	EM-2226		
	1962		LH Front	After 7/4/62	1	EM-2226			
	1963-65		RH Front		1	EM-2225			
	1962		RH Front	After 7/4/62	1	EM-2225			
	1960-61		Trans	w/ Cantelever	1			EM-2172	
		Trans	w/o Cantelever	1			EM-2172		



# Engine, Transmission, And Torque Strut Mounts

CYL	ENG. SIZE	YEAR	LOCATION	DESCRIPTION	QTY	ENGINE	TORQUE STRUT	TRANSMISSION
<b>FORD PASSENGER CAR (continued)</b>								
<b>FALCON (continued)</b>								
L6	L6 2.8L 170ci	1962-65	Trans	Auto	1			EM-2253
			Trans	Manual	1			EM-2253
		1960-61	Trans		1			EM-2171
			Trans		1			EM-2171
	L6 3.3L 200ci	1966-70	L & R Front		2	EM-2333		
			1964-65	LH Front		1	EM-2226	
			RH Front		1	EM-2225		
		1966-70	Trans	Auto	1			EM-2253
			Trans	Manual	1			EM-2253
		1964-65	Trans		1			EM-2171
	V8	V8 4.3L 260ci	1963-64	LH Front		1	EM-2220	
				RH Front		1	EM-2221	
Trans					1		EM-2171	
V8 4.7L 289ci		1966-68	L & R Front		2	EM-2257		
			1964-65	LH Front	exc Convertible	1	EM-2220	
			RH Front	exc Convertible	1	EM-2221		
		1966-68	Trans	Auto	1			EM-2253
			Trans	Manual	1			EM-2253
1964-65		Trans		1			EM-2171	
V8 5.0L 302ci		1968-70	L & R Front		2	EM-2257		
			Trans	Auto	1			EM-2253
			Trans	Manual	1			EM-2253
<b>FESTIVA</b>								
L4	L4 1.3L 1295cc	1990-93	Front	Manual	1	EM-2654		
			RH Front	Auto	1	EM-8511		
			RH Front	Manual	1	EM-2655		
		1988-89	RH Front	Manual	1	EM-2655		
		1988-93	Trans	Manual	1			EM-2653
<b>FIESTA</b>								
8	L4 1.3L 79ci	1998-00	Torq Str - Rear	Mexican Vehicle	1		EM-9002	
L3	L3 1.0L 61ci	2014-16	Trans		1			EM-4154
L4	L4 1.3L 79ci	1998-00	Right	Style 1	1	EM-9002		
			Trans - LH	Mexican Vehicle	1		EM-90029	
			L4 1.4L 85ci	1998-00	Right	Mexican Vehicle	1	EM-9002
	Torq Str - Rear	Mexican Vehicle	1			EM-9002		
	Trans - LH	Mexican Vehicle	1			EM-90029		
	L4 1.6L 97ci	2003-10	RH Front	Mexican Vehicle	1	EM-9000		
			2011-16	Right		1	EM-4074	
		2015-16	Torq Str - Rear	US & Canada; Manual	1		EM-3193	
		2011-14	Torq Str - Rear	US & Canada; Auto (Dual Clutch)	1		EM-4164	
			Torq Str - Rear	US & Canada; Manual	1		EM-3193	
		2008-10	Torq Str - Rear	Manual; Mexican Vehicle	1		EM-9000	
		2003-07	Torq Str - Rear	Manual; Mexican Vehicle	1		EM-9000	
		2003-10	Trans - LH	Mexican Vehicle	1			EM-90029
2011-16	Trans		1			EM-4154		
2003-10	Trans	Mexican Vehicle	1			EM-90030		
L4 1.6L 98ci	2011-16	Torq Str - Rear	Mexico; Manual	1		EM-3193		
<b>FIESTA IKON (MEXICO)</b>								
L4	L4 1.6L 97ci	2003-04	RH Front	Mexican Vehicle	1	EM-9000		
<b>FIVE HUNDRED</b>								
V6	V6 3.0L 181ci	2005-07	Torq Str - Front	Auto	1		EM-4160	
			Torq Str - Front	Mexico; Auto	1		EM-4160	
			Torq Str - Upper	Complete Unit; Auto; 6 Speed Select Shift	1		EM-4065	

# Engine, Transmission, And Torque Strut Mounts

CYL	ENG. SIZE	YEAR	LOCATION	DESCRIPTION	QTY	ENGINE	TORQUE STRUT	TRANSMISSION
<b>FORD PASSENGER CAR (continued)</b>								
<b>FIVE HUNDRED (continued)</b>								
V6	V6 3.0L 181ci	2005-07	Torq Str - Upper	Complete Unit; CVT	1		EM-4066	
			Torq Str - Upper	Mexico; Complete Unit; Auto	1		EM-4065	
	V6 3.0L 183ci	2005-07	LH Front		1	EM-3080*		
			RH Front		1	EM-3079*		
			Rear		1	EM-4141		
			Trans		1		EM-3080 *	
<b>FOCUS</b>								
		2012-14	Torq Str - Rear L	Electric Vehicle	1		EM-4110	
L4	L4 2.0L 121ci	2008-11	RH Front	Mexico; Complete Unit	1	EM-4082		
			RH Front	Mexico; Insert	1	EM-3103		
		2005-07	RH Front	Mexico	1	EM-3103		
	L4 2.0L 121ci DOHC	2002-04	RH Front	exc SVT	1	EM-3003*		
			RH Front	SVT	1	EM-3085*		
			RH Front	DOHC	1	EM-3003*		
	L4 2.0L 121ci SOHC	2000-04	RH Front	SOHC	1	EM-2938*		
	L4 2.0L 122ci	2014-17	RH Front	Complete Unit; Turbo	1	EM-4152		
			2013	RH Front	To 2/4/13; Insert	1	EM-3103	
		2012	RH Front	Insert	1	EM-3103		
		2008-11	RH Front	US & Canada; Complete Unit	1	EM-4082		
			RH Front	US & Canada; Insert	1	EM-3103		
		2005-07	RH Front	US & Canada	1	EM-3103		
		2014-17	Right	Insert	1	EM-4229		
		2000-07	Torq Str - Rear		1		EM-2939#	
		2013-18	Torq Str - Rear L	Non-Turbo; Exc. ST Model	1		EM-4057	
			Torq Str - Rear L	Non-Turbo; ST Model Only - Per Ford TSB	1		EM-4110	
			Torq Str - Rear L	Turbo; ST Model Only - Per Ford TSB	1		EM-4110	
		2012	Torq Str - Rear L	Non-Turbo	1		EM-4057	
		2008-11	Torq Str - Rear L		1		EM-3087	
	2012-18	Trans - Upper		1			EM-4121	
	2000-11	Trans	Auto	1			EM-2986 #	
		Trans	Manual	1			EM-2986 #	
L4 2.3L 140ci	2003-07	RH Front		1	EM-3103			
		Torq Str - Rear		1		EM-3100		
	2007	Trans	Auto	1			EM-2986 #	
		Trans	Manual	1			EM-2986 #	
	2005-06	Trans	Manual	1			EM-2986 #	
	2003-04	Trans	Auto	1			EM-2986 #	
		Trans	Manual	1			EM-2986 #	
<b>FREESTYLE</b>								
V6	V6 3.0L 181ci	2005-07	LH Front		1	EM-3080*		
			RH Front		1	EM-3079*		
			Rear		1	EM-4141		
			Torq Str - Upper	Complete Unit; CVT	1		EM-4066	
			Trans		1			EM-3080 *
<b>FUSION</b>								
L4	L4 1.5L 91ci	2014-17	Front		1	EM-4254		
		2014-18	Torq Str - Rear		1		EM-4184	
		2014-17	Trans		1			EM-4251
	L4 1.6L 97ci	2013-14	Front		1	EM-4254		
			Torq Str - Rear		1		EM-4184	
L4 2.0L 122ci	2013-18	RH Front	Turbo	1	EM-4205			

\* = Hydraulic Mount, "S" suffix = solid replacement. # = Available in the Westar Gold Line

## Engine, Transmission, And Torque Strut Mounts

CYL	ENG. SIZE	YEAR	LOCATION	DESCRIPTION	QTY	ENGINE	TORQUE STRUT	TRANSMISSION	
<b>FORD PASSENGER CAR (continued)</b>									
<b>FUSION (continued)</b>									
L4	L4 2.0L 122ci	2013-18	Torq Str - Rear		1		EM-4184		
		2013-17	Trans	Turbo	1			EM-4251	
	L4 2.3L 140ci	2006-09	Right		Auto	1	EM-7044		
		2006-08	Torq Str - Front			1		EM-3107	
		2006-09	Trans		Auto	1			EM-4034
			Trans		Manual	1			EM-4034
	L4 2.5L 152ci	2013-17	Front			1	EM-4252		
		2010-12	Right		Gas	1	EM-7044		
		2013-18	Torq Str - Rear			1		EM-4184	
		2013-17	Trans			1			EM-4251
	L4 2.5L 153ci	2011-12	Torq Str - Front		Hybrid	1		EM-4058	
			Torq Str - Front		Gas	1		EM-4146	
		2010-12	Trans		Gas; Auto; US & Canada	1			EM-4067
			Trans		Gas; Manual; US & Canada	1			EM-4034
			Trans		Mexico; Auto	1			EM-4067
V6	V6 3.0L 181ci	2007-09	Torq Str - Front		1		EM-3105		
			Torq Str - Front		FWD	1		EM-3107	
			Torq Str - Front		Mexico; FWD	1		EM-3107	
		2006	Torq Str - Front			1		EM-3107	
		2010-12	Torq Str - Front			1		EM-3105	
	V6 3.0L 183ci	2010-12	Right			1	EM-7044		
		2006-09	Right			1	EM-4044		
		2010-12	Trans			1			EM-4255
			2006-09	Trans		Auto	1		EM-4034
	V6 3.5L 213ci	2010-12	Trans		Manual	1			EM-4034
			Right			1	EM-4208		
			Torq Str - Front			1		EM-4059	
Trans					1			EM-4255	
Trans					1			EM-4255	
<b>GALAXIE</b>									
L6	L6 3.9L 240ci	1965-67	L & R Front		2	EM-2319			
			Trans		Auto	1		EM-2242	
			Trans		Manual	1		EM-2242	
V8	V8 4.3L 260ci	1964	LH Front		1	EM-2220			
			RH Front			1	EM-2221		
			Trans		Auto	1		EM-2242	
			Trans		Manual	1		EM-2242	
	V8 4.7L 289ci	1965-67	L & R Front			2	EM-2287		
			1963-64	LH Front		1	EM-2220		
		1963-67	RH Front			1	EM-2221		
			Trans		Auto	1		EM-2242	
			Trans		Manual	1		EM-2242	
	V8 5.8L 352ci	1959-62	L & R Front			2	EM-2141		
		1965-66	LH Front			1	EM-2241		
		1963-64	LH Front			1	EM-2223		
		1965-66	RH Front			1	EM-2240		
		1963-64	RH Front			1	EM-2222		
			1959-66	Trans		Auto	1		EM-2242
	V8 6.4L 390ci	1962	Trans		Manual	1		EM-2242	
			Trans		Manual	1		EM-2242	
	V8 7.0L 427ci	1965-67	L & R Front			2	EM-2141		
LH Front					1	EM-2223			
RH Front					1	EM-2222			
Trans				Auto	1		EM-2242		
V8 7.0L 427ci	1965-67	Trans		Manual	1		EM-2242		
		LH Front			1	EM-2241			
		RH Front			1	EM-2240			
		Trans		Auto	1		EM-2242		
V8 7.0L 427ci	1965-67	Trans		Manual	1		EM-2242		
		LH Front			1	EM-2241			
		RH Front			1	EM-2240			
		Trans		Auto	1		EM-2242		
V8 7.0L 427ci	1965-67	Trans		Manual	1		EM-2242		
		LH Front			1	EM-2241			
		RH Front			1	EM-2240			
		Trans		Auto	1		EM-2242		

# Engine, Transmission, And Torque Strut Mounts

CYL	ENG. SIZE	YEAR	LOCATION	DESCRIPTION	QTY	ENGINE	TORQUE STRUT	TRANS-MISSION
<b>FORD PASSENGER CAR (continued)</b>								
<b>GALAXIE (continued)</b>								
V8	V8 7.0L 428ci	1966-67	Trans	Auto	1			EM-2242
			Trans	Manual	1			EM-2242
<b>GALAXIE 500</b>								
L6	L6 3.9L 240ci	1968-72	L & R Front		2	EM-2319		
			Trans		1			EM-2311
		1968	Trans	Auto	1			EM-2242
			Trans	Manual	1			EM-2242
V8	V8 5.0L 302ci	1968-72	L & R Front		2	EM-2287		
			Trans	Auto	1			EM-2311
		1969-72	Trans	Manual	1			EM-2311
			Trans	Auto	1			EM-2242
			Trans	Manual	1			EM-2242
			L & R Front		2	EM-2287		
	1969-74	Trans	Auto	1			EM-2311	
		Trans	Manual	1			EM-2311	
	V8 5.8L 351ci	1969-72	L & R Front		2	EM-2287		
			Trans	Auto	1			EM-2311
		1969-74	Trans	Manual	1			EM-2311
			LH Front		1	EM-2271		
LH Front				1	EM-2241			
RH Front				1	EM-2270			
1968	RH Front		1	EM-2240				
	Trans	Auto	1			EM-2242		
Trans	Manual	1			EM-2242			
V8 6.4L 390ci	1969-71	LH Front		1	EM-2271			
		LH Front		1	EM-2241			
	1968	RH Front		1	EM-2270			
		RH Front		1	EM-2240			
1968-71	Trans	Auto	1			EM-2242		
	Trans	Manual	1			EM-2242		
	V8 6.6L 400ci	1971-74	LH Front		1	EM-2359		
			RH Front		1	EM-2358		
Trans		Auto	1			EM-2345		
		Manual	1			EM-2345		
V8 7.0L 427ci	1968	LH Front		1	EM-2241			
		RH Front		1	EM-2240			
		Trans	Auto	1			EM-2242	
		Trans	Manual	1			EM-2242	
V8 7.0L 428ci	1969	LH Front		1	EM-2271			
		LH Front		1	EM-2241			
	1968	RH Front		1	EM-2270			
		RH Front		1	EM-2240			
	1968-69	Trans	Auto	1			EM-2242	
		Trans	Manual	1			EM-2242	
V8 7.0L 429ci	1969-73	LH Front		1	EM-2368			
		RH Front		1	EM-2367			
		Trans	C-4/C-6 Transmission	1			EM-2311	
		Trans	FMX (AOD)	1			EM-2345	
		Trans	Auto	1			EM-2345	
1973-74	Trans	Manual	1			EM-2345		
	Trans	Manual	1			EM-2345		
<b>GHIA (MEXICAN VEHICLE)</b>								
L4	L4 2.3L 140ci	1991	LH Front	Auto; Bracket Only	1	EM-5063		
			RH Front		1	EM-2558		
			Trans	Auto; Hydraulic Mount	1			EM-2696 *
V6	V6 3.0L	1992-94	LH Front		1	EM-2804		
			RH Front		1	EM-2805		
			Trans	Auto; Hydraulic Mount	1			EM-2696 *
<b>GRAND MARQUIS (MEXICAN VEHICLE)</b>								
V8	V8 4.6L 281ci	1998-01	LH Front		1	EM-2861		
		1995-97	LH Front		1	EM-2807		
		1998-01	RH Front		1	EM-2860		
		1995-97	RH Front		1	EM-2806		
		1998-01	Trans		1			EM-2822
		1993-97	Trans		1			EM-2822

\* = Hydraulic Mount, "S" suffix = solid replacement.

# Engine, Transmission, And Torque Strut Mounts

CYL	ENG. SIZE	YEAR	LOCATION	DESCRIPTION	QTY	ENGINE	TORQUE STRUT	TRANSMISSION
<b>FORD PASSENGER CAR (continued)</b>								
<b>GRAN TORINO</b>								
L6	L6 4.1L 250ci	1973-74	Trans		1			EM-2347
		1972	Trans	Auto	1			EM-2253
			Trans	Manual	1			EM-2253
V8	V8 5.0L 302ci	1972-74	LH Front		1	EM-2370		
			RH Front		1	EM-2371		
		1973-74	Trans	C4	1			EM-2372
			Trans	FMX (AOD)	1			EM-2347
			Trans	Manual	1			EM-2347
		1972	Trans		1			EM-2372
	V8 5.8L 351ci	1975-76	L & R Front	Modified Engine	2	EM-2371		
			L & R Front	Windsor Engine	2	EM-2370		
		1972-74	LH Front		1	EM-2371		
			RH Front		1	EM-2370		
	1972-76	Trans		1			EM-2347	
	V8 6.6L 400ci	1972-76	LH Front		1	EM-2365		
			RH Front		1	EM-2364		
Trans				1			EM-2347	
V8 7.0L 429ci	1972-73	LH Front		1	EM-2367			
		RH Front		1	EM-2723			
		Trans		1			EM-2253	
V8 7.5L 460ci	1974-76	Trans		1			EM-2347	
<b>GRANADA</b>								
L4	L4 2.3L 140ci	1981-82	LH Front		1	EM-2458		
			RH Front		1	EM-2457		
			Trans	Auto	1			EM-2388
			Trans	Manual	1			EM-2388
L6	L6 3.3L 200ci	1981-82	L & R Front	Column Shift	2	EM-2776		
			L & R Front	Floor Shift	2	EM-2385		
		1975	L & R Front		2	EM-2341		
			LH Front		1	EM-2434		
		1976-77	RH Front		1	EM-2433		
			Trans	Auto	1			EM-2388
		1982	Trans	Manual	1			EM-2388
			Trans	Auto	1			EM-2389
		1981	Trans	Auto	1			EM-2389
			Trans	Manual	1			EM-2389
	1975-77	Trans	Auto	1			EM-2253	
		Trans	Manual	1			EM-2253	
	L6	L6 4.1L 250ci	1975	L & R Front		2	EM-2341	
1976-80			LH Front		1	EM-2434		
			RH Front		1	EM-2433		
1975-80			Trans	Auto	1			EM-2253
			Trans	Manual	1			EM-2253
V6	V6 3.8L 232ci	1982	LH Front		1	EM-2500		
			RH Front		1	EM-2501		
			Trans	Auto	1			EM-2389
			Trans	Manual	1			EM-2389
V8	V8 4.2L 255ci	1981	LH Front		1	EM-2500		
		1980	LH Front		1	EM-2504		
		1981	RH Front		1	EM-2501		
		1980	RH Front		1	EM-2503		
		1980-81	Trans	Auto	1			EM-2388
			Trans	Manual	1			EM-2388
	V8 5.0L 302ci	1976-80	LH Front		1	EM-2504		
			RH Front		1	EM-2503		
		1975-80	Trans	Auto	1			EM-2253
			Trans	Manual	1			EM-2253
	V8 5.8L 351ci	1975-77	LH Front		1	EM-2504		

# Engine, Transmission, And Torque Strut Mounts

CYL	ENG. SIZE	YEAR	LOCATION	DESCRIPTION	QTY	ENGINE	TORQUE STRUT	TRANSMISSION
<b>FORD PASSENGER CAR (continued)</b>								
<b>GRANADA (continued)</b>								
V8	V8 5.8L 351ci	1975-77	RH Front		1	EM-2503		
			Trans	Auto	1		EM-2253	
			Trans	Manual	1		EM-2253	
<b>IKON (MEXICAN VEHICLE)</b>								
L4	L4 1.6L	2003-07	Right	Style 1	1	EM-9002		
		2004-07	Torq Str - Rear	Manual	1		EM-9000	
			Trans - LH		1			EM-90029
<b>KA (MEXICAN VEHICLE)</b>								
L4	L4 1.6L	2001-08	RH Front		1	EM-9001		
<b>LTD</b>								
L4	L4 2.3L 140ci	1983-86	LH Front		1	EM-2458		
			RH Front		1	EM-2457		
			Trans	Auto	1		EM-2388	
L6	L6 3.3L 200ci	1983	RH Front		1	EM-2341		
			Trans	Auto	1		EM-2388	
			Trans	Manual	1		EM-2388	
V6	V6 3.8L 232ci	1986	LH Front		1	EM-2682		
		1985	LH Front	After 12/1/84	1	EM-2682		
			LH Front	Before 12/1/84	1	EM-2500		
		1983-84	LH Front		1	EM-2500		
		1986	RH Front		1	EM-2683		
		1985	RH Front	After 12/1/84	1	EM-2683		
			RH Front	Before 12/1/84	1	EM-2501		
		1983-84	RH Front		1	EM-2501		
		1985-86	Trans	Auto	1		EM-2388	
		1984	Trans	Auto	1		EM-2388	
		1983	Trans	Auto	1		EM-2388	
	Trans	Manual	1		EM-2388			
V8	V8 4.2L 255ci	1981-82	LH Front		1	EM-2438		
			RH Front		1	EM-2437		
			Trans		1		EM-2464	
	V8 4.7L 289ci	1967	L & R Front		2	EM-2287		
			Trans	Auto	1		EM-2242	
			Trans	Manual	1		EM-2242	
	V8 5.0L 302ci	1977-78 1968-72 1979-86	L & R Front		2	EM-2287		
			L & R Front		2	EM-2287		
			LH Front		1	EM-2438		
			RH Front		1	EM-2437		
			1977-86	Trans		1		EM-2464
			1968-72	Trans	Auto	1		EM-2311
		Trans	Manual	1		EM-2311		
	V8 5.8L 351ci	1969-78 1979-86	L & R Front		2	EM-2287		
			LH Front		1	EM-2438		
			RH Front		1	EM-2437		
				Trans		1		EM-2464
		1975-78	Trans	Auto	1		EM-2311	
		1972-74	Trans	Auto	1		EM-2311	
			Trans	Manual	1		EM-2311	
		1970-71	Trans	Auto	1		EM-2242	
Trans			Manual	1		EM-2242		
1969		Trans	Auto	1		EM-2311		
		Trans	Manual	1		EM-2311		
V8 6.4L 390ci	1969-71 1968 1969-71 1968	LH Front		1	EM-2271			
		LH Front		1	EM-2241			
		RH Front		1	EM-2270			
		RH Front		1	EM-2240			

## Engine, Transmission, And Torque Strut Mounts

CYL	ENG. SIZE	YEAR	LOCATION	DESCRIPTION	QTY	ENGINE	TORQUE STRUT	TRANS-MISSION	
<b>FORD PASSENGER CAR (continued)</b>									
<b>LTD (continued)</b>									
V8	V8 6.4L 390ci	1965-71	Trans		1			EM-2253	
	V8 6.6L 400ci	1971-78	LH Front		1	EM-2359			
			RH Front		1	EM-2358			
			Trans		1			EM-2345	
	V8 7.0L 427ci	1965-68	LH Front		1	EM-2241			
			RH Front		1	EM-2240			
			Trans	Auto	1			EM-2242	
			Trans	Manual	1			EM-2242	
	V8 7.0L 428ci	1969	LH Front		1	EM-2271			
		1967-68	LH Front		1	EM-2241			
		1969	RH Front		1	EM-2270			
		1967-68	RH Front		1	EM-2240			
			Trans	Auto	1			EM-2242	
			Trans	Manual	1			EM-2242	
	V8 7.0L 429ci	1973	LH Front		1	EM-2368			
		1969-72	LH Front		1	EM-2723			
		1973	RH Front		1	EM-2367			
		1969-72	RH Front		1	EM-2724			
		1969-73	Trans	AOD	1			EM-2345	
			Trans	C-4/C-6 Transmission	1			EM-2311	
V8 7.5L 460ci	1972-78	LH Front		1	EM-2368				
		RH Front		1	EM-2367				
		Trans		1			EM-2345		
<b>LTD II</b>									
V8	V8 5.0L 302ci	1977-79	LH Front		1	EM-2371			
			RH Front		1	EM-2370			
			Trans		1			EM-2388	
	V8 5.8L 351ci	1977-79	LH Front	Modified Engine	1	EM-2365			
			LH Front	Windsor Engine	1	EM-2370			
			RH Front	Modified Engine	1	EM-2364			
			RH Front	Windsor Engine	1	EM-2371			
				Trans		1			EM-2464
<b>MAINLINE</b>									
V8	V8 4.5L 272ci	1955-56	L & R Front		2	EM-2110			
	V8 5.1L 312ci	1956	L & R Front		2	EM-2110			
<b>MAVERICK</b>									
L6	L6 2.8L 170ci	1970-72	L & R Front		2	EM-2333			
			Trans	Auto	1			EM-2253	
			Trans	Manual	1			EM-2253	
	L6 3.3L 200ci	1973-77	L & R Front		2	EM-2341			
			1970-72	L & R Front		2	EM-2333		
			1970-77	Trans	Auto	1			EM-2253
				Trans	Manual	1			EM-2253
	L6 4.1L 250ci	1973-77	L & R Front		2	EM-2341			
			1970-72	L & R Front		2	EM-2333		
			1970-77	Trans	Auto	1			EM-2253
			Trans	Manual	1			EM-2253	
V8	V8 5.0L 302ci	1971-77	L & R Front		2	EM-2316			
			Trans	Auto	1			EM-2253	
			Trans	Manual	1			EM-2253	
<b>MUSTANG</b>									
L4	L4 2.3L 140ci	1987-93	LH Front		1	EM-5109			
		1983-86	LH Front	exc Convertible	1	EM-2458			
		1979-82	LH Front		1	EM-2458			
		1987-93	RH Front		1	EM-5108			

# Engine, Transmission, And Torque Strut Mounts

CYL	ENG. SIZE	YEAR	LOCATION	DESCRIPTION	QTY	ENGINE	TORQUE STRUT	TRANSMISSION	
<b>FORD PASSENGER CAR (continued)</b>									
<b>MUSTANG (continued)</b>									
L4	L4 2.3L 140ci	1983-86	RH Front	exc. Convertible	1	EM-2457			
		1979-82	RH Front		1	EM-2457			
		1987-93	Trans	Auto	1			EM-2707 *	
			Trans	Manual	1			EM-2388	
		1983-86	Trans	Auto	1			EM-2388	
			Trans	Manual	1			EM-2388	
		1979-82	Trans	Auto	1			EM-2565	
			Trans	Manual	1			EM-2388	
L6	L6 3.3L 200ci	1979-82	L & R Front		2	EM-2385			
		1967-70	L & R Front		2	EM-2333			
		1964-66	LH Front		1	EM-2226			
			RH Front		1	EM-2225			
		1982	Trans	Auto	1			EM-2388	
			Trans	Manual	1			EM-2388	
		1979-81	Trans		1			EM-2389	
		1964-70	Trans	Auto	1			EM-2253	
			Trans	Manual	1			EM-2253	
		L6 4.1L 250ci	1969-73	Trans	Auto	1		EM-2253	
	Trans			Manual	1		EM-2253		
	V6	V6 2.8L 171ci	1979	LH Front		1	EM-2458		
				RH Front		1	EM-2457		
				Trans	Auto	1		EM-2388	
Trans				Manual	1		EM-2388		
V6 3.7L 227ci		2011-16	L & R Front		2	EM-4029			
			Trans	Auto	1		EM-4230		
			Trans	Manual	1		EM-4230		
V6 3.8L 232ci		1996-04	LH Front		1	EM-2904			
		1994-95	LH Front		1	EM-2998			
		1985-86	LH Front	exc Convertible	1	EM-2683			
		1984	LH Front	Convertible	1	EM-2683			
			LH Front	Coupe	1	EM-2682			
		1983	LH Front	Convertible	1	EM-2683			
			LH Front	Coupe; Hatchback	1	EM-2500			
		1996-04	RH Front		1	EM-2905			
		1994-95	RH Front		1	EM-2997			
		1985-86	RH Front	exc Convertible	1	EM-2683			
		1984	RH Front	Convertible	1	EM-2683			
			RH Front	Coupe	1	EM-2683			
		1983	RH Front	Convertible	1	EM-2501			
			RH Front	Coupe; Hatchback	1	EM-2501			
		1996		Trans	After 11/7/95	1			EM-2707 *
				Trans	Before 11/7/95	1			EM-2707 *
		1999-04		Trans	Auto	1			EM-5380
				Trans	Manual	1			EM-5380
		1997-98		Trans		1			EM-2784
		1996		Trans		1			EM-2784
Trans					1			EM-2784	
1994-95			Trans	Auto	1			EM-2707 *	
			Trans	Manual	1			EM-2707 *	
1985-86			Trans	Auto; C5	1			EM-2389	
1983-84			Trans	C3 & C5	1			EM-2389	
V6 3.9L 238ci		2004	LH Front		1	EM-2904			
			RH Front		1	EM-2905			
			Trans		1			EM-5380	
V6 4.0L 245ci		2005-10	L & R Front		2	EM-4029			
			Trans		1			EM-4124	

\* = Hydraulic Mount, "S" suffix = solid replacement.



## Engine, Transmission, And Torque Strut Mounts

CYL	ENG. SIZE	YEAR	LOCATION	DESCRIPTION	QTY	ENGINE	TORQUE STRUT	TRANSMISSION
<b>FORD PASSENGER CAR (continued)</b>								
<b>MUSTANG (continued)</b>								
V8	V8 4.2L 255ci	1980-82	LH Front		1	EM-2458		
			RH Front		1	EM-2457		
			Trans	Auto	1			EM-2388
			Trans	Manual	1			EM-2388
V8	V8 4.3L 260ci	1964	LH Front		1	EM-2220		
			RH Front		1	EM-2221		
			Trans		1			EM-2171
V8	V8 4.6L 281ci	2005-10	L & R Front		2	EM-4029		
		1996-04	LH Front	w/o Appearance Group	1	EM-3002		
			RH Front	w/o Appearance Group	1	EM-3001		
		1999-04	Trans	Exc. Cobra SVT	1			EM-5380
		2005-10	Trans		1			EM-4124
		1999-04	Trans		1			EM-5380
		1996-98	Trans		1			EM-2784
V8	V8 4.7L 289ci	1967-68	L & R Front		2	EM-2257		
		1966	L & R Front	After 3/66	2	EM-2257		
			LH Front	Before 3/66	1	EM-2220		
		1964-65	LH Front		1	EM-2220		
		1966	RH Front	Before 3/66	1	EM-2221		
		1964-65	RH Front		1	EM-2221		
		1964-68	Trans	Auto	1			EM-2253
			Trans	Manual	1			EM-2253
V8	V8 5.0L 302ci	2011-16	L & R Front		2	EM-4029		
		1973	L & R Front	Convertible	2	EM-2286		
			L & R Front	Coupe	2	EM-2257		
		1968-72	L & R Front		2	EM-2257		
		1993-95	LH Front		1	EM-2725		
		1992	LH Front	Convertible	1	EM-2725		
			LH Front	Exc. Convertible Before 2/20/1992	1	EM-2682		
		1984-91	LH Front	Convertible	1	EM-2725		
			LH Front	Sedan & Hatchback	1	EM-2682		
		1982-83	LH Front		1	EM-2458		
		1979	LH Front		1	EM-2458		
		1993-95	RH Front		1	EM-2726		
		1992	RH Front	Convertible	1	EM-2726		
			RH Front	Exc. Convertible Before 2/20/1992	1	EM-2683		
		1984-91	RH Front	Convertible	1	EM-2726		
			RH Front	Sedan & Hatchback	1	EM-2683		
		1982-83	RH Front		1	EM-2457		
		1979	RH Front		1	EM-2457		
		1994-95	Trans		1			EM-2784
		1987-93	Trans	Auto	1			EM-2388
			Trans	Manual	1			EM-2388
		1982-85	Trans	Auto	1			EM-2388
			Trans	Manual	1			EM-2388
		1979	Trans	Auto	1			EM-2388
			Trans	Manual	1			EM-2388
		1968-73	Trans	Auto	1			EM-2253
			Trans	Manual	1			EM-2253
V8	V8 5.4L 330ci	2007-12	L & R Front		2	EM-4216		
			Trans		1			EM-4124
V8	V8 5.8L 351ci	1969-73	L & R Front	exc Convertible	2	EM-2257		
			Trans	Auto	1			EM-2253
			Trans	Manual	1			EM-2253
V8	V8 5.8L 355ci	2013-14	L & R Front		2	EM-4216		

# Engine, Transmission, And Torque Strut Mounts

CYL	ENG. SIZE	YEAR	LOCATION	DESCRIPTION	QTY	ENGINE	TORQUE STRUT	TRANSMISSION	
<b>FORD PASSENGER CAR (continued)</b>									
<b>MUSTANG (continued)</b>									
V8	V8 5.8L 355ci	2013-14	Trans		1			EM-4124	
			Trans		1		EM-4124		
	V8 6.4L 390ci	1967-69	Trans	Auto	1			EM-2253	
			Trans	Manual	1		EM-2253		
	V8 7.0L 428ci	1970	L & R Front		2	EM-2257			
			1968-69	LH Front		1	EM-2241		
				RH Front		1	EM-2240		
			1968-70	Trans	Auto	1			EM-2253
	Trans	Manual		1			EM-2253		
	V8 7.0L 429ci	1969-71	LH Front		1	EM-2724			
			RH Front		1	EM-2723			
			Trans	Auto	1			EM-2253	
Trans			Manual	1			EM-2253		
<b>MUSTANG II</b>									
L4	L4 2.3L 140ci	1974-78	L & R Front		2	EM-2344			
			Trans	Auto	1		EM-2565		
			Trans	Manual	1		EM-2565		
V6	V6 2.8L 171ci	1974-78	LH Front		1	EM-2344			
			1975-78	Trans	Auto	1		EM-2566	
		Trans		Manual	1		EM-2566		
		1974		Trans	Auto	1		EM-2388	
		1975-78	Trans	Manual	1		EM-2388		
1975-78	Trans		Auto	1		EM-2566			
	1975-78	Trans	Manual	1		EM-2566			
<b>MYSTIQUE (MEXICAN VEHICLE)</b>									
L4	L4 2.0L 122ci	1995	Front	Auto; Insert Only	1	EM-2866#			
			RH Front	Complete Unit	1	EM-2899			
			RH Front	Insert Only	1	EM-5105			
			Trans - Front	Auto; Complete Unit	1		EM-5107		
			Trans - Front	Auto; Insert Only	1		EM-2887		
V6	V6 2.5L 155ci	1998-00	Front	Auto; Insert Only	1	EM-2885			
			1995-97	Front	Auto; Insert Only	1	EM-2886		
		1998-00	RH Front	Hydraulic Mount	1	EM-5352			
			1995-97	RH Front	Complete Unit	1	EM-2889		
		1998-00		RH Front	Insert Only	1	EM-5105		
			1998-00	Trans - Front	Auto; Complete Unit	1		EM-2873	
		1995-97		Trans - Front	Auto; Insert Only	1		EM-5106	
			1998-00	Trans - Front	Auto; Complete Unit	1		EM-2873	
		1995-97		Trans - Front	Auto; Insert Only	1		EM-5106	
			1998-00	Trans - Rear	Auto; Insert Only	1		EM-2888	
		1995-97		Trans - Rear	Auto; Complete Unit	1		EM-5107	
1998-00	Trans - Rear		Auto; Insert Only	1		EM-2887			
	<b>PARK LANE WAGON</b>								
V8	V8 4.5L 272ci	1956	L & R Front		2	EM-2110			
<b>PINTO</b>									
L4	L4 1.6L 1598cc	1971-73	L & R Front		2	EM-2363			
			Trans	Auto	1		EM-2471		
			Trans	Manual	1		EM-2471		
	L4 2.0L 1989cc	1971-74	1973-74	L & R Front		2	EM-2363		
				Trans	Auto	1		EM-2346	
		1972	Trans	Manual	1		EM-2346		
			Trans	Auto	1		EM-2471		
		1974-80	Trans	Manual	1		EM-2471		
	1974-80		1974-80	L & R Front		2	EM-2344		
		Trans		Auto	1		EM-2346		

# = Available in the Westar Gold Line

# Engine, Transmission, And Torque Strut Mounts

CYL	ENG. SIZE	YEAR	LOCATION	DESCRIPTION	QTY	ENGINE	TORQUE STRUT	TRANSMISSION		
<b>FORD PASSENGER CAR (continued)</b>										
<b>PINTO (continued)</b>										
L4	L4 2.3L 140ci	1974-80	Trans	Manual	1			EM-2346		
V6	V6 2.8L 171ci	1975-79	L & R Front		2	EM-2344				
			Trans	Auto	1			EM-2346		
			Trans	Manual	1			EM-2346		
<b>POLICE INTERCEPTOR SEDAN</b>										
V6	V6 3.5L 213ci	2013-17	RH Front	Non Turbo	1	EM-5427				
			RH Front	Turbo	1	EM-4209				
		2013-19	Torq Str - Front	Turbo	1			EM-4056		
			Torq Str - Rear	Turbo	1			EM-4055		
	V6 3.7L 227ci	2013-17	RH Front	Non Turbo	1	EM-5427				
<b>PROBE</b>										
L4	L4 2.0L 122ci	1994-97	Front	Auto	1	EM-5155				
			Front	Manual	1	EM-8073				
		1993	Front	Auto	1	EM-5110				
			Front	Manual	1	EM-8073				
		1994-97	RH Front		1	EM-8074				
		1993	RH Front		1	EM-8074				
		1994-97	Rear	Auto	1	EM-8691				
			Rear	Manual	1	EM-8456				
		1993	Rear	Auto	1	EM-8075				
			Rear	Manual	1	EM-8456				
		L4 2.0L 1989cc	1994-97	Trans - Center Lower	Auto	1			EM-9087	
				Trans - Center Lower	Manual	1			EM-9082	
	1993		Trans - Center Lower	Auto	1			EM-9087		
			Trans - Center Lower	Manual	1			EM-9082		
	1994-97		Trans - Upper	Auto	1			EM-8691		
	1993		Trans - Upper	Auto	1			EM-8075		
			Trans - Upper	Manual	1			EM-8456		
	L4 2.2L 133ci		1989-92	Front	Auto; w/o Turbo	1	EM-8083			
		Front		Manual	1	EM-8085				
		RH Front		Manual; w/ Turbo	1	EM-8086				
		RH Front		w/o Turbo	1	EM-9131				
Rear		Auto; w/o Turbo		1	EM-8087					
Rear		Manual; w/o Turbo		1	EM-8088					
Trans		Auto		1			EM-8516			
Trans		Manual		1			EM-8089			
V6	V6 2.5L 2497cc	1993-97	Front		1	EM-8073				
			LH Rear	Auto	1	EM-8075				
			LH Rear	Manual	1	EM-8456				
			Trans - Center Lower	Auto	1			EM-9087		
			Trans - Center Lower	Manual	1			EM-9082		
			V6 3.0L 182ci	1990-92	Front	Manual	1	EM-8085		
	Rear		1		EM-8087					
	<b>RANCH WAGON</b>									
	V8	V8 4.5L 272ci	1955-57		L & R Front		2	EM-2110		
	<b>SABLE (MEXICAN VEHICLE)</b>									
V6	V6 3.0L 182ci	2000-01	RH Front	Hydraulic Mount	1	EM-2894*				
		1997-99	RH Front	Hydraulic Mount; DOHC	1	EM-2934*				
		1996	RH Front	Hydraulic Mount	1	EM-2934*				

\* = Hydraulic Mount, "S" suffix = solid replacement.

# Engine, Transmission, And Torque Strut Mounts

CYL	ENG. SIZE	YEAR	LOCATION	DESCRIPTION	QTY	ENGINE	TORQUE STRUT	TRANSMISSION	
<b>FORD PASSENGER CAR (continued)</b>									
<b>SABLE (MEXICAN VEHICLE) (continued)</b>									
V6	V6 3.0L 182ci	2000-01	RH Rear	DOHC	1	EM-2862			
		1997-99	RH Rear	DOHC	1	EM-2862			
		1996	RH Rear		1	EM-2862			
		2000-01	Torq Str - Rear		1		EM-2872		
			Trans	Hydraulic Mount	1			EM-2974 *	
	1996-99	Trans	Hydraulic Mount	1			EM-2717 *		
	V6 3.8L 232ci	1995	RH Front	Hydraulic Mount	1	EM-2812'			
RH Rear			Hydraulic Mount	1	EM-2813'				
Trans			Hydraulic Mount	1			EM-2717 *		
<b>SKYLINER</b>									
V8	V8 4.5L 272ci	1955-57	L & R Front		2	EM-2110			
<b>SUNLINER</b>									
V8	V8 4.5L 272ci	1955-57	L & R Front		2	EM-2110			
<b>SUPER DELUXE</b>									
V8	V8 3.9L 239ci	1946-48	L & R Front Upper		2	EM-2009			
<b>TAURUS</b>									
L4	L4 2.5L 153ci	1986-91	RH Front		1	EM-2692			
			RH Rear		1	EM-2770			
		1988-91	Trans	Auto	1			EM-2686	
		1986-87	Trans	Auto	1			EM-2687	
Trans	Manual		1			EM-2965			
V6	V6 3.0L 181ci	2000-05	RH Front	DOHC; DOHC	1	EM-2894'			
		1996-99	RH Front	DOHC; DOHC	1	EM-2934'			
		2000-05	RH Rear	DOHC; DOHC	1	EM-2862			
		1996-99	RH Rear	DOHC; DOHC	1	EM-2862			
	V6 3.0L 182ci	2006-07	RH Front		1	EM-2894'			
		2000-05	RH Front	OHV; OHV	1	EM-2894'			
		1996-99	RH Front	OHV; OHV	1	EM-2789'			
		1994-95	RH Front	exc SHO	1	EM-2790'			
		1993	RH Front	OHV	1	EM-2792'			
		1991-92	RH Front	OHV	1	EM-2791'			
		1986-90	RH Front	VIN U	1	EM-2623			
		2006-07	RH Rear		1	EM-2973			
		2000-05	RH Rear	OHV; OHV	1	EM-2973			
		1996-99	RH Rear	OHV; Hydraulic Mount; OHV	1	EM-2840'			
		1994-95	RH Rear	exc SHO	1	EM-2788'			
		1993	RH Rear	OHV	1	EM-2788'			
		1991-92	RH Rear	OHV	1	EM-2788'			
		1986-90	RH Rear	VIN U	1	EM-2622			
		2006-07	Torq Str - Rear		1		EM-3099		
		2004-05	Torq Str - Rear	OHV; VIN2; VINU	1		EM-3099		
		2000-03	Torq Str - Rear	OHV	1		EM-2872		
		2000-07	Trans	Auto	1			EM-2974 *	
		1990-99	Trans	Auto	1			EM-2717 *	
		1988-89	Trans	Auto	1			EM-2686	
	1986-87	Trans		1			EM-2687		
	V6 3.0L 182ci SHO Engine	1989-95	RH Front	VIN Y	1	EM-4005			
				VIN Y	1	EM-4005			
				VIN Y	1	EM-2964			
			Trans	Manual	1			EM-2717 *	
	V6 3.2L 195ci SHO Engine	1993-95	Front		1	EM-2967'			
				1	EM-2967'				

\* = Hydraulic Mount, "S" suffix = solid replacement.

# Engine, Transmission, And Torque Strut Mounts

CYL	ENG. SIZE	YEAR	LOCATION	DESCRIPTION	QTY	ENGINE	TORQUE STRUT	TRANSMISSION	
<b>FORD PASSENGER CAR (continued)</b>									
<b>TAURUS (continued)</b>									
V6	V6 3.2L 195ci SHO Engine	1993-95	Rear		1	EM-2968*			
			Trans	Auto	1	EM-2968*		EM-2717 *	
V6	V6 3.5L 213ci	2013-17	RH Front	Non Turbo	1	EM-5427			
			RH Front	Turbo	1	EM-4209			
			2010-12	RH Front	Non Turbo	1	EM-5427		
				RH Front	Turbo	1	EM-4209		
		2008-09	RH Front		1	EM-5427			
		2013-19	Torq Str - Front	Turbo	1		EM-4056		
		2010-12	Torq Str - Front	Turbo	1		EM-4056		
		2008-09	Torq Str - Front	Exc. SHO	1		EM-3142		
		2013-19	Torq Str - Rear	Turbo	1		EM-4055		
		2010-12	Torq Str - Rear	Non Turbo	1		EM-3142		
			Torq Str - Rear	Turbo	1		EM-4055		
		2010-19	Trans - Upper	Non Turbo	1			EM-4040	
		2008-09	Trans - Upper		1			EM-4040	
V6	V6 3.8L 232ci	1989-95	RH Front		1	EM-2812*			
			1988	RH Front		1	EM-2812*		
			1989-95	RH Rear		1	EM-2813*		
			1988	RH Rear		1	EM-2813*		
			1988-95	Trans		1			EM-2717 *
V8	V8 3.4L 207ci	1996-99	Front		1	EM-2934*			
			Rear		1	EM-2862			
			Trans		1			EM-2717 *	
<b>TAURUS X</b>									
V6	V6 3.5L 213ci	2008-09	RH Front		1	EM-5427			
			Torq Str - Rear		1		EM-3142		
			Trans - Upper		1			EM-4040	
<b>TEMPO</b>									
L4	L4 2.0L 1989cc Diesel	1984-86	Front	Manual; w/ Bracket	1	EM-5065			
			Front	Manual; w/o Bracket	1	EM-2559			
			LH Front	Auto; w/ Bracket	1	EM-5063			
	L4 2.3L 140ci	1992-94	Front		1	EM-2804			
			1986-91	Front	Auto	1	EM-2696*		
		1984-85	Front	Manual	1	EM-2559			
			Front		1	EM-2559			
			LH Front	Auto; w/ Bracket	1	EM-5063			
			LH Front	Manual; w/ Bracket	1	EM-5065			
		1992-94	RH Front		1	EM-2805			
		1986-91	RH Front		1	EM-2558			
		1984-85	RH Front		1	EM-2558			
		1986-94	Trans	Auto	1			EM-2696 *	
			Trans	Manual; 5 Spd	1			EM-2665	
		1984-85	Trans	Auto	1			EM-2632	
			Trans	Manual; 4 Spd	1			EM-2634	
			Trans	Manual; 5 Spd	1			EM-2665	
V6	V6 3.0L 182ci	1992-94	LH Front	Auto; Attached To Transaxle	1	EM-2804			
			Trans	Auto	1		EM-2696 *		
			Trans	Manual	1		EM-2665		
<b>THUNDERBIRD</b>									
L4	L4 2.3L 140ci	1983-84	LH Front		1	EM-5109			
			RH Front		1	EM-5108			
		1985-88	Trans	Auto	1			EM-2707 *	
			Trans	Manual	1			EM-2707 *	

\* = Hydraulic Mount, "S" suffix = solid replacement.

# Engine, Transmission, And Torque Strut Mounts

CYL	ENG. SIZE	YEAR	LOCATION	DESCRIPTION	QTY	ENGINE	TORQUE STRUT	TRANSMISSION
<b>FORD PASSENGER CAR (continued)</b>								
<b>THUNDERBIRD (continued)</b>								
L4	L4 2.3L 140ci	1983-84	Trans	Auto	1			EM-2388
			Trans	Manual	1			EM-2388
L6	L6 3.3L 200ci	1980-82	L & R Front		2	EM-2776		
		1982	Trans	Auto; AOT	1			EM-2784
			Trans	Auto; C5	1			EM-2389
1981	Trans	Auto	1			EM-2389		
V6	V6 3.8L 232ci	1986-97	L & R Front		2	EM-2661*		
		1983-85	LH Front		1	EM-2682		
		1982	LH Front		1	EM-2500		
		1983-85	RH Front		1	EM-2683		
		1982	RH Front		1	EM-2501		
		1996-97	Trans	Auto	1			EM-2707 *
		1989-95	Trans	Auto	1			EM-2707 *
			Trans	Manual	1			EM-2707 *
V8	V8 3.9L 242ci	2002-05	Trans		1			EM-3063
	V8 4.2L 255ci	1980-82	LH Front	w/ Shake Condition	1	EM-2725		
	LH Front		w/o Shake Condition	1	EM-2500			
	RH Front		w/ Shake Condition	1	EM-2726			
	RH Front		w/o Shake Condition	1	EM-2501			
	Trans		Auto	1			EM-2388	
	V8 4.6L 281ci	1994-97	L & R Front		2	EM-2995*		
		1996-97	Trans	Auto	1			EM-2707 *
		1994-95	Trans	Auto	1			EM-2707 *
	V8 4.8L	1955	L & R Front		2	EM-2110		
	V8 4.8L 292ci	1956-58	Center Front Lower		1	EM-2120		
V8	V8 5.0L 302ci	1991-93	L & R Front		2	EM-2995*		
		1986-88	L & R Front		2	EM-2661*		
		1977-79	L & R Front		2	EM-2371		
		1983-85	LH Front		1	EM-2682		
		1980-81	LH Front	Shake Condition	1	EM-2725		
			LH Front	w/o Shake Condition	1	EM-2500		
		1983-85	RH Front		1	EM-2683		
		1980-81	RH Front	Shake Condition	1	EM-2726		
			RH Front	w/o Shake Condition	1	EM-2501		
		1991-93	Trans	Auto	1			EM-2707 *
		1983-88	Trans	Auto	1			EM-2388
1980-81	Trans	Auto	1			EM-2388		
1977-79	Trans	Auto	1			EM-2464		
	V8 5.1L 312ci	1956-57	L & R Front		2	EM-2110		
V8	V8 5.8L 351ci	1977-79	LH Front	Modified Engine	1	EM-2365		
			LH Front	Windsor Engine	1	EM-2370		
			RH Front	Modified Engine	1	EM-2364		
			RH Front	Windsor Engine	1	EM-2371		
			Trans	Auto	1			EM-2464
V8	V8 6.4L 390ci	1967-68	LH Front		1	EM-2241		
			RH Front		1	EM-2240		
		1961-66	Trans	Auto	1			EM-2242
			Trans	Manual	1			EM-2242
V8	V8 6.6L 400ci	1977-78	LH Front		1	EM-2365		
			RH Front		1	EM-2364		
			Trans	Auto	1			EM-2464
V8	V8 7.0L 428ci	1966-67	LH Front		1	EM-2241		
			RH Front		1	EM-2240		
V8	V8 7.5L 460ci	1972-76	Trans		1			EM-2345

\* = Hydraulic Mount, "S" suffix = solid replacement.

## Engine, Transmission, And Torque Strut Mounts

CYL	ENG. SIZE	YEAR	LOCATION	DESCRIPTION	QTY	ENGINE	TORQUE STRUT	TRANSMISSION
<b>FORD PASSENGER CAR (continued)</b>								
<b>TORINO</b>								
L6	L6 4.1L 250ci	1969-71	L & R Front	Convertible	2	EM-2333		
		1973-74	Trans	Auto	1			EM-2347
			Trans	Manual	1			EM-2347
		1969-72	Trans	Auto	1			EM-2253
Trans	Manual		1			EM-2253		
V8	V8 5.0L 302ci	1968-71	L & R Front		2	EM-2257		
		1972-74	LH Front		1	EM-2370		
			RH Front		1	EM-2371		
		1973-74	Trans	Auto	1			EM-2347
			Trans	Manual	1			EM-2347
		1972	Trans	Auto	1			EM-2372
			Trans	Manual	1			EM-2372
		1968-71	Trans	Auto	1			EM-2253
	Trans		Manual	1			EM-2253	
	V8 5.8L 351ci	1975-76	L & R Front	Modified Engine	2	EM-2371		
			L & R Front	Windsor Engine	2	EM-2370		
		1969-71	L & R Front		2	EM-2257		
		1972-74	LH Front		1	EM-2371		
			RH Front		1	EM-2370		
		1975-76	Trans		1			EM-2347
		1972-74	Trans	Auto	1			EM-2347
			Trans	Manual	1			EM-2347
		1969-71	Trans	Auto	1			EM-2253
			Trans	Manual	1			EM-2253
	V8 6.4L 390ci	1968-69	LH Front		1	EM-2241		
			RH Front		1	EM-2240		
			Trans	Auto	1			EM-2253
			Trans	Manual	1			EM-2253
V8 6.6L 400ci	1972-76	LH Front		1	EM-2365			
		RH Front		1	EM-2364			
		Trans		1			EM-2372	
V8 7.0L 428ci	1968-69	LH Front		1	EM-2241			
		RH Front		1	EM-2240			
		Trans	Auto	1			EM-2253	
		Trans	Manual	1			EM-2253	
V8 7.5L 460ci	1973-76	Trans		1			EM-2372	
<b>VICTORIA</b>								
V8	V8 4.5L 272ci	1955-57	L & R Front		2	EM-2110		
<b>FORD SPORT UTILITY</b>								
<b>BRONCO</b>								
L6	L6 2.8L 170ci	1967-72	L & R Front		2	EM-2319		
			Trans		1			EM-2348
	L6 3.9L 240ci	1967	LH Front		1	EM-2332		
			RH Front		1	EM-2331		
			Trans		1			EM-2349
	L6 4.9L 300ci	1989-92	L & R Front		2	EM-2698*		
			1985-88	LH Front		1	EM-2636	
		1980-84	LH Front		1	EM-2442		
		1985-88	RH Front		1	EM-2635		
		1980-84	RH Front		1	EM-2441		
		1988-92	Trans	Auto	1			EM-2557
			Trans	Manual	1			EM-2557
		1987	Trans	Auto	1			EM-2557
	Trans		Manual	1			EM-2557	
	1985-86	Trans	Auto	1			EM-2448	

\* = Hydraulic Mount, "S" suffix = solid replacement.

# Engine, Transmission, And Torque Strut Mounts

CYL	ENG. SIZE	YEAR	LOCATION	DESCRIPTION	QTY	ENGINE	TORQUE STRUT	TRANSMISSION	
<b>FORD SPORT UTILITY (continued)</b>									
<b>BRONCO (continued)</b>									
L6	L6 4.9L 300ci	1985-86	Trans	Manual	1			EM-2448	
		1980-84	Trans	Auto	1			EM-2448	
			Trans	Manual	1			EM-2448	
V8	V8 4.7L 289ci	1966-68	L & R Front		2	EM-2329			
			Trans		1			EM-2348	
	V8 5.0L 302ci	1987-96 1980-86 1968-77 1994-96 1987-93 1985-86 1980-84 1968-77	L & R Front		2	EM-2564			
			L & R Front		2	EM-2329			
			L & R Front		2	EM-2329			
			Trans	Auto	1			EM-2884	
			Trans	Manual	1			EM-2884	
			Trans	Auto	1			EM-2557	
			Trans	Manual	1			EM-2557	
			Trans	Auto	1			EM-2448	
			Trans	Manual	1			EM-2448	
			Trans	Auto	1			EM-2448	
			Trans	Manual	1			EM-2448	
			Trans	Auto	1			EM-2448	
	V8 5.8L 351ci	1987-96 1983-86 1980-82 1978-79 1996 1994-95 1988-93 1985-86 1980-84	L & R Front		2	EM-2564			
			L & R Front		2	EM-2329			
			L & R Front		2	EM-2329			
			L & R Front	Windsor Engine	2	EM-2329			
			LH Front	Modified Engine	1	EM-2445			
			RH Front	Modified Engine	1	EM-2444			
			Trans	Auto	1			EM-2970	
			Trans	Manual	1			EM-2970	
			Trans		1			EM-2870	
			Trans	Auto	1			EM-2557	
			Trans	Manual	1			EM-2557	
			Trans	Auto	1			EM-2448	
	V8 6.6L 400ci	1978-79	LH Front		1	EM-2445			
			RH Front		1	EM-2444			
			Trans	Auto	1			EM-2349	
			Trans	Manual	1			EM-5111	
	<b>BRONCO II</b>								
	V6	V6 2.8L 171ci	1984-85	LH Front		1	EM-2940		
				RH Front		1	EM-2941		
V6 2.9L 177ci		1986-90	LH Front	4WD	1	EM-2643			
			LH Front	RWD	1	EM-2642			
			RH Front		1	EM-2641			
			Trans	Auto	1			EM-2639	
Trans	Manual	1			EM-2639				
<b>ECOSPORT (MEXICO)</b>									
L4	L4 2.0L 121ci	2007-08	Trans	Auto	1			EM-90030	
			Trans	Manual	1			EM-90030	
		2005-06 2004	Trans	Manual	1			EM-90030	
			Trans	Auto	1			EM-90030	
			Trans	Manual	1			EM-90030	
	L4 2.0L 122ci	2010-12	Trans	Auto	1			EM-90030	
Trans			Manual	1			EM-90030		



# Engine, Transmission, And Torque Strut Mounts

CYL	ENG. SIZE	YEAR	LOCATION	DESCRIPTION	QTY	ENGINE	TORQUE STRUT	TRANSMISSION	
<b>FORD SPORT UTILITY (continued)</b>									
<b>EDGE</b>									
L4	L4 2.0L 122ci	2012-14	Right		1	EM-4221			
			Torq Str - Rear		1		EM-3142		
			Trans		1			EM-4081	
	L4 2.0L 122ci	2015-17	Torq Str - Rear		1		EM-4184		
			Trans		1			EM-4251	
V6	V6 3.5L 213ci	2015-18	RH Front		1	EM-4270			
		2007-14	RH Front		1	EM-5427			
		2007-10	Torq Str - Front		1		EM-3144		
		2015-16	Torq Str - Lower		1		EM-4200		
		2011-14	Torq Str - Rear		1		EM-3142		
		2015-16	Torq Str - Upper		1		EM-4202		
		2007-14	Trans		1			EM-4081	
	V6 3.7L 227ci	2011-14	RH Front		1	EM-5427			
			Torq Str - Rear		1		EM-3142		
		Trans		1			EM-4081		
<b>ESCAPE</b>									
L4	L4 1.5L 91ci	2017	Right	Complete Unit	1	EM-4190			
			Right	Insert	1	EM-4256			
			Torq Str - Front		1		EM-4057		
			2017-19	Trans - Upper		1			EM-4121
	L4 1.6L 98ci	2013-16	Right	Complete Unit	1	EM-4190			
			Right	Insert	1	EM-4256			
			Torq Str - Front		1		EM-4057		
			Trans - Upper		1			EM-4121	
	L4 2.0L 121ci	2001-04	RH Front		1	EM-3056*			
			Rear		1	EM-3057*			
		2013-17	Torq Str - Front		1		EM-4057		
		2001-04	Trans	Auto	1			EM-3037	
	L4 2.0L 122ci	2013-17	Right	Gas; Complete Unit	1	EM-4152			
			Right	Gas; Insert	1	EM-4229			
		2013-19	Trans - Upper		1			EM-4121	
	L4 2.3L 140ci	2005-08	Front	Gas	1	EM-4033			
			LH Front	Gas	1	EM-4071			
			LH Front	Hybrid	1	EM-4071			
			Rear	Gas	1	EM-4019			
			Right	Hybrid	1	EM-4033			
			Torq Str - Rear	Hybrid; Hybrid	1		EM-4051		
			Trans	Gas; Auto	1			EM-4117	
	L4 2.5L 152ci	2009-11	Front	Gas	1	EM-4033			
			LH Front	Gas	1	EM-4071			
			Rear	Gas	1	EM-4019			
		2013-17	Right	Gas; Complete Unit	1	EM-4152			
			Right	Gas; Insert	1	EM-4229			
				Torq Str - Front		1		EM-4057	
		2009-12	Torq Str - Rear	Hybrid	1		EM-4051		
2013-19		Trans		1			EM-4121		
2009-12	Trans	Auto	1			EM-4117			
V6	V6 3.0L 182ci	2001-04	RH Front		1	EM-3056*			
			Rear		1	EM-3037			
			Trans		1			EM-3057*	
	V6 3.0L 183ci	2009-12	Front		1	EM-4033			
			Front		1	EM-4071			
		2009-12	LH Front		1	EM-4071			
			Rear	FWD	1	EM-4019			
		2005-08	Rear		1	EM-4019			
			Right		1	EM-4033			

\* = Hydraulic Mount, "S" suffix = solid replacement.

# Engine, Transmission, And Torque Strut Mounts

CYL	ENG. SIZE	YEAR	LOCATION	DESCRIPTION	QTY	ENGINE	TORQUE STRUT	TRANSMISSION	
<b>FORD SPORT UTILITY (continued)</b>									
<b>ESCAPE (continued)</b>									
V6	V6 3.0L 183ci	2005-12	Trans	Auto	1			EM-4117	
			Trans	Manual	1			EM-4117	
<b>EXCURSION</b>									
V8	V8 5.4L 330ci	2000-05	LH Front		1	EM-5424			
			RH Front	4WD	1	EM-5425			
			Trans	Auto; w/o Damper	1			EM-2884	
	V8 6.0L 363ci	2003-05	Left		1	EM-4268			
			Right		1	EM-4269			
			Trans	2WD	1			EM-4024	
			Trans	4WD	1			EM-4023	
V8 7.3L 445ci Diesel	2000-03	Trans	Auto; w/o Damper	1			EM-2884		
V10	V10 6.8L 415ci	2000-05	Left	4WD	1	EM-4022			
			Right	4WD	1	EM-4021			
		2000-04	Trans	Auto; w/o Damper	1			EM-2884	
<b>EXPEDITION</b>									
V6	V6 3.5L 213ci	2015-17	LH Front		1	EM-4143			
			RH Front		1	EM-4142			
V8	V8 4.6L 281ci	1999-02	LH Front	4WD	1	EM-2972			
			LH Front	RWD	1	EM-2832			
		1997-98	LH Front	4WD; US & Canada	1	EM-2972			
			LH Front	RWD	1	EM-2832			
		2004	Left		1	EM-4097			
		2003	Left		1	EM-4097			
		1999-02	RH Front		1	EM-2835			
		1997-98	RH Front		1	EM-2835			
		1997-04	Trans		1			EM-2870	
		V8 5.4L 330ci	2007-14	LH Front		1	EM-4143		
	LH Front				1	EM-4097			
	LH Front				1	EM-4097			
	LH Front				1	EM-4097			
	LH Front			4WD	1	EM-2972			
	LH Front			RWD	1	EM-2832			
	LH Front			4WD; US & Canada	1	EM-2972			
	LH Front			RWD	1	EM-2832			
	RH Front				1	EM-4142			
	RH Front				1	EM-4099			
	RH Front		1	EM-4099					
RH Front		1	EM-4098						
RH Front		1	EM-2835						
RH Front	4WD; US & Canada	1	EM-2834						
RH Front	RWD	1	EM-2835						
1997-04	Trans		1			EM-2870			
<b>EXPLORER</b>									
L4	L4 2.0L 122ci	2012-14	Front		1	EM-4125			
		2012-15	Torq Str - Front		1		EM-4120		
	L4 2.3L 140ci	2016-19	RH Front		1	EM-4125			
Trans	Auto		1			EM-4121			
V6	V6 3.5L 213ci	2013-19	Front	Non Turbo	1	EM-4298			
			Front	Turbo	1	EM-4139			
		2015	Torq Str - Front	Turbo; Mexico; Turbo	1		EM-4056		
		2013-17	Torq Str - Front	Turbo; US Models; Turbo	1		EM-4056		
		2015	Torq Str - Rear	Turbo; Mexico; Turbo	1		EM-4055		
		2013-17	Torq Str - Rear	Turbo; US Models; Turbo	1		EM-4055		
		2011-15	Torq Str - Rear	Non Turbo	1		EM-4138		
	2011-17	Trans		1			EM-4140		
V6 4.0L 245ci	2006-10	LH Front		1	EM-4106				

## Engine, Transmission, And Torque Strut Mounts

CYL	ENG. SIZE	YEAR	LOCATION	DESCRIPTION	QTY	ENGINE	TORQUE STRUT	TRANSMISSION	
<b>FORD SPORT UTILITY (continued)</b>									
<b>EXPLORER (continued)</b>									
V6	V6 4.0L 245ci	2002-05	LH Front		1	EM-3047			
		1997-01	LH Front		1	EM-2851			
		1995-96	LH Front		1	EM-2869			
		1991-94	LH Front		1	EM-2643			
		2006-10	RH Front		1	EM-3048			
		2002-05	RH Front		1	EM-3048			
		1997-01	RH Front		1	EM-2850			
		1995-96	RH Front		1	EM-2850			
		1991-94	RH Front		1	EM-2641			
		2006-10	Trans	4WD		1			EM-4095
			Trans	RWD		1			EM-3062
		2005	Trans	4WD		1			EM-3061
			Trans	RWD		1			EM-3062
		2004	Trans	AWD & 4WD		1			EM-3061
			Trans	RWD		1			EM-3062
		2002-03	Trans	4WD		1			EM-3061
Trans	RWD			1			EM-3062		
1991-01	Trans	Auto		1			EM-2639		
	Trans	Manual		1			EM-2639		
V8	V8 4.6L 281ci	2007-10	LH Front		1	EM-4106			
		2002-06	LH Front		1	EM-3047			
		2007-10	RH Front		1	EM-3048			
		2002-06	RH Front		1	EM-3048			
		2006-10	Trans	4WD		1			EM-4095
			Trans	RWD		1			EM-3062
		2004-05	Trans	AWD & 4WD		1			EM-3061
			Trans	RWD		1			EM-3062
		2002-03	Trans	4WD		1			EM-3061
			Trans	RWD		1			EM-3062
	V8 5.0L 302ci	1996-01	LH Front		1	EM-3000			
			RH Front		1	EM-2999			
		Trans		1			EM-2868		
<b>EXPLORER SPORT TRAC</b>									
V6	V6 4.0L 245ci	2001-05	LH Front		1	EM-2851			
		2007-10	RH Front		1	EM-3048			
		2001-05	RH Front		1	EM-2850			
		2007	Trans	2WD		1			EM-2868
			Trans	4WD		1			EM-2639
		2001-05	Trans	2WD		1			EM-2868
Trans	4WD			1			EM-2639		
V8	V8 4.6L 281ci	2007-10	RH Front		1	EM-3048			
<b>FLEX</b>									
V6	V6 3.5L 213ci	2010-16	RH Front	Non Turbo	1	EM-5427			
			RH Front	Turbo	1	EM-4209			
		2009	RH Front	Non Turbo	1	EM-5427			
		2013-19	Torq Str - Front	Turbo	1		EM-4056		
		2010-12	Torq Str - Front	Non Turbo	1		EM-3142		
			Torq Str - Front	Turbo	1		EM-4056		
		2009	Torq Str - Front	Non Turbo	1		EM-3142		
		2013-19	Torq Str - Rear	Turbo	1		EM-4055		
		2010-12	Torq Str - Rear	Turbo	1		EM-4055		
2009-19	Trans - Upper	Non Turbo		1			EM-4040		

# Engine, Transmission, And Torque Strut Mounts

CYL	ENG. SIZE	YEAR	LOCATION	DESCRIPTION	QTY	ENGINE	TORQUE STRUT	TRANSMISSION
<b>FORD SPORT UTILITY (continued)</b>								
<b>POLICE INTERCEPTOR UTILITY</b>								
V6	V6 3.5L 213ci	2014-19	RH Front	Turbo	1	EM-4139		
<b>FORD TRUCK</b>								
<b>COURIER SEDAN DELIVERY</b>								
V8	V8 4.4L	1955-57	L & R Front		2	EM-2110		
<b>COURIER</b>								
L4	L4 1.6L 98ci	2001-08	RH Front	Mexican Vehicle	1	EM-9002		
			Torg Str - Rear	Mexican Vehicle	1		EM-9002	
			Trans - LH	Mexican Vehicle	1			EM-90029
	L4 1.8L 110ci	1972-79	LH Front		1	EM-2775		
			RH Front		1	EM-2774		
			1975-79	Trans		1		EM-2759
			1972-74	Trans	Auto	1		EM-2759
	L4 2.0L 121ci	1981-82	Trans		1			EM-2759
			1979	Trans		1		EM-2759
			Trans	Manual	1			EM-2759
	L4 2.0L 122ci	1981-82	LH Front		1	EM-2775		
			1979	LH Front		1	EM-2775	
		1981-82	RH Front		1	EM-2774		
			1979	RH Front		1	EM-2774	
L4 2.3L 140ci	1977-82	LH Front		1	EM-2775			
		RH Front		1	EM-2774			
		Trans		1			EM-2759	
<b>F SERIES</b>								
L6	L6 3.7L 223ci	1957-59	L & R Front Lower		2	EM-2048		
			L & R Front Upper		2	EM-2050		
			Trans - L & R Lower		2			EM-2121
			Trans - L & R Upper		2			EM-2119
	L6 3.7L 226ci	1949-50	Front		1	EM-5465		
V8	V8 3.9L 239ci	1948-51	L & R Front Lower		2	EM-2010		
			L & R Front Upper		2	EM-2009		
		1953-55	Trans - Lower		1			EM-2121
			Trans - Upper		1			EM-2119
	V8 4.5L 272ci	1957	L & R Front Lower		2	EM-2048		
			L & R Front Upper		2	EM-2050		
			Trans - L & R Lower		2			EM-2121
			Trans - L & R Upper		2			EM-2119
V8 4.8L 292ci	1957-59	L & R Front Lower		2	EM-2048			
		L & R Front Upper		2	EM-2050			
<b>F-100 PICKUP</b>								
L6	L6 3.6L 223ci	1957-64	L & R Front Lower		2	EM-2048		
			L & R Front Upper		2	EM-2050		

## Engine, Transmission, And Torque Strut Mounts

CYL	ENG. SIZE	YEAR	LOCATION	DESCRIPTION	QTY	ENGINE	TORQUE STRUT	TRANSMISSION	
<b>FORD TRUCK (continued)</b>									
<b>F-100 PICKUP (continued)</b>									
L6	L6 3.6L 223ci	1954-64	Trans - L & R Lower		2			EM-2121	
			Trans - L & R Upper		2			EM-2119	
	L6 3.9L 240ci	1965-74	LH Front		1	EM-2332			
			1965-66	LH Front		1	EM-2332		
			1965-74	RH Front		1	EM-2331		
			1965-66	RH Front		1	EM-2331		
			1953-55	Trans - L & R Lower		2			EM-2121
				Trans - L & R Upper		2			EM-2119
			1965-66	Trans - Lower	4WD	1			EM-2306
				Trans - Upper	4WD	1			EM-2305
			1967-74	Trans	4WD	1			EM-2349
				Trans	Auto; C4; 2WD	1			EM-2327
				Trans	Auto; C6; 2WD	1			EM-2362
				Trans	Manual; 2WD	1			EM-2327
			1965-66	Trans	Auto; C4; 2WD	1			EM-2327
				Trans	Auto; C6; 2WD	1			EM-2362
	Trans	Manual; 2WD		1			EM-2327		
	L6 4.9L 300ci	1974-83		LH Front		1	EM-2442		
				1965-73	LH Front		1	EM-2332	
				1974-83	RH Front		1	EM-2441	
			1965-73	RH Front		1	EM-2331		
			1980-83	Trans	Auto; 2WD	1			EM-2448
				Trans	Manual; 2WD	1			EM-2448
			1976-79	Trans	Auto	1			EM-2349
			1973-75	Trans	Auto	1			EM-2349
				Trans	Manual	1			EM-2349
	1965-72	Trans	4WD	1			EM-2349		
		Trans	Auto; 2WD	1			EM-2362		
		Trans	Manual; 2WD	1			EM-2327		
	V6	V6 3.8L 232ci	1982-83	LH Front		1	EM-2728		
				RH Front		1	EM-2727		
				Trans	Auto; 2WD	1			EM-2448
				Trans	Manual; 2WD	1			EM-2448
V8	V8 3.9L 239ci	1953-55	Center Front Lower		1	EM-2120			
			V8 4.2L 255ci	1981-82	L & R Front		2	EM-2329	
	Trans	Auto	1				EM-2448		
	Trans	Manual	1			EM-2448			
	V8 4.4L 272ci	1956-58	Trans - L & R Lower		2			EM-2121	
			Trans - L & R Upper		2			EM-2119	
	V8 4.8L 292ci	1960-64	L & R Front Lower		2	EM-2048			
			L & R Front Upper		2	EM-2050			
			Trans - L & R Lower		2			EM-2121	
			Trans - L & R Upper		2			EM-2119	
	V8 5.0L 302ci	1969-83	L & R Front		2	EM-2329			
			1980-83	Trans	Auto	1			EM-2448
				Trans	Manual	1			EM-2448

# Engine, Transmission, And Torque Strut Mounts

CYL	ENG. SIZE	YEAR	LOCATION	DESCRIPTION	QTY	ENGINE	TORQUE STRUT	TRANSMISSION	
<b>FORD TRUCK (continued)</b>									
<b>F-100 PICKUP (continued)</b>									
V8	V8 5.0L 302ci	1979	Trans	Auto; C6	1			EM-2327	
		1977-78	Trans	Auto; C4	1			EM-2362	
			Trans	Auto; C6	1			EM-2327	
		1976	Trans	Auto; C4	1			EM-2362	
			Trans	Auto; C6	1			EM-2327	
			Trans	Auto; FMX	1			EM-2349	
		1975	Trans	Auto; C4	1			EM-2362	
			Trans	Auto; C6	1			EM-2327	
			Trans	Auto; CM	1			EM-2349	
		1973-74	Trans			1		EM-2327	
		1972	Trans	4WD			1		EM-2327
			Trans	Auto; C6; 2WD			1		EM-2327
			Trans	Manual; 2WD			1		EM-2327
	1969-71	Trans	4WD			1		EM-2327	
		Trans	Manual; 2WD			1		EM-2327	
	V8 5.8L 351ci	1977-79	LH Front			1	EM-2445		
			RH Front			1	EM-2444		
			Trans	Auto		1			EM-2448
	V8 5.8L 352ci	1966-67	LH Front			1	EM-2290		
			RH Front			1	EM-2289		
			Trans			1			EM-2327
	V8 5.9L 360ci	1968-76	LH Front			1	EM-2290		
			RH Front			1	EM-2289		
		1976	Trans	Auto; 4WD			1		EM-2751
			Trans	Auto; RWD			1		EM-2349
		1975	Trans	RWD			1		EM-2349
			Trans	Auto; 4WD			1		EM-2751
		1973-74	Trans	Manual; 4WD			1		EM-2349
			Trans	RWD			1		EM-2349
			Trans	Auto; 4WD			1		EM-2751
		1969-72	Trans	Manual; 4WD			1		EM-2349
			Trans	Auto			1		EM-2349
	1968	Trans	Manual			1		EM-2349	
	V8 6.4L 390ci	1968-76	LH Front			1	EM-2290		
RH Front					1	EM-2289			
1976		Trans	Auto			1		EM-2349	
1970-75		Trans	Auto			1		EM-2349	
		Trans	Manual			1		EM-2327	
1968-69		Trans	Auto			1		EM-2349	
		Trans	Manual			1		EM-2349	
V8 6.6L 400ci	1977-79	LH Front			1	EM-2445			
		RH Front			1	EM-2444			
		Trans	Auto; 2WD		1			EM-2327	
V8 7.5L 460ci	1979	L & R Front			2	EM-2502			
	1973-74	L & R Front			2	EM-2502			
	1979	Trans	Auto		1			EM-2349	
	1973-74	Trans	Auto			1		EM-2349	
		Trans	Manual			1		EM-2349	
<b>F-150 HERITAGE</b>									
V6	V6 4.2L 256ci	2004	LH Front		1	EM-2831			
			RH Front		1	EM-2833			
			Trans	Auto	1			EM-2871	
			Trans	Manual	1			EM-2871	
V8	V8 4.6L 281ci	2004	LH Front	4WD	1	EM-2972			
			LH Front	RWD, Auto	1	EM-2832			
			LH Front	RWD, Manual	1	EM-5732			

# Engine, Transmission, And Torque Strut Mounts

CYL	ENG. SIZE	YEAR	LOCATION	DESCRIPTION	QTY	ENGINE	TORQUE STRUT	TRANSMISSION	
<b>FORD TRUCK (continued)</b>									
<b>F-150 HERITAGE (continued)</b>									
V8	V8 4.6L 281ci	2004	RH Front		1	EM-2835			
			Trans	Auto; 4WD	1		EM-2871		
			Trans	Manual; 4WD	1		EM-2871		
	V8 5.4L 330ci	2004	LH Front	4WD	1	EM-2972			
			LH Front	RWD	1	EM-2832			
			LH Front	RWD, Manual	1	EM-5732			
RH Front				1	EM-2835				
<b>F-150 PICKUP</b>									
L6	L6 4.9L 300ci	1989-93	L & R Front		2	EM-2698*			
		1994-96	LH Front		1	EM-2636			
		1985-88	LH Front		1	EM-2636			
		1975-84	LH Front		1	EM-2442			
		1994-96	RH Front		1	EM-2635			
		1985-88	RH Front		1	EM-2635			
		1975-84	RH Front		1	EM-2441			
		1996	Trans	Auto	1		EM-2970		
			Trans	Manual	1		EM-2970		
		1994-95	Trans	Auto	1		EM-2884		
			Trans	Manual	1		EM-2884		
		1987-93	Trans	Auto	1		EM-2557		
			Trans	Manual	1		EM-2557		
		1985-86	Trans	Auto	1		EM-2448		
			Trans	Manual	1		EM-2448		
		1980-84	Trans	Auto; 2WD	1		EM-2448		
			Trans	Manual; 2WD	1		EM-2448		
1975-79	Trans		1		EM-2349				
V6	V6 2.7L 164ci	2015-17	LH Front		1	EM-4143			
			RH Front		1	EM-4142			
	V6 3.3L 204ci	2018	LH Front		1	EM-4143			
			RH Front		1	EM-4142			
	V6 3.5L 213ci	2011-18	LH Front		1	EM-4143			
			RH Front		1	EM-4142			
	V6 3.7L 227ci	2011-14	LH Front		1	EM-4143			
			RH Front		1	EM-4142			
	V6 4.2L 256ci	1997-03		LH Front	Auto	1	EM-2831		
				RH Front	Auto	1	EM-2833		
		2005-08	Trans		1		EM-4025		
		1997-03	Trans	Auto	1		EM-2871		
Trans			Manual	1		EM-2871			
V8	V8 4.6L 281ci	2009-10	LH Front		1	EM-4143			
		1998-03	LH Front	4WD	1	EM-2972			
			LH Front	RWD, Auto	1	EM-2832			
			LH Front	RWD, Manual	1	EM-5732			
		1997	LH Front	2WD	1	EM-2972			
			LH Front	Auto; 4WD	1	EM-2972			
			LH Front	Manual; 4WD	1	EM-2832			
		2005-08	Left		1	EM-4038			
		2004	Left		1	EM-3151			
		2009-10	RH Front		1	EM-4142			
		1998-03	RH Front		1	EM-2835			
		1997	RH Front	2WD & 4WD	1	EM-2835			
		2005-08	Right		1	EM-4039			
		2004	Right		1	EM-3150			
		2006-08	Trans	Auto; 2WD	1		EM-4025		
			Trans	Auto; 4WD	1		EM-3136		
			Trans	Manual; 2WD	1		EM-4025		

\* = Hydraulic Mount, "S" suffix = solid replacement.

# Engine, Transmission, And Torque Strut Mounts

CYL	ENG. SIZE	YEAR	LOCATION	DESCRIPTION	QTY	ENGINE	TORQUE STRUT	TRANSMISSION		
<b>FORD TRUCK (continued)</b>										
<b>F-150 PICKUP (continued)</b>										
V8	V8 4.6L 281ci	2006-08	Trans	Manual; 4WD	1			EM-3136		
		2005	Trans	Auto; 2WD	1			EM-4025		
			Trans	Auto; 4WD	1			EM-3136		
		2004	Trans	2WD	1			EM-2870		
			Trans	Auto; 4WD	1			EM-2871		
		1997-03	Trans	2WD	1			EM-2870		
			Trans	Auto; 4WD	1			EM-2871		
			Trans	Manual; 4WD	1			EM-2871		
		V8 5.0L 302ci	1987-96	L & R Front			2	EM-2564		
	1975-86		L & R Front			2	EM-2329			
	2015-18		LH Front			1	EM-4143			
	2011-14		LH Front			1	EM-4143			
	2015-18		RH Front			1	EM-4142			
	2011-14		RH Front			1	EM-4142			
	1996		Trans	Auto			1			EM-2970
			Trans	Manual			1			EM-2970
	1994-95		Trans	Auto			1			EM-2884
			Trans	Manual			1			EM-2884
	1987-93		Trans	Auto			1			EM-2557
			Trans	Manual			1			EM-2557
	1985-86		Trans	4WD, exc. Auto - AOD			1			EM-2448
			Trans	Auto; 2WD			1			EM-2448
			Trans	Manual; 2WD			1			EM-2448
			Trans	Manual; 4WD			1			EM-2448
	1980-84		Trans	Auto			1			EM-2448
			Trans	Manual			1			EM-2448
	1979		Trans	Auto; C6			1			EM-2327
			Trans	Manual; 4WD			1			EM-2327
			Trans	Manual; RWD			1			EM-2349
	1977-78		Trans	Auto; C4			1			EM-2362
			Trans	Auto; C6			1			EM-2327
			Trans	Manual; 4WD			1			EM-2327
	1976		Trans	Manual; RWD			1			EM-2349
			Trans	Auto; C6			1			EM-2327
			Trans	Manual; 4WD			1			EM-2327
	1975		Trans	Manual; RWD			1			EM-2349
Trans			Auto			1			EM-2349	
Trans			Manual			1			EM-2349	
V8 5.4L 330ci	2009-10		LH Front			1	EM-4143			
	1997-98		LH Front	4WD		1	EM-2972			
			LH Front	RWD		1	EM-2832			
	1997-03		LH Front	4WD		1	EM-2972			
			LH Front	RWD, Auto		1	EM-2832			
			LH Front	RWD, Manual		1	EM-5732			
	2005-08	Left			1	EM-4038				
	2004	Left			1	EM-3151				
	2009-10	RH Front			1	EM-4142				
	1997-98	RH Front			1	EM-2835				
	1997-03	RH Front			1	EM-2835				
	2005-08	Right			1	EM-4039				
	2004	Right			1	EM-3150				
	2004-08	Trans	2WD			1			EM-2884	
		Trans	4WD			1			EM-3136	
	1997-03	Trans	Auto; 2WD			1			EM-2870	
		Trans	Auto; 4WD			1			EM-2871	
		Trans	Manual; 2WD			1			EM-2870	
	Trans	Manual; 4WD			1			EM-2871		



# Engine, Transmission, And Torque Strut Mounts

CYL	ENG. SIZE	YEAR	LOCATION	DESCRIPTION	QTY	ENGINE	TORQUE STRUT	TRANSMISSION	
<b>FORD TRUCK (continued)</b>									
<b>F-150 PICKUP (continued)</b>									
V8	V8 5.8L 351ci	1987-96	L & R Front		2	EM-2564			
		1980-86	L & R Front		2	EM-2329			
		1977-79	LH Front		1	EM-2445			
			RH Front		1	EM-2444			
		1996	Trans	Auto; 2WD		1			EM-2969
			Trans	Auto; 4WD		1			EM-2970
			Trans	Manual; 2WD		1			EM-2969
			Trans	Manual; 4WD		1			EM-2970
		1994-95	Trans	Auto		1			EM-2969
			Trans	Manual		1			EM-2969
		1987-93	Trans	Auto		1			EM-2557
			Trans	Manual		1			EM-2557
		1980-86	Trans	Auto		1			EM-2448
			Trans	Manual		1			EM-2448
		1977-79	Trans	Auto; 2WD		1			EM-2448
	Trans		Manual; 2WD		1			EM-2448	
	V8 5.9L 360ci	1975-76	LH Front		1	EM-2290			
			RH Front		1	EM-2289			
		1976	Trans	RWD		1			EM-2349
			Trans	Auto; 4WD		1			EM-2751
		1975	Trans	Manual; 4WD		1			EM-2349
	Trans				1			EM-2349	
	V8 6.2L 379ci	2010-14	LH Front		1	EM-4143			
			RH Front		1	EM-4142			
	V8 6.4L 390ci	1975-76	LH Front		1	EM-2290			
			RH Front		1	EM-2289			
			Trans	Auto		1			EM-2349
	V8 6.6L 400ci	1977-79	LH Front		1	EM-2445			
			RH Front		1	EM-2444			
			Trans		1			EM-2327	
	V8 6.9L 420ci Diesel	1984	Trans	Auto		1		EM-2448	
			Trans	Manual		1		EM-2448	
	V8 7.5L 460ci	1975-79	L & R Front		2	EM-2502			
Trans				1			EM-2349		
<b>F-250 PICKUP</b>									
L6	L6 3.6L 223ci	1957-64	L & R Front Lower		2	EM-2048			
			L & R Front Upper		2	EM-2050			
		1954-64	Trans - L & R Lower		2			EM-2121	
			Trans - L & R Upper		2			EM-2119	
		L6 3.9L 240ci	1967-74	LH Front		1	EM-2332		
	1965-66		LH Front	RWD	1	EM-2332			
	1967-74		RH Front		1	EM-2331			
	1965-66		RH Front	RWD		1	EM-2331		
			Trans - L & R Lower	4WD		2			EM-2306
			Trans - L & R Upper	4WD		2			EM-2305
	1967-74		Trans	2WD		1			EM-2327
			Trans	4WD		1			EM-2349
	1965-66	Trans	2WD		1			EM-2327	
	L6 4.9L 300ci	1989-93	L & R Front		2	EM-2698*			
		1994-96	LH Front		1	EM-2636			

\* = Hydraulic Mount, "S" suffix = solid replacement.

# Engine, Transmission, And Torque Strut Mounts

CYL	ENG. SIZE	YEAR	LOCATION	DESCRIPTION	QTY	ENGINE	TORQUE STRUT	TRANSMISSION	
<b>FORD TRUCK (continued)</b>									
<b>F-250 PICKUP (continued)</b>									
L6	L6 4.9L 300ci	1985-88	LH Front		1	EM-2636			
		1974-84	LH Front		1	EM-2442			
		1965-73	LH Front		1	EM-2332			
		1994-96	RH Front		1	EM-2635			
		1985-88	RH Front		1	EM-2635			
		1974-84	RH Front		1	EM-2441			
		1965-73	RH Front		1	EM-2331			
		1996	Trans	Auto		1			EM-2970
			Trans	Manual		1			EM-2970
		1994-95	Trans	Auto		1			EM-2884
			Trans	Manual		1			EM-2884
		1987-93	Trans	Auto		1			EM-2557
			Trans	Manual		1			EM-2557
		1980-86	Trans	Auto		1			EM-2448
			Trans	Manual		1			EM-2448
		1973-79	Trans	Auto		1			EM-2349
			Trans	Manual		1			EM-2349
1965-72	Trans	4WD		1			EM-2349		
	Trans	Auto; 2WD		1			EM-2362		
	Trans	Manual; 2WD		1			EM-2327		
V8	V8 3.9L 239ci	1953-55	Center Front		1	EM-2120			
			Lower						
	V8 4.6L 281ci	1997-99	LH Front		1	EM-2832			
			RH Front		1	EM-2835			
			Trans	Auto; 4WD; US & Canada	1			EM-2871	
			Trans	Manual; 4WD	1			EM-2871	
			Trans	Auto; 4WD; US & Canada	1			EM-2871	
	1997	Trans	Auto; 4WD; US & Canada	1			EM-2871		
		Trans	Manual; 4WD	1			EM-2871		
		Trans	Manual; 4WD	1			EM-2871		
	V8 4.8L 292ci	1960-64	L & R Front		2	EM-2048			
			Lower						
			L & R Front		2	EM-2050			
			Upper						
	Trans - L & R	Lower		2			EM-2119		
Trans - L & R	Upper		2			EM-2121			
V8 5.0L 302ci	1987-96	L & R Front		2	EM-2564				
		L & R Front		2	EM-2329				
		L & R Front		2	EM-2329				
		L & R Front		2	EM-2329				
	1996	Trans	Auto; 2WD		1			EM-2884	
		Trans	Auto; 4WD		1			EM-2970	
		Trans	Manual; 2WD		1			EM-2884	
		Trans	Manual; 4WD		1			EM-2970	
	1994-95	Trans	Auto		1			EM-2884	
		Trans	Manual		1			EM-2884	
	1987-93	Trans	Auto		1			EM-2557	
		Trans	Manual		1			EM-2557	
	1985-86	Trans	4WD, exc. Auto - AOD		1			EM-2448	
		Trans	Auto; 2WD		1			EM-2448	
		Trans	Manual; 2WD		1			EM-2448	
		Trans	Manual; 4WD		1			EM-2448	
	1980-84	Trans	Auto		1			EM-2448	
		Trans	Manual		1			EM-2448	
1978	Trans	Auto; C6		1			EM-2362		
	Trans	Manual; 4WD		1			EM-2327		

## Engine, Transmission, And Torque Strut Mounts

CYL	ENG. SIZE	YEAR	LOCATION	DESCRIPTION	QTY	ENGINE	TORQUE STRUT	TRANSMISSION
<b>FORD TRUCK (continued)</b>								
<b>F-250 PICKUP (continued)</b>								
V8	V8 5.0L 302ci	1978	Trans	Manual; RWD	1			EM-2349
		1977	Trans	Auto; C4	1			EM-2349
			Trans	Auto; C6	1			EM-2362
			Trans	Manual; 4WD	1			EM-2327
			Trans	Manual; RWD	1			EM-2349
			Trans	Auto; Cruise-O-Matic; 4WD	1			EM-2349
		1973-74	Trans	Auto; RWD	1			EM-2362
			Trans	Manual; 4WD	1			EM-2327
			Trans	Manual; RWD	1			EM-2349
		1972	Trans		1			EM-2327
V8 5.4L 330ci	1997-99	LH Front	4WD	1	EM-2972			
		LH Front	RWD	1	EM-2832			
		RH Front		1	EM-2835			
		Trans	Auto; 2WD	1			EM-2870	
		Trans	Auto; 4WD	1			EM-2871	
		Trans	Manual; 2WD	1			EM-2870	
		Trans	Manual; 4WD	1			EM-2871	
V8 5.8L 351ci	1987-97	L & R Front		2	EM-2564			
		L & R Front		2	EM-2329			
	1977-79	LH Front		1	EM-2445			
		RH Front		1	EM-2444			
	1994-95	Trans	Auto	1			EM-2969	
		Trans	Manual	1			EM-2969	
	1987-93	Trans	Auto	1			EM-2557	
		Trans	Manual	1			EM-2557	
	1980-86	Trans	Auto	1			EM-2448	
		Trans	Manual	1			EM-2448	
V8 5.8L 352ci	1966-67	LH Front		1	EM-2290			
		RH Front		1	EM-2289			
		Trans		1			EM-2327	
V8 5.9L 360ci	1968-76	LH Front		1	EM-2290			
		RH Front		1	EM-2289			
	1973-76	Trans	2WD	1			EM-2349	
		Trans	Auto; 4WD	1			EM-2751	
		Trans	Manual; 4WD	1			EM-2349	
	1969-72	Trans	Auto	1			EM-2349	
		Trans	Manual	1			EM-2349	
	1968	Trans	4WD	1			EM-2349	
V8 6.4L 390ci	1968-76	LH Front		1	EM-2290			
		RH Front		1	EM-2289			
	1970-76	Trans	Auto; 2WD	1			EM-2349	
		Trans	Auto; 4WD	1			EM-2751	
		Trans	Manual; 2WD	1			EM-2327	
		Trans	Manual; 4WD	1			EM-2349	
	1968-69	Trans	2WD	1			EM-2349	
V8 6.6L 400ci	1977-82	LH Front		1	EM-2445			
		RH Front		1	EM-2444			
	1980-82	Trans	Auto; 2WD	1			EM-2448	
		Trans	Manual; 2WD	1			EM-2448	
	1977-79	Trans	2WD	1			EM-2327	
		Trans	Auto; 4WD	1			EM-2349	
		Trans	Auto; 4WD	1			EM-2557	
V8 6.9L 420ci Diesel	1987	Trans		1			EM-2557	
	1983-86	Trans	Auto; 2WD	1			EM-2448	
		Trans	Manual; 2WD	1			EM-2448	
V8 7.3L 445ci Diesel	1988-96	LH Front		1	EM-2765			
		RH Front		1	EM-2764			
	1988-93	Trans	Auto	1			EM-2557	

# Engine, Transmission, And Torque Strut Mounts

CYL	ENG. SIZE	YEAR	LOCATION	DESCRIPTION	QTY	ENGINE	TORQUE STRUT	TRANSMISSION		
<b>FORD TRUCK (continued)</b>										
<b>F-250 PICKUP (continued)</b>										
V8	V8 7.3L 445ci Diesel	1988-93	Trans	Manual	1			EM-2557		
		1983-96	L & R Front		2	EM-2709				
	V8 7.5L 460ci	1973-79	L & R Front			2	EM-2502			
		1996	Trans	Auto; 2WD		1			EM-2970	
			Trans	Auto; 4WD		1			EM-2557	
			Trans	Manual; 2WD		1			EM-2970	
			Trans	Manual; 4WD		1			EM-2557	
		1987-95	Trans			1			EM-2557	
	1983-86	Trans	Auto		1			EM-2448		
		Trans	Manual		1			EM-2448		
1973-79	Trans	Auto		1			EM-2349			
	Trans	Manual		1			EM-2349			
<b>F-250 SUPER DUTY PICKUP</b>										
V8	V8 5.4L 330ci	1999-04	LH Front		1	EM-5424				
			RH Front		1	EM-5425				
		2008-10	Trans	Auto; 4WD		1			EM-4187	
			Trans	Auto; RWD		1			EM-4176	
			Trans	Manual; 4WD		1			EM-4187	
			Trans	Manual; RWD		1			EM-4176	
		1999-07	Trans	2WD		1			EM-2884	
			Trans	4WD		1			EM-2971	
		V8 6.0L 363ci	2003-07	Trans	2WD		1		EM-4024	
				Trans	4WD		1		EM-4023	
	V8 6.0L 363ci Diesel	2005-07	Left			1	EM-4137			
		2003-04	Left			1	EM-4268			
			Right			1	EM-4269			
	V8 6.2L 379ci	2011-16	Trans	Auto		1		EM-4177		
	V8 6.4L 391ci	2008-10	Trans	Auto; 4WD		1		EM-4187		
			Trans	Auto; RWD		1		EM-4176		
			Trans	Manual; 4WD		1		EM-4187		
			Trans	Manual; RWD		1		EM-4176		
			Trans	Auto		1		EM-4177		
	V8 6.7L 406cid	2011-16	Trans	Auto		1		EM-4177		
	V8 7.3L 445ci Diesel	1999-03	LH Front			1	EM-3029			
			RH Front			1	EM-3030			
			Trans	Auto; 2WD		1		EM-2884		
Trans			Auto; 4WD		1		EM-2971			
Trans			Manual; 2WD		1		EM-2884			
Trans			Manual; 4WD		1		EM-2971			
V10	V10 6.8L 415ci	1999-04	Left		1	EM-4022				
			Right		1	EM-4021				
		2008-10	Trans	Auto; 4WD		1		EM-4187		
			Trans	Auto; RWD		1		EM-4176		
			Trans	Manual; 4WD		1		EM-4187		
			Trans	Manual; RWD		1		EM-4176		
		1999-07	Trans	2WD		1		EM-2884		
			Trans	4WD		1		EM-2971		
		<b>F-350 PICKUP</b>								
		L6	L6 3.6L 223ci	1957-64	L & R Front Lower		2	EM-2048		
L & R Front Upper					2	EM-2050				
1954-64	Trans - L & R Lower				2		EM-2121			
	Trans - L & R Upper				2		EM-2119			
L6 3.9L 240ci	1965-74		LH Front		1	EM-2332				

# Engine, Transmission, And Torque Strut Mounts

CYL	ENG. SIZE	YEAR	LOCATION	DESCRIPTION	QTY	ENGINE	TORQUE STRUT	TRANSMISSION	
<b>FORD TRUCK (continued)</b>									
<b>F-350 PICKUP (continued)</b>									
L6	L6 3.9L 240ci	1965-74	RH Front		1	EM-2331			
		1965-66	Trans - L & R Lower	4WD 4WD	2			EM-2306	
			Trans - L & R Upper	4WD 4WD	2			EM-2305	
		1967-74	Trans	2WD	1			EM-2327	
			Trans	4WD	1			EM-2349	
		1965-66	Trans	2WD	1			EM-2327	
	L6 4.9L 300ci	1989-93	L & R Front		2	EM-2698*			
		1994-96	LH Front		1	EM-2636			
		1985-88	LH Front		1	EM-2636			
		1974-84	LH Front		1	EM-2442			
		1965-73	LH Front		1	EM-2332			
		1994-96	RH Front		1	EM-2635			
		1985-88	RH Front		1	EM-2635			
		1974-84	RH Front		1	EM-2441			
		1965-73	RH Front		1	EM-2331			
		1996	Trans	Auto	1			EM-2970	
			Trans	Manual	1			EM-2970	
		1994-95	Trans	Auto	1			EM-2884	
			Trans	Manual	1			EM-2884	
		1987-93	Trans	Auto	1			EM-2557	
			Trans	Manual	1			EM-2557	
		1980-86	Trans	Auto	1			EM-2448	
			Trans	Manual	1			EM-2448	
		1973-79	Trans	Auto	1			EM-2349	
			Trans	Manual	1			EM-2349	
		1965-72	Trans	4WD	1			EM-2349	
	Trans		Auto; 2WD	1			EM-2362		
	Trans		Manual; 2WD	1			EM-2327		
	V8	V8 3.9L 239ci	1953-55	Center Front Lower		1	EM-2120		
		V8 4.8L 292ci	1960-64	L & R Front Lower		2	EM-2048		
				L & R Front Upper		2	EM-2050		
			1961-64	Trans - L & R Lower		2			EM-2121
				Trans - L & R Upper		2			EM-2119
V8 5.0L 302ci		1980	L & R Front		2	EM-2329			
		1972-78	L & R Front		2	EM-2329			
		1980	Trans	Auto	1			EM-2448	
			Trans	Manual	1			EM-2448	
		1975-78	Trans	Auto	1			EM-2362	
			Trans	Manual	1			EM-2349	
		1973-74	Trans	4WD, Auto - C5	1			EM-2327	
			Trans	Auto; C6; 2WD	1			EM-2327	
			Trans	Auto; Cruise-O-Matic; 4WD	1			EM-2349	
			Trans	Manual; 2WD	1			EM-2349	
Trans			Manual; 4WD	1			EM-2327		
1972		Trans		1			EM-2327		
V8 5.8L 351ci		1987-97	L & R Front		2	EM-2564			
		1980-86	L & R Front		2	EM-2329			
		1977-79	LH Front		1	EM-2445			
	RH Front			1	EM-2444				
1994-95	Trans	Auto	1			EM-2969			

\* = Hydraulic Mount, "S" suffix = solid replacement.

# Engine, Transmission, And Torque Strut Mounts

CYL	ENG. SIZE	YEAR	LOCATION	DESCRIPTION	QTY	ENGINE	TORQUE STRUT	TRANSMISSION
<b>FORD TRUCK (continued)</b>								
<b>F-350 PICKUP (continued)</b>								
V8	V8 5.8L 351ci	1994-95	Trans	Manual	1			EM-2969
		1987-93	Trans	Auto	1			EM-2557
			Trans	Manual	1			EM-2557
		1980-86	Trans	Auto	1			EM-2448
			Trans	Manual	1			EM-2448
	V8 5.8L 352ci	1966-67	LH Front		1	EM-2290		
			RH Front		1	EM-2289		
			Trans		1		EM-2327	
	V8 5.9L 360ci	1968-76	LH Front		1	EM-2290		
			RH Front		1	EM-2289		
		1973-76	Trans	2WD	1			EM-2349
		1969-72	Trans		1			EM-2349
	V8 6.4L 390ci	1968-76	LH Front		1	EM-2290		
			RH Front		1	EM-2289		
		1970-76	Trans	Auto; 2WD	1			EM-2349
			Trans	Manual; 2WD	1			EM-2327
	V8 6.6L 400ci	1977-82	LH Front		1	EM-2445		
			RH Front		1	EM-2444		
		1980-82	Trans	Auto; 2WD	1			EM-2448
			Trans	Manual; 2WD	1			EM-2448
	1979	Trans	RWD	1			EM-2327	
		Trans	Auto; 4WD	1			EM-2349	
		Trans	Manual; 4WD	1			EM-5111	
	V8 6.9L 420ci Diesel	1987	Trans		1			EM-2557
		1983-86	Trans	Auto; 2WD	1			EM-2448
			Trans	Manual; 2WD	1			EM-2448
	V8 7.3L 445ci Diesel	1988-97	LH Front		1	EM-2765		
			RH Front		1	EM-2764		
		1988-93	Trans	Auto	1			EM-2557
			Trans	Manual	1			EM-2557
	V8 7.5L 460ci	1983-97	L & R Front		2	EM-2709		
		1973-79	L & R Front		2	EM-2502		
		1996-97	Trans	Auto; 2WD	1			EM-2970
			Trans	Auto; 4WD	1			EM-2557
			Trans	Manual; 2WD	1			EM-2970
			Trans	Manual; 4WD	1			EM-2557
		1987-95	Trans	Auto	1			EM-2557
			Trans	Manual	1			EM-2557
		1983-86	Trans	Auto	1			EM-2448
			Trans	Manual	1			EM-2448
		1973-79	Trans	Auto	1			EM-2349
	Trans		Manual	1			EM-2349	
	<b>F-350 SUPER DUTY PICKUP</b>							
V8	V8 5.4L 330ci	1999-04	LH Front		1	EM-5424		
			RH Front		1	EM-5425		
		2008-10	Trans	Auto; 4WD	1			EM-4187
			Trans	Auto; RWD	1			EM-4176
			Trans	Manual; 4WD	1			EM-4187
	Trans		Manual; RWD	1			EM-4176	
	1999-07	Trans	2WD	1			EM-2884	
		Trans	4WD	1			EM-2971	
	V8 6.0L 363ci	2003-07	Trans	2WD	1			EM-4024
			Trans	4WD	1			EM-4023
V8 6.0L 363ci Diesel	2005-07	Left		1	EM-4137			

## Engine, Transmission, And Torque Strut Mounts

CYL	ENG. SIZE	YEAR	LOCATION	DESCRIPTION	QTY	ENGINE	TORQUE STRUT	TRANSMISSION		
<b>FORD TRUCK (continued)</b>										
<b>F-350 SUPER DUTY PICKUP (continued)</b>										
V8	V8 6.0L 363ci Diesel	2003-04	Left		1	EM-4268				
			Right		1	EM-4269				
	V8 6.2L 379ci	2011-16	Trans	Auto	1			EM-4177		
	V8 6.4L 391ci	2008-10	Trans	Auto; 4WD	1			EM-4187		
			Trans	Auto; RWD	1			EM-4176		
			Trans	Manual; 4WD	1			EM-4187		
			Trans	Manual; RWD	1			EM-4176		
	V8 6.7L 406cid	2011-16	Trans	Auto	1			EM-4177		
	V8 7.3L 445ci Diesel	1999-03	LH Front		1	EM-3029				
			RH Front		1	EM-3030				
			Trans	Auto; 2WD	1			EM-2884		
			Trans	Auto; 4WD	1			EM-2971		
			Trans	Manual; 2WD	1			EM-2884		
			Trans	Manual; 4WD	1			EM-2971		
V10	V10 6.8L 415ci	1999-04	Left		1	EM-4022				
			Right		1	EM-4021				
		2008-10	Trans	Auto; 4WD	1			EM-4187		
			Trans	Auto; RWD	1			EM-4176		
			Trans	Manual; 4WD	1			EM-4187		
			Trans	Manual; RWD	1			EM-4176		
		1999-07	Trans	2WD	1			EM-2884		
			Trans	4WD	1			EM-2971		
		<b>LOBO (MEXICAN VEHICLE)</b>								
		V8	V8 4.6L 281ci	2009-10	LH Front		1	EM-4143		
2004	LH Front				Mexican Vehicle; RWD	1	EM-2832			
2009-10	2004			RH Front		1	EM-4142			
				RH Front	Mexican Vehicle	1	EM-2835			
Trans	RWD			1			EM-2870			
V8 5.0L 302ci	2011-14		Left		1	EM-4143				
			Right		1	EM-4142				
V8 5.4L 330ci	2009-10		LH Front		1	EM-4143				
			2002-04	LH Front	Mexican Vehicle; RWD	1	EM-2832			
	2001		2009-10	LH Front	Mexican Vehicle; RWD	1	EM-2832			
				RH Front		1	EM-4142			
	2002-04		2001	RH Front	Mexican Vehicle	1	EM-2835			
				RH Front	Mexican Vehicle	1	EM-2835			
	2002-04		2001	Trans	4WD	1			EM-2871	
				Trans	RWD	1			EM-2870	
2001	Trans		RWD	1			EM-2870			
V8 6.2L 379ci	2011-14		LH Front		1	EM-4143				
			RH Front		1	EM-4142				
<b>RANCHERO</b>										
L6	L6 2.4L 144ci		1960-64	LH Front		1	EM-2226			
		RH Front			1	EM-2225				
		Trans		Auto	1			EM-2253		
		Trans		Manual	1			EM-2253		
	L6 2.8L 170ci	1964-65	1961	LH Front		1	EM-2226			
				LH Front		1	EM-2226			
		1964-65	1961	RH Front		1	EM-2225			
				RH Front		1	EM-2225			
		1964-65	1961	Trans	Auto	1			EM-2253	
				Trans	Manual	1			EM-2253	
		1961	1961	Trans	Auto	1			EM-2253	
				Trans	Manual	1			EM-2253	
	L6 3.3L 200ci	1964-68	L & R Front		2	EM-2333				
			Trans	Auto	1			EM-2253		

# Engine, Transmission, And Torque Strut Mounts

CYL	ENG. SIZE	YEAR	LOCATION	DESCRIPTION	QTY	ENGINE	TORQUE STRUT	TRANSMISSION
<b>FORD TRUCK (continued)</b>								
<b>RANCHERO (continued)</b>								
L6	L6 3.3L 200ci	1964-68	Trans	Manual	1			EM-2253
	L6 4.1L 250ci	1973	Trans	Auto	1			EM-2347
			Trans	Manual	1			EM-2347
		1969-72	Trans	Auto	1			EM-2253
			Trans	Manual	1			EM-2253
V8	V8 4.7L 289ci	1966-67	L & R Front		2	EM-2286		
		1965	LH Front		1	EM-2220		
			RH Front		1	EM-2221		
		1966-67	Trans	Auto	1			EM-2253
			Trans	Manual	1			EM-2253
	1965	Trans		1			EM-2171	
		V8 4.8L 292ci	1957-59	L & R Front Lower		2	EM-2048	
	L & R Front Upper				2	EM-2050		
	V8 5.0L 302ci	1968-71	L & R Front		2	EM-2257		
			1977-79	LH Front		1	EM-2504	
		1973-74	LH Front		1	EM-2370		
		1972	LH Front		1	EM-2371		
		1977-79	RH Front		1	EM-2503		
		1973-74	RH Front		1	EM-2371		
		1972	RH Front		1	EM-2370		
		1977-79	Trans	Auto	1			EM-2253
		1973-74	Trans	Auto; AOD	1			EM-2347
			Trans	Auto; FX	1			EM-2372
			Trans	Manual	1			EM-2347
		1972	Trans	Auto	1			EM-2372
			Trans	Manual	1			EM-2372
		1968-71	Trans	Auto	1			EM-2253
			Trans	Manual	1			EM-2253
	V8 5.8L 351ci	1969-71	L & R Front		2	EM-2286		
		1972-79	LH Front		1	EM-2370		
			RH Front		1	EM-2371		
		1977-79	Trans	Auto	1			EM-2464
		1972-76	Trans	Auto	1			EM-2347
			Trans	Manual	1			EM-2347
		1969-71	Trans	Auto	1			EM-2253
			Trans	Manual	1			EM-2253
	V8 6.4L 390ci	1967-69	LH Front		1	EM-2241		
			RH Front		1	EM-2240		
			Trans	Auto	1			EM-2253
			Trans	Manual	1			EM-2253
	V8 6.6L 400ci	1972-78	LH Front		1	EM-2365		
			RH Front		1	EM-2364		
		1977-78	Trans		1			EM-2464
		1972-76	Trans	Auto	1			EM-2372
			Trans	Manual	1			EM-2372
	V8 7.0L 428ci	1968-69	LH Front		1	EM-2241		
			RH Front		1	EM-2240		
		1968-73	Trans	Auto	1			EM-2253
			Trans	Manual	1			EM-2253
		V8 7.0L 429ci	1970-73	LH Front		1	EM-2723	
RH Front				1	EM-2724			
V8 7.5L 460ci	1974-77	Trans	Auto	1			EM-2372	
		Trans	Manual	1			EM-2372	



# Engine, Transmission, And Torque Strut Mounts

CYL	ENG. SIZE	YEAR	LOCATION	DESCRIPTION	QTY	ENGINE	TORQUE STRUT	TRANSMISSION		
<b>FORD TRUCK (continued)</b>										
<b>RANGER</b>										
L4	L4 2.0L 122ci	1988	L & R Front		2	EM-2698*				
		1985-87	LH Front		1	EM-2786				
			RH Front		1	EM-2785				
	L4 2.0L 1989cc	1988	Trans	Auto		1			EM-2639	
			Trans	Manual		1			EM-2639	
		1986-87	Trans			1			EM-2631	
			Trans	Manual		1			EM-2631	
		1985	Trans			1			EM-2631	
			Trans	Manual		1			EM-2631	
	L4 2.3L 140ci	1988-97	L & R Front		2	EM-2698*				
		1985-87	L & R Front	Gas; Auto; RWD	2	EM-2698*				
		2001-11	LH Front		1	EM-3078				
		1985-87	LH Front	Gas; 4WD		1	EM-2786			
			LH Front	Gas; Manual; RWD		1	EM-2786			
		2001-11	RH Front			1	EM-5377			
			RH Front	Gas; 4WD		1	EM-2785			
		1985-87	RH Front	Gas; 4WD		1	EM-2785			
			RH Front	Gas; Manual; RWD		1	EM-2785			
		2001-09	Trans	Auto		1				EM-2639
			Trans	Manual		1				EM-2639
		1995-97	Trans	Auto		1				EM-2639
			Trans	Manual		1				EM-2639
		1991-94	Trans	Auto		1				EM-2639
			Trans	Manual		1				EM-2639
		1990	Trans	Auto		1				EM-2639
			Trans	Manual		1				EM-2639
		1988-89	Trans	Auto; 4WD		1				EM-2639
			Trans	Auto; Regular Cab; 2WD		1				EM-2631
			Trans	Manual; 4WD		1				EM-2639
			Trans	Manual; Regular Cab; 2WD		1				EM-2639
		1985-87	Trans	Gas; Auto		1				EM-2639
			Trans	Gas; Manual		1				EM-2639
	L4 2.3L 140ci Diesel	1985-87	LH Front	4WD		1	EM-2786			
			Trans	Auto		1			EM-2639	
			Trans	Manual		1			EM-2639	
	L4 2.5L 153ci	1998-99	L & R Front		2	EM-2853				
		2000-01	LH Front	2WD		1	EM-2853			
			LH Front	4WD		1	EM-2853			
			RH Front	4WD		1	EM-2853			
		1998-01	Trans	Auto		1				EM-2639
			Trans	Manual		1				EM-2639
	V6	V6 2.8L 171ci	1983-85	LH Front	4WD		1	EM-2940		
				RH Front	2WD		1	EM-2941		
RH Front				4WD		1	EM-2941			
V6 2.9L 177ci		1986-92	LH Front	4WD		1	EM-2643			
			LH Front	RWD		1	EM-2642			
			RH Front			1	EM-2641			
			Trans	Auto		1			EM-2639	
			Trans	Manual		1			EM-2639	
V6 3.0L 182ci		2005-08	L & R Front	RWD; w/ Coil Spring Susp.	2	EM-2853				
		2002-04	L & R Front	RWD	2	EM-2853				
		2000-01	L & R Front	RWD	2	EM-2853				
		1995-97	L & R Front	RWD	2	EM-2643				
		2000-01	LH Front	4WD	1	EM-2851				
		1998-99	LH Front	4WD		1	EM-2851			
			LH Front	RWD		1	EM-2853			
	1995-97	LH Front	4WD	1	EM-2643					
1991-94	LH Front	4WD	1	EM-2643						

\* = Hydraulic Mount, "S" suffix = solid replacement.

# Engine, Transmission, And Torque Strut Mounts

CYL	ENG. SIZE	YEAR	LOCATION	DESCRIPTION	QTY	ENGINE	TORQUE STRUT	TRANS-MISSION
<b>FORD TRUCK (continued)</b>								
<b>RANGER (continued)</b>								
V6	V6 3.0L 182ci	1991-94	LH Front	RWD	1	EM-2642		
		2000-01	RH Front	4WD	1	EM-2936		
		1998-99	RH Front	4WD	1	EM-2936		
			RH Front	RWD	1	EM-2853		
		1995-97	RH Front	4WD	1	EM-2640		
		1991-94	RH Front	4WD	1	EM-2640		
			RH Front	RWD	1	EM-2640		
		1991-08	Trans	Auto	1			EM-2639
	Trans		Manual	1			EM-2639	
	V6 4.0L 245ci	1999-11	LH Front	4WD	1	EM-2851		
		1998	LH Front	4WD	1	EM-2851		
		1990-97	LH Front	4WD	1	EM-2643		
			LH Front	RWD	1	EM-2642		
		1999-11	RH Front	4WD	1	EM-2935		
			RH Front	RWD	1	EM-2853		
		1998	RH Front	4WD	1	EM-2850		
			RH Front	RWD	1	EM-2853		
		1990-97	RH Front	4WD	1	EM-2641		
			RH Front	RWD	1	EM-2641		
		1990-09	Trans	Auto	1			EM-2639
Trans			Manual	1			EM-2639	
<b>FORD VAN</b>								
<b>AEROSTAR</b>								
L4	L4 2.3L 140ci	1986-87	Trans	Auto	1			EM-2633
			Trans	Manual	1			EM-2633
V6	V6 2.8L 171ci	1986	Trans	Auto	1			EM-2633
			Trans	Manual	1			EM-2633
	V6 3.0L 182ci	1986-97	LH Front		1	EM-2646		
			RH Front		1	EM-2645		
		1995-97	Trans	Auto	1			EM-2639
		1989-94	Trans	Auto	1			EM-2639
		1986-88	Trans	Manual	1			EM-2639
			Trans	Auto	1			EM-2633
	Trans	Manual	1			EM-2633		
	V6 4.0L 245ci	1990-97	LH Front		1	EM-2646		
			RH Front		1	EM-2644		
		1995-97	Trans	Auto	1			EM-2639
1990-94		Trans	Auto	1			EM-2639	
Trans	Manual	1			EM-2639			
<b>CLUB WAGON</b>								
V8	V8 6.0L 363ci Diesel	2004-05	LH Front	Turbo	1	EM-5551		
			RH Front	Turbo	1	EM-5578		
<b>E-100 ECONOLINE</b>								
L6	L6 2.8L 170ci	1969-71	Trans		1			EM-2307
	L6 3.9L 240ci	1969-74	LH Front		1	EM-2332		
			RH Front		1	EM-2331		
		1973-74	Trans	Auto	1			EM-2362
			Trans	Manual	1			EM-2327
	1969-72	Trans		1			EM-2327	
	L6 4.9L 300ci	1977-83	LH Front		1	EM-2442		
		1972-76	LH Front		1	EM-2332		
		1977-83	RH Front		1	EM-2441		
		1972-76	RH Front		1	EM-2331		
		1980-83	Trans	Auto	1			EM-2448
	Trans		Manual	1			EM-2448	

## Engine, Transmission, And Torque Strut Mounts

CYL	ENG. SIZE	YEAR	LOCATION	DESCRIPTION	QTY	ENGINE	TORQUE STRUT	TRANSMISSION	
<b>FORD VAN (continued)</b>									
<b>E-100 ECONOLINE (continued)</b>									
L6	L6 4.9L 300ci	1977-79	Trans	Auto	1			EM-2448	
			Trans	Manual	1			EM-2448	
		1975-76	Trans	Auto	1				EM-2372
			1972-74	Trans	Auto	1			
					Trans	Manual	1		
V8	V8 5.0L 302ci	1969-74	L & R Front		2	EM-2329			
		1979-83	LH Front		1	EM-2440			
		1975	LH Front		1	EM-2440			
		1979-83	RH Front		1	EM-2439			
		1975	RH Front		1	EM-2439			
		1979-83	Trans	Auto	1				EM-2448
			Trans	Manual	1				EM-2448
		1975	Trans	Auto	1				EM-2448
			Trans	Manual	1				EM-2448
		1969-74	Trans	Auto	1				EM-2362
	Trans		Manual	1				EM-2327	
	V8 5.8L 351ci	1975-83	LH Front		1	EM-2440			
			RH Front		1	EM-2439			
			Trans	Auto	1			EM-2448	
			Trans	Manual	1			EM-2448	
V8 7.5L 460ci	1978	L & R Front		2	EM-2536				
<b>E-150 ECONOLINE</b>									
L6	L6 4.9L 300ci	1985-96	LH Front		1	EM-2636			
			1977-84	LH Front		1	EM-2442		
		1975-76	LH Front		1	EM-2332			
		1985-96	RH Front		1	EM-2635			
		1977-84	RH Front		1	EM-2441			
		1975-76	RH Front		1	EM-2331			
		1990-96	Trans	Auto	1			EM-2557	
		1988-89	Trans	Auto	1				EM-2557
			Trans	Manual	1				EM-2557
		1980-87	Trans	Auto	1				EM-2448
			Trans	Manual	1				EM-2448
		1977-79	Trans	Auto	1				EM-2448
			Trans	Manual	1				EM-2448
		1975-76	Trans	Auto	1				EM-2372
V6	V6 4.2L 256ci	1997-03	LH Front		1	EM-3059			
			RH Front		1	EM-3060			
		2003	Trans	Auto	1			EM-2557	
		1997-03	Trans	Auto	1			EM-2557	
V8	V8 4.6L 281ci	1997-13	LH Front		1	EM-2930			
			RH Front		1	EM-2929			
		1997-11	Trans	Auto	1			EM-2557	
	V8 5.0L 302ci	1979-96	LH Front		1	EM-2440			
			1975	LH Front		1	EM-2440		
		1979-96	RH Front		1	EM-2439			
			1975	RH Front		1	EM-2439		
		1992-96	Trans	Auto	1			EM-2557	
		1990-91	Trans	Auto	1			EM-2448	
		1979-89	Trans	Auto	1				EM-2448
			Trans	Manual	1				EM-2448
	1975	Trans	Auto	1				EM-2448	
		Trans	Manual	1				EM-2448	
V8 5.4L 330ci	1997-13	LH Front		1	EM-2930				
		RH Front		1	EM-2929				
		1997-11	Trans	Auto	1			EM-2557	
V8 5.8L 351ci	1975-96	LH Front		1	EM-2440				

# Engine, Transmission, And Torque Strut Mounts

CYL	ENG. SIZE	YEAR	LOCATION	DESCRIPTION	QTY	ENGINE	TORQUE STRUT	TRANSMISSION	
<b>FORD VAN (continued)</b>									
<b>E-150 ECONOLINE (continued)</b>									
V8	V8 5.8L 351ci	1975-96	RH Front		1	EM-2439			
		1992-96	Trans	Auto	1			EM-2557	
		1990-91	Trans	Auto	1			EM-2448	
		1975-89	Trans	Auto	1			EM-2448	
			Trans	Manual	1			EM-2448	
<b>E-200 ECONOLINE</b>									
L6	L6 2.8L 170ci	1969-70	Trans		1			EM-2307	
		L6 3.9L 240ci	1969-74	LH Front		1	EM-2332		
			RH Front		1	EM-2331			
	1973-74		Trans	Auto	1			EM-2362	
			Trans	Manual	1			EM-2327	
	1969-72	Trans		1			EM-2327		
	L6 4.9L 300ci	1972-74	LH Front		1	EM-2332			
			RH Front		1	EM-2331			
Trans			Auto	1			EM-2362		
V8	V8 5.0L 302ci	1969-74	L & R Front		2	EM-2329			
			Trans	Auto	1			EM-2362	
			Trans	Manual	1			EM-2327	
<b>E-250 ECONOLINE</b>									
L6	L6 4.9L 300ci	1985-96	LH Front		1	EM-2636			
		1977-84	LH Front		1	EM-2442			
		1975-76	LH Front		1	EM-2332			
		1985-96	RH Front		1	EM-2635			
		1977-84	RH Front		1	EM-2441			
		1975-76	RH Front		1	EM-2331			
		1988-96	Trans	Auto	1			EM-2557	
		1983-87	Trans	Auto	1			EM-2448	
		1977-82	Trans	Auto	1			EM-2448	
			Trans	Manual	1			EM-2448	
		1975-76	Trans	Auto	1			EM-2372	
		V6	V6 4.2L 256ci	1997-03	LH Front		1	EM-3059	
RH Front					1	EM-3060			
Trans	Auto				1			EM-2557	
V8	V8 4.6L 281ci	2003-13	LH Front		1	EM-2930			
			RH Front		1	EM-2929			
			2003-11	Trans	Auto	1			EM-2557
	V8 5.0L 302ci		1979-91	LH Front		1	EM-2440		
				1975	LH Front		1	EM-2440	
			1979-91	RH Front		1	EM-2439		
				1975	RH Front		1	EM-2439	
			1983-91	Trans	Auto	1			EM-2448
			1979-82	Trans	Auto	1			EM-2448
				Trans	Manual	1			EM-2448
			1975	Trans	Auto	1			EM-2448
	Trans	Manual	1			EM-2448			
	V8 5.4L 330ci		1997-13	LH Front		1	EM-2930		
				RH Front		1	EM-2929		
			1997-11	Trans	Auto	1			EM-2557
	V8 5.8L 351ci		1975-96	LH Front		1	EM-2440		
				RH Front		1	EM-2439		
			1992-96	Trans	Auto	1			EM-2557
1984-91			Trans	Auto	1			EM-2448	
1983			Trans	Auto	1			EM-2448	
1975-82			Trans	Auto	1			EM-2448	
	Trans	Manual	1			EM-2448			
V8 6.6L 400ci		1980-82	LH Front		1	EM-2754			

## Engine, Transmission, And Torque Strut Mounts

CYL	ENG. SIZE	YEAR	LOCATION	DESCRIPTION	QTY	ENGINE	TORQUE STRUT	TRANSMISSION	
<b>FORD VAN (continued)</b>									
<b>E-250 ECONOLINE (continued)</b>									
V8	V8 6.6L 400ci	1980-82	Trans	Auto	1			EM-2448	
			Trans	Manual	1			EM-2448	
	V8 6.9L 420ci Diesel	1983-87	LH Front		1	EM-2768			
			RH Front		1	EM-2767			
			Trans	Auto	1			EM-2448	
	V8 7.3L 445ci Diesel	1988-91	LH Front		1	EM-2768			
			RH Front		1	EM-2767			
			Trans	Auto	1			EM-2557	
	V8 7.5L 460ci	1975-91	L & R Front		2	EM-2536			
			1988-91	Trans	Auto	1			EM-2557
			1980-87	Trans	Auto	1			EM-2448
			1980-82	Trans	Auto	1			EM-2448
			1980-82	Trans	Manual	1			EM-2448
<b>E-300 ECONOLINE</b>									
L6	L6 2.8L 170ci	1969-70	Trans		1			EM-2307	
			L6 3.9L 240ci	1969-74	LH Front		1	EM-2332	
	RH Front		1		EM-2331				
	L6 4.9L 300ci	1973-74	Trans	Auto	1			EM-2362	
			Trans	Manual	1			EM-2327	
			1969-72	Trans		1			EM-2327
			1972-74	LH Front		1	EM-2332		
	RH Front			1	EM-2331				
Trans	Auto	1				EM-2362			
V8	V8 5.0L 302ci	1969-74	L & R Front		2	EM-2329			
			Trans	Auto	1			EM-2362	
			Trans	Manual	1			EM-2327	
<b>E-350 ECONOLINE</b>									
L6	L6 4.9L 300ci	1985-96	LH Front		1	EM-2636			
		1977-84	LH Front		1	EM-2442			
		1975-76	LH Front		1	EM-2332			
		1985-96	RH Front		1	EM-2635			
		1977-84	RH Front		1	EM-2441			
		1975-76	RH Front		1	EM-2331			
		1988-96	Trans	Auto	1			EM-2557	
		1985-87	Trans	Auto	1			EM-2448	
		1980-84	Trans	Auto	1			EM-2448	
			Trans	Manual	1			EM-2448	
		1977-79	Trans	Auto	1			EM-2448	
			Trans	Manual	1			EM-2448	
		1975-76	Trans	Auto	1			EM-2372	
		V8	V8 5.0L 302ci	1979-82	LH Front		1	EM-2440	
1975	LH Front				1	EM-2440			
1979-82	RH Front				1	EM-2439			
1975	RH Front				1	EM-2439			
1979-82	Trans			Auto	1			EM-2448	
	Trans			Manual	1			EM-2448	
1975	Trans			Auto	1			EM-2448	
	Trans			Manual	1			EM-2448	
V8 5.4L 330ci	2007		LH Front	Mexico	1	EM-2930			
	1997-05		LH Front		1	EM-2930			
	2007		RH Front	Mexico	1	EM-2929			
	1997-05		RH Front		1	EM-2929			
	2007		Trans	Auto	1			EM-2557	
1997-05	Trans	Auto	1			EM-2557			
V8 5.8L 351ci	1975-96	LH Front		1	EM-2440				
		RH Front		1	EM-2439				

# Engine, Transmission, And Torque Strut Mounts

CYL	ENG. SIZE	YEAR	LOCATION	DESCRIPTION	QTY	ENGINE	TORQUE STRUT	TRANS-MISSION
<b>FORD VAN (continued)</b>								
<b>E-350 ECONOLINE (continued)</b>								
V8	V8 5.8L 351ci	1992-96	Trans	Auto	1			EM-2557
		1985-91	Trans	Auto	1			EM-2448
		1975-84	Trans	Auto	1			EM-2448
			Trans	Manual	1			EM-2448
	V8 6.0L 363ci	2004-05	Trans		1			EM-2557
	V8 6.0L 363ci Diesel	2004-05	LH Front	Turbo	1	EM-5551		
			RH Front	Turbo	1	EM-5578		
	V8 6.6L 400ci	1980-82	LH Front		1	EM-2754		
			Trans	Auto	1			EM-2448
			Trans	Manual	1			EM-2448
	V8 6.9L 420ci Diesel	1983-87	LH Front		1	EM-2768		
			RH Front		1	EM-2767		
		1985-87	Trans	Auto	1			EM-2448
		1983-84	Trans	Auto	1			EM-2448
	Trans		Manual	1			EM-2448	
	V8 7.3L 445ci Diesel	1988-03	LH Front		1	EM-2768		
			RH Front		1	EM-2767		
		1988-00	Trans	Auto	1			EM-2557
	V8 7.5L 460ci	1975-96	L & R Front		2	EM-2536		
		1990-96	Trans	Auto	1			EM-2557
		1988-89	Trans	Auto	1			EM-2557
		1985-87	Trans	Auto	1			EM-2448
		1980-84	Trans	Auto	1			EM-2448
Trans	Manual		1			EM-2448		
V10	V10 6.8L 415ci	2005	Trans	Auto	1			EM-2557
		1997-03	Trans	Auto	1			EM-2557
<b>E-350 SUPER DUTY</b>								
V8	V8 5.4L 330ci	1999-13	LH Front		1	EM-2930		
			RH Front		1	EM-2929		
	1999-12	Trans	Auto	1			EM-2557	
	V8 6.0L 363ci	2004-10	Trans		1			EM-2557
	V8 6.0L 363ci Diesel	2004-10	LH Front	Turbo	1	EM-5551		
			RH Front	Turbo	1	EM-5578		
	V8 7.3L 445ci Diesel	1999-03	LH Front		1	EM-2768		
RH Front				1	EM-2767			
Trans			Auto	1			EM-2557	
V10	V10 6.8L 415ci	1999-13	Trans		1			EM-2557
<b>FREESTAR</b>								
V6	V6 3.9L 238ci	2004-07	RH Front		1	EM-3075*		
			RH Rear		1	EM-3076*		
			Torq Str - Rear		1		EM-3101	
			Trans		1			EM-3106
	V6 4.2L 256ci	2004-07	RH Front		1	EM-3075*		
			RH Rear		1	EM-3076*		
			Torq Str - Rear		1		EM-3101	
			Trans		1			EM-3106
<b>P350 MICROBUS (MEXICAN VEHICLE)</b>								
V8	V8 5.0L 302ci	1989-91	LH Front		1	EM-2440		
			RH Front		1	EM-2439		
			Trans		1			EM-2347
	V8 5.8L 351ci	1993-97	LH Front		1	EM-5440		
			RH Front		1	EM-2439		
1986-87	Trans		1			EM-8887		

\* = Hydraulic Mount, "S" suffix = solid replacement.

# Engine, Transmission, And Torque Strut Mounts

CYL	ENG. SIZE	YEAR	LOCATION	DESCRIPTION	QTY	ENGINE	TORQUE STRUT	TRANSMISSION	
<b>FORD VAN (continued)</b>									
<b>TRANSIT CONNECT</b>									
L4	L4 1.6L 97ci	2014-16	Right	Insert	1	EM-4256			
			Torq Str - Rear L		1		EM-4057		
			Trans - Upper		1			EM-4121	
	L4 2.0L 121ci	2010-13	RH Front	Complete Unit	1	EM-4082			
			RH Front	Insert	1	EM-3103			
			Torq Str - Rear		1		EM-2939#		
			Trans		1			EM-2986 #	
	L4 2.5L 152ci	2014-17	Right	Complete Unit	1	EM-4152			
			Right	Insert	1	EM-4229			
			Torq Str - Rear L		1		EM-4057		
			2014-19	Trans - Upper		1			EM-4121
	<b>TRANSIT-150</b>								
L5	L5 3.2L 195ci	2015-17	Trans		1			EM-4211	
V6	V6 3.5L 213ci	2015-17	Trans		1			EM-4211	
	V6 3.7L 227ci	2015-17	Trans		1			EM-4211	
<b>TRANSIT-250</b>									
L5	L5 3.2L 195ci	2015-17	Trans		1			EM-4211	
V6	V6 3.5L 213ci	2015-17	Trans		1			EM-4211	
	V6 3.7L 227ci	2015-17	Trans		1			EM-4211	
<b>TRANSIT-350</b>									
L5	L5 3.2L 195ci	2015-17	Trans		1			EM-4211	
V6	V6 3.5L 213ci	2015-17	Trans		1			EM-4211	
	V6 3.7L 227ci	2015-17	Trans		1			EM-4211	
<b>TRANSIT-350 HD</b>									
L5	L5 3.2L 195ci	2015-17	Trans		1			EM-4211	
V6	V6 3.5L 213ci	2015-17	Trans		1			EM-4211	
	V6 3.7L 227ci	2015-17	Trans		1			EM-4211	
<b>WINDSTAR</b>									
V6	V6 3.0L 182ci	1995-00	RH Front		1	EM-2623			
			RH Rear		1	EM-2622			
			Trans		1		EM-2686		
	V6 3.8L 232ci	1999-03	RH Front		1	EM-2931			
			1996-98	RH Front		1	EM-2915		
			1995	RH Front		1	EM-2812'		
			1999-03	RH Rear		1	EM-2813'		
			1996-98	RH Rear		1	EM-2813'		
			1995	RH Rear		1	EM-2813'		
			1999-03	Trans		1		EM-2717 *	
			1997-98	Trans		1		EM-2977	
			1995-96	Trans		1		EM-2717 *	
<b>FORD MEDIUM/HEAVY DUTY</b>									
<b>B600/800</b>									
	L6 5.9L 359ci Diesel	1992-94	Trans	Auto	2			EM-2769	
			Trans	Manual	2		EM-2769		
	L6 6.6L 401cid Diesel	1987-89	L & R Front		2	EM-2462			
	L6 6.7L 408ci Diesel	1987-89	Trans	Auto	2			EM-2769	
Trans			Manual	2		EM-2769			
<b>B7000</b>									
V8	V8 10.4L 636ci	1983-87	Trans	Auto	1			EM-2753	
			Trans	Manual	1		EM-2752		

\* = Hydraulic Mount, "S" suffix = solid replacement. # = Available in the Westar Gold Line

# Engine, Transmission, And Torque Strut Mounts

CYL	ENG. SIZE	YEAR	LOCATION	DESCRIPTION	QTY	ENGINE	TORQUE STRUT	TRANSMISSION
<b>FORD MEDIUM/HEAVY DUTY (continued)</b>								
<b>C7000</b>								
V8	V8 10.4L 636ci	1980-82	Trans	Auto	1			EM-2753
			Trans	Manual	1			EM-2752
<b>C8000</b>								
V8	V8 10.4L 636ci	1980-82	Trans	Auto	1			EM-2753
			Trans	Manual	1			EM-2752
<b>E-450 SUPER DUTY</b>								
V8	V8 5.4L 330ci	2006-13	LH Front		1	EM-2930		
			2000-04	LH Front		1	EM-2930	
		2006-13	RH Front		1	EM-2929		
			2000-04	RH Front		1	EM-2929	
		2006-13	Trans		1			EM-2557
			2004	Trans		1		EM-2557
	V8 6.0L 363ci	2004-07	Trans		1			EM-2557
	V8 6.0L 363ci Diesel	2004-10	LH Front	Turbo	1	EM-5551		
			RH Front	Turbo	1	EM-5578		
	V8 7.3L 445ci Diesel	2000-03	LH Front		1	EM-2768		
RH Front				1	EM-2767			
Trans			Auto	1			EM-2557	
V10	V10 6.8L 415ci	2000-13	Trans	Auto	1			EM-2557
<b>E-550 SUPER DUTY</b>								
V8	V8 7.3L 445ci Diesel	2003	LH Front		1	EM-2768		
			RH Front		1	EM-2767		
			Trans	Auto	1			EM-2557
V10	V10 6.8L 415ci	2003	Trans		1			EM-2557
<b>E SUPER DUTY</b>								
V8	V8 5.4L 330ci	1997-99	LH Front		1	EM-2930		
			RH Front		1	EM-2929		
			Trans		1			EM-2557
	V8 5.8L 351ci	1996	LH Front		1	EM-2440		
			RH Front		1	EM-2439		
			Trans	Auto	1			EM-2557
	V8 7.3L 445ci Diesel	1996-99	LH Front		1	EM-2768		
			RH Front		1	EM-2767		
			Trans	Auto	1			EM-2557
	V10	V10 6.8L 415ci	1997-99	Trans	Auto	1		
<b>F SUPER DUTY</b>								
V8	V8 7.3L 445ci Diesel	1990-93	Trans		1			EM-2557
	V8 7.5L	1996	Trans	Manual	1			EM-2970
		1990-95	Trans	Auto	1			EM-2557
	V8 7.5L 460ci	1997	Trans	4X2	1			EM-2557
<b>F-450 SUPER DUTY PICKUP</b>								
V8	V8 6.0L 363ci Diesel	2005-07	Left		1	EM-4137		
		2003-07	Trans	4 X 2; RWD	1			EM-4024
			Trans	4 X 4; 4WD	1			EM-4023
	V8 7.3L 445ci Diesel	1999-03	LH Front		1	EM-3029		
			RH Front		1	EM-3030		
			Trans	4 X 2; RWD	1			EM-2884
			Trans	Auto; 4 X 2 (2WD)	1			EM-2884
			Trans	Auto; 4 X 4 (4WD)	1			EM-2971
			Trans	Manual; 4 X 2 (2WD)	1			EM-2884
			Trans	Manual; 4 X 4 (4WD)	1			EM-2971
	V8 7.5L 460ci	1997	L & R Front		2	EM-2709		
			Trans	4 X 2; RWD	1			EM-2557
	V10	V10 6.8L 415ci	1999-04	Left		1	EM-4022	



## Engine, Transmission, And Torque Strut Mounts

CYL	ENG. SIZE	YEAR	LOCATION	DESCRIPTION	QTY	ENGINE	TORQUE STRUT	TRANSMISSION
<b>FORD MEDIUM/HEAVY DUTY (continued)</b>								
<b>F-450 SUPER DUTY PICKUP (continued)</b>								
V10	V10 6.8L 415ci	1999-04	Right		1	EM-4021		
		1999-07	Trans	4 X 2; RWD	1			EM-2884
			Trans	4 X 4; 4WD	1			EM-2971
<b>F53 STRIPPED CHASSIS</b>								
V8	V8 7.5L 460ci	1988-97	Trans	Manual	1			EM-2866 #
<b>F-500 PICKUP</b>								
V8	V8 5.4L 330ci	1975-77	L & R Front Lower		2	EM-2298		
			L & R Front Upper		2	EM-2297		
			Trans - Lower	Manual	2			EM-2306
	V8 5.9L 360ci	1975-77	L & R Front Lower		2	EM-2298		
			L & R Front Upper		2	EM-2297		
			Trans		1			EM-2750
<b>F-550 SUPER DUTY PICKUP</b>								
V8	V8 6.0L 363ci Diesel	2005-07	Left		1	EM-4137		
		2003-07	Trans	4 X 2; RWD	1			EM-4024
			Trans	4 X 4; 4WD	1			EM-4023
	V8 7.3L 445ci Diesel	1999-03	LH Front		1	EM-3029		
			RH Front		1	EM-3030		
		2000-03	Trans	Auto; 4 X 2 (2WD)	1			EM-2884
			Trans	Auto; 4 X 4 (4WD)	1			EM-2971
			Trans	Manual; 4 X 2 (2WD)	1			EM-2884
			Trans	Manual; 4 X 4 (4WD)	1			EM-2971
	1999	Trans	Manual; 4 X 2 (2WD)	1			EM-2884	
		Trans	Manual; 4 X 4 (4WD)	1			EM-2971	
V10	V10 6.8L 415ci	1999-04	Left		1	EM-4022		
			Right		1	EM-4021		
		1999-07	Trans	4 X 2; RWD	1			EM-2884
			Trans	4 X 4; 4WD	1			EM-2971
<b>F600</b>								
L6	L6 5.9L 359ci	1992-94	L & R Front		2	EM-2462		
			Trans	Auto	2			EM-2769
	L6 5.9L 359ci Diesel	1992-94	Trans	Manual	2			EM-2769
			L & R Front		2	EM-2462		
	L6 6.6L 401cid Diesel	1987-93	Trans	Auto	2			EM-2769
			Trans	Manual	2			EM-2769
<b>F700</b>								
L6	L6 5.9L 359ci	1992-97	L & R Front		2	EM-2462		
			Trans	Auto	2			EM-2769
	L6 5.9L 359ci Diesel	1992-97	Trans	Manual	2			EM-2769
			L & R Front		2	EM-2462		
	L6 6.6L 401cid Diesel	1987-93	Trans	Auto	2			EM-2769
			Trans	Manual	2			EM-2769
<b>F800</b>								
L6	L6 6.6L 401cid Diesel	1987-91	L & R Front		2	EM-2462		
			Trans	Auto	2			EM-2769
			Trans	Manual	2			EM-2769

# = Available in the Westar Gold Line

# Engine, Transmission, And Torque Strut Mounts

CYL	ENG. SIZE	YEAR	LOCATION	DESCRIPTION	QTY	ENGINE	TORQUE STRUT	TRANSMISSION
<b>FORD MEDIUM/HEAVY DUTY (continued)</b>								
<b>L800</b>								
V8		1970-78	Trans - L & R Upper	Manual Manual	1			EM-2299
<b>LN600</b>								
V8	V8 5.9L 361ci	1970-79	L & R Front		2	EM-2462		
			Trans - L & R Upper	Manual Manual	1			EM-2299
<b>LN700</b>								
V8	V8 5.9L 361ci	1970-79	L & R Front		2	EM-2462		
			Trans - L & R Upper	Manual Manual	1			EM-2299
<b>LN7000</b>								
V8	V8 5.9L 361ci	1970-79	L & R Front		2	EM-2462		
			Trans - L & R Upper	Manual Manual	1			EM-2299
<b>LN800</b>								
V8	V8 5.9L 361ci	1970-79	L & R Front		2	EM-2462		
			Trans - L & R Upper	Manual Manual	1			EM-2299
<b>LN8000</b>								
V8	V8 5.9L 361ci	1970-79	L & R Front		2	EM-2462		
			Trans - L & R Upper	Manual Manual	1			EM-2299
<b>LN900</b>								
V8	V8 5.9L 361ci	1970-79	L & R Front		2	EM-2462		
			Trans - L & R Upper	Manual Manual	1			EM-2299
<b>LN9000</b>								
V8	V8 5.9L 361ci	1970-79	L & R Front		2	EM-2462		
			Trans - L & R Upper	Manual Manual	1			EM-2299
<b>FREIGHTLINER</b>								
<b>SPRINTER 2500</b>								
L4	L4 2.1L 131ci	2014-16	L & R Front		2	EM-7265		
			Trans		1			EM-7159
L5	L5 2.7L 165ci	2003-06	L & R Front		2	EM-3190		
			Trans		1			EM-3189
V6	V6 3.0L 2987cc	2007-16	L & R Front		2	EM-7265		
			Trans	Auto	1			EM-7159
	V6 3.5L 3498cc	2007-08	L & R Front		2	EM-7265		
			Trans	Auto	1			EM-7159
<b>SPRINTER 3500</b>								
L4	L4 2.1L 131ci	2014-16	L & R Front		2	EM-7265		
			Trans		1			EM-7159
V6	V6 3.0L 2987cc	2007-16	L & R Front		2	EM-7265		
			Trans	Auto	1			EM-7159
	V6 3.5L 3498cc	2007-08	Trans	Auto	1			EM-7159
			Trans	Auto	1			EM-7159

## Engine, Transmission, And Torque Strut Mounts

CYL	ENG. SIZE	YEAR	LOCATION	DESCRIPTION	QTY	ENGINE	TORQUE STRUT	TRANSMISSION	
<b>GEO PASSENGER CAR</b>									
<b>METRO</b>									
L3	L3 1.0L	1991	Front	Manual	1	EM-8517			
		1989-90	Front	Manual	1	EM-8517			
		1991	LH Front	Auto	1	EM-5591			
		1989-90	LH Front	Auto	1	EM-5591			
		1991	RH Front	Auto; To 3-1-1991	1	EM-5733			
			RH Front	Manual	1	EM-8514			
		1989-90	RH Front	Auto	1	EM-5733			
			RH Front	Manual	1	EM-8514			
		L3 1.0L 993cc	1991	Rear	Manual	1	EM-8294		
	1989-90		Rear	Manual	1	EM-8294			
	1995-97		Front	Manual	1	EM-8517			
	1992-94		Front	Manual	1	EM-8517			
			LH Front	Auto	1	EM-5591			
	1989-97		Torq Str - Rear	Auto	1		EM-8658		
1989-90	Trans	Manual	1			EM-8277			
L4	L4 1.3L 1295cc	1992-97	Front		1	EM-5608			
			Rear		1	EM-8277			
		1995-97	Torq Str - Front		1		EM-8658		
			Trans		1			EM-8277	
<b>PRIZM</b>									
L4	L4 1.6L 1588cc	1993-97	Front	Auto	1	EM-8177			
			Front	Manual	1	EM-8180			
		1989-92	Front	Auto	1	EM-8180			
			Front	Manual	1	EM-8181			
		1993-97	RH Front		1	EM-8178			
		1989-92	RH Front		1	EM-8183			
		1993-97	Rear		1	EM-8179			
		1989-92	Rear	Auto	1	EM-8185			
			Rear	Manual	1	EM-8187			
		1993-97	Trans		1			EM-8191	
	1989-92	Trans	Auto	1			EM-8188		
	L4 1.8L 1762cc	1996-97	Trans	Auto	1			EM-8415	
			Trans	Manual	1			EM-8191	
		1993-95	Trans	Manual	1			EM-8191	
	L4 1.8L 1788cc	1993-97	Front	Auto	1	EM-8177			
			Front	Manual	1	EM-8180			
			RH Front		1	EM-8178			
			Rear		1	EM-8179			
<b>SPECTRUM</b>									
L4	L4 1.5L	1989	Trans		1			EM-8976	
			Trans		1			EM-8976	
	L4 1.5L 1471cc	1989	Front		1	EM-8442			
			RH Front		1	EM-8439			
<b>GEO SPORT UTILITY</b>									
<b>TRACKER</b>									
L4	L4 1.6L 1588cc	1989-97	L & R Front		2	EM-8568			
		1996-97	Torq Str - Front	Auto; 3 Spd; 4WD	1		EM-8657		
			Torq Str - Front	Auto; 4 Spd; 4WD	1		EM-8656		
		1989-95	Torq Str - Front	Auto; 3 Spd; 4WD	1		EM-8657		
			Torq Str - Front	Manual	1		EM-8657		
		1989-97	Trans		1			EM-8825	
	L4 1.6L 1590cc 97ci	1995	Torq Str - Front	Auto	1		EM-8657		

# Engine, Transmission, And Torque Strut Mounts

CYL	ENG. SIZE	YEAR	LOCATION	DESCRIPTION	QTY	ENGINE	TORQUE STRUT	TRANSMISSION	
<b>GMC SPORT UTILITY</b>									
<b>ACADIA</b>									
V6	V6 3.6L 217ci	2009-17	Front		1	EM-4037			
		2007-08	Front		1	EM-3192			
		2009-17	Rear		1	EM-4035			
		2007-08	Rear		1	EM-3192			
		2009-17	Torq Str - Right		1		EM-3141		
		2007-08	Torq Str - Right	Bracket Only	1		EM-3143		
			Torq Str - Right	Strut	1		EM-3133		
		2009-17	Trans		1			EM-4036	
	2007-08	Trans		1			EM-4253		
<b>C15/C1500 SUBURBAN</b>									
L6	L6 4.1L 250ci	1973-80	L & R Front		2	EM-2292			
		1967-72	L & R Front		2	EM-2282			
		1973-80	Trans	Auto; THM350 (M38) THM350C (MV4)	1			EM-2378 @	
			Trans	Auto; THM400	1			EM-2268 @	
			Trans	Manual	1			EM-2378 @	
		1968-72	Trans	Auto; THM350 (M38) THM350C (MV4)	1			EM-2378 @	
	Trans		Manual	1			EM-2378 @		
	L6 4.8L 292ci		1973-74	L & R Front		2	EM-2292		
		1967-71	L & R Front		2	EM-2282			
		1973-74	Trans	Auto; THM350	1		EM-2378 @		
			Trans	Auto; THM400	1		EM-2268 @		
			Trans	Manual	1		EM-2378 @		
		1968-71	Trans		1		EM-2378 @		
	V8	V8 5.0L 305ci	1977-86	L & R Front		2	EM-2292		
			1986	Trans	Auto; THM700-R4/4L60 (MD8)	1		EM-2392	
			1985	Trans	Auto; THM700-R4/4L60 (MD8)	1		EM-2392	
			1982-84	Trans	Auto; THM350 (M38) THM700R4 (MD8)	1		EM-2392	
				Trans	Auto; THM400 (M40)	1		EM-2513	
Trans				Manual	1		EM-2392		
1977-81			Trans	Auto; THM350 (M38) THM350C (MV4)	1		EM-2378 @		
			Trans	Auto; THM400	1		EM-2268 @		
			Trans	Manual	1		EM-2378 @		
			V8 5.0L 307ci	1973	L & R Front		2	EM-2292	
				1968-72	L & R Front		2	EM-2282	
			1968-73	Trans	Auto; THM350	1		EM-2378 @	
		Trans		Auto; THM400	1		EM-2268 @		
		Trans		Manual	1		EM-2378 @		
V8 5.4L 327ci		1967-68	L & R Front		2	EM-2282			
			Trans	Auto; THM400	1		EM-2268 @		
			Trans	Manual	1		EM-2378 @		
V8 5.7L 350 ci Gas		1979-81	L & R Front		2	EM-2292			
			Trans	Auto; THM350	1		EM-2378 @		
			Trans	Auto; THM400	1		EM-2268 @		
			Trans	Manual	1		EM-2378 @		
V8 5.7L 350ci		1992-99	L & R Front		2	EM-2621			
		1982-86	L & R Front		2	EM-2292			
		1973-78	L & R Front		2	EM-2292			
	1969-72	L & R Front		2	EM-2282				
	1994-99	Trans		1		EM-2817			
	1992-93	Trans	Auto; RWD	1		EM-2659 @			

@ = Universal Mount EM-5000 also available.

## Engine, Transmission, And Torque Strut Mounts

CYL	ENG. SIZE	YEAR	LOCATION	DESCRIPTION	QTY	ENGINE	TORQUE STRUT	TRANSMISSION		
<b>GMC SPORT UTILITY (continued)</b>										
<b>C15/C1500 SUBURBAN (continued)</b>										
V8	V8 5.7L 350ci	1986	Trans	Auto; THM350 (M38) THM700R4 (MD8)	1			EM-2392		
		1985	Trans	Auto; THM700-R4/4L60 (MD8)	1			EM-2392		
		1982-84	Trans	Auto; THM350 (M38) THM700R4 (MD8)	1			EM-2392		
			Trans	Auto; THM400 (M40)	1			EM-2513		
			Trans	Manual	1			EM-2392		
		1969-81	Trans	Auto; THM350	1			EM-2378 @		
			Trans	Auto; THM400	1			EM-2268 @		
			Trans	Manual	1			EM-2378 @		
		V8 5.7L 350ci Diesel	1979-81	L & R Front	VIN Z	2	EM-2328			
	Trans			Auto; THM350	1		EM-2378 @			
	Trans			Auto; THM400	1		EM-2268 @			
	Trans			Manual	1		EM-2378 @			
	V8 6.2L 379ci Diesel	1984-86	L & R Front		2	EM-2395				
			L & R Front		2	EM-2292				
		1983-86	Trans	Auto; THM700-R4/4L60 (MD8)	1		EM-2393			
		1982	Trans		1		EM-2392			
	V8 6.5L 395ci Diesel	1995-99	L & R Front		2	EM-2621				
			Trans		1		EM-2817			
	V8 6.6L 402ci	1970-72	L & R Front		2	EM-2283				
			Trans	Auto; THM350	1		EM-2378 @			
			Trans	Auto; THM400	1		EM-2268 @			
			Trans	Manual	1		EM-2378 @			
	V8 7.4L 454ci	1973-80	L & R Front		2	EM-2395				
			Trans	Auto; THM350	1		EM-2378 @			
Trans			Auto; THM400	1		EM-2268 @				
Trans			Manual	1		EM-2378 @				
<b>C25/C2500 SUBURBAN</b>										
L6	L6 4.1L 250ci	1973-74	L & R Front		2	EM-2292				
		1967-72	L & R Front		2	EM-2282				
		1973-74	Trans	Auto; THM350 (M38) THM350C (MV4)	1		EM-2378 @			
			Trans	Auto; THM400	1		EM-2268 @			
			Trans	Manual	1		EM-2378 @			
		1967-72	Trans		1		EM-2378 @			
	L6 4.8L 292ci	1984	L & R Front		2	EM-2292				
			L & R Front		2	EM-2292				
		1967-72	L & R Front		2	EM-2282				
			Trans	Auto; THM400	1		EM-2513			
			Trans	Auto; THM700-R4/4L60 (MD8)	1		EM-2392			
		1982	Trans	Manual	1		EM-2392			
			Trans	Auto; THM400	1		EM-2513			
			Trans	Auto; THM700-R4/4L60 (MD8)	1		EM-2392			
		1967-81	Trans	Manual	1		EM-2392			
			Trans	Auto; THM400	1		EM-2268 @			
			Trans	Manual	1		EM-2378 @			
		V8	V8 5.0L 305ci	1982-86	L & R Front		2	EM-2292		
				1977-78	L & R Front		2	EM-2292		
				1986	Trans	Auto; THM350C (MV4)	1		EM-2392	
Trans	Auto; THM400 (M40)				1		EM-2513			
1985	Trans			Auto; THM400 (M40)	1		EM-2513			
1982-84	Trans			Auto; THM350C (MV4)	1		EM-2392			
	Trans	Auto; THM400 (M40)	1		EM-2513					

@ = Universal Mount EM-5000 also available.

# Engine, Transmission, And Torque Strut Mounts

CYL	ENG. SIZE	YEAR	LOCATION	DESCRIPTION	QTY	ENGINE	TORQUE STRUT	TRANS-MISSION	
<b>GMC SPORT UTILITY (continued)</b>									
<b>C25/C2500 SUBURBAN (continued)</b>									
V8	V8 5.0L 305ci	1977-78	Trans	Auto; THM350 (M38)	1			EM-2378 @	
			Trans	Auto; THM400	1			EM-2268 @	
			Trans	Manual	1			EM-2378 @	
	V8 5.0L 307ci	1973	L & R Front		2	EM-2292			
			L & R Front		2	EM-2282			
		1968-73	Trans	Auto; Powerglide	1				EM-2378 @
			Trans	Auto; THM400	1				EM-2268 @
			Trans	Manual	1				EM-2378 @
	V8 5.4L 327ci	1967-68	L & R Front		2	EM-2282			
			Trans	Auto; THM400	1			EM-2268 @	
			Trans	Manual	1			EM-2378 @	
	V8 5.7L 350 ci Gas	1980	L & R Front		2	EM-2292			
			Trans	Auto; THM350	1			EM-2378 @	
			Trans	Auto; THM400	1			EM-2268 @	
			Trans	Manual	1			EM-2378 @	
	V8 5.7L 350ci	1992-99	L & R Front		2	EM-2621			
		1981-86	L & R Front		2	EM-2292			
		1974-79	L & R Front		2	EM-2292			
		1969-72	L & R Front		2	EM-2282			
		1994-99	Trans		1			EM-2817	
		1992-93	Trans	Auto; RWD	1			EM-2659 @	
		1985-86	Trans	Auto; THM350 (M38) THM700R4 (MD8)	1				EM-2392
			Trans	Auto; THM400 (M40)	1				EM-2513
		1982-84	Trans	Auto; THM350 (M38) THM700R4 (MD8)	1				EM-2392
			Trans	Auto; THM400 (M40)	1				EM-2513
			Trans	Manual	1				EM-2392
		1981	Trans	Auto; THM350	1				EM-2378 @
			Trans	Auto; THM400	1				EM-2268 @
			Trans	Manual	1				EM-2378 @
		1974-79	Trans	Auto; THM350	1				EM-2378 @
			Trans	Auto; THM400	1				EM-2268 @
			Trans	Manual	1				EM-2378 @
	V8 5.7L 350ci Diesel	1980	L & R Front	VIN Z	2	EM-2328			
			Trans	Auto; THM350	1			EM-2378 @	
			Trans	Auto; THM400	1			EM-2268 @	
			Trans	Manual	1			EM-2378 @	
	V8 6.2L 379ci Diesel	1984-86	L & R Front		2	EM-2395			
		1982-83	L & R Front		2	EM-2292			
		1982-86	Trans	Auto; THM400	1				EM-2515
	Trans		Auto; THM700R4 (MD8)	1				EM-2393	
	V8 6.5L 395ci Diesel	1994-99	L & R Front		2	EM-2621			
			Trans		1			EM-2817	
	V8 6.6L 400ci	1980	L & R Front		2	EM-2292			
			L & R Front		2	EM-2292			
		1980	Trans	Auto; THM350	1				EM-2378 @
			Trans	Auto; THM400	1				EM-2268 @
			Trans	Manual	1				EM-2378 @
	1978	Trans		1				EM-2378 @	
	V8 6.6L 402ci	1970-72	L & R Front		2	EM-2283			
			Trans	Auto; THM350	1			EM-2378 @	
Trans			Auto; THM400	1			EM-2268 @		

@ = Universal Mount EM-5000 also available.

# Engine, Transmission, And Torque Strut Mounts

CYL	ENG. SIZE	YEAR	LOCATION	DESCRIPTION	QTY	ENGINE	TORQUE STRUT	TRANSMISSION	
<b>GMC SPORT UTILITY (continued)</b>									
<b>C25/C2500 SUBURBAN (continued)</b>									
V8	V8 6.6L 402ci	1970-72	Trans	Manual	1			EM-2378 @	
	V8 7.4L 454ci	1992-99	L & R Front		2	EM-2621			
		1974-86	L & R Front		2	EM-2395			
		1996-99	Trans		1			EM-2817	
		1992-95	Trans	Auto; RWD		1		EM-2659 @	
		1984-86	Trans	Auto; THM400 (M40)		1			EM-2513
			Trans	Auto; THM700-R4/4L60 (MD8)		1			EM-2392
		1982-84	Trans	Auto; THM400 (M40)		1			EM-2513
			Trans	Auto; THM700-R4/4L60 (MD8)		1			EM-2392
			Trans	Manual		1			EM-2392
		1974-81	Trans	Auto; THM350		1			EM-2378 @
			Trans	Auto; THM400		1			EM-2268 @
			Trans	Manual		1			EM-2378 @
<b>ENVOY</b>									
L6	L6 4.2L 256ci	2002-09	L & R Front		2	EM-3021*			
		2002-07	Trans		1			EM-3027	
V8	V8 5.3L 325ci	2005-09	LH Front		1	EM-5694			
			RH Front		1	EM-5693			
		2005	Trans	RWD		1		EM-4119	
<b>ENVOY XL / XUV</b>									
L6	L6 4.2L 256ci	2002-06	Trans		1			EM-3027	
V8	V8 5.3L 325ci	2005-06	LH Front		1	EM-5694			
			RH Front		1	EM-5693			
<b>JIMMY</b>									
L6	L6 4.1L 250ci	1973-82	L & R Front		2	EM-2292			
		1970-72	L & R Front		2	EM-2282			
		1975-76	Trans - L & R Lower	4WD 4WD		2			EM-2108
			Trans - L & R Upper	4WD 4WD		2			EM-2107
		1982	Trans - Lower	Auto; 4WD		2			EM-2108
			Trans - Lower	Manual; 4WD		2			EM-2108
		1977-81	Trans - Lower	Auto; 4WD		2			EM-2108
			Trans - Lower	Manual; 4WD		2			EM-2108
		1970-74	Trans - Lower	Auto; 4WD		2			EM-2108
			Trans - Lower	Manual; 4WD		2			EM-2108
		1982	Trans - Upper	Auto; 4WD		2			EM-2107
			Trans - Upper	Manual; 4WD		2			EM-2392
		1977-81	Trans - Upper	Auto; 4WD		2			EM-2107
			Trans - Upper	Manual; 4WD		2			EM-2378 @
		1970-74	Trans - Upper	Auto; 4WD		2			EM-2107
			Trans - Upper	Manual; 4WD		2			EM-2378 @
		1982	Trans	Auto; THM350C (MV4); 2WD		1			EM-2392
			1977-81	Trans	Auto; THM350 (M38)		1		EM-2268 @
					THM350C (MV4); RWD				
					Auto; THM400 (M40); 2WD		1		EM-2378 @
		1975-76	Trans	Auto, M40; 2WD		1			EM-2268 @
			Trans	Auto; THM350 (M38)		1			EM-2378 @
					THM350C (MV4); RWD				
		1970-74	Trans	Manual; 2WD		1			EM-2378 @
			Trans	Auto; THM350 (M38)		1			EM-2268 @
					THM350C (MV4); RWD				
				Auto; THM400 (M40); 2WD		1			EM-2378 @

\* = Hydraulic Mount, "S" suffix = solid replacement. @ = Universal Mount EM-5000 also available.

# Engine, Transmission, And Torque Strut Mounts

CYL	ENG. SIZE	YEAR	LOCATION	DESCRIPTION	QTY	ENGINE	TORQUE STRUT	TRANSMISSION
<b>GMC SPORT UTILITY (continued)</b>								
<b>JIMMY (continued)</b>								
L6	L6 4.8L 292ci	1973	L & R Front		2	EM-2292		
			Trans - Lower	Auto; 4WD	2			EM-2108
			Trans - Lower	Manual; 4WD	2			EM-2108
			Trans - Upper	Auto; 4WD	2			EM-2107
			Trans - Upper	Manual; 4WD	2			EM-2378 @
			Trans	Auto; THM350 (M38); 2WD	1			EM-2268 @
V6	V6 4.3L 262ci	1996-05	L & R Front		2	EM-2802		
			1995	L & R Front		2	EM-2627	
		2002-05	Trans	Auto; 4WD	1			EM-2638
			1995-01	Trans	Auto; 4WD	1		EM-2839
		Trans	Auto; RWD	1			EM-2394	
		Trans	Manual; 4WD	1			EM-2839	
		Trans	Manual; RWD	1			EM-2394	
		V8	V8 5.0L 305ci	1977-87	L & R Front		2	EM-2292
1983-84	Trans - Lower				Auto; 4WD	2		EM-2108
1983-84	Trans - Lower			Manual; 4WD	2		EM-2108	
	1977-82			Trans - Lower	Auto; 4WD	2		EM-2108
1983-84	Trans - Lower			Manual; 4WD	2		EM-2108	
	1977-82			Trans - Upper	Auto; 4WD	2		EM-2107
1985-87	Trans - Upper			Manual; 4WD	2		EM-2513	
	1977-82			Trans - Upper	Auto; 4WD	2		EM-2107
1983-84	Trans			Auto; 4WD	1		EM-2638	
	Trans			Manual; 4WD	1		EM-2638	
1983-84	Trans		Auto; THM400 (M40); RWD	1		EM-2392		
	Trans		Auto; THM700-R4/4L60 (MD8) RWD	1		EM-2392		
V8 5.0L 307ci	1970-72		L & R Front		2	EM-2282		
			Trans - Lower	Auto; 4WD	2		EM-2108	
			Trans - Lower	Manual; 4WD	2		EM-2108	
			Trans - Upper	Auto; 4WD	2		EM-2107	
Trans - Upper	Manual; 4WD		2		EM-2268 @			
V8 5.7L 350ci	1988-91		L & R Front	4WD	2	EM-2637		
			1973-87	L & R Front		2	EM-2292	
	1970-72		L & R Front		2	EM-2282		
		1982-84	Trans - Lower	Auto; 4WD	2		EM-2108	
	1977-81	Trans - Lower	Manual; 4WD	2		EM-2108		
		1975-76	Trans - Lower	Auto; 4WD	2		EM-2108	
	1970-74	Trans - Lower	Manual; 4WD	2		EM-2108		
		1982-84	Trans - Lower	Auto; 4WD	2		EM-2108	
	1977-81	Trans - Lower	Manual; 4WD	2		EM-2108		
		1975-76	Trans - Upper	Auto; 4WD	2		EM-2107	
	1970-74	Trans - Upper	Manual; 4WD	2		EM-2392		
		1982-84	Trans - Upper	Auto; 4WD	2		EM-2107	
	1977-81	Trans - Upper	Manual; 4WD	2		EM-2378 @		
		1975-76	Trans - Upper	Auto; 4WD	2		EM-2107	
	1970-74	Trans - Upper	Manual; 4WD	2		EM-2268 @		
		1985-91	Trans - Upper	Auto; 4WD	2		EM-2107	
	1982-84	Trans - Upper	Manual; 4WD	2		EM-2378 @		
		Trans	Auto; 4WD	1		EM-2638		
	Trans	Manual; 4WD	1		EM-2638			
	Trans	Auto; THM350 (M38) THM700R4 (MD8); 2WD	1		EM-2513			
Trans	Auto; THM400 (M40); 2WD	1		EM-2392				

@ = Universal Mount EM-5000 also available.



# Engine, Transmission, And Torque Strut Mounts

CYL	ENG. SIZE	YEAR	LOCATION	DESCRIPTION	QTY	ENGINE	TORQUE STRUT	TRANSMISSION	
<b>GMC SPORT UTILITY (continued)</b>									
<b>JIMMY (continued)</b>									
V8	V8 5.7L 350ci	1977-81	Trans	Auto; THM350 (M38); 2WD	1			EM-2268 @	
			Trans	Auto; THM400 (M40); 2WD	1			EM-2378 @	
		1975-76	Trans	Auto, M40; 2WD	1				EM-2378 @
			Trans	Auto; THM350 (M38); 2WD	1				EM-2378 @
		1970-74	Trans	Auto; THM350 (M38); 2WD	1				EM-2268 @
			Trans	Auto; THM400 (M40); 2WD	1				EM-2378 @
	V8 6.2L 379ci Diesel	1988-91	L & R Front		2	EM-2637			
			L & R Front		2	EM-2395			
			L & R Front		2	EM-2292			
			Trans - Lower	Auto; 4WD	2				EM-2108
		1985-91	Trans - Lower	Manual; 4WD	2				EM-2108
			Trans - Upper	Auto; 4WD	2				EM-2107
			Trans - Upper	Manual; 4WD	2				EM-2393
			Trans	Auto; 4WD	1				EM-2638
	V8 7.4L 454ci	1976	Trans	Manual; 4WD	1				EM-2638
			L & R Front		2	EM-2292			
			Trans - Lower	Auto; 4WD	2				EM-2108
			Trans - Lower	Manual; 4WD	2				EM-2108
			Trans - Upper	Auto; 4WD	2			EM-2107	
<b>K15/K1500 SUBURBAN</b>									
L6	L6 4.1L 250ci	1973-80	L & R Front		2	EM-2292			
			L & R Front		2	EM-2282			
		1967-80	Trans - Lower	Auto	2				EM-2108
			Trans - Lower	Manual	2				EM-2108
			Trans - Upper	Auto	2				EM-2107
	L6 4.8L 292ci	1967-68	L & R Front		2	EM-2282			
			Trans - Lower	Auto	2				EM-2108
			Trans - Lower	Manual	2				EM-2108
			Trans - Upper	Auto	2				EM-2107
V8	V8 5.0L 305ci	1982-85	L & R Front		2	EM-2292			
			L & R Front		2	EM-2292			
		1985	Trans - Lower	Auto	2				EM-2108
			Trans - Lower	Auto	2				EM-2108
		1982-84	Trans - Lower	Manual	2				EM-2108
			Trans - Lower	Auto	2				EM-2108
		1977-79	Trans - Lower	Auto	2				EM-2108
			Trans - Lower	Manual	2				EM-2108
		1985	Trans - Upper	Auto	2				EM-2107
			Trans - Upper	Auto	2				EM-2107
		1977-79	Trans - Upper	Auto	2				EM-2107
	V8 5.0L 307ci	1973	L & R Front		2	EM-2292			
			L & R Front		2	EM-2282			
			L & R Front		2	EM-2282			
		1970-73	Trans - Lower	Auto	2				EM-2108
			Trans - Lower	Manual	2				EM-2108
		1968	Trans - Lower	Auto	2				EM-2108
			Trans - Lower	Manual	2				EM-2108
		1970-73	Trans - Upper	Auto	2				EM-2107
			Trans - Upper	Auto	2				EM-2107
	V8 5.7L 350ci	1992-99	L & R Front		2	EM-2637			
L & R Front				2	EM-2292				
1969-72		L & R Front		2	EM-2282				
		Trans - Lower	Auto	2				EM-2108	
1969-84		Trans - Lower	Manual	2				EM-2108	
		Trans - Upper	Auto	2				EM-2107	
1992-99		Trans	Auto	1				EM-2638	
		Trans	Auto	1				EM-2638	

@ = Universal Mount EM-5000 also available.

# Engine, Transmission, And Torque Strut Mounts

CYL	ENG. SIZE	YEAR	LOCATION	DESCRIPTION	QTY	ENGINE	TORQUE STRUT	TRANSMISSION	
<b>GMC SPORT UTILITY (continued)</b>									
<b>K15/K1500 SUBURBAN (continued)</b>									
V8	V8 6.2L 379ci Diesel	1984-86	L & R Front		2	EM-2395			
		1982-83	L & R Front		2	EM-2292			
		1982-84	Trans - Lower	Auto	2			EM-2108	
			Trans - Lower	Manual	2			EM-2108	
			Trans - Upper	Auto	2			EM-2107	
		1985-86	Trans		1			EM-2638	
	V8 6.5L 395ci Diesel	1995-99	L & R Front		2	EM-2637			
			Trans	Auto	1			EM-2638	
	V8 6.6L 400ci	1975-79	L & R Front		2	EM-2292			
			Trans - Lower	Auto	2			EM-2108	
			Trans - Lower	Manual	2			EM-2108	
			Trans - Upper	Auto	2			EM-2107	
<b>K25/K2500 SUBURBAN</b>									
L6	L6 4.1L 250ci	1973-74	L & R Front		2	EM-2292			
		1967-72	L & R Front		2	EM-2282			
		1967-74	Trans - Lower	Auto	2			EM-2108	
			Trans - Lower	Manual	2			EM-2108	
			Trans - Upper	Auto	2			EM-2107	
	L6 4.8L 292ci	1984	L & R Front		2	EM-2292			
		1973-82	L & R Front		2	EM-2292			
		1967-72	L & R Front		2	EM-2282			
		1984	Trans - Lower	Auto	2			EM-2108	
			Trans - Lower	Manual	2			EM-2108	
		1967-82	Trans - Lower	Auto	2			EM-2108	
			Trans - Lower	Manual	2			EM-2108	
		1984	Trans - Upper	Auto	2			EM-2107	
		1967-82	Trans - Upper	Auto	2			EM-2107	
	V8	V8 5.0L 305ci	1977-78	L & R Front		2	EM-2292		
Trans - Lower				Auto	2			EM-2108	
Trans - Lower				Manual	2			EM-2108	
Trans - Upper				Auto	2			EM-2107	
V8 5.0L 307ci		1973	L & R Front		2	EM-2292			
			1968-72	L & R Front		2	EM-2282		
			1968-73	Trans - Lower	Auto	2			EM-2108
				Trans - Lower	Manual	2			EM-2108
				Trans - Upper	Auto	2			EM-2107
V8 5.7L 350ci		1992-99	L & R Front		2	EM-2637			
			L & R Front		2	EM-2292			
		1973-86	L & R Front		2	EM-2282			
			Trans - Lower	Auto	2			EM-2108	
			Trans - Lower	Manual	2			EM-2108	
		1969-84	Trans - Upper	Auto	2			EM-2107	
			1992-99	Trans	Auto	1			EM-2638
			1985-86	Trans	Auto	1			EM-2638
V8 6.2L 379ci Diesel		1984-86	L & R Front		2	EM-2395			
			L & R Front		2	EM-2292			
		1982-84	Trans - Lower	Auto	2			EM-2108	
			Trans - Lower	Manual	2			EM-2108	
	Trans - Upper		Auto	2			EM-2107		
	1985-86	Trans	Auto	1			EM-2638		
V8 6.5L 395ci Diesel	1994-99	L & R Front		2	EM-2637				
		Trans	Auto	1			EM-2638		
V8 6.6L 400ci	1975-80	L & R Front		2	EM-2292				
		Trans - Lower	Auto	2			EM-2108		
		Trans - Lower	Manual	2			EM-2108		
		Trans - Upper	Auto	2			EM-2107		
V8 7.4L 454ci	1992-99	L & R Front		2	EM-2637				

## Engine, Transmission, And Torque Strut Mounts

CYL	ENG. SIZE	YEAR	LOCATION	DESCRIPTION	QTY	ENGINE	TORQUE STRUT	TRANSMISSION	
<b>GMC SPORT UTILITY (continued)</b>									
<b>K25/K2500 SUBURBAN (continued)</b>									
V8	V8 7.4L 454ci	1977	L & R Front		2	EM-2395			
			Trans - Lower	Auto	2			EM-2108	
			Trans - Lower	Manual	2			EM-2108	
			Trans - Upper	Auto	2			EM-2107	
		1992-99	Trans	Auto	1			EM-2638	
<b>R1500 SUBURBAN</b>									
V8	V8 5.0L 305ci	1987	L & R Front		2	EM-2292			
			Trans		1			EM-2392	
	V8 5.7L 350ci	1989-91	L & R Front		2	EM-2621			
			1991	Trans	Auto; THM700R4 (MD8)	1		EM-2392	
			1987-90	Trans	Auto; THM700R4 (MD8)	1		EM-2392	
	V8 6.2L 379ci Diesel	1987-91	L & R Front		2	EM-2395			
			1991	Trans	Auto; THM700-R4/4L60 (MD8)	1		EM-2393	
			1987-90	Trans	Auto; THM700-R4/4L60 (MD8)	1		EM-2393	
<b>R2500 SUBURBAN</b>									
V8	V8 5.7L 350ci	1989-91	L & R Front		2	EM-2621			
			1991	Trans	Auto; THM700R4 (MD8)	1		EM-2392	
			1987-90	Trans	Auto; THM400	1		EM-2513	
				Trans	Auto; THM700R4 (MD8)	1		EM-2392	
	V8 6.2L 379ci Diesel	1987-91	L & R Front		2	EM-2395			
			1991	Trans	Auto; 4L80E (MT1)	1		EM-2515	
			1987-90	Trans	Auto; THM700R4 (MD8)	1		EM-2393	
				Trans	Auto; THM400 (M40)	1		EM-2515	
	V8 7.4L 454ci	1987-91	L & R Front		2	EM-2395			
				Trans		1		EM-2515	
			Trans	Auto; THM700R4 (MD8)	1		EM-2393		
				Auto; THM700R4 (MD8)	1		EM-2393		
<b>S15 JIMMY</b>									
L4	L4 1.9L 119ci	1983-84	L & R Front		2	EM-2381			
			1984	Trans	Auto; 2WD	1		EM-2531	
				Trans	Auto; 4WD	1		EM-2638	
				Trans	Manual; 2WD	1		EM-2531	
		Trans		Manual; 4WD	1		EM-2638		
		1983	Trans	Auto; 2WD	1		EM-2771		
			Trans	Auto; 4WD	1		EM-2638		
			Trans	Manual; 2WD	1		EM-2771		
			Trans	Manual; 4WD	1		EM-2638		
		L4 2.0L 122ci	1983-84	LH Front		1	EM-2755		
				RH Front		1	EM-2756		
			1984	Trans	Manual; 2WD	1		EM-2531	
	Trans			4WD	1		EM-2638		
	Trans				1		EM-2531		
	Trans			Auto; 2WD	1		EM-2531		
	1983		Trans	Auto; 2WD	1		EM-2772		
			Trans	Auto; 4WD	1		EM-2638		
		Trans	Manual; 2WD	1		EM-2772			
	L4 2.5L 2474cc	1985-88	LH Front		1	EM-2549			
			RH Front		1	EM-2550			
		1988	Trans	Auto; 2WD	1		EM-2508		
			Trans	Auto; 4WD	1		EM-2638		
			Trans	Manual; 2WD	1		EM-2508		
			Trans	Manual; 4WD	1		EM-2638		
		1985-87	Trans	Auto; 2WD	1		EM-2531		
			Trans	Auto; 4WD	1		EM-2638		
			Trans	Manual; 2WD	1		EM-2531		
			Trans	Manual; 4WD	1		EM-2638		
Trans			Auto; 2WD	1		EM-2531			
Trans			Auto; 4WD	1		EM-2638			

# Engine, Transmission, And Torque Strut Mounts

CYL	ENG. SIZE	YEAR	LOCATION	DESCRIPTION	QTY	ENGINE	TORQUE STRUT	TRANSMISSION
<b>GMC SPORT UTILITY (continued)</b>								
<b>S15 JIMMY (continued)</b>								
V6	V6 2.8L 173ci	1983-89	L & R Front		2	EM-2436		
		1988-89	Trans	Auto; 2WD	1			EM-2508
			Trans	Manual; 2WD	1			EM-2508
		1984-87	Trans	Auto; 2WD	1			EM-2531
			Trans	Manual; 2WD	1			EM-2531
		1983	Trans	Auto; 2WD	1			EM-2772
			Trans	Auto; 4WD	1			EM-2638
			Trans	Manual; 2WD	1			EM-2772
	V6 4.3L 262ci	1988-94	L & R Front		2	EM-2627		
			Trans	Auto; 2WD	1			EM-2508
		Trans	Auto; 4WD	1			EM-2638	
		Trans	Manual; 2WD	1			EM-2508	
		Trans	Manual; 4WD	1			EM-2638	
		Trans	Manual; 4WD	1			EM-2638	
<b>SUBURBAN</b>								
L6	L6 4.1L 250ci	1966	L & R Front		2	EM-2282		
			Trans	2WD	1			EM-2378 @
<b>TERRAIN</b>								
L4	L4 2.4L 145ci	2010-15	Right		1	EM-4161		
			Trans - Center		1			EM-4192
			Trans - Front		1			EM-4111
			Trans - Rear		1			EM-4135
V6	V6 3.0L 182ci	2010-12	Front		1	EM-4155		
			Trans - Center		1			EM-4180
			Trans - Front		1			EM-4175
			Trans - Rear		1			EM-4135
	V6 3.6L 217ci	2013-17	Front		1	EM-4155		
Trans - Center				1			EM-4180	
2013-16		Trans - Front		1			EM-4175	
Trans - Rear		1			EM-4135			
<b>TYPHOON</b>								
V6	V6 4.3L 262ci	1992-93	L & R Front		2	EM-2627		
			Trans	AWD	1			EM-2638
<b>V1500 SUBURBAN</b>								
V8	V8 5.7L 350ci	1988-91	L & R Front		2	EM-2637		
		1987	L & R Front		2	EM-2292		
		1989-91	Trans	Auto	1			EM-2638
		1987-88	Trans	Auto	1			EM-2638
			Trans	Manual	1			EM-2638
	V8 6.2L 379ci Diesel	1988-91	L & R Front		2	EM-2637		
		1987	L & R Front		2	EM-2395		
		1989-91	Trans	Auto	1			EM-2638
		1987-88	Trans	Auto	1			EM-2638
			Trans	Manual	1			EM-2638
<b>V2500 SUBURBAN</b>								
V8	V8 5.7L 350ci	1989-91	L & R Front		2	EM-2637		
			Trans	Auto	1			EM-2638
		1987-88	Trans	Auto	1			EM-2638
			Trans	Manual	1			EM-2638
	V8 6.2L 379ci Diesel	1988-91	L & R Front		2	EM-2637		
		1987	L & R Front		2	EM-2395		
		1989-91	Trans	Auto	1			EM-2638
		1987-88	Trans	Auto	1			EM-2638
Trans	Manual		1			EM-2638		

@ = Universal Mount EM-5000 also available.

# Engine, Transmission, And Torque Strut Mounts

CYL	ENG. SIZE	YEAR	LOCATION	DESCRIPTION	QTY	ENGINE	TORQUE STRUT	TRANSMISSION
<b>GMC SPORT UTILITY (continued)</b>								
<b>YUKON</b>								
V8	V8 4.8L 294ci	2001-06	L & R Front		2	EM-2909#		
		2007-09	LH Front	2WD	1	EM-4000		
			RH Front		1	EM-4017		
		2000-09	Trans	2WD	1			EM-2811
			Trans	4WD	1			EM-2638
	V8 5.3L 325ci	2007-12	L & R Front		2	EM-5583#		
		2001-06	L & R Front		2	EM-2909#		
			LH Front		1	EM-4173		
		2015-16	RH Front		1	EM-4174		
			Trans	2WD	1			EM-2811
		2006-14	Trans	4WD	1			EM-2638
			Trans	2WD	1			EM-2811
	2000-05	Trans	4WD	1			EM-2638	
		Trans	4WD	1			EM-2638	
	V8 5.7L 350ci	1992-99	L & R Front	4WD	2	EM-2637		
			L & R Front	RWD	2	EM-2621		
		1997-99	Trans	4WD	1			EM-2638
			Trans	RWD	1			EM-2817
		1995-96	Trans	Auto; 2WD	1			EM-2817
			Trans	Auto; 4WD	1			EM-2638
			Trans	Manual; 2WD	1			EM-2817
			Trans	Manual; 4WD	1			EM-2638
		1992-94	Trans	Auto; 4WD	1			EM-2638
			Trans	Auto; RWD	1			EM-2659 @
			Trans	Manual; 4WD	1			EM-2638
			Trans	Manual; RWD	1			EM-2659 @
			Trans	Manual; RWD	1			EM-2659 @
	V8 6.0L 364ci	2008-13	L & R Front		2	EM-5583#		
		2001-06	L & R Front		2	EM-2909#		
			Trans	4WD; Auto	1			EM-2638
		2008-13	Trans	Auto; 2WD	1			EM-2811
	V8 6.2L 376ci	2007-14	L & R Front		2	EM-5583#		
		2015-16	LH Front		1	EM-4173		
RH Front				1	EM-4174			
2007-14		Trans	AWD	1			EM-2638	
V8 6.5L 395ci Diesel	1994-97	L & R Front	4WD	2	EM-2637			
		L & R Front	RWD	2	EM-2621			
	1997	Trans	Auto; 2WD	1			EM-2817	
		Trans	Auto; 4WD	1			EM-2638	
	1994-96	Trans	Auto; 2WD	1			EM-2817	
		Trans	Auto; 4WD	1			EM-2638	
		Trans	Manual; 2WD	1			EM-2817	
		Trans	Manual; 4WD	1			EM-2638	
<b>YUKON XL 1500</b>								
V8	V8 5.3L 325ci	2007-12	L & R Front		2	EM-5583#		
		2000-06	L & R Front		2	EM-2909#		
			Trans	Auto; 2WD	1			EM-2811
		2007-14	Trans	Auto; 4WD	1			EM-2638
			Trans	Auto; 2WD	1			EM-2811
		2000-03	Trans	2WD	1			EM-2811
			Trans	4WD	1			EM-2638
	V8 6.0L 364ci	2007-09	L & R Front		2	EM-5583#		
			Trans	2WD	1			EM-2811
			Trans	4WD	1			EM-2638
	V8 6.2L 378ci	2007-14	L & R Front		2	EM-5583#		
			Trans	AWD	1			EM-2638

@ = Universal Mount EM-5000 also available. # = Available in the Westar Gold Line

# Engine, Transmission, And Torque Strut Mounts

CYL	ENG. SIZE	YEAR	LOCATION	DESCRIPTION	QTY	ENGINE	TORQUE STRUT	TRANSMISSION	
<b>GMC SPORT UTILITY (continued)</b>									
<b>YUKON XL 2500</b>									
V8	V8 6.0L 364ci	2007-12	L & R Front		2	EM-5583#			
		2000-06	L & R Front		2	EM-2909#			
		2000-13	Trans	2WD	1			EM-2817	
			Trans	4WD	1			EM-2638	
	2001-06	L & R Front		2	EM-5353				
	V8 8.1L 496ci		Trans		1			EM-2839	
<b>GMC TRUCK</b>									
<b>1000 SERIES</b>									
L6	L6 3.8L 230ci	1964-65	L & R Front		2	EM-2282			
			Trans - L & R Lower	4WD 4WD	1			EM-2108	
			Trans - L & R Upper	4WD 4WD	1			EM-2107	
V6	V6 5.0L 305ci	1961-65	Trans - L & R Lower	4WD 4WD	1			EM-2108	
			Trans - L & R Upper	4WD 4WD	1			EM-2107	
<b>1500 SERIES</b>									
L6	L6 3.8L 230ci	1964-65	L & R Front		2	EM-2282			
			Trans - L & R Lower	4WD 4WD	1			EM-2108	
			Trans - L & R Upper	4WD 4WD	1			EM-2107	
V6	V6 5.0L 305ci	1961-65	Trans - L & R Lower	4WD 4WD	1			EM-2108	
			Trans - L & R Upper	4WD 4WD	1			EM-2107	
<b>2500 SERIES</b>									
L6	L6 3.8L 230ci	1964-65	L & R Front		2	EM-2282			
			Trans - L & R Lower	4WD 4WD	1			EM-2108	
			Trans - L & R Upper	4WD 4WD	1			EM-2107	
V6	V6 5.0L 305ci	1961-63	Trans - L & R Lower	4WD 4WD	1			EM-2108	
			Trans - L & R Upper	4WD 4WD	1			EM-2107	
<b>C15/C1500 PICKUP</b>									
L6	L6 3.8L 230ci	1966	L & R Front		2	EM-2282			
		1973-84	L & R Front		2	EM-2292			
			L & R Front		2	EM-2282			
			1982-84	Trans		1			EM-2392
			1973-81	Trans	Auto; THM350 (M38) THM350C (MV4)	1			EM-2378 @
				Trans	Auto; THM400 (M40)	1			EM-2268 @
				Trans	Manual	1			EM-2378 @
		1967-72	Trans		1			EM-2378 @	
		L6 4.8L 292ci	1973-80	L & R Front		2	EM-2292		
	1966-71		L & R Front		2	EM-2282			
	1973-80		Trans	Auto; THM350 (M38)	1			EM-2378 @	
		Trans	Auto; THM400 (M40)	1			EM-2268 @		
Trans		Manual	1			EM-2378 @			
1966-71	Trans		1			EM-2378 @			

@ = Universal Mount EM-5000 also available. # = Available in the Westar Gold Line

# Engine, Transmission, And Torque Strut Mounts

CYL	ENG. SIZE	YEAR	LOCATION	DESCRIPTION	QTY	ENGINE	TORQUE STRUT	TRANSMISSION		
<b>GMC TRUCK (continued)</b>										
<b>C15/C1500 PICKUP (continued)</b>										
V6	V6 4.3L 262ci	1988-95	L & R Front		2	EM-2436				
		1985-86	L & R Front		2	EM-2436				
		1996-98	LH Front		1	EM-3028				
			RH Front		1	EM-3044				
			Trans		1			EM-2817		
		1991-95	Trans	Auto		1			EM-2394	
			Trans	Manual		1			EM-2394	
		1988-90	Trans	Auto; THM400 (M40)		1			EM-2510 @	
			Trans	Auto; THM700-R4/4L60 (MD8)		1			EM-2394	
			Trans	Manual		1			EM-2394	
	1985-86	Trans	Auto		1			EM-2394		
		Trans	Manual		1			EM-2394		
	V6 5.0L 305ci	1967	Trans - L & R Lower		2			EM-2108		
			Trans - L & R Upper		2			EM-2107		
	V8	V8 4.6L 283ci	1967	L & R Front		2	EM-2282			
Trans - L & R Lower				Manual		2			EM-2108	
Trans - L & R Upper				Manual		2			EM-2107	
Trans				Auto		1			EM-2378 @	
V8 5.0L		1982-86	LH Front		1	EM-2292				
V8 5.0L 305ci			1988-99	L & R Front		2	EM-2621			
			1977-81	L & R Front		2	EM-2292			
			1999	Trans	Auto; 2WD		1			EM-2817
			1996-98	Trans	Auto; 2WD		1			EM-2817
				Trans	Manual; 2WD		1			EM-2817
			1992-95	Trans	Auto; RWD		1			EM-2659 @
				Trans	Manual; RWD		1			EM-2659 @
			1991	Trans	Auto; THM700-R4/4L60 (MD8)		1			EM-2392
				Trans	Manual		1			EM-2392
			1988-90	Trans	Auto; 4L80E THM700-R4/4L60 (MD8)		1			EM-2392
				Trans	Auto; THM400 (M40)		1			EM-2513
				Trans	Manual		1			EM-2392
			1982-86	Trans	Auto; THM350C (MV4) THM700-R4/4L60 (MD8)		1			EM-2392
				Trans	Auto; THM400 (M40)		1			EM-2513
				Trans	Manual		1			EM-2392
1977-81		Trans	Auto; THM350 (M38) THM350C (MV4)		1			EM-2378 @		
		Trans	Auto; THM400 (M40)		1			EM-2268 @		
		Trans	Manual		1			EM-2378 @		
V8 5.0L 307ci		1973	L & R Front		2	EM-2292				
			L & R Front		2	EM-2282				
			Trans	Auto; THM350 (M38)		1			EM-2378 @	
			Trans	Auto; THM400 (M40)		1			EM-2268 @	
V8 5.4L 327ci		1967-68	Trans	Manual		1		EM-2378 @		
			L & R Front		2	EM-2282				
			Trans	Auto; THM350 (M38)		1			EM-2378 @	
V8 5.7L 350 ci Gas		1979-81	Trans	Auto; THM400 (M40)		1		EM-2268 @		
			Trans	Manual		1		EM-2378 @		
V8 5.7L 350ci		1988-99	L & R Front		2	EM-2621				

@ = Universal Mount EM-5000 also available.

# Engine, Transmission, And Torque Strut Mounts

CYL	ENG. SIZE	YEAR	LOCATION	DESCRIPTION	QTY	ENGINE	TORQUE STRUT	TRANSMISSION	
<b>GMC TRUCK (continued)</b>									
<b>C15/C1500 PICKUP (continued)</b>									
V8	V8 5.7L 350ci	1973-78	L & R Front		2	EM-2292			
		1969-72	L & R Front		2	EM-2282			
		1982-86	LH Front		1	EM-2292			
		1999	Trans	Auto; 2WD		1			EM-2817
		1996-98	Trans	Auto; 2WD		1			EM-2817
			Trans	Manual; 2WD		1			EM-2817
		1992-95	Trans	Auto; RWD		1			EM-2659 @
			Trans	Manual; RWD		1			EM-2659 @
		1991	Trans			1			EM-2392
		1988-90	Trans	Auto; THM400 (M40)		1			EM-2513
			Trans	Auto; THM700R4 (MD8)		1			EM-2392
			Trans	Manual		1			EM-2392
		1986	Trans	Auto; THM350C (MV4) THM700-R4/4L60 (MD8)		1			EM-2392
			Trans	Auto; THM400 (M40)		1			EM-2513
			Trans	Manual		1			EM-2392
		1985	Trans	Auto; THM400 (M40)		1			EM-2513
			Trans	Auto; THM700R4 (MD8)		1			EM-2392
			Trans	Manual		1			EM-2392
		1982-84	Trans	Auto; THM350C (MV4) THM700-R4/4L60 (MD8)		1			EM-2392
			Trans	Auto; THM400 (M40)		1			EM-2513
			Trans	Manual		1			EM-2392
		1979-81	Trans	Auto; THM350 (M38)		1			EM-2378 @
			Trans	Auto; THM400 (M40)		1			EM-2268 @
			Trans	Manual		1			EM-2378 @
	V8 5.7L 350ci Diesel	1979-81	L & R Front	VIN Z	2	EM-2328			
	V8 6.2L 379ci Diesel	1988-93	L & R Front		2	EM-2621			
		1984-86	L & R Front		2	EM-2395			
		1982-83	L & R Front		2	EM-2292			
		1992-93	Trans	Auto; RWD		1			EM-2659 @
			Trans	Manual; RWD		1			EM-2659 @
		1991	Trans	Auto; THM700-R4/4L60 (MD8)		1			EM-2392
			Trans	Manual		1			EM-2392
		1989-90	Trans	Auto; THM400 (M40)		1			EM-2513
			Trans	Auto; THM700-R4/4L60 (MD8)		1			EM-2392
			Trans	Manual		1			EM-2392
		1988	Trans	Auto; THM400 (M40)		1			EM-2513
			Trans	Auto; THM700-R4/4L60 (MD8)		1			EM-2392
			Trans	Manual; 4 Spd		1			EM-2393
			Trans	Manual; 5 Spd		1			EM-2392
		1983-86	Trans	Auto; THM400 (M40)		1			EM-2515
			Trans	Auto; THM700-R4/4L60 (MD8)		1			EM-2393
			Trans	Manual		1			EM-2393
		1982	Trans	Auto; THM400 (M40)		1			EM-2515
			Trans	Auto; THM700-R4/4L60 (MD8)		1			EM-2392
			Trans	Manual		1			EM-2392
		V8 6.5L 395ci Diesel	1994-97	RH Front		1	EM-2621		
				Trans	Auto; 2WD	1			EM-2817
				Trans	Manual; 2WD	1			EM-2817
V8 6.6L 400ci		1978-80	L & R Front		2	EM-2292			
	1976	L & R Front		2	EM-2292				
		Trans - LH	Auto; THM400 (M40)	1			EM-2268 @		
	1978-80	Trans	Auto; THM350 (M38)		1			EM-2378 @	
		Trans	Auto; THM400 (M40)		1			EM-2268 @	
Trans	Manual		1			EM-2378 @			

@ = Universal Mount EM-5000 also available.



## Engine, Transmission, And Torque Strut Mounts

CYL	ENG. SIZE	YEAR	LOCATION	DESCRIPTION	QTY	ENGINE	TORQUE STRUT	TRANSMISSION	
<b>GMC TRUCK (continued)</b>									
<b>C15/C1500 PICKUP (continued)</b>									
V8	V8 6.6L 400ci	1976	Trans	Auto; THM350 (M38)	1			EM-2378 @	
			Trans	Manual	1			EM-2378 @	
	V8 6.6L 402ci	1970-72	L & R Front		2	EM-2283			
			Trans	Auto; THM350 (M38)	1			EM-2378 @	
			Trans	Auto; THM400 (M40)	1			EM-2268 @	
			Trans	Manual	1			EM-2378 @	
	V8 7.4L 454ci	1973-80	L & R Front		2	EM-2395			
			Trans	Auto; THM350 (M38)	1			EM-2378 @	
			Trans	Auto; THM400 (M40)	1			EM-2268 @	
			Trans	Manual	1			EM-2378 @	
<b>C25/C2500 PICKUP</b>									
L6	L6 3.8L 230ci	1966	L & R Front		2	EM-2282			
	L6 4.1L 250ci	1977-84	L & R Front		2	EM-2292			
		1973-75	L & R Front		2	EM-2292			
		1967-72	L & R Front		2	EM-2282			
		1982-84	Trans		1			EM-2392	
		1977-81	Trans	Auto; THM350 (M38)	1				EM-2378 @
				THM350C (MV4)					
			Trans	Auto; THM400 (M40)	1				EM-2268 @
			Trans	Manual	1				EM-2378 @
		1973-75	Trans	Auto; THM350 (M38)	1				EM-2378 @
				THM350C (MV4)					
			Trans	Auto; THM400 (M40)	1				EM-2268 @
			Trans	Manual	1				EM-2378 @
	1967-72	Trans		1				EM-2378 @	
	L6 4.8L 292ci	1973-81	L & R Front		2	EM-2292			
		1966-72	L & R Front		2	EM-2282			
		1982-86	LH Front		1	EM-2292			
		1986	Trans	Auto; THM350C (MV4) THM700-R4/4L60 (MD8)	1				EM-2392
			Trans	Auto; THM400 (M40)	1				EM-2513
			Trans	Manual	1				EM-2392
		1985	Trans	Auto; THM400 (M40)	1				EM-2513
			Trans	Auto; THM700R4 (MD8)	1				EM-2392
			Trans	Manual	1				EM-2392
		1983-84	Trans	Auto; THM350C (MV4) THM700-R4/4L60 (MD8)	1				EM-2392
			Trans	Auto; THM400 (M40)	1				EM-2513
			Trans	Manual	1				EM-2392
		1982	Trans	Auto; THM350C (MV4) THM700-R4/4L60 (MD8)	1				EM-2392
			Trans	Auto; THM400 (M40)	1				EM-2513
			Trans	Manual	1				EM-2378 @
1973-81		Trans	Auto; THM350 (M38)	1				EM-2378 @	
		Trans	Auto; THM400 (M40)	1				EM-2268 @	
	Trans	Manual	1				EM-2378 @		
1966-72	Trans		1				EM-2378 @		
V6	V6 4.3L 262ci	1988-95	L & R Front		2	EM-2436			
		1985-86	L & R Front		2	EM-2436			
		1991-95	Trans		1			EM-2394	
		1988-90	Trans	Auto; THM400 (M40)	1				EM-2510 @
			Trans	Auto; THM700-R4/4L60 (MD8)	1				EM-2394
			Trans	Manual	1				EM-2394
		1985-86	Trans		1			EM-2394	

@ = Universal Mount EM-5000 also available.

# Engine, Transmission, And Torque Strut Mounts

CYL	ENG. SIZE	YEAR	LOCATION	DESCRIPTION	QTY	ENGINE	TORQUE STRUT	TRANSMISSION		
<b>GMC TRUCK (continued)</b>										
<b>C25/C2500 PICKUP (continued)</b>										
V6	V6 5.0L 305ci	1967	Trans - L & R Lower		2			EM-2108		
			Trans - L & R Upper		2			EM-2107		
V8	V8 4.6L 283ci	1967	L & R Front	C-40 Thru C-85	2	EM-2309				
			Trans - L & R Lower	Manual Manual	2			EM-2108		
			Trans - L & R Upper	Manual Manual	2			EM-2107		
			Trans	Auto	1			EM-2378 @		
V8	V8 5.0L 305ci	1988-98	L & R Front		2	EM-2621				
		1977-86	L & R Front		2	EM-2292				
		1996-98	Trans		1			EM-2817		
		1992-95	Trans	Auto; RWD	1			EM-2659 @		
			Trans	Manual; RWD	1			EM-2659 @		
		1990-91	Trans		1			EM-2392		
		1988-89	Trans	Auto; THM400 (M40)	1			EM-2513		
			Trans	Auto; THM700-R4/4L60 (MD8)	1			EM-2392		
		1982-86	Trans	Manual	1			EM-2392		
			Trans	Auto; THM350C (MV4) THM700-R4/4L60 (MD8)	1			EM-2392		
		1977-81	Trans	Auto; THM400 (M40)	1			EM-2513		
			Trans	Manual	1			EM-2392		
		V8	V8 5.0L 307ci	1973	Trans	Auto; THM350 (M38)	1			EM-2378 @
					Trans	Auto; THM400 (M40)	1			EM-2268 @
Trans	Manual				1			EM-2378 @		
Trans	Auto; THM400 (M40)				1			EM-2268 @		
V8	V8 5.4L 327ci	1967-68	L & R Front		2	EM-2282				
			Trans	Auto; THM350 (M38)	1			EM-2378 @		
			Trans	Auto; THM400 (M40)	1			EM-2268 @		
V8	V8 5.7L 350ci	1988-00	L & R Front		2	EM-2621				
		1973-84	L & R Front		2	EM-2292				
		1969-72	L & R Front		2	EM-2282				
		1985-86	LH Front		1	EM-2292				
		1995-00	Trans	Auto; 2WD	1			EM-2817		
			Trans	Manual; 2WD	1			EM-2817		
		1992-94	Trans	Auto; RWD	1			EM-2659 @		
			Trans	Manual; RWD	1			EM-2659 @		
		1991	Trans	Auto; THM700-R4/4L60 (MD8)	1			EM-2392		
			Trans	Manual	1			EM-2392		
		1988-90	Trans	Auto; THM400 (M40)	1			EM-2513		
			Trans	Auto; THM700-R4/4L60 (MD8)	1			EM-2392		
			Trans	Manual	1			EM-2392		
		1986	Trans	Auto; THM350C (MV4) THM700-R4/4L60 (MD8)	1			EM-2392		
			Trans	Auto; THM400 (M40)	1			EM-2513		
			Trans	Manual	1			EM-2392		
		1985	Trans	Auto; THM400 (M40)	1			EM-2513		
			Trans	Auto; THM700-R4/4L60 (MD8)	1			EM-2392		

@ = Universal Mount EM-5000 also available.

## Engine, Transmission, And Torque Strut Mounts

CYL	ENG. SIZE	YEAR	LOCATION	DESCRIPTION	Q T Y	ENGINE	TORQUE STRUT	TRANS- MISSION	
<b>GMC TRUCK (continued)</b>									
<b>C25/C2500 PICKUP (continued)</b>									
V8	V8 5.7L 350ci	1985	Trans	Manual	1			EM-2392	
		1982-84	Trans	Auto; THM350C (MV4) THM700-R4/4L60 (MD8)	1			EM-2392	
			Trans	Auto; THM400 (M40)	1			EM-2513	
			Trans	Manual	1			EM-2392	
		1973-81	Trans	Auto; THM350 (M38)	1			EM-2378 @	
			Trans	Auto; THM400 (M40)	1			EM-2268 @	
			Trans	Manual	1			EM-2378 @	
	V8 6.2L 379ci Diesel	1988-93	L & R Front			2	EM-2621		
			L & R Front			2	EM-2395		
			L & R Front			2	EM-2292		
		1992-93	Trans	Auto; RWD	1				EM-2659 @
			Trans	Manual; RWD	1				EM-2659 @
		1991	Trans	Auto; 4L80E THM700-R4/4L60 (MD8)	1				EM-2392
			Trans	Manual	1				EM-2392
		1989-90	Trans	Auto; THM400 (M40)	1				EM-2515
			Trans	Auto; THM700-R4/4L60 (MD8)	1				EM-2392
			Trans	Manual	1				EM-2392
		1988	Trans	Auto; THM400 (M40)	1				EM-2515
			Trans	Auto; THM700-R4/4L60 (MD8)	1				EM-2392
			Trans	Manual; 4 Spd	1				EM-2393
			Trans	Manual; 5 Spd	1				EM-2392
		1983-86	Trans	Auto; THM400 (M40)	1				EM-2515
			Trans	Auto; THM700-R4/4L60 (MD8)	1				EM-2393
			Trans	Manual	1				EM-2393
		1982	Trans		1				EM-2392
		V8 6.5L 395ci Diesel	1992-00	L & R Front			2	EM-2621	
	Trans			Auto; 2WD	1				EM-2817
	1995-00		Trans	Manual; 2WD	1				EM-2817
			Trans	Auto; RWD	1				EM-2659 @
			Trans	Manual; RWD	1				EM-2659 @
	V8 6.6L 400ci	1976-79	L & R Front			2	EM-2292		
			Trans	Auto; THM350 (M38)	1				EM-2378 @
			Trans	Auto; THM400 (M40)	1				EM-2268 @
			Trans	Manual	1				EM-2378 @
	V8 6.6L 402ci	1970-72	L & R Front			2	EM-2283		
			Trans	Auto; THM350 (M38)	1				EM-2378 @
			Trans	Auto; THM400 (M40)	1				EM-2268 @
			Trans	Manual	1				EM-2378 @
	V8 7.4L 454ci	1991-00	L & R Front			2	EM-2621		
			L & R Front			2	EM-2395		
		1973-86	Trans	Auto; 2WD	1				EM-2817
			Trans	Manual; 2WD	1				EM-2817
		1992-95	Trans	Auto; RWD	1				EM-2659 @
			Trans	Manual; RWD	1				EM-2659 @
		1991	Trans		1				EM-2392
		1982-86	Trans	Auto; THM400 (M40)	1				EM-2513
			Trans	Auto; THM700-R4/4L60 (MD8)	1				EM-2392
Trans			Manual	1				EM-2392	
1973-81		Trans	Auto; THM350 (M38)	1				EM-2378 @	
		Trans	Auto; THM400 (M40)	1				EM-2268 @	
		Trans	Manual	1				EM-2378 @	

@ = Universal Mount EM-5000 also available.

# Engine, Transmission, And Torque Strut Mounts

CYL	ENG. SIZE	YEAR	LOCATION	DESCRIPTION	QTY	ENGINE	TORQUE STRUT	TRANSMISSION	
<b>GMC TRUCK (continued)</b>									
<b>C35/C3500 PICKUP</b>									
L6	L6 4.1L 250ci	1978-80	L & R Front		2	EM-2292			
		1973-75	L & R Front		2	EM-2292			
		1967-72	L & R Front		2	EM-2282			
		1978-80	Trans	Auto; THM350 (M38)		1			EM-2378 @
				THM350C (MV4)					
			Trans	Auto; THM400		1			EM-2268 @
		1973-75	Trans	Manual		1			EM-2378 @
			Trans	Auto; THM350 (M38)		1			EM-2378 @
				THM350C (MV4)					
			Trans	Auto; THM400		1			EM-2268 @
	1967-72	Trans	Manual		1			EM-2378 @	
		Trans			1			EM-2378 @	
		Trans			1			EM-2378 @	
	L6 4.8L 292ci	1973-86	L & R Front		2	EM-2292			
		1967-72	L & R Front		2	EM-2282			
		1983-86	Trans	Auto; THM400		1			EM-2513
			Trans	Auto; THM700-R4/4L60 (MD8)		1			EM-2392
			Trans	Manual		1			EM-2392
		1982	Trans	Auto; THM350C (MV4)		1			EM-2378 @
			Trans	Auto; THM400 (M40)		1			EM-2513
			Trans	Auto; THM700-R4/4L60 (MD8)		1			EM-2392
			Trans	Manual		1			EM-2378 @
		1973-81	Trans	Auto; THM350		1			EM-2378 @
			Trans	Auto; THM400		1			EM-2268 @
			Trans	Manual		1			EM-2378 @
		1967-72	Trans		1			EM-2378 @	
	V8	V8 4.6L 283ci	1967	L & R Front		2	EM-2282		
			Trans - L & R Lower	Manual		2			EM-2108
Trans - L & R Upper			Manual		2			EM-2107	
Trans			Auto		1			EM-2378 @	
V8 5.0L 305ci			1986	L & R Front		2	EM-2292		
		1978	L & R Front		2	EM-2292			
		1986	Trans	Auto; THM400		1			EM-2513
			Trans	Auto; THM700-R4/4L60 (MD8)		1			EM-2392
			Trans	Manual		1			EM-2392
		1978	Trans	Auto; THM350 (M38)		1			EM-2378 @
				THM350C (MV4)					
Trans			Auto; THM400		1			EM-2268 @	
Trans		Manual		1			EM-2378 @		
V8 5.0L 307ci		1973	L & R Front		2	EM-2292			
		1968-72	L & R Front		2	EM-2282			
		1968-73	Trans	Auto; THM350		1			EM-2378 @
			Trans	Auto; THM400		1			EM-2268 @
			Trans	Manual		1			EM-2378 @
V8 5.4L 327ci		1967-68	L & R Front		2	EM-2282			
		Trans	Auto; THM350		1			EM-2378 @	
		Trans	Auto; THM400		1			EM-2268 @	
		Trans	Manual		1			EM-2378 @	
		Trans			1			EM-2378 @	
V8 5.7L 350ci		1988-00	L & R Front		2	EM-2621			
		1973-83	L & R Front		2	EM-2292			
		1969-72	L & R Front		2	EM-2282			
		1984-86	LH Front		1	EM-2292			
		1994	Trans	C309, 2nd Design		1			EM-2817

@ = Universal Mount EM-5000 also available.

# Engine, Transmission, And Torque Strut Mounts

CYL	ENG. SIZE	YEAR	LOCATION	DESCRIPTION	QTY	ENGINE	TORQUE STRUT	TRANSMISSION	
<b>GMC TRUCK (continued)</b>									
<b>C35/C3500 PICKUP (continued)</b>									
V8	V8 5.7L 350ci	1994	Trans	C314 & C318, 15,000 GVW	1			EM-2638	
		1995-00	Trans	Auto; 2WD	1			EM-2817	
			Trans	Manual; 2WD	1			EM-2817	
		1994	Trans		1			EM-2659 @	
			Trans		1			EM-2659 @	
			Trans	C309, 1st Design	1			EM-2817	
		1992-93	Trans	Auto; RWD	1			EM-2659 @	
			Trans	Manual; RWD	1			EM-2659 @	
		1991	Trans	Auto; THM700-R4/4L60 (MD8)	1			EM-2392	
			Trans	Manual, C309	1			EM-2392	
			Trans	Manual, C310	1			EM-2360 @	
			Trans	Manual, C314 & C318	1			EM-2638	
		1988-90	Trans	Auto; THM400	1			EM-2513	
			Trans	Auto; THM700-R4/4L60 (MD8)	1			EM-2392	
			Trans	Manual, C309	1			EM-2392	
			Trans	Manual, C310	1			EM-2360 @	
		1986	Trans	Manual, C314 & C318	1			EM-2638	
			Trans	Auto; THM350C (MV4) THM700-R4/4L60 (MD8)	1			EM-2392	
			Trans	Auto; THM400 (M40)	1			EM-2513	
		1985	Trans	Manual	1			EM-2392	
			Trans	Auto; THM400 (M40)	1			EM-2513	
			Trans	Auto; THM700-R4/4L60 (MD8)	1			EM-2392	
		1982-84	Trans	Manual	1			EM-2392	
			Trans	Auto; THM350C (MV4) THM700-R4/4L60 (MD8)	1			EM-2392	
			Trans	Auto; THM400 (M40)	1			EM-2513	
		1973-81	Trans	Manual	1			EM-2392	
			Trans	Auto; THM350	1			EM-2378 @	
			Trans	Auto; THM400	1			EM-2268 @	
		V8 6.2L 379ci Diesel	1988-93	Trans	Manual	1			EM-2378 @
				L & R Front		2	EM-2621		
				L & R Front		2	EM-2395		
			1982-83	L & R Front		2	EM-2292		
				Trans	Auto; RWD	1			EM-2659 @
			1992-93	Trans	Manual; RWD	1			EM-2659 @
				Trans	Auto; RWD	1			EM-2659 @
			1991	Trans	Auto; 4L80E THM700-R4/4L60 (MD8)	1			EM-2392
	Trans			Manual	1			EM-2392	
	1988-90		Trans	Auto; THM400 (M40)	1			EM-2513	
			Trans	Auto; THM700-R4/4L60 (MD8)	1			EM-2392	
			Trans	Manual	1			EM-2392	
	1983-86		Trans	Auto; MD8	1			EM-2393	
			Trans	Auto; THM400	1			EM-2515	
			Trans	Manual	1			EM-2393	
	1982	Trans		1			EM-2393		
	V8 6.5L 395ci Diesel	1992-02	L & R Front		2	EM-2621			
			Trans	Auto; 2WD	1			EM-2817	
		1995-02	Trans	Manual; 2WD	1			EM-2817	
			Trans	Auto; RWD	1			EM-2659 @	
		1992-94	Trans	Manual; RWD	1			EM-2659 @	
	V8 6.6L 400ci	1976-79	L & R Front		2	EM-2292			
			Trans	Auto; THM350	1			EM-2378 @	
			Trans	Auto; THM400	1			EM-2268 @	
			Trans	Manual	1			EM-2378 @	

@ = Universal Mount EM-5000 also available.

# Engine, Transmission, And Torque Strut Mounts

CYL	ENG. SIZE	YEAR	LOCATION	DESCRIPTION	QTY	ENGINE	TORQUE STRUT	TRANSMISSION	
<b>GMC TRUCK (continued)</b>									
<b>C35/C3500 PICKUP (continued)</b>									
V8	V8 6.6L 402ci	1970-72	L & R Front		2	EM-2283			
			Trans	Auto; THM350	1			EM-2378 @	
			Trans	Auto; THM400	1			EM-2268 @	
			Trans	Manual	1			EM-2378 @	
	V8 7.4L 454ci	1988-00	1973-86	L & R Front		2	EM-2621		
				L & R Front		2	EM-2395		
		1996-00	Trans	Auto; 4L80E (MT1)	1			EM-2817	
			Trans	Manual, C310, C314 & C318	1			EM-2638	
			Trans	Manual, FleetSide	1			EM-2817	
		1992-95	Trans	Auto; RWD	1			EM-2659 @	
			Trans	Manual; RWD	1			EM-2659 @	
		1988-91	Trans		1			EM-2392	
		1982-86	Trans	Auto; THM400	1			EM-2513	
			Trans	Auto; THM700-R4/4L60 (MD8)	1			EM-2392	
			Trans	Manual	1			EM-2392	
		1973-81	Trans	Auto; THM350	1			EM-2378 @	
	Trans		Auto; THM400	1			EM-2268 @		
	V8 8.1L 496ci	2001-02	Trans	Auto; THM-R2 (MT1) 4L80E	1			EM-2817	
			Trans	Manual	1			EM-2817	
	<b>CABALLERO</b>								
V6	V6 3.3L 200ci	1978-79	LH Front		1	EM-2382			
			RH Front		1	EM-2384			
			Trans		1			EM-2353	
	V6 3.8L 229ci	1980-84	1983-84	L & R Front		2	EM-2436		
				Trans		1			EM-2360 @
		1982	Trans	Auto	1			EM-2379	
		1980-81	Trans	Auto	1			EM-2379	
			Trans	Manual	1			EM-2379	
	V6 3.8L 231ci	1978-84	1982-84	LH Front		1	EM-2382		
				RH Front		1	EM-2384		
		1978-81	Trans	Auto	1			EM-2379	
			Trans	Auto	1			EM-2379	
			Trans	Manual	1			EM-2379	
	V6 4.3L 262ci	1985-87	L & R Front		2	EM-2436			
			Trans	Auto	1			EM-2379	
V8	V8 4.4L 267ci	1980-82	L & R Front		2	EM-2292			
			1982	Trans	Auto	1			EM-2360 @
			1980-81	Trans	Auto	1			EM-2360 @
				Trans	Manual	1			EM-2360 @
	V8 5.0L 305ci	1978-87	1982-87	L & R Front		2	EM-2292		
				Trans		1			EM-2360 @
		1978-81	Trans	Auto	1			EM-2337	
			Trans	Manual	1			EM-2337	
	V8 5.7L 350ci	1978-79	L & R Front		2	EM-2292			
			Trans	Auto	1			EM-2378 @	
			Trans	Manual	1			EM-2378 @	
	V8 5.7L 350ci Diesel	1983-84	L & R Front		2	EM-2328			
Trans				1			EM-2360 @		
<b>CANYON</b>									
L4	L4 2.5L 153ci	2015-18	Right		1	EM-4238			
			Trans	Manual	1			EM-4196	
	L4 2.8L 169ci	2004-06	LH Front		1	EM-3121			
			RH Front		1	EM-3120			

@ = Universal Mount EM-5000 also available.

## Engine, Transmission, And Torque Strut Mounts

CYL	ENG. SIZE	YEAR	LOCATION	DESCRIPTION	QTY	ENGINE	TORQUE STRUT	TRANSMISSION	
<b>GMC TRUCK (continued)</b>									
<b>CANYON (continued)</b>									
L4	L4 2.8L 169ci	2006	Trans	4WD	1			EM-2638	
		2004-05	Trans	2WD	1			EM-3122	
			Trans	4WD	1			EM-2638	
	L4 2.8L 171 ci Diesel	2016-18	Right		1	EM-4238			
	L4 2.9L 178ci	2007-12	LH Front			1	EM-3121		
			RH Front			1	EM-3120		
			Trans	Auto; 2WD		1			EM-3122
			Trans	Auto; 4WD		1			EM-2638
			Trans	Manual; 2WD		1			EM-3122
			Trans	Manual; 4WD		1			EM-2638
L5	L5 3.5L 211ci	2004-06	LH Front		1	EM-3121			
			RH Front		1	EM-3120			
			Trans	Auto; 2WD		1			EM-3122
			Trans	Auto; 4WD		1			EM-2638
			Trans	Manual; 2WD		1			EM-3122
			Trans	Manual; 4WD		1			EM-2638
	L5 3.7L 223ci	2007-12	LH Front			1	EM-3121		
			RH Front			1	EM-3120		
			Trans	Auto; 2WD		1			EM-3122
			Trans	Auto; 4WD		1			EM-2638
Trans			Manual; 2WD		1			EM-3122	
		Trans	Manual; 4WD		1			EM-2638	
V6	V6 3.6L 217ci	2015-18	Left		1	EM-4237			
			Right		1	EM-4238			
			Trans	RWD, Auto		1			EM-4196
V8	V8 5.3L 325ci	2009-12	LH Front		1	EM-4231			
			RH Front		1	EM-4232			
			Trans	Auto		1			EM-3172
<b>K15/K1500 PICKUP</b>									
L6	L6 4.1L 250ci	1973-84	L & R Front		2	EM-2292			
		1967-72	L & R Front		2	EM-2282			
		1967-84	Trans - Lower	Auto		2			EM-2108
			Trans - Lower	Manual		2			EM-2108
			Trans - Upper	Auto		2			EM-2107
	L6 4.8L 292ci	1979-80	L & R Front		2	EM-2292			
			1975-76	L & R Front		2	EM-2292		
				1967	L & R Front		2	EM-2282	
		1979-80	Trans - L & R Lower		2				EM-2108
			1975-76	Trans - L & R Upper		2			EM-2107
				1967	Trans - L & R Upper		2		
		1979-80	Trans - Lower	Auto		2			EM-2108
			Trans - Lower	Manual		2			EM-2108
		1975-76	Trans - Lower	Auto		2			EM-2108
			Trans - Lower	Manual		2			EM-2108
		1979-80	Trans - Upper	Auto		2			EM-2107
1975-76	Trans - Upper		Auto		2			EM-2107	
V6	V6 4.3L 262ci	1988-95	L & R Front		2	EM-2436			
		1985-86	L & R Front		2	EM-2436			
		1998	Trans	Auto		1			EM-2638
			Trans	Manual		1			EM-2638
		1988-97	Trans	Auto		1			EM-2638
			Trans	Manual		1			EM-2638
		1985-86	Trans	Auto		1			EM-2638
			Trans	Manual		1			EM-2638
V8	V8 4.6L 283ci	1967	L & R Front		2	EM-2282			
			Trans - Lower	Auto		2			EM-2108

# Engine, Transmission, And Torque Strut Mounts

CYL	ENG. SIZE	YEAR	LOCATION	DESCRIPTION	QTY	ENGINE	TORQUE STRUT	TRANSMISSION
<b>GMC TRUCK (continued)</b>								
<b>K15/K1500 PICKUP (continued)</b>								
V8	V8 4.6L 283ci	1967	Trans - Lower	Manual	2			EM-2108
			Trans - Upper	Auto	2			EM-2107
	V8 5.0L 305ci	1988-99	L & R Front		2	EM-2637		
			1981-86	L & R Front		2	EM-2292	
		1977-79	L & R Front		2	EM-2292		
		1981-84	Trans - Lower	Auto	2			EM-2108
			Trans - Lower	Manual	2			EM-2108
		1977-79	Trans - Lower	Auto	2			EM-2108
			Trans - Lower	Manual	2			EM-2108
		1981-84	Trans - Upper	Auto	2			EM-2107
		1977-79	Trans - Upper	Auto	2			EM-2107
		1999	Trans	Auto	1			EM-2638
		1988-98	Trans	Auto	1			EM-2638
			Trans	Manual	1			EM-2638
	1985-86	Trans	Auto	1			EM-2638	
		Trans	Manual	1			EM-2638	
	V8 5.0L 307ci	1968-70	L & R Front		2	EM-2282		
			Trans - Lower	Auto	2			EM-2108
			Trans - Lower	Manual	2			EM-2108
			Trans - Upper	Auto	2			EM-2107
	V8 5.7L 350ci	1988-99	L & R Front		2	EM-2637		
		1973-86	L & R Front		2	EM-2292		
		1969-72	L & R Front		2	EM-2282		
		1969-84	Trans - Lower	Auto	2			EM-2108
			Trans - Lower	Manual	2			EM-2108
			Trans - Upper	Auto	2			EM-2107
		1999	Trans	Auto	1			EM-2638
		1988-98	Trans	Auto	1			EM-2638
			Trans	Manual	1			EM-2638
		1985-86	Trans	Auto	1			EM-2638
	Trans		Manual	1			EM-2638	
	V8 6.2L 379ci Diesel	1988-93	L & R Front		2	EM-2637		
		1984-86	L & R Front		2	EM-2395		
		1982-83	L & R Front		2	EM-2292		
		1982-84	Trans - Lower	Auto	2			EM-2108
			Trans - Lower	Manual	2			EM-2108
			Trans - Upper	Auto	2			EM-2107
		1988-93	Trans	Auto	1			EM-2638
			Trans	Manual	1			EM-2638
		1985-86	Trans	Auto	1			EM-2638
	Trans		Manual	1			EM-2638	
	V8 6.5L 395ci Diesel	1994-98	L & R Front		2	EM-2637		
			Trans	Auto	1			EM-2638
			Trans	Manual	1			EM-2638
	V8 6.6L 400ci	1975-80	L & R Front		2	EM-2292		
			Trans - Lower	Auto	2			EM-2108
			Trans - Lower	Manual	2			EM-2108
			Trans - Upper	Auto	2			EM-2107
	V8 7.4L 454ci	1979-80	L & R Front		2	EM-2395		
		1976	L & R Front		2	EM-2395		
		1979-80	Trans - Lower	Auto	2			EM-2108
			Trans - Lower	Manual	2			EM-2108
1976		Trans - Lower	Auto	2			EM-2108	
		Trans - Lower	Manual	2			EM-2108	
1979-80		Trans - Upper	Auto	2			EM-2107	
1976	Trans - Upper	Auto	2			EM-2107		



## Engine, Transmission, And Torque Strut Mounts

CYL	ENG. SIZE	YEAR	LOCATION	DESCRIPTION	Q T Y	ENGINE	TORQUE STRUT	TRANS- MISSION	
<b>GMC TRUCK (continued)</b>									
<b>K25/K2500 PICKUP</b>									
L6	L6 4.1L 250ci	1980	L & R Front		2	EM-2292			
		1978	L & R Front		2	EM-2292			
		1973-76	L & R Front		2	EM-2292			
		1967-72	L & R Front		2	EM-2282			
		1980	Trans - Lower	Auto		2			EM-2108
			Trans - Lower	Manual		2			EM-2108
		1978	Trans - Lower	Auto		2			EM-2108
			Trans - Lower	Manual		2			EM-2108
		1967-76	Trans - Lower	Auto		2			EM-2108
			Trans - Lower	Manual		2			EM-2108
	1980	Trans - Upper	Auto		2			EM-2107	
	1978	Trans - Upper	Auto		2			EM-2107	
	1967-76	Trans - Upper	Auto		2			EM-2107	
	L6 4.8L 292ci	1973-86	L & R Front		2	EM-2292			
		1970-72	L & R Front		2	EM-2282			
		1967	L & R Front		2	EM-2282			
		1970-84	Trans - Lower	Auto		2			EM-2108
			Trans - Lower	Manual		2			EM-2108
		1967	Trans - Lower	Auto		2			EM-2108
			Trans - Lower	Manual		2			EM-2108
1970-84		Trans - Upper	Auto		2		EM-2107		
1967		Trans - Upper	Auto		2		EM-2107		
1985-86		Trans	Auto		1			EM-2638	
Trans	Manual		1				EM-2638		
V6	V6 4.3L 262ci	1988-95	L & R Front		2	EM-2436			
		1985	L & R Front		2	EM-2436			
		1988-95	Trans	Auto		1			EM-2638
			Trans	Manual		1			EM-2638
		1985	Trans	Auto		1			EM-2638
			Trans	Manual		1			EM-2638
V8	V8 4.6L 283ci	1967	L & R Front		2	EM-2282			
			Trans - Lower	Auto		2		EM-2108	
			Trans - Lower	Manual		2		EM-2108	
			Trans - Upper	Auto		2		EM-2107	
	V8 5.0L 305ci	1998	L & R Front		2	EM-2637			
		1988-95	L & R Front		2	EM-2637			
		1977-78	L & R Front		2	EM-2292			
			Trans - Lower	Auto		2		EM-2108	
			Trans - Lower	Manual		2		EM-2108	
		1998	Trans - Upper	Auto		2		EM-2107	
			Trans	Auto		1		EM-2638	
		Trans	Manual		1		EM-2638		
	1988-95	Trans	Auto		1		EM-2638		
	Trans	Manual		1		EM-2638			
	V8 5.0L 307ci	1968-70	L & R Front		2	EM-2282			
			Trans - Lower	Auto		2		EM-2108	
			Trans - Lower	Manual		2		EM-2108	
			Trans - Upper	Auto		2		EM-2107	
	V8 5.7L 350ci	1988-00	L & R Front		2	EM-2637			
		1973-86	L & R Front		2	EM-2292			
1969-72		L & R Front		2	EM-2282				
1969-84		Trans - Lower	Auto		2		EM-2108		
		Trans - Lower	Manual		2		EM-2108		
		Trans - Upper	Auto		2		EM-2107		
1988-00		Trans	Auto		1		EM-2638		
		Trans	Manual		1		EM-2638		
1985-86	Trans	Auto		1		EM-2638			

# Engine, Transmission, And Torque Strut Mounts

CYL	ENG. SIZE	YEAR	LOCATION	DESCRIPTION	QTY	ENGINE	TORQUE STRUT	TRANSMISSION		
<b>GMC TRUCK (continued)</b>										
<b>K25/K2500 PICKUP (continued)</b>										
V8	V8 5.7L 350ci	1985-86	Trans	Manual	1			EM-2638		
	V8 6.2L 379ci Diesel	1988-93	L & R Front			2	EM-2637			
		1984-86	L & R Front			2	EM-2395			
		1982-83	L & R Front			2	EM-2292			
		1982-84	Trans - Lower	Auto			2			EM-2108
			Trans - Lower	Manual			2			EM-2108
			Trans - Upper	Auto			2			EM-2107
		1988-93	Trans	Auto			1			EM-2638
			Trans	Manual			1			EM-2638
		1985-86	Trans	Auto			1			EM-2638
			Trans	Manual			1			EM-2638
	V8 6.5L 395ci Diesel	1992-00	L & R Front			2	EM-2637			
			Trans	Auto		1			EM-2638	
			Trans	Manual		1			EM-2638	
	V8 6.6L 400ci	1975-80	L & R Front			2	EM-2292			
			Trans - Lower	Auto		2			EM-2108	
			Trans - Lower	Manual		2			EM-2108	
			Trans - Upper	Auto		2			EM-2107	
	V8 7.4L 454ci	1991-00	L & R Front			2	EM-2637			
		1976-78	L & R Front			2	EM-2395			
		1973-74	L & R Front			2	EM-2395			
		1976-78	Trans - Lower	Auto			2			EM-2108
			Trans - Lower	Manual			2			EM-2108
		1973-74	Trans - Lower	Auto			2			EM-2108
			Trans - Lower	Manual			2			EM-2108
		1976-78	Trans - Upper	Auto		2			EM-2107	
		1973-74	Trans - Upper	Auto		2			EM-2107	
1991-00		Trans	Auto		1			EM-2638		
Trans	Manual			1			EM-2638			
<b>K35/K3500 PICKUP</b>										
L6	L6 4.1L 250ci	1973-74	L & R Front		2	EM-2292				
		1968-72	L & R Front		2	EM-2282				
		1968-74	Trans - Lower	Auto		2			EM-2108	
			Trans - Lower	Manual		2			EM-2108	
			Trans - Upper	Auto		2			EM-2107	
	L6 4.8L 292ci	1977-86	L & R Front			2	EM-2292			
		1973-74	L & R Front			2	EM-2292			
		1968-72	L & R Front			2	EM-2282			
		1977-84	Trans - Lower	Auto			2			EM-2108
			Trans - Lower	Manual			2			EM-2108
		1968-74	Trans - Lower	Auto			2			EM-2108
			Trans - Lower	Manual			2			EM-2108
		1977-84	Trans - Upper	Auto		2			EM-2107	
		1968-74	Trans - Upper	Auto		2			EM-2107	
		1985-86	Trans	Auto			1			EM-2638
			Trans	Manual			1			EM-2638
		V8	V8 5.0L 307ci	1973	L & R Front		2	EM-2292		
1968-72	L & R Front				2	EM-2282				
1968-73	Trans - Lower			Auto		2			EM-2108	
	Trans - Lower			Manual		2			EM-2108	
	Trans - Upper			Auto		2			EM-2107	
V8 5.7L 350ci	1988-00		L & R Front			2	EM-2637			
	1977-86		L & R Front			2	EM-2292			
	1973-74		L & R Front			2	EM-2292			
	1969-72		L & R Front			2	EM-2282			
	1977-84		Trans - Lower	Auto			2			EM-2108
			Trans - Lower	Manual			2			EM-2108

## Engine, Transmission, And Torque Strut Mounts

CYL	ENG. SIZE	YEAR	LOCATION	DESCRIPTION	QTY	ENGINE	TORQUE STRUT	TRANSMISSION
<b>GMC TRUCK (continued)</b>								
<b>K35/K3500 PICKUP (continued)</b>								
V8	V8 5.7L 350ci	1969-74	Trans - Lower	Auto	2			EM-2108
			Trans - Lower	Manual	2			EM-2108
		1977-84	Trans - Upper	Auto	2			EM-2107
		1969-74	Trans - Upper	Auto	2			EM-2107
		1988-00	Trans	Auto	1			EM-2638
			Trans	Manual	1			EM-2638
		1985-86	Trans	Auto	1			EM-2638
			Trans	Manual	1			EM-2638
	V8 6.2L 379ci Diesel	1988-93	L & R Front		2	EM-2637		
			L & R Front		2	EM-2395		
		1984-86	L & R Front		2	EM-2292		
		1982-83	L & R Front		2	EM-2292		
			Trans - Lower	Auto	2			EM-2108
		1982-84	Trans - Lower	Manual	2			EM-2108
			Trans - Upper	Auto	2			EM-2107
		1988-93	Trans	Auto	1			EM-2638
			Trans	Manual	1			EM-2638
		1985-86	Trans	Auto	1			EM-2638
	Trans		Manual	1			EM-2638	
	V8 6.5L 395ci Diesel	1992-00	L & R Front		2	EM-2637		
			Trans	Auto	1			EM-2638
			Trans	Manual	1			EM-2638
	V8 6.6L 400ci	1977-80	L & R Front		2	EM-2292		
			Trans - Lower	Auto	2			EM-2108
			Trans - Lower	Manual	2			EM-2108
			Trans - Upper	Auto	2			EM-2107
	V8 7.4L 454ci	1988-00	L & R Front		2	EM-2637		
			L & R Front		2	EM-2395		
		1979-86	L & R Front		2	EM-2395		
			L & R Front		2	EM-2395		
		1973-74	Trans - Lower	Auto	2			EM-2108
			Trans - Lower	Manual	2			EM-2108
		1979-84	Trans - Lower	Auto	2			EM-2108
Trans - Lower			Manual	2			EM-2108	
1973-74		Trans - Lower	Auto	2			EM-2108	
		Trans - Lower	Manual	2			EM-2108	
1979-84		Trans - Upper	Auto	2			EM-2107	
		Trans - Upper	Auto	2			EM-2107	
1988-00	Trans	Auto	1			EM-2638		
	Trans	Manual	1			EM-2638		
1985-86	Trans	Auto	1			EM-2638		
	Trans	Manual	1			EM-2638		
<b>R1500 PICKUP</b>								
V6	V6 4.3L 262ci	1987	L & R Front		2	EM-2436		
			Trans	Auto; THM700-R4/4L60 (MD8)	1			EM-2394
			Trans	Manual	1			EM-2394
V8	V8 5.0L 305ci	1987	L & R Front		2	EM-2292		
			Trans	Auto	1			EM-2513
			Trans	Manual	1			EM-2392
	V8 5.7L 350ci	1987	L & R Front		2	EM-2292		
			Trans		1			EM-2392
	V8 6.2L 379ci Diesel	1987	L & R Front		2	EM-2395		
			Trans	Auto; THM400	1			EM-2515
Trans			Auto; THM700-R4/4L60 (MD8)	1			EM-2393	
Trans	Manual	1			EM-2393			
<b>R2500 PICKUP</b>								
L6	L6 4.8L 292ci	1987-88	L & R Front		2	EM-2292		
			Trans	Auto	1			EM-2513
			Trans	Manual	1			EM-2392
V6	V6 4.3L 262ci	1987	L & R Front		2	EM-2436		

# Engine, Transmission, And Torque Strut Mounts

CYL	ENG. SIZE	YEAR	LOCATION	DESCRIPTION	QTY	ENGINE	TORQUE STRUT	TRANSMISSION
<b>GMC TRUCK (continued)</b>								
<b>R2500 PICKUP (continued)</b>								
V6	V6 4.3L 262ci	1987	Trans	Auto; THM700-R4/4L60 (MD8)	1			EM-2394
			Trans	Manual	1			EM-2394
V8	V8 5.0L 305ci	1987	L & R Front		2	EM-2292		
			Trans	Auto	1			EM-2513
			Trans	Manual	1			EM-2392
			Trans	Manual	1			EM-2392
	V8 5.7L 350ci	1988-89	L & R Front		2	EM-2621		
			Trans	Auto; THM400 (M40)	1			EM-2513
		1987	L & R Front		2	EM-2292		
			Trans	Auto; THM700-R4/4L60 (MD8)	1			EM-2392
		1988-89	Trans	Manual, FleetSide 164.5WB	1			EM-2392
			Trans	Auto; THM180C (MD2)	1			EM-2392
			Trans	Auto; THM700-R4/4L60 (MD8)	1			EM-2513
			Trans	Manual, FleetSide; 131.5WB	1			EM-2360 @
	1987	Trans	Manual; StepSide; 164.5WB	1			EM-2392	
		Trans	Auto; THM400 (M40)	1			EM-2513	
		Trans	Manual, FleetSide; 131.5WB	1			EM-2360 @	
V8 6.2L 379ci Diesel	1987-89	L & R Front		2	EM-2395			
		Trans	Auto; THM400	1			EM-2515	
		Trans	Auto; THM700-R4/4L60 (MD8)	1			EM-2393	
		Trans	Manual	1			EM-2393	
V8 7.4L 454ci	1987-89	L & R Front		2	EM-2395			
		Trans	Auto; THM400	1			EM-2513	
		Trans	Auto; THM700-R4/4L60 (MD8)	1			EM-2392	
		Trans	Manual	1			EM-2392	
<b>R3500 PICKUP</b>								
L6	L6 4.8L 292ci	1987-88	L & R Front		2	EM-2292		
			Trans	Auto	1			EM-2513
			Trans	Manual	1			EM-2392
V8	V8 5.7L 350ci	1987-91	L & R Front		2	EM-2292		
			Trans		1			EM-2392
	V8 6.2L 379ci Diesel	1987-91	L & R Front		2	EM-2395		
			Trans	Auto; THM700-R4/4L60 (MD8)	1			EM-2393
			Trans	Manual	1			EM-2393
	V8 7.4L 454ci	1987-91	L & R Front		2	EM-2395		
Trans			Auto	1			EM-2513	
Trans			Manual	1			EM-2392	
<b>S15 PICKUP</b>								
L4	L4 1.9L 119ci	1982-85	L & R Front		2	EM-2381		
		1984-85	Trans	Auto; 2WD	1			EM-2531
			Trans	Auto; 4WD	1			EM-2638
			Trans	Manual; 2WD	1			EM-2531
			Trans	Manual; 4WD	1			EM-2638
		1983	Trans	Auto; 2WD	1			EM-2771
			Trans	Auto; 4WD	1			EM-2638
			Trans	Manual; 2WD	1			EM-2771
			Trans	Manual; 4WD	1			EM-2638
		1982	Trans	Auto; 2WD	1			EM-2771
			Trans	Manual; 2WD	1			EM-2771
		L4 2.0L 122ci	1983-84	LH Front		1	EM-2755	
	RH Front				1	EM-2756		
	1984		Trans	Auto; 2WD	1			EM-2531
			Trans	Auto; 4WD	1			EM-2638
			Trans	Manual; 2WD	1			EM-2531
			Trans	Manual; 4WD	1			EM-2638
	1983		Trans	Auto; 2WD	1			EM-2772
			Trans	Auto; 4WD	1			EM-2638
	Trans	Manual; 2WD	1			EM-2772		

@ = Universal Mount EM-5000 also available.

# Engine, Transmission, And Torque Strut Mounts

CYL	ENG. SIZE	YEAR	LOCATION	DESCRIPTION	QTY	ENGINE	TORQUE STRUT	TRANSMISSION		
<b>GMC TRUCK (continued)</b>										
<b>S15 PICKUP (continued)</b>										
L4	L4 2.0L 122ci	1983	Trans	Manual; 4WD	1			EM-2638		
	L4 2.2L 134ci Diesel	1984-85	LH Front		1	EM-2549				
			RH Front		1	EM-2550				
			Trans	Auto; 2WD	1			EM-2531		
			Trans	Manual; 2WD	1			EM-2531		
	L4 2.5L 2474cc	1985-90	LH Front		1	EM-2549				
			RH Front		1	EM-2550				
		1988-90	Trans	Auto; 2WD	1			EM-2508		
			Trans	Manual; 2WD	1			EM-2508		
		1985-87	Trans	Auto; 2WD	1			EM-2531		
			Trans	Manual; 2WD	1			EM-2531		
		V6	V6 2.8L 173ci	1982-90	L & R Front		2	EM-2436		
				1983	Trans	Manual; 4WD	1			EM-2638
	1988-90			Trans	Auto; 2WD	1			EM-2508	
Trans				Auto; 4WD	1			EM-2638		
Trans				Manual; 2WD	1			EM-2508		
Trans				Manual; 4WD	1			EM-2638		
Trans				Auto; 2WD	1			EM-2531		
1984-87	Trans			Auto; 4WD	1			EM-2638		
	Trans			Manual; 2WD	1			EM-2531		
	Trans			Manual; 4WD	1			EM-2638		
	Trans			Auto; 4WD	1			EM-2638		
1983	Trans			2WD	1			EM-2772		
	Trans			Auto; 4WD	1			EM-2638		
1982	Trans			Auto; 2WD	1			EM-2771		
	Trans		Manual; 2WD	1			EM-2771			
V6 4.3L 262ci	1988-90		L & R Front		2	EM-2627				
			Trans	Auto; 2WD	1			EM-2508		
			Trans	Auto; 4WD	1			EM-2638		
		Trans	Manual; 2WD	1			EM-2508			
		Trans	Manual; 4WD	1			EM-2638			
<b>SIERRA 1500</b>										
V6	V6 4.3L 262ci	2007-13	L & R Front		2	EM-4073				
		1999-06	L & R Front		2	EM-2994				
		2014-16	LH Front		1	EM-4173				
			RH Front		1	EM-4174				
		2008-09	Trans	4WD	1			EM-2638		
			Trans	RWD	1			EM-2811		
		2007	Trans	Classic SL and Classic WT, 4WD	1			EM-2638		
			Trans	Classic SL and Classic WT, RWD	1			EM-2811		
			Trans	WT, 4WD	1			EM-2638		
		1999-06	Trans	4WD	1			EM-2638		
			Trans	RWD	1			EM-2811		
V8	V8 4.8L 294ci	2007	L & R Front	Classic Body Style	2	EM-2909#				
		1999-06	L & R Front		2	EM-2909#				
		2008-13	LH Front		1	EM-4000				
		2007	LH Front	New Body Style	1	EM-4000				
		2008-13	RH Front		1	EM-4017				
		2007	RH Front	New Body Style	1	EM-4017				
		2007-12	Trans	4WD	1			EM-3172		
			Trans	RWD	1			EM-2811		
		1999-06	Trans	4WD	1			EM-2638		
			Trans	RWD	1			EM-2811		
		V8 5.3L 325ci	2008-13	L & R Front		2	EM-5583#			

# = Available in the Westar Gold Line

# Engine, Transmission, And Torque Strut Mounts

CYL	ENG. SIZE	YEAR	LOCATION	DESCRIPTION	QTY	ENGINE	TORQUE STRUT	TRANSMISSION
<b>GMC TRUCK (continued)</b>								
<b>SIERRA 1500 (continued)</b>								
V8	V8 5.3L 325ci	2007	L & R Front	Gas; New Body Style	2	EM-5583#		
			L & R Front	Gas; Old Body Style	2	EM-2909#		
		2006	L & R Front		2	EM-2909#		
		1999-05	L & R Front		2	EM-2909#		
		2014-16	LH Front		1	EM-4173		
			RH Front		1	EM-4174		
		2006-14	Trans	4WD	1			EM-2638
			Trans	RWD	1			EM-2811
	1999-05	Trans	4WD	1			EM-2638	
		Trans	RWD	1			EM-2811	
	V8 6.0L 364ci	2008-12	L & R Front		2	EM-5583#		
		2007	L & R Front	New Body Style	2	EM-5583#		
			L & R Front	Old Body Style	2	EM-2909#		
		2002-06	L & R Front		2	EM-2909#		
		2005-13	Trans	4WD	1			EM-2638
			Trans	RWD	1			EM-2811
	2002-04	Trans	AWD	1			EM-2638	
	V8 6.2L 376ci	2007-13	L & R Front		2	EM-5583#		
		2014-16	LH Front		1	EM-4173		
			RH Front		1	EM-4174		
2009-14		Trans	4WD	1			EM-2638	
		Trans	RWD	1			EM-2811	
2007-08		Trans	AWD	1			EM-2638	
	Trans	RWD	1			EM-2811		
<b>SIERRA 1500 HD</b>								
V8	V8 6.0L 364ci	2005-06	L & R Front		2	EM-2909#		
		2001-03	L & R Front		2	EM-2909#		
		2005-06	Trans	2WD	1			EM-2811
			Trans	4WD	1			EM-2638
		2001-03	Trans	2WD	1			EM-2811
			Trans	4WD	1			EM-2638
<b>SIERRA 2500</b>								
V8	V8 5.3L 325ci	1999-00	L & R Front		2	EM-2909#		
			Trans	2WD	1		EM-2811	
			Trans	4WD	1		EM-2638	
	V8 6.0L 364ci	1999-04	L & R Front	w/Heat Shield	2	EM-5423		
			L & R Front	w/o Heat Shield	2	EM-2909#		
			Trans	2WD	1		EM-2811	
Trans	4WD	1		EM-2638				
<b>SIERRA 2500 HD</b>								
V8	V8 6.0L 364ci	2011-16	L & R Front		2	EM-4163		
		2008-10	L & R Front		2	EM-5583#		
		2001-07	L & R Front	w/Heat Shield	2	EM-5423		
			L & R Front	w/o Heat Shield	2	EM-2909#		
		2011-16	Trans	Auto; RWD	1			EM-4156
		2001-06	Trans	4WD	1			EM-2638
			Trans	RWD	1			EM-2811
		V8 6.6L 400ci Diesel	2011-16	LH Front		1	EM-4249	
	2001-10		Left	Complete Unit	1	EM-5582		
			Left	w/o Heat Shield	1	EM-3102		
	2011-16		RH Front		1	EM-4249		
	2001-10	Right		1	EM-3102			
2011-16	Trans	Auto; 4WD	1			EM-4159		

# = Available in the Westar Gold Line

# Engine, Transmission, And Torque Strut Mounts

CYL	ENG. SIZE	YEAR	LOCATION	DESCRIPTION	QTY	ENGINE	TORQUE STRUT	TRANSMISSION	
<b>GMC TRUCK (continued)</b>									
<b>SIERRA 2500 HD (continued)</b>									
V8	V8 6.6L 400ci Diesel	2011-16	Trans	Auto; RWD	1			EM-4156	
		2007-10	Trans	GM Transmission	1			EM-2839	
		2001-06	Trans		1			EM-2839	
	V8 8.1L 496ci	2001-06	L & R Front		2	EM-5353			
			Trans		1			EM-2839	
<b>SIERRA 3500</b>									
V8	V8 6.0L 364ci	2001-07	L & R Front	w/Heat Shield	2	EM-5423			
			L & R Front	w/o Heat Shield	2	EM-2909#			
		2004-07	Trans	4WD	1			EM-2638	
			2001-03	Trans	2WD	1		EM-2811	
	V8 6.6L 400ci Diesel	2001-06	LH Front		1	EM-3102			
			RH Front	Complete Unit	1	EM-5582			
			RH Front	w/o Heat Shield	1	EM-3102			
			Trans		1			EM-2839	
	V8 8.1L 496ci	2001-07	L & R Front		2	EM-5353			
			Trans		1			EM-2839	
	<b>SIERRA 3500 HD</b>								
	V8	V8 6.0L 364ci	2011-16	L & R Front		2	EM-4163		
2007-10			L & R Front		2	EM-5583#			
2011-16			Trans	Auto; RWD	1			EM-4156	
V8 6.6L 400ci Diesel		2011-16	LH Front		1	EM-4249			
			LH Front		1	EM-3102			
			RH Front		1	EM-4249			
			RH Front	Complete Unit	1	EM-5582			
			RH Front	w/o Heat Shield	1	EM-3102			
			Trans	Auto; 4WD	1			EM-4159	
2007-10		Trans	Auto; RWD	1			EM-4156		
		2007-10	Trans	GM Transmission	1			EM-2839	
		<b>SIERRA C3</b>							
V8	V8 6.0L 364ci	2001	L & R Front		2	EM-2909#			
			Trans	AWD	1			EM-2638	
<b>SONOMA</b>									
L4	L4 2.2L 134ci	1994-03	L & R Front	Insert	2	EM-2819			
			LH Front	Complete Unit	1	EM-5426			
			RH Front	Complete Unit	1	EM-5350			
		1998-03	Trans	Auto	1			EM-2957	
			Trans	Manual	1			EM-2957	
		1994-97	Trans	Auto	1			EM-2957	
	Trans		Manual	1			EM-2956		
	L4 2.5L 2474cc	1991-93	LH Front		1	EM-2549			
			RH Front		1	EM-2550			
			Trans	Auto; 2WD	1			EM-2508	
			Trans	Manual; 2WD	1			EM-2508	
	V6	V6 2.8L 173ci	1991-93	L & R Front		2	EM-2436		
Trans				Auto; 2WD	1			EM-2508	
Trans				Auto; 4WD	1			EM-2638	
Trans				Manual; 2WD	1			EM-2508	
Trans				Manual; 4WD	1			EM-2638	
V6 4.3L 262ci		1996-04	L & R Front		2	EM-2802			
			1991-95	L & R Front		2	EM-2627		
		2004	Trans	Auto	1			EM-2638	
		1995-03	Trans	Auto; 4WD	1			EM-2638	
			Trans	Auto; RWD	1			EM-2394	
Trans	Manual; 4WD	1			EM-2638				

# = Available in the Westar Gold Line

# Engine, Transmission, And Torque Strut Mounts

CYL	ENG. SIZE	YEAR	LOCATION	DESCRIPTION	QTY	ENGINE	TORQUE STRUT	TRANSMISSION	
<b>GMC TRUCK (continued)</b>									
<b>SONOMA (continued)</b>									
V6	V6 4.3L 262ci	1995-03	Trans	Manual; RWD	1			EM-2394	
		1991-94	Trans	Auto; 2WD	1			EM-2508	
			Trans	Auto; 4WD	1			EM-2638	
			Trans	Manual; 2WD	1			EM-2508	
			Trans	Manual; 4WD	1			EM-2638	
<b>SPRINT</b>									
L6	L6 4.1L 250ci	1975-77	L & R Front		2	EM-2284			
		1971-72	L & R Front		2	EM-2284			
		1975-77	Trans		1			EM-2378 @	
		1971-72	Trans		1			EM-2378 @	
V8	V8 5.0L 305ci	1976-77	L & R Front		2	EM-2292			
			Trans		1		EM-2513		
	V8 5.7L 350ci	1973-77	1973-77	L & R Front		2	EM-2292		
				1971-72	L & R Front		2	EM-2282	
			1976-77	Trans	Auto	1			EM-2378 @
				Trans	Manual	1			EM-2378 @
				Trans	Auto; THM350	1			EM-2378 @
				Trans	Auto; THM400	1			EM-2268 @
	V8 6.6L 400ci	1976	L & R Front		2	EM-2292			
			Trans		1			EM-2378 @	
V8 7.4L 454ci	1973-75	1973-75	L & R Front		2	EM-2395			
			1971-72	L & R Front		2	EM-2283		
		1973-75	Trans		1			EM-2360 @	
			1971-72	Trans		1			EM-2294
<b>SYCLONE</b>									
V6	V6 4.3L 262ci	1991	L & R Front		2	EM-2627			
			Trans	AWD	1			EM-2638	
<b>V1500 PICKUP</b>									
V6	V6 4.3L 262ci	1987	L & R Front		2	EM-2436			
			Trans	Auto	1			EM-2638	
			Trans	Manual	1			EM-2638	
V8	V8 5.0L 305ci	1987	L & R Front		2	EM-2292			
			Trans	Auto	1			EM-2638	
			Trans	Manual	1			EM-2638	
	V8 5.7L 350ci	1987	L & R Front		2	EM-2292			
			Trans	Auto	1			EM-2638	
			Trans	Manual	1			EM-2638	
V8 6.2L 379ci Diesel	1987	L & R Front		2	EM-2395				
		Trans	Auto	1			EM-2638		
		Trans	Manual	1			EM-2638		
<b>V2500 PICKUP</b>									
L6	L6 4.8L 292ci	1987	L & R Front		2	EM-2292			
			Trans	Auto	1			EM-2638	
			Trans	Manual	1			EM-2638	
V8	V8 5.7L 350ci	1987	L & R Front		2	EM-2292			
			Trans	Auto	1			EM-2638	
			Trans	Manual	1			EM-2638	
	V8 6.2L 379ci Diesel	1987	L & R Front		2	EM-2395			
			Trans	Auto	1			EM-2638	
			Trans	Manual	1			EM-2638	

@ = Universal Mount EM-5000 also available.



# Engine, Transmission, And Torque Strut Mounts

CYL	ENG. SIZE	YEAR	LOCATION	DESCRIPTION	QTY	ENGINE	TORQUE STRUT	TRANSMISSION
<b>GMC TRUCK (continued)</b>								
<b>V3500 PICKUP</b>								
L6	L6 4.8L 292ci	1987-88	L & R Front		2	EM-2292		
			Trans	Auto	1			EM-2638
			Trans	Manual	1			EM-2638
V8	V8 5.7L 350ci	1987-91	L & R Front		2	EM-2292		
			Trans	Auto	1			EM-2638
			Trans	Manual	1			EM-2638
	V8 6.2L 379ci Diesel	1987-91	L & R Front		2	EM-2395		
			Trans	Auto	1			EM-2638
			Trans	Manual	1			EM-2638
V8 7.4L 454ci	1987-91	L & R Front		2	EM-2395			
		Trans	Auto	1			EM-2513	
		Trans	Manual	1			EM-2392	
<b>GMC VAN</b>								
<b>G1000 SERIES</b>								
L6	L6 3.2L 194ci	1966	L & R Front		2	EM-2282		
			L & R Rear Lower	Manual	2	EM-2108		
			L & R Rear Upper	Manual	2	EM-2107		
<b>G15/G1500 VAN</b>								
L6	L6 4.1L 250ci	1971-84	L & R Front		2	EM-2292		
		1967-70	L & R Front		2	EM-2282		
		1983-84	Trans	Auto; THM400 (M40)	1			EM-2515
			Trans	Auto; THM700-R4/4L60 (MD8)	1			EM-2393
			Trans	Manual	1			EM-2393
		1982	Trans	Auto; THM350 (M38)	1			EM-2378 @
			Trans	THM350C (MV4)				
			Trans	Auto; THM400 (M40)	1			EM-2268 @
		1977-81	Trans	Manual	1			EM-2378 @
			Trans	Auto; THM350 (M38)	1			EM-2378 @
			Trans	Auto; THM400 (M40)	1			EM-2268 @
		1975-76	Trans	Manual	1			EM-2378 @
			Trans	Auto; THM350 (M38)	1			EM-2378 @
		1971-74	Trans	Auto	1			EM-2378 @
			Trans	Manual	1			EM-2378 @
		1967-70	Trans	Auto	1			EM-2378 @
			Trans	Manual	1			EM-2378 @
		V6	V6 4.3L 262ci	1997-98	L & R Front		2	EM-2621
1985-96	L & R Front				2	EM-2436		
1997-98	Trans				1			EM-2817
1996	Trans				1			EM-2816
1991-95	Trans				1			EM-2811
1990	Trans			Auto; THM400	1			EM-2515
	Trans			Auto; THM700-R4/4L60 (MD8)	1			EM-2394
1985-89	Trans			Auto; THM400	1			EM-2515
	Trans			Auto; THM700-R4/4L60 (MD8)	1			EM-2508
	Trans			Manual	1			EM-2508
V8	V8 5.0L 305ci			1996-98	L & R Front		2	EM-2621
		1977-95	L & R Front		2	EM-2292		
		1991-98	Trans		1			EM-2816
		1983-90	Trans	Auto; THM400	1			EM-2515
			Trans	Auto; THM700-R4/4L60 (MD8)	1			EM-2393
Trans	Manual	1			EM-2393			

@ = Universal Mount EM-5000 also available.

# Engine, Transmission, And Torque Strut Mounts

CYL	ENG. SIZE	YEAR	LOCATION	DESCRIPTION	QTY	ENGINE	TORQUE STRUT	TRANSMISSION		
<b>GMC VAN (continued)</b>										
<b>G15/G1500 VAN (continued)</b>										
V8	V8 5.0L 305ci	1977-82	Trans	Auto; THM350 (M38)	1			EM-2378 @		
				THM350C (MV4)						
			Trans	Auto; THM400	1			EM-2268 @		
			Trans	Manual	1			EM-2378 @		
V8	V8 5.0L 307ci	1972-73	L & R Front		2	EM-2292				
			1968-71	L & R Front		2	EM-2282			
		1968-73	Trans	Auto; THM350	1			EM-2378 @		
			Trans	Auto; THM400	1			EM-2268 @		
			Trans	Manual	1			EM-2378 @		
V8	V8 5.7L 350ci	1996-98	L & R Front		2	EM-2621				
			1971-93	L & R Front		2	EM-2292			
		1993	Trans	Auto, 4L60E (M30)	1			EM-2816		
			Trans	Auto; THM700-R4/4L60 (MD8)	1			EM-2817		
		1992	Trans	Auto; THM700-R4/4L60 (MD8)	1			EM-2817		
			Trans	Auto; THM-R2 (MT1)	1			EM-2816		
		1990	Trans	Auto; THM400 (M40)	1			EM-2515		
			Trans	Auto; THM700-R4/4L60 (MD8)	1			EM-2394		
		1987-89	Trans	Auto; THM400 (M40)	1			EM-2515		
			Trans	Auto; THM700-R4/4L60 (MD8)	1			EM-2393		
			Trans	Manual	1			EM-2393		
		1986	Trans	Auto; THM350C (MV4) THM700-R4/4L60 (MD8)	1			EM-2393		
			Trans	Auto; THM400 (M40)	1			EM-2515		
			Trans	Manual	1			EM-2393		
		1985	Trans	Auto; THM400-475 (M40)	1			EM-2515		
			Trans	Auto; THM700-R4/4L60 (MD8)	1			EM-2393		
			Trans	Manual	1			EM-2393		
		1984	Trans	Auto; THM350C (MV4)	1			EM-2393		
			Trans	Auto; THM400 (M40)	1			EM-2515		
			Trans	Auto; THM700-R4/4L60 (MD8)	1			EM-2393		
			Trans	Manual	1			EM-2393		
		1983	Trans	Auto; THM400 (M40)	1			EM-2515		
			Trans	Auto; THM700-R4/4L60 (MD8)	1			EM-2393		
			Trans	Manual	1			EM-2393		
		1982	Trans	Auto; THM350C (MV4)	1			EM-2378 @		
			Trans	Auto; THM400 (M40)	1			EM-2268 @		
			Trans	Manual	1			EM-2378 @		
		1979-81	Trans	Auto; THM350 (M38)	1			EM-2378 @		
			Trans	Auto; THM400 (M40)	1			EM-2268 @		
			Trans	Manual	1			EM-2378 @		
		1971-78	Trans	Auto	1			EM-2378 @		
			Trans	Manual	1			EM-2378 @		
		V8	V8 6.6L 400ci	1979	L & R Front		2	EM-2292		
					1976	L & R Front		2	EM-2292	
				1979	Trans	Auto; THM350	1			EM-2378 @
					Trans	Auto; THM400	1			EM-2268 @
					Trans	Manual	1			EM-2378 @
				1976	Trans	Auto	1			EM-2378 @
		Trans	Manual		1			EM-2378 @		
		<b>G25/G2500 VAN</b>								
L6	L6 4.1L 250ci	1978-84	L & R Front		2	EM-2292				
			1971-74	L & R Front		2	EM-2292			
		1967-70	L & R Front		2	EM-2282				
			1983-84	Trans	Auto; THM400	1			EM-2515	

@ = Universal Mount EM-5000 also available.

# Engine, Transmission, And Torque Strut Mounts

CYL	ENG. SIZE	YEAR	LOCATION	DESCRIPTION	QTY	ENGINE	TORQUE STRUT	TRANSMISSION	
<b>GMC VAN (continued)</b>									
<b>G25/G2500 VAN (continued)</b>									
L6	L6 4.1L 250ci	1983-84	Trans	Auto; THM700-R4/4L60 (MD8)	1			EM-2393	
			Trans	Manual	1			EM-2393	
		1982	Trans	Auto; THM350C (MV4)	1			EM-2378 @	
			Trans	Auto; THM400 (M40)	1			EM-2268 @	
			Trans	Manual	1			EM-2378 @	
		1978-81	Trans	Auto; THM350 (M38)	1			EM-2378 @	
			Trans	Auto; THM400 (M40)	1			EM-2268 @	
			Trans	Manual	1			EM-2378 @	
		1971-74	Trans	Auto; THM350	1			EM-2378 @	
			Trans	Auto; THM400	1			EM-2268 @	
			Trans	Manual	1			EM-2378 @	
		1967-70	Trans		1			EM-2378 @	
	L6 4.8L 292ci		1974-78	L & R Front		2	EM-2292		
				Trans	Auto	1			EM-2373
		Trans		Manual	1			EM-2268 @	
V6	V6 4.3L 262ci	1998	L & R Front		2	EM-2621			
		1985-95	L & R Front		2	EM-2436			
		1998	Trans		1			EM-2817	
		1991-95	Trans		1			EM-2817	
		1990	Trans	Auto; THM400	1			EM-2515	
			Trans	Auto; THM700-R4/4L60 (MD8)	1			EM-2394	
		1985-89	Trans	Auto; THM400	1			EM-2515	
			Trans	Auto; THM700-R4/4L60 (MD8)	1			EM-2508	
		Trans	Manual	1			EM-2508		
V8	V8 5.0L 305ci	1996-98	L & R Front		2	EM-2621			
		1977-95	L & R Front		2	EM-2292			
		1991-98	Trans		1			EM-2816	
		1983-90	Trans	Auto; THM400	1			EM-2515	
			Trans	Auto; THM700-R4/4L60 (MD8)	1			EM-2393	
		Trans	Manual	1			EM-2393		
		1977-82	Trans	Auto; THM350 (M38)	1			EM-2378 @	
			Trans	THM350C (MV4)					
			Trans	Auto; THM400	1			EM-2268 @	
		Trans	Manual	1			EM-2378 @		
	V8 5.0L 307ci	1972-73	L & R Front		2	EM-2292			
		1968-71	L & R Front		2	EM-2282			
		1968-73	Trans	Auto; THM350	1			EM-2378 @	
			Trans	Auto; THM400	1			EM-2268 @	
	Trans	Manual	1			EM-2378 @			
	V8 5.7L 350ci	1996-98	L & R Front		2	EM-2621			
		1970-95	L & R Front		2	EM-2292			
		1993-95	Trans	Auto, 4L60E (M30)	1			EM-2816	
		1991-92	Trans	Auto; THM700-R4/4L60 (MD8)	1			EM-2817	
		1983-90	Trans	Auto; THM400	1			EM-2515	
			Trans	Auto; THM700-R4/4L60 (MD8)	1			EM-2393	
Trans			Manual	1			EM-2393		
1982		Trans	Auto; THM350C (MV4)	1			EM-2378 @		
		Trans	Auto; THM400 (M40)	1			EM-2268 @		
		Trans	Manual	1			EM-2378 @		
1979-81		Trans	Auto; THM350 (M38)	1			EM-2378 @		
		Trans	Auto; THM400 (M40)	1			EM-2268 @		
		Trans	Manual	1			EM-2378 @		
1970-78		Trans		1			EM-2378 @		
V8 6.2L 379ci Diesel		1983-93	L & R Front		2	EM-2292			

@ = Universal Mount EM-5000 also available.

# Engine, Transmission, And Torque Strut Mounts

CYL	ENG. SIZE	YEAR	LOCATION	DESCRIPTION	QTY	ENGINE	TORQUE STRUT	TRANSMISSION
<b>GMC VAN (continued)</b>								
<b>G25/G2500 VAN (continued)</b>								
V8	V8 6.2L 379ci Diesel	1992-93	Trans		1			EM-2817
		1990-91	Trans	Auto; THM700-R4/4L60 (MD8)	1			EM-2394
		1983-89	Trans	Auto; THM400	1			EM-2515
			Trans	Auto; THM700-R4/4L60 (MD8)	1			EM-2393
			Trans	Manual	1			EM-2393
	V8 6.5L 395ci Diesel	1997-98	L & R Front		2	EM-2621		
		1994-96	L & R Front		2	EM-2292		
		1994-98	Trans		1			EM-2816
	V8 6.6L 400ci	1975-80	L & R Front		2	EM-2292		
			Trans	Auto; THM350	1			EM-2378 @
			Trans	Auto; THM400	1			EM-2268 @
			Trans	Manual	1			EM-2378 @
	<b>G35/G3500 VAN</b>							
L6	L6 4.1L 250ci	1982-84	L & R Front		2	EM-2292		
		1978-79	L & R Front		2	EM-2292		
		1971-74	L & R Front		2	EM-2292		
		1983-84	Trans	Auto; THM400	1			EM-2515
			Trans	Auto; THM700-R4/4L60 (MD8)	1			EM-2393
			Trans	Manual	1			EM-2393
		1982	Trans	Auto; THM350C (MV4)	1			EM-2378 @
			Trans	Auto; THM400 (M40)	1			EM-2268 @
			Trans	Manual	1			EM-2378 @
		1978-79	Trans	Auto; THM350	1			EM-2378 @
			Trans	Auto; THM400	1			EM-2268 @
			Trans	Manual	1			EM-2378 @
		1971-74	Trans	Auto; THM350	1			EM-2378 @
	Trans		Auto; THM400	1			EM-2268 @	
	Trans		Manual	1			EM-2378 @	
	Trans		Manual	1			EM-2378 @	
	L6 4.8L 292ci	1974-78	L & R Front		2	EM-2292		
			Trans	Auto	1			EM-2373
			Trans	Manual	1			EM-2268 @
	V6	V6 4.3L 262ci	1985-95	L & R Front		2	EM-2436	
1991-95			Trans		1			EM-2817
1990			Trans	Auto; THM400	1			EM-2515
			Trans	Auto; THM700-R4/4L60 (MD8)	1			EM-2394
1985-89			Trans	Auto; THM400	1			EM-2515
			Trans	Auto; THM700-R4/4L60 (MD8)	1			EM-2508
			Trans	Manual	1			EM-2508
V8	V8 5.0L 305ci	1981	L & R Front		2	EM-2292		
		Trans	Auto; THM350 (M38) THM350C (MV4)	1			EM-2378 @	
		Trans	Auto; THM400	1			EM-2268 @	
		Trans	Manual	1			EM-2378 @	
	V8 5.7L 350ci	1996-98	L & R Front		2	EM-2621		
			L & R Front		2	EM-2292		
		1993-96	Trans	Auto; 4L80E (MT1)	1			EM-2816
		1991-92	Trans	Auto; THM700-R4/4L60 (MD8)	1			EM-2817
		1990	Trans	Auto; THM700-R4/4L60 (MD8)	1			EM-2394
			Trans	Auto; THM400 (M40)	1			EM-2515
		1983-89	Trans	Auto; THM400	1			EM-2515
			Trans	Auto; THM700-R4/4L60 (MD8)	1			EM-2393
			Trans	Manual	1			EM-2393
1982	Trans	Auto; THM350C (MV4)	1			EM-2378 @		
Trans	Auto; THM400 (M40)	1			EM-2268 @			

@ = Universal Mount EM-5000 also available.

# Engine, Transmission, And Torque Strut Mounts

CYL	ENG. SIZE	YEAR	LOCATION	DESCRIPTION	QTY	ENGINE	TORQUE STRUT	TRANSMISSION	
<b>GMC VAN (continued)</b>									
<b>G35/G3500 VAN (continued)</b>									
V8	V8 5.7L 350ci	1982	Trans	Manual	1			EM-2378 @	
		1979-81	Trans	Auto; THM350 (M38)	1			EM-2378 @	
			Trans	Auto; THM400 (M40)	1			EM-2268 @	
			Trans	Manual	1			EM-2378 @	
		1971-78	Trans		1			EM-2378 @	
	V8 6.2L 379ci Diesel	1983-93	L & R Front		2	EM-2292			
		1992-93	Trans		1			EM-2816	
		1991	Trans	Auto; THM700-R4/4L60 (MD8)	1			EM-2394	
		1990	Trans	Auto; THM400	1			EM-2515	
		1983-89	Trans	Auto; THM700-R4/4L60 (MD8)	1			EM-2394	
			Trans	Auto; THM400	1			EM-2515	
			Trans	Auto; THM700-R4/4L60 (MD8)	1			EM-2393	
		Trans	Manual	1			EM-2393		
	V8 6.5L 395ci Diesel	1997-98	L & R Front		2	EM-2621			
		1994-96	L & R Front		2	EM-2292			
		1994-98	Trans		1			EM-2816	
	V8 6.6L 400ci	1975-80	L & R Front		2	EM-2292			
		Trans	Auto; THM350	1				EM-2378 @	
		Trans	Auto; THM400	1				EM-2268 @	
		Trans	Manual	1				EM-2378 @	
	V8 7.4L 454ci	1997-98	L & R Front		2	EM-2621			
		1988-96	L & R Front		2	EM-2292			
		1990-98	Trans	MT1	1			EM-2816	
1988-89		Trans		1			EM-2515		
<b>P15/P1500 VAN</b>									
L6	L6 4.1L 250ci	1973-74	L & R Front		2	EM-2292			
		1968-72	L & R Front		2	EM-2282			
		1968-74	Trans	2WD	1			EM-2378 @	
	L6 4.8L 292ci	1975-80	L & R Front		2	EM-2292			
		Trans	Auto; 2WD	1				EM-2378 @	
		Trans	Manual; 2WD	1				EM-2268 @	
V8	V8 7.4L 454ci	1979	L & R Front		2	EM-2395			
		Trans	Auto; 2WD	1			EM-2513		
		Trans	Manual; 2WD	1			EM-2378 @		
<b>P25/P2500 VAN</b>									
L6	L6 4.1L 250ci	1973-74	L & R Front		2	EM-2292			
		1972	L & R Front		2	EM-2282			
		1970	L & R Front		2	EM-2282			
		1967	L & R Front		2	EM-2282			
		1972-74	Trans	2WD	1			EM-2378 @	
		1970	Trans	2WD	1			EM-2378 @	
		1967	Trans	2WD	1			EM-2378 @	
		L6 4.8L 292ci	1989	L & R Front		2	EM-2292		
			1973-87	L & R Front		2	EM-2292		
	1970-72		L & R Front		2	EM-2282			
	1989		Trans	Auto; 2WD	1			EM-2513	
	Trans		Manual; 2WD	1			EM-2392		
	1985-87		Trans	Auto; 2WD	1			EM-2513	
			Trans	Manual; 2WD	1			EM-2392	
	1983-84		Trans	Auto; 2WD	1			EM-2513	
		Trans	Manual; 2WD	1			EM-2268 @		
	1970-82	Trans	Auto; 2WD	1			EM-2378 @		
Trans		Manual; 2WD	1			EM-2268 @			
V8	V8 5.7L 350ci	1973-89	L & R Front		2	EM-2292			

@ = Universal Mount EM-5000 also available.

# Engine, Transmission, And Torque Strut Mounts

CYL	ENG. SIZE	YEAR	LOCATION	DESCRIPTION	QTY	ENGINE	TORQUE STRUT	TRANSMISSION	
<b>GMC VAN (continued)</b>									
<b>P25/P2500 VAN (continued)</b>									
V8	V8 5.7L 350ci	1970-72	L & R Front		2	EM-2282			
		1985-89	Trans	2WD	1			EM-2392	
		1970-84	Trans	2WD	1			EM-2378 @	
	V8 6.2L 379ci Diesel	1982-89	L & R Front		2	EM-2292			
			Trans	Auto; 2WD	1			EM-2513	
			Trans	Manual; 2WD	1			EM-2392	
<b>P35/P3500 VAN</b>									
L4	L4 3.9L 239ci Diesel	1989-91	Trans	2WD	1			EM-2513	
L6	L6 4.1L 250ci	1973-74	L & R Front		2	EM-2292			
		1970-72	L & R Front		2	EM-2282			
		1967	L & R Front		2	EM-2282			
		1970-74	Trans	2WD	1			EM-2378 @	
		1967	Trans	2WD	1			EM-2378 @	
	L6 4.8L 292ci	1973-89	L & R Front		2	EM-2292			
		1970-72	L & R Front		2	EM-2282			
		1985-89	Trans	Auto; 2WD	1			EM-2513	
			Trans	Manual; 2WD	1			EM-2392	
		1983-84	Trans	Auto; 2WD	1			EM-2513	
			Trans	Manual; 2WD	1			EM-2268 @	
		1970-82	Trans	Auto; 2WD	1			EM-2378 @	
	Trans	Manual; 2WD	1			EM-2268 @			
V6	V6 4.3L 262ci	1990-99	L & R Front		2	EM-2436			
		1992-99	Trans	RWD	1			EM-2922	
		1991	Trans	Auto	1			EM-2510 @	
			Trans	Manual; 5 Spd	1			EM-2922	
		1990	Trans	Auto	1			EM-2510 @	
			Trans	Manual; 4 Spd	1			EM-2515	
V8	V8 5.7L 350ci	1973-99	L & R Front		2	EM-2292			
		1970-72	L & R Front		2	EM-2282			
		1991-99	Trans	Auto	1			EM-2392	
			Trans	Manual; 5 Spd	1			EM-2922	
		1985-90	Trans	Auto; 2WD	1			EM-2513	
			Trans	Manual; 2WD	1			EM-2392	
		1970-84	Trans	Auto; 2WD	1			EM-2268 @	
			Trans	Manual; 2WD	1			EM-2378 @	
		V8 6.2L 379ci Diesel	1982-93	L & R Front		2	EM-2292		
			1991-93	Trans	Auto	1			EM-2922
				Trans	Manual; 5 Spd	1			EM-2922
	1982-90		Trans	Auto; 2WD	1			EM-2513	
			Trans	Manual; 2WD	1			EM-2392	
	V8 6.5L 395ci Diesel	1994-99	L & R Front		2	EM-2292			
			Trans	2WD	1			EM-2922	
	V8 7.4L 454ci	1998-99	L & R Front		2	EM-2621			
		1973-97	L & R Front		2	EM-2395			
		1991-99	Trans	2WD	1			EM-2922	
		1985-90	Trans	Auto; 2WD	1			EM-2513	
			Trans	Manual; 2WD	1			EM-2393	
		1981-84	Trans	Auto; 2WD	1			EM-2513	
		1979-80	Trans	Auto; 2WD	1			EM-2513	
			Trans	Manual; 2WD	1			EM-2378 @	
		1973-78	Trans	Auto; 2WD	1			EM-2268 @	
			Trans	Manual; 2WD	1			EM-2378 @	

@ = Universal Mount EM-5000 also available.

# Engine, Transmission, And Torque Strut Mounts

CYL	ENG. SIZE	YEAR	LOCATION	DESCRIPTION	QTY	ENGINE	TORQUE STRUT	TRANSMISSION
<b>GMC VAN (continued)</b>								
<b>SAFARI</b>								
L4	L4 2.5L 2474cc	1985-90	LH Front		1	EM-2549		
			RH Front		1	EM-2550		
		1990	Trans	Auto	1			EM-2508
		1985-89	Trans	Auto	1			EM-2508
Trans	Manual		1			EM-2508		
V6	V6 4.3L 262ci	1985-05	L & R Front		2	EM-2436		
		1994-05	Trans	AWD	1			EM-2839
			Trans	RWD	1			EM-2879
		1990-93	Trans	2WD	1			EM-2394
			Trans	AWD	1			EM-2950
		1985-89	Trans	Auto	1			EM-2508
Trans	Manual		1			EM-2508		
<b>SAVANA 1500</b>								
V6	V6 4.3L 262ci	2003-12	L & R Front		2	EM-3177		
		1999-02	L & R Front		2	EM-2621		
V8	V8 5.0L 305ci	1999-02	L & R Front		2	EM-2621		
			Trans		1			EM-2816
	V8 5.3L 325ci	2003-14	L & R Front	RWD	2	EM-5354		
			LH Front	AWD	1	EM-3175		
			RH Front	AWD	1	EM-5354		
			Trans	RWD	1			EM-3098
			Trans	AWD	1			EM-4108
	V8 5.7L 350ci	1999-02	L & R Front		2	EM-2621		
Trans				1			EM-2817	
<b>SAVANA 2500</b>								
V6	V6 4.3L 262ci	1999-02	L & R Front		2	EM-2621		
			Trans		1			EM-2817
V8	V8 4.8L 294ci	2006-17	L & R Front	RWD	2	EM-5354		
		2003-05	L & R Front	RWD	2	EM-5354		
			LH Front	AWD	1	EM-3175		
			RH Front	AWD	1	EM-5354		
		2003-16	Trans	RWD	1			EM-3098
	V8 5.0L 305ci	1999-02	L & R Front		2	EM-2621		
			Trans		1			EM-2816
	V8 5.3L 325ci	2003-05	L & R Front	RWD	2	EM-5354		
			LH Front	AWD	1	EM-3175		
			RH Front	AWD	1	EM-5354		
			Trans	RWD	1			EM-3098
			Trans	AWD	1			EM-2638
	V8 5.7L 350ci	1999-02	L & R Front		2	EM-2621		
			Trans		1			EM-2817
	V8 6.0L 364ci	2003-17	L & R Front	RWD	2	EM-5354		
			2006-16	Trans - Front		1		
2003-05			Trans	RWD	1			EM-3098
			Trans	AWD	1			EM-2638
V8 6.5L 395ci Diesel	1999-02	L & R Front		2	EM-2621			
		Trans		1			EM-2816	
V8 6.6L 400cc Turbo Diesel	2006-09		Turbo	1			EM-5663	
		Trans	Turbo	1			EM-5663	
<b>SAVANA 3500</b>								
V8	V8 4.8L 294ci	2006-17	L & R Front	RWD	2	EM-5354		
		2006-16	Trans	RWD	1			EM-3098
	V8 5.7L 350ci	1999-02	L & R Front		2	EM-2621		
			Trans		1			EM-2817
	V8 6.0L 364ci	2003-17	L & R Front		2	EM-5354		
2003-16			Trans		1			EM-3098

\* = Hydraulic Mount, "S" suffix = solid replacement.

# Engine, Transmission, And Torque Strut Mounts

CYL	ENG. SIZE	YEAR	LOCATION	DESCRIPTION	QTY	ENGINE	TORQUE STRUT	TRANSMISSION	
<b>GMC VAN (continued)</b>									
<b>SAVANA 3500 (continued)</b>									
V8	V8 6.5L 395ci Diesel	1999-02	L & R Front		2	EM-2621			
			Trans		1		EM-2816		
	V8 6.6L 403ci	2006-09	Trans	Turbo	1		EM-5663		
	V8 7.4L 454ci	1999-00	L & R Front		2	EM-2621			
			Trans	Auto	1		EM-2816		
V8 8.1L 496ci	2001-02	L & R Front		2	EM-2621				
		Trans	Auto	1		EM-2816			
<b>HONDA PASSENGER CAR</b>									
<b>ACCORD</b>									
L4	L4 1.6L 1599cc	1976-78	Rear		1	EM-8660			
			Trans		1		EM-8825		
	L4 1.8L 1751cc	1982-83	1979-81	Front		1	EM-8012		
			1982-83	Front		1	EM-2451		
			1979-81	Rear		1	EM-8012		
			1979-81	Rear		1	EM-8660		
			1982-83	Torq Str - Front	Insert	1		EM-8614	
				Torq Str - Front	Tube	1		EM-8802	
			1979-81	Torq Str - Front	Insert	1		EM-8293	
			1982-83	Torq Str - Rear	Insert	1		EM-8615	
			1982	Trans - Lower		1			EM-8031
			1979-81	Trans - Lower	Auto	1			EM-2452
				Trans - Lower	Manual	1			EM-2452
			1982	Trans - Upper	Auto	1			EM-8022
			1979-81	Trans - Upper	Auto	1			EM-8022
	1983	Trans		1			EM-8031		
	L4 1.8L 1829cc	1984-85	Front		1	EM-8574			
			Rear		1	EM-8574			
			Torq Str - Front	Insert	1		EM-8614		
			Torq Str - Rear	Insert	1		EM-8615		
			Trans	Auto	1			EM-8014	
			Trans	Manual	1			EM-8012	
	L4 2.0L 1955cc	1989	1986-88	Front	Vibration Damper	1	EM-5382		
			1986-88	Front	Vibration Damper	1	EM-5382		
			1989	Front Center	Auto	1	EM-5371		
			1986-88	Front Center	Auto	1	EM-5371		
			1989	LH Front		1	EM-8019		
			1986-88	LH Front		1	EM-8019		
			1989	RH Front		1	EM-9128		
			1986-88	RH Front		1	EM-8005		
			1989	Rear		1	EM-8014		
			1986-88	Rear		1	EM-8014		
			1986-89	Torq Str - Front	Insert	1		EM-8614	
				Torq Str - Front	Tube	1		EM-8025	
				Torq Str - Rear	Insert	1		EM-8615	
	L4 2.0L 1993cc	2017	2014-15	Right	Hybrid	1	EM-7134		
			2014-15	Right	Hybrid	1	EM-7134		
	L4 2.2L 2156cc	1996-97	1994-95	Front	Auto	1	EM-8026		
				Front	Manual	1	EM-8432		
			1996-97	Front	Auto	1	EM-8026		
				Front	Manual	1	EM-8432		
			1996-97	LH Front		1	EM-8404		
			1994-95	LH Front		1	EM-8404		
			1990-93	LH Front		1	EM-8016		
			1996-97	Rear	Auto; w/ Solenoid Valve	1	EM-8984		
				Rear	Auto; w/o Solenoid Valve	1	EM-8011		
	1996-97	Rear	Manual; DX; LX	1	EM-8228				



## Engine, Transmission, And Torque Strut Mounts

CYL	ENG. SIZE	YEAR	LOCATION	DESCRIPTION	QTY	ENGINE	TORQUE STRUT	TRANSMISSION	
<b>HONDA PASSENGER CAR (continued)</b>									
<b>ACCORD (continued)</b>									
L4	L4 2.2L 2156cc	1996-97	Rear	Manual; EX	1	EM-8009			
		1994-95	Rear	Auto; w/ Solenoid Valve	1	EM-8984			
			Rear	Auto; w/o Solenoid Valve	1	EM-8011			
			Rear	Manual; DX; LX	1	EM-9137			
			Rear	Manual; EX	1	EM-8009			
		1990-93	Rear	Auto; w/ Solenoid Valve	1	EM-8984			
			Rear	Auto; w/o Solenoid Valve	1	EM-8011			
			Rear	Manual; DX; LX	1	EM-9137			
			Rear	Manual; EX	1	EM-8009			
		1991-93	Torq Str - Front		1		EM-8024		
		1996-97	Trans	Auto	1			EM-8002	
			Trans	Manual	1			EM-9055	
		1994-95	Trans	Auto	1			EM-8002	
			Trans	Manual	1			EM-9055	
		1990-93	Trans	Auto	1			EM-8002	
	Trans		Manual	1			EM-8002		
	L4 2.3L 2254cc	1998-02	Front		1	EM-8801			
			LH Front		1	EM-8899			
			Rear	Auto	1	EM-8845			
			Rear	Manual	1	EM-8849			
		2000-02	Trans	Auto	1			EM-8983	
			Trans	Manual	1			EM-8971	
		1998-99	Trans	Auto	1			EM-8799	
			Trans	Manual	1			EM-8971	
		L4 2.4L 2354cc	2009-12	Front		1	EM-9488		
				Front	Hydraulic Mount; Auto	1	EM-9247		
	2009-12		LH Rear	Auto	1	EM-9443			
			LH Rear	Manual	1	EM-9554			
	2008		LH Rear	Auto	1	EM-9443			
			LH Rear	Manual	1	EM-9554			
	2003-07		Rear	Hydraulic Mount	1	EM-9194			
	2009-12		Right		1	EM-9457			
	2008		Right	Auto	1	EM-9457			
2003-07	Right		Auto	1	EM-9297				
	Trans - Front		Auto	1			EM-9426		
	Trans - Front		Manual	1			EM-9152		
2010-12	Trans - Lower		US & Canada; Auto	1			EM-9428		
	Trans - Lower		US & Canada; Manual	1			EM-9417		
	Trans - Lower		Mexico; Auto	1			EM-9428		
2008-09	Trans - Lower		Auto	1			EM-9428		
	Trans - Lower		Manual	1			EM-9417		
2003-07	Trans - Rear		Auto	1			EM-9438		
	Trans - Rear		Manual	1			EM-9225		
2010-12	Trans - Upper		US & Canada; Auto	1			EM-9459		
	Trans - Upper		US & Canada; Auto; When Current Stock is Depleted, Re-order EM-9459	1			EM-5784		
	Trans - Upper		Mexico; Auto	1			EM-9459		
	Trans - Upper		Mexico; Auto; When Current Stock is Depleted, Re-order EM-9459	1			EM-5784		
2008-09	Trans - Upper		Auto	1			EM-9459		
	Trans - Upper		Auto; When Current Stock is Depleted, Re-order EM-9459	1			EM-5784		
L4 2.4L 2356cc	2013-17		Front	Gas; Auto	1	EM-7179			
			Rear	Gas; Auto	1	EM-7155			
			Right	Gas	1	EM-7134			

# Engine, Transmission, And Torque Strut Mounts

CYL	ENG. SIZE	YEAR	LOCATION	DESCRIPTION	QTY	ENGINE	TORQUE STRUT	TRANSMISSION
<b>HONDA PASSENGER CAR (continued)</b>								
<b>ACCORD (continued)</b>								
L4	L4 2.4L 2356cc	2013-17	Right	Hybrid	1	EM-7134		
			Trans - Lower	Gas; Auto	1			EM-7178
			Trans - Upper	Gas; Auto	1			EM-7129
V6	V6 2.7L 2675cc	1995-97	Front		1	EM-9178		
			RH Front		1	EM-8900		
			Rear	w/o Vacuum Switch	1	EM-5471		
			Rear	With Vacuum Switch	1	EM-7094		
			Trans		1			EM-8896
	V6 3.0L 2977cc	2003-05	Front	US & Canada; Gas Engine Hydraulic Mount; Auto	1	EM-9247		
			Front	Mexico; Hydraulic Mount; Auto	1	EM-9247		
			Rear	US & Canada; Gas Engine Hydraulic Mount	1	EM-9451		
			Rear	Mexico; Hydraulic Mount	1	EM-9451		
			Right	US & Canada; Gas Engine Auto	1	EM-9297		
			Right	US & Canada; Gas Engine Manual	1	EM-5787		
			Right	Mexico; Auto	1	EM-9297		
	V6 3.0L 2997cc	2007	Front	Gas; Auto	1	EM-9247		
			Front	Gas; Manual	1	EM-5790		
		2006	Front	Gas; Auto	1	EM-9247		
			Front	Gas; Manual	1	EM-5790		
		2005-07	Front	Hybrid	1	EM-5903		
		1998-02	Front		1	EM-9185		
			RH Front		1	EM-8974#		
		2007	Rear	Gas	1	EM-9451		
		2006	Rear	Gas	1	EM-9451		
		1998-02	Rear		1	EM-9149		
		2007	Right	Gas; Auto	1	EM-9297		
			Right	Gas; Manual	1	EM-5787		
		2006	Right	Gas; Auto	1	EM-9297		
			Right	Gas; Manual	1	EM-5787		
		2006-07	Trans - Front	Auto	1			EM-9214
		2005	Trans - Front	Auto; EX	1			EM-9214
			Trans - Front	Auto; LX & SE	1			EM-9434
		2003-04	Trans - Front	Auto	1			EM-9215
			Trans - Front	Auto; EX	1			EM-9409
		1998-02	Trans - Front		1			EM-8898
		2003-04	Trans - Front Upper		1			EM-9220
		2006-07	Trans - Rear	Auto	1			EM-9434
			Trans - Rear	Manual	1			EM-9220
		2005	Trans - Rear	Auto	1			EM-9220
		2003-04	Trans - Rear	Auto	1			EM-9214
			Trans - Rear	Manual	1			EM-9434
		1998-02	Trans - Rear		1			EM-8986
	V6 3.5L 3471cc	2008-15	Front	US & Canada; Manual; Coupe	1	EM-7038		
			Front	US & Canada; Sedan	1	EM-5793		
			Front	Mexico; Sedan	1	EM-5793		
		2014-15	Rear	Auto	1	EM-5875		
		2008-15	Rear	US & Canada; Auto	1	EM-5875		
			Rear	US & Canada; Manual	1	EM-9554		
			Rear	Mexico; Auto	1	EM-5875		
			Right	US & Canada	1	EM-9467		
			Right	Mexico	1	EM-9467		
		2013-17	Trans - Lower	Auto	1			EM-7231

# = Available in the Westar Gold Line

## Engine, Transmission, And Torque Strut Mounts

CYL	ENG. SIZE	YEAR	LOCATION	DESCRIPTION	QTY	ENGINE	TORQUE STRUT	TRANSMISSION
<b>HONDA PASSENGER CAR (continued)</b>								
<b>ACCORD (continued)</b>								
V6	V6 3.5L 3471cc	2008-12	Trans - Lower	Auto	1			EM-9439
			Trans - Lower	Manual	1		EM-9450	
			Trans - Upper	Auto	1		EM-9516	
<b>ACCORD CROSSTOUR</b>								
V6	V6 3.5L 3471cc	2010-11	Front		1	EM-5793		
			Rear		1	EM-5875		
			Trans - Lower		1		EM-9439	
			Trans - Upper		1		EM-9516	
<b>CIVIC</b>								
L4	L4 1.2L 1237cc	1973-79	L & R Front		2	EM-2449		
			Torq Str - Front	Insert	1		EM-8029	
	L4 1.3L 1335cc	1981 1980-83	Front	Auto	1	EM-2451		
			Torq Str - Front		1		EM-8525	
			Trans - Lower		1		EM-8012	
			Trans - Upper		1		EM-8031	
	L4 1.3L 1339cc	2006-11 2003-05	RH Front		1	EM-5906		
			Rear		1	EM-8973		
			Right		1	EM-5376		
		2006-11	Torq Str - Rear		1		EM-9553	
			Trans		1		EM-9617	
	L4 1.3L 1342cc	1984-87	Front	Front	1	EM-8018		
			RH Front		1	EM-8402		
			Trans	Auto	1		EM-8004	
			Trans	Manual	1		EM-8004	
	L4 1.5L 1487cc	1980-83	Front		1	EM-8012		
			L & R Front		2	EM-2449		
		1984-87	LH Front		1	EM-8402		
			Rear		1	EM-8004		
		1980-83	Rear		1	EM-8012		
		1976-79	Torq Str - Front	Insert	1		EM-8029	
		1984-87	Trans	Auto	1		EM-8004	
			Trans	Manual	1		EM-8018	
		1980-83	Trans	Auto	1		EM-8031	
			Trans	Manual	1		EM-8031	
	L4 1.5L 1493cc	1994-95	Front		1	EM-8575		
		1992-93	Front		1	EM-8575		
		1988-91	Front	Auto	1	EM-8431		
			Front	Manual	1	EM-8411		
			LH Front		1	EM-8020		
		1994-95	LH Front Lower		1	EM-8435		
		1992-93	LH Front Lower		1	EM-8435		
		1994-95	LH Front Upper	CX	1	EM-9136		
			LH Front Upper	LIFT	1	EM-8021		
			LH Front Upper	VX	1	EM-8894		
		1992-93	LH Front Upper	CX, DX, LX	1	EM-9136		
			LH Front Upper	VX	1	EM-8021		
		1994-95	Rear		1	EM-8010		
		1992-93	Rear		1	EM-8010		
			Rear	Auto	1	EM-8007		
		1988-91	Rear	Manual	1	EM-8006		
			Trans	Auto; DX; LX	1		EM-8572	
		1994-95	Trans	Manual; DX; LX	1		EM-8329	
			Trans	Auto; DX; LX	1		EM-8330	
		1992-93	Trans	CX	1		EM-8495	
			Trans	Manual; DX; LX; VX	1		EM-8329	
			Trans	Auto	1		EM-8001	

# Engine, Transmission, And Torque Strut Mounts

CYL	ENG. SIZE	YEAR	LOCATION	DESCRIPTION	QTY	ENGINE	TORQUE STRUT	TRANSMISSION
<b>HONDA PASSENGER CAR (continued)</b>								
<b>CIVIC (continued)</b>								
L4	L4 1.5L 1493cc	1988-91	Trans	Manual	1			EM-8034
	L4 1.6L 1588cc	1996-00	Front		1	EM-8575		
		1989-91	Front	Auto	1	EM-8431		
			Front	Manual	1	EM-8411		
		1988	Front	Manual	1	EM-8411		
		1994-95	LH Front	Auto	1	EM-8431		
			LH Front	Manual	1	EM-8435		
		1989-91	LH Front	Manual	1	EM-8020		
		1988	LH Front	Manual	1	EM-8020		
		1996-00	LH Front Lower		1	EM-8435		
		1994-95	LH Front Lower		1	EM-8435		
		1992-93	LH Front Lower		1	EM-8435		
		1994-95	LH Front Upper	Coupe	1	EM-8894		
			LH Front Upper	Sedan	1	EM-8021		
		1992-93	LH Front Upper		1	EM-8021		
			LH Front Upper		1	EM-9136		
		1996-00	LH Rear Upper		1	EM-8710		
		1994-95	RH Front	Auto	1	EM-8575		
			RH Front	Manual	1	EM-8434		
		1992-93	RH Front		1	EM-8575		
			RH Front	Auto	1	EM-8575		
			RH Front	Manual	1	EM-8434		
		1989-91	RH Front	Auto	1	EM-8001		
			RH Front	Manual	1	EM-8034		
		1988	RH Front	Manual	1	EM-8034		
		1996-00	Rear		1	EM-8010		
		1994-95	Rear		1	EM-8010		
		1992-93	Rear		1	EM-8010		
		1989-91	Rear	Auto	1	EM-8007		
			Rear	Manual	1	EM-8006		
		1988	Rear	Manual	1	EM-8006		
		1996-00	Trans	Auto	1			EM-8300
			Trans	Manual	1			EM-8300
		1994-95	Trans	Auto	1			EM-8572
	Trans		Manual	1			EM-8329	
	1989-91	Trans	Auto	1			EM-8001	
		Trans	Manual	1			EM-8034	
	1988	Trans	Manual	1			EM-8034	
	L4 1.6L 1590cc	1996-00	Front	HX Model	1	EM-8575		
			LH Front Lower	HX Model	1	EM-8435		
			LH Rear Upper	HX Model	1	EM-8710		
			Rear	HX Model	1	EM-8010		
			Trans	Auto	1			EM-8300
			Trans	Manual	1			EM-8300
			Trans	HX Model; Auto; HX w/CVT	1			EM-5449
			Trans	Auto	1			EM-8330
	1992-93	Trans	Manual	1			EM-8329	
		Trans	Manual	1			EM-8329	
	L4 1.6L 1595cc	1999-00	Front	Si Model	1	EM-8575		
			LH Front Lower	Si Model	1	EM-8435		
			LH Rear Upper	Si Model	1	EM-8710		
			Rear	Si Model	1	EM-8010		
			Trans	Si Model; SI	1			EM-8300
	L4 1.7L 1668cc	2001-05	Front	Auto	1	EM-8988		
			Front	Manual	1	EM-8975		
			LH Front	Coupe	1	EM-9277		
			LH Front	Sedan	1	EM-9016		
Rear				1	EM-8973			

## Engine, Transmission, And Torque Strut Mounts

CYL	ENG. SIZE	YEAR	LOCATION	DESCRIPTION	QTY	ENGINE	TORQUE STRUT	TRANSMISSION	
<b>HONDA PASSENGER CAR (continued)</b>									
<b>CIVIC (continued)</b>									
L4	L4 1.7L 1668cc	2003-05	Trans	Auto; CVT	1			EM-9470	
			Trans	Auto; Exc. CVT	1			EM-5794	
			Trans	Manual, EX & LX	1			EM-9479	
			Trans	Manual; SLW Trans.	1			EM-9204	
		2001-02	Trans	Auto; CVT	1			EM-9470	
			Trans	Auto; Exc. CVT	1			EM-5794	
			Trans	Manual	1			EM-9204	
	L4 1.8L 1799cc	2014-15	Front	Auto; Coupe	1	EM-7148			
			Front	Auto; Sedan	1	EM-7148			
			Front	Manual; Sedan	1	EM-7145			
		2013	Front	Auto; Sedan; Exc. HF	1	EM-7148			
			Front	Auto; Sedan; HF Only	1	EM-7145			
			Front	Manual; Sedan	1	EM-7145			
		2012	Front	Auto; Sedan	1	EM-7145			
			Front	Manual; Sedan	1	EM-7145			
		2006-11	Front		1	EM-9280			
		2012-15	Torq Str - Lower	Auto	1		EM-7116		
			Torq Str - Lower	Manual	1		EM-7170		
		2006-11	Torq Str - Lower	Auto	1		EM-9218		
			Torq Str - Lower	Manual	1		EM-9487		
			Torq Str - Upper	Auto	1		EM-9213		
			Torq Str - Upper	Manual	1		EM-5689		
		2012-15	Trans	Auto	1			EM-5990	
			Trans	Manual	1			EM-7012	
		2006-11	Trans	Auto	1			EM-9216	
			Trans	Manual	1			EM-9216	
	L4 2.0L 1998cc	2006-10	Front		1	EM-9542			
			2002-05	Front		1	EM-9424		
		2006-10	RH Front		1	EM-9282			
			2002-05	RH Front		1	EM-9413		
		2006-10	Rear		1	EM-9396			
			Torq Str - Lower	Lower	1		EM-9386		
			Torq Str - Upper	Upper	1		EM-9385		
		2005	Trans	SI	1			EM-9433	
		2002-04	Trans	Si; SiR	1			EM-9433	
	L4 2.4L 2354cc	2013-15	RH Front		1	EM-7258			
		2012-15	Torq Str - Lower		1		EM-7168		
			Torq Str - Upper		1		EM-7169		
		Trans	Auto	1			EM-7177		
		Trans	Manual	1			EM-7177		
	<b>CIVIC DEL SOL</b>								
	L4	L4 1.5L 1493cc	1993-95	LH Front		1	EM-8435		
				LH Rear	After VIN PS003627	1	EM-8021		
LH Rear				Before VIN PS003627	1	EM-9136			
RH Front					1	EM-8575			
Rear					1	EM-8010			
1994-95			Trans	Auto	1			EM-8572	
			Trans	Manual	1			EM-8329	
1993			Trans	Auto	1			EM-8330	
			Trans	Manual	1			EM-8329	
L4 1.6L 1588cc			1996-97	Front	SOHC	1	EM-8575		
		LH Front Lower		SOHC; Auto	1	EM-8431			
		LH Front Lower		SOHC; Manual	1	EM-8435			
		1993	LH Front Lower		1	EM-8435			
		1996-97	LH Front Upper	SOHC; S, After VIN PS003627	1	EM-8021			
			LH Front Upper	SOHC; S, Before VIN PS003627	1	EM-9136			

# Engine, Transmission, And Torque Strut Mounts

CYL	ENG. SIZE	YEAR	LOCATION	DESCRIPTION	QTY	ENGINE	TORQUE STRUT	TRANSMISSION
<b>HONDA PASSENGER CAR (continued)</b>								
<b>CIVIC DEL SOL (continued)</b>								
L4	L4 1.6L 1588cc	1996-97	LH Front Upper	SOHC; SI	1	EM-8894		
		1993	LH Front Upper	SI, After VIN PS001140	1	EM-8021		
			LH Front Upper	SI, Before VIN PS001140	1	EM-9136		
		1994-95	RH Front	Auto	1	EM-8435		
		1993	RH Front	Auto	1	EM-8575		
			RH Front	Manual	1	EM-8434		
		1996-97	Rear	SOHC; Rear	1	EM-8010		
		1994-95	Rear	Rear	1	EM-8010		
		1993	Rear		1	EM-8010		
	Trans		SOHC; Auto	1			EM-8572	
	L4 1.6L 1595cc	1996-97	Trans	SOHC; Manual	1			EM-8329
			Trans	Auto	1			EM-8330
			Trans	Manual	1			EM-8329
			Front	DOHC	1	EM-8575		
			LH Front Lower	DOHC	1	EM-8435		
			LH Front Upper	DOHC	1	EM-8021		
			Rear	DOHC; Rear	1	EM-8010		
Trans			DOHC; Manual	1			EM-8329	
<b>CRX</b>								
L4	L4 1.3L 1342cc	1984	Trans - Rear		1			EM-8004
			Trans	Auto	1			EM-8004
	L4 1.5L 1487cc	1984-87	Trans	Manual	1			EM-8018
			L4 1.5L 1493cc	1988-91	Front	Auto	1	EM-8431
	Front	Manual	1		EM-8411			
	LH Front		1		EM-8020			
	Rear	Auto	1		EM-8007			
	Rear	Manual	1		EM-8006			
	Trans	Auto	1				EM-8001	
	Trans	Manual	1				EM-8034	
	L4 1.6L 1588cc	1988-91	Front		1	EM-8411		
			LH Front		1	EM-8020		
			Rear		1	EM-8006		
Trans			Manual	1			EM-8034	
<b>CROSSTOUR</b>								
L4	L4 2.4L 2354cc	2013-15	Front		1	EM-9488		
			LH Rear	Auto	1	EM-9443		
			Right		1	EM-9457		
		2012-15	Trans - Lower	Auto	1			EM-9428
			Trans - Upper	Auto	1			EM-9459
	Trans - Upper	Auto; When Current Stock is Depleted, Re-order EM-9459	1			EM-5784		
V6	V6 3.5L 3471cc	2012-14	Front		1	EM-5793		
			Rear		1	EM-5875		
<b>CR-Z</b>								
L4	L4 1.5L 1497cc	2011-13	Torq Str - Left	Manual	1		EM-5792	
<b>FIT</b>								
L4	L4 1.5L 1497cc	2015-19	Front	EX	1	EM-7296		
		2009-12	Front		1	EM-5872		
		2007-08	Front	Manual	1	EM-9250		
			Rear		1	EM-9437		
		2015-19	Torq Str - Rear		1		EM-7127	
		2009-14	Torq Str - Rear	Auto	1		EM-5785	
			Torq Str - Rear	Manual	1		EM-5792	
		2009-12	Trans	Auto	1			EM-5891
2007-08	Trans	Auto	1			EM-9285		

## Engine, Transmission, And Torque Strut Mounts

CYL	ENG. SIZE	YEAR	LOCATION	DESCRIPTION	QTY	ENGINE	TORQUE STRUT	TRANSMISSION	
<b>HONDA PASSENGER CAR (continued)</b>									
<b>FIT (continued)</b>									
L4	L4 1.5L 1497cc	2007-08	Trans	Manual	1			EM-9286	
<b>INSIGHT</b>									
L4	L4 1.3L 1339cc	2010-13	Torq Str - Left		1		EM-5792		
<b>PRELUDE</b>									
L4	L4 1.8L 1751cc	1979-82	Front		1	EM-2451			
			Side		1	EM-2452			
	L4 1.8L 1829cc	1983-87	L & R Front		2	EM-8014			
			Rear	Auto	1	EM-8660			
			Rear	Manual	1	EM-8014			
			Side		1	EM-8014			
			Torq Str - Front	Insert	1		EM-8614		
			Torq Str - Rear	Insert	1		EM-8615		
			Trans	Auto	1			EM-8031	
			Trans	Manual	1			EM-8031	
	L4 2.0L	1985-87	Trans		1			EM-5400	
	L4 2.0L 1955cc	1985-87	L & R Front		2	EM-8005			
			Rear		1	EM-8014			
			Torq Str - Front	Insert	1		EM-8614		
			Torq Str - Rear	Insert	1		EM-8615		
	L4 2.0L 1958cc	1988	Front		1	EM-9172			
			1990-91	LH Front		1	EM-5510		
		1989	LH Front		1	EM-5510			
			RH Front	Auto	1	EM-8497			
		1989	RH Front	Manual	1	EM-8030			
			RH Front	Auto	1	EM-8497			
		1988	RH Front	Manual	1	EM-8030			
			RH Front	Auto	1	EM-8497			
		1990-91	RH Front	Manual	1	EM-8030			
			Rear	Auto	1	EM-8349			
		1989	Rear	Manual	1	EM-8008			
			Rear	Auto	1	EM-8349			
		1988	Rear	Auto	1	EM-8008			
			Rear	Manual	1	EM-8008			
		1988-91	Trans	Auto	1			EM-8987	
			Trans	Manual	1			EM-8374	
	L4 2.2L 2156cc	1997-01	Front		1	EM-8806			
			1992-96	Front	Auto	1	EM-8859		
			Front	Manual	1	EM-8806			
		1997-01	LH Front		1	EM-9150			
			LH Front		1	EM-9085			
		1997-01	Rear		1	EM-9137			
			Rear		1	EM-8008			
		1997-01	Trans	Auto	1			EM-9183	
		1995-96	Trans	Auto	1			EM-8002	
			Trans	Manual	1			EM-9055	
		1992-94	Trans	Auto	1			EM-8002	
			Trans	Manual	1			EM-9055	
		L4 2.3L 2259cc	1992-96	Front		1	EM-8806		
				LH Front		1	EM-9085		
	Rear				1	EM-8008			
	1995-96		Trans	Auto	1			EM-8002	
Trans			Manual	1			EM-9055		
1992-94	Trans		Auto	1			EM-8002		
Trans	Manual	1			EM-9055				

# Engine, Transmission, And Torque Strut Mounts

CYL	ENG. SIZE	YEAR	LOCATION	DESCRIPTION	QTY	ENGINE	TORQUE STRUT	TRANSMISSION	
<b>HONDA PASSENGER CAR (continued)</b>									
<b>S2000</b>									
L4	L4 2.0L 1997cc	2000-03	L & R Front		2	EM-5786			
			Trans		2		EM-9490		
	L4 2.2L 2157cc	2004-09	L & R Front		2	EM-5786			
			Trans		2		EM-9490		
<b>HONDA SPORT UTILITY</b>									
<b>CR-V</b>									
L4	L4 2.0L 1972cc	1998-01	LH Front		1	EM-8709			
			1997	LH Front		1	EM-8709		
		1998-01	Left	Auto		1	EM-8982		
				Manual		1	EM-8710		
		1997	Left	Auto		1	EM-8982		
		1998-01	RH Front		1	EM-8575			
		1997	RH Front		1	EM-8575			
		1998-01	Rear	Auto		1	EM-8897		
				Manual		1	EM-8010		
		1997	Rear	Auto		1	EM-8897		
	Trans			Differential Mount; 4WD	2		EM-5995		
	1997-01	Trans	4WD		1		EM-8300		
	L4 2.4L 2351cc	2007-11	Torq Str - Right			1		EM-9303	
						1		EM-9302	
	L4 2.4L 2354cc	2012-14	Front			1	EM-7073		
				2006	Front	Auto	1	EM-9066	
		2002-05	Front	US & Canada; Auto		1	EM-9066		
				US & Canada; Manual		1	EM-9424		
				Mexico; Auto		1	EM-9066		
		2007-11	RH Front		1	EM-9496			
		2006	RH Front		1	EM-9139			
		2002-05	RH Front	US & Canada		1	EM-9139		
				Mexico		1	EM-9139		
		2006	Rear	Auto		1	EM-9168		
				Manual		1	EM-9175		
		2002-05	Rear	US & Canada; Auto		1	EM-9168		
				US & Canada; Manual		1	EM-9175		
				Mexico; Auto		1	EM-9168		
		2012-14	Right			1	EM-5958		
				Torq Str - Lower		1		EM-7055	
				Torq Str - Upper		1		EM-5954	
		2012-16	Trans		1			EM-7111	
		2010-11	Trans	US & Mexico Built	1			EM-9397	
		2009	Trans	US & Mexico Built	1			EM-9397	
	2008	Trans		1			EM-9397		
	2007	Trans	EX & LX		1		EM-9433		
			EX-L		1		EM-9397		
	2002-11	Trans	Differential Mount; 4WD	2			EM-5871		
	2002-06	Trans	US & Canada; Auto		1		EM-9205		
			US & Canada; Manual		1		EM-9433		
			Mexico; Auto		1		EM-9205		
	L4 2.4L 2356cc	2015-16	Front			1	EM-7302		
				Right		1	EM-5958		
				Torq Str - Lower		1		EM-7055	
				Torq Str - Upper		1		EM-5954	
	<b>ELEMENT</b>								
	L4	L4 2.4L 2354cc	2007-11	Front	FWD	1	EM-9066		
			2003-06	Front		1	EM-9066		
				RH Front		1	EM-9445		
			2007-11	Rear		1	EM-9168		



## Engine, Transmission, And Torque Strut Mounts

CYL	ENG. SIZE	YEAR	LOCATION	DESCRIPTION	QTY	ENGINE	TORQUE STRUT	TRANSMISSION	
<b>HONDA SPORT UTILITY (continued)</b>									
<b>ELEMENT (continued)</b>									
L4	L4 2.4L 2354cc	2003-06	Rear		1	EM-9168			
		2007-09	Torq Str - Right	Lower	1		EM-9303		
			Torq Str - Right	Upper	1		EM-9302		
			Trans	Auto	1			EM-9473	
			Trans	Manual	1			EM-9433	
		2003-11	Trans	Differential Mount; 4WD		2			EM-5871
		2003-06	Trans	Auto		1			EM-9473
			Trans	Manual		1			EM-9433
<b>HR-V</b>									
L4	L4 1.8L 1799cc	2016-18	Torq Str - Rear	FWD; CVT Trans.	1		EM-7127		
<b>PASSPORT</b>									
L4	L4 2.6L 2559cc	1996	LH Front		1	EM-8499			
		1994-95	LH Front		1	EM-9141			
		1996	RH Front		1	EM-8352			
		1994-95	RH Front		1	EM-9140			
		1994-96	Trans	Manual		1			EM-8586
V6	V6 3.2L 3165cc	2001-02	LH Front		1	EM-5813			
		1998-00	LH Front		1	EM-8351			
		1996-97	LH Front		1	EM-8351			
		1994-95	LH Front		1	EM-8445			
		1998-00	RH Front		1	EM-5814			
		1996-97	RH Front		1	EM-8352			
		1994-95	RH Front		1	EM-9144			
		1998-02	Trans	Auto; 2WD		1			EM-5609
			Trans	Manual; 2WD		1			EM-5610
		1994-97	Trans	Auto; 4WD		1			EM-9142
Trans	Auto; RWD			1			EM-8586		
			Trans	Manual; RWD	1			EM-8586	
<b>PILOT</b>									
V6	V6 3.5L 3471cc	2009-15	Front		1	EM-7186			
		2006-08	Front	AWD	1	EM-9441			
			Front	FWD	1	EM-5903			
		2005	Front		1	EM-9441			
		2003-04	Front		1	EM-9441			
		2009-15	RH Front		1	EM-9411			
		2006-08	RH Front	w/o Counter Weight	1	EM-9299			
		2005	RH Front	w/o Counter Weight	1	EM-9299			
		2003-04	RH Front		1	EM-9389			
		2016-19	Rear		1	EM-7300			
		2009-15	Rear		1	EM-7187			
		2006-08	Rear	AWD	1	EM-9300			
			Rear	FWD	1	EM-5795			
		2005	Rear		1	EM-9300			
		2003-04	Rear		1	EM-9300			
		2006-08	Trans - Front		1			EM-9301	
		2005	Trans - Front	Auto	1			EM-8898	
		2003-04	Trans - Front	Auto	1			EM-8898	
		2006-08	Trans - Rear		1			EM-9298	
		2005	Trans - Rear	Auto	1			EM-8986	
		2003-04	Trans - Rear	Auto	1			EM-8986	
		2009-14	Trans		1			EM-9512	

# Engine, Transmission, And Torque Strut Mounts

CYL	ENG. SIZE	YEAR	LOCATION	DESCRIPTION	QTY	ENGINE	TORQUE STRUT	TRANS-MISSION
<b>HONDA TRUCK</b>								
<b>RIDGELINE</b>								
V6	V6 3.5L 3471cc	2006-14	Front	Hydraulic Mount	1	EM-9441		
		2017-18	Rear		1	EM-7300		
		2006-14	Rear		1	EM-9300		
		2009-14	Trans - Front		1			EM-9594
		2006-08	Trans - Front		1			EM-9301
		2009-14	Trans - Rear		1			EM-7085
		2006-08	Trans - Rear		1			EM-7085
<b>HONDA VAN</b>								
<b>WAGOVAN</b>								
L4	L4 1.5L	1986-87	Front		1	EM-8018		
		1984	Front		1	EM-8018		
		1986-87	Rear		1	EM-2451		
		1984	Rear		1	EM-2451		
		1986-87	Trans		1			EM-8004
		1984	Trans		1			EM-8004
<b>ODYSSEY</b>								
L4	L4 2.2L 2156cc	1995-97	Front		1	EM-8026		
			LH Front		1	EM-8404		
			Rear	w/ Solenoid Valve	1	EM-8984		
			Rear	w/o Solenoid Valve	1	EM-8011		
			Trans		1			EM-8002
	L4 2.3L 2234cc	1998	Front		1	EM-8026		
			LH Front		1	EM-8404		
			Rear	w/ Solenoid Valve	1	EM-8984		
			Rear	w/o Solenoid Valve	1	EM-8011		
V6	V6 3.5L 3471cc	2011-17	Front		1	EM-5793		
		2008-10	Front	VTEC Engine; VTEC Engine	1	EM-5925		
			Front	I-VTEC Engine; i-VTEC Engine	1	EM-5793		
		2007	Front	EX & LX	1	EM-9247		
			Front	EX-L & Touring	1	EM-5840		
		2005-06	Front	EX & LX	1	EM-9247		
			Front	EX-L & Touring	1	EM-5840		
		2011-17	RH Front		1	EM-9415		
		2008-10	RH Front	VTEC Engine	1	EM-9415		
			RH Front	I-VTEC Engine	1	EM-9415		
		2007	RH Front		1	EM-9415		
		2005-06	RH Front		1	EM-9411		
		2008-10	Rear	VTEC Engine; VTEC Engine	1	EM-9431		
			Rear	I-VTEC Engine; i-VTEC Engine	1	EM-5904		
		2007	Rear	EX & LX	1	EM-9431		
			Rear	EX-L & Touring	1	EM-5795		
		2005-06	Rear	EX & LX	1	EM-9431		
			Rear	EX-L & Touring	1	EM-5795		
		2007-10	Trans - Front		1			EM-9530
		2005-06	Trans - Front		1			EM-8898
		2007-10	Trans - Rear		1			EM-9427
		2005-06	Trans - Rear		1			EM-9423
		2014-16	Trans	Auto	1			EM-5956
		2011-13	Trans	Auto; 5 Spd	1			EM-9512
	Trans		Auto; 6 Spd	1			EM-5956	
	V6 3.5L 3474cc	1999-04	Front		1	EM-9441		
			RH Front		1	EM-8974#		
			Rear		1	EM-9202		
			Trans - Front	Auto	1			EM-8898
			Trans - Rear	Auto	1			EM-8986

# = Available in the Westar Gold Line

# Engine, Transmission, And Torque Strut Mounts

CYL	ENG. SIZE	YEAR	LOCATION	DESCRIPTION	QTY	ENGINE	TORQUE STRUT	TRANSMISSION
<b>HUMMER</b>								
<b>H1</b>								
V8	V8 6.5L 395ci Diesel	2002-04	Front		2	EM-4001		
	V8 6.6L 400ci	2006	Front		2	EM-4001		
<b>H2</b>								
V8	V8 6.0L 364ci	2003-07	L & R Front		2	EM-2909#		
		2003-06	Trans		1			EM-2638
<b>H3</b>								
L5	L5 3.5L 211ci	2006	LH Front		1	EM-4015		
			RH Front		1	EM-4016		
			Trans		1			EM-4096
	L5 3.7L 223ci	2007-10	LH Front		1	EM-4015		
			RH Front		1	EM-4016		
			Trans		1			EM-4096
<b>HYUNDAI PASSENGER CAR</b>								
<b>ACCENT</b>								
L4	L4 1.5L 1495cc	2000-02	Front	Manual	1	EM-8958		
		1997-99	Front	Auto	1	EM-8747		
			Front	Manual	1	EM-8746		
		1996	Front	Auto	1	EM-8748		
			Front	Manual	1	EM-8750		
		1995	Front	Auto	1	EM-8680		
			Front	Manual	1	EM-8676		
		2000-02	LH Front		1	EM-8936		
		1997-99	LH Front		1	EM-8715		
		1996	LH Front		1	EM-8715		
		1995	LH Front	Complete Unit	1	EM-8253		
			LH Front	Insert Only	1	EM-8560		
		2000-02	Rear		1	EM-8937		
		1997-99	Rear		1	EM-8751		
		1996	Rear		1	EM-8677		
		1995	Rear		1	EM-8677		
		2001-02	Trans	Auto	1			EM-8939
			Trans	Manual	1			EM-8938
		2000	Trans	Auto	1			EM-8939
			Trans	Manual	1			EM-8938
		1998-99	Trans	Auto	1			EM-8726
			Trans	Manual	1			EM-8724
		1996-97	Trans	DOHC, Auto	1			EM-8727
			Trans	Manual	1			EM-8725
			Trans	SOHC, Auto	1			EM-8726
		1995	Trans	Auto	1			EM-8679
			Trans	Manual	1			EM-8678
	L4 1.6L 1591cc	2012-14	Front		1	EM-7062		
			Torq Str - Front		1		EM-7065	
		2012-17	Trans	Auto	1			EM-7090
			Trans	Manual	1			EM-7057
	L4 1.6L 1599cc	2006-11	Front Lower		1	EM-9309		
			Front Upper		1	EM-9324		
			Rear		1	EM-9310		
		2006-09	Trans		1			EM-9308
	L4 1.6L 1600cc	2003-05	Front	Auto	1	EM-9253		
			Front	Manual	1	EM-9255		
		2001-02	Front	Auto	1	EM-8935		
			Front	Manual	1	EM-8958		
		2003-05	LH Front		1	EM-8940		
		2001-02	LH Front		1	EM-8940		

# = Available in the Westar Gold Line

# Engine, Transmission, And Torque Strut Mounts

CYL	ENG. SIZE	YEAR	LOCATION	DESCRIPTION	QTY	ENGINE	TORQUE STRUT	TRANSMISSION	
<b>HYUNDAI PASSENGER CAR (continued)</b>									
<b>ACCENT (continued)</b>									
L4	L4 1.6L 1600cc	2003-05	Rear	Auto	1	EM-9352			
			Rear	Manual	1	EM-9254			
		2001-02	Rear		1	EM-8937			
		2003-05	Trans	Auto	1			EM-9296	
			Trans	Manual	1			EM-9295	
		2001-02	Trans	Auto	1			EM-8941	
			Trans	Manual	1			EM-8938	
<b>AZERA</b>									
V6	V6 3.3L 3342cc	2012-17	Front		1	EM-9317			
		2011	Front		1	EM-7207			
		2007-10	Front		1	EM-9317			
		2012-17	RH Front		1	EM-7092			
		2011	RH Front	Complete Unit	1	EM-9353			
			RH Front	Insert Only	1	EM-9340			
		2007-10	RH Front	Complete Unit	1	EM-9353			
			RH Front	Insert Only	1	EM-9340			
		2012-17	Rear		1	EM-9354			
		2011	Rear		1	EM-9354			
		2007-10	Rear		1	EM-9354			
			Trans		1			EM-9370	
		V6 3.8L 3778cc	2011	Front		1	EM-7207		
	2006-10		Front		1	EM-9317			
	2011		RH Front	Complete Unit	1	EM-9353			
			RH Front	Insert Only	1	EM-9340			
	2006-10		RH Front	Complete Unit	1	EM-9353			
			RH Front	Insert Only	1	EM-9340			
	2011		Rear		1	EM-9354			
	2006-10		Rear		1	EM-9354			
			Trans		1			EM-9370	
	<b>ELANTRA</b>								
	L4	L4 1.6L 1596cc	1994-95	Front	Auto	1	EM-8596		
Front				Manual	1	EM-8759			
1992-93			Front	Auto	1	EM-8596			
			Front	Manual	1	EM-8759			
1994-95			LH Front	Auto	1	EM-8255			
			LH Front	Manual	1	EM-8718			
1992-93			LH Front	Auto	1	EM-8255			
			LH Front	Manual	1	EM-8716			
1994-95			Rear	Auto	1	EM-8774			
			Rear	Manual	1	EM-8771			
1992-93			Rear	Auto	1	EM-8774			
			Rear	Manual	1	EM-8771			
1994-95			Trans	Auto	1			EM-8040	
			Trans	Manual	1			EM-8731	
1992-93			Trans	Auto	1			EM-8040	
		Trans	Manual	1			EM-8730		
L4 1.8L 1795cc		1996-98	Front		1	EM-8762			
			RH Front		1	EM-8719			
			Rear	Auto	1	EM-8778			
			Rear	Manual	1	EM-8775			
			Trans	Auto	1			EM-8734	
		Trans	Manual	1			EM-8733		
L4 1.8L 1797cc		2011-16	Front	Made in Korea	1	EM-7057			
	Front		Made in USA	1	EM-7064				
	2014-16	Torq Str - Front		1		EM-7066			
	2013	Torq Str - Front	Exc. GT	1		EM-7066			

## Engine, Transmission, And Torque Strut Mounts

CYL	ENG. SIZE	YEAR	LOCATION	DESCRIPTION	QTY	ENGINE	TORQUE STRUT	TRANSMISSION
<b>HYUNDAI PASSENGER CAR (continued)</b>								
<b>ELANTRA (continued)</b>								
L4	L4 1.8L 1797cc	2011-12	Torg Str - Front		1		EM-7066	
		2011-16	Trans		1			EM-7090
			Trans	Manual	1			EM-7160
	L4 1.8L 1836cc	1994-95	Front	Auto	1	EM-8042		
Front			Manual	1	EM-8760			
1993		Front	Auto	1	EM-8042			
		Front	Manual	1	EM-8760			
1994-95		LH Front	Auto	1	EM-8717			
		LH Front	Manual	1	EM-8718			
1993		LH Front	Auto	1	EM-8255			
		LH Front	Manual	1	EM-8716			
1994-95		Rear	Auto	1	EM-8774			
		Rear	Manual	1	EM-8772			
1993		Rear	Auto	1	EM-8774			
		Rear	Manual	1	EM-8772			
1994-95		Trans	Auto	1			EM-8732	
		Trans	Manual	1			EM-8731	
1993		Trans	Auto	1			EM-8732	
	Trans	Manual	1			EM-8730		
L4 2.0L 1975cc	2012	Front	Auto	1	EM-9357			
		Front	Manual	1	EM-9377			
	2011	Front	Auto	1	EM-9357			
		Front	Manual	1	EM-9377			
	2009-10	Front	Auto; Exc. Touring Edition	1	EM-7113			
		Front	Auto; Touring Edition	1	EM-9357			
		Front	Manual	1	EM-9377			
	2007-08	Front	Auto	1	EM-7113			
		Front	Manual	1	EM-9377			
	2001-06	Front	Auto	1	EM-8943			
		Front	Manual	1	EM-8943			
	1999-00	Front	Auto	1	EM-8764			
		Front	Manual	1	EM-8762			
	2011	RH Front		1	EM-9345			
	2009-10	RH Front		1	EM-9345			
	2007-08	RH Front		1	EM-9345			
	2001-06	RH Front		1	EM-8944			
	1999-00	RH Front		1	EM-8719			
	2011	Rear		1	EM-9316			
	2009-10	Rear		1	EM-9316			
	2007-08	Rear		1	EM-9316			
	2001-06	Rear	Auto	1	EM-8945			
		Rear	Manual	1	EM-8945			
	1999-00	Rear	Auto	1	EM-8778			
		Rear	Manual	1	EM-8775			
	2012	Right		1	EM-9345			
	2007-12	Trans		1			EM-9339	
	2001-06	Trans	Auto	1			EM-9376	
		Trans	Manual	1			EM-8947	
	1999-00	Trans	Auto	1			EM-8734	
		Trans	Manual	1			EM-8733	
	L4 2.0L 1999cc	2017-19	RH Front		1	EM-7064		
			Torg Str - Front		1		EM-7065	
2014-16		Trans	Manual	1			EM-7160	

# Engine, Transmission, And Torque Strut Mounts

CYL	ENG. SIZE	YEAR	LOCATION	DESCRIPTION	QTY	ENGINE	TORQUE STRUT	TRANSMISSION
<b>HYUNDAI PASSENGER CAR (continued)</b>								
<b>ELANTRA GT</b>								
L4	L4 1.8L 1797cc	2013	Trans	Auto	1			EM-7090
			Trans	Manual	1			EM-7160
<b>EQUUS</b>								
V8	V8 4.6L 4627cc	2011	LH Front		1	EM-5881		
			RH Front		1	EM-5882		
			Trans - L & R	Insert	2			EM-7112
	V8 5.0L 5038cc	2012-16	LH Front		1	EM-5881		
			RH Front		1	EM-5882		
			Trans - L & R	Insert	2			EM-7112
<b>EXCEL</b>								
L4	L4 1.5L 1468cc	1990-94	Front		1	EM-8103		
		1986-89	Front		1	EM-8933		
		1990-94	LH Front		1	EM-8039		
			Rear		1	EM-8672		
		1986-89	Rear	Auto	1	EM-8803		
		1990-94	Torq Str - Front		1		EM-8047	
		1986-89	Torq Str - Front	Complete Unit; Auto	1		EM-8932	
			Torq Str - Front	Complete Unit; Manual	1		EM-8045	
			Torq Str - Front	Insert Only; Large (70mm) Bushing	1		EM-5453	
			Torq Str - Front	Insert Only; Small (50mm) Bushing	1		EM-5398	
		1990-94	Trans	Auto	1			EM-8675
Trans	Manual		1			EM-8674		
1986-89	Trans	Auto	1			EM-8934		
<b>GENESIS</b>								
V6	V6 3.8L 3778cc	2009-11	L & R Front		2	EM-9344		
		2012-14	Trans - L & R	Insert	2			EM-7112
		2010-11	Trans - L & R	Insert	2			EM-7112
		2009	Trans - L & R	Insert	2			EM-7112
		2010-11	Trans	Complete Unit	1			EM-9356
			2009	Trans	Complete Unit; After 5/1/08	1		EM-9356
			Trans	Complete Unit; Before 4/30/08	1			EM-9350
V8	V8 4.6L 4627cc	2009-12	LH Front		1	EM-5881		
			RH Front		1	EM-5882		
			Trans - L & R	Insert	2			EM-7112
	V8 5.0L 5038cc	2012-16	LH Front		1	EM-5881		
			RH Front		1	EM-5882		
			2012-14	Trans - L & R	Insert	2		
<b>GENESIS COUPE</b>								
L4	L4 2.0L 1998cc	2010-12	RH Front		1	EM-7153		
V6	V6 3.8L 3778cc	2010-12	L & R Front		2	EM-9344		
			Trans		1			EM-9356
<b>SCOPE</b>								
L4	L4 1.5L 1468cc	1991-92	Front		1	EM-8103		
			RH Front	Auto	1	EM-8675		
			RH Front	Manual	1	EM-8674		
			Rear		1	EM-8672		
			Torq Str - Right	Manual	1		EM-8047	
			Trans	Auto	1			EM-8039
			Trans	Manual	1			EM-8039
	L4 1.5L 1495cc	1993-95	Front	Auto	1	EM-8596		
			Front	Manual	1	EM-8759		
			RH Front		1	EM-8254		
			Rear	Auto	1	EM-8752		

# Engine, Transmission, And Torque Strut Mounts

CYL	ENG. SIZE	YEAR	LOCATION	DESCRIPTION	QTY	ENGINE	TORQUE STRUT	TRANSMISSION	
<b>HYUNDAI PASSENGER CAR (continued)</b>									
<b>SCOUPE (continued)</b>									
L4	L4 1.5L 1495cc	1993-95	Rear	Manual	1	EM-8753			
			Trans	Auto	1			EM-8728	
			Trans	Manual	1			EM-8729	
<b>SONATA</b>									
L4	L4 2.0L 1997cc	1998	Front	Auto	1	EM-8788			
			Front	Manual	1	EM-8788			
		1997	Front	Auto	1	EM-8788			
			Front	Manual	1	EM-8788			
		1995-96	Front	Auto	1	EM-8597			
		1992-94	Front	Auto	1	EM-8599			
			Front	Manual	1	EM-8598			
		1998	LH Front	Auto	1	EM-8721			
			LH Front	Manual	1	EM-8790			
		1997	LH Front	Auto	1	EM-8721			
			LH Front	Manual	1	EM-8790			
		1995-96	LH Front		1	EM-8595			
		1992-94	LH Front	Auto	1	EM-8736			
			LH Front	Manual	1	EM-9206			
		1998	Rear	Auto	1	EM-8781			
			Rear	Manual	1	EM-8782			
		1997	Rear	Auto	1	EM-8781			
			Rear	Manual	1	EM-8782			
		1995-96	Rear	Auto	1	EM-8781			
			Rear	Manual	1	EM-8780			
		1992-94	Rear	Auto	1	EM-8041			
			Rear	Manual	1	EM-8041			
		1997-98	Trans	Auto	1			EM-8741	
			Trans	Manual	1			EM-8791	
		1995-96	Trans	Auto	1			EM-8741	
			Trans	Manual	1			EM-8738	
		1992-94	Trans	Auto	1			EM-8757	
			Trans	Manual	1			EM-8755	
		L4 2.0L 1998cc	2011-14	Right		1	EM-7092		
				Trans		1			EM-5996
		L4 2.4L 2351cc	2005	Front		1	EM-9317		
				2002-04	Front	Auto	1	EM-8769	
				Front	Manual	1	EM-8770		
	1999-01		Front		1	EM-8768			
	1989-91		Front		1	EM-8042			
			LH Front		1	EM-8044			
	2005		RH Front	Korea Built; 6/05 - 12/05	1	EM-9353			
			RH Front	US Built	1	EM-9353			
	2002-04		RH Front		1	EM-8722			
	1999-01		RH Front		1	EM-8722			
	2005		Rear		1	EM-9318			
	2002-04		Rear		1	EM-8783			
	1999-01		Rear		1	EM-8783			
	1989-91		Rear		1	EM-8041			
	2005		Trans	Korea Built; 3/05 - 6/05	1			EM-7225	
			Trans	Korea Built; 6/05 - 12/05	1			EM-9373	
			Trans	Manual	1			EM-9367	
			Trans	US Built	1			EM-9373	
	2002-04		Trans	Auto	1			EM-9373	
			Trans	Manual	1			EM-9367	
	1999-01		Trans	Auto	1			EM-8744	
			Trans	Manual	1			EM-8743	
	1989-91		Trans	Auto	1			EM-8756	

# Engine, Transmission, And Torque Strut Mounts

CYL	ENG. SIZE	YEAR	LOCATION	DESCRIPTION	QTY	ENGINE	TORQUE STRUT	TRANSMISSION	
HYUNDAI PASSENGER CAR (continued)									
SONATA (continued)									
L4	L4 2.4L 2351cc	1989-91	Trans	Manual	1			EM-8754	
	L4 2.4L 2359cc	2011-14	Front	Gas; Auto	1	EM-7091			
		2009-10	Front		1	EM-9317			
		2006-08	Front		1	EM-9317			
			RH Front	Complete Unit	1	EM-9353			
			RH Front	Insert Only	1	EM-9340			
		2011-14	Rear	Gas	1	EM-7087			
		2009-10	Rear		1	EM-9318			
		2006-08	Rear		1	EM-9318			
		2011-14	Right	Gas; w/ Sport Suspension	1	EM-7092			
			Right	Gas; w/ Standard Suspension	1	EM-7093			
			Right	Hybrid; Hybrid	1	EM-7092			
		2009-10	Right	Complete Unit	1	EM-5936			
		2013-14	Trans	Gas; Auto; Sport Suspension	1			EM-5996	
			Trans	Gas; Auto; Standard Suspension	1			EM-7034	
		2011-14	Trans	Hybrid; Auto	1			EM-5996	
		2011-12	Trans	Gas; Auto; Sport Suspension	1			EM-5996	
			Trans	Gas; Auto; Standard Suspension	1			EM-7034	
			Trans	Gas; Manual; Standard Suspension	1			EM-7035	
		2009-10	Trans	Auto	1			EM-9381	
		Trans	Manual	1			EM-9361		
	2006-08	Trans		1			EM-9361		
V6	V6 2.5L 2493cc	1999-01	Front	Auto	1	EM-8769			
			Front	Manual	1	EM-8768			
			RH Front		1	EM-8723			
			Rear		1	EM-8783			
			Trans	Auto	1		EM-8745		
			Trans	Manual	1		EM-8743		
	V6 2.7L 2656cc	2004-05	2002-03	Front		1	EM-8769		
				Front	Auto	1	EM-8769		
				Front	Manual	1	EM-8770		
				RH Front		1	EM-8723		
				RH Front		1	EM-8723		
				Rear		1	EM-8783		
				Rear	Auto	1	EM-8784		
				Rear	Manual	1	EM-8783		
	Trans	Auto	1		EM-9373				
	Trans	Manual	1		EM-9367				
	V6 3.0L 2972cc	1997-98	1995-96	Front		1	EM-8597		
				Front		1	EM-8597		
				Front		1	EM-8680		
				Front		1	EM-2673		
				LH Front		1	EM-8787		
				LH Front		1	EM-8786		
				LH Front		1	EM-8742		
				LH Front		1	EM-8740		
				Rear		1	EM-9365		
				Rear		1	EM-9365		
				Rear		1	EM-8041		
				Rear		1	EM-8041		
				Trans		1		EM-8789	
				Trans		1		EM-8791	
Trans		1		EM-8756					
Trans		1		EM-8758					



## Engine, Transmission, And Torque Strut Mounts

CYL	ENG. SIZE	YEAR	LOCATION	DESCRIPTION	QTY	ENGINE	TORQUE STRUT	TRANS-MISSION			
<b>HYUNDAI PASSENGER CAR (continued)</b>											
<b>SONATA (continued)</b>											
V6	V6 3.3L 3342cc	2009-10	Front		1	EM-9317					
		2006-08	Front		1	EM-9317					
		2009-10	RH Front	Complete Unit	1	EM-9363					
		2006-08	RH Front	Complete Unit	1	EM-9353					
		2009-10	Rear		1	EM-9318					
		2006-08	Rear		1	EM-9318					
		2006-10	Trans		1			EM-9370			
<b>TIBURON</b>											
L4	L4 1.8L 1795cc	1997	Front		1	EM-8762					
			RH Front		1	EM-8719					
			Rear	Auto	1	EM-8778					
			Rear	Manual	1	EM-8775					
			Trans	Auto	1			EM-8734			
			Trans	Manual	1			EM-8733			
	L4 2.0L 1975cc	2007-08 2006 2003-05 1998-01 1997 2007-08 2006 2003-05 1998-01 1997 2007-08 2006 2003-05 1998-01 1997 2007-08 2006 2003-05 2007-08 2006 2003-05 1998-01 1997 2003-08 1997-01	Front		1	EM-8943					
			Front		1	EM-8943					
			Front		1	EM-8943					
			Front	Auto	1	EM-8764					
			Front	Manual	1	EM-8762					
			Front		1	EM-8762					
			RH Front		1	EM-9372					
			RH Front		1	EM-9379					
			RH Front		1	EM-8944					
			RH Front		1	EM-8719					
			RH Front		1	EM-8719					
			RH Rear	Manual	1	EM-5533					
			RH Rear	Manual	1	EM-5533					
			RH Rear	Manual	1	EM-5533					
			Rear		1	EM-8945					
			Rear		1	EM-8945					
			Rear		1	EM-8945					
			Rear	Auto	1	EM-8778					
			Rear	Manual	1	EM-8775					
			Rear	Auto	1	EM-8778					
			Rear	Manual	1	EM-8775					
			Trans	Auto	1			EM-9376			
			Trans	Manual	1			EM-9376			
			Trans	Auto	1			EM-8734			
			Trans	Manual	1			EM-8733			
			V6	V6 2.7L 2656cc	2007-08	Front		1	EM-9307		
					2005-06	Front		1	EM-9307		
2003-04	Front				1	EM-9307					
2007-08	RH Front				1	EM-9372					
2005-06	RH Front	Auto			1	EM-9372					
	RH Front	Manual			1	EM-9358					
2003-04	RH Front	Auto			1	EM-9372					
	RH Front	Manual			1	EM-9358					
	RH Rear	Manual			1	EM-5533					
2007-08	Rear	Auto			1	EM-9314					
	Rear	Manual			1	EM-8945					
2005-06	Rear	Auto			1	EM-9314					
	Rear	Manual			1	EM-8945					
2003-04	Rear	Auto			1	EM-9314					
	Rear	Manual			1	EM-8945					
2005-08	Trans	Auto			1			EM-9366			
	Trans	Manual; 5 Spd			1			EM-9369			
	Trans	Manual; 6 Spd			1			EM-9364			

# Engine, Transmission, And Torque Strut Mounts

CYL	ENG. SIZE	YEAR	LOCATION	DESCRIPTION	QTY	ENGINE	TORQUE STRUT	TRANSMISSION		
<b>HYUNDAI PASSENGER CAR (continued)</b>										
<b>TIBURON (continued)</b>										
V6	V6 2.7L 2656cc	2003-04	Trans	Auto	1			EM-9366		
			Trans	Manual	1			EM-8947		
<b>VELOSTER</b>										
L4	L4 1.6L 1591cc	2012-14	Front		1	EM-7062				
			2012-16	Torq Str - Front		1		EM-7065		
		2012-16	Trans	Auto (Dual Clutch)	1			EM-7090		
			Trans	Manual	1			EM-7057		
<b>XG300</b>										
V6	V6 3.0L 2972cc	2001	Front		1	EM-8948				
			RH Front		1	EM-8949				
			Rear		1	EM-8950				
			Trans		1			EM-8951		
<b>XG350</b>										
V6	V6 3.5L 3500cc	2002-05	Front		1	EM-8948				
			RH Front		1	EM-8949				
			Rear		1	EM-8950				
			Trans		1			EM-8951		
<b>HYUNDAI SPORT UTILITY</b>										
<b>SANTA FE</b>										
L4	L4 2.4L 2351cc	2004-06	Front	Auto	1	EM-8952				
			Front	Manual	1	EM-8953				
		2001-03	Front	Auto	1	EM-8952				
			Front	Manual	1	EM-8953				
		2004-06	RH Front		1	EM-8954				
			2001-03	RH Front		1	EM-8954			
		L4 2.4L 2359cc	2010-12	Rear	Auto	1	EM-8955			
				Front		1	EM-5883			
	Rear			AWD	1	EM-7061				
	Rear			FWD	1	EM-7110				
	Trans			Auto	1			EM-7060		
	V6	V6 2.7L 2656cc	2007-09	Front		1	EM-9348			
				2001-06	Front		1	EM-8952		
2007-09			RH Front		1	EM-9355				
			2001-06	RH Front		1	EM-8954			
2007-09			Rear		1	EM-9315				
			2001-06	Rear		1	EM-8955			
V6 3.3L 3342cc			2007-09	Trans	4WD	1			EM-8957	
				Trans	FWD	1			EM-8956	
		Front			1	EM-9348				
V6 3.5L 3471cc		2010-12	RH Front		1	EM-9355				
			Rear		1	EM-9315				
			Front		1	EM-5883				
			Rear	FWD	1	EM-7110				
			Right		1	EM-9355				
V6 3.5L 3500cc		2003-06	Trans		1			EM-7060		
	Front			1	EM-9371					
L4	L4 2.0L 1975cc	2005-09	Front		1	EM-9322				
			RH Front		1	EM-9368				
			Rear		1	EM-9306				
		2011-13	Right		1	EM-7104				
		2011-14	Torq Str - Lower		1		EM-7105			
		2014-15	Trans	Auto	1			EM-7214		
		<b>TUCSON</b>								

## Engine, Transmission, And Torque Strut Mounts

CYL	ENG. SIZE	YEAR	LOCATION	DESCRIPTION	QTY	ENGINE	TORQUE STRUT	TRANS-MISSION
<b>HYUNDAI SPORT UTILITY (continued)</b>								
<b>TUCSON (continued)</b>								
L4	L4 2.0L 1975cc	2011-13	Trans	Auto	1			EM-7056
		2005-09	Trans	Auto	1			EM-9374
			Trans	Manual	1			EM-9380
	L4 2.0L 1999cc	2014-15	Right		1	EM-7289		
	L4 2.4L 2359cc	2010-13	Right		1	EM-7104		
		2010-15	Torq Str - Lower		1		EM-7105	
		2010-13	Trans	Auto	1			EM-7056
V6	V6 2.7L 2656cc	2005-09	Front		1	EM-9338		
			RH Front		1	EM-9368		
			Rear		1	EM-9306		
		2005-08	Trans	Auto	1			EM-9378
<b>VERACRUZ</b>								
V6	V6 3.8L 3778cc	2007-12	Front		1	EM-9348		
			RH Front		1	EM-9355		
			Rear	AWD	1	EM-9315		
			Trans	Auto	1			EM-9341
<b>HYUNDAI VAN</b>								
<b>ENTOURAGE</b>								
V6	V6 3.8L 3778cc	2007-08	Front		1	EM-9375		
			RH Front		1	EM-9343		
			Rear		1	EM-9347		
			Trans		1			EM-9349
<b>INFINITI PASSENGER CAR</b>								
<b>G20</b>								
L4	L4 2.0L 1998cc	1991-96	Center Front	Manual	1	EM-5468		
			Lower	Manual				
			Front	Auto	1	EM-8858		
			RH Front	Auto	1	EM-5131		
			Rear		1	EM-7286		
			Trans	Auto	1			EM-9288
		Manual	1			EM-5332		
	L4 2.0L 2000cc	1999-02	Front		1	EM-8682		
		Rear		1	EM-8681			
		Trans - BUSHING	Bushing Only; Auto Bushing Only; Auto	1			EM-9224	
<b>G25</b>								
V6	V6 2.5L	2011-12	L & R Front	AWD	2	EM-7193		
			L & R Front	RWD	2	EM-7008		
<b>G35</b>								
V6	V6 3.5L 3498cc	2007-08	L & R Front	AWD	2	EM-7193		
			L & R Front	RWD	2	EM-7008		
		2004-06	L & R Front	2 Door	1	EM-9180		
			L & R Front	Sedan; 2WD	1	EM-9416		
		2003	L & R Front	Coupe	1	EM-9180		
			L & R Front	Sedan	1	EM-9416		
		2004-06	LH Front	Sedan; AWD	1	EM-5776		
			RH Front	Sedan; AWD	1	EM-9416		
		2004-08	Trans	AWD	1			EM-5911
			Trans	RWD	1			EM-9464
		2003	Trans	RWD	1			EM-9464

# Engine, Transmission, And Torque Strut Mounts

CYL	ENG. SIZE	YEAR	LOCATION	DESCRIPTION	QTY	ENGINE	TORQUE STRUT	TRANSMISSION
<b>INFINITI PASSENGER CAR (continued)</b>								
<b>G37</b>								
V6	V6 3.7L 3696cc	2012-13	Front	RWD	1	EM-7008		
		2009-11	Front	RWD	1	EM-7008		
		2008	Front	RWD	1	EM-7008		
		2012-13	L & R Front	AWD	2	EM-7193		
		2009-11	L & R Front	AWD	2	EM-7193		
		2008-13	Trans	RWD	1			EM-7058
<b>I30</b>								
V6	V6 3.0L 2988cc	2000-01	Front	w/ Wires	1	EM-5670		
			Front	w/o Wires	1	EM-5132		
		1998-99	Front	Auto, w/ Wires	1	EM-5670		
			Front	Auto. w/o Wires	1	EM-5132		
		1996-97	Front	Auto, w/ Wires	1	EM-5670		
			Front	Auto. w/o Wires	1	EM-5132		
			Front	Manual	1	EM-8865		
		2000-01	RH Front		1	EM-9251		
		1998-99	RH Front		1	EM-9031		
		1996-97	RH Front		1	EM-9031		
		2000-01	Rear	w/ Wires	1	EM-5655		
			Rear	w/o Wires	1	EM-9634		
		1998-99	Rear	Auto	1	EM-5774		
			Rear	Manual	1	EM-8866		
		1996-97	Rear		1	EM-8866		
		2000-01	Trans - BUSHING	Bushing Only; Auto Bushing Only; Auto	1			EM-8959
		1997-99	Trans - BUSHING	Bushing Only; Auto Bushing Only; Auto	1			EM-8959
			Trans - BUSHING	Bushing Only; Manual Bushing Only; Manual	1			EM-9035
		1996	Trans - BUSHING	Bushing Only; Auto Bushing Only; Auto	1			EM-5937
			Trans - BUSHING	Bushing Only; Manual Bushing Only; Manual	1			EM-9035
<b>I35</b>								
V6	V6 3.5L 3498cc	2002-04	Front	w/ Wires	1	EM-5670		
			Front	w/o Wires	1	EM-5132		
			RH Front		1	EM-9031		
			Rear	w/ Wires	1	EM-5655		
			Rear	w/o Wires	1	EM-9634		
			Trans		1			EM-8959
<b>M35</b>								
V6	V6 3.5L 3498cc	2009-10	L & R Front	RWD	2	EM-7008		
		2006-10	Trans	AWD	1			EM-5911
			Trans	RWD	1			EM-7058
<b>M37</b>								
V6	V6 3.7L 3696cc	2011-13	L & R Front	AWD	2	EM-7193		
			L & R Front	RWD	2	EM-7008		
			Trans	RWD	1			EM-7058
<b>M45</b>								
V8	V8 4.5L 4494cc	2006-10	Trans	RWD	1			EM-7058
	V8 4.5L 4500cc	2003-04	Trans	RWD	1			EM-9464
<b>M56</b>								
V8	V8 5.6L 5552cc	2011-13	L & R Front	AWD	2	EM-7193		

## Engine, Transmission, And Torque Strut Mounts

CYL	ENG. SIZE	YEAR	LOCATION	DESCRIPTION	QTY	ENGINE	TORQUE STRUT	TRANSMISSION
<b>INFINITI PASSENGER CAR (continued)</b>								
<b>Q40</b>								
V6	V6 3.7L 3696cc	2015	L & R Front	AWD	2	EM-7193		
			L & R Front	RWD	2	EM-7008		
			Trans	RWD	1			EM-7058
<b>Q45</b>								
V8	V8 4.5L 4494cc	2002-06	Trans		1			EM-9464
		1990-96	Trans		1			EM-5948
<b>Q50</b>								
V6	V6 3.0L 2997cc	2016-18	L & R Front	AWD	2	EM-7193		
			L & R Front	RWD	2	EM-7008		
	V6 3.5L 3498cc	2014-18	L & R Front	AWD	2	EM-7193		
			L & R Front	RWD	2	EM-7008		
	V6 3.7L 3696cc	2014-15	L & R Front	AWD	2	EM-7193		
			L & R Front	RWD	2	EM-7008		
2014	Trans	RWD	1			EM-7058		
<b>Q60</b>								
V6	V6 3.7L 3696cc	2014-15	L & R Front	AWD	2	EM-7193		
			L & R Front	RWD	2	EM-7008		
		2014	Trans	RWD	1			EM-7058
<b>Q70</b>								
V6	V6 3.7L 3696cc	2014-15	LH Front	AWD; US & Canada	1	EM-7193		
			Right	AWD; US & Canada	1	EM-7128		
			Trans	RWD	1			EM-7058
V8	V8 5.6L 5552cc	2014-18	L & R Front	AWD	2	EM-7193		
<b>INFINITI SPORT UTILITY</b>								
<b>EX35</b>								
V6	V6 3.5L 3498cc	2008-12	L & R Front	AWD	2	EM-7193		
			L & R Front	RWD	2	EM-7008		
			Trans	AWD	1			EM-5911
			Trans	RWD	1			EM-7058
<b>EX37</b>								
V6	V6 3.7L 3696cc	2013	L & R Front	AWD	2	EM-7193		
			L & R Front	RWD	2	EM-7008		
			Trans	RWD	1			EM-7058
<b>FX35</b>								
V6	V6 3.5L 3498cc	2009-12	L & R Front	RWD	2	EM-7008		
		2003-08	L & R Front	2WD	2	EM-9416		
		2009-12	LH Front	AWD	1	EM-7193		
		2003-08	LH Front	AWD	1	EM-5776		
		2009-12	RH Front	AWD	1	EM-7128		
		2003-08	RH Front	AWD	1	EM-9416		
		2009-12	Trans	RWD	1			EM-7058
		2003-08	Trans	AWD	1			EM-5911
			Trans	RWD	1		EM-9464	
<b>FX37</b>								
V6	V6 3.7L 3696cc	2013	L & R Front	2WD	2	EM-7008		
			LH Front	AWD	1	EM-7193		
			RH Front	AWD	1	EM-7128		
			Trans	RWD	1			EM-7058

# Engine, Transmission, And Torque Strut Mounts

CYL	ENG. SIZE	YEAR	LOCATION	DESCRIPTION	QTY	ENGINE	TORQUE STRUT	TRANSMISSION
<b>INFINITI SPORT UTILITY (continued)</b>								
<b>FX50</b>								
V8	V8 5.0L 5026cc	2009-13	Right	AWD	1	EM-7128		
<b>JX35</b>								
V6	V6 3.5L 3498cc	2013	Front	AWD	1	EM-7333		
			Front	FWD	1	EM-5869		
			Rear	FWD	1	EM-7175		
			Right		1	EM-5866		
			Torq Str - Front		1		EM-7171	
			Torq Str - Rear		1		EM-9551	
<b>QX4</b>								
V6	V6 3.3L 3275cc	1997-00	L & R Front		2	EM-8311		
			Trans	Auto; 4WD	1		EM-9038	
	V6 3.5L 3498cc	2001-03	L & R Front		2	EM-9408		
			Trans	Auto; 4WD	1		EM-9395	
			Trans	Auto; RWD	1		EM-8322	
<b>QX50</b>								
V6	V6 3.7L 3696cc	2014-17	L & R Front	AWD	2	EM-7193		
			L & R Front	RWD	2	EM-7008		
		2014-15	Trans	RWD	1		EM-7058	
<b>QX56</b>								
V8	V8 5.6L 5552cc	2004-11	L & R Front		2	EM-5404		
			2012-13	Trans	4WD; US & Canada	1		EM-5407
		2012-13	Trans	AWD; Mexico Vehicle	1		EM-5407	
			Trans	RWD	1		EM-5406	
			2004-11	Trans	4WD	1		EM-5407
		2004-11	Trans	RWD	1		EM-5406	
<b>QX60</b>								
L4	L4 2.5L 2488cc	2014-15	Torq Str - Rear	Hybrid	1		EM-7126	
	L4 2.5L 2500cc	2014-15	Trans	Auto	1			EM-7234
V6	V6 3.5L 3498cc	2014-18	Front	AWD	1	EM-7333		
			Front	FWD	1	EM-5869		
			Rear	FWD	1	EM-7175		
			Right		1	EM-5866		
		2014-15	Torq Str - Front		1		EM-7171	
			Torq Str - Rear		1		EM-9551	
<b>QX70</b>								
V6	V6 3.7L 3696cc	2014-17	L & R Front	RWD; US & Canada	2	EM-7008		
			LH Front	AWD	1	EM-7193		
			Right	AWD	1	EM-7128		
		2014	Trans	RWD	1		EM-7058	
V8	V8 5.0L 5026cc	2014-18	L & R Front	AWD	2	EM-7193		
<b>ISUZU PASSENGER CAR</b>								
<b>I-MARK</b>								
L4	L4 1.5L	1985-89	Front		1	EM-8442		
			Rear		1	EM-8826		
	L4 1.5L 1471cc	1985-89	Torq Str - Front	Complete Unit	1		EM-8438	
			Torq Str - Front	Insert Only	1		EM-8539	
			Trans	Auto	1			EM-8439
			Trans	Manual	1			EM-8439
	L4 1.6L	1989	Torq Str - Front	Complete Unit	1		EM-8438	
			Torq Str - Front	Insert Only	1		EM-8539	
	L4 1.6L 1588cc	1989	Front		1	EM-8442		
			RH Front		1	EM-8439		
Trans				1			EM-8976	

# Engine, Transmission, And Torque Strut Mounts

CYL	ENG. SIZE	YEAR	LOCATION	DESCRIPTION	QTY	ENGINE	TORQUE STRUT	TRANSMISSION	
<b>ISUZU PASSENGER CAR (continued)</b>									
<b>I-MARK (continued)</b>									
L4	L4 1.6L 1588cc	1989	Trans		1			EM-8976	
	L4 1.8L 1817cc Diesel	1981-84	LH Front		1	EM-8621			
			LH Front		1	EM-8621			
<b>ISUZU SPORT UTILITY</b>									
<b>AMIGO</b>									
L4	L4 2.2L 2180cc	1998-00	LH Front		1	EM-8351			
			RH Front		1	EM-5812			
			Trans	Auto; 2WD	1			EM-5609	
			Trans	Auto; 4WD	1			EM-9142	
	L4 2.3L 2254cc	1989-93	LH Front		1	EM-8576			
			RH Front		1	EM-8579			
			Trans	Manual; 4WD	1			EM-9143	
			Trans	Manual; 4WD	1			EM-9143	
	L4 2.6L 2559cc	1989-94	LH Front		1	EM-8576			
			RH Front		1	EM-8579			
			Trans	Manual; 4WD	1			EM-9143	
			Trans	Manual; 4WD	1			EM-9143	
V6	V6 3.2L 3165cc	1998-00	RH Front		1	EM-5814			
			Trans	RWD	1			EM-8586	
<b>ASCENDER</b>									
L6	L6 4.2L 256ci	2003-08	L & R Front	Hydraulic Mount; RWD	2	EM-3021*			
		2003-07	Trans		1			EM-3027	
V8	V8 5.3L 325ci	2005-06	LH Front		1	EM-5694			
			RH Front		1	EM-5693			
<b>AXIOM</b>									
V6	V6 3.5L 3494cc	2002-04	LH Front		1	EM-5813			
			Trans	RWD	1			EM-5609	
<b>RODEO</b>									
L4	L4 2.2L 2180cc	1998-03	LH Front		1	EM-8351			
			RH Front		1	EM-5812			
			Trans	Auto	1			EM-5609	
			Trans	Manual	1			EM-5610	
	L4 2.6L 2559cc	1996-97	LH Front		1	EM-8499			
			LH Front	After 5/95	1	EM-8499			
		1995	LH Front	Before 5/95	1	EM-9141			
			LH Front		1	EM-9141			
		1996-97	RH Front		1	EM-8352			
			RH Front	After 5/95	1	EM-8352			
		1995	RH Front	Before 5/95	1	EM-9140			
			RH Front		1	EM-9140			
		1991-97	Trans	Auto; 2WD	1			EM-8586	
			Trans	Manual; 2WD	1			EM-8586	
	V6	V6 3.1L 3137cc	1991-92	LH Front		1	EM-9141		
				RH Front		1	EM-9140		
				Trans	Auto; 2WD	1			EM-8586
				Trans	Manual; 2WD	1			EM-8586
V6 3.2L 3165cc		2001-04	LH Front		1	EM-5813			
			LH Front		1	EM-8351			
			LH Front		1	EM-8351			
			LH Front		1	EM-8445			
			RH Front		1	EM-5814			
			RH Front		1	EM-8352			
1995	RH Front	After 5/95	1	EM-8352					
	RH Front	Before 5/95	1	EM-9144					

\* = Hydraulic Mount, "S" suffix = solid replacement.

# Engine, Transmission, And Torque Strut Mounts

CYL	ENG. SIZE	YEAR	LOCATION	DESCRIPTION	QTY	ENGINE	TORQUE STRUT	TRANSMISSION		
<b>ISUZU SPORT UTILITY (continued)</b>										
<b>RODEO (continued)</b>										
V6	V6 3.2L 3165cc	1993-94	RH Front	4WD	1	EM-9144				
			RH Front	RWD	1	EM-8579				
		1998-04	Trans	Auto; 2WD	1			EM-5609		
			Trans	Manual; 2WD	1			EM-5610		
		1993-97	Trans	Auto; 4WD	1			EM-9142		
			Trans	Auto; 2WD	1			EM-8586		
	V6 3.5L 3494cc	2004	Trans	Manual; 2WD	1		EM-8586			
			LH Front		1	EM-5813				
			Trans	Auto; 2WD	1			EM-5609		
			Trans	Manual; 2WD	1			EM-5610		
<b>RODEO SPORT</b>										
L4	L4 2.2L 2180cc	2001-03	LH Front		1	EM-8351				
			RH Front		1	EM-5812				
			Trans	Auto	1			EM-5609		
			Trans	Manual	1			EM-5610		
V6	V6 3.2L 3165cc	2001-03	Trans	Auto; 2WD	1			EM-5609		
			Trans	Manual; 2WD	1			EM-5610		
<b>TROOPER</b>										
L4	L4 1.9L 1949cc	1984-85	LH Front		1	EM-8053				
			RH Front		1	EM-8054				
			Trans	Manual	1			EM-8586		
	L4 2.2L 2238cc Diesel	1986	1987	L & R Front		2	EM-8048			
				LH Front		1	EM-8576			
				LH Front		1	EM-8048			
				RH Front		1	EM-8579			
				RH Front		1	EM-8049			
				Trans	Manual	1			EM-8586	
				Trans	Manual; 4WD	1			EM-9138	
				Trans	Manual; 4WD	1			EM-9138	
	L4 2.3L 2254cc	1987	1986	LH Front		1	EM-8576			
				LH Front		1	EM-8053			
				RH Front		1	EM-8579			
				RH Front		1	EM-8054			
				Trans	Manual	1			EM-8586	
	L4 2.6L 2559cc	1988-91	1986	Trans	Manual; 4WD	1			EM-9138	
				LH Front		1	EM-8576			
				RH Front		1	EM-8579			
	V6	V6 2.8L 2827cc	1989-91	Trans	Manual	1			EM-8586	
				Trans	Auto	1			EM-9143	
		V6 3.2L 3165cc	1996-97	1992-95	LH Front		1	EM-8351		
					LH Front		1	EM-8445		
RH Front						1	EM-8352			
RH Front						1	EM-9144			
Trans					Auto	1			EM-9142	
V6 3.5L		1998-99	1992-97	LH Front		1	EM-8351			
				RH Front		1	EM-8352			
V6 3.5L 3475cc		2000-02	1998-02	LH Front	4WD	1	EM-8351			
				RH Front	4WD	1	EM-8352			
				Trans	Auto; 4WD; w/o Torque Control	1			EM-9142	
<b>VEHICROSS</b>										
V6	V6 3.5L 3475cc	1999-01	LH Front		1	EM-8351				
			RH Front		1	EM-8352				



## Engine, Transmission, And Torque Strut Mounts

CYL	ENG. SIZE	YEAR	LOCATION	DESCRIPTION	QTY	ENGINE	TORQUE STRUT	TRANSMISSION	
<b>ISUZU TRUCK</b>									
<b>HOMBRE</b>									
L4	L4 2.2L 2180cc	1996-00	L & R Front	Insert	2	EM-2819			
			LH Front	Complete Unit	1	EM-5426			
			RH Front	Complete Unit	1	EM-5350			
		1998-00	Trans	Auto	1			EM-2957	
			Trans	Manual	1			EM-2957	
		1996-97	Trans	Auto; RWD	1			EM-2957	
Trans	Manual; RWD		1			EM-2956			
V6	V6 4.3L 4294cc	1997-00	L & R Front		2	EM-2802			
			1998-00	Trans	Auto; 4WD	1		EM-2638	
		Trans		Auto; RWD	1		EM-2394		
		Trans		Manual; 4WD	1		EM-2839		
		1997	Trans	Auto; RWD	1		EM-2394		
			Trans	Manual; RWD	1		EM-2394		
<b>I-350</b>									
L5	L5 3.5L 3460cc	2006	Trans		1			EM-2638	
<b>PICKUP</b>									
L4	L4 1.8L 1817cc	1981-82	LH Front		1	EM-8053			
			RH Front		1	EM-8054			
			Trans	Manual; 2WD	1		EM-8586		
	L4 1.9L 1949cc	1983-87	LH Front		1	EM-8053			
			RH Front		1	EM-8054			
			Trans	Auto; 2WD	1		EM-8586		
	L4 2.2L 2238cc Diesel	1987	L & R Front		2	EM-8577			
			1981-86	LH Front		1	EM-8048		
				RH Front		1	EM-8049		
	1982-87	Trans	Auto; 2WD	1		EM-8586			
		Trans	Manual; 2WD	1		EM-8586			
		1981	Trans	Manual; 2WD	1		EM-8586		
	L4 2.3L	1986-87	LH Front	4WD	1	EM-8576			
			LH Front	RWD	1	EM-8053			
			RH Front	4WD	1	EM-8579			
			RH Front	RWD	1	EM-8054			
			1988-92	Trans	Manual; 4WD	1		EM-9143	
	L4 2.3L 2254cc	1988-92	LH Front		1	EM-8576			
			RH Front		1	EM-8579			
		1986-87	Trans	4WD	1		EM-9143		
			Trans	Auto; 2WD	1		EM-8586		
	1988-92	Trans	Manual; 2WD	1		EM-8586			
	L4 2.6L 2559cc	1995	LH Front		1	EM-8576			
			1994	LH Front	Built in Japan	1	EM-8576		
				LH Front	Built in USA	1	EM-9141		
			1988-93	LH Front	Built in USA	1	EM-8576		
			1995	RH Front		1	EM-8579		
			1994	RH Front	Built in Japan	1	EM-8579		
				RH Front	Built in USA	1	EM-9140		
			1988-93	RH Front	Built in USA	1	EM-8579		
			1995	Trans	Manual; 4WD	1		EM-8586	
			1988-94	Trans	Auto; 4WD	1		EM-8586	
				Trans	Manual; 4WD	1		EM-8586	
	V6	V6 3.1L 3137cc	1991-94	LH Front		1	EM-9141		
				RH Front		1	EM-9140		
				Trans	Auto; 2WD	1		EM-9143	
				Trans	Manual; 2WD	1		EM-9143	

# Engine, Transmission, And Torque Strut Mounts

CYL	ENG. SIZE	YEAR	LOCATION	DESCRIPTION	QTY	ENGINE	TORQUE STRUT	TRANS-MISSION			
<b>ISUZU VAN</b>											
<b>OASIS</b>											
L4	L4 2.2L 2156cc	1996-97	Front		1	EM-8026					
			LH Front		1	EM-8404					
			Rear	w/ Solenoid Valve	1	EM-8984					
			Rear	w/o Solenoid Valve	1	EM-8011					
			Trans	Auto	1			EM-8002			
	L4 2.3L 2234cc	1998-99	Trans	Auto	1			EM-8002			
	L4 2.3L 2254cc	1998-99	Front		1	EM-8026					
			LH Front		1	EM-8404					
			Rear	w/ Solenoid Valve	1	EM-8984					
			Rear	w/o Solenoid Valve	1	EM-8011					
<b>JAGUAR</b>											
<b>S-TYPE</b>											
V6	V6 3.0L 2968cc	2000-04	L & R Front		2	EM-3077'					
		2000-02	Trans		1			EM-3063			
V8	V8 4.0L 3996cc	2000-02	L & R Front		2	EM-3077'					
			Trans		1			EM-3063			
	V8 4.2L 4196cc	2003-08	L & R Front		2	EM-3077'					
		2003-05	Trans		1			EM-3063			
<b>JEEP SPORT UTILITY</b>											
<b>CHEROKEE</b>											
L4	L4 2.1L 126ci Diesel	1985-87	L & R Front		2	EM-2569					
			Trans	Auto	1			EM-2625			
			Trans	Manual	1			EM-2570			
	L4 2.4L 144ci	2014-18	Trans	Auto	1			EM-4266			
	L4 2.5L 150ci	1992-00	LH Front		1	EM-2569					
			LH Front		1	EM-2569					
			LH Front		1	EM-2569					
			RH Front		1	EM-2571					
			RH Front		1	EM-2920					
			RH Front		1	EM-2571					
			Trans	Auto	1			EM-2570			
			Trans	Manual; Cushion	1			EM-5383			
			Trans	Auto	1			EM-2570			
			Trans	Manual; Cushion	1			EM-5383			
			Trans	Auto	1			EM-2625			
			Trans	Manual; Aisin Trans.	1			EM-5383			
			Trans	Manual; Peugeot Trans.	1			EM-2570			
			Trans	Auto	1			EM-2625			
			Trans	Manual; Aisin Trans.	1			EM-5383			
			Trans	Manual; Peugeot Trans.	1			EM-2570			
			Trans	Auto	1			EM-2625			
			Trans	Manual; Aisin Trans.	1			EM-5383			
			Trans	Manual; Borg Warner Trans.	1			EM-2570			
			L6	L6 4.0L 242ci	2000-01	L & R Front	exc RH Drive	2	EM-2572		
					1997-99	L & R Front	exc RH Drive	2	EM-2572		
		L & R Front			RH Drive	2	EM-2919				
	1987-96	L & R Front			LH Drive	2	EM-2572				
	2000-01	Trans			US & Canada; Auto	1			EM-5428		
		Trans			US & Canada; Manual	1			EM-5428		
	1998-01	Trans			Mexico; Auto	1			EM-2625		
	1997-99	Trans			US & Canada; Auto	1			EM-2625		
		Trans			US & Canada; Manual Cushion	1			EM-5383		
	1987-96	Trans			exc Peugeot Transmission	1			EM-2625		

\* = Hydraulic Mount, "S" suffix = solid replacement.

## Engine, Transmission, And Torque Strut Mounts

CYL	ENG. SIZE	YEAR	LOCATION	DESCRIPTION	QTY	ENGINE	TORQUE STRUT	TRANSMISSION
<b>JEEP SPORT UTILITY (continued)</b>								
<b>CHEROKEE (continued)</b>								
L6	L6 4.0L 242ci	1987-96	Trans	Manual; Cushion	1			EM-5383
	L6 4.2L 258ci	1978-83	L & R Front	w/ Interlock	2	EM-2330		
		1977	L & R Front	w/ Interlock	2	EM-2330		
			L & R Front	w/o Interlock	2	EM-2280		
			L & R Front	w/o Interlock	2	EM-2280		
		1974-76	L & R Front	w/o Interlock	2	EM-2280		
1974-83	Trans	Auto	1			EM-2693		
			Trans	Manual	1		EM-2693	
V6	V6 2.8L 173ci	1984-86	L & R Front		2	EM-2569		
			Trans	Auto	1		EM-2570	
			Trans	Manual; Cushion	1		EM-5383	
	V6 3.2L 198ci	2014-18	RH Front		1	EM-4265		
			2014-16	Torq Str - Rear	1		EM-4193	
			2014-18	Trans	Auto	1		EM-4266
V8	V8 5.9L 360ci	1974-83	L & R Front		2	EM-2351		
			Trans	Auto	1		EM-2693	
			Trans	Manual	1		EM-2693	
<b>CJ3</b>								
L4	L4 2.2L 134ci	1959-60	L & R Front		2	EM-2040		
			Trans	Manual; 4 Spd	1		EM-5401	
<b>CJ5A</b>								
L4	L4 2.2L 134ci	1966-68	Trans	Manual; 4 Spd	1			EM-5401
<b>CJ5</b>								
L4	L4 2.2L 134ci	1968-71	L & R Front		2	EM-2040		
		1959-60	L & R Front		2	EM-2040		
		1968-71	Trans	Manual; 4 Spd	1		EM-5401	
		1959-60	Trans	Manual; 4 Spd	1		EM-5401	
		L4 2.5L 151ci	1980-83	L & R Front		2	EM-2446	
	Trans			Auto	1		EM-2921	
			Trans	Manual	1		EM-2693	
L6	L6 3.8L 232ci	1972-78	L & R Front		2	EM-2330		
	L6 4.2L 258ci	1978-83	L & R Front	w/ Interlock	2	EM-2330		
		1977	L & R Front	w/ Interlock	2	EM-2330		
			L & R Front	w/o Interlock	2	EM-2280		
			L & R Front	w/o Interlock	2	EM-2280		
		1972-76	L & R Front	w/o Interlock	2	EM-2280		
1972-83	Trans	Auto	1		EM-2693			
			Trans	Manual	1		EM-2693	
V8	V8 5.0L 304ci	1972-81	L & R Front		2	EM-2351		
			Trans	Auto	1		EM-2693	
			Trans	Manual	1		EM-2693	
<b>CJ6</b>								
L4	L4 2.2L 134ci	1968-71	L & R Front		2	EM-2040		
		1959-60	L & R Front		2	EM-2040		
		1968-71	Trans	Manual; 4 Spd	1		EM-5401	
		1959-60	Trans	Manual; 4 Spd	1		EM-5401	
L6	L6 3.8L 232ci	1972-75	L & R Front		2	EM-2280		
	L6 4.2L 258ci	1972-75	L & R Front	w/o Interlock	2	EM-2280		
		1974-75	Trans	Auto	1		EM-2693	
			Trans	Manual	1		EM-2693	
V8	V8 5.0L 304ci	1972-75	L & R Front		2	EM-2351		
			Trans	Auto	1		EM-2693	
			Trans	Manual	1		EM-2693	

# Engine, Transmission, And Torque Strut Mounts

CYL	ENG. SIZE	YEAR	LOCATION	DESCRIPTION	QTY	ENGINE	TORQUE STRUT	TRANSMISSION	
<b>JEEP SPORT UTILITY (continued)</b>									
<b>CJ6A</b>									
L4	L4 2.2L 134ci	1966-68	Trans	Manual; 4 Spd	1			EM-5401	
<b>CJ7</b>									
L4	L4 2.5L 151ci	1980-86	L & R Front		2	EM-2446			
			Trans	Auto	1			EM-2921	
			Trans	Manual	1			EM-2693	
L6	L6 3.8L 232ci	1976-78	L & R Front		2	EM-2330			
	L6 4.2L 258ci	1976-86	L & R Front	w/ Interlock	2	EM-2330			
			Trans	Auto	1			EM-2693	
			Trans	Manual	1			EM-2693	
V8	V8 5.0L 304ci	1976-81	L & R Front		2	EM-2351			
			Trans	Auto	1			EM-2693	
			Trans	Manual	1			EM-2693	
<b>COMANCHE</b>									
L4	L4 2.1L 126ci Diesel	1986-87	L & R Front		2	EM-2569			
			Trans	Auto	1			EM-2625	
			Trans	Manual	1			EM-2570	
	L4 2.5L 150ci	1992	1991	LH Front		1	EM-2569		
				LH Front		1	EM-2569		
				LH Front		1	EM-2569		
				RH Front		1	EM-2571		
				RH Front		1	EM-2920		
				RH Front		1	EM-2571		
				Trans	Auto	1			EM-2570
				Trans	Manual; Cushion	1			EM-5383
				1986-90	Trans	Auto	1		EM-2625
					Trans	Manual	1		EM-2570
L6	L6 4.0L 242ci	1987-92	L & R Front		2	EM-2572			
			Trans	exc Peugeot Transmission	1			EM-2625	
			Trans	Manual; Cushion	1			EM-5383	
V6	V6 2.8L 173ci	1986	L & R Front		2	EM-2569			
			Trans	Auto	1			EM-2570	
			Trans	Manual; Cushion	1			EM-5383	
<b>COMMANDER</b>									
V6	V6 3.7L 226ci	2006-10	LH Front		1	EM-4103			
			RH Front		1	EM-4104			
			Trans	Auto	1			EM-4153	
V8	V8 4.7L 285ci	2006-09	Trans	Auto	1			EM-4153	
	V8 4.7L 287ci	2006-09	LH Front		1	EM-4100			
			RH Front		1	EM-4105			
	V8 5.7L 345ci	2006-10	RH Front	RWD	1	EM-4123			
			Trans	Auto	1			EM-4153	
<b>COMPASS</b>									
L4	L4 2.0L 122ci	2007-16	Front		1	EM-3131			
			RH Front		1	EM-3130			
			Rear		1	EM-3145			
		2012-13	Trans	Auto	1			EM-3134	
			Trans	Auto (CVT)	1			EM-3134	
			Trans	Manual	1			EM-3134	
		2007-11	Trans	Auto (CVT)	1			EM-3134	
			Trans	Manual	1			EM-3134	
		L4 2.4L 144ci	2007-16	2012-13	Front		1	EM-3131	
	RH Front					1	EM-3130		
	Rear				4WD	1	EM-3157		
	Rear				FWD	1	EM-3145		
Trans	Auto				1			EM-3134	

## Engine, Transmission, And Torque Strut Mounts

CYL	ENG. SIZE	YEAR	LOCATION	DESCRIPTION	QTY	ENGINE	TORQUE STRUT	TRANSMISSION	
<b>JEEP SPORT UTILITY (continued)</b>									
<b>COMPASS (continued)</b>									
L4	L4 2.4L 144ci	2012-13	Trans	Auto (CVT)	1			EM-3134	
			Trans	Manual	1			EM-3134	
		2007-11	Trans	Auto (CVT)	1			EM-3134	
			Trans	Manual	1			EM-3134	
<b>GRAND CHEROKEE</b>									
L6	L6 4.0L 242ci	1999-04	LH Front		1	EM-3019			
		1993-98	LH Front		1	EM-2794			
		1999-04	RH Front		1	EM-3039			
		1993-98	RH Front		1	EM-2793			
		2004	Trans	2WD		1			EM-2988
			Trans	4WD		1			EM-3051
		1999-03	Trans	2WD		1			EM-2988
			Trans	4WD; US & Canada		1			EM-3051
			Trans	AWD; Including Mexico		1			EM-3051
		1996-98	Trans			1			EM-2828
		1995	Trans	Auto		1			EM-2864
		1993-94	Trans	Auto		1			EM-2864
			Trans	Manual		1			EM-2863
V6	V6 3.0L 182ci	2014-15	L & R Front		2	EM-4168			
		2014-17	Trans	4WD	1			EM-4228	
	V6 3.6L 220ci	2011-15	L & R Front		2	EM-4168			
		2014-16	Trans	4WD	1			EM-4228	
		2011-13	Trans		1			EM-4172	
	V6 3.7L 226ci	2005-10	LH Front		1	EM-4103			
			RH Front		1	EM-4104			
Trans	Auto		1			EM-4153			
V8	V8 4.7L 287ci	2005-09	LH Front		1	EM-4100			
		1999-04	LH Front		1	EM-3012			
		2005-09	RH Front		1	EM-4105			
		1999-04	RH Front		1	EM-3008			
		2005-09	Trans	4WD; US & Canada		1			EM-4153
			Trans	AWD; Mexico Vehicle		1			EM-4153
		2004	Trans	2WD		1			EM-3018
			Trans	4WD; US & Canada		1			EM-3013
			Trans	AWD; Mexico Vehicle		1			EM-3013
		1999-03	Trans	2WD		1			EM-3018
			Trans	4WD; US & Canada		1			EM-3013
			Trans	AWD; Including Mexico		1			EM-3013
		V8 5.2L 318ci	1993-98	LH Front		1	EM-2809		
				RH Front		1	EM-2808		
			1997-98	Trans		1			EM-2828
	1993-96		Trans		1			EM-2828	
	V8 5.7L 345ci	2011-15	L & R Front		2	EM-4168			
		2005-10	LH Front		1	EM-4185			
			RH Front		1	EM-4123			
		2015-16	Trans	4WD		1			EM-4228
			Trans	RWD		1			EM-4172
		2011-14	Trans	Auto		1			EM-4172
	2006-10	Trans	Auto		1			EM-4153	
	V8 5.9L 360ci	1998	LH Front		1	EM-2916			
			RH Front		1	EM-2808			
			Trans		1			EM-2828	
	V8 6.1L 370cid	2006-10	RH Front		1	EM-4123			
	V8 6.4L 392ci	2012-15	L & R Front		2	EM-4168			
		2014-16	Trans		1			EM-4228	
		2012-13	Trans	Auto	1			EM-4172	

# Engine, Transmission, And Torque Strut Mounts

CYL	ENG. SIZE	YEAR	LOCATION	DESCRIPTION	QTY	ENGINE	TORQUE STRUT	TRANSMISSION
<b>JEEP SPORT UTILITY (continued)</b>								
<b>GRAND WAGONEER</b>								
L6	L6 4.2L 258ci	1984-86	L & R Front		2	EM-2330		
			Trans	Auto	1		EM-2693	
			Trans	Manual	1		EM-2693	
V8	V8 5.2L 318ci	1993	L & R Front		2	EM-2351		
			Trans	Auto	1		EM-2693	
			Trans	Manual	1		EM-2693	
	V8 5.9L 360ci	1984-91	L & R Front		2	EM-2351		
			Trans	Auto	1		EM-2693	
			Trans	Manual	1		EM-2693	
<b>LIBERTY</b>								
L4	L4 2.4L 148ci	2002-05	LH Front		1	EM-3009		
			RH Front		1	EM-3010		
			Trans		1		EM-3016	
V6	V6 3.7L 226ci	2008-12	LH Front		1	EM-4101		
		2002-05	LH Front		1	EM-3015		
		2008-12	RH Front		1	EM-4258		
		2002-05	RH Front		1	EM-3014		
		2009-12	Trans	Auto	1		EM-4217	
		2006-08	Trans	Auto	1		EM-4217	
			Trans	Manual	1		EM-4217	
			2004-05	Trans	Auto; 2WD	1		EM-3054
		2002-03	Trans	Auto; 4WD	1		EM-3055	
			Trans	Manual	1		EM-3054	
			Trans	Auto; 2WD	1		EM-3053	
			Trans	Auto; 4WD	1		EM-3007	
			Trans	Manual; 2WD	1		EM-3052	
Trans	Manual; 4WD	1		EM-3055				
<b>PATRIOT</b>								
L4	L4 2.0L 122ci	2007-16	Front		1	EM-3131		
			RH Front		1	EM-3130		
			Rear		1	EM-3145		
	L4 2.4L 144ci	2007-16	Front		1	EM-3131		
			RH Front		1	EM-3130		
			Rear	4WD	1	EM-3157		
			Rear	FWD	1	EM-3145		
			2007-09	Trans	Auto; CVT	1		EM-3134
				Trans	Manual	1		EM-3137
	<b>SCRAMBLER</b>							
L4	L4 2.5L 151ci	1981-85	L & R Front		2	EM-2446		
			Trans	Auto	1		EM-2921	
			Trans	Manual	1		EM-2693	
L6	L6 4.2L 258ci	1981-85	L & R Front		2	EM-2330		
			Trans	Auto	1		EM-2693	
			Trans	Manual	1		EM-2693	
<b>WAGONEER</b>								
L4	L4 2.1L 126ci Diesel	1985	L & R Front		2	EM-2569		
			Trans	Auto	1		EM-2625	
			Trans	Manual	1		EM-2570	
	L4 2.5L 150ci	1984-87	LH Front		1	EM-2569		
			RH Front		1	EM-2571		
			Trans	Auto	1		EM-2625	
Trans	Manual	1		EM-2570				
L6	L6 3.8L 230ci	1963-67	L & R Front		2	EM-2279		
	L6 3.8L 232ci	1971	L & R Front		2	EM-2279		
	L6 4.0L 242ci	1987-90	L & R Front		2	EM-2572		

# Engine, Transmission, And Torque Strut Mounts

CYL	ENG. SIZE	YEAR	LOCATION	DESCRIPTION	QTY	ENGINE	TORQUE STRUT	TRANS-MISSION
<b>JEEP SPORT UTILITY (continued)</b>								
<b>WAGONEER (continued)</b>								
L6	L6 4.0L 242ci	1987-90	Trans	exc Peugot Transmission	1			EM-2625
			Trans	Manual; Cushion	1			EM-5383
	L6 4.2L 258ci	1980-83	L & R Front	w/ Interlock	2	EM-2330		
			L & R Front	w/o Interlock	2	EM-2280		
			Trans	Auto	1			EM-2693
			Trans	Manual	1			EM-2693
	1972-73	Trans		1			EM-2268 @	
V6	V6 2.8L 173ci	1984-86	L & R Front		2	EM-2569		
			Trans	Auto	1			EM-2693
			Trans	Manual; Cushion	1			EM-5383
V8	V8 5.9L 360ci	1972-83	L & R Front		2	EM-2351		
			Trans	Auto	1			EM-2693
			Trans	Manual	1			EM-2693
<b>WRANGLER</b>								
L4	L4 2.4L 148ci	2003-06	L & R Front		2	EM-2883		
			Trans	Auto	1			EM-2882
			Trans	Manual	1			EM-2882
	L4 2.5L 150ci	1997-02	L & R Front		2	EM-2883		
			L & R Front		2	EM-2569		
			LH Front		1	EM-2569		
			RH Front		1	EM-2920		
			Trans	Auto	1			EM-2882
			Trans	Manual	1			EM-2882
			1987-95	Trans	Auto	1		
	Trans	Manual	1			EM-2628		
L6	L6 4.0L 242ci	1997-06	L & R Front		2	EM-2883		
			L & R Front		2	EM-2572		
			Trans	Auto	1			EM-2882
			Trans	Manual	1			EM-2882
			1991-95	Trans	Auto	1		
		Trans	Manual	1			EM-2628	
	L6 4.2L 258ci	1987-90	L & R Front		2	EM-2572		
			Trans	Auto	1			EM-2628
			Trans	Manual	1			EM-2628
	V6	V6 3.6L 220ci	2012-17	LH Front		1	EM-4213	
RH Front					1	EM-4214		
2012-16			Trans		1			EM-4215
			Trans	Manual	1			EM-4215
V6 3.8L 231ci		2007-11	L & R Front	Bushing	1	EM-4041		
			Left	Complete Unit	1	EM-4181		
			Right	Complete Unit	1	EM-4182		
			Trans	Auto	1			EM-4043
	Trans	Manual	1			EM-4043		
<b>JEEP TRUCK</b>								
<b>FC150</b>								
L4	L4 2.2L 134ci	1958-62	L & R Front		2	EM-2040		
			Trans - Lower	Transfer Case	1			EM-2009
			Trans - Upper	Transfer Case	1			EM-2010
<b>J10</b>								
L6	L6 4.2L 258ci	1974-87	L & R Front		2	EM-2330		
			Trans		1			EM-2268 @
V8	V8 5.9L 360ci	1974-88	L & R Front		2	EM-2351		
			Trans	Auto	1			EM-2693
			Trans	Manual	1			EM-2693

@ = Universal Mount EM-5000 also available.

# Engine, Transmission, And Torque Strut Mounts

CYL	ENG. SIZE	YEAR	LOCATION	DESCRIPTION	QTY	ENGINE	TORQUE STRUT	TRANSMISSION
<b>JEEP TRUCK (continued)</b>								
<b>J20</b>								
L6	L6 4.2L 258ci	1976	L & R Front		2	EM-2330		
			1974	L & R Front		2	EM-2330	
		1976	Trans	Auto	1			EM-2693
			Trans	Manual	1			EM-2693
			1974	Trans	Auto	1		EM-2693
			Trans	Manual	1		EM-2693	
V8	V8 5.9L 360ci	1974-88	L & R Front		2	EM-2351		
			Trans	Auto	1		EM-2693	
			Trans	Manual	1		EM-2693	
<b>JEEPSTER</b>								
L4	L4 2.2L 134ci	1949-51	L & R Front		2	EM-2040		
			Trans - L & R		2		EM-2039	
<b>KIA PASSENGER CAR</b>								
<b>AMANTI</b>								
V6	V6 3.5L 3497cc	2004-06	Front		1	EM-8948		
			RH Front		1	EM-8949		
			Rear		1	EM-8950		
			Trans		1		EM-5121	
	V6 3.8L 3778cc	2007-09	Front		1	EM-9317		
			RH Front		1	EM-9332		
			Rear		1	EM-9330		
			Trans	Auto	1		EM-9333	
<b>FORTE</b>								
L4	L4 1.8L 1797cc	2014-16	Torq Str - Front		1		EM-7066	
			Trans	Manual	1		EM-7160	
	L4 2.0L 1998cc	2010-13	Front	Auto	1	EM-9360		
			Rear	Auto	1	EM-5999		
			Rear	Manual	1	EM-7006		
			Right		1	EM-9345		
			2014-16	Trans		1		EM-7160
	L4 2.4L 2359cc	2010-13	Trans		1		EM-7049	
			Trans		1		EM-5997	
			Trans		1		EM-7049	
L5	L4 2.4L 2359cc		Front	Auto	1	EM-9360		
			Rear	Auto	1	EM-5999		
			Right		1	EM-9345		
<b>FORTE KOUP</b>								
L4	L4 1.6L 1591cc	2014-16	RH Front		1	EM-7062		
			Trans	Auto	1		EM-7090	
			Trans	Manual	1		EM-7160	
	L4 2.0L 1998cc	2010-13	Rear	Auto	1	EM-5999		
			Rear	Manual	1	EM-7006		
			Right		1	EM-9345		
			Trans		1		EM-7049	
L5	L4 2.4L 2359cc	2010-13	Trans		1		EM-7049	
<b>FORTE5</b>								
L4	L4 1.6L 1591cc	2014-16	RH Front		1	EM-7062		
			Trans	Auto	1		EM-7090	
			Trans	Manual	1		EM-7160	
	L4 2.0L 1998cc	2012-13	Rear	Auto	1	EM-5999		
			Rear	Manual	1	EM-7006		



## Engine, Transmission, And Torque Strut Mounts

CYL	ENG. SIZE	YEAR	LOCATION	DESCRIPTION	QTY	ENGINE	TORQUE STRUT	TRANSMISSION		
<b>KIA PASSENGER CAR (continued)</b>										
<b>FORTE5 (continued)</b>										
L4	L4 2.0L 1998cc	2012-13	Right		1	EM-9345				
L5	L4 2.4L 2359cc	2012-13	Rear	Auto	1	EM-5999				
			Right		1	EM-9345				
<b>MAGENTIS</b>										
L4	L4 2.4L 2351cc	2005	Front		1	EM-8770				
		2001-04	Front		1	EM-8770				
			RH Front		1	EM-8722				
			Rear		1	EM-8783				
		2001-04	Rear		1	EM-8783				
			Trans	Auto		1			EM-9373	
	Trans		Auto		1			EM-9373		
	L4 2.4L 2359cc	2009-10	Front	Auto		1	EM-7037			
			Front	Manual		1	EM-9311			
			Front			1	EM-9311			
		2009-10	RH Front		1	EM-9335				
		2006-08	RH Front		1	EM-9335				
		2009-10	Rear		1	EM-9323				
		2006-08	Rear		1	EM-9323				
		2006-10	Trans		1			EM-9334		
		V6	V6 2.5L 2500cc	2001	Front		1	EM-8769		
					Rear		1	EM-8784		
V6 2.7L 2656cc	2007-10		RH Front		1	EM-9335				
			2005-06	RH Front		1	EM-9335			
V6 2.7L 2700cc	2002-04		Front		1	EM-8769				
			Rear		1	EM-8784				
<b>OPTIMA</b>										
L4	L4 2.0L 1998cc	2011-13	Right		1	EM-7092				
		2011-14	Trans	Auto	1			EM-5996		
	L4 2.4L 2351cc	2006	Front	To 9-17-2006		1	EM-8770			
		2001-05	Front			1	EM-8770			
		2006	RH Front	To 9-17-2006		1	EM-8722			
		2001-05	RH Front			1	EM-8722			
		2006	Rear	To 9-17-2006		1	EM-8783			
		2001-05	Rear			1	EM-8783			
		2006	Trans	Auto; 4 Spd			1			EM-9373
			Trans	Auto; 5 Spd			1			EM-9334
			Trans	Manual			1			EM-9367
		2005	Trans	Auto; 4 Spd			1			EM-9373
			Trans	Manual			1			EM-9367
		2001-04	Trans	Auto			1			EM-9373
			Trans	Manual			1			EM-9367
	L4 2.4L 2359cc	2009-10	Front	Auto		1	EM-7037			
			Front	Manual		1	EM-9311			
		2007-08	Front	Auto		1	EM-9311			
		2006	Front	From 9-17-2006		1	EM-9311			
		2009-10	RH Front			1	EM-9335			
		2007-08	RH Front			1	EM-9335			
		2006	RH Front	From 9-17-2006		1	EM-9335			
		2009-10	Rear			1	EM-9323			
		2007-08	Rear			1	EM-9323			
		2006	Rear	From 9-17-2006		1	EM-9323			
		2011-15	Right	Gas Engine		1	EM-7092			
	2009-14	Torq Str - Front	Gas Engine			1		EM-7105		
		Torq Str - Front	Hybrid			1		EM-7105		

# Engine, Transmission, And Torque Strut Mounts

CYL	ENG. SIZE	YEAR	LOCATION	DESCRIPTION	QTY	ENGINE	TORQUE STRUT	TRANS-MISSION		
<b>KIA PASSENGER CAR (continued)</b>										
<b>OPTIMA (continued)</b>										
L4	L4 2.4L 2359cc	2011-15	Trans	Auto	1			EM-5996		
		2007-10	Trans		1			EM-9334		
		2006	Trans	Auto; 4 Spd	1			EM-9373		
			Trans	Auto; 5 Spd	1			EM-9334		
			Trans	Manual	1			EM-9367		
V6	V6 2.5L 2500cc	2001	Front		1	EM-8769				
			RH Front		1	EM-8723				
			Rear		1	EM-8784				
			Trans		1			EM-9373		
	V6 2.7L 2656cc	2002-05	2007-09	Front		1	EM-8769			
				RH Front		1	EM-9335			
		2006	2002-05	RH Front		1	EM-9335			
				RH Front		1	EM-8723			
		2006	2002-05	Rear		1	EM-9323			
				Rear		1	EM-8784			
		2002-06	Trans	Auto		1			EM-9373	
		<b>RIO</b>								
		L4	L4 1.5L 1493cc	2001-02	Front		1	EM-8914		
RH Front					1	EM-8913				
Rear					1	EM-8914				
Trans - Front	Auto				1			EM-5738		
L4 1.6L 1591cc	2012-14		2015-17	Front		1	EM-7062			
				Torq Str - Front		1		EM-7065		
			2012-14	Trans	Manual		1		EM-7160	
L4 1.6L 1594cc	2003-05		2012-14	Trans	Manual	1			EM-7057	
				Front		1	EM-8914			
				RH Front		1	EM-9346			
				Rear		1	EM-8914			
L4 1.6L 1599cc	2006-11		2006-09	Trans - Front	Manual	1			EM-5738	
				Front Lower		1	EM-9309			
				Front Upper		1	EM-9324			
				Rear		1	EM-9310			
2006-09	Trans			1			EM-9308			
<b>RIO5</b>										
L4	L4 1.6L 1599cc	2006-08	Front Lower		1	EM-9309				
			Front Upper		1	EM-9324				
		2009	Rear	Auto		1	EM-9310			
			Rear	Auto		1	EM-9310			
		2006-08	Trans		1			EM-9308		
<b>RONDO</b>										
L4	L4 2.4L 2359cc	2007-10	Front		1	EM-9311				
			RH Front		1	EM-9335				
			Rear		1	EM-9323				
			Trans	Auto	1			EM-9342		
V6	V6 2.7L 2656cc	2007-10	RH Front		1	EM-9335				
			Rear		1	EM-9323				
<b>SOUL</b>										
L4	L4 1.6L 1591cc	2014-16	RH Front		1	EM-7099				
		2010-11	RH Front		1	EM-5880				
		2014-17	Trans	Auto		1		EM-7221		
		2012-13	Trans	Manual		1		EM-7151		
		2010-11	Trans	Manual		1		EM-7151		
	L4 2.0L 1975cc	2012-13	2010-11	RH Front		1	EM-7163			
				Torq Str - Front		1		EM-7066		
				Trans	Manual	1			EM-7151	

## Engine, Transmission, And Torque Strut Mounts

CYL	ENG. SIZE	YEAR	LOCATION	DESCRIPTION	QTY	ENGINE	TORQUE STRUT	TRANS-MISSION	
<b>KIA PASSENGER CAR (continued)</b>									
<b>SOUL (continued)</b>									
L4	L4 2.0L 1999cc	2014-16	RH Front		1	EM-7099			
		2014-17	Trans	Auto	1			EM-7221	
<b>SEPHIA</b>									
L4	L4 1.6L 1597cc	1994-97	Front		1	EM-8903			
			RH Front		1	EM-8609			
			Rear	Auto	1	EM-8612			
			Rear	Manual	1	EM-8611			
			Trans		1			EM-2815	
	L4 1.8L 1793cc	1998-01	Front	Auto	1	EM-8906			
			Front	Manual	1	EM-8904			
			RH Front		1	EM-8902			
			Rear	Auto	1	EM-8908			
			Rear	Manual	1	EM-8905			
			2001	Trans	Auto	1			EM-8907
			2001	Trans	Manual	1			EM-8910
			1998-00	Trans	Auto	1			EM-8912
	L4 1.8L 1839cc	1995-97	Trans	Manual	1			EM-8911	
			Front		1	EM-8903			
			RH Front		1	EM-8609			
			Rear		1	EM-8612			
			Trans		1			EM-2815	
<b>SPECTRA</b>									
L4	L4 1.8L 1793cc	2003-04	Front	Auto	1	EM-8906			
			Front	Manual	1	EM-8904			
		2000-02	Front	Auto	1	EM-8906			
			Front	Manual	1	EM-8904			
		2003-04	RH Front		1	EM-8902			
			2000-02	RH Front		1	EM-8902		
		2003-04	Rear	Manual	1	EM-8905			
			2000-02	Rear	Auto	1	EM-8908		
		2000-04	Rear	Manual	1	EM-8905			
			Trans	Auto	1			EM-8907	
			Trans	Manual	1			EM-8910	
		L4 2.0L 1975cc	2006-09	Front	Auto	1	EM-9362		
				Front	Manual	1	EM-9312		
			2004-05	Front		1	EM-9312		
	2006-09		Front Upper	Bracket Only	1	EM-9328			
	2004-05		Front Upper	Bracket Only	1	EM-9328			
	2006-09		RH Front		1	EM-9325			
	2004-05		RH Front		1	EM-9325			
	2006-09		Rear	Auto	1	EM-9313			
			Rear	Manual	1	EM-9313			
	2004-05		Rear	Auto	1	EM-9326			
		Rear	Manual	1	EM-9313				
	2006-09	Rear Upper	Bracket Only	1	EM-9327				
2004-05	Rear Upper	Bracket Only	1	EM-9327					
2004-09	Trans	Auto	1			EM-9337			
	Trans	Manual	1			EM-9319			
<b>SPECTRA5</b>									
L4	L4 2.0L 1975cc	2007-09	Front	Auto	1	EM-9362			
			Front	Manual	1	EM-9312			
		2005-06	Front	Manual	1	EM-9312			
		2007-09	Front Upper	Bracket Only	1	EM-9328			
		2005-06	Front Upper	Bracket Only	1	EM-9328			
		2007-09	RH Front		1	EM-9325			
		2005-06	RH Front	Manual	1	EM-9325			

# Engine, Transmission, And Torque Strut Mounts

CYL	ENG. SIZE	YEAR	LOCATION	DESCRIPTION	QTY	ENGINE	TORQUE STRUT	TRANSMISSION	
<b>KIA PASSENGER CAR (continued)</b>									
<b>SPECTRA5 (continued)</b>									
L4	L4 2.0L 1975cc	2007-09	Rear	Auto	1	EM-9313			
			Rear	Manual	1	EM-9313			
		2005-06	Rear	Auto	1	EM-9326			
			Rear	Manual	1	EM-9313			
		2007-09	Rear Upper	Bracket Only	1	EM-9327			
		2005-06	Rear Upper	Bracket Only	1	EM-9327			
		2005-09	Trans	Auto	1			EM-9337	
			Trans	Manual	1			EM-9319	
<b>KIA SPORT UTILITY</b>									
<b>BORREGO</b>									
V6	V6 3.8L 3778cc	2009-10	L & R Front		2	EM-9329			
		2009-11	Trans		1			EM-7051	
V8	V8 4.6L 4627cc	2009-10	L & R Front		2	EM-9329			
<b>SORENTO</b>									
L4	L4 2.4L 2359cc	2011-13	Front		1	EM-5883			
			Rear	AWD	1	EM-7061			
			Rear	FWD	1	EM-7110			
			Trans	Auto	1			EM-7060	
V6	V6 3.3L 3342cc	2008-09	Trans	Auto; 4WD	1			EM-9320	
			Trans	Auto; RWD	1			EM-7051	
V6	V6 3.5L 3470cc	2011-13	Front		1	EM-5883			
			Rear	FWD	1	EM-7110			
V6	V6 3.5L 3471cc	2011-12	Right		1	EM-9355			
			Trans		1			EM-7060	
V6	V6 3.5L 3497cc	2003-06	L & R Front		2	EM-9331			
			Trans	Auto	1			EM-9320	
		2005-06	Trans	Manual; 4WD	1			EM-9336	
			Trans	Auto	1			EM-9336	
		2004	Trans	Auto	1			EM-9336	
			Trans	Manual; 4WD	1			EM-9336	
2003	Trans	Auto	1			EM-9336			
	Trans	Auto	1			EM-9336			
V6	V6 3.8L 3778cc	2007-09	L & R Front		2	EM-9329			
			Trans	Auto; 4WD	1			EM-9320	
			Trans	Auto; RWD	1			EM-7051	
<b>SPORTAGE</b>									
L4	L4 2.0L 1975cc	2005-09	Front		1	EM-9322			
			RH Front		1	EM-9368			
			Rear		1	EM-9306			
			Trans	Auto	1			EM-9374	
			Trans	Manual	1			EM-9380	
	L4 2.0L 1998cc	1995-02	LH Front		1	EM-8607			
			RH Front		1	EM-8606			
		2011-13	Right		1	EM-7104			
		2011-16	Torg Str - Lower		1		EM-7105		
		1995-02	Trans - LH	Auto; 4WD	1			EM-8901	
			Trans - LH	Manual; 4WD	1			EM-8901	
		2011-13	Trans		1			EM-7056	
		1995-02	Trans	Auto	1			EM-8608	
			Trans	Manual	1			EM-8608	
		L4 2.4L 2359cc	2011-13	Right		1	EM-7104		
				Torg Str - Lower		1		EM-7105	
2014-16	Trans		Auto	1			EM-7224		
2011-13	Trans		Auto	1			EM-7056		
V6	V6 2.7L 2656cc	2005-09	Front		1	EM-9338			
			RH Front		1	EM-9368			
			Rear		1	EM-9306			

## Engine, Transmission, And Torque Strut Mounts

CYL	ENG. SIZE	YEAR	LOCATION	DESCRIPTION	QTY	ENGINE	TORQUE STRUT	TRANSMISSION		
<b>KIA SPORT UTILITY (continued)</b>										
<b>SPORTAGE (continued)</b>										
V6	V6 2.7L 2656cc	2005-09	Trans		1			EM-9378		
<b>KIA VAN</b>										
<b>SEDONA</b>										
V6	V6 3.5L 3470cc	2014	Rear		1	EM-9347				
		2011-12	Rear		1	EM-9347				
	V6 3.5L 3471cc	2011-12	Trans	Auto	1			EM-9349		
	V6 3.5L 3497cc	2002-05	Front		1	EM-9351				
			Rear		1	EM-9359				
			Right		1	EM-5526				
			Trans		1			EM-5482		
	V6 3.8L 3778cc	2010	Front		1	EM-9375				
			2006-09	Front		1	EM-9375			
		2006-10	RH Front		1	EM-9343				
			Rear		1	EM-9347				
			Trans	Auto	1			EM-9349		
<b>LAND ROVER SPORT UTILITY</b>										
<b>RANGE ROVER</b>										
V8	V8 4.2L 4196cc	2006-09	LH Front		1	EM-5893				
			RH Front		1	EM-5894				
	V8 4.4L 4394cc	2006-09	LH Front		1	EM-5893				
			RH Front		1	EM-5894				
	V8 4.4L 4398cc	2003-05	LH Front		1	EM-5895				
			RH Front		1	EM-5896				
<b>RANGE ROVER SPORT</b>										
V8	V8 4.2L 4196cc	2006-09	L & R Front		2	EM-5892				
	V8 4.4L 4394cc	2006-09	L & R Front		2	EM-5892				
	V8 5.0L 5000cc	2010-12	L & R Front		2	EM-5892				
<b>LEXUS PASSENGER CAR</b>										
<b>CT200H</b>										
L4	L4 1.8L 1798cc	2011-16	Front		1	EM-9514				
			Rear		1	EM-7077				
			Right		1	EM-5970				
<b>ES250</b>										
V6	V6 2.5L 2508cc	1990-91	LH Front	Auto	1	EM-8193				
			LH Front	Manual	1	EM-8192				
			RH Front	Manual	1	EM-8207				
			Rear		1	EM-8197				
			Trans - Center		1			EM-8208		
<b>ES300</b>										
V6	V6 3.0L 2959cc	1997-98	Front	w/o Variable Timing	1	EM-8967				
			1992-93	Front	Auto	1	EM-8965			
				Front	Manual	1	EM-9146			
		1997-98	1992-93	Rear	Insert Only	1	EM-8699			
				Rear		1	EM-8398			
		1997-01	Torq Str - Front	Auto		1		EM-8697		
		1992-96	Torq Str - Front	Auto		1		EM-8201		
		1997-98	Trans	w/o Variable Timing	1			EM-8644		
		1992-93	Trans	Auto, w/o Variable Timing	1			EM-8644		
			Trans	Manual	1			EM-8529		
		V6 3.0L 2995cc	2002-03	Front		1	EM-5991			
				1999-01	Front	w/ Variable Timing	1	EM-5804		
					Front	w/o Variable Timing	1	EM-8967		
				1994-96	Front		1	EM-8711		

# Engine, Transmission, And Torque Strut Mounts

CYL	ENG. SIZE	YEAR	LOCATION	DESCRIPTION	QTY	ENGINE	TORQUE STRUT	TRANS-MISSION
<b>LEXUS PASSENGER CAR (continued)</b>								
<b>ES300 (continued)</b>								
V6	V6 3.0L 2995cc	2002-03	RH Front		1	EM-9239		
		1999-01	Rear		1	EM-9421		
		1994-96	Rear		1	EM-8398		
		2002-03	Torq Str - Front		1		EM-9197	
			Trans - LH		1			EM-9165
		1999-01	Trans	w/ Variable Timing	1			EM-5809
			Trans	w/o Variable Timing	1			EM-8644
1994-96	Trans	Auto, w/o Variable Timing	1			EM-8644		
<b>ES300H</b>								
L4	L4 2.5L 2494cc	2013-18	Right		1	EM-7053		
<b>ES330</b>								
V6	V6 3.3L 3300cc	2004-06	Front		1	EM-5842		
			RH Rear		1	EM-9212		
			Torq Str - Front		1		EM-9197	
			Trans		1			EM-9165
<b>ES350</b>								
V6	V6 3.5L 3456cc	2007-12	RH Front		1	EM-9238		
		2007-15	Torq Str - Rear		1		EM-9601	
		2007-14	Trans		1			EM-9236
<b>GS300</b>								
L6	L6 3.0L 2997cc	1998-05	L & R Front	Hydraulic Mount	2	EM-5921		
		1993-97	L & R Front	Hydraulic Mount	2	EM-5399		
		1998-05	Trans		1			EM-5941
		1993-97	Trans		1			EM-5950
V6	V6 3.0L 2994cc	2006	L & R Front	RWD	2	EM-7303		
			Trans	RWD	1			EM-5963
<b>GS350</b>								
V6	V6 3.5L 3456cc	2007-11	Trans	RWD	1			EM-5963
<b>GS400</b>								
V8	V8 4.0L 3969cc	1998-00	L & R Front	Hydraulic Mount	2	EM-5142		
			Trans		1			EM-5403
<b>GS430</b>								
V8	V8 4.3L 4293cc	2001-05	L & R Front	Hydraulic Mount	2	EM-5142		
		2006-07	Trans		1			EM-5963
		2001-05	Trans		1			EM-5403
<b>GS450H</b>								
V6	V6 3.5L 3456cc	2007-11	L & R Front		2	EM-7303		
<b>GS460</b>								
V8	V8 4.6L 4608cc	2008-11	Trans		1			EM-5963
<b>IS250</b>								
V6	V6 2.5L 2499cc	2014-15	L & R Front	Convertible	2	EM-7303		
		2006-13	L & R Front	Auto; RWD	2	EM-7303		
		2006-12	Trans	Auto; RWD	1			EM-5963
			Trans	Manual; RWD	1			EM-5975
<b>IS300</b>								
L6	L6 3.0L 2997cc	2001-05	L & R Front	Hydraulic Mount	2	EM-5921		
		2002-05	Trans	Auto	1			EM-5941
			Trans	Manual	1			EM-5801
		2001	Trans	Auto	1			EM-5941

## Engine, Transmission, And Torque Strut Mounts

CYL	ENG. SIZE	YEAR	LOCATION	DESCRIPTION	QTY	ENGINE	TORQUE STRUT	TRANSMISSION
<b>LEXUS PASSENGER CAR (continued)</b>								
<b>IS350</b>								
V6	V6 3.5L 3456cc	2006-12	Trans	RWD	1			EM-5963
<b>LS400</b>								
V8	V8 4.0L 3969cc	1990-00	L & R Front		2	EM-5143		
		1996-00	Trans		1			EM-5942
		1990-95	Trans		1			EM-5144
<b>LS430</b>								
V8	V8 4.3L 4293cc	2001-06	L & R Front		2	EM-5952		
		2004-06	Trans		1			EM-5976
		2001-03	Trans		1			EM-5967
<b>RC350</b>								
V6	V6 3.5L 3456cc	2015-17	Trans		1			EM-5963
<b>RC F</b>								
V8	V8 5.0L 4969cc	2015-17	Trans		1			EM-5963
<b>SC300</b>								
L6	L6 3.0L	1992-00	L & R Front		2	EM-5367		
	L6 3.0L 2997cc	1998-00	Trans	Auto	1			EM-5769
		1992-97	Trans	Auto	1			EM-5769
			Trans	Manual	1			EM-5768
<b>SC430</b>								
V8	V8 4.3L 4293cc	2002-10	RH Front		1	EM-5142		
			Trans		1			EM-5403
<b>LEXUS SPORT UTILITY</b>								
<b>GX470</b>								
V8	V8 4.7L 4663cc	2003-09	L & R Front		2	EM-5649		
		2003-07	Trans		1			EM-9511
<b>LX450</b>								
L6	L6 4.5L 4477cc	1996-97	L & R Front		2	EM-8353		
			Trans		1			EM-8395
<b>LX470</b>								
V8	V8 4.7L 4663cc	1998-07	L & R Front		2	EM-9050		
			Trans		1			EM-8991
<b>RX300</b>								
V6	V6 3.0L 2995cc	1999-03	Front		1	EM-9173		
			Rear	AWD	1	EM-9179		
			Rear	FWD	1	EM-9192		
			Torq Str - Front		1		EM-8995	
			Trans		1			EM-9073
<b>RX330</b>								
V6	V6 3.3L 3300cc	2004-06	Front	4WD; Built in Japan	1	EM-5800		
			RH Front		1	EM-9212		
			Rear	AWD; Bushing Only	1	EM-9590		
			Rear	AWD; Complete Kit	1	EM-5837		
			Rear	FWD	1	EM-7039		
			Torq Str - Front		1		EM-9227	
			Trans		1			EM-9165
<b>RX350</b>								
V6	V6 3.5L 3456cc	2013-15	Front	AWD; A/T; 6 Spd.	1	EM-7335		
			Front	FWD	1	EM-7335		
			RH Front		1	EM-9238		
		2010-12	RH Front		1	EM-9238		
		2007-09	RH Front		1	EM-9238		

# Engine, Transmission, And Torque Strut Mounts

CYL	ENG. SIZE	YEAR	LOCATION	DESCRIPTION	QTY	ENGINE	TORQUE STRUT	TRANS-MISSION
<b>LEXUS SPORT UTILITY (continued)</b>								
<b>RX350 (continued)</b>								
V6	V6 3.5L 3456cc	2007-09	Rear	AWD; Bushing Only	1	EM-9590		
			Rear	AWD; Complete Kit	1	EM-5837		
			Rear	FWD; Japan Built	1	EM-7039		
			Torq Str - Front		1		EM-5861	
		2010-15	Torq Str - Right		1		EM-7084	
			Trans		1			EM-9236
		2007-09	Trans		1			EM-9165
<b>RX400H</b>								
V6	V6 3.3L 3300cc	2006-08	Front		1	EM-7188		
			RH Front		1	EM-9212		
			Torq Str - Rear	AWD	1		EM-9232	
			Trans		1			EM-9165
<b>RX450H</b>								
V6	V6 3.5L 3456cc	2010-15	Front		1	EM-7188		
			Right		1	EM-9238		
			Torq Str - Right		1		EM-7083	
			Trans		1			EM-7189
<b>LINCOLN PASSENGER CAR</b>								
<b>CONTINENTAL</b>								
V6	V6 3.7L 227ci	2017-18	RH Front		1	EM-4270		
	V6 3.8L 232ci	1988-94	RH Front		1	EM-2812*		
			RH Rear		1	EM-2813*		
			Trans		1			EM-2717 *
V8	V8 4.6L 281ci	2001-02	RH Front		1	EM-2996*		
		1998-02	RH Front		1	EM-2996*		
		1995-97	RH Front		1	EM-2996*		
		2001-02	RH Rear		1	EM-2813*		
		1995-97	RH Rear	Hydraulic Mount	1	EM-5148		
		1998-02	Torq Str - Rear		1		EM-3111	
		2001-02	Trans		1			EM-2974 *
		1995-00	Trans		1			EM-2717 *
	V8 5.0L 302ci	1982-87	LH Front		1	EM-2725		
		1980	LH Front		1	EM-2725		
		1982-87	RH Front		1	EM-2726		
		1980	RH Front		1	EM-2726		
		1982-87	Trans		1			EM-2679
		1980	Trans		1			EM-2679
V8 5.8L 351ci	1980	LH Front		1	EM-2438			
		RH Front		1	EM-2437			
		Trans		1			EM-2464	
V8 6.6L 400ci	1977-79	LH Front		1	EM-2749			
		Trans		1			EM-2619	
V8 7.0L 430ci	1958-65	L & R Front		2	EM-2141			
V8 7.5L 460ci	1968-78	Trans		1			EM-2619	
V8 7.6L 462ci	1966-68	L & R Front		2	EM-2141			
<b>LS</b>								
V6	V6 3.0L 182ci	2000-05	L & R Front		2	EM-3077*		
			Trans		1			EM-3063
V8	V8 3.9L 242ci	2000-06	L & R Front		2	EM-3077*		
			Trans		1			EM-3063

\* = Hydraulic Mount, "S" suffix = solid replacement.



# Engine, Transmission, And Torque Strut Mounts

CYL	ENG. SIZE	YEAR	LOCATION	DESCRIPTION	QTY	ENGINE	TORQUE STRUT	TRANSMISSION
<b>LINCOLN PASSENGER CAR (continued)</b>								
<b>MARK III</b>								
V8	V8 7.5L 460ci	1968-71	Trans		1			EM-2619
	V8 7.6L 462ci	1968	L & R Front		2	EM-2141		
<b>MARK IV</b>								
V8	V8 7.5L 460ci	1972-76	Trans		1			EM-2619
<b>MARK V</b>								
V8	V8 6.6L 400ci	1977-79	LH Front		1	EM-2365		
			RH Front		1	EM-2364		
			Trans		1			EM-2619
	V8 7.5L 460ci	1977-78	Trans		1			EM-2619
<b>MARK VI</b>								
V8	V8 5.0L 302ci	1980-83	LH Front		1	EM-2438		
			RH Front		1	EM-2437		
			Trans		1			EM-2464
	V8 5.8L 351ci	1980	LH Front		1	EM-2438		
RH Front				1	EM-2437			
Trans				1			EM-2464	
<b>MARK VII</b>								
V8	V8 5.0L 302ci	1984-92	LH Front	Std Suspension	1	EM-2725		
			RH Front	Std Suspension	1	EM-2726		
			Trans		1			EM-2679
<b>MARK VIII</b>								
V8	V8 4.6L 281ci	1993-98	L & R Front		2	EM-5048*		
<b>MKS</b>								
V6	V6 3.5L 213ci	2013-15	Front	Turbo	1	EM-4209		
		2010-12	Front		1	EM-5427		
		2010-15	Torq Str - Front	Turbo	1		EM-4056	
			Torq Str - Rear	Turbo	1		EM-4055	
	2013-16	Trans - Upper		1			EM-4040	
	V6 3.7L 227ci	2009-15	Front		1	EM-5427		
		2013-15	Torq Str - Lower		1		EM-4055	
		2009-11	Torq Str - Rear		1		EM-3142	
2009-15		Trans - Upper	Non Turbo	1			EM-4040	
<b>MKZ</b>								
L4	L4 2.0L 122ci	2013-18	RH Front		1	EM-4205		
			Torq Str - Rear		1		EM-4184	
		2013-17	Trans		1			EM-4251
	L4 2.5L 152ci	2011-12	Trans		1			EM-4067
V6	V6 3.5L 213ci	2009-12	Right		1	EM-4208		
		2007-08	Right		1	EM-4208		
		2007-12	Torq Str - Front		1		EM-4059	
	Trans			1			EM-4255	
	V6 3.7L 227ci	2013-16	Right		1	EM-4270		
		Torq Str - Lower		1		EM-4200		
		Torq Str - Upper		1		EM-4202		
<b>TOWN CAR</b>								
V8	V8 4.6L 281ci	2009	LH Front		1	EM-3025		
		2003-08	LH Front		1	EM-3071*		
		1998-02	LH Front		1	EM-2861		
		1991-97	LH Front		1	EM-2807		
		2009	RH Front		1	EM-3024		
		2003-08	RH Front		1	EM-3072*		
		1998-02	RH Front		1	EM-2860		
		1991-97	RH Front		1	EM-2806		

\* = Hydraulic Mount, "S" suffix = solid replacement.

# Engine, Transmission, And Torque Strut Mounts

CYL	ENG. SIZE	YEAR	LOCATION	DESCRIPTION	QTY	ENGINE	TORQUE STRUT	TRANSMISSION	
<b>LINCOLN PASSENGER CAR (continued)</b>									
<b>TOWN CAR (continued)</b>									
V8	V8 4.6L 281ci	2003-09	Trans		1			EM-3038	
		1998-02	Trans		1			EM-2822	
		1992-97	Trans		1			EM-2822	
		1991	Trans		1			EM-4147	
	V8 5.0L 302ci	1982-90	LH Front		1	EM-2438			
			RH Front		1	EM-2437			
		1982-85	Trans	before 1/28/82	1			EM-2464	
<b>ZEPHYR</b>									
V6	V6 3.0L 181ci	2006	Right		1	EM-4044			
			Torq Str - Front		1		EM-3107		
			Trans		1			EM-4034	
<b>VERSAILLES</b>									
V8	V8 5.0L 302ci	1977-80	LH Front		1	EM-2504			
			RH Front		1	EM-2503			
			Trans		1			EM-2253	
	V8 5.8L 351ci	1977	LH Front		1	EM-2504			
			RH Front		1	EM-2503			
			Trans	Auto	1			EM-2253	
<b>LINCOLN SPORT UTILITY</b>									
<b>MKC</b>									
L4	L4 2.0L 122ci	2015-18	Right	Insert	1	EM-4229			
	L4 2.0L 122ci	2015-18	Trans		1			EM-4121	
	L4 2.3L 140ci	2015-18	Right	Insert	1	EM-4229			
			Trans		1			EM-4121	
<b>MKT</b>									
V6	V6 3.5L 213ci	2010-15	RH Front	Turbo	1	EM-4209			
			Torq Str - Front	Turbo	1		EM-4056		
			Torq Str - Rear	Turbo	1		EM-4055		
	V6 3.7L 227ci	2010-12	RH Front		1	EM-5427			
			2010-13	Torq Str - Front		1		EM-3142	
			2010-15	Trans - Upper	Non Turbo	1			EM-4040
<b>MKX</b>									
V6	V6 3.5L 213ci	2007-10	RH Front		1	EM-5427			
			Torq Str - Rear		1		EM-3144		
			Trans		1			EM-4081	
	V6 3.7L 227ci	2016-18	RH Front		1	EM-4270			
			2011-15	RH Front		1	EM-5427		
			2016	Torq Str - Lower		1		EM-4200	
			2011-14	Torq Str - Rear		1		EM-3142	
			2016	Torq Str - Upper		1		EM-4202	
			2011-15	Trans		1			EM-4081
<b>NAVIGATOR</b>									
V6	V6 3.5L 213ci	2015-17	LH Front		1	EM-4143			
			RH Front		1	EM-4142			
V8	V8 5.4L 330ci	2007-13	LH Front		1	EM-4143			
		2005-06	LH Front		1	EM-4097			
		2004	LH Front		1	EM-4097			
		2003	LH Front		1	EM-4097			
		2000-02	LH Front	4WD		1	EM-2972		
			LH Front	RWD		1	EM-2832		
		1998-99	LH Front	4WD		1	EM-2972		
			LH Front	RWD		1	EM-2832		
		2007-13	RH Front		1	EM-4142			
		2005-06	RH Front		1	EM-4099			

## Engine, Transmission, And Torque Strut Mounts

CYL	ENG. SIZE	YEAR	LOCATION	DESCRIPTION	QTY	ENGINE	TORQUE STRUT	TRANSMISSION
<b>LINCOLN SPORT UTILITY (continued)</b>								
<b>NAVIGATOR (continued)</b>								
V8	V8 5.4L 330ci	2004	RH Front		1	EM-4099		
		2003	RH Front		1	EM-4098		
		2000-02	RH Front		1	EM-2835		
		1998-99	RH Front	4WD	1	EM-2834		
			RH Front	RWD	1	EM-2835		
		2006	Trans	RWD	1			EM-2971
		2005	Trans	RWD	1			EM-2971
1998-04	Trans	2WD	1			EM-2870		
<b>LINCOLN TRUCK</b>								
<b>BLACKWOOD</b>								
V8	V8 5.4L 330ci	2002	LH Front		1	EM-2972		
			RH Front		1	EM-2835		
			Trans		1			EM-2870
<b>MARK LT</b>								
V8	V8 5.0L 302ci	2011-14	LH Front		1	EM-4143		
			RH Front		1	EM-4142		
	V8 5.4L 330ci	2010	LH Front		1	EM-4143		
		2006-08	Left	Gas	1	EM-4038		
			RH Front		1	EM-4142		
		2006-08	Right	Gas	1	EM-4039		
			Trans	4WD	1			EM-3136
<b>MAZDA PASSENGER CAR</b>								
<b>2</b>								
L4	L4 1.5L 1498cc	2011-14	Right	Auto	1	EM-4074		
			Torq Str - Rear	Auto	1		EM-7241	
			Torq Str - Rear	Manual	1		EM-5909	
			Trans	Auto	1			EM-7022
			Trans	Manual	1			EM-7046
<b>3</b>								
L4	L4 2.0L 1998cc	2012-13	Rear	SkyActiv Tech; Mount	1	EM-9222		
			Torq Str - Rear		1		EM-7172	
		2012-13	Torq Str - Rear		1		EM-5783	
			2014-18	Trans	Auto	1		
		Trans		Manual	1			EM-7235
		2012-13	Trans	Auto	1			EM-5864
			Trans	Manual	1			EM-9534
		L4 2.0L 2000cc	2004-10	RH Front	Complete Unit	1	EM-5375	
	RH Front			Insert Only	1	EM-3103		
	2011-13		Rear	exc. SkyActiv Tech; Mount	1	EM-9222		
	2004-10		Rear	Mount	1	EM-9222		
	2004-13		Torq Str - Rear		1		EM-5783	
	2010-13		Trans	Auto	1			EM-5864
			Trans	Manual	1			EM-9534
	2004-09	Trans		1			EM-9196	
	L4 2.3L 2260cc	2007-09	RH Front	Complete Unit	1	EM-5362		
			RH Front	Insert Only	1	EM-3103		
		2004-06	RH Front	Complete Unit; w/o Turbo	1	EM-5362		
			RH Front	Insert Only; w/o Turbo	1	EM-3103		
		2010-13	Rear	Mount	1	EM-9222		
		2007-09	Rear	Mount	1	EM-9222		
		2004-06	Rear		1	EM-9222		
		2004-09	Torq Str - Rear		1		EM-5783	
2010-11		Trans		1			EM-5863	
2008-09		Trans	Auto; w/ Turbo	1			EM-9526	

# Engine, Transmission, And Torque Strut Mounts

CYL	ENG. SIZE	YEAR	LOCATION	DESCRIPTION	QTY	ENGINE	TORQUE STRUT	TRANSMISSION	
<b>MAZDA PASSENGER CAR (continued)</b>									
<b>3 (continued)</b>									
L4	L4 2.3L 2260cc	2008-09	Trans	Auto; w/o Turbo	1			EM-9196	
			Trans	Manual; w/ Turbo	1			EM-7043	
			Trans	Manual; w/o Turbo	1			EM-9196	
		2007	Trans	Auto; w/ Turbo	1				EM-9526
			Trans	Auto; w/o Turbo	1				EM-9196
			Trans	Manual; w/ Turbo	1				EM-7043
			Trans	Manual; w/o Turbo	1				EM-9196
		2004-06	Trans	Auto	1				EM-9196
	Trans		Manual	1				EM-9196	
	L4 2.5L 2488cc	2014-17	RH Front	Complete Unit	1	EM-7325			
			RH Front	Insert	1	EM-7230			
		2010-13	Rear		1	EM-9222			
			Torq Str - Rear		1			EM-5783	
		2014-17	Trans	Auto	1				EM-7235
			Trans	Manual	1				EM-7235
		2010-13	Trans	Auto	1				EM-5864
Trans			Manual	1				EM-9534	
<b>3 SPORT</b>									
L4	L4 2.0L 1998cc	2014-15	Torq Str - Rear		1		EM-7172		
	L4 2.0L 2000cc	2012-13	RH Front	Insert Only	1	EM-3103			
			RH Front	Insert Only	1	EM-3103			
		2012-13	Rear	Mount	1	EM-9222			
			Rear	Mount	1	EM-9222			
		2012-13	Torq Str - Rear		1		EM-5783		
		2009-10	Torq Str - Rear		1		EM-5783		
		2012-13	Trans	Auto	1				EM-5864
			Trans	Manual	1				EM-9534
		2010	Trans	Auto	1				EM-5864
			Trans	Manual	1				EM-9534
	2009	Trans		1				EM-9196	
	L4 2.5L 2488cc	2012-13	Rear		1	EM-9222			
			Rear		1	EM-9222			
		2012-13	Torq Str - Rear		1			EM-5783	
			Torq Str - Rear		1			EM-5783	
		2012-13	Trans	Auto	1				EM-5864
			Trans	Manual	1				EM-9534
		2010	Trans	Auto	1				EM-5864
Trans	Manual	1				EM-9534			
<b>6</b>									
L4	L4 2.3L 2260cc	2003-08	RH Front	Auto; i Sedan	1	EM-9182			
		2006-08	Torq Str - Rear		1		EM-5943		
		2003-05	Torq Str - Rear		1		EM-9195		
		2003-08	Trans		1			EM-9539	
	L4 2.5L 153ci	2009-13	Trans	Auto	1			EM-4034	
			Trans	Manual	1			EM-4034	
	L4 2.5L 2488cc	2014-17	RH Front	Complete Unit	1	EM-7325			
			RH Front	Insert	1	EM-7230			
		2009-13	Right		1	EM-7044			
		2014-15	Torq Str - Rear		1		EM-7172		
		2009-13	Torq Str - Rear		1		EM-7174		
		2014-18	Trans	Auto	1				EM-7235
			Trans	Manual	1				EM-7235
	V6	V6 3.0L 2968cc	2003-08	RH Front	Auto	1	EM-5152		
2006-08			Torq Str - Rear	Auto	1		EM-7125		
			Torq Str - Rear	Manual	1		EM-9221		
2005			Torq Str - Rear	Auto; 4 Spd & 5 Spd	1		EM-9221		

## Engine, Transmission, And Torque Strut Mounts

CYL	ENG. SIZE	YEAR	LOCATION	DESCRIPTION	QTY	ENGINE	TORQUE STRUT	TRANSMISSION
<b>MAZDA PASSENGER CAR (continued)</b>								
<b>6 (continued)</b>								
V6	V6 3.0L 2968cc	2005	Torq Str - Rear	Manual	1		EM-9221	
		2003-04	Torq Str - Rear		1		EM-9221	
		2003-08	Trans		1			EM-9536
	V6 3.7L	2009-13	Right		1	EM-7044		
			Torq Str - Rear		1		EM-7174	
			Trans		1		EM-7264	
<b>323</b>								
L4	L4 1.6L 1597cc	1988-89	Front		1	EM-8065		
		1986-87	Front	Auto	1	EM-8065		
			Front	Manual	1	EM-8101		
		1990-94	RH Front		1	EM-9131		
		1988-89	RH Front	Auto	1	EM-8234		
			RH Front	Manual	1	EM-8060		
		1986-87	RH Front	Auto	1	EM-8234		
			RH Front	Manual	1	EM-8262		
		1990-94	Rear		1	EM-8453		
		1988-89	Rear		1	EM-2650		
		1986-87	Rear	Manual	1	EM-8068		
			Trans - Front	Manual; FWD	1			EM-8068
	1990	Trans	Auto	1			EM-8223	
	1988-89	Trans	w/o Turbo	1			EM-8068	
	1986-87	Trans	Auto; FWD	1			EM-8424	
L4 1.8L 1839cc	1990-91	RH Front		1	EM-8609			
		Trans	Auto	1		EM-2815		
		Trans	Manual	1		EM-2650		
<b>626</b>								
L4	L4 2.0L 1970cc	1983	Front		1	EM-8080		
		1979-82	L & R Front		2	EM-8055		
		1983	RH Front	Auto	1	EM-8077		
			RH Front	Manual	1	EM-8514		
			Rear		1	EM-8078		
		1979-82	Trans		1			EM-8512
	L4 2.0L 1991cc	2001-02	Front	Auto	1	EM-9466		
			Front	Manual	1	EM-9478		
		2000	Front	Auto	1	EM-5155		
			Front	Manual	1	EM-9478		
		1994-97	Front	Auto	1	EM-5155		
			Front	Manual	1	EM-8073		
		1993	Front		1	EM-8073		
		1998-99	LH Front	Auto	1	EM-5155		
			LH Front	Manual	1	EM-9478		
		2001-02	RH Front	Auto	1	EM-9469		
			RH Front	Manual	1	EM-8074		
		2000	RH Front		1	EM-9469		
		1998-99	RH Front		1	EM-8074		
		1994-97	RH Front		1	EM-8074		
		1993	RH Front		1	EM-8074		
		2001-02	Rear	Auto	1	EM-8075		
			Rear	Manual	1	EM-8456		
		2000	Rear	Auto	1	EM-9481		
			Rear	Manual	1	EM-9480		
		1998-99	Rear	Auto	1	EM-9481		
			Rear	Manual	1	EM-9480		
		1994-97	Rear	Auto	1	EM-9476		
			Rear	Manual	1	EM-8456		
		1993	Rear	Auto	1	EM-8075		

# Engine, Transmission, And Torque Strut Mounts

CYL	ENG. SIZE	YEAR	LOCATION	DESCRIPTION	QTY	ENGINE	TORQUE STRUT	TRANSMISSION	
<b>MAZDA PASSENGER CAR (continued)</b>									
<b>626 (continued)</b>									
L4	L4 2.0L 1991cc	1993	Rear	Manual	1	EM-8456			
		1998-02	Trans - Center	Auto	1			EM-9087	
			Lower	Auto					
		1994-97	Trans - Center	Manual	1				EM-9082
			Lower	Manual					
		1998-02	Trans - Center	Auto	1				EM-9087
		1994-97	Trans - Upper	Auto	1				EM-8691
			Trans	Manual	1				EM-8457
	1993	Trans	Auto	1				EM-8460	
	L4 2.0L 1998cc Diesel	1984-85	Front	Auto; LX	1	EM-8077			
			Front	DX	1	EM-8080			
			Front	LX, Manual	1	EM-8514			
	L4 2.0L 1998cc	1984-85	Front	Auto; LX	1	EM-8077			
			Front	DX	1	EM-8080			
			Front	LX, Manual	1	EM-8514			
	L4 2.0L 1998cc Diesel	1986-87	LH Front		1	EM-8080			
	L4 2.0L 1998cc	1984-85	RH Front		1	EM-8077			
	L4 2.0L 1998cc	1986-87	RH Front		1	EM-8077			
			Rear		1	EM-8078			
	L4 2.0L 1998cc Diesel	1984-85	Rear		1	EM-8078			
	L4 2.0L 1998cc	1984-85	Rear		1	EM-8078			
			Trans - Rear	Auto	1			EM-5378	
			Trans	Manual	1			EM-8091	
			Trans	Auto	1			EM-5378	
	L4 2.2L 2184cc	1991-92	Trans	Manual	1			EM-8082	
			Front	Auto	1	EM-8083			
			Front	Auto	1	EM-8083			
		1988-90	Front	Manual	1	EM-8085			
			RH Front		1	EM-8086			
		1991-92	RH Front		1	EM-8086			
			Rear	Auto	1	EM-8087			
		1988-90	Rear	Manual	1	EM-8088			
Rear			Auto	1	EM-8087				
1990-92		Rear	Manual	1	EM-8088				
		Trans	Auto	1			EM-8516		
1988-89		Trans	Manual	1			EM-8462		
	Trans	Auto	1			EM-5156			
	Trans	Manual	1			EM-8089			
V6	V6 2.5L 2497cc	1998-02	Front	Auto	1	EM-8073			
			Front	Manual	1	EM-9478			
		1993-97	Front		1	EM-8073			
		1998-02	RH Front		1	EM-8074			
		1993-97	RH Front		1	EM-8074			
		1998-02	Rear	Manual	1	EM-8456			
			Rear	Auto	1	EM-8075			
		1993-97	Rear	Manual	1	EM-8456			
			Trans - Center	Auto	1			EM-9087	
		1998-02	Lower	Auto					
			Trans - Center	Auto	1			EM-9087	
		1993-97	Lower	Auto					
			Trans - Center	Manual	1			EM-9082	
		1998-02	Lower	Manual					
			Trans - Upper	Auto	1			EM-8460	
1998-02	Trans	Manual	1			EM-8457			

# Engine, Transmission, And Torque Strut Mounts

CYL	ENG. SIZE	YEAR	LOCATION	DESCRIPTION	QTY	ENGINE	TORQUE STRUT	TRANS-MISSION		
<b>MAZDA PASSENGER CAR (continued)</b>										
<b>808</b>										
L4	L4 1.6L 1587cc	1972-77	Trans		1			EM-2759		
<b>929</b>										
V6	V6 3.0L	1992-95	Front		1	EM-5658				
		1988-89	Trans		1			EM-5563		
<b>GLC</b>										
L4	L4 1.4L 1415cc	1979-80	Rear		1	EM-8095				
			Trans	Auto	1			EM-8512		
			Trans	Manual	1			EM-8512		
	L4 1.5L 1490cc	1983-85	1981-82	Front		1	EM-8059			
				Front		1	EM-8056			
				RH Front		1	EM-8259			
				RH Front		1	EM-8060			
				Rear		1	EM-8424			
				Rear		1	EM-8424			
				Torq Str - Front	Control Arm	1		EM-8425		
				Torq Str - Rear	Control Arm	1		EM-8563		
				Trans	Auto	1			EM-8061	
				Trans	Manual	1			EM-8061	
				Trans	Auto	1			EM-8263	
Trans	Manual	1			EM-8061					
<b>MIATA - MX5</b>										
L4	L4 1.6L 1597cc	1990-93	L & R Front		2	EM-8909				
	L4 1.8L 1839cc	1999-05	L & R Front		2	EM-8909				
		1994-97	L & R Front		2	EM-8909				
<b>MILLENNIA</b>										
V6	V6 2.3L 2254cc	1995-02	Front		1	EM-9007				
			RH Front		1	EM-9017				
			Rear		1	EM-9008				
			Trans		1			EM-8863		
	V6 2.5L 2497cc	2001-02	1997-00	Front		1	EM-9007			
				Front		1	EM-8864			
				Front		1	EM-9007			
				RH Front		1	EM-9021			
				RH Front		1	EM-9021			
				RH Front		1	EM-9021			
				Rear		1	EM-9008			
				Rear		1	EM-9008			
				Rear		1	EM-9008			
				Trans		1			EM-8862	
<b>MX-3</b>										
L4	L4 1.6L 1597cc	1994-96	Front	Auto	1	EM-2910*				
			Front		1	EM-2651				
			RH Front		1	EM-8609				
			RH Front		1	EM-9131				
			Rear	Manual	1	EM-8453				
			Rear		1	EM-2815				
			Trans	Manual	1			EM-2650		
V6	V6 1.8L 1597cc	1994	RH Front		1	EM-8609				
			Rear		1	EM-2815				
	V6 1.8L 1845cc	1992-93	RH Front		1	EM-8813				
			Rear		1	EM-2815				
			Trans		1			EM-2650		

\* = Hydraulic Mount, "S" suffix = solid replacement.

# Engine, Transmission, And Torque Strut Mounts

CYL	ENG. SIZE	YEAR	LOCATION	DESCRIPTION	QTY	ENGINE	TORQUE STRUT	TRANSMISSION
<b>MAZDA PASSENGER CAR (continued)</b>								
<b>MX-6</b>								
L4	L4 2.0L 1991cc	1994-97	Front	Auto	1	EM-5155		
			Front	Manual	1	EM-8073		
		1993	Front	Auto	1	EM-5110		
			Front	Manual	1	EM-8073		
		1994-97	RH Front		1	EM-8074		
			RH Front		1	EM-8074		
		1994-97	Rear	Auto	1	EM-9476		
			Rear	Manual	1	EM-8456		
		1993	Rear	Auto	1	EM-8075		
			Rear	Manual	1	EM-8456		
		1994-97	Trans	Auto	1			EM-8691
			Trans	Manual	1			EM-8457
	1993	Trans	Auto	1			EM-8460	
		Trans	Manual	1			EM-8457	
	L4 2.2L 2184cc	1990-92	Front	Auto	1	EM-8083		
			Front	Manual	1	EM-8085		
		1988-89	Front	Auto	1	EM-8083		
			Front	Manual	1	EM-8085		
		1990-92	RH Front		1	EM-8086		
			RH Front	LIFT	1	EM-8086		
		1990-92	Rear	Auto	1	EM-8087		
			Rear	Manual; Exc. GT	1	EM-8088		
			Rear	Manual; GT	1	EM-9130		
		1988-89	Rear	Auto; DX; LX	1	EM-8087		
			Rear	Manual; DX; LX	1	EM-8088		
			Rear	Manual; GT	1	EM-9130		
		1992	Trans	Auto	1			EM-8516
			Trans	Manual	1			EM-9064
1988-91		Trans	Auto	1			EM-8516	
		Trans	Manual	1			EM-8462	
V6	V6 2.5L 2497cc	1994-97	Front		1	EM-8073		
			Front		1	EM-8073		
		1994-97	Rear	Auto	1	EM-8075		
			Rear	Manual	1	EM-8456		
		1993	Rear	Auto	1	EM-8075		
			Rear	Manual	1	EM-8456		
		1993-97	Trans	Auto	1			EM-8460
			Trans	Manual	1			EM-8457
<b>PROTEGE</b>								
L4	L4 1.5L 1489cc	1995-98	Front	Auto	1	EM-8513		
			Front	Manual	1	EM-8062		
			RH Front		1	EM-8740		
			Rear		1	EM-8261		
			Trans		1			EM-8063
	L4 1.6L 1589cc	1999-01	Front		1	EM-8885		
			RH Front		1	EM-8884		
		2001-03	Rear	Auto	1	EM-8889		
			Rear	Auto	1	EM-8889		
		1999-01	Rear	Manual	1	EM-8886		
			Trans	Auto	1			EM-8978
			Trans	Manual	1			EM-8977
	L4 1.8L 1839cc	1999-00	Front		1	EM-8885		
			Front	Auto	1	EM-8513		
		1995-98	Front	Manual	1	EM-8062		
			LH Front		1	EM-2815		
		1999-00	RH Front		1	EM-9072		
	1995-98	RH Front		1	EM-8740			



# Engine, Transmission, And Torque Strut Mounts

CYL	ENG. SIZE	YEAR	LOCATION	DESCRIPTION	QTY	ENGINE	TORQUE STRUT	TRANS-MISSION	
<b>MAZDA PASSENGER CAR (continued)</b>									
<b>PROTEGE (continued)</b>									
L4	L4 1.8L 1839cc	1990-94	RH Front		1	EM-2649			
		1999-00	Rear		1	EM-8882			
		1995-98	Rear		1	EM-8261			
		1990-94	Rear	Auto	1	EM-2650			
			Rear	Manual	1	EM-8453			
		1999-00	Trans	Auto	1			EM-8978	
			Trans	Manual	1			EM-8977	
		1996-98	Trans	Auto	1			EM-8063	
		1995	Trans	Auto	1			EM-8063	
			Trans	Manual	1			EM-8063	
	1990-94	Trans	Auto	1			EM-2815		
		Trans	Manual	1			EM-2815		
	L4 2.0L 1998cc	2003	Front		1	EM-8885			
			RH Front	Auto	1	EM-9072			
			Rear	Auto	1	EM-8882			
			Trans	Manual	1			EM-8978	
			Trans	Auto	1			EM-8978	
	L4 2.0L 2000cc	2003	Front	Manual	1	EM-8885			
			Front		1	EM-8885			
		2001-02	RH Front	Auto	1	EM-9072			
Rear			Auto	1	EM-8882				
Trans			Auto	1			EM-8978		
<b>PROTEGE5</b>									
		2002-03	Trans	Auto	1			EM-8978	
L4	L4 2.0L 2000cc	2002-03	Front		1	EM-8885			
			RH Front	Auto	1	EM-9072			
			Rear	Auto	1	EM-8882			
<b>RX-7</b>									
R2	R2 1.1L 1146cc	1979-85	L & R Front		2	EM-8055			
			Trans	Auto	1			EM-8512	
			Trans	Manual	1			EM-8095	
	R2 1.3L 1308cc	1986-91	L & R Front		2	EM-8424			
			L & R Front		2	EM-8055			
			Trans	Coupe	2			EM-8068	
			Trans		2			EM-8068	
			1984-85	Trans	Manual	1			EM-8095
				Trans	Manual	1			EM-8095
<b>MAZDA SPORT UTILITY</b>									
<b>CX-5</b>									
L4	L4 2.0L 1998cc	2013-16	RH Front	Insert	1	EM-7239			
		2014-15	Torq Str - Rear		1		EM-7172		
		2017	Trans	Auto	1			EM-7235	
		2013-16	Trans	Auto	1			EM-7235	
			Trans	Manual	1			EM-7235	
	L4 2.5L 2488cc	2014-17	RH Front	Complete Unit	1	EM-7325			
			RH Front	Insert	1	EM-7230			
		2014-15	Torq Str - Rear		1		EM-7172		
		2014-16	Trans	Auto	1			EM-7235	
Trans	Manual		1			EM-7235			
<b>CX-7</b>									
L4	L4 2.3L 2260cc	2007-12	Right		1	EM-7018			
		2007-09	Torq Str - Rear		1		EM-9507		
		2007-12	Trans		1			EM-9537	

# Engine, Transmission, And Torque Strut Mounts

CYL	ENG. SIZE	YEAR	LOCATION	DESCRIPTION	QTY	ENGINE	TORQUE STRUT	TRANSMISSION		
<b>MAZDA SPORT UTILITY (continued)</b>										
<b>CX-9</b>										
V6	V6 3.5L 3456cc	2007	Torg Str - Rear		1		EM-9507			
			Trans		1		EM-9537			
	V6 3.7L 3726cc	2010-12	Right		1	EM-7004				
		2008-09	Torg Str - Rear		1		EM-9507			
		2008-14	Trans		1		EM-9537			
<b>NAVAJO</b>										
V6	V6 4.0L 4016cc	1991-94	LH Front		1	EM-2643				
			RH Front		1	EM-2641				
		1992-94	Trans	Auto		1			EM-2639	
			Trans	Manual		1			EM-2639	
<b>TRIBUTE</b>										
L4	L4 2.0L 1991cc	2001-04	RH Front		1	EM-3056*				
			Rear		1	EM-3057*				
			Trans	Auto		1		EM-3037		
	L4 2.3L 140ci	2008	2005-06	Front	Gas	1	EM-4033			
				Front	Gas	1	EM-4033			
				LH Front	Gas	1	EM-4071			
				LH Front	Gas	1	EM-4071			
				Rear	Gas	1	EM-4019			
				Rear	Gas	1	EM-4019			
				Trans	Auto		1		EM-4117	
	2005-06	Trans	Auto		1		EM-4117			
	L4 2.5L 2488cc	2009-11	LH Front	Gas	1	EM-4071				
			Rear	Gas	1	EM-4019				
			Trans	Auto		1		EM-4117		
V6	V6 3.0L 2968cc	2009-11	Front		1	EM-4033				
			2008	Front		1	EM-4033			
			2005-06	Front		1	EM-4033			
			2009-11	LH Front		1	EM-4071			
			2008	LH Front		1	EM-4071			
			2005-06	LH Front		1	EM-4071			
			2001-04	RH Front		1	EM-3056*			
			2009-11	Rear	FWD		1	EM-4019		
			2008	Rear			1	EM-4019		
			2005-06	Rear			1	EM-4019		
			2001-04	Rear			1	EM-3037		
			2008-11	Trans	Auto		1		EM-4117	
			2005-06	Trans	Auto		1		EM-4117	
2001-04	Trans	Auto		1		EM-3057*				
<b>MAZDA TRUCK</b>										
<b>B1600</b>										
L4	L4 1.6L 1586cc	1972-76	LH Front		1	EM-2775				
			RH Front		1	EM-2774				
			Rear		1	EM-8095				
			Trans	Manual		1		EM-8079		
<b>B1800</b>										
L4	L4 1.8L 1796cc	1977-78	LH Front		1	EM-2775				
			RH Front		1	EM-2774				
			Trans	Manual		1		EM-8079		
<b>B2000</b>										
L4	L4 2.0L 1970cc	1979-84	LH Front		1	EM-2775				
			RH Front		1	EM-2774				
			Trans	Manual		1		EM-8095		
	L4 2.0L 1998cc	1986-87	L & R Front		2	EM-8094				

\* = Hydraulic Mount, "S" suffix = solid replacement.

# Engine, Transmission, And Torque Strut Mounts

CYL	ENG. SIZE	YEAR	LOCATION	DESCRIPTION	QTY	ENGINE	TORQUE STRUT	TRANSMISSION	
<b>MAZDA TRUCK (continued)</b>									
<b>B2000 (continued)</b>									
L4	L4 2.0L 1998cc	1986-87	Trans	Manual	1			EM-8095	
<b>B2200</b>									
L4	L4 2.2L 2184cc	1987-93	L & R Front		2	EM-8094			
			Trans	Manual	1		EM-8095		
	L4 2.2L 2209cc Diesel	1982-84	LH Front		1	EM-2775			
			RH Front		1	EM-2774			
			Trans		1		EM-8079		
<b>B2300</b>									
L4	L4 2.3L 140ci	1994-97	L & R Front		2	EM-2698*			
			2001-09	LH Front		1	EM-3078		
				RH Front		1	EM-5377		
				Trans	Auto	1			EM-2639
				Trans	Manual	1			EM-2639
				1994-97	Trans	Auto	1		EM-2639
			Trans	Manual	1		EM-2639		
<b>B2500</b>									
L4	L4 2.5L 2492cc	1998-01	RH Front		1	EM-2853			
			Trans	Auto	1		EM-2639		
			Trans	Manual	1		EM-2639		
<b>B2600</b>									
L4	L4 2.6L 2555cc	1987-88	L & R Front		2	EM-8084			
		1987-89	Trans	Manual	1			EM-8095	
	L4 2.6L 2606cc	1989-93	L & R Front		2	EM-8578			
		1990-93	Trans	Manual	1			EM-8095	
<b>B3000</b>									
V6	V6 3.0L 2954cc	1998-07	L & R Front		2	EM-2853			
			Trans	Auto	1		EM-2639		
			Trans	Manual	1		EM-2639		
	V6 3.0L 2983cc	1994-96	LH Front	4WD	1	EM-2643			
			LH Front	RWD	1	EM-2643			
			RH Front	4WD	1	EM-2641			
			RH Front	RWD	1	EM-2640			
			Trans	Auto	1		EM-2639		
Trans	Manual	1		EM-2639					
<b>B4000</b>									
V6	V6 4.0L 4016cc	2005-09	LH Front	4WD	1	EM-2851			
		1994-97	LH Front	4WD	1	EM-2643			
			LH Front	RWD	1	EM-2642			
		2005-09	RH Front	4WD	1	EM-2935			
		1998-04	RH Front	4WD	1	EM-2935			
			RH Front	RWD	1	EM-2853			
		1994-97	RH Front	4WD	1	EM-2641			
			RH Front	RWD	1	EM-2641			
		1994-08	Trans	Auto	1		EM-2639		
			Trans	Manual	1		EM-2639		
<b>MAZDA VAN</b>									
<b>5</b>									
L4	L4 2.3L 2260cc	2006-10	RH Front	Complete Unit	1	EM-5362			
			RH Front	Insert Only	1	EM-3103			
			Rear	Mount	1	EM-9222			
			Torg Str - Rear		1		EM-5783		
			Trans	Auto	1		EM-5923		
			Trans	Manual	1		EM-5923		

\* = Hydraulic Mount, "S" suffix = solid replacement.

# Engine, Transmission, And Torque Strut Mounts

CYL	ENG. SIZE	YEAR	LOCATION	DESCRIPTION	QTY	ENGINE	TORQUE STRUT	TRANSMISSION
<b>MAZDA VAN (continued)</b>								
<b>5 (continued)</b>								
L4	L4 2.5L 2488cc	2012	Trans	Auto	1			EM-5864
<b>MPV</b>								
L4	L4 2.6L 2606cc	1989-94	L & R Front		2	EM-8093		
		1992-94	Trans	4WD	1			EM-8814
			Trans	RWD	1			EM-8693
		1989-91	Trans	Manual	1			EM-8693
V6	V6 2.5L 2450cc	2000-01	Front		1	EM-9468		
			Rear		1	EM-9472		
	V6 2.5L 2497cc	2000-01	Trans		1			EM-9527
	V6 3.0L 2954cc	1996-98	L & R Front		2	EM-8868		
			L & R Front		2	EM-8093		
			Trans	2WD	1			EM-8693
	V6 3.0L 2968cc	2002-06	Trans	4WD	1			EM-8814
			Front		1	EM-9468		
			Left		1	EM-9461		
			Rear		1	EM-9472		
			Trans		1			EM-9527
<b>MERCEDES-BENZ PASSENGER CAR</b>								
<b>190D</b>								
L4	L4 2.2L 2197cc Diesel	1984-85	L & R Front	Auto	2	EM-9270		
			L & R Front	Manual	2	EM-9269		
			Trans	Auto	1			EM-9266
L5	L5 2.5L	1988-89	Trans	Auto	1			EM-9266
			Trans	Turbo	1			EM-8632
		1987	Trans	Auto; w/o Turbo	1			EM-9266
			Trans		1			EM-9266
	L5 2.5L 2497cc Diesel	1988-89	L & R Front		2	EM-8662		
			L & R Front	Turbo	2	EM-8836		
			L & R Front	w/o Turbo	2	EM-8662		
L5 2.5L 2497cc	1986	L & R Front		2	EM-8662			
<b>190E</b>								
L4	L4 2.3L 2299cc	1991-93	L & R Front		2	EM-8662		
		1984-88	L & R Front		2	EM-8662		
		1991-93	Trans	Auto	1			EM-9266
L6	L6 2.6L 2599cc	1987-93	L & R Front		2	EM-8662		
<b>230</b>								
L4	L4 2.3L 2307cc	1974-78	L & R Front		2	EM-8630		
		1974	Trans	Manual	1			EM-8629
<b>240D</b>								
L4	L4 2.4L 2404cc Diesel	1974-83	L & R Front		2	EM-8229		
<b>260E</b>								
L6	L6 2.6L 2599cc	1987-89	L & R Front		2	EM-8662		
			Trans	Auto	1			EM-9266
<b>280CE</b>								
L6	L6 2.8L 2746cc	1978-81	L & R Front		2	EM-8662		
			Trans		1			EM-8631
<b>280E</b>								
L6	L6 2.8L 2746cc	1977-81	L & R Front		2	EM-8662		
			Trans		1			EM-8631

## Engine, Transmission, And Torque Strut Mounts

CYL	ENG. SIZE	YEAR	LOCATION	DESCRIPTION	QTY	ENGINE	TORQUE STRUT	TRANSMISSION
<b>MERCEDES-BENZ PASSENGER CAR (continued)</b>								
<b>300CD</b>								
L5	L5 3.0L 3005cc Diesel	1978-81	Trans		1			EM-8631
<b>300CDT</b>								
L5	L5 3.0L 3005cc Diesel	1982-85	L & R Front		2	EM-8229		
			Trans		1			EM-8631
<b>300CE</b>								
L6	L6 3.0L	1988-89	Trans		1			EM-8632
	L6 3.0L 2962cc	1988-93	L & R Front		2	EM-8662		
		1990-92	Trans	Auto	1			EM-9266
	L6 3.2L 3199cc	1993	L & R Front		2	EM-8662		
			Trans		1			EM-9266
<b>300D</b>								
L5	L5 2.5L 2497cc Diesel	1990-93	L & R Front		2	EM-8836		
			Trans	Auto	1			EM-9266
	L5 3.0L 3005cc Diesel	1975-81	Trans		1			EM-8629
L6	L6 3.0L 2998cc Diesel	1987	L & R Front		2	EM-8662		
			Trans		1			EM-9266
<b>300DT</b>								
L5	L5 3.0L 3005cc Diesel	1982-85	L & R Front		2	EM-8229		
			Trans	Auto	1			EM-8230
<b>300E</b>								
L6	L6 2.6L 2599cc	1992	Trans	Auto	1			EM-9266
	L6 2.8L 2799cc	1993	L & R Front		2	EM-8662		
			Trans	Auto	1			EM-9091
	L6 3.0L 2962cc	1986-93	L & R Front		2	EM-8662		
			Trans		1			EM-8632
	L6 3.2L 3199cc	1993	L & R Front		2	EM-8662		
			Trans	Auto	1			EM-9266
<b>300SD</b>								
L5	L5 3.0L 3005cc Diesel	1978-85	L & R Front		2	EM-8229		
			Trans	Auto	1			EM-8629
L6	L6 3.4L 3449cc	1992-93	L & R Front		2	EM-8662		
	L6 3.4L 3449cc Diesel	1992-93	Trans		1			EM-9002
<b>300SDL</b>								
L6	L6 3.0L 2998cc Diesel	1986-87	L & R Front		2	EM-8229		
			Trans	Auto	1			EM-9266
<b>300SE</b>								
L6	L6 3.0L 2962cc	1988-91	LH Front		1	EM-8630		
			RH Front		1	EM-5374		
			Trans	Auto	1			EM-8230
	L6 3.2L 3199cc	1992-93	Trans		1			EM-9002
<b>300SEL</b>								
L6	L6 3.0L 2962cc	1988-91	LH Front		1	EM-8630		
			RH Front		1	EM-5374		
			Trans	Auto	1			EM-8230
<b>300SL</b>								
L6	L6 3.0L 2962cc	1990-93	L & R Front		2	EM-8834		
			Trans		1			EM-9266
<b>300TD</b>								
L5	L5 3.0L 3005cc Diesel	1979-81	L & R Front		2	EM-8229		
			Trans	Auto	1			EM-8631

# Engine, Transmission, And Torque Strut Mounts

CYL	ENG. SIZE	YEAR	LOCATION	DESCRIPTION	QTY	ENGINE	TORQUE STRUT	TRANSMISSION
<b>MERCEDES-BENZ PASSENGER CAR (continued)</b>								
<b>300TE</b>								
L6	L6 3.0L 2962cc	1988-93	L & R Front		2	EM-8662		
			Trans	Auto	1		EM-9266	
	L6 3.2L 3199cc	1993	L & R Front		2	EM-8662		
			Trans		1		EM-8632	
<b>350SD</b>								
L6	L6 3.4L 3449cc Diesel	1991	Trans	Auto	1			EM-9266
<b>350SDL</b>								
L6	L6 3.4L 3449cc Diesel	1990-91	Trans	Auto	1			EM-9266
<b>380SE</b>								
V8	V8 3.8L 3839cc	1984-85	L & R Front		2	EM-8229		
			Trans		1		EM-8230	
<b>380SEC</b>								
V8	V8 3.8L 3839cc	1982-83	L & R Front		2	EM-8229		
			Trans		1		EM-8230	
<b>380SEL</b>								
V8	V8 3.8L 3839cc	1981-83	L & R Front		2	EM-8229		
			Trans	Auto	1		EM-8230	
<b>380SL</b>								
V8	V8 3.8L 3839cc	1981-85	Trans	Auto	1			EM-8629
<b>380SLC</b>								
V8	V8 3.8L 3839cc	1981	Trans		1			EM-8629
<b>400E</b>								
V8	V8 4.2L 4196cc	1992-93	L & R Front		2	EM-8834		
<b>400SE</b>								
V8	V8 4.2L 4196cc	1992	LH Front		1	EM-8834		
			Trans		1		EM-9002	
<b>400SEL</b>								
V8	V8 4.2L 4196cc	1993	LH Front		1	EM-8834		
			Trans		1		EM-9002	
<b>420SEL</b>								
V8	V8 4.2L 4196cc	1986-91	L & R Front		2	EM-8229		
			Trans		1		EM-8230	
<b>450SE</b>								
V8	V8 4.5L 4520cc	1973-76	Trans		1			EM-8629
<b>450SEL</b>								
V8	V8 4.5L 4520cc	1973-80	Trans		1			EM-8629
<b>450SL</b>								
V8	V8 4.5L 4520cc	1973-80	Trans		1			EM-8629
<b>450SLC</b>								
V8	V8 4.5L 4520cc	1973-80	Trans		1			EM-8629
<b>500E</b>								
V8	V8 5.0L 4973cc DOH				2	EM-8834		
<b>500SEC</b>								
V8	V8 5.0L 4973cc DOH				2	EM-8834		
					2	EM-8229		
			Trans		1		EM-9002	
			Trans		1		EM-8230	

## Engine, Transmission, And Torque Strut Mounts

CYL	ENG. SIZE	YEAR	LOCATION	DESCRIPTION	QTY	ENGINE	TORQUE STRUT	TRANSMISSION	
<b>MERCEDES-BENZ PASSENGER CAR (continued)</b>									
<b>500SEL</b>									
V8	V8 5.0L 4973cc DOH				2	EM-8229			
					1	EM-8834			
					1			EM-9002	
					1			EM-8230	
<b>500SL</b>									
V8	V8 5.0L 4973cc DOH				2	EM-8835			
					1			EM-9266	
<b>560SEC</b>									
V8	V8 5.6L 5547cc	1986-91	L & R Front		2	EM-8229			
			Trans	Auto	1		EM-8230		
<b>560SEL</b>									
V8	V8 5.6L 5547cc	1986-91	L & R Front		2	EM-8229			
			Trans	Auto	1		EM-8230		
<b>600SEC</b>									
V12	V12 6.0L 5987cc	1993	L & R Front		2	EM-8838			
			Trans	Auto	1		EM-9002		
<b>600SEL</b>									
V12	V12 6.0L 5987cc	1992-93	L & R Front		2	EM-8838			
			Trans	Auto	1		EM-9002		
<b>600SL</b>									
V12	V12 6.0L 5987cc	1993	L & R Front		2	EM-8838			
<b>C220</b>									
L4	L4 2.2L 2199cc	1994-96	L & R Front		2	EM-8832			
			Trans	Auto	1		EM-9091		
<b>C230</b>									
L4	L4 1.8L 1796cc	2003-05	L & R Front		2	EM-5734			
			Trans		1		EM-9268		
	L4 2.3L 2295cc	2002	L & R Front		2	EM-8832			
			1997-00	L & R Front		2	EM-8832		
			1999-00	Trans		1		EM-9268	
V6	V6 2.5L 2496cc	2006-07	LH Front		1	EM-9562			
			RH Front		1	EM-9562			
			Trans		1		EM-9268		
<b>C240</b>									
V6	V6 2.6L 2597cc	2003-05	L & R Front	AWD	2	EM-8832			
			L & R Front	RWD	2	EM-7130			
		2001-02	L & R Front		2	EM-7130			
			2001-05	Trans		1		EM-9268	
<b>C280</b>									
L6	L6 2.8L 2799cc	1994-96	Trans		1			EM-9091	
V6	V6 2.8L 2799cc	1998-00	Trans	Auto	1			EM-9268	
			V6 3.0L 2996cc	2006-07	LH Front		1	EM-9562	
	RH Front				1	EM-9562			
	Trans				1		EM-9268		
<b>C300</b>									
V6	V6 3.0L 2996cc	2008-12	L & R Front	AWD	2	EM-7156			
		2008-09	L & R Front	AWD; US & Canada	2	EM-7156			
		2012	Trans	4-Matic	1			EM-7280	
		2010-11	Trans	Mexico; RWD	1			EM-5858	
		2008-11	Trans	US & Canada; 4-Matic	1			EM-7280	
			Trans	US & Canada; RWD	1			EM-5858	
		2013-14	L & R Front	AWD	2	EM-7156			

# Engine, Transmission, And Torque Strut Mounts

CYL	ENG. SIZE	YEAR	LOCATION	DESCRIPTION	QTY	ENGINE	TORQUE STRUT	TRANSMISSION
<b>MERCEDES-BENZ PASSENGER CAR (continued)</b>								
<b>C300 (continued)</b>								
V6	V6 3.5L 3498cc	2013-14	Trans	AWD	1			EM-7280
<b>C320</b>								
V6	V6 3.2L 3199cc	2003-05	L & R Front	RWD	2	EM-7130		
		2001-02	L & R Front		2	EM-7130		
		2001-05	Trans		1			EM-9268
<b>C32 AMG</b>								
V6	V6 3.2L 3199cc	2002-04	L & R Front		1	EM-5434		
			Trans	Auto	1			EM-9268
<b>C350</b>								
V6	V6 3.5L 3498cc	2013-15	L & R Front	RWD	2	EM-5859		
			2008-12	L & R Front	US & Canada; AWD	2	EM-7156	
		2008-09	L & R Front	US & Canada; RWD	2	EM-5859		
			L & R Front	Mexico; RWD	2	EM-5859		
			LH Front	US & Canada	1	EM-9562		
		2006-07	LH Front	Mexico	1	EM-9562		
			RH Front	US & Canada	1	EM-9562		
			RH Front	Mexico	1	EM-9562		
			2013-15	Trans	Mexico; RWD	1		
		2010-15	Trans	US & Canada; RWD	1			EM-5858
			Trans	US & Canada; 4-Matic	2			EM-7280
2006-08	Trans	US Vehicle	1			EM-9268		
<b>C43 AMG</b>								
V8	V8 4.3L 4266cc	1998-00	LH Front		1	EM-9562		
			RH Front		1	EM-9562		
		1998-99	Trans		1			EM-9268
<b>C55 AMG</b>								
V8	V8 5.4L 5439cc	2005-06	L & R Front	Mexico	2	EM-5434		
			Trans	Mexico; Auto	1			EM-9268
	V8 5.5L 5439cc	2005-06	L & R Front	US & Canada	2	EM-5434		
			Trans	US & Canada; Auto	1			EM-9268
<b>CL500</b>								
V8	V8 5.0L 4966cc	2006	L & R Front		2	EM-9562		
		2001-05	L & R Front	Mexico	2	EM-5434		
		2006	Trans	Mexico	1			EM-9268
		2001-05	Trans	Mexico; Mexican Vehicle	1			EM-9268
	V8 5.0L 4973cc	2000-05	L & R Front	US & Canada	2	EM-5434		
		1998-99	L & R Front		2	EM-8835		
		1998-05	Trans	US & Canada	1			EM-9268
<b>CL550</b>								
V8	V8 5.5L 5461cc	2007-09	L & R Front		2	EM-5434		
		2010	Trans	4-Matic	1			EM-7280
<b>CL55 AMG</b>								
V8	V8 5.5L 5439cc	2001-02	L & R Front		2	EM-5434		
		2003-06	LH Front		1	EM-9562		
			RH Front		1	EM-9562		
		2001-06	Trans	Auto	1			EM-9268
<b>CL600</b>								
V12	V12 5.5L 5513cc	2003-06	Trans	Auto	1			EM-9268
	V12 5.8L 5786cc	2001-02	Trans	Auto	1			EM-9268
	V12 6.0L 5987cc	1998-99	L & R Front		2	EM-8838		
			Trans		1			EM-9268



## Engine, Transmission, And Torque Strut Mounts

CYL	ENG. SIZE	YEAR	LOCATION	DESCRIPTION	QTY	ENGINE	TORQUE STRUT	TRANS-MISSION	
<b>MERCEDES-BENZ PASSENGER CAR (continued)</b>									
<b>CL63 AMG</b>									
V8	V8 6.2L 6208cc	2008-10	LH Front		1	EM-9562			
			RH Front		1	EM-9562			
<b>CL65 AMG</b>									
V12	V12 6.0L 5980cc	2008-14	Trans		1			EM-9268	
		2005-06	Trans		1			EM-9268	
<b>CLA250</b>									
L4	L4 2.0L 1991cc	2013-19	Right		1	EM-7122			
			2013-16	Torq Str - Lower		1		EM-7120	
		2013-16	Torq Str - Upper		1		EM-7121		
			Trans		1				EM-7123
<b>CLA45 AMG</b>									
L4	L4 2.0L 1991cc	2014-19	Right		1	EM-7122			
			2014-16	Torq Str - Lower		1		EM-7120	
		2014-16	Torq Str - Upper		1		EM-7121		
			Trans		1				EM-7123
<b>CLK320</b>									
V6	V6 3.2L 3199cc	1998-05	Trans	Auto	1			EM-9268	
<b>CLK350</b>									
V6	V6 3.5L 3498cc	2006-09	LH Front		1	EM-9562			
			RH Front		1	EM-9562			
<b>CLK430</b>									
V8	V8 4.3L 4266cc	1999-03	LH Front		1	EM-9562			
			RH Front		1	EM-9562			
			Trans	Auto	1			EM-9268	
<b>CLK500</b>									
V8	V8 5.0L 4966cc	2006	L & R Front		2	EM-5434			
		2003-05	L & R Front	Mexico	2	EM-5434			
		2006	Trans	Auto	1			EM-9268	
		2003-05	Trans	Mexico; Auto	1			EM-9268	
	V8 5.0L 4973cc	2003-05	L & R Front	US & Canada	2	EM-5434			
			Trans	US & Canada; Auto	1			EM-9268	
<b>CLK550</b>									
V8	V8 5.5L 5461cc	2007-09	L & R Front		2	EM-5434			
			Trans		1			EM-9268	
<b>CLK55 AMG</b>									
V8	V8 5.5L 5439cc	2004-06	L & R Front		2	EM-5434			
		2002-03	LH Front		1	EM-9562			
			RH Front		1	EM-9562			
		2001-06	Trans	Auto	1			EM-9268	
<b>CLK63 AMG</b>									
V8	V8 6.2L 6208cc	2007-08	L & R Front		2	EM-5434			
<b>CLS400</b>									
V6	V6 3.0L 2996cc	2015-16	Trans	4-Matic	1			EM-7280	
<b>CLS500</b>									
V8	V8 5.0L 4966cc	2006	Trans		1			EM-9268	
<b>CLS550</b>									
V8	V8 4.6L 4663cc	2012-15	Trans	4-Matic	1			EM-7280	
	V8 5.5L 5461cc	2007-11	L & R Front		2	EM-5434			
		2010-11	Trans	RWD	1			EM-5858	

# Engine, Transmission, And Torque Strut Mounts

CYL	ENG. SIZE	YEAR	LOCATION	DESCRIPTION	QTY	ENGINE	TORQUE STRUT	TRANSMISSION	
<b>MERCEDES-BENZ PASSENGER CAR (continued)</b>									
<b>CLS55 AMG</b>									
V8	V8 5.5L 5439cc	2006	LH Front		1	EM-9562			
			RH Front		1	EM-9562			
<b>CLS63 AMG S</b>									
V8	V8 5.5L 5461cc	2014-17	Trans	4-Matic	1			EM-7280	
<b>CLS63 AMG</b>									
V8	V8 5.5L 5461cc	2014	Trans	AWD	1			EM-7280	
	V8 6.2L 6208cc	2007-11	LH Front		1	EM-9562			
			RH Front		1	EM-9562			
<b>E250</b>									
L4	L4 2.1L 2143cc	2014-16	Trans	AWD	1			EM-7280	
V6	V6 3.5L 3498cc	2011	L & R Front	Mexico	2	EM-5859			
<b>E300D</b>									
L6	L6 3.0L 2996cc Diesel	1995-99	L & R Front		2	EM-8832			
<b>E320</b>									
L6	L6 3.2L 3199cc	1996-97	L & R Front		2	EM-5394			
		1994-95	L & R Front		2	EM-8662			
		2004-05	Trans	Auto		1			EM-9268
		1998-03	Trans	Exc. 4-Matic		1			EM-9268
		1996-97	Trans	Auto		1			EM-9268
		1994-95	Trans	Auto		1			EM-9266
	L6 3.2L 3222cc Diesel	2005-06	Trans	Auto		1			EM-9268
V6	V6 3.0L 2987cc	2007-09	L & R Front		2	EM-9562			
	V6 3.0L 2987cc Diese		Trans	Auto	1			EM-9268	
	V6 3.2L 3199cc	1998-00	L & R Front		2	EM-9562			
		2003-05	LH Front	Gas	1	EM-9562			
		2001-02	LH Front	RWD	1	EM-9562			
		2003-05	RH Front	Gas	1	EM-9562			
2001-02	RH Front		1	EM-9562					
<b>E350</b>									
V6	V6 3.0L 2987cc	2011-13	L & R Front		2	EM-7124			
			Trans	RWD	1			EM-5858	
	V6 3.5L 3498cc	2010-16	L & R Front	RWD	2	EM-5859			
			Trans	Mexico; RWD	1			EM-5858	
			Trans	US & Canada; RWD	1			EM-5858	
			Trans	US & Canada; AWD	1			EM-7280	
			Trans	Mexico; RWD	1			EM-5858	
			Trans	RWD	1			EM-5858	
<b>E400</b>									
V6	V6 3.0L 2996cc	2014-16	L & R Front	RWD	2	EM-5859			
		2015-16	Trans	US & Canada; RWD	1			EM-5858	
			Trans	US & Canada; AWD	1			EM-7280	
		2014-16	Trans	Mexico; RWD	1			EM-5858	
	V6 3.5L 3498cc	2013-15	L & R Front	RWD	2	EM-5859			
<b>E420</b>									
V8	V8 4.2L	1997	Trans	Auto	1			EM-9268	
	V8 4.2L 4196cc	1994-95	L & R Front		2	EM-8834			
<b>E430</b>									
V8	V8 4.3L 4266cc	1998-02	Trans	Exc. 4-Matic	1			EM-9268	
<b>E500</b>									
V8	V8 5.0L 4973cc	2003-06	L & R Front		2	EM-9562			
		1994	L & R Front		2	EM-8834			
		2003-06	Trans	Auto		1			EM-9268

## Engine, Transmission, And Torque Strut Mounts

CYL	ENG. SIZE	YEAR	LOCATION	DESCRIPTION	QTY	ENGINE	TORQUE STRUT	TRANS-MISSION	
<b>MERCEDES-BENZ PASSENGER CAR (continued)</b>									
<b>E550</b>									
V8	V8 4.6L 4663cc	2012-16	Trans	4-Matic	1			EM-7280	
	V8 5.5L 5461cc	2007-09	L & R Front		2	EM-5434			
		2010-11	Trans	RWD		1			EM-5858
			Trans	4-Matic		1			EM-7280
<b>E55 AMG</b>									
V8	V8 5.5L 5439cc	1998-06	L & R Front		2	EM-9562			
		1999-06	Trans	Auto	1			EM-9268	
<b>E63 AMG</b>									
V6	V8 6.2L 6208cc	2007-09	L & R Front		2	EM-5434			
V8	V8 5.5L 5461cc	2014-15	Trans	US & Canada; AWD	1			EM-7280	
<b>E63 AMG S</b>									
V8	V8 5.5L 5461cc	2014-16	Trans	4-Matic	1			EM-7280	
<b>G500</b>									
V8	V8 5.0L 4966cc	2002-06	Trans		1			EM-9268	
<b>G55 AMG</b>									
V8	V8 5.5L 5439cc	2003-09	Trans		1			EM-9268	
<b>R320</b>									
V6	V6 3.0L 2987cc Diese				2	EM-5972			
<b>R350</b>									
V6	V6 3.0L 2987cc Diese				2	EM-5972			
	V6 3.5L 3498cc	2008-09	L & R Front	RWD; US & Canada	2	EM-5972			
<b>R63 AMG</b>									
V8	V8 6.2L 6208cc	2007	L & R Front		2	EM-5972			
			Trans		1			EM-7020	
<b>S320</b>									
L6	L6 3.2L	1997-99	Trans	Auto	1			EM-9268	
	L6 3.2L 3199cc	1994-99	L & R Front		2	EM-8838			
		1994-96	Trans		1			EM-9002	
<b>S350</b>									
L6	L6 3.4L 3449cc	1994-95	L & R Front		2	EM-8662			
V6	V6 3.0L 2987cc	2013	Trans	4-Matic	1			EM-7280	
<b>S350D</b>									
L6	L6 3.4L 3449cc Diesel	1994-95	Trans		1			EM-9002	
<b>S420</b>									
V8	V8 4.2L	1996-99	Trans	Auto	1			EM-9268	
	V8 4.2L 4196cc	1996-99	LH Front		1	EM-8835			
		1994-95	LH Front		1	EM-8834			
			RH Front		1	EM-8662			
		Trans	Auto		1			EM-9002	
<b>S430</b>									
V8	V8 4.3L 4266cc	1999-06	L & R Front		2	EM-5434			
		2000-06	Trans		1			EM-9268	
<b>S500</b>									
V8	V8 5.0L 4966cc	2000-06	L & R Front		2	EM-5434			
		1996-06	Trans	Auto	1			EM-9268	
	V8 5.0L 4973cc DOH				2	EM-8835			
				Trans		1			EM-9002

# Engine, Transmission, And Torque Strut Mounts

CYL	ENG. SIZE	YEAR	LOCATION	DESCRIPTION	QTY	ENGINE	TORQUE STRUT	TRANSMISSION	
<b>MERCEDES-BENZ PASSENGER CAR (continued)</b>									
<b>S550</b>									
V8	V8 5.5L 5461cc	2007-11	L & R Front		2	EM-5434			
			Trans	4-Matic	1			EM-7280	
<b>S55 AMG</b>									
V8	V8 5.5L 5439cc	2001-06	L & R Front		2	EM-5434			
		2001-05	Trans	Auto	1			EM-9268	
<b>S600</b>									
V12	V12 5.5L 5513cc	2003-06	L & R Front		2	EM-5434			
			Trans		1			EM-9268	
	V12 5.8L 5786cc	2001-02	L & R Front		2	EM-5434			
			Trans	Auto	1			EM-9268	
	V12 6.0L 5987cc	1994-01	L & R Front		2	EM-8838			
			1996-01	Trans	Auto	1			EM-9268
1994-95			Trans		1			EM-9002	
<b>S63 AMG</b>									
V8	V8 6.2L 6208cc	2008-12	LH Front		1	EM-9562			
			RH Front		1	EM-9562			
<b>SL320</b>									
L6	L6 3.2L 3199cc	1994-97	L & R Front		2	EM-8834			
			1997	Trans	Auto	1			EM-9268
			1994-96	Trans	Auto	1			EM-9266
<b>SL500</b>									
V8	V8 5.0L 4973cc	1998	L & R Front		2	EM-8838			
		1994-97	L & R Front		2	EM-8835			
		2003-06	LH Front		1	EM-9562			
			RH Front		1	EM-9562			
		1996-06	Trans	Auto	1			EM-9268	
		1994-95	Trans	Auto	1			EM-9266	
<b>SL550</b>									
V8	V8 5.5L 5461cc	2007-11	LH Front		1	EM-9562			
			RH Front		1	EM-9562			
<b>SL55 AMG</b>									
V8	V8 5.5L 5439cc	2003-08	LH Front		1	EM-9562			
			RH Front		1	EM-9562			
<b>SL65 AMG</b>									
V12	V12 6.0L 5980cc	2005-09	Trans		1			EM-9268	
<b>SL600</b>									
V12	V12 5.5L 5513cc	2004-09	Trans		1			EM-9268	
	V12 6.0L 5987cc	1994-02	L & R Front		2	EM-8838			
		1996-02	Trans	Auto	1			EM-9268	
<b>SLK230</b>									
L4	L4 2.3L 2295cc	1998-99	L & R Front		2	EM-8832			
		2000-04	Trans	Auto	1			EM-9268	
		1998-99	Trans		1			EM-5737	
<b>SLK280</b>									
V6	V6 3.0L 2997cc	2006-08	Trans		1			EM-5858	
<b>SLK300</b>									
V6	V6 3.0L 2996cc	2009-11	Trans		1			EM-5858	
<b>SLK320</b>									
V6	V6 3.2L 3199cc	2001-04	Trans		1			EM-5858	

## Engine, Transmission, And Torque Strut Mounts

CYL	ENG. SIZE	YEAR	LOCATION	DESCRIPTION	QTY	ENGINE	TORQUE STRUT	TRANSMISSION
<b>MERCEDES-BENZ PASSENGER CAR (continued)</b>								
<b>SLK32 AMG</b>								
V6	V6 3.2L 3199cc	2002-04	Trans		1			EM-9268
<b>SLK350</b>								
V6	V6 3.5L 3498cc	2005-11	LH Front		1	EM-9562		
			RH Front		1	EM-9562		
			Trans	RWD	1			EM-5858
<b>SLK55 AMG</b>								
V8	V8 5.5L 5439cc	2005-11	LH Front		1	EM-9562		
			RH Front		1	EM-9562		
		2010-11	Trans		1			EM-5858
		2005-09	Trans		1			EM-9268
<b>SLR MCLAREN</b>								
V8	V8 5.5L 5439cc	2005-09	Trans		1			EM-9268
<b>MERCEDES-BENZ SPORT UTILITY</b>								
<b>G550</b>								
V8	V8 5.5L 5461cc	2009-11	L & R Front		2	EM-5972		
<b>GL350</b>								
V6	V6 3.0L 2987cc	2010-12	L & R Front		2	EM-5972		
<b>GL450</b>								
V8	V8 4.7L 4663cc	2007-12	L & R Front		2	EM-5972		
<b>GL550</b>								
V8	V8 5.5L 5461cc	2008-12	L & R Front		2	EM-5972		
<b>GLA250</b>								
L4	L4 2.0L 1991cc	2015-19	Right		1	EM-7122		
			2015-16	Torq Str - Lower		1		EM-7120
			Torq Str - Upper		1		EM-7121	
			Trans		1		EM-7123	
<b>GLA45 AMG</b>								
L4	L4 2.0L 1991cc	2014-19	2014-16	Right	1	EM-7122		
			Torq Str - Lower		1		EM-7120	
			Torq Str - Upper		1		EM-7121	
			Trans		1		EM-7123	
<b>GLK350</b>								
V6	V6 3.5L 3498cc	2010-15	Trans	US & Canada; RWD	1			EM-5858
<b>ML320</b>								
V6	V6 3.0L 2987cc	2009	L & R Front		2	EM-5972		
		2007-09	Trans	Auto; w/ Off-Road Package	1			EM-7020
	V6 3.2L 3199cc	1998-03	L & R Front		2	EM-9265		
			Trans		1			EM-9267
<b>ML350</b>								
V6	V6 3.0L 2987cc	2010-11	L & R Front		2	EM-5972		
	V6 3.5L 3498cc	2006-11	L & R Front		2	EM-5972		
			Trans	Auto; w/ Off-Road Package	1			EM-7020
	V6 3.7L 3699cc	2003-05	L & R Front	US & Canada	2	EM-9265		
			Trans	US & Canada; Auto	1			EM-9267
	V6 3.7L 3724cc	2003-05	L & R Front	Mexico	2	EM-9265		
Trans			Mexico; Auto	1			EM-9267	
<b>ML430</b>								
V8	V8 4.3L 4266cc	1999-01	L & R Front		2	EM-9265		

# Engine, Transmission, And Torque Strut Mounts

CYL	ENG. SIZE	YEAR	LOCATION	DESCRIPTION	QTY	ENGINE	TORQUE STRUT	TRANSMISSION	
<b>MERCEDES-BENZ SPORT UTILITY (continued)</b>									
<b>ML450</b>									
V6	V6 3.5L 3498cc	2010-11	L & R Front		2	EM-5972			
<b>ML500</b>									
V8	V8 5.0L 4966cc	2006-07	L & R Front		2	EM-5972			
		2002-05	L & R Front		2	EM-9265			
			Trans		1			EM-9267	
<b>ML550</b>									
V8	V8 5.5L 5461cc	2008-11	L & R Front		2	EM-5972			
<b>ML63 AMG</b>									
V8	V8 6.2L 6208cc	2007-11	L & R Front		2	EM-5972			
			Trans	Auto	1			EM-7020	
<b>MERCEDES-BENZ VAN</b>									
<b>METRIS</b>									
L4	L4 2.0L 1991cc	2016-17	Trans		1			EM-7280	
<b>SPRINTER 2500</b>									
L4	L4 2.1L 2143cc	2014-16	L & R Front		2	EM-7265			
			Trans	Auto	1			EM-7159	
V6	V6 3.0L 2987cc	2010-16	L & R Front		2	EM-7265			
			Trans	Auto	1			EM-7159	
<b>SPRINTER 3500</b>									
L4	L4 2.1L 2143cc	2014-16	L & R Front		2	EM-7265			
			Trans	Auto	1			EM-7159	
V6	V6 3.0L 2987cc	2010-16	L & R Front		2	EM-7265			
			Trans	Auto	1			EM-7159	
<b>MERCURY PASSENGER CAR</b>									
<b>BOBCAT</b>									
L4	L4 2.3L 140ci	1975-80	L & R Front		2	EM-2344			
			Trans	Auto	1			EM-2346	
			Trans	Manual	1			EM-2346	
V6	V6 2.8L 171ci	1975-79	L & R Front		2	EM-2344			
			Trans	Auto	1			EM-2346	
			Trans	Manual	1			EM-2346	
<b>BROUGHAM</b>									
V8	V8 6.7L 410ci	1967	LH Front		1	EM-2241			
			RH Front		1	EM-2240			
			Trans		1			EM-2242	
	V8 7.0L 427ci	1967	LH Front		1	EM-2241			
			RH Front		1	EM-2240			
			Trans		1			EM-2242	
<b>CALIENTE</b>									
L6	L6 3.3L 200ci	1966-67	L & R Front		2	EM-2333			
		1964-65	LH Front		1	EM-2226			
			RH Front		1	EM-2225			
		1966-67	Trans		1			EM-2253	
V8	V8 4.3L 260ci	1964	LH Front		1	EM-2220			
			RH Front		1	EM-2221			
			Trans		1			EM-2253	
	V8 4.7L 289ci	1966-67	L & R Front		2	EM-2257			
			1964-65	LH Front		1	EM-2220		
				RH Front		1	EM-2221		
	1966-67	Trans		1			EM-2253		
	V8 6.4L 390ci	1966-67	Trans		1			EM-2253	
V8 7.0L 427ci	1965	LH Front		1	EM-2241				
		RH Front		1	EM-2240				

## Engine, Transmission, And Torque Strut Mounts

CYL	ENG. SIZE	YEAR	LOCATION	DESCRIPTION	QTY	ENGINE	TORQUE STRUT	TRANSMISSION		
<b>MERCURY PASSENGER CAR (continued)</b>										
<b>CAPRI</b>										
L4	L4 1.6L 1598cc	1971-72	L & R Front		2	EM-2363				
			Trans	Auto	1			EM-2471		
			Trans	Manual	1			EM-2471		
	L4 2.0L 1989cc	1971-74	1973-74	L & R Front		2	EM-2363			
				Trans	Auto	1			EM-2346	
		1972	Trans	Manual	1			EM-2346		
			Trans	After 10/1/72	1			EM-2346		
			Trans	Before 10/1/72	1			EM-2471		
		1971	Trans	Auto	1			EM-2471		
			Trans	Manual	1			EM-2471		
	L4 2.3L 140ci	1979-86	1976-77	LH Front	w/o Turbo	1	EM-2458			
				RH Front		1	EM-2458			
		1979-86	1976-77	RH Front	w/o Turbo	1	EM-2457			
				Trans	Auto	1			EM-2388	
		1976-77	Trans	Manual	1			EM-2388		
			Trans	Auto	1			EM-2388		
			Trans	Manual	1			EM-2388		
			Trans	Manual	1			EM-2388		
	L6	L6 3.3L 200ci	1979-82	L & R Front		2	EM-2385			
Trans				Auto	1			EM-2388		
1982			Trans	Manual	1			EM-2388		
			Trans	Auto	1			EM-2389		
			Trans	Manual	1			EM-2389		
			1976-77	L & R Front		2	EM-2344			
				L & R Front		2	EM-2344			
1979	LH Front		1	EM-2458						
	RH Front		1	EM-2457						
V6	V6 2.8L 171ci	1976-77	L & R Front		2	EM-2344				
			L & R Front		2	EM-2344				
		1974	LH Front		1	EM-2458				
			RH Front		1	EM-2457				
			Trans	Auto	1			EM-2388		
			Trans	Manual	1			EM-2388		
		1976-77	Trans		1			EM-2566		
			Trans		1			EM-2566		
		V6 3.8L 232ci	1985-86	1984	LH Front		1	EM-2682		
					LH Front	After 12/1/83	1	EM-2682		
	1983		LH Front	Before 12/1/83	1	EM-2500				
			LH Front		1	EM-2500				
	1985-86		1984	RH Front		1	EM-2683			
				RH Front	After 12/1/83	1	EM-2683			
	1983		RH Front	Before 12/1/83	1	EM-2501				
			RH Front		1	EM-2501				
	1985-86		Trans	Auto; C5	1			EM-2389		
			Trans	Manual	1			EM-2389		
		1983-84	Trans	Auto; C3 & C5 Canada	1			EM-2389		
			Trans	Auto; C3 & C5 US	1			EM-2388		
1980-82	1980-82	LH Front		1	EM-2458					
		RH Front		1	EM-2457					
V8	V8 4.2L 255ci		Trans	Auto	1			EM-2388		
			Trans	Manual	1			EM-2388		
			1985-86	LH Front		1	EM-2682			
				LH Front	After 12/1/83	1	EM-2682			
	1984	LH Front	Before 12/1/83	1	EM-2458					
		LH Front		1	EM-2458					
	1982-83	LH Front		1	EM-2458					
		LH Front		1	EM-2458					
	1985-86	1984	RH Front		1	EM-2683				
			RH Front	After 12/1/83	1	EM-2683				
	1982-83	1982-83	RH Front	Before 12/1/83	1	EM-2457				
			RH Front		1	EM-2457				

# Engine, Transmission, And Torque Strut Mounts

CYL	ENG. SIZE	YEAR	LOCATION	DESCRIPTION	QTY	ENGINE	TORQUE STRUT	TRANSMISSION
<b>MERCURY PASSENGER CAR (continued)</b>								
<b>CAPRI (continued)</b>								
V8	V8 5.0L 302ci	1979	RH Front		1	EM-2457		
		1982-86	Trans	Auto	1			EM-2388
			Trans	Manual	1			EM-2388
		1979	Trans	Auto	1			EM-2388
			Trans	Manual	1			EM-2388
<b>COLONY PARK</b>								
V8	V8 4.8L 292ci	1961-62	L & R Front		2	EM-2141		
	V8 5.0L 302ci	1984-91	LH Front		1	EM-2438		
		1979-82	LH Front		1	EM-2438		
		1984-91	RH Front		1	EM-2437		
		1979-82	RH Front		1	EM-2437		
		1984-91	Trans		1			EM-2464
		1979-82	Trans		1			EM-2464
	V8 5.1L 312ci	1959-60	L & R Front		2	EM-2141		
	V8 5.8L 351ci	1979-81	LH Front		1	EM-2438		
		1971-73	LH Front		1	EM-2359		
		1979-81	RH Front		1	EM-2437		
		1971-73	RH Front		1	EM-2358		
		1979-81	Trans		1			EM-2464
		1971-73	Trans	Auto	1			EM-2345
				Trans	Manual	1		EM-2345
	V8 5.8L 352ci	1961-62	L & R Front		2	EM-2141		
	V8 6.4L 390ci	1969-70	LH Front		1	EM-2271		
		1967-68	LH Front		1	EM-2241		
		1962-64	LH Front		1	EM-2226		
		1969-70	RH Front		1	EM-2270		
		1967-68	RH Front		1	EM-2240		
		1962-64	RH Front		1	EM-2225		
		1969-70	Trans	Auto	1			EM-2345
			Trans	Manual	1			EM-2345
		1965-68	Trans	Auto	1			EM-2242
			Trans	Manual	1			EM-2242
		1962-64	Trans		1			EM-2349
	V8 6.6L 400ci	1971-76	LH Front		1	EM-2359		
			RH Front		1	EM-2358		
		1971-74	Trans	Auto	1			EM-2345
			Trans	Manual	1			EM-2345
	V8 6.7L 410ci	1966-67	LH Front		1	EM-2241		
			RH Front		1	EM-2240		
			Trans		1			EM-2242
	V8 7.0L 427ci	1965-67	LH Front		1	EM-2241		
			RH Front		1	EM-2240		
	V8 7.0L 428ci	1966-68	LH Front		1	EM-2241		
			RH Front		1	EM-2240		
			Trans		1			EM-2242
	V8 7.0L 429ci	1969-73	LH Front		1	EM-2368		
			RH Front		1	EM-2367		
			Trans	Auto	1			EM-2345
			Trans	Manual	1			EM-2345
	V8 7.5L 460ci	1976	LH Front		1	EM-2368		
		1972-74	LH Front		1	EM-2368		
		1976	RH Front		1	EM-2367		
		1972-74	RH Front		1	EM-2367		
			Trans	Auto	1			EM-2345
			Trans	Manual	1			EM-2345



## Engine, Transmission, And Torque Strut Mounts

CYL	ENG. SIZE	YEAR	LOCATION	DESCRIPTION	QTY	ENGINE	TORQUE STRUT	TRANSMISSION	
<b>MERCURY PASSENGER CAR (continued)</b>									
<b>COMET</b>									
L6	L6 2.4L 144ci	1962	L & R Front	Before 5/7/62	2	EM-2170			
		1960-61	L & R Front		2	EM-2170			
		1963	LH Front		1	EM-2226			
		1962	LH Front	After 5/7/62	1	EM-2226			
		1963	RH Front		1	EM-2225			
		1962	RH Front	After 5/7/62	1	EM-2225			
		1960-61	Trans	w/ Cantelever	1			EM-2172	
			Trans	w/o Cantelever	1			EM-2172	
		1962-63	Trans		1			EM-2171	
		1960-61	Trans		1			EM-2171	
		Trans		1			EM-2171		
	L6 2.8L 170ci	1971-72	L & R Front		2	EM-2333			
		1962	L & R Front	Before 5/7/62	2	EM-2170			
		1961	L & R Front		2	EM-2170			
		1963-64	LH Front		1	EM-2226			
		1962	LH Front	After 5/7/62	1	EM-2226			
		1963-64	RH Front		1	EM-2225			
		1962	RH Front	After 5/7/62	1	EM-2225			
		1961	Trans	w/ Cantelever	1			EM-2172	
			Trans	w/o Cantelever	1			EM-2172	
		1971-72	Trans	Auto	1			EM-2253	
			Trans	Manual	1			EM-2253	
		1962-64	Trans		1			EM-2171	
		1961	Trans		1			EM-2171	
			Trans		1			EM-2171	
	L6 3.3L 200ci	1971-77	L & R Front		2	EM-2341			
		1966-68	L & R Front		2	EM-2333			
		1964-65	LH Front		1	EM-2226			
			RH Front		1	EM-2225			
		1971-77	Trans	Auto	1			EM-2253	
			Trans	Manual	1			EM-2253	
		1966-68	Trans	Auto	1			EM-2253	
			Trans	Manual	1			EM-2253	
	1964-65	Trans		1			EM-2171		
	L6 4.1L 250ci	1973-77	L & R Front		2	EM-2341			
		1971-72	L & R Front		2	EM-2333			
		1969	L & R Front		2	EM-2333			
		1971-77	Trans	Auto	1			EM-2253	
			Trans	Manual	1			EM-2253	
		1969	Trans	Auto	1			EM-2253	
		Trans	Manual	1			EM-2253		
	V8	V8 4.3L 260ci	1963-64	LH Front		1	EM-2220		
				RH Front		1	EM-2221		
V8 4.7L 289ci		1966-67	L & R Front	Convertible	2	EM-2286			
			L & R Front	Coupe	2	EM-2257			
		1964-65	LH Front		1	EM-2220			
			RH Front		1	EM-2221			
		1966-67	Trans	Auto	1			EM-2253	
		Trans	Manual	1			EM-2253		
1964-65		Trans		1			EM-2171		
V8 5.0L 302ci		1971-77	L & R Front		2	EM-2316			
		1968-69	L & R Front		2	EM-2286			
		1971-77	Trans	Auto	1			EM-2253	
			Trans	Manual	1			EM-2253	
	1968-69	Trans	Auto	1			EM-2253		
	Trans	Manual	1			EM-2253			
V8 6.4L 390ci	1968-69	LH Front		1	EM-2241				

# Engine, Transmission, And Torque Strut Mounts

CYL	ENG. SIZE	YEAR	LOCATION	DESCRIPTION	QTY	ENGINE	TORQUE STRUT	TRANSMISSION	
<b>MERCURY PASSENGER CAR (continued)</b>									
<b>COMET (continued)</b>									
V8	V8 6.4L 390ci	1968-69	RH Front		1	EM-2240			
		1966-69	Trans	Auto	1			EM-2253	
			Trans	Manual	1			EM-2253	
	V8 7.0L 427ci	1965-67	LH Front		1	EM-2241			
			RH Front		1	EM-2240			
			Trans	Auto	1			EM-2253	
			Trans	Manual	1			EM-2253	
	<b>COMMUTER</b>								
V8	V8 5.1L 312ci	1957-60	L & R Front		2	EM-2141			
	V8 5.8L 352ci	1961	L & R Front		2	EM-2141			
	V8 6.7L 410ci	1966-67	LH Front		1	EM-2241			
			RH Front		1	EM-2240			
			Trans		1			EM-2242	
	V8 7.0L 427ci	1966-68	LH Front		1	EM-2241			
			RH Front		1	EM-2240			
Trans				1			EM-2242		
<b>COUGAR</b>									
L4	L4 2.0L 121ci	1999-02	Front	Auto; Insert	1	EM-2885			
			Front	Manual; Insert	1	EM-2888			
			RH Front		1	EM-2890*			
		2002	Trans - LH		1			EM-2873	
			1999-01	Trans - LH		1		EM-2873	
				Trans - Rear	Auto; Insert	1		EM-2888	
	L4 2.3L 140ci	1984	LH Front		1	EM-5109			
			LH Front		1	EM-2457			
			RH Front		1	EM-5108			
			RH Front		1	EM-2458			
			1985-86	Trans	Auto	1			EM-2707 *
				Trans	Manual	1			EM-2707 *
			1984	Trans	Auto	1			EM-2388
				1981	Trans	Auto	1		EM-2388
			Trans	Manual	1			EM-2388	
	L6	L6 3.3L 200ci	1981-82	L & R Front	Column Shift	2	EM-2776		
L & R Front				Floor Shift	2	EM-2385			
1980			L & R Front		2	EM-2776			
			Trans	Auto; C5	1			EM-2388	
1982			Trans	XR7	1			EM-2389	
			1981	Trans	Auto; C3	1		EM-2389	
Trans				Auto; C4	1		EM-2388		
1980			Trans	Auto	1		EM-2388		
V6	V6 2.5L 155ci	1999-02	LH Front	Auto; Insert	1	EM-2885			
			LH Front	Manual; Insert	1	EM-2888			
			RH Front	Complete Unit	1	EM-5352			
			Trans - Front	Auto; Complete Unit; Att. to Fender Apron	1			EM-2888	
			Trans - Front	Auto; Insert; Att. to Fender Apron	1			EM-3119	
	V6 3.8L 232ci	1986-97	L & R Front		2	EM-2661*			
			1983-85	LH Front		1	EM-2682		
			1982	LH Front		1	EM-2500		
			1983-85	RH Front		1	EM-2683		
			1982	RH Front		1	EM-2501		
			1991-97	Trans	Auto	1			EM-2707 *
			1989-90	Trans	Auto	1			EM-2707 *
				Trans	Manual	1			EM-2707 *

\* = Hydraulic Mount, "S" suffix = solid replacement.

# Engine, Transmission, And Torque Strut Mounts

CYL	ENG. SIZE	YEAR	LOCATION	DESCRIPTION	QTY	ENGINE	TORQUE STRUT	TRANSMISSION
<b>MERCURY PASSENGER CAR (continued)</b>								
<b>COUGAR (continued)</b>								
V6	V6 3.8L 232ci	1985-86	Trans	Auto; C5	1			EM-2389
		1983-84	Trans	Auto; AOT	1			EM-2388
			Trans	Auto; C5	1			EM-2389
		1982	Trans	Auto	1			EM-2388
V8	V8 4.2L 255ci	1980-82	LH Front	w/ Shake Condition	1	EM-2725		
			LH Front	w/o Shake Condition	1	EM-2500		
			RH Front	w/ Shake Condition	1	EM-2726		
			RH Front	w/o Shake Condition	1	EM-2501		
			Trans	Auto	1			EM-2388
	V8 4.6L 281ci	1994-97	L & R Front		2	EM-5048*		
			Trans	Auto	1			EM-2707 *
	V8 4.7L 289ci	1967-68	L & R Front		2	EM-2257		
			Trans	Auto	1			EM-2253
			Trans	Manual	1			EM-2253
	V8 5.0L 302ci	1991-93	L & R Front		2	EM-2995*		
			L & R Front		2	EM-2661*		
		1983-85	LH Front		1	EM-2682		
		1980-81	LH Front	w/ Shake Condition	1	EM-2725		
			LH Front	w/o Shake Condition	1	EM-2500		
		1977-79	LH Front		1	EM-2371		
		1983-85	RH Front		1	EM-2683		
		1980-81	RH Front	w/ Shake Condition	1	EM-2726		
			RH Front	w/o Shake Condition	1	EM-2501		
		1977-79	RH Front		1	EM-2370		
1991-93		Trans	Auto	1			EM-2707 *	
1987-88		Trans	Auto	1			EM-2388	
1985-86		Trans	Auto	1			EM-2388	
1983-84		Trans	Auto	1			EM-2388	
1977-81	Trans	Auto	1			EM-2388		
V8 5.8L 351ci	1969-72	L & R Front		2	EM-2257			
		LH Front	Modified Engine	1	EM-2365			
	1975-76	LH Front	Cleveland Engine; Windsor Engine	1	EM-2371			
		LH Front	Modified Engine	1	EM-2365			
	1974	LH Front	Cleveland Engine; Windsor Engine	1	EM-2371			
	1973	LH Front	Windsor Engine	1	EM-2371			
	1977-79	RH Front	Modified Engine	1	EM-2364			
	1975-76	RH Front	Cleveland Engine; Windsor Engine	1	EM-2370			
		RH Front	Modified Engine	1	EM-2364			
	1974	RH Front	Cleveland Engine; Windsor Engine	1	EM-2370			
	1973	RH Front	Windsor Engine	1	EM-2370			
	1977-79	Trans	Auto	1			EM-2464	
	1975-76	Trans	Auto; Modified Engine	1			EM-2464	
		Trans	Auto; C4; Windsor Engine	1			EM-2372	
		Trans	Auto; C6	1			EM-2347	
	1974	Trans	Auto; AOD; Windsor & Cleveland Engines	1			EM-2347	
		Trans	Auto; C4; Windsor & Cleveland Engines	1			EM-2372	
	1969-73	Trans	Auto	1			EM-2253	
		Trans	Manual	1			EM-2253	
V8 6.4L 390ci	1967-69	L & R Front		2	EM-2257			
		Trans	Auto	1			EM-2253	

\* = Hydraulic Mount, "S" suffix = solid replacement.

# Engine, Transmission, And Torque Strut Mounts

CYL	ENG. SIZE	YEAR	LOCATION	DESCRIPTION	QTY	ENGINE	TORQUE STRUT	TRANSMISSION	
<b>MERCURY PASSENGER CAR (continued)</b>									
<b>COUGAR (continued)</b>									
V8	V8 6.4L 390ci	1967-69	Trans	Manual	1			EM-2253	
	V8 6.6L 400ci	1973-78	LH Front		1	EM-2365			
			RH Front		1	EM-2364			
		1977-78	Trans	Auto	1			EM-2464	
		1973-76	Trans		1			EM-2372	
	V8 7.0L 427ci	1968	L & R Front		2	EM-2257			
			Trans	Auto	1			EM-2253	
			Trans	Manual	1			EM-2253	
	V8 7.0L 428ci	1968-70	L & R Front		2	EM-2257			
			Trans	Auto	1			EM-2253	
			Trans	Manual	1			EM-2253	
	V8 7.0L 429ci	1970-71	Trans	Auto	1			EM-2253	
Trans			Manual	1			EM-2253		
V8 7.5L 460ci	1973-76	Trans		1			EM-2372		
<b>COUNTRY CRUISER</b>									
V8	V8 5.1L 312ci	1959-60	L & R Front		2	EM-2141			
<b>CUSTOM</b>									
V8	V8 5.1L 312ci	1956	L & R Front		2	EM-2141			
<b>GRAND MARQUIS</b>									
V8	V8 4.2L 255ci	1981-82	LH Front		1	EM-2438			
			RH Front		1	EM-2437			
			Trans		1			EM-2464	
	V8 4.6L 281ci	2003-10	1998-02	LH Front		1	EM-3025		
				LH Front		1	EM-2861		
				LH Front		1	EM-2807		
			2003-10	RH Front		1	EM-3024		
			1998-02	RH Front		1	EM-2860		
			1992-97	RH Front		1	EM-2806		
			2003-10	Trans		1			EM-3038
			1998-02	Trans		1			EM-2822
			1994-97	Trans		1			EM-2822
	V8 5.0L 302ci	1979-91	LH Front		1	EM-2438			
			RH Front		1	EM-2437			
			Trans		1			EM-2464	
	V8 5.8L 351ci	1983-89	LH Front		1	EM-2438			
			LH Front		1	EM-2359			
			RH Front		1	EM-2437			
			RH Front		1	EM-2358			
			Trans		1			EM-2464	
	V8 6.6L 400ci	1975-78	Trans		1			EM-2345	
			LH Front		1	EM-2359			
			RH Front		1	EM-2358			
			Trans		1			EM-2345	
			LH Front		1	EM-2368			
	V8 7.5L 460ci	1975-78	RH Front		1	EM-2367			
			Trans		1			EM-2345	
			Trans		1			EM-2345	
	<b>LN7</b>								
	L4	L4 1.6L 1598cc	1982-83	Front	Auto	1	EM-2461		
				Front	Manual	1	EM-2460		
				RH Front	RH Front	1	EM-2459		
Trans				Auto	1			EM-2463	
Trans				Manual	1			EM-2463	

## Engine, Transmission, And Torque Strut Mounts

CYL	ENG. SIZE	YEAR	LOCATION	DESCRIPTION	QTY	ENGINE	TORQUE STRUT	TRANSMISSION	
<b>MERCURY PASSENGER CAR (continued)</b>									
<b>LYNX</b>									
L4	L4 1.6L 1598cc	1984-85	Front		1	EM-2559			
		1981-83	Front	Auto	1	EM-2461			
			Front	Manual	1	EM-2460			
		1984-85	RH Front		1	EM-2558			
		1981-83	RH Front		1	EM-2459			
		1984-85	Trans	Auto	1			EM-2632	
			Trans	Manual; 4 Spd	1			EM-2634	
			Trans	Manual; 5 Spd	1			EM-2665	
		1981-83	Trans	Auto	1			EM-2463	
	Trans		Manual	1			EM-2463		
	L4 1.9L 116ci	1985-87	Front		1	EM-2559			
			LH Front	Auto	1	EM-5063			
			LH Front	Manual	1	EM-5064			
			RH Front		1	EM-2558			
			Trans	Auto	1			EM-2632	
	Trans	Manual	1			EM-2665			
	L4 2.0L 1989cc Diesel	1984	Front	Manual; 4 Spd	1	EM-2559			
			LH Front	Auto	1	EM-5063			
			LH Front	Manual; 4 Spd	1	EM-5065			
LH Front			Manual; 5 Spd	1	EM-5064				
<b>MARAUDER</b>									
V8	V8 4.6L 281ci	2003-04	LH Front		1	EM-3024			
			RH Front		1	EM-3025			
			Trans		1			EM-3038	
	V8 6.4L 390ci	1969-70	LH Front		1	EM-2271			
			1967	LH Front		1	EM-2241		
			1963-64	LH Front		1	EM-2226		
			1969-70	RH Front		1	EM-2270		
			1967	RH Front		1	EM-2240		
			1963-64	RH Front		1	EM-2225		
			1969-70	Trans	Auto	1			EM-2345
			Trans	Manual	1			EM-2345	
	1965-67	Trans		1			EM-2242		
	V8 7.0L 427ci	1965	LH Front		1	EM-2241			
			RH Front		1	EM-2240			
	V8 7.0L 429ci	1969-70	LH Front		1	EM-2368			
			RH Front		1	EM-2367			
			Trans	Auto	1			EM-2345	
	Trans	Manual	1			EM-2345			
	<b>MARQUIS</b>								
L4	L4 2.3L 140ci	1983-86	LH Front		1	EM-2458			
			RH Front		1	EM-2457			
			Trans		1			EM-2388	
L6	L6 3.3L 200ci	1983	Trans		1			EM-2388	
V6	V6 3.8L 232ci	1985-86	LH Front		1	EM-2682			
			1984	LH Front	After 12/1/83	1	EM-2682		
			LH Front	Before 12/1/83	1	EM-2500			
		1983	LH Front		1	EM-2500			
		1985-86	RH Front		1	EM-2683			
		1984	RH Front	After 12/1/83	1	EM-2683			
			RH Front	Before 12/1/83	1	EM-2501			
		1983	RH Front		1	EM-2501			
		1985-86	Trans	Auto	1			EM-2388	
1983-84	Trans	Auto	1			EM-2388			
V8	V8 4.2L 255ci	1981-82	LH Front		1	EM-2504			
			RH Front		1	EM-2503			

# Engine, Transmission, And Torque Strut Mounts

CYL	ENG. SIZE	YEAR	LOCATION	DESCRIPTION	QTY	ENGINE	TORQUE STRUT	TRANS-MISSION	
<b>MERCURY PASSENGER CAR (continued)</b>									
<b>MARQUIS (continued)</b>									
V8	V8 4.2L 255ci	1981-82	Trans	Auto	1			EM-2253	
	V8 5.0L 302ci	1979-82	LH Front		1	EM-2682			
			RH Front		1	EM-2683			
			Trans		1			EM-2388	
	V8 5.8L 351ci	1971-73	L & R Front		2	EM-2287			
			1978-81	LH Front		1	EM-2438		
				RH Front		1	EM-2437		
		1971-73	Trans	Auto	1			EM-2464	
			Trans	Manual	1			EM-2345	
	V8 6.4L 390ci	1968-70	LH Front		1	EM-2241			
			RH Front		1	EM-2240			
			Trans		1			EM-2253	
	V8 6.6L 400ci	1971-78	LH Front		1	EM-2359			
			RH Front		1	EM-2358			
		1975-78	Trans	Auto	1			EM-2345	
		1971-74	Trans	Auto	1			EM-2345	
	Trans		Manual	1			EM-2345		
	V8 6.7L 410ci	1967	LH Front		1	EM-2241			
			RH Front		1	EM-2240			
			Trans		1			EM-2242	
	V8 7.0L 427ci	1967	LH Front		1	EM-2241			
			RH Front		1	EM-2240			
			Trans		1			EM-2242	
	V8 7.0L 428ci	1967-69	LH Front		1	EM-2241			
			RH Front		1	EM-2240			
			Trans		1			EM-2242	
	V8 7.0L 429ci	1969-73	LH Front		1	EM-2368			
			RH Front		1	EM-2367			
Trans			Auto	1			EM-2345		
Trans			Manual	1			EM-2345		
V8 7.5L 460ci	1972-78	LH Front		1	EM-2368				
		RH Front		1	EM-2367				
	1975-78	Trans	Auto	1			EM-2345		
	1972-74	Trans	Auto	1			EM-2345		
Trans		Manual	1			EM-2345			
<b>MEDALIST</b>									
V8	V8 5.1L 312ci	1956-58	L & R Front		2	EM-2141			
<b>METEOR</b>									
L6	L6 2.8L 170ci	1961-63	LH Front		1	EM-2226			
			RH Front		1	EM-2225			
			Trans	Auto	1			EM-2349	
			Trans	Manual	1			EM-2349	
V8	V8 3.6L 221ci	1962-63	Trans	Auto	1			EM-2349	
			Trans	Manual	1			EM-2349	
<b>MILAN</b>									
L4	L4 2.3L 140ci	2006-09	Right		1	EM-7044			
			Torq Str - Front	FWD	1		EM-3107		
			Trans	Auto	1			EM-4034	
			Trans	Manual	1			EM-4034	
	L4 2.5L 152ci	2010-11	Right		1	EM-7044			
			Torq Str - Front	Hybrid	1		EM-4058		
			Torq Str - Front	Gas	1		EM-4146		
			Trans	Auto	1			EM-4067	
			Trans	Manual	1			EM-4034	
V6	V6 3.0L 183ci	2010-11	Right		1	EM-7044			

# Engine, Transmission, And Torque Strut Mounts

CYL	ENG. SIZE	YEAR	LOCATION	DESCRIPTION	QTY	ENGINE	TORQUE STRUT	TRANSMISSION	
<b>MERCURY PASSENGER CAR (continued)</b>									
<b>MILAN (continued)</b>									
V6	V6 3.0L 183ci	2006-09	Right		1	EM-4044			
		2010-11	Torq Str - Front		1		EM-3105		
		2007-09	Torq Str - Front	AWD	1		EM-3105		
			Torq Str - Front	FWD	1		EM-3107		
		2006	Torq Str - Front	FWD	1		EM-3107		
		2010-11	Trans		1			EM-4255	
		2006-09	Trans	Auto	1			EM-4034	
Trans	Manual		1			EM-4034			
<b>MONARCH</b>									
L6	L6 3.3L 200ci	1975-77	L & R Front		2	EM-2341			
			Trans	Auto	1		EM-2253		
			Trans	Manual	1		EM-2253		
	L6 4.1L 250ci	1975-80	L & R Front		2	EM-2341			
			LH Front		1	EM-2434			
			RH Front		1	EM-2433			
			Trans	Auto	1		EM-2253		
				Manual	1		EM-2253		
V8	V8 4.2L 255ci	1980	LH Front		1	EM-2504			
			RH Front		1	EM-2503			
			Trans	Auto	1		EM-2253		
				Manual	1		EM-2253		
	V8 5.0L 302ci	1976-80	LH Front		1	EM-2504			
			RH Front		1	EM-2503			
			Trans	Auto	1		EM-2253		
				Manual	1		EM-2253		
	V8 5.8L 351ci	1975-77	LH Front		1	EM-2504			
			RH Front		1	EM-2503			
			Trans	Auto	1		EM-2253		
				Manual	1		EM-2253		
<b>MONTCLAIR</b>									
V8	V8 5.1L 312ci	1956-60	L & R Front		2	EM-2141			
			V8 6.4L 390ci	1967-68	LH Front	1	EM-2241		
	V8 6.7L 410ci	1966-67	1964	LH Front	1	EM-2226			
			1967-68	RH Front	1	EM-2240			
			1964	RH Front	1	EM-2225			
			1965-68	Trans	1		EM-2242		
	V8 7.0L 427ci	1965-68	LH Front		1	EM-2241			
			RH Front		1	EM-2240			
			Trans		1		EM-2242		
	<b>MONTEGO</b>								
	L6	L6 4.1L 250ci	1969-74	L & R Front		2	EM-2333		
Trans				Auto	1		EM-2253		
Trans				Manual	1		EM-2253		
V6	V6 3.0L 181ci	2005-07	LH Front		1	EM-3080*			
			RH Front		1	EM-3079*			
			Rear		1	EM-4141			
	V6 3.0L 183ci	2005-07	Torq Str - Front	Auto	1		EM-4160		
			Torq Str - Front	Mexico; Auto	1		EM-4160		
			Torq Str - Upper	Complete Unit; Auto; 6 Speed Select Shift	1		EM-4065		
			Torq Str - Upper	Complete Unit; CVT	1		EM-4066		
			Torq Str - Upper	Mexico; Complete Unit; Auto	1		EM-4065		

\* = Hydraulic Mount, "S" suffix = solid replacement.

# Engine, Transmission, And Torque Strut Mounts

CYL	ENG. SIZE	YEAR	LOCATION	DESCRIPTION	QTY	ENGINE	TORQUE STRUT	TRANSMISSION
<b>MERCURY PASSENGER CAR (continued)</b>								
<b>MONTEGO (continued)</b>								
V6	V6 3.0L 183ci	2005-07	Trans		1			EM-3080 *
V8	V8 5.0L 302ci	1971-74	LH Front		1	EM-2371		
			RH Front		1	EM-2370		
		1973-74	Trans	Auto; C4	1			EM-2347
			Trans	Auto; Cruise-O-Matic	1			EM-2372
		1971-72	Trans	Auto	1			EM-2253
			Trans	Manual	1			EM-2253
V8	V8 5.8L 351ci	1969-71	L & R Front	Convertible	2	EM-2286		
			L & R Front	Coupe	2	EM-2257		
		1975-76	LH Front	VIN H	1	EM-2365		
		1972-74	LH Front	VIN Q	1	EM-2371		
		1975-76	RH Front	VIN H	1	EM-2364		
		1972-74	RH Front	VIN Q	1	EM-2370		
		1975-76	Trans	Auto; C4	1			EM-2372
			Trans	Auto; FMX	1			EM-2347
		1974	Trans	Auto; AOD; Cleveland Engine	1			EM-2347
			Trans	Auto; C4; Cleveland Engine	1			EM-2372
			Trans	Manual; Cleveland Engine	1			EM-2347
		1972-73	Trans	Auto; AOD; Cleveland Engine	1			EM-2347
			Trans	Auto; C4; Cleveland Engine	1			EM-2372
		1969-71	Trans	Manual; Cleveland Engine	1			EM-2347
Trans	Auto		1			EM-2253		
			Trans	Manual	1		EM-2253	
V8	V8 6.4L 390ci	1968-69	LH Front		1	EM-2241		
			RH Front		1	EM-2240		
			Trans	Auto	1			EM-2253
			Trans	Manual	1			EM-2253
V8	V8 6.6L 400ci	1972-76	LH Front		1	EM-2365		
			RH Front		1	EM-2364		
			Trans		1			EM-2372
V8	V8 7.0L 428ci	1968-69	LH Front		1	EM-2241		
			RH Front		1	EM-2240		
			Trans	Auto	1			EM-2253
			Trans	Manual	1			EM-2253
V8	V8 7.0L 429ci	1970-73	L & R Front		2	EM-2257		
			Trans	Auto	1			EM-2253
			Trans	Manual	1			EM-2253
V8	V8 7.5L 460ci	1973-76	LH Front		1	EM-2368		
			RH Front		1	EM-2367		
			Trans		1			EM-2345
<b>MONTEREY</b>								
V8	V8 5.1L 312ci	1956-60	L & R Front		2	EM-2141		
	V8 5.8L 351ci	1971-73	L & R Front		2	EM-2287		
			Trans	Auto	1			EM-2311
			Trans	Manual	1			EM-2311
	V8 6.6L 400ci	1971-74	LH Front		1	EM-2359		
			RH Front		1	EM-2358		
			Trans	Auto	1			EM-2345
			Trans	Manual	1			EM-2345
	V8 6.7L 410ci	1966-67	LH Front		1	EM-2241		
			RH Front		1	EM-2240		
			Trans		1			EM-2242
	V8 7.0L 427ci	1965-67	LH Front		1	EM-2241		
			RH Front		1	EM-2240		
			Trans	Auto	1			EM-2242
Trans			Manual	1			EM-2242	

\* = Hydraulic Mount, "S" suffix = solid replacement.



## Engine, Transmission, And Torque Strut Mounts

CYL	ENG. SIZE	YEAR	LOCATION	DESCRIPTION	QTY	ENGINE	TORQUE STRUT	TRANSMISSION
<b>MERCURY PASSENGER CAR (continued)</b>								
<b>MONTEREY (continued)</b>								
V8	V8 7.0L 428ci	1966-70	LH Front		1	EM-2241		
			RH Front		1	EM-2240		
			Trans	Auto	1			EM-2242
			Trans	Manual	1			EM-2242
	V8 7.0L 429ci	1969-73	LH Front		1	EM-2368		
			RH Front		1	EM-2367		
			Trans	Auto	1			EM-2345
			Trans	Manual	1			EM-2345
	V8 7.5L 460ci	1972-74	LH Front		1	EM-2368		
			RH Front		1	EM-2367		
			Trans	Auto	1			EM-2345
			Trans	Manual	1			EM-2345
<b>MYSTIQUE</b>								
L4	L4 2.0L 121ci	1998-00	Front	Auto; Complete Unit	1	EM-5521		
			Front	Auto; Insert	1	EM-2885		
			Front	Manual; Insert	1	EM-2888		
		1995-97	Front	Auto; Complete Unit	1	EM-5596		
			Front	Auto; Insert	1	EM-2886		
			Front	Manual; Insert	1	EM-2978		
		1998-00	RH Front		1	EM-2890		
		1995-97	RH Front		1	EM-2889		
		1998-00	Trans - Front	Auto, Complete Unit	1			EM-2873
			Trans - Front	Auto; Insert	1			EM-5106
		1995-97	Trans - Front	Auto, Complete Unit	1			EM-2873
			Trans - Front	Auto; Insert	1			EM-5106
		1998-00	Trans - Rear	Auto; Insert	1			EM-2888
		1995-97	Trans - Rear	Auto, Complete Unit	1			EM-5107
			Trans - Rear	Auto; Insert	1			EM-2887
		1998-00	Trans	Manual; Complete Unit	2			EM-3119
1995-97	Trans	Manual; Complete Unit	2			EM-3119		
V6	V6 2.5L 155ci	1998-00	Front	Auto; Insert Only	1	EM-2885		
			Front	Manual; Insert Only	1	EM-2888		
		1995-97	Front	Auto; Complete Unit	1	EM-5596		
			Front	Auto; Insert	1	EM-2886		
			Front	Manual; Insert	1	EM-2978		
		1998-00	RH Front	Complete Unit	1	EM-5352		
			RH Front	Insert Only	1	EM-5105		
		1995-97	RH Front	Complete Unit	1	EM-2889		
			RH Front	Insert	1	EM-5105		
		1998-00	Trans - Front	Auto, Complete Unit	1			EM-2873
			Trans - Front	Auto; Insert	1			EM-5106
		1995-97	Trans - Front	Auto, Complete Unit	1			EM-2873
			Trans - Front	Auto; Insert	1			EM-5106
		1998-00	Trans - Rear	Auto; Insert	1			EM-2888
		1995-97	Trans - Rear	Auto, Complete Unit	1			EM-5107
			Trans - Rear	Auto; Insert	1			EM-2885
1998-00	Trans	Manual; Complete Unit	2			EM-3119		
1995-97	Trans	Manual; Complete Unit	2			EM-3119		
<b>PARK LANE</b>								
V8	V8 6.7L 410ci	1966-67	LH Front		1	EM-2241		
			RH Front		1	EM-2240		
			Trans		1			EM-2242
	V8 7.0L 427ci	1966-68	LH Front		1	EM-2241		
			RH Front		1	EM-2240		
			Trans		1			EM-2242

\* = Hydraulic Mount, "S" suffix = solid replacement.

# Engine, Transmission, And Torque Strut Mounts

CYL	ENG. SIZE	YEAR	LOCATION	DESCRIPTION	QTY	ENGINE	TORQUE STRUT	TRANS-MISSION
<b>MERCURY PASSENGER CAR (continued)</b>								
<b>SABLE</b>								
L4	L4 2.5L 153ci	1986	RH Front		1	EM-2692		
			RH Rear		1	EM-2770		
			Trans		1			EM-2687
V6	V6 3.0L 181ci	2000-05	RH Front	DOHC; Hydraulic Mount DOHC	1	EM-2894*		
			1996-99	RH Front	DOHC; Hydraulic Mount DOHC	1	EM-2934*	
		2000-05	RH Rear	DOHC; DOHC	1	EM-2862		
		1996-99	RH Rear	DOHC; Hydraulic Mount DOHC	1	EM-2862		
	V6 3.0L 182ci	2000-05	RH Front	OHV; Hydraulic Mount; OHV	1	EM-2894*		
			1996-99	RH Front	OHV; Hydraulic Mount; OHV	1	EM-2789*	
		1994-95	RH Front		1	EM-2790*		
		1993	RH Front		1	EM-2792*		
		1991-92	RH Front		1	EM-2791*		
		1986-90	RH Front		1	EM-2623		
		1996-99	RH Rear	OHV; Hydraulic Mount; OHV	1	EM-2840*		
		1994-95	RH Rear		1	EM-2788*		
		1993	RH Rear		1	EM-2788*		
		1991-92	RH Rear		1	EM-2788*		
		1986-90	RH Rear		1	EM-2622		
		2000-03	Torq Str - Rear		1		EM-2872	
	2000-05	Trans		1			EM-2974 *	
	1990-99	Trans		1			EM-2717 *	
	1988-89	Trans		1			EM-2686	
	1986-87	Trans		1			EM-2687	
V6 3.5L 213ci	2008-09	RH Front		1	EM-5427			
		Torq Str - Rear		1		EM-3142		
		Trans - Upper		1			EM-4040	
V6 3.8L 232ci	1988-95	RH Front		1	EM-2812*			
		RH Rear		1	EM-2813*			
		Trans		1			EM-2717 *	
<b>TOPAZ</b>								
L4	L4 2.0L 1989cc Diesel	1984-86	LH Front	Manual	1	EM-5065		
			1992-94	Front		1	EM-2804	
	L4 2.3L 140ci	1986-91	Front	Auto; Hydraulic Mount	1	EM-2696*		
			Front	Manual	1	EM-2559		
	1984-85	Front		1	EM-2559			
		LH Front	Auto	1	EM-5063			
	LH Front	Manual	1	EM-5065				
	1992-94	RH Front		1	EM-2805			
	1986-91	RH Front		1	EM-2558			
	1984-85	RH Front		1	EM-2558			
	1986-94	Trans	Auto; Hydraulic Mount	1			EM-2696 *	
		Trans	Manual	1			EM-2665	
	1984-85	Trans	Auto	1			EM-2632	
		Trans	Manual; 4 Spd	1			EM-2634	
Trans	Manual; 5 Spd	1			EM-2665			
V6	V6 3.0L 182ci	1992-94	LH Front	Auto; Attached To Transaxle	1	EM-2804		
			Trans	Auto; Hydraulic Mount	1			EM-2696 *
			Trans	Manual	1			EM-2665

\* = Hydraulic Mount, "S" suffix = solid replacement.

# Engine, Transmission, And Torque Strut Mounts

CYL	ENG. SIZE	YEAR	LOCATION	DESCRIPTION	QTY	ENGINE	TORQUE STRUT	TRANSMISSION	
<b>MERCURY PASSENGER CAR (continued)</b>									
<b>TRACER</b>									
L4	L4 1.6L	1987-89	Trans		1			EM-8068	
	L4 1.6L 1598cc	1987-89	LH Front	Manual	1	EM-8060			
			RH Front	Auto	1	EM-8234			
	L4 1.8L 112ci	1994-96	Front	Auto; Hydraulic Mount	1	EM-2910*			
			Front	Manual	1	EM-2651			
			1991-93	Front		1	EM-2651		
			1994-96	LH Rear		1	EM-2650		
			1991-93	LH Rear		1	EM-2650		
			1994-96	RH Front		1	EM-2650		
			1991-93	RH Front		1	EM-2649		
			1991-96	Trans	Auto	1			EM-2815
	L4 1.9L 116ci	1991-96	Trans	Manual	1			EM-2815	
			Front		1	EM-2651			
	L4 1.9L 116ci	1991-96	LH Rear		1	EM-2650			
			RH Front		1	EM-2649			
			Trans	Auto	1			EM-2815	
			Trans	Manual	1			EM-2815	
			L4 2.0L 1989cc	1997-99	Front	Auto; Hydraulic Mount	1	EM-2910*	
	L4 2.0L 1989cc	1997-99	Front	Manual	1	EM-2651			
			RH Front		1	EM-2649			
			Rear	Auto	1	EM-2912			
			Rear	Manual	1	EM-2911			
			Trans	Auto	1			EM-2843	
Trans			Manual	1			EM-2843		
<b>VOYAGER</b>									
V8	V8 5.1L 312ci	1957-59	L & R Front		2	EM-2141			
<b>ZEPHYR</b>									
L4	L4 2.3L 140ci	1978-83	LH Front		1	EM-2458			
			RH Front		1	EM-2457			
			Trans	Auto	1			EM-2388	
			Trans	Manual	1			EM-2388	
L6	L6 3.3L 200ci	1978-83	L & R Front		2	EM-2385			
			Trans	Auto	1			EM-2388	
			Trans	Manual	1			EM-2388	
V8	V8 4.2L 255ci	1980-82	LH Front		1	EM-2458			
			RH Front		1	EM-2457			
			Trans	Auto	1			EM-2388	
			Trans	Manual	1			EM-2388	
	V8 5.0L 302ci	1978-79	LH Front		1	EM-2458			
RH Front				1	EM-2457				
Trans			Auto	1			EM-2388		
Trans			Manual	1			EM-2388		
<b>MERCURY SPORT UTILITY</b>									
<b>MARINER</b>									
L4	L4 2.3L 140ci	2005-08	Front	Gas	1	EM-4033			
		2006-08	LH Front	Hybrid	1	EM-4071			
		2005-08	LH Front	Gas	1	EM-4071			
			Rear	Gas	1	EM-4019			
		2006-08	Right	Hybrid	1	EM-4033			
			Torq Str - Rear	Hybrid	1			EM-4051	
	2005-08	Trans	Auto	1			EM-4117		
	L4 2.5L 152ci	2009-11	Front	Gas	1	EM-4033			
			LH Front	Gas	1	EM-4071			
			Rear	Gas	1	EM-4019			
Torq Str - Rear			Hybrid	1			EM-4051		

\* = Hydraulic Mount, "S" suffix = solid replacement.

# Engine, Transmission, And Torque Strut Mounts

CYL	ENG. SIZE	YEAR	LOCATION	DESCRIPTION	QTY	ENGINE	TORQUE STRUT	TRANSMISSION	
<b>MERCURY SPORT UTILITY (continued)</b>									
<b>MARINER (continued)</b>									
L4	L4 2.5L 152ci	2009-11	Trans	Auto	1			EM-4117	
V6	V6 3.0L 182ci	2005-08	Front		1	EM-4033			
			LH Front		1	EM-4071			
			Rear	FWD	1	EM-4019			
	V6 3.0L 183ci	2009-11	Trans		1			EM-4117	
			Front		1	EM-4033			
			LH Front		1	EM-4071			
			Rear	FWD	1	EM-4019			
<b>MOUNTAINEER</b>									
V6	V6 4.0L 245ci	2006-10	LH Front		1	EM-4106			
		2002-05	LH Front		1	EM-3047			
		1998-01	LH Front		1	EM-2851			
		2006-10	RH Front		1	EM-3048			
		2002-05	RH Front		1	EM-3048			
		1998-01	RH Front		1	EM-2850			
		2006-10	Trans	RWD		1			EM-3062
		2002-05	Trans	AWD		1			EM-3061
			Trans	RWD		1			EM-3062
		1998-01	Trans			1			EM-2639
V8	V8 4.6L 281ci	2006-10	LH Front		1	EM-4106			
		2004-05	LH Front		1	EM-3047			
		2002-03	LH Front		1	EM-3047			
		2006-10	RH Front		1	EM-3048			
		2004-05	RH Front		1	EM-3048			
		2002-03	RH Front		1	EM-3048			
		2006-07	Trans	RWD		1			EM-3062
		2002-05	Trans	AWD		1			EM-3061
			Trans	RWD		1			EM-3062
		V8	V8 5.0L 302ci	1997-01	LH Front		1	EM-3000	
RH Front					1	EM-2999			
Trans					1			EM-2868	
<b>MERCURY VAN</b>									
<b>MONTEREY</b>									
V6	V6 4.2L 256ci		LH Front		1	EM-3075*			
			RH Front		1	EM-3076*			
			Torq Str - Front		1		EM-3101		
			Trans		1			EM-3106	
<b>VILLAGER</b>									
V6	V6 3.0L 182ci	1993-98	Front		1	EM-2855			
			LH Rear		1	EM-2856			
			RH Rear	Complete Unit	1	EM-2857			
			Trans		1			EM-2854	
	V6 3.3L 3275cc	1999-02	Front		1	EM-2989			
			LH Rear		1	EM-2985			
			RH Rear	Complete Unit	1	EM-2857			
			Trans		1			EM-2854	
<b>MG PASSENGER CAR</b>									
<b>MGA</b>									
L4	L4 1.6L 1588cc	1958-61	LH Front		1	EM-2736			
			RH Front		1	EM-2735			

\* = Hydraulic Mount, "S" suffix = solid replacement.

## Engine, Transmission, And Torque Strut Mounts

CYL	ENG. SIZE	YEAR	LOCATION	DESCRIPTION	QTY	ENGINE	TORQUE STRUT	TRANSMISSION	
<b>MG PASSENGER CAR (continued)</b>									
<b>MGB</b>									
L4	L4 1.8L 1798cc	1963-74	LH Front		1	EM-2736			
			RH Front		1	EM-2735			
<b>MINI</b>									
<b>COOPER</b>									
L4	L4 1.6L 1598cc	2007-08	Front	DOHC	1	EM-5922			
			L4 1.6L 1600cc	2004	Front	SOHC; From 12/03	1	EM-5922	
	2002-03	2002-08	RH Rear	SOHC	1	EM-5844			
			RH Rear		1	EM-5844			
			Torq Str - Rear		1		EM-5860		
<b>MITSUBISHI PASSENGER CAR</b>									
<b>3000GT</b>									
V6	V6 3.0L	1994-99	Front	FWD	1	EM-9191			
		1992-93	Front	FWD	1	EM-9191			
		1991	Front	FWD	1	EM-9191			
<b>CORDIA</b>									
L4	L4 1.8L 1795cc	1984-88	1983	Front Lower		1	EM-8270		
			Front Lower		1	EM-8270			
			Rear	Auto; 3 Spd	1	EM-8271			
		1983-88	Rear	Manual	1	EM-8506			
			Torq Str - Front	Manual, Complete Unit	1		EM-8272		
			Torq Str - Front	Manual, Insert	1		EM-5739		
	L4 2.0L 1997cc	1984-88	Trans	Manual; 5 Spd	1		EM-8510		
			Front	Manual	1	EM-8270			
			Front Upper	Auto	1	EM-8105			
			Torq Str - Front	Manual	1		EM-8867		
			Trans	Auto	1		EM-8807		
			Trans	Manual; 5 Spd	1		EM-8510		
<b>DIAMANTE</b>									
V6	V6 3.0L 2972cc	1996	Front		1	EM-5929			
		1993-95	Front	Sedan	1	EM-5929			
			Front	Wagon	1	EM-8667			
		1996	Rear		1	EM-8668			
		1993-95	Rear		1	EM-8668			
		1992-93	Trans		1		EM-5574		
	V6 3.5L 3497cc	1999-04	1997-98	Front		1	EM-9193		
			1999-04	Front		1	EM-9193		
			1999-04	RH Front		1	EM-9189		
			1997-98	RH Front		1	EM-9189		
			1999-04	Rear		1	EM-5907		
			1997-98	Rear		1	EM-5575		
			1997-04	Trans		1		EM-9387	
<b>ECLIPSE</b>									
L4	L4 1.8L 1755cc	1990-94	Front		1	EM-8103			
			LH Front		1	EM-9056			
			Rear	Auto	1	EM-8104			
			Rear	Manual	1	EM-5098			
			Trans	Auto; w/o Cruise Control	1		EM-8700		
			Trans	Manual; w/o Cruise Control	1		EM-8686		
	L4 2.0L 1997cc	1995-99	1990-94	Front		1	EM-8670		
				Front	Auto; AWD	1	EM-8559		
				Front	FWD	1	EM-8103		
				Front	Manual; AWD	1	EM-9078		
				LH Front	Auto; AWD	1	EM-9206		
				1995-99	RH Front	Turbo	1	EM-8792	

# Engine, Transmission, And Torque Strut Mounts

CYL	ENG. SIZE	YEAR	LOCATION	DESCRIPTION	QTY	ENGINE	TORQUE STRUT	TRANSMISSION	
<b>MITSUBISHI PASSENGER CAR (continued)</b>									
<b>ECLIPSE (continued)</b>									
L4	L4 2.0L 1997cc	1995-99	RH Front	w/o Turbo	1	EM-9198			
			Rear	Auto	1	EM-9394			
			Rear	Manual	1	EM-8798			
		1990-94	Rear	Auto	1	EM-8104			
			Rear	Manual, AWD	1	EM-5101			
			Rear	Manual, FWD	1	EM-5098			
		1995-99	Trans	Auto; w/ Turbo	1			EM-9058	
			Trans	Auto; w/o Turbo	1			EM-9174	
			Trans	Manual; w/ Turbo	1			EM-8793	
			Trans	Manual; w/o Turbo	1			EM-9174	
		1990-94	Trans	Auto; w/o Cruise Control	1			EM-8700	
			Trans	Manual; w/o Cruise Control	1			EM-8686	
	L4 2.4L 2351cc	2000-05	Front	Auto	1	EM-9160			
			Front	Manual	1	EM-5159			
		1996-99	Front		1	EM-8670			
			LH Front		1	EM-8792			
		2000-05	RH Front		1	EM-9184			
			Rear	Auto	1	EM-9161			
			Rear	Manual	1	EM-9485			
		1996-99	Rear	Auto	1	EM-9394			
			Rear	Manual	1	EM-8798			
		2000-05	Trans	Auto	1			EM-9162	
			Trans	Manual	1			EM-5452	
		1996-99	Trans	Auto	1			EM-8797	
			Trans	Manual	1			EM-8793	
		L4 2.4L 2378cc	2006-12	Front		1	EM-9305		
				RH Front		1	EM-9281		
	Rear			Auto	1	EM-9382			
	Rear			Manual	1	EM-9510			
	Trans			Auto	1			EM-9304	
	Trans			Manual	1			EM-5980	
	V6	V6 3.0L 2972cc	2000-05	Front		1	EM-5159		
				LH Rear		1	EM-5349		
RH Front					1	EM-9187			
Trans - LH				Auto	1			EM-9384	
V6 3.8L 3828cc			2010-12	Front		1	EM-9305		
		2006-09	Front		1	EM-9305			
			RH Front		1	EM-9278			
			Rear		1	EM-9382			
<b>GALANT</b>									
L4	L4 2.0L 1997cc	1993	Front	FWD	1	EM-8103			
		1991-92	Front	AWD	1	EM-9078			
			Front	FWD	1	EM-8103			
		1990	Front	AWD; GSX	1	EM-9078			
			Front	FWD	1	EM-8103			
		1989	Front		1	EM-8103			
		1993	LH Front	FWD	1	EM-9071			
		1991-92	LH Front	Auto; AWD; GSX	1	EM-8559			
			LH Front	FWD w/ DOHC	1	EM-8790			
			LH Front	FWD w/ SOHC	1	EM-9071			
			LH Front	VR-4	1	EM-9206			
		1990	LH Front	AWD; GSX	1	EM-8281			
			LH Front	BASE; LS	1	EM-9071			
			LH Front	GS	1	EM-8790			
		1989	LH Front	FWD w/ DOHC	1	EM-8790			
			LH Front	FWD w/ SOHC	1	EM-9071			
		1993	Rear	Auto; FWD	1	EM-8105			

## Engine, Transmission, And Torque Strut Mounts

CYL	ENG. SIZE	YEAR	LOCATION	DESCRIPTION	QTY	ENGINE	TORQUE STRUT	TRANSMISSION	
<b>MITSUBISHI PASSENGER CAR (continued)</b>									
<b>GALANT (continued)</b>									
L4	L4 2.0L 1997cc	1993	Rear	Manual; FWD	1	EM-8104			
		1991-92	Rear	Auto; AWD	1	EM-8104			
			Rear	Manual; AWD	1	EM-8105			
			Rear	Manual; FWD	1	EM-5098			
		1990	Rear	Auto; FWD	1	EM-8105			
			Rear	AWD; GSX	1	EM-8105			
			Rear	Manual; FWD	1	EM-8104			
		1989	Rear	Auto; FWD	1	EM-8105			
			Rear	Manual; FWD	1	EM-5098			
		1993	Trans	Auto; FWD	1			EM-8694	
			Trans	Manual; FWD	1			EM-8106	
		1990-92	Trans	AWD	1			EM-8106	
			Trans	Auto; FWD	1			EM-8694	
			Trans	Manual; FWD	1			EM-8106	
		1989	Trans	Auto; FWD	1			EM-8694	
			Trans	Manual; FWD	1			EM-8106	
		L4 2.4L 2351cc	1999-03	Front		1	EM-9160		
				1985-87	Front		1	EM-8292	
	1994-98			LH Front		1	EM-8792		
	1985-87		LH Front		1	EM-8292			
	1999-03		RH Front		1	EM-9184			
	1994-98		RH Front	Auto	1	EM-9203			
			RH Front	Manual	1	EM-8670			
	1999-03		Rear	Auto	1	EM-9161			
	1994-98		Rear	Auto	1	EM-9161			
			Rear	Manual	1	EM-8798			
	1985-87		Rear	HD Suspension	1	EM-5098			
			Rear	Std Suspension	1	EM-8105			
	1999-03		Trans	Auto	1		EM-9162		
	1994-98		Trans	Auto	1		EM-8797		
			Trans	Manual	1		EM-8793		
	L4 2.4L 2378cc	2009-12	Front		1	EM-9305			
			2008	Front		1	EM-9305		
		2004-07	Front		1	EM-9305			
			RH Front		1	EM-9281			
		2008	Rear		1	EM-9382			
2004-07		Rear		1	EM-9382				
		2004-09	Trans		1		EM-9304		
V6	V6 3.0L 2972cc	1999-03	Front		1	EM-5159			
			LH Rear		1	EM-5349			
			RH Front		1	EM-9187			
		Trans - LH		1		EM-9384			
	V6 3.8L 3800cc	2004-07	Front		1	EM-9305			
			RH Front		1	EM-9278			
			Rear		1	EM-9154			
	V6 3.8L 3828cc	2008-09	Front		1	EM-9305			
			RH Front		1	EM-9278			
Rear				1	EM-9382				
2004-06	Trans		1		EM-9383				
<b>LANCER</b>									
L4	L4 2.0L 1997cc	2005-06	Rear	Turbo; Manual	1	EM-5876			
			Trans	Turbo; Manual	1		EM-9088		
	L4 2.0L 1998cc	2013-15	Front	Turbo; Turbo	1	EM-5856			
			2012	Front	Turbo; Turbo	1	EM-5856		
		2008-16	Front	Non-Turbo; w/o Turbo	1	EM-3131			
		2008-11	Front	Turbo; Turbo	1	EM-5856			
2008-16	RH Front	Non-Turbo; w/o Turbo	1	EM-3130					

# Engine, Transmission, And Torque Strut Mounts

CYL	ENG. SIZE	YEAR	LOCATION	DESCRIPTION	QTY	ENGINE	TORQUE STRUT	TRANS-MISSION
<b>MITSUBISHI PASSENGER CAR (continued)</b>								
<b>LANCER (continued)</b>								
L4	L4 2.0L 1998cc	2013-15	Rear	Turbo; Turbo, Manual	1	EM-5924		
			Rear	Turbo; Turbo; Automatic Dual Clutch	1	EM-9489		
		2012	Rear	Turbo; Turbo, Manual	1	EM-5924		
			Rear	Turbo; Turbo; Automatic Dual Clutch	1	EM-9489		
		2008-16	Rear	Non-Turbo; w/o Turbo	1	EM-3132		
		2008-11	Rear	Turbo; Turbo, Manual	1	EM-5924		
			Rear	Turbo; Turbo; Automatic Dual Clutch	1	EM-9489		
		2008-16	Trans	Non-Turbo; Auto; CVT	1			EM-3134
			Trans	Non-Turbo; Manual	1			EM-3137
	Trans		Turbo; Manual	1			EM-3137	
	L4 2.0L 1999cc	2007	Front	Non-Turbo	1	EM-9181		
			2002-06	Front	Non-Turbo	1	EM-9181	
		2007	RH Front	Non-Turbo	1	EM-9188		
		2002-06	RH Front	Non-Turbo	1	EM-9188		
		2007	Rear	Non-Turbo; Auto	1	EM-9170		
		2002-06	Rear	Non-Turbo; Auto	1	EM-9170		
			Rear	Non-Turbo; Manual	1	EM-5876		
		2007	Trans	Auto	1			EM-5825
			Trans	Mexican Vehicle; Manual	1			EM-8817
	2005-06	Trans	Non-Turbo; Auto	1			EM-5825	
		Trans	Non-Turbo; Manual	1			EM-9088	
	L4 2.0L 2000cc	2002-04	Front	Non-Turbo	1	EM-9181		
			RH Front	Non-Turbo	1	EM-9188		
		Rear	Turbo; Auto	1	EM-9170			
		Rear	Turbo; Manual	1	EM-5876			
		Rear	Non-Turbo; Auto	1	EM-9170			
		Rear	Non-Turbo; Manual	1	EM-5876			
		Trans	Auto	1			EM-5825	
		Trans	Manual	1			EM-9088	
	L4 2.4L 2360cc	2009-16	Front	w/o Turbo	1	EM-3131		
			RH Front		1	EM-3130		
		2013-16	Trans	US & Canada; Manual	1			EM-3137
		2009-15	Trans	Mexico; Auto	1			EM-3134
2009-12		Trans	US & Canada; Auto (CVT)	1			EM-3134	
		Trans	US & Canada; Manual	1			EM-3137	
L4 2.4L 2378cc	2004-06	Trans	Auto	1			EM-5825	
		Trans	Manual	1			EM-9088	
L4 2.4L 2400cc	2004-06	Front		1	EM-5796			
		Rear	Auto	1	EM-9170			
		Rear	Manual	1	EM-5876			
<b>MIRAGE</b>								
L4	L4 1.5L 1468cc	1999-02	Front	Auto	1	EM-8818		
			Front	Manual	1	EM-9037		
		1997-98	Front	Auto	1	EM-8818		
			Front	Manual	1	EM-9037		
		1995-96	Front		1	EM-8100		
		1993-94	Front	Auto	1	EM-8097		
			Front	Manual	1	EM-8100		
		1989-92	Front	Auto	1	EM-2673		
			Front	Manual	1	EM-8107		
		1987-88	Front	Complete Unit	1	EM-8103		
			Front	Insert Only	1	EM-8553		
		1986	Front	Auto	1	EM-8235		
			Front	Manual	1	EM-8103		



## Engine, Transmission, And Torque Strut Mounts

CYL	ENG. SIZE	YEAR	LOCATION	DESCRIPTION	QTY	ENGINE	TORQUE STRUT	TRANSMISSION
<b>MITSUBISHI PASSENGER CAR (continued)</b>								
<b>MIRAGE (continued)</b>								
L4	L4 1.5L 1468cc	1985	Front	Auto	1	EM-8235		
			Front	Manual	1	EM-8103		
		1989-92	LH Front		1	EM-8108		
		1987-88	LH Front		1	EM-8619		
		1986	LH Front	w/o Power Steering	1	EM-8232		
		1985	LH Front	w/ Power Steering	1	EM-8556		
			LH Front	w/o Power Steering	1	EM-8232		
		1999-02	RH Front		1	EM-9068		
		1997-98	RH Front		1	EM-8853		
		1995-96	RH Front	w/ Power Steering	1	EM-8238		
			RH Front	w/o Power Steering	1	EM-8206		
		1993-94	RH Front	w/ Power Steering	1	EM-8238		
			RH Front	w/o Power Steering	1	EM-8206		
		1999-02	Rear	Auto	1	EM-8819		
			Rear	Manual	1	EM-9059		
		1997-98	Rear	Auto	1	EM-8819		
			Rear	Manual	1	EM-9059		
		1995-96	Rear		1	EM-8100		
		1993-94	Rear	Auto	1	EM-8100		
			Rear	Manual	1	EM-8100		
		1989-92	Rear		1	EM-8102		
		1987-88	Rear	Auto	1	EM-8266		
			Rear	Manual	1	EM-8554		
		1986	Rear		1	EM-8267		
		1985	Rear		1	EM-8267		
		1997-02	Trans	Auto	1			EM-8879
			Trans	Manual	1			EM-8880
		1993-96	Trans	Auto	1			EM-8582
			Trans	Manual	1			EM-8099
		1989-92	Trans	Auto	1			EM-8584
			Trans	Manual	1			EM-8669
		1987-88	Trans	Auto	1			EM-8205
	Trans		Manual	1			EM-8242	
	1985-86	Trans	Auto	1			EM-8875	
		Trans	Manual; 4 Spd	1			EM-8107	
		Trans	Manual; 5 Spd	1			EM-8552	
	L4 1.6L 1597cc	1991-92	Front	Auto	1	EM-2673		
			Front	Manual	1	EM-8107		
		1989	Front		1	EM-2673		
		1987-88	Front	Auto	1	EM-8235		
			Front	Manual	1	EM-8103		
		1985-86	Front	Auto	1	EM-8235		
			Front	Manual	1	EM-8103		
		1991-92	LH Front		1	EM-9207		
		1989	LH Front		1	EM-9207		
		1991-92	Rear		1	EM-8102		
		1989	Rear		1	EM-8102		
		1987-88	Rear		1	EM-8267		
		1985-86	Rear		1	EM-8267		
		1991-92	Trans		1			EM-8584
1989		Trans		1			EM-8584	
1987-88		Trans	Manual	1			EM-8242	
1985-86		Trans	Auto	1			EM-8875	
		Trans	Manual; Insert	1			EM-8552	
L4 1.8L 1834cc		1997-02	Front	Auto	1	EM-8818		
			Front	Manual	1	EM-9037		
	1995-96	Front		1	EM-8100			

# Engine, Transmission, And Torque Strut Mounts

CYL	ENG. SIZE	YEAR	LOCATION	DESCRIPTION	QTY	ENGINE	TORQUE STRUT	TRANSMISSION
<b>MITSUBISHI PASSENGER CAR (continued)</b>								
<b>MIRAGE (continued)</b>								
L4	L4 1.8L 1834cc	1993-94	Front	Auto	1	EM-8097		
			Front	Manual	1	EM-8100		
		1997-02	RH Front		1	EM-8877		
			Rear	Auto	1	EM-8819		
			Rear	Manual	1	EM-9059		
		1995-96	Rear	Auto	1	EM-8100		
			Rear	Manual	1	EM-9057		
		1993-94	Rear	Auto	1	EM-8100		
			Rear	Manual	1	EM-9057		
		1997-02	Trans	Auto	1			EM-8816
Trans	Manual		1			EM-8817		
1993-96	Trans	Auto	1			EM-8619		
	Trans	Manual	1			EM-8099		
<b>PRECIS</b>								
L4	L4 1.5L 1468cc	1990-94	Front		1	EM-8103		
			Front		1	EM-8933		
		1990-94	LH Front		1	EM-8039		
			Rear		1	EM-8672		
		1987-89	Rear	Auto	1	EM-8803		
		1990-94	Torq Str - Front		1		EM-8047	
		1987-89	Torq Str - Front	Complete Unit; Auto	1		EM-8932	
			Torq Str - Front	Complete Unit; Manual	1		EM-8045	
			Torq Str - Front	Insert Only; Large (70mm) Bushing	1		EM-5453	
			Torq Str - Front	Insert Only; Small (50mm) Bushing	1		EM-5398	
		1990-94	Trans	Auto	1			EM-8675
			Trans	Manual	1			EM-8674
1987-89	Trans	Auto	1			EM-8934		
<b>SIGMA</b>								
V6	V6 3.0L 2972cc	1989-90	Trans	Auto	1			EM-2730
<b>STARION</b>								
L4	L4 2.6L 2555cc	1983-89	Front		1	EM-2731		
			Rear		1	EM-8205		
		1989	Trans	Manual	1			EM-2730
		1984-88	Trans	Auto	1			EM-8292
			Trans	Manual	1			EM-2730
		1983	Trans	Manual	1			EM-2730
<b>TREDIA</b>								
L4	L4 1.8L 1795cc	1984-88	Front Lower	Insert	1	EM-8270		
			1983	Front Lower		1	EM-8803	
		1983-88	Rear	Auto	1	EM-8271		
			Rear	Manual	1	EM-8506		
		1983-88	Torq Str - Front	Manual, Complete Unit	1		EM-8272	
			Torq Str - Front	Manual, Insert	1		EM-5739	
		1984-88	Trans	Manual; 5 Spd	1			EM-8510
			L4 2.0L 1997cc	1984-88	Front	Manual	1	EM-8270
Front Upper	Auto				1	EM-8105		
Torq Str - Front	Manual				1		EM-8867	
Trans	Auto				1			EM-8807
Trans	Manual; 5 Spd				1			EM-8510

## Engine, Transmission, And Torque Strut Mounts

CYL	ENG. SIZE	YEAR	LOCATION	DESCRIPTION	QTY	ENGINE	TORQUE STRUT	TRANSMISSION	
<b>MITSUBISHI SPORT UTILITY</b>									
<b>ENDEAVOR</b>									
V6	V6 3.8L 3828cc	2010-11	Front		1	EM-9305			
		2004-08	Front		1	EM-9305			
		2010-11	Rear		1	EM-9510			
		2004-08	Rear		1	EM-9510			
		2010-11	Trans	Auto		1			EM-9383
		2004-08	Trans	Auto		1			EM-9383
<b>MONTERO</b>									
L4	L4 2.6L 2555cc	1983-89	L & R Front		2	EM-2731			
			Trans	Auto; 4WD	1			EM-8096	
			Trans	Manual; 4WD	1			EM-8248	
V6	V6 3.0L 2972cc	1995-96	L & R Front		2	EM-8878			
			1994	L & R Front	After 6/94	2	EM-8876		
		1992-93	L & R Front	Before 6/94	2	EM-8205			
			L & R Front		2	EM-8205			
			1996	Trans	Auto	1			EM-7017
		1995	Trans	Manual	1			EM-7017	
			Trans	Auto	1			EM-8695	
		1992-94	Trans	Manual	1			EM-7017	
			Trans	Auto; 4WD	1			EM-8244	
			Trans	Manual; 4WD	1			EM-8243	
	V6 3.5L 3497cc	2001-02	L & R Front		2	EM-9186			
			1995-00	L & R Front		2	EM-8878		
		1994	L & R Front		2	EM-8876			
		2001-02	Trans	Auto	1			EM-9201	
		1994-00	Trans	Auto	1			EM-8695	
V6 3.8L 3797cc	2003-06	L & R Front	4WD	2	EM-9186				
		Trans	Auto	1			EM-9201		
<b>MONTERO SPORT</b>									
V6	V6 3.0L 2972cc	2000-03	LH Front	SOHC	1	EM-5820			
			Trans	4WD	1			EM-8695	
		1997-99	Trans	Auto; 2WD	1			EM-8111	
			Trans	Auto; 4WD	1			EM-8695	
			Trans	Manual; 2WD	1			EM-8111	
			Trans	Manual; 4WD	1			EM-8243	
	V6 3.5L 3497cc	2000-04	LH Front		1	EM-5820			
			1999	LH Front		1	EM-8876		
		1999	RH Front		1	EM-8878			
			Trans	2WD	1			EM-8111	
<b>OUTLANDER</b>									
L4	L4 2.4L 2351cc	2008-10	Front	Mexico	1	EM-5856			
		2003-04	Front		1	EM-5796			
		2008-10	Rear	Mexico; FWD	1	EM-3145			
		2003-04	Rear	Auto; FWD	1	EM-9153			
			Rear	AWD; US & Canada	1	EM-5912			
		2008-10	Right	Mexico	1	EM-5857			
		2003-04	Right		1	EM-5798			
			Trans		1			EM-5797	
		L4 2.4L 2360cc	2008-13	Front		1	EM-5856		
				Rear	AWD	1	EM-3157		
				Rear	FWD	1	EM-3145		
				Right		1	EM-5857		
	2008-16	Trans	Auto	1			EM-3134		
	L4 2.4L 2378cc	2005-06	Front		1	EM-5796			
			2004	Front	Mexico	1	EM-5796		
		2005-06	Rear	Auto; FWD	1	EM-9153			
			Rear	AWD; US & Canada	1	EM-5912			

# Engine, Transmission, And Torque Strut Mounts

CYL	ENG. SIZE	YEAR	LOCATION	DESCRIPTION	QTY	ENGINE	TORQUE STRUT	TRANSMISSION
<b>MITSUBISHI SPORT UTILITY (continued)</b>								
<b>OUTLANDER (continued)</b>								
L4	L4 2.4L 2378cc	2004	Rear	Mexico; Auto; FWD	1	EM-9153		
		2005-06	Right		1	EM-5798		
		2004	Right	Mexico	1	EM-5798		
		2004-06	Trans		1			EM-5797
V6	V6 3.0L 2998cc	2007-13	Front		1	EM-5856		
			Right		1	EM-5927		
		2007-12	Trans		1			EM-5928
<b>OUTLANDER SPORT</b>								
L4	L4 2.0L 1998cc	2011-16	Front		1	EM-3131		
			Rear		1	EM-3132		
			Right		1	EM-3130		
			Trans	Auto (CVT)	1			EM-3134
			Trans	Manual	1			EM-3137
<b>MITSUBISHI TRUCK</b>								
<b>MIGHTY MAX</b>								
L4	L4 2.0L 1997cc	1987-89	L & R Front		2	EM-2731		
		1983-86	RH Front		1	EM-2731		
		1987-89	Trans	Auto; 2WD	1			EM-8556
			Trans	Auto; 4WD	1			EM-8096
			Trans	Manual; 2WD	1			EM-8556
			Trans	Manual; 4WD	1			EM-8096
		1986	Trans	Auto; 2WD	1			EM-8556
			Trans	Auto; 4WD	1			EM-8248
			Trans	Manual; 2WD	1			EM-8556
			Trans	Manual; 4WD	1			EM-8248
		1984-85	Trans	Auto; 2WD	1			EM-8556
			Trans	Manual; 2WD	1			EM-8556
		1983	Trans	Auto; 2WD	1			EM-8556
			Trans	Auto; 4WD	1			EM-8248
	Trans		Manual; 2WD	1			EM-8556	
	Trans		Manual; 4WD	1			EM-8248	
	L4 2.3L 2346cc Diesel	1983-85	LH Front		1	EM-8205		
			Trans	Auto; 2WD	1			EM-8556
			Trans	Auto; 4WD	1			EM-8096
			Trans	Manual; 2WD	1			EM-8556
			Trans	Manual; 4WD	1			EM-8096
	L4 2.4L 2351cc	1990-96	L & R Front		2	EM-2731		
			Trans	Auto; 2WD	1			EM-9199
			Trans	Manual	1			EM-8111
	L4 2.6L 2555cc	1987-89	L & R Front		2	EM-2731		
			1983-86	RH Front		1	EM-2731	
		1987-89	Trans	Auto; 2WD	1			EM-8111
Trans			Auto; 4WD	1			EM-8096	
Trans			Manual; 2WD	1			EM-8111	
Trans			Manual; 4WD	1			EM-8096	
1983-86		Trans	4WD	1			EM-8248	
		Trans	Auto; 2WD	1			EM-8556	
Trans	Manual; 2WD	1			EM-8556			
V6	V6 3.0L 2972cc	1992-94	L & R Front		2	EM-2731		
		1991	L & R Front		2	EM-2731		
		1990	L & R Front		2	EM-2731		
		1992-94	Rear	4WD	1	EM-8696		
		1991	Rear	4WD, After 3/91	1	EM-8696		
		1990-94	Trans	Auto; 2WD	1			EM-9199
			Trans	Auto; 4WD	1			EM-8111
Trans	Manual; 2WD	1			EM-8111			

## Engine, Transmission, And Torque Strut Mounts

CYL	ENG. SIZE	YEAR	LOCATION	DESCRIPTION	QTY	ENGINE	TORQUE STRUT	TRANS-MISSION	
<b>MITSUBISHI TRUCK (continued)</b>									
<b>MIGHTY MAX (continued)</b>									
V6	V6 3.0L 2972cc	1990-94	Trans	Manual; 4WD	1			EM-8111	
<b>MITSUBISHI VAN</b>									
<b>EXPO</b>									
L4	L4 2.4L 2351cc	1993-95	Front	FWD	1	EM-8688			
			1992	Front	Auto; AWD	1	EM-8687		
		1992	Front	Auto; FWD	1	EM-8102			
			Front	Manual; AWD	1	EM-8688			
			Front	Manual; FWD	1	EM-8821			
			1993-95	LH Front		1	EM-8820		
		1992	LH Front		1	EM-8820			
		1993-95	Rear	Auto; FWD	1	EM-8690			
			Rear	Manual; FWD	1	EM-8689			
		1992	Rear	FWD	1	EM-8689			
			Rear	Manual; AWD	1	EM-8689			
		1993-95	Trans	Auto; FWD	1			EM-8822	
		1992	Trans	Auto; FWD	1			EM-8881	
			Trans	Manual; AWD	1			EM-8686	
Trans	Manual; FWD		1			EM-8686			
<b>EXPO LRV</b>									
L4	L4 1.8L 1834cc	1992-93	Front	Auto; AWD	1	EM-8100			
			Front	FWD	1	EM-9057			
			LH Front	Manual; AWD	1	EM-8685			
			Rear	Auto; AWD	1	EM-8690			
			Rear	Manual; FWD	1	EM-8689			
		1993-94	Trans	Auto	1			EM-8822	
		1992	Trans	Auto; FWD	1			EM-8881	
			Trans	Manual; FWD	1			EM-8696	
		L4 2.4L 2351cc	1993-94	Front	FWD	1	EM-9057		
				LH Front	FWD	1	EM-8685		
	Rear			Auto; FWD	1	EM-8690			
	Rear			Manual; FWD	1	EM-8689			
				Trans	Auto	1			EM-8822
	<b>VAN</b>								
L4	L4 2.4L 2351cc	1987-90	LH Front		1	EM-8466			
			RH Front		1	EM-8467			
			Trans		1			EM-8556	
<b>NISSAN PASSENGER CAR</b>									
<b>200SX</b>									
L4	L4 1.6L 1597cc	1995-98	Front	Manual	1	EM-8130			
			RH Front		1	EM-8122			
			Rear	Auto	1	EM-8132			
			Rear	Manual	1	EM-8701			
			Trans	Auto	1			EM-8150	
			Trans	Manual, Complete Unit	1			EM-8683	
			Trans	Manual; Bushing	1			EM-7114	
			L4 1.8L 1809cc	1984	Trans - LH	Auto	1		
	Trans - RH	Auto			1			EM-9025	
	1985-86	Trans			1			EM-2488	
	1984	Trans	Manual	1			EM-2488		
	L4 2.0L	1995-98	Trans		1			EM-8891	
	L4 2.0L 1952cc	1980-81	L & R Front		2	EM-2680			
			1977-79	L & R Front		2	EM-2405		
			Trans	Auto	1			EM-2487	
				Trans	Manual	1			EM-2487

# Engine, Transmission, And Torque Strut Mounts

CYL	ENG. SIZE	YEAR	LOCATION	DESCRIPTION	QTY	ENGINE	TORQUE STRUT	TRANSMISSION
<b>NISSAN PASSENGER CAR (continued)</b>								
<b>200SX (continued)</b>								
L4	L4 2.0L 1974cc	1984-88	Trans - LH	Auto	1			EM-9049
			Trans - RH	Auto	1			EM-9025
			Trans	Manual	1			EM-2488
	L4 2.0L 1998cc	1995-98	Front	Manual	1	EM-8130		
			RH Front		1	EM-8307		
			Rear	Auto	1	EM-8132		
			Rear	Manual	1	EM-8701		
	L4 2.2L 2187cc	1982-83	L & R Front		2	EM-2680		
			Trans		1			EM-2488
V6	V6 3.0L 2960cc	1987-88	L & R Front		2	EM-8600		
			Trans	Auto	1			EM-5162
			Trans	Manual	1			EM-2488
<b>210</b>								
L4	L4 1.2L 1237cc	1979-82	L & R Front		2	EM-2681		
			Trans	Manual	1			EM-2489
	L4 1.4L 1393cc	1979-82	L & R Front		2	EM-2681		
			Trans	Manual	1			EM-2489
	L4 1.5L 1488cc	1980-82	L & R Front		2	EM-2681		
			Trans	Manual	1			EM-2489
<b>240SX</b>								
L4	L4 2.4L 2389cc	1989-98	L & R Front		2	EM-8296		
		1989-94	Trans	Auto	1			EM-8323
			Trans	Manual	1			EM-8323
<b>240Z</b>								
L6	L6 2.4L 2393cc	1970-73	L & R Front		2	EM-2401		
			Trans	Auto	1			EM-2487
			Trans	Manual	1			EM-2487
<b>280ZX</b>								
L6	L6 2.8L 2753cc	1979-83	L & R Front		2	EM-2401		
			Trans	Auto	1			EM-2741
			Trans	Manual	1			EM-2741
<b>300ZX</b>								
V6	V6 3.0L 2960cc	1990-96	L & R Front	Coupe	2	EM-9044		
		1984-89	L & R Front		2	EM-9009		
		1990-96	Rear	Turbo	1	EM-5561		
		1984-89	Trans		1			EM-8963
<b>310</b>								
L4	L4 1.4L 1393cc	1979-80	LH Front		1	EM-9033		
			RH Front		1	EM-9033		
			Trans		1			EM-5163
	L4 1.5L 1488cc	1981-82	LH Front		1	EM-9033		
			RH Front		1	EM-9033		
			Trans		1			EM-5163
<b>350Z</b>								
V6	V6 3.5L 3498cc	2009	L & R Front		2	EM-9180		
		2003-08	L & R Front		2	EM-9180		
		2009	Trans		1			EM-9464
		2003-08	Trans		1			EM-9464
<b>370Z</b>								
V6	V6 3.7L 3696cc	2009-19	Front		1	EM-7008		

## Engine, Transmission, And Torque Strut Mounts

CYL	ENG. SIZE	YEAR	LOCATION	DESCRIPTION	QTY	ENGINE	TORQUE STRUT	TRANSMISSION	
<b>NISSAN PASSENGER CAR (continued)</b>									
<b>510</b>									
L4	L4 1.6L 1595cc	1968-73	L & R Front		2	EM-2533			
		1981	L & R Front		2	EM-2456			
	1978-80	LH Front		1	EM-2456				
		RH Front		1	EM-2680				
		Trans		1			EM-2488		
<b>610</b>									
L4	L4 1.8L 1770cc	1973	L & R Front		2	EM-2405			
			Trans		1			EM-2487	
	L4 2.0L 1952cc	1974-76	L & R Front		2	EM-2405			
			Trans		1			EM-2487	
<b>710</b>									
L4	L4 1.8L 1770cc	1974	L & R Front		2	EM-2404			
			Trans		1			EM-2487	
	L4 2.0L 1952cc	1975-77	L & R Front		2	EM-2404			
			Trans		1			EM-2487	
<b>810</b>									
L6	L6 2.4L 2393cc	1981	L & R Front		2	EM-8138			
		1978-80	L & R Front		2	EM-2456			
		1978-81	Trans		2			EM-2742	
	L6 2.8L 2793cc Diesel	1981	L & R Front		2	EM-8138			
			Trans		1			EM-2487	
<b>1200</b>									
L4	L4 1.2L 1171cc	1971-73	L & R Front		2	EM-2402			
			Trans		1			EM-8115	
<b>1600</b>									
L4	L4 1.6L	1966-70	L & R Front		2	EM-2403			
<b>2000</b>									
L4	L4 2.0L 1982cc	1968-70	L & R Front		2	EM-2533			
			Trans		1			EM-2487	
<b>APRIO (MEXICO)</b>									
L4	L4 1.6L 1598cc	2008-10	Torg Str - Lower		1		EM-8694		
<b>ALMERA (MEXICO)</b>									
L4	L4 1.8L 1769cc	2001-02	RH Front		1	EM-9200			
			Rear		1	EM-9166			
		2001-05	Trans - BUSHING	Bushing Only; Auto Bushing Only; Auto		1			EM-9217
<b>ALTIMA</b>									
L4	L4 2.4L 2389cc	2000-01	Front		1	EM-8682			
		1996-99	Front		1	EM-8682			
		1993-95	Front		1	EM-8682			
		2000-01	RH Front		1	EM-8994			
		1996-99	RH Front	Auto, Complete Unit		1	EM-8704		
			RH Front	Auto; Insert Only		1	EM-5502		
			RH Front	Manual		1	EM-8994		
		1993-95	RH Front	Auto, Complete Unit		1	EM-8704		
			RH Front	Auto; Insert Only		1	EM-5502		
		2000-01	Rear	Auto		1	EM-8681		
		1996-99	Rear	Auto		1	EM-8681		
		1993-95	Rear	Auto		1	EM-8681		
		1998-01	Trans	Auto		1			EM-8705
		1993-97	Trans	Auto		1			EM-8705
					Trans	Manual	1		
	L4 2.5L 2488cc	2002-06	Front		1	EM-9167			

# Engine, Transmission, And Torque Strut Mounts

CYL	ENG. SIZE	YEAR	LOCATION	DESCRIPTION	QTY	ENGINE	TORQUE STRUT	TRANSMISSION
<b>NISSAN PASSENGER CAR (continued)</b>								
<b>ALTIMA (continued)</b>								
L4	L4 2.5L 2488cc	2002-06	RH Front		1	EM-9190#		
		2012-13	Rear		1	EM-9446		
		2007-11	Rear	Gas	1	EM-9446		
			Rear	Hybrid	1	EM-9544		
		2002-06	Rear	w/o Wires	1	EM-9209		
		2012-13	Right		1	EM-5865		
		2007-11	Right	Gas	1	EM-5865		
			Right	Hybrid	1	EM-5865		
		2007-13	Torq Str - Front		1		EM-9444	
		2013-17	Trans		1			EM-7080
2007-12	Trans	Auto; CVT	1			EM-9465		
2002-06	Trans	Auto	1			EM-5817		
V6	V6 3.5L 3498cc	2013-16	Front		1	EM-5869		
		2007-12	Front		1	EM-5869		
		2005-06	Front	Auto, w/ Wires	1	EM-5672		
			Front	Auto; w/o Wires	1	EM-9252		
			Front	Manual, w/o Wires	1	EM-5772		
		2004	Front	Auto, w/ Wires	1	EM-5672		
			Front	Auto; w/o Wires	1	EM-9252		
			Front	Manual, w/o Wires	1	EM-5772		
		2002-03	Front	Auto, w/ Wires	1	EM-5672		
			Front	Auto; w/o Wires	1	EM-9252		
			Front	Manual, w/o Wires	1	EM-5772		
		2007-12	Rear		1	EM-5870		
		2005-06	Rear	Auto; 5 Spd; w/Wires	1	EM-5818		
			Rear	Manual	1	EM-9547		
		2004	Rear	Auto; w/o Wires	1	EM-9248		
			Rear	Auto; w/Wires	1	EM-5818		
			Rear	Manual, w/o Wires	1	EM-9547		
		2002-03	Rear	Auto; w/o Wires	1	EM-9248		
			Rear	Auto; w/Wires	1	EM-5818		
			Rear	Manual, w/o Wires	1	EM-9547		
		2013-16	Right		1	EM-5866		
		2007-12	Right		1	EM-5867		
		2005-06	Right		1	EM-9223#		
		2004	Right		1	EM-9223#		
		2002-03	Right		1	EM-9223#		
		2013-16	Torq Str - Front		1		EM-7171	
			Torq Str - Rear		1		EM-9551	
		2008-17	Torq Str - Rear		1		EM-9551	
			Torq Str - Right		1		EM-9545	
		2008-12	Trans	Auto; CVT	1			EM-9460
Trans	Manual		1			EM-7082		
2007	Trans	Auto; CVT	1			EM-9460		
2005-06	Trans	Auto	1			EM-9410		
	Trans	Manual	1			EM-9575		
2002-04	Trans	Auto	1			EM-9219		
	Trans	Manual	1			EM-9577		
<b>B210</b>								
L4	L4 1.3L 1288cc	1974	L & R Front		2	EM-2400		
		1973	L & R Front		2	EM-2403		
		1974	Trans	Auto	1			EM-2760
			Trans	Manual	1			EM-5165
	L4 1.4L 1393cc	1978	L & R Front		2	EM-2681		
		1975-77	L & R Front		2	EM-2400		
		1978	Trans	Manual	1			EM-2489

# = Available in the Westar Gold Line



## Engine, Transmission, And Torque Strut Mounts

CYL	ENG. SIZE	YEAR	LOCATION	DESCRIPTION	QTY	ENGINE	TORQUE STRUT	TRANSMISSION
<b>NISSAN PASSENGER CAR (continued)</b>								
<b>B210 (continued)</b>								
L4	L4 1.4L 1393cc	1975-77	Trans	Manual, 2 Door	1			EM-8117
			Trans	Manual; 4 Door	1			EM-5166
<b>CUBE</b>								
L4	L4 1.8L 1798cc	2009-14	RH Front		1	EM-5656		
			Torq Str - Rear		1		EM-9228	
			Torq Str - Right		1		EM-9422	
			Trans		1			EM-9230
<b>F10</b>								
L4	L4 1.4L 1393cc	1976-78	L & R Front		2	EM-8138		
			Trans		1			EM-5815
<b>HIKARI (MEXICO)</b>								
L4	L4 1.6L	1988-92	RH Front		1	EM-8304		
			Rear		1	EM-8324		
			Torq Str - Front		1		EM-8125	
			Torq Str - Rear		1		EM-8133	
			Trans		1			EM-8121
<b>LUCINO (MEXICO)</b>								
L4	L4 1.6L	1996-00	Front		1	EM-8130		
			RH Front		1	EM-8122		
			Rear	Auto	1	EM-8132		
			Rear	Manual; Complete Unit	1	EM-8154		
			Rear	Manual; Insert Only	1	EM-8152		
		1999-00	Trans	Auto	1			EM-8150
			Trans	Manual	1			EM-8148
		1996-98	Trans	Auto	1			EM-8150
			Trans	Manual	1			EM-8891
		L4 2.0L	2000	Front	Manual	1	EM-8130	
	RH Front				1	EM-8307		
	Rear				1	EM-8132		
				Trans		1		
<b>MAXIMA</b>								
L6	L6 2.4L 2393cc	1982-84	L & R Front		2	EM-8138		
			Trans	Manual	1			EM-2487
	L6 2.8L 2793cc Diesel	1982-83	L & R Front		2	EM-8138		
			Trans		1			EM-2487
V6	V6 3.0L 2960cc	1992-94	Front	DOHC	1	EM-9048		
			Front	SOHC	1	EM-8600		
		1989-91	Front		1	EM-8600		
			Front	Auto	1	EM-8605		
		1985-88	Front	Manual	1	EM-8962		
			Front	Auto	1	EM-8601		
		1992-94	LH Front	Manual	1	EM-9010		
			LH Front	Auto	1	EM-8601		
		1989-91	LH Front	Manual	1	EM-9010		
			LH Front	Auto - DOHC	1	EM-5777		
		1992-94	LH Rear	Manual - DOHC	1	EM-5779		
			LH Rear	SOHC	1	EM-8603		
		1989-91	LH Rear	Auto	1	EM-8603		
			LH Rear	Manual	1	EM-5779		
		1985-88	RH Front		1	EM-8140		
		1992-94	RH Rear	DOHC	1	EM-9171		
			RH Rear	SOHC	1	EM-8602		
		1989-91	RH Rear	Auto	1	EM-8602		
		1985-88	Rear		1	EM-8141		
1992-94	Trans	Auto, DOHC	1			EM-9176		

# Engine, Transmission, And Torque Strut Mounts

CYL	ENG. SIZE	YEAR	LOCATION	DESCRIPTION	QTY	ENGINE	TORQUE STRUT	TRANSMISSION
<b>NISSAN PASSENGER CAR (continued)</b>								
<b>MAXIMA (continued)</b>								
V6	V6 3.0L 2960cc	1992-94	Trans	Auto, SOHC	1			EM-8601
			Trans	Manual	1			EM-9010
		1989-91	Trans	Auto	1			EM-8601
			Trans	Manual	1			EM-9010
		1985-88	Trans	Auto	1			EM-8604
	Trans		Manual	1			EM-8604	
	V6 3.0L 2988cc	2000-01	Front	Auto, GXE & SE	1	EM-5670		
			Front	Manual	1	EM-8865		
		1997-99	Front	Auto; GLE; SE w/ Wires	1	EM-5670		
			Front	Auto; GLE; SE; w/o Wires	1	EM-5132		
			Front	Auto; GXE	1	EM-8865		
		1996	Front	Manual, SE & GLE	1	EM-8865		
			Front	Auto, GXE	1	EM-8865		
			Front	Auto, w/ Wires; GLE and SE from 2/96	1	EM-5670		
			Front	Auto; GLE; SE; w/o Wires	1	EM-5132		
		1995	Front	Manual	1	EM-8865		
			Front	Auto, GXE	1	EM-8865		
		2000-01	RH Front	Manual	1	EM-8865		
			RH Front	Auto, GXE & SE	1	EM-9251		
			RH Front	GLE	1	EM-9251		
		1997-99	RH Front	Manual, GXE & SE	1	EM-9031		
			RH Front		1	EM-9031		
		2000-01	Rear	Auto	1	EM-5846		
			Rear	Manual	1	EM-8866		
		1997-99	Rear		1	EM-8866		
		1996	Rear		1	EM-8866		
		1995	Rear		1	EM-8866		
		2000-01	Trans - BUSHING	Bushing Only; Auto	1			EM-5937
			Trans - BUSHING	Bushing Only; Manual	1			EM-9035
		1997-99	Trans - BUSHING	Bushing Only; Auto	1			EM-5937
			Trans - BUSHING	Bushing Only; Manual	1			EM-9035
		1995-96	Trans - BUSHING	Bushing Only; Auto	1			EM-9035
			Trans - BUSHING	Bushing Only; Manual	1			EM-5937
	V6 3.5L 3498cc	2016	Front		1	EM-5869		
2009-14		Front		1	EM-5869			
2007-08		Front	w/ Wires	1	EM-5672			
		Front	w/o Wires	1	EM-9252			
2006		Front	w/ Wires	1	EM-5672			
		Front	w/o Wires	1	EM-9252			
2004-05		Front	w/ Wires	1	EM-5672			
		Front	w/o Wires	1	EM-9252			
2003		Front	Auto; w/o Wires	1	EM-5132			
		Front	Auto; w/Wires	1	EM-5670			
		Front	Manual	1	EM-8865			
2002		Front		1	EM-8865			
2007-08		RH Front		1	EM-9223#			
2006		RH Front		1	EM-9223#			
2004-05		RH Front		1	EM-9223#			
2003		RH Front	Auto	1	EM-9031			
	RH Front	Manual	1	EM-9031				

# = Available in the Westar Gold Line

# Engine, Transmission, And Torque Strut Mounts

CYL	ENG. SIZE	YEAR	LOCATION	DESCRIPTION	QTY	ENGINE	TORQUE STRUT	TRANS-MISSION	
<b>NISSAN PASSENGER CAR (continued)</b>									
<b>MAXIMA (continued)</b>									
V6	V6 3.5L 3498cc	2002	RH Front	Auto	1	EM-9031			
		2009-14	Rear		1	EM-5870			
		2007-08	Rear	w/ Wires		1	EM-5748		
		2006	Rear	Auto; From 6/06		1	EM-5748		
			Rear	Auto; to 6/06		1	EM-5818		
			Rear	Manual		1	EM-9547		
		2004-05	Rear	Auto; w/ Wires; SE		1	EM-5818		
			Rear	Auto; w/ Wires; SL		1	EM-5748		
			Rear	Manual		1	EM-9547		
		2003	Rear	Auto		1	EM-5411		
			Rear	Manual		1	EM-8866		
		2002	Rear	Auto		1	EM-5411		
		2016	Right			1	EM-5867		
		2009-14	Right			1	EM-5867		
		2016-17	Torq Str - Front			1		EM-7171	
		2009-15	Torq Str - Front			1		EM-9545	
		2016-17	Torq Str - Rear	Torque Strut Buffer		1		EM-9551	
		2009-15	Torq Str - Rear	Torque Strut Buffer		1		EM-9551	
		2002-03	Trans - BUSHING	Bushing Only; Auto Bushing Only; Auto		1			EM-8959
			Trans - BUSHING	Bushing Only; Manual Bushing Only; Manual		1			EM-9589
		2009-12	Trans			1			EM-9460
		2007-08	Trans			1			EM-9414
		2005-06	Trans	Auto & CVT		1			EM-9410
			Trans	Manual		1			EM-9575
		2004	Trans	Auto; 4 Spd		1			EM-9219
			Trans	Auto; 5 Spd		1			EM-9410
Trans	Manual			1			EM-9575		
<b>MULTI</b>									
L4	L4 2.0L	1986-88	LH Front		1	EM-5500			
<b>NX</b>									
L4	L4 1.6L 1597cc	1991-93	Front	Manual	1	EM-8130			
			LH Front		1	EM-8427			
			RH Front		1	EM-8122			
			Rear	Auto	1	EM-8132			
			Rear	Manual	1	EM-8701			
			Trans	Auto	1		EM-8150		
			Trans	Manual, Complete Unit	1		EM-8149		
			Trans	Manual; Bushing	1		EM-7114		
	L4 2.0L 1998cc	1991-93	Front	Manual	1	EM-8130			
			RH Front	Auto	1	EM-8290			
			RH Front	Bushing Only	1	EM-8427			
			Rear	Auto	1	EM-8132			
			Rear	Manual	1	EM-8701			
			Trans	Manual, Complete Unit	1		EM-8149		
			Trans	Manual; Bushing	1		EM-7114		
			<b>PLATINA (MEXICO)</b>						
L4	L4 1.6L 1598cc	2009-10	Torq Str - Lower	Manual	1		EM-9000		
		2002-08	Torq Str - Lower	Auto	1		EM-9000		
			Torq Str - Lower	Manual	1		EM-9000		
		2009	Trans	Mexican Vehicle; Manual	1			EM-90001	
		2002-08	Trans	Mexican Vehicle; Auto	1			EM-90031	
			Trans	Mexican Vehicle; Manual	1			EM-90001	

# Engine, Transmission, And Torque Strut Mounts

CYL	ENG. SIZE	YEAR	LOCATION	DESCRIPTION	QTY	ENGINE	TORQUE STRUT	TRANSMISSION	
<b>NISSAN PASSENGER CAR (continued)</b>									
<b>PULSAR</b>									
L4	L4 1.6L 1597cc	1983	RH Front		1	EM-8118			
			Rear		1	EM-8119			
			Torq Str - Front		1		EM-8120		
			Torq Str - Rear		1		EM-8142		
			Trans	Auto	1			EM-8151	
			Trans	Manual	1			EM-8121	
<b>PULSAR NX</b>									
L4	L4 1.5L 1488cc	1983-84	LH Front		1	EM-8151			
			RH Front		1	EM-8118			
			Torq Str - Front	Auto	1		EM-8142		
			Torq Str - Rear	Auto	1		EM-8284		
			Trans	Auto	1			EM-8119	
			Trans	Manual	1			EM-8121	
	L4 1.6L 1597cc	1988-90	LH Rear	Auto	1	EM-8324			
			LH Rear	Manual	1	EM-8154			
		1987	LH Rear	Manual	1	EM-8154			
			RH Front		1	EM-8304			
		1988-90	RH Front		1	EM-8304			
			RH Front		1	EM-8118			
		1987-90	Torq Str - Front		1		EM-8125		
			Torq Str - Front		1		EM-8142		
		1987-90	Torq Str - Rear		1		EM-8133		
			Torq Str - Rear		1		EM-8284		
		1988-90	Trans	Auto	1			EM-8128	
			Trans	Manual	1			EM-8312	
		1987	Trans	Manual	1			EM-8312	
			Trans	Auto	1			EM-8151	
		1983-86	Trans	Manual	1			EM-8121	
			Trans	Manual	1			EM-8121	
		L4 1.8L 1809cc	1988-89	RH Front		1	EM-9134		
	Torq Str - Front				1		EM-8125		
	Torq Str - Rear				1		EM-8133		
	Trans				1			EM-8312	
	Trans				1			EM-8312	
	<b>SAKURA (MEXICO)</b>								
	L4	L4 1.8L	1985-86	Trans - LH	Auto	1			EM-9049
				Trans - RH	Auto	1			EM-9025
				Trans	Manual	1			EM-2488
	<b>SENTRA</b>								
	L4	L4 1.5L 1488cc	1982-83	Front	Auto	1	EM-8151		
Front				Manual	1	EM-8118			
Torq Str - Front				Auto	1		EM-8142		
Torq Str - Rear				Auto	1		EM-8284		
Trans				Auto	1			EM-8119	
Trans				Manual	1			EM-8121	
L4 1.6L 1597cc		2000	Front	Mexico	1	EM-8130			
			Front	Manual	1	EM-8130			
		1995-99	Front	Manual	1	EM-8130			
			RH Front	Mexico	1	EM-8122			
		1995-99	RH Front		1	EM-8122			
			RH Front		1	EM-8427			
		1989-90	RH Front	Complete Unit	1	EM-8304			
			RH Front	Insert Only	1	EM-8295			
		1987-88	RH Front		1	EM-8304			
		1983-86	RH Front		1	EM-8118			
			Rear	Mexico; Auto; Complete Unit	1	EM-8132			
		2000	Rear	Mexico; Auto; Insert	1	EM-8152			
			Rear	Mexico; Manual; Complete Unit	1	EM-8154			

## Engine, Transmission, And Torque Strut Mounts

CYL	ENG. SIZE	YEAR	LOCATION	DESCRIPTION	QTY	ENGINE	TORQUE STRUT	TRANSMISSION	
<b>NISSAN PASSENGER CAR (continued)</b>									
<b>SENTRA (continued)</b>									
L4	L4 1.6L 1597cc	2000	Rear	Mexico; Manual; Insert	1	EM-8152			
		1995-99	Rear	Auto	1	EM-8132			
		1991-94	Rear		1	EM-8132			
		1989-90	Rear	Auto	1	EM-8324			
			Rear	Manual, Complete Unit	1	EM-8154			
			Rear	Manual; Insert Only	1	EM-8152			
		1987-88	Rear	Auto	1	EM-8324			
			Rear	Manual, Complete Unit	1	EM-8154			
			Rear	Manual; Insert Only	1	EM-8152			
		1983-86	Rear		1	EM-8119			
		1989-90	Torq Str - Front		1		EM-8125		
		1987-88	Torq Str - Front		1		EM-8125		
		1983-86	Torq Str - Front		1		EM-8142		
		1987-88	Torq Str - Rear		1		EM-8133		
		1983-86	Torq Str - Rear		1		EM-8284		
		2000	Trans	Mexican Vehicle; Auto	1			EM-8150	
			Trans	Mexican Vehicle; Manual	1			EM-8891	
		1995-99	Trans	Auto	1			EM-8150	
			Trans	Manual, Made in Mexico	1			EM-8149	
			Trans	Manual; Made in U.S.A.	1			EM-8683	
		1993-94	Trans	Auto; 4 Spd	1			EM-8150	
			Trans	Manual; 5 Spd	1			EM-8149	
		1991-92	Trans	Auto; 3 Spd	1			EM-5771	
			Trans	Auto; 4 Spd	1			EM-8150	
			Trans	Manual; 4 Spd	1			EM-8148	
			Trans	Manual; 5 Spd	1			EM-8149	
		1990	Trans	Auto; 4WD	1			EM-8317	
			Trans	Auto; FWD	1			EM-8128	
			Trans	Manual; FWD	1			EM-8274	
		1989	Trans	Auto; FWD	1			EM-8128	
			Trans	Manual; FWD	1			EM-8274	
		1987-88	Trans	Auto	1			EM-8128	
			Trans	Manual; After 10/1986	1			EM-8312	
			Trans	Manual; Before 10/1986	1			EM-5501	
		1986	Trans	Auto	1			EM-8151	
			Trans	Manual; After 10/1986	1			EM-8312	
			Trans	Manual; Before 10/1986	1			EM-8121	
		1983-85	Trans	Auto	1			EM-8151	
			Trans	Manual	1			EM-8121	
		L4 1.8L 1769cc	2000-06	Trans - BUSHING	Bushing Only; Auto	1			EM-9217
				Trans - BUSHING	Bushing Only; Manual	1			EM-5657
		L4 1.8L 1798cc	2013	Right		1	EM-7070		
			2013-15	Torq Str - Right		1		EM-7009	
			2013-17	Trans		1			EM-7024
		L4 1.8L 1809cc	2000-06	Front		1	EM-9200		
				RH Front		1	EM-9229		
				Rear		1	EM-9166		
		L4 2.0L 1997cc	2007-12	RH Front		1	EM-5782		
				Torq Str - Left		1		EM-9456	
				Torq Str - Rear		1		EM-9228	
Trans	CVT Trans.			1			EM-7072		
Trans	Manual			1			EM-9448		
L4 2.0L 1998cc	2000-01	Front	Auto	1	EM-9200				
	1998-99	Front	Manual	1	EM-8130				
	1991-94	Front	Manual	1	EM-8130				

# Engine, Transmission, And Torque Strut Mounts

CYL	ENG. SIZE	YEAR	LOCATION	DESCRIPTION	QTY	ENGINE	TORQUE STRUT	TRANSMISSION
<b>NISSAN PASSENGER CAR (continued)</b>								
<b>SENTRA (continued)</b>								
L4	L4 2.0L 1998cc	2000-01	RH Front	Bushing Only	1	EM-9531		
		1998-99	RH Front		1	EM-8307		
		1991-94	RH Front		1	EM-8307		
		2000-01	Rear	Auto	1	EM-9166		
		1991-94	Rear	Auto	1	EM-8132		
			Rear	Manual	1	EM-8701		
		1998-99	Trans	Auto, Made in Japan	1			EM-8150
			Trans	Auto, Made in US	1			EM-8149
			Trans	Manual, Made in Japan	1			EM-8891
		1991-94	Trans	Auto	1			EM-8149
		Trans	Manual	1			EM-8149	
	L4 2.5L 2488cc	2002-06	Front	Auto	1	EM-9442		
			Front	Manual	1	EM-5405		
			RH Front		1	EM-5773		
			Rear		1	EM-9573		
		2007-12	Right		1	EM-5953		
			Torq Str - Left		1		EM-9453	
			Torq Str - Rear		1		EM-9452	
		2002-06	Trans - BUSHING	Bushing Only; Auto Bushing Only; Auto	1			EM-9471
			Trans - BUSHING	Bushing Only; Manual Bushing Only; Manual	1			EM-5775
2007-12		Trans	Manual	1			EM-5905	
<b>STANZA</b>								
L4	L4 2.0L 1974cc	1982-86	Front		1	EM-9020		
		1987-89	LH Front		1	EM-5500		
			RH Front		1	EM-5171		
		1982-86	RH Front	Complete Unit	1	EM-8135		
			RH Front	Insert Only	1	EM-5387		
		1987-89	Rear	Auto	1	EM-8961		
			Rear	Manual	1	EM-8319		
		1982-86	Rear	Auto	1	EM-9040		
			Rear	Manual	1	EM-9042		
		1987-89	Torq Str - Front		1		EM-8133	
		1982-86	Torq Str - Front		1		EM-5170	
		1987-89	Torq Str - Rear		1		EM-8137	
		1989	Trans	Auto	1			EM-8303
			Trans	Manual; Hatchback; Sedan	1			EM-5481
		1987-88	Trans	Auto	1			EM-8303
			Trans	Manual; Hatchback; Sedan	1			EM-5481
	Trans		Manual; Wagon	1			EM-9041	
	1982-86	Trans	Auto	1			EM-9028	
		Trans	Manual	1			EM-9028	
	L4 2.4L 2389cc	1990-92	Front		1	EM-8874		
RH Front				1	EM-8846			
Rear			Auto, After 6/90	1	EM-8681			
Trans			Auto	1		EM-5770		
Trans			Manual	1		EM-8887		
<b>TIIDA (MEXICO)</b>								
L4	L4 1.8L 1798cc	2007-08	RH Front		1	EM-5656		
		2007-11	Torq Str - Front		1		EM-9422	
			Torq Str - Rear		1		EM-9228	
		2007-08	Trans		1			EM-9230

## Engine, Transmission, And Torque Strut Mounts

CYL	ENG. SIZE	YEAR	LOCATION	DESCRIPTION	QTY	ENGINE	TORQUE STRUT	TRANSMISSION		
<b>NISSAN PASSENGER CAR (continued)</b>										
<b>TSUBAME (MEXICO)</b>										
L4	L4 1.6L 1597cc	1993-04	Front		1	EM-8130				
			RH Front		1	EM-8122				
			Rear	Auto; Complete Unit	1	EM-9002				
			Rear	Manual; Complete Unit	1	EM-8154				
			Rear	Manual; Insert Only	1	EM-8152				
		1999-04	Trans	Auto	1			EM-8150		
			Trans	Manual	1			EM-8148		
		1995-98	Trans	Auto	1			EM-8150		
Trans	Manual		1			EM-8150				
<b>TSURU (MEXICO)</b>										
L4	L4 1.5L 1488cc	1985	RH Front		1	EM-8118				
			Torq Str - Front		1		EM-8142			
			Torq Str - Rear		1		EM-8284			
			Trans		1			EM-8119		
	L4 1.6L 1597cc	2011-13	Front		1	EM-8130				
			1998-10	Front		1	EM-8130			
			1995-97	Front		1	EM-8130			
			1992-94	Front		1	EM-8130			
			2011-13	RH Front		1	EM-8122			
			1998-10	RH Front		1	EM-8122			
			1995-97	RH Front		1	EM-8122			
			1992-94	RH Front	Bushing Only	1	EM-8427			
			1986-91	RH Front		1	EM-8304			
			2011-13	Rear	Manual; Complete Unit	1	EM-8154			
				Rear	Manual; Insert Only	1	EM-8152			
			1998-10	Rear	Auto; Complete Unit	1	EM-9002			
				Rear	Manual; Complete Unit	1	EM-8154			
				Rear	Manual; Insert Only	1	EM-8152			
				1995-97	Rear	Auto; Complete Unit	1	EM-9002		
				Rear	Manual; Complete Unit	1	EM-8154			
				Rear	Manual; Insert Only	1	EM-8152			
			1992-94	Rear	Auto; Complete Unit	1	EM-9002			
				Rear	Manual; Complete Unit	1	EM-8154			
				Rear	Manual; Insert Only	1	EM-8152			
				1986-91	Rear		1	EM-8324		
				Torq Str - Front		1		EM-8125		
				Torq Str - Rear		1		EM-8133		
			2011-13	Trans	Manual	1			EM-8148	
			1999-10	Trans	Auto	1			EM-8150	
				Trans	Manual	1			EM-8148	
			1998	Trans	Complete Unit	1			EM-8149	
			1995-97	Trans	Complete Unit	1			EM-8149	
			1986-91	Trans		1			EM-8121	
			L4 2.0L 1998cc	1995-96	Front	Manual	1	EM-8130		
					RH Front		1	EM-8307		
					Trans		1			EM-8891
			<b>VERSA</b>							
	L4	L4 1.6L 1598cc	2012-15	RH Front		1	EM-7088			
				2009-11	RH Front		1	EM-5781		
			2012-16	Torq Str - Lower		1		EM-5968		
			2009-11	Torq Str - Rear		1		EM-9228		
			2012-16	Trans	Auto	1			EM-5969	
				Trans	Manual	1			EM-5969	
			2009-11	Trans	Auto	1			EM-9230	
				Trans	Manual	1			EM-9230	
			L4 1.8L 1798cc	2007-12	RH Front		1	EM-5656		

# Engine, Transmission, And Torque Strut Mounts

CYL	ENG. SIZE	YEAR	LOCATION	DESCRIPTION	QTY	ENGINE	TORQUE STRUT	TRANS-MISSION
<b>NISSAN PASSENGER CAR (continued)</b>								
<b>VERSA (continued)</b>								
L4	L4 1.8L 1798cc	2012	Torq Str - Lower		1		EM-5968	
			2007-12	Torq Str - Rear		1		EM-9228
			Torq Str - Right		1		EM-9422	
			Trans	Auto	1			EM-9230
			Trans	Manual	1			EM-9230
<b>VERSA NOTE</b>								
L4	L4 1.6L 1598cc	2014-15	Right		1	EM-7088		
			Trans	Manual	1			EM-5969
<b>NISSAN SPORT UTILITY</b>								
<b>ARMADA</b>								
V8	V8 5.6L 5552cc	2005-15	L & R Front		2	EM-5404		
			Trans	AWD & 4WD	1			EM-5407
			Trans	RWD	1			EM-5406
<b>JUKE</b>								
L4	L4 1.6L 1618cc	2011-14	Right		1	EM-7070		
		2012-14	Torq Str - Left	Mexico; FWD	1		EM-7013	
		2011-14	Torq Str - Left	AWD	1		EM-7081	
			Torq Str - Left	FWD	1		EM-7013	
		2012-14	Torq Str - Right	Mexico	1		EM-7009	
		2011-14	Torq Str - Right		1		EM-7009	
		2017	Trans	Auto (CVT); AWD	1			EM-7154
			Trans	Auto (CVT); FWD	1			EM-7152
			Trans	Manual; US & Canada	1			EM-7024
		2013-16	Trans	Auto; AWD	1			EM-7154
			Trans	Auto; FWD	1			EM-7152
			Trans	Manual; FWD	1			EM-7024
		2011-12	Trans	AWD; CVT Trans.	1			EM-7154
			Trans	FWD; CVT Trans.	1			EM-7152
Trans	Manual; FWD		1			EM-7024		
<b>MURANO</b>								
V6	V6 3.5L 3498cc	2015-16	Front	FWD	1	EM-5869		
		2009-14	Front	AWD	1	EM-7333		
			Front	FWD	1	EM-5869		
		2003-07	Front	AWD; w/ Wires	1	EM-5961		
			Front	AWD; w/o Wires	1	EM-9256		
			Front	FWD, w/o Wires	1	EM-9252		
			Front	FWD, w/Wires	1	EM-5672		
			RH Front		1	EM-9223#		
		2015-16	Rear	FWD	1	EM-7175		
		2009-14	Rear	AWD	1	EM-7316		
			Rear	FWD	1	EM-7175		
		2003-07	Rear	AWD; w/ Wires	1	EM-5962		
			Rear	AWD; w/o Wires	1	EM-5441		
			Rear	FWD, w/o Wires	1	EM-9248		
			Rear	FWD, w/Wires	1	EM-5818		
		2015-16	Right		1	EM-5866		
		2009-14	Right		1	EM-5866		
		2015-17	Torq Str - Front		1		EM-7171	
		2013-14	Torq Str - Front		1		EM-9545	
		2015-17	Torq Str - Rear		1		EM-9551	
		2013-14	Torq Str - Rear		1		EM-9551	
		2015-16	Trans	Auto (CVT)	1			EM-7234
		2009-14	Trans		1			EM-5914
		2008	Trans	Mexico	1			EM-5914
		2003-07	Trans		1			EM-9414

# = Available in the Westar Gold Line



## Engine, Transmission, And Torque Strut Mounts

CYL	ENG. SIZE	YEAR	LOCATION	DESCRIPTION	QTY	ENGINE	TORQUE STRUT	TRANSMISSION
<b>NISSAN SPORT UTILITY (continued)</b>								
<b>PATHFINDER</b>								
L4	L4 2.4L 2389cc	1987-88	L & R Front		2	EM-8276		
			Trans		1			EM-8124
	L4 2.5L 2500cc	2014	Trans	Auto	1			EM-7234
V6	V6 3.0L 2960cc	1987-95	L & R Front		2	EM-8114		
		1989	Trans - LH	Auto; 2WD	1			EM-8124
			Trans - RH	4WD	1			EM-8124
		1990-95	Trans	Auto	1			EM-8124
			Trans	Manual	1			EM-8124
		1989	Trans	Auto; 2WD	1			EM-5778
			Trans	Manual; 2WD	1			EM-2719
		1987-88	Trans	Auto; 4WD	1			EM-8124
			Trans	Manual; 4WD	1			EM-8124
	V6 3.3L 3275cc	1996-00	L & R Front	Before 1/00	2	EM-8311		
		1997-00	Trans	2WD	1			EM-8322
			Trans	Auto; 4WD	1			EM-9038
			Trans	Manual; 4WD	1			EM-9011
		1996	Trans	Auto; 4WD	1			EM-9108
			Trans	Auto; RWD	1			EM-8322
	Trans		Manual; RWD	1			EM-8322	
	V6 3.5L 3498cc	2013-16	Front	AWD	1	EM-7333		
			Front	FWD	1	EM-5869		
2001-04		L & R Front		2	EM-9408			
2013-16		Rear	FWD	1	EM-7175			
		Right		1	EM-5866			
		Torq Str - Front		1		EM-7171		
		Torq Str - Rear		1		EM-9551		
2003-04		Trans	Auto	1			EM-7234	
		Trans	Auto; 4WD	1			EM-9395	
		Trans	Auto; RWD	1			EM-8322	
		2001-02	Trans	Auto; 4WD	1			EM-9395
			Trans	Auto; RWD	1			EM-8322
	Trans		Manual; 4WD	1			EM-9011	
Trans	Manual; RWD	1			EM-8322			
V6 4.0L 3954cc	2006-12	L & R Front		2	EM-9506			
	2010-12	Trans	US & Canada; 4WD	1			EM-9520	
		Trans	US & Canada; RWD	1			EM-9482	
		Trans	Mexico; RWD	1			EM-9482	
	2005-09	Trans	4WD	1			EM-9520	
Trans		RWD	1			EM-9482		
V8	V8 5.6L 5552cc	2008-12	L & R Front		2	EM-5404		
			Trans	Auto; 4WD	1			EM-5407
			Trans	Auto; RWD	1			EM-5406
<b>ROGUE</b>								
L4	L4 2.0L 1997cc	2017-18	Torq Str - Rear	Hybrid	1		EM-7024	
	L4 2.5L 2488cc	2008-13	Right		1	EM-5953		
		2014-18	Torq Str - Front	US Built	1		EM-7205	
		2010-13	Torq Str - Left	US & Canada	1		EM-9453	
			Torq Str - Left	Mexico	1		EM-9003	
		2009	Torq Str - Left		1		EM-9453	
		2008	Torq Str - Left	Mexican Vehicle	1		EM-9003	
			Torq Str - Left	US & Canada	1		EM-9453	
		2014-18	Torq Str - Rear		1		EM-7204	
		2010-13	Torq Str - Rear	US & Canada	1		EM-9452	
		2009	Torq Str - Rear		1		EM-9452	
	2008	Torq Str - Rear	US & Canada	1		EM-9452		
	L4 2.5L 2500cc	2014-18	Trans	Auto; US & Canada	1			EM-7294

# Engine, Transmission, And Torque Strut Mounts

CYL	ENG. SIZE	YEAR	LOCATION	DESCRIPTION	QTY	ENGINE	TORQUE STRUT	TRANS-MISSION
<b>NISSAN SPORT UTILITY (continued)</b>								
<b>X-TRAIL</b>								
L4	L4 2.5L 2488cc	2005-07	Front		1	EM-9442		
		2002-04	Front	Mexico	1	EM-9442		
		2005-07	RH Front		1	EM-5173		
		2002-04	RH Front	Mexico	1	EM-5173		
		2005-07	Rear	AWD; Bushing Only	1	EM-9003		
			Rear	AWD; Complete Kit	1	EM-5174		
			Rear	FWD; Bushing Only	1	EM-9003		
			Rear	FWD; Complete Kit	1	EM-5938		
		2002-04	Rear	Mexico; FWD; Bushing Only	1	EM-9003		
			Rear	Mexico; FWD; Complete Kit	1	EM-5938		
		2008-14	Torq Str - Left		1		EM-9003	
		2006-07	Trans - BUSHING	Bushing Only; Auto Bushing Only; Auto	1			EM-5981
		2005	Trans - BUSHING	Bushing Only; Auto Bushing Only; Auto	1			EM-5981
		2002-04	Trans - BUSHING	Bushing Only; Auto Bushing Only; Auto	1			EM-5981
2006-07	Trans	Auto	1			EM-5175		
2005	Trans	Auto	1			EM-5175		
<b>XTERRA</b>								
L4	L4 2.4L 2389cc	2000-04	LH Front		1	EM-9012		
			RH Front		1	EM-8276		
			Trans		1			EM-8964
V6	V6 3.3L 3275cc	2000-04	L & R Front		2	EM-8960		
			Trans	Auto; 2WD	1			EM-5556
			Trans	Auto; 4WD	1			EM-8964
			Trans	Manual; 2WD	1			EM-5556
			Trans	Manual; 4WD	1			EM-8964
	V6 4.0L 3954cc	2005-12	L & R Front		2	EM-9506		
			2005-14	Trans	4WD	1		
			Trans	Auto; RWD	1			EM-9482
			Trans	Manual; RWD	1			EM-9482
<b>NISSAN TRUCK</b>								
<b>521 PICKUP</b>								
L4	L4 1.6L 1595cc	1970-72	L & R Front		2	EM-8566		
			Trans	2WD	1			EM-2742
<b>620 PICKUP</b>								
L4	L4 1.6L 1595cc	1972-73	L & R Front		2	EM-2404		
			Trans	Auto; 2WD	1			EM-2742
			Trans	Manual; 2WD	1			EM-2742
	L4 1.8L 1770cc	1974	L & R Front		2	EM-2404		
			Trans	2WD	1			EM-2742
			Trans	Auto; 2WD	1			EM-2742
			Trans	Manual; 2WD	1			EM-2742
	L4 2.0L 1952cc	1975-79	LH Front		1	EM-2532		
			RH Front		1	EM-2533		
			Trans	2WD	1			EM-2742
			Trans	Auto; 2WD	1			EM-2742
			Trans	Manual; 2WD	1			EM-2742
	<b>720 PICKUP</b>							
L4	L4 2.0L 1952cc	1983-85	LH Front		1	EM-2740		
		1980	LH Front	4WD	1	EM-8310		
			LH Front	RWD	1	EM-2740		
		1983-85	RH Front		1	EM-8566		
		1980	RH Front	4WD	1	EM-8144		

## Engine, Transmission, And Torque Strut Mounts

CYL	ENG. SIZE	YEAR	LOCATION	DESCRIPTION	QTY	ENGINE	TORQUE STRUT	TRANSMISSION		
<b>NISSAN TRUCK (continued)</b>										
<b>720 PICKUP (continued)</b>										
L4	L4 2.0L 1952cc	1980	RH Front	RWD	1	EM-8566				
		1984-85	Trans	Auto	1			EM-2742		
			Trans	Manual	1			EM-2742		
		1983	Trans	Manual	1			EM-2742		
		1980	Trans	Auto	1			EM-2742		
			Trans	Manual	1			EM-2742		
	L4 2.2L 2164cc Diesel	1981-83	LH Front		1	EM-8145				
			RH Front		1	EM-8146				
			Trans	Auto	1			EM-2742		
			Trans	Manual	1			EM-2742		
	L4 2.2L 2187cc	1983	L & R Front	4WD	2	EM-8310				
			LH Front	RWD	1	EM-2740				
		1981-82	LH Front	4WD	1	EM-8310				
			LH Front	RWD	1	EM-2740				
		1983	RH Front	RWD	1	EM-8566				
		1981-82	RH Front	RWD	1	EM-8566				
			Trans	Auto	1			EM-2742		
		Trans	Manual	1			EM-2742			
	L4 2.4L 2389cc	1986	L & R Front	4WD	2	EM-8276				
			L & R Front	RWD	2	EM-2718				
		1983-85	L & R Front	4WD	2	EM-8310				
			LH Front	RWD	1	EM-2740				
		1986	RH Front	RWD	1	EM-8566				
			Trans	Auto; 4WD	1			EM-8124		
			Trans	Manual; 4WD	1			EM-8124		
		1983-85	Trans	Manual; RWD	1			EM-2719		
			Trans	Auto	1			EM-2742		
Trans			Manual	1			EM-2742			
L4 2.5L 2488cc	1983-86	Trans	Auto; 2WD	1			EM-2742			
		Trans	Manual; 2WD	1			EM-2742			
L4 2.5L 2500cc	1983-86	LH Front		1	EM-8157					
<b>D21 PICKUP</b>										
L4	L4 2.4L 2389cc	1986-94	L & R Front	4WD	2	EM-8276				
			L & R Front	RWD	2	EM-2718				
		1986-89	Trans - RH	Auto; 2WD	1			EM-5780		
		1990-94	Trans	Auto; 2WD	1			EM-8328		
			Trans	Auto; 4WD	1			EM-8124		
			Trans	Manual; 2WD	1			EM-2719		
			Trans	Manual; 4WD	1			EM-8124		
		1986-89	Trans	Auto; 4WD	1			EM-8124		
			Trans	Manual; 2WD	1			EM-2719		
			Trans	Manual; 4WD	1			EM-8124		
		V6	V6 3.0L 2960cc	1986-94	L & R Front		2	EM-8114		
				1986-89	Trans - LH	Auto; 2WD	1			EM-8124
Trans - RH	Auto; 2WD				1			EM-5778		
1990-94	Trans			Auto	1			EM-2719		
	Trans			Manual	1			EM-8124		
1986-89	Trans			4WD	1			EM-8124		
Trans	Manual; 2WD	1			EM-2719					
<b>FRONTIER</b>										
L4	L4 2.4L 2389cc	1998-04	LH Front		1	EM-9012				
			RH Front		1	EM-8276				
		2001-04	Trans	Mexico; Auto; 2WD	1			EM-2719		
			Trans	Mexico; Manual; 2WD	1			EM-2719		
		1998-04	Trans	US & Canada; Auto; 2WD	1			EM-2719		
Trans	US & Canada; Auto; 4WD; US & Canada		1			EM-8964				

# Engine, Transmission, And Torque Strut Mounts

CYL	ENG. SIZE	YEAR	LOCATION	DESCRIPTION	QTY	ENGINE	TORQUE STRUT	TRANSMISSION
<b>NISSAN TRUCK (continued)</b>								
<b>FRONTIER (continued)</b>								
L4	L4 2.4L 2389cc	1998-04	Trans	US & Canada; Manual; 2WD	1			EM-2719
			Trans	US & Canada; Manual; 4WD US & Canada	1		EM-8964	
	L4 2.5L 2488cc	2005-18	L & R Front		1	EM-9483		
		2005-11	Trans	RWD	1			EM-9482
V6	V6 3.3L 3275cc	1999-04	L & R Front		2	EM-8960		
		2000-04	Trans	Auto; 2WD	1			EM-5556
			Trans	Auto; 4WD	1			EM-8964
			Trans	Manual; 2WD	1			EM-5556
			Trans	Manual; 4WD	1			EM-8964
	1999	Trans		1			EM-8964	
	V6 4.0L 3954cc	2005-12	L & R Front		2	EM-9506		
		2005-15	Trans	4WD	1			EM-9520
Trans		RWD	1				EM-9482	
<b>PICKUP</b>								
L4	L4 1.8L 1750cc	1985-92	LH Front	Mexican Vehicle; RWD Mexican Vehicle	1	EM-2740		
			RH Front	Mexican Vehicle; RWD Mexican Vehicle	1	EM-2533		
			Trans	Mexican Vehicle	1			EM-2742
	L4 2.4L 2389cc	1998-02	L & R Front	RWD; Mexican Vehicle	2	EM-2718		
			L & R Front	4WD	2	EM-8276		
		1995-97	L & R Front	RWD	2	EM-2718		
			Trans	RWD; Mexican Vehicle	1			EM-2719
		1997	Trans	Auto; 4WD	1			EM-2742
			Trans	Auto; RWD	1			EM-8328
			Trans	Manual; 4WD	1			EM-8124
		1994-96	Trans	Manual; RWD	1			EM-2719
	Trans		4WD	1			EM-8124	
	V6	V6 3.0L 2960cc	1995	L & R Front		2	EM-8114	
Trans				4WD	1			EM-8124
			Trans	RWD	1			EM-2719
<b>TITAN</b>								
V8	V8 5.6L 5552cc	2004-14	L & R Front		2	EM-5404		
		2007-14	Trans	4WD; US & Canada	1			EM-5407
			Trans	AWD; Mexico Vehicle	1			EM-5407
			Trans	RWD	1			EM-5406
		2004-06	Trans	4WD	1			EM-5407
			Trans	RWD	1			EM-5406
<b>NISSAN VAN</b>								
<b>AXCESS</b>								
L4	L4 2.4L	1991-92	Torg Str - Front	4WD	1		EM-8133	
		L4 2.4L 2389cc	1993-95	Front	Manual	1	EM-8874	
	1991-92		Front	Manual; FWD	1	EM-8874		
	1990		Front	Manual; FWD	1	EM-8874		
	1993-95		Rear		1	EM-8681		
	1991-92		Rear	FWD	1	EM-8681		
	1990		Rear	FWD	1	EM-8681		
	1990-95		Trans	Auto; FWD	1			EM-8887
<b>ICHI (MEXICO)</b>								
L4	L4 1.8L	1988-92	L & R Front		2	EM-2456		
			Trans		1			EM-2487

## Engine, Transmission, And Torque Strut Mounts

CYL	ENG. SIZE	YEAR	LOCATION	DESCRIPTION	QTY	ENGINE	TORQUE STRUT	TRANSMISSION
<b>NISSAN VAN (continued)</b>								
<b>NV1500</b>								
V6	V6 4.0L 3954cc	2012-13	L & R Front		2	EM-9506		
<b>NV200</b>								
L4	L4 2.0L 1997cc	2013-17	Front		1	EM-7115		
			Right		1	EM-5656		
			Torq Str - Rear		1		EM-9228	
<b>NV2500</b>								
V6	V6 4.0L 3954cc	2012-13	L & R Front		2	EM-9506		
V8	V8 5.6L 5552cc	2012-16	L & R Front		2	EM-5404		
			Trans	Auto	1			EM-5406
<b>NV3500</b>								
V6	V6 4.0L 3954cc	2012-13	L & R Front		2	EM-9506		
V8	V8 5.6L 5552cc	2012-16	L & R Front		2	EM-5404		
			Trans	Auto	1			EM-5406
<b>QUEST</b>								
V6	V6 3.0L 2960cc	1993-98	Front		1	EM-2855		
			RH Front		1	EM-2856		
			Rear	Complete Unit	1	EM-2857		
			Trans		1			EM-2854
	V6 3.3L 3275cc	1999-02	Front		1	EM-2989		
			LH Rear		1	EM-2985		
			RH Rear	Complete Unit	1	EM-2857		
			Trans		1			EM-2854
	V6 3.5L 3498cc	2009	Front	w/ Wires	1	EM-5672		
			Front	w/o Wires	1	EM-9252		
		2007-08	Front	w/ Wires	1	EM-5672		
			Front	w/o Wires	1	EM-9252		
		2004-06	Front	w/ Wires	1	EM-5672		
			Front	w/o Wires	1	EM-9252		
		2009	RH Front		1	EM-9223#		
		2007-08	RH Front		1	EM-9223#		
		2004-06	RH Front		1	EM-9223#		
		2011-15	Rear		1	EM-7175		
		2009	Rear	w/ Wires	1	EM-5818		
			Rear	w/o Wires	1	EM-9248		
		2007-08	Rear	w/o Wires	1	EM-9548		
		2004-06	Rear	4 spd A/T; w/ Wires	1	EM-5818		
			Rear	4 spd A/T; w/o Wires	1	EM-9248		
			Rear	5 spd A/T; w/o Wires	1	EM-9548		
		2011-15	Right		1	EM-5866		
		2011-14	Trans		1			EM-5914
		2007-09	Trans	Auto	1			EM-9410
		2004-06	Trans	Auto; 4 Spd	1			EM-9219
			Trans	Auto; 5 Spd	1			EM-9410
<b>URVAN (MEXICO)</b>								
L4	L4 2.4L 2389cc	2000-08	LH Front	Mexican Vehicle	1	EM-9003		
		2003-08	Trans	Mexican Vehicle; Insert Only	1			EM-90032
<b>VAN</b>								
L4	L4 2.4L	1987-88	Trans	Manual	1			EM-5481
	L4 2.4L 2389cc	1987-88	LH Front		1	EM-5500		
			Rear		1	EM-8303		

# = Available in the Westar Gold Line

# Engine, Transmission, And Torque Strut Mounts

CYL	ENG. SIZE	YEAR	LOCATION	DESCRIPTION	QTY	ENGINE	TORQUE STRUT	TRANSMISSION	
<b>OLDSMOBILE PASSENGER CAR</b>									
<b>98</b>									
V6	V6 3.0L 181ci	1985	RH Front	1st Design	1	EM-2630			
			RH Front	Hydraulic Mount; 2nd Design	1	EM-2551*			
			Trans - LH Front		1			EM-2537	
			Trans - LH Rear		1			EM-2568	
			Trans - RH Rear	1st Design - 3 Stud	1			EM-2663	
			Trans - RH Rear	2nd Design - 4 Stud	1			EM-2664	
			Trans - RH Rear	Hydraulic Mount; 3rd Design	1			EM-2556 *	
	V6 3.8L 231ci	1991-96	RH Front		1	EM-2801			
			1987-90	RH Front	Hydraulic Mount; 2nd Design	1	EM-2551*		
			1985-86	RH Front	1st Design	1	EM-2630		
				RH Front	Hydraulic Mount; 2nd Design	1	EM-2551*		
		1991-96	Torq Str - Front		1		EM-2662		
		1994-96	Trans - LH Front	Shock Mount	1			EM-2881	
		1991-93	Trans - LH Front		1			EM-2800	
		1987-90	Trans - LH Front		1			EM-2537	
		1985-86	Trans - LH Front		1			EM-2537	
		1994-96	Trans - LH Rear		1			EM-2778	
		1991-93	Trans - LH Rear		1			EM-2823 *	
		1987-90	Trans - LH Rear		1			EM-2568	
		1985-86	Trans - LH Rear		1			EM-2568	
		1987-90	Trans - RH Rear	Hydraulic Mount; 3rd Design	1			EM-2556 *	
		1985-86	Trans - RH Rear	1st Design - 3 Stud	1			EM-2663	
	Trans - RH Rear		2nd Design - 4 Stud	1			EM-2664		
	Trans - RH Rear		Hydraulic Mount; 3rd Design	1			EM-2556 *		
	V6 4.1L 252ci	1981-83	LH Front		1	EM-2382			
			RH Front		1	EM-2384			
			Trans		1			EM-2379	
	V6 4.3L 260ci Diesel	1985	Front	1st Design	1	EM-2630			
			Front	Hydraulic Mount; 2nd Design	1	EM-2551*			
			Trans - LH Front		1			EM-2537	
			Trans - LH Rear		1			EM-2568	
		Trans - RH Rear	Hydraulic Mount; 2nd Design	1			EM-2556 *		
	V8	V8 5.0L 307ci	1980-84	L & R Front		2	EM-2328		
Trans					1			EM-2360 @	
V8 5.7L GAS		1977-80	L & R Front		2	EM-2328			
V8 5.7L 350ci		1977-80	Trans	Gas	1			EM-2360 @	
V8 5.7L 350ci Diesel		1978-84	L & R Front		2	EM-2328			
			Trans		1			EM-2360 @	
V8 6.5L 394ci		1960-64	Trans - LH		1			EM-2216	
			Trans - RH		1			EM-2217	
V8 6.6L 400ci		1977-79	L & R Front		2	EM-2328			
		1975	L & R Front		2	EM-2328			
			Trans	Auto; THM400 (M40)	1			EM-2360 @	
V8 6.6L 403ci		1977-79	Trans	Auto; THM350 (M38)	1			EM-2288 @	
			Trans	Auto; THM400-475 (M40)	1			EM-2360 @	
V8 7.0L 425ci		1965-67	LH Front		1	EM-2263			
			RH Front		1	EM-2262			
			Trans		1			EM-2378 @	
V8 7.5L 455ci		1971-76	L & R Front		2	EM-2328			
			1968-70	LH Front		1	EM-2263		
				RH Front		1	EM-2262		
		1976	Trans	Auto; THM350 (M38)	1			EM-2337	
	Trans		Auto; THM400-475 (M40)	1			EM-2360 @		
	1975		Trans	Auto; THM400 (M40)	1			EM-2360 @	

\* = Hydraulic Mount, "S" suffix = solid replacement. @ = Universal Mount EM-5000 also available.

# Engine, Transmission, And Torque Strut Mounts

CYL	ENG. SIZE	YEAR	LOCATION	DESCRIPTION	QTY	ENGINE	TORQUE STRUT	TRANSMISSION	
<b>OLDSMOBILE PASSENGER CAR (continued)</b>									
<b>98 (continued)</b>									
V8	V8 7.5L 455ci	1971-74	Trans	Auto	1			EM-2337	
		1968-70	Trans	Auto; THM350 (M38)	1			EM-2378 @	
<b>442</b>									
V8	V8 6.6L 400ci	1965-69	L & R Front		2	EM-2328			
			Trans	Auto	1			EM-2378 @	
			Trans	Manual	1			EM-2378 @	
	V8 7.5L 455ci	1971	L & R Front		2	EM-2328			
			Trans		1			EM-2337	
			1968-70	Trans	Auto	1			EM-2378 @
			Trans	Manual	1			EM-2378 @	
<b>ACHIEVA</b>									
L4	L4 2.3L 138ci	1992-95	RH Front	Complete Unit	1	EM-5031*			
			RH Front	Insert Only	1	EM-2803'			
		1995	Torq Str - Front	Auto	1			EM-2814	
			Torq Str - Front	Manual	1			EM-2782	
		1992-94	Torq Str - Front		1			EM-2782	
		1992-95	Trans - LH Front	Insert	1				EM-2923
	Trans		Auto	1				EM-2715	
	L4 2.4L	1997-98	Trans	NL Body, Auto	1			EM-2715	
	L4 2.4L 146ci	1996-98	RH Front	Complete Unit	1	EM-5031*			
			RH Front	Insert Only	1	EM-2803'			
		1998	Torq Str - Front	Auto	1			EM-2814	
		1996-97	Torq Str - Front	Auto	1			EM-2814	
			Torq Str - Front	Manual	1			EM-2782	
		1996	Trans - Front	Manual; Bushing	1				EM-2874
	Trans - Rear	Manual; Bushing	1				EM-2875		
	Trans	Auto	1				EM-2715		
V6	V6 3.1L 189ci	1994-98	RH Front	Insert	1	EM-2803'			
		1995-98	Torq Str - Front		1			EM-2814	
		1994	Torq Str - Front		1			EM-2782	
		1994-98	Trans		1			EM-2715	
	V6 3.3L 204ci	1992-93	RH Front	Insert	1	EM-2803'			
			Torq Str - Front		1			EM-2782	
			Trans		1			EM-2715	
<b>ALERO</b>									
L4	L4 2.2L 134ci	2002-04	Right		1	EM-3129			
			Trans - Center		1			EM-2874	
			Trans - LH Front	Complete Unit	1			EM-3070	
			Trans - LH Front	Insert Only	1			EM-5422	
			Trans - LH Rear	Complete Unit	1			EM-5078	
				Trans - LH Rear	Insert Only	1			EM-2875
	L4 2.4L 146ci	1999-01	RH Front		1	EM-2933'			
			Trans - Center	Auto	1			EM-2874	
			Trans - LH Front	Auto; Complete Unit	1			EM-5079	
			Trans - LH Rear	Auto; Complete Unit	1			EM-5078	
Trans - LH Rear			Auto; Insert	1			EM-2875		
V6	V6 3.4L 207ci	1999-04	Front		1	EM-2933'			
			Trans - Center	Auto	1			EM-2874	
			Trans - LH Front	Auto; Complete Unit	1			EM-5079	
			Trans - LH Front	Auto; Insert	1			EM-2875	
			Trans - LH Rear	Auto; Complete Unit	1			EM-5078	
			Trans - LH Rear	Auto; Insert	1			EM-2875	

\* = Hydraulic Mount, "S" suffix = solid replacement. @ = Universal Mount EM-5000 also available.

# Engine, Transmission, And Torque Strut Mounts

CYL	ENG. SIZE	YEAR	LOCATION	DESCRIPTION	QTY	ENGINE	TORQUE STRUT	TRANSMISSION	
<b>OLDSMOBILE PASSENGER CAR (continued)</b>									
<b>AURORA</b>									
V6	V6 3.5L 214ci	2001-02	Trans - Center		1			EM-2895 *	
			Trans - LH Rear		1		EM-2898		
			Trans		1		EM-2897 #		
V8	V8 4.0L 244ci	2001-03	Front		1	EM-2896*			
			1999	Front		1	EM-3083*		
		2001-03	Trans - Center		1		EM-2895 *		
			1999	Trans - Center		1		EM-2895 *	
		1997-98	Trans - Center		1		EM-2895 *		
		2001-03	Trans - LH Front		1		EM-3020 *		
		1999	Trans - LH Front		1		EM-3083 *		
		2001-03	Trans - LH Rear		1		EM-2898		
		1999	Trans - LH Rear		1		EM-3068		
		1997-98	Trans - LH Rear	Complete Unit	1	EM-5075			
			Trans - LH Rear	Insert Only	1	EM-3065			
		1995-96	Trans - LH Rear	Complete Unit	1	EM-5075			
			Trans - LH Rear	Insert Only	1	EM-3065			
<b>CALAIS</b>									
L4	L4 2.5L 2474cc	1985-87	RH Front		1	EM-2538			
			RH Rear		1	EM-2477			
			Torq Str - Rear		1		EM-2528		
			Trans		1		EM-2601		
V6	V6 3.0L 181ci	1985-87	RH Front		1	EM-2626			
			RH Rear		1	EM-2477			
			Torq Str - Rear		1		EM-2528		
			Trans		1		EM-2601		
<b>CUSTOM CRUISER</b>									
V8	V8 5.0L 305ci	1991-92	L & R Front		2	EM-2292			
			V8 5.0L 307ci	1980-90	L & R Front		2	EM-2328	
					Trans		1		EM-2360 @
	V8 5.7L 350ci	1992	L & R Front		2	EM-2292			
			1977-80	L & R Front	Gas	2	EM-2328		
				Trans		1		EM-2360 @	
			1977-80	Trans	Gas	1		EM-2360 @	
	V8 5.7L 350ci Diesel	1978-83	L & R Front		2	EM-2328			
			Trans		1		EM-2360 @		
	V8 6.6L 400ci	1975	L & R Front		2	EM-2375			
			Trans		1		EM-2374 @		
	V8 6.6L 403ci	1977-79	L & R Front		2	EM-2328			
			Trans	Auto; THM350	1		EM-2288 @		
			Trans	Auto; THM400	1		EM-2360 @		
	V8 7.5L 455ci	1971-76	L & R Front		2	EM-2328			
1976			Trans	Auto; THM350	1		EM-2337		
1971-75		Trans	Auto; THM400	1		EM-2360 @			
		Trans	Auto; THM350	1		EM-2337			
<b>CUTLASS</b>									
L6	L6 4.1L 250ci	1975-76	L & R Front		2	EM-2292			
			1968-71	L & R Front		2	EM-2284		
		1975-76	Trans	Auto	1		EM-2360 @		
			Trans	Manual	1		EM-2337		
		1968-71	Trans	Auto	1		EM-2378 @		
			Trans	Manual	1		EM-2378 @		
V6	V6 3.1L 189ci	1997-99	RH Front		1	EM-2876*			
			Trans - Center		1		EM-2874		

\* = Hydraulic Mount, "S" suffix = solid replacement.

@ = Universal Mount EM-5000 also available.

# = Available in the Westar Gold Line



# Engine, Transmission, And Torque Strut Mounts

CYL	ENG. SIZE	YEAR	LOCATION	DESCRIPTION	QTY	ENGINE	TORQUE STRUT	TRANSMISSION
<b>OLDSMOBILE PASSENGER CAR (continued)</b>								
<b>CUTLASS (continued)</b>								
V6	V6 3.1L 189ci	1997-99	Trans - LH Front	Complete Unit	1			EM-5079
			Trans - LH Front	Insert Only	1			EM-2875
			Trans - LH Rear		1			EM-5078
			Trans - LH Rear	Insert Only	1			EM-2875
	V6 3.8L 231ci	1977-81	LH Front		1	EM-2382		
			RH Front		1	EM-2384		
		1978-81	Trans	Auto	1			EM-2392
	V8 5.7L 350ci	1980	Trans	Gas	1			EM-2360 @
			Trans		1			EM-2360 @
	V8	V8 4.3L 260ci	1975-81	L & R Front		2	EM-2328	
Trans				Auto	1			EM-2360 @
Trans				Manual	1			EM-2337
V8 4.4L 267ci		1981	L & R Front		2	EM-2292		
			Trans		1			EM-2360 @
V8 5.0L 305ci		1985-87	L & R Front		2	EM-2292		
		1978-80	L & R Front		2	EM-2292		
		1985-87	Trans		1			EM-2360 @
		1978-80	Trans		1			EM-2360 @
V8 5.4L 330ci		1964-67	LH Front		1	EM-2263		
			RH Front		1	EM-2262		
			Trans	Auto	1			EM-2378 @
			Trans	Manual	1			EM-2378 @
V8 5.7L GAS		1980	L & R Front		2	EM-2328		
		1979	L & R Front	VIN L	2	EM-2292		
			L & R Front	Vin N & R	2	EM-2328		
		1978	L & R Front	VIN L	2	EM-2292		
V8 5.7L 350ci		1976-77	L & R Front	VIN R	2	EM-2328		
		1974-75	L & R Front		2	EM-2328		
		1968-73	L & R Front		2	EM-2261		
		1978-79	Trans	Auto	1			EM-2360 @
			Trans	Manual	1			EM-2392
		1976-77	Trans	Auto; THM200 (M29)	1			EM-2360 @
			Trans	Auto; THM250C (M31)				
			Trans	Auto; THM350 (M38)	1			EM-2378 @
		1973-75	Trans	Manual; 3 Spd	1			EM-2337
			Trans	Auto; THM350	1			EM-2378 @
			Trans	Auto; THM400	1			EM-2360 @
			Trans	Manual; 3 Spd	1			EM-2337
1968-72		Trans	Auto; THM350	1			EM-2378 @	
	Trans	Auto; THM400	1			EM-2268 @		
	Trans	Manual; 3 Spd	1			EM-2378 @		
V8 5.7L 350ci Diesel	1979-81	L & R Front		2	EM-2328			
	1980-81	Trans	VIN N	1			EM-2531	
V8 6.6L 400ci	1965-68	L & R Front		2	EM-2328			
		Trans	Auto	1			EM-2378 @	
		Trans	Manual	1			EM-2378 @	
V8 6.6L 403ci	1977	L & R Front		2	EM-2328			
		Trans	Auto	1			EM-2288 @	
V8 7.5L 455ci	1971-76	L & R Front		2	EM-2328			
		LH Front		1	EM-2263			
		RH Front		1	EM-2262			
	1976	Trans	Auto; THM350 (M38)	1			EM-2337	
	1971-75	Trans	Auto; THM350 (M38)	1			EM-2337	

@ = Universal Mount EM-5000 also available.

# Engine, Transmission, And Torque Strut Mounts

CYL	ENG. SIZE	YEAR	LOCATION	DESCRIPTION	QTY	ENGINE	TORQUE STRUT	TRANSMISSION
<b>OLDSMOBILE PASSENGER CAR (continued)</b>								
<b>CUTLASS (continued)</b>								
V8	V8 7.5L 455ci	1971-75	Trans	Auto; THM400 (M40)	1			EM-2360 @
		1970	Trans	Auto; THM350 (M38)	1			EM-2378 @
			Trans	Auto; THM400 (M40)	1			EM-2360 @
<b>CUTLASS CALAIS</b>								
L4	L4 2.3L 138ci	1988-91	RH Front		1	EM-2859*		
			RH Rear		1	EM-2952		
			Trans	Insert; Auto	1			EM-3058
			Trans	Manual; Insert	1			EM-2766
	L4 2.3L 140ci	1989-91	RH Front		1	EM-2859*		
			RH Rear		1	EM-2952		
			Torq Str - Rear		1		EM-2528	
			Trans	Manual; Insert	1			EM-2766
	L4 2.5L 2474cc	1988-91	RH Front		1	EM-2538		
			RH Rear		1	EM-2477		
			Torq Str - Rear		1		EM-2528	
			Trans		1			EM-2601
V6	V6 3.0L 181ci	1988	RH Front		1	EM-2626		
			RH Rear		1	EM-2477		
			Torq Str - Rear		1		EM-2528	
			Trans		1			EM-2601
	V6 3.3L 204ci	1989-91	RH Front		1	EM-2626		
			RH Rear		1	EM-2477		
			Torq Str - Rear		1		EM-2528	
			Trans		1			EM-2601
	V6 3.8L 231ci	1978-84	LH Front		1	EM-2382		
			RH Front		1	EM-2384		
		1980-84 1978-79	Trans	Auto	1			EM-2379
			Trans	Auto	1			EM-2379
Trans			Manual; 3 Spd	1			EM-2379	
1978-79	Trans	Manual; 5 Spd	1			EM-2392		
	V6 4.3L 260ci Diesel	1982-84	L & R Front		2	EM-2292		
Trans				1			EM-2360 @	
V8	V8 4.3L 260ci	1978-82	L & R Front		2	EM-2328		
			Trans	Auto	1			EM-2360 @
		1978-79	Trans	Auto	1			EM-2360 @
			Trans	Manual	1			EM-2392
	V8 4.3L 260ci Diesel	1979	L & R Front		2	EM-2328		
			Trans	Auto	1			EM-2360 @
			Trans	Manual	1			EM-2392
	V8 4.4L 267ci	1982	L & R Front		2	EM-2292		
			Trans		1			EM-2360 @
	V8 5.0L 305ci	1984	L & R Front		2	EM-2292		
			L & R Front		2	EM-2292		
		1978-80 1984	Trans		1			EM-2360 @
			Trans	Auto	1			EM-2360 @
			Trans	Auto	1			EM-2360 @
	1978-79	Trans	Auto	1			EM-2360 @	
		Trans	Manual	1			EM-2360 @	
V8 5.0L 307ci	1982-84	L & R Front		2	EM-2328			
		Trans		1			EM-2360 @	
V8 5.7L 350 ci Gas	1979-80	L & R Front		2	EM-2328			
V8 5.7L 350ci	1979-80	Trans	Gas; Auto	1			EM-2360 @	
V8 5.7L 350ci Diesel	1980-84	L & R Front		2	EM-2328			
		Trans		1			EM-2360 @	

\* = Hydraulic Mount, "S" suffix = solid replacement. @ = Universal Mount EM-5000 also available.

# Engine, Transmission, And Torque Strut Mounts

CYL	ENG. SIZE	YEAR	LOCATION	DESCRIPTION	QTY	ENGINE	TORQUE STRUT	TRANSMISSION
<b>OLDSMOBILE PASSENGER CAR (continued)</b>								
<b>CUTLASS CIERA</b>								
L4	L4 2.2L 134ci	1993-94	Front		1	EM-2548*		
		1995-96	Torq Str - Front	Complete Unit	1		EM-2866#	
			Torq Str - Front	Insert Only	1		EM-2716	
		1993-94	Torq Str - Front		1		EM-2609	
			Trans		1			EM-2543
	L4 2.5L 151ci	1985-92	Front		1	EM-2548*		
		1982-84	Front		1	EM-2472		
		1982-92	Torq Str - Front		1		EM-2396	
		1985-92	Trans		1			EM-2543
	L4 2.5L 2474cc	1982-84	Trans - LH Front		1			EM-2466
			Trans - LH Rear		1			EM-2467
	V6 3.1L 189ci	1995-96	Torq Str - Front	Complete Unit	2		EM-2866#	
			Torq Str - Front	Insert Only; LH & RH Front	2		EM-2716	
V6	V6 2.8L 173ci	1985-89	Front		1	EM-2548*		
		1982-84	Front		1	EM-2472		
			Torq Str - Front		1		EM-2396	
		1982-89	Trans - LH Front		1			EM-2466
			Trans - LH Rear		1			EM-2467
	V6 3.0L 181ci	1985	Front		1	EM-2548*		
		1982-84	Front		1	EM-2472		
			Torq Str - Front		1		EM-2396	
		1982-85	Trans - LH Front		1			EM-2466
	Trans - LH Rear			1			EM-2467	
	V6 3.1L 189ci	1994	Front		1	EM-2548*		
			Torq Str - Front		1		EM-2396	
			Trans - LH Front		1			EM-2466
			Trans - LH Rear		1			EM-2467
	V6 3.3L 204ci	1989-93	Front		1	EM-2548*		
			Torq Str - Front		1		EM-2396	
			Trans - LH Front		1			EM-2466
			Trans - LH Rear		1			EM-2467
	V6 3.8L 231ci	1985-88	Front		1	EM-2548*		
		1984	Front		1	EM-2472		
		1987-88	Torq Str - Front		1		EM-2396	
		1984-86	Torq Str - Front		1		EM-2490	
		1984-88	Trans - LH Front		1			EM-2466
	Trans - LH Rear			1			EM-2467	
	V6 4.3L 260ci Diesel	1982-85	Front		1	EM-2472		
			Torq Str - Front		1		EM-2396	
			Trans - LH Front		1			EM-2466
Trans - LH Rear				1			EM-2467	
<b>CUTLASS CRUISER</b>								
L4	L4 2.5L 2474cc	1987-90	Torq Str - Front		1		EM-2396	
V6	V6 2.8L 173ci	1987-89	Torq Str - Front		1		EM-2396	
	V6 3.1L 189ci	1994	Torq Str - Front		1		EM-2396	
	V6 3.3L 204ci	1989-93	Torq Str - Front		1		EM-2396	
	V6 3.8L 231ci	1978-83	LH Front		1	EM-2382		
			RH Front		1	EM-2384		
Trans				1			EM-2379	
V8	V8 4.3L 260ci	1978-82	L & R Front		2	EM-2328		
			Trans		1			EM-2360 @
	V8 4.3L 260ci Diesel	1979	L & R Front		2	EM-2328		
			Trans		1			EM-2360 @
V8 4.4L 267ci	1982	L & R Front		2	EM-2292			
			Trans		1			EM-2360 @

\* = Hydraulic Mount, "S" suffix = solid replacement.

@ = Universal Mount EM-5000 also available.

# = Available in the Westar Gold Line

# Engine, Transmission, And Torque Strut Mounts

CYL	ENG. SIZE	YEAR	LOCATION	DESCRIPTION	QTY	ENGINE	TORQUE STRUT	TRANSMISSION	
<b>OLDSMOBILE PASSENGER CAR (continued)</b>									
<b>CUTLASS CRUISER (continued)</b>									
V8	V8 5.0L 305ci	1982-83	L & R Front		2	EM-2292			
		1980	L & R Front		2	EM-2292			
		1982-83	Trans		1			EM-2360 @	
		1980	Trans		1			EM-2360 @	
	V8 5.0L 307ci	1981-83	L & R Front		2	EM-2328			
			Trans		1			EM-2360 @	
	V8 5.7L GAS	1980	L & R Front		2	EM-2328			
	V8 5.7L 350ci	1980	Trans	Gas	1			EM-2360 @	
V8 5.7L 350ci Diesel	1980-83	L & R Front		2	EM-2328				
		Trans		1			EM-2531		
<b>CUTLASS SALON</b>									
V8	V8 4.3L	1978-81	Trans	Auto	1			EM-2360 @	
			Trans	Manual	1			EM-2337	
		1975-77	Trans	Auto	1			EM-2360 @	
			Trans	Manual	1			EM-2337	
	V8 4.3L 260ci	1975-81	L & R Front		2	EM-2328			
	V8 5.0L 305ci	1978-80	L & R Front		2	EM-2292			
	V8 5.7L	1975-76	Trans	Auto; THM200 (M29)	1			EM-2360 @	
				THM250C (M31)					
			Trans	Auto; THM350 (M38)	1			EM-2378 @	
			Trans	Auto; THM400 (M40)	1			EM-2360 @	
		Trans	Manual; 3 Spd	1			EM-2337		
	V8 5.7L GAS	1979	L & R Front		2	EM-2328			
	V8 5.7L 350ci Diesel	1985	L & R Front		2	EM-2328			
		1980-81	L & R Front		2	EM-2328			
	V8 7.5L	1976	Trans	Auto; THM350 (M38)	1			EM-2337	
Trans			Auto; THM350 (M38)	1			EM-2337		
Trans			Auto; THM400 (M40)	1			EM-2360 @		
<b>CUTLASS SUPREME</b>									
L4	L4 2.3L 138ci	1990-91	Front		1	EM-2796*			
			Torq Str - Front		1		EM-2396		
			Trans	Auto	1			EM-2620	
L6	L6 4.1L 250ci	1975-76	L & R Front		2	EM-2292			
			Trans	Auto	1			EM-2360 @	
			Trans	Manual	1			EM-2337	
V6	V6 2.8L 173ci	1988-89	Front		1	EM-2660*			
			Torq Str - Front	Auto	1		EM-2609		
			Torq Str - Front	Manual	1		EM-5177		
			Torq Str - Front		1		EM-2609		
			Trans	Auto	1			EM-2620	
	V6 3.1L 189ci	1994-97	RH Front		1	EM-2796*			
			RH Front		1	EM-2660*			
		1994-97	Torq Str - Front	Bracket to Radiator Support Complete Unit	2			EM-2901	
			Torq Str - Front	Bracket to Radiator Support Insert	2			EM-4169	
			Torq Str - Front	Complete Unit; LH & RH Front 2nd Design	2			EM-2866#	
			Torq Str - Front	LH & RH Front, 1st Design	2			EM-2609	
			Torq Str - Front	LH & RH Front, 2nd Design, Insert Only	2			EM-2716	
		1989-93	Torq Str - Front	LH & RH Front	2			EM-2609	
1994-97	Trans		1			EM-2712 *			
1989-93	Trans		1			EM-2620			

\* = Hydraulic Mount, "S" suffix = solid replacement.

@ = Universal Mount EM-5000 also available.

# = Available in the Westar Gold Line

# Engine, Transmission, And Torque Strut Mounts

CYL	ENG. SIZE	YEAR	LOCATION	DESCRIPTION	QTY	ENGINE	TORQUE STRUT	TRANSMISSION
<b>OLDSMOBILE PASSENGER CAR (continued)</b>								
<b>CUTLASS SUPREME (continued)</b>								
V6	V6 3.4L 207ci	1991-96	RH Front		1	EM-2555*		
			RH Rear		1	EM-2676		
			Torq Str - Front		1		EM-2799	
		1994-96	Trans	Auto	1			EM-2712 *
		1993	Trans	Auto	1			EM-2620
		1991-92	Trans	Auto	1			EM-2712 *
	V6 3.8L 231ci	1977-87	LH Front		1	EM-2382		
			RH Front		1	EM-2384		
		1982-87	Trans		1			EM-2379
		1978-81	Trans	Auto	1			EM-2379
		1977	Trans		1			EM-2337
	V6 4.3L 260ci Diesel	1982-84	L & R Front		2	EM-2292		
			Trans		1			EM-2360 @
V8	V8 4.3L 260ci	1975-82	L & R Front		2	EM-2328		
			Trans	Auto	1			EM-2360 @
		1978-79	Trans	Auto	1			EM-2360 @
			Trans	Manual	1			EM-2392
		1975-77	Trans	Auto	1			EM-2360 @
			Trans	Manual	1			EM-2337
	V8 4.3L 260ci Diesel	1979	L & R Front		2	EM-2328		
	V8 4.4L 267ci	1982	L & R Front		2	EM-2292		
			Trans	Auto	1			EM-2360 @
	V8 5.0L 305ci	1985-87	L & R Front		2	EM-2292		
			L & R Front		2	EM-2292		
		1978-80	L & R Front		2	EM-2292		
		1985-87	Trans	Auto	1			EM-2360 @
			Trans	Auto	1			EM-2360 @
		1980	Trans	Auto	1			EM-2360 @
		1978-79	Trans	Auto	1			EM-2360 @
			Trans	Manual	1			EM-2360 @
	V8 5.0L 307ci	1982-88	L & R Front		2	EM-2328		
			Trans		1			EM-2360 @
	V8 5.7L 350ci	1974-80	L & R Front	Gas	2	EM-2328		
			L & R Front		2	EM-2261		
		1980	Trans	Gas; Auto	1			EM-2360 @
			Trans	Gas; Auto	1			EM-2360 @
		1977-79	Trans	Gas; Manual	1			EM-2360 @
			Trans	Auto; THM350 (M38)	1			EM-2378 @
		1975-76	Trans	Manual	1			EM-2378 @
			Trans	Auto; THM350 (M38)	1			EM-2378 @
		1973-74	Trans	Auto; THM400 (M40)	1			EM-2360 @
			Trans	Auto; THM350 (M38)	1			EM-2378 @
	1972	Trans	Auto; THM350 (M38)	1			EM-2378 @	
		Trans	Auto; THM400 (M40)	1			EM-2268 @	
	V8 5.7L 350ci Diesel	1979-85	L & R Front		2	EM-2328		
			Trans	Auto	1			EM-2360 @
V8 6.6L 403ci	1977	L & R Front		2	EM-2328			
		Trans	Auto; THM350 (M38)	1			EM-2288 @	
		Trans	Manual	1			EM-2337	
V8 7.5L 455ci	1971-76	L & R Front		2	EM-2328			
		Trans	Auto; THM350 (M38)	1			EM-2337	

\* = Hydraulic Mount, "S" suffix = solid replacement. @ = Universal Mount EM-5000 also available.

# Engine, Transmission, And Torque Strut Mounts

CYL	ENG. SIZE	YEAR	LOCATION	DESCRIPTION	QTY	ENGINE	TORQUE STRUT	TRANSMISSION		
<b>OLDSMOBILE PASSENGER CAR (continued)</b>										
<b>DELMONT 88</b>										
V8	V8 5.4L	1967	LH Front		1	EM-2263				
			RH Front		1	EM-2262				
	V8 5.4L 330ci	1967	Trans	Auto	1			EM-2378 @		
			Trans	Manual	1			EM-2378 @		
	V8 5.7L	1968	LH Front		1	EM-2263				
			RH Front		1	EM-2262				
	V8 5.7L 350ci	1968	Trans	Auto	1			EM-2378 @		
			Trans	Manual	1			EM-2378 @		
	V8 7.0L	1967	LH Front		1	EM-2263				
			RH Front		1	EM-2262				
	V8 7.0L 425ci	1967	Trans	Auto	1			EM-2378 @		
			Trans	Manual	1			EM-2378 @		
	<b>DELTA 88</b>									
	V6	V6 3.0L 181ci	1986	Front	1st Design	1	EM-2630			
Front				Hydraulic Mount; 2nd Design	1	EM-2551*				
Trans - LH Front					1			EM-2537		
Trans - LH Rear					1			EM-2568		
Trans - RH Rear				1st Design - 3 Stud	1			EM-2663		
Trans - RH Rear				2nd Design - 4 Stud	1			EM-2664		
Trans - RH Rear				Hydraulic Mount; 3rd Design	1			EM-2556 *		
V6 3.8L 231ci		1977-85	1992-99	LH Front		1	EM-2382			
				RH Front		1	EM-2801			
		1987-91	1986	RH Front	Hydraulic Mount; 2nd Design	1	EM-2551*			
				RH Front	1st Design	1	EM-2630			
		1977-85	1992-99	RH Front	Hydraulic Mount; 2nd Design	1	EM-2551*			
				RH Front		1	EM-2384			
		1994-99	1992-93	Torq Str - Front		1		EM-2662		
				Trans - LH Front	Shock Mount	1			EM-2881	
		1987-91	1986	Trans - LH Front		1			EM-2800	
				Trans - LH Front		1			EM-2537	
		1986	1994-99	Trans - LH Front		1			EM-2537	
				Trans - LH Rear		1			EM-2778	
		1992-93	1987-91	Trans - LH Rear		1			EM-2823 *	
				Trans - LH Rear		1			EM-2568	
		1986	1987-91	Trans - LH Rear		1			EM-2568	
				Trans - LH Rear		1			EM-2568	
		1987-91	1986	Trans - RH Rear	Hydraulic Mount; 3rd Design	1			EM-2556 *	
				Trans - RH Rear	1st Design - 3 Stud	1			EM-2663	
		1986	1994-99	Trans - RH Rear	2nd Design - 4 Stud	1			EM-2664	
				Trans - RH Rear	Hydraulic Mount; 3rd Design	1			EM-2556 *	
1977-85		1992-99	Trans		1			EM-2379		
			Trans		1			EM-2379		
V8		V8 4.3L 260ci	1977-82	L & R Front		2	EM-2328			
				Trans		1			EM-2360 @	
		V8 4.4L 267ci	1981-82	L & R Front		2	EM-2292			
				Trans		1			EM-2360 @	
		V8 4.9L 301ci	1979	L & R Front		2	EM-2387			
				Trans		1			EM-2360 @	
		V8 5.0L 307ci	1980-85	L & R Front		2	EM-2328			
				Trans		1			EM-2360 @	
		V8 5.7L GAS	1978-80	L & R Front		2	EM-2328			
				L & R Front		2	EM-2292			
		V8 5.7L 350ci	1977	1971-76	L & R Front		2	EM-2328		
					LH Front		1	EM-2263		
	RH Front					1	EM-2262			
	Trans				Gas	1			EM-2360 @	

\* = Hydraulic Mount, "S" suffix = solid replacement. @ = Universal Mount EM-5000 also available.

# Engine, Transmission, And Torque Strut Mounts

CYL	ENG. SIZE	YEAR	LOCATION	DESCRIPTION	QTY	ENGINE	TORQUE STRUT	TRANSMISSION
<b>OLDSMOBILE PASSENGER CAR (continued)</b>								
<b>DELTA 88 (continued)</b>								
V8	V8 5.7L 350ci	1976	Trans		1			EM-2337
		1974-75	Trans		1			EM-2374 @
		1971-73	Trans		1			EM-2337
		1968-70	Trans	Auto	1		EM-2378 @	
			Trans	Manual	1		EM-2378 @	
	V8 5.7L 350ci Diesel	1978-85	L & R Front		2	EM-2328		
			Trans		1		EM-2360 @	
	V8 6.6L 400ci	1977-79	L & R Front		2	EM-2328		
			1975	L & R Front		2	EM-2328	
		1977-79	Trans	Auto; THM350	1		EM-2288 @	
			Trans	Auto; THM400	1		EM-2360 @	
		1975	Trans	Auto; THM350	1		EM-2288 @	
	Trans		Auto; THM400	1		EM-2360 @		
	V8 7.0L 425ci	1965-67	LH Front		1	EM-2263		
			RH Front		1	EM-2262		
			Trans	Auto	1		EM-2378 @	
			Trans	Manual	1		EM-2378 @	
	V8 7.5L 455ci	1971-76	L & R Front		2	EM-2328		
			1968-70	LH Front		1	EM-2263	
		1976	RH Front		1	EM-2262		
Trans			Auto; THM350	1		EM-2337		
1971-75		Trans	Auto; THM400	1		EM-2360 @		
		1968-70	Trans	Auto; THM350	1		EM-2337	
		Trans	Auto	1		EM-2378 @		
Trans	Manual	1		EM-2378 @				
<b>DYNAMIC</b>								
V8	V8 6.5L 394ci	1960-64	Trans - LH		1			EM-2216
			Trans - RH		1		EM-2217	
	V8 7.0L 425ci	1965-66	LH Front		1	EM-2263		
			RH Front		1	EM-2262		
			Trans		1		EM-2378 @	
<b>F85</b>								
L6	L6 3.7L 225ci	1964-65	L & R Front		2	EM-2261		
			Trans	Auto	1		EM-2378 @	
			Trans	Manual	1		EM-2378 @	
	L6 4.1L 250ci	1966-71	L & R Front		2	EM-2284		
			Trans	Auto	1		EM-2378 @	
Trans	Manual	1		EM-2378 @				
V8	V8 3.5L 215ci	1961-63	L & R Front		2	EM-2218		
	V8 5.4L 330ci	1964-67	L & R Front		2	EM-2261		
			Trans	Auto	1		EM-2378 @	
	Trans	Manual	1		EM-2378 @			
	V8 5.7L 350ci	1968-72	L & R Front		2	EM-2261		
			Trans	Auto	1		EM-2378 @	
			Trans	Manual	1		EM-2378 @	
	V8 7.5L 455ci	1972	L & R Front		2	EM-2328		
			L & R Front		2	EM-2328		
		1970	Trans	Auto	1		EM-2378 @	
Trans			Manual	1		EM-2378 @		
1970		Trans	Auto	1		EM-2378 @		
Trans	Manual	1		EM-2378 @				

@ = Universal Mount EM-5000 also available.

# Engine, Transmission, And Torque Strut Mounts

CYL	ENG. SIZE	YEAR	LOCATION	DESCRIPTION	QTY	ENGINE	TORQUE STRUT	TRANSMISSION	
<b>OLDSMOBILE PASSENGER CAR (continued)</b>									
<b>FIESTA</b>									
V8	V8 6.5L 394ci	1960-63	Trans - LH		1			EM-2216	
			Trans - RH		1			EM-2217	
<b>FIRENZA</b>									
L4	L4 1.8L 112ci	1985-86	RH Front		1	EM-2538			
			1983-84	RH Front		1	EM-2496		
		1982	RH Front	Auto; 3 Spd; Vin G; w/ Air	1	EM-2474			
			RH Front	Auto; 3 Spd; VIN G; w/o Air	1	EM-2506			
			RH Front	Manual; Code G; w/ Air	1	EM-2473			
			RH Front	Manual; Code G; w/o Air	1	EM-2524			
			RH Front	VIN 0	1	EM-2496			
		1985-86	RH Rear		1	EM-2477			
		1983-84	RH Rear		1	EM-2477			
		1982	RH Rear		1	EM-2477			
		1982-86	Torq Str - Rear	Lateral	1		EM-2492		
			Torq Str - Rear	Longitudinal	1		EM-2528		
	1985-86	Trans	Auto	1			EM-2601		
		Trans	Manual	1			EM-2601		
	1982-84	Trans	Auto; Insert	1			EM-2720		
		Trans	Manual; Insert	1			EM-2720		
	L4 2.0L 121ci	1987-88	RH Front		1	EM-2538			
			RH Rear		1	EM-2477			
			Torq Str - Rear		1		EM-2528		
	L4 2.0L 122ci	1985-88	RH Front		1	EM-2538			
			1983-84	RH Front	Auto w/o Air	1	EM-2506		
				RH Front	Auto; w/ Air	1	EM-2474		
				RH Front	Manual; w/ Air	1	EM-2473		
				RH Front	Manual; w/o Air	1	EM-2524		
		1985-88	RH Rear		1	EM-2477			
		1983-84	RH Rear		1	EM-2477			
		1983-86	Torq Str - Rear	Lateral	1		EM-2492		
			Torq Str - Rear	Longitudinal	1		EM-2528		
		1983-88	Trans	Auto	1			EM-2601	
			Trans	Manual	1			EM-2601	
V6		V6 2.8L 173ci	1985-87	RH Front		1	EM-2538		
	RH Rear			Auto	1	EM-2477			
	RH Rear			Manual	1	EM-2708			
	Torq Str - Rear			Lateral	1		EM-2492		
	Torq Str - Rear			Longitudinal	1		EM-2528		
	Trans			Auto	1			EM-2601	
	Trans			Manual	1			EM-2601	
<b>INTRIGUE</b>									
V6	V6 3.5L 214ci	1999-02	Front	Hydraulic Mount	1	EM-3093			
			RH Rear		1	EM-2990			
			Torq Str - Front	Bracket to Radiator Support Complete Unit	1		EM-3088		
			Torq Str - Front	Bracket to Radiator Support Insert	1		EM-4169		
			Torq Str - Front	Complete Unit	1		EM-2899		
			Torq Str - Front	Insert	2		EM-2716		
			Trans - LH		1			EM-2712	
			Trans - LH		1			EM-2712S	
	V6 3.8L 231ci	1998-99	Front		1	EM-2796*			
			Torq Str - Front	Bracket to Radiator Support Complete Unit	2		EM-3088		
			Torq Str - Front	Bracket to Radiator Support Insert	2		EM-4169		

\* = Hydraulic Mount, "S" suffix = solid replacement.



# Engine, Transmission, And Torque Strut Mounts

CYL	ENG. SIZE	YEAR	LOCATION	DESCRIPTION	QTY	ENGINE	TORQUE STRUT	TRANSMISSION
<b>OLDSMOBILE PASSENGER CAR (continued)</b>								
<b>INTRIGUE (continued)</b>								
V6	V6 3.8L 231ci	1998-99	Torq Str - Front	Complete Unit; LH & RH Front	2		EM-2866#	
				2nd Design				
			Torq Str - Front	Insert; LH & RH Front	2		EM-2716	
			Trans		1			EM-2712
<b>JETFIRE</b>								
V8	V8 3.5L 215ci	1962-63	L & R Front		2	EM-2218		
<b>JETSTAR 88</b>								
V8	V8 5.4L 330ci	1964-66	LH Front		1	EM-2263		
			RH Front		1	EM-2262		
			Trans	Auto	1		EM-2378 @	
			Trans	Manual	1		EM-2378 @	
<b>LSS</b>								
V6	V6 3.8L 231ci	1996-99	RH Front		1	EM-2801		
			Torq Str - Front		1		EM-2662	
			Trans - LH Front		1		EM-2881	
			Trans - LH Rear		1		EM-2778	
<b>OMEGA</b>								
L4	L4 2.5L 151ci	1982-84 1980-81 1980-84	RH Front		1	EM-2472		
			RH Front		1	EM-2505		
			Torq Str - Front		1		EM-2396	
			Trans - Front	Auto	1		EM-2466	
			Trans - Front	Manual	1		EM-2467	
			Trans - Rear	Auto	1		EM-2467	
L6	L6 4.1L 250ci	1973-76	L & R Front		2	EM-2292		
			Trans	Auto	1		EM-2360 @	
		1976	Trans	Manual	1		EM-2378 @	
			Trans	Auto	1		EM-2378 @	
			Trans	Manual	1		EM-2378 @	
V6	V6 2.8L 173ci	1982-84	RH Front		1	EM-2472		
			RH Front		1	EM-2505		
		1980-84	Torq Str - Front		1		EM-2396	
			Trans - Front	Auto	1		EM-2466	
			Trans - Front	Manual	1		EM-2467	
			Trans - Rear	Auto	1		EM-2467	
	V6 3.8L 231ci	1977-79	LH Front		1	EM-2382		
			RH Front		1	EM-2384		
		1978-79	Trans	Auto	1		EM-2393	
			Trans	Manual	1		EM-2394	
		1977	Trans	Auto	1		EM-2394	
			Trans	Manual; 3 Spd	1		EM-2394	
V8	V8 4.3L 260ci	1975-77	L & R Front		2	EM-2328		
			Trans	Auto	1		EM-2360 @	
			Trans	Manual	1		EM-2360 @	
	V8 5.0L 305ci	1977-79	L & R Front		2	EM-2292		
			Trans	Auto	1		EM-2360 @	
			Trans	Manual	1		EM-2360 @	
	V8 5.7L 350ci	1973-79	L & R Front		2	EM-2292		
			Trans	Auto	1		EM-2360 @	
			Trans	Manual	1		EM-2360 @	

\* = Hydraulic Mount, "S" suffix = solid replacement.

@ = Universal Mount EM-5000 also available.

# = Available in the Westar Gold Line

# Engine, Transmission, And Torque Strut Mounts

CYL	ENG. SIZE	YEAR	LOCATION	DESCRIPTION	QTY	ENGINE	TORQUE STRUT	TRANSMISSION	
<b>OLDSMOBILE PASSENGER CAR (continued)</b>									
<b>REGENCY</b>									
V6	V6 3.8L 231ci	1997-98	Front		1	EM-2801			
			Torq Str - Front		1		EM-2662		
			Trans - LH Front		1			EM-2881	
			Trans - LH Rear		1			EM-2778	
<b>STARFIRE</b>									
L4	L4 2.3L 140ci	1976-77	LH Front		1	EM-2357			
			RH Front		1	EM-2356			
			Trans	Auto	1			EM-2353	
			Trans	Manual	1			EM-2353	
	L4 2.5L 2474cc	1978-80	1980	L & R Front		2	EM-2446		
				Trans	Auto	1			EM-2531
		1978-79	1980	Trans	Manual; 4 Spd	1			EM-2531
				Trans	Auto	1			EM-2531
				Trans	Manual; 4 Spd	1			EM-2531
				Trans	Manual; 5 Spd	1			EM-2353
V6	V6 3.8L 231ci	1975-80	LH Front		1	EM-2382			
			RH Front		1	EM-2384			
		1980	1978-79	Trans	Auto	1			EM-2393
				Trans	Auto	1			EM-2393
		1975-77	1980	Trans	Manual; 5 Spd	1			EM-2393
				Trans	Auto	1			EM-2353
				Trans	Manual	1			EM-2353
				<b>SUPER 88</b>					
V8	V8 6.5L 394ci	1960-64	Trans - LH		1			EM-2216	
			Trans - RH		1			EM-2217	
<b>TORONADO</b>									
V6	V6 3.8L 231ci	1986-91	Front		1	EM-2943*			
		1988-92	Torq Str - Front		1		EM-2662		
		1989-91	Trans - LH		1			EM-2779	
		1986-88	Trans - LH		1			EM-2671	
		1989-91	Trans - RH		1			EM-2691	
	V6 4.1L 252ci	1981-84	L & R Front		2	EM-2777			
			Trans - LH		1			EM-2495	
			Trans - RH		1			EM-2494	
	V8	V8 5.0L 307ci	1980-85	L & R Front		2	EM-2629		
			1982-85	Trans - LH		1			EM-2495
1981			Trans - LH		1			EM-2497	
1982-85			Trans - RH		1			EM-2494	
1981			Trans - RH		1			EM-2494	
V8 5.7L 350ci Diesel		1981-85	L & R Front		2	EM-2629			
			Trans - LH		1			EM-2495	
			Trans - RH		1			EM-2494	
V8 6.6L 403ci		1977-78	L & R Front		2	EM-2328			
			1978	Trans - LH Rear		1			EM-5450
	1977		Trans - LH Rear		1			EM-5450	
V8 7.0L 425ci	1966-67	LH Front		1	EM-2263				
		RH Front		1	EM-2262				

\* = Hydraulic Mount, "S" suffix = solid replacement. @ = Universal Mount EM-5000 also available.

# Engine, Transmission, And Torque Strut Mounts

CYL	ENG. SIZE	YEAR	LOCATION	DESCRIPTION	QTY	ENGINE	TORQUE STRUT	TRANSMISSION	
<b>OLDSMOBILE PASSENGER CAR (continued)</b>									
<b>TORONADO (continued)</b>									
V8	V8 7.0L 425ci	1966-67	Trans		1			EM-2378 @	
	V8 7.5L 455ci	1971-76	L & R Front		2	EM-2328			
		1968-70	LH Front		1	EM-2263			
			RH Front		1	EM-2262			
		1975-76	Trans - LH Rear		1			EM-5450	
		1974	Trans - LH Rear		1			EM-5450	
1971-73	Trans	Auto; THM350 (M38)		1			EM-2337		
<b>VISTA CRUISER</b>									
V8	V8 4.9L 301ci	1978-79	Trans	Auto	1			EM-2393	
			Trans	Manual	1			EM-2392	
	V8 5.4L 330ci	1964-67	LH Front		1	EM-2263			
			RH Front		1	EM-2262			
			Trans	Auto	1			EM-2378 @	
			Trans	Manual	1			EM-2378 @	
	V8 5.7L 350ci	1974-75	L & R Front		2	EM-2328			
			1968-73	L & R Front		2	EM-2261		
		1975	Trans	Auto; THM350 (M38)		1			EM-2378 @
			Trans	Auto; THM400 (M40)		1			EM-2360 @
		1973-74	Trans	Auto; THM350 (M38)		1			EM-2378 @
			Trans	Auto; THM400 (M40)		1			EM-2360 @
			Trans	Manual		1			EM-2337
		1968-72	Trans	Auto; THM350		1			EM-2378 @
			Trans	Auto; THM400		1			EM-2268 @
	Trans		Manual		1			EM-2378 @	
	V8 6.6L 400ci	1968-69	L & R Front		2	EM-2328			
			Trans	Auto	1			EM-2378 @	
			Trans	Manual	1			EM-2378 @	
	V8 7.5L 455ci	1971-75	L & R Front		2	EM-2328			
			1970	LH Front		1	EM-2263		
RH Front				1	EM-2262				
1971-75		Trans	Auto; THM350		1			EM-2337	
		Trans	Auto; THM400		1			EM-2360 @	
1970		Trans	Auto; THM350		1			EM-2378 @	
	Trans	Auto; THM400		1			EM-2360 @		
<b>OLDSMOBILE SPORT UTILITY</b>									
<b>BRAVADA</b>									
L6	L6 4.2L 256ci	2002-04	L & R Front		2	EM-3021*			
			Trans		1			EM-3027	
V6	V6 4.3L 262ci	1996-01	L & R Front		2	EM-2802			
		1991-94	L & R Front		2	EM-2627			
		1996-01	Trans		1			EM-2839	
		1991-94	Trans		1			EM-2638	
<b>OLDSMOBILE VAN</b>									
<b>SILHOUETTE</b>									
V6	V6 3.1L 189ci	1990-94	Front		1	EM-2548*			
			Torq Str - Front		1		EM-2396		
			Trans - LH Front		1			EM-2466	
			Trans - LH Rear		1			EM-2467	
	V6 3.4L 207ci	1997-04	1996	Front		1	EM-2796*		
			1997-04	Front		1	EM-2548*		
				Torq Str - Front	Bracket to Radiator Support Complete Unit	2		EM-2900	

\* = Hydraulic Mount, "S" suffix = solid replacement. @ = Universal Mount EM-5000 also available.

# Engine, Transmission, And Torque Strut Mounts

CYL	ENG. SIZE	YEAR	LOCATION	DESCRIPTION	QTY	ENGINE	TORQUE STRUT	TRANSMISSION	
<b>OLDSMOBILE VAN (continued)</b>									
<b>SILHOUETTE (continued)</b>									
V6	V6 3.4L 207ci	1997-04	Torq Str - Front	Bracket to Radiator Support Insert	2		EM-4169		
			Torq Str - Front	Complete Unit; LH & RH Front	2		EM-2899		
			Torq Str - Front	Insert Only; LH & RH Front	2		EM-2716		
		1996	Torq Str - Front	Complete Unit	1		EM-2866#		
			Torq Str - Front	Insert Only	1		EM-2716		
			Trans - LH Front		1			EM-2466	
	1997-04	Trans - LH Rear		1			EM-2467		
		Trans		1			EM-2818 #		
	V6 3.8L 231ci	1992-95	Front		1	EM-2548'			
			Torq Str - Front		1		EM-2396		
			Trans - LH Front		1			EM-2466	
			Trans - LH Rear		1			EM-2467	
<b>PLYMOUTH PASSENGER CAR</b>									
<b>ACCLAIM</b>									
L4	L4 2.5L 2507cc	1990-95	Front		1	EM-2615			
			1989	Front		1	EM-2615		
		1990-95	RH Front		1	EM-2616			
			1989	RH Front		1	EM-2600		
		1994-95	Trans	Auto	1			EM-2618	
		1993	Trans	Auto	1			EM-2618	
			Trans	Manual	1			EM-2618	
		1989	Trans	Auto	1			EM-2617	
			Trans	Manual	1			EM-2617	
V6	V6 3.0L 2972cc	1990-95	Front		1	EM-2615			
			1989	Front		1	EM-2615		
		1990-95	RH Front	Hydraulic Mount	1	EM-2711			
			RH Front	Rubber Mount	1	EM-2616			
		1989	RH Front		1	EM-2600			
		1994-95	Trans	Auto	1			EM-2618	
		1990-93	Trans	Auto	1			EM-2618	
			Trans	Manual	1			EM-2618	
		1989	Trans	Auto	1			EM-2617	
<b>ARROW</b>									
L4	L4 1.6L 1597cc	1976-80	L & R Front		2	EM-2731			
			Trans		1			EM-8502	
	L4 2.0L 1997cc	1976-78	L & R Front		2	EM-2731			
			Trans		1			EM-8503	
	L4 2.6L 2555cc	1979-80	L & R Front		2	EM-2731			
			Rear		1	EM-8556			
Trans		1			EM-8503				
<b>BARRACUDA</b>									
L6	L6 3.2L 198ci	1970-71	LH Front		1	EM-2275			
			RH Front		1	EM-2277			
			Trans	Auto; Complete Unit	1			EM-2512	
			Trans	Auto; Insert Only	1			EM-2525	
			Trans	Manual; Complete Unit	1			EM-2512	
			Trans	Manual; Insert Only	1			EM-2525	
	L6 3.7L 225ci	1970-72	LH Front		1	EM-2275			
			1965-69	LH Front		1	EM-2265		
			1970-72	RH Front		1	EM-2276		
			1965-69	RH Front		1	EM-2264		
			1970-72	Trans	Auto; Complete Unit	1			EM-2512
				Trans	Auto; Insert Only	1			EM-2525
				Trans	Manual; Complete Unit	1			EM-2512

\* = Hydraulic Mount, "S" suffix = solid replacement. # = Available in the Westar Gold Line

## Engine, Transmission, And Torque Strut Mounts

CYL	ENG. SIZE	YEAR	LOCATION	DESCRIPTION	QTY	ENGINE	TORQUE STRUT	TRANSMISSION	
<b>PLYMOUTH PASSENGER CAR (continued)</b>									
<b>BARRACUDA (continued)</b>									
L6	L6 3.7L 225ci	1970-72	Trans	Manual; Insert Only	1			EM-2525	
		1965-69	Trans	Auto	1			EM-2272	
			Trans	Manual	1			EM-2272	
V8	V8 4.5L 273ci	1967	L & R Front		2	EM-2266			
		1964-66	L & R Front		2	EM-2338			
			Trans	Auto	1			EM-2272	
		1964-67	Trans	Manual	1			EM-2272	
	V8 5.2L 318ci		1970-74	L & R Front		2	EM-2250		
		L & R Front			2	EM-2266			
		1970-74	Trans	Auto; Complete Unit	1			EM-2340	
			Trans	Auto; Complete Unit; HD Pkg.	1			EM-2512	
			Trans	Auto; Insert Only	1			EM-2525	
			Trans	Manual; Complete Unit	1			EM-2340	
			Trans	Manual; Complete Unit; HD Pkg.	1			EM-2512	
			Trans	Manual; Insert Only	1			EM-2525	
	1968-69	Trans	Auto	1			EM-2272		
		Trans	Manual	1			EM-2272		
	V8 5.6L 340ci	1968-73	L & R Front		2	EM-2250			
			Trans	Auto; Complete Unit	1			EM-2340	
			Trans	Auto; Complete Unit; HD Pkg.	1			EM-2512	
			Trans	Auto; Insert Only	1			EM-2525	
Trans			Manual; Complete Unit	1			EM-2340		
Trans			Manual; Complete Unit; HD Pkg.	1			EM-2512		
V8 5.9L 360ci	1974	L & R Front		2	EM-2250				
		Trans	Auto; Complete Unit	1			EM-2340		
		Trans	Auto; Complete Unit; HD Pkg.	1			EM-2512		
		Trans	Auto; Insert Only	1			EM-2525		
		Trans	Manual; Complete Unit	1			EM-2340		
		Trans	Manual; Complete Unit; HD Pkg.	1			EM-2512		
V8 6.3L 383ci	1967-71	L & R Front		2	EM-2250				
		Trans	Auto	1			EM-2272		
		Trans	Manual	1			EM-2272		
<b>BELVEDERE</b>									
L6	L6 3.6L 218ci	1953-54	Front Center		1	EM-2018			
			Trans - L & R Upper		2			EM-2014	
	L6 3.7L 225ci	1965-70	LH Front		1	EM-2275			
			1962-64	LH Front		1	EM-2235		
			1965-70	RH Front		1	EM-2276		
			1962-64	RH Front		1	EM-2234		
1962-70	Trans	Auto	1			EM-2272			
	Trans	Manual	1			EM-2272			
V8	V8 4.5L 273ci	1966-68	L & R Front		2	EM-2250			
		1964-65	LH Front		1	EM-2228			
			RH Front		1	EM-2227			
		1966-68	Trans	Auto	1			EM-2272	
			Trans	Manual	1			EM-2272	
	1964-65	Trans		1			EM-5087		
	V8 5.2L 318ci	1965-70	L & R Front		2	EM-2250			
			1962-64	LH Front		1	EM-2228		
RH Front				1	EM-2227				
1958-70	Trans	Auto	1			EM-2272			

# Engine, Transmission, And Torque Strut Mounts

CYL	ENG. SIZE	YEAR	LOCATION	DESCRIPTION	QTY	ENGINE	TORQUE STRUT	TRANSMISSION		
<b>PLYMOUTH PASSENGER CAR (continued)</b>										
<b>BELVEDERE (continued)</b>										
V8	V8 5.2L 318ci	1958-70	Trans	Manual	1			EM-2272		
		1966-70	L & R Front		2	EM-2250				
	V8 6.3L 383ci	1960-65	LH Front		1	EM-2228				
			RH Front		1	EM-2227				
		1966-70	Trans	Auto	1			EM-2272		
			Trans	Manual	1			EM-2272		
		1960-65	Trans		1			EM-5087		
	V8 7.0L 426ci	1963-67	L & R Front		2	EM-2250				
			Trans	Auto	1			EM-2272		
			Trans	Manual	1			EM-2272		
	V8 7.2L 440ci	1966-67	L & R Front		2	EM-2250				
			Trans	Complete Unit	1			EM-2340		
			Trans	Complete Unit - HD	1			EM-2512		
Trans			Insert Only	1			EM-2525			
<b>BREEZE</b>										
L4	L4 2.0L 122ci	1996-97	Bushing Kit	Cradle Insert Kit - Front & Rear	1	EM-5178				
		1998-00	Front		1	EM-2958				
		1996-97	Front	Cradle-Insert	1	EM-2980				
		1998-00	RH Front		1	EM-2841*				
		1996-97	RH Front		1	EM-2841*				
		1998-00	Rear		1	EM-3089				
		1996-97	Rear	Cradle-Insert	1	EM-3011				
		1996-00	Trans	Auto		1			EM-2842 *	
			Trans	Manual		1			EM-2842 *	
	L4 2.4L 148ci	1998-99	Bushing Kit	Cradle Insert Kit (2 pieces) Recommended	1	EM-5178				
			2000	Front		1	EM-2958			
			1998-99	Front	Cradle-Insert	1	EM-2980			
			2000	RH Front		1	EM-2841*			
			1998-99	RH Front		1	EM-2841*			
			2000	Rear		1	EM-2945			
			1998-99	Rear	Cradle-Insert	1	EM-3011			
			1998-00	Trans	Auto		1			EM-2842 *
				Trans	Manual		1			EM-2842 *
	<b>CARAVELLE</b>									
	L4	L4 2.2L 135ci	1983-88	Front		1	EM-2493			
				RH Front		1	EM-2600			
			1985-88	Torq Str - Front		1		EM-2491		
			1984-86	Trans	Auto	1			EM-2617	
1983				Trans	Auto	1		EM-2600		
		Trans	Manual	1		EM-2600				
L4 2.5L 153ci		1986-88	Front		1	EM-2493				
			RH Front		1	EM-2600				
			Torq Str - Front		1		EM-2491			
			Trans	Auto	1		EM-2617			
L4 2.6L 156ci		1983-85	Front		1	EM-2493				
			RH Front		1	EM-2600				
		1984-85	Trans	Auto	1		EM-2617			
			1983	Trans	Auto	1		EM-2600		
				Trans	Manual	1		EM-2600		
L6	L6 3.7L 225ci	1978-83	LH Front	Complete Unit	1	EM-2324				
			LH Front	Insert Only	1	EM-2376				
			RH Front	Complete Unit	1	EM-2323				
			RH Front	Insert Only	1	EM-2376				
			Trans	Complete Unit	1		EM-2340			

\* = Hydraulic Mount, "S" suffix = solid replacement.

# Engine, Transmission, And Torque Strut Mounts

CYL	ENG. SIZE	YEAR	LOCATION	DESCRIPTION	QTY	ENGINE	TORQUE STRUT	TRANS-MISSION	
<b>PLYMOUTH PASSENGER CAR (continued)</b>									
<b>CARAVELLE (continued)</b>									
L6	L6 3.7L 225ci	1978-83	Trans	Complete Unit - HD	1			EM-2512	
			Trans	Insert Only	1			EM-2525	
V8	V8 5.2L 318ci	1978-88	LH Front	Complete Unit	1	EM-2326			
			LH Front	Insert Only	1	EM-2369			
			RH Front	Complete Unit	1	EM-2325			
			RH Front	Insert Only	1	EM-2369			
		1978-89	Trans	Complete Unit	1			EM-2340	
			Trans	Complete Unit - HD	1			EM-2512	
	Trans		Insert Only	1			EM-2525		
	V8 5.9L 360ci	1978-79	LH Front	Complete Unit	1	EM-2326			
			LH Front	Insert Only	1	EM-2369			
			RH Front	Complete Unit	1	EM-2325			
			RH Front	Insert Only	1	EM-2369			
			Trans	Complete Unit	1			EM-2340	
			Trans	Complete Unit - HD	1			EM-2512	
			Trans	Insert Only	1			EM-2525	
<b>CHAMP</b>									
L4	L4 1.4L 1410cc	1979-82	L & R Front		2	EM-8542			
			Trans	Auto	1			EM-8548	
			Trans	Manual	1			EM-8542	
	L4 1.6L 1597cc	1979-82	RH Front		1	EM-8803			
			Trans	Auto	1			EM-8545	
			Trans	Manual	1			EM-8544	
<b>COLT</b>									
L4	L4 1.4L 1410cc		LH Front		1	EM-8205			
			RH Front		1	EM-2731			
			Trans		1			EM-2730	
	L4 1.5L 1468cc	1993-94	1989-92	Front		1	EM-8100		
				Front	Auto	1	EM-2673		
		1987-88	1985-86	Front	Manual	1	EM-8107		
				Front	Auto	1	EM-8235		
		1993-94	1989-92	Front	Manual	1	EM-8103		
				Front	Auto	1	EM-8235		
		1987-88	1985-86	Front	Manual	1	EM-8103		
				Front	Auto	1	EM-8235		
		1993-94	1989-92	RH Front	w/ Power Steering	1	EM-8238		
				RH Front	w/o Power Steering	1	EM-8206		
		1987-88	1985-86	RH Front		1	EM-8108		
				RH Front		1	EM-8242		
		1993-94	1989-92	Rear	Auto	1	EM-8100		
				Rear	Manual	1	EM-8818		
		1987-88	1985-86	Rear		1	EM-8102		
				Rear		1	EM-8267		
		1993-94	1989-92	Trans	Auto	1			EM-8582
				Trans	Manual	1			EM-8099
		1987-88	1985-86	Trans	Auto	1			EM-8584
				Trans	Manual	1			EM-8669
		1993-94	1989-92	Trans	Auto	1			EM-8242
	Trans			Manual	1			EM-8575	
	1987-88	1985-86	Trans	Auto	1			EM-8552	
			Trans	Manual; Insert	1			EM-8552	
	L4 1.6L 1597cc	1989-90	1985-88	Front	Auto	1	EM-2673		
				Front	Manual	1	EM-8107		
		1982-84	Front	Auto	1	EM-8235			
			Front	Manual	1	EM-8103			

# Engine, Transmission, And Torque Strut Mounts

CYL	ENG. SIZE	YEAR	LOCATION	DESCRIPTION	QTY	ENGINE	TORQUE STRUT	TRANSMISSION
PLYMOUTH PASSENGER CAR (continued)								
COLT (continued)								
L4	L4 1.6L 1597cc	1981	Front		1	EM-8803		
		1976-80	L & R Front		2	EM-2731		
		1989-90	Rear		1	EM-8102		
		1985-88	Rear		1	EM-8267		
		1982-84	Rear	Auto	1	EM-8803		
			Rear	Manual	1	EM-8542		
		1981	Rear		1	EM-8542		
		1989-90	Trans	Auto	1			EM-8584
			Trans	Manual	1			EM-8669
		1987-88	Trans		1			EM-8242
1985-86	Trans	w/ Manual Steering	1			EM-8232		
	Trans	w/ Power Steering	1			EM-8556		
1981-84	Trans		1			EM-8545		
1976-80	Trans	Manual	1			EM-8542		
L4	L4 1.8L 1754cc	1989-90	Front	Auto	1	EM-8103		
			Front	Manual	1	EM-8103		
			Torq Str - Front	Manual	1		EM-8867	
L4	L4 1.8L 1834cc	1993-94	Front	Auto	1	EM-8097		
			Front	Manual	1	EM-9057		
		1992	Front	Auto	1	EM-8690		
			Front	Manual	1	EM-8100		
		1993-94	RH Front	Auto	1	EM-8238		
			RH Front	Manual	1	EM-9147		
		1992	RH Front	Auto	1	EM-8238		
			RH Front	Manual	1	EM-9147		
		1993-94	Rear	Auto	1	EM-8690		
			Rear	Manual	1	EM-8689		
		1992	Rear	Auto	1	EM-8690		
			Rear	Manual	1	EM-8689		
		1993-94	Trans	Auto	1			EM-8619
			Trans	Manual	1			EM-8686
1992	Trans	Auto	1			EM-8881		
	Trans	Manual	1			EM-8686		
L4	L4 2.0L 1997cc	1984-91	RH Front	Auto	1	EM-8270		
			Trans	Auto	1		EM-8807	
		1985-91	Trans	Manual	1		EM-8510	
			1984	Trans	Auto	1		EM-8510
			Trans	Manual	1		EM-8807	
L4	L4 2.4L 2351cc	1993-94	Front	Auto; FWD	1	EM-8102		
			Front	Manual; FWD	1	EM-8821		
			RH Front		1	EM-8820		
		1992	RH Front		1	EM-8820		
		1993-94	Rear	Auto; FWD	1	EM-8690		
			Rear	Manual; FWD	1	EM-8689		
		1994	Trans	Auto; FWD	1			EM-8822
			Trans	Manual; FWD	1			EM-8686
		1993	Trans	Auto; FWD	1			EM-8881
			Trans	Manual; AWD	1			EM-8686
			Trans	Manual; FWD	1			EM-8686
		1992	Trans	Auto; FWD	1			EM-8881
			Trans	Manual; AWD	1			EM-8686
			Trans	Manual; FWD	1			EM-8686
L4	L4 2.6L 2555cc	1978-80	L & R Front		2	EM-2731		
			Trans		1		EM-2730	



## Engine, Transmission, And Torque Strut Mounts

CYL	ENG. SIZE	YEAR	LOCATION	DESCRIPTION	QTY	ENGINE	TORQUE STRUT	TRANSMISSION		
<b>PLYMOUTH PASSENGER CAR (continued)</b>										
<b>CONCORD</b>										
L6	L6 3.6L 218ci	1951-52	Trans - L & R Upper		2			EM-2014		
<b>CONQUEST</b>										
L4	L4 2.6L 2555cc	1984-86	LH Front		1	EM-8205				
			RH Front		1	EM-2731				
			Trans	Manual	1			EM-2730		
<b>CRANBROOK</b>										
L6	L6 3.6L 218ci	1951-53	Trans - L & R Upper		2			EM-2014		
<b>CUDA</b>										
V8	V8 5.2L 318ci	1973-74	L & R Front		2	EM-2250				
			Trans	Auto; Complete Unit	1			EM-2340		
			Trans	Auto; Complete Unit; HD Pkg.	1			EM-2512		
			Trans	Auto; Insert Only	1			EM-2525		
			Trans	Manual; Complete Unit	1			EM-2340		
			Trans	Manual; Complete Unit; HD Pkg.	1			EM-2512		
	V8 5.6L 340ci	1970-73	L & R Front		2	EM-2250				
			Trans	Auto; Complete Unit	1			EM-2340		
			Trans	Auto; Complete Unit; HD Pkg.	1			EM-2512		
			Trans	Auto; Insert Only	1			EM-2525		
			Trans	Manual; Complete Unit	1			EM-2340		
			Trans	Manual; Complete Unit; HD Pkg.	1			EM-2512		
	V8 5.9L 360ci	1974	L & R Front		2	EM-2250				
			Trans	Auto; Complete Unit	1			EM-2340		
			Trans	Auto; Complete Unit; HD Pkg.	1			EM-2512		
			Trans	Auto; Insert Only	1			EM-2525		
			Trans	Manual; Complete Unit	1			EM-2340		
			Trans	Manual; Complete Unit; HD Pkg.	1			EM-2512		
	V8 6.3L 383ci	1970-71	L & R Front		2	EM-2250				
			Trans		1			EM-2272		
			V8 7.0L 426ci	1970-71	L & R Front		2	EM-2250		
					Trans	Auto	1			EM-2272
			V8 7.2L 440ci	1970-71	L & R Front		2	EM-2250		
					Trans	Manual	1			EM-2272
	V8 7.2L 440ci	1970-71	L & R Front		2	EM-2250				
			Trans	Auto; Complete Unit	1			EM-2340		
			Trans	Auto; Complete Unit; HD Pkg.	1			EM-2512		
			Trans	Auto; Insert Only	1			EM-2525		
			Trans	Manual; Complete Unit	1			EM-2340		
			Trans	Manual; Complete Unit; HD Pkg.	1			EM-2512		
V8 7.2L 440ci	1970-71	L & R Front		2	EM-2250					
		Trans	Manual; Insert Only	1			EM-2525			
		<b>DUSTER</b>								
		L6	L6 3.2L 198ci	1973-74	LH Front	Complete Unit	1	EM-2324		
					LH Front	Insert Only	2	EM-2376		
				1970-72	LH Front		1	EM-2265		
1973-74	RH Front				Complete Unit	1	EM-2323			
	RH Front			Insert Only	2	EM-2376				
1970-72	RH Front				1	EM-2264				
1973-74	Trans			Auto; Complete Unit	1			EM-2340		

# Engine, Transmission, And Torque Strut Mounts

CYL	ENG. SIZE	YEAR	LOCATION	DESCRIPTION	QTY	ENGINE	TORQUE STRUT	TRANSMISSION	
<b>PLYMOUTH PASSENGER CAR (continued)</b>									
<b>DUSTER (continued)</b>									
L6	L6 3.2L 198ci	1973-74	Trans	Auto; Complete Unit; HD Pkg.	1			EM-2512	
			Trans	Auto; Insert Only	1			EM-2525	
			Trans	Manual; Complete Unit	1			EM-2340	
			Trans	Manual; Complete Unit; HD Pkg.	1			EM-2512	
			Trans	Manual; Insert Only	1			EM-2525	
		1970-72	Trans	Auto	1			EM-2272	
	Trans		Manual	1			EM-2272		
	L6 3.7L 225ci	1973-76	LH Front	Complete Unit	1	EM-2324			
			LH Front	Insert Only	2	EM-2376			
		1970-72	LH Front	Complete Unit	1	EM-2275			
			RH Front	Complete Unit	1	EM-2323			
		1973-76	RH Front	Insert Only	2	EM-2376			
			RH Front	Complete Unit	1	EM-2276			
		1970-72	Trans	Auto; Complete Unit	1			EM-2340	
			Trans	Auto; Complete Unit; HD Pkg.	1			EM-2512	
			Trans	Auto; Insert Only	1			EM-2525	
			Trans	Manual; Complete Unit	1			EM-2340	
			Trans	Manual; Complete Unit; HD Pkg.	1			EM-2512	
			Trans	Manual; Insert Only	1			EM-2525	
		1970-72	Trans	Auto	1			EM-2272	
			Trans	Manual	1			EM-2272	
	V8	V8 5.2L 318ci	1970-72	L & R Front	Complete Unit	2	EM-2266		
				1973-76	LH Front	Complete Unit	1	EM-2326	
			LH Front		Insert Only	2	EM-2369		
RH Front			Complete Unit		1	EM-2325			
RH Front			Insert Only		2	EM-2369			
Trans			Auto; Complete Unit		1			EM-2340	
Trans			Auto; Complete Unit; HD Pkg.		1			EM-2512	
Trans			Auto; Insert Only		1			EM-2525	
Trans			Manual; Complete Unit		1			EM-2340	
Trans			Manual; Complete Unit; HD Pkg.		1			EM-2512	
Trans			Manual; Insert Only		1			EM-2525	
1970-72			Trans		Auto	1			EM-2272
			Trans		Manual	1			EM-2272
V8 5.6L 340ci			1970-73	LH Front	Complete Unit	1	EM-2326		
		LH Front		Insert Only	2	EM-2369			
		RH Front		Complete Unit	1	EM-2325			
		RH Front		Insert Only	2	EM-2369			
		Trans		Auto; Complete Unit	1			EM-2340	
		Trans		Auto; Complete Unit; HD Pkg.	1			EM-2512	
		Trans		Auto; Insert Only	1			EM-2525	
		Trans		Manual; Complete Unit	1			EM-2340	
		Trans		Manual; Complete Unit; HD Pkg.	1			EM-2512	
		Trans		Manual; Insert Only	1			EM-2525	
V8 5.9L 360ci		1974-76	LH Front	Complete Unit	1	EM-2326			
	LH Front		Insert Only	2	EM-2369				
	RH Front		Complete Unit	1	EM-2325				
	RH Front		Insert Only	2	EM-2369				
	Trans		Auto; Complete Unit	1			EM-2340		
	Trans		Auto; Complete Unit; HD Pkg.	1			EM-2512		
	Trans		Auto; Insert Only	1			EM-2525		
	Trans		Manual; Complete Unit	1			EM-2340		
Trans	Manual; Complete Unit; HD Pkg.	1			EM-2512				

## Engine, Transmission, And Torque Strut Mounts

CYL	ENG. SIZE	YEAR	LOCATION	DESCRIPTION	QTY	ENGINE	TORQUE STRUT	TRANSMISSION
<b>PLYMOUTH PASSENGER CAR (continued)</b>								
<b>DUSTER (continued)</b>								
V8	V8 5.9L 360ci	1974-76	Trans	Manual; Insert Only	1			EM-2525
<b>EXPO</b>								
L4	L4 2.2L 135ci	1987-89	Front		1	EM-2493		
			RH Front		1	EM-2600		
			Trans		1			EM-2617
<b>FURY</b>								
L6	L6 3.7L 225ci	1975-78	LH Front	Complete Unit	1	EM-2324		
			LH Front	Insert Only	2	EM-2376		
		1970	LH Front		1	EM-2275		
		1968	LH Front		1	EM-2275		
		1975-78	RH Front	Complete Unit	1	EM-2323		
			RH Front	Insert Only	2	EM-2376		
		1970	RH Front		1	EM-2276		
		1968	RH Front		1	EM-2276		
		1975-78	Trans	Auto; Complete Unit	1			EM-2340
			Trans	Auto; Complete Unit; HD Pkg.	1			EM-2512
			Trans	Auto; Insert Only	1			EM-2525
			Trans	Manual; Complete Unit	1			EM-2340
			Trans	Manual; Complete Unit; HD Pkg.	1			EM-2512
			Trans	Manual; Insert Only	1			EM-2525
		1970	Trans	Auto	1			EM-2272
			Trans	Manual	1			EM-2272
		1968	Trans	Auto	1			EM-2272
			Trans	Manual	1			EM-2272
V8	V8 4.5L 273ci	1964-65	LH Front		1	EM-2228		
			RH Front		1	EM-2227		
			Trans	Auto	1			EM-2272
			Trans	Manual	1			EM-2272
	V8 5.2L 318ci	1967-73	L & R Front		2	EM-2250		
		1975-78	LH Front	Complete Unit	1	EM-2326		
			LH Front	Insert Only	2	EM-2369		
			RH Front	Complete Unit	1	EM-2325		
			RH Front	Insert Only	2	EM-2369		
			Trans	Auto; Complete Unit	1			EM-2340
			Trans	Auto; Complete Unit; HD Pkg.	1			EM-2512
			Trans	Auto; Insert Only	1			EM-2525
			Trans	Manual; Complete Unit	1			EM-2340
			Trans	Manual; Complete Unit; HD Pkg.	1			EM-2512
			Trans	Manual; Insert Only	1			EM-2525
		1971-73	Trans	Auto; Complete Unit	1			EM-2340
			Trans	Auto; Complete Unit; HD Pkg.	1			EM-2512
			Trans	Auto; Insert Only	1			EM-2525
			Trans	Manual; Complete Unit	1			EM-2340
			Trans	Manual; Complete Unit; HD Pkg.	1			EM-2512
			Trans	Manual; Insert Only	1			EM-2525
		1967-70	Trans	Auto	1			EM-2272
			Trans	Manual	1			EM-2272
	V8 5.9L 360ci	1971-73	L & R Front		2	EM-2250		
		1974-78	LH Front	Complete Unit	1	EM-2326		
			LH Front	Insert Only	2	EM-2369		
			RH Front	Complete Unit	1	EM-2325		
			RH Front	Insert Only	2	EM-2369		
		1971-78	Trans	Auto; Complete Unit	1			EM-2340

# Engine, Transmission, And Torque Strut Mounts

CYL	ENG. SIZE	YEAR	LOCATION	DESCRIPTION	QTY	ENGINE	TORQUE STRUT	TRANSMISSION	
<b>PLYMOUTH PASSENGER CAR (continued)</b>									
<b>FURY (continued)</b>									
V8	V8 5.9L 360ci	1971-78	Trans	Auto; Complete Unit; HD Pkg.	1			EM-2512	
			Trans	Auto; Insert Only	1			EM-2525	
			Trans	Manual; Complete Unit	1				EM-2340
			Trans	Manual; Complete Unit; HD Pkg.	1				EM-2512
			Trans	Manual; Insert Only	1				EM-2525
	V8 5.9L 361ci	1966	1966-65	L & R Front		2	EM-2250		
				LH Front		1	EM-2228		
				RH Front		1	EM-2227		
		1966	Trans	Auto		1			EM-2272
			Trans	Manual		1			EM-2272
	V8 6.3L 383ci	1966-71	1960-65	L & R Front		2	EM-2250		
				LH Front		1	EM-2228		
				RH Front		1	EM-2227		
		1960-71	Trans	Auto		1			EM-2272
			Trans	Manual		1			EM-2272
	V8 6.6L 400ci	1972	1973-78	L & R Front		2	EM-2250		
				LH Front	Complete Unit	1	EM-2326		
		1972-78	LH Front	Insert Only	2	EM-2369			
			RH Front	Complete Unit	1	EM-2325			
			RH Front	Insert Only	2	EM-2369			
		1972-78	Trans	Auto; Complete Unit		1			EM-2340
			Trans	Auto; Complete Unit; HD Pkg.		1			EM-2512
			Trans	Auto; Insert Only		1			EM-2525
			Trans	Manual; Complete Unit		1			EM-2340
			Trans	Manual; Complete Unit; HD Pkg.		1			EM-2512
			Trans	Manual; Insert Only		1			EM-2525
	V8 7.0L 426ci	1966	1963-65	L & R Front		2	EM-2250		
				LH Front		1	EM-2228		
				RH Front		1	EM-2227		
		1963-66	Trans	Auto		1			EM-2272
			Trans	Manual		1			EM-2272
	V8 7.2L 440ci	1967-73	1977-78	L & R Front		2	EM-2250		
				LH Front	Complete Unit	1	EM-2326		
		1974-75	LH Front	Insert Only	2	EM-2369			
			LH Front	Complete Unit	1	EM-2326			
		1977-78	LH Front	Insert Only	2	EM-2369			
			RH Front	Complete Unit	1	EM-2325			
		1974-75	RH Front	Insert Only	2	EM-2369			
			RH Front	Complete Unit	1	EM-2325			
		1977-78	RH Front	Insert Only	2	EM-2369			
			Trans	Auto; Complete Unit		1			EM-2340
		1969-75	Trans	Auto; Insert Only		1			EM-2525
			Trans	Manual; Complete Unit		1			EM-2340
			Trans	Manual; Insert Only		1			EM-2525
Trans			Auto; Complete Unit		1			EM-2340	
Trans			Auto; Insert Only		1			EM-2525	
1969-75		Trans	Manual; Complete Unit		1			EM-2340	
		Trans	Manual; Insert Only		1			EM-2525	
<b>FURY I</b>									
L6	L6 3.7L 225ci	1973	LH Front	Complete Unit	1	EM-2324			
			LH Front	Insert Only	2	EM-2376			
		1973	LH Front		1	EM-2275			
			RH Front	Complete Unit	1	EM-2323			
		1968-72	RH Front	Insert Only	2	EM-2376			
			RH Front		1	EM-2276			

## Engine, Transmission, And Torque Strut Mounts

CYL	ENG. SIZE	YEAR	LOCATION	DESCRIPTION	QTY	ENGINE	TORQUE STRUT	TRANSMISSION	
<b>PLYMOUTH PASSENGER CAR (continued)</b>									
<b>FURY I (continued)</b>									
L6	L6 3.7L 225ci	1973	Trans	Auto; Complete Unit	1			EM-2340	
			Trans	Auto; Complete Unit; HD Pkg.	1			EM-2512	
			Trans	Auto; Insert Only	1			EM-2525	
			Trans	Manual; Complete Unit	1			EM-2340	
			Trans	Manual; Complete Unit; HD Pkg.	1			EM-2512	
			Trans	Manual; Insert Only	1			EM-2525	
	L6 3.7L 226ci	1968-72	Trans		1			EM-2272	
V8	V8 5.2L 318ci	1968-73	L & R Front		2	EM-2250			
		1971-73	Trans	Auto; Complete Unit	1			EM-2340	
			Trans	Auto; Complete Unit; HD Pkg.	1			EM-2512	
			Trans	Auto; Insert Only	1			EM-2525	
			Trans	Manual; Complete Unit	1			EM-2340	
			Trans	Manual; Complete Unit; HD Pkg.	1			EM-2512	
	Trans	Manual; Insert Only	1			EM-2525			
			1968-70	Trans		1			EM-2272
	V8 5.9L 360ci	1971-73	L & R Front		2	EM-2250			
			1974	LH Front	Complete Unit	1	EM-2326		
				LH Front	Insert Only	2	EM-2369		
				RH Front	Complete Unit	1	EM-2325		
		1971-73	Trans	Auto; Complete Unit	1			EM-2340	
			Trans	Auto; Complete Unit; HD Pkg.	1			EM-2512	
			Trans	Auto; Insert Only	1			EM-2525	
			Trans	Manual; Complete Unit	1			EM-2340	
			Trans	Manual; Complete Unit; HD Pkg.	1			EM-2512	
			Trans	Manual; Insert Only	1			EM-2525	
	V8 6.3L 383ci	1968-71	L & R Front		2	EM-2250			
			Trans		1			EM-2272	
	V8 6.6L 400ci	1972	L & R Front		2	EM-2250			
			1973-74	LH Front	Complete Unit	1	EM-2326		
				LH Front	Insert Only	2	EM-2369		
				RH Front	Complete Unit	1	EM-2325		
RH Front		Insert Only		2	EM-2369				
1972-74		Trans	Auto; Complete Unit	1			EM-2340		
		Trans	Auto; Complete Unit; HD Pkg.	1			EM-2512		
		Trans	Auto; Insert Only	1			EM-2525		
		Trans	Manual; Complete Unit	1			EM-2340		
		Trans	Manual; Complete Unit; HD Pkg.	1			EM-2512		
	Trans	Manual; Insert Only	1			EM-2525			
V8 7.2L 440ci	1968-73	L & R Front		2	EM-2250				
		Trans	Auto; Complete Unit	1			EM-2340		
		Trans	Auto; Complete Unit; HD Pkg.	1			EM-2512		
		Trans	Auto; Insert Only	1			EM-2525		
		Trans	Manual; Complete Unit	1			EM-2340		
		Trans	Manual; Complete Unit; HD Pkg.	1			EM-2512		
			Trans	Manual; Insert Only	1			EM-2525	
<b>FURY II</b>									
L6	L6 3.7L 225ci	1968-70	LH Front		1	EM-2275			
			RH Front		1	EM-2276			
			Trans		1			EM-2272	
V8	V8 5.2L 318ci	1968-73	L & R Front		2	EM-2250			
		1971-73	Trans	Auto; Complete Unit	1			EM-2340	

# Engine, Transmission, And Torque Strut Mounts

CYL	ENG. SIZE	YEAR	LOCATION	DESCRIPTION	QTY	ENGINE	TORQUE STRUT	TRANSMISSION	
<b>PLYMOUTH PASSENGER CAR (continued)</b>									
<b>FURY II (continued)</b>									
V8	V8 5.2L 318ci	1971-73	Trans	Auto; Complete Unit; HD Pkg.	1			EM-2512	
			Trans	Auto; Insert Only	1			EM-2525	
			Trans	Manual; Complete Unit	1			EM-2340	
			Trans	Manual; Complete Unit; HD Pkg.	1			EM-2512	
			Trans	Manual; Insert Only	1			EM-2525	
		1968-70	Trans			1			EM-2272
	V8 5.9L 360ci	1971-73	L & R Front			2	EM-2250		
			1974	LH Front	Complete Unit	1	EM-2326		
				LH Front	Insert Only	2	EM-2369		
				RH Front	Complete Unit	1	EM-2325		
		1971-74	RH Front	Insert Only	2	EM-2369			
			Trans	Auto; Complete Unit	1			EM-2340	
			Trans	Auto; Complete Unit; HD Pkg.	1			EM-2512	
			Trans	Auto; Insert Only	1			EM-2525	
			Trans	Manual; Complete Unit	1			EM-2340	
			Trans	Manual; Complete Unit; HD Pkg.	1			EM-2512	
			Trans	Manual; Insert Only	1			EM-2525	
			V8 6.3L 383ci	1968-71	L & R Front		2	EM-2250	
			Trans		1			EM-2272	
	V8 6.6L 400ci	1972	L & R Front			2	EM-2250		
		1973-74	LH Front	Complete Unit	1	EM-2326			
			LH Front	Insert Only	2	EM-2369			
			RH Front	Complete Unit	1	EM-2325			
			RH Front	Insert Only	2	EM-2369			
		1972-74	Trans	Auto; Complete Unit	1			EM-2340	
			Trans	Auto; Complete Unit; HD Pkg.	1			EM-2512	
			Trans	Auto; Insert Only	1			EM-2525	
			Trans	Manual; Complete Unit	1			EM-2340	
			Trans	Manual; Complete Unit; HD Pkg.	1			EM-2512	
	Trans		Manual; Insert Only	1			EM-2525		
	V8 7.2L 440ci	1974	L & R Front	Insert Only	2	EM-2369			
		1968-73	L & R Front		2	EM-2250			
		1968-74	Trans	Auto; Complete Unit	1			EM-2340	
Trans			Auto; Complete Unit; HD Pkg.	1			EM-2512		
Trans			Auto; Insert Only	1			EM-2525		
Trans			Manual; Complete Unit	1			EM-2340		
Trans			Manual; Complete Unit; HD Pkg.	1			EM-2512		
Trans			Manual; Insert Only	1			EM-2525		
<b>FURY III</b>									
L6	L6 3.7L 225ci	1968-71	LH Front		1	EM-2275			
			RH Front		1	EM-2276			
			Trans		1			EM-2272	
V8	V8 5.2L 318ci	1968-73	L & R Front		2	EM-2250			
		1971-73	Trans	Auto; Complete Unit	1			EM-2340	
			Trans	Auto; Complete Unit; HD Pkg.	1			EM-2512	
			Trans	Auto; Insert Only	1			EM-2525	
			Trans	Manual; Complete Unit	1			EM-2340	
			Trans	Manual; Complete Unit; HD Pkg.	1			EM-2512	
			Trans	Manual; Insert Only	1			EM-2525	
	1968-70	Trans			1			EM-2272	
	V8 5.9L 360ci	1971-73	L & R Front			2	EM-2250		
		1974	LH Front	Complete Unit	1	EM-2326			

## Engine, Transmission, And Torque Strut Mounts

CYL	ENG. SIZE	YEAR	LOCATION	DESCRIPTION	QTY	ENGINE	TORQUE STRUT	TRANS-MISSION			
<b>PLYMOUTH PASSENGER CAR (continued)</b>											
<b>FURY III (continued)</b>											
V8	V8 5.9L 360ci	1974	LH Front	Insert Only	2	EM-2369					
			RH Front	Complete Unit	1	EM-2325					
			RH Front	Insert Only	2	EM-2369					
		1971-74	Trans	Auto; Complete Unit	1			EM-2340			
			Trans	Auto; Complete Unit; HD Pkg.	1			EM-2512			
			Trans	Auto; Insert Only	1			EM-2525			
			Trans	Manual; Complete Unit	1			EM-2340			
			Trans	Manual; Complete Unit; HD Pkg.	1			EM-2512			
			Trans	Manual; Insert Only	1			EM-2525			
			Trans	Manual; Insert Only	1			EM-2525			
	V8 6.3L 383ci	1968-71	L & R Front		2	EM-2250					
			Trans		1			EM-2272			
	V8 6.6L 400ci	1972	1973-74	L & R Front		2	EM-2250				
				LH Front		1	EM-2326				
		1972-74	LH Front	Insert Only	2	EM-2369					
			RH Front		1	EM-2325					
			RH Front	Insert Only	2	EM-2369					
			Trans	Auto; Complete Unit	1			EM-2340			
			Trans	Auto; Complete Unit; HD Pkg.	1			EM-2512			
			Trans	Auto; Insert Only	1			EM-2525			
		1972-74	Trans	Manual; Complete Unit	1			EM-2340			
			Trans	Manual; Complete Unit; HD Pkg.	1			EM-2512			
			Trans	Manual; Insert Only	1			EM-2525			
			V8 7.2L 440ci	1974	1968-73	L & R Front	Insert Only	2	EM-2369		
						L & R Front		2	EM-2250		
				1968-74	Trans	Auto; Complete Unit	1			EM-2340	
	Trans	Auto; Complete Unit; HD Pkg.			1			EM-2512			
	Trans	Auto; Insert Only			1			EM-2525			
Trans	Manual; Complete Unit	1					EM-2340				
Trans	Manual; Complete Unit; HD Pkg.	1				EM-2512					
Trans	Manual; Insert Only	1				EM-2525					
<b>GRAN FURY</b>											
L6	L6 3.7L 225ci	1980-83	LH Front	Complete Unit	1	EM-2324					
			LH Front	Insert Only	2	EM-2376					
			RH Front	Complete Unit	1	EM-2323					
			RH Front	Insert Only	2	EM-2376					
			Trans	Complete Unit	1			EM-2340			
			Trans	Complete Unit - HD	1			EM-2512			
			Trans	Insert Only	1			EM-2525			
V8	V8 5.2L 318ci	1972-73	L & R Front		2	EM-2250					
			Trans		1			EM-2340			
		1980-89	LH Front	Complete Unit	1	EM-2326					
			LH Front	Insert Only	2	EM-2369					
		1975-77	LH Front	Complete Unit	1	EM-2326					
			LH Front	Insert Only	2	EM-2369					
		1980-89	RH Front	Complete Unit	1	EM-2325					
			RH Front	Insert Only	2	EM-2369					
		1975-77	RH Front	Complete Unit	1	EM-2325					
			RH Front	Insert Only	2	EM-2369					
		1980-89	Trans	Complete Unit	1			EM-2340			
			Trans	Complete Unit - HD	1			EM-2512			
			Trans	Insert Only	1			EM-2525			
		1975-77	Trans	Complete Unit	1			EM-2340			
			Trans	Complete Unit - HD	1			EM-2512			
Trans	Insert Only		1			EM-2525					
1972-73	Trans	Complete Unit	1			EM-2340					

# Engine, Transmission, And Torque Strut Mounts

CYL	ENG. SIZE	YEAR	LOCATION	DESCRIPTION	QTY	ENGINE	TORQUE STRUT	TRANSMISSION
<b>PLYMOUTH PASSENGER CAR (continued)</b>								
<b>GRAN FURY (continued)</b>								
V8	V8 5.2L 318ci	1972-73	Trans	Complete Unit - HD	1			EM-2512
			Trans	Insert Only	1		EM-2525	
	V8 5.9L 360ci	1972-73	L & R Front		2	EM-2250		
			1980	LH Front	Complete Unit	1	EM-2326	
		1974-77	LH Front	Insert Only	2	EM-2369		
			LH Front	Complete Unit	1	EM-2326		
		1980	LH Front	Insert Only	2	EM-2369		
			RH Front	Complete Unit	1	EM-2325		
		1974-77	RH Front	Insert Only	2	EM-2369		
			RH Front	Complete Unit	1	EM-2325		
		1980	RH Front	Insert Only	2	EM-2369		
			Trans	Complete Unit	1			EM-2340
		1972-77	Trans	Complete Unit - HD	1			EM-2512
			Trans	Insert Only	1			EM-2525
	1972-77	Trans	Complete Unit	1			EM-2340	
		Trans	Complete Unit - HD	1			EM-2512	
	1972-77	Trans	Insert Only	1			EM-2525	
		Trans	Complete Unit	1			EM-2340	
	V8 6.6L 400ci	1972	L & R Front		2	EM-2250		
			1973-77	LH Front	Complete Unit	1	EM-2326	
		1972-77	LH Front	Insert Only	2	EM-2369		
			RH Front	Complete Unit	1	EM-2325		
		1972-77	RH Front	Insert Only	2	EM-2369		
			Trans	Complete Unit	1			EM-2340
		Trans	Complete Unit - HD	1			EM-2512	
	Trans	Insert Only	1			EM-2525		
	V8 7.2L 440ci	1972	L & R Front		2	EM-2250		
			1973-77	LH Front	Complete Unit	1	EM-2326	
		1972-77	LH Front	Insert Only	2	EM-2369		
			RH Front	Complete Unit	1	EM-2325		
		1972-77	RH Front	Insert Only	2	EM-2369		
			Trans	Complete Unit	1			EM-2340
		Trans	Complete Unit - HD	1			EM-2512	
Trans	Insert Only	1			EM-2525			
<b>GTX</b>								
V8	V8 5.2L 318ci	1968	L & R Front		2	EM-2266		
			Trans	Auto	1		EM-2272	
			Trans	Manual	1		EM-2272	
	V8 6.3L 383ci	1968	L & R Front		2	EM-2250		
			Trans	Auto	1		EM-2272	
			Trans	Manual	1		EM-2272	
	V8 7.0L 426ci	1967-71	L & R Front		2	EM-2250		
			Trans	Auto	1		EM-2272	
			Trans	Manual	1		EM-2272	
	V8 7.2L 440ci	1967-71	L & R Front		2	EM-2250		
			Trans	Complete Unit	1		EM-2340	
			Trans	Complete Unit - HD	1		EM-2512	
Trans			Insert Only	1		EM-2525		
<b>HORIZON</b>								
L4	L4 1.6L 1595cc	1983-86	Front		1	EM-2493		
			RH Front		1	EM-2600		
			Torq Str - Front	Manual	1		EM-2491	
		1984-86	Trans	Auto	1		EM-2617	
			Trans	Manual	1		EM-2617	
		1983	Trans	Auto	1		EM-2600	
	Trans		Manual	1		EM-2600		
	L4 1.7L 105ci	1978-83	Front	Complete Unit	1	EM-2733		



# Engine, Transmission, And Torque Strut Mounts

CYL	ENG. SIZE	YEAR	LOCATION	DESCRIPTION	QTY	ENGINE	TORQUE STRUT	TRANSMISSION
<b>PLYMOUTH PASSENGER CAR (continued)</b>								
<b>HORIZON (continued)</b>								
L4	L4 1.7L 105ci	1978-83	Front	Insert Only	1	EM-2447		
			RH Front		1	EM-2600		
		1981-83	Trans	Auto	1			EM-2600
			Trans	Manual	1			EM-2600
		1978-80	Trans	Complete Unit	1			EM-2734
			Trans	Insert Only	1			EM-2721
			Trans	Manual; Complete Unit	1			EM-2734
			Trans	Manual; Insert Only	1			EM-2721
	L4 2.2L 135ci	1982-90	Front		1	EM-2493		
			1981	Front		1	EM-2447	
		1982-90	RH Front		1	EM-2600		
			1981	RH Front		1	EM-2600	
		1984-87	Torq Str - Front	Manual	1		EM-2491	
			1984-90	Trans	Auto	1		EM-2617
		1984-90	Trans	Manual	1			EM-2617
			1981-83	Trans	Auto	1		EM-2600
1981-83	Trans	Manual	1			EM-2600		
<b>LASER</b>								
L4	L4 1.8L 1755cc	1990-94	Front		1	EM-8103		
			LH Front		1	EM-9056		
			Rear	Auto	1	EM-5098		
			Rear	Manual	1	EM-8104		
			Trans	Auto	1			EM-8700
			Trans	Manual	1			EM-8686
	L4 2.0L 1997cc	1992-94	Front	Auto; AWD	1	EM-8559		
			Front	FWD	1	EM-8103		
			Front	Manual; AWD	1	EM-9078		
		1990-91	Front	FWD	1	EM-8103		
			1992-94	LH Front		1	EM-9206	
		1990-91	LH Front		1	EM-9206		
			1992-94	Rear	Auto; AWD	1	EM-8104	
		Rear		Auto; FWD	1	EM-8104		
		Rear		Manual; AWD	1	EM-5101		
		Rear		Manual; FWD	1	EM-5098		
		1990-91	Rear	Auto; FWD	1	EM-8104		
			Rear	Manual; FWD	1	EM-5098		
		1990-94	Trans	Auto	1			EM-8700
		<b>NEON</b>						
L4	L4 2.0L 1996cc	1995-99	Front	Complete Unit	1	EM-2867		
			Front	Insert	1	EM-2846		
		2000-01	LH Rear Upper	Auto	1	EM-2948#		
		1995-99	RH Front	Complete Unit	1	EM-2979		
			RH Front	Insert	1	EM-2847		
		2000-01	RH Front Lower		1	EM-2949#		
			Rear		1	EM-2947		
		1995-99	Trans	Auto	1			EM-2975
			Trans	Manual	1			EM-3050
		1995-99	Trans	Auto, Complete Unit	1			EM-5052
			Trans	Auto; Insert	1			EM-2848
			Trans	Manual, Complete Unit	1			EM-5180
			Trans	Manual; Insert	1			EM-2848
<b>PROWLER</b>								
V6	V6 3.5L 3497cc	1999	Trans		1			EM-2810
		1997	Trans		1			EM-2810

# = Available in the Westar Gold Line

# Engine, Transmission, And Torque Strut Mounts

CYL	ENG. SIZE	YEAR	LOCATION	DESCRIPTION	QTY	ENGINE	TORQUE STRUT	TRANSMISSION
<b>PLYMOUTH PASSENGER CAR (continued)</b>								
<b>RELIANT</b>								
L4	L4 2.2L 135ci	1982-89	Front		1	EM-2493		
			1981	Front	Auto	1	EM-2447	
		1982-89	Front	Manual; 4 Spd	1	EM-2493		
			Front	Manual; 5 Spd	1	EM-2447		
			RH Front		1	EM-2600		
			RH Front	RH Front	1	EM-2600		
		1981-87	Torq Str - Front	Manual	1		EM-2491	
		1984-89	Trans	Auto	1			EM-2617
			Trans	Manual	1			EM-2617
		1981-83	Trans	Auto	1			EM-2600
	Trans		Manual	1			EM-2600	
	L4 2.5L 153ci	1986-89	Front		1	EM-2493		
			RH Front		1	EM-2600		
			Torq Str - Front	Manual	1		EM-2491	
			Trans	Auto	1			EM-2617
			Trans	Manual	1			EM-2617
	L4 2.6L 156ci	1981-85	Front		1	EM-2493		
			RH Front		1	EM-2600		
		1984-85	Trans	Auto	1			EM-2617
			Trans	Manual	1			EM-2617
1981-83		Trans	Auto	1			EM-2600	
		Trans	Manual	1			EM-2600	
<b>ROADRUNNER</b>								
V8	V8 4.5L 273ci	1968	L & R Front		2	EM-2250		
			Trans		1			EM-2272
	V8 5.2L 318ci	1972-74	L & R Front		2	EM-2250		
			1968	L & R Front		2	EM-2250	
		1975	LH Front	Complete Unit	1	EM-2326		
			LH Front	Insert Only	2	EM-2369		
			RH Front	Complete Unit	1	EM-2325		
			RH Front	Insert Only	2	EM-2369		
			Trans	Auto; Complete Unit	1			EM-2340
		1972-75	Trans	Auto; Complete Unit; HD Pkg.	1			EM-2512
			Trans	Auto; Insert Only	1			EM-2525
			Trans	Manual; Complete Unit	1			EM-2340
			Trans	Manual; Complete Unit; HD Pkg.	1			EM-2512
	Trans		Manual; Insert Only	1			EM-2525	
	1968	Trans		1			EM-2272	
	V8 5.6L 340ci	1971-73	L & R Front		2	EM-2250		
			Trans	Auto; Complete Unit	1			EM-2340
			Trans	Auto; Complete Unit; HD Pkg.	1			EM-2512
			Trans	Auto; Insert Only	1			EM-2525
			Trans	Manual; Complete Unit	1			EM-2340
			Trans	Manual; Complete Unit; HD Pkg.	1			EM-2512
			Trans	Manual; Insert Only	1			EM-2525
	V8 5.9L 360ci	1974-75	LH Front	Complete Unit	1	EM-2326		
			LH Front	Insert Only	2	EM-2369		
			RH Front	Complete Unit	1	EM-2325		
			RH Front	Insert Only	2	EM-2369		
			Trans	Auto; Complete Unit	1			EM-2340
			Trans	Auto; Complete Unit; HD Pkg.	1			EM-2512
			Trans	Auto; Insert Only	1			EM-2525
			Trans	Manual; Complete Unit	1			EM-2340
			Trans	Manual; Complete Unit; HD Pkg.	1			EM-2512

# Engine, Transmission, And Torque Strut Mounts

CYL	ENG. SIZE	YEAR	LOCATION	DESCRIPTION	QTY	ENGINE	TORQUE STRUT	TRANSMISSION		
<b>PLYMOUTH PASSENGER CAR (continued)</b>										
<b>ROADRUNNER (continued)</b>										
V8	V8 5.9L 360ci	1974-75	Trans	Manual; Insert Only	1			EM-2525		
	V8 6.3L 383ci	1968-71	L & R Front		2	EM-2250				
			Trans	Auto	1		EM-2272			
			Trans	Manual	1		EM-2272			
	V8 6.6L 400ci	1972	L & R Front		2	EM-2250				
			1973-75	LH Front	Complete Unit	1	EM-2326			
				LH Front	Insert Only	2	EM-2369			
				RH Front	Complete Unit	1	EM-2325			
		RH Front		Insert Only	2	EM-2369				
		1972-75	Trans	Auto; Complete Unit	1		EM-2340			
			Trans	Auto; Complete Unit; HD Pkg.	1		EM-2512			
			Trans	Auto; Insert Only	1		EM-2525			
			Trans	Manual; Complete Unit	1		EM-2340			
			Trans	Manual; Complete Unit; HD Pkg.	1		EM-2512			
		V8 7.0L 426ci	1968-71	L & R Front		2	EM-2250			
				Trans	Auto	1		EM-2272		
	Trans			Manual	1		EM-2272			
	V8 7.2L 440ci	1969-72	L & R Front		2	EM-2250				
			1973-74	LH Front	Complete Unit	1	EM-2326			
		LH Front		Insert Only	2	EM-2369				
		RH Front		Complete Unit	1	EM-2325				
		RH Front		Insert Only	2	EM-2369				
		1969-74	Trans	Auto; Complete Unit	1		EM-2340			
			Trans	Auto; Complete Unit; HD Pkg.	1		EM-2512			
			Trans	Auto; Insert Only	1		EM-2525			
			Trans	Manual; Complete Unit	1		EM-2340			
			Trans	Manual; Complete Unit; HD Pkg.	1		EM-2512			
			Trans	Manual; Insert Only	1		EM-2525			
		<b>SAPPORO</b>								
	L4	L4 1.6L 1597cc	1978-79	Front		1	EM-8542			
				Trans	Auto	1		EM-8545		
				Trans	Manual	1		EM-8542		
		L4 2.6L 2555cc	1978-83	L & R Front		2	EM-2731			
Trans					1		EM-2730			
<b>SATELLITE</b>										
L6	L6 3.7L 225ci	1973-74	LH Front	Complete Unit	1	EM-2324				
			LH Front	Insert Only	2	EM-2369				
		1971-72	LH Front		1	EM-2275				
		1966-67	LH Front		1	EM-2275				
		1973-74	RH Front	Complete Unit	1	EM-2323				
			RH Front	Insert Only	2	EM-2376				
		1971-72	RH Front		1	EM-2276				
		1966-67	RH Front		1	EM-2276				
		1971-74	Trans	Auto; Complete Unit	1		EM-2340			
			Trans	Auto; Complete Unit; HD Pkg.	1		EM-2512			
			Trans	Auto; Insert Only	1		EM-2525			
			Trans	Manual; Complete Unit	1		EM-2340			
			Trans	Manual; Complete Unit; HD Pkg.	1		EM-2512			
			Trans	Manual; Insert Only	1		EM-2525			
		1966-67	Trans		1		EM-2272			
		V8	V8 4.5L 273ci	1965-68	L & R Front		2	EM-2250		
					Trans		1		EM-2272	

# Engine, Transmission, And Torque Strut Mounts

CYL	ENG. SIZE	YEAR	LOCATION	DESCRIPTION	QTY	ENGINE	TORQUE STRUT	TRANSMISSION	
<b>PLYMOUTH PASSENGER CAR (continued)</b>									
<b>SATELLITE (continued)</b>									
V8	V8 5.2L 318ci	1965-74 1971-74	L & R Front		2	EM-2250			
			Trans	Auto; Complete Unit	1			EM-2340	
			Trans	Auto; Complete Unit; HD Pkg.	1			EM-2512	
			Trans	Auto; Insert Only	1			EM-2525	
			Trans	Manual; Complete Unit	1			EM-2340	
			Trans	Manual; Complete Unit; HD Pkg.	1			EM-2512	
		1965-69	Trans	Manual; Insert Only	1			EM-2525	
		1965-69	Trans		1			EM-2272	
		V8 5.6L 340ci	1972	L & R Front		2	EM-2250		
				Trans	Auto; Complete Unit	1			EM-2340
Trans	Auto; Complete Unit; HD Pkg.			1			EM-2512		
Trans	Auto; Insert Only			1			EM-2525		
Trans	Manual; Complete Unit			1			EM-2340		
Trans	Manual; Complete Unit; HD Pkg.			1			EM-2512		
Trans	Manual; Insert Only			1			EM-2525		
V8 5.9L 360ci	1974			L & R Front		2	EM-2250		
		Trans	Auto; Complete Unit	1			EM-2340		
		Trans	Auto; Complete Unit; HD Pkg.	1			EM-2512		
		Trans	Auto; Insert Only	1			EM-2525		
		Trans	Manual; Complete Unit	1			EM-2340		
		Trans	Manual; Complete Unit; HD Pkg.	1			EM-2512		
V8 6.3L 383ci	1965-71	L & R Front		2	EM-2250				
		Trans	Auto	1			EM-2272		
		Trans	Manual	1			EM-2272		
		V8 6.6L 400ci	1972	L & R Front		2	EM-2250		
				1973-74	LH Front	Complete Unit	1	EM-2326	
1972-74	LH Front		Insert Only	2	EM-2369				
	RH Front		Complete Unit	1	EM-2325				
	RH Front	Insert Only	2	EM-2369					
	Trans	Auto; Complete Unit	1			EM-2340			
	Trans	Auto; Complete Unit; HD Pkg.	1			EM-2512			
	Trans	Auto; Insert Only	1			EM-2525			
V8 7.0L 426ci	1965-67	L & R Front		2	EM-2250				
		Trans		1			EM-2272		
V8 7.2L 440ci	1974	L & R Front	Insert Only	2	EM-2369				
		1966-67	L & R Front		2	EM-2250			
	1974	Trans	Auto; Complete Unit	1			EM-2340		
		Trans	Auto; Complete Unit; HD Pkg.	1			EM-2512		
		Trans	Auto; Insert Only	1			EM-2525		
		Trans	Manual; Complete Unit	1			EM-2340		
		Trans	Manual; Complete Unit; HD Pkg.	1			EM-2512		
		Trans	Manual; Insert Only	1			EM-2525		
		1966-67	Trans	Auto; Complete Unit	1			EM-2340	
			Trans	Auto; Complete Unit; HD Pkg.	1			EM-2512	
	Trans		Auto; Insert Only	1			EM-2525		
	Trans		Manual; Complete Unit	1			EM-2340		
	Trans	Manual; Complete Unit; HD Pkg.	1			EM-2512			

# Engine, Transmission, And Torque Strut Mounts

CYL	ENG. SIZE	YEAR	LOCATION	DESCRIPTION	QTY	ENGINE	TORQUE STRUT	TRANSMISSION
<b>PLYMOUTH PASSENGER CAR (continued)</b>								
<b>SATELLITE (continued)</b>								
V8	V8 7.2L 440ci	1966-67	Trans	Manual; Insert Only	1			EM-2525
<b>SCAMP</b>								
L4	L4 2.2L 135ci	1983	Front		1	EM-2493		
			RH Front		1	EM-2600		
			Torq Str - Front	Manual	1		EM-2491	
			Trans	Auto	1			EM-2600
			Trans	Manual	1			EM-2600
L6	L6 3.2L 198ci	1973-74	LH Front	Complete Unit	1	EM-2324		
			LH Front	Insert Only	2	EM-2369		
		1971-72	LH Front		1	EM-2265		
			1973-74	RH Front	Complete Unit	1	EM-2323	
			RH Front	Insert Only	2	EM-2376		
		1971-72	RH Front		1	EM-2264		
			1973-74	Trans	Auto; Complete Unit	1		
		Trans		Auto; Complete Unit; HD Pkg.	1			EM-2512
		Trans		Auto; Insert Only	1			EM-2525
		Trans		Manual; Complete Unit	1			EM-2340
		Trans		Manual; Complete Unit; HD Pkg.	1			EM-2512
		Trans		Manual; Insert Only	1			EM-2525
	1971-72	Trans		1			EM-2272	
	L6 3.7L 225ci	1973-76	LH Front	Complete Unit	1	EM-2324		
			LH Front	Insert Only	2	EM-2369		
		1971-72	LH Front		1	EM-2265		
			1973-76	RH Front	Complete Unit	1	EM-2323	
			RH Front	Insert Only	2	EM-2376		
		1971-72	RH Front		1	EM-2264		
			1973-76	Trans	Auto; Complete Unit	1		
Trans		Auto; Complete Unit; HD Pkg.		1			EM-2512	
Trans		Auto; Insert Only		1			EM-2525	
Trans		Manual; Complete Unit		1			EM-2340	
Trans	Manual; Complete Unit; HD Pkg.	1				EM-2512		
Trans	Manual; Insert Only	1				EM-2525		
1971-72	Trans		1			EM-2272		
V8	V8 5.2L 318ci	1971-72	L & R Front		2	EM-2266		
		1973-76	LH Front	Complete Unit	1	EM-2326		
			LH Front	Insert Only	2	EM-2369		
			RH Front	Complete Unit	1	EM-2325		
			RH Front	Insert Only	2	EM-2369		
		1971-76	Trans	Auto; Complete Unit	1			EM-2340
			Trans	Auto; Complete Unit; HD Pkg.	1			EM-2512
			Trans	Auto; Insert Only	1			EM-2525
			Trans	Manual; Complete Unit	1			EM-2340
			Trans	Manual; Complete Unit; HD Pkg.	1			EM-2512
			Trans	Manual; Insert Only	1			EM-2525

## SUNDANCE

L4	L4 2.2L 135ci	1991-94	Front		1	EM-2615		
		1990	Front		1	EM-2493		
		1987-89	Front		1	EM-2493		
		1991-94	RH Front		1	EM-2616		
		1990	RH Front		1	EM-2616		
		1987-89	RH Front		1	EM-2600		
		1987	Torq Str - Front	Manual	1		EM-2491	
		1990-94	Trans	Auto	1			EM-2618

# Engine, Transmission, And Torque Strut Mounts

CYL	ENG. SIZE	YEAR	LOCATION	DESCRIPTION	QTY	ENGINE	TORQUE STRUT	TRANSMISSION		
<b>PLYMOUTH PASSENGER CAR (continued)</b>										
<b>SUNDANCE (continued)</b>										
L4	L4 2.2L 135ci	1990-94	Trans	Manual	1			EM-2618		
		1987-89	Trans	Auto	1			EM-2617		
			Trans	Manual	1			EM-2617		
	L4 2.5L 153ci	1991-94	Front			1	EM-2615			
		1988-90	Front			1	EM-2493			
		1991-94	RH Front			1	EM-2616			
		1988-90	RH Front			1	EM-2600			
		1990-94	Trans	Auto			1			EM-2618
			Trans	Manual			1			EM-2618
		1988-89	Trans	Auto			1			EM-2617
Trans	Manual				1			EM-2617		
V6	V6 3.0L 181ci	1992-94	Front		1	EM-2615				
			RH Front	Hydraulic Mount	1	EM-2711				
			RH Front	Rubber Mount	1	EM-2616				
			Trans	Auto	1			EM-2618		
		Trans	Manual	1			EM-2618			
<b>TURISMO</b>										
L4	L4 1.6L 97ci	1983-85	Front		1	EM-2493				
			RH Front		1	EM-2600				
			Torq Str - Front	Manual	1		EM-2491			
		1983	Trans	Auto	1			EM-2600		
	Trans		Manual	1			EM-2600			
	L4 1.6L 98ci	1984-85	Trans	Auto	1			EM-2617		
Trans			Manual	1			EM-2617			
<b>VALIANT</b>										
L6	L6 2.8L 170ci	1967-69	LH Front		1	EM-2265				
		1960-66	LH Front		1	EM-2303				
		1967-69	RH Front		1	EM-2264				
		1960-66	RH Front		1	EM-2304				
		1960-69	Trans	Auto	1			EM-2272		
			Trans	Manual	1			EM-2272		
	L6 3.2L 198ci	1973-74	LH Front	Complete Unit	1	EM-2324				
			LH Front	Insert Only	2	EM-2369				
		1970-72	LH Front		1	EM-2265				
		1973-74	RH Front	Complete Unit	1	EM-2323				
			RH Front	Insert Only	2	EM-2376				
		1970-72	RH Front		1	EM-2264				
			Trans	Auto; Complete Unit	1			EM-2340		
		1973-74	Trans	Auto; Complete Unit; HD Pkg.	1			EM-2512		
			Trans	Auto; Insert Only	1			EM-2525		
			Trans	Manual; Complete Unit	1			EM-2340		
			Trans	Manual; Complete Unit; HD Pkg.	1			EM-2512		
			Trans	Manual; Insert Only	1			EM-2525		
	1970-72	Trans	Auto	1			EM-2272			
		Trans	Manual	1			EM-2272			
	L6 3.7L 225ci	1973-76	LH Front	Complete Unit	1	EM-2324				
			LH Front	Insert Only	2	EM-2369				
		1965-72	LH Front		1	EM-2265				
		1961	LH Front		1	EM-2235				
		1973-76	RH Front	Complete Unit	1	EM-2323				
			RH Front	Insert Only	2	EM-2376				
		1965-72	RH Front		1	EM-2264				
		1961	RH Front		1	EM-2234				
		1973-76	Trans	Auto; Complete Unit	1			EM-2340		
			Trans	Auto; Complete Unit; HD Pkg.	1			EM-2512		

## Engine, Transmission, And Torque Strut Mounts

CYL	ENG. SIZE	YEAR	LOCATION	DESCRIPTION	QTY	ENGINE	TORQUE STRUT	TRANSMISSION		
<b>PLYMOUTH PASSENGER CAR (continued)</b>										
<b>VALIANT (continued)</b>										
L6	L6 3.7L 225ci	1973-76	Trans	Auto; Insert Only	1			EM-2525		
			Trans	Manual; Complete Unit	1			EM-2340		
			Trans	Manual; Complete Unit; HD Pkg.	1			EM-2512		
			Trans	Manual; Insert Only	1			EM-2525		
		1965-72	Trans	Auto	1			EM-2272		
			Trans	Manual	1			EM-2272		
		1961	Trans	Auto	1			EM-2272		
			Trans	Manual	1			EM-2272		
V8	V8 4.5L 273ci	1966-69	L & R Front		2	EM-2266				
		1964-65	LH Front		1	EM-2228				
			RH Front		1	EM-2227				
			Trans	Auto	1			EM-2272		
		1964-69	Trans	Manual	1			EM-2272		
			V8 5.2L 318ci	1968-72	L & R Front		2	EM-2266		
	1973-76	LH Front			Complete Unit	1	EM-2326			
		LH Front		Insert Only	2	EM-2369				
		RH Front		Complete Unit	1	EM-2325				
		RH Front		Insert Only	2	EM-2369				
		Trans		Auto; Complete Unit	1			EM-2340		
		Trans		Auto; Complete Unit; HD Pkg.	1			EM-2512		
		Trans		Auto; Insert Only	1			EM-2525		
		Trans		Manual; Complete Unit	1			EM-2340		
	1968-72	Trans		Manual; Complete Unit; HD Pkg.	1			EM-2512		
		Trans		Manual; Insert Only	1			EM-2525		
	V8 5.9L 360ci	1976		1968-72	Trans	Auto	1			EM-2272
					Trans	Manual	1			EM-2272
					1976	LH Front	Complete Unit	1	EM-2326	
			LH Front			Insert Only	2	EM-2369		
			RH Front	Complete Unit		1	EM-2325			
			RH Front	Insert Only		2	EM-2369			
			Trans	Auto; Complete Unit		1			EM-2340	
			Trans	Auto; Complete Unit; HD Pkg.		1			EM-2512	
			Trans	Auto; Insert Only		1			EM-2525	
			Trans	Manual; Complete Unit		1			EM-2340	
			Trans	Manual; Complete Unit; HD Pkg.	1			EM-2512		
			Trans	Manual; Insert Only	1			EM-2525		
<b>VIP</b>										
V8	V8 5.2L 318ci	1967	L & R Front		2	EM-2250				
			Trans		1			EM-2272		
	V8 6.3L 383ci	1967	L & R Front		2	EM-2250				
			Trans		1			EM-2272		
	V8 7.2L 440ci	1967	L & R Front		2	EM-2250				
			Trans	Complete Unit	1			EM-2340		
			Trans	Complete Unit - HD	1			EM-2512		
			Trans	Insert Only	1			EM-2525		
<b>VOLARE</b>										
L6	L6 3.7L 225ci	1976-80	LH Front	Complete Unit	1	EM-2324				
			LH Front	Insert Only	2	EM-2369				
			RH Front	Complete Unit	1	EM-2323				
			RH Front	Insert Only	2	EM-2376				
		1980	Trans	Auto; Complete Unit	1			EM-2340		
			Trans	Auto; Complete Unit; HD Pkg.	1			EM-2512		
			Trans	Auto; Insert Only	1			EM-2525		

# Engine, Transmission, And Torque Strut Mounts

CYL	ENG. SIZE	YEAR	LOCATION	DESCRIPTION	QTY	ENGINE	TORQUE STRUT	TRANS-MISSION		
<b>PLYMOUTH PASSENGER CAR (continued)</b>										
<b>VOLARE (continued)</b>										
L6	L6 3.7L 225ci	1980	Trans	Manual; Complete Unit	1			EM-2340		
			Trans	Manual; Complete Unit; HD Pkg.	1			EM-2512		
			Trans	Manual; Insert Only	1			EM-2525		
		1979	Trans	Manual; Complete Unit	1			EM-2340		
			Trans	Manual; Complete Unit; HD Pkg.	1			EM-2512		
			Trans	Manual; Insert Only	1			EM-2525		
		1976-78	Trans	Auto; Complete Unit	1			EM-2340		
			Trans	Auto; Complete Unit; HD Pkg.	1			EM-2512		
			Trans	Auto; Insert Only	1			EM-2525		
			Trans	Manual; Complete Unit	1			EM-2340		
			Trans	Manual; Complete Unit; HD Pkg.	1			EM-2512		
			Trans	Manual; Insert Only	1			EM-2525		
		V8	V8 5.2L 318ci	1976-80	LH Front	Complete Unit	1	EM-2326		
LH Front	Insert Only				2	EM-2369				
RH Front	Complete Unit				1	EM-2325				
RH Front	Insert Only				2	EM-2369				
1980	Trans			Auto; Complete Unit	1			EM-2340		
	Trans			Auto; Complete Unit; HD Pkg.	1			EM-2512		
	Trans			Auto; Insert Only	1			EM-2525		
	Trans			Manual; Complete Unit	1			EM-2340		
	Trans			Manual; Complete Unit; HD Pkg.	1			EM-2512		
	Trans			Manual; Insert Only	1			EM-2525		
1979	Trans			Manual; Complete Unit	1			EM-2340		
	Trans			Manual; Complete Unit; HD Pkg.	1			EM-2512		
	Trans			Manual; Insert Only	1			EM-2525		
1976-78	Trans			Auto; Complete Unit	1			EM-2340		
	Trans			Auto; Complete Unit; HD Pkg.	1			EM-2512		
	Trans			Auto; Insert Only	1			EM-2525		
	Trans			Manual; Complete Unit	1			EM-2340		
	Trans			Manual; Complete Unit; HD Pkg.	1			EM-2512		
	Trans			Manual; Insert Only	1			EM-2525		
V8 5.9L 360ci	V8 5.9L 360ci			1976-79	LH Front	Complete Unit	1	EM-2326		
					LH Front	Insert Only	2	EM-2369		
		RH Front	Complete Unit		1	EM-2325				
		RH Front	Insert Only		2	EM-2369				
		1979	Trans	Manual; Complete Unit	1			EM-2340		
			Trans	Manual; Complete Unit; HD Pkg.	1			EM-2512		
			Trans	Manual; Insert Only	1			EM-2525		
		1976-78	Trans	Auto; Complete Unit	1			EM-2340		
			Trans	Auto; Complete Unit; HD Pkg.	1			EM-2512		
			Trans	Auto; Insert Only	1			EM-2525		
			Trans	Manual; Complete Unit	1			EM-2340		
			Trans	Manual; Complete Unit; HD Pkg.	1			EM-2512		
			Trans	Manual; Insert Only	1			EM-2525		
			Trans	Manual; Insert Only	1			EM-2525		



## Engine, Transmission, And Torque Strut Mounts

CYL	ENG. SIZE	YEAR	LOCATION	DESCRIPTION	QTY	ENGINE	TORQUE STRUT	TRANS-MISSION	
<b>PLYMOUTH SUV</b>									
<b>TRAILDUSTER</b>									
L6	L6 3.7L 225ci	1979-80	L & R Front		2	EM-2469			
		1975-78	L & R Front		2	EM-2265			
		1975-80	Trans - Lower	4WD	2			EM-2668	
			Trans - Upper	Complete Unit; 2WD	1			EM-2340	
			Trans	Complete Unit; HD; 2WD	1			EM-2512	
			Trans	Insert Only; 2WD	1			EM-2525	
			Trans	4WD	2			EM-2667	
V8	V8 5.2L 318ci	1979-81	L & R Front		2	EM-2469			
		1974-78	L & R Front		2	EM-2265			
		1974-81	Trans - L & R Lower	4WD 4WD	2			EM-2668	
			Trans - L & R Upper	4WD 4WD	2			EM-2667	
			Trans	Complete Unit; 2WD	1			EM-2340	
			Trans	Complete Unit; HD; 2WD	1			EM-2512	
			Trans	Insert Only; 2WD	1			EM-2525	
			V8 5.9L 360ci	1979-81	L & R Front		2	EM-2469	
		1974-78		L & R Front		2	EM-2265		
	1974-81	Trans - L & R Lower		4WD 4WD	2			EM-2668	
		Trans - L & R Upper		4WD 4WD	2			EM-2667	
		Trans		Complete Unit; 2WD	1			EM-2340	
		Trans		Complete Unit; HD; 2WD	1			EM-2512	
	V8 6.6L 400ci	1977-78	L & R Front		2	EM-2265			
			Trans	Complete Unit	1		EM-2340		
			Trans	Complete Unit - HD	1		EM-2512		
		1974-78	Trans	Insert Only	1			EM-2525	
			L & R Front		2	EM-2265			
			Trans	Complete Unit	1			EM-2340	
			Trans	Complete Unit - HD	1			EM-2512	
			Trans	Insert Only	1			EM-2525	
Trans			Insert Only	1			EM-2525		
V8 7.2L 440ci	1974-78	L & R Front		2	EM-2265				
		Trans	Complete Unit	1		EM-2340			
		Trans	Complete Unit - HD	1		EM-2512			
		Trans	Insert Only	1		EM-2525			
<b>PLYMOUTH TRUCK</b>									
<b>ARROW PICKUP</b>									
L4	L4 2.0L 1997cc	1979-82	L & R Front		2	EM-2731			
			Trans		1		EM-8503		
	L4 2.6L 2555cc	1982	1979-81	L & R Front		2	EM-2731		
				L & R Front		2	EM-2731		
			1982	Rear		1	EM-8248		
			1979-81	Rear		1	EM-8556		
			1979-82	Trans	exc Optional	1			EM-8503
				Trans	Optional	1			EM-2730
<b>PLYMOUTH VAN</b>									
<b>GRAND VOYAGER</b>									
L4	L4 2.4L 2429cc	1996-97	RH Front	Complete Unit	1	EM-2959			
			RH Front	Insert	1	EM-2844			
			Trans - Center	Auto, Complete Unit	1			EM-2984	
			Trans - Center	Auto; Insert	1			EM-2845	
			Trans - LH Front	Auto, Complete Unit	1			EM-2960	
			Trans - LH Front	Auto; Insert	1			EM-2849	
			Trans - LH Rear	Auto, Complete Unit	1			EM-3017	
			Trans - LH Rear	Auto; Insert	1			EM-2849	
	L4 2.5L 2507cc	1988	Front		1	EM-2493			
			RH Front		1	EM-2600			

# Engine, Transmission, And Torque Strut Mounts

CYL	ENG. SIZE	YEAR	LOCATION	DESCRIPTION	QTY	ENGINE	TORQUE STRUT	TRANSMISSION	
<b>PLYMOUTH VAN (continued)</b>									
<b>GRAND VOYAGER (continued)</b>									
L4	L4 2.5L 2507cc	1988	Trans		1			EM-2617	
<b>PB100 VAN</b>									
L6	L6 3.7L 225ci	1979-80	L & R Front		2	EM-2469			
		1974-78	L & R Front		2	EM-2265			
		1974-80	Trans	Complete Unit	1			EM-2512	
			Trans	Insert Only	1			EM-2525	
<b>PB150 VAN</b>									
L6	L6 3.7L 3687cc	1981-83	L & R Front		2	EM-2469			
			Trans	Complete Unit	1		EM-2512		
			Trans	Insert Only	1		EM-2525		
<b>GRAND VOYAGER</b>									
V6	V6 3.0L 2972cc	1992-95	Front		1	EM-2615			
		1988-89	Front		1	EM-2493			
		1997-00	RH Front	Complete Unit	1	EM-2959			
			RH Front	Insert	1	EM-2844			
		1992-95	RH Front	Hydraulic Mount	1	EM-2711			
			RH Front	w/ Rubber Mount	1	EM-2616			
		1988-89	RH Front		1	EM-2600			
					1			EM-2984	
		1996-00	Trans - Center	Auto, Complete Unit	1			EM-2845	
				Auto; Insert	1			EM-2960	
				Auto, Complete Unit	1			EM-2849	
				Auto; Insert	1			EM-3017	
				Auto, Complete Unit	1			EM-2849	
				Auto; Insert	1			EM-2618	
	1992-95	Trans		1			EM-2617		
	1988-89	Trans		1					
	V6 3.3L 201ci	V6 3.3L 201ci	1990-95	Front		1	EM-2615		
			1996-00	RH Front	Complete Unit	1	EM-2959		
				RH Front	Insert	1	EM-2844		
			1990-95	RH Front	Hydraulic Mount	1	EM-2711		
				RH Front	w/ Rubber Mount	1	EM-2616		
			1996-00	Trans - Center	Auto, Complete Unit	1			EM-2984
					Auto; Insert	1			EM-2845
					Auto, Complete Unit	1			EM-2960
					Auto; Insert	1			EM-2849
					Auto, Complete Unit	1			EM-3017
					Auto; Insert	1			EM-2849
			1990-95	Trans		1			EM-2618
	V6 3.8L 230ci	V6 3.8L 230ci	1994-95	Front	FWD	1	EM-2615		
			1999	RH Front	Complete Unit	1	EM-2959		
				RH Front	Insert Only	1	EM-2844		
			1994-95	RH Front	FWD, Rubber Mount	1	EM-2616		
				RH Front	Hydraulic Mount; FWD	1	EM-2711		
1999			Trans - Center	Auto, Complete Unit	1			EM-2984	
				Auto; Insert	1			EM-2845	
				Auto, Complete Unit	1			EM-2960	
				Auto; Insert	1			EM-2849	
				Auto, Complete Unit	1			EM-3017	
				Auto; Insert	1			EM-2849	
1994-95	Trans		1			EM-2618			
<b>PB150 VAN</b>									
V8	V8 5.2L 318ci	1983	L & R Front		2	EM-2469			
		1981	L & R Front		2	EM-2469			

# Engine, Transmission, And Torque Strut Mounts

CYL	ENG. SIZE	YEAR	LOCATION	DESCRIPTION	QTY	ENGINE	TORQUE STRUT	TRANSMISSION	
<b>PLYMOUTH VAN (continued)</b>									
<b>PB100 VAN</b>									
V8	V8 5.2L 318ci	1979-80	L & R Front		2	EM-2469			
		1974-78	L & R Front		2	EM-2265			
<b>PB150 VAN</b>									
V8	V8 5.2L 318ci	1983	Trans	Complete Unit	1			EM-2512	
			Trans	Insert Only	1			EM-2525	
		1981	Trans	Complete Unit	1			EM-2512	
			Trans	Insert Only	1			EM-2525	
<b>PB100 VAN</b>									
V8	V8 5.2L 318ci	1974-80	Trans	Complete Unit	1			EM-2512	
			Trans	Insert Only	1			EM-2525	
	V8 5.9L 360ci	1976-78	L & R Front		2	EM-2265			
			L & R Front		2	EM-2265			
	1974	1976-78	Trans	Complete Unit	1			EM-2512	
			Trans	Insert Only	1			EM-2525	
		1974	Trans	Complete Unit	1			EM-2512	
			Trans	Insert Only	1			EM-2525	
<b>PB200 VAN</b>									
L6	L6 3.7L 225ci	1980	L & R Front		2	EM-2469			
			1974-78	L & R Front		2	EM-2265		
		1980	Trans	Complete Unit	1			EM-2512	
			Trans	Insert Only	1			EM-2525	
		1974-78	Trans	Complete Unit	1			EM-2512	
			Trans	Insert Only	1			EM-2525	
V8	V8 5.2L 318ci	1979-80	L & R Front		2	EM-2469			
			1974-78	L & R Front		2	EM-2265		
		1974-80	Trans	Complete Unit	1			EM-2512	
			Trans	Insert Only	1			EM-2525	
	V8 5.9L 360ci	1979-80	L & R Front		2	EM-2469			
			1974-78	L & R Front		2	EM-2265		
			1974-80	Trans	Complete Unit	1			EM-2512
	V8 6.6L 400ci	1976-78	1976-78	L & R Front		2	EM-2265		
				Trans	Complete Unit	1			EM-2512
			1976-78	Trans	Insert Only	1			EM-2525
				1976-78	L & R Front		2	EM-2265	
	V8 7.2L 440ci	1976-78	1976-78	L & R Front		2	EM-2265		
				Trans	Complete Unit	1			EM-2512
			1976-78	Trans	Insert Only	1			EM-2525
1976-78				L & R Front		2	EM-2265		
<b>PB250 VAN</b>									
L6	L6 3.7L 3687cc	1981-83	L & R Front		2	EM-2469			
			Trans	Complete Unit	1			EM-2512	
			Trans	Insert Only	1			EM-2525	
V8	V8 5.2L 318ci	1981-83	L & R Front		2	EM-2469			
			Trans	Complete Unit	1			EM-2512	
			Trans	Insert Only	1			EM-2525	
	V8 5.9L 360ci	1981	L & R Front		2	EM-2469			
			Trans	Complete Unit	1			EM-2512	
Trans	Insert Only	1			EM-2525				
<b>PB300 VAN</b>									
V8	V8 5.2L 318ci	1979-80	L & R Front		2	EM-2469			
		1974-78	L & R Front		2	EM-2265			
		1974-80	Trans	Complete Unit	1			EM-2512	
			Trans	Insert Only	1			EM-2525	
	V8 5.9L 360ci	1979-80	L & R Front		2	EM-2469			
		1974-78	L & R Front		2	EM-2265			
1974-80	Trans	Complete Unit	1			EM-2512			

# Engine, Transmission, And Torque Strut Mounts

CYL	ENG. SIZE	YEAR	LOCATION	DESCRIPTION	QTY	ENGINE	TORQUE STRUT	TRANSMISSION			
<b>PLYMOUTH VAN (continued)</b>											
<b>PB300 VAN (continued)</b>											
V8	V8 5.9L 360ci	1974-80	Trans	Insert Only	1			EM-2525			
	V8 6.6L 400ci	1976-78	L & R Front		2	EM-2265					
			Trans	Complete Unit	1			EM-2512			
			Trans	Insert Only	1			EM-2525			
	V8 7.2L 440ci	1976-78	L & R Front		2	EM-2265					
			Trans	Complete Unit	1			EM-2512			
Trans			Insert Only	1			EM-2525				
<b>PB350 VAN</b>											
V8	V8 5.2L 318ci	1981-83	L & R Front		2	EM-2469					
			Trans	Complete Unit	1			EM-2512			
			Trans	Insert Only	1			EM-2525			
	V8 5.9L 360ci	1981-83	L & R Front		2	EM-2469					
			Trans	Complete Unit	1			EM-2512			
			Trans	Insert Only	1			EM-2525			
<b>VOYAGER</b>											
L4	L4 2.2L 135ci	1984-87	Front		1	EM-2493					
			RH Front		1	EM-2600					
		1984-86	Torq Str - Front	Manual		1		EM-2491			
			Trans	Auto		1			EM-2617		
		1984-87	Trans	Manual		1			EM-2617		
			L4 2.4L 148ci	1996-00	RH Front	Complete Unit	1	EM-2959			
	RH Front	Insert			1	EM-2844					
	Trans - Center	Auto, Complete Unit			1			EM-2984			
	Trans - Center	Auto; Insert			1			EM-2845			
	Trans - LH Front	Auto, Complete Unit			1			EM-2960			
	Trans - LH Front	Auto; Insert			1			EM-2849			
	Trans - LH Rear	Auto, Complete Unit			1			EM-3017			
	Trans - LH Rear	Auto; Insert			1			EM-2849			
	L4 2.5L 153ci	1991-95	Front		1	EM-2615					
			Front		1	EM-2493					
		1991-95	RH Front		1	EM-2616					
			RH Front		1	EM-2600					
		1991-95	Trans		1			EM-2618			
			1987-90	Trans	Auto	1			EM-2617		
	Trans	Manual		1			EM-2617				
	L4 2.6L 156ci	1984-87	Front		1	EM-2493					
			RH Front		1	EM-2600					
			Trans	Auto	1			EM-2617			
			Trans	Manual	1			EM-2617			
			V6	V6 3.0L 181ci	1990-95	Front		1	EM-2615		
						Front		1	EM-2493		
	1997-00	RH Front			Complete Unit	1	EM-2959				
RH Front		Insert			1	EM-2844					
1990-95	RH Front	Hydraulic Mount			1	EM-2711					
	RH Front	Rubber Mount			1	EM-2616					
1987-89	RH Front				1	EM-2600					
1996-99	Trans - Center	Auto, Complete Unit			1			EM-2984			
	Trans - Center	Auto; Insert			1			EM-2845			
	Trans - LH Front	Auto, Complete Unit			1			EM-2960			
	Trans - LH Front	Auto; Insert			1			EM-2849			
	Trans - LH Rear	Auto, Complete Unit			1			EM-3017			
	Trans - LH Rear	Auto; Insert	1			EM-2849					
	1990-95	Trans		1		EM-2618					
	1987-89	Trans		1		EM-2617					
V6 3.3L 201ci	1991-95	Front		1	EM-2615						
		1996-00	RH Front	Complete Unit	1	EM-2959					

# Engine, Transmission, And Torque Strut Mounts

CYL	ENG. SIZE	YEAR	LOCATION	DESCRIPTION	QTY	ENGINE	TORQUE STRUT	TRANS-MISSION		
<b>PLYMOUTH VAN (continued)</b>										
<b>VOYAGER (continued)</b>										
V6	V6 3.3L 201ci	1996-00	RH Front	Insert	1	EM-2844				
		1991-95	RH Front	Hydraulic Mount	1	EM-2711				
			RH Front	w/ Rubber Mount	1	EM-2616				
			Trans - Center	Auto, Complete Unit	1			EM-2984		
		1996-00	Trans - Center	Auto; Insert	1			EM-2845		
			Trans - LH Front	Auto, Complete Unit	1			EM-2960		
			Trans - LH Front	Auto; Insert	1			EM-2849		
			Trans - LH Rear	Auto, Complete Unit	1			EM-3017		
			Trans - LH Rear	Auto; Insert	1			EM-2849		
	Trans			1			EM-2618			
	V6 3.8L 230ci	1998-99	RH Front	Complete Unit	1	EM-2959				
			RH Front	Insert Only	1	EM-2844				
			Trans - Center	Auto, Complete Unit	1			EM-2984		
			Trans - Center	Auto; Insert	1			EM-2845		
			Trans - LH Front	Auto, Complete Unit	1			EM-2960		
			Trans - LH Front	Auto; Insert	1			EM-2849		
			Trans - LH Rear	Auto, Complete Unit	1			EM-3017		
			Trans - LH Rear	Auto; Insert	1			EM-2849		
<b>PONTIAC PASSENGER CAR</b>										
<b>6000</b>										
L4	L4 2.5L 151ci	1985-91	RH Front		1	EM-2548*				
		1982-84	RH Front		1	EM-2472				
		1982-91	Torq Str - Front		1		EM-2396			
		1982-84	Trans - LH Front		1			EM-2466		
			Trans - LH Rear		1			EM-2467		
		1989-91	Trans		1			EM-2543		
		1986-88	Trans	Auto	1			EM-2543		
			Trans	Manual	1			EM-2543		
		1985	Trans	Auto	1			EM-2543		
V6	V6 2.8L 173ci	1985-89	RH Front		1	EM-2548*				
		1982-84	RH Front		1	EM-2472				
		1982-89	Torq Str - Front	Auto	1		EM-2396			
		1989	Trans - LH Front		1			EM-2466		
		1987-88	Trans - LH Front	Auto	1			EM-2466		
			Trans - LH Front	Manual	1			EM-2762		
		1982-86	Trans - LH Front		1			EM-2466		
		1989	Trans - LH Rear		1			EM-2467		
		1987-88	Trans - LH Rear		1			EM-2467		
		1982-86	Trans - LH Rear		1			EM-2467		
	V6 3.1L 189ci	1988-91	RH Front		1	EM-2548*				
			Torq Str - Front		1		EM-2396			
			Trans - LH Front		1			EM-2466		
			Trans - LH Rear		1			EM-2467		
			V6 4.3L 260ci Diesel	1982-85	RH Front		1	EM-2472		
					Torq Str - Front		1		EM-2490	
					Trans - LH Front		1			EM-2466
					Trans - LH Rear		1			EM-2467
<b>ACADIAN</b>										
L4	L4 1.4L 1393cc	1976-77	L & R Front		2	EM-2381				
			Trans		1			EM-2391		
	L4 1.6L 1606cc	1976-87	L & R Front		2	EM-2381				
			Trans		1			EM-2391		
	L4 1.8L 1819cc Diesel	1981-86	L & R Front		2	EM-2381				
			Trans		1			EM-2391		

\* = Hydraulic Mount, "S" suffix = solid replacement.

# Engine, Transmission, And Torque Strut Mounts

CYL	ENG. SIZE	YEAR	LOCATION	DESCRIPTION	QTY	ENGINE	TORQUE STRUT	TRANSMISSION	
<b>PONTIAC PASSENGER CAR (continued)</b>									
<b>ASTRE</b>									
L4	L4 2.3L 140ci	1975-77	LH Front		1	EM-2357			
			RH Front		1	EM-2356			
			Trans	Auto	1			EM-2353	
			Trans	Manual	1			EM-2353	
	L4 2.5L 2474cc	1977	L & R Front		2	EM-2446			
			L & R Rear	OEM Design	2	EM-2374@			
			Trans	Auto	1			EM-2531	
			Trans	Manual	1			EM-2531	
<b>BONNEVILLE</b>									
V6	V6 3.8L 231ci	1980-86 2000-05 1997-99 1992-99 1987-91 1980-86 1992-99 2000-05 1997-99 1994-99 1992-93 1987-91 2000-05 1997-99 1994-99 1992-93 1987-91 2000-05 1997-99 1994-99 1992-93 1987-91 1980-86	LH Front		1	EM-2382			
			RH Front		1	EM-2896*			
			RH Front	Mexico	1	EM-2801			
			RH Front		1	EM-2801			
			RH Front		1	EM-2551*			
			RH Front		1	EM-2384			
			Torq Str - Front		1		EM-2662		
			Trans - Center		1			EM-2895 *	
			Trans - LH Front		1			EM-2897 #	
			Trans - LH Front	Mexico; Shock Mount	1			EM-2881	
			Trans - LH Front	Shock Mount	1			EM-2881	
			Trans - LH Front		1			EM-2800	
			Trans - LH Front		1			EM-2537	
			Trans - LH Rear		1			EM-2898	
			Trans - LH Rear	Mexico; VIN K; VIN L	1			EM-2778	
			Trans - LH Rear	VIN K; VIN L	1			EM-2778	
			Trans - LH Rear		1			EM-2823 *	
			Trans - LH Rear		1			EM-2568	
			Trans - RH Rear		1			EM-2556 *	
			Trans		1			EM-2379	
	V6 4.1L 252ci	1982	LH Front		1	EM-2382			
			RH Front		1	EM-2384			
			Trans		1			EM-2379	
	V6 4.3L 262ci	1986	L & R Front		2	EM-2436			
			Trans		1			EM-2337	
V8	V8 4.3L 265ci	1980-81	L & R Front		2	EM-2387			
			Trans		1			EM-2379	
	V8 4.9L 301ci	1977-80 1978-80 1977	L & R Front		2	EM-2387			
			Trans		1			EM-2392	
			Trans		1			EM-2531	
	V8 5.0L 305ci	1983-86	L & R Front		2	EM-2292			
			Trans		1			EM-2393	
	V8 5.0L 307ci	1981	L & R Front		2	EM-2328			
			Trans		1			EM-2392	
	V8 5.7L GAS	1978-80	L & R Front	VIN R	2	EM-2328			
			L & R Front	VIN X	2	EM-2281			
	V8 5.7L 350ci	1977	L & R Front	VIN R; VIN R	2	EM-2328			
			L & R Front	VIN P; VIN P	2	EM-2387			
		1978-80	Trans	Gas	1			EM-2392	
		1977	Trans	VIN P	1			EM-2531	
	V8 5.7L 350ci Diesel	1980-84	Trans	VIN R	1			EM-2392	
			L & R Front	VIN N	2	EM-2328			
	V8 6.4L 389ci	1965-66 1959-64	Trans		1			EM-2360 @	
			L & R Front		2	EM-2254			
			LH Front		1	EM-2204			
				RH Front		1	EM-2205		

\* = Hydraulic Mount, "S" suffix = solid replacement.

@ = Universal Mount EM-5000 also available.

# = Available in the Westar Gold Line

# Engine, Transmission, And Torque Strut Mounts

CYL	ENG. SIZE	YEAR	LOCATION	DESCRIPTION	QTY	ENGINE	TORQUE STRUT	TRANSMISSION
<b>PONTIAC PASSENGER CAR (continued)</b>								
<b>BONNEVILLE (continued)</b>								
V8	V8 6.4L 389ci	1965-66	Trans		1			EM-2321
		1961-64	Trans	Manual	2			EM-2206
	V8 6.6L 400ci	1973-78	L & R Front		2	EM-2375		
		1968-70	L & R Front		2	EM-2254		
		1971	LH Front		1	EM-2336		
			RH Front		1	EM-2335		
		1976-78	Trans	Auto	1			EM-2360 @
		1975	Trans	Auto; THM400 (M40)	1			EM-2360 @
		1973-74	Trans	Auto	1			EM-2360 @
		1971	Trans	Auto; THM400	1			EM-2374 @
		1968-70	Trans	Auto; THM400	1			EM-2321
	V8 6.6L 403ci	1977-79	L & R Front		2	EM-2387		
			Trans		1			EM-2392
	V8 6.9L 421ci	1965	L & R Front		2	EM-2254		
			LH Front		1	EM-2204		
		1963-64	RH Front		1	EM-2205		
	V8 7.0L 428ci	1967-69	L & R Front		2	EM-2254		
			Trans	Auto	1			EM-2268 @
			Trans	Manual	1			EM-2378 @
	V8 7.5L 455ci	1973-76	L & R Front		2	EM-2375		
L & R Front				2	EM-2254			
1971-72		LH Front		1	EM-2336			
		RH Front		1	EM-2335			
1973-76		Trans		1			EM-2360 @	
1971-72		Trans		1			EM-2374 @	
1970	Trans		1			EM-2321		
<b>CATALINA</b>								
L6	L6 4.1L 250ci	1977-79	L & R Front		2	EM-2292		
			Trans	Auto	1			EM-2378 @
V6	V6 3.8L 231ci	1977-81	LH Front		1	EM-2382		
			RH Front		1	EM-2384		
			Trans		1			EM-2379
V8	V8 4.3L 265ci	1980-81	L & R Front		2	EM-2387		
			Trans		1			EM-2379
	V8 4.4L 267ci	1980-81	L & R Front		2	EM-2292		
			Trans	Auto	1			EM-2393
	V8 4.9L 301ci	1977-80	L & R Front		2	EM-2387		
			1978-80	Trans		1		EM-2392
			1977	Trans		1		EM-2531
	V8 5.0L 305ci	1980-81	L & R Front		2	EM-2292		
			Trans	Auto	1			EM-2393
	V8 5.0L 307ci	1981	L & R Front		2	EM-2328		
			Trans		1			EM-2392
	V8 5.7L 350ci	1978-80	L & R Front	VIN R	2	EM-2328		
			L & R Front	VIN X	2	EM-2281		
		1977	L & R Front	VIN P; VIN P	2	EM-2387		
			L & R Front	VIN R; VIN R	2	EM-2328		
1976		L & R Front	VIN M	2	EM-2387			
		1970-73	LH Front		1	EM-2336		
RH Front				1	EM-2335			
1978-80		Trans	Gas; VIN R; VIN X	1			EM-2392	
1977		Trans	VIN R; VIN R	1			EM-2392	
		Trans	VIN P; VIN P	1			EM-2531	
1976	Trans	VIN M	1			EM-2531		
1970-73	Trans	Manual	1			EM-2288 @		

@ = Universal Mount EM-5000 also available.

# Engine, Transmission, And Torque Strut Mounts

CYL	ENG. SIZE	YEAR	LOCATION	DESCRIPTION	QTY	ENGINE	TORQUE STRUT	TRANSMISSION
<b>PONTIAC PASSENGER CAR (continued)</b>								
<b>CATALINA (continued)</b>								
V8	V8 5.7L 350ci Diesel	1980-81	L & R Front		2	EM-2328		
			Trans	VIN N	1			EM-2360 @
	V8 6.4L 389ci	1965-66 1959-64 1965-66 1961-64	L & R Front		2	EM-2254		
			LH Front		1	EM-2204		
			RH Front		1	EM-2205		
			Trans		1			EM-2321
			Trans	Manual	2			EM-2206
	V8 6.6L 400ci	1973-78 1967-70 1971-72 1978 1976-77 1975 1973-74 1971-72 1967-70	L & R Front		2	EM-2375		
			L & R Front		2	EM-2254		
			LH Front		1	EM-2336		
			RH Front		1	EM-2335		
			Trans	Auto; THM350 (M38)	1			EM-2288 @
			Trans	Auto; THM400-475 (M40)	1			EM-2360 @
			Trans	Auto; THM400 (M40)	1			EM-2360 @
			Trans	Auto	1			EM-2360 @
			Trans	Auto; THM400	1			EM-2374 @
			Trans	Auto; THM400	1			EM-2321
	V8 6.6L 403ci	1977-79	L & R Front		2	EM-2387		
			Trans		1			EM-2392
	V8 6.9L 421ci	1965-66 1963-64 1963-66	L & R Front		2	EM-2254		
			LH Front		1	EM-2204		
			RH Front		1	EM-2205		
			Trans	Auto; THM400	1			EM-2321
	V8 7.0L 428ci	1967-69	Trans	Manual	1			EM-2206
			L & R Front		2	EM-2254		
	V8 7.0L 428ci	1967-69	Trans	Auto	1			EM-2268 @
			Trans	Manual	1			EM-2378 @
			L & R Front		2	EM-2254		
	V8 7.5L 455ci	1973-76 1970 1971-72 1973-76 1971-72 1970	L & R Front		2	EM-2375		
			L & R Front		2	EM-2254		
			LH Front		1	EM-2336		
			RH Front		1	EM-2335		
			Trans		1			EM-2360 @
Trans				1			EM-2374 @	
Trans		1			EM-2321			
<b>EXECUTIVE</b>								
V8	V8 6.6L 400ci	1967-70	L & R Front		2	EM-2254		
			Trans		1			EM-2321
	V8 7.0L 428ci	1967-69	L & R Front		2	EM-2254		
			Trans	Auto	1			EM-2268 @
			Trans	Manual	1			EM-2378 @
	V8 7.5L 455ci	1970	L & R Front		2	EM-2254		
Trans				1			EM-2321	
<b>FIERO</b>								
L4	L4 2.5L 2474cc	1986-88 1984-85 1984-88	RH Front	Auto	1	EM-2548*		
			RH Front		1	EM-2472		
			Torq Str - Front		1			EM-2761
			Trans - LH Front	Auto	1			EM-2466
			Trans - LH Front	Manual	1			EM-2466
			Trans - LH Rear	Auto	1			EM-2467
			Trans - LH Rear	Manual	1			EM-2467
V6	V6 2.8L 173ci	1985-88	Front		1	EM-2472		
			Trans - LH Front	Auto	1			EM-2466
			Trans - LH Front	Manual	1			EM-2466
			Trans - LH Rear	Auto	1			EM-2467

\* = Hydraulic Mount, "S" suffix = solid replacement. @ = Universal Mount EM-5000 also available.



# Engine, Transmission, And Torque Strut Mounts

CYL	ENG. SIZE	YEAR	LOCATION	DESCRIPTION	QTY	ENGINE	TORQUE STRUT	TRANSMISSION	
<b>PONTIAC PASSENGER CAR (continued)</b>									
<b>FIERO (continued)</b>									
V6	V6 2.8L 173ci	1985-88	Trans - LH Rear	Manual	1			EM-2467	
<b>FIREBIRD</b>									
L4	L4 2.5L 151ci	1982-86	LH Front		1	EM-2549			
			RH Front		1	EM-2550			
		1983-86	Trans	Auto	1			EM-2393	
			Trans	Manual	1			EM-2393	
1982	Trans		1			EM-2531			
L6	L6 4.1L 250ci	1973-76	L & R Front		2	EM-2292			
		1968-72	L & R Front		2	EM-2284			
		1976	Trans		1			EM-2288 @	
		1968-75	Trans		1			EM-2378 @	
V6	V6 2.8L 173ci	1982-89	L & R Front		2	EM-2436			
		1988-89	Trans	Auto	1			EM-2394	
		1982-87	Trans	Auto	1			EM-2393	
			Trans	Manual	1			EM-2393	
	V6 3.1L 189ci	1990-92	L & R Front		2	EM-2436			
			Trans	Auto	1			EM-2394	
	V6 3.4L 207ci	1993-95	L & R Front		2	EM-2436			
			Trans	Auto	1			EM-2880 *	
			Trans	Manual	1			EM-2880 *	
	V6 3.8L 231ci	V6 3.8L 231ci	1995-02	LH Front		1	EM-2436		
			1977-81	LH Front		1	EM-2382		
			1995-02	RH Front		1	EM-2878		
			1989	RH Front		1	EM-2627		
			1977-81	RH Front		1	EM-2384		
			1995-02	Trans	Auto	1			EM-2880 *
				Trans	Manual	1			EM-2880 *
1989			Trans	Auto	1			EM-2394	
			Trans	Manual	1			EM-2394	
1977-81			Trans	Auto	1			EM-2394	
Trans	Manual	1				EM-2394			
V8	V8 4.3L 265ci	1980-81	L & R Front		2	EM-2292			
			Trans		1			EM-2392	
	V8 4.4L 267ci	1981	L & R Front		2	EM-2292			
			Trans		1			EM-2392	
	V8 4.9L 301ci	1979-81	L & R Front		2	EM-2387			
			1977	L & R Front		2	EM-2387		
			1979-81	Trans		1			EM-2392
			1977	Trans		1			EM-2392
	V8 5.0L 305ci	1977-92	L & R Front		2	EM-2292			
			1984-92	Trans	Auto	1			EM-2394
			Trans	Manual	1			EM-2394	
			1977-83	Trans	Auto	1			EM-2392
	Trans	Manual	1			EM-2393			
	V8 5.3L 326ci	1967	LH Front		1	EM-2256			
			RH Front		1	EM-2255			
	V8 5.7L 350ci	V8 5.7L 350ci	1998-02	L & R Front		2	EM-3064		
			1987-92	L & R Front		2	EM-2292		
			1978-79	L & R Front		2	EM-2387		
1977			L & R Front		2	EM-2387			
1975-76			L & R Front		2	EM-2387			
1993-97			LH Front		1	EM-3045			
1968-74			LH Front		1	EM-2336			
1993-97			RH Front		1	EM-3046			
1968-74			RH Front		1	EM-2335			
1998-02	Trans	Manual	1			EM-3125			

\* = Hydraulic Mount, "S" suffix = solid replacement. @ = Universal Mount EM-5000 also available.

# Engine, Transmission, And Torque Strut Mounts

CYL	ENG. SIZE	YEAR	LOCATION	DESCRIPTION	QTY	ENGINE	TORQUE STRUT	TRANS-MISSION
<b>PONTIAC PASSENGER CAR (continued)</b>								
<b>FIREBIRD (continued)</b>								
V8	V8 5.7L 350ci	1994-97	Trans		1			EM-2817
		1988-93	Trans	Auto	1			EM-2394
			Trans	Manual	1			EM-2394
		1987	Trans	Auto	1			EM-2392
			Trans	Manual	1			EM-2392
		1977-79	Trans		1			EM-2392
		1975-76	Trans		1			EM-2288 @
		1968-74	Trans	Auto; THM350	1			EM-2378 @
			Trans	Auto; THM400	1			EM-2268 @
	Trans		Manual	1			EM-2378 @	
	V8 6.6L 400ci	1975-79	L & R Front		2	EM-2387		
			L & R Front		2	EM-2254		
		1970-74	LH Front		1	EM-2336		
			RH Front		1	EM-2335		
		1979	Trans	Auto; THM350 (M38)	1			EM-2378 @
			Trans	Manual	1			EM-2288 @
		1978	Trans	Auto; THM350 (M38)	1			EM-2378 @
			Trans	Manual	1			EM-2288 @
		1976-77	Trans	Auto; THM350 (M38)	1			EM-2378 @
			Trans	Auto; THM400-475 (M40)	1			EM-2268 @
			Trans	Manual	1			EM-2288 @
		1975	Trans	Auto; THM350 (M38)	1			EM-2378 @
				THM350C (MV4)				
			Trans	Auto; THM400 (M40)	1			EM-2268 @
			Trans	Manual	1			EM-2288 @
	1967-74	Trans	Auto; THM350	1			EM-2378 @	
		Trans	Auto; THM400	1			EM-2268 @	
		Trans	Manual	1			EM-2378 @	
	V8 6.6L 403ci	1977-79	Trans		1			EM-2392
	V8 7.5L 455ci	1975-76	L & R Front		2	EM-2387		
			LH Front		1	EM-2336		
		1975-76	RH Front		1	EM-2335		
			Trans		1			EM-2288 @
1971-74		Trans	Auto; THM350	1			EM-2378 @	
		Trans	Auto; THM400	1			EM-2268 @	
Trans	Manual	1			EM-2378 @			
<b>FIREFLY</b>								
L3	L3 1.0L 61ci	1994	LH Front	Auto	1	EM-5591		
			LH Front	Manual	1	EM-8517		
		1991	LH Front	Auto	1	EM-5591		
			LH Front	Manual	1	EM-8517		
		1989-90	LH Front	Auto	1	EM-5591		
			LH Front	Manual	1	EM-8517		
		1991	RH Front	Auto; To 3-1-1991	1	EM-5733		
			RH Front	Manual	1	EM-8514		
		1989-90	RH Front	Auto	1	EM-5733		
			RH Front	Manual	1	EM-8514		
		1991	Rear	Manual	1	EM-8294		
		1989-90	Rear	Manual	1	EM-8294		
		L4	L4 1.3L 79ci	1994-00	Front		1	EM-5608
Rear					1	EM-8277		

@ = Universal Mount EM-5000 also available.

# Engine, Transmission, And Torque Strut Mounts

CYL	ENG. SIZE	YEAR	LOCATION	DESCRIPTION	QTY	ENGINE	TORQUE STRUT	TRANSMISSION	
<b>PONTIAC PASSENGER CAR (continued)</b>									
<b>G3</b>									
L4	L4 1.6L 98ci	2009-10	Torq Str - Front		1		EM-3114		
<b>G3 Wave</b>									
L4	L4 1.6L 98ci	2009	Torq Str - Rear		1		EM-3114		
<b>G5</b>									
L4	L4 2.2L 134ci	2007-08	RH Front	Auto	1	EM-3109			
			RH Front	Manual	1	EM-3108			
		2007-09	Trans - Center		1			EM-4158	
			Trans - Front	Bushing Only; Auto	1			EM-3081	
			Trans - LH Front	Auto	1			EM-3086	
			Trans - Rear	Auto	1			EM-3043	
	L4 2.4L 145ci	2007-08	RH Front	Auto	1	EM-3109			
			RH Front	Manual	1	EM-3108			
		2007-08	Trans - Center		1			EM-4158	
			Trans - Front	Bushing Only; Auto	1			EM-3081	
			Trans - LH Front	Auto	1			EM-3086	
			Trans - Rear	Auto	1			EM-3043	
			Trans - Center		1			EM-4158	
			Trans - Front	Bushing Only; Auto	1			EM-3081	
Trans - LH Front	Auto	1			EM-3086				
Trans - Rear	Auto	1			EM-3043				
<b>G6</b>									
L4	L4 2.4L 145ci	2010	RH Front		1	EM-3117			
		2009	RH Front		1	EM-3118			
		2006-08	RH Front		1	EM-3117			
		2009-10	Trans - Center	Auto; 4 Spd	1			EM-4047	
			Trans - Center	Auto; 6 Spd	1			EM-4134	
		2008	Trans - Center	Auto; 4 Spd	1			EM-4047	
			Trans - Center	Auto; 6 Spd	1			EM-4134	
		2009-10	Trans - Front	Auto; 4 Spd; Complete Unit	1			EM-4027	
			Trans - Front	Auto; 4 Spd; Insert	1			EM-4206	
			Trans - Front	Auto; 6 Spd	1			EM-4046	
		2008	Trans - Front	Auto; 4 Spd; Complete Unit	1			EM-4027	
			Trans - Front	Auto; 4 Spd; Insert	1			EM-4206	
			Trans - Front	Auto; 6 Spd	1			EM-4046	
		2009-10	Trans - Rear	Auto; 4 Spd; Complete Unit	1			EM-5862	
			Trans - Rear	Auto; 4 Spd; Insert	1			EM-4206	
			Trans - Rear	Auto; 6 Spd	1			EM-4045	
		2008	Trans - Rear	Auto; 4 Spd; 1st Design Stamped Part	1			EM-3094	
			Trans - Rear	Auto; 4 Spd; 2nd Design; Cast Part	1			EM-5862	
			Trans - Rear	Auto; 4 Spd; Insert	1			EM-4206	
			Trans - Rear	Auto; 6 Spd	1			EM-4045	
V6	V6 3.5L 213ci	2010	RH Front	Hydraulic Mount	1	EM-3097			
		2007-09	RH Front	Convertible	1	EM-3116			
			RH Front	Hydraulic Mount; Coupe & Sedan	1	EM-3097			
		2005-06	Right	Hydraulic Mount; Auto	1	EM-3097			
		2010	Trans - Center		1			EM-3096	
		2007-09	Trans - Center	Convertible	1			EM-4047	
			Trans - Center	Coupe & Sedan	1			EM-3096	
		2005-06	Trans - Center		1			EM-3096	
		2010	Trans - Front	Bushing	1			EM-4027	
			Trans - Front	Complete Unit	1			EM-4206	
			Trans - Front	Insert	1			EM-5862	
		2007-09	Trans - Front		1			EM-4027	
			Trans - Front	Insert	1			EM-4206	
		2005-07	Trans - Front	Mexico; Insert	1			EM-4206	
Trans - Front	Mexico; Mexican Vehicle Complete Unit		1			EM-5659			

# Engine, Transmission, And Torque Strut Mounts

CYL	ENG. SIZE	YEAR	LOCATION	DESCRIPTION	QTY	ENGINE	TORQUE STRUT	TRANSMISSION	
<b>PONTIAC PASSENGER CAR (continued)</b>									
<b>G6 (continued)</b>									
V6	V6 3.5L 213ci	2005-06	Trans - Front	Complete Unit	1			EM-5659	
			Trans - Front	Insert	1			EM-4206	
		2010	Trans - Rear	Complete Unit	1			EM-4206	
			2007-09	Trans - Rear	Complete Unit; Coupe & Seda	1			EM-5862
		2007-09	Trans - Rear	Insert; Convertible	1			EM-4206	
			Trans - Rear	Insert; Coupe & Sedan	1			EM-4206	
			2005-07	Trans - Rear	Mexico; Insert	1			EM-4206
		2005-07	Trans - Rear	Mexico; Mexican Vehicle	1			EM-3094	
			2005-06	Trans - Rear	Complete Unit	1			EM-3094
		V6 3.6L 217ci	2007-09	Trans - Rear	Insert	1			EM-4206
	RH Front			Hydraulic Mount	1	EM-3097			
	2007-09		Trans - Center		1			EM-3135	
			Trans - Front	Complete Unit	1			EM-4061	
			Trans - Front	Insert	1			EM-4206	
			Trans - Rear	Complete Unit	1			EM-4062	
	2007-09		Trans - Rear	Insert	1			EM-4206	
			V6 3.9L 237ci	2008-09	Front	Auto; Convertible	1	EM-3116	
	Front				Hydraulic Mount; Sedan Coupe	1	EM-3097		
	2006-07		Front	Auto; Convertible	1	EM-3116			
		Front	Auto; Hydraulic Mount; Sedan Coupe	1	EM-3097				
Front		Manual; Hydraulic Mount	1	EM-3097					
2006-09		Trans - Center		1			EM-3112		
		Trans - Front		1			EM-4195		
Trans - Rear		1			EM-4194				
<b>GRAND AM</b>									
L4	L4 2.0L 122ci	1987-89	RH Front		1	EM-2538			
			RH Rear		1	EM-2477			
			Torq Str - Rear	Lateral	1		EM-2492		
			Torq Str - Rear	Longitudinal	1		EM-2528		
			Trans	Auto	1			EM-2601	
			Trans	Manual	1			EM-2601	
	L4 2.2L 134ci	2002-05	Right		1	EM-3129			
			Trans - Center		1		EM-2874		
			Trans - LH Front	Complete Unit	1		EM-3070		
			Trans - LH Front	Insert Only	1		EM-5422		
			Trans - LH Rear	Complete Unit	1		EM-5078		
			Trans - LH Rear	Insert Only	1		EM-2875		
	L4 2.3L 138ci	1992-95	RH Front	Complete Unit	1	EM-5031*			
			RH Front	Insert	1	EM-2803*			
		1988-91	RH Front		1	EM-2859*			
			RH Rear		1	EM-2952			
		1994-95	Torq Str - Front	Auto	1		EM-2814		
			Torq Str - Front	Manual	1		EM-2782		
		1992-93	Torq Str - Front		1		EM-2782		
		1988-91	Torq Str - Front		1		EM-2528		
		1992-95	Trans - LH Front	Manual; Insert	1			EM-2923	
			Trans - LH Rear	Auto	1			EM-2715	
			Trans - LH Rear	Manual; Insert	1			EM-2924	
		1988-91	Trans	Complete Unit; Auto	1			EM-3058	
	Trans		Insert Only; Manual	1			EM-2766		
	L4 2.4L 146ci	1999-01	Front		1	EM-2933*			
			1996-98	RH Front	Complete Unit	1	EM-5031*		
		RH Front		Insert	1	EM-2803*			

\* = Hydraulic Mount, "S" suffix = solid replacement.

# Engine, Transmission, And Torque Strut Mounts

CYL	ENG. SIZE	YEAR	LOCATION	DESCRIPTION	QTY	ENGINE	TORQUE STRUT	TRANSMISSION	
<b>PONTIAC PASSENGER CAR (continued)</b>									
<b>GRAND AM (continued)</b>									
L4	L4 2.4L 146ci	1996-98	Torq Str - Front	Auto	1		EM-2814		
			Torq Str - Front	Manual	1		EM-2782		
		1999-01	Trans - Center		1				EM-2874
			Trans - LH Front	Complete Unit	1				EM-5079
			Trans - LH Rear	Complete Unit	1				EM-5078
			Trans - LH Rear	Insert	1				EM-2875
	1996-98	Trans	Auto	1			EM-2715		
	L4 2.5L 151ci	1985-91	RH Front		1	EM-2538			
			RH Rear		1	EM-2477			
			Torq Str - Rear		1		EM-2528		
			Trans	Auto	1			EM-2601	
			Trans	Manual	1			EM-2601	
	V6	V6 3.0L 181ci	1985-87	RH Front		1	EM-2626		
RH Rear					1	EM-2477			
Torq Str - Rear					1		EM-2528		
Trans				Auto	1		EM-2601		
Trans				Manual	1		EM-2601		
V6 3.1L 189ci		1994-98	RH Front	Insert	1	EM-2803*			
			Torq Str - Front		1		EM-2814		
			Torq Str - Front		1		EM-2782		
			Trans		1		EM-2715		
V6 3.3L 204ci		1992-93	RH Front	Insert	1	EM-2803*			
			Torq Str - Front		1		EM-2782		
			Trans		1		EM-2715		
V6 3.4L 207ci		1999-05	Front		1	EM-2933*			
			Trans - Center		1		EM-2874		
			Trans - Front	Complete Unit	1		EM-5079		
			Trans - Rear	Complete Unit	1		EM-5078		
V6 3.8L 231ci		1979	LH Front		1	EM-2382			
			RH Front		1	EM-2384			
			Trans		1		EM-2379		
V8		V8 4.9L 301ci	1978-80	L & R Front		2	EM-2387		
				Trans	Auto	1		EM-2393	
			1978-79	Trans	Auto	1		EM-2393	
	Trans			Manual	1		EM-2392		
	V8 5.0L 305ci	1978-80	L & R Front		2	EM-2292			
			Trans	Auto	1		EM-2393		
		1978-79	Trans	Auto	1		EM-2393		
			Trans	Manual	1		EM-2393		
	V8 5.7L 350ci	1975	L & R Front		2	EM-2254			
			L & R Front		2	EM-2254			
			Trans		1		EM-2378 @		
	V8 6.6L 400ci	1973-75	L & R Front		2	EM-2292			
			Trans		1		EM-2288 @		
	V8 7.5L 455ci	1975	L & R Front		2	EM-2375			
			LH Front		1	EM-2336			
		1973-74	RH Front		1	EM-2335			
			Trans	Auto; THM350	1		EM-2268 @		
			Trans	Auto; THM400	1		EM-2360 @		
	1973-75	Trans	Manual	1		EM-2360 @			
	<b>GRAND LEMANS</b>								
L6	L6 4.1L 250ci	1975-77	L & R Front		2	EM-2292			
		1976-77	Trans		1		EM-2337		
		1975	Trans		1		EM-2288 @		

\* = Hydraulic Mount, "S" suffix = solid replacement.

@ = Universal Mount EM-5000 also available.

# Engine, Transmission, And Torque Strut Mounts

CYL	ENG. SIZE	YEAR	LOCATION	DESCRIPTION	QTY	ENGINE	TORQUE STRUT	TRANSMISSION
<b>PONTIAC PASSENGER CAR (continued)</b>								
<b>GRAND LEMANS (continued)</b>								
V6	V6 3.3L 200ci	1978-79	Trans		1			EM-2288 @
	V6 3.8L 229ci	1980-81	L & R Front		2	EM-2436		
			Trans		1		EM-2378 @	
	V6 3.8L 231ci	1977-83	LH Front		1	EM-2382		
			RH Front		1	EM-2384		
			Trans		1		EM-2379	
	V6 4.1L 252ci	1982	LH Front		1	EM-2382		
			RH Front		1	EM-2384		
			Trans		1		EM-2379	
	V8	V8 4.3L 260ci	1976	L & R Front		2	EM-2328	
Trans					1		EM-2393	
V8 4.3L 265ci		1980-81	L & R Front		2	EM-2387		
			Trans		1		EM-2379	
V8 4.4L 267ci		1979-82	L & R Front		2	EM-2292		
			Trans		1		EM-2393	
V8 4.9L 301ci		1979-81	L & R Front		2	EM-2387		
		1977	L & R Front		2	EM-2387		
		1979-81	Trans		1		EM-2393	
		1977	Trans		1		EM-2360 @	
V8 5.0L 305ci		1976-83	L & R Front		2	EM-2292		
		1981-83	Trans		1		EM-2393	
		1976-80	Trans	Auto	1		EM-2393	
			Trans	Manual	1		EM-2393	
V8 5.7L 350ci		1975-79	L & R Front		2	EM-2387		
			Trans		1		EM-2288 @	
V8 5.7L 350ci Diesel		1982-83	L & R Front		2	EM-2328		
			Trans		1		EM-2360 @	
V8 6.6L 400ci		1975-77	LH Front		1	EM-2256		
			RH Front		1	EM-2255		
	Trans			1		EM-2288 @		
V8 6.6L 403ci	1977	L & R Front		2	EM-2387			
		Trans		1		EM-2392		
V8 7.5L 455ci	1975-76	L & R Front		2	EM-2292			
	1976	Trans		1		EM-2268 @		
	1975	Trans		1		EM-2360 @		
<b>GRAND PRIX</b>								
L4	L4 2.3L 138ci	1990-91	Front		1	EM-2859*		
			Torq Str - Front	LH & RH Front	2		EM-2396	
			Trans	Auto	1		EM-2620	
V6	V6 2.8L 173ci	1988-89	Front		1	EM-2660*		
			Torq Str - Front	Auto	1		EM-2609	
			Torq Str - Front	Manual	1		EM-5177	
			Torq Str - Front		1		EM-2609	
			Trans	Auto	1		EM-2620	
			Trans	Manual	1		EM-5181	
	V6 3.1L 189ci	1989-93 1994-03 1995-03	Front		1	EM-2660*		
			RH Front		1	EM-2796*		
			Torq Str - Front	Auto, Complete Unit; LH & RH Front	2		EM-2866#	
			Torq Str - Front	Bracket to Radiator Support Complete Unit	2		EM-2901	
			Torq Str - Front	Bracket to Radiator Support Insert	2		EM-4169	
			Torq Str - Front	Insert; LH & RH Front; Auto	2		EM-2716	
1994	Torq Str - Front	Bracket to Radiator Support Complete Unit	2		EM-2901			

\* = Hydraulic Mount, "S" suffix = solid replacement.

@ = Universal Mount EM-5000 also available.

# = Available in the Westar Gold Line

# Engine, Transmission, And Torque Strut Mounts

CYL	ENG. SIZE	YEAR	LOCATION	DESCRIPTION	QTY	ENGINE	TORQUE STRUT	TRANSMISSION	
<b>PONTIAC PASSENGER CAR (continued)</b>									
<b>GRAND PRIX (continued)</b>									
V6	V6 3.1L 189ci	1994	Torq Str - Front	Bracket to Radiator Support Insert	2		EM-4169		
			Torq Str - Front	Complete Unit; LH & RH Front 1st Design	2		EM-2609		
			Torq Str - Front	Complete Unit; LH & RH Front 2nd Design	2		EM-2866#		
			Torq Str - Front	Insert Only; LH & RH Front 2nd Design	2		EM-2716		
		1991-93	Torq Str - Front	Auto, LH & RH Front	2		EM-2609		
		1989-90	Torq Str - Front	Auto, LH & RH Front	2		EM-2609		
			Torq Str - Front	Manual	1		EM-5177		
			Torq Str - Front	Manual	1		EM-2609		
		1994-03	Trans	Auto	1			EM-2712 *	
		1991-93	Trans	Auto	1			EM-2620	
		1989-90	Trans	Auto	1			EM-2620	
			Trans	Manual	1			EM-5181	
	V6 3.4L 207ci	1991-96	RH Front		1	EM-2555*			
			RH Rear		1	EM-2676			
			Torq Str - Front		1		EM-2799		
		1994-96	Trans	Auto	1			EM-2712 *	
		1992-93	Trans	Auto	1			EM-2620	
		1991	Trans	Auto	1			EM-2712 *	
	V6 3.8L 231ci	1997-03	Front		1	EM-2796*			
			1978-87	LH Front		1	EM-2382		
			2004-08	RH Front		1	EM-2987#		
			1978-87	RH Front		1	EM-2384		
			2004-08	Torq Str - Front	Bracket to Radiator Support Complete Unit	2		EM-3088	
				Torq Str - Front	Bracket to Radiator Support Insert	2		EM-4169	
Torq Str - Front				Complete Unit; LH & RH Front	2		EM-2866#		
1997-03			Torq Str - Front	Insert; LH & RH Front	2		EM-2716		
			Torq Str - Front	Bracket to Radiator Support Complete Unit	2		EM-2901		
1997-03			Torq Str - Front	Bracket to Radiator Support Insert	2		EM-4169		
		Torq Str - Front	Complete Unit; LH & RH Front	2		EM-2866#			
2007-08		Torq Str - Front	Insert; LH & RH Front	2		EM-2716			
		Trans		1			EM-2818 #		
1997-06		Trans		1			EM-2712 *		
		1982-87	Trans		1		EM-2379		
1978-81	Trans	Auto	1			EM-2379			
V6 4.1L 252ci	1982	LH Front		1	EM-2382				
		RH Front		1	EM-2384				
		Trans	Auto	1		EM-2379			
V6 4.3L 262ci	1986-87	L & R Front		2	EM-2436				
		Trans		1		EM-2337			
V8	V8 4.3L 265ci	1980-81	L & R Front		2	EM-2387			
			Trans	Auto	1		EM-2379		
	V8 4.4L 267ci	1981-82	L & R Front		2	EM-2292			
			Trans	Auto	1		EM-2393		
	V8 4.9L 301ci	1977-80	L & R Front		2	EM-2387			
			1980	Trans	Auto	1		EM-2393	
1978-79			Trans	Auto	1		EM-2393		
	Trans	Manual	1		EM-2392				

\* = Hydraulic Mount, "S" suffix = solid replacement. # = Available in the Westar Gold Line

# Engine, Transmission, And Torque Strut Mounts

CYL	ENG. SIZE	YEAR	LOCATION	DESCRIPTION	QTY	ENGINE	TORQUE STRUT	TRANSMISSION	
<b>PONTIAC PASSENGER CAR (continued)</b>									
<b>GRAND PRIX (continued)</b>									
V8	V8 4.9L 301ci	1977	Trans	Auto	1			EM-2393	
	V8 5.0L 305ci	1983-87	L & R Front		2	EM-2292			
		1978-80	L & R Front		2	EM-2292			
		1983-87	Trans	Auto	1			EM-2393	
		1978-80	Trans	Auto	1			EM-2393	
	V8 5.3L 325ci	2005-08	Front	Hydraulic Mount		1	EM-3093		
			Rear			1	EM-2990		
			Torq Str - Front	Bracket to Radiator Support Complete Unit		1		EM-3088	
			Torq Str - Front	Bracket to Radiator Support Insert		1		EM-4169	
			Torq Str - Front	Complete Unit		2		EM-3090	
			Torq Str - Front	Insert Only; LH & RH Front		2		EM-2716	
			Trans			1			EM-5661
	V8 5.7L 350ci	1977	L & R Front			2	EM-2292		
		1976	L & R Front			2	EM-2292		
		1976-77	Trans	Auto; THM350		1			EM-2288 @
			Trans	Auto; THM400		1			EM-2360 @
	V8 5.7L 350ci Diesel	1981-84	L & R Front			2	EM-2328		
			Trans			1			EM-2360 @
	V8 6.4L 389ci	1965-66	L & R Front			2	EM-2254		
		1962-64	LH Front			1	EM-2204		
			RH Front			1	EM-2205		
		1965-66	Trans			1			EM-2321
	1962-64	Trans	Manual			2			EM-2206
		V8 6.6L 400ci	1974-77	L & R Front			2	EM-2292	
	1970-73		LH Front			1	EM-2336		
	1968-69		LH Front			1	EM-2204		
	1970-73		RH Front			1	EM-2335		
	1968-69		RH Front			1	EM-2205		
	1976-77		Trans	Auto; THM350 (M38)		1			EM-2288 @
	1973-74		Trans	Auto		1			EM-2288 @
	1972		Trans	Auto		1			EM-2268 @
	1968-71		Trans	Auto		1			EM-2268 @
			Trans	Manual		1			EM-2378 @
	V8 6.6L 403ci	1977	L & R Front			2	EM-2387		
			Trans	Auto; THM350 (M38)		1			EM-2288 @
			Trans	Auto; THM400-475 (M40)		1			EM-2392
	V8 6.9L 421ci	1963-66	LH Front			1	EM-2204		
			RH Front			1	EM-2205		
			Trans			1			EM-2206
	V8 7.0L 428ci	1967-69	L & R Front			2	EM-2254		
			Trans	Auto		1			EM-2268 @
			Trans	Manual		1			EM-2378 @
	V8 7.5L 455ci	1974-76	L & R Front			2	EM-2292		
		1970-73	LH Front			1	EM-2336		
			RH Front			1	EM-2335		
		1976	Trans	Auto; THM350 (M38)		1			EM-2268 @
			Trans	Auto; THM400-475 (M40)		1			EM-2360 @
		1975	Trans	Auto; THM350 (M38)		1			EM-2268 @
		1974	Trans	Auto; THM400 (M40)		1			EM-2360 @
		1970-73	Trans	Auto; THM350 (M38)		1			EM-2268 @
Trans			Auto; THM400 (M40)		1			EM-2360 @	
1970-73	Trans	Manual		1			EM-2378 @		

@ = Universal Mount EM-5000 also available.



# Engine, Transmission, And Torque Strut Mounts

CYL	ENG. SIZE	YEAR	LOCATION	DESCRIPTION	QTY	ENGINE	TORQUE STRUT	TRANSMISSION	
<b>PONTIAC PASSENGER CAR (continued)</b>									
<b>GRAND SAFARI</b>									
V8	V8 4.9L 301ci	1977	L & R Front		2	EM-2387			
			Trans	Auto	1			EM-2392	
	V8 5.7L 350ci	1977	L & R Front		2	EM-2387			
			Trans		1			EM-2531	
	V8 6.6L 400ci	1973-76	L & R Front		2	EM-2375			
			1971	LH Front		1	EM-2336		
			RH Front		1	EM-2335			
		1977-78	Trans		1			EM-2392	
		1973-76	Trans		1			EM-2360 @	
		1971	Trans		1			EM-2374 @	
	V8 6.6L 403ci	1977-78	L & R Front		2	EM-2387			
	V8 7.5L 455ci	1973-76	L & R Front		2	EM-2375			
			1971-72	LH Front		1	EM-2336		
			RH Front		1	EM-2335			
		1973-76	Trans		1			EM-2360 @	
1971-72		Trans		1			EM-2374 @		
<b>GRANDVILLE</b>									
V8	V8 6.6L 400ci	1975	L & R Front		2	EM-2292			
		1973	L & R Front		2	EM-2375			
		1975	Trans		1			EM-2360 @	
		1973	Trans		1			EM-2360 @	
	V8 7.5L 455ci	1973-75	L & R Front		2	EM-2375			
			1971-72	LH Front		1	EM-2336		
			RH Front		1	EM-2335			
		1973-75	Trans		1			EM-2360 @	
		1971-72	Trans		1			EM-2374 @	
		<b>GTO</b>							
V8	V8 5.7L 350ci	2004	L & R Front		2	EM-2993*			
			Trans	Auto	1			EM-5182	
	V8 6.0L 364ci	2005-06	L & R Front		2	EM-2993*			
			Trans		1			EM-5182	
	V8 6.4L 389ci	1964-66	L & R Front		2	EM-2256			
			Trans	Auto	1			EM-2268 @	
	V8 6.6L 400ci	1967-73	LH Front		1	EM-2256			
			RH Front		1	EM-2255			
		1970-73	Trans	Auto; THM350		1			EM-2378 @
			Trans	Auto; THM400		1			EM-2268 @
			Trans	Manual		1			EM-2360 @
		1967-69	Trans	Auto; THM400		1			EM-2268 @
	Trans		Manual		1			EM-2378 @	
	V8 7.5L 455ci	1970-73	LH Front		1	EM-2336			
			RH Front		1	EM-2335			
Trans			Auto	1			EM-2378 @		
<b>J2000</b>									
L4	L4 1.8L 112ci	1983-84	RH Front		1	EM-2496			
			1982	RH Front	Auto; 3 Spd; Vin G; w/ Air	1	EM-2474		
			RH Front	Auto; 3 Spd; VIN G; w/o Air	1	EM-2506			
			RH Front	Manual; Code G; w/ Air	1	EM-2473			
			RH Front	Manual; Code G; w/o Air	1	EM-2524			
			RH Front	VIN 0	1	EM-2496			
		1983-84	RH Rear		1	EM-2477			
		1982	RH Rear	RH Rear	1	EM-2477			
		1982-84	Torq Str - Rear	Lateral	1			EM-2492	

\* = Hydraulic Mount, "S" suffix = solid replacement. @ = Universal Mount EM-5000 also available.

# Engine, Transmission, And Torque Strut Mounts

CYL	ENG. SIZE	YEAR	LOCATION	DESCRIPTION	QTY	ENGINE	TORQUE STRUT	TRANSMISSION	
<b>PONTIAC PASSENGER CAR (continued)</b>									
<b>J2000 (continued)</b>									
L4	L4 1.8L 112ci	1982-84	Torq Str - Rear	Longitudinal	1		EM-2528		
			Trans	Auto; Insert	1		EM-2720		
			Trans	Manual; Insert	1		EM-2720		
	L4 2.0L 122ci	1983-84	RH Front	Auto w/o Air	1	EM-2506			
			RH Front	Auto; w/ Air	1	EM-2474			
			RH Front	Manual; w/ Air	1	EM-2473			
			RH Front	Manual; w/o Air	1	EM-2524			
			RH Rear		1	EM-2477			
			Torq Str - Rear	Lateral	1		EM-2492		
			Torq Str - Rear	Longitudinal	1		EM-2528		
			Trans	Auto; Insert	1			EM-2720	
			Trans	Manual; Insert	1			EM-2720	
	<b>LEMANS</b>								
L4	L4 1.6L 1588cc	1990-93	Front		1	EM-2657			
		1988-89	Front		1	EM-2657			
		1990-93	RH Front		1	EM-2658			
		1988-89	RH Front	w/ Air	1	EM-2658			
			RH Front	w/o Air	1	EM-8225			
		1990-93	Rear		1	EM-2657			
		1988-89	Rear		1	EM-2657			
		1988-93	Trans	Auto	1		EM-2656		
			Trans	Manual	1		EM-2656		
	L4 2.0L 122ci	1990	1990	Front		1	EM-2657		
			1989	Front		1	EM-2656		
			1990	RH Front		1	EM-2658		
			1989	RH Front	w/ Air	1	EM-2658		
			1989-90	Trans	Auto	1		EM-2656	
				Trans	Manual	1		EM-2656	
	L6	L6 3.5L 215ci	1964-65	LH Front		1	EM-2204		
				RH Front		1	EM-2205		
Trans					1		EM-2378 @		
L6 4.1L 250ci		1973-77	1973-77	L & R Front		2	EM-2292		
			1968-72	L & R Front		2	EM-2284		
			1976-77	Trans		1		EM-2337	
			1974-75	Trans		1		EM-2288 @	
			1968-73	Trans		1		EM-2378 @	
V6		V6 3.3L 200ci	1978-79	Trans		1			EM-2288 @
		V6 3.8L 229ci	1980-81	L & R Front		2	EM-2436		
	Trans				1		EM-2378 @		
	V6 3.8L 231ci	1977-81	LH Front		1	EM-2382			
RH Front				1	EM-2384				
1978-81		Trans	Auto	1		EM-2379			
		Trans	Manual	1		EM-2379			
1977	Trans		1		EM-2360 @				
V8	V8 4.3L 260ci	1976	L & R Front		2	EM-2328			
			Trans	Auto	1		EM-2393		
			Trans	Manual	1		EM-2393		
	V8 4.3L 265ci	1980-81	L & R Front		2	EM-2292			
			Trans	Auto	1		EM-2393		
			Trans	Manual	1		EM-2393		
	V8 4.4L 267ci	1979-81	L & R Front		2	EM-2292			
			Trans	Auto	1		EM-2393		
			Trans	Manual	1		EM-2393		
	V8 4.9L 301ci	1979-81	L & R Front		2	EM-2387			
			1977	L & R Front		2	EM-2387		
		1979-81	Trans	Auto	1		EM-2392		

@ = Universal Mount EM-5000 also available.

# Engine, Transmission, And Torque Strut Mounts

CYL	ENG. SIZE	YEAR	LOCATION	DESCRIPTION	QTY	ENGINE	TORQUE STRUT	TRANSMISSION	
<b>PONTIAC PASSENGER CAR (continued)</b>									
<b>LEMANS (continued)</b>									
V8	V8 4.9L 301ci	1979-81	Trans	Manual	1			EM-2393	
		1977	Trans	Auto; THM400	1			EM-2360 @	
			Trans	Manual	1			EM-2393	
	V8 5.0L 305ci	1976-81	L & R Front		2	EM-2292			
			Trans	Auto	1			EM-2393	
			Trans	Manual	1			EM-2393	
	V8 5.3L 326ci	1964-67	LH Front		1	EM-2256			
			1963	LH Front		1	EM-2204		
		1964-67	RH Front		1	EM-2255			
		1964-67	Trans	Auto; THM350	1			EM-2378 @	
			Trans	Auto; THM400	1			EM-2268 @	
			Trans	Manual	1			EM-2378 @	
		1963	Trans		1			EM-2206	
	V8 5.7L 350ci	1978-79	L & R Front		2	EM-2292			
			1977	L & R Front	VIN P	2	EM-2387		
		1975-76	L & R Front	VIN L; VIN L	2	EM-2292			
			L & R Front	VIN R; VIN R	2	EM-2328			
			L & R Front	VIN R	2	EM-2328			
			L & R Front		2	EM-2387			
		1968-74	LH Front		1	EM-2256			
			RH Front		1	EM-2255			
		1978-79	Trans	Auto	1				EM-2393
			Trans	Manual	1				EM-2393
		1977	Trans	VIN P; Auto; THM350 (M38)	1				EM-2288 @
			Trans	VIN P					
			Trans	VIN P; Auto; THM400-475 (M40); VIN P	1				EM-2360 @
			Trans	VIN P; Manual, Code P	1				EM-2288 @
			Trans	VIN R; Auto; THM350 (M38)	1				EM-2392
			Trans	VIN R; Manual; VIN R	1				EM-2392
			Trans	VIN L; Auto; THM350	1				EM-2392
			Trans	VIN L; Auto; THM400-475 (M40)	1				EM-2360 @
			Trans	VIN L; Manual; VIN L	1				EM-2392
			Trans	VIN M & VIN P; Auto; THM350 (M38); VIN P	1				EM-2288 @
		1976	Trans	VIN M & VIN P; Auto	1				EM-2360 @
			Trans	THM400-475 (M40); VIN P					
			Trans	VIN M & VIN P; Manual, Code P	1				EM-2288 @
			Trans	VIN M & VIN P; VIN M	1				EM-2394
		1975	Trans	Auto; THM350 (M38)	1				EM-2288 @
			Trans	Auto; THM400-475 (M40)	1				EM-2268 @
			Trans	Manual	1				EM-2288 @
	1968-74	Trans	Auto; M15	1				EM-2288 @	
		Trans	Auto; THM350	1				EM-2378 @	
		Trans	Auto; THM400	1				EM-2268 @	
		Trans	Manual	1				EM-2288 @	
	V8 6.6L 400ci	1968-77	LH Front		1	EM-2256			
			RH Front		1	EM-2255			
		1975-77	Trans		1			EM-2288 @	
		1968-74	Trans		1			EM-2378 @	

@ = Universal Mount EM-5000 also available.

# Engine, Transmission, And Torque Strut Mounts

CYL	ENG. SIZE	YEAR	LOCATION	DESCRIPTION	QTY	ENGINE	TORQUE STRUT	TRANSMISSION	
<b>PONTIAC PASSENGER CAR (continued)</b>									
<b>LEMANS (continued)</b>									
V8	V8 6.6L 403ci	1977	L & R Front		2	EM-2387			
			Trans		1			EM-2392	
	V8 7.5L 455ci	1976 1972-74 1970 1972-74 1970 1972-74 1970 1972-74	L & R Front		2	EM-2292			
			LH Front		1	EM-2336			
			LH Front		1	EM-2336			
			RH Front		1	EM-2335			
			RH Front		1	EM-2335			
			Trans	Auto; THM350	1			EM-2378 @	
			Trans	Auto; THM400	1			EM-2268 @	
			Trans	Manual	1			EM-2378 @	
1970	Trans		1			EM-2268 @			
<b>OPTIMA</b>									
L4	L4 1.6L 98ci	1990-91 1988-89 1990-91 1988-89 1990-91 1988-89 1988-91	Front		1	EM-2657			
			Front		1	EM-2657			
			RH Front		1	EM-2658			
			RH Front	w/ Air	1	EM-2658			
			RH Front	w/o Air	1	EM-8225			
			Rear		1	EM-2657			
			Rear		1	EM-2657			
			Trans		1			EM-2656	
	L4 2.0L 122ci	1988-90	Front		1	EM-2657			
			RH Front		1	EM-2658			
Trans				1			EM-2656		
<b>PARISIENNE</b>									
L6	L6 4.1L 250ci	1977-79	L & R Front		2	EM-2292			
			Trans		1			EM-2337	
V6	V6 3.8L 229ci	1980	L & R Front		2	EM-2436			
			Trans		1			EM-2360 @	
	V6 3.8L 231ci	1981-85	LH Front		1	EM-2382			
			RH Front		1	EM-2384			
			Trans		1			EM-2379	
	V6 4.3L 262ci	1985-86	L & R Front		2	EM-2436			
Trans				1			EM-2360 @		
V8	V8 4.3L 265ci	1981	L & R Front		2	EM-2387			
			Trans		1			EM-2379	
	V8 4.4L 267ci	1980-82	L & R Front		2	EM-2292			
			Trans	Auto	1			EM-2393	
			Trans	Manual	1			EM-2393	
	V8 5.0L 305ci	1977-86	L & R Front		2	EM-2292			
			Trans		1			EM-2360 @	
	V8 5.0L 307ci	1986 1981 1986 1981	L & R Front		2	EM-2328			
			L & R Front		2	EM-2328			
			Trans		1			EM-2360 @	
			Trans		1			EM-2360 @	
	V8 5.7L 350ci	1978-85 1976-77 1980-85 1978-79 1976-77	L & R Front	Gas	2	EM-2328			
			L & R Front		2	EM-2387			
			Trans	Gas	1			EM-2360 @	
			Trans		1			EM-2392	
			Trans		1			EM-2531	
	V8 5.7L 350ci Diesel	1980-85	L & R Front		2	EM-2328			
			Trans		1			EM-2360 @	
V8 6.6L 400ci	1976	L & R Front		2	EM-2375				
		Trans		1			EM-2360 @		
V8 7.5L 455ci	1976	L & R Front		2	EM-2375				

@ = Universal Mount EM-5000 also available.

# Engine, Transmission, And Torque Strut Mounts

CYL	ENG. SIZE	YEAR	LOCATION	DESCRIPTION	QTY	ENGINE	TORQUE STRUT	TRANSMISSION	
<b>PONTIAC PASSENGER CAR (continued)</b>									
<b>PARISIENNE (continued)</b>									
V8	V8 7.5L 455ci	1976	Trans		1			EM-2360 @	
<b>PHOENIX</b>									
L4	L4 2.5L 151ci	1980-81	L & R Front		2	EM-2505			
		1977-78	L & R Front		2	EM-2446			
		1982-84	RH Front		1	EM-2472			
		1980-84	Torq Str - Front		1		EM-2396		
			Trans - Front	Auto	1			EM-2499	
			Trans - Front	Manual	1			EM-2467	
			Trans - Rear	Auto	1			EM-2467	
1977-78	Trans	Manual	1			EM-2531			
V6	V6 2.8L 173ci	1982-84	RH Front		1	EM-2472			
		1980-81	RH Front		1	EM-2505			
		1980-84	Torq Str - Front		1		EM-2396		
			Trans - Front	Auto	1			EM-2466	
			Trans - Front	Manual	1			EM-2467	
	V6 3.8L 231ci	1977-79	LH Front		1	EM-2382			
			RH Front		1	EM-2384			
		1978-79	Trans	Auto	1			EM-2379	
			Trans	Manual	1			EM-2379	
		1977	Trans	Auto; THM350 (M38)	1			EM-2379	
			Trans	Manual; 3 Spd	1			EM-2394	
V8	V8 5.0L 305ci	1977-79	L & R Front		2	EM-2292			
			Trans	Auto	1		EM-2393		
			Trans	Manual	1		EM-2393		
	V8 5.7L 350ci	1977-79	L & R Front		2	EM-2292			
			Trans	Auto	1		EM-2393		
			Trans		Manual	1		EM-2393	
			Trans		Manual; 5 Spd	1		EM-2531	
<b>SAFARI</b>									
V8	V8 5.0L 307ci	1987-89	L & R Front		2	EM-2328			
			Trans		1			EM-2360 @	
<b>SOLSTICE</b>									
L4	L4 2.0L 122ci	2007-09	LH Front		1	EM-3160			
			RH Front	Re-use Old Heat Shield	1	EM-3160			
			Trans	Adapter	1		EM-4126		
			Trans	Complete Unit	1		EM-3161		
	L4 2.4L 145ci	2007-09	LH Front		1	EM-3160			
			RH Front	Re-use Old Heat Shield	1	EM-3160			
			Trans	Adapter	1		EM-4126		
			Trans	Complete Unit	1		EM-3161		
<b>STAR CHIEF</b>									
V8	V8 6.4L 389ci	1959-66	LH Front		1	EM-2204			
			RH Front		1	EM-2205			
		1962-64	Trans	Manual	1		EM-2206		
	V8 6.9L 421ci	1963-66	LH Front		1	EM-2204			
			RH Front		1	EM-2205			
			1963-64	Trans	Manual	1		EM-2206	
<b>SUNBIRD</b>									
L4	L4 1.8L 112ci	1985-86	RH Front		1	EM-2538			
			RH Rear		1	EM-2477			
			Torq Str - Rear	Lateral	1		EM-2492		
			Torq Str - Rear	Longitudinal	1		EM-2528		
			Trans	Auto	1		EM-2601		

@ = Universal Mount EM-5000 also available.

# Engine, Transmission, And Torque Strut Mounts

CYL	ENG. SIZE	YEAR	LOCATION	DESCRIPTION	QTY	ENGINE	TORQUE STRUT	TRANSMISSION
<b>PONTIAC PASSENGER CAR (continued)</b>								
<b>SUNBIRD (continued)</b>								
L4	L4 1.8L 112ci	1985-86	Trans	Manual, 4 Speed, Insert	1			EM-2720
			Trans	Manual; 5 Spd	1		EM-2601	
	L4 2.0L 122ci	1985-94	RH Front		1	EM-2538		
			RH Rear		1	EM-2477		
			Torq Str - Rear	Longitudinal	1		EM-2528	
			Torq Str - Rear	Lateral	1		EM-2492	
			Torq Str - Rear	Longitudinal	1		EM-2528	
			Torq Str - Rear	Lateral	1		EM-2492	
			Torq Str - Rear	Longitudinal	1		EM-2528	
			Trans	Auto	1			EM-2601
	L4 2.3L 140ci	1976-77	LH Front		1	EM-2357		
			RH Front		1	EM-2356		
			Trans	Auto	1		EM-2353	
			Trans	Manual	1		EM-2353	
	L4 2.5L 2474cc	1977-80	L & R Front		2	EM-2446		
			L & R Rear	OEM Design	2	EM-2374@		
			Trans	Auto	1		EM-2531	
			Trans	Manual	1		EM-2531	
V6	V6 3.1L 189ci	1991-94	RH Front		1	EM-2538		
			RH Rear	Auto	1	EM-2477		
			RH Rear	Manual	1	EM-2708		
			Torq Str - Rear		1		EM-2528	
			Trans	Auto	1		EM-2601	
	Trans	Manual	1		EM-2601			
	V6 3.8L 231ci	1976-80	LH Front		1	EM-2382		
			RH Front		1	EM-2384		
			Trans	Auto	1		EM-2353	
			Trans	Manual	1		EM-2353	
Trans			Manual	1		EM-2353		
V8	V8 5.0L 305ci	1978-79	L & R Front		2	EM-2292		
			Trans	Auto	1		EM-2353	
			Trans	Manual	1		EM-2353	
<b>SUNBURST</b>								
L4	L4 1.5L 1471cc	1985-88	Front	Manual	1	EM-8442		
			RH Front		1	EM-8439		
			Trans		1		EM-8976	
<b>SUNFIRE</b>								
L4	L4 2.2L 134ci	2002-05	RH Front	DOHC	1	EM-3128		
			RH Front	OHV; Complete Unit	1	EM-5026*		
		1995-02	RH Front	OHV; Insert	1	EM-2803*		
			Torq Str - Front		1		EM-2798	
			Trans - LH Front	Manual; Insert	1		EM-2923	
			Trans - LH Rear	Manual; Insert	1		EM-2924	
	Trans	Auto	1		EM-2820			
	L4 2.3L 138ci	1995	RH Front	Insert	1	EM-2803*		
			Torq Str - Front		1		EM-2798	
			Trans - LH Front	Manual; Insert	1		EM-2923	
			Trans - LH Rear	Manual; Insert	1		EM-2924	
			Trans	Auto	1		EM-2820	
	L4 2.4L 146ci	1996-02	RH Front	Insert	1	EM-2803*		
			Torq Str - Front		1		EM-2798	
			Trans - LH Front	Manual; Insert	1		EM-2923	
			Trans - LH Rear	Manual; Insert	1		EM-2924	
Trans			Auto	1		EM-2820		

\* = Hydraulic Mount, "S" suffix = solid replacement. @ = Universal Mount EM-5000 also available.

# Engine, Transmission, And Torque Strut Mounts

CYL	ENG. SIZE	YEAR	LOCATION	DESCRIPTION	QTY	ENGINE	TORQUE STRUT	TRANSMISSION	
<b>PONTIAC PASSENGER CAR (continued)</b>									
<b>SUNRUNNER</b>									
L4	L4 1.6L 1588cc	1994-97	L & R Front		2	EM-8568			
			Trans		1			EM-8825	
<b>T1000</b>									
L4	L4 1.6L 98ci	1981-87	L & R Front		2	EM-2381			
			Trans	Auto	1			EM-2391	
			Trans	Manual	1			EM-2391	
<b>TEMPEST</b>									
L4	L4 2.0L 122ci	1987-89	Front		1	EM-2538			
			Rear		1	EM-2477			
			Torq Str - Rear	Lateral	1		EM-2492		
			Torq Str - Rear	Longitudinal	1		EM-2528		
			Trans		1			EM-2657	
	L4 2.2L 134ci	1990-91	Front		1	EM-2538			
			Rear		1	EM-2477			
			Torq Str - Front		1		EM-2528		
			Trans		1			EM-2601	
L6	L6 3.5L 215ci	1964-65	LH Front		1	EM-2204			
			RH Front		1	EM-2205			
			Trans	Auto	1			EM-2378 @	
L6 4.1L 250ci	1968-70	L & R Front		2	EM-2284				
		Trans		1			EM-2378 @		
V6	V6 3.1L 189ci	1990-91	Front		1	EM-2538			
			Rear		1	EM-2477			
			Torq Str - Front		1		EM-2528		
			Trans		1			EM-2601	
V8	V8 5.3L 326ci	1964-67	LH Front		1	EM-2256			
			1963	LH Front		1	EM-2204		
		1964-67	RH Front		1	EM-2255			
			1963	RH Front		1	EM-2205		
		Trans		1			EM-2206		
	V8 5.7L 350ci	1968-70	LH Front		1	EM-2256			
			RH Front		1	EM-2255			
			Trans	Auto; THM350	1			EM-2378 @	
			Trans	Auto; THM400	1			EM-2268 @	
	Trans	Manual	1			EM-2288 @			
	V8 6.4L 389ci	1961	LH Front		2	EM-2256			
			RH Front		1	EM-2255			
			Trans	Manual	2			EM-2206	
	V8 6.6L 400ci	1968-70	LH Front		1	EM-2256			
			RH Front		1	EM-2255			
Trans			Auto; THM350	1			EM-2378 @		
Trans			Auto; THM400	1			EM-2268 @		
Trans	Manual	1			EM-2378 @				
<b>VENTURA</b>									
L4	L4 2.5L 2474cc	1977	L & R Front		2	EM-2446			
			Trans	Manual	1			EM-2531	
L6	L6 4.1L 250ci	1973-76	L & R Front		2	EM-2292			
			1971-72	L & R Front		2	EM-2284		
		1975-76	Trans		1			EM-2337	
			1971-74	Trans	Auto	1			EM-2378 @
			Trans	Manual	1			EM-2378 @	
V6	V6 3.8L 231ci	1977	LH Front		1	EM-2382			
			RH Front		1	EM-2384			
			Trans	Auto; THM350 (M38)	1			EM-2379	

@ = Universal Mount EM-5000 also available.

# Engine, Transmission, And Torque Strut Mounts

CYL	ENG. SIZE	YEAR	LOCATION	DESCRIPTION	QTY	ENGINE	TORQUE STRUT	TRANSMISSION	
<b>PONTIAC PASSENGER CAR (continued)</b>									
<b>VENTURA (continued)</b>									
V6	V6 3.8L 231ci	1977	Trans	Manual	1			EM-2394	
V8	V8 4.3L 260ci	1975-76	L & R Front		2	EM-2328			
			Trans	Auto	1		EM-2393		
V8	V8 4.9L 301ci	1977	Trans	Manual	1			EM-2393	
			L & R Front		2	EM-2387			
V8	V8 5.0L 305ci	1977	Trans		1			EM-2392	
			L & R Front		2	EM-2387			
V8	V8 5.0L 307ci	1971-72	Trans		1			EM-2392	
			L & R Front		2	EM-2387			
			Trans	Auto	1	EM-2267		EM-2378 @	
V8	V8 5.7L 350ci	1977	Trans	Manual	1			EM-2378 @	
			L & R Front	VIN L	2	EM-2292			
			L & R Front	VIN R	2	EM-2328			
V8	V8 5.7L 350ci	1976	L & R Front		2	EM-2281			
			1972-75	L & R Front		2	EM-2254		
		1977	Trans		1			EM-2392	
			Trans		1			EM-2394	
		1972-75	Trans	Manual	1			EM-2394	
			Trans	Auto	1			EM-2378 @	
V8	V8 6.4L 389ci	1960-61	Trans	Manual	1			EM-2378 @	
			LH Front		1	EM-2204			
			RH Front		1	EM-2205			
			Trans	Manual	2			EM-2206	
<b>VIBE</b>									
L4	L4 1.8L 1794cc	2007	Front		1	EM-9158			
			2003-06	Front		1	EM-9158		
		2007	RH Front	Auto	1	EM-9164			
			2003-06	RH Front	Auto; AWD	1	EM-9525		
		2007	RH Front	Auto; FWD	1	EM-9164			
			Rear	Auto	1	EM-9155			
		2003-06	Rear	Manual	1	EM-9157			
			Rear	Auto, AWD	1	EM-9418			
	2003-07	Rear	Auto; FWD	1	EM-9155				
		Rear	Manual; FWD	1	EM-9157				
	L4	L4 1.8L 1795cc	2003-06	Trans	Exc. GT; Auto	1			EM-9163
				Trans	Exc. GT; Manual	1			EM-9163
	L4	L4 1.8L 1798cc	2009-10	Front	GT	1	EM-9158		
				RH Front	GT	1	EM-9412		
				Rear	GT	1	EM-9157		
				Trans	GT; Manual	1			EM-9163
L4	L4 1.8L 1798cc	2009-10	Front		1	EM-9391			
			RH Front		1	EM-9449			
			Rear		1	EM-9400			
			Trans	Auto	1			EM-9390	
L4	L4 2.4L 2362cc	2009-10	Front		1	EM-9419			
			RH Front	AWD	1	EM-9447			
			Rear	AWD	1	EM-9436			
			Rear	FWD	1	EM-9491			
			Trans	Auto	1			EM-9462	
<b>WAVE</b>									
L4	L4 1.6L 98ci	2005-07	Front	Hydraulic Mount	1	EM-3113			
			Torq Str - Front		1		EM-3114		
			Trans		1			EM-3113	

@ = Universal Mount EM-5000 also available.



# Engine, Transmission, And Torque Strut Mounts

CYL	ENG. SIZE	YEAR	LOCATION	DESCRIPTION	QTY	ENGINE	TORQUE STRUT	TRANSMISSION	
<b>PONTIAC SPORT UTILITY</b>									
<b>AZTEK</b>									
V6	V6 3.4L 207ci	2001-05	RH Front	AWD	1	EM-2987#			
			RH Front	FWD	1	EM-2987#			
			Torq Str - Front	Bracket to Radiator Support Complete Unit	1		EM-2900		
			Torq Str - Front	Bracket to Radiator Support Insert	2		EM-4169		
			Torq Str - Front	Complete Unit; LH & RH Front	2		EM-2899		
			Torq Str - Front	Insert; LH & RH Front	2		EM-2716		
			Trans		1			EM-2818 #	
<b>TORRENT</b>									
V6	V6 3.4L 207ci	2006-09	RH Front		1	EM-3110			
			2007-09	Trans - LH Front		1		EM-3082	
			2006	Trans - LH Front		1		EM-3082	
		2007-09	2006	Trans - LH Rear		1		EM-3069	
			2006	Trans - LH Rear		1		EM-3069	
			2006	Trans - Upper		1		EM-5475	
	V6 3.6L 217ci	2008-09	Trans - Center		1		EM-3154		
			Trans - Front		1		EM-4079		
			Trans - Rear		1		EM-4078		
<b>PONTIAC VAN</b>									
<b>MONTANA</b>									
V6	V6 3.4L 207ci	1999-05	Front		1	EM-2796*			
			Torq Str - Front	Bracket to Radiator Support Complete Unit	1		EM-2900		
			Torq Str - Front	Bracket to Radiator Support Insert	2		EM-4169		
			Torq Str - Front	Complete Unit; LH & RH Front	2		EM-2899		
			Torq Str - Front	Insert; LH & RH Front	2		EM-2716		
			Trans		1			EM-2818 #	
	V6 3.5L 213ci	2005-06	Front	AWD	1	EM-2987#			
			LH Front	FWD	1	EM-2987#			
			LH Front	Mexico; FWD	1	EM-2987#			
			Torq Str - Front	LH & RH Front	2		EM-2899		
			Trans	Auto	1			EM-2818 #	
	V6 3.9L 3880cc	2006	Front		1	EM-2987#			
			Torq Str - Front		1		EM-2899		
			Torq Str - Rear		1		EM-2899		
			Trans	Auto	1			EM-2818 #	
	<b>TRANS SPORT</b>								
	V6	V6 3.1L 189ci	1990-95	Front	FWD	1	EM-2548*		
				Torq Str - Front		1		EM-2396	
				Trans - LH Front		1			EM-2466
Trans - LH Rear					1			EM-2467	
V6 3.4L 207ci		1997-98	1996	Front		1	EM-2796*		
			1997-98	Front		1	EM-2548*		
		1997-98	Torq Str - Front	Bracket to Radiator Support Complete Unit	2		EM-2900		
			Torq Str - Front	Bracket to Radiator Support Insert	2		EM-4169		
			Torq Str - Front	Complete Unit; LH & RH Front	2		EM-2899		
			Torq Str - Front	Insert; LH & RH Front	2		EM-2716		
		1996	Torq Str - Front	Insert	1		EM-2716		
			Trans - LH Front		1			EM-2466	

\* = Hydraulic Mount, "S" suffix = solid replacement. # = Available in the Westar Gold Line

# Engine, Transmission, And Torque Strut Mounts

CYL	ENG. SIZE	YEAR	LOCATION	DESCRIPTION	QTY	ENGINE	TORQUE STRUT	TRANSMISSION
<b>PONTIAC VAN (continued)</b>								
<b>TRANS SPORT (continued)</b>								
V6	V6 3.4L 207ci	1996	Trans - LH Rear		1			EM-2467
		1997-98	Trans		1			EM-2818 #
	V6 3.8L 231ci	1992-95	Front		1	EM-2548*		
			Torq Str - Front		1		EM-2396	
			Trans - LH Front		1			EM-2466
			Trans - LH Rear		1		EM-2467	
<b>PORSCHE</b>								
<b>PANAMERA</b>								
V6	V6 3.0L 2997cc	2014-16	Torq Str - Rear		1		EM-7031	
	V6 3.6L 3605cc	2011-16	Torq Str - Rear		1		EM-7031	
V8	V8 4.8L 4806cc	2011-16	Torq Str - Rear		1		EM-7031	
<b>PORSCHE SUV</b>								
<b>CAYENNE</b>								
V8	V8 4.5L 4511cc	2003-06	Torq Str - Rear		1		EM-7031	
	V8 4.8L 4806cc	2008-10	Torq Str - Rear		1		EM-7031	
<b>RAM TRUCK</b>								
<b>1500 PICKUP</b>								
V6	V6 3.7L 226ci	2011-12	LH Front		1	EM-4275		
<b>2500 PICKUP</b>								
L6	L6 6.7L 408ci Diesel	2010-12	LH Front		1	EM-4090		
			RH Front		1	EM-4091		
			Trans	Auto	1			EM-4060
			Trans	Manual	1			EM-4060
V8	V8 5.7L 345ci	2010-12	Trans	Auto	1			EM-4060
			Trans	Manual	1			EM-4060
<b>3500 PICKUP</b>								
L6	L6 6.7L 408ci Diesel	2011-12	Trans	Auto	1			EM-4060
			Trans	Manual	1			EM-4060
V8	V8 5.7L 345ci	2011-12	Trans	Auto	1			EM-4060
			Trans	Manual	1			EM-4060
<b>RAM VAN</b>								
<b>C/V (CARGO VAN)</b>								
V6	V6 3.6L 220ci	2012-15	Front	Complete Unit	1	EM-4050		
			Front	Insert	1	EM-4186		
			Rear		1	EM-4132		
			Right		1	EM-4012		
			Trans		1			EM-4077
<b>RAM MEDIUM/HEAVY DUTY TRUCK</b>								
<b>4000</b>								
L6	L6 6.7L 408ci Diesel	2011-13	LH Front		1	EM-4090		
<b>4500</b>								
L6	L6 6.7L 408ci Diesel	2011-13	LH Front		1	EM-4090		
<b>5500</b>								
L6	L6 6.7L 408ci Diesel	2011-13	LH Front		1	EM-4090		
<b>4000</b>								
L6	L6 6.7L 408ci Diesel	2011-13	RH Front		1	EM-4091		

\* = Hydraulic Mount, "S" suffix = solid replacement. # = Available in the Westar Gold Line

## Engine, Transmission, And Torque Strut Mounts

CYL	ENG. SIZE	YEAR	LOCATION	DESCRIPTION	QTY	ENGINE	TORQUE STRUT	TRANSMISSION
<b>RAM MEDIUM/HEAVY DUTY TRUCK (continued)</b>								
<b>4500</b>								
L6	L6 6.7L 408ci Diesel	2011-13	RH Front		1	EM-4091		
<b>5500</b>								
L6	L6 6.7L 408ci Diesel	2011-13	RH Front		1	EM-4091		
<b>4000</b>								
L6	L6 6.7L 408ci Diesel	2011-12	Trans	Auto	1			EM-4060
			Trans	Manual	1			EM-4060
<b>4500</b>								
L6	L6 6.7L 408ci Diesel	2011-12	Trans	Auto	1			EM-4060
			Trans	Manual	1			EM-4060
<b>5500</b>								
L6	L6 6.7L 408ci Diesel	2011-12	Trans	Auto	1			EM-4060
			Trans	Manual	1			EM-4060
<b>4000</b>								
V8	V8 5.7L 345ci	2011-12	Trans	Auto	1			EM-4060
			Trans	Manual	1			EM-4060
<b>RENAULT PASSENGER CAR</b>								
<b>CLIO (MEXICAN VEHICLE)</b>								
L4	L4 1.6L 1598cc	2003-10	Torq Str - Lower	Auto	1		EM-9000	
			Torq Str - Lower	Manual	1		EM-9000	
		2002-08	Trans	Auto	1			EM-90031
			Trans	Manual	1			EM-90001
	L4 2.0L 1998cc	2003-06	Torq Str - Lower	Manual	1		EM-9000	
<b>LECAR</b>								
L4	L4 1.3L 1289cc	1977-79	LH Front		1	EM-2738		
			RH Front		1	EM-2737		
			Trans		1			EM-2739
	L4 1.4L 1397cc	1980-83	LH Front		1	EM-2738		
			RH Front		1	EM-2737		
			Trans		1			EM-2739
<b>R5</b>								
L4	L4 1.3L 1289cc	1976	LH Front		1	EM-2738		
			RH Front		1	EM-2737		
			Trans		1			EM-2739
<b>SANDERO (MEXICO)</b>								
L4	L4 1.6L 1597cc	2010-15	Torq Str - Lower		1		EM-8694	
<b>STEPWAY (MEXICO)</b>								
L4	L4 1.6L 1597cc	2010-15	Torq Str - Lower		1		EM-8694	
<b>RENAULT SPORT UTILITY</b>								
<b>KOLEOS (MEXICO)</b>								
L4	L4 2.5L 2488cc	2009-14	Right		1	EM-5953		
			Torq Str - Left		1		EM-9003	
<b>RENAULT VAN</b>								
<b>KANGOO (MEXICO)</b>								
L4	L4 2.0L 1998cc	2008	Torq Str - Lower	Manual	1		EM-9000	
			Trans		1			EM-90001

# Engine, Transmission, And Torque Strut Mounts

CYL	ENG. SIZE	YEAR	LOCATION	DESCRIPTION	QTY	ENGINE	TORQUE STRUT	TRANSMISSION	
<b>SAAB PASSENGER CAR</b>									
<b>9-3</b>									
L4	L4 2.0L 1985cc	1999-03	RH Front	Auto	1	EM-5617			
			RH Front	Manual	1	EM-5492			
			Rear	Auto	1	EM-9291			
	L4 2.3L 2290cc	1999-02	Trans	Auto	1			EM-5372	
			Trans	Manual	1			EM-5947	
			Trans	Manual	1			EM-5947	
<b>9-5</b>									
L4	L4 2.3L 2290cc	1999-01	LH Front		1	EM-5436			
		2000-09	Torq Str - Front	Auto	1		EM-9292		
		1999	Torq Str - Front	Auto	1		EM-9290		
		1999	Torq Str - Rear	Manual	1		EM-5437		
V6	V6 2.8L 2792cc	2010-11	Trans - Rear	AWD	1			EM-4261	
		1999-01	LH Front		1	EM-5436			
	V6 3.0L 2961cc	2000-03	Torq Str - Front		1		EM-9292		
		1999	Torq Str - Rear	Auto	1		EM-9290		
		1999	Torq Str - Rear	Manual	1		EM-5437		
<b>900</b>									
L4	L4 2.0L	1991-94	Front		1	EM-5461			
		1990	Front		1	EM-5461			
		1986-88	Front		1	EM-5397			
		1981-85	Front		1	EM-5397			
		1996-98	RH Front	Auto	1	EM-5617			
			RH Front	Manual	1	EM-5492			
		1991-94	RH Front		1	EM-5462			
			RH Front		1	EM-5462			
		1986-88	RH Front		1	EM-5460			
			RH Front		1	EM-5460			
		1996-98	Rear	Auto	1	EM-9291			
			Trans	Auto	1			EM-5372	
			Trans	Manual	1			EM-5947	
		1994-95	Trans	Auto	1			EM-5372	
	Trans		Manual	1			EM-5947		
	1981-88	Trans		1			EM-5488		
	L4 2.1L	1991-94	Front		1	EM-5461			
			RH Front		1	EM-5462			
		1994	Trans	Auto	1			EM-5372	
			Trans	Manual	1			EM-5947	
		L4 2.3L	1994-98	RH Front	Auto	1	EM-5617		
				RH Front	Manual	1	EM-5492		
	Rear	Auto		1	EM-9291				
	1996-98	Trans	Auto	1			EM-5372		
Trans		Manual	1			EM-5947			
1994-95	Trans	Auto	1			EM-5372			
	Trans	Manual	1			EM-5947			
V6	V6 2.5L	1996-97	RH Front	Auto	1	EM-5617			
		1994-95	RH Front	Auto	1	EM-5617			
			RH Front	Manual	1	EM-5492			
		1996-97	Trans	Auto	1			EM-5372	
<b>9000</b>									
L4	L4 2.0L	1986-89	Front		1	EM-9293			
		1990	LH Rear		1	EM-9289			
		1986-89	Rear		1	EM-9294			
		1986-90	Torq Str - Rear		1		EM-5373		
		1986-89	Trans	Auto	1			EM-5489	
	L4 2.3L	1990-98	Front		1	EM-5490			

# Engine, Transmission, And Torque Strut Mounts

CYL	ENG. SIZE	YEAR	LOCATION	DESCRIPTION	QTY	ENGINE	TORQUE STRUT	TRANSMISSION
<b>SAAB PASSENGER CAR (continued)</b>								
<b>9000 (continued)</b>								
L4	L4 2.3L	1990-98	LH Rear		1	EM-9289		
			Torq Str - Rear		1		EM-5373	
			Trans		1			EM-5489
V6	V6 3.0L	1995-97	Front		1	EM-5490		
			LH Rear		1	EM-9289		
			Trans		1			EM-5489
<b>SAAB SUV</b>								
<b>9-7X</b>								
L6	L6 4.2L 256ci	2005-09	L & R Front		2	EM-3021*		
			Trans		1			EM-3027
V8	V8 5.3L 325ci	2005-09	LH Front		1	EM-5694		
			RH Front		1	EM-5693		
			Trans		1			EM-4119
<b>SATURN PASSENGER CAR</b>								
<b>ASTRA</b>								
L4	L4 1.8L 110ci	2008-09	Right		1	EM-4122		
<b>AURA</b>								
L4	L4 2.4L 145ci	2007-08	Front		1	EM-3117		
			2009	RH Front		1	EM-3118	
		2009	Trans - Center	Auto; 4 Spd	1			EM-4047
			Trans - Center	Auto; 6 Spd	1			EM-4134
		2008	Trans - Center		1			EM-4134
		2009	Trans - Front	Auto; 4 Spd; Complete Unit	1			EM-4027
			Trans - Front	Auto; 4 Spd; Insert	1			EM-4206
			Trans - Front	Auto; 6 Spd	1			EM-4046
		2008	Trans - Front	Auto; 4 Spd; Complete Unit	1			EM-4027
			Trans - Front	Auto; 4 Spd; Insert	1			EM-4206
		2007	Trans - Front	Insert	1			EM-4206
		2009	Trans - Rear	Auto; 4 Spd; Complete Unit	1			EM-5862
			Trans - Rear	Auto; 4 Spd; Insert	1			EM-4206
			Trans - Rear	Auto; 6 Spd	1			EM-4045
		2008	Trans - Rear	Auto; 4 Spd; 1st Design Stamped Part	1			EM-3094
			Trans - Rear	Auto; 4 Spd; 2nd Design; Cast Part	1			EM-5862
			Trans - Rear	Auto; 4 Spd; Insert	1			EM-4206
2007	Trans - Rear	Complete Unit	1			EM-3094		
	Trans - Rear	Insert	1			EM-4206		
V6	V6 3.5L 213ci	2007-08	Front	Hydraulic Mount	1	EM-3097		
		2008	Trans - Center		1			EM-3096
			Trans - Front	Complete Unit	1			EM-4027
			Trans - Front	Insert	1			EM-4206
		2007	Trans - Front	Complete Unit	1			EM-5659
			Trans - Front	Insert	1			EM-4206
		2008	Trans - Rear	Insert	1			EM-4206
			2007	Trans - Rear	Complete Unit	1		EM-3094
		2007	Trans - Rear	Insert	1			EM-4206
		V6 3.6L 217ci	2007-09	Front	Hydraulic Mount	1	EM-3097	
	Trans - Center				1			EM-3135
Trans - Front	Complete Unit			1			EM-4061	
Trans - Front	Insert			1			EM-4206	
Trans - Rear	Complete Unit			1			EM-4062	
2007	Trans - Rear	Insert	1			EM-4206		

\* = Hydraulic Mount, "S" suffix = solid replacement.

# Engine, Transmission, And Torque Strut Mounts

CYL	ENG. SIZE	YEAR	LOCATION	DESCRIPTION	QTY	ENGINE	TORQUE STRUT	TRANSMISSION
<b>SATURN PASSENGER CAR (continued)</b>								
<b>ION</b>								
L4	L4 2.0L 122ci	2004-07	Front	Red Line	1	EM-3108		
		2005-07	Trans - Front	Red Line	1			EM-3092
			Trans - Rear	Red Line	1			EM-3092
	L4 2.2L 134ci	2005-07	Front	Auto; 4 Spd	1	EM-3109		
			Front	Manual	1	EM-3108		
		2003-04	Front	Auto; 5 Spd	1	EM-3108		
			Front	CVT Trans.	1	EM-3108		
			Front	Manual	1	EM-3108		
		2005-07	Trans - Center		1			EM-4158
		2003-04	Trans - Center	Auto	1			EM-5645
		2005-07	Trans - Front	Bushing Only; Auto	1			EM-3081
		2003-04	Trans - Front	Bushing Only; Auto	1			EM-3041
		2005-07	Trans - LH Front	Auto	1			EM-3086
	2003-04	Trans - LH Front	Auto	1			EM-3042	
		Trans - LH Front	Manual	1			EM-3043	
	L4 2.4L 145ci	2006-07	Front	Auto; 4 Spd	1	EM-3109		
Front			Manual	1	EM-3108			
Trans - Center				1			EM-4158	
Trans - Front			Auto	1			EM-3086	
Trans - Front			Bushing Only; Auto	1			EM-3043	
<b>L100</b>								
L4	L4 2.2L 134ci	2001-02	RH Front	Auto	1	EM-3022'		
			RH Front	Manual	1	EM-3091		
			Rear	Auto	1	EM-3031		
			Trans	Auto	1			EM-3032
<b>L200</b>								
L4	L4 2.2L 134ci	2001-03	RH Front	Auto	1	EM-3022'		
			RH Front	Manual	1	EM-3091		
			Rear	Auto	1	EM-3031		
			Trans	Auto	1			EM-3032
<b>L300</b>								
L4	L4 2.2L 134ci	2004	LH Front		1	EM-3033'		
			RH Front		1	EM-3023'		
			Rear		1	EM-3031		
			Trans	Auto	1			EM-3032
V6	V6 3.0L 181ci	2001-05	LH Front		1	EM-3033'		
			RH Front		1	EM-3023'		
			Rear		1	EM-3031		
			Trans	Auto	1			EM-3032
<b>LS</b>								
L4	L4 2.2L 134ci	2000	RH Front	Auto	1	EM-3022'		
			RH Front	Manual	1	EM-3091		
			Rear	Auto	1	EM-3031		
			Trans	Auto	1			EM-3032
<b>LS1</b>								
L4	L4 2.2L 134ci	2000	RH Front	Auto	1	EM-3022'		
			RH Front	Manual	1	EM-3091		
			Rear	Auto	1	EM-3031		
			Trans	Auto	1			EM-3032
<b>LS2</b>								
V6	V6 3.0L 181ci	2000	LH Front	Hydraulic Mount	1	EM-3033'		
			RH Front		1	EM-3023'		
			Rear	Auto	1	EM-3031		

\* = Hydraulic Mount, "S" suffix = solid replacement.

# Engine, Transmission, And Torque Strut Mounts

CYL	ENG. SIZE	YEAR	LOCATION	DESCRIPTION	QTY	ENGINE	TORQUE STRUT	TRANSMISSION
<b>SATURN PASSENGER CAR (continued)</b>								
<b>LS2 (continued)</b>								
V6	V6 3.0L 181ci	2000	Trans	Auto	1			EM-3032
<b>LW1</b>								
L4	L4 2.2L 134ci	2000	RH Front		1	EM-3022'		
			Rear		1	EM-3031		
			Trans	Auto	1			EM-3032
<b>LW2</b>								
V6	V6 3.0L 181ci	2000	LH Front		1	EM-3033'		
			RH Front		1	EM-3023'		
			Rear		1	EM-3031		
			Trans	Auto	1			EM-3032
<b>LW200</b>								
L4	L4 2.2L 134ci	2001-03	RH Front	Auto	1	EM-3022'		
			RH Front	Manual	1	EM-3091		
			Rear	Auto	1	EM-3031		
			Trans	Auto	1			EM-3032
<b>LW300</b>								
V6	V6 3.0L 181ci	2001-03	LH Front		1	EM-3033'		
			RH Front		1	EM-3023'		
			Rear		1	EM-3031		
			Trans	Auto	1			EM-3032
<b>SKY</b>								
L4	L4 2.0L 122ci	2007-10	LH Front		1	EM-3160		
			RH Front	Re-use Old Heat Shield	1	EM-3160		
			Trans	Adapter	1			EM-4126
			Trans	Complete Unit	1			EM-3161
	L4 2.4L 145ci	2007-10	LH Front		1	EM-3160		
			RH Front	Re-use Old Heat Shield	1	EM-3160		
			Trans	Adapter	1			EM-4126
			Trans	Complete Unit	1			EM-3161
<b>SC</b>								
L4	L4 1.9L 116ci	1991-92	RH Front		1	EM-2827		
			Torq Str - Front		1		EM-2825	
		1992	Torq Str - Rear		1		EM-2825	
		1991-92	Trans	Auto	1			EM-2826
			Trans	Manual	1			EM-2826
<b>SC1</b>								
L4	L4 1.9L 116ci	1993-02	RH Front		1	EM-2827		
			Torq Str - Front		1		EM-2825	
			Torq Str - Rear		1		EM-2825	
			Trans	Auto	1			EM-2826
			Trans	Manual	1			EM-2826
<b>SC2</b>								
L4	L4 1.9L 116ci	1993-02	RH Front		1	EM-2827		
			Torq Str - Front		1		EM-2825	
			Torq Str - Rear		1		EM-2825	
			Trans	Auto	1			EM-2826
			Trans	Manual	1			EM-2826
<b>SL</b>								
L4	L4 1.9L 116ci	1992-02	RH Front		1	EM-2827		
			Torq Str - Front		1		EM-2825	
			Torq Str - Rear		1		EM-2825	
			Trans	Auto	1			EM-2826

\* = Hydraulic Mount, "S" suffix = solid replacement.

# Engine, Transmission, And Torque Strut Mounts

CYL	ENG. SIZE	YEAR	LOCATION	DESCRIPTION	QTY	ENGINE	TORQUE STRUT	TRANSMISSION	
<b>SATURN PASSENGER CAR (continued)</b>									
<b>SL (continued)</b>									
L4	L4 1.9L 116ci	1992-02	Trans	Manual	1			EM-2826	
<b>SL1</b>									
L4	L4 1.9L 116ci	1992-02	RH Front		1	EM-2827			
			Torq Str - Front		1		EM-2825		
			Torq Str - Rear		1		EM-2825		
			Trans	Auto	1			EM-2826	
			Trans	Manual	1			EM-2826	
<b>SL2</b>									
L4	L4 1.9L 116ci	1992-02	RH Front		1	EM-2827			
			Torq Str - Front		1		EM-2825		
			Torq Str - Rear		1		EM-2825		
			Trans	Auto	1			EM-2826	
			Trans	Manual	1			EM-2826	
<b>SW1</b>									
L4	L4 1.9L 116ci	1993-99	RH Front		1	EM-2827			
			Torq Str - Front		1		EM-2825		
			Torq Str - Rear		1		EM-2825		
			Trans		1			EM-2826	
<b>SW2</b>									
L4	L4 1.9L 116ci	1993-01	RH Front		1	EM-2827			
			Torq Str - Front		1		EM-2825		
			Trans		1			EM-2826	
<b>SATURN SUV</b>									
<b>OUTLOOK</b>									
V6	V6 3.6L 217ci	2009-10	Front		1	EM-4037			
			2007-08	Front		1	EM-3192		
		2009-10	Rear		1	EM-4035			
			2007-08	Rear		1	EM-3192		
		2009-10	Torq Str - Right		1		EM-3141		
		2007-08	Torq Str - Right	Bracket Only		1		EM-3143	
			Torq Str - Right	Strut		1		EM-3133	
		2009-10	Trans		1			EM-4036	
		2007-08	Trans		1			EM-4253	
<b>VUE</b>									
L4	L4 2.2L 134ci	2002-07	RH Front	Auto	1	EM-3109			
			RH Front	Manual	1	EM-3108			
		L4 2.4L 145ci	2008-10	Trans - Upper		1		EM-4064	
V6	V6 3.0L 181ci	2002-03	RH Front		1	EM-3110			
			Trans - LH Rear		1			EM-3040	
	V6 3.6L 217ci	2008-10	Front		1	EM-4155			
			Trans - Rear		1			EM-4063	
<b>SATURN VAN</b>									
<b>RELAY</b>									
V6	V6 3.5L 213ci	2005-06	Front	AWD	1	EM-2987#			
			Front	FWD	1	EM-2987#			
			Torq Str - Front	Bracket to Radiator Support Complete Unit	2		EM-2900		
			Torq Str - Front	Bracket to Radiator Support Insert	2		EM-4169		
			Torq Str - Front	Complete Unit; LH & RH Front	2		EM-2899		
			Torq Str - Front	Insert Only; LH & RH Front	2		EM-2716		
			Trans		1			EM-2818 #	

# = Available in the Westar Gold Line



# Engine, Transmission, And Torque Strut Mounts

CYL	ENG. SIZE	YEAR	LOCATION	DESCRIPTION	QTY	ENGINE	TORQUE STRUT	TRANSMISSION
<b>SATURN VAN (continued)</b>								
<b>RELAY (continued)</b>								
V6	V6 3.9L 237ci	2006-07	RH Front		1	EM-2987#		
			Torq Str - Front	Bracket to Radiator Support Complete Unit	2		EM-2900	
			Torq Str - Front	Bracket to Radiator Support Insert	2		EM-4169	
			Torq Str - Front	Complete Unit; LH & RH Front	2		EM-2899	
			Torq Str - Front	Insert Only; LH & RH Front	2		EM-2716	
			Trans		1			EM-2818 #
<b>SCION PASSENGER CAR</b>								
<b>FR-S</b>								
H4	H4 2.0L 1998cc	2013-16	LH Front		1	EM-7254		
			RH Front		1	EM-7255		
<b>TC</b>								
L4	L4 2.4L 2398cc	2005-10	Front		1	EM-9158		
			Rear	Auto	1	EM-5986		
			Rear	Manual	1	EM-5988		
			Right		1	EM-5916		
			Trans		1		EM-5989	
	L4 2.5L 2494cc	2011-16	Rear	Auto	1	EM-7201		
			Right		1	EM-7307		
<b>XA</b>								
L4	L4 1.5L 1497cc	2004-06	RH Front		1	EM-9015		
			Rear		1	EM-8968		
			Trans	Auto	1		EM-9284	
			Trans	Manual	1		EM-8888	
<b>XD</b>								
L4	L4 1.8L 1798cc	2008-14	Torq Str - Rear L	Auto	1		EM-5944	
			Torq Str - Rear L	Manual	1		EM-9612	
			Torq Str - Upper	Auto	1		EM-7042	
			Trans	Auto	1		EM-7015	
<b>SCION VAN</b>								
<b>XB</b>								
L4	L4 1.5L 1497cc	2004-06	RH Front		1	EM-9015		
			Rear		1	EM-8968		
			Trans	Auto	1		EM-9284	
			Trans	Manual	1		EM-8888	
	L4 2.4L 2362cc	2008-15	Front		1	EM-9497		
			Rear	Auto	1	EM-7048		
			Right		1	EM-5973		
<b>SEAT PASSENGER CAR</b>								
<b>ALTEA</b>								
L4	L4 2.0L 1984cc	2005-06	Front Lower	Mexican Vehicle	1	EM-9260		
			Front Upper	Mexican Vehicle	1	EM-9263		
			RH Front	Hydraulic Mount; Mexican Vehicle	1	EM-9092		
			Rear	Mexican Vehicle	1	EM-9283		
			Trans	Auto; Hydraulic Mount Mexican Vehicle	1		EM-9262	

# = Available in the Westar Gold Line

# Engine, Transmission, And Torque Strut Mounts

CYL	ENG. SIZE	YEAR	LOCATION	DESCRIPTION	QTY	ENGINE	TORQUE STRUT	TRANS-MISSION	
<b>SEAT PASSENGER CAR (continued)</b>									
<b>CORDOBA</b>									
L4	L4 1.6L 1595cc	2001-02	Front	Auto; Mexico Vehicle	1	EM-8224			
			Front	Manual; Bracket Only; Mexican Vehicle	1	EM-5612			
			Front	Manual; Mexican Vehicle	1	EM-8224			
			RH Front	Mexican Vehicle	1	EM-8222			
			Trans	Mexican Vehicle	1			EM-8287	
<b>IBIZA</b>									
L4	L4 1.6L 1595cc	2001-02	Front	Auto; Mexico Vehicle	1	EM-8224			
			Front	Manual; Bracket Only; Mexican Vehicle	1	EM-5612			
			Front	Manual; Mexican Vehicle	1	EM-8224			
			RH Front	Mexican Vehicle	1	EM-8222			
			Trans	Mexican Vehicle	1			EM-8287	
	L4 1.8L 1781cc	2005-08	RH Front	Hydraulic Mount; Mexican Vehicle	1	EM-9092			
			Rear	Mexican Vehicle	1	EM-9208			
			2005-06	Trans	Hydraulic Mount; Mexican Vehicle	1			EM-9101
<b>LEON</b>									
L4	L4 1.8L 1781cc	2001-06	RH Front	Hydraulic Mount; Mexican Vehicle	1	EM-9092			
			Rear	Mexican Vehicle	1	EM-9208			
			Trans	Hydraulic Mount; Mexican Vehicle	1			EM-9101	
	L4 2.0L 1984cc	2007-08	Front Lower	Mexican Vehicle	1	EM-9260			
			Front Upper	Mexican Vehicle	1	EM-9263			
			RH Front	Hydraulic Mount; Mexican Vehicle	1	EM-9092			
			Rear	Mexican Vehicle	1	EM-9283			
			Trans	Manual; Hydraulic Mount Mexican Vehicle	1			EM-9245	
	<b>TOLEDO</b>								
	L4	L4 1.8L 1781cc	2002-05	RH Front	Hydraulic Mount; Mexican Vehicle	1	EM-9092		
Rear				Mexican Vehicle	1	EM-9208			
Trans				Hydraulic Mount; Mexican Vehicle	1			EM-9101	
<b>SRT</b>									
<b>VIPER</b>									
V10	V10 8.4L 515cid	2013-14	Trans		1			EM-5587	
<b>STERLING MEDIUM/HEAVY DUTY TRUCK</b>									
<b>BULLET 45</b>									
L6	L6 6.7L 408ci Diesel	2008-10	Left		1	EM-4090			
<b>BULLET 55</b>									
L6	L6 6.7L 408ci Diesel	2008-10	Left		1	EM-4090			
<b>BULLET 45</b>									
L6	L6 6.7L 408ci Diesel	2008-10	Right		1	EM-4091			
<b>BULLET 55</b>									
L6	L6 6.7L 408ci Diesel	2008-10	Right		1	EM-4091			

# Engine, Transmission, And Torque Strut Mounts

CYL	ENG. SIZE	YEAR	LOCATION	DESCRIPTION	QTY	ENGINE	TORQUE STRUT	TRANS-MISSION	
<b>STERLING MEDIUM/HEAVY DUTY TRUCK (continued)</b>									
<b>BULLET 45</b>									
L6	L6 6.7L 408ci Diesel	2008-10	Trans	Auto	1			EM-4060	
			Trans	Manual	1			EM-4060	
<b>BULLET 55</b>									
L6	L6 6.7L 408ci Diesel	2008-10	Trans	Auto	1			EM-4060	
			Trans	Manual	1			EM-4060	
<b>SUBARU PASSENGER CAR</b>									
<b>BRZ</b>									
H4	H4 2.0L 1998cc	2013-17	LH Front		1	EM-7254			
			RH Front		1	EM-7255			
<b>DL</b>									
H4	H4 1.6L 1595cc	1982-84	L & R Front		2	EM-8641			
		1976-84	Trans - L & R		2			EM-8665	
	H4 1.8L	1985-89	Torq Str - Front	Complete Unit	1		EM-5602		
			Torq Str - Front	Insert Only; Small Bushing	1		EM-5603		
		1986-87	Trans	Auto	1			EM-5599	
			Trans	Manual	2			EM-8640	
	1985	Trans	Manual	2			EM-8640		
	H4 1.8L 1781cc	1986-89	Front	Auto	1	EM-8641			
			Front	Auto	1	EM-8661			
			Front	Manual	1	EM-8641			
		1986-89	Rear	Manual	1	EM-8640			
			1985	Rear		1	EM-8640		
			1980-84	Trans - L & R		2			EM-8665
	1988-89	Trans	Manual	2			EM-8640		
<b>GL</b>									
H4	H4 1.6L 1595cc	1979-80	L & R Front		2	EM-8641			
		1986-87	Trans - Lower	Manual	2			EM-8665	
			Trans	Auto	2			EM-5186	
		1979-80	Trans	Auto	1			EM-8661	
			Trans	Manual	1			EM-8665	
	H4 1.8L	1985-89	Torq Str - Front	Complete Unit	1		EM-5602		
			Torq Str - Front	Insert Only; Small Bushing	1		EM-5603		
	H4 1.8L 1781cc	1985-89	Front		1	EM-8641			
			1980-84	Front	Auto	1	EM-8661		
				Front	Manual	1	EM-8641		
		1985-89	Rear	Manual	1	EM-8640			
			1980-84	Rear	Manual	1	EM-8665		
				1988-89	Trans	Manual, Hatchback	1		
		1985-87	Trans	Manual; exc. Hatchback	2			EM-8640	
			Trans	Auto	1			EM-5599	
			Trans	Manual, Hatchback	1			EM-8665	
	Trans		Manual; exc. Hatchback	1			EM-8640		
	1980-84	Trans	Manual	1			EM-8665		
	<b>GL-10</b>								
H4	H4 1.8L	1988-89	Torq Str - Front	Complete Unit	1		EM-5602		
			Torq Str - Front	Insert Only; Small Bushing	1		EM-5603		
<b>IMPREZA</b>									
H4	H4 1.8L 1781cc	1993-97	L & R Front		2	EM-9024			
			Torq Str - Front		1		EM-5187		
		1996-97	Trans - LH	Auto; AWD	1			EM-5189	
		1993-95	Trans - LH	Auto; AWD	1			EM-5189	
		1996-97	Trans - RH	Auto; AWD	1			EM-5188	
		1993-95	Trans - RH	Auto; AWD	1			EM-5188	
1996-97	Trans	Manual; AWD	1			EM-5190			

# Engine, Transmission, And Torque Strut Mounts

CYL	ENG. SIZE	YEAR	LOCATION	DESCRIPTION	QTY	ENGINE	TORQUE STRUT	TRANSMISSION
<b>SUBARU PASSENGER CAR (continued)</b>								
<b>IMPREZA (continued)</b>								
H4	H4 1.8L 1781cc	1993-95	Trans	Auto; FWD	1			EM-7007
			Trans	Manual; AWD	1		EM-5190	
			Trans	Manual; FWD	1		EM-5597	
	H4 2.0L 1994cc	2002-05	L & R Front		2	EM-9023		
			Trans	Auto	1		EM-9074	
			Trans	Manual	1		EM-5515	
	H4 2.0L 1995cc	2012-13	LH Front	US & Canada; Auto; CVT	1	EM-5959		
			RH Front	US & Canada; Auto; CVT	1	EM-5960		
		2012-15	Trans		1			EM-5945
			Trans	Manual	1			EM-5515
	H4 2.2L 2212cc	1996-01	L & R Front		2	EM-9023		
			1995	L & R Front	Auto	2	EM-9024	
		1995-98	L & R Front	Manual	2	EM-9023		
			Rear	FWD	1	EM-5597		
		1995-98	Torq Str - Front		1		EM-5187	
		1995-99	Trans - LH	Auto	1			EM-5189
			Trans - RH	Auto	1			EM-5188
		2000-01	Trans	Auto	1			EM-9074
			Trans	Manual; AWD	1			EM-5515
		1995-99	Trans	Manual; AWD	1			EM-5515
	H4 2.5L 2458cc	2008-11	L & R Front	Non Turbo	2	EM-9024		
		2002-07	L & R Front	AWD	2	EM-9024		
		1998-01	L & R Front	AWD	2	EM-9023		
		1998	Torq Str - Front		1		EM-5187	
		2008-11	Trans	Manual; 5 Spd	1			EM-5515
		2002-07	Trans	Auto	1			EM-9074
		1998-01	Trans	Manual; 5 Spd	1			EM-5515
Trans			Auto	1			EM-9074	
1998-01		Trans	Manual	1			EM-5515	
<b>LEGACY</b>								
	H6 3.6L 3630cc	2010-14	Center Lower		1	EM-7247		
		2015-16	L & R Front		2	EM-7267		
		2010-14	L & R Front		2	EM-7248		
			Trans		1			EM-7246
H4	H4 2.2L 2212cc	1996-99	L & R Front	Auto	2	EM-9024		
		1995	L & R Front	Auto; FWD	2	EM-9024		
		1992-94	LH Front	LS, AWD, Auto	1	EM-5597		
			LH Front		1	EM-5601		
		1990-91	LH Front		1	EM-5601		
		1995	RH Front	LS, AWD, Auto	1	EM-5600		
		1992-94	RH Front		1	EM-5600		
		1990-91	RH Front		1	EM-5600		
			Rear	FWD	1	EM-5597		
		1999	Torq Str - Front	AWD	1		EM-5191	
		1997-98	Torq Str - Front	AWD	1		EM-5191	
		1995-96	Torq Str - Front	AWD	1		EM-5191	
			Torq Str - Front	FWD	1		EM-5187	
		1990-94	Torq Str - Front	Insert Only; Small Bushing	1		EM-5603	
		1995-96	Trans - LH	Auto; AWD	1			EM-5189
		1992-94	Trans - LH	Auto; AWD	1			EM-5189
		1995-96	Trans - RH	Auto; AWD	1			EM-5188
		1992-94	Trans - RH	Auto; AWD	1			EM-5188
		1997-99	Trans	Auto; AWD	1			EM-9074
			Trans	Manual	1			EM-5515
1995-96	Trans	Auto; FWD	1			EM-7007		
	Trans	Manual	1			EM-5515		
1992-94	Trans	Auto; FWD	1			EM-7007		

# Engine, Transmission, And Torque Strut Mounts

CYL	ENG. SIZE	YEAR	LOCATION	DESCRIPTION	QTY	ENGINE	TORQUE STRUT	TRANS-MISSION	
<b>SUBARU PASSENGER CAR (continued)</b>									
<b>LEGACY (continued)</b>									
H4	H4 2.2L 2212cc	1992-94	Trans	Manual, AWD	1			EM-5515	
			Trans	Manual; FWD	1			EM-5597	
		1990-91	Trans	Manual	1			EM-5515	
	H4 2.5L 2458cc	2010-12	Front Center	Turbo	1	EM-7253			
			L & R Front	Turbo	2	EM-7248			
		2000-04	L & R Front	Auto	2	EM-9024			
			L & R Front	Auto	2	EM-9024			
		1996-99	L & R Front	Auto	2	EM-9024			
			L & R Front	Manual	2	EM-9023			
		2005-09	LH Front	Non Turbo	1	EM-5971			
			LH Front	Turbo	1	EM-5971			
		2000-04	LH Front	Manual	1	EM-7256			
			RH Front	Non Turbo	1	EM-5983			
		2005-09	RH Front	Non Turbo	1	EM-5983			
			RH Front	Turbo	1	EM-5983			
		2000-04	RH Front	Manual	1	EM-7257			
			Torq Str - Front		1			EM-5191	
		2006-09	Torq Str - Rear		1			EM-9559	
		2000-05	Torq Str - Rear		1			EM-9559	
		2010-12	Trans	Manual	1				EM-5515
			Trans	Auto w/o Turbo	1				EM-9074
		2007-09	Trans	Manual; w/o Turbo	1				EM-5515
			Trans	Turbo, Auto	1				EM-9560
			Trans	Turbo, Manual	1				EM-9566
	Trans		Turbo, Manual	1				EM-9566	
	2005-06	Trans	Auto w/o Turbo	1				EM-9074	
		Trans	Manual; 5 Spd	1				EM-5515	
		Trans	Turbo, Auto	1				EM-9560	
	2000-04	Trans	Auto	1				EM-9074	
		Trans	Manual; 5 Spd	1				EM-5515	
1996-99	Trans	Auto	1				EM-9074		
	Trans	Manual	1				EM-5515		
H4 2.5L 2498cc	2013-16	L & R Front		2	EM-7284				
		2013-14	Trans	Auto	1			EM-5945	
<b>LOYALE</b>									
H4	H4 1.8L	1990-94	Torq Str - Front	Complete Unit	1		EM-5602		
			Torq Str - Front	Insert Only; Small Bushing	1		EM-5603		
	H4 1.8L 1781cc	1994	L & R Front		2	EM-8641			
			L & R Front		2	EM-5598			
			Rear		1	EM-8665			
			Trans - Center	Auto	1			EM-9570	
		Trans	Manual	2			EM-8640		
<b>RX</b>									
H4	H4 1.8L 1781cc	1986-89	Trans	Manual	2			EM-8640	
<b>STANDARD</b>									
H4	H4 1.6L 1595cc	1987	Front	Auto	1	EM-8661			
			RH Front		1	EM-8640			
		1985-86	RH Front		1	EM-8640			
		1980-84	RH Front		1	EM-8640			
		1987	Rear	Manual	1	EM-8641			
		1985-86	Rear	Manual	1	EM-8641			
		1980-84	Rear	Manual	1	EM-8641			
		1980-87	Trans - L & R		1			EM-8665	
	H4 1.8L 1781cc	1987	L & R Front		2	EM-8641			
			L & R Front		2	EM-8641			
		1981-82	Trans	Auto	1			EM-5186	
			Trans	Manual	1			EM-8665	

# Engine, Transmission, And Torque Strut Mounts

CYL	ENG. SIZE	YEAR	LOCATION	DESCRIPTION	QTY	ENGINE	TORQUE STRUT	TRANS-MISSION	
<b>SUBARU PASSENGER CAR (continued)</b>									
<b>SVX</b>									
H6	H6 3.3L 3318cc	1992-97	Torq Str - Front		1		EM-5187		
<b>WRX</b>									
H4	H4 2.0L 1998cc	2015-16	LH Front		1	EM-7254			
			RH Front		1	EM-7255			
<b>XT</b>									
H4	H4 1.8L	1985-89	Torq Str - Front	Complete Unit	1		EM-5602		
			Torq Str - Front	Insert Only; Small Bushing	1		EM-5603		
	H4 1.8L 1781cc	1985-91	Front		1	EM-8641			
			Trans	Auto	1			EM-5599	
			Trans	Manual	2			EM-8640	
H6	H6 2.7L	1988-91	Torq Str - Front	Insert Only; Small (50mm) Bushing	1		EM-5603		
<b>XV CROSSTREK</b>									
H4	H4 2.0L 1995cc	2013	LH Front	Auto; CVT	1	EM-5959			
			RH Front	Auto; CVT	1	EM-5960			
		2013-14	Trans		1			EM-5945	
			Trans	Manual	1			EM-5515	
<b>SUBARU SPORT UTILITY</b>									
<b>BAJA</b>									
H4	H4 2.5L 2458cc	2004-06	L & R Front	Auto, w/ Turbo	2	EM-9023			
			L & R Front	Auto, w/o Turbo	2	EM-9024			
		2003	L & R Front	Auto	2	EM-9024			
		2004-06	LH Front	Manual	1	EM-7256			
		2003	LH Front	Manual	1	EM-7256			
		2004-06	RH Front	Manual	1	EM-7257			
		2003	RH Front	Manual	1	EM-7257			
		2003-06	Torq Str - Front		1		EM-9559		
			Trans		1			EM-9552	
	Trans	Manual	1			EM-5515			
<b>BRAT</b>									
H4	H4 1.6L 1595cc	1978-80	L & R Front		2	EM-8641			
			Trans - L & R		1			EM-8665	
	H4 1.8L 1781cc	1982-87	Torq Str - Front	Insert Only; Small Bushing	1		EM-5603		
			Rear	Manual	1	EM-8665			
			Rear		1	EM-8665			
	1984-87	Trans		1			EM-5186		
<b>FORESTER</b>									
H4	H4 2.0L 1998cc	2014-16	LH Front		1	EM-7254			
			RH Front		1	EM-7255			
	H4 2.5L 2458cc	2009-10	2009-10	L & R Front	Non Turbo	2	EM-9024		
				L & R Front		2	EM-9024		
		1998-02	2009-10	L & R Front		2	EM-9023		
				Left	Turbo	1	EM-5971		
				Right	Turbo	1	EM-5983		
		2002-08	Torq Str - Front		1		EM-5187		
		1998-01	Torq Str - Front	Complete Unit	1		EM-5191		
			Torq Str - Front	Insert Only; Small Bushing	1		EM-5603		
		2011-13	Trans	Turbo; Auto; AWD	1			EM-9074	
		2005-10	Trans	Auto; AWD	1			EM-9074	
			Trans	Manual	1			EM-5515	
		2004	Trans	Auto; AWD	1			EM-9074	
			Trans	Manual; w/o Turbo	1			EM-5515	
Trans	Turbo, Manual		1			EM-5515			
2003	Trans	Auto; AWD	1			EM-9074			

## Engine, Transmission, And Torque Strut Mounts

CYL	ENG. SIZE	YEAR	LOCATION	DESCRIPTION	QTY	ENGINE	TORQUE STRUT	TRANSMISSION	
<b>SUBARU SPORT UTILITY (continued)</b>									
<b>FORESTER (continued)</b>									
H4	H4 2.5L 2458cc	2003	Trans	Manual; w/o Turbo	1			EM-5515	
		1998-02	Trans	Auto; AWD	1			EM-9074	
			Trans	Manual	1			EM-5515	
	H4 2.5L 2498cc	2011-12	L & R Front	Non-Turbo; Non Turbo	2	EM-9024			
			2013	LH Front	Non-Turbo; Auto; Exc. Turbo	1	EM-5959		
				RH Front	Non-Turbo; Auto; Exc. Turbo	1	EM-5960		
		2014-15	Trans	CVT Trans.	1			EM-5945	
			Trans	Manual	1			EM-5515	
		2011-13	Trans	Non-Turbo; Auto; AWD	1			EM-9074	
Trans	Non-Turbo; Manual		1			EM-5515			
<b>TRIBECA</b>									
H6	H6 3.0L 3000cc	2006-07	Torq Str - Rear		1		EM-9559		
			Trans		1		EM-9560		
	H6 3.6L 3630cc	2009-14	Torq Str - Rear		1		EM-9559		
		2008-14	Trans		1		EM-9560		
<b>OUTBACK</b>									
H4	H4 2.5L	2001-04	Torq Str - Front	Insert Only; Small (50mm) Bushing	1		EM-5603		
	H4 2.5L 2458cc	2000-04	L & R Front	Auto	2	EM-9024			
			LH Front	Manual	1	EM-7256			
			RH Front	Manual	1	EM-7257			
		2005-09	Trans	Auto w/o Turbo	1			EM-9074	
			Trans	Manual; w/o Turbo	1			EM-5515	
			Trans	Turbo, Auto	1			EM-9560	
			Trans	Turbo, Manual	1			EM-9566	
		2000-04	Trans	Auto	1			EM-9074	
	Trans		Manual	1			EM-5515		
	H4 2.5L 2498cc	2013-16	L & R Front		2	EM-7284			
		2013-14	Trans		1			EM-5945	
H6	H6 3.0L 3000cc	2005-09	Torq Str - Rear		1		EM-9559		
			Trans	Auto	1		EM-9560		
	H6 3.6L 3630cc	2010-14	Center Lower		1	EM-7247			
		2015-16	L & R Front		2	EM-7267			
		2010-14	L & R Front		2	EM-7248			
	Trans			1			EM-7246		
<b>SUZUKI PASSENGER CAR</b>									
<b>SA310</b>									
L3	L3 1.0L 993cc	1985	Trans - LH	Manual	1			EM-5457	
<b>AERIO</b>									
L4	L4 2.0L 2000cc	2002-03	Front	FWD	1	EM-5873			
			Front	Manual	1	EM-9022			
			RH Front		1	EM-9156			
			Rear	FWD	1	EM-9159			
			Trans	Auto	1			EM-9177	
	L4 2.3L 2290cc	2004-07	Front	FWD	1	EM-5873			
			RH Front	Auto	1	EM-9156			
			RH Front	Manual	1	EM-5359			
			Rear	FWD	1	EM-9159			
		2004-06	Trans	Auto	1			EM-9177	
	Trans	Manual	1			EM-9177			
<b>ESTEEM</b>									
L4	L4 1.6L 1590cc	1995-00	Front		1	EM-9022			
			RH Front		1	EM-9242			
			Rear	Auto	1	EM-8805			

# Engine, Transmission, And Torque Strut Mounts

CYL	ENG. SIZE	YEAR	LOCATION	DESCRIPTION	QTY	ENGINE	TORQUE STRUT	TRANSMISSION	
<b>SUZUKI PASSENGER CAR (continued)</b>									
<b>ESTEEM (continued)</b>									
L4	L4 1.6L 1590cc	1995-00	Rear	Manual	1	EM-8804			
			Trans	Auto	1		EM-8890		
			Trans	Manual	1		EM-8890		
	L4 1.8L 1790cc	1999-02	Front		1	EM-9022			
			RH Front		1	EM-5358			
			Rear		1	EM-8804			
			Trans		1		EM-8890		
<b>FORENZA</b>									
L4	L4 2.0L 1998cc	2004-08	Right		1	EM-5931			
			Torq Str - Lower		1		EM-5933		
			Torq Str - Right		1		EM-5932		
			Trans		1		EM-5868		
<b>RENO</b>									
L4	L4 2.0L 1998cc	2005-08	Right		1	EM-5931			
			Torq Str - Lower		1		EM-5933		
			Torq Str - Right		1		EM-5932		
			Trans		1		EM-5868		
<b>SA310</b>									
L3	L3 1.0L 993cc	1985	Front	Auto	1	EM-8283			
			Front	Manual	1	EM-8489			
			Rear	Manual	1	EM-8294			
			Torq Str - Front		1		EM-8521		
			Torq Str - Rear		1		EM-8524		
			Trans	Auto	1		EM-8522		
			Trans	Manual	1		EM-8490		
<b>SX4</b>									
L4	L4 2.0L 1995cc	2010-13	Front		1	EM-5951			
			Rear	AWD	1	EM-7029			
		2007-09	Rear	AWD; AWD	1	EM-7029			
<b>SWIFT</b>									
L3	L3 1.0L 993cc	1992-94	Front		1	EM-8517			
			RH Front		1	EM-9133			
			Trans		1		EM-8277		
L4	L4 1.3L 1298cc	1995-01	Front		1	EM-8517			
			1989-94	Front		1	EM-8517		
				RH Front		1	EM-9133		
		1995-01	Rear	Manual	1	EM-8277			
			1989-94	Rear	Auto w/ DOHC	1	EM-8277		
				Rear	Auto w/ SOHC	1	EM-8659		
		1989-01	Rear	Manual	1	EM-8277			
			Torq Str - Rear	Auto	1		EM-8658		
			1995-01	Trans	Auto	1		EM-8314	
Trans	Manual	1			EM-8314				
<b>SUZUKI SPORT UTILITY</b>									
<b>GRAND VITARA</b>									
L4	L4 2.4L 2393cc	2009-11	Trans	Auto	1			EM-9613	
			Trans	Manual	1			EM-9613	
V6	V6 2.5L 2500cc	1999-05	L & R Front		2	EM-9240			
		1999-02	Trans		1		EM-8825		
	V6 2.7L 2737cc	2001	L & R Front		2	EM-9240			
		2006-08	Trans	Auto	1		EM-9613		
			Trans	Manual	1		EM-9613		
	2001	Trans		1		EM-8825			
V6 3.2L 3195cc	2009-10	Trans	Auto	1		EM-9613			



## Engine, Transmission, And Torque Strut Mounts

CYL	ENG. SIZE	YEAR	LOCATION	DESCRIPTION	QTY	ENGINE	TORQUE STRUT	TRANSMISSION
<b>SUZUKI SPORT UTILITY (continued)</b>								
<b>SAMURAI</b>								
L4	L4 1.3L 1325cc	1985-95	L & R Front		2	EM-8161		
			Trans	Manual	1			EM-8160
<b>SIDEKICK</b>								
L4	L4 1.3L 1325cc	1989	L & R Front		2	EM-8161		
			Torq Str - Front	2 Door	1		EM-8657	
			Trans	4WD	1			EM-8825
	L4 1.6L 1590cc	1991-98	L & R Front		2	EM-8568		
		1989-90	L & R Front		2	EM-8568		
		1992-98	Torq Str - Front	Auto	1		EM-8657	
		1989-91	Torq Str - Front	Auto	1		EM-8657	
		1991-98	Trans - LH		1			EM-8825
		1989-90	Trans		1			EM-8825
	L4 1.8L 1840cc	1996-98	L & R Front		2	EM-8093		
			Trans		1			EM-8825
<b>VITARA</b>								
L4	L4 1.6L 1590cc	1999-01	L & R Front		2	EM-9240		
		1999-02	Trans	Auto	1			EM-9241
	L4 2.0L 2000cc	1999-03	L & R Front		2	EM-9240		
		1999-02	Trans	Auto	1			EM-9241
V6	V6 2.5L 2500cc	2004	L & R Front		2	EM-9240		
<b>X-90</b>								
L4	L4 1.6L 1590cc	1996-98	L & R Front		2	EM-8568		
			Torq Str - Front	Auto	1		EM-8656	
			Torq Str - Front	Manual	1		EM-8657	
			Trans - LH		1			EM-8825
<b>XL-7</b>								
V6	V6 2.7L 2737cc	2002-06	L & R Front		2	EM-9240		
<b>SUZUKI TRUCK</b>								
<b>FORSA</b>								
L3	L3 1.0L	1987-88	Trans - Front		1			EM-5483
			Trans - LH Rear		1			EM-5458
<b>TOYOTA PASSENGER CAR</b>								
<b>86</b>								
H4	H4 2.0L 1998cc	2017	LH Front		1	EM-7254		
			RH Front		1	EM-7255		
<b>AVALON</b>								
L4	L4 2.5L 2494cc	2013-17	Right	Hybrid	1	EM-7053		
			Torq Str - Front	Hybrid	1		EM-7266	
V6	V6 3.0L 2995cc	2004	Front	Hydraulic Mount	1	EM-5384		
		2000-03	Front	Hydraulic Mount	1	EM-5384		
		1995-96	Front		1	EM-8711		
		2000-03	Rear		1	EM-9421		
		1997-99	Rear	Insert	1	EM-8699		
		1995-96	Rear		1	EM-8398		
		2004	Torq Str - Front		1		EM-9388	
		2000-03	Torq Str - Front		1		EM-9388	
		1997-99	Torq Str - Front		1		EM-8697	
		1995-96	Torq Str - Front		1		EM-8201	
		2004	Trans		1			EM-8644
		2000-03	Trans		1			EM-8644
		1997-99	Trans		1			EM-8644
		1995-96	Trans		1			EM-8644
	V6 3.5L 3456cc	2008-12	RH Front		1	EM-9238		

# Engine, Transmission, And Torque Strut Mounts

CYL	ENG. SIZE	YEAR	LOCATION	DESCRIPTION	QTY	ENGINE	TORQUE STRUT	TRANSMISSION
<b>TOYOTA PASSENGER CAR (continued)</b>								
<b>AVALON (continued)</b>								
V6	V6 3.5L 3456cc	2005-07	RH Front		1	EM-9238		
		2008-13	Torq Str - Front		1		EM-5834	
		2005-07	Torq Str - Rear		1		EM-9535	
		2008-16	Trans		1			EM-9236
		2005-07	Trans		1			EM-9165
<b>CAMRY</b>								
L4	L4 1.8L 1839cc Diesel	1985-86	Front		1	EM-8348		
		1984	Front		1	EM-8348		
			LH Front		1	EM-8189		
		1985-86	RH Front		1	EM-8368		
		1984	RH Front		1	EM-8368		
		1985-86	Rear		1	EM-9122		
		1984	Rear		1	EM-8493		
	L4 1.8L 1839cc	1985-86	Trans	Auto	1			EM-8189
	L4 2.0L 1974cc Diesel	1986	Front		1	EM-8368		
			RH Front		1	EM-8482		
			Rear		1	EM-9122		
	L4 2.0L 1995cc	1986	Front	Gas; Auto	1	EM-8195		
			Front	Gas; Manual	1	EM-2677		
		1985	Front	Auto	1	EM-8195		
			Front	Manual	1	EM-2677		
		1983-84	Front	Auto	1	EM-8195		
			Front	Manual	1	EM-2677		
		1986	RH Front	Gas	1	EM-9051		
		1985	RH Front		1	EM-9051		
		1983-84	RH Front		1	EM-9051		
		1986	Rear	Gas; Auto	1	EM-9122		
			Rear	Gas; Manual; w/ Counter Weight	1	EM-5042		
			Rear	Gas; Manual; w/o Counter Weight	1	EM-2678		
		1985	Rear	Auto, After 6/85	1	EM-9122		
			Rear	Manual; w/ Counter Weight	1	EM-5042		
			Rear	Manual; w/o Counter Weight	1	EM-2678		
		1983-84	Rear	Manual; w/ Counter Weight	1	EM-5042		
			Rear	Manual; w/o Counter Weight	1	EM-2678		
	1983-86	Trans	Auto	1			EM-9053	
		Trans	Manual; Canada	1			EM-9053	
	L4 2.0L 1998cc	1991	Front	Auto; 4WD	1	EM-8192		
			Front	Auto; FWD	1	EM-8193		
			Front	Manual; FWD	1	EM-8194		
		1989-90	Front	Auto; 4WD	1	EM-8192		
			Front	Auto; FWD	1	EM-8193		
			Front	Manual; 4WD	1	EM-8195		
		1987-88	Front	Manual; FWD	1	EM-8194		
			Front	Auto	1	EM-8193		
		1991	Front	Manual	1	EM-8194		
			RH Front	4WD	1	EM-8196		
		1989-90	RH Front	FWD	1	EM-8207		
			RH Front	4WD	1	EM-8196		
		1987-88	RH Front	FWD	1	EM-8207		
			RH Front		1	EM-8196		
		1991	Rear	Auto; 4WD	1	EM-9127		
			Rear	FWD	1	EM-8197		
		1989-90	Rear	Auto; 4WD	1	EM-9127		
Rear			FWD	1	EM-8197			
		Rear	Manual; 4WD	1	EM-8385			

# Engine, Transmission, And Torque Strut Mounts

CYL	ENG. SIZE	YEAR	LOCATION	DESCRIPTION	QTY	ENGINE	TORQUE STRUT	TRANSMISSION	
<b>TOYOTA PASSENGER CAR (continued)</b>									
<b>CAMRY (continued)</b>									
L4	L4 2.0L 1998cc	1987-88	Rear	Auto	1	EM-8198			
			Rear	Manual	1	EM-8406			
		1990-91	Trans - Center	Auto; FWD	1			EM-8208	
		1989	Trans - Center	Auto	1			EM-8208	
			Trans - Center	Manual	1			EM-8684	
		1987-88	Trans - Center	Auto	1			EM-8208	
			Trans - Center	Manual	1			EM-8195	
		1990-91	Trans	Auto; FWD	1			EM-8684	
			Trans	All Trac; Auto; 4WD	1			EM-8189	
		L4 2.2L 2164cc	1997-01	Front	All; Made in Japan	1	EM-8795		
				Front	Auto, Made in USA	1	EM-8795		
				Front	Manual, Made in USA	1	EM-8361		
			1992-96	Front	Auto	1	EM-8485		
				Front	Manual, Made in USA	1	EM-8361		
	1997-01		Rear	Auto	1	EM-8796			
			Rear	Manual	1	EM-8414			
	1992-96		Rear	Auto	1	EM-8209			
			Rear	Manual	1	EM-8414			
	1997-01		Torq Str - Right	Auto	1		EM-8698		
			Torq Str - Right	Manual	1		EM-8200		
	1992-96		Torq Str - Right		1		EM-8200		
	1992-01		Trans	Auto	1			EM-8979	
			Trans	Manual	1			EM-8529	
	L4 2.4L 2362cc		2007-09	Front	Hybrid	1	EM-5742		
				Front		1	EM-9211		
		2007-09	LH Front	Gas	1	EM-5742			
			RH Front	Gas	1	EM-9237			
		2002-06	RH Front		1	EM-5141			
		2010-11	Right	Hybrid	1	EM-9237			
		2007-09	Right	Hybrid	1	EM-9237			
		2010-11	Torq Str - Front	Gas	1		EM-5750		
			Torq Str - Front	Hybrid	1		EM-5750		
		2007-09	Torq Str - Front		1		EM-5750		
		2002-06	Torq Str - Front		1		EM-9148		
		2007-09	Torq Str - Rear		1		EM-9210		
		2002-06	Torq Str - Rear		1		EM-9492		
		2007-09	Trans	Gas	1			EM-5757	
			Trans	Gas; Gas Engine	1			EM-9236	
		2004-06	Trans	Auto, Made in USA	1			EM-9165	
			Trans	Manual, Made in Japan	1			EM-5757	
		2002-03	Trans	Manual, Made in USA	1			EM-9165	
			Trans	Auto	1			EM-9165	
			Trans	Manual, Made in Japan	1			EM-5757	
			Trans	Manual, Made in USA	1			EM-5554	
		L4 2.5L	2012-17	Torq Str - Front	Hybrid	1		EM-7266	
	L4 2.5L 2494cc	2012-17	Front	Gas	1	EM-7016			
			Front	Gas	1	EM-5742			
2012-17		Right	Hybrid	1	EM-7053				
		Right	Gas	1	EM-7053				
2010-11		Right	Gas	1	EM-9237				
2010-17		Torq Str - Front	Gas	1		EM-9588			
2012-17		Trans	Gas Engine	1			EM-7054		
2010-11		Trans	Auto	1			EM-9236		
		Trans	Manual	1			EM-9236		
V6	V6 2.5L 2508cc	1988-91	Front	Auto	1	EM-8192			
			Front	Manual	1	EM-8194			
			RH Front		1	EM-9129			

# Engine, Transmission, And Torque Strut Mounts

CYL	ENG. SIZE	YEAR	LOCATION	DESCRIPTION	QTY	ENGINE	TORQUE STRUT	TRANSMISSION	
<b>TOYOTA PASSENGER CAR (continued)</b>									
<b>CAMRY (continued)</b>									
V6	V6 2.5L 2508cc	1988-91	Rear		1	EM-8197			
			Trans		1		EM-8208		
	V6 3.0L 2959cc	1994-96 1992-93 1994-96 1992-93 1992-96 1997-01 1994-96 1993 1992	1994-96 1992-93 1994-96 1992-93 1992-96 1997-01 1994-96 1993 1992	Front		1	EM-8711		
				Front	Auto	1	EM-8965		
				Front	Manual	1	EM-9146		
				Rear	Auto	1	EM-8398		
				Rear		1	EM-8398		
				Torq Str - Front		1		EM-8201	
				Trans	Auto	1			EM-8644
				Trans	Manual	1			EM-8529
				Trans	Auto	1			EM-8644
				Trans	Auto	1			EM-8644
				Trans	Manual	1			EM-8529
				Trans	Auto	1			EM-8979
	Trans	Manual	1			EM-8529			
	V6 3.0L 2995cc	1999-01 1997-98 2002-03 1999-01 1997-98 1997-01 2002-03 2002-06	1999-01 1997-98 2002-03 1999-01 1997-98 1997-01 2002-03 2002-06	Front	Auto	1	EM-8967		
				Front	Auto	1	EM-8967		
				RH Front		1	EM-9239		
				Rear	Auto; Insert Only	1	EM-8699		
				Rear	Manual	1	EM-8398		
				Rear	Auto; Insert Only	1	EM-8699		
				Rear	Manual	1	EM-8398		
				Torq Str - Front	Auto	1		EM-8697	
				Torq Str - Front	Manual	1		EM-7287	
				Torq Str - Front		1		EM-9197	
	Trans	Auto, Made in USA	1			EM-9165			
	V6 3.0L 3000cc	2004-06	2004-06	Torq Str - Front		1		EM-9197	
	V6 3.3L 3300cc	2006 2004-05 2006 2004-05 2004-06	2006 2004-05 2006 2004-05 2004-06	LH Front	Made in Japan	1	EM-5842		
				LH Front	Made in Japan	1	EM-5842		
				RH Front		1	EM-9212		
				RH Front		1	EM-9212		
				Torq Str - Front		1		EM-9197	
	Trans	Auto	1			EM-9165			
V6 3.5L 3456cc	2007-11 2007-14 2007-16	2007-11 2007-14 2007-16	RH Front		1	EM-9238			
			Torq Str - Front		1		EM-5834		
			Trans		1			EM-9236	
<b>CARINA</b>									
L4	L4 1.6L 1588cc	1972-73	L & R Front		2	EM-2406			
			Trans	Auto	1		EM-2410		
			Trans	Manual	1		EM-2409		
<b>CELICA</b>									
L4	L4 1.6L 1587cc	1990-93	Front	Auto	1	EM-8639			
			Front	Manual	1	EM-8491			
			Rear	Auto	1	EM-8385			
			Rear	Manual	1	EM-9118			
	L4 1.8L 1762cc	1994-95 1996-97 1994-95 1996-97 1994-95 1994-95 1994-97	1994-95 1996-97 1994-95 1996-97 1994-95 1994-95 1994-97	Front		1	EM-8848		
				RH Front		1	EM-5819		
				RH Front		1	EM-5819		
				Rear	Auto	1	EM-9013		
				Rear	Manual	1	EM-8871		
				Rear	Auto	1	EM-9013		
				Rear	Manual	1	EM-8871		
	Trans		1			EM-7096			
	L4 1.8L 1794cc	2000-05	2000-05	Front	GT	1	EM-9484		
				Rear	GT	1	EM-9574		
				Right	GT	1	EM-9525		

## Engine, Transmission, And Torque Strut Mounts

CYL	ENG. SIZE	YEAR	LOCATION	DESCRIPTION	QTY	ENGINE	TORQUE STRUT	TRANSMISSION	
<b>TOYOTA PASSENGER CAR (continued)</b>									
<b>CELICA (continued)</b>									
L4	L4 1.8L 1794cc	2000-05	Trans		1			EM-9541	
	L4 1.8L 1795cc	2000-05	Front	Auto	1	EM-9484			
			RH Front	Auto	1	EM-9525			
			RH Front	Manual	1	EM-5759			
			Rear	GTS	1	EM-9574			
			Trans		1			EM-9541	
	L4 1.9L 1898cc	1971	RH Front		1	EM-2743			
			Trans	Auto	1			EM-2410	
			Trans	Manual	1			EM-2409	
	L4 2.0L 1968cc	1972-74	RH Front		1	EM-2743			
			Trans	Auto	1			EM-2410	
			Trans	Manual	1			EM-2409	
	L4 2.0L 1995cc	1986	Front	Auto	1	EM-8348			
			Front	Manual	1	EM-8195			
			Rear	Auto	1	EM-8407			
			Rear	Manual	1	EM-8385			
			Trans	Auto	1			EM-8970	
	L4 2.0L 1998cc	1990-93	Front		1	EM-8213			
		1987-89	Front	Auto	1	EM-8348			
			Front	Manual	1	EM-8213			
		1990-93	RH Front	Insert Only	1	EM-5743			
		1987-89	RH Front		1	EM-8692			
		1990-93	Rear		1	EM-9119			
		1987-89	Rear	Auto	1	EM-8407			
			Rear	Manual	1	EM-9119			
	1986-89	Trans	Auto	1			EM-8970		
	L4 2.0L Turbo	1988-89	Front	Manual; All Trac; Turbo	1	EM-8195			
			RH Front	Manual; All Trac; Turbo	1	EM-5762			
			Rear	Manual; All Trac; Turbo	1	EM-9119			
	L4 2.2L 2164cc	1994-99	Front		1	EM-5753			
		1990-93	Front	Auto	1	EM-8359			
			Front	Manual	1	EM-8213			
		1994-99	RH Front	exc Convertible	1	EM-8869			
		1990-93	RH Front	Coupe & Liftback	1	EM-5763			
		1994-99	Rear	Auto	1	EM-9013			
			Rear	Manual	1	EM-8871			
		1990-93	Rear		1	EM-8413			
		1994-99	Trans	Auto	1			EM-9495	
			Trans	Manual	1			EM-8852	
	L4 2.2L 2189cc	1975-80	L & R Front		2	EM-2407			
			Trans	Auto	1			EM-2410	
			Trans	Manual	1			EM-2410	
	L4 2.4L 2366cc	1981-85	L & R Front		2	EM-8162			
			Trans	Auto	1			EM-2410	
			Trans	Manual	1			EM-2410	
	L6	L6 2.8L 2754cc	1981-86	L & R Front		2	EM-8212		
	<b>COROLLA</b>								
L4	L4 1.2L 1166cc	1969-79	LH Front		1	EM-2747			
			RH Front		1	EM-2748			
			Trans	Manual	1			EM-2408	
	L4 1.6L 1587cc	1993-97	Front		1	EM-8177			
			Front	Auto	1	EM-8180			
		1990-92	Front	Manual	1	EM-8181			
			Front	Auto	1	EM-8180			
		1988-89	Front	Auto	1	EM-8180			
			Front	Manual	1	EM-8181			
		1986-87	Front	FWD	1	EM-8211			
1984-85	Front	FWD	1	EM-8211					

# Engine, Transmission, And Torque Strut Mounts

CYL	ENG. SIZE	YEAR	LOCATION	DESCRIPTION	QTY	ENGINE	TORQUE STRUT	TRANSMISSION
<b>TOYOTA PASSENGER CAR (continued)</b>								
<b>COROLLA (continued)</b>								
L4	L4 1.6L 1587cc	1983	Front	RWD	1	EM-8211		
		1986-87	L & R Front	RWD	2	EM-8210		
		1984-85	L & R Front	RWD	2	EM-8210		
		1993-97	RH Front		1	EM-8178		
		1990-92	RH Front		1	EM-8183		
		1988-89	RH Front		1	EM-9117		
		1986-87	RH Front	FWD	1	EM-8233		
		1984-85	RH Front	FWD	1	EM-8233		
		1983	RH Front	RWD	1	EM-8233		
		1993-97	Rear	Auto	1	EM-8179		
			Rear	Manual	1	EM-9116		
		1990-92	Rear	Auto; 3 Spd FWD	1	EM-8186		
			Rear	Auto; 4 Spd FWD	1	EM-8185		
			Rear	Manual; FWD	1	EM-8187		
		1988-89	Rear	Auto; 3 Spd FWD	1	EM-8186		
			Rear	Auto; 4 Spd FWD	1	EM-8185		
			Rear	Manual; FWD	1	EM-8187		
		1986-87	Rear	Auto; FWD	1	EM-2688		
			Rear	Manual; FWD	1	EM-8375		
		1984-85	Rear	Auto; FWD	1	EM-2688		
			Rear	Manual; FWD	1	EM-8492		
		1983	Rear	Auto; RWD	1	EM-2688		
			Rear	Manual; RWD	1	EM-8214		
		1990-92	Right	AWD	1	EM-5761		
		1992	Trans - Center		1			EM-8190
		1989-91	Trans - Center		1			EM-8190
			Trans - LH	Under Trans	1			EM-8188
			Trans - LH	Auto; 4 Spd FWD	1			EM-8188
		1993-97	Trans		1			EM-8191
		1992	Trans	Under Trans	1			EM-8188
			Trans	Auto; 3 Spd FWD	1			EM-8643
			Trans	Auto; 4 Spd FWD	1			EM-8643
			Trans	Auto; AWD	1			EM-8643
			Trans	Manual, AWD	1			EM-8188
		1989-91	Trans	Manual; FWD	1			EM-8422
			Trans	Auto; 3 Spd	1			EM-8643
			Trans	Auto; 4 Spd FWD	1			EM-8643
			Trans	Auto; AWD	1			EM-8643
		1988	Trans	Auto; 3 Spd FWD	1			EM-8188
			Trans	Auto; 4 Spd FWD	1			EM-8643
			Trans	Auto; AWD	1			EM-8643
			Trans	FX	1			EM-5810
			Trans	Manual, AWD	1			EM-8643
			Trans	Manual; FWD	1			EM-8188
			Trans	Manual; GTS	1			EM-8422
		1985-87	Trans	Auto; FWD	1			EM-9121
			Trans	Auto; RWD	1			EM-2690
			Trans	Manual; FWD	1			EM-8648
			Trans	Manual; RWD	1			EM-9114
		1984	Trans	Auto; FWD	1			EM-8220
	Trans	Manual; FWD	1			EM-8189		
	Trans	Manual; RWD	1			EM-2409		
	Trans	RWD, Auto	1			EM-2690		
1983	Trans	Auto; RWD	1			EM-2690		
	Trans	Manual; RWD	1			EM-2409		
	L4 1.6L 1588cc	1971-79	LH Front		1	EM-5473		
			RH Front		1	EM-2406		

# Engine, Transmission, And Torque Strut Mounts

CYL	ENG. SIZE	YEAR	LOCATION	DESCRIPTION	QTY	ENGINE	TORQUE STRUT	TRANSMISSION	
<b>TOYOTA PASSENGER CAR (continued)</b>									
<b>COROLLA (continued)</b>									
L4	L4 1.6L 1588cc	1971-79	Trans	Auto	1			EM-2410	
			Trans	Manual	1			EM-2409	
	L4 1.8L 1762cc	1993-97	Front	Auto	1	EM-8177			
			Front	Manual	1	EM-5198			
			RH Front		1	EM-8178			
			Rear	Auto	1	EM-8179			
			Rear	Manual	1	EM-9116			
		1996-97	Trans	Auto, Made in Japan	1			EM-9125	
			Trans	Auto, Made in US	1			EM-8415	
			Trans	Manual	1			EM-8191	
		1993-95	Trans	Auto, Made in Japan	1			EM-9125	
			Trans	Auto, Made in US	1			EM-8415	
	Trans		MManual, Made in US	1			EM-8191		
	L4 1.8L 1770cc	1980-82	L & R Front		2	EM-8430			
			Trans	Auto	1			EM-2410	
			Trans	Manual	1			EM-2409	
	L4 1.8L 1794cc	2005-08	Front		1	EM-9158			
		2003-04	Front		1	EM-9158			
		1998-02	Front	Auto	1	EM-8870			
			Front	Manual	1	EM-8177			
		2005-08	RH Front	Auto	1	EM-9164			
			RH Front	Manual, 5 Spd	1	EM-9164			
		2003-04	RH Front		1	EM-9164			
		1998-02	RH Front		1	EM-8850			
		2005-08	Rear	Auto	1	EM-9155			
			Rear	Manual	1	EM-9157			
		2003-04	Rear	Auto	1	EM-9155			
			Rear	Manual	1	EM-9157			
		1998-02	Rear	Auto	1	EM-8851			
			Trans - BUSHING		1			EM-8872	
		2003-08	Trans	Auto	1			EM-9163	
			Trans	Manual	1			EM-9163	
		1998-02	Trans	Bracket Damper	1			EM-8873	
			Trans	Auto, 3 Spd	1			EM-9474	
	L4 1.8L 1795cc	2005-06	RH Front		1	EM-9412			
			Trans	XRS; Manual	1			EM-9163	
	L4 1.8L 1798cc	2014-17	Front	Auto	1	EM-9390			
			Front	Auto, Made in USA	1	EM-9391			
		2009-13	Front	Manual	1	EM-9391			
			RH Front		1	EM-9449			
		2014-17	Rear		1	EM-9400			
		2009-13	Rear		1	EM-9400			
			Trans	Auto; Made in Japan	1			EM-5898	
			Trans	Auto; Made in USA	1			EM-9390	
	Trans	Manual, Made in USA	1			EM-9390			
	L4 1.8L 1839cc Diesel	1985	Front	Auto	1	EM-8368			
			Front	Manual	1	EM-8491			
			1984	Front	Auto	1	EM-8368		
				Front	Manual	1	EM-8348		
		1985	RH Front		1	EM-8368			
			RH Front		1	EM-8368			
		1985	Rear	Auto	1	EM-8401			
Rear			Manual	1	EM-8400				
1984		Rear	Auto	1	EM-8401				
		Rear	Manual	1	EM-8400				
1984-85		Trans	Auto	1			EM-8189		

# Engine, Transmission, And Torque Strut Mounts

CYL	ENG. SIZE	YEAR	LOCATION	DESCRIPTION	QTY	ENGINE	TORQUE STRUT	TRANSMISSION	
<b>TOYOTA PASSENGER CAR (continued)</b>									
<b>COROLLA (continued)</b>									
L4	L4 2.4L 2362cc	2009-10	Front		1	EM-9419			
			RH Front		1	EM-9447			
			Rear		1	EM-9491			
	2009	Torq Str - Left		1		EM-9210			
		Trans		1			EM-9236		
<b>CORONA</b>									
L4	L4 1.9L 1898cc	1967-71	L & R Front		2	EM-2407			
			Trans	Auto	1		EM-2410		
			Trans	Manual	1		EM-2409		
	L4 2.0L 1968cc	1972	1973-74	L & R Front		2	EM-2407		
				LH Front		1	EM-2745		
				RH Front		1	EM-2743		
			1972-74	Trans	Auto	1		EM-2410	
				Trans	Manual	1		EM-2409	
	L4 2.2L 2189cc	1975-80	L & R Front		2	EM-2407			
			Trans	Auto	1		EM-2410		
			Trans	Manual	1		EM-2410		
	L4 2.4L 2366cc	1981-82	L & R Front		2	EM-2407			
			Trans	Auto	1		EM-2410		
Trans			Manual	1		EM-2410			
<b>CRESSIDA</b>									
L6	L6 2.6L 2563cc	1978-80	L & R Front		2	EM-2744			
			Rear	Auto	1	EM-5200			
			Trans		1		EM-2690		
	L6 2.8L 2754cc	1983-88	Front		1	EM-8212			
	L6 2.8L 2759cc	1981-82	Front		1	EM-2744			
			1981-84	Trans		1		EM-2690	
	L6 3.0L 2954cc	1989-92	L & R Front		2	EM-8344			
			Trans		1		EM-2410		
<b>CROWN</b>									
L6	L6 2.3L	1967-70	Trans		1			EM-5456	
	L6 2.6L	1971-72	LH Front		1	EM-5455			
			LH Front		1	EM-5455			
		1967-70	RH Front		1	EM-5454			
			RH Front		1	EM-5454			
		1971-72	Trans		1		EM-5456		
<b>ECHO</b>									
L4	L4 1.5L 1497cc	2000-05	RH Front		1	EM-9015			
			Rear		1	EM-8968			
			Trans	Auto	1		EM-8883		
			Trans	Manual	1		EM-8888		
<b>MARK II</b>									
L6	L6 2.3L	1972	LH Front		1	EM-5455			
			RH Front		1	EM-5454			
	L6 2.3L 2253cc	1972	Trans		1		EM-5456		
	L6 2.6L	1973-76	LH Front		1	EM-5455			
			RH Front		1	EM-5454			
	L6 2.6L 2563cc	1973-76	Trans		1		EM-5456		
<b>MATRIX</b>									
L4	L4 1.8L 1794cc	2007	Front		1	EM-9158			
			2003-06	Front		1	EM-9158		
		2003-06	RH Front	AWD		1	EM-9525		
			RH Front	FWD		1	EM-9164		
			Rear	Auto; AWD		1	EM-9418		



## Engine, Transmission, And Torque Strut Mounts

CYL	ENG. SIZE	YEAR	LOCATION	DESCRIPTION	QTY	ENGINE	TORQUE STRUT	TRANS-MISSION	
<b>TOYOTA PASSENGER CAR (continued)</b>									
<b>MATRIX (continued)</b>									
L4	L4 1.8L 1794cc	2003-06	Rear	Auto; FWD	1	EM-9155			
			Rear	Manual; FWD	1	EM-9157			
		2003-08	Trans	Auto	1			EM-9163	
			Trans	Manual	1			EM-9163	
	L4 1.8L 1795cc	2003-06	Front	XRS	1	EM-9158			
			RH Front	XRS	1	EM-9412			
			Rear	XRS	1	EM-9157			
	L4 1.8L 1798cc	2004-06	Trans	XRS; Manual	1			EM-9163	
			Trans		1				
		2009-11	Front		1	EM-9391			
			RH Front		1	EM-9449			
	Rear			1	EM-9400				
	2009-13	Trans	Auto	1			EM-9390		
		Trans	Manual	1			EM-9390		
	L4 2.4L 2362cc	2010-11	Front		1	EM-9419			
			2009	Front		1	EM-9419		
		2010-11	RH Front		1	EM-9447			
			2009	RH Front		1	EM-9447		
		2010-11	Rear	AWD	1	EM-9436			
			Rear	FWD	1	EM-9491			
2009		Rear	FWD	1	EM-9491				
		2009-10	Trans	Auto	1			EM-9462	
Trans	Manual, AWD	1				EM-9462			
<b>MR2</b>									
L4	L4 1.6L 1587cc	1987-89	Front		1	EM-8339			
			1986	Front		1	EM-8339		
			1985	Front		1	EM-8339		
		1987-89	Rear	Auto	1	EM-8187			
			Rear	Manual	1	EM-8384			
		1986	Rear	Auto	1	EM-2685			
			Rear	Manual	1	EM-8384			
		1985	Rear	Auto	1	EM-2685			
			Rear	Manual, After 3/85	1	EM-8384			
	Rear	Manual, Before 3/85	1	EM-8339					
	L4 2.0L 1998cc	1991-95	Front		1	EM-5767			
			Right		1	EM-5802			
	L4 2.2L 2164cc	1991-95	Front	Auto	1	EM-5751			
			Front	Manual	1	EM-5799			
RH Front			Auto	1	EM-5756				
RH Front			Manual	1	EM-5805				
<b>PASEO</b>									
L4	L4 1.5L 1497cc	1996-99	RH Front		1	EM-8166			
			1995	RH Front		1	EM-8166		
		1992-94	RH Front		1	EM-8166			
			1996-99	Rear	Calif Emission	1	EM-8167		
		1995	Rear	Calif Emission	1	EM-8167			
			Rear	Federal Emission	1	EM-8169			
		1992-94	Rear	Auto	1	EM-8169			
			Rear	Manual	1	EM-8168			
		1996-99	Trans	Auto	1			EM-9123	
			Trans	Manual, Complete Unit	1			EM-8418	
			Trans	Manual, Insert	1			EM-5736	
		1992-95	Trans	Auto	1			EM-9123	
Trans	Manual		1			EM-8170			

# Engine, Transmission, And Torque Strut Mounts

CYL	ENG. SIZE	YEAR	LOCATION	DESCRIPTION	QTY	ENGINE	TORQUE STRUT	TRANSMISSION			
<b>TOYOTA PASSENGER CAR (continued)</b>											
<b>PRIUS</b>											
L4	L4 1.5L 1497cc	2001-03	Right		1	EM-5832					
		2004-09	Torq Str - Front		1		EM-9454				
		2001-03	Torq Str - Front		1		EM-9455				
		2004-09	Trans		1			EM-5647			
		2001-03	Trans	Made in USA	1			EM-9284			
	L4 1.8L 1798cc	2010-15	Front		1	EM-9514					
			Rear		1	EM-7077					
Right				1	EM-5970						
<b>PRIUS C</b>											
L4	L4 1.5L 1497cc	2012-13	Right		1	EM-7251					
		2012-17	Torq Str - Rear	Control Rod	1		EM-7250				
			Torq Str - Rear	Lateral Rod	1		EM-7249				
<b>PRIUS V</b>											
L4	L4 1.8L 1798cc	2012-16	Front		1	EM-9514					
			Rear		1	EM-7077					
			Right		1	EM-5970					
<b>SOLARA</b>											
L4	L4 2.2L 2164cc	1999-01	Front	Auto, Made in USA	1	EM-8795					
			Front	Manual, Made in USA	1	EM-8361					
			Rear	Auto	1	EM-8796					
			Rear	Manual	1	EM-8414					
			Torq Str - Right	Auto	1		EM-8698				
			Trans	Auto	1			EM-8979			
			Trans	Manual	1			EM-8529			
	L4 2.4L 2362cc	2007-08 2004-06 2002-03 2007-08 2004-06 2002-03 2007-08 2004-06 2002-03 2007-08 2004-06 2002-03 2007-08 2004-06 2002-03 2007-08 2004-06 2002-03 2007-08 2004-06 2002-03	Front		1	EM-9211					
			Front		1	EM-9211					
			Front		1	EM-9572					
			RH Front		1	EM-9237					
			RH Front		1	EM-5141					
			RH Front		1	EM-9475					
			Torq Str - Front		1		EM-9504				
			Torq Str - Front		1		EM-9148				
			Torq Str - Front		1		EM-9148				
			Torq Str - Rear		1		EM-9210				
			Torq Str - Rear		1		EM-9492				
			Torq Str - Rear		1		EM-9492				
			Trans		1			EM-5757			
			Trans	Auto	1			EM-9165			
			Trans	Auto	1			EM-9165			
			Trans	Manual	1			EM-5757			
			Trans	Auto	1			EM-9576			
			Trans	Manual	1			EM-5554			
			V6	V6 3.0L 2995cc	2002-03	Front		1	EM-8967		
					1999-01	Front		1	EM-8967		
					2002-03	Rear	Auto; Insert Only	1	EM-8699		
					1999-01	Rear	Auto; Insert Only	1	EM-8699		
2000-03	Rear	Manual			1	EM-8398					
	Torq Str - Front	Auto; Convertible			1		EM-5758				
	Torq Str - Front	Auto; Coupe			1		EM-8697				
1999	Torq Str - Front	Manual; Coupe			1		EM-7287				
	Torq Str - Front	Auto			1		EM-8697				
	Torq Str - Front	Manual; Coupe			1		EM-7287				
1999-03	Trans	Auto			1			EM-8644			
	Trans	Manual			1			EM-8529			
V6 3.3L 3300cc	2004-08	RH Front		1	EM-9212						
		Torq Str - Front		1		EM-9197					

# Engine, Transmission, And Torque Strut Mounts

CYL	ENG. SIZE	YEAR	LOCATION	DESCRIPTION	QTY	ENGINE	TORQUE STRUT	TRANSMISSION	
<b>TOYOTA PASSENGER CAR (continued)</b>									
<b>SOLARA (continued)</b>									
V6	V6 3.3L 3300cc	2004-08	Trans		1			EM-9165	
<b>STARLET</b>									
L4	L4 1.3L	1981-82	Trans		1			EM-8181	
	L4 1.3L 1290cc	1983-84	L & R Front	w/2 Mounting Studs	2	EM-8163			
			L & R Front	w/3 Mounting Studs	2	EM-5448			
		1981-82	LH Front		1	EM-2406			
			RH Front	w/2 Mounting Studs	1	EM-8163			
			RH Front	w/3 Mounting Studs	1	EM-5448			
1983-84	Trans		1			EM-2748			
<b>SUPRA</b>									
L6	L6 3.0L 2954cc	1990-92	L & R Front		2	EM-5653			
		1986-89	L & R Front		2	EM-9034			
		1990-92	Trans	Auto	1			EM-2410	
			Trans	Manual	1			EM-2410	
		1986-89	Trans		1			EM-8218	
	L6 3.0L 2997cc	1996-98	L & R Front		2	EM-5764			
		1995	L & R Front	After 5/95	2	EM-5764			
			L & R Front	Before 5/95	2	EM-5467			
		1993-94	L & R Front	Before 5/95	2	EM-5467			
		1993-98	Trans	Non Turbo	1			EM-5769	
			Trans	Turbo	1			EM-5752	
<b>TERCEL</b>									
L4	L4 1.5L 1452cc	1987-88	Front		1	EM-8363			
		1980-86	L & R Front		2	EM-8279			
		1987-88	RH Front		1	EM-8278			
			Rear	Auto	1	EM-8173			
			Rear	Manual	1	EM-8174			
		1987-90	Trans	Auto	1			EM-8176	
			Trans	Manual	1			EM-9124	
		1984-86	Trans	Auto	1			EM-2685	
			Trans	Manual	1			EM-8377	
		1980-83	Trans	Auto, After 6/83	1			EM-2685	
			Trans	Auto, Before 6/83	1			EM-8214	
			Trans	Manual	1			EM-8377	
		L4 1.5L 1456cc	1987-90	Front		1	EM-8363		
				RH Front		1	EM-8166		
				RH Front		1	EM-8278		
	1991-94		Rear	Auto	1	EM-9019			
			Rear	Manual	1	EM-8171			
			Rear	Manual; 5 Spd	1	EM-8167			
	1987-90		Rear		1	EM-8173			
			Trans	Auto	1			EM-8175	
	1991-94		Trans	Manual	1			EM-8170	
			Trans	Auto	1			EM-8176	
	1987-88		Trans	Manual	1			EM-9124	
			Trans	Manual	1			EM-9124	
	L4 1.5L 1497cc	1995-99	RH Front		1	EM-8166			
			Rear		1	EM-8167			
		1999	Trans	Complete Unit	1			EM-8418	
			Trans	Insert	1			EM-5736	
		1998	Trans	Auto	1			EM-8175	
			Trans	Manual, Complete Unit	1			EM-8418	
			Trans	Manual, Insert	1			EM-5736	
		1995-97	Trans	Auto, 3 Spd	1			EM-8175	
			Trans	Auto, 4 Spd	1			EM-9123	
Trans	Manual, Complete Unit		1			EM-8418			
Trans	Manual, Insert		1			EM-5736			

# Engine, Transmission, And Torque Strut Mounts

CYL	ENG. SIZE	YEAR	LOCATION	DESCRIPTION	QTY	ENGINE	TORQUE STRUT	TRANSMISSION
<b>TOYOTA PASSENGER CAR (continued)</b>								
<b>YARIS</b>								
L4	L4 1.5L 1497cc	2015-18	RH Front	Auto	1	EM-5654		
		2012-14	RH Front	Auto	1	EM-5654		
		2007-11	RH Front	Auto	1	EM-5654		
			RH Front	Manual	1	EM-9279		
		2007-17	Torq Str - Rear	Manual	1		EM-9246	
			Torq Str - Rear L	Auto	1		EM-9249	
		2015-17	Trans	Auto	1			EM-5930
			Trans	Manual	1			EM-5827
		2012-14	Trans	Auto	1			EM-7259
		2006-11	Trans	Auto	1			EM-5930
Trans	Manual		1			EM-5827		
<b>TOYOTA SPORT UTILITY</b>								
<b>4RUNNER</b>								
L4	L4 2.4L 2366cc	1990-95	L & R Front	4WD	2	EM-8162		
			L & R Front	RWD	2	EM-8164		
		1984-89	L & R Front		2	EM-8162		
			1991-95	Trans	Auto; 2WD	1		EM-8165
		Trans		Auto; 4WD	1		EM-8165	
		Trans		Manual; 2WD	1		EM-9113	
		Trans		Manual; 4WD	1		EM-9113	
		1990	Trans	Auto; 2WD	1		EM-8508	
			Trans	Auto; 4WD	1		EM-8508	
			Trans	Manual; 2WD	1		EM-9113	
			Trans	Manual; 4WD	1		EM-9113	
		1987-89	Trans	Auto; 4WD	1		EM-8388	
			Trans	Manual; 4WD	1		EM-9113	
		1984-86	Trans	Auto; 4WD	1		EM-8388	
	L4 2.7L 2694cc	1996-00	L & R Front		2	EM-8164		
		2010	Trans	Auto	1		EM-9619	
		1996-00	Trans	2WD	1		EM-8993	
			Trans	4WD	1		EM-8990	
		V6	V6 3.0L 2959cc	1988-95	L & R Front		2	EM-8164
1995	Trans				Auto; 2WD	1		EM-8508
	Trans			Auto; 4WD	1		EM-8508	
	Trans			Manual; 2WD	1		EM-8165	
	Trans			Manual; 4WD	1		EM-8165	
1993-94	Trans			Auto; 2WD	1		EM-9086	
	Trans			Auto; 4WD	1		EM-9086	
	Trans			Manual; 2WD	1		EM-8165	
	Trans			Manual; 4WD	1		EM-8165	
1990-92	Trans			Auto; 2WD	1		EM-8508	
	Trans			Auto; 4WD	1		EM-8508	
	Trans			Manual; 2WD	1		EM-8165	
	Trans			Manual; 4WD	1		EM-8165	
1988-89	Trans			4WD	1		EM-8508	
V6 3.4L 3378cc	1999-02		L & R Front		2	EM-9014		
	1996-98		L & R Front	4WD	2	EM-8164		
			L & R Front	RWD	2	EM-8162		
	2002		Trans	Auto; 2WD	1		EM-8993	
			Trans	Auto; 4WD	1		EM-8990	
	1999-01		Trans	Auto; 2WD	1		EM-8993	
Trans		Auto; 4WD	1		EM-8990			
Trans		Manual; 2WD	1		EM-8993			
1996-98	Trans	Manual; 4WD	1		EM-5908			
	Trans	Auto; 2WD	1		EM-2410			
Trans	Auto; 4WD	1		EM-8990				

## Engine, Transmission, And Torque Strut Mounts

CYL	ENG. SIZE	YEAR	LOCATION	DESCRIPTION	QTY	ENGINE	TORQUE STRUT	TRANSMISSION	
<b>TOYOTA SPORT UTILITY (continued)</b>									
<b>4RUNNER (continued)</b>									
V6	V6 3.4L 3378cc	1996-98	Trans	Manual; 2WD	1			EM-2410	
			Trans	Manual; 4WD	1		EM-5908		
	V6 4.0L 3956cc	2003-13 2003-12	L & R Front		2	EM-9599			
			Trans	4WD	1		EM-9494		
			Trans	RWD	1		EM-9425		
V8	V8 4.7L 4663cc	2003-09	L & R Front		2	EM-5649			
			Trans	4WD	1		EM-9511		
			Trans	Auto; 2WD	1		EM-9499		
<b>FJ CRUISER</b>									
V6	V6 4.0L 3956cc	2007-14 2008-11	L & R Front		2	EM-9599			
			Trans	Mexico; 4WD	1		EM-9494		
		2007-12	Trans	4WD	1		EM-9494		
			Trans	RWD; US & Canada	1		EM-9425		
<b>HIGHLANDER</b>									
L4	L4 2.4L 2362cc	2001-07	Front		1	EM-9477			
			RH Front		1	EM-5141			
			Rear	Bushing	1	EM-9591			
			Rear	Complete Kit	1	EM-5741			
		2004-07	Torq Str - Front	AWD	1		EM-9233		
			Torq Str - Front	FWD	1		EM-9234		
		2001-03	Torq Str - Front	AWD	1		EM-9231		
			Torq Str - Front	FWD	1		EM-9235		
		2001-07	Trans	Auto	1			EM-9165	
		L4 2.7L 2672cc	2009-13	Front		1	EM-5900		
	2014-16		Rear		1	EM-9237			
	2009-13		Right		1	EM-9237			
			Torq Str - Right		1		EM-9610		
	2009-16		Trans		1			EM-9236	
	V6	V6 3.0L 2995cc	2001-03	Front		1	EM-7244		
Rear				AWD	1	EM-5741			
Rear				FWD	1	EM-5755			
Right				AWD	1	EM-5766			
Right				FWD	1	EM-9239			
Torq Str - Front				AWD, RH Front	1		EM-9227		
Torq Str - Front				FWD, RH Front	1		EM-5206		
Trans					1			EM-9165	
V6 3.3L 3300cc			2008-10	Front	Hybrid	1	EM-7188		
			2006-07	Front	Hybrid	1	EM-7188		
			2008-10	Rear	Hybrid; AWD	1	EM-7039		
			2006-07	Rear	Hybrid; AWD	1	EM-7039		
				Rear	Hybrid; FWD	1	EM-5837		
		2004-07	Rear	Gas; AWD	1	EM-7039			
			Rear	Gas; FWD	1	EM-5837			
		2006-07	Right	Hybrid; FWD	1	EM-9212			
		2004-07	Right	Gas; FWD	1	EM-9212			
		2008-10	Torq Str - Front	Hybrid	1		EM-7041		
		2006-07	Torq Str - Right	AWD	1		EM-9232		
			Torq Str - Right	FWD	1		EM-9227		
2004-05		Torq Str - Right	FWD	1		EM-9227			
2004-07		Trans		1			EM-9165		
V6 3.5L 3456cc		2011-16	Front	Hybrid	1	EM-7188			
			Rear	Hybrid	1	EM-7185			
		2008-10	Rear	FWD; Japan Built	1	EM-7039			
		2014-16	Right	Gas	1	EM-9238			
		2011-16	Right	Hybrid	1	EM-9238			
		2011-13	Right	Gas	1	EM-7027			

# Engine, Transmission, And Torque Strut Mounts

CYL	ENG. SIZE	YEAR	LOCATION	DESCRIPTION	QTY	ENGINE	TORQUE STRUT	TRANSMISSION
<b>TOYOTA SPORT UTILITY (continued)</b>								
<b>HIGHLANDER (continued)</b>								
V6	V6 3.5L 3456cc	2008-10	Right		1	EM-7027		
		2011-13	Torq Str - Front	Gas	1		EM-7086	
		2010	Torq Str - Front	Gas; Japan Built	1		EM-9538	
			Torq Str - Front	Gas; US Built	1		EM-7086	
		2008-09	Torq Str - Front	Gas; Japan Built	1		EM-9538	
		2011-15	Torq Str - Right	Hybrid	1		EM-7083	
		2014-16	Trans	Gas; Gas Engine	1			EM-9236
2011-18	Trans	Hybrid; Hybrid	1			EM-7189		
<b>LAND CRUISER</b>								
L4	L4 3.4L 3431cc Diesel	1983-85	L & R Front	After 1/82	2	EM-8488		
		1982	L & R Front	After 1/82	2	EM-8488		
			L & R Front	Before 1/82	2	EM-5208		
		1981	L & R Front		2	EM-5208		
		1984-85	Trans	Auto	1			EM-2410
			Trans	Manual	1			EM-2410
		1982-83	Trans	Manual	1			EM-2410
		1981	Trans	Auto	1			EM-2410
	Trans	Manual	1			EM-2410		
L6	L6 3.9L 3878cc	1967-74	L & R Front		2	EM-8280		
			Trans	Auto	1		EM-8650	
			Trans	Manual	1		EM-8651	
	L6 4.0L 3956cc	1988-90	L & R Front		2	EM-8163		
			1991-92	LH Front		1	EM-8365	
				RH Front		1	EM-8571	
			Trans		1		EM-8393	
	1988-90	Trans	Auto	1		EM-8642		
	L6 4.2L 4227cc	1981-87	L & R Front		2	EM-8163		
			L & R Front		2	EM-8280		
		1976-80	L & R Front		2	EM-5370		
			Trans	After 11/84	1		EM-8392	
		1985	Trans	Before 11/84	1		EM-8392	
		1986-87	Trans	Manual	1		EM-8393	
		1985	Trans		1		EM-8393	
			Trans		1		EM-8393	
		1981-84	Trans	Manual	1		EM-8392	
	1975-80	Trans	Manual	1		EM-8651		
	L6 4.5L 4477cc	1993-97	L & R Front		2	EM-8353		
			Trans		1		EM-8395	
V8	V8 4.7L 4663cc	1998-07	L & R Front		2	EM-9050		
		1998-03	Trans		1		EM-8991	
<b>RAV4</b>								
L4	L4 2.0L 1998cc	2004-05	Front	Auto	1	EM-9081		
		2001-03	Front	Auto	1	EM-9081		
			Front	Manual	1	EM-5464		
		1996-00	Front	Auto	1	EM-8847		
			Front	Manual	1	EM-8848		
		2001-03	RH Front		1	EM-9432		
		1996-00	RH Front		1	EM-8854		
		2001-03	Rear	Canada	1	EM-9393		
		1996-00	Rear		1	EM-8855		
		2001-03	Trans		1		EM-9420	
		1998-00	Trans	Auto	1		EM-9026	
			Trans	Manual	1		EM-9026	
		1996-97	Trans	Auto; AWD	1		EM-9061	
			Trans	Auto; FWD	1		EM-5209	
	Trans	Manual; AWD	1		EM-8856			

## Engine, Transmission, And Torque Strut Mounts

CYL	ENG. SIZE	YEAR	LOCATION	DESCRIPTION	QTY	ENGINE	TORQUE STRUT	TRANSMISSION	
<b>TOYOTA SPORT UTILITY (continued)</b>									
<b>RAV4 (continued)</b>									
L4	L4 2.0L 1998cc	1996-97	Trans	Manual; FWD	1			EM-8856	
	L4 2.4L 2362cc	2006-08	Front		1	EM-9497			
			Front	Mexico	1	EM-9497			
		2004-05	Front	Auto	1	EM-9081			
			2006-08	Rear	4WD	1	EM-9518		
				Rear	FWD	1	EM-9513		
		Rear		Mexico; AWD	1	EM-9518			
		2004-05	Rear	Mexico; FWD	1	EM-9513			
			Rear	AWD	1	EM-9393			
		2006-08	Rear	FWD	1	EM-9502			
			Right	4WD	1	EM-5940			
			Right	FWD	1	EM-5982			
		2004-05	Right	Mexico; AWD	1	EM-5940			
			Right	Mexico; FWD	1	EM-5982			
		2004-05	Right		1	EM-7011			
		2006-08	Trans		1			EM-9549	
	2004-05		Trans		1		EM-9420		
	L4 2.5L 2488cc	2013	Front	Mexico; Gas Engine	1	EM-9498			
			Rear	Mexico; Gas Engine; FWD	1	EM-7232			
	L4 2.5L 2494cc	2016-18	Front	Hybrid; Hybrid	1	EM-9497			
			2014-18	Front	Gas; Gas Engine	1	EM-9498		
		2013	Front	US & Canada; Gas Engine	1	EM-9498			
		2010-12	Front	Mexico	1	EM-9498			
		2009-12	Front		1	EM-9498			
		2014-18	Rear	Gas; Gas Engine; AWD	1	EM-7233			
			Rear	Gas; Gas Engine; FWD	1	EM-7232			
		2013	Rear	US & Canada; Gas Engine AWD	1	EM-7233			
Rear			US & Canada; Gas Engine FWD	1	EM-7232				
2010-12		Rear	Mexico; FWD	1	EM-9513				
2009-12		Rear	4WD	1	EM-9518				
		Rear	FWD	1	EM-9513				
2010-12		Right	Mexico; FWD	1	EM-5979				
		2009-12	Right	4WD	1	EM-5977			
Right	FWD		1	EM-5979					
Trans			1			EM-9549			
V6	V6 3.5L 3456cc	2006-12	Front		1	EM-9509			
			Rear	4WD	1	EM-7078			
			Rear	FWD	1	EM-7107			
			Right		1	EM-5964			
			Trans	Auto	1			EM-9550	
<b>SEQUOIA</b>									
V8	V8 4.6L 4608cc	2010-12	LH Front		1	EM-5902			
			RH Front		1	EM-5901			
			Trans	4WD; US & Canada	1			EM-9522	
	V8 4.7L 4663cc	2001-07	L & R Front		2	EM-5646			
			2008-09	LH Front		1	EM-7197		
		RH Front			1	EM-7198			
		Trans		2WD	1			EM-9519	
		Trans	4WD	1			EM-7108		
		2005-07	Trans	4WD	1		EM-5919		
		2001-04	Trans	2WD	1		EM-5808		
	Trans		4WD	1		EM-5807			
	V8 5.7L 5663ci	2008-16	LH Front		1	EM-5902			
			RH Front		1	EM-5901			
		2011-17	Trans	2WD	1			EM-7238	

# Engine, Transmission, And Torque Strut Mounts

CYL	ENG. SIZE	YEAR	LOCATION	DESCRIPTION	QTY	ENGINE	TORQUE STRUT	TRANSMISSION	
<b>TOYOTA SPORT UTILITY (continued)</b>									
<b>SEQUOIA (continued)</b>									
V8	V8 5.7L 5663ci	2011-17	Trans	4WD	1			EM-9522	
		2008-10	Trans	4WD	1			EM-9522	
<b>VENZA</b>									
L4	L4 2.7L 2672cc	2009-15	Front		1	EM-5742			
			Rear	Bushing	1	EM-9591			
			Right		1	EM-9237			
		2009-13	Trans		1			EM-9236	
L5	L4 2.7L 2672cc		Torq Str - Right		1		EM-9610		
V6	V6 3.5L 3456cc	2009-15	RH Front	Hydraulic Mount	1	EM-9238			
			Rear	Bushing	1	EM-9590			
			Torq Str - Right		1		EM-9593		
		2009-16	Trans		1			EM-9236	
<b>TOYOTA TRUCK</b>									
<b>PICKUP</b>									
L4	L4 1.9L 1858cc	1970-71	L & R Front		2	EM-2407			
			Trans	Auto	1			EM-2409	
			Trans	Manual	1			EM-2409	
	L4 2.0L 1968cc	1972-74	L & R Front		2	EM-2407			
			Trans	Auto	1			EM-2409	
			Trans	Manual	1			EM-2409	
	L4 2.2L 2188cc Diesel	1983	L & R Front		2	EM-8488			
			1982	L & R Front	After 1/82	2	EM-8488		
				L & R Front	Before 1/82	2	EM-5208		
			1981	L & R Front		2	EM-5208		
			1981-83	Trans	2WD	1			EM-2410
	Trans	4WD		1			EM-8389		
	L4 2.2L 2189cc	1975-80	L & R Front		2	EM-2407			
			Trans	4WD	1			EM-8389	
		1979-80	Trans	Auto; 2WD	1			EM-2410	
			Trans	Manual; 4 Spd; 2WD	1			EM-2746	
			Trans	Manual; 5 Spd; 2WD	1			EM-2410	
			Trans	Auto; 2WD	1			EM-2410	
		1978	Trans	Manual; 4 Spd; 2WD; After 8/78	1			EM-2746	
			Trans	Manual; 4 Spd; 2WD; Before 8/78	1			EM-2409	
			Trans	Manual; 5 Spd; 2WD	1			EM-2410	
			1975-77	Trans	Auto; RWD	1		EM-2410	
	Trans	Manual; RWD	1			EM-2409			
	L4 2.4L 2366cc	1984-95	L & R Front		2	EM-8488			
		1984-86	Trans - LH	Auto; 2WD	1			EM-2410	
		1992-95	Trans	Auto; 4WD	1			EM-8165	
			Trans	Manual; 4WD	1			EM-9113	
		1990-91	Trans	2WD	1			EM-2410	
			Trans	Auto; 4WD	1			EM-8165	
			Trans	Manual; 4WD	1			EM-9113	
		1989	Trans	2WD	1			EM-2410	
			Trans	Manual; 4WD	1			EM-9113	
		1987-88	Trans	4WD	1			EM-8388	
			Trans	Auto; 2WD	1			EM-2410	
			Trans	Manual; 2WD	1			EM-2410	
		1984-86	Trans	Manual; 2WD	1			EM-2410	
Trans			Manual; 4WD	1			EM-2690		
1981-83		Trans	2WD	1			EM-2410		
	Trans	4WD	1			EM-8388			
L4 2.4L 2446cc Diesel	1984-87	L & R Front		2	EM-8488				



## Engine, Transmission, And Torque Strut Mounts

CYL	ENG. SIZE	YEAR	LOCATION	DESCRIPTION	QTY	ENGINE	TORQUE STRUT	TRANSMISSION
<b>TOYOTA TRUCK (continued)</b>								
<b>PICKUP (continued)</b>								
L4	L4 2.4L 2446cc Diesel	1984-87	Trans	Auto; 2WD	1			EM-2410
			Trans	Auto; 4WD	1			EM-8389
			Trans	Manual; 2WD	1			EM-2410
			Trans	Manual; 4WD	1			EM-8389
V6	V6 3.0L 2959cc	1988-95	L & R Front	4WD	2	EM-8164		
			L & R Front	RWD	2	EM-8162		
		1990-95	Trans	Auto; 2WD	1			EM-9086
			Trans	Auto; 4WD	1			EM-8508
			Trans	Manual; 4WD	1			EM-8165
		1988-89	Trans	Auto; 2WD	1			EM-9086
			Trans	Auto; 4WD; After 4/89	1			EM-8508
			Trans	Manual; 4WD	1			EM-8165
<b>T100</b>								
L4	L4 2.7L 2694cc	1994-98	L & R Front		2	EM-8164		
V6	V6 3.0L 2959cc	1993-94	L & R Front	4WD	2	EM-9080		
			L & R Front	RWD	2	EM-9120		
			Trans	4WD	1			EM-8165
			Trans	RWD, Auto	1			EM-2410
			Trans	RWD, Manual	1			EM-8165
	V6 3.4L 3378cc	1995-98	L & R Front	4WD	2	EM-9080		
			L & R Front	RWD	2	EM-9120		
Trans			Auto; 4WD	1			EM-2410	
Trans			Manual; 4WD	1			EM-8165	
Trans	Manual; RWD	1			EM-2410			
<b>TACOMA</b>								
L4	L4 2.4L 2438cc	1995-04	L & R Front		2	EM-8164		
		2004	Trans	RWD	1			EM-2410
		1998-03	Trans	2WD, w/o Pre-Runner	1			EM-2410
	L4 2.7L 2694cc	2005-15	L & R Front		2	EM-7010		
			L & R Front		2	EM-8164		
		2011-15	Trans	Auto; 4WD	1			EM-7079
			Trans	Auto; RWD	1			EM-9500
			Trans	Manual; 4WD	1			EM-5910
			Trans	Manual; RWD	1			EM-9500
		2005-10	Trans	Auto; RWD	1			EM-9500
			Trans	Manual; 4WD	1			EM-5910
			Trans	Manual; RWD	1			EM-9500
		1998-04	Trans	2WD, w/ Pre-Runner	1			EM-8989
			Trans	2WD, w/o Pre-Runner	1			EM-2410
V6	V6 3.4L 3378cc	2000-04	L & R Front		2	EM-9014		
		1995-99	L & R Front		2	EM-8162		
		1998-04	Trans	2WD, w/ Pre-Runner	1			EM-8996
			Trans	2WD, w/o Pre-Runner	1			EM-2410
			Trans	4WD; Auto	1			EM-9515
			Trans	Manual; 4WD	1			EM-9018
		1995-97	Trans	4WD; Auto	1			EM-9515
			Trans	RWD	1			EM-2410
	Trans		Manual; 4WD	1			EM-9115	
	V6 4.0L 3956cc	2005-11	L & R Front		2	EM-9599		
		2006-12	Trans	Mexico; Auto; 2WD	1			EM-9430
			Trans	Mexico; Manual; 2WD	1			EM-9429
		2005-12	Trans	4WD; US & Canada	1			EM-9494
Trans			Auto; 2WD	1			EM-9430	
Trans	Manual; 2WD	1			EM-9429			

# Engine, Transmission, And Torque Strut Mounts

CYL	ENG. SIZE	YEAR	LOCATION	DESCRIPTION	QTY	ENGINE	TORQUE STRUT	TRANSMISSION	
<b>TOYOTA TRUCK (continued)</b>									
<b>TUNDRA</b>									
V6	V6 3.4L 3378cc	2000-04	L & R Front		2	EM-9079			
			Trans	2WD	1		EM-8993		
			Trans	Manual; 4WD	1		EM-9018		
	V6 4.0L 3956cc	2005-06 2007-14	L & R Front		2	EM-5754			
			LH Front		1	EM-7183			
			RH Front		1	EM-7184			
	V6 4.0L 4000cc	2005-06	Trans		1			EM-9523	
			Trans	2WD	1		EM-9543		
	V8	V8 4.6L 4608cc	2010-12	LH Front		1	EM-5902		
				RH Front		1	EM-5901		
Trans				4WD	1		EM-9522		
V8 4.7L 4663cc		2000-06 2007-09	L & R Front		2	EM-5646			
			LH Front		1	EM-7197			
			RH Front		1	EM-7198			
		2005-06 2000-04	Trans	2WD	1		EM-9519		
			Trans	4WD	1		EM-7108		
			Trans	4WD	1		EM-5920		
V8 5.7L 5663ci		2007-16	LH Front		1	EM-5902			
			RH Front		1	EM-5901			
		2011-17 2007-10	Trans	2WD	1		EM-7238		
			Trans	4WD	1		EM-9522		
<b>TOYOTA VAN</b>									
<b>AVANZA (MEXICO)</b>									
L4		L4 1.5L 1495cc	2007-18	Trans	Auto	1			EM-90071
<b>HIACE (MEXICO)</b>									
L4	L4 2.7L 2694cc	2006-18	L & R Front		2	EM-9003			
<b>PREVIA</b>									
L4	L4 2.4L 2438cc	1996-97 1994-95 1991-93 1994-95 1991-93 1996-97 1994-95 1991-95	RH Front		1	EM-8892			
			RH Front		1	EM-8892			
			RH Front		1	EM-8892			
			Rear	w/o Supercharger	1	EM-9027			
			Rear		1	EM-9027			
			Trans	Insert; w/ Supercharger	1		EM-9063		
			Trans	Insert; w/ Supercharger	1		EM-9063		
			Trans	Auto; w/o Supercharger	1		EM-9032		
Trans	Auto; w/o Supercharger	1		EM-9032					
<b>SIENNA</b>									
L4	L4 2.7L 2672cc	2011-12	Front		1	EM-5900			
			Right		1	EM-9237			
		2011-13	Trans	Hydraulic Mount	1		EM-9236		
V6	V6 3.0L 2995cc	1998-03	RH Front		1	EM-5356			
			Rear	Insert	1	EM-8699			
			Torq Str - Front		1		EM-9226		
			Trans		1		EM-8644		
	V6 3.3L 3300cc	2004-06	Front		1	EM-5900			
			Rear	Bushing	1	EM-9591			
			Rear	Complete Kit	1	EM-5741			
			Right		1	EM-9212			
Torq Str - Front	AWD	1		EM-5874					
Torq Str - Front	FWD	1		EM-5835					
Trans	Auto	1		EM-9165					

## Engine, Transmission, And Torque Strut Mounts

CYL	ENG. SIZE	YEAR	LOCATION	DESCRIPTION	QTY	ENGINE	TORQUE STRUT	TRANSMISSION	
<b>TOYOTA VAN (continued)</b>									
<b>SIENNA (continued)</b>									
V6	V6 3.5L 3456cc	2007-10	Front		1	EM-5949			
			RH Front		1	EM-9238			
		2011-16	2007-10	Rear	Bushing	1	EM-9591		
				Rear	Bushing	1	EM-9591		
		2011-16	2007-10	Rear	Complete Kit	1	EM-5741		
				Right		1	EM-9238		
		2007-10	2011-14	Torq Str - Front		1		EM-9546	
				Torq Str - Rear	AWD	1		EM-9595	
		2015-19	2011-14	Torq Str - Rear	FWD	1		EM-9587	
				Torq Str - Rear	Mexico; FWD	1		EM-9587	
	2011-16	2015-19	Torq Str - Right	AWD	1		EM-7192		
			Torq Str - Right	FWD	1		EM-7236		
	2007-10	2011-16	Trans		1			EM-9236	
			Trans	Hydraulic Mount	1			EM-9165	
V6 3.5L 3496cc	2007	Front	Mexico	1	EM-5949				
		RH Front	Mexico	1	EM-9238				
		Rear	Mexico; Bushing	1	EM-9591				
		Rear	Mexico; Complete Kit	1	EM-5741				
<b>VAN</b>									
L4	L4 2.0L 1998cc	1984-85	L & R Front		2	EM-2407			
			Rear		1	EM-8649			
	L4 2.2L 2237cc	1987-89	L & R Front		2	EM-9029			
			1986	L & R Front		2	EM-9029		
		1987-89	1986-89	Rear	4WD	1	EM-5749		
				Trans	Auto	1		EM-8649	
	Trans	Manual	1		EM-8649				
<b>VAN WAGON</b>									
L4	L4 2.3L 2245cc	1988	L & R Front		2	EM-9029			
			Rear		1	EM-8649			
<b>VOLKSWAGEN PASSENGER CAR</b>									
<b>411</b>									
H4	H4 1.7L 1679cc	1971-72	L & R Front		2	EM-2415			
<b>412</b>									
H4	H4 1.7L 1679cc	1973-74	L & R Front		2	EM-2415			
	H4 1.8L 1795cc	1974	L & R Front		2	EM-2415			
<b>ATLANTIC (MEXICO)</b>									
L4	L4 1.6L	1981	L & R Front		2	EM-9045			
			L4 1.6L 1588cc	1981	Trans - Rear Lower	1		EM-2420	
		Trans - Rear Upper	1			EM-2417			
	L4 1.7L	1982-86	L & R Front		2	EM-9045			
			Trans - Rear Lower	1		EM-2420			
			Trans - Rear Upper	1		EM-2417			
<b>BEEBLE</b>									
H4	H4 1.2L 1192cc	1955-66	L & R Rear		2	EM-2167			
			Trans	Manual	1		EM-2293		
	H4 1.3L 1285cc	1966	L & R Rear		2	EM-2167			
			Trans	Manual	1		EM-2293		
	H4 1.5L 1457cc	1967-69	Rear Inner		1	EM-2167			
			Rear Outer		1	EM-2414			
	Trans	Manual	1		EM-2293				

# Engine, Transmission, And Torque Strut Mounts

CYL	ENG. SIZE	YEAR	LOCATION	DESCRIPTION	QTY	ENGINE	TORQUE STRUT	TRANSMISSION	
<b>VOLKSWAGEN PASSENGER CAR (continued)</b>									
<b>BEETLE (continued)</b>									
H4	H4 1.6L 1584cc	1970-79	L & R Rear		2	EM-2167			
			1973-79	Trans - LH	Auto	1			EM-2419
			Trans - RH	Auto	1				EM-2418
			Trans	Manual	1				EM-8850
		1970-72	Trans	Manual	1			EM-2293	
L4	L4 1.8L 1781cc	1999-05	RH Front		1	EM-9092			
			Rear		1	EM-9208			
			Trans		1			EM-9101	
		L4 1.8L 1798cc	2014-17	Rear		1	EM-7262		
	L4 1.9L 1896cc Diesel	1998-03	RH Front		1	EM-9092			
			Rear	Auto	1	EM-9208			
			Trans	Manual	1			EM-9101	
	L4 2.0L 1984cc	2012-15	Front	Gas	1	EM-9092			
			2006-09	RH Front	Hydraulic Mount; Mexican Vehicle	1	EM-9092		
		1998-05	RH Front		1	EM-9092			
		2014-15	Rear	Diesel	1	EM-7262			
		2012-15	Rear	Gas	1	EM-7262			
		2006-09	Rear	Auto; Mexico Vehicle	1	EM-9208			
		1998-05	Rear		1	EM-9208			
	2006-09	Trans	Hydraulic Mount; Mexican Vehicle	1				EM-9101	
	1998-05	Trans	Manual	1				EM-9101	
L5	L5 2.5L 2480cc	2012-14	Rear		1	EM-7262			
		2006-07	Trans	Manual	1			EM-9101	
<b>BORA (MEXICO)</b>									
L4	L4 1.9L Diesel	2008	Front Lower		1	EM-9260			
			Front Upper		1	EM-9263			
			RH Front	Hydraulic Mount	1	EM-9092			
			Rear		1	EM-9283			
			Trans	Auto; Hydraulic Mount	1			EM-9262	
L5	L5 2.5L 2480cc	2006-08	Front Lower		1	EM-9260			
			Front Upper		1	EM-9263			
			LH Front		1	EM-9259			
			RH Front		1	EM-9257			
			Rear		1	EM-9283			
<b>BRASILIA (MEXICO)</b>									
H4	H4 1.6L 1584cc	1975-82	L & R Front		2	EM-9045			
			Trans - Rear Lower		1			EM-2420	
			Trans - Rear Upper		1			EM-2417	
<b>CC</b>									
L4	L4 2.0L 1984cc	2013-15	Front		1	EM-9092			
		2009-12	Front		1	EM-9092			
		2013-15	Front Upper		1	EM-7270			
			L & R Rear		2	EM-9401			
		2009-12	L & R Rear		2	EM-9401			
			Lower Rear		1	EM-9260			
		2013-15	Rear		1	EM-7176			
		2009-12	Rear		1	EM-7176			
			Trans	Manual	1			EM-5934	
			Trans	w/ Auto-manual	1			EM-5935	
	Trans	w/o Auto-manual	1			EM-7138			
V6	V6 3.6L 3597cc	2009-15	L & R Front		2	EM-9401			
			Rear		1	EM-7075			

## Engine, Transmission, And Torque Strut Mounts

CYL	ENG. SIZE	YEAR	LOCATION	DESCRIPTION	QTY	ENGINE	TORQUE STRUT	TRANS-MISSION
<b>VOLKSWAGEN PASSENGER CAR (continued)</b>								
<b>CC (continued)</b>								
V6	V6 3.6L 3597cc	2009-15	Right		1	EM-9405		
		2009-16	Trans	Auto	1			EM-7272
			Trans	Manual	1			EM-7272
<b>CABRIO</b>								
L4	L4 2.0L 1984cc	2000-02	Front	Mexican Vehicle	1	EM-8617		
			Front	US Vehicle	1	EM-8664		
		1995-99	Front		1	EM-8664		
		2000-02	LH Rear		1	EM-8224		
		1995-99	LH Rear		1	EM-8224		
		2000-02	RH Front	Mexican Vehicle	1	EM-8616		
			RH Rear	Mexican Vehicle	1	EM-8589		
			RH Rear	US Vehicle	1	EM-8616		
		1995-99	RH Rear		1	EM-8616		
		2000-02	Trans	US & Canada	1			EM-8287
			Trans	Mexican Vehicle	1			EM-8236
			Trans		1			EM-8287
			1995-99	Trans	Auto	1		EM-8287
					Trans	Manual	1	
<b>CABRIOLET</b>								
L4	L4 1.8L 1780cc	1985-93	Front	Insert	1	EM-9045		
			Front Center		1	EM-9077		
			Trans - Rear Lower		1			EM-2420
			Trans - Rear Upper		1			EM-2417
<b>CARIBE (MEXICO)</b>								
L4	L4 1.6L	1977-83	L & R Front		2	EM-9045		
			Trans - Rear Lower		1			EM-2420
			Trans - Rear Upper		1			EM-2417
	L4 1.7L	1981-86	L & R Front		2	EM-9045		
			Trans - Rear Lower		1			EM-2420
			Trans - Rear Upper		1			EM-2417
	L4 1.8L	1987	Front		1	EM-8224		
			Front	Bracket Only	1	EM-5612		
		1984-86	Front	Bracket Only	1	EM-5612		
			Front	Mount	1	EM-8224		
		1987	RH Front	8 Valve Engine	1	EM-8222		
		1984-86	RH Front	8 Valve Engine	1	EM-8222		
	1987	RH Rear	Hydraulic Mount; GLI; 16 Valve Engine	1	EM-9001			
				Trans		1		EM-8236
<b>CORRADO</b>								
L4	L4 1.8L 1780cc	1990-92	Front		1	EM-8224		
			LH Rear		1	EM-8236		
			RH Rear		1	EM-9001		
			Trans		1			EM-8287
V6	V6 2.8L 2792cc	1992-95	Front		1	EM-9000		
			RH Rear		1	EM-9065		
			Trans	Auto	1			EM-8236
			Trans	Manual	1			EM-8236

# Engine, Transmission, And Torque Strut Mounts

CYL	ENG. SIZE	YEAR	LOCATION	DESCRIPTION	QTY	ENGINE	TORQUE STRUT	TRANSMISSION	
<b>VOLKSWAGEN PASSENGER CAR (continued)</b>									
<b>CORSAR (MEXICO)</b>									
L4	L4 1.8L 1781cc	1984-88	Front	Bracket Only	1	EM-5612			
			Front	Mount	1	EM-8224			
			RH Front		1	EM-8222			
			RH Rear		1	EM-9001			
			Trans		1			EM-8287	
<b>DASHER</b>									
L4	L4 1.5L 1471cc Diesel	1979-80	L & R Front		2	EM-9109			
			Rear		1	EM-2421			
	L4 1.5L 1471cc	1974-75	Rear		1	EM-2421			
	L4 1.5L 1471cc Diesel	1979-80	Trans	Auto	1			EM-8221	
	L4 1.5L 1471cc	1974-75	Trans	Auto	1			EM-8221	
			Trans	Manual	1			EM-8623	
	L4 1.6L 1588cc Diesel	1981	L & R Front		2	EM-9109			
	L4 1.6L 1588cc	1976-80	L & R Front		2	EM-9109			
L4 1.6L 1588cc Diesel	1981	Trans		1			EM-8221		
L4 1.6L 1588cc	1976-80	Trans	Auto	1			EM-8221		
<b>DERBY (MEXICO)</b>									
L4	L4 1.8L 1781cc	1995-00	Front		1	EM-8617			
			2001-08	RH Front	Hydraulic Mount	1	EM-9092		
			1995-00	RH Front		1	EM-8616		
			2001-08	Rear		1	EM-9208		
			Trans	Hydraulic Mount	1			EM-9101	
	1995-00	Trans	Manual	1			EM-8236		
	L4 2.0L 1984cc	2002-03	RH Front	Hydraulic Mount	1	EM-9092			
			Rear		1	EM-9208			
Trans			Hydraulic Mount	1			EM-9101		
<b>EOS</b>									
L4	L4 2.0L 1984cc	2013-14	Front		1	EM-9092			
			2007-12	Front		1	EM-9092		
		2013-14	Front Upper		1	EM-7270			
			LH Front		1	EM-9259			
		2007-12	LH Front		1	EM-9259			
			LH Front Upper		1	EM-9263			
			Lower Rear		1	EM-9260			
		2013-14	RH Front		1	EM-9257			
		2007-12	RH Front		1	EM-9257			
		2013-14	Rear		1	EM-9283			
		2007-12	Rear		1	EM-9283			
		V6	V6 3.2L 3189cc	2007-08	LH Front Upper		1	EM-9263	
Lower Rear					1	EM-9260			
RH Front					1	EM-9257			
Rear					1	EM-9283			
Right					1	EM-9405			
<b>FASTBACK</b>									
H4	H4 1.6L 1584cc	1966-73	Rear		1	EM-2167			
			Trans		1			EM-2293	
<b>FOX</b>									
L4	L4 1.8L 1780cc	1987-93	L & R Front		2	EM-9109			
			Trans	Manual	1			EM-9093	
<b>GOLF</b>									
L4	L4 1.6L 1588cc Diesel	1985-92	Front	Bracket Only	1	EM-5612			
			Front	Hydraulic Mount	1	EM-8224			
			RH Front		1	EM-8222			
			Trans	Auto	1			EM-8236	

## Engine, Transmission, And Torque Strut Mounts

CYL	ENG. SIZE	YEAR	LOCATION	DESCRIPTION	QTY	ENGINE	TORQUE STRUT	TRANSMISSION	
<b>VOLKSWAGEN PASSENGER CAR (continued)</b>									
<b>GOLF (continued)</b>									
L4	L4 1.6L 1588cc Diesel	1985-92	Trans	Manual	1			EM-8236	
	L4 1.8L 1780cc	1990-92	Front	Auto, Before 3/1/91	1	EM-8224			
			Front	Manual; Bracket Only	1	EM-5612			
	1987-89	Front	Manual; Mount Only	1	EM-8224				
		Front	8 Valve Engine w/ Auto	1	EM-8224				
		Front	8 Valve Engine w/ Manual	1	EM-8224				
		Front	GLI; 16 Valve Engine	1	EM-8224				
		Front	Manual; Bracket Only	1	EM-5612				
		Front	8 Valve Engine w/ Auto	1	EM-8224				
	1985-86	Front	8 Valve Engine w/ Manual	1	EM-8224				
		Front	Manual; Bracket Only	1	EM-5612				
		Front	8 Valve Engine w/ Auto	1	EM-8224				
	1990-92	RH Rear	Calif Emission, After VIN# 1GM20635	1	EM-8287				
		RH Rear	Calif Emission, Before VIN# 1GM20635	1	EM-9001				
		RH Rear	Federal Emission	1	EM-8222				
	1987-89	RH Rear	8 Valve Engine, Cal Emission, After VIN# 1GM20635	1	EM-8287				
		RH Rear	8 Valve Engine, Cal Emission, Before VIN# 1GM20635	1	EM-9001				
		RH Rear	8 Valve Engine, Fed Emission	1	EM-8222				
		RH Rear	GLI; 16 Valve Engine	1	EM-9001				
	1985-86	RH Rear	8 Valve Engine, Fed Emission	1	EM-8222				
	1995-98	Trans	Manual	1				EM-8236	
	1985-94	Trans	Auto	1				EM-8236	
		Trans	Manual	1				EM-8236	
	L4 1.8L 1781cc	2000-06	RH Front		1	EM-9092			
			Rear		1	EM-9208			
			Trans	Auto	1			EM-7000	
			Trans	Manual	1			EM-9101	
	L4 1.8L 1788cc	1993-97	Front	Hydraulic Mount	1	EM-8224			
			Front	Manual; Bracket Only	1	EM-5612			
			RH Rear	8 Valve Engine, Cal Emission	1	EM-8589			
			RH Rear	8 Valve Engine, Fed Emission	1	EM-8222			
	L4 1.8L 1798cc	2015-18	Trans		1			EM-7261	
	L4 1.9L 1896cc Diesel	1995-97	Front		1	EM-8843			
			Front		1	EM-8843			
			Front		1	EM-8843			
			RH Front		1	EM-9092			
			RH Front		1	EM-9092			
			RH Rear		1	EM-5445			
			RH Rear		1	EM-5445			
			RH Rear		1	EM-5445			
			Rear		1	EM-9208			
			Trans	Auto	1			EM-7000	
			Trans	Manual	1			EM-9101	
			1993-98	Trans	Auto	1			EM-8236
				Trans	Manual	1			EM-8236
	L4 2.0L 1968cc Diesel	2015	Right		1	EM-7275			
		2010-14	Trans	Manual	1			EM-7271	
L4 2.0L 1984cc	1993-98	Front		1	EM-8617				
		Front	Manual; Bracket Only	1	EM-5612				
	2006	LH Front		1	EM-9259				
		LH Front Upper		1	EM-9263				
		Lower Rear		1	EM-9260				
	2007	RH Front	Mexican Vehicle; Hydraulic Mount	1	EM-9092				

# Engine, Transmission, And Torque Strut Mounts

CYL	ENG. SIZE	YEAR	LOCATION	DESCRIPTION	QTY	ENGINE	TORQUE STRUT	TRANSMISSION
<b>VOLKSWAGEN PASSENGER CAR (continued)</b>								
<b>GOLF (continued)</b>								
L4	L4 2.0L 1984cc	2006	RH Front		1	EM-9092		
		1999-05	RH Front		1	EM-9092		
		1993-98	RH Front		1	EM-8616		
		1990-92	RH Front	Manual; GLI 16 Valve Engine	1	EM-9001		
		2006	Rear	Auto	1	EM-9208		
		1999-05	Rear		1	EM-9208		
		1999-06	Trans	Auto	1			EM-9101
			Trans	Manual	1			EM-9101
		1993-98	Trans	Auto	1			EM-8236
			Trans	Manual	1			EM-8236
1990-92	Trans	Manual	1			EM-8236		
V6	V6 2.8L 2771cc	1999-05	RH Front		1	EM-9261		
			Rear		1	EM-9208		
			Trans	Manual	1			EM-9101
	V6 2.8L 2792cc	1995-98	Front		1	EM-9000		
			RH Rear		1	EM-9065		
			Trans	Manual	1			EM-8236
	V6 3.2L 3189cc	2004	RH Front		1	EM-9261		
<b>GTI</b>								
L4	L4 2.0L 1984cc	2013-14	Front		1	EM-9092		
		2010-12	Front		1	EM-9092		
		2006-09	Front		1	EM-9092		
		2010-12	Front Lower		1	EM-9260		
		2013-14	Front Upper		1	EM-7270		
		2010-12	Front Upper		1	EM-9263		
		2006-09	Front Upper		1	EM-9263		
			LH Front		1	EM-9259		
			Lower Rear		1	EM-9260		
			RH Front		1	EM-9257		
		2013-14	Rear		1	EM-9283		
		2010-12	Rear		1	EM-9283		
		2006-09	Rear		1	EM-9283		
		2010	Trans	Hydraulic Mount	1			EM-9262
		2009	Trans	Hydraulic Mount	1			EM-9262
		2006-08	Trans	Manual, Hydraulic Mount	1			EM-9262
<b>JETTA</b>								
L4	L4 1.6L 1588cc Diesel	1989-92	Front	Bracket Only	1	EM-5612		
			Front	Hydraulic Mount	1	EM-8224		
		1981-88	L & R Front		2	EM-9045		
	L4 1.6L 1588cc	1980	L & R Front		2	EM-9045		
	L4 1.6L 1588cc Diesel	1989-92	RH Front		1	EM-8222		
			Trans	Auto	1			EM-8236
			Trans	Manual	1			EM-8236
		1981-88	Trans	Auto	1			EM-2420
			Trans	Manual	1			EM-2420
	L4 1.6L 1588cc	1980	Trans	Auto	1			EM-2420
			Trans	Manual	1			EM-2420
	L4 1.7L 1715cc	1981-84	L & R Front	Insert	2	EM-9045		
			Trans	Auto	1			EM-2420
			Trans	Manual	1			EM-2420
	L4 1.8L 1780cc	1990-92	Front	Auto	1	EM-8224		
			Front	Manual; Bracket Only	1	EM-5612		
			Front	Manual; Mount Only	1	EM-8224		
		1987-89	Front	Auto	1	EM-8224		
			Front	Manual; Bracket Only	1	EM-5612		
Front			Manual; Mount Only	1	EM-8224			



## Engine, Transmission, And Torque Strut Mounts

CYL	ENG. SIZE	YEAR	LOCATION	DESCRIPTION	QTY	ENGINE	TORQUE STRUT	TRANSMISSION
<b>VOLKSWAGEN PASSENGER CAR (continued)</b>								
<b>JETTA (continued)</b>								
L4	L4 1.8L 1780cc	1984-86	Front	Auto	1	EM-8224		
			Front	Manual; Bracket Only	1	EM-5612		
			Front	Manual; Mount Only	1	EM-8224		
		1987-89	RH Rear	8 Valve Engine	1	EM-8222		
			RH Rear	GLI; 16 Valve Engine	1	EM-9001		
		1984-86	RH Rear		1	EM-8222		
	1984-95		Trans	Auto	1			EM-8236
		Trans	Manual	1			EM-8236	
	L4 1.8L 1781cc	1987-89	Front	Mexico; Auto	1	EM-8224		
			Front	Mexico; Manual; Bracket Only	1	EM-5612		
			Front	Mexico; Manual; Mount Only	1	EM-8224		
		2000-05	RH Front		1	EM-7019		
			1987-89	RH Rear	Mexico	1	EM-8222	
		2000-05	Rear		1	EM-9208		
	Trans		Auto; Hydraulic Mount	1			EM-7000	
	Trans		Manual; Hydraulic Mount	1			EM-9101	
	L4 1.8L 1788cc	1993-95	Front	Auto	1	EM-8224		
			Front	Manual; Bracket Only	1	EM-5612		
			Front	Manual; Mount Only	1	EM-8224		
			Rear		1	EM-8222		
	L4 1.9L 1896cc Diesel	2005-06	Front		1	EM-9092		
		1993-98	Front		1	EM-8843		
		2007-08	Front Lower	Mexican Vehicle	1	EM-9260		
		2005-06	Front Lower		1	EM-9260		
		2007-08	Front Upper	Mexican Vehicle	1	EM-9263		
			LH Front	Mexican Vehicle	1	EM-9259		
		2005-06	LH Front		1	EM-9259		
		2007-08	RH Front	Mexican Vehicle	1	EM-9257		
		2005-06	RH Front		1	EM-9257		
	2000-04	RH Front		1	EM-9092			
	L4 1.9L 1896cc	1999	RH Front		1	EM-9092		
	L4 1.9L 1896cc Diesel	2005-06	RH Rear		1	EM-9263		
		2007-08	Rear	Mexican Vehicle	1	EM-9283		
			2005-06	Rear		1	EM-9283	
		2000-04	Rear		1	EM-9208		
	L4 1.9L 1896cc	1999	Rear	Auto	1	EM-9208		
	L4 1.9L 1896cc Diesel	1993-98	Rear	Hydraulic Mount	1	EM-9065		
			2007-08	Trans	Mexican Vehicle; Manual Hydraulic Mount	1		
		2005-06	Trans	Auto; Hydraulic Mount	1			EM-7000
			Trans	Manual; Hydraulic Mount	1			EM-9101
		1999-04	Trans	Auto; Hydraulic Mount	1			EM-7000
			Trans	Manual; Hydraulic Mount	1			EM-9101
		1993-98	Trans	Auto	1			EM-8236
			Trans	Manual	1			EM-8236
		L4 2.0L 1968cc Diesel	2009-11	Front		1	EM-9402	
	LH Front				1	EM-9259		
	LH Front Lower				1	EM-9260		
RH Front				1	EM-9257			
Rear				1	EM-9283			
2009-14	Trans	Manual	1			EM-7271		
L4 2.0L 1984cc	2013-14	Front	Gas	1	EM-9092			
	2011-12	Front	Gas	1	EM-9092			
	2006-10	Front	Gas	1	EM-9092			
	1993-98	Front		1	EM-8617			
	1990-92	Front	Hydraulic Mount	1	EM-8224			
		Front	Manual; Bracket Only	1	EM-5612			

# Engine, Transmission, And Torque Strut Mounts

CYL	ENG. SIZE	YEAR	LOCATION	DESCRIPTION	QTY	ENGINE	TORQUE STRUT	TRANSMISSION	
<b>VOLKSWAGEN PASSENGER CAR (continued)</b>									
<b>JETTA (continued)</b>									
L4	L4 2.0L 1984cc	2013-14	Front Upper	Gas	1	EM-7270			
			LH Front	Gas	1	EM-9259			
		2011-12	LH Front	Gas	1	EM-9259			
			LH Front Upper	Gas	1	EM-9263			
		2006-10	LH Front Upper	Gas	1	EM-9263			
			Lower Rear	Gas	1	EM-9260			
		2006-10	Lower Rear	Gas	1	EM-9260			
			RH Front	Gas	1	EM-9257			
		2011-12	RH Front	Gas	1	EM-9257			
			RH Front	Gas	1	EM-9257			
		1999-05	RH Front		1	EM-9092			
			RH Rear	Auto	1	EM-8616			
		1993-98	RH Rear	Manual	1	EM-8616			
			RH Rear		1	EM-9001			
		2013-14	Rear	Gas; exc Turbo	1	EM-7262			
			Rear	Gas; Turbo	1	EM-9283			
		2011-12	Rear	Gas; exc Turbo	1	EM-7262			
			Rear	Gas; Turbo	1	EM-9283			
		2006-10	Rear	Gas	1	EM-9283			
			Rear		1	EM-9208			
		2006-09	Trans		1			EM-9262	
			Trans	Auto; Hydraulic Mount	1			EM-9101	
		1999-05	Trans	Manual; Hydraulic Mount	1			EM-9101	
Trans	Auto		1			EM-8236			
1993-98	Trans	Manual	1			EM-8236			
	Trans	Manual	1			EM-8236			
L5	L5 2.5L 2480cc	2005-09	Front Lower		1	EM-9260			
			Front Upper		1	EM-9263			
			LH Front		1	EM-9259			
			RH Front	Bracket	1	EM-9257			
			Rear		1	EM-9283			
		2015	Trans	Auto; Hydraulic Mount	1			EM-9245	
			Trans	Manual, Hydraulic Mount	1			EM-9245	
		2011-14	Trans	Auto; Wagon	1			EM-9245	
			Trans	Manual; Wagon	1			EM-9245	
		2005-10	Trans	Auto; Hydraulic Mount	1			EM-9245	
			Trans	Manual, Hydraulic Mount	1			EM-9245	
		V6	V6 2.8L 2771cc	1994-98	Trans	Auto	1		EM-8236
					Trans	Manual	1		EM-8236
V6 2.8L 2792cc	1994-98		Front		1	EM-9000			
			RH Front		1	EM-9261			
			RH Rear		1	EM-9065			
1999-04	Rear		1	EM-9208					
	<b>KARMANN GHIA</b>								
H4	H4 1.2L 1192cc	1956-65	Rear		1	EM-2167			
			Trans	Manual	1		EM-2293		
	H4 1.5L 1457cc	1967-69	Rear Inner		1	EM-2167			
			Rear Outer		1	EM-2414			
	H4 1.6L 1584cc	1970-74	Trans	Manual	1		EM-2293		
			L & R Rear		2	EM-2167			
Trans	Manual	1		EM-2293					
<b>PASSAT</b>									
L4	L4 1.8L 1780cc	1991-93	Front		1	EM-8224			
			Rear	Auto	1	EM-8222			
			Rear	Manual	1	EM-9001			

## Engine, Transmission, And Torque Strut Mounts

CYL	ENG. SIZE	YEAR	LOCATION	DESCRIPTION	QTY	ENGINE	TORQUE STRUT	TRANSMISSION
<b>VOLKSWAGEN PASSENGER CAR (continued)</b>								
<b>PASSAT (continued)</b>								
L4	L4 1.8L 1780cc	1991-93	Trans		1			EM-8589
	L4 1.8L 1781cc	1998-05	Center Front		1	EM-5485		
			Lower					
			LH Front		1	EM-8998		
		RH Front		1	EM-8997			
		2004-05	Trans - L & R	AWD	2			EM-9258
		2001-03	Trans - LH	Auto	1			EM-8999
			Trans - LH	Manual	1			EM-9106
		1998-00	Trans - LH		1			EM-9106
	2001-03	Trans - RH	Auto	1			EM-8999	
		Trans - RH	Manual	1			EM-8999	
	1998-00	Trans - RH		1			EM-8999	
	L4 1.8L 1798cc	2014-15	Front		1	EM-9092		
	L4 1.9L 1896cc Diesel	1993-94	Front	Manual	1	EM-8224		
			LH Front		1	EM-8998		
			RH Front		1	EM-8997		
		1993-94	Trans - LH		1			EM-8236
			Trans - RH	Auto	1			EM-8222
		1995-97	Trans - RH	Manual	1			EM-9001
	1995-97	Trans	Manual	2			EM-8999	
	L4 2.0L 1967cc Diesel	2005	LH Front		1	EM-8998		
			RH Front		1	EM-8997		
		2004-05	Trans - LH	Manual	1			EM-9106
			Trans - RH	Manual	1			EM-8999
	2004-05	Trans	Auto	2			EM-8999	
	L4 2.0L 1984cc	1995-96	Front		1	EM-8664		
		1990-94	Front		1	EM-8224		
		2006-10	L & R Front		2	EM-9401		
		1995-96	RH Rear		1	EM-8616		
		1990-94	RH Rear	Auto	1	EM-8222		
			RH Rear	Manual	1	EM-9001		
	2006-10	Rear		1	EM-7176			
L4 2.0L 1984cc Turbo	2006-08	Right		1	EM-9092			
L4 2.0L 1984cc	1995-96	Trans - RH	Auto	1			EM-8589	
	2006-10	Trans	Auto	1			EM-7138	
	1995-96	Trans	Manual	1			EM-8236	
	1990-94	Trans	Auto	1			EM-8589	
		Trans	Manual	1			EM-8589	
V6	V6 2.8L 2771cc	1998-05	Center Front		1	EM-5485		
			Lower					
		L & R Front		2	EM-8997			
		2005	Trans - L & R	GLS & GLX 4 MOTIon	2			EM-9258
		2003-04	Trans - L & R	AWD	2			EM-9258
			Trans - L & R	FWD	2			EM-8999
		2001-02	Trans - L & R	Auto	2			EM-9258
		1998-00	Trans	Manual	2			EM-8999
	V6 2.8L 2792cc	1993-97	Front		1	EM-9000		
			RH Front		1	EM-8616		
			Trans		1			EM-8236
	V6 3.6L 3597cc	2006-09	L & R Front		2	EM-9401		
			Rear		1	EM-7075		
		2012-14	Right		1	EM-9405		
2006-09		Right		1	EM-9405			
W8	W8 4.0L 3998cc	2002-04	Trans - L & R		1			EM-9258

# Engine, Transmission, And Torque Strut Mounts

CYL	ENG. SIZE	YEAR	LOCATION	DESCRIPTION	QTY	ENGINE	TORQUE STRUT	TRANSMISSION
<b>VOLKSWAGEN PASSENGER CAR (continued)</b>								
<b>PASSAT CC</b>								
L4	L4 2.0L 1984cc	2009-12	Trans	Manual	1			EM-5934
			Trans	w/ Auto-manual	1			EM-5935
			Trans	w/o Auto-manual	1			EM-7138
<b>POINTER (MEXICAN VEHICLE)</b>								
L4	L4 1.8L 1781cc	1998-08	L & R Front		2	EM-2421		
			Trans		1			EM-9093
	L4 2.0L 1985cc	2000-03	L & R Front	GTI	2	EM-2421		
			Trans	GTI	1			EM-9093
<b>QUANTUM</b>								
L4	L4 1.6L 1588cc Diesel	1982-85	L & R Front		2	EM-2421		
	L4 1.7L 1715cc	1982-83	L & R Front		2	EM-2421		
	L4 1.8L 1780cc	1985	L & R Front		2	EM-9109		
L5	L5 2.2L 2144cc	1983-88	L & R Front		2	EM-8663		
	L5 2.2L 2226cc	1985-88	Trans		1			EM-9046
<b>R32</b>								
V6	V6 3.2L 3189cc	2008	Front		1	EM-9405		
			LH Front		1	EM-9259		
			LH Front Upper		1	EM-9263		
			Lower Rear		1	EM-9260		
			RH Front		1	EM-9257		
<b>RABBIT</b>								
L4	L4 1.5L 1471cc	1977-80	Front	Insert	1	EM-9045		
			Front	Insert	1	EM-9045		
		1977-80	Front Center		1	EM-9077		
			Front Center		1	EM-9077		
		1977-80	Trans - Lower	Auto	1			EM-2420
			Trans - Lower	Manual	1			EM-2420
		1975	Trans - Lower	Auto	1			EM-2420
			Trans - Lower	Manual	1			EM-2420
		1977-80	Trans - Upper	Auto	1			EM-2417
	1975	Trans - Upper	Auto	1			EM-2417	
	L4 1.6L 1588cc Diesel	1981-84	Front	Insert	1	EM-9045		
	L4 1.6L 1588cc	1980	Front	Insert	1	EM-9045		
			Front	Insert	1	EM-9045		
	L4 1.6L 1588cc Diesel	1981-84	Front Center		1	EM-9077		
	L4 1.6L 1588cc	1980	Front Center		1	EM-9077		
			Front Center		1	EM-9077		
	L4 1.6L 1588cc Diesel	1981-84	Trans - Lower	Auto	1			EM-2420
			Trans - Lower	Manual	1			EM-2420
	L4 1.6L 1588cc	1980	Trans - Lower	Auto	1			EM-2420
			Trans - Lower	Manual	1			EM-2420
			Trans - Lower	Auto	1			EM-2420
	1976-77	Trans - Lower	Auto	1			EM-2420	
		Trans - Lower	Manual	1			EM-2420	
	L4 1.6L 1588cc Diesel	1981-84	Trans - Upper	Auto	1			EM-2417
	L4 1.6L 1588cc	1980	Trans - Upper	Auto	1			EM-2417
			Trans - Upper	Auto	1			EM-2417
	L4 1.7L 1715cc	1981-84	Front	Insert	1	EM-9045		
			Front Center		1	EM-9077		
			Trans - Lower	Auto	1			EM-2420
			Trans - Lower	Manual	1			EM-2420
			Trans - Upper	Auto	1			EM-2417
	L4 1.8L 1780cc	1983-84	Front	Insert	1	EM-9045		
			Front Center		1	EM-9077		
Trans - Lower			Manual	1			EM-2420	
L5	L5 2.5L 2480cc	2006-09	LH Front		1	EM-9259		

## Engine, Transmission, And Torque Strut Mounts

CYL	ENG. SIZE	YEAR	LOCATION	DESCRIPTION	QTY	ENGINE	TORQUE STRUT	TRANSMISSION	
<b>VOLKSWAGEN PASSENGER CAR (continued)</b>									
<b>RABBIT (continued)</b>									
L5	L5 2.5L 2480cc	2006-09	LH Front Upper		1	EM-9263			
			Lower Rear		1	EM-9260			
			RH Front	Bracket	1	EM-9257			
			Rear		1	EM-9283			
			Trans	Auto	1			EM-9245	
			Trans	Manual	1			EM-9245	
<b>RABBIT CONVERTIBLE</b>									
L4	L4 1.6L 1588cc	1980	Front	Insert	1	EM-9045			
			Front Center		1	EM-9077			
			Trans - Lower	Auto	1			EM-2420	
			Trans - Lower	Manual	1			EM-2420	
			Trans - Upper	Auto	1			EM-2417	
	L4 1.7L 1715cc	1981-83	Front	Insert	1	EM-9045			
			Front Center		1	EM-9077			
			Trans - Lower	Auto	1			EM-2420	
			Trans - Lower	Manual	1			EM-2420	
			Trans - Upper	Auto	1			EM-2417	
	L4 1.8L 1780cc	1984	Front	Insert	1	EM-9045			
			Front Center		1	EM-9077			
			Trans - Lower	Auto	1			EM-2420	
			Trans - Lower	Manual	1			EM-2420	
			Trans - Upper	Auto	1			EM-2417	
<b>SAFARI (MEXICAN VEHICLE)</b>									
L4	L4 1.6L	1974-80	L & R Rear		2	EM-2167			
			LH Rear		1	EM-2419			
			RH Rear		1	EM-2418			
			Trans		1			EM-2293	
<b>SEDAN (MEXICAN VEHICLE)</b>									
H4	H4 1.6L 1584cc	1997-04	L & R Rear		2	EM-2167			
			Trans		1			EM-8857	
<b>SCIROCCO</b>									
L4	L4 1.5L 1457cc	1978	L & R Front	Insert	2	EM-9045			
			Trans	Auto	1			EM-2420	
			Trans	Manual	1			EM-2420	
	L4 1.5L 1471cc	1975	L & R Front	Insert	2	EM-9045			
			Trans	Auto	1			EM-2420	
			Trans	Manual	1			EM-2420	
	L4 1.6L 1588cc	1979-80	L & R Front	Insert	2	EM-9045			
			L & R Front	Insert	2	EM-9045			
		1979-80	Trans	Auto	1			EM-2420	
			Trans	Manual	1			EM-2420	
			1976-77	Trans	Auto	1			EM-2420
				Trans	Manual	1			EM-2420
	L4 1.7L 1715cc	1981-83	L & R Front	Insert	2	EM-9045			
			Trans	Auto	1			EM-2420	
			Trans	Manual	1			EM-2420	
	L4 1.8L 1780cc	1984-89	Front	Insert	1	EM-9045			
			Front Center	Insert	1	EM-9077			
		1989	Trans	Auto	1			EM-2420	
			Trans	Manual	1			EM-2420	
			Trans	Manual	1			EM-2420	
		1988	Trans	Manual	1			EM-2420	
1984-87			Trans	Auto	1			EM-2420	
		Trans	Manual	1			EM-2420		

# Engine, Transmission, And Torque Strut Mounts

CYL	ENG. SIZE	YEAR	LOCATION	DESCRIPTION	QTY	ENGINE	TORQUE STRUT	TRANSMISSION
<b>VOLKSWAGEN PASSENGER CAR (continued)</b>								
<b>SQUAREBACK</b>								
H4	H4 1.6L 1584cc	1966-73	Rear		1	EM-2167		
			Trans		1			EM-2293
<b>SUPER BEETLE</b>								
H4	H4 1.6L 1584cc	1971-75	L & R Rear		2	EM-2167		
			Trans - LH		1			EM-2419
			Trans - RH		1			EM-8857
		1976-80	Trans		1			EM-8857
		1971-75	Trans		1			EM-2418
<b>TIGUAN</b>								
L4	L4 2.0L 1984cc	2013-15	Front Upper		1	EM-7270		
			L & R Front		2	EM-9401		
		2009-12	L & R Front		2	EM-9401		
		2013-15	Rear	Auto	1	EM-7075		
			Rear	Manual	1	EM-7268		
		2009-12	Rear	Auto	1	EM-7075		
			Rear	Manual	1	EM-7268		
		2013-15	Right		1	EM-7021		
		2009-12	Right		1	EM-7021		
		2015	Trans	Manual	1			EM-7076
		2009-14	Trans		1			EM-5935
Trans	Manual		1			EM-7076		
<b>THING</b>								
H4	H4 1.6L 1584cc	1973-74	LH Rear		1	EM-2419		
			RH Rear		1	EM-2418		
<b>VOLKSWAGEN SPORT UTILITY</b>								
<b>TOUAREG</b>								
V6	V6 3.0L 2967cc Diese				2	EM-5879		
	V6 3.0L 2995cc	2011-17	L & R Front		2	EM-5879		
	V6 3.6L 3597cc	2007-12	L & R Front		2	EM-5879		
V8	V8 4.2L 4163cc	2011-12	L & R Front	Mexico	2	EM-5879		
		2007-09	L & R Front		2	EM-5879		
V10	V10 4.9L 4921cc	2004	L & R Front		2	EM-5879		
	V10 5.0L 4921cc	2005-08	L & R Front		2	EM-5879		
<b>VOLKSWAGEN TRUCK</b>								
<b>HORMIGA (MEXICAN VEHICLE)</b>								
6 &	H4 1.6L 1584cc	1977-78	L & R Front		2	EM-2167		
			Rear Inner		1	EM-2415		
			Rear Outer		1	EM-2414		
H4	H4 1.6L 1584cc		Trans		1			EM-2293
<b>POINTER PICKUP (MEXICAN VEHICLE)</b>								
L4	L4 1.8L 1781cc	1999-07	L & R Front		2	EM-2421		
			Trans		1			EM-9093
<b>RABBIT PICKUP</b>								
L4	L4 1.5L 1457cc	1980	Front	Insert	1	EM-9045		
			Front Center		1	EM-9077		
			Trans - Rear Lower		1			EM-2420
			Trans - Rear Upper		1			EM-2417
			L4 1.6L 1588cc	1980-83	Front	Insert	1	EM-9045
	Front Center		1		EM-9077			
	Trans - Rear Lower		1				EM-2420	

## Engine, Transmission, And Torque Strut Mounts

CYL	ENG. SIZE	YEAR	LOCATION	DESCRIPTION	QTY	ENGINE	TORQUE STRUT	TRANS-MISSION
<b>VOLKSWAGEN TRUCK (continued)</b>								
<b>RABBIT PICKUP (continued)</b>								
L4	L4 1.6L 1588cc	1980-83	Trans - Rear Upper		1			EM-2417
			Front	Insert	1	EM-9045		
	L4 1.7L 1715cc	1981-83	Front Center		1	EM-9077		
			Trans - Rear Lower		1		EM-2420	
			Trans - Rear Upper		1		EM-2417	
<b>VOLKSWAGEN VAN</b>								
<b>COMBI (MEXICAN VEHICLE)</b>								
H4	H4 1.6L 1584cc	1975-88	L & R Rear		2	EM-2167		
			Rear Inner		1	EM-2415		
			Rear Outer		1	EM-2414		
			Trans		1		EM-2293	
L4	L4 1.8L 1781cc	1995-01	L & R Front		2	EM-2421		
<b>EUROVAN</b>								
L5	L5 2.4L 2370cc	1993-97	Front	Hydraulic Mount	1	EM-5446		
			RH Front		1	EM-5527		
	L5 2.5L 2459cc	1992-96	Front	Hydraulic Mount	1	EM-5446		
			RH Front		1	EM-5527		
			Trans		1		EM-5213	
V6	V6 2.8L 2792cc	1999-03	RH Front		1	EM-5527		
		1997	RH Front		1	EM-5527		
		1999-03	Trans		1		EM-5213	
		1997	Trans		1		EM-5213	
<b>PANEL (MEXICAN VEHICLE)</b>								
H4	H4 1.6L 1584cc	1975-88	L & R Rear		2	EM-2167		
			Rear Inner		1	EM-2415		
			Rear Outer		1	EM-2414		
			Trans		1		EM-2293	
L4	L4 1.8L 1781cc	1988-01	L & R Front		2	EM-2421		
<b>ROUTAN</b>								
V6	V6 3.6L 3604cc	2011-14	Front	Complete Unit	1	EM-4050		
			Front	Insert	1	EM-4186		
			Rear		1	EM-4132		
			Right		1	EM-4012		
			Trans		1		EM-4077	
	V6 3.8L 3778cc	2009-10	Front	Complete Unit	1	EM-3156		
			Front	Insert	1	EM-4094		
			Rear	Complete Unit	1	EM-4042		
			Right		1	EM-4011		
			Trans	Bushing	1		EM-4127	
				Trans	Complete Unit	1		EM-4013
	V6 4.0L 3592cc	2009-10	Front	Complete Unit	1	EM-3156		
			Front	Insert	1	EM-4094		
			Rear	Complete Unit	1	EM-4042		
			Right		1	EM-4011		
			Trans	Bushing	1		EM-4127	
			Trans	Complete Unit	1		EM-4013	
<b>TRANSPORTER</b>								
H4	H4 1.2L 1192cc	1954-64	Rear		1	EM-2167		
			Rear Inner		1	EM-2415		
			Rear Outer		1	EM-2414		
			Trans		1		EM-2293	

# Engine, Transmission, And Torque Strut Mounts

CYL	ENG. SIZE	YEAR	LOCATION	DESCRIPTION	QTY	ENGINE	TORQUE STRUT	TRANSMISSION
<b>VOLKSWAGEN VAN (continued)</b>								
<b>TRANSPORTER (continued)</b>								
H4	H4 1.5L 1457cc	1963-67	Rear		1	EM-2167		
			Rear Inner		1	EM-2415		
			Rear Outer		1	EM-2414		
			Trans		1			EM-2293
	H4 1.6L 1584cc	1968-71	L & R Rear		2	EM-2413		
			Trans		1			EM-2167
	H4 1.7L 1679cc	1972-73	Rear Inner		1	EM-2415		
			Rear Outer		1	EM-2414		
			Trans		1			EM-2167
	H4 1.8L 1795cc	1974-75	Rear Inner		1	EM-2415		
			Rear Outer		1	EM-2414		
			Trans		1			EM-2167
	H4 1.9L 1915cc	1985	Rear Inner		1	EM-2415		
			Rear Outer		1	EM-2414		
Trans				1			EM-2167	
H4 2.0L 1970cc	1976-79	Rear Inner		1	EM-2415			
		Rear Outer		1	EM-2414			
		Trans		1			EM-2167	
H4 2.1L 2109cc	1986-91	RH Front Inner		1	EM-9076			
L5	L5 2.4L	1993-94	Trans		1			EM-5213
	L5 2.5L	1992-93	Front	Hydraulic Mount	1	EM-5446		
			RH Front		1	EM-5527		
L5 2.5L 2459cc	1992-93	Trans		1			EM-5213	
<b>VANAGON</b>								
L4	L4 1.6L 1588cc Diesel	1982-84	L & R Front		2	EM-9076		
			Rear		1	EM-5484		
	L4 1.6L 1588cc	1982-84	Trans		1			EM-5213
<b>VOLVO PASSENGER CAR</b>								
<b>142</b>								
L4	L4 2.0L 1990cc	1969-74	L & R Front		2	EM-2424		
			Trans	Auto	1			EM-2425
			Trans	Manual	1			EM-2425
<b>144</b>								
L4	L4 2.0L 1990cc	1969-74	L & R Front		2	EM-2424		
			Trans	Auto	1			EM-2425
			Trans	Manual	1			EM-2425
<b>145</b>								
L4	L4 2.0L 1990cc	1969-74	L & R Front		2	EM-2424		
			Trans	Auto	1			EM-2425
			Trans	Manual	1			EM-2425
<b>164</b>								
L6	L6 3.0L	1970-75	Rear		1	EM-5459		
	L6 3.0L 2980cc	1975	Trans	Auto	1			EM-2425
			Trans	Auto	1			EM-2425
			Trans	Manual	1			EM-2425
<b>240</b>								
L4	L4 2.3L 2316cc	1990-93	LH Front		1	EM-2426		
			RH Front		1	EM-2429		
			Trans	Auto w/o Air	1			EM-2428
			Trans	Auto; w/ Air	1			EM-8800
			Trans	Manual	1			EM-5214



## Engine, Transmission, And Torque Strut Mounts

CYL	ENG. SIZE	YEAR	LOCATION	DESCRIPTION	QTY	ENGINE	TORQUE STRUT	TRANSMISSION	
<b>VOLVO PASSENGER CAR (continued)</b>									
<b>242</b>									
L4	L4 2.0L 1990cc	1975	L & R Front		2	EM-2427			
			Trans		1			EM-2428	
	L4 2.1L 2127cc	1976-84	L & R Front		2	EM-2426			
			Trans	Auto	1			EM-8800	
			Trans	Manual w/ Overdrive	1			EM-2428	
			Trans	Manual w/o Overdrive	1			EM-8800	
	L4 2.3L 2316cc	1981-84	L & R Front		2	EM-2429			
			Trans	Auto	1			EM-8800	
			Trans	Manual w/ Overdrive	1			EM-2428	
			Trans	Manual w/o Overdrive	1			EM-8800	
	<b>244</b>								
	L4	L4 2.0L 1990cc	1975	L & R Front		2	EM-2427		
Trans				Auto	1			EM-2428	
Trans				Manual	1			EM-2428	
L4 2.1L 2127cc		1976-84	L & R Front		2	EM-2426			
			Trans	Auto	1			EM-8800	
			Trans	Manual w/ Overdrive	1			EM-2428	
			Trans	Manual w/o Overdrive	1			EM-8800	
L4 2.3L 2316cc		1981-89	LH Front		1	EM-2426			
			RH Front		1	EM-2429			
			Trans		1			EM-5214	
L6		L6 2.4L 2383cc Diesel	1982-84	Trans	Auto	1			EM-2428
				Trans	Manual	1			EM-2428
<b>245</b>									
L4	L4 2.0L 1990cc	1975	L & R Front		2	EM-2427			
			Trans	Auto	1			EM-2428	
			Trans	Manual	1			EM-2428	
	L4 2.1L 2127cc	1985 1983-84 1976-82 1985 1983-84 1976-82 1976-85	LH Front		1	EM-2426			
			LH Front		1	EM-2426			
			LH Front		1	EM-2426			
			RH Front		1	EM-2429			
			RH Front	w/ Turbo	1	EM-2429			
			RH Front	w/o Turbo	1	EM-2426			
			RH Front		1	EM-2426			
			Trans	Auto	1			EM-8800	
			Trans	Manual w/ Overdrive	1			EM-2428	
	Trans	Manual w/o Overdrive	1			EM-8800			
	L4 2.3L 2316cc	1981-89	LH Front		1	EM-2426			
			RH Front		1	EM-2429			
			Trans	Auto	1			EM-2428	
			Trans	Manual	1			EM-2428	
	L6	L6 2.4L 2383cc Diesel	1982-84	Trans	Auto	1			EM-2428
Trans				Manual	1			EM-2428	
<b>262</b>									
V6	V6 2.7L 2673cc	1979	L & R Front		2	EM-2689			
			L & R Front		2	EM-2689			
	V6 2.8L 2849cc	1980-81	Trans	Auto	1			EM-8800	
			Trans	Manual	1			EM-2428	
<b>264</b>									
L4	L4 2.1L 2127cc	1980-81	L & R Front		2	EM-2426			
			Trans		1			EM-2428	
L6	L6 2.4L 2383cc Diesel	1980-81	Trans		1			EM-2428	
V6	V6 2.7L 2673cc	1976-79	L & R Front		2	EM-2689			
			L & R Front		2	EM-2689			
	V6 2.8L 2849cc	1980-82	Trans	Auto	1			EM-8800	

# Engine, Transmission, And Torque Strut Mounts

CYL	ENG. SIZE	YEAR	LOCATION	DESCRIPTION	QTY	ENGINE	TORQUE STRUT	TRANSMISSION
<b>VOLVO PASSENGER CAR (continued)</b>								
<b>264 (continued)</b>								
V6	V6 2.8L 2849cc	1980-82	Trans	Manual	1			EM-2428
<b>265</b>								
L6	L6 2.4L 2383cc Diesel	1980	Trans		1			EM-2428
V6	V6 2.7L 2673cc V6 2.8L 2849cc	1976-79	L & R Front		2	EM-2689		
			L & R Front		2	EM-2689		
		1980-81	Trans	Auto	1			EM-8800
			Trans	Manual	1			EM-2428
<b>740</b>								
L4	L4 2.3L 2316cc SOH L4 2.3L 2316cc DOH L4 2.3L 2316cc SOH			SOHC	2	EM-8622		
				DOHC	2	EM-8794		
					2	EM-8622		
					2	EM-2684		
	1985-92	L4 2.3L 2316cc	Trans	Auto; w/ Turbo	1			EM-2675
			Trans	Auto; w/o Turbo	1			EM-2428
			Trans	Manual; w/ Turbo	1			EM-2675
			Trans	Manual; w/o Turbo	1			EM-2428
L6	L6 2.4L 2377cc Diesel	1985-86	LH Front		1	EM-9047		
			RH Front		1	EM-9062		
		1986	Trans	Auto	1			EM-2428
			Trans	Manual	1			EM-2428
<b>745</b>								
L4	L4 2.3L 2316cc	1985	L & R Front		2	EM-2684		
			Trans	Auto	1			EM-2428
			Trans	Manual	1			EM-2428
L6	L6 2.4L 2383cc Diesel	1985	LH Front		1	EM-9047		
			RH Front		1	EM-9062		
			Trans	Auto	1			EM-2428
			Trans	Manual	1			EM-2428
<b>760</b>								
L4	L4 2.3L 2316cc SOH				2	EM-8622		
					2	EM-2684		
			Trans	Auto	1			EM-2675
			Trans	Auto	1			EM-2675
			Trans	Manual	1			EM-2675
			Trans	Auto	1			EM-2428
			Trans	Manual	1			EM-2428
L6	L6 2.4L 2377cc Diesel	1985	LH Front		1	EM-2426		
			RH Front		1	EM-5669		
			Trans	Auto	1			EM-2675
			Trans	Manual	1			EM-2675
	L6 2.4L 2383cc Diesel	1983-84	LH Front		1	EM-2426		
			RH Front		1	EM-5669		
			Trans	Auto	1			EM-2675
V6	V6 2.8L 2849cc	1985	L & R Front	Before Chassis# 164577	2	EM-8620		
			L & R Front	Before Chassis# 164577	2	EM-8620		
		1986-90	LH Front	After Chassis# 164577	1	EM-9047		
			RH Front	After Chassis# 164577	1	EM-9062		
		1985	LH Front	After Chassis# 164577	1	EM-9047		
			RH Front	After Chassis# 164577	1	EM-9062		
		1988-90	Trans	Auto	1			EM-8800
		1985-87	Trans	Auto	1			EM-8800
			Trans	Manual	1			EM-8800
1983-84	Trans	Auto	1			EM-8800		

## Engine, Transmission, And Torque Strut Mounts

CYL	ENG. SIZE	YEAR	LOCATION	DESCRIPTION	QTY	ENGINE	TORQUE STRUT	TRANSMISSION
<b>VOLVO PASSENGER CAR (continued)</b>								
<b>780</b>								
L4	L4 2.3L 2316cc	1989-91	L & R Front		2	EM-8622		
			Trans	Auto	1			EM-2675
V6	V6 2.8L 2849cc	1987-90	LH Front		1	EM-9047		
			RH Front		1	EM-9062		
			Trans	Auto	1			EM-8800
<b>850</b>								
L5	L5 2.3L 2319cc	1994-97	LH Front		1	EM-9145		
			RH Front		1	EM-5215		
		1996-97	Trans		1			EM-5216
		1994-95	Trans		1			EM-8985
	L5 2.4L 2435cc	1993-97	LH Front		1	EM-9145		
			RH Front		1	EM-5215		
		1996-97	Trans		1			EM-5216
		1993-95	Trans		1			EM-8985
<b>940</b>								
L4	L4 2.3L 2316cc	1994-95	L & R Front		2	EM-8622		
		1991-93	L & R Front	Turbo; Turbo	2	EM-8622		
		1991-92	L & R Front	Non-Turbo; w/o Turbo	2	EM-8794		
	L4 2.3L 2316cc SOH		Trans	Auto	1			EM-2675
			Trans	Auto; w/o Turbo	1			EM-2675
			Trans	Turbo	1			EM-2428
	L4 2.3L 2316cc DOH		Trans	Auto; w/o Turbo	1			EM-2675
	L4 2.3L 2316cc SOH		Trans	Turbo	1			EM-2428
<b>960</b>								
L6	L6 2.9L	1994-97	Trans		1			EM-5487
		1992-93	Trans		1			EM-2428
	L6 2.9L 2917cc	1992-97	L & R Front		2	EM-5396		
<b>1800</b>								
L4	L4 2.0L 1990cc	1969-73	L & R Front		2	EM-2424		
			Trans		1			EM-2425
<b>C30</b>								
L5	L5 2.5L	2008-13	Rear		1	EM-9222		
<b>C70</b>								
L5	L5 2.3L 2319cc	2001-04	Front Upper		1	EM-5528		
		1998-00	Front Upper		1	EM-5528		
		2001-04	LH Front		1	EM-9145		
		1998-00	LH Front		1	EM-9145		
		2001-04	RH Front		1	EM-5215		
		1998-00	RH Front		1	EM-5215		
		2001-04	Right		1	EM-5993		
		1998-04	Trans		1			EM-5216
	L5 2.4L 2435cc	1998-00	Front Upper		1	EM-5528		
			LH Front		1	EM-9145		
			RH Front		1	EM-5215		
			Right		1	EM-5993		
		1998-04	Trans		1			EM-5216
	L5 2.5L 2521cc	2006-13	Rear		1	EM-9222		
		2006	Trans	Auto	1			EM-4121
<b>DL</b>								
L4	L4 2.1L 2127cc	1984	LH Front		1	EM-2426		
			RH Front		1	EM-2429		
			Trans	Auto	1			EM-2428
			Trans	Manual	1			EM-2428

# Engine, Transmission, And Torque Strut Mounts

CYL	ENG. SIZE	YEAR	LOCATION	DESCRIPTION	QTY	ENGINE	TORQUE STRUT	TRANSMISSION	
<b>VOLVO PASSENGER CAR (continued)</b>									
<b>GLE</b>									
L4	L4 2.3L 2316cc	1984	LH Front		1	EM-2426			
			RH Front		1	EM-2429			
			Trans		1			EM-2428	
<b>S40</b>									
L4	L4 1.9L 1948cc	2001-04	Front		1	EM-5494			
			2000	Front		1	EM-5495		
		2001-04	Left		1	EM-5847			
			RH Lower		1	EM-5495			
		2000	RH Rear		1	EM-5518			
		2001-04	Rear		1	EM-5440			
		2000	Rear		1	EM-5439			
1999-03	Trans		1			EM-5847			
L5	L5 2.4L 2435cc	2004-10	Torq Str - Rear L		1		EM-4057		
	Trans		Auto	1			EM-4121		
	L5 2.5L 2521cc	2004-11	Trans	Auto	1			EM-4121	
<b>S60</b>									
L5	L5 2.3L 2319cc	2001-04	Front	Hydraulic Mount	1	EM-9244			
			Front Upper		1	EM-5528			
			L & R Front	Hydraulic Mount	2	EM-9244			
			Right		1	EM-5993			
			Torq Str - Lower		1		EM-5530		
	L5 2.4L 2435cc	2009	2001-08	Front Upper		1	EM-5528		
				L & R Front	Hydraulic Mount	2	EM-9244		
		2009	Rear Upper		1	EM-5616			
		2001-09	Torq Str - Lower		1		EM-5530		
		2001-08	Trans	Auto	1			EM-7194	
	L5 2.5L 2521cc	2009	2003-08	Front Upper		1	EM-5528		
				2009	Rear Upper		1	EM-5616	
		2003-09	Torq Str - Lower		1		EM-5530		
		2003-08	Trans	Auto	1			EM-7194	
L6	L6 3.0L 2953cc	2011-16	Right		1	EM-7242			
<b>S70</b>									
L5	L5 2.3L 2319cc	1998-00	Front Upper		1	EM-5528			
			LH Front		1	EM-9145			
			RH Front		1	EM-5215			
			Rear		1	EM-5747			
			Trans	FWD w/ 280mm Front Disc	1			EM-5216	
	L5 2.4L 2435cc	1998-00	Front Upper		1	EM-5528			
			LH Front		1	EM-9145			
			RH Front		1	EM-5215			
			Rear		1	EM-5747			
			Trans	FWD w/ 280mm Front Disc	1			EM-5216	
<b>S80</b>									
L5	L5 2.5L 2521cc	2004-06	Front Upper		1	EM-5528			
			L & R Front	Hydraulic Mount	2	EM-9244			
			Right		1	EM-5993			
			Torq Str - Lower		1		EM-5530		
L6	L6 2.8L 2798cc	1999-01	Front		1	EM-9244			
			Lower Rear		1	EM-9244			
			RH Front		1	EM-5553			
			Rear Upper		1	EM-9580			
			Torq Str - Lower		1		EM-9579		
L6	L6 2.9L 2917cc	2004-05	Front		1	EM-9244			

## Engine, Transmission, And Torque Strut Mounts

CYL	ENG. SIZE	YEAR	LOCATION	DESCRIPTION	QTY	ENGINE	TORQUE STRUT	TRANSMISSION	
<b>VOLVO PASSENGER CAR (continued)</b>									
<b>S80 (continued)</b>									
L6	L6 2.9L 2917cc	1999-03	Front		1	EM-9244			
		2004-05	Lower Rear		1	EM-9244			
		1999-03	Lower Rear		1	EM-9244			
		2004-05	RH Front		1	EM-5553			
		1999-03	RH Front		1	EM-5553			
		2004-05	Rear Upper		1	EM-9580			
		1999-03	Rear Upper		1	EM-9580			
		1999-05	Torg Str - Lower		1		EM-9579		
	L6 3.0L 2953cc	2008-15	Right		1	EM-7242			
L6 3.2L 3192cc	2007-14	Right		1	EM-7242				
<b>S90</b>									
L6	L6 2.9L	1998	Front		1	EM-5396			
<b>V40</b>									
L4	L4 1.9L 1948cc	2001-04	Front		1	EM-5494			
		2000	Front		1	EM-5495			
		2001-04	Left		1	EM-5847			
			RH Lower		1	EM-5495			
		2000	RH Rear		1	EM-5518			
		2001-04	Rear		1	EM-5440			
		2000	Rear		1	EM-5439			
<b>V50</b>									
L5	L5 2.4L 2435cc	2005-10	Rear		1	EM-9222			
	L5 2.5L	2005-11	Rear		1	EM-9222			
	L5 2.5L 2521cc	2005-11	Torg Str - Rear L		1		EM-4057		
<b>V60</b>									
L6	L6 3.0L 2953cc	2015-16	Right		1	EM-7242			
<b>V70</b>									
L5	L5 2.3L 2319cc	2001-04	Front Upper		1	EM-5528			
		1998-00	Front Upper		1	EM-5528			
		2001-04	LH Front		1	EM-9145			
		1998-00	LH Front		1	EM-9145			
		2001-04	RH Front		1	EM-5215			
		1998-00	RH Front		1	EM-5215			
			Rear	AWD	1	EM-5747			
		2001-04	Torg Str - Lower		1		EM-5530		
		1998-00	Trans	AWD	1			EM-5747	
			Trans	FWD w/ 280mm Front Disc	1			EM-5216	
		L5 2.4L 2435cc	2001-07	Front		1	EM-9244		
				Front Upper		1	EM-5528		
	1998-00		Front Upper		1	EM-5528			
			LH Front		1	EM-9145			
			RH Front		1	EM-5215			
			Rear	AWD	1	EM-5747			
	2001-07		Right		1	EM-5993			
			Torg Str - Lower		1		EM-5530		
	1998-00	Trans	AWD	1			EM-5747		
	Trans	FWD w/ 280mm Front Disc	1			EM-5216			
L5 2.5L 2521cc	2003-07	Torg Str - Lower		1		EM-5530			
L6	L6 3.2L 3192cc	2008-10	Right		1	EM-7242			
<b>V90</b>									
L6	L6 2.9L	1998	Front		1	EM-5396			

# Engine, Transmission, And Torque Strut Mounts

CYL	ENG. SIZE	YEAR	LOCATION	DESCRIPTION	QTY	ENGINE	TORQUE STRUT	TRANSMISSION
<b>VOLVO SPORT UTILITY</b>								
<b>XC60</b>								
L6	L6 3.0L 2953cc	2010-16	Right		1	EM-7242		
	L6 3.2L 3192cc	2010-15	Right		1	EM-7242		
<b>XC70</b>								
L5	L5 2.5L 2521cc	2003-06	Front		1	EM-9244		
			Front Upper		1	EM-5528		
			Lower Rear	Hydraulic Mount	1	EM-5493		
			Rear		1	EM-9244		
			Right		1	EM-5993		
L6	L6 3.0L 2953cc	2009-15	Right		1	EM-7242		
	L6 3.2L 3192cc	2008-15	Right		1	EM-7242		
<b>XC90</b>								
L5	L5 2.5L 2521cc	2003-06	Front		1	EM-9244		
			Front Upper		1	EM-5528		
			Lower Rear	Hydraulic Mount	1	EM-5493		
			Rear		1	EM-9244		
			Right		1	EM-5993		
			Torq Str - Lower		1		EM-5530	
L6	L6 2.9L 2917cc	2003-05	Front		1	EM-9244		
			Lower Rear		1	EM-9244		
			RH Front		1	EM-5553		
			Rear Upper		1	EM-9580		
			Torq Str - Lower		1		EM-9579	







## Drive Shaft Center Supports

Models	Years	Shaft Type / Series	Bearing Inside Diameter	Part No. Complete Assembly	Part No. Bushing Only
<b>AUDI SPORTS UTILITY</b>					
Q7	2007-12			DS-6042	
<b>BMW PASSENGER CAR</b>					
128I	2008-13		I.D. = 1.1811" (30mm)	DS-6024	
135I	2008-13		I.D. = 1.1811" (30mm)	DS-6037	
228I	2014-16		I.D. = 1.1811" (30mm)	DS-6024	
228I XDRIVE	2015-16		I.D. = 1.1811" (30mm)	DS-6024	
230I	2017		I.D. = 1.1811" (30mm)	DS-6024	
230I XDRIVE	2017		I.D. = 1.1811" (30mm)	DS-6024	
3.0SI	1975-76			DS-8626	
318I	1984-85		I.D. = 1.1810" (30mm)	DS-8627	
320I	2012-16		I.D. = 1.1811" (30mm)	DS-6024	
	1977-83			DS-8626	
320I XDRIVE	2013-16		I.D. = 1.1811" (30mm)	DS-6024	
323I	2006-11		I.D. = 1.1811" (30mm)	DS-6024	
325	1986		I.D. = 1.1810" (30mm)	DS-8627	
325CI	2004-06		I.D. = 1.1811" (30mm)	DS-6024	
325E	1984-86		I.D. = 1.1810" (30mm)	DS-8627	
325ES	1986		I.D. = 1.1810" (30mm)	DS-8627	
325I	2007	Mexican Vehicle	I.D. = 1.1811" (30mm)	DS-6024	
	2004-06		I.D. = 1.1811" (30mm)	DS-6024	
328D XDRIVE	2014-16		I.D. = 1.1811" (30mm)	DS-6024	
328I	2007-12		I.D. = 1.1811" (30mm)	DS-6024	
328I GT XDRIVE	2014-16		I.D. = 1.1811" (30mm)	DS-6024	
328XI	2007-08		I.D. = 1.1811" (30mm)	DS-6024	
330I	2004-07		I.D. = 1.1811" (30mm)	DS-6024	
330E	2016-17		I.D. = 1.1811" (30mm)	DS-6024	
335D	2009-11		I.D. = 1.349"	DS-6037	
335I	2007-12		I.D. = 1.1811" (30mm)	DS-6037	
330XI	2004-06		I.D. = 1.1811" (30mm)	DS-6024	
335I XDRIVE	2009-12		I.D. = 1.1811" (30mm)	DS-6024	
335IS	2011-12		I.D. = 1.349"	DS-6037	
335XI	2007-08		I.D. = 1.1811" (30mm)	DS-6037	
340I	2016-17		I.D. = 1.1811" (30mm)	DS-6024	
340I GT XDRIVE	2017		I.D. = 1.1811" (30mm)	DS-6024	
340I XDRIVE	2016-17		I.D. = 1.1811" (30mm)	DS-6024	
428I GRAN COUPE	2015-16		I.D. = 1.1811" (30mm)	DS-6024	
428I	2014-16		I.D. = 1.1811" (30mm)	DS-6024	
428I XDRIVE	2014-16		I.D. = 1.1811" (30mm)	DS-6024	
435I	2014-16		I.D. = 1.1811" (30mm)	DS-6024	
435I GRAN COUPE	2015-16		I.D. = 1.1811" (30mm)	DS-6024	
435I XDRIVE	2014-16		I.D. = 1.1811" (30mm)	DS-6024	
435I XDRIVE GRAN CO	2015-16		I.D. = 1.1811" (30mm)	DS-6024	
525XI	2006-07			DS-5236	
525I	2004-07			DS-5236	
528I	2009-10			DS-5236	
	1979-81			DS-8626	
528XI	2008			DS-5236	
530I	2004-07			DS-5236	
530XI	2006-07			DS-5236	
533I	1983-84			DS-8626	
535I	2011-16			DS-5236	
	2008-10	Auto		DS-5236	
		Manual Trans	I.D. = 1.181" (30mm)	DS-6517	
	1987-88			DS-8626	
1985-86			DS-8626		
535XI	2008			DS-5236	
545I	2004-06		I.D. = 1.181" (30mm)	DS-6517	

## Drive Shaft Center Supports

Models	Years	Shaft Type / Series	Bearing Inside Diameter	Part No. Complete Assembly	Part No. Bushing Only
<b>BMW PASSENGER CAR (continued)</b>					
550I	2006-10		I.D. = 1.181" (30mm)	DS-6517	
633CSI	1978-84			DS-8626	
635CSI	1985-89			DS-8626	
645CI	2004-05		I.D. = 1.181" (30mm)	DS-6517	
650I	2006-10		I.D. = 1.181" (30mm)	DS-6517	
733I	1978-84			DS-8626	
735I	1985-86			DS-8626	
ACTIVEHYBRID 3	2013-15		I.D. = 1.1811" (30mm)	DS-6024	
M2	2016-17		I.D. = 1.1811" (30mm)	DS-6024	
M235I	2014-16		I.D. = 1.1811" (30mm)	DS-6024	
M235I XDRIVE	2015-16		I.D. = 1.1811" (30mm)	DS-6024	
M3	2008-13		I.D. = 1.1811" (30mm)	DS-6024	
M5	1988			DS-8626	
M6	2012		I.D. = 1.349"	DS-6037	
	1987-88			DS-8626	
<b>BMW SPORT UTILITY</b>					
X1	2012-15		I.D. = 1.1811" (30mm)	DS-6024	
X3	2004-10			DS-5236	
X5	2000-07			DS-6095	
<b>CADILLAC PASSENGER CAR</b>					
CTS	2003-07		I.D. = 1.181" (30mm)	DS-6503	
STS	2005-11		I.D. = 1.181" (30mm)	DS-6503	
<b>CADILLAC SPORT UTILITY</b>					
ESCALADE	2007-12	Octagon Shaped Assembly	I.D. = 1.5748 - 1.5743" (40)	DS-6092	
	2002-06		I.D. = 1.575" (40mm)	DS-6099	
	1999-00		I.D. = 1.575" (40mm)	DS-6099	
ESCALADE ESV	2007-12	Octagon Shaped Assembly	I.D. = 1.5748 - 1.5743" (40)	DS-6092	
	2003-06		I.D. = 1.575" (40mm)	DS-6099	
ESCALADE EXT	2007-12	Octagon Shaped Assembly	I.D. = 1.5748 - 1.5743" (40)	DS-6092	
	2002-06		I.D. = 1.575" (40mm)	DS-6099	
<b>CHECKER PASSENGER CAR</b>					
TAXICAB	1969-74	Spicer 1260 thru 1410	I.D. = 1.3780 - 1.3775"	DS-6056	DS-6027
MARATHON	1968-82	Spicer 1260 thru 1410	I.D. = 1.3780 - 1.3775"	DS-6056	DS-6027
<b>CHEVROLET PASSENGER CAR</b>					
BEL AIR	1958-64	Spicer 1280	I.D. = 1.1811 - 1.1807"	DS-6035	
BISCAYNE	1958-64	Spicer 1280	I.D. = 1.1811 - 1.1807"	DS-6035	
CHEVELLE	1964	Spicer 1280	I.D. = 1.1811 - 1.1807"	DS-6035	
CHEVY II / NOVA (PRE	1962-64	Spicer 1280	I.D. = 1.1811 - 1.1807"	DS-6035	
CORVAIR	1960-64	Spicer 1280	I.D. = 1.1811 - 1.1807"	DS-6035	
CORVETTE	1958-64	Spicer 1280	I.D. = 1.1811 - 1.1807"	DS-6035	
DEL RAY	1958	Spicer 1280	I.D. = 1.1811 - 1.1807"	DS-6035	
IMPALA	1959-64	Spicer 1280	I.D. = 1.1811 - 1.1807"	DS-6035	
MALIBU	1964	Spicer 1280	I.D. = 1.1811 - 1.1807"	DS-6035	
<b>CHEVROLET SPORT UTILITY</b>					
AVALANCHE	2007-12	Octagon Shaped Assembly	I.D. = 1.5748 - 1.5743" (40)	DS-6092	
		U-Shaped Bracket; w/ Studs w/o Spacer Block	I.D = 1.575" (40mm)	DS-6510	
		U-Shaped Bracket; w/o Studs	I.D. = 1.575" (40mm)	DS-6099	
AVALANCHE 1500	2002-06	U-Shaped Bracket; w/ Studs; w/ Spacer Block	I.D. = 1.575" (40mm)	DS-6064	
		U-Shaped Bracket; w/ Studs w/o Spacer Block	I.D = 1.575" (40mm)	DS-6510	
		U-Shaped Bracket; w/o Studs	I.D. = 1.575" (40mm)	DS-6099	
		Wing Shaped Bracket	I.D. = 1.37" (35mm)	DS-6063	

## Drive Shaft Center Supports

Models	Years	Shaft Type / Series	Bearing Inside Diameter	Part No. Complete Assembly	Part No. Bushing Only
<b>CHEVROLET SPORT UTILITY (continued)</b>					
AVALANCHE 2500	2002-06	U-Shaped Bracket; w/ Studs; w/ Spacer Block	I.D. = 1.575" (40mm)	DS-6064	
		U-Shaped Bracket; w/ Studs w/o Spacer Block	I.D. = 1.575" (40mm)	DS-6510	
		U-Shaped Bracket; w/o Studs	I.D. = 1.575" (40mm)	DS-6099	
		Wing Shaped Bracket	I.D. = 1.37" (35mm)	DS-6063	
EQUINOX	2005-09			DS-6066	
BLAZER	1995-05	Spicer 1280 - 1310 - 1410 (Square Housing)	1.378" Bearing ID (35mm)	DS-6079	
C10/C1500 SUBURBAN	1992-99	Cleveland "O" Shaft	I.D. = 1.5748 - 1.5743"	DS-6053	DS-6027
		Spicer 1280-1310 End Yolk Style	I.D. = 1.1811 - 1.1807"	DS-6035	DS-6028
		Spicer 1280-1410 Slip Yolk Style	I.D. = 1.3780 - 1.3775"	DS-6056	DS-6027
		Spicer 1410, 1480	I.D. = 1.5748 - 1.5743"	DS-6038	
		Spicer 1550, 1650	I.D. = 1.7717 - 1.7712"	DS-6040	
		Spicer 1700, 1710	I.D. = 1.9685 - 1.9680"	DS-6048	
		Spicer 1800, 1850	I.D. = 2.3622 - 2.3616"	DS-6049	
	1967-86	Cleveland "O" Shaft	I.D. = 1.5748 - 1.5743"	DS-6053	DS-6027
		Spicer 1280-1310 End Yolk Style	I.D. = 1.1811 - 1.1807"	DS-6035	DS-6028
		Spicer 1280-1410 Slip Yolk Style	I.D. = 1.3780 - 1.3775"	DS-6056	DS-6027
		Spicer 1410, 1480	I.D. = 1.5748 - 1.5743"	DS-6038	
		Spicer 1550, 1650	I.D. = 1.7717 - 1.7712"	DS-6040	
		Spicer 1700, 1710	I.D. = 1.9685 - 1.9680"	DS-6048	
		Spicer 1800, 1850	I.D. = 2.3622 - 2.3616"	DS-6049	
C20/C2500 SUBURBAN	1992-99	Cleveland "O" Shaft	I.D. = 1.5748 - 1.5743"	DS-6053	DS-6027
		Spicer 1280-1310 End Yolk Style	I.D. = 1.1811 - 1.1807"	DS-6035	DS-6028
		Spicer 1280-1410 Slip Yolk Style	I.D. = 1.3780 - 1.3775"	DS-6056	DS-6027
		Spicer 1410, 1480	I.D. = 1.5748 - 1.5743"	DS-6038	
		Spicer 1550, 1650	I.D. = 1.7717 - 1.7712"	DS-6040	
		Spicer 1700, 1710	I.D. = 1.9685 - 1.9680"	DS-6048	
		Spicer 1800, 1850	I.D. = 2.3622 - 2.3616"	DS-6049	
	1967-86	Cleveland "O" Shaft	I.D. = 1.5748 - 1.5743"	DS-6053	DS-6027
		Spicer 1280-1310 End Yolk Style	I.D. = 1.1811 - 1.1807"	DS-6035	DS-6028
		Spicer 1280-1410 Slip Yolk Style	I.D. = 1.3780 - 1.3775"	DS-6056	DS-6027
		Spicer 1410, 1480	I.D. = 1.5748 - 1.5743"	DS-6038	
		Spicer 1550, 1650	I.D. = 1.7717 - 1.7712"	DS-6040	
		Spicer 1700, 1710	I.D. = 1.9685 - 1.9680"	DS-6048	
		Spicer 1800, 1850	I.D. = 2.3622 - 2.3616"	DS-6049	
K10/K1500 SUBURBAN	1992-99	Spicer 1280-1330	I.D. = 1.3780 - 1.3775"	DS-6056	DS-6027
		Spicer 1410, 1480	I.D. = 1.5748 - 1.5743"	DS-6038	
	1967-86	Spicer 1280-1330	I.D. = 1.3780 - 1.3775"	DS-6056	DS-6027
		Spicer 1410, 1480	I.D. = 1.5748 - 1.5743"	DS-6038	
K20/K2500 SUBURBAN	1992-99	Spicer 1280-1330	I.D. = 1.3780 - 1.3775"	DS-6056	DS-6027
		Spicer 1410, 1480	I.D. = 1.5748 - 1.5743"	DS-6038	
	1967-86	Spicer 1280-1330	I.D. = 1.3780 - 1.3775"	DS-6056	DS-6027
		Spicer 1410, 1480	I.D. = 1.5748 - 1.5743"	DS-6038	
R10/R1500 SUBURBAN	1989-91	Spicer 1280-1410	I.D. = 1.3780 - 1.3775"	DS-6056	DS-6027
		Spicer 1410, 1480	I.D. = 1.5748 - 1.5743"	DS-6038	
	1987-88	Spicer 1280-1410	I.D. = 1.3780 - 1.3775"	DS-6056	DS-6027
		Spicer 1410, 1480	I.D. = 1.5748 - 1.5743"	DS-6038	
R20/R2500 SUBURBAN	1989-91	Spicer 1280-1410	I.D. = 1.3780 - 1.3775"	DS-6056	DS-6027

## Drive Shaft Center Supports

Models	Years	Shaft Type / Series	Bearing Inside Diameter	Part No. Complete Assembly	Part No. Bushing Only
<b>CHEVROLET SPORT UTILITY (continued)</b>					
R20/R2500 SUBURBAN	1989-91	Spicer 1410, 1480	I.D. = 1.5748 - 1.5743"	DS-6038	
	1987-88	Spicer 1280-1410	I.D. = 1.3780 - 1.3775"	DS-6056	DS-6027
		Spicer 1410, 1480	I.D. = 1.5748 - 1.5743"	DS-6038	
S10 BLAZER	1983-94	Spicer 1280-1410	I.D. = 1.3780 - 1.3775"	DS-6056	DS-6027
SUBURBAN	1961-64	Spicer 1280	I.D. = 1.1811 - 1.1807"	DS-6035	
	1965				DS-6054
	1966				DS-6054
	1965-66				DS-6054
SUBURBAN 1500	2007-12	Octagon Shaped Assembly	I.D. = 1.5748 - 1.5743" (40	DS-6092	
		U-Shaped Bracket; w/ Studs; w/ Spacer Block	I.D. = 1.575" (40mm)	DS-6064	
		U-Shaped Bracket; w/o Studs	I.D. = 1.575" (40mm)	DS-6099	
	2000-06	Wing Shaped Bracket	I.D. = 1.37" (35mm)	DS-6063	
		U-Shaped Bracket; w/ Studs; w/ Spacer Block	I.D. = 1.575" (40mm)	DS-6064	
		U-Shaped Bracket; w/o Studs	I.D. = 1.575" (40mm)	DS-6099	
SUBURBAN 2500	2000-12	Wing Shaped Bracket	I.D. = 1.37" (35mm)	DS-6063	
		U-Shaped Bracket; w/ Studs; w/ Spacer Block	I.D. = 1.575" (40mm)	DS-6064	
		U-Shaped Bracket; w/o Studs	I.D. = 1.575" (40mm)	DS-6099	
TAHOE	2000-12	Wing Shaped Bracket	I.D. = 1.37" (35mm)	DS-6063	
		U-Shaped Bracket; w/ Studs; w/ Spacer Block	I.D. = 1.575" (40mm)	DS-6064	
		U-Shaped Bracket; w/ Studs w/o Spacer Block	I.D. = 1.575" (40mm)	DS-6510	
		U-Shaped Bracket; w/o Studs	I.D. = 1.575" (40mm)	DS-6099	
TRAILBLAZER	2002-03		1.378" Bearing ID (35mm)	DS-6079	
TRAILBLAZER EXT	2002-03		1.378" Bearing ID (35mm)	DS-6079	
<b>CHEVROLET TRUCK</b>					
C10/C1500 P/U	1988-99	Cleveland "O" Shaft	I.D. = 1.5748 - 1.5743"	DS-6053	DS-6027
		Spicer 1280-1310 End Yolk Style	I.D. = 1.1811 - 1.1807"	DS-6035	DS-6028
		Spicer 1280-1410 Slip Yolk Style	I.D. = 1.3780 - 1.3775"	DS-6056	DS-6027
		Spicer 1410, 1480	I.D. = 1.5748 - 1.5743"	DS-6038	
		Spicer 1550, 1650	I.D. = 1.7717 - 1.7712"	DS-6040	
		Spicer 1700, 1710	I.D. = 1.9685 - 1.9680"	DS-6048	
		Spicer 1800, 1850	I.D. = 2.3622 - 2.3616"	DS-6049	
	1965-86	Cleveland "O" Shaft	I.D. = 1.5748 - 1.5743"	DS-6053	DS-6027
		Spicer 1280-1310 End Yolk Style	I.D. = 1.1811 - 1.1807"	DS-6035	DS-6028
		Spicer 1280-1410 Slip Yolk Style	I.D. = 1.3780 - 1.3775"	DS-6056	DS-6027
		Spicer 1410, 1480	I.D. = 1.5748 - 1.5743"	DS-6038	
		Spicer 1550, 1650	I.D. = 1.7717 - 1.7712"	DS-6040	
		Spicer 1700, 1710	I.D. = 1.9685 - 1.9680"	DS-6048	
		Spicer 1800, 1850	I.D. = 2.3622 - 2.3616"	DS-6049	
	1961-64	Cleveland "O" Shaft	I.D. = 1.5748 - 1.5743"	DS-6053	DS-6027
		Spicer 1280	I.D. = 1.1811 - 1.1807"	DS-6035	DS-6028
		Spicer 1280-1310 End Yolk Style	I.D. = 1.1811 - 1.1807"	DS-6035	DS-6027
		Spicer 1280-1410 Slip Yolk Style	I.D. = 1.3780 - 1.3775"	DS-6056	
		Spicer 1410, 1480	I.D. = 1.5748 - 1.5743"	DS-6038	
		Spicer 1550, 1650	I.D. = 1.7717 - 1.7712"	DS-6040	
		Spicer 1700, 1710	I.D. = 1.9685 - 1.9680"	DS-6048	

## Drive Shaft Center Supports

Models	Years	Shaft Type / Series	Bearing Inside Diameter	Part No. Complete Assembly	Part No. Bushing Only
<b>CHEVROLET TRUCK (continued)</b>					
C10/C1500 P/U C20/C2500 P/U	1961-64	Spicer 1800, 1850	I.D. = 2.3622 - 2.3616"	DS-6049	
	1988-00	Cleveland "O" Shaft	I.D. = 1.5748 - 1.5743"	DS-6053	DS-6027
Spicer 1280-1310 End Yolk Style		I.D. = 1.1811 - 1.1807"	DS-6035	DS-6028	
Spicer 1280-1410 Slip Yolk Style		I.D. = 1.3780 - 1.3775"	DS-6056	DS-6027	
Spicer 1410, 1480		I.D. = 1.5748 - 1.5743"	DS-6038		
Spicer 1550, 1650		I.D. = 1.7717 - 1.7712"	DS-6040		
Spicer 1700, 1710		I.D. = 1.9685 - 1.9680"	DS-6048		
Spicer 1800, 1850		I.D. = 2.3622 - 2.3616"	DS-6049		
1965-86		Cleveland "O" Shaft	I.D. = 1.5748 - 1.5743"	DS-6053	DS-6027
		Spicer 1280-1310 End Yolk Style	I.D. = 1.1811 - 1.1807"	DS-6035	DS-6028
		Spicer 1280-1410 Slip Yolk Style	I.D. = 1.3780 - 1.3775"	DS-6056	DS-6027
		Spicer 1410, 1480	I.D. = 1.5748 - 1.5743"	DS-6038	
		Spicer 1550, 1650	I.D. = 1.7717 - 1.7712"	DS-6040	
		Spicer 1700, 1710	I.D. = 1.9685 - 1.9680"	DS-6048	
		Spicer 1800, 1850	I.D. = 2.3622 - 2.3616"	DS-6049	
1961-64	Cleveland "O" Shaft	I.D. = 1.5748 - 1.5743"	DS-6053	DS-6027	
	Spicer 1280-1310 End Yolk Style	I.D. = 1.1811 - 1.1807"	DS-6035	DS-6028	
	Spicer 1280-1410 Slip Yolk Style	I.D. = 1.3780 - 1.3775"	DS-6056	DS-6027	
	Spicer 1410, 1480	I.D. = 1.5748 - 1.5743"	DS-6038		
	Spicer 1550, 1650	I.D. = 1.7717 - 1.7712"	DS-6040		
	Spicer 1700, 1710	I.D. = 1.9685 - 1.9680"	DS-6048		
	Spicer 1800, 1850	I.D. = 2.3622 - 2.3616"	DS-6049		
C30/C3500 P/U	2001-04	Mexico; Cleveland "O" Shaft	I.D. = 1.5748 - 1.5743"	DS-6053	DS-6027
		Mexico; Spicer 1280-1310 End Yolk Style	I.D. = 1.1811 - 1.1807"	DS-6035	DS-6028
		Mexico; Spicer 1280-1410 Slip Yolk Style	I.D. = 1.3780 - 1.3775"	DS-6056	DS-6027
		Mexico; Spicer 1410, 1480	I.D. = 1.5748 - 1.5743"	DS-6038	
		Mexico; Spicer 1550, 1650	I.D. = 1.7717 - 1.7712"	DS-6040	
		Mexico; Spicer 1700, 1710	I.D. = 1.9685 - 1.9680"	DS-6048	
		Mexico; Spicer 1800, 1850	I.D. = 2.3622 - 2.3616"	DS-6049	
	1988-00	Cleveland "O" Shaft	I.D. = 1.5748 - 1.5743"	DS-6053	DS-6027
		Spicer 1280-1310 End Yolk Style	I.D. = 1.1811 - 1.1807"	DS-6035	DS-6028
		Spicer 1280-1410 Slip Yolk Style	I.D. = 1.3780 - 1.3775"	DS-6056	DS-6027
		Spicer 1410, 1480	I.D. = 1.5748 - 1.5743"	DS-6038	
		Spicer 1550, 1650	I.D. = 1.7717 - 1.7712"	DS-6040	
		Spicer 1700, 1710	I.D. = 1.9685 - 1.9680"	DS-6048	
		Spicer 1800, 1850	I.D. = 2.3622 - 2.3616"	DS-6049	
	1965-86	Cleveland "O" Shaft	I.D. = 1.5748 - 1.5743"	DS-6053	DS-6027
		Spicer 1280-1310 End Yolk Style	I.D. = 1.1811 - 1.1807"	DS-6035	DS-6028
		Spicer 1280-1410 Slip Yolk Style	I.D. = 1.3780 - 1.3775"	DS-6056	DS-6027
		Spicer 1410, 1480	I.D. = 1.5748 - 1.5743"	DS-6038	
		Spicer 1550, 1650	I.D. = 1.7717 - 1.7712"	DS-6040	
		Spicer 1700, 1710	I.D. = 1.9685 - 1.9680"	DS-6048	
		Spicer 1800, 1850	I.D. = 2.3622 - 2.3616"	DS-6049	
	1961-64	Cleveland "O" Shaft	I.D. = 1.5748 - 1.5743"	DS-6053	DS-6027
		Spicer 1280	I.D. = 1.1811 - 1.1807"	DS-6035	DS-6028
		Spicer 1280-1310 End Yolk Style	I.D. = 1.1811 - 1.1807"	DS-6035	DS-6027

## Drive Shaft Center Supports

Models	Years	Shaft Type / Series	Bearing Inside Diameter	Part No. Complete Assembly	Part No. Bushing Only
<b>CHEVROLET TRUCK (continued)</b>					
C30/C3500 P/U	1961-64	Spicer 1280-1410 Slip Yolk Style	I.D. = 1.3780 - 1.3775"	DS-6056	
		Spicer 1410, 1480	I.D. = 1.5748 - 1.5743"	DS-6038	
		Spicer 1550, 1650	I.D. = 1.7717 - 1.7712"	DS-6040	
		Spicer 1700, 1710	I.D. = 1.9685 - 1.9680"	DS-6048	
		Spicer 1800, 1850	I.D. = 2.3622 - 2.3616"	DS-6049	
COLORADO	2004-12			DS-6068	
EL CAMINO	1964	Spicer 1280	I.D. = 1.1811 - 1.1807"	DS-6035	
	1959-60	Spicer 1280	I.D. = 1.1811 - 1.1807"	DS-6035	
K10/K1500 P/U	1988-99	Spicer 1280-1330	I.D. = 1.3780 - 1.3775"	DS-6056	DS-6027
		Spicer 1410, 1480	I.D. = 1.5748 - 1.5743"	DS-6038	
	1965-86	Spicer 1280-1330	I.D. = 1.3780 - 1.3775"	DS-6056	DS-6027
		Spicer 1410, 1480	I.D. = 1.5748 - 1.5743"	DS-6038	
	1961-64	Spicer 1280	I.D. = 1.1811 - 1.1807"	DS-6035	DS-6027
		Spicer 1280-1330	I.D. = 1.3780 - 1.3775"	DS-6056	
		Spicer 1410, 1480	I.D. = 1.5748 - 1.5743"	DS-6038	
K20/K2500 P/U	1988-00	Spicer 1280-1330	I.D. = 1.3780 - 1.3775"	DS-6056	DS-6027
		Spicer 1410, 1480	I.D. = 1.5748 - 1.5743"	DS-6038	
	1965-86	Spicer 1280-1330	I.D. = 1.3780 - 1.3775"	DS-6056	DS-6027
		Spicer 1410, 1480	I.D. = 1.5748 - 1.5743"	DS-6038	
	1961-64	Spicer 1280	I.D. = 1.1811 - 1.1807"	DS-6035	DS-6027
		Spicer 1280-1330	I.D. = 1.3780 - 1.3775"	DS-6056	
		Spicer 1410, 1480	I.D. = 1.5748 - 1.5743"	DS-6038	
K30/K3500 P/U	1988-00	Spicer 1280-1330	I.D. = 1.3780 - 1.3775"	DS-6056	DS-6027
		Spicer 1410, 1480	I.D. = 1.5748 - 1.5743"	DS-6038	
	1977-86	Spicer 1280-1330	I.D. = 1.3780 - 1.3775"	DS-6056	DS-6027
		Spicer 1410, 1480	I.D. = 1.5748 - 1.5743"	DS-6038	
	1968-74	Spicer 1280-1330	I.D. = 1.3780 - 1.3775"	DS-6056	DS-6027
		Spicer 1410, 1480	I.D. = 1.5748 - 1.5743"	DS-6038	
		Spicer 1410, 1480	I.D. = 1.5748 - 1.5743"	DS-6038	
R10 PICKUP	1987	Spicer 1280-1410	I.D. = 1.3780 - 1.3775"	DS-6056	DS-6027
		Spicer 1410, 1480	I.D. = 1.5748 - 1.5743"	DS-6038	
R20/R2500 P/U	1989	Spicer 1280-1410	I.D. = 1.3780 - 1.3775"	DS-6056	DS-6027
		Spicer 1410, 1480	I.D. = 1.5748 - 1.5743"	DS-6038	
	1987-88	Spicer 1280-1410	I.D. = 1.3780 - 1.3775"	DS-6056	DS-6027
		Spicer 1410, 1480	I.D. = 1.5748 - 1.5743"	DS-6038	
R30/R3500 P/U	1989-91	Spicer 1280-1410	I.D. = 1.3780 - 1.3775"	DS-6056	DS-6027
		Spicer 1410, 1480	I.D. = 1.5748 - 1.5743"	DS-6038	
	1987-88	Spicer 1280-1410	I.D. = 1.3780 - 1.3775"	DS-6056	DS-6027
		Spicer 1410, 1480	I.D. = 1.5748 - 1.5743"	DS-6038	
S10 PICKUP	1994-04	Spicer 1280 - 1310 - 1410 (Square Housing)	1.378" Bearing ID (35mm)	DS-6079	
		Spicer 1280-1410 (Rounded Housing)	I.D. = 1.3780 - 1.3775"	DS-6056	
	1982-93	Spicer 1280-1410	I.D. = 1.3780 - 1.3775"	DS-6056	DS-6027
SILVERADO 1500	2008-12	Octagon Shaped Assembly	I.D = 1.575" (40mm)	DS-6510	DS-6092
		U-Shaped Bracket; w/ Studs w/o Spacer Block	I.D. = 1.5748 - 1.5743" (40	DS-6071	
	1999-07	U-Shaped Bracket; w/ Studs; w/ Spacer Block	I.D. = 1.575" (40mm)	DS-6064	
		U-Shaped Bracket; w/ Studs w/o Spacer Block	I.D = 1.575" (40mm)	DS-6510	
		U-Shaped Bracket; w/o Studs	I.D. = 1.575" (40mm)	DS-6099	
		Wing Shaped Bracket	I.D. = 1.37" (35mm)	DS-6063	
SILVERADO 1500 CLAS	2007	U-Shaped Bracket; w/ Studs; w/ Spacer Block	I.D. = 1.575" (40mm)	DS-6064	
		U-Shaped Bracket; w/ Studs w/o Spacer Block	I.D = 1.575" (40mm)	DS-6510	
		U-Shaped Bracket; w/o Studs	I.D. = 1.575" (40mm)	DS-6099	

## Drive Shaft Center Supports

Models	Years	Shaft Type / Series	Bearing Inside Diameter	Part No. Complete Assembly	Part No. Bushing Only
<b>CHEVROLET TRUCK (continued)</b>					
SILVERADO 1500 CLAS	2007	Wing Shaped Bracket	I.D. = 1.37" (35mm)	DS-6063	
SILVERADO 1500 HD	2005-06	U-Shaped Bracket; w/ Studs; w/ Spacer Block	I.D. = 1.575" (40mm)	DS-6064	
		U-Shaped Bracket; w/ Studs w/o Spacer Block	I.D. = 1.575" (40mm)	DS-6510	
		U-Shaped Bracket; w/o Studs	I.D. = 1.575" (40mm)	DS-6099	
		Wing Shaped Bracket	I.D. = 1.37" (35mm)	DS-6063	
	2001-03	U-Shaped Bracket; w/ Studs; w/ Spacer Block	I.D. = 1.575" (40mm)	DS-6064	
		U-Shaped Bracket; w/ Studs w/o Spacer Block	I.D. = 1.575" (40mm)	DS-6510	
		U-Shaped Bracket; w/o Studs	I.D. = 1.575" (40mm)	DS-6099	
		Wing Shaped Bracket	I.D. = 1.37" (35mm)	DS-6063	
SILVERADO 2500	2000-04	U-Shaped Bracket; w/ Studs; w/ Spacer Block	I.D. = 1.575" (40mm)	DS-6064	
		U-Shaped Bracket; w/ Studs w/o Spacer Block	I.D. = 1.575" (40mm)	DS-6510	
		U-Shaped Bracket; w/o Studs	I.D. = 1.575" (40mm)	DS-6099	
		Wing Shaped Bracket	I.D. = 1.37" (35mm)	DS-6063	
SILVERADO 2500 HD	2008-12	Octagon Shaped Assembly	I.D. = 1.575" (40mm)	DS-6510	DS-6092
		U-Shaped Bracket; w/ Studs w/o Spacer Block	I.D. = 1.5748 - 1.5743" (40)	DS-6071	
	2001-07	U-Shaped Bracket; w/ Studs; w/ Spacer Block	I.D. = 1.575" (40mm)	DS-6064	
		U-Shaped Bracket; w/ Studs w/o Spacer Block	I.D. = 1.575" (40mm)	DS-6510	
		U-Shaped Bracket; w/o Studs	I.D. = 1.575" (40mm)	DS-6099	
		Wing Shaped Bracket	I.D. = 1.37" (35mm)	DS-6063	
SILVERADO 3500	2001-06	U-Shaped Bracket; w/ Studs; w/ Spacer Block	I.D. = 1.575" (40mm)	DS-6064	
		U-Shaped Bracket; w/ Studs w/o Spacer Block	I.D. = 1.575" (40mm)	DS-6510	
		U-Shaped Bracket; w/o Studs	I.D. = 1.575" (40mm)	DS-6099	
		Wing Shaped Bracket	I.D. = 1.37" (35mm)	DS-6063	
SILVERADO 3500 HD	2008-12	Octagon Shaped Assembly	I.D. = 1.575" (40mm)	DS-6510	DS-6092
		U-Shaped Bracket; w/ Studs w/o Spacer Block	I.D. = 1.5748 - 1.5743" (40)	DS-6071	
	2007	U-Shaped Bracket; w/ Studs; w/ Spacer Block	I.D. = 1.575" (40mm)	DS-6064	
		U-Shaped Bracket; w/ Studs w/o Spacer Block	I.D. = 1.575" (40mm)	DS-6510	
		U-Shaped Bracket; w/o Studs	I.D. = 1.575" (40mm)	DS-6099	
		Wing Shaped Bracket	I.D. = 1.37" (35mm)	DS-6063	
<b>CHEVROLET VAN</b>					
EXPRESS 1500	1999-12	U-Shaped Bracket; w/ Studs w/o Spacer Block	I.D. = 1.575" (40mm)	DS-6510	
		U-Shaped Bracket; w/o Studs	I.D. = 1.575" (40mm)	DS-6099	
EXPRESS 2500	2010-15	Octagon Shaped Assembly	I.D. = 1.5748 - 1.5743" (40)	DS-6092	
		U-Shaped Bracket; w/ Studs w/o Spacer Block	I.D. = 1.575" (40mm)	DS-6510	
		U-Shaped Bracket; w/o Studs	I.D. = 1.575" (40mm)	DS-6099	
	1997-09	U-Shaped Bracket; w/ Studs w/o Spacer Block	I.D. = 1.575" (40mm)	DS-6510	
EXPRESS 3500	2010-15	U-Shaped Bracket; w/o Studs	I.D. = 1.575" (40mm)	DS-6099	
		Octagon Shaped Assembly	I.D. = 1.5748 - 1.5743" (40)	DS-6092	
		U-Shaped Bracket; w/ Studs w/o Spacer Block	I.D. = 1.575" (40mm)	DS-6510	

## Drive Shaft Center Supports

Models	Years	Shaft Type / Series	Bearing Inside Diameter	Part No. Complete Assembly	Part No. Bushing Only	
<b>CHEVROLET VAN (continued)</b>						
EXPRESS 3500	2010-15	U-Shaped Bracket; w/o Studs	I.D. = 1.575" (40mm)	DS-6099		
	1997-09	U-Shaped Bracket; w/ Studs w/o Spacer Block	I.D. = 1.575" (40mm)	DS-6510		
		U-Shaped Bracket; w/o Studs	I.D. = 1.575" (40mm)	DS-6099		
EXPRESS 4500	2010-15	Octagon Shaped Assembly	I.D. = 1.5748 - 1.5743" (40)	DS-6092		
G10/G1500 VAN	1998	Spicer 1280-1310 End Yolk Style	I.D. = 1.1811 - 1.1807"	DS-6035	DS-6028	
		Spicer 1280-1410 Slip Yolk Style	I.D. = 1.3780 - 1.3775"	DS-6056	DS-6027	
		Spicer 1410, 1480	I.D. = 1.5748 - 1.5743"	DS-6038		
	1965-97	Spicer 1280-1310 End Yolk Style	I.D. = 1.1811 - 1.1807"	DS-6035	DS-6028	
		Spicer 1280-1410 Slip Yolk Style	I.D. = 1.3780 - 1.3775"	DS-6056	DS-6027	
		Spicer 1410, 1480	I.D. = 1.5748 - 1.5743"	DS-6038		
	1964	Spicer 1280	I.D. = 1.1811 - 1.1807"	DS-6035	DS-6028	
		Spicer 1280-1310 End Yolk Style	I.D. = 1.1811 - 1.1807"	DS-6035	DS-6027	
		Spicer 1280-1410 Slip Yolk Style	I.D. = 1.3780 - 1.3775"	DS-6056		
			Spicer 1410, 1480	I.D. = 1.5748 - 1.5743"	DS-6038	
	G20/G2500 VAN	1998	Spicer 1280-1310 End Yolk Style	I.D. = 1.1811 - 1.1807"	DS-6035	DS-6028
			Spicer 1280-1410 Slip Yolk Style	I.D. = 1.3780 - 1.3775"	DS-6056	DS-6027
Spicer 1410, 1480			I.D. = 1.5748 - 1.5743"	DS-6038		
1967-97		Spicer 1280-1310 End Yolk Style	I.D. = 1.1811 - 1.1807"	DS-6035	DS-6028	
		Spicer 1280-1410 Slip Yolk Style	I.D. = 1.3780 - 1.3775"	DS-6056	DS-6027	
		Spicer 1410, 1480	I.D. = 1.5748 - 1.5743"	DS-6038		
G30/G3500 VAN	1998	Spicer 1280-1310 End Yolk Style	I.D. = 1.1811 - 1.1807"	DS-6035	DS-6028	
		Spicer 1280-1410 Slip Yolk Style	I.D. = 1.3780 - 1.3775"	DS-6056	DS-6027	
		Spicer 1410, 1480	I.D. = 1.5748 - 1.5743"	DS-6038		
	1971-97	Spicer 1280-1310 End Yolk Style	I.D. = 1.1811 - 1.1807"	DS-6035	DS-6028	
		Spicer 1280-1410 Slip Yolk Style	I.D. = 1.3780 - 1.3775"	DS-6056	DS-6027	
		Spicer 1410, 1480	I.D. = 1.5748 - 1.5743"	DS-6038		
P10 VAN	1962-64	Spicer 1280	I.D. = 1.1811 - 1.1807"	DS-6035		
<b>CHRYSLER PASSENGER CAR</b>						
300	2005-14		I.D. = 1.181" (30mm)	DS-6500		
<b>DODGE PASSENGER CAR</b>						
CHALLENGER	2008-13		I.D. = 1.181" (30mm)	DS-6500		
CHARGER	2006-13		I.D. = 1.181" (30mm)	DS-6500		
MAGNUM	2005-08		I.D. = 1.181" (30mm)	DS-6500		
<b>DODGE TRUCK</b>						
D50 PICKUP	1979-82		I.D. = 1.1811"	DS-8549		
D100 PICKUP	1986-89	Spicer 1260, 1410	I.D. = 1.3780 - 1.3775"	DS-6056	DS-6027	
		Spicer 1480, 1550	I.D. = 1.5748 - 1.5743"	DS-6038		
		Spicer 1610, 1650	I.D. = 1.7717 - 1.7712"	DS-6040		
		Spicer 1700, 1710	I.D. = 1.9685 - 1.9680"	DS-6048		
	Spicer 1800, 1850	I.D. = 2.3622 - 2.3616"	DS-6049			
	1968-79	Spicer 1260, 1410	I.D. = 1.3780 - 1.3775"	DS-6056	DS-6027	



## Drive Shaft Center Supports

Models	Years	Shaft Type / Series	Bearing Inside Diameter	Part No. Complete Assembly	Part No. Bushing Only
<b>DODGE TRUCK (continued)</b>					
D100 PICKUP	1968-79	Spicer 1480, 1550	I.D. = 1.5748 - 1.5743"	DS-6038	
		Spicer 1610, 1650	I.D. = 1.7717 - 1.7712"	DS-6040	
		Spicer 1700, 1710	I.D. = 1.9685 - 1.9680"	DS-6048	
		Spicer 1800, 1850	I.D. = 2.3622 - 2.3616"	DS-6049	
	1960-67	Spicer 1260, 1410	I.D. = 1.3780 - 1.3775"	DS-6056	DS-6027
		Spicer 1480, 1550	I.D. = 1.5748 - 1.5743"	DS-6038	
		Spicer 1610, 1650	I.D. = 1.7717 - 1.7712"	DS-6040	
		Spicer 1700, 1710	I.D. = 1.9685 - 1.9680"	DS-6048	
D150 PICKUP	1977-93	Spicer 1260, 1410	I.D. = 1.3780 - 1.3775"	DS-6056	DS-6027
		Spicer 1480, 1550	I.D. = 1.5748 - 1.5743"	DS-6038	
		Spicer 1610, 1650	I.D. = 1.7717 - 1.7712"	DS-6040	
		Spicer 1700, 1710	I.D. = 1.9685 - 1.9680"	DS-6048	
		Spicer 1800, 1850	I.D. = 2.3622 - 2.3616"	DS-6049	
D200 PICKUP	1968-80	Spicer 1260, 1410	I.D. = 1.3780 - 1.3775"	DS-6056	DS-6027
		Spicer 1480, 1550	I.D. = 1.5748 - 1.5743"	DS-6038	
		Spicer 1610, 1650	I.D. = 1.7717 - 1.7712"	DS-6040	
		Spicer 1700, 1710	I.D. = 1.9685 - 1.9680"	DS-6048	
		Spicer 1800, 1850	I.D. = 2.3622 - 2.3616"	DS-6049	
	1960-67	Spicer 1260, 1410	I.D. = 1.3780 - 1.3775"	DS-6056	DS-6027
		Spicer 1480, 1550	I.D. = 1.5748 - 1.5743"	DS-6038	
		Spicer 1610, 1650	I.D. = 1.7717 - 1.7712"	DS-6040	
		Spicer 1700, 1710	I.D. = 1.9685 - 1.9680"	DS-6048	
		Spicer 1800, 1850	I.D. = 2.3622 - 2.3616"	DS-6049	
D250 PICKUP	1981-93	Spicer 1260, 1410	I.D. = 1.3780 - 1.3775"	DS-6056	DS-6027
		Spicer 1480, 1550	I.D. = 1.5748 - 1.5743"	DS-6038	
		Spicer 1610, 1650	I.D. = 1.7717 - 1.7712"	DS-6040	
		Spicer 1700, 1710	I.D. = 1.9685 - 1.9680"	DS-6048	
		Spicer 1800, 1850	I.D. = 2.3622 - 2.3616"	DS-6049	
D300 PICKUP	1968-80	Spicer 1260, 1410	I.D. = 1.3780 - 1.3775"	DS-6056	DS-6027
		Spicer 1480, 1550	I.D. = 1.5748 - 1.5743"	DS-6038	
		Spicer 1610, 1650	I.D. = 1.7717 - 1.7712"	DS-6040	
		Spicer 1700, 1710	I.D. = 1.9685 - 1.9680"	DS-6048	
		Spicer 1800, 1850	I.D. = 2.3622 - 2.3616"	DS-6049	
	1960-67	Spicer 1260, 1410	I.D. = 1.3780 - 1.3775"	DS-6056	DS-6027
		Spicer 1480, 1550	I.D. = 1.5748 - 1.5743"	DS-6038	
		Spicer 1610, 1650	I.D. = 1.7717 - 1.7712"	DS-6040	
		Spicer 1700, 1710	I.D. = 1.9685 - 1.9680"	DS-6048	
		Spicer 1800, 1850	I.D. = 2.3622 - 2.3616"	DS-6049	
D350 PICKUP	1981-93	Spicer 1260, 1410	I.D. = 1.3780 - 1.3775"	DS-6056	DS-6027
		Spicer 1480, 1550	I.D. = 1.5748 - 1.5743"	DS-6038	
		Spicer 1610, 1650	I.D. = 1.7717 - 1.7712"	DS-6040	
		Spicer 1700, 1710	I.D. = 1.9685 - 1.9680"	DS-6048	
		Spicer 1800, 1850	I.D. = 2.3622 - 2.3616"	DS-6049	
DAKOTA	2005	Square Housing	1.378" Bearing ID (35mm)	DS-6079	
	2003-04		I.D. = 1.5748 - 1.5743" (40	DS-6071	
	1998-02	Square Housing; 1.378" Bearing ID (35mm)	1.378" Bearing ID (35mm)	DS-6079	
	1987-98		I.D. = 1.3780 - 1.3775"	DS-6056	DS-6027
RAM 50	1983-85		I.D. = 1.1811"	DS-8549	
	1987-91		I.D. = 1.1811" - 1.1807"	DS-5224	
RAM 1500 PICKUP	2007-10	Square Housing	1.378" Bearing ID (35mm)	DS-6079	
	2004-06	Square Housing; 1.378" Bearing ID (35mm)	1.378" Bearing ID (35mm)	DS-6079	
		U-Shaped Housing	I.D. = 1.5748 - 1.5743" (40	DS-6071	
	2003	Square Housing	1.378" Bearing ID (35mm)	DS-6079	
	1994-02	Spicer 1260, 1410	I.D. = 1.3780 - 1.3775"	DS-6056	DS-6027
Spicer 1480, 1550		I.D. = 1.5748 - 1.5743"	DS-6038		

## Drive Shaft Center Supports

Models	Years	Shaft Type / Series	Bearing Inside Diameter	Part No. Complete Assembly	Part No. Bushing Only
<b>DODGE TRUCK (continued)</b>					
RAM 1500 PICKUP	1994-02	Spicer 1610, 1650	I.D. = 1.7717 - 1.7712"	DS-6040	
		Spicer 1700, 1710	I.D. = 1.9685 - 1.9680"	DS-6048	
		Spicer 1800, 1850	I.D. = 2.3622 - 2.3616"	DS-6049	
		w/ Dana 60, 70, 80	I.D. = 1.575	DS-6065	
RAM 2500 PICKUP	2010	Wing Shaped Bracket	I.D. = 1.575" (40mm)	DS-6516	
	2007-09	Round Housing	I.D. = 1.575" (40mm)	DS-6516	
		Square Housing; 1.575" Bearing ID (40mm)	1.575" Bearing I.D. (40mm)	DS-6509	
	2005-06	Square Housing; 1.378" Bearing ID (35mm)	1.378" Bearing ID (35mm)	DS-6079	
		Square Housing; 1.575" Bearing ID (40mm)	1.575" Bearing I.D. (40mm)	DS-6509	
		U-Shaped Housing	I.D. = 1.5748 - 1.5743" (40	DS-6071	
	2003-04	Square Housing; 1.378" Bearing ID (35mm)	1.378" Bearing ID (35mm)	DS-6079	
		Square Housing; 1.575" Bearing ID (40mm)	1.575" Bearing I.D. (40mm)	DS-6509	
	1994-02	Spicer 1260, 1410	I.D. = 1.3780 - 1.3775"	DS-6056	DS-6027
		Spicer 1480, 1550	I.D. = 1.5748 - 1.5743"	DS-6038	
		Spicer 1610, 1650	I.D. = 1.7717 - 1.7712"	DS-6040	
		Spicer 1700, 1710	I.D. = 1.9685 - 1.9680"	DS-6048	
		Spicer 1800, 1850	I.D. = 2.3622 - 2.3616"	DS-6049	
	RAM 3500 PICKUP	2010	Wing Shaped Bracket	I.D. = 1.575" (40mm)	DS-6516
2007-09		Round Housing	I.D. = 1.575" (40mm)	DS-6516	
		Square Housing; 1.575" Bearing ID (40mm)	1.575" Bearing I.D. (40mm)	DS-6509	
2005-06		Square Housing; 1.378" Bearing ID (35mm)	1.378" Bearing ID (35mm)	DS-6079	
		Square Housing; 1.575" Bearing ID (40mm)	1.575" Bearing I.D. (40mm)	DS-6509	
		U-Shaped Housing	I.D. = 1.5748 - 1.5743" (40	DS-6071	
2003-04		Square Housing; 1.378" Bearing ID (35mm)	1.378" Bearing ID (35mm)	DS-6079	
		Square Housing; 1.575" Bearing ID (40mm)	1.575" Bearing I.D. (40mm)	DS-6509	
1994-02		Spicer 1260, 1410	I.D. = 1.3780 - 1.3775"	DS-6056	DS-6027
		Spicer 1480, 1550	I.D. = 1.5748 - 1.5743"	DS-6038	
		Spicer 1610, 1650	I.D. = 1.7717 - 1.7712"	DS-6040	
		Spicer 1700, 1710	I.D. = 1.9685 - 1.9680"	DS-6048	
		Spicer 1800, 1850	I.D. = 2.3622 - 2.3616"	DS-6049	
W100 PICKUP		1986-89	Spicer 1260, 1410	I.D. = 1.3780 - 1.3775"	DS-6056
	Spicer 1480, 1550		I.D. = 1.5748 - 1.5743"	DS-6038	
	Spicer 1610, 1650		I.D. = 1.7717 - 1.7712"	DS-6040	
	Spicer 1700, 1710		I.D. = 1.9685 - 1.9680"	DS-6048	
	Spicer 1800, 1850		I.D. = 2.3622 - 2.3616"	DS-6049	
	1968-77	Spicer 1260, 1410	I.D. = 1.3780 - 1.3775"	DS-6056	DS-6027
		Spicer 1480, 1550	I.D. = 1.5748 - 1.5743"	DS-6038	
		Spicer 1610, 1650	I.D. = 1.7717 - 1.7712"	DS-6040	
		Spicer 1700, 1710	I.D. = 1.9685 - 1.9680"	DS-6048	
		Spicer 1800, 1850	I.D. = 2.3622 - 2.3616"	DS-6049	
	1960-67	Spicer 1260, 1410	I.D. = 1.3780 - 1.3775"	DS-6056	DS-6027
		Spicer 1480, 1550	I.D. = 1.5748 - 1.5743"	DS-6038	
		Spicer 1610, 1650	I.D. = 1.7717 - 1.7712"	DS-6040	
		Spicer 1700, 1710	I.D. = 1.9685 - 1.9680"	DS-6048	
W150 PICKUP	1977-93	Spicer 1260, 1410	I.D. = 1.3780 - 1.3775"	DS-6056	DS-6027
		Spicer 1480, 1550	I.D. = 1.5748 - 1.5743"	DS-6038	
		Spicer 1610, 1650	I.D. = 1.7717 - 1.7712"	DS-6040	

## Drive Shaft Center Supports

Models	Years	Shaft Type / Series	Bearing Inside Diameter	Part No. Complete Assembly	Part No. Bushing Only
<b>DODGE TRUCK (continued)</b>					
W150 PICKUP	1977-93	Spicer 1700, 1710	I.D. = 1.9685 - 1.9680"	DS-6048	
		Spicer 1800, 1850	I.D. = 2.3622 - 2.3616"	DS-6049	
W200 PICKUP	1969-80	Spicer 1260, 1410	I.D. = 1.3780 - 1.3775"	DS-6056	DS-6027
		Spicer 1480, 1550	I.D. = 1.5748 - 1.5743"	DS-6038	
		Spicer 1610, 1650	I.D. = 1.7717 - 1.7712"	DS-6040	
		Spicer 1700, 1710	I.D. = 1.9685 - 1.9680"	DS-6048	
		Spicer 1800, 1850	I.D. = 2.3622 - 2.3616"	DS-6049	
	1960-67	Spicer 1260, 1410	I.D. = 1.3780 - 1.3775"	DS-6056	DS-6027
		Spicer 1480, 1550	I.D. = 1.5748 - 1.5743"	DS-6038	
		Spicer 1610, 1650	I.D. = 1.7717 - 1.7712"	DS-6040	
		Spicer 1700, 1710	I.D. = 1.9685 - 1.9680"	DS-6048	
		Spicer 1800, 1850	I.D. = 2.3622 - 2.3616"	DS-6049	
W250 PICKUP	1981-93	Spicer 1260, 1410	I.D. = 1.3780 - 1.3775"	DS-6056	DS-6027
		Spicer 1480, 1550	I.D. = 1.5748 - 1.5743"	DS-6038	
		Spicer 1610, 1650	I.D. = 1.7717 - 1.7712"	DS-6040	
		Spicer 1700, 1710	I.D. = 1.9685 - 1.9680"	DS-6048	
		Spicer 1800, 1850	I.D. = 2.3622 - 2.3616"	DS-6049	
W300 PICKUP	1968-80	Spicer 1260, 1410	I.D. = 1.3780 - 1.3775"	DS-6056	DS-6027
		Spicer 1480, 1550	I.D. = 1.5748 - 1.5743"	DS-6038	
		Spicer 1610, 1650	I.D. = 1.7717 - 1.7712"	DS-6040	
		Spicer 1700, 1710	I.D. = 1.9685 - 1.9680"	DS-6048	
		Spicer 1800, 1850	I.D. = 2.3622 - 2.3616"	DS-6049	
	1960-67	Spicer 1260, 1410	I.D. = 1.3780 - 1.3775"	DS-6056	DS-6027
		Spicer 1480, 1550	I.D. = 1.5748 - 1.5743"	DS-6038	
		Spicer 1610, 1650	I.D. = 1.7717 - 1.7712"	DS-6040	
W350 PICKUP	1981-93	Spicer 1260, 1410	I.D. = 1.3780 - 1.3775"	DS-6056	DS-6027
		Spicer 1480, 1550	I.D. = 1.5748 - 1.5743"	DS-6038	
		Spicer 1610, 1650	I.D. = 1.7717 - 1.7712"	DS-6040	
		Spicer 1700, 1710	I.D. = 1.9685 - 1.9680"	DS-6048	
		Spicer 1800, 1850	I.D. = 2.3622 - 2.3616"	DS-6049	
<b>DODGE VAN</b>					
RAM 1500 VAN	2002-03		1.378" Bearing ID (35mm)	DS-6079	
RAM 2500 VAN	2003		1.378" Bearing ID (35mm)	DS-6079	
RAM 3500 VAN	1999-03	Square Housing	1.378" Bearing ID (35mm)	DS-6079	
SPRINTER 2500	2007-09	1-Piece Shaft; w/ Shims		DS-6505	
		1-Piece Shaft; w/o Shims		DS-6504	
		2- & 3-Piece Shaft; w/ Shims		DS-6507	
		Slider Section			
		2- & 3-Piece Shaft; w/o Shims		DS-6506	
	Slider Section				
2003-06				DS-6078	
SPRINTER 3500	2007-09	1-Piece Shaft; w/ Shims		DS-6505	
		1-Piece Shaft; w/o Shims		DS-6504	
		2- & 3-Piece Shaft; w/ Shims		DS-6507	
		Slider Section			
	2- & 3-Piece Shaft; w/o Shims		DS-6506		
Slider Section					
2003-06				DS-6078	
<b>DODGE MEDIUM/HEAVY DUTY</b>					
D400 PICKUP	1978-81	Spicer 1260, 1410	I.D. = 1.3780 - 1.3775"	DS-6056	DS-6027
		Spicer 1480, 1550	I.D. = 1.5748 - 1.5743"	DS-6038	
		Spicer 1610, 1650	I.D. = 1.7717 - 1.7712"	DS-6040	
		Spicer 1700, 1710	I.D. = 1.9685 - 1.9680"	DS-6048	
		Spicer 1800, 1850	I.D. = 2.3622 - 2.3616"	DS-6049	
D450 PICKUP	1978-81	Spicer 1260, 1410	I.D. = 1.3780 - 1.3775"	DS-6056	DS-6027

## Drive Shaft Center Supports

Models	Years	Shaft Type / Series	Bearing Inside Diameter	Part No. Complete Assembly	Part No. Bushing Only	
<b>DODGE MEDIUM/HEAVY DUTY (continued)</b>						
D450 PICKUP	1978-81	Spicer 1480, 1550	I.D. = 1.5748 - 1.5743"	DS-6038		
		Spicer 1610, 1650	I.D. = 1.7717 - 1.7712"	DS-6040		
		Spicer 1700, 1710	I.D. = 1.9685 - 1.9680"	DS-6048		
		Spicer 1800, 1850	I.D. = 2.3622 - 2.3616"	DS-6049		
<b>FORD SPORT UTILITY</b>						
BRONCO II	1984-90		I.D. = 1.2573 - 1.2568"	DS-6061		
ESCAPE	2001-07			DS-6076		
EXPLORER	1991-98	Spicer 1210	I.D. = 1.1811 - 1.1807"	DS-6062		
		Spicer 1280	I.D. = 1.2573 - 1.2568"	DS-6061		
<b>FORD TRUCK</b>						
F SERIES	1957-59	Cleveland "O" Shaft	I.D. = 1.5000 - 1.4945"	DS-6051	DS-6027	
		Cleveland "R" & "S" Shaft	I.D. = 1.3740 - 1.3745"	DS-6050	DS-6027	
		Spicer 1210, 1310	I.D. = 1.3780 - 1.3775"	DS-6056		
		Spicer 1280, 1410	I.D. = 1.3780 - 1.3775"	DS-6056		
		Spicer 1410	I.D. = 1.5748 - 1.5743"	DS-6053		
		Spicer 1480, 1550	I.D. = 1.5748 - 1.5743"	DS-6038		
		Spicer 1610, 1650	I.D. = 1.7717 - 1.7712"	DS-6040		
		Spicer 1700, 1710	I.D. = 1.9685 - 1.9680"	DS-6048		
		Spicer 1800, 1850	I.D. = 2.3622 - 2.3616"	DS-6049		
F-100 PICKUP	1960-83	Spicer 1280, 1410	I.D. = 1.3780 - 1.3775"	DS-6056	DS-6027	
		Spicer 1480, 1550	I.D. = 1.5748 - 1.5743"	DS-6038		
F-150 PICKUP	2002-04	U-Shaped Bracket; w/o Studs w/o Spacer Block	I.D. = 1.5748 - 1.5743"	DS-6056		
		1997-01	U-Shaped Bracket; w/o Studs w/ Spacer Block	I.D. = 1.378" (35mm)	DS-6531	
			U-Shaped Bracket; w/o Studs w/o Spacer Block	I.D. = 1.5748 - 1.5743"	DS-6056	
	1977-96	Spicer 1280, 1410	I.D. = 1.3780 - 1.3775"	DS-6056	DS-6027	
		Spicer 1480, 1550	I.D. = 1.5748 - 1.5743"	DS-6038		
	1975	Spicer 1280, 1410	I.D. = 1.3780 - 1.3775"	DS-6056	DS-6027	
		Spicer 1480, 1550	I.D. = 1.5748 - 1.5743"	DS-6038		
	1976	Spicer 1280, 1410	I.D. = 1.3780 - 1.3775"	DS-6056	DS-6027	
		Spicer 1480, 1550	I.D. = 1.5748 - 1.5743"	DS-6038		
		Spicer 1280, 1410	I.D. = 1.3780 - 1.3775"	DS-6056	DS-6027	
		Spicer 1480, 1550	I.D. = 1.5748 - 1.5743"	DS-6038		
		Spicer 1280, 1410	I.D. = 1.3780 - 1.3775"	DS-6056	DS-6027	
			Spicer 1480, 1550	I.D. = 1.5748 - 1.5743"	DS-6038	
		Spicer 1480, 1550	I.D. = 1.5748 - 1.5743"	DS-6038		
F-250 PICKUP	1999-04	U-Shaped; 2.50" Centerline	I.D. = 1.575" (40mm)	DS-6501		
	1960-98	Spicer 1280, 1410	I.D. = 1.3780 - 1.3775"	DS-6056	DS-6027	
Spicer 1480, 1550		I.D. = 1.5748 - 1.5743"	DS-6038			
F-250 SUPER DUTY PIC	2007-12	U-Shaped; 2.25" Centerline	I.D. = 1.5748 - 1.5743"	DS-6038		
		U-Shaped; 2.70" Centerline	I.D. = 1.575" (40mm)	DS-6502		
	2006	U-Shaped; 2.25" Centerline	I.D. = 1.5748 - 1.5743"	DS-6038		
	2005	U-Shaped; 2.25" Centerline	I.D. = 1.5748 - 1.5743"	DS-6038		
		U-Shaped; 2.70" Centerline	I.D. = 1.575" (40mm)	DS-6502		
	2003-04	U-Shaped; 2.25" Centerline	I.D. = 1.5748 - 1.5743"	DS-6038		
		U-Shaped; 2.50" Centerline	I.D. = 1.575" (40mm)	DS-6501		
		U-Shaped; 2.70" Centerline	I.D. = 1.575" (40mm)	DS-6502		
	1999-02	U-Shaped; 2.25" Centerline	I.D. = 1.5748 - 1.5743"	DS-6038		
		U-Shaped; 2.50" Centerline	I.D. = 1.575" (40mm)	DS-6501		
F-350 PICKUP	1960-97	Spicer 1280, 1410	I.D. = 1.3780 - 1.3775"	DS-6056	DS-6027	
		Spicer 1480, 1550	I.D. = 1.5748 - 1.5743"	DS-6038		
F-350 SUPER DUTY PIC	2008-15	Round Shape; 1.65" Centerline	I.D. = 1.575" (40mm)	DS-6536		
		Round Shape; 2.20" Centerline	I.D. = 1.575" (40mm)	DS-6533		
		Round Shape; 2.50" Centerline	I.D. = 1.575" (40mm)	DS-6535		
		Round Shape; 2.65" Centerline	I.D. = 1.575" (40mm)	DS-6534		
		U-Shaped; 2.70" Centerline	I.D. = 1.575" (40mm)	DS-6502		

## Drive Shaft Center Supports

Models	Years	Shaft Type / Series	Bearing Inside Diameter	Part No. Complete Assembly	Part No. Bushing Only
<b>FORD TRUCK (continued)</b>					
F-350 SUPER DUTY PIC	2004-07	U-Shaped; 2.25" Centerline	I.D. = 1.5748 - 1.5743"	DS-6038	
		U-Shaped; 2.70" Centerline	I.D. = 1.575" (40mm)	DS-6502	
	1999-02	U-Shaped; 2.25" Centerline	I.D. = 1.5748 - 1.5743"	DS-6038	
		U-Shaped; 2.50" Centerline	I.D. = 1.575" (40mm)	DS-6501	
RANGER	1990-98	Spicer 1210	I.D. = 1.1811 - 1.1807"	DS-6062	
	1986-89	Spicer 1210	I.D. = 1.2573 - 1.2568"	DS-6061	
<b>FORD VAN</b>					
AEROSTAR	1986-90		I.D. = 1.2573 - 1.2568"	DS-6061	
E-100 ECONOLINE	1968-83	Spicer 1280, 1410	I.D. = 1.3780 - 1.3775"	DS-6056	DS-6027
		Spicer 1480, 1550	I.D. = 1.5748 - 1.5743"	DS-6038	
E-150 ECONOLINE	1975-98	Spicer 1280, 1410	I.D. = 1.3780 - 1.3775"	DS-6056	DS-6027
		Spicer 1480, 1550	I.D. = 1.5748 - 1.5743"	DS-6038	
E-200 ECONOLINE	1969-74	Spicer 1280, 1410	I.D. = 1.3780 - 1.3775"	DS-6056	DS-6027
		Spicer 1480, 1550	I.D. = 1.5748 - 1.5743"	DS-6038	
E-250 ECONOLINE	2004-05	U-Shaped; 2.25" Centerline	I.D. = 1.5748 - 1.5743"	DS-6038	
	1975-98	Spicer 1280, 1410	I.D. = 1.3780 - 1.3775"	DS-6056	DS-6027
		Spicer 1480, 1550	I.D. = 1.5748 - 1.5743"	DS-6038	
E-300 ECONOLINE	1969-74	Spicer 1280, 1410	I.D. = 1.3780 - 1.3775"	DS-6056	DS-6027
		Spicer 1480, 1550	I.D. = 1.5748 - 1.5743"	DS-6038	
E-350 ECONOLINE	1975-98	Spicer 1280, 1410	I.D. = 1.3780 - 1.3775"	DS-6056	DS-6027
		Spicer 1480, 1550	I.D. = 1.5748 - 1.5743"	DS-6038	
E-350 SUPER DUTY	2004-10	U-Shaped; 2.25" Centerline	I.D. = 1.5748 - 1.5743"	DS-6038	
<b>FORD MEDIUM/HEAVY DUTY</b>					
E-450 SUPER DUTY	2000-13	U-Shaped; 2.25" Centerline	I.D. = 1.5748 - 1.5743"	DS-6038	
F-450 SUPER DUTY PIC	2011-14	U-Shaped; 2.70" Centerline	I.D. = 1.575" (40mm)	DS-6502	
	2006-07	U-Shaped; 2.25" Centerline	I.D. = 1.5748 - 1.5743"	DS-6038	
	2004-05	U-Shaped; 2.25" Centerline	I.D. = 1.5748 - 1.5743"	DS-6038	
		U-Shaped; 2.70" Centerline	I.D. = 1.575" (40mm)	DS-6502	
	1999-03	U-Shaped; 2.25" Centerline	I.D. = 1.5748 - 1.5743"	DS-6038	
	1997	Cleveland "O" Shaft	I.D. = 1.5000 - 1.4945"	DS-6051	DS-6027
		Cleveland "R" & "S" Shaft	I.D. = 1.3740 - 1.3745"	DS-6050	
		Spicer 1210, 1310	I.D. = 1.3780 - 1.3775"	DS-6056	
		Spicer 1410	I.D. = 1.5748 - 1.5743"	DS-6053	
		Spicer 1480, 1550	I.D. = 1.5748 - 1.5743"	DS-6038	
		Spicer 1610, 1650	I.D. = 1.7717 - 1.7712"	DS-6040	
		Spicer 1700, 1710	I.D. = 1.9685 - 1.9680"	DS-6048	
	Spicer 1800, 1850	I.D. = 2.3622 - 2.3616"	DS-6049		
	w/ Cleveland "O" Shaft	I.D. = 1.5748 - 1.5743"	DS-6053		
F-500 PICKUP	1975-77	Cleveland "O" Shaft	I.D. = 1.5000 - 1.4945"	DS-6051	DS-6027
		Cleveland "R" & "S" Shaft	I.D. = 1.3740 - 1.3745"	DS-6050	
		Spicer 1210, 1310	I.D. = 1.3780 - 1.3775"	DS-6056	
		Spicer 1410	I.D. = 1.5748 - 1.5743"	DS-6053	
		Spicer 1480, 1550	I.D. = 1.5748 - 1.5743"	DS-6038	
		Spicer 1610, 1650	I.D. = 1.7717 - 1.7712"	DS-6040	
		Spicer 1700, 1710	I.D. = 1.9685 - 1.9680"	DS-6048	
Spicer 1800, 1850	I.D. = 2.3622 - 2.3616"	DS-6049			
F-550 SUPER DUTY PIC	1999-07	U-Shaped; 2.25" Centerline	I.D. = 1.5748 - 1.5743"	DS-6038	
<b>FREIGHTLINER</b>					
SPRINTER 2500	2007-09	1-Piece Shaft; w/ Shims		DS-6505	
		1-Piece Shaft; w/o Shims		DS-6504	
		2- & 3-Piece Shaft; w/ Shims Slider Section		DS-6507	
		2- & 3-Piece Shaft; w/o Shims Slider Section		DS-6506	
SPRINTER 3500	2007-09	1-Piece Shaft; w/ Shims		DS-6505	
		1-Piece Shaft; w/o Shims		DS-6504	

## Drive Shaft Center Supports

Models	Years	Shaft Type / Series	Bearing Inside Diameter	Part No. Complete Assembly	Part No. Bushing Only
<b>FREIGHTLINER (continued)</b>					
SPRINTER 3500	2007-09	2- & 3-Piece Shaft; w/ Shims Slider Section		DS-6507	
		2- & 3-Piece Shaft; w/o Shims Slider Section		DS-6506	
<b>GMC SPORT UTILITY</b>					
C15/C1500 SUBURBAN	1992-99	Cleveland "O" Shaft	I.D. = 1.5748 - 1.5743"	DS-6053	DS-6027
		Spicer 1280-1310 End Yolk Style	I.D. = 1.1811 - 1.1807"	DS-6035	DS-6028
		Spicer 1280-1410 Slip Yolk Style	I.D. = 1.3780 - 1.3775"	DS-6056	DS-6027
		Spicer 1410, 1480	I.D. = 1.5748 - 1.5743"	DS-6038	
		Spicer 1550, 1650	I.D. = 1.7717 - 1.7712"	DS-6040	
		Spicer 1700, 1710	I.D. = 1.9685 - 1.9680"	DS-6048	
		Spicer 1800, 1850	I.D. = 2.3622 - 2.3616"	DS-6049	
	1967-86	Cleveland "O" Shaft	I.D. = 1.5748 - 1.5743"	DS-6053	DS-6027
		Spicer 1280-1310 End Yolk Style	I.D. = 1.1811 - 1.1807"	DS-6035	DS-6028
		Spicer 1280-1410 Slip Yolk Style	I.D. = 1.3780 - 1.3775"	DS-6056	DS-6027
		Spicer 1410, 1480	I.D. = 1.5748 - 1.5743"	DS-6038	
		Spicer 1550, 1650	I.D. = 1.7717 - 1.7712"	DS-6040	
		Spicer 1700, 1710	I.D. = 1.9685 - 1.9680"	DS-6048	
		Spicer 1800, 1850	I.D. = 2.3622 - 2.3616"	DS-6049	
C25/C2500 SUBURBAN	1992-99	Cleveland "O" Shaft	I.D. = 1.5748 - 1.5743"	DS-6053	DS-6027
		Spicer 1280-1310 End Yolk Style	I.D. = 1.1811 - 1.1807"	DS-6035	DS-6028
		Spicer 1280-1410 Slip Yolk Style	I.D. = 1.3780 - 1.3775"	DS-6056	DS-6027
		Spicer 1410, 1480	I.D. = 1.5748 - 1.5743"	DS-6038	
		Spicer 1550, 1650	I.D. = 1.7717 - 1.7712"	DS-6040	
		Spicer 1700, 1710	I.D. = 1.9685 - 1.9680"	DS-6048	
		Spicer 1800, 1850	I.D. = 2.3622 - 2.3616"	DS-6049	
	1967-86	Cleveland "O" Shaft	I.D. = 1.5748 - 1.5743"	DS-6053	DS-6027
		Spicer 1280-1310 End Yolk Style	I.D. = 1.1811 - 1.1807"	DS-6035	DS-6028
		Spicer 1280-1410 Slip Yolk Style	I.D. = 1.3780 - 1.3775"	DS-6056	DS-6027
		Spicer 1410, 1480	I.D. = 1.5748 - 1.5743"	DS-6038	
		Spicer 1550, 1650	I.D. = 1.7717 - 1.7712"	DS-6040	
		Spicer 1700, 1710	I.D. = 1.9685 - 1.9680"	DS-6048	
		Spicer 1800, 1850	I.D. = 2.3622 - 2.3616"	DS-6049	
ENVOY	2002-03		1.378" Bearing ID (35mm)	DS-6079	
ENVOY XL / XUV	2002-03		1.378" Bearing ID (35mm)	DS-6079	
JIMMY	1995-05	Spicer 1280 - 1310 - 1410 (Square Housing)	1.378" Bearing ID (35mm)	DS-6079	
K15/K1500 SUBURBAN	1992-99	Spicer 1280-1330	I.D. = 1.3780 - 1.3775"	DS-6056	DS-6027
		Spicer 1410, 1480	I.D. = 1.5748 - 1.5743"	DS-6038	
	1967-86	Spicer 1280-1330	I.D. = 1.3780 - 1.3775"	DS-6056	DS-6027
		Spicer 1410, 1480	I.D. = 1.5748 - 1.5743"	DS-6038	
K25/K2500 SUBURBAN	1992-99	Spicer 1280-1330	I.D. = 1.3780 - 1.3775"	DS-6056	DS-6027
		Spicer 1410, 1480	I.D. = 1.5748 - 1.5743"	DS-6038	
	1967-86	Spicer 1280-1330	I.D. = 1.3780 - 1.3775"	DS-6056	DS-6027
		Spicer 1410, 1480	I.D. = 1.5748 - 1.5743"	DS-6038	
R1500 SUBURBAN	1987-91	Spicer 1280-1410	I.D. = 1.3780 - 1.3775"	DS-6056	DS-6027
		Spicer 1410, 1480	I.D. = 1.5748 - 1.5743"	DS-6038	
R2500 SUBURBAN	1987-91	Spicer 1280-1410	I.D. = 1.3780 - 1.3775"	DS-6056	DS-6027
		Spicer 1410, 1480	I.D. = 1.5748 - 1.5743"	DS-6038	

## Drive Shaft Center Supports

Models	Years	Shaft Type / Series	Bearing Inside Diameter	Part No. Complete Assembly	Part No. Bushing Only	
<b>GMC SPORT UTILITY (continued)</b>						
S15 JIMMY	1994-04	Spicer 1280 - 1310 - 1410 (Square Housing)	1.378" Bearing ID (35mm)	DS-6079		
	1983-94	Spicer 1280-1410	I.D. = 1.3780 - 1.3775"	DS-6056	DS-6027	
SUBURBAN	1965				DS-6054	
YUKON	2007-12	Octagon Shaped Assembly	I.D. = 1.5748 - 1.5743" (40	DS-6092		
		U-Shaped Bracket; w/ Studs; w/ Spacer Block	I.D. = 1.575" (40mm)	DS-6064		
		U-Shaped Bracket; w/ Studs w/o Spacer Block	I.D. = 1.575" (40mm)	DS-6510		
		U-Shaped Bracket; w/o Studs	I.D. = 1.575" (40mm)	DS-6099		
		Wing Shaped Bracket	I.D. = 1.37" (35mm)	DS-6063		
	2000-06	U-Shaped Bracket; w/ Studs; w/ Spacer Block	I.D. = 1.575" (40mm)	DS-6064		
		U-Shaped Bracket; w/ Studs w/o Spacer Block	I.D. = 1.575" (40mm)	DS-6510		
		U-Shaped Bracket; w/o Studs	I.D. = 1.575" (40mm)	DS-6099		
		Wing Shaped Bracket	I.D. = 1.37" (35mm)	DS-6063		
YUKON XL 1500	2007-12	Octagon Shaped Assembly	I.D. = 1.5748 - 1.5743" (40	DS-6092		
		U-Shaped Bracket; w/ Studs; w/ Spacer Block	I.D. = 1.575" (40mm)	DS-6064		
		U-Shaped Bracket; w/ Studs w/o Spacer Block	I.D. = 1.575" (40mm)	DS-6510		
		U-Shaped Bracket; w/o Studs	I.D. = 1.575" (40mm)	DS-6099		
		Wing Shaped Bracket	I.D. = 1.37" (35mm)	DS-6063		
	2000-06	U-Shaped Bracket; w/ Studs; w/ Spacer Block	I.D. = 1.575" (40mm)	DS-6064		
		U-Shaped Bracket; w/ Studs w/o Spacer Block	I.D. = 1.575" (40mm)	DS-6510		
		U-Shaped Bracket; w/o Studs	I.D. = 1.575" (40mm)	DS-6099		
		Wing Shaped Bracket	I.D. = 1.37" (35mm)	DS-6063		
YUKON XL 2500	2007-12	Octagon Shaped Assembly	I.D. = 1.5748 - 1.5743" (40	DS-6092		
		U-Shaped Bracket; w/ Studs; w/ Spacer Block	I.D. = 1.575" (40mm)	DS-6064		
		U-Shaped Bracket; w/ Studs w/o Spacer Block	I.D. = 1.575" (40mm)	DS-6510		
		U-Shaped Bracket; w/o Studs	I.D. = 1.575" (40mm)	DS-6099		
		Wing Shaped Bracket	I.D. = 1.37" (35mm)	DS-6063		
	2000-06	U-Shaped Bracket; w/ Studs; w/ Spacer Block	I.D. = 1.575" (40mm)	DS-6064		
		U-Shaped Bracket; w/ Studs w/o Spacer Block	I.D. = 1.575" (40mm)	DS-6510		
		U-Shaped Bracket; w/o Studs	I.D. = 1.575" (40mm)	DS-6099		
		Wing Shaped Bracket	I.D. = 1.37" (35mm)	DS-6063		
<b>GMC TRUCK</b>						
C15/C1500 PICKUP	1988-99	Cleveland "O" Shaft	I.D. = 1.5748 - 1.5743"	DS-6053	DS-6027	
		Spicer 1280-1310 End Yolk Style	I.D. = 1.1811 - 1.1807"	DS-6035	DS-6028	
		Spicer 1280-1410 Slip Yolk Style	I.D. = 1.3780 - 1.3775"	DS-6056	DS-6027	
		Spicer 1410, 1480	I.D. = 1.5748 - 1.5743"	DS-6038		
		Spicer 1550, 1650	I.D. = 1.7717 - 1.7712"	DS-6040		
		Spicer 1700, 1710	I.D. = 1.9685 - 1.9680"	DS-6048		
		Spicer 1800, 1850	I.D. = 2.3622 - 2.3616"	DS-6049		
	1966-86	Cleveland "O" Shaft	I.D. = 1.5748 - 1.5743"	DS-6053	DS-6027	
		Spicer 1280-1310 End Yolk Style	I.D. = 1.1811 - 1.1807"	DS-6035	DS-6028	
		Spicer 1280-1410 Slip Yolk Style	I.D. = 1.3780 - 1.3775"	DS-6056	DS-6027	

## Drive Shaft Center Supports

Models	Years	Shaft Type / Series	Bearing Inside Diameter	Part No. Complete Assembly	Part No. Bushing Only
<b>GMC TRUCK (continued)</b>					
C15/C1500 PICKUP	1966-86	Spicer 1410, 1480	I.D. = 1.5748 - 1.5743"	DS-6038	
		Spicer 1550, 1650	I.D. = 1.7717 - 1.7712"	DS-6040	
		Spicer 1700, 1710	I.D. = 1.9685 - 1.9680"	DS-6048	
		Spicer 1800, 1850	I.D. = 2.3622 - 2.3616"	DS-6049	
C25/C2500 PICKUP	1988-00	Cleveland "O" Shaft	I.D. = 1.5748 - 1.5743"	DS-6053	DS-6027
		Spicer 1280-1310 End Yolk Style	I.D. = 1.1811 - 1.1807"	DS-6035	DS-6028
		Spicer 1280-1410 Slip Yolk Style	I.D. = 1.3780 - 1.3775"	DS-6056	DS-6027
		Spicer 1410, 1480	I.D. = 1.5748 - 1.5743"	DS-6038	
		Spicer 1550, 1650	I.D. = 1.7717 - 1.7712"	DS-6040	
		Spicer 1700, 1710	I.D. = 1.9685 - 1.9680"	DS-6048	
		Spicer 1800, 1850	I.D. = 2.3622 - 2.3616"	DS-6049	
	1966-86	Cleveland "O" Shaft	I.D. = 1.5748 - 1.5743"	DS-6053	DS-6027
		Spicer 1280-1310 End Yolk Style	I.D. = 1.1811 - 1.1807"	DS-6035	DS-6028
		Spicer 1280-1410 Slip Yolk Style	I.D. = 1.3780 - 1.3775"	DS-6056	DS-6027
		Spicer 1410, 1480	I.D. = 1.5748 - 1.5743"	DS-6038	
		Spicer 1550, 1650	I.D. = 1.7717 - 1.7712"	DS-6040	
		Spicer 1700, 1710	I.D. = 1.9685 - 1.9680"	DS-6048	
		Spicer 1800, 1850	I.D. = 2.3622 - 2.3616"	DS-6049	
C35/C3500 PICKUP	1988-02	Cleveland "O" Shaft	I.D. = 1.5748 - 1.5743"	DS-6053	DS-6027
		Spicer 1280-1310 End Yolk Style	I.D. = 1.1811 - 1.1807"	DS-6035	DS-6028
		Spicer 1280-1410 Slip Yolk Style	I.D. = 1.3780 - 1.3775"	DS-6056	DS-6027
		Spicer 1410, 1480	I.D. = 1.5748 - 1.5743"	DS-6038	
		Spicer 1550, 1650	I.D. = 1.7717 - 1.7712"	DS-6040	
		Spicer 1700, 1710	I.D. = 1.9685 - 1.9680"	DS-6048	
		Spicer 1800, 1850	I.D. = 2.3622 - 2.3616"	DS-6049	
	1967-86	Cleveland "O" Shaft	I.D. = 1.5748 - 1.5743"	DS-6053	DS-6027
		Spicer 1280-1310 End Yolk Style	I.D. = 1.1811 - 1.1807"	DS-6035	DS-6028
		Spicer 1280-1410 Slip Yolk Style	I.D. = 1.3780 - 1.3775"	DS-6056	DS-6027
		Spicer 1410, 1480	I.D. = 1.5748 - 1.5743"	DS-6038	
		Spicer 1550, 1650	I.D. = 1.7717 - 1.7712"	DS-6040	
		Spicer 1700, 1710	I.D. = 1.9685 - 1.9680"	DS-6048	
		Spicer 1800, 1850	I.D. = 2.3622 - 2.3616"	DS-6049	
CANYON	2004-12			DS-6068	
K15/K1500 PICKUP	1988-99	Spicer 1280-1330	I.D. = 1.3780 - 1.3775"	DS-6056	DS-6027
		Spicer 1410, 1480	I.D. = 1.5748 - 1.5743"	DS-6038	
	1966-86	Spicer 1280-1330	I.D. = 1.3780 - 1.3775"	DS-6056	DS-6027
		Spicer 1410, 1480	I.D. = 1.5748 - 1.5743"	DS-6038	
K25/K2500 PICKUP	1988-00	Spicer 1280-1330	I.D. = 1.3780 - 1.3775"	DS-6056	DS-6027
		Spicer 1410, 1480	I.D. = 1.5748 - 1.5743"	DS-6038	
	1967-86	Spicer 1280-1330	I.D. = 1.3780 - 1.3775"	DS-6056	DS-6027
		Spicer 1410, 1480	I.D. = 1.5748 - 1.5743"	DS-6038	
K35/K3500 PICKUP	1988-00	Spicer 1280-1330	I.D. = 1.3780 - 1.3775"	DS-6056	DS-6027
		Spicer 1410, 1480	I.D. = 1.5748 - 1.5743"	DS-6038	
	1977-86	Spicer 1280-1330	I.D. = 1.3780 - 1.3775"	DS-6056	DS-6027
		Spicer 1410, 1480	I.D. = 1.5748 - 1.5743"	DS-6038	
	1967-74	Spicer 1280-1330	I.D. = 1.3780 - 1.3775"	DS-6056	DS-6027
		Spicer 1410, 1480	I.D. = 1.5748 - 1.5743"	DS-6038	
R1500 PICKUP	1987	Spicer 1280-1410	I.D. = 1.3780 - 1.3775"	DS-6056	DS-6027
		Spicer 1410, 1480	I.D. = 1.5748 - 1.5743"	DS-6038	
R2500 PICKUP	1987-89	Spicer 1280-1410	I.D. = 1.3780 - 1.3775"	DS-6056	DS-6027



## Drive Shaft Center Supports

Models	Years	Shaft Type / Series	Bearing Inside Diameter	Part No. Complete Assembly	Part No. Bushing Only		
<b>GMC TRUCK (continued)</b>							
R2500 PICKUP	1987-89	Spicer 1410, 1480	I.D. = 1.5748 - 1.5743"	DS-6038			
R3500 PICKUP	1987-91	Spicer 1280-1410	I.D. = 1.3780 - 1.3775"	DS-6056	DS-6027		
		Spicer 1410, 1480	I.D. = 1.5748 - 1.5743"	DS-6038			
S15 PICKUP	1982-90	Spicer 1280-1410	I.D. = 1.3780 - 1.3775"	DS-6056	DS-6027		
SIERRA 1500	2008-12	Octagon Shaped Assembly	I.D. = 1.575" (40mm)	DS-6510	DS-6092		
		U-Shaped Bracket; w/ Studs w/o Spacer Block	I.D. = 1.5748 - 1.5743" (40	DS-6071			
	1999-07	U-Shaped Bracket; w/ Studs; w/ Spacer Block	I.D. = 1.575" (40mm)	DS-6064			
		U-Shaped Bracket; w/ Studs w/o Spacer Block	I.D. = 1.575" (40mm)	DS-6510			
		U-Shaped Bracket; w/o Studs	I.D. = 1.575" (40mm)	DS-6099			
		Wing Shaped Bracket	I.D. = 1.37" (35mm)	DS-6063			
SIERRA 1500 HD	2005-06	U-Shaped Bracket; w/ Studs; w/ Spacer Block	I.D. = 1.575" (40mm)	DS-6064			
		U-Shaped Bracket; w/ Studs w/o Spacer Block	I.D. = 1.575" (40mm)	DS-6510			
		U-Shaped Bracket; w/o Studs	I.D. = 1.575" (40mm)	DS-6099			
		Wing Shaped Bracket	I.D. = 1.37" (35mm)	DS-6063			
	2001-03	U-Shaped Bracket; w/ Studs; w/ Spacer Block	I.D. = 1.575" (40mm)	DS-6064			
		U-Shaped Bracket; w/ Studs w/o Spacer Block	I.D. = 1.575" (40mm)	DS-6510			
		U-Shaped Bracket; w/o Studs	I.D. = 1.575" (40mm)	DS-6099			
		Wing Shaped Bracket	I.D. = 1.37" (35mm)	DS-6063			
		SIERRA 2500	1999-04	U-Shaped Bracket; w/ Studs; w/ Spacer Block	I.D. = 1.575" (40mm)	DS-6064	
				U-Shaped Bracket; w/ Studs w/o Spacer Block	I.D. = 1.575" (40mm)	DS-6510	
		U-Shaped Bracket; w/o Studs	I.D. = 1.575" (40mm)	DS-6099			
		Wing Shaped Bracket	I.D. = 1.37" (35mm)	DS-6063			
		SIERRA 2500 HD	2008-12	Octagon Shaped Assembly	I.D. = 1.575" (40mm)	DS-6510	DS-6092
U-Shaped Bracket; w/ Studs w/o Spacer Block	I.D. = 1.5748 - 1.5743" (40			DS-6071			
2001-07	U-Shaped Bracket; w/ Studs; w/ Spacer Block		I.D. = 1.575" (40mm)	DS-6064			
	U-Shaped Bracket; w/ Studs w/o Spacer Block		I.D. = 1.575" (40mm)	DS-6510			
		U-Shaped Bracket; w/o Studs	I.D. = 1.575" (40mm)	DS-6099			
		Wing Shaped Bracket	I.D. = 1.37" (35mm)	DS-6063			
		SIERRA 3500	2001-06	U-Shaped Bracket; w/ Studs; w/ Spacer Block	I.D. = 1.575" (40mm)	DS-6064	
				U-Shaped Bracket; w/ Studs w/o Spacer Block	I.D. = 1.575" (40mm)	DS-6510	
U-Shaped Bracket; w/o Studs	I.D. = 1.575" (40mm)			DS-6099			
Wing Shaped Bracket	I.D. = 1.37" (35mm)			DS-6063			
SIERRA 3500 HD	2008-12	Octagon Shaped Assembly	I.D. = 1.575" (40mm)	DS-6510	DS-6092		
		U-Shaped Bracket; w/ Studs w/o Spacer Block	I.D. = 1.5748 - 1.5743" (40	DS-6071			
SIERRA C3	2001	U-Shaped Bracket; w/ Studs; w/ Spacer Block	I.D. = 1.575" (40mm)	DS-6064			
		U-Shaped Bracket; w/ Studs w/o Spacer Block	I.D. = 1.575" (40mm)	DS-6510			
		U-Shaped Bracket; w/o Studs	I.D. = 1.575" (40mm)	DS-6099			
		Wing Shaped Bracket	I.D. = 1.37" (35mm)	DS-6063			
SONOMA	1994-04	Spicer 1280 - 1310 - 1410 (Square Housing)	1.378" Bearing ID (35mm)	DS-6079			

## Drive Shaft Center Supports

Models	Years	Shaft Type / Series	Bearing Inside Diameter	Part No. Complete Assembly	Part No. Bushing Only
<b>GMC VAN</b>					
G1000 SERIES	1964-66	Spicer 1280-1310 End Yolk Style	I.D. = 1.1811 - 1.1807"	DS-6035	DS-6028
		Spicer 1280-1410 Slip Yolk Style	I.D. = 1.3780 - 1.3775"	DS-6056	DS-6027
		Spicer 1410, 1480	I.D. = 1.5748 - 1.5743"	DS-6038	
G15/G1500 VAN	1967-98	Spicer 1280-1310 End Yolk Style	I.D. = 1.1811 - 1.1807"	DS-6035	DS-6028
		Spicer 1280-1410 Slip Yolk Style	I.D. = 1.3780 - 1.3775"	DS-6056	DS-6027
		Spicer 1410, 1480	I.D. = 1.5748 - 1.5743"	DS-6038	
G25/G2500 VAN	1967-98	Spicer 1280-1310 End Yolk Style	I.D. = 1.1811 - 1.1807"	DS-6035	DS-6028
		Spicer 1280-1410 Slip Yolk Style	I.D. = 1.3780 - 1.3775"	DS-6056	DS-6027
		Spicer 1410, 1480	I.D. = 1.5748 - 1.5743"	DS-6038	
G35/G3500 VAN	1971-98	Spicer 1280-1310 End Yolk Style	I.D. = 1.1811 - 1.1807"	DS-6035	DS-6028
		Spicer 1280-1410 Slip Yolk Style	I.D. = 1.3780 - 1.3775"	DS-6056	DS-6027
		Spicer 1410, 1480	I.D. = 1.5748 - 1.5743"	DS-6038	
	1967	Spicer 1280-1310 End Yolk Style	I.D. = 1.1811 - 1.1807"	DS-6035	DS-6028
		Spicer 1280-1410 Slip Yolk Style	I.D. = 1.3780 - 1.3775"	DS-6056	DS-6027
		Spicer 1410, 1480	I.D. = 1.5748 - 1.5743"	DS-6038	
SAVANA 1500	1999-12	U-Shaped Bracket; w/ Studs w/o Spacer Block	I.D = 1.575" (40mm)	DS-6510	
SAVANA 2500	2010-15	Octagon Shaped Assembly	I.D. = 1.5748 - 1.5743" (40	DS-6092	
		U-Shaped Bracket; w/ Studs w/o Spacer Block	I.D = 1.575" (40mm)	DS-6510	
		U-Shaped Bracket; w/o Studs	I.D. = 1.575" (40mm)	DS-6099	
	1997-09	U-Shaped Bracket; w/ Studs w/o Spacer Block	I.D = 1.575" (40mm)	DS-6510	
		U-Shaped Bracket; w/o Studs	I.D. = 1.575" (40mm)	DS-6099	
SAVANA 3500	2010-15	Octagon Shaped Assembly	I.D. = 1.5748 - 1.5743" (40	DS-6092	
		U-Shaped Bracket; w/ Studs w/o Spacer Block	I.D = 1.575" (40mm)	DS-6510	
		U-Shaped Bracket; w/o Studs	I.D. = 1.575" (40mm)	DS-6099	
	1997-09	U-Shaped Bracket; w/ Studs w/o Spacer Block	I.D = 1.575" (40mm)	DS-6510	
		U-Shaped Bracket; w/o Studs	I.D. = 1.575" (40mm)	DS-6099	
<b>GMC MEDIUM/HEAVY DUTY TRUCK</b>					
SAVANA 4500	2009-15	Octagon Shaped Assembly	I.D. = 1.5748 - 1.5743" (40	DS-6092	
<b>HONDA SPORT UTILITY</b>					
CR-V	2002-06			DS-6069	
	1997-01			DS-5235	
PASSPORT	1994-98			DS-5222	
<b>HYUNDAI SPORT UTILITY</b>					
SANTA FE	2001-06			DS-6514	
<b>INFINITI PASSENGER CAR</b>					
G25	2011-12			DS-8474	
G35	2003-08			DS-8474	
G37	2008-12			DS-8474	
J30	1993-97			DS-8474	
M30	1990-92			DS-8474	

## Drive Shaft Center Supports

Models	Years	Shaft Type / Series	Bearing Inside Diameter	Part No. Complete Assembly	Part No. Bushing Only
<b>INFINITI PASSENGER CAR (continued)</b>					
M35	2006			DS-8474	
M45	2006-07			DS-8474	
<b>INFINITI SPORT UTILITY</b>					
FX35	2003-07			DS-8474	
<b>INTERNATIONAL MEDIUM/HEAVY DUTY TRUCK</b>					
4000 Series	2002	Cleveland "R" & "S" Shaft	I.D. = 1.3740 - 1.3745"	DS-6050	
		Cleveland "U" Shaft		DS-6052	
		Spicer 1260	I.D. = 1.1811 - 1.1807"	DS-6035	
		Spicer 1280 - 1310 - 1410 & Cleveland S55	I.D. = 1.3780 - 1.3775"	DS-6056	
		Spicer 1480 - 1550 & Mechanics 6C	I.D. = 1.5748 - 1.5743"	DS-6038	
		Spicer 1610 - 1650 & Mechanics 7C	I.D. = 1.7717 - 1.7712"	DS-6040	
		Spicer 1700 - 1710 & Mechanics 8C	I.D. = 1.9685 - 1.9680"	DS-6048	
		Spicer 1800 - 1850	I.D. = 2.3622 - 2.3616"	DS-6049	
3000 Series	1996-02	Cleveland "R" & "S" Shaft	I.D. = 1.3740 - 1.3745"	DS-6050	
		Cleveland "U" Shaft		DS-6052	
		Spicer 1260	I.D. = 1.1811 - 1.1807"	DS-6035	
		Spicer 1280 - 1310 - 1410 & Cleveland S55	I.D. = 1.3780 - 1.3775"	DS-6056	
		Spicer 1480 - 1550 & Mechanics 6C	I.D. = 1.5748 - 1.5743"	DS-6038	
		Spicer 1610 - 1650 & Mechanics 7C	I.D. = 1.7717 - 1.7712"	DS-6040	
		Spicer 1700 - 1710 & Mechanics 8C	I.D. = 1.9685 - 1.9680"	DS-6048	
		Spicer 1800 - 1850	I.D. = 2.3622 - 2.3616"	DS-6049	
2000 Series	1990-02	Cleveland "R" & "S" Shaft	I.D. = 1.3740 - 1.3745"	DS-6050	
		Cleveland "U" Shaft		DS-6052	
		Spicer 1260	I.D. = 1.1811 - 1.1807"	DS-6035	
		Spicer 1280 - 1310 - 1410 & Cleveland S55	I.D. = 1.3780 - 1.3775"	DS-6056	
		Spicer 1480 - 1550 & Mechanics 6C	I.D. = 1.5748 - 1.5743"	DS-6038	
		Spicer 1610 - 1650 & Mechanics 7C	I.D. = 1.7717 - 1.7712"	DS-6040	
		Spicer 1700 - 1710 & Mechanics 8C	I.D. = 1.9685 - 1.9680"	DS-6048	
		Spicer 1800 - 1850	I.D. = 2.3622 - 2.3616"	DS-6049	
1000 Series	1986-02	Cleveland "R" & "S" Shaft	I.D. = 1.3740 - 1.3745"	DS-6050	
		Cleveland "U" Shaft		DS-6052	
		Spicer 1260	I.D. = 1.1811 - 1.1807"	DS-6035	
		Spicer 1280 - 1310 - 1410 & Cleveland S55	I.D. = 1.3780 - 1.3775"	DS-6056	
		Spicer 1480 - 1550 & Mechanics 6C	I.D. = 1.5748 - 1.5743"	DS-6038	
		Spicer 1610 - 1650 & Mechanics 7C	I.D. = 1.7717 - 1.7712"	DS-6040	
		Spicer 1700 - 1710 & Mechanics 8C	I.D. = 1.9685 - 1.9680"	DS-6048	
		Spicer 1800 - 1850	I.D. = 2.3622 - 2.3616"	DS-6049	
ALL MODELS	1993-97	Cleveland "R" & "S" Shaft	I.D. = 1.3740 - 1.3745"	DS-6050	
		Cleveland "U" Shaft		DS-6052	
		Spicer 1260	I.D. = 1.1811 - 1.1807"	DS-6035	
		Spicer 1280 - 1310 - 1410 & Cleveland S55	I.D. = 1.3780 - 1.3775"	DS-6056	

## Drive Shaft Center Supports

Models	Years	Shaft Type / Series	Bearing Inside Diameter	Part No. Complete Assembly	Part No. Bushing Only
<b>INTERNATIONAL MEDIUM/HEAVY DUTY TRUCK (continued)</b>					
ALL MODELS	1993-97	Spicer 1480 - 1550 & Mechanics 6C	I.D. = 1.5748 - 1.5743"	DS-6038	
		Spicer 1610 - 1650 & Mechanics 7C	I.D. = 1.7717 - 1.7712"	DS-6040	
		Spicer 1700 - 1710 & Mechanics 8C	I.D. = 1.9685 - 1.9680"	DS-6048	
		Spicer 1800 - 1850	I.D. = 2.3622 - 2.3616"	DS-6049	
<b>ISUZU SPORT UTILITY</b>					
RODEO	1991-97			DS-5223	
<b>ISUZU TRUCK</b>					
HOMBRE	1996-99	Spicer 1280, 1310, 1330, 1410	I.D. = 1.3780 - 1.3775"	DS-6056	DS-6027
I-290	2007-08			DS-6068	
I-370	2007-08			DS-6068	
I-280	2006			DS-6068	
I-350	2006			DS-6068	
PICKUP	1987-95	Complete Unit; 2WD		DS-8591	DS-8538
	1981-86	2WD		DS-8535	
<b>KIA SPORT UTILITY</b>					
SORENTO	2003-06	4WD	I.D. = 1.181" (30mm)	DS-6524	
		RWD, Auto		DS-6077	
<b>LEXUS PASSENGER CAR</b>					
ES300	1992-97			DS-8509	
GS300	1999-05			DS-6085	
	1993-97			DS-8509	
GS350	2013-15	RWD	I.D. = 1.181" (30mm)	DS-6519	
	2007-11	RWD	I.D. = 1.181" (30mm)	DS-6519	
GS400	1998-00			DS-6085	
GS430	2006-07		I.D. = 1.181" (30mm)	DS-6519	
	2001-05			DS-6085	
GS450H	2013-15		I.D. = 1.181" (30mm)	DS-6519	
	2007-11		I.D. = 1.181" (30mm)	DS-6519	
IS F	2008-14		I.D. = 1.181" (30mm)	DS-6519	
IS300	2001-05			DS-6086	
LS400	1995-00			DS-6086	
LS430	2001-06			DS-6085	
LS600H	2008-14		I.D. = 1.181" (30mm)	DS-6519	
LS460	2007-15		I.D. = 1.181" (30mm)	DS-6519	
SC430	2002-10			DS-6085	
<b>MAZDA PASSENGER CAR</b>					
323	1988-89			DS-8551	
<b>MAZDA SPORT UTILITY</b>					
TRIBUTE	2001-06			DS-6076	
<b>MAZDA TRUCK</b>					
B1600	1972-76	2WD		DS-8565	
B2200	1988-93			DS-8551	
	1987	2WD		DS-8550	
	1982-84	2WD		DS-8550	
B2600	1987-93	4WD			DS-5234
B3000	1994-96	RWD		DS-8551	

## Drive Shaft Center Supports

Models	Years	Shaft Type / Series	Bearing Inside Diameter	Part No. Complete Assembly	Part No. Bushing Only
<b>MERCEDES-BENZ PASSENGER CAR</b>					
190	1964-65	2WD		DS-8636	
190D	1984-89				DS-5232
190E	1984-89				DS-5232
280	1973-76			DS-8635	
280C	1973-76			DS-8635	
280CE	1978-79			DS-8635	
280E	1977-79			DS-8635	
280S	1975-76			DS-8635	
280SE	1977-79			DS-8635	
	1972-73			DS-8635	
280SEL	1972-73			DS-8635	
300CDT	1984-85				DS-8634
300CE	1988-89				DS-8634
300D	1987				DS-8634
300DT	1987				DS-8634
	1984-85				DS-8634
300E	1986-89				DS-8634
300SD	1984-85				DS-8634
300SDL	1986-87				DS-8634
300SE	1988-89				DS-8634
300SEL	1988-89				DS-8634
300TDT	1987				DS-8634
	1984-85				DS-8634
300TE	1988-89				DS-8634
380SE	1984-85				DS-8634
380SL	1984-85				DS-8634
C230	2002			DS-6520	
C55 AMG	2005-07			DS-6520	
CLK55 AMG	2003-06			DS-6520	
CLK63 AMG	2007-09			DS-6520	
SLK55 AMG	2005-10			DS-6520	
<b>MERCEDES-BENZ VAN</b>					
SPRINTER	2004-06	Mexico; *		DS-6521	
SPRINTER 2500	2010-13	1-Piece Shaft; w/ Shims		DS-6505	
		1-Piece Shaft; w/o Shims		DS-6504	
		2- & 3-Piece Shaft; w/ Shims Slider Section		DS-6507	
		2- & 3-Piece Shaft; w/o Shims Slider Section		DS-6506	
SPRINTER 3500	2010-13	1-Piece Shaft; w/ Shims		DS-6505	
		1-Piece Shaft; w/o Shims		DS-6504	
		2- & 3-Piece Shaft; w/ Shims Slider Section		DS-6507	
		2- & 3-Piece Shaft; w/o Shims Slider Section		DS-6506	
<b>MERCURY SPORT UTILITY</b>					
MARINER	2005-07			DS-6076	
<b>MITSUBISHI TRUCK</b>					
MIGHTY MAX	1990-92	2WD		DS-8318	
	1983-89		I.D. = 1.1811"	DS-8549	

## Drive Shaft Center Supports

Models	Years	Shaft Type / Series	Bearing Inside Diameter	Part No. Complete Assembly	Part No. Bushing Only
<b>NISSAN PASSENGER CAR</b>					
200SX	1984-88			DS-8474	
240SX	1989-98	RWD		DS-8474	
300ZX	1990-96			DS-6031	
MAXIMA	1982-84	RWD		DS-8474	
MULTI	1986-88			DS-8474	
STANZA	1986-88	4WD		DS-8474	
<b>NISSAN SPORT UTILITY</b>					
PATHFINDER	1996-04	2WD		DS-8474	
	1989-95	2WD		DS-8474	
		4WD		DS-8473	
	1987-88	4WD		DS-8473	
XTERRA	2000-04			DS-8474	
<b>NISSAN TRUCK</b>					
620 PICKUP	1973-79	2WD		DS-8475	
720 PICKUP	1986	2WD		DS-8474	
		4WD		DS-8473	
	1980-85		1.1811" I.D. (30mm)	DS-8472	
D21 PICKUP	1986-94	2WD		DS-8474	
		4WD		DS-8473	
	1991-93	2WD		DS-8474	
		4WD		DS-8473	
FRONTIER	2005-12		I.D. = 1.5748 - 1.5743" (40)	DS-6071	
	1998-04	2WD		DS-8474	
		4WD		DS-8473	
PICKUP	1996-97	2WD		DS-8474	
	1994-95	2WD		DS-8474	
		4WD		DS-8473	
	1995			DS-8473	
TITAN	2004-15	RWD	I.D. = 1.5748 - 1.5743" (40)	DS-6071	
<b>PLYMOUTH TRUCK</b>					
ARROW PICKUP	1979-82		I.D. = 1.1811"	DS-8549	
<b>PONTIAC SPORT UTILITY</b>					
TORRENT	2006-09	AWD		DS-6066	
<b>PORSCHE SUV</b>					
CAYENNE	2008-10			DS-6042	
	2003-06			DS-6042	
<b>RAM TRUCK</b>					
2500 PICKUP	2010-12	Wing Shaped Bracket	I.D. = 1.575" (40mm)	DS-6516	
3500 PICKUP	2011-12	Wing Shaped Bracket	I.D. = 1.575" (40mm)	DS-6516	
<b>SATURN SUV</b>					
VUE	2002-07	AWD		DS-6066	
<b>TOYOTA PASSENGER CAR</b>					
CELICA	1982-85		I.D. = 1.181"	DS-8468	
COROLLA	1980-87	RWD			DS-8531
CORONA	1982	RWD	I.D. = 1.181"	DS-8468	
CRESSIDA	1985-88		I.D. = 1.000"	DS-8588	
	1983-84	RWD		DS-8587	
	1979-80	RWD		DS-8587	
SUPRA	1986-87		I.D. = 1.000"	DS-8588	
TERCEL	1983-88	4WD	I.D. = 1.181"	DS-8468	

## Drive Shaft Center Supports

Models	Years	Shaft Type / Series	Bearing Inside Diameter	Part No. Complete Assembly	Part No. Bushing Only
<b>TOYOTA SPORT UTILITY</b>					
4RUNNER	1990-95	2WD		DS-8533	
		4WD		DS-5231	
	1989 1984-88	4WD		DS-5231	
				DS-8470	
LAND CRUISER	1984-90		DS-8470		
RAV4	2001-05			DS-6072	
	1996-00			DS-5230	
<b>TOYOTA TRUCK</b>					
PICKUP	1984-87	2WD		DS-8532	
		4WD		DS-8470	
	1979-83			DS-8469	
	1989-95	2WD		DS-8533	
		4WD		DS-8471	
	1988	2WD		DS-8532	
		4WD		DS-8470	
T100	1995-98	2WD		DS-5225	
		4WD		DS-5226	
	1993-94			DS-5225	
TACOMA	1995-15	2WD		DS-5225	
		4WD		DS-5227	
TUNDRA	2000-19	2WD		DS-5225	
		4WD		DS-5227	
<b>TOYOTA VAN</b>					
SIENNA	2004-14			DS-5229	
<b>VOLKSWAGEN SPORT UTILITY</b>					
TOUAREG	2004-12			DS-6042	







## Suspension Strut Mounts

Model	Years	Location/ Options	Front	Rear
<b>ACURA PASSENGER CAR</b>				
CL	2001-03	Lower Spring Isolator	ST-1940	ST-1961
		Lower Bushing		ST-6949
	1997-99	Lower Spring Isolator	ST-1940	ST-1961
		Lower Bushing		ST-6949
CSX	2006-11		ST-6964	
			ST-7957	
EL	2001-03	Left Side	ST-6920	
		Right Side	ST-6919	
	1997-00			ST-1940
ILX	2013-18		ST-6964	
INTEGRA	1994-01	exc. Type R	ST-1940	ST-1940
		Lower Bushing		ST-6916
	1990-93	Lower Bushing	ST-1940	ST-1940
				ST-6916
1986-89	Lower Bushing	ST-1939	ST-1961	
			ST-6915	
LEGEND	1991-95		ST-2928	ST-2991
	1989-90	Coupe	ST-1940	ST-1961
		Sedan, exc Auto Leveling	ST-1940	ST-1961
	1987-88	Lower Bushing		ST-6915
		Coupe	ST-1940	ST-1961
		Sedan	ST-1940	ST-2967
1986	Lower Bushing		ST-6915	
1986	Sedan	ST-1940	ST-2967	
NSX	1991-01		ST-1940	ST-1940
RL	1996-04	incl. Type S	ST-4976	ST-4977
		Lower Spring Isolator	ST-7958	ST-7968
RSX	2005-06	Left Side, exc Type S	ST-6920	ST-1940
		Left Side, incl. Type S	ST-4997	ST-1940
		Right Side, exc Type S	ST-6919	ST-1940
		Right Side, incl. Type S	ST-4996	ST-1940
	2002-04	Left Side	ST-6920	
		Right Side	ST-6919	
				ST-1940
TL	2009-14	Upper Spring Isolator	ST-1940	ST-1940
		Lower Spring Isolator	ST-9922	
			ST-6950	
	2004-08	Lower Spring Isolator	ST-1940	ST-1940
			ST-6950	ST-6951
	1999-03	Lower Spring Isolator	ST-1940	ST-1940
				ST-6949
	1995-98	Lower Spring Isolator	ST-1940	ST-1961
		ST-7958		
TLX	2015-17			ST-9912
TSX	2009-14	Stud Plate; Left Side	ST-9917	
		Stud Plate; Right Side	ST-9918	
		Upper Spring Isolator	ST-9922	
	2004-08	Lower Spring Isolator	ST-1940	ST-1940
		ST-6950	ST-6951	
VIGOR	1992-94		ST-1940	ST-1961

## Suspension Strut Mounts

Model	Years	Location/ Options	Front	Rear
<b>ACURA SPORT UTILITY</b>				
MDX	2007-13		ST-7983	
	2001-06		ST-4975	
RDX	2007-12		ST-6966	
<b>AUDI PASSENGER CAR</b>				
80	1988-92		ST-1942	
80 QUATTRO	1988-92		ST-1942	
90	1993-95		ST-1942	
	1988-91		ST-1942	
90 QUATTRO	1993-95		ST-1942	
	1988-91		ST-1942	
100	1992-94	Sedan, exc. Sport Susp.	ST-3912	ST-3913
	1991	Sedan, exc. Sport Susp.	ST-1985	ST-3913
	1989-90		ST-1985	ST-3913
100 QUATTRO	1992-94	Sedan, exc. Sport Susp.	ST-3912	
		Sedan & Wagon, exc Sport Susp.		ST-3913
	1989-91	Sedan, exc. Sport Susp.	ST-1985	ST-3913
200	1989-91	Sedan	ST-1985	ST-3913
200 QUATTRO	1989-91	Sedan & Wagon	ST-1985	ST-3913
4000	1980-83		ST-1942	
4000CS QUATTRO	1986-87		ST-1942	
4000S	1984-87		ST-1942	
4000S QUATTRO	1984-85		ST-1942	
5000	1980-88	Sedan	ST-1985	
	1978-79		ST-2925	
5000 QUATTRO	1986-88		ST-1985	
A3	2008-13	w/o Magnetic Ride Control Suspension	ST-7949	
		w/o Magnetic Ride Control Suspension; w/ Oval Jounce Bumper		ST-8923
		w/o Magnetic Ride Control Suspension; w/ Round Jounce Bumper		ST-7947
	2006-07	w/o Magnetic Ride Control Suspension	ST-7949	ST-7947
A3 QUATTRO	2008-13	w/o Magnetic Ride Control Suspension	ST-7949	
		w/o Magnetic Ride Control Suspension; w/ Oval Jounce Bumper		ST-8923
		w/o Magnetic Ride Control Suspension; w/ Round Jounce Bumper		ST-7947
	2006-07	w/o Magnetic Ride Control Suspension	ST-7949	ST-7947
A4	2009-15	w/ Active Dampening System	ST-10012	
				ST-10008
	2007		ST-4992	
	2006	Sedan	ST-4908	ST-4907
	1996-05	Sedan & Wagon, incl. Sport Susp.	ST-4908	ST-4907
A4 QUATTRO	2009-15	w/ Active Dampening System	ST-10012	
				ST-10008
	2001-07	Sedan & Wagon, incl. Sport Susp.	ST-4908	ST-4965
	1996-00	Sedan & Wagon, incl. Sport Susp.	ST-4908	
A5	2009-15	w/ Active Dampening System	ST-10012	
				ST-10008
A5 QUATTRO	2009-15	w/ Active Dampening System	ST-10012	
				ST-10008
A6	2006-11	Exc. Air Suspension	ST-10003	
	1998-04		ST-4908	ST-4909
	1997	After 7/97	ST-4908	ST-4909
		Before 7/97	ST-3912	ST-4913
	1995-96	Before 7/97	ST-3912	ST-4913
A6 QUATTRO	2005-11	Exc. Air Suspension	ST-10003	
	1998-04		ST-4908	ST-9907

## Suspension Strut Mounts

Model	Years	Location/ Options	Front	Rear
<b>AUDI PASSENGER CAR (continued)</b>				
A6 QUATTRO	1997	<u>After 7/97</u>	ST-4908	ST-9907
		<u>Before 7/97</u>	ST-3912	ST-4913
A8 QUATTRO	1997-03		ST-4908	
A8	1997-00		ST-4908	
ALLROAD	2013-15			ST-10008
ALLROAD QUATTRO	2001-05		ST-4908	
CABRIOLET	1994-98	Convertible	ST-1942	
COUPE	1981-87		ST-1942	
COUPE QUATTRO	1990-91		ST-1942	
FOX	1973-79	Sedan & Wagon	ST-1903	
QUATTRO	1984-86		ST-1985	
RS5	2013-15			ST-10008
S4	2010-15	<u>w/ Active Dampening System</u>	ST-10012	
				ST-10008
	1992-94		ST-1985	
S5	2008-15	<u>w/ Active Dampening System</u>	ST-10012	
				ST-10008
S6	2008-11	Exc. Air Suspension	ST-10003	
	2002-03		ST-4908	
	1995-97		ST-3912	ST-3913
TT	2008-14		ST-7949	ST-8923
	2000-06		ST-4905	ST-4910
TT QUATTRO	2008-15		ST-7949	ST-8923
	2000-06		ST-4905	ST-4910
V8 QUATTRO	1992-94		ST-3912	
	1990-91		ST-1985	
<b>AUDI SPORTS UTILITY</b>				
Q5	2009-15	<u>w/ Electronic Shocks</u>	ST-10012	
				ST-10008
<b>BMW PASSENGER CAR</b>				
128I	2008-13	<u>exc Sport Suspension</u>	ST-3918	
		<u>Lower Spring Isolator: exc. Sport Suspension</u>	ST-7967	
		<u>Upper; exc. Elec. Suspension</u>	ST-7984	
		<u>Lower; exc. Elec. Suspension</u>		ST-7985
135I	2008-13	<u>exc Sport Suspension</u>	ST-3918	
		<u>Lower Spring Isolator: exc. Sport Suspension</u>	ST-7967	
		<u>Upper; exc. Elec. Suspension</u>	ST-7984	
		<u>Lower; exc. Elec. Suspension</u>		ST-7985
318I	1993-98		ST-2905	ST-1965
		<u>Lower Spring Isolator</u>	ST-6944	
	1992	<u>After 6/92</u>	ST-2905	
		<u>Before 6/92</u>	ST-2904	
				ST-1965
		<u>Lower Spring Isolator</u>	ST-6944	
	1991		ST-2904	ST-1965
	1984-85		ST-2904	ST-1965
318IS	1993-98		ST-2905	ST-1965
		<u>Lower Spring Isolator</u>	ST-6944	
	1992	<u>After 6/92</u>	ST-2905	
		<u>Before 6/92</u>	ST-2904	
				ST-1965
		<u>Lower Spring Isolator</u>	ST-6944	
	1991		ST-2904	ST-1965
318TI	1995-99		ST-2905	ST-1965
		<u>Lower Spring Isolator</u>	ST-6944	
320I	2001-05		ST-3918	
	1993-95		ST-2905	ST-1965

## Suspension Strut Mounts

Model	Years	Location/ Options	Front	Rear
<b>BMW PASSENGER CAR (continued)</b>				
320I	1993-95	Lower Spring Isolator	ST-6944	
	1977-83	exc HD Suspension	ST-2903	
323CI	2000		ST-3918	ST-4966
323I	1999-00	Lower Spring Isolator	ST-3918	
	1998	Lower Spring Isolator	ST-2905	ST-1965
323IS	1998-99	Lower Spring Isolator	ST-6944	
		Lower Spring Isolator	ST-2905	ST-1965
325	1987-88		ST-2904	ST-1965
325CI	2001-06	Upper Spring Isolator: RWD	ST-3918	ST-4966
		Upper Spring Seat: RWD	ST-7974	
		Lower Spring Isolator: RWD	ST-7973	
325E	1984-87		ST-2904	ST-1965
325ES	1986-87		ST-2904	ST-1965
325I	2001-06	Upper Spring Isolator: RWD	ST-3918	ST-4966
		Upper Spring Seat: RWD	ST-7974	
			ST-7973	
	1992-95	Lower Spring Isolator	ST-2905	ST-1965
	1991	after 12/90 exc Sport Suspension	ST-6944	
		before 12/90 w/ Sport Suspension	ST-2905	
	1987-90		ST-2904	ST-1965
325IC	1993-95		ST-2905	ST-1965
	1987-92		ST-2904	ST-1965
325IS	1992-95	Lower Spring Isolator	ST-2905	ST-1965
			ST-6944	
	1991	after 12/90 exc Sport Suspension	ST-2905	
		before 12/90 w/ Sport Suspension	ST-2904	
	1987-90		ST-2904	ST-1965
325IX	1988-91	E30 w/ 4WD		ST-1965
325XI	2001-06		ST-3918	ST-4966
328CI	2000		ST-3918	ST-4966
328I	2007-13	exc Sport Suspension	ST-3918	
		Lower Spring Isolator; exc. Sport Suspension	ST-7967	
		Upper; exc. Elec. Suspension	ST-7984	
		Lower; exc. Elec. Suspension		ST-7985
	1999-00		ST-3918	ST-1965
1996-98			ST-2905	ST-1965
	Lower Spring Isolator	ST-6944		
328IC	1996-98		ST-2905	ST-1965
328IS	1996-98		ST-2905	ST-1965
		Lower Spring Isolator	ST-6944	
330I	2001-06		ST-3918	
330CI	2001-06		ST-3918	
335I	2007-13	exc Sport Suspension	ST-3918	
		Lower Spring Isolator; exc. Sport Suspension	ST-7967	
		Upper; exc. Elec. Suspension	ST-7984	
		Lower; exc. Elec. Suspension		ST-7985
525XI	2006-07			ST-9908
525I	2004-07			ST-9908
	2001-03	Sedan	ST-3918	
		Wagon		ST-3921
	1989-95		ST-2904	ST-3915

## Suspension Strut Mounts

Model	Years	Location/ Options	Front	Rear
<b>BMW PASSENGER CAR (continued)</b>				
525iT	1993	exc elec adj suspension	ST-2904	ST-3915
528E	1982-88		ST-2904	
528i	2008-10			ST-9908
	1999-00	Exc Elec Adj Suspension	ST-3918	
		Sedan, exc Active Suspension Wagon; exc. Electronic Suspension		ST-3921 ST-10009
	1998	Exc Elec Adj Suspension	ST-3918	
		Sedan, exc Active Suspension		ST-3921
1996	Exc Elec Adj Suspension	ST-3918	ST-3921	
528XI	2008			ST-9908
530i	2001-03	exc elec adj suspension	ST-3918	ST-3921
	1994-95	exc elec adj suspension	ST-2904	ST-3915
530XI	2006-07			ST-9908
533i	1983-84		ST-2904	
535i	1988-93	Exc Elec Adj Suspension	ST-2904	ST-3915
	1985-87		ST-2904	
535i GT	2011-17			ST-9908
535i XDRIVE	2011-15			ST-9908
535iS	1988	exc M5 or elec adj suspension	ST-2904	ST-3915
535XI	2008			ST-9908
540i	1999-03	exc elec adj suspension	ST-3919	
		Sedan, exc Active Suspension Wagon; exc. Electronic Suspension		ST-3921 ST-10008
		exc elec adj suspension	ST-3919	ST-3921
	1994-95	E34 exc Sport Suspension	ST-2904	ST-3915
545i	2004-06			ST-9908
550i	2006-10			ST-9908
550i GT	2010-15			ST-9908
635CSI	1985-89	exc elec adj suspension	ST-2904	
645Ci	2004-05			ST-9908
650i	2006-08		ST-3918	ST-9908
735i	1986-92	exc elec adj suspension		ST-2956
735iL	1988-92	exc elec adj suspension		ST-2956
740i	1997-01	exc elec adj suspension	ST-3922	ST-3920
		Lower Spring Isolator	ST-6953	
	1995	exc elec adj suspension	ST-3922	ST-3920
		Lower Spring Isolator	ST-6953	
	1993-94	E38 exc elec adj susp	ST-3922	ST-3920
E32 exc elec adj susp			ST-2956	
740iL	1995-01	exc elec adj suspension	ST-3922	ST-3920
		Lower Spring Isolator	ST-6953	
	1993-94	E38 exc elec adj susp	ST-3922	ST-3920
E32 exc elec adj susp			ST-2956	
750iL	1994-01	exc elec adj suspension	ST-3922	
		Lower Spring Isolator	ST-6953	
		exc Sport Suspension	ST-3918	
M3	2008-13	Lower Spring Isolator; exc. Sport Suspension	ST-7967	
		Upper; exc. Elec. Suspension	ST-7984	
		Lower; exc. Elec. Suspension		ST-7985
				ST-4966
	2001-05	Left Side	ST-3917	
		Right Side	ST-3916	
1988-91		ST-2904	ST-1965	
M5	2000-03		ST-3919	ST-3920
	1991-93		ST-2904	
	1988		ST-2904	
Z3	1996-02	exc sport suspension	ST-2905	ST-1965
Z4	2003-06	exc M Series	ST-5905	

## Suspension Strut Mounts

Model	Years	Location/ Options	Front	Rear	
<b>BMW SPORT UTILITY</b>					
X1	2016-18	Bushing Kit Bushing Kit		ST-8911	
X3	2004-10	Stud Plate Only	ST-3918	ST-8992	
X5	2007-13	Exc. M Model	ST-10000		
	2006		ST-3914		
	2000-05		ST-3914	ST-3923	
X6	2008-14	Exc. M Model	ST-10000		
<b>BUICK PASSENGER CAR</b>					
ALLURE	2005-09	Left Side	ST-2973	ST-2969	
		Right Side		ST-2968	
CASCADA	2016-19		ST-10004		
CENTURY	1997-05	Left Side	ST-2973	ST-2969	
		Right Side	ST-2973	ST-2968	
		Upper Spring Isolator	ST-4942		
		Lower Spring Isolator	ST-4943	ST-4941	
	1984-96		ST-1934	ST-1951	
		Upper Spring Seat & Isolator	ST-3971		
1982-83		ST-1934			
ELECTRA	1985-90	Bearing Only	ST-1928		
		Upper Spring Seat & Isolator	ST-3974		
		Lower Spring Isolator	ST-4923		
				ST-1953	
LACROSSE	2010-13	Exc Elec Adj Suspension		ST-7989	
			ST-7987	ST-7988	
	2005-09	exc w/ 17" or 18" wheels	ST-2973		
		Left Side, exc w/ 17" or 18" wheels		ST-2969	
		Right Side, exc w/ 17" or 18" wheels		ST-2968	
LESABRE	2000-05		ST-2972	ST-2998	
	1991-99	late Design w/o Spring guard	ST-1922	ST-1953	
		Upper Spring Seat & Isolator	ST-3973		
		Lower Spring Isolator	ST-4925		
		1990	early Design w/ Spring guard	ST-1973	
			late Design w/o Spring guard	ST-1922	
					ST-1953
			Bearing Only	ST-1928	
	Upper Spr Seat & Iso w/o Spr Guard exc Auto Level	ST-3973			
	Upper Spr Seat & Iso w/o Spr Guard w/ Auto Level	ST-3972			
	Upper Spr Seat & Isolator w/ Spring GUARD	ST-3974			
	Lower Spring Isolator; w/ Spring Guard	ST-4923			
	Lower Spring Isolator; w/o Spring Guard	ST-4925			
	1986-89		ST-1973	ST-1953	
Bearing Only		ST-1928			
Upper Spring Seat & Isolator		ST-3974			
Lower Spring Isolator		ST-4923			
LUCERNE	2006-11		ST-8948	ST-2998	
		Lower Spring Isolator	ST-9901		
PARK AVENUE	1998-05	exc elec adj suspension	ST-2972	ST-2998	
	1997	exc elec adj suspension	ST-2930	ST-2998	
	1991-96		ST-1922	ST-1953	
		Bearing Only	ST-1928		
		Upper Spring Seat & Isolator	ST-3973		
	Lower Spring Isolator	ST-4925			
REATA	1990-91		ST-2965	ST-2971	

## Suspension Strut Mounts

Model	Years	Location/ Options	Front	Rear
<b>BUICK PASSENGER CAR (continued)</b>				
REATA	1988-89		ST-1990	ST-2971
REGAL	2011-13	exc Active Suspension	ST-7991	
		Exc. Active Suspension; Left Side		ST-8924
		Exc. Active Suspension; Right Side		ST-8925
	1997-04	Left Side; w/ FWD	ST-2973	ST-2969
		Right Side; w/ FWD	ST-2973	ST-2968
		Upper Spring Isolator	ST-4942	
		Lower Spring Isolator	ST-4943	ST-4941
	1988-96	w/ FWD	ST-1921	ST-2941
		Lower Spring Seat & Bearing; Left Side; w/ FWD	ST-2994	
		Lower Spring Seat & Bearing; Ride Side; w/ FWD	ST-2995	
RIVIERA	1998-99		ST-2972	ST-2998
	1995-97		ST-2930	ST-2998
		Upper Spring Seat & Isolator	ST-3973	
	1990-93		ST-2965	ST-2971
SKYHAWK	1986-89		ST-1990	ST-2971
			ST-1913	ST-1951
	1984-89	Upper Spring Seat & Isolator	ST-3969	
		Lower Spring Isolator	ST-4924	
	1983		ST-1913	
		Upper Spring Seat & Isolator	ST-3969	
	1982	Lower Spring Isolator	ST-4924	
			ST-1913	
SKYLARK	1995-98	exc elec suspension	ST-4912	ST-1951
		Upper Spring Seat & Isolator	ST-3970	
	1992-94		ST-1946	ST-1951
		Upper Spring Seat & Isolator	ST-3972	
	1986-91		ST-1913	ST-1951
		Upper Spring Seat & Isolator	ST-3969	
	1984-85	Lower Spring Isolator	ST-4924	
Upper Spring Seat & Isolator		ST-1934	ST-1951	
SOMERSET	1985-87		ST-3971	
			ST-1934	
			ST-1913	ST-1951
VERANO	2012-17	Upper Spring Seat & Isolator	ST-3969	
		Lower Spring Isolator	ST-4924	
			ST-10004	
<b>BUICK SPORT UTILITY</b>				
ENCLAVE	2008-16		ST-7986	
		Upper Spring Isolator	ST-9923	
		Lower Spring Isolator	ST-9924	
ENCORE	2013-19		ST-10004	
RAINIER	2004-07		ST-4968	
RENDEZVOUS	2002-07		ST-2973	
		Upper Spring Isolator	ST-4942	
		Lower Spring Isolator	ST-4943	
<b>BUICK VAN</b>				
TERRAZA	2005-07		ST-2973	
		Upper Spring Isolator	ST-4942	
		Lower Spring Isolator	ST-4943	



## Suspension Strut Mounts

Model	Years	Location/ Options	Front	Rear
<b>CADILLAC PASSENGER CAR</b>				
ALLANTE	1987-92	exc elec suspension	ST-2965	ST-2971
ATS	2016			ST-9910
				ST-9911
	2013-15		ST-9909	ST-9910
CTS	2014-16	w/o Electronic Suspension	ST-9909	
	2003	FE3 (Soft Ride Suspension)		ST-8991
CATERA	1997-01		ST-3932	
CIMARRON	1984-88		ST-1913	ST-1951
		Upper Spring Seat & Isolator	ST-3969	
		Lower Spring Isolator	ST-4924	
	1983		ST-1913	
		Upper Spring Seat & Isolator	ST-3969	
		Lower Spring Isolator	ST-4924	
1982		ST-1913		
	Upper Spring Seat & Isolator	ST-3969		
DTS	2006-11		ST-8948	ST-2998
		Lower Spring Isolator	ST-9901	
DEVILLE	2000-05		ST-2972	ST-2998
	1994-99		ST-2965	ST-3929
	1991-93	w/ FWD	ST-1922	ST-1953
		Bearing Only	ST-1928	
		w/ FWD - Upper Spring Seat & Isolator	ST-3973	
		w/ FWD & CCR - Lower Spring Isolator	ST-4925	
	1987-90	w/ FWD	ST-1973	ST-1953
		Bearing Only	ST-1928	
		w/ FWD - Upper Spring Seat & Isolator	ST-3974	
		Lower Spring Isolator; w/ FWD	ST-4923	
1985-86	w/ FWD	ST-1991	ST-1953	
	Lower Spring Isolator; w/ FWD	ST-4923		
ELDORADO	1994-02		ST-2965	ST-3929
		Bearing Only	ST-1928	
	1987-93		ST-2965	ST-2971
		Bearing Only	ST-1928	
1986		ST-1990	ST-2971	
ELR	2014-16	REAR		
FLEETWOOD	1991-93		ST-1922	ST-1953
		Bearing Only	ST-1928	
		w/o CCR - Upper Spring Seat & Isolator	ST-3973	
		w/o CCR - Lower Spring Isolator	ST-4925	
	1987-90	FWD	ST-1973	ST-1953
		w/ FWD - Upper Spring Seat & Isolator	ST-3974	
		Lower Spring Isolator; w/ FWD	ST-4923	
	1985-86	w/ FWD	ST-1991	ST-1953
		w/ FWD - Upper Spring Seat & Isolator	ST-3974	
		Lower Spring Isolator; w/ FWD	ST-4923	
SEVILLE	1998-04	Exc Elec Adj Suspension	ST-2972	ST-2998
	1994-97		ST-3930	ST-3929
		Bearing Only	ST-1928	
	1987-93		ST-2965	ST-2971
		Bearing Only	ST-1928	
1986		ST-1990	ST-2971	

## Suspension Strut Mounts

Model	Years	Location/ Options	Front	Rear
<b>CADILLAC SPORT UTILITY</b>				
ESCALADE	2007-14	2WD & 4WD, exc Z55 and ZW7 Suspension Upper Spring Isolator	ST-5910 ST-7942	
ESCALADE ESV	2007-14	2WD & 4WD, exc Z55 and ZW7 Suspension Upper Spring Isolator	ST-5910 ST-7942	
ESCALADE EXT	2007-13	2WD & 4WD, exc Z55 and ZW7 Suspension Upper Spring Isolator	ST-5910 ST-7942	
<b>CHEVROLET PASSENGER CAR</b>				
AVEO5	2007-08		ST-5906	ST-5981
AVEO	2004-11		ST-5906	ST-5981
ASTRA (MEXICO)	2000-08		ST-98005	
BERETTA	1995-96		ST-4912	ST-1951
		Upper Spring Seat & Isolator	ST-3970	
	1992-94		ST-1946	ST-1951
		Upper Spring Seat & Isolator	ST-3972	
1987-91		ST-1929	ST-1951	
	Upper Spring Seat & Isolator Lower Spring Isolator	ST-3969 ST-4924		
CAMARO	2010-13	exc Active Suspension	ST-7991	ST-7992
	1993-02	Left Side	ST-2947	
		Right Side	ST-2948	
		Upper Spring Isolator Lower Spring Seat	ST-3933 ST-4962	
	1982-92	Left Side	ST-1924	
Right Side		ST-1923		
CAPRICE	2011-13			ST-7992
CAVALIER	2000-05		ST-4919	ST-2949
		Upper Spring Isolator	ST-4939	
		Lower Spring Isolator	ST-4940	
	1995-99		ST-4912	ST-2949
		Upper Spring Isolator Lower Spring Isolator	ST-4939 ST-4940	
	1992-94		ST-1929	ST-1951
		Upper Spring Seat & Isolator	ST-3969	
	1984-91		ST-1913	ST-1951
		Upper Spring Seat & Isolator Lower Spring Isolator	ST-3969 ST-4924	
	1983		ST-1913	
Upper Spring Seat & Isolator Lower Spring Isolator		ST-3969 ST-4924		
1982		ST-1913		
	Upper Spring Seat & Isolator	ST-3969		
CELEBRITY	1984-90		ST-1934	ST-1951
		Upper Spring Seat & Isolator	ST-3971	
	1982-83		ST-1934	
CHEVY (MEXICO)	1994-12		ST-98003	
CITATION	1984-85		ST-1934	ST-1951
		Upper Spring Seat & Isolator	ST-3971	
	1982-83		ST-1934	
CLASSIC	2004-05		ST-2999	ST-3900
		Upper Spring Isolator Lower Spring Isolator	ST-4944 ST-4945	
COBALT	2005-10		ST-5907	
		Upper Spring Isolator	ST-7909	
		Upper Spring Seat	ST-7908	
		Lower Spring Isolator	ST-7910	
CORSA (MEXICO)	2002-08		ST-98005	
CORSICA	1995-96		ST-4912	ST-1951

## Suspension Strut Mounts

Model	Years	Location/ Options	Front	Rear
<b>CHEVROLET PASSENGER CAR (continued)</b>				
CORSICA	1995-96	Upper Spring Seat & Isolator	ST-3970	
	1994		ST-1946	ST-1951
		Upper Spring Seat & Isolator	ST-3970	
	1992-93		ST-1946	ST-1951
		Upper Spring Seat & Isolator	ST-3972	
1987-91		ST-1929	ST-1951	
	Upper Spring Seat & Isolator	ST-3969		
	Lower Spring Isolator	ST-4924		
CRUZE	2011-15		ST-10004	
CRUZE LIMITED	2016		ST-10004	
HHR	2006-11		ST-5907	
IMPALA	2014	Left Side; Police		ST-2969
		Right Side; Police		ST-2968
	2000-13	Left Side, exc w/ 17" or 18" wheels	ST-2973	ST-2969
		Right Side, exc w/ 17" or 18" wheels	ST-2973	ST-2968
		Upper Spr Iso, exc w/ 17" or 18" wheels	ST-4942	
		Lower Spr Iso, exc w/ 17" or 18" wheels	ST-4943	
Lower Spr Iso, exc 17" or 18" whl, Police or Taxi		ST-4941		
LUMINA	1995-01	Left Side	ST-1921	ST-2969
		Right Side	ST-1921	ST-2968
		Lower Spring Seat & Bearing - Left Side	ST-2994	
		Lower Spring Seat & Bearing - Right Side	ST-2995	
	1990-94		ST-1921	ST-2941
		Lower Spring Seat & Bearing - Left Side	ST-2994	
		Lower Spring Seat & Bearing - Right Side	ST-2995	
MALIBU	2013		ST-7987	
	2008-12	Left Side	ST-5909	
		Right Side	ST-5908	
				ST-7990
	2004-07	Left Side	ST-5909	
		Right Side	ST-5908	
		Hatchback		ST-7990
	1997-03		ST-2999	ST-3900
		Upper Spring Isolator	ST-4944	
	Lower Spring Isolator	ST-4945		
MERIVA (MEXICO)	2004-08		ST-98005	
METRO	1998-01		ST-1987	ST-1988
MONTE CARLO	2000-07	Left Side, exc w/ 17" or 18" wheels	ST-2973	ST-2969
		Right Side, exc w/ 17" or 18" wheels	ST-2973	ST-2968
		Upper Spr Iso, exc w/ 17" or 18" wheels	ST-4942	
		Lower Spr Iso, exc w/ 17" or 18" wheels	ST-4943	ST-4941
	1995-99	Left Side	ST-1921	ST-2969
		Right Side	ST-1921	ST-2968
		Lower Spring Seat & Bearing - Left Side	ST-2994	
		Lower Spring Seat & Bearing - Right Side	ST-2995	
NOVA	1985-88	exc twin cam engine	ST-1943	ST-1958
PRIZM	1998-02		ST-5912	ST-2901
SPARK	2015-16	REAR		
SPECTRUM	1985-88		ST-1932	
SPRINT	1989-91		ST-1987	ST-1988
	1985-88		ST-2933	
VECTRA (MEXICAN VEH	2003-08		ST-98005	
VOLT	2011-15		ST-10004	

## Suspension Strut Mounts

Model	Years	Location/ Options	Front	Rear
<b>CHEVROLET SPORT UTILITY</b>				
AVALANCHE	2007-13	2WD & 4WD, exc Z55 and ZW7 Suspension Upper Spring Isolator	ST-5910 ST-7942	
CAPTIVA SPORT	2012-15		ST-6956	
EQUINOX	2007-17		ST-6956	
	2005-06	Upper Spring Isolator	ST-5980 ST-8954	
BLAZER	1988-99	Torsion Bar Mount; w/ 4WD	ST-2992	
S10 BLAZER	1988-94	Torsion Bar Mount; w/ 4WD	ST-2992	
SUBURBAN 1500	2007-13	2WD & 4WD, exc Z55 and ZW7 Suspension	ST-5910	
		Upper Spring Isolator	ST-7942	
TAHOE	2007-13	2WD & 4WD, exc Z55 and ZW7 Suspension Upper Spring Isolator	ST-5910 ST-7942	
TRACKER	1999-04	L4 2.0L & V6 2.5L,*	ST-4932	
	1999-02	L4 1.6L,*	ST-4933	
	1998		ST-1994	
	1989-91	exc ABS Brakes	ST-1994	
TRAILBLAZER	2002-09	2WD & 4WD	ST-4968	
TRAILBLAZER EXT	2002-06	2WD & 4WD	ST-4968	
TRAVERSE	2009-16		ST-7986	
		Upper Spring Isolator Lower Spring Isolator	ST-9923 ST-9924	
TRAX	2013-19		ST-10004	
<b>CHEVROLET TRUCK</b>				
COLORADO	2004-12	RWD	ST-9921	
S10 PICKUP	1988-99	Torsion Bar Mount; w/ 4WD	ST-2992	
SILVERADO 1500	2007-13	2WD & 4WD, exc Z55 and ZW7 Suspension	ST-5910	
		Upper Spring Isolator	ST-7942	
SSR	2004-06	w/ Rear Coil Spring Suspension	ST-4968	
TORNADO (MEXICO)	2004-11	L4 1.8L 1796cc,*	ST-98005	
<b>CHEVROLET VAN</b>				
LUMINA APV	1990-96		ST-1934	ST-1951
		Upper Spring Seat & Isolator	ST-3971	
UPLANDER	2005-09		ST-2973	
		Upper Spring Isolator	ST-4942	
		Lower Spring Isolator	ST-4943	
VENTURE	1997-05		ST-2973	
		Upper Spring Isolator	ST-4942	
		Lower Spring Isolator	ST-4943	
ZAFIRA (MEXICAN VEHI	2002-06		ST-98005	
<b>CHRYSLER PASSENGER CAR</b>				
200	2011-14		ST-6958	ST-6959
		Upper Spring Isolator		ST-8943
300	2011-14	Lower Spring Isolator	ST-5968	
		RWD	ST-6995	ST-8972
		Stud Plate Only	ST-5966	ST-8943
		AWD	ST-5967	
	2005-10	exc. NIVOMAT Rear Suspension	ST-5968	
		RWD	ST-6995	ST-5970
300M	1999-04	w/ NIVOMAT Rear Suspension	ST-5966	
		AWD	ST-5967	ST-5969
		Upper Spring Isolator	ST-3901	ST-3902
CIRRUS	1995-00	Upper Spring Isolator	ST-5989	ST-5973
		Lower Spring Isolator	ST-5988	ST-5982
CONCORDE	1998-04		ST-1940	ST-2946
			ST-3901	ST-3902

## Suspension Strut Mounts

Model	Years	Location/ Options	Front	Rear
<b>CHRYSLER PASSENGER CAR (continued)</b>				
CONCORDE	1998-04	Upper Spring Isolator	ST-5989	ST-5973
		Lower Spring Isolator	ST-5988	ST-5982
	1993-97	Upper Spring Seat	ST-3977	ST-1978
		Lower Spring Isolator	ST-5954	ST-5955
CONQUEST	1987-89	exc adj suspension	ST-2961	ST-2962
DAYTONA	1989-93	Upper Spring Seat & Isolator	ST-1908	
		Lower Spring Isolator	ST-4916	
		Lower Spring Isolator	ST-3980	
	1987-88	Upper Spring Seat & Isolator	ST-1908	
		Lower Spring Isolator	ST-4916	
	1986	after JAN 1	ST-3980	
		before JAN 1	ST-1908	
		after JAN 1, Upper Spring Seat	ST-1907	
		after JAN 1, Lower Spring Isolator	ST-4916	
	1984-85		ST-3980	
1984-85		ST-1907		
DYNASTY	1988-93	Upper Spring Seat & Isolator	ST-1908	
		Lower Spring Isolator	ST-4916	
		Lower Spring Isolator	ST-3980	
E CLASS	1984		ST-1907	
	1983		ST-1906	
EXECUTIVE LIMOUSINE	1985		ST-1907	
EXECUTIVE SEDAN	1984		ST-1907	
	1983		ST-1906	
IMPERIAL	1990-93	exc full air suspension	ST-1908	
		Upper Spring Seat & Isolator	ST-4916	
		Lower Spring Isolator	ST-3980	
INTREPID	1998-04	Upper Spring Isolator	ST-3901	ST-3902
		Lower Spring Isolator	ST-5989	ST-5973
		Lower Spring Isolator	ST-5988	ST-5982
	1993-97	Upper Spring Seat	ST-1980	ST-1978
		Upper Spring Seat	ST-3977	
		Upper Spring Seat	ST-3977	
LASER	1986	after JAN 1	ST-1908	
		before JAN 1	ST-1907	
		after JAN 1, Upper Spring Seat & Isolator	ST-4916	
		after Jan 1, Lower Spring Isolator	ST-3980	
	1984-85		ST-1907	
LEBARON	1987-95	exc elec suspension	ST-1908	
		Upper Spring Seat & Isolator	ST-4916	
		Lower Spring Isolator	ST-3980	
	1986	after JAN 1	ST-1908	
		before JAN 1	ST-1907	
	1984-85		ST-1907	
	1983		ST-1906	
1982		ST-1905		
LHS	1999-01	Upper Spring Isolator	ST-3901	ST-3902
		Lower Spring Isolator	ST-5989	ST-5973
		Lower Spring Isolator	ST-5988	ST-5982
	1994-97	Upper Spring Seat	ST-1980	ST-1978
		Upper Spring Seat	ST-3977	
NEON	2000-02	Lower Spring Isolator	ST-3926	ST-3924
NEW YORKER	1994-96	Lower Spring Isolator	ST-5992	
		Lower Spring Isolator	ST-1980	ST-1978
	1988-93	Upper Spring Seat	ST-3977	
		Upper Spring Seat	ST-1908	
		Upper Spring Seat & Isolator	ST-4916	
Lower Spring Isolator	ST-3980			

## Suspension Strut Mounts

Model	Years	Location/ Options	Front	Rear
<b>CHRYSLER PASSENGER CAR (continued)</b>				
NEW YORKER	1987	Upper Spring Seat & Isolator	ST-1908	
			ST-4916	
	1986	after JAN 1	ST-1908	
		before JAN 1	ST-1907	
	1984-85	after JAN 1, Upper Spring Seat & Isolator	ST-4916	
1983		ST-1907		
PT CRUISER	2001-09		ST-1906	
SEBRING	2007-10		ST-3926	
			ST-6958	ST-6959
Stud Plate Only			ST-8972	
	2006	Upper Spring Isolator		ST-8943
		Sedan & Convertible	ST-1940	
		Sedan & Convertible; Bushing Kit		ST-1940
		Sedan & Convertible	ST-1940	ST-1940
		Convertible		ST-6955
		Sedan		ST-6917
		Upper Spring Isolator		ST-7993
		Lower Spring Isolator; Conv. & Sedan		ST-7911
		Lower Spring Isolator; Conv. & Sedan		ST-7911
		2001-05	Coupe	ST-4957
	Sedan & Convertible		ST-1940	
	Sedan & Convertible; Bushing Kit			ST-1940
	Bushing Kit; Coupe			ST-2923
	Convertible			ST-6955
	Sedan			ST-6917
	Stud Plate Only; Coupe			ST-9947
	Lower Spring Isolator; Coupe		ST-6938	
	Upper Spring Isolator; Convertible & Sedan			ST-7993
	Upper Spring Isolator; Coupe			ST-9969
	Lower Spring Isolator; Conv. & Sedan		ST-7911	
	1996-00	Convertible	ST-1940	
		Convertible; Bushing Kit		ST-6957
		Convertible; Stud Plate Only		ST-7912
		Upper Spring Isolator; Convertible		ST-7913
	1995-00	Coupe	ST-2923	ST-2923
		Upper Spring Isolator; Coupe		ST-7993
TC MASERATI	1989-91		ST-1908	
		Upper Spring Seat & Isolator	ST-4916	
		Lower Spring Isolator	ST-3980	
<b>CHRYSLER SUV</b>				
PACIFICA	2004-08		ST-5911	
		Upper Spring Isolator	ST-8960	
		Upper Spring Seat	ST-8959	
		Lower Spring Isolator	ST-8958	
<b>CHRYSLER VAN</b>				
GRAND VOYAGER	2000	Upper Spring Seat	ST-2945	
			ST-3975	
		Lower Spring Isolator	ST-4921	
TOWN & COUNTRY	2008-15	exc. NIVOMAT Rear Suspension	ST-6960	
	2001-07		ST-5911	
		Upper Spring Isolator	ST-5972	
		Lower Spring Isolator	ST-5971	
	1996-00		ST-2945	
		Upper Spring Seat	ST-3975	
		Lower Spring Isolator	ST-4921	
1995	after MAR 1		ST-2945	
	before MAR 1		ST-1908	

## Suspension Strut Mounts

Model	Years	Location/ Options	Front	Rear
<b>CHRYSLER VAN (continued)</b>				
TOWN & COUNTRY	1995	after MAR 1, Upper Spring Seat & Isolator	ST-3975	
		before MAR 1, Upper Spring Seat & Isolator	ST-4916	
		after MAR 1, Lower Spring Isolator	ST-4921	
		before MAR 1, Lower Spring Isolator	ST-3980	
	1990-94	Upper Spring Seat & Isolator	ST-1908	
		Lower Spring Isolator	ST-4916	
VOYAGER	2001-03		ST-5911	
		Upper Spring Isolator	ST-5972	
		Lower Spring Isolator	ST-5971	
	2000		ST-2945	
		Upper Spring Seat	ST-3975	
		Lower Spring Isolator	ST-4921	
<b>DAIHATSU PASSENGER CAR</b>				
CHARADE	1988-92			ST-3939
<b>DODGE PASSENGER CAR</b>				
400	1983		ST-1906	
	1982		ST-1905	
600	1987-88		ST-1908	
		Upper Spring Seat & Isolator	ST-4916	
		Lower Spring Isolator	ST-3980	
			ST-1908	
	1986	after JAN 1	ST-1907	
		before JAN 1	ST-4916	
		after JAN 1, Upper Spring Seat & Isolator	ST-3980	
	1984-85		ST-1907	
1983		ST-1906		
2000 GTX	1989-90	exc Auto leveling system		ST-2923
ARIES	1987-89		ST-1908	
		Upper Spring Seat & Isolator	ST-4916	
		Lower Spring Isolator	ST-3980	
			ST-1908	
	1986	after 1/86	ST-1907	
		before 1/86	ST-4916	
		after 1/86, Upper Spring Seat & Isolator	ST-3980	
	1984-85		ST-1907	
1983		ST-1906		
1981-82		ST-1905		
ATOS (MEXICAN VEHICL	2005-10		ST-98004	
AVENGER	2008-14	Stud Plate Only	ST-6958	ST-6959
		Upper Spring Isolator		ST-8972
	1995-00		ST-2923	ST-8943
		Upper Spring Isolator		ST-2923
CALIBER	2007-12		ST-7994	
		Bushing Kit		ST-6959
		Stud Plate Only		ST-8972
		Upper Spring Isolator	ST-8970	ST-8973
		Upper Spring Seat	ST-8969	
		Lower Spring Isolator	ST-8971	
CHALLENGER	2011-14	w/o Electronic Suspension	ST-5966	ST-5970
		Lower Spring Isolator	ST-6995	
	2008-10		ST-5966	
		Exc. High Performance Suspension		ST-5969
		w/ High Performance Suspension		ST-5970
	1981-83	Lower Spring Isolator	ST-6995	
		ST-2963		

## Suspension Strut Mounts

Model	Years	Location/ Options	Front	Rear
<b>DODGE PASSENGER CAR (continued)</b>				
CHALLENGER	1978-80		ST-1992	
CHARGER	2011-14	RWD	ST-5968	
		RWD	ST-5966	
		AWD	ST-5967	
	2007-10	exc. NIVOMAT Rear Suspension	ST-5968	
		RWD	ST-6995	ST-5970
		w/ NIVOMAT Rear Suspension	ST-5966	
		AWD	ST-5967	ST-5969
	2006	RWD	ST-5966	
				ST-5969
	1983-87	Lower Spring Isolator	ST-6995	
		ST-1905		
			ST-1952	
COLT	1993-95		ST-2958	ST-2923
	1991-92	Hatchback	ST-1977	ST-2923
	1989-90	Hatchback	ST-1977	ST-2923
		Wagon	ST-2918	
	1987-88		ST-2918	
	1985-86	L4 1.5L 1468cc;w/o Turbo	ST-2917	
		L4 2.0L 1997cc;w/o Turbo	ST-2917	
	1984		ST-1937	
	1981-83		ST-1937	
	1979-80	Hatchback	ST-1937	
		Sedan & Coupe	ST-1937	
		Wagon	ST-1992	
	1977-78	Sedan & Coupe	ST-1937	
Wagon		ST-1992		
1971-76	Sedan & Coupe	ST-1992		
	Wagon	ST-1992		
CONQUEST	1984-86	exc adj suspension	ST-2961	ST-2962
DART	2013-16	Upper Spring Isolator	ST-9988	
		Lower Spring Isolator	ST-9989	
DAYTONA	1987-93	exc IROC & IROC RT	ST-1908	
		exc IROC & IROC RT, Upper Spr Seat & Isolator	ST-4916	
		exc IROC & IROC RT, Lower Spring Isolator	ST-3980	
	1986	after 1/86	ST-1908	
		before 1/86	ST-1907	
		after 1/86, Upper Spring Seat & Isolator	ST-4916	
	after 1/86, Lower Spring Isolator	ST-3980		
1984-85		ST-1907		
DYNASTY	1988-93		ST-1908	
		Upper Spring Seat & Isolator	ST-4916	
		Lower Spring Isolator	ST-3980	
INTREPID	1998-04		ST-3901	ST-3902
		Upper Spring Isolator	ST-5989	ST-5973
		Lower Spring Isolator	ST-5988	ST-5982
	1993-97		ST-1980	ST-1978
		Upper Spring Seat	ST-3977	
	Lower Spring Isolator	ST-5954	ST-5955	
LANCER	1987-89		ST-1908	
		Upper Spring Seat & Isolator	ST-4916	
		Lower Spring Isolator	ST-3980	
	1986	after 1/86	ST-1908	
		before 1/86	ST-1907	
		after 1/86, Upper Spring Seat & Isolator	ST-4916	
		after 1/86, Lower Spring Isolator	ST-3980	
1985		ST-1907		



## Suspension Strut Mounts

Model	Years	Location/ Options	Front	Rear
<b>DODGE PASSENGER CAR (continued)</b>				
MAGNUM	2005-08	exc. NIVOMAT Rear Suspension	ST-5968	
		RWD	ST-6995	ST-5970
		w/ NIVOMAT Rear Suspension	ST-5966	
		AWD	ST-5967	ST-5969
MONACO	1990-92	w/ FWD	ST-2929	
NEON	2000-05		ST-3926	ST-3924
		Upper Spring Seat & Isolator	ST-4956	
		Lower Spring Isolator	ST-5992	
	1995-99		ST-2907	ST-2908
		Upper Spring Seat & Isolator	ST-3976	
		Lower Spring Isolator		ST-4948
OMNI	1978-90		ST-1905	
		exc GLH 4 Door		ST-1952
SHADOW	1987-94		ST-1908	
		Upper Spring Seat & Isolator	ST-4916	
		Lower Spring Isolator	ST-3980	
SPIRIT	1989-95		ST-1908	
		Upper Spring Seat & Isolator	ST-4916	
		Lower Spring Isolator	ST-3980	
STEALTH	1991-96	w/o Electronic Suspension	ST-2955	ST-2923
STRATUS	2006	Sedan	ST-1940	ST-6917
		Sedan; Bushing Kit		ST-1940
		Upper Spring Isolator; Sedan		ST-7993
		Lower Spring Isolator; Conv. & Sedan		ST-7911
	2001-05	Coupe	ST-4957	ST-2923
		Sedan	ST-1940	ST-6917
		Sedan; Bushing Kit		ST-1940
		Stud Plate Only; Coupe		ST-9947
		Lower Spring Isolator; Coupe	ST-6938	
		Upper Spring Isolator; Convertible & Sedan		ST-7993
		Upper Spring Isolator; Coupe		ST-9969
	Lower Spring Isolator; Conv. & Sedan		ST-7911	
1995-00		ST-1940	ST-2946	
<b>DODGE SPORT UTILITY</b>				
DURANGO	2011-15	exc Auto Leveling System		ST-8999
JOURNEY	2009-15		ST-8984	ST-7995
		Stud Plate Only		ST-8972
		Upper Spring Isolator	ST-8983	ST-8943
		Lower Spring Isolator	ST-8971	
NITRO	2007-11	Left Side	ST-5903	
		Right Side	ST-5902	
<b>DODGE TRUCK</b>				
DAKOTA	2009-10			
	2005-09	2WD & 4WD	ST-5913	
RAM 1500 PICKUP	2009-10	4WD	ST-7930	
		Upper Spring Seat; 4WD	ST-7931	
	2006-08	4WD	ST-5914	
RAMPAGE	1982-84		ST-1905	
<b>DODGE VAN</b>				
CARAVAN	2001-07		ST-5911	
		Upper Spring Isolator	ST-5972	
		Lower Spring Isolator	ST-5971	
	1996-00		ST-2945	
		Upper Spring Seat	ST-3975	
		Lower Spring Isolator	ST-4921	
1995	after 3/95	ST-2945		

## Suspension Strut Mounts

Model	Years	Location/ Options	Front	Rear
<b>DODGE VAN (continued)</b>				
CARAVAN	1995	before 3/95	ST-1908	
		after 3/95, Upper Spring Seat	ST-3975	
		before 3/95, Upper Spring Seat & Isolator	ST-4916	
		after 3/95, Lower Spring Isolator	ST-4921	
		before 3/95, Lower Spring Isolator	ST-3980	
	1986-94	Upper Spring Seat	ST-1908	
		Upper Spring Seat & Isolator	ST-2993	
		Lower Spring Isolator	ST-4916	
	1984-85		ST-3980	
			ST-1907	
GRAND CARAVAN	2013-15	exc. NIVOMAT Rear Suspension	ST-6960	
	2008-12	exc. NIVOMAT Rear Suspension	ST-6960	
		Upper Spring Isolator	ST-8982	
		Lower Spring Isolator	ST-8971	
	2001-07		ST-5911	
		Upper Spring Isolator	ST-5972	
		Lower Spring Isolator	ST-5971	
	1996-00		ST-2945	
		Upper Spring Seat	ST-3975	
		Lower Spring Isolator	ST-4921	
	1995	after 3/95	ST-2945	
		before 3/95	ST-1908	
		after 3/95, Upper Spring Seat	ST-3975	
		before 3/95, Upper Spring Seat & Isolator	ST-4916	
		after 3/95, Lower Spring Isolator	ST-4921	
before 3/95, Lower Spring Isolator		ST-3980		
1988-94		ST-1908		
	Upper Spring Seat & Isolator	ST-4916		
	Lower Spring Isolator	ST-3980		
MINI RAM	1986-88		ST-1908	
		Upper Spring Seat & Isolator	ST-4916	
		Lower Spring Isolator	ST-3980	
	1984-85		ST-1907	
<b>EAGLE PASSENGER CAR</b>				
2000 GTX	1991-93	exc Auto leveling system		ST-2923
MEDALLION	1988-89		ST-2929	
PREMIER	1988-92		ST-2929	
SUMMIT	1993-96		ST-2958	ST-2923
	1989-92		ST-1977	ST-2923
TALON	1995-98		ST-2923	
		Bushing Kit		ST-2923
		Stud Plate Only		ST-9947
	Upper Spring Isolator		ST-7993	
	1990-94		ST-2920	ST-2923
VISION	1993-97		ST-1980	ST-1978
		Upper Spring Seat	ST-3977	
		Lower Spring Isolator	ST-5954	ST-5955
VISTA	1989-92	exc Wagon	ST-2918	
<b>FORD PASSENGER CAR</b>				
ASPIRE	1994-97	exc ABS Brakes	ST-2940	ST-2970
CONTOUR	1995-00		ST-2953	ST-2954
CROWN VICTORIA	2003-11	exc. Police Cars	ST-7944	
		Upper Spring Seat; Exc. Police Car	ST-7945	
C-MAX	2013-18		ST-8961	
ESCORT	1997-03	exc ABS Brakes	ST-4913	ST-1963
		exc ABS Brakes, Upper Spring Seat & Isolator	ST-4936	
		exc ABS Brakes, Lower Spring Isolator	ST-4922	

## Suspension Strut Mounts

Model	Years	Location/ Options	Front	Rear
<b>FORD PASSENGER CAR (continued)</b>				
ESCORT	1991-96	Upper Spring Seat & Isolator	ST-2936	ST-1963
		Lower Spring Isolator	ST-3965	ST-4922
				ST-1956
	1986-90	Bearing Only	ST-1927	ST-1956
			ST-1901	
	1985	after 3/85	ST-1927	
before 3/85		ST-1916	ST-1956	
		Bearing Only	ST-1901	
	1981-84		ST-1916	ST-1956
EXP	1986-88		ST-1927	ST-1956
		Bearing Only	ST-1901	
	1985	after 3/85	ST-1927	
		before 3/85	ST-1916	ST-1956
	1982-84		ST-1916	ST-1956
FAIRMONT	1978-83		ST-1925	
FESTIVA	1988-93		ST-2940	ST-2970
FIESTA	2011-18		ST-7996	ST-7997
	2003-10		ST-98001	
	1998-01		ST-98000	
FIESTA IKON (MEXICO)	2002-04		ST-98000	
FIGO (MEXICO)	2016-18		ST-7996	
FIVE HUNDRED	2005-07	FWD		ST-7901
		Upper Spring Isolator, exc AWD		ST-6996
		Upper Spring Isolator; AWD		ST-6997
			ST-5915	
		AWD	ST-7948	ST-7900
		Upper Spring Isolator; AWD		ST-7998
FOCUS	2017-18	REAR		
	2012-16		ST-8961	
	2008-11		ST-8968	
		Sedan & Hatchback, exc SVT		ST-4927
	2006-07	exc SVT	ST-3928	
		Sedan & Hatchback, exc SVT		ST-4927
	2000-05	Sedan & Hatchback, exc SVT	ST-3928	ST-4927
Station Wagon		ST-3928		
		Upper Spring Seat	ST-6932	
FREESTYLE	2005-07	FWD		ST-7901
		Upper Spring Isolator		ST-6998
		Upper Spring Isolator; AWD		ST-6999
			ST-5915	
		AWD	ST-7948	ST-7900
		Upper Spring Isolator; AWD		ST-7998
FUSION	2006-12		ST-5918	
		Upper Spring Seat & Bearing	ST-6961	
		Lower Spring Isolator	ST-9929	
GRAND MARQUIS (MEXI)	2003-04		ST-7944	
		Upper Spring Seat & Isolator	ST-7945	
GRANADA	1981-82		ST-1925	
IKON (MEXICAN VEHICL	2003-07		ST-98000	
KA (MEXICAN VEHICLE)	2001-07		ST-98000	
LTD	1983-86		ST-1925	
MUSTANG	2011-14		ST-9906	
	2005-10		ST-5915	
		Upper Spring Isolator	ST-7948	
	1985-04		ST-1925	
MUSTANG II	1985-04		ST-1925	

## Suspension Strut Mounts

Model	Years	Location/ Options	Front	Rear
<b>FORD PASSENGER CAR (continued)</b>				
POLICE INTERCEPTOR PROBE	2013-19		ST-9916	
	1993-97	Left Side	ST-2922	ST-2952
		Right Side	ST-2922	ST-2951
		Upper Spring Seat	ST-3964	
	1989-92	w/ Auto Trans	ST-1999	ST-1960
w/ Manual Trans exc Programmed Ride Control w/ Man Trans, exc PRC, Upper Spring Seat		ST-2935 ST-3905	ST-1960	
SPECIAL SERVICE POLI TAURUS	2014-18		ST-9916	
	2013-19		ST-9916	
	2012		ST-9915	
	2010-11		ST-6962	
		Upper Spring Isolator	ST-9914	
		Lower Spring Isolator	ST-7999	
	2009		ST-6962	
		Left Side; AWD		ST-7900
		Left Side; w/ FWD		ST-6998
		Right Side; AWD		ST-7901
		Right Side; w/ FWD		ST-6999
		Upper Spring Isolator	ST-9914	
		Lower Spring Isolator	ST-7999	
	2008	Upper Spring Isolator; AWD		ST-7998
			ST-6962	
		Left Side; AWD		ST-7900
		Left Side; w/ FWD		ST-6998
		Right Side; AWD		ST-7901
		Right Side; w/ FWD		ST-6999
		Upper Spring Isolator; From 8/13/08	ST-9914	
	Lower Spring Isolator	ST-7999		
	1996-07	Upper Spring Isolator; AWD		ST-7998
		exc SHO	ST-2944	
exc SHO & Station Wagon			ST-1954	
exc SHO, Upper Spring Seat exc SHO, Lower Spring Isolator		ST-3968 ST-4937	ST-5964	
1986-95		ST-1926		
	exc Station Wagon		ST-1954	
	Bearing Only	ST-1902		
	Upper Spring Seat	ST-3967		
TAURUS X	2008-09	Lower Spring Isolator	ST-5965	
		Upper Spring Isolator; AWD	ST-6962	
		Left Side; AWD		ST-7900
		Left Side; w/ FWD		ST-6998
		Right Side; AWD		ST-7901
		Right Side; w/ FWD		ST-6999
		Upper Spring Isolator	ST-9914	
Lower Spring Isolator	ST-7999			
TEMPO	1984-94	Upper Spring Isolator; AWD		ST-7998
			ST-1927	ST-1955
		Bearing Only	ST-1901	
THUNDERBIRD	1984-94	Upper Spring Isolator		ST-3966
			ST-1927	ST-1955
	2002-05		ST-4972	ST-4972
	1989-97	exc Super Coupe	ST-1970	
		exc Super Coupe, Lower Spring Isolator	ST-4920	
1987-88	exc Turbo Coupe	ST-1974		
1980-86		ST-1971		

## Suspension Strut Mounts

Model	Years	Location/ Options	Front	Rear
<b>FORD SPORT UTILITY</b>				
ECOSPORT (MEXICO)	2013-16		ST-7996	
	2004-12		ST-98001	
EDGE	2011-15		ST-9906	
	2007-10	Upper Spring Isolator	ST-6962 ST-7948	
ESCAPE	2013-18		ST-8961	
	2001-12	Upper Spring Isolator	ST-4938 ST-7906	
		Upper Spring Seat	ST-7905	
		Lower Spring Isolator	ST-7907	
EXPEDITION	2007-18	Exc. Air Suspension	ST-6963	ST-7934
		Upper Spring Isolator; Exc. Air Suspension		ST-7936
		Upper Spring Seat; Exc. Air Suspension		ST-7935
	2003-06	Exc. Air Suspension	ST-4974	ST-4973
EXPLORER	2014-19		ST-9916	
	2013	From 9/3/12	ST-9916	
		To 9/3/12	ST-9905	
	2011-12		ST-9905	
	2006-10		ST-7937	ST-7940
		Upper Spring Isolator	ST-7939	
		Upper Spring Isolator	ST-7938	ST-7941
2002-05	Stud Plate Only	ST-6918	ST-6927	
	Upper Spring Isolator	ST-6923	ST-6925	
	Upper Spring Seat	ST-6924	ST-6926	
EXPLORER SPORT TRA	2007-10		ST-7937 ST-7939	ST-7940 ST-7941
		Upper Spring Isolator		
FLEX	2013-19		ST-9916	
	2012		ST-9915	
	2009		ST-6962	
		Upper Spring Isolator	ST-9914	
<b>FORD TRUCK</b>				
F-150 PICKUP	2009-18		ST-6963	
	2004-08	2WD & 4WD, exc Heritage	ST-4970	
LOBO (MEXICAN VEHIC	2009-14		ST-6963	
<b>FORD VAN</b>				
FREESTAR	2004-07		ST-4971	
		Upper Spring Seat	ST-6994	
TRANSIT CONNECT	2014-19		ST-8961	
	2010-13		ST-8900	
WINDSTAR	1995-03		ST-2910	
		Lower Spring Isolator	ST-4949	
<b>GEO PASSENGER CAR</b>				
METRO	1989-97	exc ABS Brakes	ST-1987	ST-1988
PRIZM	1989-97		ST-5912	ST-2901
SPECTRUM	1989		ST-1932	
STORM	1990-93		ST-2932	ST-2959
<b>GEO SPORT UTILITY</b>				
TRACKER	1989-97	exc ABS Brakes	ST-1994	
<b>GMC SPORT UTILITY</b>				
ACADIA	2007-16		ST-7986	
		Upper Spring Isolator	ST-9923	
		Lower Spring Isolator	ST-9924	
ENVOY	2002-08	2WD & 4WD	ST-4968	
ENVOY XL / XUV	2002-06	2WD & 4WD	ST-4968	
JIMMY	1988-99	Torsion Bar Mount; 4WD	ST-2992	

## Suspension Strut Mounts

Model	Years	Location/ Options	Front	Rear
<b>GMC SPORT UTILITY (continued)</b>				
S15 JIMMY	1988-94	Torsion Bar Mount: w/ 4WD	ST-2992	
TERRAIN	2010-16	Exc. 19" Wheels	ST-6956	
TRACKER	1989-91		ST-1994	
YUKON	2007-14	4 Door, 2WD & 4WD, exc Z55 & ZW7 Suspensions	ST-5910	
		Upper Spring Isolator	ST-7942	
YUKON XL 1500	2007-14	4 Door, 2WD & 4WD, exc Z55 & ZW7 Suspensions	ST-5910	
		Upper Spring Isolator	ST-7942	
<b>GMC TRUCK</b>				
CANYON	2004-12	RWD	ST-9921	
SIERRA 1500	2007-14	2WD & 4WD, exc Z55 and ZW7 Suspension Upper Spring Isolator	ST-5910 ST-7942	
SONOMA	1991-99	Torsion Bar Mount; 4WD	ST-2992	
<b>HONDA PASSENGER CAR</b>				
ACCORD	2013-14			ST-9912
	2008-12	Stud Plate; Left Side	ST-9917	
		Stud Plate; Right Side	ST-9918	
		Upper Spring Isolator	ST-9922	
	2003-07	Bushing Kit	ST-1940	ST-1961
		Stud Plate Only	ST-7976	
		Upper Spring Isolator	ST-7977	
		Lower Spring Isolator	ST-6950	ST-6951
	1998-02	Bushing	ST-1940	ST-1961
		Stud Plate Only	ST-5986	ST-5987
		Upper Spring Isolator	ST-5993	ST-5994
		Lower Spring Isolator		ST-6949
	1994-97	Bushing Kit	ST-1940	ST-1961
		Stud Plate Only	ST-5901	ST-4993
		Upper Spring Isolator		ST-5974
Lower Spring Isolator			ST-5975	
1990-93	Stud Plate Only	ST-5901	ST-4993	
	Bushing Kit		ST-1961	
	Upper Spring Isolator	ST-5920		
	Lower Bushing		ST-6915	
1986-89		ST-1940	ST-1961	
	Lower Bushing		ST-6915	
1982-85		ST-1933	ST-1961	
1979-81			ST-1961	
CIVIC	2012-15	Sedan	ST-7957	
	2006-11	Sedan	ST-9945	
			ST-6964	
		Coupe	ST-7957	
	2002-05	Sedan & Coupe, Left Side	ST-4997	
		Si Hatchback, Left Side	ST-6920	
		Sedan & Coupe, Right Side	ST-4996	
		Si Hatchback, Right Side	ST-6919	
		Bushing Kit		ST-1940
		Stud Plate Only		ST-7915
		Upper Spring Isolator	ST-7917	ST-7914
	2001	Upper Spring Seat	ST-7916	
		Left Side	ST-6920	
		Right Side	ST-6919	
		Bushing Kit		ST-1940
Stud Plate Only			ST-7915	
Upper Spring Seat		ST-7916		
Upper Spring Isolator			ST-7914	

## Suspension Strut Mounts

Model	Years	Location/ Options	Front	Rear	
<b>HONDA PASSENGER CAR (continued)</b>					
CIVIC	1996-00	Upper Spring Isolator	ST-1940	ST-1940	
		Bushing Kit	ST-5976	ST-5977	
	1992-95	Stud Plate Only	ST-1940	ST-1940	
		Upper Spring Isolator	ST-5919	ST-5956	
		Lower Bushing	ST-5976	ST-5977	
	1989-91			ST-1940	ST-1940
		Lower Bushing			ST-6916
	1988	exc Wagon		ST-1940	
Lower Bushing				ST-1940	
1984-87	FWD		ST-1939	ST-1961	
	Lower Bushing			ST-6915	
				ST-1961	
CIVIC DEL SOL	1993-97		ST-1940	ST-1940	
		Lower Bushing		ST-6916	
CRX	1989-91		ST-1940	ST-1940	
		Lower Bushing		ST-6916	
	1988	Lower Bushing	ST-1940	ST-1940	
CROSSTOUR	2012-15	Stud Plate; Left Side	ST-9917		
		Stud Plate; Right Side	ST-9918		
		Upper Spring Isolator	ST-9922		
CR-Z	2011-12		ST-6965		
FIT	2007-12		ST-6965		
INSIGHT	2010-12		ST-6965		
PRELUDE	1992-01		ST-1940	ST-1961	
		Upper Spring Seat		ST-3982	
	1988-91		ST-1940	ST-2950	
	1983-87		ST-1940	ST-1961	
S2000	2002-08		ST-1940	ST-1940	
<b>HONDA SPORT UTILITY</b>					
CR-V	2012-14		ST-6966	ST-1940	
	2007-11		ST-6966		
		Bushing Kit		ST-1940	
		Stud Plate Only		ST-9946	
		Upper Spring Isolator		ST-7914	
		Upper Spring Seat		ST-9959	
	2002-06	Left Side	ST-6920		
		Right Side	ST-6919		
Upper Spring Isolator			ST-1940		
	1997-01		ST-1940	ST-1940	
ELEMENT	2007-11	Bushing Kit	ST-9927		
		Right Side	ST-6920	ST-9920	
		Stud Plate Only	ST-6919		
			ST-9930	ST-1940	
	2003-06	Bushing Kit	ST-9927		
		Right Side	ST-6920	ST-9920	
		Stud Plate Only	ST-6919		
		ST-9930	ST-1940		
PILOT	2009-15		ST-5904		
	2003-08		ST-4975		

## Suspension Strut Mounts

Model	Years	Location/ Options	Front	Rear	
<b>HONDA TRUCK</b>					
RIDGELINE	2006-14		ST-7983		
<b>HONDA VAN</b>					
WAGOVAN	1986-87	Lower Bushing		ST-6915	
	1984	Lower Bushing		ST-6915	
ODYSSEY	2013-17		ST-5904		
	2008-10		ST-5904		
	2005-07		Upper Spring Isolator	ST-9978	
			Upper Spring Seat	ST-9977	
				ST-4975	
	1999-04		Upper Spring Isolator	ST-7919	
			Lower Spring Isolator	ST-7920	
				ST-1940	ST-1940
<b>HYUNDAI PASSENGER CAR</b>					
ACCENT	2006-11	Left Side	ST-6970		
		Right Side	ST-6969		
				ST-6971	
		Upper Spring Isolator	ST-9938		
		Upper Spring Seat	ST-9937		
		Lower Spring Isolator	ST-7950		
	2000-05		Bushing	ST-3938	ST-6936
			Stud Plate Only		ST-3939
			Upper Spring Isolator	ST-8930	
			Upper Spring Seat	ST-8929	
	1997-99		Bushing	ST-2915	ST-6936
			Stud Plate Only		ST-3939
	1995-96		ST-2915	ST-3939	
AZERA	2012-17		ST-8997		
	2006-11		ST-5983	ST-5984	
ELANTRA	2007-12		ST-6967		
		Upper Spring Isolator	ST-9949		
		Upper Spring Seat	ST-9948		
		Lower Spring Isolator	ST-7953		
	2001-06	Left Side	ST-2984	ST-3935	
		Right Side	ST-2984	ST-3936	
		Upper Spring Isolator	ST-8932	ST-8950	
		Upper Spring Seat	ST-8931		
		Lower Spring Isolator		ST-6948	
	1996-00	Left Side	ST-2984	ST-3935	
		Right Side	ST-2984	ST-3936	
		Lower Spring Isolator	ST-6943	ST-6939	
		Upper Spring Isolator		ST-8950	
1992-95	exc ABS Brakes	ST-1977	ST-2923		
EXCEL	1990-94		ST-1938		
	1986-89	exc sealed strut	ST-1937		
SCOUPE	1991-95		ST-1938		
SONATA	2011-17		ST-8997		
	2006-10		ST-5983	ST-5984	
	2001-05	Bushing Kit	ST-2923	ST-2923	
		Stud Plate Only	ST-8976		
		Upper Spring Isolator	ST-8978		
	2000	Bushing Kit	ST-2923	ST-2923	
		Stud Plate Only	ST-8976	ST-3937	
		Upper Spring Isolator	ST-8978		
1999		ST-2923	ST-3937		



## Suspension Strut Mounts

Model	Years	Location/ Options	Front	Rear
<b>HYUNDAI PASSENGER CAR (continued)</b>				
SONATA	1995-98		ST-2914	ST-2964
	1989-94		ST-1976	ST-2964
TIBURON	2003-08	Left Side		ST-3935
		Right Side		ST-3936
	1997-01	Left Side	ST-2984	ST-3935
		Right Side	ST-2984	ST-3936
		Upper Spring Seat	ST-8931	
		Lower Spring Isolator	ST-6943	ST-6939
XG300	2001		ST-2923	ST-2923
XG350	2002-05		ST-2923	ST-2923
<b>HYUNDAI SPORT UTILITY</b>				
SANTA FE	2007-09		ST-6968	
		Lower Spring Isolator	ST-7952	
	2001-06		ST-4957	
		Upper Spring Isolator	ST-8980	
		Upper Spring Seat	ST-8979	
	Lower Spring Isolator	ST-8981		
TUCSON	2005-10		ST-4957	
		Left Side		ST-3935
		Right Side		ST-3936
		Upper Spring Isolator	ST-8938	
		Upper Spring Seat	ST-8937	
<b>HYUNDAI VAN</b>				
ENTOURAGE	2007-08		ST-6968	
<b>INFINITI PASSENGER CAR</b>				
G20	1999-02		ST-3911	ST-3911
	1991-96		ST-3911	
I30	2000-01		ST-6914	ST-4979
		Stud Plate Only	ST-8956	
		Upper Spring Isolator	ST-8957	
		Upper Spring Seat	ST-8955	
I35	1996-99		ST-3910	ST-3911
			ST-6914	ST-4979
		Stud Plate Only	ST-8956	
		Upper Spring Isolator	ST-8957	
		Upper Spring Seat	ST-8955	
M30	1990-92	w/ Sonar Suspension - bearing Only; Coupe	ST-1947	
Q45	1997-05	exc Active Suspension	ST-3958	ST-3911
	1994-96	exc Active Suspension	ST-3910	ST-3911
	1993	after 1/93, exc Active Suspension	ST-3910	
		exc Active Suspension		ST-3911
	1990-92	exc Active Suspension		ST-3911
<b>INFINITI SPORT UTILITY</b>				
QX4	2002-03		ST-3954	
	1999-01		ST-3954	
		Stud Plate Only	ST-7978	
		Upper Spring Isolator	ST-7980	
		Upper Spring Seat	ST-7979	
	1997-98		ST-3954	

## Suspension Strut Mounts

Model	Years	Location/ Options	Front	Rear
<b>ISUZU PASSENGER CAR</b>				
I-MARK	1985-89		ST-1932	
IMPULSE	1990-92	exc ABS Brakes	ST-2932	ST-2959
STYLUS	1991-93		ST-2932	ST-2959
<b>ISUZU SPORT UTILITY</b>				
ASCENDER	2003-08	w/ Rear Coil Spring Suspension	ST-4968	
		w/ Rear Air Spring Susp, Lower Spring Seat	ST-4962	
<b>ISUZU VAN</b>				
OASIS	1996-99		ST-1940	ST-1940
<b>JAGUAR</b>				
S-TYPE	2000-05	exc Computer Active Tech. Suspension	ST-4972	ST-4972
X-TYPE	2002-08	w/o Electronic Suspension	ST-8967	
<b>JEEP SPORT UTILITY</b>				
COMMANDER	2006-10		ST-5922	
COMPASS	2007-16	Lower Spring Isolator	ST-8949	
		Stud Plate Only	ST-7994	ST-6959
GRAND CHEROKEE	2011-13	Upper Spring Isolator		ST-8972
		Stud Plate Only		ST-8943
				ST-8999
LIBERTY	2005-10	Lower Spring Isolator	ST-5922	
			ST-8949	
PATRIOT	2002-12	Left Side	ST-5903	
		Right Side	ST-5902	
PATRIOT	2007-16		ST-7994	ST-6959
		Stud Plate Only		ST-8972
		Upper Spring Isolator		ST-8943
<b>KIA PASSENGER CAR</b>				
AMANTI	2007-09		ST-5983	ST-5984
	2004-06		ST-5923	ST-5923
CADENZA	2014-16		ST-8997	
MAGENTIS	2001-06		ST-2923	ST-5990
OPTIMA	2011-17		ST-8997	
	2007-10	Left Side	ST-6973	
		Right Side	ST-6974	
		Upper Spring Isolator	ST-9999	
		Upper Spring Seat	ST-9998	
		Lower Spring Isolator	ST-7953	
		2006	New Body Style; Left Side	ST-6973
		New Body Style; Right Side	ST-6974	
		New Body Style; Upper Spring Isolator	ST-9999	
		Upper Spring Seat	ST-9998	
		Lower Spring Isolator	ST-7953	
2001-05		ST-2923	ST-5990	
RIO	2006-11	Lower Spring Isolator	ST-6975	
		Upper Spring Isolator	ST-7950	
		Upper Spring Seat	ST-9938	
			ST-6976	ST-6971
		Upper Spring Seat	ST-9937	
	2003-05	Left Side	ST-5926	
		Right Side	ST-5925	
	2001-02	To 7/1/02	ST-5925	
To 7/1/02		ST-4980		
From 7/1/02		ST-5926		
RIO5	2006-11	Lower Spring Isolator	ST-6975	
			ST-6976	ST-6971
		Lower Spring Isolator	ST-7950	

## Suspension Strut Mounts

Model	Years	Location/ Options	Front	Rear
<b>KIA PASSENGER CAR (continued)</b>				
RONDO	2007-11	Upper Spring Seat	ST-7953	
		Upper Spring Seat	ST-6974	
			ST-6973	ST-5984
		Upper Spring Seat	ST-9998	
SEPHIA	2001	Left Side		ST-3940
		Right Side		ST-3941
	2000	before 6/00	ST-2922	ST-3940
		before 6/00		ST-3941
	1998-99		ST-2922	
		Left Side		ST-3940
		Right Side		ST-3941
	1995-97	Left Side	ST-3942	ST-3940
Right Side		ST-3942	ST-3941	
SPECTRA	2005-09		ST-2984	
		Left Side		ST-3935
		Right Side		ST-3936
		Upper Spring Seat	ST-8931	
		Lower Spring Isolator	ST-7951	
	2004	Lower Spring Isolator		ST-8904
		Lower Spring Isolator		ST-8905
		EX & LX	ST-2984	ST-3935
		Exc. EX & LX	ST-8903	ST-3936
		Lower Spring Isolator		ST-7951
	2002-03		ST-8903	ST-8904
				ST-8905
	2001	From 6/01	ST-2922	ST-8905
			ST-8903	ST-8904
	2000		ST-2922	
SPECTRA5	2005-09		ST-2984	
		Left Side		ST-3935
		Right Side		ST-3936
		Lower Spring Isolator		ST-7951
<b>KIA SPORT UTILITY</b>				
SORENTO	2003-06		ST-5927	
SPORTAGE	2005-10	Left Side		ST-3935
		Right Side		ST-3936
		Upper Spring Isolator	ST-8938	
	Upper Spring Seat	ST-8937		
1995-02		ST-4981		
<b>KIA VAN</b>				
SEDONA	2002-05		ST-6977	
		Lower Spring Isolator	ST-7954	
<b>LAND ROVER SPORT UTILITY</b>				
FREELANDER	2002-05			ST-5929
<b>LEXUS PASSENGER CAR</b>				
CT200H	2011-17		ST-6988	
ES250	1990-91		ST-1944	ST-1962
			ST-6936	
ES300	1997-03	exc Adaptive Variable Suspension, Left Side	ST-3906	ST-3904
		exc Adaptive Variable Suspension, Right Side	ST-3903	ST-3904
		Upper Spring Seat & Isolator	ST-4950	
		Lower Spring Isolator	ST-4951	ST-4953
	1995-96		ST-3991	
		Upper Spring Seat & Isolator	ST-4950	
		Lower Spring Isolator	ST-4951	ST-4953

## Suspension Strut Mounts

Model	Years	Location/ Options	Front	Rear
<b>LEXUS PASSENGER CAR (continued)</b>				
ES300	1995-96	Upper Spring Isolator		ST-4952
	1992-94	Lower Spring Isolator	ST-5997	ST-4952
		Upper Spring Isolator	ST-6937	
			ST-2926	ST-4953
ES300H	2013-15	Upper Spring Seat	ST-9942	
ES330	2004-06	exc Adaptive Variable Suspension	ST-4989	ST-3904
		Lower Spring Isolator	ST-6935	ST-6935
ES350	2013-15	Upper Spring Seat	ST-9942	
	2010-12	Lower Spring Isolator		ST-8965
				ST-6986
	2007-09	Lower Spring Isolator	ST-6986	ST-8966
GS300	1998-05		ST-3997	ST-5930
	1993-97		ST-3997	ST-5931
		Lower Spring Isolator		ST-7961
GS400	1998-00		ST-3997	ST-5930
GS430	2001-05		ST-3997	ST-5930
HS250H	2010-12	Upper Spring Isolator	ST-9931	
IS300	2001-05		ST-5932	ST-5930
LS400	1995-00	exc Auto Leveling System	ST-5933	ST-3999
	1990-94	exc Auto Leveling System	ST-3998	ST-4918
LS430	2001-06		ST-5934	ST-5935
SC300	1992-00		ST-5938	ST-4902
SC400	1992-00		ST-5938	ST-4902
SC430	2002-08		ST-3997	ST-5940
<b>LEXUS SPORT UTILITY</b>				
RX300	1999-03	Left Side	ST-3906	ST-3904
		Right Side	ST-3903	ST-3904
RX330	2004-06	Left Side, exc Air Suspension	ST-4989	ST-5937
		Right Side, exc Air Suspension	ST-4989	ST-5936
		Upper Spring Isolator; Exc. Air Suspension	ST-9943	
		Upper Spring Seat; Exc. Air Suspension	ST-9942	
RX350	2007-14	Upper Spring Isolator; Exc. Air Suspension	ST-9943	
		Upper Spring Seat; Exc. Air Suspension	ST-9942	
RX400H	2006-08	Upper Spring Isolator	ST-9943	
		Upper Spring Seat	ST-9942	
RX450H	2010-15	Upper Spring Isolator; Exc. Air Suspension	ST-9943	
		Upper Spring Seat; Exc. Air Suspension	ST-9942	
<b>LINCOLN PASSENGER CAR</b>				
CONTINENTAL	1997-02		ST-4911	
	1988-94	Repl. strut Mount for Coil Spring Conversion Kit	ST-1926	ST-2997
	1982-87		ST-1971	
LS	2000-06		ST-4972	ST-4972
MARK VII	1984-92		ST-1971	
MKS	2013-16		ST-9916	
	2012		ST-9915	
	2010-11	Upper Spring Isolator	ST-9914	
Lower Spring Isolator		ST-7999		
MKZ	2007-12		ST-5918	
		Upper Spring Seat & Isolator	ST-6961	
		Lower Spring Isolator	ST-9929	
TOWN CAR	2003-09		ST-7944	
		Upper Spring Isolator	ST-7945	
ZEPHYR	2006		ST-5918	
		Upper Spring Seat & Isolator	ST-6961	

## Suspension Strut Mounts

Model	Years	Location/ Options	Front	Rear
<b>LINCOLN SPORT UTILITY</b>				
MKC	2015-19		ST-8961	
MKT	2016-19	w/o Electronic Suspension	ST-9916	
	2013-15		ST-9916	
	2012		ST-9915	
	2010-11	Upper Spring Isolator Lower Spring Isolator	ST-9914 ST-7999	
MKX	2011-15		ST-9906	
	2007-10		ST-6962	
		Upper Spring Isolator	ST-7948	
<b>LINCOLN TRUCK</b>				
MARK LT	2006-08		ST-4970	
<b>MAZDA PASSENGER CAR</b>				
2	2011-16		ST-7996	ST-7997
3	2004-12		ST-6980	ST-6981
6	2009-13	Stud Plate Only	ST-8994	
		Upper Spring Seat & Bearing	ST-6961	
	2005-08	Upper Spring Seat & Isolator	ST-5918	
		Lower Spring Isolator	ST-6961	
	2003-04	Upper Spring Isolator	ST-9929 ST-5917 ST-9903	
323	1990-94		ST-2936	ST-1963
	1986-89	Sedan & Hatchback, 2WD	ST-1930	ST-1959
		Sedan & Hatchback, AWD Wagon	ST-1930 ST-1930	
626	2000-02	Left Side	ST-4954	ST-4999
		Right Side	ST-4954	ST-4998
		Upper Spring Seat	ST-3964	
	1998-99	Left Side	ST-4954	ST-2952
		Right Side	ST-4954	ST-2951
		Upper Spring Seat	ST-3964	
	1993-97	Left Side	ST-2922	ST-2952
		Right Side	ST-2922	ST-2951
		Upper Spring Seat	ST-3964	
	1988-92	Auto Trans; exc. Turbo 4WS Model	ST-1999	ST-1960
		Manual Trans.; exc. Turbo 4WS Model Upper Spring Seat	ST-2935 ST-3905	ST-1960
1986-87	w/ Manual TRANS, exc Auto Adj Suspension	ST-2939		
1983-85	Left Side, exc Auto Adj Suspension	ST-2939	ST-2943	
	Right Side, exc Auto Adj Suspension	ST-2939	ST-2942	
929	1990-91		ST-2934 ST-3943	
		exc Auto adj suspension		ST-2966
	1988-89	exc Auto adj suspension	ST-2960	ST-2966
GLC	1981-85	exc Wagon	ST-1930	ST-1959
MIATA - MX5	2006-12		ST-6982	ST-6982
	1999-05		ST-2970	ST-2970
	1990-97		ST-2919	ST-2919
MILLENNIA	1997-00			ST-8908
	1995			ST-8909
MX-3	1992-95	Coupe	ST-2936	ST-1963
MX-6	1993-97	Left Side	ST-2922	ST-2952
		Right Side	ST-2922	ST-2951
		Upper Spring Seat	ST-3964	
	1988-92	Auto Trans; exc. GT 4WS Model	ST-1999	ST-1960
		Manual Trans; exc. GT 4WS Model Upper Spring Seat	ST-2935 ST-3905	ST-1960

## Suspension Strut Mounts

Model	Years	Location/ Options	Front	Rear
<b>MAZDA PASSENGER CAR (continued)</b>				
PROTEGE	1999-03	Left Side	ST-4983	
		Right Side		ST-4995
		Upper Spring Isolator	ST-8934	
		Upper Spring Seat	ST-8933	
		Lower Spring Isolator	ST-6942	
	1995-98	Left Side	ST-3907	ST-3909
		Right Side	ST-3907	ST-3908
		Lower Spring Isolator	ST-6940	
	1992-94	FWD	ST-2936	ST-1963
	1990-91	AWD	ST-2936	
FWD		ST-2936	ST-1963	
PROTEGE5	2002-03		ST-4983	
		Left Side		ST-4995
		Right Side		ST-4994
		Lower Spring Isolator	ST-6942	
RX-7	1986-91	exc Auto adj suspension	ST-2974	ST-2975
	1981-85	exc GSL-SE	ST-2934	
	1980	after NOV 1, exc GSL-SE	ST-2934	
RX-8	2004-11		ST-6982	ST-6982
<b>MAZDA SPORT UTILITY</b>				
CX-7	2007-12		ST-8907	
CX-9	2007-14		ST-8907	
TRIBUTE	2008-11	2WD & 4WD	ST-4938	
		Upper Spring Isolator	ST-7906	
		Upper Spring Seat	ST-7905	
		Lower Spring Isolator	ST-7907	
		AWD	ST-4938	
	2006	Upper Spring Isolator	ST-7906	
		Upper Spring Seat	ST-7905	
		Lower Spring Isolator	ST-7907	
	2001-05	2WD & 4WD	ST-4938	
		Upper Spring Isolator	ST-7906	
Upper Spring Seat		ST-7905		
		Lower Spring Isolator	ST-7907	
<b>MAZDA VAN</b>				
5	2012-14		ST-6980	ST-6981
	2006-10		ST-6980	ST-6981
MPV	2000-06	FWD	ST-4958	
	1989-98	exc Auto leveling system	ST-2921	
<b>MERCEDES-BENZ PASSENGER CAR</b>				
190D	1984-89		ST-2902	
190E	1984-93		ST-2902	
260E	1987-89	exc 4 MATIC	ST-2902	
300CE	1988-93		ST-2902	
300D	1990-93	exc 4 MATIC	ST-2902	
	1987	exc 4 MATIC	ST-2902	
300E	1986-93		ST-2902	
300TE	1988-93	exc 4 MATIC	ST-2902	
400E	1992-93		ST-2902	
B200	2006-11		ST-10005	
C240	2003-05	RWD	ST-6934	
	2001-02		ST-6934	
C250	2012-15		ST-10007	
		Bearing Only	ST-10010	
C300	2008-14		ST-10007	

## Suspension Strut Mounts

Model	Years	Location/ Options	Front	Rear
<b>MERCEDES-BENZ PASSENGER CAR (continued)</b>				
C300	2008-14	Bearing Only	ST-10010	
C320	2003-05	RWD	ST-6934	
	2001-02		ST-6934	
C350	2008-15		ST-10007	
		Bearing Only	ST-10010	
C63 AMG	2008-15		ST-10007	
		Bearing Only	ST-10010	
CLA250	2013-18	Bearing Only	ST-10010	
CLA45 AMG	2014-18	Bearing Only	ST-10010	
CLS400	2015	Exc. Air Suspension	ST-10006	
		Bearing Only; exc. 4-Matic; exc. Airmatic Suspension	ST-10010	
CLS500	2005-06	exc. Airmatic Suspension	ST-10002	
CLS550	2013-15	exc. Airmatic Suspension	ST-10006	
		Bearing Only; Exc. AWD; exc. Air Suspension	ST-10010	
CLS55 AMG	2006	Exc. Air Suspension	ST-10002	
CLS63 AMG S	2014-15	exc. Airmatic Suspension	ST-10006	
		Bearing Only; exc. 4-Matic; exc. Airmatic Suspension	ST-10010	
CLS63 AMG	2013-14	exc. Airmatic Suspension	ST-10006	
		Bearing Only; exc. 4-Matic; exc. Airmatic Suspension	ST-10010	
E250	2014-15	exc. Airmatic Suspension	ST-10006	
		Bearing Only; exc. 4-Matic; exc. Airmatic Suspension	ST-10010	
E300D	1995	exc Rear Axle Level Control	ST-2902	
E320	2003-09	exc. Airmatic Suspension; exc. 4-Matic	ST-10002	
	1994-96		ST-2902	
E350	2010-15	Airmatic Suspension; w/o VDS	ST-10007	
		Coil Spring Suspension	ST-10006	
		Bearing Only; exc. 4-Matic; exc. Airmatic Suspension	ST-10010	
E400	2006-09	exc. Airmatic Suspension; exc. 4-Matic	ST-10002	
E400	2013-15	Airmatic Suspension; w/o VDS	ST-10007	
		Coil Spring Suspension	ST-10006	
		Bearing Only; exc. 4-Matic; exc. Airmatic Suspension	ST-10010	
E420	1994-95		ST-2902	
E500	2003-06	exc. Airmatic Suspension	ST-10002	
	1994		ST-2902	
E550	2010-15	Airmatic Suspension; w/o VDS	ST-10007	
		Coil Spring Suspension	ST-10006	
		Bearing Only; exc. 4-Matic; exc. Airmatic Suspension	ST-10010	
	2007-09	exc. Airmatic Suspension	ST-10002	
E55 AMG	2003-06	exc. Airmatic Suspension	ST-10002	
E63 AMG	2010-15	exc. Airmatic Suspension	ST-10006	
		Bearing Only; exc. 4-Matic; exc. Airmatic Suspension	ST-10010	
	2007-09	exc. Airmatic Suspension	ST-10002	
E63 AMG S	2014-15	exc. Airmatic Suspension	ST-10006	
		Bearing Only; exc. 4-Matic; exc. Airmatic Suspension	ST-10010	
SL320	1994-97		ST-3944	
SL500	1994-02		ST-3944	
SL600	1994-02		ST-3944	
SLK250	2012-15	Bearing Only; exc. 4-Matic; exc. Airmatic Suspension	ST-10010	

## Suspension Strut Mounts

Model	Years	Location/ Options	Front	Rear
<b>MERCEDES-BENZ PASSENGER CAR (continued)</b>				
SLK350	2012-15	Bearing Only; exc. 4-Matic; exc. Airmatic Suspension	ST-10010	
SLK55 AMG	2012-15	Bearing Only; exc. 4-Matic; exc. Airmatic Suspension	ST-10010	
<b>MERCEDES-BENZ SPORT UTILITY</b>				
GLA250	2015-18	Bearing Only; FWD; exc. Air Suspension	ST-10010	
GLA45 AMG	2014-15	Bearing Only; exc. 4-Matic; exc. Airmatic Suspension	ST-10010	
GLK250	2013-15	Bearing Only; exc. 4-Matic; exc. Airmatic Suspension	ST-10010	
GLK350	2009-15	Bearing Only; exc. 4-Matic; exc. Airmatic Suspension	ST-10010	
<b>MERCURY PASSENGER CAR</b>				
CAPRI	1991-93		ST-2976	ST-1959
	1979-86		ST-1925	
COUGAR	2001-02		ST-2953	
	1999-00		ST-2953	ST-2954
	1992-97	exc Auto Adj Suspension	ST-1970	
		exc Auto Adj Suspension, Lower Spring Isolator	ST-4920	
	1989-91	exc XR7	ST-1970	
		exc XR7, Lower Spring Isolator	ST-4920	
	1987-88		ST-1974	
	1983-86		ST-1971	
1981-82		ST-1925		
GRAND MARQUIS	2003-11		ST-7944	
		Upper Spring Seat after 2/83	ST-7945	
LN7	1983		ST-1916	
	1982			ST-1956
LYNX	1986-87	Bearing Only	ST-1927	ST-1956
		after 3/85	ST-1901	
	1985	before 3/85	ST-1927	
			ST-1916	
		Bearing Only	ST-1901	ST-1956
	1984		ST-1916	ST-1956
	1983	after 2/83	ST-1916	
			ST-1956	
MARQUIS	1983-86		ST-1925	
MILAN	2006-11		ST-5918	
		Upper Spring Seat & Isolator	ST-6961	
		Lower Spring Isolator	ST-9929	
MONTEGO	2005-07		ST-5915	
		Left Side; AWD		ST-7900
		Left Side; w/ FWD		ST-6996
		Right Side; AWD		ST-7901
		Right Side; w/ FWD		ST-6997
		Upper Spring Isolator	ST-7948	
	Upper Spring Isolator; AWD		ST-7998	
MYSTIQUE	1995-00		ST-2953	ST-2954
SABLE	2009		ST-6962	
		Left Side; AWD		ST-7900
		Left Side; w/ FWD		ST-6998
		Right Side; AWD		ST-7901
		Right Side; w/ FWD		ST-6999



## Suspension Strut Mounts

Model	Years	Location/ Options	Front	Rear	
<b>MERCURY PASSENGER CAR (continued)</b>					
SABLE	2009	Upper Spring Isolator	ST-9914		
		Lower Spring Isolator	ST-7999		
		Upper Spring Isolator; AWD		ST-7998	
	2008			ST-6962	
		Left Side; AWD			ST-7900
		Left Side; w/ FWD			ST-6998
		Right Side; AWD			ST-7901
		Right Side; w/ FWD			ST-6999
		Upper Spring Isolator; From 8/13/08	ST-9914		
		Lower Spring Isolator	ST-7999		
	1996-05	Upper Spring Isolator; AWD			ST-7998
		Sedan	ST-2944		ST-1954
		Station Wagon	ST-2944		
		Upper Spring Seat	ST-3968		
	1986-95	Lower Spring Isolator	ST-4937		
		Sedan	ST-1926		ST-1954
		Station Wagon	ST-1926		
Bearing Only		ST-1902			
Upper Spring Seat		ST-3967			
Lower Spring Isolator		ST-5965			
after 3/94, Lower Spring Isolator				ST-5964	
TOPAZ	1984-94	AWD	ST-1927		
		FWD	ST-1927	ST-1955	
		Bearing Only	ST-1901		
		Upper Spring Isolator, exc AWD		ST-3966	
TRACER	1997-99	exc ABS Brakes	ST-4913	ST-1963	
		exc ABS Brakes, Upper Spring Seat & Isolator	ST-4936		
		Lower Spring Isolator		ST-4922	
	1991-96		ST-2936	ST-1963	
		Upper Spring Seat & Isolator	ST-3965		
		Lower Spring Isolator		ST-4922	
1987-89		ST-1930	ST-1959		
ZEPHYR	1978-83		ST-1925		
<b>MERCURY SPORT UTILITY</b>					
MARINER	2005-11	Upper Spring Isolator	ST-4938		
		Upper Spring Seat	ST-7906		
		Upper Spring Seat	ST-7905		
		Lower Spring Isolator	ST-7907		
MOUNTAINEER	2006-10		ST-7937	ST-7940	
		Upper Spring Isolator	ST-7939		
		Upper Spring Isolator	ST-7938	ST-7941	
	2002-05	Stud Plate Only	ST-6918	ST-6927	
		Upper Spring Isolator	ST-6923	ST-6925	
		Upper Spring Seat	ST-6924	ST-6926	
<b>MERCURY VAN</b>					
MONTEREY	2004-07		ST-4971		
VILLAGER	1999-02		ST-2989		
	1993-98	Upper Spring Seat	ST-2989		
		Lower Spring Isolator	ST-5921		
			ST-5924		
<b>MINI</b>					
COOPER CLUBMAN	2016-18	Bushing Kit		ST-8911	
COOPER PACEMAN	2013-16		ST-8910		
		Bushing Kit		ST-8911	
COOPER COUNTRYMAN	2011-17		ST-8910		
		Bushing Kit		ST-8911	

## Suspension Strut Mounts

Model	Years	Location/ Options	Front	Rear
<b>MINI (continued)</b>				
COOPER	2007-17		ST-8910	
		Bushing Kit		ST-8911
	2002-06		ST-6983	
		Bushing Kit Lower Spring Isolator		ST-6984 ST-7969
<b>MITSUBISHI PASSENGER CAR</b>				
3000GT	1991-99	exc adj suspension	ST-2955	ST-2923
CORDIA	1983-88	Hatchback	ST-3948	
DIAMANTE	1997-03		ST-2914	ST-5942
		Lower Spring Isolator	ST-6938	
	1992-96	exc Active Suspension	ST-2914	
		Sedan, exc Active Suspension		ST-5941
ECLIPSE	2006-12		ST-8944	
		Lower Spring Isolator	ST-7965	
	2000-05		ST-4957	
		Bushing Kit		ST-2923
		Stud Plate Only		ST-9947
		Lower Spring Isolator	ST-6938	
	1995-99	Upper Spring Isolator		ST-9969
			ST-2923	
		Bushing		ST-2923
		Stud Plate Only		ST-9947
GALANT	2009-12		ST-8944	
		2004-08	ST-8944	
	1999-03	Lower Spring Isolator	ST-7965	
			ST-4957	
		Bushing Kit		ST-2923
		Stud Plate Only		ST-9947
	1994-98	Lower Spring Isolator	ST-6938	
		Upper Spring Isolator		ST-9969
		ST-2923	ST-2923	
Upper Spring Isolator			ST-7993	
1985-93	exc Auto leveling system	ST-2977	ST-2923	
LANCER	2009-17	Base Model, FWD	ST-8912	
		Lower Spring Isolator; DE, ES, GTS Models	ST-7966	
	2008	FWD	ST-8912	
		Lower Spring Isolator; w/ FWD	ST-7966	
	2007		ST-5944	ST-5945
		Lower Spring Isolator		ST-7962
	2006	ES; Exc. Revolution	ST-5943	
		Exc. ES; Exc. Evolution	ST-5944	
		Exc. Evolution		ST-5945
		Lower Spring Isolator; Exc. ES Model	ST-7963	
	2004-05	Lower Spring Isolator		ST-7962
		ES; Exc. Revolution	ST-5943	
		Exc. ES; Exc. Evolution	ST-5944	
		Exc. Evolution		ST-5945
Lower Spring Isolator; ES Model		ST-7964		
Lower Spring Isolator; Exc. ES Model		ST-7963		
2002-03	Lower Spring Isolator		ST-7962	
	ES; Exc. Revolution	ST-5943		
	Exc. ES; Exc. Evolution	ST-5944		
	Exc. Evolution		ST-5945	
	Lower Spring Isolator; ES Model	ST-7964		
Lower Spring Isolator; Exc. ES Model	ST-7963			

## Suspension Strut Mounts

Model	Years	Location/ Options	Front	Rear
<b>MITSUBISHI PASSENGER CAR (continued)</b>				
LANCER	2002-03	Lower Spring Isolator		ST-7962
MIRAGE	1998-02		ST-3947	ST-2923
	1997	after 4/97	ST-3947	
		before 4/97	ST-3945	
	1993-96		ST-2958	ST-2923
	1989-92		ST-1977	ST-2923
	1987-88		ST-2918	
	1985-86		ST-2917	
PRECIS	1989-94		ST-1938	
	1987-88		ST-1937	
SIGMA	1989-90	exc ABS brakes & Auto leveling system	ST-3946	ST-2923
STARION	1983-89	exc adj suspension	ST-2961	ST-2962
TREDIA	1983-88		ST-3948	
<b>MITSUBISHI SPORT UTILITY</b>				
ASX	2013-15		ST-8912	
ENDEAVOR	2004-11		ST-8944	
MONTERO	2001-03	w/o Electronic Suspension	ST-4984	
OUTLANDER	2007-13		ST-8912	
	2003-06	Lower Spring Isolator	ST-7964	
OUTLANDER SPORT	2011-19		ST-8912	
<b>MITSUBISHI VAN</b>				
EXPO	1992-95	FWD	ST-1976	
				ST-2923
EXPO LRV	1992-94	FWD	ST-1976	
				ST-2923
<b>NISSAN PASSENGER CAR</b>				
200SX	1995-98		ST-2938	ST-2978
			ST-5996	
	1984-88		ST-3949	
240SX	1989-98	exc adj suspension	ST-2979	ST-2980
240Z	1970-73		ST-1947	
260Z	1974-75		ST-1947	
280Z	1975-78		ST-1947	
280ZX	1979-83		ST-1947	
300ZX	1990-96	exc adj suspension	ST-2985	ST-2978
	1984-89	V6 3.0L 2960cc:w/o Turbo	ST-3951	
		V6 3.0L 2960cc;bearing Only, exc Turbo	ST-1947	
350Z	2003-08		ST-5985	
510	1972-73	Bearing Only	ST-1947	
	1971	after AUG 1	ST-1947	
610	1973-76	bearing Only; Sedan & Wagon	ST-1947	
710	1974-77		ST-1947	
810	1980-81		ST-1947	
ALTIMA	2009-13		ST-8913	
		Lower Spring Isolator	ST-9904	
	2007-08		ST-8913	ST-4985
		Lower Spring Isolator	ST-9904	
	2002-06		ST-6914	ST-4985
		Upper Spring Seat	ST-7904	
		Lower Spring Isolator	ST-6945	
	2000-01		ST-3957	ST-2981
		Lower Spring Isolator		ST-5996
	1993-99		ST-1975	ST-2981
Upper Spring Seat		ST-6929		
	Upper Spring Isolator		ST-5995	

## Suspension Strut Mounts

Model	Years	Location/ Options	Front	Rear
<b>NISSAN PASSENGER CAR (continued)</b>				
ALTIMA	1993-99	Upper Spring Seat; Right		ST-6931
		Lower Spring Isolator		ST-5996
		Upper Spring Seat; Left		ST-6930
MAXIMA	2009-14		ST-8913	
	2004-08		ST-6914	
		Lower Spring Isolator	ST-6945	
	2000-03		ST-6914	ST-4979
		Stud Plate Only	ST-8956	
		Upper Spring Isolator	ST-8957	
		Upper Spring Seat	ST-8955	
	1995-99	Mount	ST-3910	
		Stud Plate Only	ST-5962	ST-5939
		Bushing Kit		ST-3911
		Upper Spring Isolator	ST-5978	ST-5979
	1989-94	w/o Sonar Suspension, Left Side	ST-2989	
		w/o Sonar Suspension, Right Side	ST-2989	
		Left Side		ST-2982
Right Side			ST-2983	
	w/o Sonar Suspension, bearing Only - both Sides	ST-1947		
1985-88	exc Elec Control Shocks, Left Side	ST-1948	ST-2982	
	exc Elec Control Shocks, Right Side	ST-1948	ST-2983	
1982-84	Bearing Only	ST-1947		
MULTI	1986-88	2WD & 4WD	ST-2937	
NX	1991-93	exc ABS Brakes	ST-2938	ST-1989
			ST-5996	ST-5996
PLATINA (MEXICO)	2002-10		ST-98002	
PULSAR	1983		ST-2937	
PULSAR NX	1987-90		ST-2937	ST-2937
	1983-86		ST-2937	
SENTRA	2007-12	Base, S, SL, & SR Models; Left Side	ST-8914	
		Base, S, SL, & SR Models; Right Side	ST-8915	
		Lower Spring Isolator	ST-9925	
	2002-06		ST-3950	ST-4955
		Upper Spring Isolator	ST-7903	
		Upper Spring Seat	ST-7902	
	2000-01		ST-3950	ST-4955
	1996-99		ST-2938	ST-2978
		Lower Spring Isolator	ST-5996	
	1995		ST-2938	
		B13; Sedan, Coupe & Hatchback		ST-1989
		B14; Sedan, Coupe & Hatchback		ST-2978
		Lower Spring Isolator	ST-5996	ST-5996
	1993-94		ST-2938	ST-1989
		Lower Spring Isolator	ST-5996	ST-5996
	1991-92	exc Sentra Classic	ST-2938	ST-1989
		Sentra Classic	ST-2937	ST-2937
		ST-5996	ST-5996	
1987-90	B12; Sedan, Coupe & Hatchback	ST-2937	ST-2937	
	Station Wagon w/ 2WD	ST-2937	ST-2937	
	Station Wagon w/ 4WD	ST-2937		
1984-86		ST-2937		
STANZA	1990-92	Left Side	ST-1975	ST-2982
		Right Side	ST-1975	ST-2983
	1989	Left Side; Sedan	ST-1948	ST-2982
		Right Side; Sedan	ST-1948	ST-2983
	1987-88	Wagon 2WD & 4WD	ST-2937	
		Left Side; Sedan	ST-1948	ST-2982
	Right Side; Sedan	ST-1948	ST-2983	

## Suspension Strut Mounts

Model	Years	Location/ Options	Front	Rear
<b>NISSAN PASSENGER CAR (continued)</b>				
STANZA	1986	Wagon 2WD & 4WD	ST-2937	
TIIDA (MEXICO)	2007-18		ST-8916	
			ST-8917	
VERSA	2007-12		ST-8916	
			ST-8917	
<b>NISSAN SPORT UTILITY</b>				
ARMADA	2005-15		ST-7932	
		Upper Spring Isolator	ST-7933	
MURANO	2009-14		ST-8998	
	2003-07		ST-6914	
PATHFINDER	2005-11		ST-8975	
		Upper Spring Isolator	ST-7928	
		ST-7929		
	2002-04		ST-3954	
	1999-01		ST-3954	
		Stud Plate Only	ST-7978	
		Upper Spring Isolator	ST-7980	
	Upper Spring Seat	ST-7979		
1996-98		ST-3954		
ROGUE	2008-12		ST-8916	
			ST-8917	
<b>NISSAN TRUCK</b>				
FRONTIER	2005-11		ST-7928	
		Upper Spring Isolator	ST-7929	
TITAN	2004-15		ST-7932	
		Upper Spring Isolator	ST-7933	
<b>NISSAN VAN</b>				
AXXESS	1990-94	AWD, Left Side	ST-2989	
		FWD, Left Side	ST-2989	ST-2982
		AWD, Right Side	ST-2989	
		FWD, Right Side	ST-2989	ST-2983
QUEST	2011-14		ST-8998	
	2004-09		ST-6914	
	1993-02		ST-2989	
<b>OLDSMOBILE PASSENGER CAR</b>				
98	1991-96	Complete Unit	ST-1922	
				ST-1953
		Bearing Only	ST-1928	
		Upper Spring Seat & Isolator exc elec suspension, Lower Spring Isolator	ST-3973	
	1985-90		ST-4925	
			ST-1973	ST-1953
		Bearing Only	ST-1928	
ACHIEVA	1995-98	Upper Spring Seat & Isolator	ST-3974	
		Lower Spring Isolator	ST-4923	
		exc elec suspension	ST-4912	ST-1951
	1992-94	exc elec suspension - Upper Spr Seat & Isolator	ST-3970	
			ST-1946	ST-1951
		exc elec suspension - bearing Only	ST-1928	
ALERO	1999-04	exc elec suspension - Upper Spr Seat & Isolator	ST-3972	
			ST-2999	ST-3900
		Upper Spring Isolator	ST-4944	
AURORA	2001-03	Lower Spring Isolator	ST-4945	
			ST-2972	ST-2998
	1998-99		ST-2972	ST-2998
	1995-97		ST-2930	ST-2998

## Suspension Strut Mounts

Model	Years	Location/ Options	Front	Rear
<b>OLDSMOBILE PASSENGER CAR (continued)</b>				
AURORA	1995-97	Bearing Only Upper Spring Seat & Isolator	ST-1928 ST-3973	
CALAIS	1985-87	Upper Spring Seat & Isolator Lower Spring Isolator	ST-1913 ST-3969 ST-4924	ST-1951
CUTLASS	1997-99	Upper Spring Isolator Lower Spring Isolator	ST-2999 ST-4944 ST-4945	ST-3900
CUTLASS CALAIS	1988-91	Upper Spring Seat & Isolator Lower Spring Isolator	ST-1913 ST-3969 ST-4924	ST-1951
CUTLASS CIERA	1984-96	Upper Spring Seat & Isolator	ST-1934 ST-3971	ST-1951
	1982-83		ST-1934	
CUTLASS CRUISER	1982-83		ST-1934	
CUTLASS SUPREME	1988-97	w/ FWD Bearing Only Lower Spring Seat & Bearing - Left Side; w/ FWD Lower Spring Seat & Bearing - Right Side; w/ FWD	ST-1921 ST-1986 ST-2994 ST-2995	ST-2941
DELTA 88	1991-99	exc elec adj suspension Bearing Only exc elec suspension - Upper Spr Seat & Isolator exc elec suspension, Lower Spring Isolator	ST-1922 ST-1928 ST-3973 ST-4925	ST-1953
	1990	early Design w/ Spring guard late Design w/o Spring guard	ST-1973 ST-1922	
		Bearing Only Upper Spr Seat & Isolator w/ Spring GUARD Upper Spr Seat & Isolator, w/o Spring GUARD Lower Spring Isolator; w/ Spring Guard Lower Spring Isolator; w/o Spring Guard	ST-1928 ST-3974 ST-3973 ST-4923 ST-4925	ST-1953
	1986-89	Bearing Only Upper Spring Seat & Isolator Lower Spring Isolator	ST-1973 ST-1928 ST-3974 ST-4923	ST-1953
FIRENZA	1984-88	Upper Spring Seat & Isolator Lower Spring Isolator	ST-1913 ST-3969 ST-4924	ST-1951
	1983	Upper Spring Seat & Isolator Lower Spring Isolator	ST-1913 ST-3969 ST-4924	
	1982	Upper Spring Seat & Isolator	ST-1913 ST-3969	
INTRIGUE	1998-02	Left Side Right Side	ST-2973 ST-2973	ST-2969 ST-2968
LSS	1996-99	Bearing Only Upper Spring Seat & Isolator	ST-1922 ST-1928 ST-3973	ST-1953
OMEGA	1984		ST-1934	ST-1951
	1982-83		ST-1934	
REGENCY	1997-98	exc elec adj suspension exc elec adj suspension - bearing Only exc elec adj suspension - Upper Spr Seat & IsoLATO	ST-1922 ST-1928 ST-3973	ST-1953
TORONADO	1990-92	Bearing Only	ST-2965 ST-1928	ST-2971
	1986-89		ST-1990	ST-2971

## Suspension Strut Mounts

Model	Years	Location/ Options	Front	Rear
<b>OLDSMOBILE SPORT UTILITY</b>				
BRAVADA	2002-04	2WD & 4WD	ST-4968	
	1996-99	Torsion Bar Mount; w/ 4WD	ST-2992	
	1991-94	Torsion Bar Mount; w/ 4WD	ST-2992	
<b>OLDSMOBILE VAN</b>				
SILHOUETTE	1997-04	2WD & AWD	ST-2973	
		Upper Spring Isolator	ST-4942	
		Lower Spring Isolator	ST-4943	
	1990-96	2WD & AWD	ST-1934	ST-1951
		Upper Spring Seat & Isolator	ST-3971	
<b>PLYMOUTH PASSENGER CAR</b>				
ACCLAIM	1989-95		ST-1908	
		Upper Spring Seat & Isolator	ST-4916	
		Lower Spring Isolator	ST-3980	
ARROW	1976-80		ST-1937	
BREEZE	1996-00		ST-1940	ST-2946
CARAVELLE	1987-88	w/ FWD	ST-1908	
		Upper Spring Seat & Isolator	ST-4916	
		Lower Spring Isolator	ST-3980	
	1986	w/ FWD after JAN 1	ST-1908	
		w/ FWD before JAN 1	ST-1907	
		after JAN 1, Upper Spring Seat & Isolator	ST-4916	
	1984-85	after JAN 1, Lower Spring Isolator	ST-3980	
w/ FWD		ST-1907		
1983	w/ FWD	ST-1906		
CHAMP	1979-82		ST-1937	
COLT	1993-94	Sedan	ST-2958	ST-2923
		VISTA Wagon 2WD	ST-1976	
		Wagon 2WD & 4WD		ST-2923
	1992	Hatchback	ST-1977	
		VISTA Wagon 2WD	ST-1976	ST-2923
		VISTA Wagon 4WD		ST-2923
	1991	Hatchback	ST-1977	
	1989-90	Hatchback	ST-1977	
		Wagon 2WD & 4WD	ST-2918	
	1987-88		ST-2918	
	1985-86	Sedan & Hatchback	ST-2917	
	1984	Sedan & Hatchback	ST-1937	
		Wagon	ST-1992	
	1980-83	Sedan & Hatchback	ST-1937	
	1977-79	Sedan & Hatchback	ST-1937	
Wagon		ST-1992		
1976	Sedan & Wagon	ST-1992		
CONQUEST	1984-86	exc adj suspension	ST-2961	ST-2962
EXPO	1987-89		ST-1905	ST-1952
HORIZON	1978-90		ST-1905	ST-1952
LASER	1994	w/ FWD	ST-2920	ST-2923
	1990-93	w/ FWD	ST-2920	ST-2923
NEON	2000-01		ST-3926	ST-3924
	1995-99		ST-2907	ST-2908
		Upper Spring Seat & Isolator	ST-3976	
RELIANT	1987-89	Lower Spring Isolator		ST-4948
			ST-1908	
		Upper Spring Seat & Isolator	ST-4916	
	1986	Lower Spring Isolator	ST-3980	
		after JAN 1	ST-1908	
		before JAN 1	ST-1907	
		after JAN 1, Upper Spring Seat & Isolator	ST-4916	

## Suspension Strut Mounts

Model	Years	Location/ Options	Front	Rear
<b>PLYMOUTH PASSENGER CAR (continued)</b>				
RELIANT	1986	after JAN 1, Lower Spring Isolator	ST-3980	
	1984-85		ST-1907	
	1983		ST-1906	
	1981-82		ST-1905	
SAPPORO	1981-83		ST-2963	
	1978-80		ST-1992	
SCAMP	1983		ST-1905	
SUNDANCE	1987-94		ST-1908	
		Upper Spring Seat & Isolator	ST-4916	
		Lower Spring Isolator	ST-3980	
TURISMO	1983-85		ST-1905	ST-1952
<b>PLYMOUTH VAN</b>				
GRAND VOYAGER	1996-00		ST-2945	
		Upper Spring Seat	ST-3975	
		Lower Spring Isolator	ST-4921	
	1995	after MAR 1	ST-2945	
		before MAR 1	ST-1908	
		after MAR 1, Upper Spring Seat	ST-3975	
		before MAR 1, - Upper Spring Seat	ST-4916	
		after MAR 1, Lower Spring Isolator	ST-4921	
	1988-94	before MAR 1, Lower Spring Isolator	ST-3980	
			ST-1908	
Upper Spring Seat & Isolator		ST-4916		
Lower Spring Isolator		ST-3980		
VOYAGER	1996-00		ST-2945	
		Upper Spring Seat	ST-3975	
		Lower Spring Isolator	ST-4921	
	1995	after MAR 1	ST-2945	
		before MAR 1	ST-1908	
		after MAR 1, Upper Spring Seat	ST-3975	
		before MAR 1, - Upper Spring Seat	ST-4916	
		after MAR 1, Lower Spring Isolator	ST-4921	
	1986-94	before MAR 1, Lower Spring Isolator	ST-3980	
			ST-1908	
Upper Spring Seat & Isolator		ST-4916		
1984-85	Lower Spring Isolator	ST-3980		
		ST-1907		
<b>PONTIAC PASSENGER CAR</b>				
6000	1985-91	AWD	ST-1934	
		FWD	ST-1934	ST-1951
		Upper Spring Seat & Isolator	ST-3971	
	1984		ST-1934	ST-1951
	w/ HD Suspension, Upper Spring Seat & Isolator	ST-3971		
	1982-83		ST-1934	
BONNEVILLE	2000-05		ST-2972	ST-2998
	1991-99		ST-1922	ST-1953
		Bearing Only	ST-1928	
		Upper Spring Seat & Isolator	ST-3973	
		exc Computer Command Ride, Lower Spring Isolator	ST-4925	
	1990	w/ Spring Guard	ST-1973	
		w/o Spring Guard	ST-1922	
				ST-1953
Bearing Only		ST-1928		
w/ Spring Guard, Upper Spring Seat & Isolator		ST-3974		
	w/o Spring Guard, Upper Spring Seat & Isolator	ST-3973		
	w/ Spring Guard, Lower Spring Isolator	ST-4923		



## Suspension Strut Mounts

Model	Years	Location/ Options	Front	Rear
<b>PONTIAC PASSENGER CAR (continued)</b>				
BONNEVILLE	1990	w/o Spring Guard, Lower Spring Isolator	ST-4925	
	1987-89		ST-1973	ST-1953
		Bearing Only	ST-1928	
		Upper Spring Seat & Isolator	ST-3974	
		Lower Spring Isolator	ST-4923	
FIERO	1984-88			ST-2916
FIREBIRD	1993-02	Left Side	ST-2947	
		Right Side	ST-2948	
		Upper Spring Isolator	ST-3933	
		Lower Spring Seat	ST-4962	
	1982-92	Left Side	ST-1924	
		Right Side	ST-1923	
FIREFLY	1995-00		ST-1987	
	1989-91		ST-1987	ST-1988
	1985-88		ST-2933	
G3 Wave	2009		ST-5906	ST-5981
G3	2007-09		ST-5906	ST-5981
G5	2007-09		ST-5907	
G6	2005-10	Left Side	ST-5909	
		Right Side	ST-5908	
				ST-7990
G8	2008-09		ST-3932	
GRAND AM	1999-05		ST-2999	ST-3900
		Upper Spring Isolator	ST-4944	
		Lower Spring Isolator	ST-4945	
	1995-98		ST-4912	ST-1951
		Bearing Only	ST-1928	
		Upper Spring Seat & Isolator	ST-3970	
	1992-94		ST-1946	ST-1951
		Bearing Only	ST-1928	
		Upper Spring Seat & Isolator	ST-3972	
	1985-91		ST-1913	ST-1951
Upper Spring Seat & Isolator		ST-3969		
	Lower Spring Isolator	ST-4924		
GRAND PRIX	2004-08	Left Side, exc w/ 17" or 18" wheels	ST-2973	ST-2969
		Right Side, exc w/ 17" or 18" wheels	ST-2973	ST-2968
	1997-03	Left Side	ST-2973	ST-2969
		Right Side	ST-2973	ST-2968
		Upper Spring Isolator	ST-4942	
		Lower Spring Isolator	ST-4943	ST-4941
	1988-96	w/ FWD	ST-1921	ST-2941
		Lower Spring Seat & Bearing - Left Side; w/ FWD	ST-2994	
		Lower Spring Seat & Bearing - Right Side; w/ FWD	ST-2995	
GTO	2004-06		ST-3932	
J2000	1982-84		ST-1913	
		Upper Spring Seat & Isolator	ST-3969	
		Lower Spring Isolator	ST-4924	
LEMANS	1988-93		ST-1995	
OPTIMA	1988-91		ST-1995	
PHOENIX	1984		ST-1934	ST-1951
		Upper Spring Seat & Isolator	ST-3971	
	1982-83		ST-1934	
PURSUIT	2005-06		ST-5907	
		Upper Spring Isolator	ST-7909	
		Upper Spring Seat	ST-7908	
		Lower Spring Isolator	ST-7910	
SUNBIRD	1992-94		ST-1929	ST-1951

## Suspension Strut Mounts

Model	Years	Location/ Options	Front	Rear
<b>PONTIAC PASSENGER CAR (continued)</b>				
SUNBIRD	1992-94	Upper Spring Seat & Isolator	ST-3969	
	1985-91		ST-1913	ST-1951
		Upper Spring Seat & Isolator	ST-3969	
		Lower Spring Isolator	ST-4924	
SUNBURST	1985-88		ST-1932	
SUNFIRE	2000-05		ST-4919	ST-2949
		Upper Spring Isolator	ST-4939	
		Lower Spring Isolator	ST-4940	
			ST-4912	
	1999	1st Design	ST-4912	
		2nd Design	ST-4919	
				ST-2949
		Upper Spring Isolator	ST-4939	
		Lower Spring Isolator	ST-4940	
	1995-98		ST-4912	ST-2949
Bearing Only		ST-1928		
Lower Spring Isolator		ST-4940		
SUNRUNNER	1994-97		ST-1994	
TEMPEST	1987-91		ST-1929	ST-1951
		Lower Spring Isolator	ST-4924	
VIBE	2009-10		ST-8942	ST-4990
	2003-08		ST-4935	ST-4990
		Upper Spring Seat	ST-7982	
		Upper Spring Seat	ST-7981	
		Lower Spring Isolator	ST-6936	
WAVE	2005-08		ST-5906	ST-5981
<b>PONTIAC SPORT UTILITY</b>				
AZTEK	2001-05	FWD	ST-2973	
		Upper Spring Isolator	ST-4942	
		w/ AWD - Upper Spring Seat & Isolator	ST-3973	
		Lower Spring Isolator	ST-4943	
TORRENT	2007-09		ST-6956	
	2006		ST-5980	
		Upper Spring Isolator	ST-8954	
<b>PONTIAC VAN</b>				
MONTANA	1999-09		ST-2973	
		Upper Spring Isolator	ST-4942	
		Lower Spring Isolator	ST-4943	
TRANS SPORT	1997-98		ST-2973	
		Upper Spring Isolator	ST-4942	
		Lower Spring Isolator	ST-4943	
	1990-96		ST-1934	ST-1951
		Upper Spring Seat & Isolator	ST-3971	
<b>PORSCHE SUV</b>				
MACAN	2015	exc Auto Leveling System		ST-10008
<b>RAM TRUCK</b>				
1500 PICKUP	2011-18	4WD		
DAKOTA	2010-11			
<b>RAM VAN</b>				
C/V (CARGO VAN)	2012-15		ST-6960	

## Suspension Strut Mounts

Model	Years	Location/ Options	Front	Rear
<b>RENAULT PASSENGER CAR</b>				
ALLIANCE	1983-87		ST-2909	
CLIO (MEXICAN VEHICL	2002-10		ST-98002	
ENCORE	1984-86		ST-2909	
<b>RENAULT VAN</b>				
KANGOO (MEXICO)	2007-09		ST-98002	
<b>SAAB PASSENGER CAR</b>				
9-3	2003-11		ST-6985	
	1999-02		ST-3961	
9-3X	2010-11		ST-6985	
9-5	2010-11			ST-7988
				ST-7989
	1999-08		ST-3959	
900	1994-98		ST-3960	
9000	1986-98	exc self leveling system	ST-2987	
<b>SAAB SUV</b>				
9-7X	2005-09		ST-4968	
<b>SATURN PASSENGER CAR</b>				
AURA	2007-09	Left Side	ST-5909	
		Right Side	ST-5908	
				ST-7990
ION	2003-07	Bushing Kit	ST-5948	
		Stud Plate Only	ST-8953	
		Upper Spring Seat	ST-8952	
L100	2001-02		ST-4915	ST-4987
L200	2001-03		ST-4915	ST-4987
L300	2001-05		ST-4915	ST-4987
LS	2000		ST-4915	ST-4987
LS1	2000		ST-4915	ST-4987
LS2	2000		ST-4915	
LW1	2000		ST-4915	ST-4987
LW2	2000		ST-4915	ST-4987
LW200	2001-03		ST-4915	ST-4987
LW300	2001-03		ST-4915	ST-4987
SC	1991-92		ST-1950	ST-1964
		Upper Spring Seat	ST-6928	
SC1	1993-02		ST-1950	ST-1964
		Upper Spring Seat	ST-6928	
SC2	1993-02		ST-1950	ST-1964
		Upper Spring Seat	ST-6928	
SL	1991-02		ST-1950	ST-1964
		Upper Spring Seat	ST-6928	
SL1	1991-02		ST-1950	ST-1964
		Upper Spring Seat	ST-6928	
SL2	1991-02		ST-1950	ST-1964
		Upper Spring Seat	ST-6928	
SW1	1993-99		ST-1950	ST-1964
		Upper Spring Seat	ST-6928	
SW2	1993-01		ST-1950	ST-1964
		Upper Spring Seat	ST-6928	

## Suspension Strut Mounts

Model	Years	Location/ Options	Front	Rear
<b>SATURN SUV</b>				
OUTLOOK	2007-10		ST-7986	
		Upper Spring Isolator	ST-9923	
		Lower Spring Isolator	ST-9924	
VUE	2008-10		ST-6956	
	2006-07		ST-5949	
		Upper Spring Isolator	ST-6921	
		Upper Spring Seat	ST-6922	
2002-05		ST-5949		
<b>SATURN VAN</b>				
RELAY	2005-07		ST-2973	
		Upper Spring Isolator	ST-4942	
		Lower Spring Isolator	ST-4943	
<b>SCION PASSENGER CAR</b>				
IM	2016		ST-6988	
TC	2011-16		ST-6987	
	2005-10		ST-7943	ST-4990
		Upper Spring Isolator	ST-9931	
		Upper Spring Seat	ST-9962	
XA	2004-05		ST-4988	
XD	2008-14		ST-6989	
<b>SCION VAN</b>				
XB	2008-15		ST-6988	
	2004-06		ST-4988	
<b>SEAT PASSENGER CAR</b>				
CORDOBA	2001-09	REAR		
IBIZA	2002-18	REAR		
LEON	2001-19	REAR		
TOLEDO	2001-06	REAR		
<b>SMART</b>				
FORTWO	2008-14		ST-10011	
<b>SUBARU PASSENGER CAR</b>				
DL	1986-89	Coupe, exc 4WD w/ Air Suspension	ST-2913	ST-3985
		Sedan & Wagon, exc 4WD; w/o Air Suspension	ST-2913	ST-3984
	1985	Sedan & Wagon, exc 4WD; w/o Air Suspension	ST-2913	ST-3984
	1980-84	2WD	ST-2931	
4WD		ST-2931		
GL	1986-89	Coupe, Sedan & Wagon, w/o Air Suspension	ST-2913	
		Hatchback	ST-2931	
		Coupe, exc Air Suspension		ST-3985
		Sedan & Wagon, exc Air Suspension		ST-3984
	1985	Hatchback	ST-2931	
		Sedan & Wagon, exc Air Suspension	ST-2913	ST-3984
1980-84	2WD	ST-2931		
	4WD	ST-2931		
IMPREZA	2008-13		ST-8926	
	2004-07		ST-2924	ST-5950
	2002-03	Left Side, exc WXR	ST-2924	ST-3987
		Right Side, exc WXR	ST-2924	ST-3986
		Exc. WRX		ST-6936
	1993-01	2WD	ST-2924	
AWD		ST-2924	ST-3983	
Lower Spring Isolator			ST-6952	
LEGACY	2010-14		ST-2924	
	2008-09	Exc. Spec. B Model	ST-8926	ST-4934

## Suspension Strut Mounts

Model	Years	Location/ Options	Front	Rear	
<b>SUBARU PASSENGER CAR (continued)</b>					
LEGACY	2007	Exc. Spec. B Model	ST-8926	ST-4934	
	2006	Exc. Spec. B Model	ST-8926	ST-4934	
	2005		ST-8926	ST-4934	
	2000-04	exc air suspension	ST-2924	ST-4934	
	1997-99		AWD, exc air suspension, Left Side	ST-2924	ST-3987
			AWD, exc air suspension, Right Side	ST-2924	ST-3986
			Lower Spring Isolator	ST-6946	ST-6952
	1995-96		2WD, exc air suspension, Left Side	ST-2924	ST-3989
			AWD, exc air suspension, Left Side	ST-2924	ST-3987
			2WD, exc air suspension, Right Side	ST-2924	ST-3988
			AWD, exc air suspension, Right Side	ST-2924	ST-3986
			Lower Spring Isolator	ST-6946	ST-6952
	1992-94		2WD, exc air suspension	ST-2924	
		AWD, exc air suspension	ST-2924	ST-3983	
		Lower Spring Isolator	ST-6946	ST-6952	
1990-91		exc air suspension	ST-2924		
		Lower Spring Isolator		ST-6952	
LOYALE	1990-94	2WD & 4WD	ST-2913	ST-3984	
XT	1990-91	2WD, exc XT6 & air suspension	ST-2913	ST-3984	
		4WD, exc XT6 & air suspension	ST-2913	ST-3985	
	1985-89	4WD, exc XT6 & air suspension	ST-2913	ST-3985	
		2WD, exc XT6 & air suspension		ST-3984	
<b>SUBARU SPORT UTILITY</b>					
BAJA	2003-06		ST-2924	ST-4934	
BRAT	1983-87	4WD	ST-2931		
FORESTER	2009-13		ST-8926		
	2006-08	AWD	ST-2924	ST-5950	
	2003-05		ST-2924	ST-5950	
	1998-02		Left Side	ST-2924	ST-3987
		Right Side	ST-2924	ST-3986	
		Lower Spring Isolator	ST-6946		
TRIBECA	2006-14			ST-8918	
OUTBACK	2010-14		ST-2924		
	2005-09		ST-8926	ST-4934	
	2000-04		ST-2924	ST-4934	
<b>SUZUKI PASSENGER CAR</b>					
AERIO	2002-07		ST-5951	ST-5953	
ESTEEM	2000-02		ST-5951	ST-5953	
	1995-99		ST-5951	ST-5952	
FORENZA	2004-08		ST-8946	ST-8947	
RENO	2005-08		ST-8946	ST-8947	
SWIFT	2004-08		ST-5906	ST-5981	
	1989-01		ST-1987	ST-1988	
<b>SUZUKI SPORT UTILITY</b>					
GRAND VITARA	2006-13		ST-8919		
	1999-05	2WD & 4WD	ST-4932		
SIDEKICK	1989-98		ST-1994		
VITARA	1999-04	L4 2.0L & V6 2.5L,*	ST-4932		
	1999-02	L4 1.6L,*	ST-4933		
X-90	1996-98		ST-1994		
XL-7	2007-09		ST-6956		
	2005-06		ST-4932		

## Suspension Strut Mounts

Model	Years	Location/ Options	Front	Rear
<b>SUZUKI TRUCK</b>				
FORSA	1985-88		ST-2933	
<b>TOYOTA PASSENGER CAR</b>				
AVALON	2006-12	Lower Spring Isolator		ST-8965
			ST-6986	ST-8966
	2004	Left Side	ST-3906	ST-3904
		Right Side	ST-3903	ST-3904
	1997-03	Left Side	ST-3906	ST-3904
		Right Side	ST-3903	ST-3904
		Upper Spring Seat & Isolator	ST-4950	
		Lower Spring Isolator	ST-4951	ST-4953
	1995-96		ST-3991	ST-2927
		Upper Spring Seat & Isolator	ST-4950	
		Lower Spring Isolator	ST-4951	ST-4953
		Upper Spring Isolator		ST-4952
CAMRY	2007-11		ST-6986	ST-8966
		Lower Spring Isolator	ST-6935	ST-8965
	2004-06		ST-4989	ST-3904
		Lower Spring Isolator	ST-6935	ST-6935
	2002-03		ST-4989	ST-3904
	1997-01	Left Side	ST-3906	ST-3904
		Right Side	ST-3903	ST-3904
		Upper Spring Seat & Isolator	ST-4950	
		Lower Spring Isolator	ST-4951	ST-4953
	1995-96		ST-3991	ST-2927
		Upper Spring Seat & Isolator	ST-4950	
		Lower Spring Isolator	ST-4951	ST-4953
		Upper Spring Isolator		ST-4952
	1992-94		ST-2926	ST-2927
		Upper Spring Isolator	ST-6937	ST-4952
Lower Spring Isolator		ST-5997	ST-4953	
1988-91		2WD, exc ABS Brakes	ST-1944	ST-1962
		4WD, exc ABS Brakes	ST-1944	ST-1958
1987			ST-6936	
		exc ABS Brakes	ST-1944	ST-1962
1983-86		ST-1943	ST-1958	
CELICA	2000-05		ST-4935	ST-4990
		Lower Spring Isolator	ST-6936	
	1994-99		ST-3992	ST-2957
	1990-93	AWD	ST-1979	
		FWD	ST-1979	ST-2957
1986-89		ST-1979	ST-1958	
1975-85		ST-1993		
COROLLA	2016-17		ST-8942	ST-4990
	2014-15		ST-8942	ST-4990
		Upper Spring Seat	ST-9955	
	2009-13		ST-8942	ST-4990
		Upper Spring Isolator	ST-9956	
		Upper Spring Seat	ST-9955	
		Lower Spring Isolator	ST-9957	
	2003-08		ST-5957	
		Bushing Kit		ST-4990
		Stud Plate; Left Side		ST-8989
		Stud Plate; Right Side		ST-8988
Upper Spring Isolator		ST-9956		
Upper Spring Seat		ST-9962		
Lower Spring Isolator	ST-6936			

## Suspension Strut Mounts

Model	Years	Location/ Options	Front	Rear
<b>TOYOTA PASSENGER CAR (continued)</b>				
COROLLA	1993-02	Upper Spring Isolator	ST-5912	ST-2901
		Lower Spring Isolator	ST-5947	
			ST-5960	ST-5961
	1989-92	2WD, Wagon	ST-5912	ST-2901
		4WD, Wagon	ST-5912	
		FWD	ST-5912	
		GTS Coupe		ST-2901
	1988	2WD, Wagon	ST-5912	ST-2901
		4WD, Wagon	ST-5912	
		FX & FX16	ST-1943	ST-1958
		GTS Coupe		ST-2901
	1984-87	FWD	ST-1943	ST-1958
		RWD, w/ Power Steering, Left Side	ST-1912	
		RWD, w/o Power Steering, Left Side	ST-1910	
		RWD, w/ Power Steering, Right Side	ST-1911	
RWD, w/o Power Steering, Right Side		ST-1909		
1982-83	Left Side	ST-1910		
	Right Side	ST-1909		
1980-81		ST-1968		
1975-79		ST-1996		
1974	after AUG 1	ST-1996		
	before AUG 1	ST-1968		
1970-73		ST-1968		
CORONA	1980-82		ST-1993	
CRESSIDA	1989-92		ST-2912	ST-2988
	1985-88		ST-2912	
	1978-82		ST-1948	
ECHO	2000-05	Centered Hole Placement	ST-5900	
		Offset Hole Placement	ST-4988	
MATRIX	2009-13	Upper Spring Isolator	ST-8942	ST-4990
		Upper Spring Seat	ST-9956	ST-8990
		Upper Spring Seat	ST-9955	
		Lower Spring Isolator	ST-9957	
	2007-08	FWD	ST-4935	
		Upper Spring Seat		ST-4990
		Upper Spring Seat	ST-7982	
		Lower Spring Isolator	ST-7981	
	2003-06	Upper Spring Seat	ST-6936	
		Upper Spring Seat	ST-4935	ST-4990
Lower Spring Isolator		ST-7982		
		ST-7981		
		ST-6936		
MR2 SPYDER	2000-05		ST-5957	ST-8922
MR2	1991-95		ST-3990	
PASEO	1996-97	Lower Spring Isolator	ST-1983	ST-2986
			ST-6947	
	1995	after AUG 1	ST-1983	ST-2986
		before AUG 1		ST-1984
	Lower Spring Isolator	ST-6947		
	1992-94			ST-1984
PRIUS	2010-15	Upper Spring Isolator	ST-6987	
			ST-9931	
	2004-09	Upper Spring Isolator	ST-5957	ST-4990
		Upper Spring Seat	ST-9956	
		Upper Spring Seat	ST-9962	
2001-03		ST-4991	ST-4990	
PRIUS C	2012-13		ST-6989	
PRIUS V	2012-15	Upper Spring Isolator	ST-9931	

## Suspension Strut Mounts

Model	Years	Location/ Options	Front	Rear	
<b>TOYOTA PASSENGER CAR (continued)</b>					
PRIUS PLUG-IN	2012-15		ST-6987		
SOLARA	2007-08		ST-4989	ST-8966	
				ST-8965	
	2004-06		ST-4989		
		Lower Spring Isolator	ST-6935	ST-6935	
	1999-03		Left Side	ST-3906	ST-3904
			Right Side	ST-3903	ST-3904
		Upper Spring Seat & Isolator	ST-4950		
	Lower Spring Isolator	ST-4951	ST-4953		
STARLET	1981-84		ST-1968		
SUPRA	1994-98			ST-4902	
	1987-93	Exc Toyota Elec Modulated Suspension	ST-3994	ST-3993	
	1986	after MAR 1, exc Elec Modulating Suspension	ST-3994	ST-3993	
		before MAR 1	ST-2912		
TERCEL	1995-99	Sedan	ST-1983	ST-2986	
		Lower Spring Isolator	ST-6947		
	1991-94	Sedan		ST-1984	
	1989-90	Sedan & Hatchback	ST-1969	ST-1984	
	1987-88	2WD, Wagon	ST-1967	ST-1958	
		4WD, Wagon	ST-1967		
	1983-86	Sedan & Hatchback	ST-1969	ST-1984	
		4WD, Wagon	ST-1967		
		FWD	ST-1967	ST-1958	
		1980-82		ST-1968	
YARIS	2007-13		ST-6989		
<b>TOYOTA SPORT UTILITY</b>					
4RUNNER	2003-11		ST-7922		
	1996-02		ST-4900		
FJ CRUISER	2007-10		ST-7922		
HIGHLANDER	2008-13		ST-6986		
		Left Side		ST-8921	
		Right Side		ST-8920	
		Upper Spring Isolator; Exc. Air Suspension	ST-9943		
		Upper Spring Seat	ST-9942		
	2004-07		Left Side	ST-4989	ST-5937
			Right Side	ST-4989	ST-5936
			Upper Spring Isolator; Exc. Air Suspension	ST-9943	
			Upper Spring Seat	ST-9942	
		2001-03		ST-4989	ST-3904
RAV4	2009-12		ST-6987		
		Upper Spring Isolator	ST-9931		
	2006-08	1 Piece Assembly	ST-6988		
		2-Piece Assembly	ST-6987		
	1996-05		ST-3995		
		Upper Spring Isolator	ST-9940		
	Upper Spring Seat	ST-9939			
SEQUOIA	2008-17		ST-7923		
VENZA	2009-11		ST-6986		
<b>TOYOTA TRUCK</b>					
PICKUP	1980-83		ST-1903		
TACOMA	2014-15		ST-7921		
	2005-13	4WD	ST-7921		
		RWD, Base model	ST-9913		
		RWD; Pre-Runner Model	ST-7921		
	1995-04	Stud Plate Only	ST-7927		
TUNDRA	2007-16		ST-7923		
		Upper Spring Isolator	ST-7924		



## Suspension Strut Mounts

Model	Years	Location/ Options	Front	Rear
<b>TOYOTA TRUCK (continued)</b>				
TUNDRA	2000-06		ST-7925	
		Upper Spring Isolator	ST-7926	
<b>TOYOTA VAN</b>				
PREVIA	1991-97		ST-1944	
SIENNA	2004-08		ST-4989	
	1998-03	Left Side	ST-3906	
		Right Side	ST-3903	
<b>VOLKSWAGEN PASSENGER CAR</b>				
BEETLE	2012-19	w/o Magnetic Ride Control Suspension	ST-7949	ST-7947
	1998-10		ST-4905	ST-4910
CC	2009-14		ST-7949	ST-8923
CABRIO	1995-02		ST-2906	ST-1966
		Upper Spring Seat		ST-3962
CABRIOLET	1985-93		ST-1903	ST-1966
CORRADO	1993-94		ST-2906	ST-1966
		Upper Spring Seat		ST-3962
	1992	G60	ST-1904	
		SLC, V6	ST-2906	
		Upper Spring Seat		ST-1966
1990-91	Upper Spring Seat	ST-1904	ST-1966	
DASHER	1974-81		ST-1903	
EOS	2007-11		ST-7949	ST-7947
FOX	1987-93	Sedan	ST-1941	ST-4906
		Station Wagon	ST-1941	
GOLF	2010-15		ST-7949	ST-7947
	1999-07		ST-4905	ST-4910
	1996-98	exc ABS Brakes	ST-2906	ST-1966
		exc ABS Brakes, Upper Spring Seat		ST-3962
	1993-95	Exc. GTi	ST-2906	ST-1966
		GTi	ST-1904	ST-1966
1985-92	exc ABS Brakes, Upper Spring Seat		ST-3962	
	Upper Spring Seat	ST-1904	ST-1966	
				ST-3962
GOLF CITY	2007-09		ST-4905	ST-4910
GTI	2006-14		ST-7949	ST-7947
JETTA	2006-14		ST-7949	ST-7947
	2005	From 5/05	ST-7949	ST-7947
		To 4/05	ST-4905	ST-4910
	1999-04		ST-4905	ST-4910
	1993-98	exc ABS Brakes	ST-2906	ST-1966
		exc ABS Brakes, Upper Spring Seat	ST-5946	ST-3962
		exc ABS brakes, Upper Spring Isolator		ST-5963
1985-92		ST-1904	ST-1966	
1980-84		ST-1903	ST-1966	
PASSAT	2012-15		ST-7949	ST-8923
	2006-10		ST-7949	
	2001-05		ST-4992	ST-4909
	1998-00	AWD	ST-4908	
		FWD	ST-4908	ST-4909
	1993-97		ST-2906	ST-2990
1990-92		ST-1904	ST-2990	
PASSAT CC	2009-10		ST-7949	
POLO (MEXICAN VEHIC	2013-17	REAR		
	2003-07	REAR		
QUANTUM	1982-88		ST-1942	ST-4907

## Suspension Strut Mounts

Model	Years	Location/ Options	Front	Rear
<b>VOLKSWAGEN PASSENGER CAR (continued)</b>				
R32	2008		ST-7949	
RABBIT	2006-09		ST-7949	ST-7947
	1975-84		ST-1903	ST-1966
RABBIT CONVERTIBLE	1980-84		ST-1903	ST-1966
SCIROCCO	1975-89		ST-1903	ST-1966
SUPER BEETLE	1974-79		ST-1941	
	1973	after AUG 1	ST-1941	
TIGUAN	2009-15		ST-7949	ST-8923
<b>VOLKSWAGEN TRUCK</b>				
RABBIT PICKUP	1980-83		ST-1903	
<b>VOLKSWAGEN VAN</b>				
ROUTAN	2009-12	exc. NIVOMAT Rear Suspension	ST-6960	
<b>VOLVO PASSENGER CAR</b>				
240	1990-93	exc. NIVOMAT Rear Suspension	ST-1981	
242	1975-84	exc. NIVOMAT Rear Suspension	ST-1981	
244	1975-89	exc. NIVOMAT Rear Suspension	ST-1981	
245	1975-89	exc. NIVOMAT Rear Suspension	ST-1981	
262	1978-81	exc. NIVOMAT Rear Suspension	ST-1981	
	1976	exc. NIVOMAT Rear Suspension	ST-1981	
264	1976-82	exc. NIVOMAT Rear Suspension	ST-1981	
265	1976-81	exc. NIVOMAT Rear Suspension	ST-1981	
740	1985-92		ST-2911	
745	1985		ST-2911	
760	1983-90		ST-2911	
780	1987-91		ST-2911	
850	1993-97	exc. NIVOMAT Rear Suspension	ST-4903	ST-4904
		Upper Spring Seat, Exc Nivomat Rear Suspension	ST-3978	
940	1991-95		ST-2911	
960	1992-97		ST-2911	
C30	2007-12		ST-6980	
C70	2008-12		ST-6980	
	2006-07		ST-4903	
		Upper Spring Seat	ST-3978	
1998-04		ST-4903	ST-4904	
		Upper Spring Seat	ST-3978	
DL	1984	exc. NIVOMAT Rear Suspension	ST-1981	
GLE	1984	exc. NIVOMAT Rear Suspension	ST-1981	
S40	2005-11	FWD	ST-6980	
	2004	Base & LSE Model	ST-5959	
		T5 Model	ST-6980	
		Base, i. & LSE Models		ST-6990
	2001-03		ST-5959	ST-6990
2000	From 4/1/00	ST-5959		
	To 3/31/00	ST-5958		
S60	2001-06		ST-4903	
		Upper Spring Seat	ST-3978	
		Lower Spring Isolator	ST-6941	
S70	1998-00	exc Auto Rear Leveling	ST-4903	ST-4904
		Upper Spring Seat exc Auto Rear Leveling	ST-3978	
S80	1999-06	exc. NIVOMAT Rear Suspension	ST-4903	ST-7946
		exc. NIVOMAT Rear Suspension, Upper Spring Seat	ST-3978	
		Lower Spring Isolator	ST-6941	
S90	1997-98		ST-2911	

## Suspension Strut Mounts

Model	Years	Location/ Options	Front	Rear
<b>VOLVO PASSENGER CAR (continued)</b>				
V40	2001-03		ST-5959	ST-6990
	2000	From 4/1/00	ST-5959	
		To 3/31/00	ST-5958	
				ST-6990
V50	2005-11	FWD	ST-6980	
V70	2001-07	w/o Electronic Suspension	ST-4903	ST-7946
		w/o Electronic Suspension; Upper Spring Seat	ST-3978	
		Lower Spring Isolator	ST-6941	
	1998-00	Upper; Upper Washer		
w/o Electronic Suspension		ST-4903		
		w/o Electronic Suspension; Upper Spring Seat	ST-3978	
V90	1997-98		ST-2911	
<b>VOLVO SPORT UTILITY</b>				
XC70	2003-07		ST-4903	
XC90	2003-14		ST-4903	
		Upper Spring Seat	ST-3978	

# BUYER'S GUIDE

## NUMERICAL LISTING - ILLUSTRATIONS

 <p><b>AS-7318</b> <b>MOUNT-TRANSMISSION</b> Auto</p> <p>BMW SPORT UTILITY ..... 2004-06</p>	 <p><b>DS-5224</b> <b>ASSEMBLY</b></p> <p>DODGE TRUCK ..... 1987-91</p>	 <p><b>DS-5228</b> <b>ASSEMBLY</b> FRONT</p> <p>LEXUS SPORT UTILITY ..... 2001-13 TOYOTA SPORT UTILITY ..... 2001-13</p>	 <p><b>DS-5232</b> <b>BUSHINGS</b></p> <p>MERCEDES-BENZ PASSENGER CAR ..... 1984-89</p>
 <p><b>DS-5222</b> <b>ASSEMBLY</b></p> <p>HONDA SPORT UTILITY ..... 1994-98</p>	 <p><b>DS-5225</b> <b>ASSEMBLY</b></p> <p>TOYOTA TRUCK ..... 1993-19</p>	 <p><b>DS-5229</b> <b>ASSEMBLY</b> REAR</p> <p>LEXUS SPORT UTILITY ..... 2001-13 TOYOTA SPORT UTILITY ..... 2001-13</p>	 <p><b>DS-5234</b> <b>BUSHINGS</b></p> <p>MAZDA TRUCK ..... 1987-93</p>
 <p><b>DS-5223</b> <b>ASSEMBLY</b></p> <p>ISUZU SPORT UTILITY ..... 1991-97</p>	 <p><b>DS-5226</b> <b>ASSEMBLY</b></p> <p>TOYOTA TRUCK ..... 1995-98</p>	 <p><b>DS-5230</b> <b>ASSEMBLY</b></p> <p>TOYOTA VAN ..... 2004-14</p>	 <p><b>DS-5235</b> <b>ASSEMBLY</b></p> <p>HONDA SPORT UTILITY ..... 1997-01</p>
	 <p><b>DS-5227</b> <b>ASSEMBLY</b></p> <p>TOYOTA TRUCK ..... 1995-19</p>	 <p><b>DS-5236</b> <b>ASSEMBLY</b></p> <p>BMW PASSENGER CAR ..... 2004-16 BMW SPORT UTILITY ..... 2004-10</p>	 <p><b>DS-5236</b> <b>ASSEMBLY</b></p> <p>BMW PASSENGER CAR ..... 2004-16 BMW SPORT UTILITY ..... 2004-10</p>
	 <p><b>DS-5231</b> <b>ASSEMBLY</b></p> <p>TOYOTA SPORT UTILITY ..... 1989-95</p>	 <p><b>DS-6024</b> <b>ASSEMBLY</b></p> <p>BMW PASSENGER CAR ..... 2004-17 BMW SPORT UTILITY ..... 2012-15</p>	 <p><b>DS-6024</b> <b>ASSEMBLY</b></p> <p>BMW PASSENGER CAR ..... 2004-17 BMW SPORT UTILITY ..... 2012-15</p>

# BUYER'S GUIDE

## NUMERICAL LISTING - ILLUSTRATIONS

 <p style="text-align: center;"><b>DS-6027 BUSHINGS</b></p> <table style="width: 100%; border-collapse: collapse;"> <tr><td>CHEVROLET PASSENGER CAR</td><td>1968-82</td></tr> <tr><td>CHEVROLET SPORT UTILITY</td><td>1967-99</td></tr> <tr><td>CHEVROLET TRUCK</td><td>1961-04</td></tr> <tr><td>CHEVROLET VAN</td><td>1964-98</td></tr> <tr><td>DODGE MEDIUM/HEAVY DUTY</td><td>1978-81</td></tr> <tr><td>DODGE TRUCK</td><td>1960-02</td></tr> <tr><td>FORD MEDIUM/HEAVY DUTY</td><td>1975-97</td></tr> <tr><td>FORD TRUCK</td><td>1957-98</td></tr> <tr><td>FORD VAN</td><td>1968-98</td></tr> <tr><td>GMC SPORT UTILITY</td><td>1967-99</td></tr> <tr><td>GMC TRUCK</td><td>1966-02</td></tr> <tr><td>GMC VAN</td><td>1964-98</td></tr> <tr><td>ISUZU TRUCK</td><td>1996-99</td></tr> </table>	CHEVROLET PASSENGER CAR	1968-82	CHEVROLET SPORT UTILITY	1967-99	CHEVROLET TRUCK	1961-04	CHEVROLET VAN	1964-98	DODGE MEDIUM/HEAVY DUTY	1978-81	DODGE TRUCK	1960-02	FORD MEDIUM/HEAVY DUTY	1975-97	FORD TRUCK	1957-98	FORD VAN	1968-98	GMC SPORT UTILITY	1967-99	GMC TRUCK	1966-02	GMC VAN	1964-98	ISUZU TRUCK	1996-99	 <p style="text-align: center;"><b>DS-6035 ASSEMBLY</b></p> <table style="width: 100%; border-collapse: collapse;"> <tr><td>CHEVROLET PASSENGER CAR</td><td>1958-64</td></tr> <tr><td>CHEVROLET SPORT UTILITY</td><td>1961-99</td></tr> <tr><td>CHEVROLET TRUCK</td><td>1959-04</td></tr> <tr><td>CHEVROLET VAN</td><td>1962-98</td></tr> <tr><td>GMC SPORT UTILITY</td><td>1967-99</td></tr> <tr><td>GMC TRUCK</td><td>1966-02</td></tr> <tr><td>GMC VAN</td><td>1964-98</td></tr> <tr><td>INTERNATIONAL MEDIUM/HEAVY DUTY TRUCK</td><td>1986-02</td></tr> </table>	CHEVROLET PASSENGER CAR	1958-64	CHEVROLET SPORT UTILITY	1961-99	CHEVROLET TRUCK	1959-04	CHEVROLET VAN	1962-98	GMC SPORT UTILITY	1967-99	GMC TRUCK	1966-02	GMC VAN	1964-98	INTERNATIONAL MEDIUM/HEAVY DUTY TRUCK	1986-02	 <p style="text-align: center;"><b>DS-6040 ASSEMBLY</b></p> <table style="width: 100%; border-collapse: collapse;"> <tr><td>CHEVROLET SPORT UTILITY</td><td>1967-99</td></tr> <tr><td>CHEVROLET TRUCK</td><td>1961-04</td></tr> <tr><td>DODGE MEDIUM/HEAVY DUTY</td><td>1978-81</td></tr> <tr><td>DODGE TRUCK</td><td>1960-02</td></tr> <tr><td>FORD MEDIUM/HEAVY DUTY</td><td>1975-97</td></tr> <tr><td>FORD TRUCK</td><td>1957-59</td></tr> <tr><td>GMC SPORT UTILITY</td><td>1967-99</td></tr> <tr><td>GMC TRUCK</td><td>1966-02</td></tr> <tr><td>INTERNATIONAL MEDIUM/HEAVY DUTY TRUCK</td><td>1986-02</td></tr> </table>	CHEVROLET SPORT UTILITY	1967-99	CHEVROLET TRUCK	1961-04	DODGE MEDIUM/HEAVY DUTY	1978-81	DODGE TRUCK	1960-02	FORD MEDIUM/HEAVY DUTY	1975-97	FORD TRUCK	1957-59	GMC SPORT UTILITY	1967-99	GMC TRUCK	1966-02	INTERNATIONAL MEDIUM/HEAVY DUTY TRUCK	1986-02	 <p style="text-align: center;"><b>DS-6049 ASSEMBLY</b></p> <table style="width: 100%; border-collapse: collapse;"> <tr><td>CHEVROLET SPORT UTILITY</td><td>1967-99</td></tr> <tr><td>CHEVROLET TRUCK</td><td>1961-04</td></tr> <tr><td>DODGE MEDIUM/HEAVY DUTY</td><td>1978-81</td></tr> <tr><td>DODGE TRUCK</td><td>1960-02</td></tr> <tr><td>FORD MEDIUM/HEAVY DUTY</td><td>1975-97</td></tr> <tr><td>FORD TRUCK</td><td>1957-59</td></tr> <tr><td>GMC SPORT UTILITY</td><td>1967-99</td></tr> <tr><td>GMC TRUCK</td><td>1966-02</td></tr> <tr><td>INTERNATIONAL MEDIUM/HEAVY DUTY TRUCK</td><td>1986-02</td></tr> </table>	CHEVROLET SPORT UTILITY	1967-99	CHEVROLET TRUCK	1961-04	DODGE MEDIUM/HEAVY DUTY	1978-81	DODGE TRUCK	1960-02	FORD MEDIUM/HEAVY DUTY	1975-97	FORD TRUCK	1957-59	GMC SPORT UTILITY	1967-99	GMC TRUCK	1966-02	INTERNATIONAL MEDIUM/HEAVY DUTY TRUCK	1986-02
CHEVROLET PASSENGER CAR	1968-82																																																																																
CHEVROLET SPORT UTILITY	1967-99																																																																																
CHEVROLET TRUCK	1961-04																																																																																
CHEVROLET VAN	1964-98																																																																																
DODGE MEDIUM/HEAVY DUTY	1978-81																																																																																
DODGE TRUCK	1960-02																																																																																
FORD MEDIUM/HEAVY DUTY	1975-97																																																																																
FORD TRUCK	1957-98																																																																																
FORD VAN	1968-98																																																																																
GMC SPORT UTILITY	1967-99																																																																																
GMC TRUCK	1966-02																																																																																
GMC VAN	1964-98																																																																																
ISUZU TRUCK	1996-99																																																																																
CHEVROLET PASSENGER CAR	1958-64																																																																																
CHEVROLET SPORT UTILITY	1961-99																																																																																
CHEVROLET TRUCK	1959-04																																																																																
CHEVROLET VAN	1962-98																																																																																
GMC SPORT UTILITY	1967-99																																																																																
GMC TRUCK	1966-02																																																																																
GMC VAN	1964-98																																																																																
INTERNATIONAL MEDIUM/HEAVY DUTY TRUCK	1986-02																																																																																
CHEVROLET SPORT UTILITY	1967-99																																																																																
CHEVROLET TRUCK	1961-04																																																																																
DODGE MEDIUM/HEAVY DUTY	1978-81																																																																																
DODGE TRUCK	1960-02																																																																																
FORD MEDIUM/HEAVY DUTY	1975-97																																																																																
FORD TRUCK	1957-59																																																																																
GMC SPORT UTILITY	1967-99																																																																																
GMC TRUCK	1966-02																																																																																
INTERNATIONAL MEDIUM/HEAVY DUTY TRUCK	1986-02																																																																																
CHEVROLET SPORT UTILITY	1967-99																																																																																
CHEVROLET TRUCK	1961-04																																																																																
DODGE MEDIUM/HEAVY DUTY	1978-81																																																																																
DODGE TRUCK	1960-02																																																																																
FORD MEDIUM/HEAVY DUTY	1975-97																																																																																
FORD TRUCK	1957-59																																																																																
GMC SPORT UTILITY	1967-99																																																																																
GMC TRUCK	1966-02																																																																																
INTERNATIONAL MEDIUM/HEAVY DUTY TRUCK	1986-02																																																																																
 <p style="text-align: center;"><b>DS-6028 BUSHINGS</b></p> <table style="width: 100%; border-collapse: collapse;"> <tr><td>CHEVROLET SPORT UTILITY</td><td>1967-99</td></tr> <tr><td>CHEVROLET TRUCK</td><td>1961-04</td></tr> <tr><td>CHEVROLET VAN</td><td>1964-98</td></tr> <tr><td>GMC SPORT UTILITY</td><td>1967-99</td></tr> <tr><td>GMC TRUCK</td><td>1966-02</td></tr> <tr><td>GMC VAN</td><td>1964-98</td></tr> </table>	CHEVROLET SPORT UTILITY	1967-99	CHEVROLET TRUCK	1961-04	CHEVROLET VAN	1964-98	GMC SPORT UTILITY	1967-99	GMC TRUCK	1966-02	GMC VAN	1964-98	 <p style="text-align: center;"><b>DS-6037 ASSEMBLY</b></p> <table style="width: 100%; border-collapse: collapse;"> <tr><td>BMW PASSENGER CAR</td><td>2007-13</td></tr> </table>	BMW PASSENGER CAR	2007-13	 <p style="text-align: center;"><b>DS-6042 ASSEMBLY</b></p> <table style="width: 100%; border-collapse: collapse;"> <tr><td>AUDI SPORTS UTILITY</td><td>2007-12</td></tr> <tr><td>PORSCHE SUV</td><td>2003-10</td></tr> <tr><td>VOLKSWAGEN SPORT UTILITY</td><td>2004-12</td></tr> </table>	AUDI SPORTS UTILITY	2007-12	PORSCHE SUV	2003-10	VOLKSWAGEN SPORT UTILITY	2004-12	 <p style="text-align: center;"><b>DS-6050 ASSEMBLY</b></p> <table style="width: 100%; border-collapse: collapse;"> <tr><td>FORD MEDIUM/HEAVY DUTY</td><td>1975-97</td></tr> <tr><td>FORD TRUCK</td><td>1957-59</td></tr> <tr><td>INTERNATIONAL MEDIUM/HEAVY DUTY TRUCK</td><td>1986-02</td></tr> </table>	FORD MEDIUM/HEAVY DUTY	1975-97	FORD TRUCK	1957-59	INTERNATIONAL MEDIUM/HEAVY DUTY TRUCK	1986-02																																																				
CHEVROLET SPORT UTILITY	1967-99																																																																																
CHEVROLET TRUCK	1961-04																																																																																
CHEVROLET VAN	1964-98																																																																																
GMC SPORT UTILITY	1967-99																																																																																
GMC TRUCK	1966-02																																																																																
GMC VAN	1964-98																																																																																
BMW PASSENGER CAR	2007-13																																																																																
AUDI SPORTS UTILITY	2007-12																																																																																
PORSCHE SUV	2003-10																																																																																
VOLKSWAGEN SPORT UTILITY	2004-12																																																																																
FORD MEDIUM/HEAVY DUTY	1975-97																																																																																
FORD TRUCK	1957-59																																																																																
INTERNATIONAL MEDIUM/HEAVY DUTY TRUCK	1986-02																																																																																
 <p style="text-align: center;"><b>DS-6031 (NEW) ASSEMBLY</b></p> <table style="width: 100%; border-collapse: collapse;"> <tr><td>NISSAN PASSENGER CAR</td><td>1990-96</td></tr> </table>	NISSAN PASSENGER CAR	1990-96	 <p style="text-align: center;"><b>DS-6038 ASSEMBLY</b></p> <table style="width: 100%; border-collapse: collapse;"> <tr><td>CHEVROLET SPORT UTILITY</td><td>1967-99</td></tr> <tr><td>CHEVROLET TRUCK</td><td>1961-04</td></tr> <tr><td>CHEVROLET VAN</td><td>1964-98</td></tr> <tr><td>DODGE MEDIUM/HEAVY DUTY</td><td>1978-81</td></tr> <tr><td>DODGE TRUCK</td><td>1960-02</td></tr> <tr><td>FORD MEDIUM/HEAVY DUTY</td><td>1975-13</td></tr> <tr><td>FORD TRUCK</td><td>1957-12</td></tr> <tr><td>FORD VAN</td><td>1968-10</td></tr> <tr><td>GMC SPORT UTILITY</td><td>1967-99</td></tr> <tr><td>GMC TRUCK</td><td>1966-02</td></tr> <tr><td>GMC VAN</td><td>1964-98</td></tr> <tr><td>INTERNATIONAL MEDIUM/HEAVY DUTY TRUCK</td><td>1986-02</td></tr> </table>	CHEVROLET SPORT UTILITY	1967-99	CHEVROLET TRUCK	1961-04	CHEVROLET VAN	1964-98	DODGE MEDIUM/HEAVY DUTY	1978-81	DODGE TRUCK	1960-02	FORD MEDIUM/HEAVY DUTY	1975-13	FORD TRUCK	1957-12	FORD VAN	1968-10	GMC SPORT UTILITY	1967-99	GMC TRUCK	1966-02	GMC VAN	1964-98	INTERNATIONAL MEDIUM/HEAVY DUTY TRUCK	1986-02	 <p style="text-align: center;"><b>DS-6048 ASSEMBLY</b></p> <table style="width: 100%; border-collapse: collapse;"> <tr><td>CHEVROLET SPORT UTILITY</td><td>1967-99</td></tr> <tr><td>CHEVROLET TRUCK</td><td>1961-04</td></tr> <tr><td>DODGE MEDIUM/HEAVY DUTY</td><td>1978-81</td></tr> <tr><td>DODGE TRUCK</td><td>1960-02</td></tr> <tr><td>FORD MEDIUM/HEAVY DUTY</td><td>1975-97</td></tr> <tr><td>FORD TRUCK</td><td>1957-59</td></tr> <tr><td>GMC SPORT UTILITY</td><td>1967-99</td></tr> <tr><td>GMC TRUCK</td><td>1966-02</td></tr> <tr><td>INTERNATIONAL MEDIUM/HEAVY DUTY TRUCK</td><td>1986-02</td></tr> </table>	CHEVROLET SPORT UTILITY	1967-99	CHEVROLET TRUCK	1961-04	DODGE MEDIUM/HEAVY DUTY	1978-81	DODGE TRUCK	1960-02	FORD MEDIUM/HEAVY DUTY	1975-97	FORD TRUCK	1957-59	GMC SPORT UTILITY	1967-99	GMC TRUCK	1966-02	INTERNATIONAL MEDIUM/HEAVY DUTY TRUCK	1986-02	 <p style="text-align: center;"><b>DS-6051 ASSEMBLY</b></p> <table style="width: 100%; border-collapse: collapse;"> <tr><td>FORD MEDIUM/HEAVY DUTY</td><td>1975-97</td></tr> <tr><td>FORD TRUCK</td><td>1957-59</td></tr> </table>	FORD MEDIUM/HEAVY DUTY	1975-97	FORD TRUCK	1957-59																														
NISSAN PASSENGER CAR	1990-96																																																																																
CHEVROLET SPORT UTILITY	1967-99																																																																																
CHEVROLET TRUCK	1961-04																																																																																
CHEVROLET VAN	1964-98																																																																																
DODGE MEDIUM/HEAVY DUTY	1978-81																																																																																
DODGE TRUCK	1960-02																																																																																
FORD MEDIUM/HEAVY DUTY	1975-13																																																																																
FORD TRUCK	1957-12																																																																																
FORD VAN	1968-10																																																																																
GMC SPORT UTILITY	1967-99																																																																																
GMC TRUCK	1966-02																																																																																
GMC VAN	1964-98																																																																																
INTERNATIONAL MEDIUM/HEAVY DUTY TRUCK	1986-02																																																																																
CHEVROLET SPORT UTILITY	1967-99																																																																																
CHEVROLET TRUCK	1961-04																																																																																
DODGE MEDIUM/HEAVY DUTY	1978-81																																																																																
DODGE TRUCK	1960-02																																																																																
FORD MEDIUM/HEAVY DUTY	1975-97																																																																																
FORD TRUCK	1957-59																																																																																
GMC SPORT UTILITY	1967-99																																																																																
GMC TRUCK	1966-02																																																																																
INTERNATIONAL MEDIUM/HEAVY DUTY TRUCK	1986-02																																																																																
FORD MEDIUM/HEAVY DUTY	1975-97																																																																																
FORD TRUCK	1957-59																																																																																

# BUYER'S GUIDE

## NUMERICAL LISTING - ILLUSTRATIONS

 <p><b>DS-6052 ASSEMBLY</b></p> <p>INTERNATIONAL MEDIUM/HEAVY DUTY TRUCK ..... 1986-02</p>	 <p><b>DS-6056 ASSEMBLY</b></p> <p>CHECKER PASSENGER CAR .... 1968-82 CHEVROLET SPORT UTILITY .... 1967-99 CHEVROLET TRUCK ..... 1961-04 CHEVROLET VAN ..... 1964-98 DODGE MEDIUM/HEAVY DUTY ..... 1978-81 DODGE TRUCK ..... 1960-02 FORD MEDIUM/HEAVY DUTY .... 1975-97 FORD TRUCK ..... 1957-04 FORD VAN ..... 1968-98 GMC SPORT UTILITY ..... 1967-99 GMC TRUCK ..... 1966-02 GMC VAN ..... 1964-98 INTERNATIONAL MEDIUM/HEAVY DUTY TRUCK ..... 1986-02 ISUZU TRUCK ..... 1996-99</p>	 <p><b>DS-6063 ASSEMBLY</b></p> <p>CHEVROLET SPORT UTILITY .... 2000-12 CHEVROLET TRUCK ..... 1999-07 GMC SPORT UTILITY ..... 2000-12 GMC TRUCK ..... 1999-07</p>	 <p><b>DS-6068 ASSEMBLY</b></p> <p>CHEVROLET TRUCK ..... 2004-12 GMC TRUCK ..... 2004-12 ISUZU TRUCK ..... 2006-08</p>
 <p><b>DS-6053 ASSEMBLY</b></p> <p>CHEVROLET SPORT UTILITY .... 1967-99 CHEVROLET TRUCK ..... 1961-04 FORD MEDIUM/HEAVY DUTY .... 1975-97 FORD TRUCK ..... 1957-59 GMC SPORT UTILITY ..... 1967-99 GMC TRUCK ..... 1966-02</p>	 <p><b>DS-6064 ASSEMBLY</b></p> <p>CHEVROLET SPORT UTILITY .... 2000-12 CHEVROLET TRUCK ..... 1999-07 GMC SPORT UTILITY ..... 2000-12 GMC TRUCK ..... 1999-07</p>	 <p><b>DS-6069 ASSEMBLY</b></p> <p>HONDA SPORT UTILITY ..... 2002-06</p>	
 <p><b>DS-6054 BUSHINGS</b></p> <p>CHEVROLET SPORT UTILITY .... 1965-66 GMC SPORT UTILITY ..... 1965</p>	 <p><b>DS-6061 ASSEMBLY</b></p> <p>FORD SPORT UTILITY ..... 1984-98 FORD TRUCK ..... 1986-89 FORD VAN ..... 1986-90</p>	 <p><b>DS-6065 ASSEMBLY</b></p> <p>DODGE TRUCK ..... 1994-02</p>	 <p><b>DS-6071 ASSEMBLY</b></p> <p>CHEVROLET TRUCK ..... 2008-12 DODGE TRUCK ..... 2003-06 GMC TRUCK ..... 2008-12 NISSAN TRUCK ..... 2004-15</p>
 <p><b>DS-6052 ASSEMBLY</b></p> <p>INTERNATIONAL MEDIUM/HEAVY DUTY TRUCK ..... 1986-02</p>	 <p><b>DS-6062 ASSEMBLY</b></p> <p>FORD SPORT UTILITY ..... 1991-98 FORD TRUCK ..... 1990-98</p>	 <p><b>DS-6066 ASSEMBLY</b></p> <p>CHEVROLET SPORT UTILITY .... 2005-09 PONTIAC SPORT UTILITY ..... 2006-09 SATURN SUV ..... 2002-07</p>	 <p><b>DS-6072 ASSEMBLY</b></p> <p>TOYOTA SPORT UTILITY ..... 2001-05</p>



# BUYER'S GUIDE

## NUMERICAL LISTING - ILLUSTRATIONS

 <p style="text-align: center;"><b>DS-6076 ASSEMBLY</b></p> <p>FORD SPORT UTILITY ..... 2001-07            MAZDA SPORT UTILITY ..... 2001-06            MERCURY SPORT UTILITY ..... 2005-07</p>	 <p style="text-align: center;"><b>DS-6085 ASSEMBLY</b></p> <p>LEXUS PASSENGER CAR ..... 1998-10</p>	 <p style="text-align: center;"><b>DS-6095 (NEW) ASSEMBLY</b></p> <p>BMW SPORT UTILITY ..... 2000-07</p>	 <p style="text-align: center;"><b>DS-6502 (NEW) ASSEMBLY</b></p> <p>FORD MEDIUM/HEAVY DUTY .... 2004-14            FORD TRUCK ..... 2003-15</p>
 <p style="text-align: center;"><b>DS-6077 (NEW) ASSEMBLY</b></p> <p>KIA SPORT UTILITY ..... 2003-06</p>	 <p style="text-align: center;"><b>DS-6086 ASSEMBLY</b></p> <p>LEXUS PASSENGER CAR ..... 1995-05</p>	 <p style="text-align: center;"><b>DS-6099 (NEW) ASSEMBLY</b></p> <p>CADILLAC SPORT UTILITY ..... 1999-06            CHEVROLET SPORT UTILITY .... 2000-12            CHEVROLET TRUCK ..... 1999-07            CHEVROLET VAN ..... 1997-15            GMC SPORT UTILITY ..... 2000-12            GMC TRUCK ..... 1999-07            GMC VAN ..... 1997-15</p>	 <p style="text-align: center;"><b>DS-6503 (NEW) ASSEMBLY</b></p> <p>CADILLAC PASSENGER CAR .... 2003-11</p>
 <p style="text-align: center;"><b>DS-6078 (NEW) ASSEMBLY</b></p> <p>DODGE VAN ..... 2003-06</p>	 <p style="text-align: center;"><b>DS-6092 (NEW) ASSEMBLY</b></p> <p>CADILLAC SPORT UTILITY ..... 2007-12            CHEVROLET SPORT UTILITY .... 2007-12</p> <p style="text-align: center;"><b>BUSHINGS</b></p> <p>CHEVROLET TRUCK ..... 2008-12</p> <p style="text-align: center;"><b>ASSEMBLY</b></p> <p>CHEVROLET VAN ..... 2010-15            GMC MEDIUM/HEAVY DUTY TRUCK ..... 2009-15            GMC SPORT UTILITY ..... 2007-12</p> <p style="text-align: center;"><b>BUSHINGS</b></p> <p>GMC TRUCK ..... 2008-12</p> <p style="text-align: center;"><b>ASSEMBLY</b></p> <p>GMC VAN ..... 2010-15</p>	 <p style="text-align: center;"><b>DS-6500 ASSEMBLY</b></p> <p>CHRYSLER PASSENGER CAR ..... 2005-14            DODGE PASSENGER CAR ..... 2005-13</p>	 <p style="text-align: center;"><b>DS-6504 ASSEMBLY</b></p> <p>DODGE VAN ..... 2007-09            FREIGHTLINER ..... 2007-09            MERCEDES-BENZ VAN ..... 2010-13</p>
 <p style="text-align: center;"><b>DS-6079 ASSEMBLY</b></p> <p>CHEVROLET SPORT UTILITY .... 1995-05            CHEVROLET TRUCK ..... 1994-04            DODGE TRUCK ..... 1998-10            DODGE VAN ..... 1999-03            GMC SPORT UTILITY ..... 1994-05            GMC TRUCK ..... 1994-04</p>	 <p style="text-align: center;"><b>DS-6501 (NEW) ASSEMBLY</b></p> <p>FORD TRUCK ..... 1999-04</p>	 <p style="text-align: center;"><b>DS-6505 ASSEMBLY</b></p> <p>DODGE VAN ..... 2007-09            FREIGHTLINER ..... 2007-09            MERCEDES-BENZ VAN ..... 2010-13</p>	

# BUYER'S GUIDE

## NUMERICAL LISTING - ILLUSTRATIONS

 <p style="text-align: center;"><b>DS-6506 ASSEMBLY</b></p> <p>DODGE VAN ..... 2007-09 FREIGHTLINER ..... 2007-09 MERCEDES-BENZ VAN ..... 2010-13</p>	<p><b>DS-6510 (Continued)</b> GMC VAN ..... 1997-15</p>  <p style="text-align: center;"><b>DS-6511 (NEW) ASSEMBLY FRONT</b></p> <p>MITSUBISHI SPORT UTILITY ..... 2003-06</p>	 <p style="text-align: center;"><b>DS-6517 (NEW) ASSEMBLY</b></p> <p>BMW PASSENGER CAR ..... 2004-10</p>	<p style="text-align: center;"><b>DS-6524 (NEW) ASSEMBLY</b></p> <p>KIA SPORT UTILITY ..... 2003-06</p> 
 <p style="text-align: center;"><b>DS-6507 ASSEMBLY</b></p> <p>DODGE VAN ..... 2007-09 FREIGHTLINER ..... 2007-09 MERCEDES-BENZ VAN ..... 2010-13</p>	 <p style="text-align: center;"><b>DS-6512 ASSEMBLY REAR</b></p> <p>MITSUBISHI SPORT UTILITY ..... 2003-06</p>	 <p style="text-align: center;"><b>DS-6519 (NEW) ASSEMBLY</b></p> <p>LEXUS PASSENGER CAR ..... 2006-15</p>	<p style="text-align: center;"><b>DS-6531 (NEW) ASSEMBLY</b></p> <p>FORD TRUCK ..... 1997-01</p> 
 <p style="text-align: center;"><b>DS-6509 ASSEMBLY</b></p> <p>DODGE TRUCK ..... 2003-09</p>	 <p style="text-align: center;"><b>DS-6514 (NEW) ASSEMBLY</b></p> <p>HYUNDAI SPORT UTILITY ..... 2001-06</p>	 <p style="text-align: center;"><b>DS-6520 (NEW) ASSEMBLY</b></p> <p>MERCEDES-BENZ PASSENGER CAR ..... 2002-10</p>	<p style="text-align: center;"><b>DS-6533 (NEW) ASSEMBLY</b></p> <p>FORD TRUCK ..... 2008-15</p> 
 <p style="text-align: center;"><b>DS-6510 (NEW) ASSEMBLY</b></p> <p>CHEVROLET SPORT UTILITY .... 2000-12 CHEVROLET TRUCK ..... 1999-12 CHEVROLET VAN ..... 1997-15 GMC SPORT UTILITY ..... 2000-12 GMC TRUCK ..... 1999-12</p>	 <p style="text-align: center;"><b>DS-6516 (NEW) ASSEMBLY</b></p> <p>DODGE TRUCK ..... 2007-10 RAM TRUCK ..... 2010-12</p>	 <p style="text-align: center;"><b>DS-6521 (NEW) ASSEMBLY</b></p> <p>MERCEDES-BENZ VAN ..... 2004-06</p>	<p style="text-align: center;"><b>DS-6534 (NEW) ASSEMBLY</b></p> <p>FORD TRUCK ..... 2008-15</p> 
 <p style="text-align: center;"><b>DS-6510 (NEW) ASSEMBLY</b></p> <p>CHEVROLET SPORT UTILITY .... 2000-12 CHEVROLET TRUCK ..... 1999-12 CHEVROLET VAN ..... 1997-15 GMC SPORT UTILITY ..... 2000-12 GMC TRUCK ..... 1999-12</p> <p style="text-align: center;">(Continued Next Column)</p>	 <p style="text-align: center;"><b>DS-6516 (NEW) ASSEMBLY</b></p> <p>DODGE TRUCK ..... 2007-10 RAM TRUCK ..... 2010-12</p>	 <p style="text-align: center;"><b>DS-6521 (NEW) ASSEMBLY</b></p> <p>MERCEDES-BENZ VAN ..... 2004-06</p>	<p style="text-align: center;"><b>DS-6535 (NEW) ASSEMBLY</b></p> <p>FORD TRUCK ..... 2008-15</p> 



# BUYER'S GUIDE

## NUMERICAL LISTING - ILLUSTRATIONS

			
<p><b>DS-6536 (NEW) ASSEMBLY</b></p> <p>FORD TRUCK ..... 2008-15</p>	<p><b>DS-8470 ASSEMBLY</b></p> <p>TOYOTA SPORT UTILITY ..... 1984-90 TOYOTA TRUCK ..... 1984-88</p>	<p><b>DS-8474 ASSEMBLY</b></p> <p>INFINITI PASSENGER CAR ..... 1990-12 INFINITI SPORT UTILITY ..... 2003-07 NISSAN PASSENGER CAR ..... 1982-98 NISSAN SPORT UTILITY ..... 1989-04 NISSAN TRUCK ..... 1986-04</p>	<p><b>DS-8532 ASSEMBLY</b></p> <p>TOYOTA TRUCK ..... 1984-88</p>
			
<p><b>DS-8318 ASSEMBLY</b></p> <p>MITSUBISHI TRUCK ..... 1990-92</p>	<p><b>DS-8471 ASSEMBLY</b></p> <p>TOYOTA TRUCK ..... 1989-95</p>	<p><b>DS-8475 ASSEMBLY</b></p> <p>NISSAN TRUCK ..... 1973-79</p>	<p><b>DS-8533 ASSEMBLY</b></p> <p>TOYOTA SPORT UTILITY ..... 1990-95 TOYOTA TRUCK ..... 1989-95</p>
			
<p><b>DS-8468 ASSEMBLY</b></p> <p>TOYOTA PASSENGER CAR ..... 1982-88</p>	<p><b>DS-8472 ASSEMBLY</b></p> <p>NISSAN TRUCK ..... 1980-85</p>	<p><b>DS-8509 ASSEMBLY</b></p> <p>LEXUS PASSENGER CAR ..... 1992-97</p>	<p><b>DS-8535 ASSEMBLY</b></p> <p>ISUZU TRUCK ..... 1981-86</p>
			
<p><b>DS-8469 ASSEMBLY</b></p> <p>TOYOTA TRUCK ..... 1979-83</p>	<p><b>DS-8473 ASSEMBLY</b></p> <p>NISSAN SPORT UTILITY ..... 1987-95 NISSAN TRUCK ..... 1986-04</p>	<p><b>DS-8531 BUSHINGS</b></p> <p>TOYOTA PASSENGER CAR ..... 1980-87</p>	<p><b>DS-8538 BUSHINGS</b></p> <p>ISUZU TRUCK ..... 1987-95</p>

# BUYER'S GUIDE

## NUMERICAL LISTING - ILLUSTRATIONS

 <p><b>DS-8549 ASSEMBLY</b></p> <p>DODGE TRUCK ..... 1979-85  MITSUBISHI TRUCK ..... 1983-89  PLYMOUTH TRUCK ..... 1979-82</p>	 <p><b>DS-8587 ASSEMBLY</b></p> <p>TOYOTA PASSENGER CAR ..... 1979-84</p>	 <p><b>DS-8627 ASSEMBLY</b></p> <p>BMW PASSENGER CAR ..... 1984-86</p>	 <p><b>EM-2007 MOUNT-ENGINE Center Front</b></p> <p>CHEVROLET TRUCK ..... 1942-53</p>
 <p><b>DS-8550 ASSEMBLY</b></p> <p>MAZDA TRUCK ..... 1982-87</p>	 <p><b>DS-8588 ASSEMBLY</b></p> <p>TOYOTA PASSENGER CAR ..... 1985-88</p>	 <p><b>DS-8634 BUSHINGS</b></p> <p>MERCEDES-BENZ PASSENGER CAR ..... 1984-89</p>	 <p><b>EM-2009 MOUNT-ENGINE L &amp; R Front Upper</b></p> <p>FORD PASSENGER CAR ..... 1946-48  FORD TRUCK ..... 1948-51</p> <p><b>MOUNT-TRANSMISSION Lower</b></p> <p>JEEP TRUCK ..... 1958-62</p>
 <p><b>DS-8551 ASSEMBLY</b></p> <p>MAZDA PASSENGER CAR ..... 1988-89  MAZDA TRUCK ..... 1988-96</p>	 <p><b>DS-8591 ASSEMBLY</b></p> <p>ISUZU TRUCK ..... 1987-95</p>	 <p><b>DS-8635 ASSEMBLY</b></p> <p>MERCEDES-BENZ PASSENGER CAR ..... 1972-79</p>	 <p><b>EM-2010 MOUNT-ENGINE L &amp; R Front Lower</b></p> <p>FORD PASSENGER CAR ..... 1946-48  FORD TRUCK ..... 1948-51</p> <p><b>MOUNT-TRANSMISSION Upper</b></p> <p>JEEP TRUCK ..... 1958-62</p>
 <p><b>DS-8565 ASSEMBLY</b></p> <p>MAZDA TRUCK ..... 1972-76</p>	 <p><b>DS-8626 ASSEMBLY</b></p> <p>BMW PASSENGER CAR ..... 1975-89</p>	 <p><b>DS-8636 ASSEMBLY</b></p> <p>MERCEDES-BENZ PASSENGER CAR ..... 1964-65</p>	

# BUYER'S GUIDE

## NUMERICAL LISTING - ILLUSTRATIONS

 <p><b>EM-2014</b> <b>MOUNT-ENGINE</b> <b>L &amp; R Rear</b></p> <p>DODGE PASSENGER CAR ..... 1953-56 <b>MOUNT-TRANSMISSION</b> <b>L &amp; R Upper</b></p> <p>PLYMOUTH PASSENGER CAR ..... 1951-54</p>	 <p><b>EM-2040</b> <b>MOUNT-ENGINE</b> <b>L &amp; R Front</b></p> <p>JEEP SPORT UTILITY ..... 1959-71 JEEP TRUCK ..... 1949-62</p>	 <p><b>EM-2050</b> <b>MOUNT-ENGINE</b> <b>L &amp; R Front Upper</b></p> <p>FORD TRUCK ..... 1957-64</p>	 <p><b>EM-2070</b> <b>MOUNT-TRANSMISSION</b></p> <p>BUICK PASSENGER CAR ..... 1953-63</p>
 <p><b>EM-2018</b> <b>MOUNT-ENGINE</b> <b>Center Front</b></p> <p>DODGE PASSENGER CAR ..... 1949-56 <b>MOUNT-ENGINE</b> <b>Front Center</b></p> <p>PLYMOUTH PASSENGER CAR ..... 1953-54</p>	 <p><b>EM-2041</b> <b>MOUNT-ENGINE</b> <b>Center Front</b></p> <p>CHEVROLET MEDIUM/HEAVY DUTY TRUCK ..... 1966-72</p>	 <p><b>EM-2053</b> <b>MOUNT-ENGINE</b> <b>L &amp; R Front</b></p> <p>CHEVROLET PASSENGER CAR ..... 1950-51</p>	 <p><b>EM-2073</b> <b>MOUNT-TRANSMISSION</b> <b>Manual</b></p> <p>CHEVROLET TRUCK ..... 1942-53</p>
 <p><b>EM-2039</b> <b>MOUNT-TRANSMISSION</b> <b>L &amp; R</b></p> <p>JEEP TRUCK ..... 1949-51</p>	 <p><b>EM-2048</b> <b>MOUNT-ENGINE</b> <b>L &amp; R Front Lower</b></p> <p>FORD TRUCK ..... 1957-64</p>	 <p><b>EM-2057</b> <b>MOUNT-TRANSMISSION</b> <b>Manual</b></p> <p>CHEVROLET PASSENGER CAR ..... 1950-51</p>	 <p><b>EM-2091</b> <b>MOUNT-ENGINE</b> <b>L &amp; R Front Upper</b></p> <p>CHEVROLET PASSENGER CAR ..... 1950-54</p>
		 <p><b>EM-2060</b> <b>MOUNT-TRANSMISSION</b> <b>Manual</b></p> <p>CHEVROLET TRUCK ..... 1942-53</p>	 <p><b>EM-2092</b> <b>MOUNT-ENGINE</b> <b>L &amp; R Front Lower</b></p> <p>CHEVROLET PASSENGER CAR ..... 1950-60</p>









# BUYER'S GUIDE

## NUMERICAL LISTING - ILLUSTRATIONS

 <p style="text-align: center;"><b>EM-2107</b> <b>MOUNT-ENGINE</b> <b>L &amp; R Rear Upper</b></p> <p>CHEVROLET TRUCK ..... 1961-65 CHEVROLET VAN ..... 1964-66 GMC VAN ..... 1966</p> <p style="text-align: center;"><b>MOUNT-TRANSMISSION</b> <b>L &amp; R Upper</b></p> <p>CHEVROLET SPORT UTILITY .... 1968-74 CHEVROLET TRUCK ..... 1961-80 GMC TRUCK ..... 1967-84 CHEVROLET SPORT UTILITY .... 1967-87 CHEVROLET TRUCK ..... 1961-84 CHEVROLET VAN ..... 1963-65 GMC SPORT UTILITY ..... 1967-85 GMC TRUCK ..... 1961-84</p>	 <p style="text-align: center;"><b>EM-2119</b> <b>MOUNT-TRANSMISSION</b> <b>Upper</b></p> <p>FORD TRUCK ..... 1953-64</p>	<p><b>EM-2122 (Continued)</b> <b>MOUNT-TRANSMISSION</b> <b>Auto</b></p> <p>CHEVROLET TRUCK ..... 1953-58</p>  <p style="text-align: center;"><b>EM-2123</b> <b>MOUNT-ENGINE</b> <b>L &amp; R Front</b></p> <p>CHEVROLET PASSENGER CAR ..... 1955-57</p> <p style="text-align: center;"><b>MOUNT-TRANSMISSION</b> <b>Auto</b></p> <p>CHEVROLET TRUCK ..... 1953-58</p>	 <p style="text-align: center;"><b>EM-2126</b> <b>MOUNT-TRANSMISSION</b> <b>RH</b></p> <p>CHEVROLET PASSENGER CAR ..... 1955-57</p>
 <p style="text-align: center;"><b>EM-2108</b> <b>MOUNT-ENGINE</b> <b>L &amp; R Rear Lower</b></p> <p>CHEVROLET TRUCK ..... 1961-65 CHEVROLET VAN ..... 1964-66 GMC VAN ..... 1966</p> <p style="text-align: center;"><b>MOUNT-TRANSMISSION</b> <b>L &amp; R Lower</b></p> <p>CHEVROLET SPORT UTILITY .... 1967-87 CHEVROLET TRUCK ..... 1961-84 CHEVROLET VAN ..... 1963-65 GMC SPORT UTILITY ..... 1967-85 GMC TRUCK ..... 1961-84</p>	 <p style="text-align: center;"><b>EM-2120</b> <b>MOUNT-ENGINE</b> <b>Center Front Lower</b></p> <p>FORD PASSENGER CAR ..... 1956-58 FORD TRUCK ..... 1953-55</p>	 <p style="text-align: center;"><b>EM-2124</b> <b>MOUNT-TRANSMISSION</b> <b>LH</b></p> <p>CHEVROLET PASSENGER CAR ..... 1955-57</p>	 <p style="text-align: center;"><b>EM-2127</b> <b>MOUNT-TRANSMISSION</b> <b>LH</b></p> <p>CHEVROLET PASSENGER CAR ..... 1955-57</p>
 <p style="text-align: center;"><b>EM-2110</b> <b>MOUNT-ENGINE</b> <b>L &amp; R Front</b></p> <p>FORD PASSENGER CAR ..... 1954-58 FORD TRUCK ..... 1955-57</p>	 <p style="text-align: center;"><b>EM-2121</b> <b>MOUNT-TRANSMISSION</b> <b>Lower</b></p> <p>FORD TRUCK ..... 1953-64</p>	 <p style="text-align: center;"><b>EM-2125</b> <b>MOUNT-TRANSMISSION</b> <b>RH</b></p> <p>CHEVROLET PASSENGER CAR ..... 1955-57</p>	 <p style="text-align: center;"><b>EM-2141</b> <b>MOUNT-ENGINE</b> <b>L &amp; R Front</b></p> <p>FORD PASSENGER CAR ..... 1959-62 LINCOLN PASSENGER CAR ..... 1958-68 MERCURY PASSENGER CAR ... 1956-62</p>
<p><b>(Continued Next Column)</b></p>			

# BUYER'S GUIDE

## NUMERICAL LISTING - ILLUSTRATIONS

 <p><b>EM-2142</b> <b>MOUNT-ENGINE</b> <b>L &amp; R Front</b></p> <p>CHEVROLET PASSENGER CAR ..... 1957-73 CHEVROLET TRUCK ..... 1960-73</p>	 <p><b>EM-2162</b> <b>MOUNT-TRANSMISSION</b> <b>L &amp; R Upper</b></p> <p>CHEVROLET MEDIUM/HEAVY DUTY TRUCK ..... 1966-72</p>	 <p><b>EM-2170</b> <b>MOUNT-ENGINE</b> <b>L &amp; R Front</b></p> <p>FORD PASSENGER CAR ..... 1960-62 MERCURY PASSENGER CAR ... 1960-62</p>	 <p><b>EM-2204</b> <b>MOUNT-ENGINE</b> <b>LH Front</b></p> <p>PONTIAC PASSENGER CAR ..... 1959-69</p>
 <p><b>EM-2143</b> <b>MOUNT-TRANSMISSION</b> <b>Auto</b></p> <p>CHEVROLET PASSENGER CAR ..... 1957-67</p>	 <p><b>EM-2163</b> <b>MOUNT-TRANSMISSION</b> <b>L &amp; R Lower</b></p> <p>CHEVROLET MEDIUM/HEAVY DUTY TRUCK ..... 1966-72</p>	 <p><b>EM-2171</b> <b>MOUNT-TRANSMISSION</b> <b>Manual</b></p> <p>FORD PASSENGER CAR ..... 1960-65 <b>MOUNT-TRANSMISSION</b></p> <p>FORD TRUCK ..... 1965 MERCURY PASSENGER CAR ... 1960-65</p>	 <p><b>EM-2205</b> <b>MOUNT-ENGINE</b> <b>RH Front</b></p> <p>PONTIAC PASSENGER CAR ..... 1959-69</p>
 <p><b>EM-2150@</b> <b>MOUNT-ENGINE</b> <b>L &amp; R Front</b></p> <p>AMERICAN MOTORS PASSENGER CAR ..... 1960-63 <b>MOUNT-TRANSMISSION</b> <b>L &amp; R</b></p> <p>AMERICAN MOTORS PASSENGER CAR ..... 1960-63</p>	 <p><b>EM-2167</b> <b>MOUNT-ENGINE</b> <b>L &amp; R Front</b></p> <p>VOLKSWAGEN TRUCK ..... 1977-78 <b>MOUNT-ENGINE</b> <b>Rear Inner</b></p> <p>VOLKSWAGEN PASSENGER CAR ..... 1955-04 <b>MOUNT-ENGINE</b> <b>Rear</b></p> <p>VOLKSWAGEN VAN ..... 1954-88 <b>MOUNT-TRANSMISSION</b></p> <p>VOLKSWAGEN VAN ..... 1968-85</p>	 <p><b>EM-2172</b> <b>MOUNT-TRANSMISSION</b> <b>Manual</b></p> <p>FORD PASSENGER CAR ..... 1960-61 <b>MOUNT-TRANSMISSION</b> <b>Auto</b></p> <p>MERCURY PASSENGER CAR ... 1960-61</p>	 <p><b>EM-2206</b> <b>MOUNT-TRANSMISSION</b> <b>Manual</b></p> <p>PONTIAC PASSENGER CAR ..... 1960-66</p>
			 <p><b>EM-2216</b> <b>MOUNT-TRANSMISSION</b> <b>LH</b></p> <p>OLDSMOBILE PASSENGER CAR ..... 1960-64</p>

@ = Universal Mount EM-5000 also available.



# BUYER'S GUIDE

## NUMERICAL LISTING - ILLUSTRATIONS

 <p style="text-align: center;"><b>EM-2217</b> <b>MOUNT-TRANSMISSION</b> <b>RH</b></p> <p>OLDSMOBILE PASSENGER CAR ..... 1960-64</p>	 <p style="text-align: center;"><b>EM-2221</b> <b>MOUNT-ENGINE</b> <b>RH Front</b></p> <p>FORD PASSENGER CAR ..... 1963-66 FORD TRUCK ..... 1965 MERCURY PASSENGER CAR ... 1963-65</p>	<p><b>EM-2225 (Continued)</b></p> <p>MERCURY PASSENGER CAR ... 1961-65</p>  <p style="text-align: center;"><b>EM-2226</b> <b>MOUNT-ENGINE</b> <b>LH Front</b></p> <p>FORD PASSENGER CAR ..... 1962-66 FORD TRUCK ..... 1960-65 MERCURY PASSENGER CAR ... 1961-65</p>	 <p style="text-align: center;"><b>EM-2231</b> <b>MOUNT-ENGINE</b> <b>L &amp; R Front</b></p> <p>CHEVROLET PASSENGER CAR ..... 1958-68 CHEVROLET TRUCK ..... 1964-69</p>
 <p style="text-align: center;"><b>EM-2218</b> <b>MOUNT-ENGINE</b> <b>L &amp; R Front</b></p> <p>BUICK PASSENGER CAR ..... 1961-63 OLDSMOBILE PASSENGER CAR ..... 1961-63</p>	 <p style="text-align: center;"><b>EM-2222</b> <b>MOUNT-ENGINE</b> <b>RH Front</b></p> <p>FORD PASSENGER CAR ..... 1958-64</p>	 <p style="text-align: center;"><b>EM-2227</b> <b>MOUNT-ENGINE</b> <b>RH Front</b></p> <p>CHRYSLER PASSENGER CAR ..... 1959-65 DODGE PASSENGER CAR ..... 1960-71 PLYMOUTH PASSENGER CAR ..... 1960-65</p>	 <p style="text-align: center;"><b>EM-2234</b> <b>MOUNT-ENGINE</b> <b>RH Front</b></p> <p>DODGE VAN ..... 1964-71 PLYMOUTH PASSENGER CAR ..... 1961-64</p>
 <p style="text-align: center;"><b>EM-2219</b> <b>MOUNT-ENGINE</b> <b>L &amp; R Front</b></p> <p>BUICK PASSENGER CAR ..... 1959-67</p>	 <p style="text-align: center;"><b>EM-2223</b> <b>MOUNT-ENGINE</b> <b>LH Front</b></p> <p>FORD PASSENGER CAR ..... 1958-64</p>	 <p style="text-align: center;"><b>EM-2228</b> <b>MOUNT-ENGINE</b> <b>LH Front</b></p> <p>CHRYSLER PASSENGER CAR ..... 1959-65 DODGE PASSENGER CAR ..... 1960-71 PLYMOUTH PASSENGER CAR ..... 1960-65</p>	 <p style="text-align: center;"><b>EM-2235</b> <b>MOUNT-ENGINE</b> <b>L &amp; R Front</b></p> <p>DODGE TRUCK ..... 1963-71</p> <p style="text-align: center;"><b>MOUNT-ENGINE</b> <b>LH Front</b></p> <p>DODGE VAN ..... 1964-71 PLYMOUTH PASSENGER CAR ..... 1961-64</p> <p style="text-align: center;"><b>MOUNT-TRANSMISSION</b></p> <p>DODGE TRUCK ..... 1971</p>
 <p style="text-align: center;"><b>EM-2220</b> <b>MOUNT-ENGINE</b> <b>LH Front</b></p> <p>FORD PASSENGER CAR ..... 1963-66 FORD TRUCK ..... 1965 MERCURY PASSENGER CAR ... 1963-65</p>	 <p style="text-align: center;"><b>EM-2225</b> <b>MOUNT-ENGINE</b> <b>RH Front</b></p> <p>FORD PASSENGER CAR ..... 1962-66 FORD TRUCK ..... 1960-65</p> <p style="text-align: center;"><b>(Continued Next Column)</b></p>		

# BUYER'S GUIDE

## NUMERICAL LISTING - ILLUSTRATIONS

 <p style="text-align: center;"><b>EM-2238</b> <b>MOUNT-ENGINE</b> <b>L &amp; R Front</b></p> <p>CADILLAC PASSENGER CAR ..... 1957-64</p>	 <p style="text-align: center;"><b>EM-2242</b> <b>MOUNT-TRANSMISSION</b> <b>Auto</b></p> <p>FORD PASSENGER CAR ..... 1959-74 <b>MOUNT-TRANSMISSION</b></p> <p>MERCURY PASSENGER CAR ... 1965-70</p>	 <p style="text-align: center;"><b>EM-2253</b> <b>MOUNT-TRANSMISSION</b> <b>Manual</b></p> <p>FORD PASSENGER CAR ..... 1962-80 FORD TRUCK ..... 1960-79 <b>MOUNT-TRANSMISSION</b> <b>Auto</b></p> <p>LINCOLN PASSENGER CAR ..... 1977-80 <b>MOUNT-TRANSMISSION</b> <b>Manual</b></p> <p>MERCURY PASSENGER CAR ... 1965-82</p>	 <p style="text-align: center;"><b>EM-2256</b> <b>MOUNT-ENGINE</b> <b>L &amp; R Front</b></p> <p>PONTIAC PASSENGER CAR ..... 1961-77</p>
 <p style="text-align: center;"><b>EM-2240</b> <b>MOUNT-ENGINE</b> <b>RH Front</b></p> <p>FORD PASSENGER CAR ..... 1965-70 FORD TRUCK ..... 1967-69 MERCURY PASSENGER CAR ... 1965-70</p>	 <p style="text-align: center;"><b>EM-2249</b> <b>MOUNT-ENGINE</b> <b>L &amp; R Front</b></p> <p>CHEVROLET PASSENGER CAR ..... 1969-82</p>	 <p style="text-align: center;"><b>EM-2254</b> <b>MOUNT-ENGINE</b> <b>L &amp; R Front</b></p> <p>PONTIAC PASSENGER CAR ..... 1965-75</p>	 <p style="text-align: center;"><b>EM-2257</b> <b>MOUNT-ENGINE</b> <b>L &amp; R Front</b></p> <p>FORD PASSENGER CAR ..... 1964-73 FORD TRUCK ..... 1968-71 MERCURY PASSENGER CAR ... 1966-73</p>
 <p style="text-align: center;"><b>EM-2241</b> <b>MOUNT-ENGINE</b> <b>LH Front</b></p> <p>FORD PASSENGER CAR ..... 1965-70 FORD TRUCK ..... 1967-69 MERCURY PASSENGER CAR ... 1965-70</p>	 <p style="text-align: center;"><b>EM-2250</b> <b>MOUNT-ENGINE</b> <b>L &amp; R Front</b></p> <p>CHRYSLER PASSENGER CAR ..... 1965-73 DODGE PASSENGER CAR ..... 1965-76 PLYMOUTH PASSENGER CAR ..... 1963-74</p>	 <p style="text-align: center;"><b>EM-2255</b> <b>MOUNT-ENGINE</b> <b>RH Front</b></p> <p>PONTIAC PASSENGER CAR ..... 1961-77</p>	 <p style="text-align: center;"><b>EM-2261</b> <b>MOUNT-ENGINE</b> <b>L &amp; R Front</b></p> <p>OLDSMOBILE PASSENGER CAR ..... 1964-73</p>

# BUYER'S GUIDE

## NUMERICAL LISTING - ILLUSTRATIONS

 <p style="text-align: center;"><b>EM-2262</b> <b>MOUNT-ENGINE</b> <b>RH Front</b></p> <p>OLDSMOBILE PASSENGER CAR ..... 1964-70</p>	 <p style="text-align: center;"><b>EM-2265</b> <b>MOUNT-ENGINE</b> <b>L &amp; R Front</b></p> <p>DODGE MEDIUM/HEAVY DUTY ..... 1978</p> <p style="text-align: center;"><b>MOUNT-ENGINE</b> <b>LH Front</b></p> <p>DODGE PASSENGER CAR ..... 1967-72</p> <p style="text-align: center;"><b>MOUNT-ENGINE</b> <b>L &amp; R Front</b></p> <p>DODGE SPORT UTILITY ..... 1974-78 DODGE TRUCK ..... 1971-81 DODGE VAN ..... 1972-78</p> <p style="text-align: center;"><b>MOUNT-ENGINE</b> <b>LH Front</b></p> <p>PLYMOUTH PASSENGER CAR ..... 1965-72</p> <p style="text-align: center;"><b>MOUNT-ENGINE</b> <b>L &amp; R Front</b></p> <p>PLYMOUTH SUV ..... 1974-78 PLYMOUTH VAN ..... 1974-78</p>	<p><b>EM-2267 (Continued)</b></p> <p>CHEVROLET PASSENGER CAR ..... 1957-73 CHEVROLET TRUCK ..... 1959-62 PONTIAC PASSENGER CAR ..... 1971-72</p>  <p style="text-align: center;"><b>EM-2268@</b> <b>MOUNT-TRANSMISSION</b> <b>Auto</b></p> <p>BUICK PASSENGER CAR ..... 1966-73 CHEVROLET PASSENGER CAR ..... 1962-82 CHEVROLET SPORT UTILITY ... 1967-82</p> <p style="text-align: center;"><b>MOUNT-TRANSMISSION</b></p> <p>CHEVROLET TRUCK ..... 1959-81</p> <p style="text-align: center;"><b>MOUNT-TRANSMISSION</b> <b>Auto</b></p> <p>CHEVROLET VAN ..... 1968-84 GMC SPORT UTILITY ..... 1967-81 GMC TRUCK ..... 1967-81 GMC VAN ..... 1968-84</p> <p style="text-align: center;"><b>MOUNT-TRANSMISSION</b></p> <p>JEEP SPORT UTILITY ..... 1972-73 JEEP TRUCK ..... 1974-87</p> <p style="text-align: center;"><b>MOUNT-TRANSMISSION</b> <b>Auto</b></p> <p>OLDSMOBILE PASSENGER CAR ..... 1968-72 PONTIAC PASSENGER CAR ..... 1964-77</p>	 <p style="text-align: center;"><b>EM-2271</b> <b>MOUNT-ENGINE</b> <b>LH Front</b></p> <p>FORD PASSENGER CAR ..... 1969-71 MERCURY PASSENGER CAR ... 1969-70</p>  <p style="text-align: center;"><b>EM-2272</b> <b>MOUNT-TRANSMISSION</b> <b>Auto</b></p> <p>CHRYSLER PASSENGER CAR ..... 1959-68</p> <p style="text-align: center;"><b>MOUNT-TRANSMISSION</b></p> <p>DODGE PASSENGER CAR ..... 1962-76</p> <p style="text-align: center;"><b>MOUNT-TRANSMISSION</b> <b>Auto</b></p> <p>PLYMOUTH PASSENGER CAR ..... 1958-72</p>  <p style="text-align: center;"><b>EM-2270</b> <b>MOUNT-ENGINE</b> <b>RH Front</b></p> <p>FORD PASSENGER CAR ..... 1969-71 MERCURY PASSENGER CAR ... 1969-70</p>  <p style="text-align: center;"><b>EM-2274</b> <b>MOUNT-ENGINE</b> <b>L &amp; R Front</b></p> <p>CADILLAC PASSENGER CAR .... 1964-67</p>
 <p style="text-align: center;"><b>EM-2263</b> <b>MOUNT-ENGINE</b> <b>LH Front</b></p> <p>OLDSMOBILE PASSENGER CAR ..... 1964-70</p>  <p style="text-align: center;"><b>EM-2264</b> <b>MOUNT-ENGINE</b> <b>RH Front</b></p> <p>DODGE PASSENGER CAR ..... 1967-72 PLYMOUTH PASSENGER CAR ..... 1965-72</p>	 <p style="text-align: center;"><b>EM-2266</b> <b>MOUNT-ENGINE</b> <b>L &amp; R Front</b></p> <p>DODGE PASSENGER CAR ..... 1964-73 DODGE TRUCK ..... 1969-71 DODGE VAN ..... 1971 PLYMOUTH PASSENGER CAR ..... 1966-72</p>  <p style="text-align: center;"><b>EM-2267</b> <b>MOUNT-ENGINE</b> <b>L &amp; R Front</b></p> <p style="text-align: center;">(Continued Next Column)</p>		

@ = Universal Mount EM-5000 also available.



# BUYER'S GUIDE

## NUMERICAL LISTING - ILLUSTRATIONS

 <p style="text-align: center;"><b>EM-2275</b> <b>MOUNT-ENGINE</b> <b>LH Front</b></p> <p>DODGE PASSENGER CAR ..... 1967-72 PLYMOUTH PASSENGER CAR ..... 1965-72</p>	<p><b>EM-2278 (Continued)</b></p> <p>CHEVROLET PASSENGER CAR ..... 1965-67</p>  <p style="text-align: center;"><b>EM-2279</b> <b>MOUNT-ENGINE</b> <b>L &amp; R Front</b></p> <p>JEEP SPORT UTILITY ..... 1963-71</p>	 <p style="text-align: center;"><b>EM-2282</b> <b>MOUNT-ENGINE</b> <b>L &amp; R Front</b></p> <p>CHEVROLET SPORT UTILITY .... 1966-72 CHEVROLET TRUCK ..... 1963-72 CHEVROLET VAN ..... 1964-72 GMC SPORT UTILITY ..... 1966-72 GMC TRUCK ..... 1964-72 GMC VAN ..... 1966-72</p>	 <p style="text-align: center;"><b>EM-2285</b> <b>MOUNT-ENGINE</b> <b>L &amp; R Front</b></p> <p>CHEVROLET PASSENGER CAR ..... 1961-69 CHEVROLET TRUCK ..... 1966-67</p>
 <p style="text-align: center;"><b>EM-2276</b> <b>MOUNT-ENGINE</b> <b>RH Front</b></p> <p>DODGE PASSENGER CAR ..... 1970-71 PLYMOUTH PASSENGER CAR ..... 1965-72</p>	 <p style="text-align: center;"><b>EM-2280</b> <b>MOUNT-ENGINE</b> <b>L &amp; R Front</b></p> <p>AMERICAN MOTORS PASSENGER CAR ..... 1964-72 JEEP SPORT UTILITY ..... 1972-77</p>	 <p style="text-align: center;"><b>EM-2283</b> <b>MOUNT-ENGINE</b> <b>L &amp; R Front</b></p> <p>CHEVROLET PASSENGER CAR ..... 1966-74 CHEVROLET SPORT UTILITY .... 1968-72 CHEVROLET TRUCK ..... 1968-72 GMC SPORT UTILITY ..... 1970-72 GMC TRUCK ..... 1970-72</p>	 <p style="text-align: center;"><b>EM-2286</b> <b>MOUNT-ENGINE</b> <b>L &amp; R Front</b></p> <p>FORD PASSENGER CAR ..... 1973 FORD TRUCK ..... 1966-71 MERCURY PASSENGER CAR ... 1966-71</p>
 <p style="text-align: center;"><b>EM-2277</b> <b>MOUNT-ENGINE</b> <b>RH Front</b></p> <p>DODGE PASSENGER CAR ..... 1967-72 PLYMOUTH PASSENGER CAR ..... 1970-71</p>	 <p style="text-align: center;"><b>EM-2281</b> <b>MOUNT-ENGINE</b> <b>L &amp; R Front</b></p> <p>BUICK PASSENGER CAR ..... 1968-81 PONTIAC PASSENGER CAR .... 1976-80</p>	 <p style="text-align: center;"><b>EM-2284</b> <b>MOUNT-ENGINE</b> <b>L &amp; R Front</b></p> <p>CHEVROLET PASSENGER CAR ..... 1964-72 CHEVROLET TRUCK ..... 1964-72 GMC TRUCK ..... 1971-77 OLDSMOBILE PASSENGER CAR ..... 1966-71 PONTIAC PASSENGER CAR .... 1968-72</p>	 <p style="text-align: center;"><b>EM-2287</b> <b>MOUNT-ENGINE</b> <b>L &amp; R Front</b></p> <p>FORD PASSENGER CAR ..... 1965-78 MERCURY PASSENGER CAR ... 1971-73</p>
 <p style="text-align: center;"><b>EM-2278</b> <b>MOUNT-ENGINE</b> <b>LH Front</b></p> <p style="text-align: center;">(Continued Next Column)</p>			

@ = Universal Mount EM-5000 also available.

# BUYER'S GUIDE

## NUMERICAL LISTING - ILLUSTRATIONS

 <p style="text-align: center;"><b>EM-2288@</b> <b>MOUNT-TRANSMISSION</b></p> <p>BUICK PASSENGER CAR ..... 1971-80 <b>MOUNT-TRANSMISSION</b> <b>Manual</b></p> <p>CHEVROLET PASSENGER CAR ..... 1976-77 <b>MOUNT-TRANSMISSION</b> <b>Auto</b></p> <p>OLDSMOBILE PASSENGER CAR ..... 1975-79 <b>MOUNT-TRANSMISSION</b> <b>Manual</b></p> <p>PONTIAC PASSENGER CAR ..... 1968-79</p>	 <p style="text-align: center;"><b>EM-2291</b> <b>MOUNT-ENGINE</b> <b>L &amp; R Front</b></p> <p>BUICK PASSENGER CAR ..... 1967-76</p>	 <p style="text-align: center;"><b>EM-2294</b> <b>MOUNT-TRANSMISSION</b></p> <p>CHEVROLET PASSENGER CAR ..... 1969-76 CHEVROLET TRUCK ..... 1970-75 GMC TRUCK ..... 1971-72</p>	 <p style="text-align: center;"><b>EM-2298</b> <b>MOUNT-ENGINE</b> <b>L &amp; R Front Lower</b></p> <p>FORD MEDIUM/HEAVY DUTY .... 1975-77</p>
 <p style="text-align: center;"><b>EM-2289</b> <b>MOUNT-ENGINE</b> <b>RH Front</b></p> <p>FORD TRUCK ..... 1966-76</p>	 <p style="text-align: center;"><b>EM-2292</b> <b>MOUNT-ENGINE</b> <b>L &amp; R Front</b></p> <p>BUICK PASSENGER CAR ..... 1968-96 CADILLAC PASSENGER CAR .... 1978-96 CHEVROLET PASSENGER CAR ..... 1972-96 CHEVROLET SPORT UTILITY ... 1973-87 CHEVROLET TRUCK ..... 1973-91 CHEVROLET VAN ..... 1970-99 GMC SPORT UTILITY ..... 1973-87 GMC TRUCK ..... 1973-91 GMC VAN ..... 1970-99 OLDSMOBILE PASSENGER CAR ..... 1973-92 PONTIAC PASSENGER CAR ..... 1973-92</p>	 <p style="text-align: center;"><b>EM-2295</b> <b>MOUNT-TRANSMISSION</b> <b>Auto</b></p> <p>CHEVROLET PASSENGER CAR ..... 1968-73</p>	 <p style="text-align: center;"><b>EM-2299</b> <b>MOUNT-TRANSMISSION</b> <b>L &amp; R Upper</b></p> <p>FORD MEDIUM/HEAVY DUTY .... 1970-79</p>
 <p style="text-align: center;"><b>EM-2290</b> <b>MOUNT-ENGINE</b> <b>LH Front</b></p> <p>FORD TRUCK ..... 1966-76</p>	 <p style="text-align: center;"><b>EM-2293</b> <b>MOUNT-TRANSMISSION</b> <b>Manual</b></p> <p>VOLKSWAGEN PASSENGER CAR ..... 1955-80 <b>MOUNT-TRANSMISSION</b></p> <p>VOLKSWAGEN TRUCK ..... 1977-78 VOLKSWAGEN VAN ..... 1954-88</p>	 <p style="text-align: center;"><b>EM-2296</b> <b>MOUNT-ENGINE</b> <b>L &amp; R Front</b></p> <p>CADILLAC PASSENGER CAR .... 1965-78</p>	 <p style="text-align: center;"><b>EM-2302</b> <b>MOUNT-TRANSMISSION</b></p> <p>DODGE PASSENGER CAR ..... 1963-64 <b>MOUNT-TRANSMISSION</b> <b>L &amp; R</b></p> <p>DODGE TRUCK ..... 1967-68</p>
 <p style="text-align: center;"><b>EM-2297</b> <b>MOUNT-ENGINE</b> <b>L &amp; R Front Upper</b></p> <p>FORD MEDIUM/HEAVY DUTY .... 1975-77</p>	 <p style="text-align: center;"><b>EM-2303</b> <b>MOUNT-ENGINE</b> <b>LH Front</b></p> <p>DODGE PASSENGER CAR ..... 1960-66</p>	<p><b>(Continued Next Page)</b></p>	

@ = Universal Mount EM-5000 also available.

# BUYER'S GUIDE

## NUMERICAL LISTING - ILLUSTRATIONS

### EM-2303 (Continued)

PLYMOUTH PASSENGER  
CAR ..... 1960-66



### EM-2304 MOUNT-ENGINE RH Front

DODGE PASSENGER CAR ..... 1960-66  
PLYMOUTH PASSENGER  
CAR ..... 1960-66



### EM-2305 MOUNT-TRANSMISSION Upper

FORD MEDIUM/HEAVY DUTY .... 1975-77  
**MOUNT-TRANSMISSION**  
FORD TRUCK ..... 1965-66



### EM-2306 MOUNT-TRANSMISSION Lower

FORD MEDIUM/HEAVY DUTY .... 1975-77  
**MOUNT-TRANSMISSION**  
FORD TRUCK ..... 1965-66



### EM-2307 MOUNT-TRANSMISSION

FORD VAN ..... 1969-71



### EM-2309 MOUNT-ENGINE L & R Front

GMC TRUCK ..... 1967



### EM-2310 MOUNT-TRANSMISSION

AMERICAN MOTORS  
PASSENGER CAR ..... 1966-68



### EM-2311 MOUNT-TRANSMISSION Auto

FORD PASSENGER CAR ..... 1968-78  
MERCURY PASSENGER CAR ... 1971-73



### EM-2316 MOUNT-ENGINE L & R Front

FORD PASSENGER CAR ..... 1971-77  
MERCURY PASSENGER CAR ... 1971-77



### EM-2317 MOUNT-TRANSMISSION Manual

AMERICAN MOTORS  
PASSENGER CAR ..... 1965-74



### EM-2319 MOUNT-ENGINE L & R Front

FORD PASSENGER CAR ..... 1965-72  
FORD SPORT UTILITY ..... 1967-72



### EM-2320 MOUNT-TRANSMISSION

CADILLAC PASSENGER CAR .... 1968-76



### EM-2321 MOUNT-TRANSMISSION

PONTIAC PASSENGER CAR ..... 1963-70



### EM-2323 MOUNT-ENGINE RH Front

CHRYSLER PASSENGER  
CAR ..... 1978-83  
DODGE PASSENGER CAR ..... 1973-83  
PLYMOUTH PASSENGER  
CAR ..... 1973-83



### EM-2324 MOUNT-ENGINE LH Front

CHRYSLER PASSENGER  
CAR ..... 1978-83  
DODGE PASSENGER CAR ..... 1973-83  
PLYMOUTH PASSENGER  
CAR ..... 1973-83

# BUYER'S GUIDE

## NUMERICAL LISTING - ILLUSTRATIONS

 <p style="text-align: center;"><b>EM-2325</b> <b>MOUNT-ENGINE</b> <b>RH Front</b></p> <p>CHRYSLER PASSENGER CAR ..... 1974-89 DODGE PASSENGER CAR ..... 1972-89 PLYMOUTH PASSENGER CAR ..... 1970-89</p>	 <p style="text-align: center;"><b>EM-2328</b> <b>MOUNT-ENGINE</b> <b>L &amp; R Front</b></p> <p>BUICK PASSENGER CAR ..... 1970-90 CHEVROLET PASSENGER CAR ..... 1980-90 CHEVROLET TRUCK ..... 1979-84 GMC SPORT UTILITY ..... 1979-81 GMC TRUCK ..... 1979-84 OLDSMOBILE PASSENGER CAR ..... 1965-90 PONTIAC PASSENGER CAR ..... 1975-89</p>	 <p style="text-align: center;"><b>EM-2331</b> <b>MOUNT-ENGINE</b> <b>RH Front</b></p> <p>FORD SPORT UTILITY ..... 1967 FORD TRUCK ..... 1965-74 FORD VAN ..... 1969-76</p>	 <p style="text-align: center;"><b>EM-2335</b> <b>MOUNT-ENGINE</b> <b>RH Front</b></p> <p>PONTIAC PASSENGER CAR ..... 1968-74</p>
 <p style="text-align: center;"><b>EM-2326</b> <b>MOUNT-ENGINE</b> <b>LH Front</b></p> <p>CHRYSLER PASSENGER CAR ..... 1974-89 DODGE PASSENGER CAR ..... 1972-89 PLYMOUTH PASSENGER CAR ..... 1970-89</p>	 <p style="text-align: center;"><b>EM-2329</b> <b>MOUNT-ENGINE</b> <b>L &amp; R Front</b></p> <p>FORD SPORT UTILITY ..... 1966-86 FORD TRUCK ..... 1969-86 FORD VAN ..... 1969-74</p>	 <p style="text-align: center;"><b>EM-2332</b> <b>MOUNT-ENGINE</b> <b>LH Front</b></p> <p>FORD SPORT UTILITY ..... 1967 FORD TRUCK ..... 1965-74 FORD VAN ..... 1969-76</p>	 <p style="text-align: center;"><b>EM-2336</b> <b>MOUNT-ENGINE</b> <b>LH Front</b></p> <p>PONTIAC PASSENGER CAR ..... 1968-74</p>
 <p style="text-align: center;"><b>EM-2327</b> <b>MOUNT-TRANSMISSION</b> <b>Auto</b></p> <p>FORD TRUCK ..... 1965-79 <b>MOUNT-TRANSMISSION</b></p> <p>FORD VAN ..... 1969-74</p>	 <p style="text-align: center;"><b>EM-2330</b> <b>MOUNT-ENGINE</b> <b>L &amp; R Front</b></p> <p>AMERICAN MOTORS PASSENGER CAR ..... 1971-88 JEEP SPORT UTILITY ..... 1972-86 JEEP TRUCK ..... 1974-87</p>	 <p style="text-align: center;"><b>EM-2333</b> <b>MOUNT-ENGINE</b> <b>L &amp; R Front</b></p> <p>FORD PASSENGER CAR ..... 1966-72 FORD TRUCK ..... 1964-68 MERCURY PASSENGER CAR ... 1966-74</p>	 <p style="text-align: center;"><b>EM-2337</b> <b>MOUNT-TRANSMISSION</b></p> <p>BUICK PASSENGER CAR ..... 1977 <b>MOUNT-TRANSMISSION</b> <b>Auto</b></p> <p>CHEVROLET PASSENGER CAR ..... 1969-84 <b>MOUNT-TRANSMISSION</b> <b>Manual</b></p> <p>CHEVROLET TRUCK ..... 1973-81 <b>MOUNT-TRANSMISSION</b> <b>Auto</b></p> <p>GMC TRUCK ..... 1978-81 <b>MOUNT-TRANSMISSION</b></p> <p>OLDSMOBILE PASSENGER CAR ..... 1971-81 PONTIAC PASSENGER CAR ..... 1975-87</p>

# BUYER'S GUIDE

## NUMERICAL LISTING - ILLUSTRATIONS

 <p style="text-align: center;"><b>EM-2338</b> <b>MOUNT-ENGINE</b> <b>L &amp; R Front</b></p> <p>DODGE VAN ..... 1964-70 PLYMOUTH PASSENGER CAR ..... 1964-66</p>	 <p style="text-align: center;"><b>EM-2341</b> <b>MOUNT-ENGINE</b> <b>L &amp; R Front</b></p> <p>FORD PASSENGER CAR ..... 1973-83 MERCURY PASSENGER CAR ... 1971-77</p>	 <p style="text-align: center;"><b>EM-2346</b> <b>MOUNT-TRANSMISSION</b> <b>Auto</b></p> <p>FORD PASSENGER CAR ..... 1973-80 <b>MOUNT-TRANSMISSION</b></p> <p>MERCURY PASSENGER CAR ... 1972-80</p>	 <p style="text-align: center;"><b>EM-2349</b> <b>MOUNT-TRANSMISSION</b> <b>Auto</b></p> <p>FORD SPORT UTILITY ..... 1967-79 <b>MOUNT-TRANSMISSION</b></p> <p>FORD TRUCK ..... 1965-79 <b>MOUNT-TRANSMISSION</b> <b>Manual</b></p> <p>MERCURY PASSENGER CAR ... 1961-64</p>
 <p style="text-align: center;"><b>EM-2339</b> <b>MOUNT-TRANSMISSION</b></p> <p>CHRYSLER PASSENGER CAR ..... 1978-79</p>	 <p style="text-align: center;"><b>EM-2344</b> <b>MOUNT-ENGINE</b> <b>LH Front</b></p> <p>FORD PASSENGER CAR ..... 1974-80 <b>MOUNT-ENGINE</b> <b>L &amp; R Front</b></p> <p>MERCURY PASSENGER CAR ... 1974-80</p>	 <p style="text-align: center;"><b>EM-2347</b> <b>MOUNT-TRANSMISSION</b> <b>Manual</b></p> <p>FORD PASSENGER CAR ..... 1972-76 <b>MOUNT-TRANSMISSION</b> <b>Manual</b></p> <p>FORD TRUCK ..... 1972-76 <b>MOUNT-TRANSMISSION</b></p> <p>FORD VAN ..... 1989-91 <b>MOUNT-TRANSMISSION</b> <b>Manual</b></p> <p>MERCURY PASSENGER CAR ... 1972-76</p>	 <p style="text-align: center;"><b>EM-2350</b> <b>MOUNT-ENGINE</b> <b>L &amp; R Front</b></p> <p>BUICK PASSENGER CAR ..... 1965-67</p>
 <p style="text-align: center;"><b>EM-2340</b> <b>MOUNT-TRANSMISSION</b> <b>Manual</b></p> <p>CHRYSLER PASSENGER CAR ..... 1969-89 <b>MOUNT-TRANSMISSION</b> <b>Manual</b></p> <p>DODGE PASSENGER CAR ..... 1966-89 <b>MOUNT-TRANSMISSION</b></p> <p>PLYMOUTH PASSENGER CAR ..... 1966-89 PLYMOUTH SUV ..... 1974-81</p>	 <p style="text-align: center;"><b>EM-2345</b> <b>MOUNT-TRANSMISSION</b> <b>Auto</b></p> <p>FORD PASSENGER CAR ..... 1969-78 <b>MOUNT-TRANSMISSION</b> <b>Manual</b></p> <p>MERCURY PASSENGER CAR ... 1969-81</p>	 <p style="text-align: center;"><b>EM-2348</b> <b>MOUNT-TRANSMISSION</b></p> <p>FORD SPORT UTILITY ..... 1966-72</p>	 <p style="text-align: center;"><b>EM-2351</b> <b>MOUNT-ENGINE</b> <b>L &amp; R Front</b></p> <p>AMERICAN MOTORS PASSENGER CAR ..... 1966-79 JEEP SPORT UTILITY ..... 1972-93 JEEP TRUCK ..... 1974-88</p>



# BUYER'S GUIDE

## NUMERICAL LISTING - ILLUSTRATIONS

 <p style="text-align: center;"><b>EM-2353</b> <b>MOUNT-TRANSMISSION</b> <b>Auto</b></p> <p>BUICK PASSENGER CAR ..... 1975-77 CHEVROLET PASSENGER CAR ..... 1971-80</p> <p style="text-align: center;"><b>MOUNT-TRANSMISSION</b></p> <p>CHEVROLET TRUCK ..... 1978-79 GMC TRUCK ..... 1978-79</p> <p style="text-align: center;"><b>MOUNT-TRANSMISSION</b> <b>Manual</b></p> <p>OLDSMOBILE PASSENGER CAR ..... 1975-79</p> <p style="text-align: center;"><b>MOUNT-TRANSMISSION</b> <b>Auto</b></p> <p>PONTIAC PASSENGER CAR ..... 1975-80</p>	 <p style="text-align: center;"><b>EM-2358</b> <b>MOUNT-ENGINE</b> <b>RH Front</b></p> <p>FORD PASSENGER CAR ..... 1971-78 MERCURY PASSENGER CAR ... 1971-81</p>  <p style="text-align: center;"><b>EM-2359</b> <b>MOUNT-ENGINE</b> <b>LH Front</b></p> <p>FORD PASSENGER CAR ..... 1971-78 MERCURY PASSENGER CAR ... 1971-81</p>	 <p style="text-align: center;"><b>EM-2362</b> <b>MOUNT-TRANSMISSION</b> <b>Auto</b></p> <p>FORD TRUCK ..... 1965-78 FORD VAN ..... 1969-74</p>  <p style="text-align: center;"><b>EM-2363</b> <b>MOUNT-ENGINE</b> <b>L &amp; R Front</b></p> <p>FORD PASSENGER CAR ..... 1971-74 MERCURY PASSENGER CAR ... 1971-74</p>	 <p style="text-align: center;"><b>EM-2365</b> <b>MOUNT-ENGINE</b> <b>LH Front</b></p> <p>FORD PASSENGER CAR ..... 1972-79 FORD TRUCK ..... 1972-78 LINCOLN PASSENGER CAR ..... 1977-79 MERCURY PASSENGER CAR ... 1972-79</p>  <p style="text-align: center;"><b>EM-2367</b> <b>MOUNT-ENGINE</b> <b>RH Front</b></p> <p>FORD PASSENGER CAR ..... 1969-78 MERCURY PASSENGER CAR ... 1969-78</p>
 <p style="text-align: center;"><b>EM-2356</b> <b>MOUNT-ENGINE</b> <b>RH Front</b></p> <p>CHEVROLET PASSENGER CAR ..... 1971-77 OLDSMOBILE PASSENGER CAR ..... 1976-77 PONTIAC PASSENGER CAR ..... 1975-77</p>	 <p style="text-align: center;"><b>EM-2360@</b> <b>MOUNT-TRANSMISSION</b> <b>Auto</b></p> <p>BUICK PASSENGER CAR ..... 1970-93</p> <p style="text-align: center;"><b>MOUNT-TRANSMISSION</b></p> <p>CADILLAC PASSENGER CAR ..... 1976-80</p> <p style="text-align: center;"><b>MOUNT-TRANSMISSION</b> <b>Auto</b></p> <p>CHEVROLET PASSENGER CAR ..... 1965-93 CHEVROLET TRUCK ..... 1967-94 GMC TRUCK ..... 1973-91 OLDSMOBILE PASSENGER CAR ..... 1970-92 PONTIAC PASSENGER CAR ..... 1970-89</p>	 <p style="text-align: center;"><b>EM-2364</b> <b>MOUNT-ENGINE</b> <b>RH Front</b></p> <p>FORD PASSENGER CAR ..... 1972-79 FORD TRUCK ..... 1972-78 LINCOLN PASSENGER CAR ..... 1977-79 MERCURY PASSENGER CAR ... 1972-79</p>	 <p style="text-align: center;"><b>EM-2368</b> <b>MOUNT-ENGINE</b> <b>LH Front</b></p> <p>FORD PASSENGER CAR ..... 1969-78 MERCURY PASSENGER CAR ... 1969-78</p>
 <p style="text-align: center;"><b>EM-2357</b> <b>MOUNT-ENGINE</b> <b>LH Front</b></p> <p>CHEVROLET PASSENGER CAR ..... 1971-77 OLDSMOBILE PASSENGER CAR ..... 1976-77 PONTIAC PASSENGER CAR ..... 1975-77</p>			

@ = Universal Mount EM-5000 also available.

# BUYER'S GUIDE

## NUMERICAL LISTING - ILLUSTRATIONS

 <p style="text-align: center;"><b>EM-2369</b> <b>MOUNT-ENGINE</b> <b>L &amp; R Front</b></p> <p>CHRYSLER PASSENGER CAR ..... 1972-89</p> <p style="text-align: center;"><b>MOUNT-ENGINE</b> <b>LH Front</b></p> <p>DODGE PASSENGER CAR ..... 1972-89 PLYMOUTH PASSENGER CAR ..... 1970-89</p>	 <p style="text-align: center;"><b>EM-2372</b> <b>MOUNT-TRANSMISSION</b></p> <p>FORD PASSENGER CAR ..... 1972-76</p> <p style="text-align: center;"><b>MOUNT-TRANSMISSION</b> <b>Manual</b></p> <p>FORD TRUCK ..... 1972-77</p> <p style="text-align: center;"><b>MOUNT-TRANSMISSION</b> <b>Auto</b></p> <p>FORD VAN ..... 1975-76 MERCURY PASSENGER CAR ... 1972-76</p>	<p><b>EM-2374 (Continued)</b></p> <p>PONTIAC PASSENGER CAR ..... 1971-72 BUICK PASSENGER CAR ..... 1970-74 CADILLAC PASSENGER CAR ..... 1977-96</p> <p style="text-align: center;"><b>MOUNT-TRANSMISSION</b> <b>Auto</b></p> <p>PONTIAC PASSENGER CAR ..... 1971-72</p>  <p style="text-align: center;"><b>EM-2375</b> <b>MOUNT-ENGINE</b> <b>L &amp; R Front</b></p> <p>OLDSMOBILE PASSENGER CAR ... 1975 PONTIAC PASSENGER CAR ..... 1973-78</p>	<p><b>EM-2378 (Continued)</b></p> <p>CHEVROLET TRUCK ..... 1959-82 CHEVROLET VAN ..... 1968-84 GMC SPORT UTILITY ..... 1966-81</p> <p style="text-align: center;"><b>MOUNT-TRANSMISSION</b> <b>Auto</b></p> <p>GMC TRUCK ..... 1966-82</p> <p style="text-align: center;"><b>MOUNT-TRANSMISSION</b></p> <p>GMC VAN ..... 1967-84 OLDSMOBILE PASSENGER CAR ..... 1964-77 PONTIAC PASSENGER CAR ..... 1964-81</p>  <p style="text-align: center;"><b>EM-2379</b> <b>MOUNT-TRANSMISSION</b></p> <p>BUICK PASSENGER CAR ..... 1975-87 CADILLAC PASSENGER CAR .... 1980-82 CHEVROLET PASSENGER CAR ..... 1978-88</p> <p style="text-align: center;"><b>MOUNT-TRANSMISSION</b> <b>Auto</b></p> <p>CHEVROLET TRUCK ..... 1978-87 GMC TRUCK ..... 1978-87</p> <p style="text-align: center;"><b>MOUNT-TRANSMISSION</b> <b>Manual</b></p> <p>OLDSMOBILE PASSENGER CAR ..... 1977-87</p> <p style="text-align: center;"><b>MOUNT-TRANSMISSION</b></p> <p>PONTIAC PASSENGER CAR ..... 1977-87</p>
 <p style="text-align: center;"><b>EM-2370</b> <b>MOUNT-ENGINE</b> <b>LH Front</b></p> <p>FORD PASSENGER CAR ..... 1972-79</p> <p style="text-align: center;"><b>MOUNT-ENGINE</b> <b>RH Front</b></p> <p>FORD TRUCK ..... 1972-79 MERCURY PASSENGER CAR ... 1971-79</p>	 <p style="text-align: center;"><b>EM-2373</b> <b>MOUNT-TRANSMISSION</b> <b>Auto</b></p> <p>AMERICAN MOTORS PASSENGER CAR ..... 1968-80</p> <p style="text-align: center;"><b>MOUNT-TRANSMISSION</b> <b>Manual</b></p> <p>CHEVROLET VAN ..... 1973-80</p> <p style="text-align: center;"><b>MOUNT-TRANSMISSION</b> <b>Auto</b></p> <p>GMC VAN ..... 1974-78</p>	 <p style="text-align: center;"><b>EM-2376</b> <b>MOUNT-ENGINE</b> <b>LH Front</b></p> <p>CHRYSLER PASSENGER CAR ..... 1978-83 DODGE PASSENGER CAR ..... 1973-83 PLYMOUTH PASSENGER CAR ..... 1973-83</p>	<p style="text-align: center;"><b>EM-2379</b> <b>MOUNT-TRANSMISSION</b></p> <p>BUICK PASSENGER CAR ..... 1975-87 CADILLAC PASSENGER CAR .... 1980-82 CHEVROLET PASSENGER CAR ..... 1978-88</p> <p style="text-align: center;"><b>MOUNT-TRANSMISSION</b> <b>Auto</b></p> <p>CHEVROLET TRUCK ..... 1978-87 GMC TRUCK ..... 1978-87</p> <p style="text-align: center;"><b>MOUNT-TRANSMISSION</b> <b>Manual</b></p> <p>OLDSMOBILE PASSENGER CAR ..... 1977-87</p> <p style="text-align: center;"><b>MOUNT-TRANSMISSION</b></p> <p>PONTIAC PASSENGER CAR ..... 1977-87</p>
 <p style="text-align: center;"><b>EM-2371</b> <b>MOUNT-ENGINE</b> <b>RH Front</b></p> <p>FORD PASSENGER CAR ..... 1972-79</p> <p style="text-align: center;"><b>MOUNT-ENGINE</b> <b>LH Front</b></p> <p>FORD TRUCK ..... 1972-79 MERCURY PASSENGER CAR ... 1971-79</p>	 <p style="text-align: center;"><b>EM-2374@</b> <b>MOUNT-ENGINE</b> <b>L &amp; R Rear</b></p> <p>PONTIAC PASSENGER CAR ..... 1977-80</p> <p style="text-align: center;"><b>MOUNT-TRANSMISSION</b></p> <p>BUICK PASSENGER CAR ..... 1973-75 CADILLAC PASSENGER CAR .... 1980-84 OLDSMOBILE PASSENGER CAR ..... 1974-75</p> <p style="text-align: center;">(Continued Next Column)</p>	 <p style="text-align: center;"><b>EM-2378@</b> <b>MOUNT-TRANSMISSION</b> <b>Manual</b></p> <p>BUICK PASSENGER CAR ..... 1966-74</p> <p style="text-align: center;"><b>MOUNT-TRANSMISSION</b></p> <p>CHEVROLET PASSENGER CAR ..... 1957-81</p> <p style="text-align: center;"><b>MOUNT-TRANSMISSION</b> <b>Manual</b></p> <p>CHEVROLET SPORT UTILITY ... 1966-84</p> <p style="text-align: center;">(Continued Next Column)</p>	 <p style="text-align: center;"><b>EM-2381</b> <b>MOUNT-ENGINE</b> <b>L &amp; R Front</b></p> <p>CHEVROLET PASSENGER CAR ..... 1976-87 CHEVROLET SPORT UTILITY ... 1983-84 CHEVROLET TRUCK ..... 1982-85 GMC SPORT UTILITY ..... 1983-84 GMC TRUCK ..... 1982-85 PONTIAC PASSENGER CAR ..... 1976-87</p>

@ = Universal Mount EM-5000 also available.

# BUYER'S GUIDE

## NUMERICAL LISTING - ILLUSTRATIONS

 <p style="text-align: center;"><b>EM-2382</b> <b>MOUNT-ENGINE</b> <b>LH Front</b></p> <p>BUICK PASSENGER CAR ..... 1975-87            CADILLAC PASSENGER CAR .... 1980-82            CHEVROLET PASSENGER            CAR ..... 1978-87            CHEVROLET TRUCK ..... 1978-84            GMC TRUCK ..... 1978-84            OLDSMOBILE PASSENGER            CAR ..... 1975-87            PONTIAC PASSENGER CAR ..... 1976-87</p>	 <p style="text-align: center;"><b>EM-2387</b> <b>MOUNT-ENGINE</b> <b>L &amp; R Front</b></p> <p>BUICK PASSENGER CAR ..... 1977-82            CADILLAC PASSENGER CAR .... 1977-90            OLDSMOBILE PASSENGER CAR ... 1979            PONTIAC PASSENGER CAR ..... 1975-81</p>	 <p style="text-align: center;"><b>EM-2391</b> <b>MOUNT-TRANSMISSION</b> <b>Auto</b></p> <p>BUICK PASSENGER CAR ..... 1980-81            CHEVROLET PASSENGER            CAR ..... 1976-87            PONTIAC PASSENGER CAR ..... 1976-87</p>	 <p style="text-align: center;"><b>EM-2393</b> <b>MOUNT-TRANSMISSION</b> <b>Manual</b></p> <p>BUICK PASSENGER CAR ..... 1977-82            CHEVROLET PASSENGER            CAR ..... 1979-86            CHEVROLET SPORT UTILITY .... 1983-90            CHEVROLET TRUCK ..... 1982-91            CHEVROLET VAN ..... 1981-90            GMC SPORT UTILITY ..... 1982-91            GMC TRUCK ..... 1982-91            GMC VAN ..... 1983-90            OLDSMOBILE PASSENGER            CAR ..... 1978-80            PONTIAC PASSENGER CAR ..... 1975-87</p>
 <p style="text-align: center;"><b>EM-2384</b> <b>MOUNT-ENGINE</b> <b>RH Front</b></p> <p>BUICK PASSENGER CAR ..... 1975-87            CADILLAC PASSENGER CAR .... 1980-82            CHEVROLET PASSENGER            CAR ..... 1978-87            CHEVROLET TRUCK ..... 1978-84            GMC TRUCK ..... 1978-84            OLDSMOBILE PASSENGER            CAR ..... 1975-87            PONTIAC PASSENGER CAR ..... 1976-87</p>	 <p style="text-align: center;"><b>EM-2388</b> <b>MOUNT-TRANSMISSION</b> <b>Manual</b></p> <p>FORD PASSENGER CAR ..... 1974-93            MERCURY PASSENGER CAR ... 1976-88</p>	 <p style="text-align: center;"><b>EM-2392</b> <b>MOUNT-TRANSMISSION</b> <b>Auto</b></p> <p>CHEVROLET PASSENGER            CAR ..... 1982-86            CHEVROLET SPORT UTILITY .... 1982-91            CHEVROLET TRUCK ..... 1982-91            CHEVROLET VAN ..... 1982-99            GMC SPORT UTILITY ..... 1982-91            GMC TRUCK ..... 1982-91            GMC VAN ..... 1982-99            OLDSMOBILE PASSENGER            CAR ..... 1978-81            PONTIAC PASSENGER CAR ..... 1977-87</p>	 <p style="text-align: center;"><b>EM-2394</b> <b>MOUNT-TRANSMISSION</b> <b>Manual</b></p> <p>BUICK PASSENGER CAR ..... 1968-96            CADILLAC PASSENGER CAR .... 1986-96            CHEVROLET PASSENGER            CAR ..... 1982-97            CHEVROLET SPORT UTILITY .... 1995-05</p>
 <p style="text-align: center;"><b>EM-2385</b> <b>MOUNT-ENGINE</b> <b>L &amp; R Front</b></p> <p>FORD PASSENGER CAR ..... 1978-83            MERCURY PASSENGER CAR .... 1978-83</p>	 <p style="text-align: center;"><b>EM-2389</b> <b>MOUNT-TRANSMISSION</b> <b>Auto</b></p> <p>FORD PASSENGER CAR ..... 1978-86            MERCURY PASSENGER CAR ... 1979-86</p>	<p style="text-align: center;"><b>(Continued Next Page)</b></p>	



# BUYER'S GUIDE

## NUMERICAL LISTING - ILLUSTRATIONS

**EM-2394 (Continued)**  
**MOUNT-TRANSMISSION**

CHEVROLET TRUCK ..... 1985-03

**MOUNT-TRANSMISSION**  
**Auto**

CHEVROLET VAN ..... 1990-93

GMC SPORT UTILITY ..... 1995-01

GMC TRUCK ..... 1985-03

GMC VAN ..... 1990-93

**MOUNT-TRANSMISSION**  
**Manual**

ISUZU TRUCK ..... 1997-00

**MOUNT-TRANSMISSION**  
**Auto**

OLDSMOBILE PASSENGER

CAR ..... 1977-79

PONTIAC PASSENGER CAR ..... 1976-93



**EM-2395**  
**MOUNT-ENGINE**  
**L & R Front**

CHEVROLET PASSENGER

CAR ..... 1972-81

CHEVROLET SPORT UTILITY ..... 1973-91

CHEVROLET TRUCK ..... 1973-91

CHEVROLET VAN ..... 1970-97

GMC SPORT UTILITY ..... 1973-91

GMC TRUCK ..... 1973-91

GMC VAN ..... 1973-97



**EM-2396**  
**Engine Torque Strut Mount**  
**Front**

BUICK PASSENGER CAR ..... 1980-94

CHEVROLET PASSENGER

CAR ..... 1980-90

CHEVROLET VAN ..... 1990-95

OLDSMOBILE PASSENGER

CAR ..... 1980-94

OLDSMOBILE VAN ..... 1990-95

PONTIAC PASSENGER CAR ..... 1980-91

PONTIAC VAN ..... 1990-95



**EM-2400**  
**MOUNT-ENGINE**  
**L & R Front**

NISSAN PASSENGER CAR ..... 1974-77



**EM-2401**  
**MOUNT-ENGINE**  
**L & R Front**

NISSAN PASSENGER CAR ..... 1970-83



**EM-2402**  
**MOUNT-ENGINE**  
**L & R Front**

NISSAN PASSENGER CAR ..... 1971-73



**EM-2403**  
**MOUNT-ENGINE**  
**L & R Front**

NISSAN PASSENGER CAR ..... 1966-73



**EM-2404**  
**MOUNT-ENGINE**  
**L & R Front**

NISSAN PASSENGER CAR ..... 1974-77

NISSAN TRUCK ..... 1972-74



**EM-2405**  
**MOUNT-ENGINE**  
**L & R Front**

NISSAN PASSENGER CAR ..... 1973-79



**EM-2406**  
**MOUNT-ENGINE**  
**L & R Front**

TOYOTA PASSENGER CAR ..... 1971-82



**EM-2407**  
**MOUNT-ENGINE**  
**L & R Front**

TOYOTA PASSENGER CAR ..... 1967-82

TOYOTA TRUCK ..... 1970-80

TOYOTA VAN ..... 1984-85



**EM-2408**  
**MOUNT-TRANSMISSION**  
**Manual**

TOYOTA PASSENGER CAR ..... 1969-79



**EM-2409**  
**MOUNT-TRANSMISSION**  
**Manual**

TOYOTA PASSENGER CAR ..... 1967-84

TOYOTA TRUCK ..... 1970-78



**EM-2410**  
**MOUNT-TRANSMISSION**  
**Auto**

TOYOTA PASSENGER CAR ..... 1967-92

**MOUNT-TRANSMISSION**  
**Manual**

TOYOTA SPORT UTILITY ..... 1981-98

**MOUNT-TRANSMISSION**  
**Auto**

TOYOTA TRUCK ..... 1975-04

# BUYER'S GUIDE

## NUMERICAL LISTING - ILLUSTRATIONS

 <p><b>EM-2413</b> <b>MOUNT-ENGINE</b> <b>L &amp; R Rear</b></p> <p>VOLKSWAGEN VAN ..... 1968-71</p>	 <p><b>EM-2417</b> <b>MOUNT-TRANSMISSION-</b> <b>Rear Upper</b></p> <p>VOLKSWAGEN PASSENGER CAR ..... 1975-93 VOLKSWAGEN TRUCK ..... 1980-83</p>	 <p><b>EM-2420</b> <b>MOUNT-TRANSMISSION</b> <b>Auto</b></p> <p>VOLKSWAGEN PASSENGER CAR ..... 1975-93</p> <p><b>EM-2420</b> <b>MOUNT-TRANSMISSION-</b> <b>Rear Lower</b></p> <p>VOLKSWAGEN TRUCK ..... 1980-83</p>	 <p><b>EM-2425</b> <b>MOUNT-TRANSMISSION</b> <b>Manual</b></p> <p>VOLVO PASSENGER CAR ..... 1969-75</p>
 <p><b>EM-2414</b> <b>MOUNT-ENGINE</b> <b>Rear Outer</b></p> <p>VOLKSWAGEN PASSENGER CAR ..... 1967-69 VOLKSWAGEN TRUCK ..... 1977-78 VOLKSWAGEN VAN ..... 1954-88</p>	 <p><b>EM-2418</b> <b>MOUNT-ENGINE</b> <b>RH Rear</b></p> <p>VOLKSWAGEN PASSENGER CAR ..... 1973-80</p> <p><b>EM-2418</b> <b>MOUNT-TRANSMISSION</b> <b>RH</b></p> <p>VOLKSWAGEN PASSENGER CAR ..... 1971-79</p>	 <p><b>EM-2421</b> <b>MOUNT-ENGINE</b> <b>L &amp; R Front</b></p> <p>AUDI PASSENGER CAR ..... 1973-90 VOLKSWAGEN PASSENGER CAR ..... 1982-08 VOLKSWAGEN TRUCK ..... 1999-07 VOLKSWAGEN VAN ..... 1988-01</p> <p><b>EM-2421</b> <b>MOUNT-ENGINE</b> <b>Rear</b></p> <p>VOLKSWAGEN PASSENGER CAR ..... 1974-80</p>	 <p><b>EM-2426</b> <b>MOUNT-ENGINE</b> <b>L &amp; R Front</b></p> <p>VOLVO PASSENGER CAR ..... 1976-93</p>
 <p><b>EM-2415</b> <b>MOUNT-ENGINE</b> <b>L &amp; R Front</b></p> <p>VOLKSWAGEN PASSENGER CAR ..... 1971-74</p> <p><b>EM-2415</b> <b>MOUNT-ENGINE</b> <b>Rear Inner</b></p> <p>VOLKSWAGEN TRUCK ..... 1977-78 VOLKSWAGEN VAN ..... 1954-88</p>	 <p><b>EM-2419</b> <b>MOUNT-ENGINE</b> <b>LH Rear</b></p> <p>VOLKSWAGEN PASSENGER CAR ..... 1973-80</p> <p><b>EM-2419</b> <b>MOUNT-TRANSMISSION</b> <b>LH</b></p> <p>VOLKSWAGEN PASSENGER CAR ..... 1971-79</p>	 <p><b>EM-2424</b> <b>MOUNT-ENGINE</b> <b>L &amp; R Front</b></p> <p>VOLVO PASSENGER CAR ..... 1969-74</p>	 <p><b>EM-2427</b> <b>MOUNT-ENGINE</b> <b>L &amp; R Front</b></p> <p>VOLVO PASSENGER CAR ..... 1975</p>
			 <p><b>EM-2428</b> <b>MOUNT-TRANSMISSION</b></p> <p>VOLVO PASSENGER CAR ..... 1975-93</p>

# BUYER'S GUIDE

## NUMERICAL LISTING - ILLUSTRATIONS

 <p><b>EM-2429</b> <b>MOUNT-ENGINE</b> <b>L &amp; R Front</b></p> <p>VOLVO PASSENGER CAR ..... 1981-93</p>	<p><b>EM-2436 (Continued)</b></p> <table style="width: 100%; border-collapse: collapse;"> <tr><td>CHEVROLET SPORT UTILITY .....</td><td>1983-89</td></tr> <tr><td>CHEVROLET TRUCK .....</td><td>1980-95</td></tr> <tr><td>CHEVROLET VAN .....</td><td>1985-05</td></tr> <tr><td>GMC SPORT UTILITY .....</td><td>1983-89</td></tr> <tr><td>GMC TRUCK .....</td><td>1980-95</td></tr> <tr><td>GMC VAN .....</td><td>1985-05</td></tr> <tr><td>PONTIAC PASSENGER CAR .....</td><td>1980-02</td></tr> </table>  <p><b>EM-2437</b> <b>MOUNT-ENGINE</b> <b>RH Front</b></p> <table style="width: 100%; border-collapse: collapse;"> <tr><td>FORD PASSENGER CAR .....</td><td>1979-91</td></tr> <tr><td>LINCOLN PASSENGER CAR .....</td><td>1980-90</td></tr> <tr><td>MERCURY PASSENGER CAR .....</td><td>1978-91</td></tr> </table>  <p><b>EM-2438</b> <b>MOUNT-ENGINE</b> <b>LH Front</b></p> <table style="width: 100%; border-collapse: collapse;"> <tr><td>FORD PASSENGER CAR .....</td><td>1979-91</td></tr> <tr><td>LINCOLN PASSENGER CAR .....</td><td>1980-90</td></tr> <tr><td>MERCURY PASSENGER CAR .....</td><td>1978-91</td></tr> </table>  <p><b>EM-2439</b> <b>MOUNT-ENGINE</b> <b>RH Front</b></p> <table style="width: 100%; border-collapse: collapse;"> <tr><td>FORD MEDIUM/HEAVY DUTY .....</td><td>1996</td></tr> <tr><td>FORD VAN .....</td><td>1975-97</td></tr> </table>	CHEVROLET SPORT UTILITY .....	1983-89	CHEVROLET TRUCK .....	1980-95	CHEVROLET VAN .....	1985-05	GMC SPORT UTILITY .....	1983-89	GMC TRUCK .....	1980-95	GMC VAN .....	1985-05	PONTIAC PASSENGER CAR .....	1980-02	FORD PASSENGER CAR .....	1979-91	LINCOLN PASSENGER CAR .....	1980-90	MERCURY PASSENGER CAR .....	1978-91	FORD PASSENGER CAR .....	1979-91	LINCOLN PASSENGER CAR .....	1980-90	MERCURY PASSENGER CAR .....	1978-91	FORD MEDIUM/HEAVY DUTY .....	1996	FORD VAN .....	1975-97	 <p><b>EM-2440</b> <b>MOUNT-ENGINE</b> <b>LH Front</b></p> <table style="width: 100%; border-collapse: collapse;"> <tr><td>FORD MEDIUM/HEAVY DUTY .....</td><td>1996</td></tr> <tr><td>FORD VAN .....</td><td>1975-96</td></tr> </table>  <p><b>EM-2441</b> <b>MOUNT-ENGINE</b> <b>RH Front</b></p> <table style="width: 100%; border-collapse: collapse;"> <tr><td>FORD SPORT UTILITY .....</td><td>1980-84</td></tr> <tr><td>FORD TRUCK .....</td><td>1974-84</td></tr> <tr><td>FORD VAN .....</td><td>1977-84</td></tr> </table>  <p><b>EM-2442</b> <b>MOUNT-ENGINE</b> <b>LH Front</b></p> <table style="width: 100%; border-collapse: collapse;"> <tr><td>FORD SPORT UTILITY .....</td><td>1980-84</td></tr> <tr><td>FORD TRUCK .....</td><td>1974-84</td></tr> <tr><td>FORD VAN .....</td><td>1977-84</td></tr> </table>  <p><b>EM-2444</b> <b>MOUNT-ENGINE</b> <b>RH Front</b></p> <table style="width: 100%; border-collapse: collapse;"> <tr><td>FORD SPORT UTILITY .....</td><td>1978-79</td></tr> <tr><td>FORD TRUCK .....</td><td>1977-82</td></tr> </table>	FORD MEDIUM/HEAVY DUTY .....	1996	FORD VAN .....	1975-96	FORD SPORT UTILITY .....	1980-84	FORD TRUCK .....	1974-84	FORD VAN .....	1977-84	FORD SPORT UTILITY .....	1980-84	FORD TRUCK .....	1974-84	FORD VAN .....	1977-84	FORD SPORT UTILITY .....	1978-79	FORD TRUCK .....	1977-82	 <p><b>EM-2445</b> <b>MOUNT-ENGINE</b> <b>LH Front</b></p> <table style="width: 100%; border-collapse: collapse;"> <tr><td>FORD SPORT UTILITY .....</td><td>1978-79</td></tr> <tr><td>FORD TRUCK .....</td><td>1977-82</td></tr> </table>  <p><b>EM-2446</b> <b>MOUNT-ENGINE</b> <b>L &amp; R Front</b></p> <table style="width: 100%; border-collapse: collapse;"> <tr><td>AMERICAN MOTORS PASSENGER CAR .....</td><td>1980-82</td></tr> <tr><td>CHEVROLET PASSENGER CAR .....</td><td>1978-80</td></tr> <tr><td>JEEP SPORT UTILITY .....</td><td>1980-86</td></tr> <tr><td>OLDSMOBILE PASSENGER CAR .....</td><td>1978-80</td></tr> <tr><td>PONTIAC PASSENGER CAR .....</td><td>1977-80</td></tr> </table>  <p><b>EM-2447</b> <b>MOUNT-ENGINE</b> <b>Front</b></p> <table style="width: 100%; border-collapse: collapse;"> <tr><td>CHRYSLER PASSENGER CAR .....</td><td>1982-84</td></tr> <tr><td>DODGE PASSENGER CAR .....</td><td>1978-87</td></tr> <tr><td>DODGE TRUCK .....</td><td>1982-84</td></tr> <tr><td>PLYMOUTH PASSENGER CAR .....</td><td>1978-83</td></tr> </table>	FORD SPORT UTILITY .....	1978-79	FORD TRUCK .....	1977-82	AMERICAN MOTORS PASSENGER CAR .....	1980-82	CHEVROLET PASSENGER CAR .....	1978-80	JEEP SPORT UTILITY .....	1980-86	OLDSMOBILE PASSENGER CAR .....	1978-80	PONTIAC PASSENGER CAR .....	1977-80	CHRYSLER PASSENGER CAR .....	1982-84	DODGE PASSENGER CAR .....	1978-87	DODGE TRUCK .....	1982-84	PLYMOUTH PASSENGER CAR .....	1978-83
CHEVROLET SPORT UTILITY .....	1983-89																																																																										
CHEVROLET TRUCK .....	1980-95																																																																										
CHEVROLET VAN .....	1985-05																																																																										
GMC SPORT UTILITY .....	1983-89																																																																										
GMC TRUCK .....	1980-95																																																																										
GMC VAN .....	1985-05																																																																										
PONTIAC PASSENGER CAR .....	1980-02																																																																										
FORD PASSENGER CAR .....	1979-91																																																																										
LINCOLN PASSENGER CAR .....	1980-90																																																																										
MERCURY PASSENGER CAR .....	1978-91																																																																										
FORD PASSENGER CAR .....	1979-91																																																																										
LINCOLN PASSENGER CAR .....	1980-90																																																																										
MERCURY PASSENGER CAR .....	1978-91																																																																										
FORD MEDIUM/HEAVY DUTY .....	1996																																																																										
FORD VAN .....	1975-97																																																																										
FORD MEDIUM/HEAVY DUTY .....	1996																																																																										
FORD VAN .....	1975-96																																																																										
FORD SPORT UTILITY .....	1980-84																																																																										
FORD TRUCK .....	1974-84																																																																										
FORD VAN .....	1977-84																																																																										
FORD SPORT UTILITY .....	1980-84																																																																										
FORD TRUCK .....	1974-84																																																																										
FORD VAN .....	1977-84																																																																										
FORD SPORT UTILITY .....	1978-79																																																																										
FORD TRUCK .....	1977-82																																																																										
FORD SPORT UTILITY .....	1978-79																																																																										
FORD TRUCK .....	1977-82																																																																										
AMERICAN MOTORS PASSENGER CAR .....	1980-82																																																																										
CHEVROLET PASSENGER CAR .....	1978-80																																																																										
JEEP SPORT UTILITY .....	1980-86																																																																										
OLDSMOBILE PASSENGER CAR .....	1978-80																																																																										
PONTIAC PASSENGER CAR .....	1977-80																																																																										
CHRYSLER PASSENGER CAR .....	1982-84																																																																										
DODGE PASSENGER CAR .....	1978-87																																																																										
DODGE TRUCK .....	1982-84																																																																										
PLYMOUTH PASSENGER CAR .....	1978-83																																																																										
<p><b>EM-2433</b> <b>MOUNT-ENGINE</b> <b>RH Front</b></p> <table style="width: 100%; border-collapse: collapse;"> <tr><td>FORD PASSENGER CAR .....</td><td>1976-80</td></tr> <tr><td>MERCURY PASSENGER CAR .....</td><td>1976-80</td></tr> </table>	FORD PASSENGER CAR .....	1976-80	MERCURY PASSENGER CAR .....	1976-80																																																																							
FORD PASSENGER CAR .....	1976-80																																																																										
MERCURY PASSENGER CAR .....	1976-80																																																																										
 <p><b>EM-2434</b> <b>MOUNT-ENGINE</b> <b>LH Front</b></p> <table style="width: 100%; border-collapse: collapse;"> <tr><td>FORD PASSENGER CAR .....</td><td>1976-80</td></tr> <tr><td>MERCURY PASSENGER CAR .....</td><td>1976-80</td></tr> </table>	FORD PASSENGER CAR .....	1976-80	MERCURY PASSENGER CAR .....	1976-80																																																																							
FORD PASSENGER CAR .....	1976-80																																																																										
MERCURY PASSENGER CAR .....	1976-80																																																																										
 <p><b>EM-2436</b> <b>MOUNT-ENGINE</b> <b>L &amp; R Front</b></p> <table style="width: 100%; border-collapse: collapse;"> <tr><td>CHEVROLET PASSENGER CAR .....</td><td>1978-02</td></tr> </table> <p><b>(Continued Next Column)</b></p>	CHEVROLET PASSENGER CAR .....	1978-02																																																																									
CHEVROLET PASSENGER CAR .....	1978-02																																																																										

# BUYER'S GUIDE

## NUMERICAL LISTING - ILLUSTRATIONS

 <p style="text-align: center;"><b>EM-2448</b> <b>MOUNT-TRANSMISSION</b></p> <p>FORD PASSENGER CAR ..... 1994-97 <b>MOUNT-TRANSMISSION</b> Auto</p> <p>FORD SPORT UTILITY ..... 1968-86 <b>MOUNT-TRANSMISSION</b> Manual</p> <p>FORD TRUCK ..... 1977-86 <b>MOUNT-TRANSMISSION</b> Auto</p> <p>FORD VAN ..... 1975-91</p>	 <p style="text-align: center;"><b>EM-2452</b> <b>MOUNT-ENGINE</b> Side</p> <p>HONDA PASSENGER CAR ..... 1979-82 <b>MOUNT-TRANSMISSION</b> Lower</p> <p>HONDA PASSENGER CAR ..... 1979-81</p>	 <p style="text-align: center;"><b>EM-2456</b> <b>MOUNT-ENGINE</b> LH Front</p> <p>NISSAN PASSENGER CAR ..... 1978-81 <b>MOUNT-ENGINE</b> L &amp; R Front</p> <p>NISSAN VAN ..... 1988-92</p>	 <p style="text-align: center;"><b>EM-2459</b> <b>MOUNT-ENGINE</b> RH Front</p> <p>FORD PASSENGER CAR ..... 1981-83 MERCURY PASSENGER CAR ... 1981-83</p>
 <p style="text-align: center;"><b>EM-2449</b> <b>MOUNT-ENGINE</b> L &amp; R Front</p> <p>HONDA PASSENGER CAR ..... 1973-79</p>	 <p style="text-align: center;"><b>EM-2453</b> <b>MOUNT-TRANSMISSION</b> Auto</p> <p>AMERICAN MOTORS PASSENGER CAR ..... 1972-82</p>	 <p style="text-align: center;"><b>EM-2457</b> <b>MOUNT-ENGINE</b> RH Front</p> <p>FORD PASSENGER CAR ..... 1978-86 MERCURY PASSENGER CAR ... 1976-86</p>	 <p style="text-align: center;"><b>EM-2460</b> <b>MOUNT-ENGINE</b> Front</p> <p>FORD PASSENGER CAR ..... 1981-83 MERCURY PASSENGER CAR ... 1981-83</p>
 <p style="text-align: center;"><b>EM-2451</b> <b>MOUNT-ENGINE</b> Front</p> <p>HONDA PASSENGER CAR ..... 1979-82 <b>MOUNT-ENGINE</b> Rear</p> <p>HONDA VAN ..... 1984-87</p>	 <p style="text-align: center;"><b>EM-2454</b> <b>MOUNT-TRANSMISSION</b> Manual</p> <p>AMERICAN MOTORS PASSENGER CAR ..... 1971-83</p>	 <p style="text-align: center;"><b>EM-2458</b> <b>MOUNT-ENGINE</b> LH Front</p> <p>FORD PASSENGER CAR ..... 1978-86 MERCURY PASSENGER CAR ... 1976-86</p>	 <p style="text-align: center;"><b>EM-2461</b> <b>MOUNT-ENGINE</b> Front</p> <p>FORD PASSENGER CAR ..... 1981-83 MERCURY PASSENGER CAR ... 1981-83</p>
			 <p style="text-align: center;"><b>EM-2462</b> <b>MOUNT-ENGINE</b> L &amp; R Front</p> <p>FORD MEDIUM/HEAVY DUTY .... 1970-97</p>

# BUYER'S GUIDE

## NUMERICAL LISTING - ILLUSTRATIONS



**EM-2463**  
**MOUNT-TRANSMISSION**  
Manual

FORD PASSENGER CAR ..... 1981-83  
**MOUNT-TRANSMISSION**  
Auto

MERCURY PASSENGER CAR ... 1981-83



**EM-2464**  
**MOUNT-TRANSMISSION**  
Auto

FORD PASSENGER CAR ..... 1977-91  
**MOUNT-TRANSMISSION**  
Auto

FORD TRUCK ..... 1977-79  
**MOUNT-TRANSMISSION**

LINCOLN PASSENGER CAR ..... 1980-85  
**MOUNT-TRANSMISSION**  
Auto

MERCURY PASSENGER CAR ... 1975-91



**EM-2466**  
**MOUNT-TRANSMISSION**  
LH Front

BUICK PASSENGER CAR ..... 1980-96  
**MOUNT-TRANSMISSION**  
Front

CHEVROLET PASSENGER  
CAR ..... 1980-93  
**MOUNT-TRANSMISSION**  
LH Front

(Continued Next Column)

**EM-2466 (Continued)**

CHEVROLET VAN ..... 1990-96  
OLDSMOBILE PASSENGER  
CAR ..... 1980-94  
OLDSMOBILE VAN ..... 1990-96  
PONTIAC PASSENGER CAR ..... 1980-91  
PONTIAC VAN ..... 1990-96



**EM-2467**  
**MOUNT-TRANSMISSION**  
Manual

CHEVROLET PASSENGER CAR ..... 1980  
**MOUNT-TRANSMISSION**  
LH Rear

BUICK PASSENGER CAR ..... 1980-96  
**MOUNT-TRANSMISSION**  
Rear

CHEVROLET PASSENGER  
CAR ..... 1980-93  
**MOUNT-TRANSMISSION**  
LH Rear

CHEVROLET VAN ..... 1990-96  
OLDSMOBILE PASSENGER  
CAR ..... 1980-94  
OLDSMOBILE VAN ..... 1990-96  
PONTIAC PASSENGER CAR ..... 1980-91  
PONTIAC VAN ..... 1990-96



**EM-2469**  
**MOUNT-ENGINE**  
L & R Front

DODGE MEDIUM/HEAVY  
DUTY ..... 1979-81  
DODGE SPORT UTILITY ..... 1979-93  
DODGE TRUCK ..... 1979-93  
DODGE VAN ..... 1979-03  
PLYMOUTH SUV ..... 1979-81  
PLYMOUTH VAN ..... 1979-83



**EM-2470**  
**MOUNT-ENGINE**  
L & R Front

CADILLAC PASSENGER CAR .... 1975-76



**EM-2471**  
**MOUNT-TRANSMISSION**  
Manual

FORD PASSENGER CAR ..... 1971-73  
**MOUNT-TRANSMISSION**

MERCURY PASSENGER CAR ... 1971-72



**EM-2472**  
**MOUNT-ENGINE**  
RH Front

BUICK PASSENGER CAR ..... 1982-85  
CHEVROLET PASSENGER  
CAR ..... 1982-85  
OLDSMOBILE PASSENGER  
CAR ..... 1982-85  
PONTIAC PASSENGER CAR ..... 1982-88



**EM-2473**  
**MOUNT-ENGINE**  
RH Front

BUICK PASSENGER CAR ..... 1982-84  
CADILLAC PASSENGER CAR .... 1982-84  
CHEVROLET PASSENGER  
CAR ..... 1982-84  
OLDSMOBILE PASSENGER  
CAR ..... 1982-84  
PONTIAC PASSENGER CAR ..... 1982-84



**EM-2474**  
**MOUNT-ENGINE**  
RH Front

BUICK PASSENGER CAR ..... 1982-84  
CADILLAC PASSENGER CAR .... 1982-84  
CHEVROLET PASSENGER  
CAR ..... 1982-84  
OLDSMOBILE PASSENGER  
CAR ..... 1982-84  
PONTIAC PASSENGER CAR ..... 1982-84



**EM-2477**  
**MOUNT-ENGINE**  
RH Rear

BUICK PASSENGER CAR ..... 1982-91  
CADILLAC PASSENGER CAR .... 1982-88  
CHEVROLET PASSENGER  
CAR ..... 1982-94  
OLDSMOBILE PASSENGER  
CAR ..... 1982-91  
PONTIAC PASSENGER CAR ..... 1982-94



# BUYER'S GUIDE

## NUMERICAL LISTING - ILLUSTRATIONS

 <p style="text-align: center;"><b>EM-2487</b> <b>MOUNT-TRANSMISSION</b> Manual</p> <p>NISSAN PASSENGER CAR ..... 1968-84 <b>MOUNT-TRANSMISSION</b></p> <p>NISSAN VAN ..... 1988-92</p>	<p><b>EM-2490 (Continued)</b></p> <p>OLDSMOBILE PASSENGER CAR ..... 1984-86 PONTIAC PASSENGER CAR ..... 1982-85</p>  <p style="text-align: center;"><b>EM-2491</b> <b>Engine Torque Strut Mount</b> Front</p> <p>CHRYSLER PASSENGER CAR ..... 1983-88 DODGE PASSENGER CAR ..... 1981-90 DODGE VAN ..... 1984-87 PLYMOUTH PASSENGER CAR ..... 1981-89 PLYMOUTH VAN ..... 1984-86</p>	<p><b>EM-2493 (Continued)</b></p> <p>DODGE PASSENGER CAR ..... 1981-91 DODGE VAN ..... 1984-90 PLYMOUTH PASSENGER CAR ..... 1981-90 PLYMOUTH VAN ..... 1984-90</p>  <p style="text-align: center;"><b>EM-2494</b> <b>MOUNT-TRANSMISSION</b> RH</p> <p>BUICK PASSENGER CAR ..... 1979-85 CADILLAC PASSENGER CAR ..... 1981-82 OLDSMOBILE PASSENGER CAR ..... 1981-85</p>	 <p style="text-align: center;"><b>EM-2497</b> <b>MOUNT-TRANSMISSION</b> LH</p> <p>BUICK PASSENGER CAR ..... 1979-81 CADILLAC PASSENGER CAR ..... 1982-85 OLDSMOBILE PASSENGER CAR ..... 1981</p>
 <p style="text-align: center;"><b>EM-2488</b> <b>MOUNT-TRANSMISSION</b></p> <p>NISSAN PASSENGER CAR ..... 1978-88</p>	 <p style="text-align: center;"><b>EM-2492</b> <b>Engine Torque Strut Mount</b> Front</p> <p>BUICK PASSENGER CAR ..... 1982-86 CHEVROLET PASSENGER CAR ..... 1985-89</p> <p style="text-align: center;"><b>Engine Torque Strut Mount</b> Rear</p> <p>BUICK PASSENGER CAR ..... 1983-88 CADILLAC PASSENGER CAR ..... 1982-88 CHEVROLET PASSENGER CAR ..... 1982-89 OLDSMOBILE PASSENGER CAR ..... 1982-87 PONTIAC PASSENGER CAR ..... 1982-91</p>	 <p style="text-align: center;"><b>EM-2495</b> <b>MOUNT-TRANSMISSION</b> LH</p> <p>BUICK PASSENGER CAR ..... 1981-85 CADILLAC PASSENGER CAR ..... 1981-82 OLDSMOBILE PASSENGER CAR ..... 1981-85</p>	 <p style="text-align: center;"><b>EM-2498</b> <b>MOUNT-TRANSMISSION</b> RH</p> <p>CADILLAC PASSENGER CAR ..... 1982-86</p>
 <p style="text-align: center;"><b>EM-2489</b> <b>MOUNT-TRANSMISSION</b> Manual</p> <p>NISSAN PASSENGER CAR ..... 1978-82</p>	 <p style="text-align: center;"><b>EM-2493</b> <b>MOUNT-ENGINE</b> Front</p> <p>CHRYSLER PASSENGER CAR ..... 1982-91</p>	 <p style="text-align: center;"><b>EM-2496</b> <b>MOUNT-ENGINE</b> RH Front</p> <p>BUICK PASSENGER CAR ..... 1983-84 OLDSMOBILE PASSENGER CAR ..... 1982-84 PONTIAC PASSENGER CAR ..... 1982-84</p>	 <p style="text-align: center;"><b>EM-2499</b> <b>MOUNT-TRANSMISSION</b> Front</p> <p>PONTIAC PASSENGER CAR ..... 1980-84 <b>MOUNT-TRANSMISSION</b></p> <p>CADILLAC PASSENGER CAR ..... 1981</p>
 <p style="text-align: center;"><b>EM-2490</b> <b>Engine Torque Strut Mount</b> Front</p> <p>BUICK PASSENGER CAR ..... 1982-86</p> <p style="text-align: center;">(Continued Next Column)</p>	<p style="text-align: center;">(Continued Next Column)</p>		

# BUYER'S GUIDE

## NUMERICAL LISTING - ILLUSTRATIONS

 <p style="text-align: center;"><b>EM-2500</b> <b>MOUNT-ENGINE</b> <b>LH Front</b></p> <p>FORD PASSENGER CAR ..... 1980-85 MERCURY PASSENGER CAR ... 1980-84</p>	<p><b>EM-2503 (Continued)</b></p> <p>LINCOLN PASSENGER CAR ..... 1977-80 MERCURY PASSENGER CAR ... 1975-82</p>  <p style="text-align: center;"><b>EM-2504</b> <b>MOUNT-ENGINE</b> <b>LH Front</b></p> <p>FORD PASSENGER CAR ..... 1975-80 FORD TRUCK ..... 1977-79 LINCOLN PASSENGER CAR ..... 1977-80 MERCURY PASSENGER CAR ... 1975-82</p>	 <p style="text-align: center;"><b>EM-2508</b> <b>MOUNT-TRANSMISSION</b> <b>Manual</b></p> <p>CHEVROLET SPORT UTILITY ... 1988-94 CHEVROLET TRUCK ..... 1987-95</p> <p style="text-align: center;"><b>MOUNT-TRANSMISSION</b> <b>Manual</b></p> <p>CHEVROLET VAN ..... 1985-90</p> <p style="text-align: center;"><b>MOUNT-TRANSMISSION</b> <b>Auto</b></p> <p>GMC SPORT UTILITY ..... 1988-94</p> <p style="text-align: center;"><b>MOUNT-TRANSMISSION</b> <b>Manual</b></p> <p>GMC TRUCK ..... 1988-94 GMC VAN ..... 1985-90</p>	<p><b>EM-2512 (Continued)</b></p> <p style="text-align: center;"><b>MOUNT-TRANSMISSION</b> <b>Auto</b></p> <p>DODGE SPORT UTILITY ..... 1974-89</p> <p style="text-align: center;"><b>MOUNT-TRANSMISSION</b> <b>Manual</b></p> <p>DODGE TRUCK ..... 1969-87</p> <p style="text-align: center;"><b>MOUNT-TRANSMISSION</b> <b>Auto</b></p> <p>DODGE VAN ..... 1971-87 PLYMOUTH PASSENGER CAR ..... 1966-89</p> <p style="text-align: center;"><b>MOUNT-TRANSMISSION</b></p> <p>PLYMOUTH SUV ..... 1974-81 PLYMOUTH VAN ..... 1974-83</p>
 <p style="text-align: center;"><b>EM-2501</b> <b>MOUNT-ENGINE</b> <b>RH Front</b></p> <p>FORD PASSENGER CAR ..... 1980-85 MERCURY PASSENGER CAR ... 1980-84</p>	 <p style="text-align: center;"><b>EM-2505</b> <b>MOUNT-ENGINE</b> <b>RH Front</b></p> <p>BUICK PASSENGER CAR ..... 1980-81 CHEVROLET PASSENGER CAR ..... 1980-81 OLDSMOBILE PASSENGER CAR ..... 1980-81</p> <p style="text-align: center;"><b>MOUNT-ENGINE</b> <b>L &amp; R Front</b></p> <p>PONTIAC PASSENGER CAR ..... 1980-81</p>	 <p style="text-align: center;"><b>EM-2510@</b> <b>MOUNT-TRANSMISSION</b> <b>Auto</b></p> <p>CHEVROLET TRUCK ..... 1988-90 CHEVROLET VAN ..... 1990-91 GMC TRUCK ..... 1988-90 GMC VAN ..... 1990-91</p>	 <p style="text-align: center;"><b>EM-2513</b> <b>MOUNT-TRANSMISSION</b> <b>Auto</b></p> <p>CHEVROLET SPORT UTILITY ... 1982-91 CHEVROLET TRUCK ..... 1982-91 CHEVROLET VAN ..... 1979-91 GMC SPORT UTILITY ..... 1982-90</p> <p style="text-align: center;"><b>MOUNT-TRANSMISSION</b></p> <p>GMC TRUCK ..... 1976-91</p> <p style="text-align: center;"><b>MOUNT-TRANSMISSION</b> <b>Auto</b></p> <p>GMC VAN ..... 1979-91</p>
 <p style="text-align: center;"><b>EM-2502</b> <b>MOUNT-ENGINE</b> <b>L &amp; R Front</b></p> <p>FORD TRUCK ..... 1973-79</p>	 <p style="text-align: center;"><b>EM-2506</b> <b>MOUNT-ENGINE</b> <b>RH Front</b></p> <p>BUICK PASSENGER CAR ..... 1982-84 CADILLAC PASSENGER CAR ..... 1982 CHEVROLET PASSENGER CAR ..... 1982-84 OLDSMOBILE PASSENGER CAR ..... 1982-84 PONTIAC PASSENGER CAR ..... 1982-84</p>	 <p style="text-align: center;"><b>EM-2512</b> <b>MOUNT-TRANSMISSION</b> <b>Auto</b></p> <p>CHRYSLER PASSENGER CAR ..... 1969-89</p> <p style="text-align: center;"><b>MOUNT-TRANSMISSION</b> <b>Manual</b></p> <p>DODGE MEDIUM/HEAVY DUTY ..... 1978-81 DODGE PASSENGER CAR ..... 1964-89</p>	 <p style="text-align: center;"><b>EM-2515</b> <b>MOUNT-TRANSMISSION</b> <b>Auto</b></p> <p>CHEVROLET SPORT UTILITY ... 1983-91 CHEVROLET TRUCK ..... 1983-90 CHEVROLET VAN ..... 1983-90 GMC SPORT UTILITY ..... 1982-91 GMC TRUCK ..... 1982-90 GMC VAN ..... 1983-90</p>
 <p style="text-align: center;"><b>EM-2503</b> <b>MOUNT-ENGINE</b> <b>RH Front</b></p> <p>FORD PASSENGER CAR ..... 1975-80 FORD TRUCK ..... 1977-79</p> <p style="text-align: center;">(Continued Next Column)</p>	<p style="text-align: center;">(Continued Next Column)</p>	<p style="text-align: center;">(Continued Next Column)</p>	<p style="text-align: center;">(Continued Next Column)</p>

@ = Universal Mount EM-5000 also available.

# BUYER'S GUIDE

## NUMERICAL LISTING - ILLUSTRATIONS

 <p style="text-align: center;"><b>EM-2524</b> <b>MOUNT-ENGINE</b> <b>RH Front</b></p> <p>BUICK PASSENGER CAR ..... 1982-84            CADILLAC PASSENGER CAR ..... 1982            CHEVROLET PASSENGER            CAR ..... 1982-84            OLDSMOBILE PASSENGER            CAR ..... 1982-84            PONTIAC PASSENGER CAR ..... 1982-84</p>	 <p style="text-align: center;"><b>EM-2528</b> <b>Engine Torque Strut Mount</b> <b>Front</b></p> <p>BUICK PASSENGER CAR ..... 1982-86            CHEVROLET PASSENGER            CAR ..... 1985-89            PONTIAC PASSENGER CAR ..... 1988-91</p> <p style="text-align: center;"><b>Engine Torque Strut Mount</b> <b>Rear</b></p> <p>BUICK PASSENGER CAR ..... 1983-91            CADILLAC PASSENGER CAR ..... 1982-88            CHEVROLET PASSENGER            CAR ..... 1982-94            OLDSMOBILE PASSENGER            CAR ..... 1982-91            PONTIAC PASSENGER CAR ..... 1982-94</p>	 <p style="text-align: center;"><b>EM-2532</b> <b>MOUNT-ENGINE</b> <b>LH Front</b></p> <p>NISSAN TRUCK ..... 1975-79</p>	 <p style="text-align: center;"><b>EM-2537</b> <b>MOUNT-TRANSMISSION</b> <b>LH Front</b></p> <p>BUICK PASSENGER CAR ..... 1985-91            CADILLAC PASSENGER CAR ..... 1985-90            OLDSMOBILE PASSENGER            CAR ..... 1985-91            PONTIAC PASSENGER CAR ..... 1987-91</p>
 <p style="text-align: center;"><b>EM-2525</b> <b>MOUNT-TRANSMISSION</b></p> <p>CHRYSLER PASSENGER            CAR ..... 1969-89</p> <p style="text-align: center;"><b>MOUNT-TRANSMISSION</b> <b>Manual</b></p> <p>DODGE MEDIUM/HEAVY            DUTY ..... 1978-81</p> <p style="text-align: center;"><b>MOUNT-TRANSMISSION</b></p> <p>DODGE PASSENGER CAR ..... 1964-89</p> <p style="text-align: center;"><b>MOUNT-TRANSMISSION</b> <b>Auto</b></p> <p>DODGE SPORT UTILITY ..... 1974-89</p> <p style="text-align: center;"><b>MOUNT-TRANSMISSION</b> <b>Manual</b></p> <p>DODGE TRUCK ..... 1969-87</p> <p style="text-align: center;"><b>MOUNT-TRANSMISSION</b> <b>Auto</b></p> <p>DODGE VAN ..... 1971-87            PLYMOUTH PASSENGER            CAR ..... 1966-89</p> <p style="text-align: center;"><b>MOUNT-TRANSMISSION</b></p> <p>PLYMOUTH SUV ..... 1974-81            PLYMOUTH VAN ..... 1974-83</p>	 <p style="text-align: center;"><b>EM-2531</b> <b>MOUNT-TRANSMISSION</b> <b>Manual</b></p> <p>CHEVROLET PASSENGER            CAR ..... 1978-80            CHEVROLET SPORT UTILITY ..... 1984-87</p> <p style="text-align: center;"><b>MOUNT-TRANSMISSION</b> <b>Auto</b></p> <p>CHEVROLET TRUCK ..... 1983-87            GMC SPORT UTILITY ..... 1984-87            GMC TRUCK ..... 1984-87</p> <p style="text-align: center;"><b>MOUNT-TRANSMISSION</b> <b>Manual</b></p> <p>OLDSMOBILE PASSENGER            CAR ..... 1978-83</p> <p style="text-align: center;"><b>MOUNT-TRANSMISSION</b></p> <p>PONTIAC PASSENGER CAR ..... 1976-82</p>	 <p style="text-align: center;"><b>EM-2533</b> <b>MOUNT-ENGINE</b> <b>L &amp; R Front</b></p> <p>NISSAN PASSENGER CAR ..... 1968-73</p> <p style="text-align: center;"><b>MOUNT-ENGINE</b> <b>RH Front</b></p> <p>NISSAN TRUCK ..... 1975-92</p>	 <p style="text-align: center;"><b>EM-2538</b> <b>MOUNT-ENGINE</b> <b>RH Front</b></p> <p>BUICK PASSENGER CAR ..... 1985-91            CADILLAC PASSENGER CAR ..... 1985-88            CHEVROLET PASSENGER            CAR ..... 1985-94            OLDSMOBILE PASSENGER            CAR ..... 1985-91            PONTIAC PASSENGER CAR ..... 1985-94</p>
		 <p style="text-align: center;"><b>EM-2534</b> <b>MOUNT-TRANSMISSION</b></p> <p>BUICK PASSENGER CAR ..... 1968-70</p>	 <p style="text-align: center;"><b>EM-2543</b> <b>MOUNT-TRANSMISSION</b> <b>Auto</b></p> <p>BUICK PASSENGER CAR ..... 1985-96            CHEVROLET PASSENGER            CAR ..... 1984-90</p> <p style="text-align: center;"><b>MOUNT-TRANSMISSION</b></p> <p>OLDSMOBILE PASSENGER            CAR ..... 1985-94            PONTIAC PASSENGER CAR ..... 1985-91</p>
		 <p style="text-align: center;"><b>EM-2536</b> <b>MOUNT-ENGINE</b> <b>L &amp; R Front</b></p> <p>FORD VAN ..... 1975-96</p>	



# BUYER'S GUIDE

## NUMERICAL LISTING - ILLUSTRATIONS

 <p style="text-align: center;"><b>EM-2548*</b> <b>MOUNT-ENGINE</b> <b>RH Front</b></p> <table style="width: 100%; border-collapse: collapse;"> <tr> <td style="width: 50%;">BUICK PASSENGER CAR .....</td> <td style="width: 50%;">1985-96</td> </tr> <tr> <td>CHEVROLET PASSENGER CAR .....</td> <td>1985-90</td> </tr> <tr> <td>CHEVROLET VAN .....</td> <td>1990-96</td> </tr> </table> <p style="text-align: center;"><b>MOUNT-ENGINE</b> <b>Front</b></p> <table style="width: 100%; border-collapse: collapse;"> <tr> <td style="width: 50%;">OLDSMOBILE PASSENGER CAR .....</td> <td style="width: 50%;">1985-94</td> </tr> <tr> <td>OLDSMOBILE VAN .....</td> <td>1990-96</td> </tr> </table> <p style="text-align: center;"><b>MOUNT-ENGINE</b> <b>RH Front</b></p> <table style="width: 100%; border-collapse: collapse;"> <tr> <td style="width: 50%;">PONTIAC PASSENGER CAR .....</td> <td style="width: 50%;">1985-91</td> </tr> </table> <p style="text-align: center;"><b>MOUNT-ENGINE</b> <b>Front</b></p> <table style="width: 100%; border-collapse: collapse;"> <tr> <td style="width: 50%;">PONTIAC VAN .....</td> <td style="width: 50%;">1990-96</td> </tr> </table>	BUICK PASSENGER CAR .....	1985-96	CHEVROLET PASSENGER CAR .....	1985-90	CHEVROLET VAN .....	1990-96	OLDSMOBILE PASSENGER CAR .....	1985-94	OLDSMOBILE VAN .....	1990-96	PONTIAC PASSENGER CAR .....	1985-91	PONTIAC VAN .....	1990-96	 <p style="text-align: center;"><b>EM-2550</b> <b>MOUNT-ENGINE</b> <b>RH Front</b></p> <table style="width: 100%; border-collapse: collapse;"> <tr> <td style="width: 50%;">CHEVROLET PASSENGER CAR .....</td> <td style="width: 50%;">1982-86</td> </tr> <tr> <td>CHEVROLET SPORT UTILITY .....</td> <td>1984-88</td> </tr> <tr> <td>CHEVROLET TRUCK .....</td> <td>1983-93</td> </tr> <tr> <td>CHEVROLET VAN .....</td> <td>1985-90</td> </tr> <tr> <td>GMC SPORT UTILITY .....</td> <td>1985-88</td> </tr> <tr> <td>GMC TRUCK .....</td> <td>1984-93</td> </tr> <tr> <td>GMC VAN .....</td> <td>1985-90</td> </tr> <tr> <td>PONTIAC PASSENGER CAR .....</td> <td>1982-86</td> </tr> </table>	CHEVROLET PASSENGER CAR .....	1982-86	CHEVROLET SPORT UTILITY .....	1984-88	CHEVROLET TRUCK .....	1983-93	CHEVROLET VAN .....	1985-90	GMC SPORT UTILITY .....	1985-88	GMC TRUCK .....	1984-93	GMC VAN .....	1985-90	PONTIAC PASSENGER CAR .....	1982-86	 <p style="text-align: center;"><b>EM-2555*</b> <b>MOUNT-ENGINE</b> <b>RH Front</b></p> <table style="width: 100%; border-collapse: collapse;"> <tr> <td style="width: 50%;">CHEVROLET PASSENGER CAR .....</td> <td style="width: 50%;">1991-97</td> </tr> <tr> <td>OLDSMOBILE PASSENGER CAR .....</td> <td>1991-96</td> </tr> <tr> <td>PONTIAC PASSENGER CAR .....</td> <td>1991-96</td> </tr> </table>	CHEVROLET PASSENGER CAR .....	1991-97	OLDSMOBILE PASSENGER CAR .....	1991-96	PONTIAC PASSENGER CAR .....	1991-96	 <p style="text-align: center;"><b>EM-2558</b> <b>MOUNT-ENGINE</b> <b>RH Front</b></p> <table style="width: 100%; border-collapse: collapse;"> <tr> <td style="width: 50%;">FORD PASSENGER CAR .....</td> <td style="width: 50%;">1984-91</td> </tr> <tr> <td>MERCURY PASSENGER CAR .....</td> <td>1984-91</td> </tr> </table>	FORD PASSENGER CAR .....	1984-91	MERCURY PASSENGER CAR .....	1984-91
BUICK PASSENGER CAR .....	1985-96																																										
CHEVROLET PASSENGER CAR .....	1985-90																																										
CHEVROLET VAN .....	1990-96																																										
OLDSMOBILE PASSENGER CAR .....	1985-94																																										
OLDSMOBILE VAN .....	1990-96																																										
PONTIAC PASSENGER CAR .....	1985-91																																										
PONTIAC VAN .....	1990-96																																										
CHEVROLET PASSENGER CAR .....	1982-86																																										
CHEVROLET SPORT UTILITY .....	1984-88																																										
CHEVROLET TRUCK .....	1983-93																																										
CHEVROLET VAN .....	1985-90																																										
GMC SPORT UTILITY .....	1985-88																																										
GMC TRUCK .....	1984-93																																										
GMC VAN .....	1985-90																																										
PONTIAC PASSENGER CAR .....	1982-86																																										
CHEVROLET PASSENGER CAR .....	1991-97																																										
OLDSMOBILE PASSENGER CAR .....	1991-96																																										
PONTIAC PASSENGER CAR .....	1991-96																																										
FORD PASSENGER CAR .....	1984-91																																										
MERCURY PASSENGER CAR .....	1984-91																																										
 <p style="text-align: center;"><b>EM-2549</b> <b>MOUNT-ENGINE</b> <b>LH Front</b></p> <table style="width: 100%; border-collapse: collapse;"> <tr> <td style="width: 50%;">CHEVROLET PASSENGER CAR .....</td> <td style="width: 50%;">1982-86</td> </tr> <tr> <td>CHEVROLET SPORT UTILITY .....</td> <td>1984-88</td> </tr> <tr> <td>CHEVROLET TRUCK .....</td> <td>1983-93</td> </tr> <tr> <td>CHEVROLET VAN .....</td> <td>1985-90</td> </tr> <tr> <td>GMC SPORT UTILITY .....</td> <td>1985-88</td> </tr> <tr> <td>GMC TRUCK .....</td> <td>1984-93</td> </tr> <tr> <td>GMC VAN .....</td> <td>1985-90</td> </tr> <tr> <td>PONTIAC PASSENGER CAR .....</td> <td>1982-86</td> </tr> </table>	CHEVROLET PASSENGER CAR .....	1982-86	CHEVROLET SPORT UTILITY .....	1984-88	CHEVROLET TRUCK .....	1983-93	CHEVROLET VAN .....	1985-90	GMC SPORT UTILITY .....	1985-88	GMC TRUCK .....	1984-93	GMC VAN .....	1985-90	PONTIAC PASSENGER CAR .....	1982-86	 <p style="text-align: center;"><b>EM-2551*</b> <b>MOUNT-ENGINE</b> <b>RH Front</b></p> <table style="width: 100%; border-collapse: collapse;"> <tr> <td style="width: 50%;">BUICK PASSENGER CAR .....</td> <td style="width: 50%;">1985-91</td> </tr> <tr> <td>CADILLAC PASSENGER CAR .....</td> <td>1988-93</td> </tr> <tr> <td>OLDSMOBILE PASSENGER CAR .....</td> <td>1985-91</td> </tr> <tr> <td>PONTIAC PASSENGER CAR .....</td> <td>1987-91</td> </tr> </table>	BUICK PASSENGER CAR .....	1985-91	CADILLAC PASSENGER CAR .....	1988-93	OLDSMOBILE PASSENGER CAR .....	1985-91	PONTIAC PASSENGER CAR .....	1987-91	 <p style="text-align: center;"><b>EM-2556*</b> <b>MOUNT-TRANSMISSION</b> <b>RH Rear</b></p> <table style="width: 100%; border-collapse: collapse;"> <tr> <td style="width: 50%;">BUICK PASSENGER CAR .....</td> <td style="width: 50%;">1985-91</td> </tr> <tr> <td>CADILLAC PASSENGER CAR .....</td> <td>1988-90</td> </tr> <tr> <td>OLDSMOBILE PASSENGER CAR .....</td> <td>1985-91</td> </tr> <tr> <td>PONTIAC PASSENGER CAR .....</td> <td>1987-91</td> </tr> </table>	BUICK PASSENGER CAR .....	1985-91	CADILLAC PASSENGER CAR .....	1988-90	OLDSMOBILE PASSENGER CAR .....	1985-91	PONTIAC PASSENGER CAR .....	1987-91	 <p style="text-align: center;"><b>EM-2559</b> <b>MOUNT-ENGINE</b> <b>LH Front</b></p> <table style="width: 100%; border-collapse: collapse;"> <tr> <td style="width: 50%;">FORD PASSENGER CAR .....</td> <td style="width: 50%;">1984-91</td> </tr> </table> <p style="text-align: center;"><b>MOUNT-ENGINE</b> <b>Front</b></p> <table style="width: 100%; border-collapse: collapse;"> <tr> <td style="width: 50%;">MERCURY PASSENGER CAR .....</td> <td style="width: 50%;">1984-91</td> </tr> </table>	FORD PASSENGER CAR .....	1984-91	MERCURY PASSENGER CAR .....	1984-91				
CHEVROLET PASSENGER CAR .....	1982-86																																										
CHEVROLET SPORT UTILITY .....	1984-88																																										
CHEVROLET TRUCK .....	1983-93																																										
CHEVROLET VAN .....	1985-90																																										
GMC SPORT UTILITY .....	1985-88																																										
GMC TRUCK .....	1984-93																																										
GMC VAN .....	1985-90																																										
PONTIAC PASSENGER CAR .....	1982-86																																										
BUICK PASSENGER CAR .....	1985-91																																										
CADILLAC PASSENGER CAR .....	1988-93																																										
OLDSMOBILE PASSENGER CAR .....	1985-91																																										
PONTIAC PASSENGER CAR .....	1987-91																																										
BUICK PASSENGER CAR .....	1985-91																																										
CADILLAC PASSENGER CAR .....	1988-90																																										
OLDSMOBILE PASSENGER CAR .....	1985-91																																										
PONTIAC PASSENGER CAR .....	1987-91																																										
FORD PASSENGER CAR .....	1984-91																																										
MERCURY PASSENGER CAR .....	1984-91																																										
 <p style="text-align: center;"><b>EM-2553*</b> <b>MOUNT-ENGINE</b> <b>RH Front</b></p> <table style="width: 100%; border-collapse: collapse;"> <tr> <td style="width: 50%;">CADILLAC PASSENGER CAR .....</td> <td style="width: 50%;">1985-87</td> </tr> </table>	CADILLAC PASSENGER CAR .....	1985-87	 <p style="text-align: center;"><b>EM-2557</b> <b>MOUNT-TRANSMISSION</b> <b>Manual</b></p> <table style="width: 100%; border-collapse: collapse;"> <tr> <td style="width: 50%;">FORD MEDIUM/HEAVY DUTY .....</td> <td style="width: 50%;">1990-13</td> </tr> </table> <p style="text-align: center;"><b>MOUNT-TRANSMISSION</b> <b>Auto</b></p> <table style="width: 100%; border-collapse: collapse;"> <tr> <td style="width: 50%;">FORD SPORT UTILITY .....</td> <td style="width: 50%;">1987-93</td> </tr> <tr> <td>FORD TRUCK .....</td> <td>1987-97</td> </tr> <tr> <td>FORD VAN .....</td> <td>1988-13</td> </tr> </table>	FORD MEDIUM/HEAVY DUTY .....	1990-13	FORD SPORT UTILITY .....	1987-93	FORD TRUCK .....	1987-97	FORD VAN .....	1988-13	 <p style="text-align: center;"><b>EM-2562</b> <b>MOUNT-ENGINE</b> <b>RH Front</b></p> <table style="width: 100%; border-collapse: collapse;"> <tr> <td style="width: 50%;">CHEVROLET TRUCK .....</td> <td style="width: 50%;">1972-82</td> </tr> </table>	CHEVROLET TRUCK .....	1972-82																													
CADILLAC PASSENGER CAR .....	1985-87																																										
FORD MEDIUM/HEAVY DUTY .....	1990-13																																										
FORD SPORT UTILITY .....	1987-93																																										
FORD TRUCK .....	1987-97																																										
FORD VAN .....	1988-13																																										
CHEVROLET TRUCK .....	1972-82																																										

\* = Hydraulic Mount, "S" suffix = solid replacement.

# BUYER'S GUIDE

## NUMERICAL LISTING - ILLUSTRATIONS

 <p style="text-align: center;"><b>EM-2563</b> <b>MOUNT-ENGINE</b> <b>LH Front</b></p> <p>CHEVROLET TRUCK ..... 1972-82</p>	<p><b>EM-2566 (Continued)</b> MERCURY PASSENGER CAR ... 1974-77</p>  <p style="text-align: center;"><b>EM-2567</b> <b>MOUNT-TRANSMISSION</b> <b>Auto</b></p> <p>CHEVROLET TRUCK ..... 1972-82</p>	 <p style="text-align: center;"><b>EM-2570</b> <b>MOUNT-TRANSMISSION</b> <b>Auto</b></p> <p>DODGE TRUCK ..... 1992-96</p> <p style="text-align: center;"><b>MOUNT-TRANSMISSION</b> <b>Manual</b></p> <p>JEEP SPORT UTILITY ..... 1984-00</p>	 <p style="text-align: center;"><b>EM-2600</b> <b>MOUNT-ENGINE</b> <b>RH Front</b></p> <p>CHRYSLER PASSENGER CAR ..... 1982-93</p> <p>DODGE PASSENGER CAR ..... 1978-90</p> <p>DODGE TRUCK ..... 1982-84</p> <p>DODGE VAN ..... 1984-90</p> <p>PLYMOUTH PASSENGER CAR ..... 1978-90</p> <p>PLYMOUTH VAN ..... 1984-90</p> <p style="text-align: center;"><b>MOUNT-TRANSMISSION</b></p> <p>CHRYSLER PASSENGER CAR ..... 1982-83</p> <p style="text-align: center;"><b>MOUNT-TRANSMISSION</b> <b>Auto</b></p> <p>DODGE PASSENGER CAR ..... 1981-83</p> <p>DODGE TRUCK ..... 1982-83</p> <p>PLYMOUTH PASSENGER CAR ..... 1981-83</p> <p>CHRYSLER PASSENGER CAR ..... 1982-83</p> <p>DODGE PASSENGER CAR ..... 1982-83</p> <p>PLYMOUTH PASSENGER CAR ..... 1983</p>
 <p style="text-align: center;"><b>EM-2564</b> <b>MOUNT-ENGINE</b> <b>L &amp; R Front</b></p> <p>FORD SPORT UTILITY ..... 1987-96</p> <p>FORD TRUCK ..... 1987-97</p>	 <p style="text-align: center;"><b>EM-2568</b> <b>MOUNT-TRANSMISSION</b> <b>LH Rear</b></p> <p>BUICK PASSENGER CAR ..... 1985-91</p> <p>CADILLAC PASSENGER CAR ..... 1985-93</p> <p>OLDSMOBILE PASSENGER CAR ..... 1985-91</p> <p>PONTIAC PASSENGER CAR ..... 1987-91</p>	 <p style="text-align: center;"><b>EM-2571</b> <b>MOUNT-ENGINE</b> <b>RH Front</b></p> <p>JEEP SPORT UTILITY ..... 1984-00</p>	 <p style="text-align: center;"><b>EM-2601</b> <b>MOUNT-TRANSMISSION</b> <b>Auto</b></p> <p>BUICK PASSENGER CAR ..... 1985-91</p> <p>CADILLAC PASSENGER CAR ..... 1985-88</p> <p style="text-align: center;"><b>MOUNT-TRANSMISSION</b></p> <p>CHEVROLET PASSENGER CAR ..... 1985-94</p> <p style="text-align: center;"><b>MOUNT-TRANSMISSION</b> <b>Auto</b></p> <p>OLDSMOBILE PASSENGER CAR ..... 1983-91</p> <p style="text-align: center;"><b>MOUNT-TRANSMISSION</b> <b>Manual</b></p> <p>PONTIAC PASSENGER CAR ..... 1985-94</p>
 <p style="text-align: center;"><b>EM-2565</b> <b>MOUNT-TRANSMISSION</b> <b>Auto</b></p> <p>FORD PASSENGER CAR ..... 1974-82</p>	 <p style="text-align: center;"><b>EM-2569</b> <b>MOUNT-ENGINE</b> <b>L &amp; R Front</b></p> <p>JEEP SPORT UTILITY ..... 1984-00</p>	 <p style="text-align: center;"><b>EM-2572</b> <b>MOUNT-ENGINE</b> <b>L &amp; R Front</b></p> <p>JEEP SPORT UTILITY ..... 1987-01</p>	 <p style="text-align: center;"><b>EM-2566</b> <b>MOUNT-TRANSMISSION</b> <b>Auto</b></p> <p>FORD PASSENGER CAR ..... 1975-78</p> <p style="text-align: center;"><b>MOUNT-TRANSMISSION</b></p> <p>(Continued Next Column)</p>

# BUYER'S GUIDE

## NUMERICAL LISTING - ILLUSTRATIONS

 <p style="text-align: center;"><b>EM-2609</b> <b>Engine Torque Strut Mount Front</b></p> <p>BUICK PASSENGER CAR ..... 1988-95            CHEVROLET PASSENGER CAR ..... 1990-94            OLDSMOBILE PASSENGER CAR ..... 1988-97</p> <p style="text-align: center;"><b>Engine Torque Strut Front Left</b></p> <p>PONTIAC PASSENGER CAR ..... 1988-94</p>	 <p style="text-align: center;"><b>EM-2617</b> <b>MOUNT-TRANSMISSION Auto</b></p> <p>CHRYSLER PASSENGER CAR ..... 1983-91</p> <p style="text-align: center;"><b>MOUNT-TRANSMISSION Manual</b></p> <p>DODGE PASSENGER CAR ..... 1984-90</p> <p style="text-align: center;"><b>MOUNT-TRANSMISSION Auto</b></p> <p>DODGE TRUCK ..... 1984            DODGE VAN ..... 1984-90</p> <p style="text-align: center;"><b>MOUNT-TRANSMISSION Auto</b></p> <p>PLYMOUTH PASSENGER CAR ..... 1984-90            PLYMOUTH VAN ..... 1984-90</p>	 <p style="text-align: center;"><b>EM-2619</b> <b>MOUNT-TRANSMISSION</b></p> <p>LINCOLN PASSENGER CAR ..... 1968-79</p>  <p style="text-align: center;"><b>EM-2620</b> <b>MOUNT-TRANSMISSION</b></p> <p>BUICK PASSENGER CAR ..... 1988-93</p> <p style="text-align: center;"><b>MOUNT-TRANSMISSION LH</b></p> <p>CADILLAC PASSENGER CAR .... 1992-95</p> <p style="text-align: center;"><b>MOUNT-TRANSMISSION Auto</b></p> <p>CHEVROLET PASSENGER CAR ..... 1990-94            OLDSMOBILE PASSENGER CAR ..... 1988-93</p> <p style="text-align: center;"><b>MOUNT-TRANSMISSION Auto</b></p> <p>PONTIAC PASSENGER CAR ..... 1988-93</p>  <p style="text-align: center;"><b>EM-2621</b> <b>MOUNT-ENGINE L &amp; R Front</b></p> <p>CHEVROLET SPORT UTILITY .... 1987-00            CHEVROLET TRUCK ..... 1988-00            CHEVROLET VAN ..... 1996-02            GMC SPORT UTILITY ..... 1989-99            GMC TRUCK ..... 1988-02            GMC VAN ..... 1996-02</p>	 <p style="text-align: center;"><b>EM-2622</b> <b>MOUNT-ENGINE RH Rear</b></p> <p>FORD PASSENGER CAR ..... 1986-90            FORD VAN ..... 1995-00            MERCURY PASSENGER CAR ... 1986-90</p>  <p style="text-align: center;"><b>EM-2623</b> <b>MOUNT-ENGINE RH Front</b></p> <p>FORD PASSENGER CAR ..... 1986-90            FORD VAN ..... 1995-00            MERCURY PASSENGER CAR ... 1986-90</p>  <p style="text-align: center;"><b>EM-2624</b> <b>MOUNT-TRANSMISSION Manual</b></p> <p>DODGE SPORT UTILITY ..... 1990-93</p> <p style="text-align: center;"><b>MOUNT-TRANSMISSION Auto</b></p> <p>DODGE TRUCK ..... 1987-03            DODGE VAN ..... 1988-98</p>
 <p style="text-align: center;"><b>EM-2615</b> <b>MOUNT-ENGINE Front</b></p> <p>CHRYSLER PASSENGER CAR ..... 1988-95            CHRYSLER VAN ..... 1990-95            DODGE PASSENGER CAR ..... 1988-95            DODGE VAN ..... 1990-95            PLYMOUTH PASSENGER CAR ..... 1989-95            PLYMOUTH VAN ..... 1990-95</p>	 <p style="text-align: center;"><b>EM-2618</b> <b>MOUNT-TRANSMISSION Auto</b></p> <p>CHRYSLER PASSENGER CAR ..... 1989-94</p> <p style="text-align: center;"><b>MOUNT-TRANSMISSION Manual</b></p> <p>CHRYSLER VAN ..... 1990-95</p> <p style="text-align: center;"><b>MOUNT-TRANSMISSION Auto</b></p> <p>DODGE PASSENGER CAR ..... 1990-95</p> <p style="text-align: center;"><b>MOUNT-TRANSMISSION Auto</b></p> <p>DODGE VAN ..... 1990-95</p> <p style="text-align: center;"><b>MOUNT-TRANSMISSION Manual</b></p> <p>PLYMOUTH PASSENGER CAR ..... 1990-95            PLYMOUTH VAN ..... 1990-95</p>	 <p style="text-align: center;"><b>EM-2616</b> <b>MOUNT-ENGINE RH Front</b></p> <p>CHRYSLER PASSENGER CAR ..... 1989-95            CHRYSLER VAN ..... 1990-95            DODGE PASSENGER CAR ..... 1990-95            DODGE VAN ..... 1990-95            PLYMOUTH PASSENGER CAR ..... 1990-95            PLYMOUTH VAN ..... 1990-95</p>	

# BUYER'S GUIDE

## NUMERICAL LISTING - ILLUSTRATIONS

 <p><b>EM-2625</b> <b>MOUNT-TRANSMISSION</b> Auto</p> <p>JEEP SPORT UTILITY ..... 1984-01</p>	 <p><b>EM-2628</b> <b>MOUNT-TRANSMISSION</b> Manual</p> <p>JEEP SPORT UTILITY ..... 1987-95</p>	 <p><b>EM-2631</b> <b>MOUNT-TRANSMISSION</b> Manual</p> <p>FORD TRUCK ..... 1985-89</p>	 <p><b>EM-2635</b> <b>MOUNT-ENGINE</b> RH Front</p> <p>FORD SPORT UTILITY ..... 1985-88 FORD TRUCK ..... 1985-96 FORD VAN ..... 1985-96</p>
 <p><b>EM-2626</b> <b>MOUNT-ENGINE</b> RH Front</p> <p>BUICK PASSENGER CAR ..... 1985-91 OLDSMOBILE PASSENGER CAR ..... 1985-91 PONTIAC PASSENGER CAR ..... 1985-87</p>	 <p><b>EM-2629</b> <b>MOUNT-ENGINE</b> L &amp; R Front <b>MOUNT-ENGINE</b> LH Front</p> <p>BUICK PASSENGER CAR ..... 1980-85 CADILLAC PASSENGER CAR .... 1978-85 OLDSMOBILE PASSENGER CAR ..... 1980-85</p>	 <p><b>EM-2632</b> <b>MOUNT-TRANSMISSION</b> Auto</p> <p>FORD PASSENGER CAR ..... 1984-90 MERCURY PASSENGER CAR ... 1984-87</p>	 <p><b>EM-2636</b> <b>MOUNT-ENGINE</b> LH Front</p> <p>FORD SPORT UTILITY ..... 1985-88 FORD TRUCK ..... 1985-96 FORD VAN ..... 1985-96</p>
 <p><b>EM-2627</b> <b>MOUNT-ENGINE</b> L &amp; R Front</p> <p>CHEVROLET PASSENGER CAR ..... 1988-93 CHEVROLET SPORT UTILITY ... 1988-95 CHEVROLET TRUCK ..... 1988-95 GMC SPORT UTILITY ..... 1988-95 GMC TRUCK ..... 1988-95 OLDSMOBILE SPORT UTILITY .. 1991-94</p> <p><b>MOUNT-ENGINE</b> RH Front</p> <p>PONTIAC PASSENGER CAR ..... 1989</p>	 <p><b>EM-2630</b> <b>MOUNT-ENGINE</b> RH Front</p> <p>BUICK PASSENGER CAR ..... 1985-86 CADILLAC PASSENGER CAR .... 1985-86 OLDSMOBILE PASSENGER CAR ..... 1985-86</p>	 <p><b>EM-2633</b> <b>MOUNT-TRANSMISSION</b> Auto</p> <p>FORD VAN ..... 1986-88</p>	 <p><b>EM-2637</b> <b>MOUNT-ENGINE</b> L &amp; R Front</p> <p>CADILLAC SPORT UTILITY ..... 1999-00 CHEVROLET SPORT UTILITY ... 1988-00 CHEVROLET TRUCK ..... 1988-00 GMC SPORT UTILITY ..... 1988-99 GMC TRUCK ..... 1988-00</p>
		 <p><b>EM-2634</b> <b>MOUNT-TRANSMISSION</b> Manual</p> <p>FORD PASSENGER CAR ..... 1984-90 MERCURY PASSENGER CAR ... 1984-85</p>	

# BUYER'S GUIDE

## NUMERICAL LISTING - ILLUSTRATIONS

 <p style="text-align: center;"><b>EM-2638</b> <b>MOUNT-TRANSMISSION</b></p> <p>CADILLAC SPORT UTILITY ..... 1999-14 CHEVROLET SPORT UTILITY .... 1983-17</p> <p style="text-align: center;"><b>MOUNT-TRANSMISSION</b> <b>Manual</b></p> <p>CHEVROLET TRUCK ..... 1983-14 <b>MOUNT-TRANSMISSION</b></p> <p>GMC SPORT UTILITY ..... 1983-14 <b>MOUNT-TRANSMISSION</b> <b>Manual</b></p> <p>GMC TRUCK ..... 1983-14 <b>MOUNT-TRANSMISSION</b> <b>Auto</b></p> <p>GMC VAN ..... 2003-05 <b>MOUNT-TRANSMISSION</b></p> <p>HUMMER ..... 2003-06 <b>MOUNT-TRANSMISSION</b> <b>Auto</b></p> <p>ISUZU TRUCK ..... 1998-06 <b>MOUNT-TRANSMISSION</b></p> <p>OLDSMOBILE SPORT UTILITY .. 1991-94</p>  <p style="text-align: center;"><b>EM-2639</b> <b>MOUNT-TRANSMISSION</b> <b>Auto</b></p> <p>FORD SPORT UTILITY ..... 1986-07 FORD TRUCK ..... 1985-09 FORD VAN ..... 1989-97 MAZDA SPORT UTILITY ..... 1992-94 MAZDA TRUCK ..... 1994-09</p> <p style="text-align: center;"><b>MOUNT-TRANSMISSION</b></p> <p>MERCURY SPORT UTILITY ..... 1998-01</p>	 <p style="text-align: center;"><b>EM-2640</b> <b>MOUNT-ENGINE</b> <b>RH Front</b></p> <p>FORD TRUCK ..... 1991-97 MAZDA TRUCK ..... 1994-96</p>  <p style="text-align: center;"><b>EM-2641</b> <b>MOUNT-ENGINE</b> <b>RH Front</b></p> <p>FORD SPORT UTILITY ..... 1986-94 FORD TRUCK ..... 1986-97 MAZDA SPORT UTILITY ..... 1991-94 MAZDA TRUCK ..... 1994-97</p>  <p style="text-align: center;"><b>EM-2642</b> <b>MOUNT-ENGINE</b> <b>LH Front</b></p> <p>FORD SPORT UTILITY ..... 1986-90 FORD TRUCK ..... 1986-97 MAZDA TRUCK ..... 1994-97</p>	 <p style="text-align: center;"><b>EM-2643</b> <b>MOUNT-ENGINE</b> <b>LH Front</b></p> <p>FORD SPORT UTILITY ..... 1986-94 FORD TRUCK ..... 1986-97 MAZDA SPORT UTILITY ..... 1991-94 MAZDA TRUCK ..... 1994-97</p>  <p style="text-align: center;"><b>EM-2644</b> <b>MOUNT-ENGINE</b> <b>RH Front</b></p> <p>FORD VAN ..... 1990-97</p>  <p style="text-align: center;"><b>EM-2645</b> <b>MOUNT-ENGINE</b> <b>RH Front</b></p> <p>FORD VAN ..... 1986-97</p>  <p style="text-align: center;"><b>EM-2646</b> <b>MOUNT-ENGINE</b> <b>LH Front</b></p> <p>FORD VAN ..... 1986-97</p>	 <p style="text-align: center;"><b>EM-2649</b> <b>MOUNT-ENGINE</b> <b>RH Front</b></p> <p>FORD PASSENGER CAR ..... 1991-02 MAZDA PASSENGER CAR ..... 1990-94 MERCURY PASSENGER CAR ... 1991-99</p>  <p style="text-align: center;"><b>EM-2650</b> <b>MOUNT-ENGINE</b> <b>RH Front</b></p> <p>MERCURY PASSENGER CAR ... 1994-96</p> <p style="text-align: center;"><b>MOUNT-ENGINE</b> <b>LH Rear</b></p> <p>FORD PASSENGER CAR ..... 1991-96</p> <p style="text-align: center;"><b>MOUNT-ENGINE</b> <b>Rear</b></p> <p>MAZDA PASSENGER CAR ..... 1988-94</p> <p style="text-align: center;"><b>MOUNT-ENGINE</b> <b>LH Rear</b></p> <p>MERCURY PASSENGER CAR ... 1991-96</p> <p style="text-align: center;"><b>MOUNT-TRANSMISSION</b> <b>Manual</b></p> <p>MAZDA PASSENGER CAR ..... 1992-96 MAZDA PASSENGER CAR ..... 1990-94</p>  <p style="text-align: center;"><b>EM-2651</b> <b>MOUNT-ENGINE</b> <b>Front</b></p> <p>FORD PASSENGER CAR ..... 1991-02 MAZDA PASSENGER CAR ..... 1992-93 MERCURY PASSENGER CAR ... 1991-99</p>
---	---	--	--



# BUYER'S GUIDE

## NUMERICAL LISTING - ILLUSTRATIONS

 <p style="text-align: center;"><b>EM-2652</b> <b>MOUNT-ENGINE</b> <b>L &amp; R Front</b></p> <p>DODGE TRUCK ..... 1987-96 DODGE VAN ..... 1992-93</p>	 <p style="text-align: center;"><b>EM-2656</b> <b>MOUNT-ENGINE</b> <b>Front</b></p> <p>PONTIAC PASSENGER CAR ..... 1989</p> <p style="text-align: center;"><b>MOUNT-TRANSMISSION</b> <b>Manual</b></p> <p>DAEWOO PASSENGER CAR ..... 1999-02 PONTIAC PASSENGER CAR ..... 1988-93</p>	 <p style="text-align: center;"><b>EM-2659@</b> <b>MOUNT-TRANSMISSION</b> <b>Auto</b></p> <p>CHEVROLET SPORT UTILITY .... 1992-95 CHEVROLET TRUCK ..... 1991-95 GMC SPORT UTILITY ..... 1992-95 GMC TRUCK ..... 1992-95</p>	 <p style="text-align: center;"><b>EM-2662</b> <b>Engine Torque Strut Mount</b> <b>Front</b></p> <p>BUICK PASSENGER CAR ..... 1988-99 CADILLAC PASSENGER CAR .... 1988-95 OLDSMOBILE PASSENGER CAR ..... 1988-99 PONTIAC PASSENGER CAR ..... 1992-99</p>
 <p style="text-align: center;"><b>EM-2653</b> <b>MOUNT-TRANSMISSION</b> <b>Manual</b></p> <p>FORD PASSENGER CAR ..... 1988-93</p>	 <p style="text-align: center;"><b>EM-2657</b> <b>MOUNT-ENGINE</b> <b>Front</b></p> <p>PONTIAC PASSENGER CAR ..... 1988-93</p> <p style="text-align: center;"><b>MOUNT-ENGINE</b> <b>Rear</b></p> <p>CHEVROLET PASSENGER CAR ..... 1997-12 DAEWOO PASSENGER CAR ..... 1999-02 PONTIAC PASSENGER CAR ..... 1988-93</p> <p style="text-align: center;"><b>MOUNT-TRANSMISSION</b></p> <p>PONTIAC PASSENGER CAR ..... 1987-89</p>	 <p style="text-align: center;"><b>EM-2660*</b> <b>MOUNT-ENGINE</b> <b>RH Front</b></p> <p>BUICK PASSENGER CAR ..... 1988-93</p> <p style="text-align: center;"><b>MOUNT-ENGINE</b> <b>Front</b></p> <p>CHEVROLET PASSENGER CAR ..... 1990-94 OLDSMOBILE PASSENGER CAR ..... 1988-93 PONTIAC PASSENGER CAR ..... 1988-93</p>	 <p style="text-align: center;"><b>EM-2663</b> <b>MOUNT-TRANSMISSION</b> <b>RH Rear</b></p> <p>BUICK PASSENGER CAR ..... 1985-86 OLDSMOBILE PASSENGER CAR ..... 1985-86</p>
 <p style="text-align: center;"><b>EM-2654</b> <b>MOUNT-ENGINE</b> <b>Front</b></p> <p>FORD PASSENGER CAR ..... 1990-93</p>	 <p style="text-align: center;"><b>EM-2658</b> <b>MOUNT-ENGINE</b> <b>Front</b></p> <p>DAEWOO PASSENGER CAR ..... 1999-02</p> <p style="text-align: center;"><b>MOUNT-ENGINE</b> <b>RH Front</b></p> <p>PONTIAC PASSENGER CAR ..... 1988-93</p>	 <p style="text-align: center;"><b>EM-2661*</b> <b>MOUNT-ENGINE</b> <b>L &amp; R Front</b></p> <p>FORD PASSENGER CAR ..... 1986-97 MERCURY PASSENGER CAR ... 1986-97</p>	 <p style="text-align: center;"><b>EM-2664</b> <b>MOUNT-TRANSMISSION</b> <b>RH Rear</b></p> <p>BUICK PASSENGER CAR ..... 1985-86 OLDSMOBILE PASSENGER CAR ..... 1985-86</p>
 <p style="text-align: center;"><b>EM-2655</b> <b>MOUNT-ENGINE</b> <b>RH Front</b></p> <p>FORD PASSENGER CAR ..... 1988-93</p>			

\* = Hydraulic Mount, "S" suffix = solid replacement.

@ = Universal Mount EM-5000 also available.

# BUYER'S GUIDE

## NUMERICAL LISTING - ILLUSTRATIONS

 <p style="text-align: center;"><b>EM-2665</b> <b>MOUNT-TRANSMISSION</b> <b>Manual</b></p> <p>FORD PASSENGER CAR ..... 1984-94 MERCURY PASSENGER CAR ... 1984-94</p>	 <p style="text-align: center;"><b>EM-2671</b> <b>MOUNT-TRANSMISSION</b> <b>LH</b></p> <p>BUICK PASSENGER CAR ..... 1986-88 OLDSMOBILE PASSENGER CAR ..... 1986-88</p>	 <p style="text-align: center;"><b>EM-2675</b> <b>MOUNT-TRANSMISSION</b> <b>Manual</b></p> <p>VOLVO PASSENGER CAR ..... 1983-95</p>	 <p style="text-align: center;"><b>EM-2678</b> <b>MOUNT-ENGINE</b> <b>Rear</b></p> <p>TOYOTA PASSENGER CAR ..... 1983-86</p>
 <p style="text-align: center;"><b>EM-2667</b> <b>MOUNT-TRANSMISSION</b> <b>Upper</b></p> <p>DODGE SPORT UTILITY ..... 1974-93 DODGE TRUCK ..... 1972-96 PLYMOUTH SUV ..... 1974-81</p>	 <p style="text-align: center;"><b>EM-2673</b> <b>MOUNT-ENGINE</b> <b>Front</b></p> <p>DODGE PASSENGER CAR ..... 1989-92 EAGLE PASSENGER CAR ..... 1989-92 HYUNDAI PASSENGER CAR ..... 1990-91 MITSUBISHI PASSENGER CAR ..... 1989-92 PLYMOUTH PASSENGER CAR ..... 1989-92</p>	 <p style="text-align: center;"><b>EM-2676</b> <b>MOUNT-ENGINE</b> <b>RH Rear</b></p> <p>BUICK PASSENGER CAR ..... 1993-95 CHEVROLET PASSENGER CAR ..... 1991-97 OLDSMOBILE PASSENGER CAR ..... 1991-96 PONTIAC PASSENGER CAR ..... 1991-96</p>	 <p style="text-align: center;"><b>EM-2679</b> <b>MOUNT-TRANSMISSION</b></p> <p>LINCOLN PASSENGER CAR ..... 1980-92</p>
 <p style="text-align: center;"><b>EM-2668</b> <b>MOUNT-TRANSMISSION</b> <b>Lower</b></p> <p>DODGE SPORT UTILITY ..... 1974-93 DODGE TRUCK ..... 1972-96 PLYMOUTH SUV ..... 1974-81</p>	 <p style="text-align: center;"><b>EM-2674</b> <b>MOUNT-ENGINE</b> <b>Front</b></p> <p>CHEVROLET PASSENGER CAR ..... 1985-88</p>	 <p style="text-align: center;"><b>EM-2677</b> <b>MOUNT-ENGINE</b> <b>Front</b></p> <p>TOYOTA PASSENGER CAR ..... 1983-86</p>	 <p style="text-align: center;"><b>EM-2680</b> <b>MOUNT-ENGINE</b> <b>RH Front</b></p> <p>NISSAN PASSENGER CAR ..... 1978-83</p>
			 <p style="text-align: center;"><b>EM-2681</b> <b>MOUNT-ENGINE</b> <b>L &amp; R Front</b></p> <p>NISSAN PASSENGER CAR ..... 1978-82</p>

# BUYER'S GUIDE

## NUMERICAL LISTING - ILLUSTRATIONS

 <p><b>EM-2682</b> <b>MOUNT-ENGINE</b> <b>LH Front</b></p> <p>FORD PASSENGER CAR ..... 1983-92 MERCURY PASSENGER CAR ... 1979-86</p>	 <p><b>EM-2685</b> <b>MOUNT-ENGINE</b> <b>Rear</b></p> <p>TOYOTA PASSENGER CAR ..... 1985-86</p> <p><b>MOUNT-TRANSMISSION</b> <b>Auto</b></p> <p>TOYOTA PASSENGER CAR ..... 1980-86</p>	 <p><b>EM-2688</b> <b>MOUNT-ENGINE</b> <b>Rear</b></p> <p>CHEVROLET PASSENGER CAR ..... 1985-88 TOYOTA PASSENGER CAR ..... 1983-87</p>	 <p><b>EM-2691</b> <b>MOUNT-TRANSMISSION</b> <b>RH</b></p> <p>BUICK PASSENGER CAR ..... 1989-90 CADILLAC PASSENGER CAR .... 1987-92 OLDSMOBILE PASSENGER CAR ..... 1989-91</p>
 <p><b>EM-2683</b> <b>MOUNT-ENGINE</b> <b>LH Front</b></p> <p>FORD PASSENGER CAR ..... 1983-92</p> <p><b>MOUNT-ENGINE</b> <b>RH Front</b></p> <p>MERCURY PASSENGER CAR ... 1979-86</p>	 <p><b>EM-2686</b> <b>MOUNT-TRANSMISSION</b> <b>Auto</b></p> <p>FORD PASSENGER CAR ..... 1988-91</p> <p><b>MOUNT-TRANSMISSION</b></p> <p>FORD VAN ..... 1995-00 MERCURY PASSENGER CAR ... 1988-89</p>	 <p><b>EM-2689</b> <b>MOUNT-ENGINE</b> <b>L &amp; R Front</b></p> <p>VOLVO PASSENGER CAR ..... 1976-82</p>	 <p><b>EM-2692</b> <b>MOUNT-ENGINE</b> <b>RH Front</b></p> <p>FORD PASSENGER CAR ..... 1986-91 MERCURY PASSENGER CAR ..... 1986</p>
 <p><b>EM-2684</b> <b>MOUNT-ENGINE</b> <b>L &amp; R Front</b></p> <p>VOLVO PASSENGER CAR ..... 1984-86</p>	 <p><b>EM-2687</b> <b>MOUNT-TRANSMISSION</b> <b>Auto</b></p> <p>FORD PASSENGER CAR ..... 1986-87</p> <p><b>MOUNT-TRANSMISSION</b></p> <p>MERCURY PASSENGER CAR ... 1986-87</p>	 <p><b>EM-2690</b> <b>MOUNT-TRANSMISSION</b> <b>Auto</b></p> <p>TOYOTA PASSENGER CAR ..... 1978-87</p> <p><b>MOUNT-TRANSMISSION</b> <b>Manual</b></p> <p>TOYOTA TRUCK ..... 1984-86</p>	 <p><b>EM-2693</b> <b>MOUNT-TRANSMISSION</b> <b>Auto</b></p> <p>JEEP SPORT UTILITY ..... 1972-93</p> <p><b>MOUNT-TRANSMISSION</b> <b>Manual</b></p> <p>JEEP TRUCK ..... 1974-88</p>



# BUYER'S GUIDE

## NUMERICAL LISTING - ILLUSTRATIONS

 <p style="text-align: center;"><b>EM-2696*</b> <b>MOUNT-ENGINE</b> <b>Front</b></p> <p>FORD PASSENGER CAR ..... 1986-91 MERCURY PASSENGER CAR ... 1986-91</p> <p style="text-align: center;"><b>MOUNT-TRANSMISSION</b> <b>Auto</b></p> <p>FORD PASSENGER CAR ..... 1991-94 FORD PASSENGER CAR ..... 1986-94 MERCURY PASSENGER CAR ... 1986-94</p>	 <p style="text-align: center;"><b>EM-2707*</b> <b>MOUNT-TRANSMISSION</b> <b>Auto</b></p> <p>FORD PASSENGER CAR ..... 1985-97 MERCURY PASSENGER CAR ... 1985-97</p>	 <p style="text-align: center;"><b>EM-2710</b> <b>MOUNT-ENGINE</b> <b>L &amp; R Front</b></p> <p>DODGE TRUCK ..... 1989-93</p>	<p><b>EM-2712S (Continued)</b></p> <p>OLDSMOBILE PASSENGER CAR ..... 1999-02</p>  <p style="text-align: center;"><b>EM-2713</b> <b>MOUNT-ENGINE</b> <b>L &amp; R Front</b></p> <p>CHEVROLET PASSENGER CAR ..... 1984-91</p>  <p style="text-align: center;"><b>EM-2711</b> <b>MOUNT-ENGINE</b> <b>RH Front</b></p> <p>CHRYSLER PASSENGER CAR ..... 1989-95 CHRYSLER VAN ..... 1990-95 DODGE PASSENGER CAR ..... 1988-95 DODGE VAN ..... 1990-95 PLYMOUTH PASSENGER CAR ..... 1990-95 PLYMOUTH VAN ..... 1990-95</p>  <p style="text-align: center;"><b>EM-2714</b> <b>BODY MOUNT BUSHING KIT</b></p> <p>CHEVROLET PASSENGER CAR ..... 1986-93</p>
 <p style="text-align: center;"><b>EM-2697*</b> <b>MOUNT-ENGINE</b> <b>RH Front</b></p> <p>BUICK PASSENGER CAR ..... 1990-95</p>	 <p style="text-align: center;"><b>EM-2708</b> <b>MOUNT-ENGINE</b> <b>RH Rear</b></p> <p>CADILLAC PASSENGER CAR .... 1985-88 CHEVROLET PASSENGER CAR ..... 1987-94 OLDSMOBILE PASSENGER CAR ..... 1985-87 PONTIAC PASSENGER CAR ..... 1991-94</p>	 <p style="text-align: center;"><b>EM-2712*</b> <b>MOUNT-TRANSMISSION</b> <b>Auto</b></p> <p>BUICK PASSENGER CAR ..... 1994-96</p> <p>CHEVROLET PASSENGER CAR ..... 1991-09 OLDSMOBILE PASSENGER CAR ..... 1991-02 PONTIAC PASSENGER CAR ..... 1991-06</p>	 <p style="text-align: center;"><b>EM-2715</b> <b>MOUNT-TRANSMISSION</b> <b>Auto</b></p> <p>BUICK PASSENGER CAR ..... 1992-95</p> <p>CHEVROLET PASSENGER CAR ..... 1992-96</p> <p>OLDSMOBILE PASSENGER CAR ..... 1992-95 PONTIAC PASSENGER CAR ..... 1992-93 BUICK PASSENGER CAR ..... 1994-98</p>
 <p style="text-align: center;"><b>EM-2698*</b> <b>MOUNT-ENGINE</b> <b>L &amp; R Front</b></p> <p>FORD SPORT UTILITY ..... 1989-92 FORD TRUCK ..... 1985-97 MAZDA TRUCK ..... 1994-97</p>	 <p style="text-align: center;"><b>EM-2709</b> <b>MOUNT-ENGINE</b> <b>L &amp; R Front</b></p> <p>FORD MEDIUM/HEAVY DUTY ..... 1997 FORD TRUCK ..... 1983-97</p>	 <p style="text-align: center;"><b>EM-2712S</b> <b>MOUNT-TRANSMISSION</b> <b>LH</b></p> <p>CHEVROLET PASSENGER CAR ..... 2006</p>	<p style="text-align: center;"><b>MOUNT-TRANSMISSION</b> <b>Auto</b></p> <p>CHEVROLET PASSENGER CAR ..... 1992-96 OLDSMOBILE PASSENGER CAR ..... 1994-98</p>

\* = Hydraulic Mount, "S" suffix = solid replacement.

(Continued Next Column)

(Continued Next Page)

# BUYER'S GUIDE

## NUMERICAL LISTING - ILLUSTRATIONS

### EM-2715 (Continued)

#### MOUNT-TRANSMISSION LH Rear

PONTIAC PASSENGER CAR ..... 1992-98



### EM-2716

#### Engine Torque Strut Mount Front

BUICK PASSENGER CAR ..... 1994-09  
 BUICK SPORT UTILITY ..... 2002-07  
 BUICK VAN ..... 2005-07  
 CHEVROLET PASSENGER  
 CAR ..... 1995-07  
 CHEVROLET VAN ..... 1996-09  
 OLDSMOBILE PASSENGER  
 CAR ..... 1994-02  
 OLDSMOBILE VAN ..... 1996-04  
 PONTIAC PASSENGER CAR ..... 1994-08  
 PONTIAC SPORT UTILITY ..... 2001-05  
 PONTIAC VAN ..... 1996-05  
 SATURN VAN ..... 2005-07



### EM-2717\*

#### MOUNT-TRANSMISSION Auto

FORD PASSENGER CAR ..... 1988-99

#### MOUNT-TRANSMISSION

FORD VAN ..... 1995-03  
 LINCOLN PASSENGER CAR ..... 1988-00  
 MERCURY PASSENGER CAR ... 1988-99



### EM-2718 MOUNT-ENGINE L & R Front

NISSAN TRUCK ..... 1986-02



### EM-2719 MOUNT-TRANSMISSION Manual

NISSAN SPORT UTILITY ..... 1989  
 NISSAN TRUCK ..... 1986-04



### EM-2720 MOUNT-TRANSMISSION Auto

BUICK PASSENGER CAR ..... 1982-84

#### MOUNT-TRANSMISSION Manual

CADILLAC PASSENGER CAR ... 1982-84

#### MOUNT-TRANSMISSION Auto

CHEVROLET PASSENGER  
 CAR ..... 1982-84

#### MOUNT-TRANSMISSION Manual

OLDSMOBILE PASSENGER  
 CAR ..... 1982-84  
 PONTIAC PASSENGER CAR ..... 1982-86



### EM-2721 MOUNT-TRANSMISSION Auto

DODGE PASSENGER CAR ..... 1978-80  
 PLYMOUTH PASSENGER  
 CAR ..... 1978-80



### EM-2722 MOUNT-ENGINE LH Front

AMERICAN MOTORS  
 PASSENGER CAR ..... 1973



### EM-2723 MOUNT-ENGINE RH Front

FORD PASSENGER CAR ..... 1969-73

#### MOUNT-ENGINE LH Front

FORD TRUCK ..... 1970-73



### EM-2724 MOUNT-ENGINE LH Front

FORD PASSENGER CAR ..... 1969-72

#### MOUNT-ENGINE RH Front

FORD TRUCK ..... 1970-73



### EM-2725 MOUNT-ENGINE LH Front

FORD PASSENGER CAR ..... 1980-95  
 LINCOLN PASSENGER CAR ..... 1980-92  
 MERCURY PASSENGER CAR ... 1980-82



### EM-2726 MOUNT-ENGINE RH Front

FORD PASSENGER CAR ..... 1980-95  
 LINCOLN PASSENGER CAR ..... 1980-92  
 MERCURY PASSENGER CAR ... 1980-82

\* = Hydraulic Mount, "S" suffix = solid replacement.

# BUYER'S GUIDE

## NUMERICAL LISTING - ILLUSTRATIONS

 <p><b>EM-2727</b> <b>MOUNT-ENGINE</b> <b>RH Front</b></p> <p>FORD TRUCK ..... 1982-83</p>	 <p><b>EM-2731</b> <b>MOUNT-ENGINE</b> <b>L &amp; R Front</b></p> <p>DODGE PASSENGER CAR ..... 1971-84 DODGE SPORT UTILITY ..... 1987-89</p> <p><b>MOUNT-ENGINE</b> <b>RH Front</b></p> <p>DODGE TRUCK ..... 1979-93</p> <p><b>MOUNT-ENGINE</b> <b>Front</b></p> <p>MITSUBISHI PASSENGER CAR ..... 1983-89</p> <p><b>MOUNT-ENGINE</b> <b>L &amp; R Front</b></p> <p>MITSUBISHI SPORT UTILITY ..... 1983-89</p> <p><b>MOUNT-ENGINE</b> <b>RH Front</b></p> <p>MITSUBISHI TRUCK ..... 1983-96</p> <p><b>MOUNT-ENGINE</b> <b>L &amp; R Front</b></p> <p>PLYMOUTH PASSENGER CAR ..... 1976-86 PLYMOUTH TRUCK ..... 1979-82</p>	 <p><b>EM-2734</b> <b>MOUNT-TRANSMISSION</b> <b>Manual</b></p> <p>DODGE PASSENGER CAR ..... 1978-80</p> <p><b>MOUNT-TRANSMISSION</b> <b>Auto</b></p> <p>PLYMOUTH PASSENGER CAR ..... 1978-80</p>	 <p><b>EM-2737</b> <b>MOUNT-ENGINE</b> <b>RH Front</b></p> <p>RENAULT PASSENGER CAR ..... 1976-83</p>
 <p><b>EM-2728</b> <b>MOUNT-ENGINE</b> <b>LH Front</b></p> <p>FORD TRUCK ..... 1982-83</p>	 <p><b>EM-2730</b> <b>MOUNT-TRANSMISSION</b> <b>Manual</b></p> <p>CHRYSLER PASSENGER CAR ..... 1987-89</p> <p><b>MOUNT-TRANSMISSION</b></p> <p>DODGE PASSENGER CAR ..... 1978-86</p> <p><b>MOUNT-TRANSMISSION</b> <b>Auto</b></p> <p>MITSUBISHI PASSENGER CAR ..... 1983-90</p> <p><b>MOUNT-TRANSMISSION</b></p> <p>PLYMOUTH PASSENGER CAR ..... 1978-86 PLYMOUTH TRUCK ..... 1979-82</p>	 <p><b>EM-2735</b> <b>MOUNT-ENGINE</b> <b>RH Front</b></p> <p>MG PASSENGER CAR ..... 1958-74</p>	 <p><b>EM-2738</b> <b>MOUNT-ENGINE</b> <b>LH Front</b></p> <p>RENAULT PASSENGER CAR ..... 1976-83</p>
 <p><b>EM-2733</b> <b>MOUNT-ENGINE</b> <b>Front</b></p> <p>DODGE PASSENGER CAR ..... 1978-83 PLYMOUTH PASSENGER CAR ..... 1978-83</p>	 <p><b>EM-2736</b> <b>MOUNT-ENGINE</b> <b>LH Front</b></p> <p>MG PASSENGER CAR ..... 1958-74</p>	 <p><b>EM-2739</b> <b>MOUNT-TRANSMISSION</b> <b>Manual</b></p> <p>RENAULT PASSENGER CAR ..... 1976-83</p>	 <p><b>EM-2740</b> <b>MOUNT-ENGINE</b> <b>LH Front</b></p> <p>NISSAN TRUCK ..... 1980-92</p>

# BUYER'S GUIDE

## NUMERICAL LISTING - ILLUSTRATIONS

 <p><b>EM-2741</b> <b>MOUNT-TRANSMISSION</b> Auto</p> <p>NISSAN PASSENGER CAR ..... 1979-83</p>	 <p><b>EM-2745</b> <b>MOUNT-ENGINE</b> LH Front</p> <p>TOYOTA PASSENGER CAR ..... 1973-74</p>	<p><b>EM-2748 (Continued)</b> TOYOTA PASSENGER CAR ..... 1983-84</p>  <p><b>EM-2749</b> <b>MOUNT-ENGINE</b> LH Front</p> <p>LINCOLN PASSENGER CAR ..... 1977-79</p>	 <p><b>EM-2753</b> <b>MOUNT-TRANSMISSION</b> Auto</p> <p>FORD MEDIUM/HEAVY DUTY .... 1980-87</p>
 <p><b>EM-2742</b> <b>MOUNT-TRANSMISSION</b></p> <p>NISSAN PASSENGER CAR ..... 1978-81 NISSAN TRUCK ..... 1970-97</p>	 <p><b>EM-2746</b> <b>MOUNT-TRANSMISSION</b> Manual</p> <p>TOYOTA TRUCK ..... 1978-80</p>	 <p><b>EM-2750</b> <b>MOUNT-TRANSMISSION</b></p> <p>FORD MEDIUM/HEAVY DUTY .... 1975-77</p>	 <p><b>EM-2754</b> <b>MOUNT-ENGINE</b> LH Front</p> <p>FORD VAN ..... 1980-82</p>
 <p><b>EM-2743</b> <b>MOUNT-ENGINE</b> RH Front</p> <p>TOYOTA PASSENGER CAR ..... 1971-74</p>	 <p><b>EM-2747</b> <b>MOUNT-ENGINE</b> LH Front</p> <p>TOYOTA PASSENGER CAR ..... 1969-79</p>	 <p><b>EM-2751</b> <b>MOUNT-TRANSMISSION</b> Auto</p> <p>FORD TRUCK ..... 1970-76</p>	 <p><b>EM-2755</b> <b>MOUNT-ENGINE</b> LH Front</p> <p>CHEVROLET SPORT UTILITY .... 1983-84 CHEVROLET TRUCK ..... 1983-84 GMC SPORT UTILITY ..... 1983-84 GMC TRUCK ..... 1983-84</p>
 <p><b>EM-2744</b> <b>MOUNT-ENGINE</b> L &amp; R Front</p> <p>TOYOTA PASSENGER CAR ..... 1978-82</p>	 <p><b>EM-2748</b> <b>MOUNT-ENGINE</b> RH Front <b>MOUNT-TRANSMISSION</b></p> <p>TOYOTA PASSENGER CAR ..... 1969-79</p> <p>(Continued Next Column)</p>	 <p><b>EM-2752</b> <b>MOUNT-TRANSMISSION</b> Manual</p> <p>FORD MEDIUM/HEAVY DUTY .... 1980-87</p>	 <p><b>EM-2756</b> <b>MOUNT-ENGINE</b> RH Front</p> <p>CHEVROLET SPORT UTILITY .... 1983-84</p> <p>(Continued Next Page)</p>

# BUYER'S GUIDE

## NUMERICAL LISTING - ILLUSTRATIONS

### EM-2756 (Continued)

CHEVROLET TRUCK ..... 1983-84  
 GMC SPORT UTILITY ..... 1983-84  
 GMC TRUCK ..... 1983-84



### EM-2759

#### MOUNT-TRANSMISSION

FORD TRUCK ..... 1972-82  
 MAZDA PASSENGER CAR ..... 1972-77



### EM-2760

#### MOUNT-TRANSMISSION Auto

NISSAN PASSENGER CAR ..... 1974



### EM-2761

#### Engine Torque Strut Mount Front

PONTIAC PASSENGER CAR ..... 1984-88



### EM-2762

#### MOUNT-TRANSMISSION LH Front

CHEVROLET PASSENGER  
 CAR ..... 1987-88  
 PONTIAC PASSENGER CAR ..... 1987-88



### EM-2763

#### MOUNT-ENGINE RH Rear

BUICK PASSENGER CAR ..... 1990-92



### EM-2764

#### MOUNT-ENGINE RH Front

FORD TRUCK ..... 1988-97



### EM-2765

#### MOUNT-ENGINE LH Front

FORD TRUCK ..... 1988-97



### EM-2766

#### MOUNT-TRANSMISSION Manual

CHEVROLET PASSENGER  
 CAR ..... 1990-91  
 OLDSMOBILE PASSENGER  
 CAR ..... 1988-91  
 PONTIAC PASSENGER CAR ..... 1988-91



### EM-2767

#### MOUNT-ENGINE RH Front

FORD MEDIUM/HEAVY DUTY .... 1996-03  
 FORD VAN ..... 1983-03



### EM-2768

#### MOUNT-ENGINE LH Front

FORD MEDIUM/HEAVY DUTY .... 1996-03  
 FORD VAN ..... 1983-03



### EM-2769

#### MOUNT-TRANSMISSION Manual

FORD MEDIUM/HEAVY DUTY .... 1987-97



### EM-2770

#### MOUNT-ENGINE RH Rear

FORD PASSENGER CAR ..... 1986-91  
 MERCURY PASSENGER CAR ..... 1986



### EM-2771

#### MOUNT-TRANSMISSION Auto

CHEVROLET SPORT UTILITY ..... 1983  
 CHEVROLET TRUCK ..... 1982  
 GMC SPORT UTILITY ..... 1983  
 GMC TRUCK ..... 1982-83



# BUYER'S GUIDE

## NUMERICAL LISTING - ILLUSTRATIONS

 <p style="text-align: center;"><b>EM-2772</b> <b>MOUNT-TRANSMISSION</b> <b>Manual</b></p> <p>CHEVROLET SPORT UTILITY ..... 1983</p> <p style="text-align: center;"><b>MOUNT-TRANSMISSION</b> <b>Auto</b></p> <p>CHEVROLET TRUCK ..... 1983 GMC SPORT UTILITY ..... 1983 GMC TRUCK ..... 1983</p>	 <p style="text-align: center;"><b>EM-2775</b> <b>MOUNT-ENGINE</b> <b>LH Front</b></p> <p>FORD TRUCK ..... 1972-82 MAZDA TRUCK ..... 1972-84</p>	 <p style="text-align: center;"><b>EM-2778</b> <b>MOUNT-TRANSMISSION</b> <b>LH Rear</b></p> <p>BUICK PASSENGER CAR ..... 1994-99 OLDSMOBILE PASSENGER CAR ..... 1994-99 PONTIAC PASSENGER CAR ..... 1994-99</p>	 <p style="text-align: center;"><b>EM-2781</b> <b>Engine Torque Strut</b> <b>Front Left</b></p> <p>CADILLAC PASSENGER CAR .... 1993-02</p>
 <p style="text-align: center;"><b>EM-2773@</b> <b>MOUNT-TRANSMISSION</b></p> <p>CADILLAC PASSENGER CAR .... 1979-85</p>	 <p style="text-align: center;"><b>EM-2776</b> <b>MOUNT-ENGINE</b> <b>L &amp; R Front</b></p> <p>FORD PASSENGER CAR ..... 1980-82 MERCURY PASSENGER CAR ... 1980-82</p>	 <p style="text-align: center;"><b>EM-2779</b> <b>MOUNT-TRANSMISSION</b> <b>LH</b></p> <p>BUICK PASSENGER CAR ..... 1988-91</p> <p style="text-align: center;"><b>MOUNT-TRANSMISSION</b> <b>Center</b></p> <p>CADILLAC PASSENGER CAR .... 1987-92</p> <p style="text-align: center;"><b>MOUNT-TRANSMISSION</b> <b>LH</b></p> <p>OLDSMOBILE PASSENGER CAR ..... 1989-91</p>	 <p style="text-align: center;"><b>EM-2782</b> <b>Engine Torque Strut Mount</b> <b>Front</b></p> <p>BUICK PASSENGER CAR ..... 1992-94 CHEVROLET PASSENGER CAR ..... 1992-96 OLDSMOBILE PASSENGER CAR ..... 1992-97 PONTIAC PASSENGER CAR ..... 1992-98</p>
 <p style="text-align: center;"><b>EM-2774</b> <b>MOUNT-ENGINE</b> <b>RH Front</b></p> <p>FORD TRUCK ..... 1972-82 MAZDA TRUCK ..... 1972-84</p>	 <p style="text-align: center;"><b>EM-2777</b> <b>MOUNT-ENGINE</b> <b>L &amp; R Front</b></p> <p>BUICK PASSENGER CAR ..... 1979-85 CADILLAC PASSENGER CAR .... 1981-82 OLDSMOBILE PASSENGER CAR ..... 1981-84</p>	 <p style="text-align: center;"><b>EM-2780</b> <b>Engine Torque Strut</b> <b>Front Right</b></p> <p>CADILLAC PASSENGER CAR .... 1993-02</p>	 <p style="text-align: center;"><b>EM-2783</b> <b>MOUNT-TRANSMISSION</b> <b>LH</b></p> <p>CADILLAC PASSENGER CAR .... 1986-87</p>

@ = Universal Mount EM-5000 also available.

# BUYER'S GUIDE

## NUMERICAL LISTING - ILLUSTRATIONS

 <p style="text-align: center;"><b>EM-2784</b> <b>MOUNT-TRANSMISSION</b> Auto</p> <p>FORD PASSENGER CAR ..... 1982-88</p>	 <p style="text-align: center;"><b>EM-2789*</b> <b>MOUNT-ENGINE</b> RH Front</p> <p>FORD PASSENGER CAR ..... 1996-99 MERCURY PASSENGER CAR ... 1996-99</p>	<p><b>EM-2792 (Continued)</b></p> <p>FORD PASSENGER CAR ..... 1993 MERCURY PASSENGER CAR ..... 1993</p>  <p style="text-align: center;"><b>EM-2793</b> <b>MOUNT-ENGINE</b> RH Front</p> <p>JEEP SPORT UTILITY ..... 1993-98</p>	 <p style="text-align: center;"><b>EM-2796*</b> <b>MOUNT-ENGINE</b> Front</p> <p>BUICK PASSENGER CAR ..... 1994-05</p> <p style="text-align: center;"><b>MOUNT-ENGINE</b> RH Front</p> <p>CHEVROLET PASSENGER CAR ..... 1995-05 CHEVROLET VAN ..... 1997-05</p> <p style="text-align: center;"><b>MOUNT-ENGINE</b> Front</p> <p>OLDSMOBILE PASSENGER CAR ..... 1990-99 OLDSMOBILE VAN ..... 1997-04</p> <p style="text-align: center;"><b>MOUNT-ENGINE</b> RH Front</p> <p>PONTIAC PASSENGER CAR ..... 1994-03</p> <p style="text-align: center;"><b>MOUNT-ENGINE</b> Front</p> <p>PONTIAC VAN ..... 1997-05</p>
 <p style="text-align: center;"><b>EM-2785</b> <b>MOUNT-ENGINE</b> RH Front</p> <p>FORD TRUCK ..... 1985-87</p>	 <p style="text-align: center;"><b>EM-2790*</b> <b>MOUNT-ENGINE</b> RH Front</p> <p>FORD PASSENGER CAR ..... 1994-95 MERCURY PASSENGER CAR ... 1994-95</p>	 <p style="text-align: center;"><b>EM-2794</b> <b>MOUNT-ENGINE</b> LH Front</p> <p>JEEP SPORT UTILITY ..... 1993-98</p>	 <p style="text-align: center;"><b>EM-2797</b> <b>TORSION BAR MOUNT</b> Front</p> <p>CHEVROLET SPORT UTILITY .... 1983-94 GMC SPORT UTILITY ..... 1983-94 OLDSMOBILE SPORT UTILITY .. 1991-94</p>
 <p style="text-align: center;"><b>EM-2786</b> <b>MOUNT-ENGINE</b> LH Front</p> <p>FORD TRUCK ..... 1985-87</p>	 <p style="text-align: center;"><b>EM-2791*</b> <b>MOUNT-ENGINE</b> RH Front</p> <p>FORD PASSENGER CAR ..... 1991-92 MERCURY PASSENGER CAR ... 1991-92</p>	 <p style="text-align: center;"><b>EM-2795*</b> <b>MOUNT-ENGINE</b> L &amp; R Front</p> <p>CHRYSLER PASSENGER CAR ..... 1993-97 DODGE PASSENGER CAR ..... 1993-95 EAGLE PASSENGER CAR ..... 1993-97</p>	
 <p style="text-align: center;"><b>EM-2788*</b> <b>MOUNT-ENGINE</b> RH Rear</p> <p>FORD PASSENGER CAR ..... 1991-95 MERCURY PASSENGER CAR ... 1991-95</p>	 <p style="text-align: center;"><b>EM-2792*</b> <b>MOUNT-ENGINE</b> RH Front</p> <p style="text-align: center;">(Continued Next Column)</p>		

\* = Hydraulic Mount, "S" suffix = solid replacement.

# BUYER'S GUIDE

## NUMERICAL LISTING - ILLUSTRATIONS

 <p style="text-align: center;"><b>EM-2798</b> <b>Engine Torque Strut Mount</b> <b>Front</b></p> <p>CHEVROLET PASSENGER CAR ..... 1995-05 PONTIAC PASSENGER CAR ..... 1995-05</p>	 <p style="text-align: center;"><b>EM-2801</b> <b>MOUNT-ENGINE</b> <b>RH Front</b></p> <p>BUICK PASSENGER CAR ..... 1991-99 OLDSMOBILE PASSENGER CAR ..... 1991-99 PONTIAC PASSENGER CAR ..... 1992-99</p>	 <p style="text-align: center;"><b>EM-2804</b> <b>MOUNT-ENGINE</b> <b>Front</b></p> <p>FORD PASSENGER CAR ..... 1992-94 MERCURY PASSENGER CAR ... 1992-94</p>	 <p style="text-align: center;"><b>EM-2807</b> <b>MOUNT-ENGINE</b> <b>LH Front</b></p> <p>FORD PASSENGER CAR ..... 1992-97 LINCOLN PASSENGER CAR ..... 1991-97 MERCURY PASSENGER CAR ... 1992-97</p>	
 <p style="text-align: center;"><b>EM-2799</b> <b>Engine Torque Strut Mount</b> <b>Front</b></p> <p>CHEVROLET PASSENGER CAR ..... 1991-97 OLDSMOBILE PASSENGER CAR ..... 1991-96 PONTIAC PASSENGER CAR ..... 1991-96</p>	 <p style="text-align: center;"><b>EM-2802</b> <b>MOUNT-ENGINE</b> <b>L &amp; R Front</b></p> <p>CHEVROLET SPORT UTILITY ... 1995-05 CHEVROLET TRUCK ..... 1996-04 GMC SPORT UTILITY ..... 1996-05 GMC TRUCK ..... 1996-04 ISUZU TRUCK ..... 1997-00 OLDSMOBILE SPORT UTILITY .. 1996-01</p>	 <p style="text-align: center;"><b>EM-2805</b> <b>MOUNT-ENGINE</b> <b>RH Front</b></p> <p>FORD PASSENGER CAR ..... 1992-94 MERCURY PASSENGER CAR ... 1992-94</p>	 <p style="text-align: center;"><b>EM-2808</b> <b>MOUNT-ENGINE</b> <b>RH Front</b></p> <p>JEEP SPORT UTILITY ..... 1993-98</p>	
 <p style="text-align: center;"><b>EM-2800</b> <b>MOUNT-TRANSMISSION</b> <b>LH Front</b></p> <p>BUICK PASSENGER CAR ..... 1991-93 CADILLAC PASSENGER CAR .... 1985-93 OLDSMOBILE PASSENGER CAR ..... 1991-93 PONTIAC PASSENGER CAR ..... 1992-93</p>	 <p style="text-align: center;"><b>EM-2803*</b> <b>MOUNT-ENGINE</b> <b>RH Front</b></p> <p>BUICK PASSENGER CAR ..... 1992-98 CHEVROLET PASSENGER CAR ..... 1992-02 OLDSMOBILE PASSENGER CAR ..... 1992-98 PONTIAC PASSENGER CAR ..... 1992-02</p>	 <p style="text-align: center;"><b>EM-2806</b> <b>MOUNT-ENGINE</b> <b>RH Front</b></p> <p>FORD PASSENGER CAR ..... 1992-97 LINCOLN PASSENGER CAR ..... 1991-97 MERCURY PASSENGER CAR ... 1992-97</p>	 <p style="text-align: center;"><b>EM-2809</b> <b>MOUNT-ENGINE</b> <b>LH Front</b></p> <p>JEEP SPORT UTILITY ..... 1993-98</p>	
				 <p style="text-align: center;"><b>EM-2810</b> <b>MOUNT-TRANSMISSION</b></p> <p>CHRYSLER PASSENGER CAR ..... 1993-97 DODGE PASSENGER CAR ..... 1993-97</p>

(Continued Next Page)

\* = Hydraulic Mount, "S" suffix = solid replacement.



# BUYER'S GUIDE

## NUMERICAL LISTING - ILLUSTRATIONS

### EM-2810 (Continued)

EAGLE PASSENGER CAR ..... 1993-97  
 PLYMOUTH PASSENGER  
 CAR ..... 1997-99



### EM-2811

**MOUNT-TRANSMISSION**

CADILLAC SPORT UTILITY ..... 2000-14  
**MOUNT-TRANSMISSION**  
**Auto**

CHEVROLET PASSENGER  
 CAR ..... 1994-97  
**MOUNT-TRANSMISSION**

CHEVROLET SPORT UTILITY ..... 2000-17  
 CHEVROLET TRUCK ..... 1996-14  
 CHEVROLET VAN ..... 1991-95  
 GMC SPORT UTILITY ..... 2000-14  
 GMC TRUCK ..... 1999-14  
 GMC VAN ..... 1991-95



### EM-2812\*

**MOUNT-ENGINE**  
**RH Front**

FORD PASSENGER CAR ..... 1988-95  
 FORD VAN ..... 1995  
 LINCOLN PASSENGER CAR ..... 1988-94  
 MERCURY PASSENGER CAR ..... 1988-95



### EM-2813\*

**MOUNT-ENGINE**  
**RH Rear**

FORD PASSENGER CAR ..... 1988-95  
 FORD VAN ..... 1995-03  
 LINCOLN PASSENGER CAR ..... 1988-02

(Continued Next Column)

### EM-2813 (Continued)

MERCURY PASSENGER CAR ... 1988-95



### EM-2814

**Engine Torque Strut Mount**  
**Front**

BUICK PASSENGER CAR ..... 1995-98  
 CHEVROLET PASSENGER  
 CAR ..... 1995-96  
 OLDSMOBILE PASSENGER  
 CAR ..... 1995-98  
 PONTIAC PASSENGER CAR ..... 1994-98



**EM-2815**  
**MOUNT-ENGINE**  
**LH Front**

MAZDA PASSENGER CAR ..... 1990-94

**MOUNT-ENGINE**  
**Rear**

MAZDA PASSENGER CAR ..... 1992-94  
**MOUNT-TRANSMISSION**  
**Auto**

FORD PASSENGER CAR ..... 1991-96  
**MOUNT-TRANSMISSION**

KIA PASSENGER CAR ..... 1994-97  
**MOUNT-TRANSMISSION**  
**Manual**

MAZDA PASSENGER CAR ..... 1990-94  
**MOUNT-TRANSMISSION**  
**Auto**

MERCURY PASSENGER CAR ... 1991-96  
 MAZDA PASSENGER CAR ..... 1990-91



**EM-2816**  
**MOUNT-TRANSMISSION**

CHEVROLET VAN ..... 1990-02  
 GMC VAN ..... 1990-02



**EM-2817**  
**MOUNT-TRANSMISSION**

CHEVROLET SPORT UTILITY ... 1994-00  
**MOUNT-TRANSMISSION**  
**Auto**

CHEVROLET TRUCK ..... 1994-12  
**MOUNT-TRANSMISSION**

CHEVROLET VAN ..... 1991-02  
 GMC SPORT UTILITY ..... 1994-13  
**MOUNT-TRANSMISSION**  
**Manual**

GMC TRUCK ..... 1994-02  
**MOUNT-TRANSMISSION**  
**Auto**

GMC VAN ..... 1991-02  
**MOUNT-TRANSMISSION**

PONTIAC PASSENGER CAR ..... 1994-97



**EM-2818#**  
**MOUNT-TRANSMISSION**

BUICK PASSENGER CAR ..... 1997-09  
 BUICK SPORT UTILITY ..... 2002-07  
 BUICK VAN ..... 2005-07  
 CHEVROLET PASSENGER  
 CAR ..... 2000-11  
 CHEVROLET VAN ..... 1997-09

(Continued Next Column)

### EM-2818 (Continued)

OLDSMOBILE VAN ..... 1997-04  
 PONTIAC PASSENGER CAR ..... 2007-08  
 PONTIAC SPORT UTILITY ..... 2001-05  
 PONTIAC VAN ..... 1997-06

**MOUNT-TRANSMISSION**  
**Auto**

SATURN VAN ..... 2005-07



**EM-2819**  
**MOUNT-ENGINE**  
**L & R Front**

CHEVROLET TRUCK ..... 1994-03  
 GMC TRUCK ..... 1994-03  
 ISUZU TRUCK ..... 1996-00



**EM-2820**  
**MOUNT-TRANSMISSION**  
**Auto**

CHEVROLET PASSENGER  
 CAR ..... 1995-05  
 PONTIAC PASSENGER CAR ..... 1995-05



**EM-2821\***  
**MOUNT-TRANSMISSION**  
**RH Rear**

CADILLAC PASSENGER CAR ... 1991-93

\* = Hydraulic Mount, "S" suffix = solid replacement.

# = Available in the Westar Gold Line

# BUYER'S GUIDE

## NUMERICAL LISTING - ILLUSTRATIONS

 <p style="text-align: center;"><b>EM-2822</b> <b>MOUNT-TRANSMISSION</b></p> <p>FORD PASSENGER CAR ..... 1993-02 LINCOLN PASSENGER CAR ..... 1992-02 MERCURY PASSENGER CAR ..... 1994-02</p>	 <p style="text-align: center;"><b>EM-2825</b> <b>Engine Torque Strut Mount Front</b></p> <p>SATURN PASSENGER CAR ..... 1992-02</p> <p style="text-align: center;"><b>Engine Torque Strut Mount Rear</b></p> <p>SATURN PASSENGER CAR ..... 1992-02</p>	 <p style="text-align: center;"><b>EM-2828</b> <b>MOUNT-TRANSMISSION</b></p> <p>JEEP SPORT UTILITY ..... 1993-98</p>	 <p style="text-align: center;"><b>EM-2832</b> <b>MOUNT-ENGINE LH Front</b></p> <p>FORD SPORT UTILITY ..... 1997-02 FORD TRUCK ..... 1997-04 LINCOLN SPORT UTILITY ..... 1998-02</p>
 <p style="text-align: center;"><b>EM-2823*</b> <b>MOUNT-TRANSMISSION LH Rear</b></p> <p>BUICK PASSENGER CAR ..... 1991-93 OLDSMOBILE PASSENGER CAR ..... 1991-93 PONTIAC PASSENGER CAR ..... 1992-93</p>	 <p style="text-align: center;"><b>EM-2826</b> <b>MOUNT-TRANSMISSION Auto</b></p> <p>SATURN PASSENGER CAR ..... 1991-02</p>	 <p style="text-align: center;"><b>EM-2829</b> <b>MOUNT-ENGINE LH Front</b></p> <p>DODGE TRUCK ..... 1994-02</p>	 <p style="text-align: center;"><b>EM-2833</b> <b>MOUNT-ENGINE RH Front</b></p> <p>FORD TRUCK ..... 1997-04</p>
 <p style="text-align: center;"><b>EM-2824*</b> <b>MOUNT-TRANSMISSION Auto</b></p> <p>CHRYSLER PASSENGER CAR ..... 1990-93 DODGE PASSENGER CAR ..... 1990-93</p>	 <p style="text-align: center;"><b>EM-2827</b> <b>MOUNT-ENGINE RH Front</b></p> <p>SATURN PASSENGER CAR ..... 1991-02</p>	 <p style="text-align: center;"><b>EM-2830</b> <b>MOUNT-ENGINE RH Front</b></p> <p>DODGE TRUCK ..... 1994-02</p>	 <p style="text-align: center;"><b>EM-2834</b> <b>MOUNT-ENGINE RH Front</b></p> <p>FORD SPORT UTILITY ..... 1997-98 LINCOLN SPORT UTILITY ..... 1998-99</p>
 <p style="text-align: center;"><b>EM-2831</b> <b>MOUNT-ENGINE LH Front</b></p> <p>FORD TRUCK ..... 1997-04</p>	 <p style="text-align: center;"><b>EM-2835</b> <b>MOUNT-ENGINE RH Front</b></p> <p>FORD SPORT UTILITY ..... 1997-02</p>	<p><b>(Continued Next Page)</b></p>	

\* = Hydraulic Mount, "S" suffix = solid replacement.

# BUYER'S GUIDE

## NUMERICAL LISTING - ILLUSTRATIONS

### EM-2835 (Continued)

FORD TRUCK ..... 1997-04  
 LINCOLN SPORT UTILITY ..... 1998-02  
 LINCOLN TRUCK ..... 2002



**EM-2836\***  
**MOUNT-ENGINE**  
**RH Front**

CADILLAC PASSENGER CAR .... 1992-95



**EM-2837\***  
**MOUNT-TRANSMISSION**  
**RH**

CADILLAC PASSENGER CAR .... 1993-02



**EM-2838\***  
**MOUNT-ENGINE**  
**RH Front**

CADILLAC PASSENGER CAR .... 1993-02



**EM-2839**  
**MOUNT-TRANSMISSION**

CHEVROLET SPORT UTILITY .... 1995-06

**MOUNT-TRANSMISSION**  
**Auto**

CHEVROLET TRUCK ..... 1995-10  
 CHEVROLET VAN ..... 1996-05

**MOUNT-TRANSMISSION**

GMC SPORT UTILITY ..... 1995-06  
 GMC TRUCK ..... 2001-10

**MOUNT-TRANSMISSION**  
**Auto**

GMC VAN ..... 1994-05

**MOUNT-TRANSMISSION**  
**Manual**

ISUZU TRUCK ..... 1998-00

**MOUNT-TRANSMISSION**

OLDSMOBILE SPORT UTILITY .. 1996-01



**EM-2840\***  
**MOUNT-ENGINE**  
**RH Rear**

FORD PASSENGER CAR ..... 1996-99  
 MERCURY PASSENGER CAR ... 1996-99



**EM-2841\***  
**MOUNT-ENGINE**  
**RH Front**

CHRYSLER PASSENGER  
 CAR ..... 1995-06

(Continued Next Column)

### EM-2841 (Continued)

DODGE PASSENGER CAR ..... 1995-06  
 PLYMOUTH PASSENGER  
 CAR ..... 1996-00



**EM-2842\***  
**MOUNT-TRANSMISSION**  
**Center**

CHRYSLER PASSENGER  
 CAR ..... 1995-06

**MOUNT-TRANSMISSION**  
**Auto**

DODGE PASSENGER CAR ..... 1995-06  
 PLYMOUTH PASSENGER  
 CAR ..... 1996-00



**EM-2843**  
**MOUNT-TRANSMISSION**  
**Auto**

FORD PASSENGER CAR ..... 1997-02

**MOUNT-TRANSMISSION**

**Manual**

MERCURY PASSENGER CAR ... 1997-99



**EM-2844**  
**MOUNT-ENGINE**  
**RH Front**

CHRYSLER VAN ..... 1996-00  
 DODGE VAN ..... 1996-00  
 PLYMOUTH VAN ..... 1996-00



**EM-2845**  
**MOUNT-TRANSMISSION**  
**Center**

CHRYSLER VAN ..... 1996-00

**MOUNT-TRANSMISSION**

DODGE VAN ..... 1996-00

**MOUNT-TRANSMISSION**

PLYMOUTH VAN ..... 1996-00



**EM-2846**  
**MOUNT-ENGINE**  
**Front**

DODGE PASSENGER CAR ..... 1995-99  
 PLYMOUTH PASSENGER  
 CAR ..... 1995-99



**EM-2847**  
**MOUNT-ENGINE**  
**RH Front**

DODGE PASSENGER CAR ..... 1995-99  
 PLYMOUTH PASSENGER  
 CAR ..... 1995-99

\* = Hydraulic Mount, "S" suffix = solid replacement.

# BUYER'S GUIDE

## NUMERICAL LISTING - ILLUSTRATIONS

 <p style="text-align: center;"><b>EM-2848</b> <b>MOUNT-TRANSMISSION</b> <b>Auto</b></p> <p>DODGE PASSENGER CAR ..... 1995-99</p> <p style="text-align: center;"><b>MOUNT-TRANSMISSION</b> <b>Manual</b></p> <p>PLYMOUTH PASSENGER CAR ..... 1995-99</p>	 <p style="text-align: center;"><b>EM-2851</b> <b>MOUNT-ENGINE</b> <b>LH Front</b></p> <p>FORD SPORT UTILITY ..... 1997-05</p> <p>FORD TRUCK ..... 1998-11</p> <p>MAZDA TRUCK ..... 2005-09</p> <p>MERCURY SPORT UTILITY ..... 1998-01</p>	 <p style="text-align: center;"><b>EM-2854</b> <b>MOUNT-TRANSMISSION</b></p> <p>MERCURY VAN ..... 1993-02</p> <p>NISSAN VAN ..... 1993-02</p>	 <p style="text-align: center;"><b>EM-2857</b> <b>MOUNT-ENGINE</b> <b>RH Rear</b></p> <p>MERCURY VAN ..... 1993-02</p> <p style="text-align: center;"><b>MOUNT-ENGINE</b> <b>Rear</b></p> <p>NISSAN VAN ..... 1993-02</p>
 <p style="text-align: center;"><b>EM-2849</b> <b>MOUNT-TRANSMISSION</b> <b>LH Front</b></p> <p>CHRYSLER VAN ..... 1996-00</p> <p style="text-align: center;"><b>MOUNT-TRANSMISSION</b></p> <p>DODGE VAN ..... 1996-04</p> <p style="text-align: center;"><b>MOUNT-TRANSMISSION</b></p> <p>PLYMOUTH VAN ..... 1996-00</p> <p style="text-align: center;"><b>MOUNT-TRANSMISSION</b> <b>LH Rear</b></p> <p>CHRYSLER VAN ..... 1996-00</p> <p style="text-align: center;"><b>MOUNT-TRANSMISSION</b></p> <p>DODGE VAN ..... 1996-04</p> <p style="text-align: center;"><b>MOUNT-TRANSMISSION</b></p> <p>PLYMOUTH VAN ..... 1996-00</p>	 <p style="text-align: center;"><b>EM-2852</b> <b>MOUNT-TRANSMISSION</b> <b>Auto</b></p> <p>DODGE TRUCK ..... 1994-03</p> <p style="text-align: center;"><b>MOUNT-TRANSMISSION</b></p> <p>DODGE VAN ..... 1999-03</p>	 <p style="text-align: center;"><b>EM-2855</b> <b>MOUNT-ENGINE</b> <b>Front</b></p> <p>MERCURY VAN ..... 1993-98</p> <p>NISSAN VAN ..... 1993-98</p>	 <p style="text-align: center;"><b>EM-2858</b> <b>MOUNT-TRANSMISSION</b></p> <p>DODGE SPORT UTILITY ..... 1998-03</p> <p style="text-align: center;"><b>MOUNT-TRANSMISSION</b> <b>Auto</b></p> <p>DODGE TRUCK ..... 1994-04</p>
 <p style="text-align: center;"><b>EM-2850</b> <b>MOUNT-ENGINE</b> <b>RH Front</b></p> <p>FORD SPORT UTILITY ..... 1995-05</p> <p>FORD TRUCK ..... 1998</p> <p>MERCURY SPORT UTILITY ..... 1998-01</p>	 <p style="text-align: center;"><b>EM-2853</b> <b>MOUNT-ENGINE</b> <b>L &amp; R Front</b></p> <p>FORD TRUCK ..... 1998-11</p> <p>MAZDA TRUCK ..... 1998-07</p>	 <p style="text-align: center;"><b>EM-2856</b> <b>MOUNT-ENGINE</b> <b>RH Front</b></p> <p>NISSAN VAN ..... 1993-98</p> <p style="text-align: center;"><b>MOUNT-ENGINE</b> <b>LH Rear</b></p> <p>MERCURY VAN ..... 1993-98</p>	 <p style="text-align: center;"><b>EM-2859*</b> <b>MOUNT-ENGINE</b> <b>RH Front</b></p> <p>BUICK PASSENGER CAR ..... 1988-91</p> <p>CHEVROLET PASSENGER CAR ..... 1990-91</p> <p>OLDSMOBILE PASSENGER CAR ..... 1988-91</p> <p>PONTIAC PASSENGER CAR ..... 1988-91</p>

\* = Hydraulic Mount, "S" suffix = solid replacement.

# BUYER'S GUIDE

## NUMERICAL LISTING - ILLUSTRATIONS

 <p style="text-align: center;"><b>EM-2860</b> <b>MOUNT-ENGINE</b> <b>RH Front</b></p> <p>FORD PASSENGER CAR ..... 1998-02 LINCOLN PASSENGER CAR ..... 1998-02 MERCURY PASSENGER CAR ... 1998-02</p>	 <p style="text-align: center;"><b>EM-2863</b> <b>MOUNT-TRANSMISSION</b> <b>Manual</b></p> <p>JEEP SPORT UTILITY ..... 1993-94</p>	 <p style="text-align: center;"><b>EM-2867</b> <b>MOUNT-ENGINE</b> <b>Front</b></p> <p>DODGE PASSENGER CAR ..... 1995-99 PLYMOUTH PASSENGER CAR ..... 1995-99</p>	<p><b>EM-2870 (Continued)</b></p> <p style="text-align: center;"><b>MOUNT-TRANSMISSION</b> <b>Auto</b></p> <p>FORD TRUCK ..... 1997-04</p> <p style="text-align: center;"><b>MOUNT-TRANSMISSION</b></p> <p>LINCOLN SPORT UTILITY ..... 1998-04 LINCOLN TRUCK ..... 2002</p>
 <p style="text-align: center;"><b>EM-2861</b> <b>MOUNT-ENGINE</b> <b>LH Front</b></p> <p>FORD PASSENGER CAR ..... 1998-02 LINCOLN PASSENGER CAR ..... 1998-02 MERCURY PASSENGER CAR ... 1998-02</p>	 <p style="text-align: center;"><b>EM-2864</b> <b>MOUNT-TRANSMISSION</b> <b>Auto</b></p> <p>JEEP SPORT UTILITY ..... 1993-95</p>	 <p style="text-align: center;"><b>EM-2868</b> <b>MOUNT-TRANSMISSION</b></p> <p>FORD SPORT UTILITY ..... 1996-07 MERCURY SPORT UTILITY ..... 1997-01</p>	 <p style="text-align: center;"><b>EM-2871</b> <b>MOUNT-TRANSMISSION</b></p> <p>FORD TRUCK ..... 1997-04</p>
 <p style="text-align: center;"><b>EM-2862</b> <b>MOUNT-ENGINE</b> <b>Rear</b></p> <p>FORD PASSENGER CAR ..... 1996-05</p> <p style="text-align: center;"><b>MOUNT-ENGINE</b> <b>RH Rear</b></p> <p>MERCURY PASSENGER CAR ... 1996-05</p>	 <p style="text-align: center;"><b>EM-2866#</b> <b>MOUNT-ENGINE</b> <b>Front</b> <b>Engine Torque Strut Mount</b></p> <p>FORD PASSENGER CAR ..... 1995</p> <p>BUICK PASSENGER CAR ..... 1994-09 CHEVROLET PASSENGER CAR ..... 1995-05 OLDSMOBILE PASSENGER CAR ..... 1994-99 OLDSMOBILE VAN ..... 1996 PONTIAC PASSENGER CAR ..... 1994-08</p> <p style="text-align: center;"><b>MOUNT-TRANSMISSION</b> <b>Manual</b></p> <p>FORD MEDIUM/HEAVY DUTY .... 1988-97</p>	 <p style="text-align: center;"><b>EM-2869</b> <b>MOUNT-ENGINE</b> <b>LH Front</b></p> <p>FORD SPORT UTILITY ..... 1995-96</p>	 <p style="text-align: center;"><b>EM-2872</b> <b>Engine Torque Strut Mount</b> <b>Rear</b></p> <p>FORD PASSENGER CAR ..... 2000-03 MERCURY PASSENGER CAR ... 2000-03</p>
 <p style="text-align: center;"><b>EM-2870</b> <b>MOUNT-TRANSMISSION</b></p> <p>FORD SPORT UTILITY ..... 1994-04</p>	 <p style="text-align: center;"><b>EM-2873</b> <b>MOUNT-TRANSMISSION</b> <b>Front</b></p> <p>FORD PASSENGER CAR ..... 1995-00 MERCURY PASSENGER CAR ... 1995-02</p>	<p style="text-align: center;"><b>(Continued Next Column)</b></p>	

# = Available in the Westar Gold Line

# BUYER'S GUIDE

## NUMERICAL LISTING - ILLUSTRATIONS

 <p style="text-align: center;"><b>EM-2874</b> <b>MOUNT-TRANSMISSION</b> <b>Center</b></p> <p>CHEVROLET PASSENGER CAR ..... 1997-05 OLDSMOBILE PASSENGER CAR ..... 1996-04 PONTIAC PASSENGER CAR ..... 1999-05</p>	 <p style="text-align: center;"><b>EM-2878</b> <b>MOUNT-ENGINE</b> <b>RH Front</b></p> <p>CHEVROLET PASSENGER CAR ..... 1995-02 PONTIAC PASSENGER CAR ..... 1995-02</p>	 <p style="text-align: center;"><b>EM-2881</b> <b>MOUNT-TRANSMISSION</b> <b>LH Front</b></p> <p>BUICK PASSENGER CAR ..... 1994-99 OLDSMOBILE PASSENGER CAR ..... 1994-99 PONTIAC PASSENGER CAR ..... 1994-99</p>	 <p style="text-align: center;"><b>EM-2884</b> <b>MOUNT-TRANSMISSION</b> <b>MOUNT-TRANSMISSION</b> <b>Auto</b></p> <p>FORD MEDIUM/HEAVY DUTY .... 1999-07 FORD SPORT UTILITY ..... 1994-05 FORD TRUCK ..... 1994-08</p>
 <p style="text-align: center;"><b>EM-2875</b> <b>MOUNT-TRANSMISSION</b> <b>LH Front</b></p> <p>OLDSMOBILE PASSENGER CAR ..... 1997-04</p> <p style="text-align: center;"><b>MOUNT-TRANSMISSION</b> <b>LH Rear</b></p> <p>CHEVROLET PASSENGER CAR ..... 1999-05 OLDSMOBILE PASSENGER CAR ..... 1996-04 PONTIAC PASSENGER CAR ..... 1999-05</p>	 <p style="text-align: center;"><b>EM-2879*</b> <b>MOUNT-TRANSMISSION</b> <b>Auto</b></p> <p>CHEVROLET VAN ..... 1994-05 GMC VAN ..... 1994-05</p>	 <p style="text-align: center;"><b>EM-2882</b> <b>MOUNT-TRANSMISSION</b> <b>Manual</b></p> <p>JEEP SPORT UTILITY ..... 1997-06</p>	 <p style="text-align: center;"><b>EM-2885</b> <b>MOUNT-ENGINE</b> <b>Front</b></p> <p>FORD PASSENGER CAR ..... 1998-00 MERCURY PASSENGER CAR ... 1998-02</p> <p style="text-align: center;"><b>MOUNT-TRANSMISSION</b> <b>Rear</b></p> <p>MERCURY PASSENGER CAR ... 1995-97</p>
 <p style="text-align: center;"><b>EM-2876*</b> <b>MOUNT-ENGINE</b> <b>RH Front</b></p> <p>CHEVROLET PASSENGER CAR ..... 1997-01 OLDSMOBILE PASSENGER CAR ..... 1997-99</p>	 <p style="text-align: center;"><b>EM-2880*</b> <b>MOUNT-TRANSMISSION</b> <b>MOUNT-TRANSMISSION</b> <b>Auto</b></p> <p>CHEVROLET PASSENGER CAR ..... 1993-02 PONTIAC PASSENGER CAR ..... 1993-02</p>	 <p style="text-align: center;"><b>EM-2883</b> <b>MOUNT-ENGINE</b> <b>L &amp; R Front</b></p> <p>JEEP SPORT UTILITY ..... 1997-06</p>	 <p style="text-align: center;"><b>EM-2886</b> <b>MOUNT-ENGINE</b> <b>Front</b></p> <p>FORD PASSENGER CAR ..... 1995-97 MERCURY PASSENGER CAR ... 1995-97</p>

\* = Hydraulic Mount, "S" suffix = solid replacement.



# BUYER'S GUIDE

## NUMERICAL LISTING - ILLUSTRATIONS



**EM-2887**  
**MOUNT-TRANSMISSION**  
**Front**

FORD PASSENGER CAR ..... 1995-97  
**MOUNT-TRANSMISSION**  
**Rear**  
FORD PASSENGER CAR ..... 1995-97  
**MOUNT-TRANSMISSION**  
MERCURY PASSENGER CAR ... 1995-97



**EM-2888**  
**MOUNT-ENGINE**  
**Front**

FORD PASSENGER CAR ..... 1998-00  
MERCURY PASSENGER CAR ... 1998-02  
**MOUNT-TRANSMISSION**  
**Rear**  
FORD PASSENGER CAR ..... 1998-00  
**MOUNT-TRANSMISSION**  
MERCURY PASSENGER CAR ... 1998-02



**EM-2889**  
**MOUNT-ENGINE**  
**RH Front**

FORD PASSENGER CAR ..... 1995-97  
MERCURY PASSENGER CAR ... 1995-97



**EM-2890\***  
**MOUNT-ENGINE**  
**RH Front**

FORD PASSENGER CAR ..... 1998-00  
MERCURY PASSENGER CAR ... 1998-02



**EM-2892\***  
**MOUNT-ENGINE**  
**RH Front**

CADILLAC PASSENGER CAR .... 1986-92



**EM-2893\***  
**MOUNT-TRANSMISSION**  
**LH**

CADILLAC PASSENGER CAR .... 1993-96



**EM-2894\***  
**MOUNT-ENGINE**  
**RH Front**

FORD PASSENGER CAR ..... 2000-07  
MERCURY PASSENGER CAR ... 2000-05



**EM-2895\***  
**MOUNT-TRANSMISSION**  
**Center**

BUICK PASSENGER CAR ..... 2000-05  
CADILLAC PASSENGER CAR ... 1998-05  
OLDSMOBILE PASSENGER  
CAR ..... 1997-03  
PONTIAC PASSENGER CAR ..... 2000-05



**EM-2896\***  
**MOUNT-ENGINE**  
**RH Front**

BUICK PASSENGER CAR ..... 2000-05  
CADILLAC PASSENGER CAR ... 1998-05

**MOUNT-ENGINE**  
**Front**

OLDSMOBILE PASSENGER  
CAR ..... 2001-03

**MOUNT-ENGINE**  
**RH Front**

PONTIAC PASSENGER CAR ..... 2000-05



**EM-2897#**  
**MOUNT-TRANSMISSION**  
**LH Front**

BUICK PASSENGER CAR ..... 1999-05  
PONTIAC PASSENGER CAR ..... 2000-05

**MOUNT-TRANSMISSION**  
**Auto**

OLDSMOBILE PASSENGER  
CAR ..... 2001-02



**EM-2898**  
**MOUNT-TRANSMISSION**  
**MOUNT-TRANSMISSION**  
**LH Rear**

BUICK PASSENGER CAR ..... 1999

BUICK PASSENGER CAR ..... 1999-05  
CADILLAC PASSENGER CAR ... 2000-05  
OLDSMOBILE PASSENGER  
CAR ..... 2001-03  
PONTIAC PASSENGER CAR ..... 2000-05



**EM-2899**  
**MOUNT-ENGINE**  
**RH Front**

FORD PASSENGER CAR ..... 1995  
**Engine Torque Strut Mount**  
**Front**

BUICK SPORT UTILITY ..... 2002-07  
BUICK VAN ..... 2005-06  
CHEVROLET VAN ..... 1997-09  
OLDSMOBILE PASSENGER  
CAR ..... 1999-02

OLDSMOBILE VAN ..... 1997-04  
PONTIAC SPORT UTILITY ..... 2001-05  
PONTIAC VAN ..... 1997-06  
SATURN VAN ..... 2005-07  
**Engine Torque Strut Mount**  
**Rear**

(Continued Next Page)

\* = Hydraulic Mount, "S" suffix = solid replacement. # = Available in the Westar Gold Line

# BUYER'S GUIDE

## NUMERICAL LISTING - ILLUSTRATIONS

### EM-2899 (Continued)

PONTIAC VAN ..... 2006



**EM-2900**  
Engine Torque Strut Mount  
Front

BUICK SPORT UTILITY ..... 2002-07  
 BUICK VAN ..... 2005-07  
 CHEVROLET VAN ..... 1997-09  
 OLDSMOBILE VAN ..... 1997-04  
 PONTIAC SPORT UTILITY ..... 2001-05  
 PONTIAC VAN ..... 1997-05  
 SATURN VAN ..... 2005-07



**EM-2901**  
Engine Torque Strut Mount  
Front

BUICK PASSENGER CAR ..... 1994-05  
 CHEVROLET PASSENGER  
 CAR ..... 1995-05  
 OLDSMOBILE PASSENGER  
 CAR ..... 1994-97  
 PONTIAC PASSENGER CAR ..... 1994-03



**EM-2902\***  
MOUNT-ENGINE  
L & R Front

CHEVROLET PASSENGER  
 CAR ..... 1992-96



**EM-2903\***  
MOUNT-ENGINE  
L & R Front

CHRYSLER PASSENGER  
 CAR ..... 1998-04  
 DODGE PASSENGER CAR ..... 1998-04



**EM-2904**  
MOUNT-ENGINE  
LH Front

FORD PASSENGER CAR ..... 1996-04



**EM-2905**  
MOUNT-ENGINE  
RH Front

FORD PASSENGER CAR ..... 1996-04

CHRYSLER PASSENGER  
 CAR ..... 2003-04



**EM-2907**  
MOUNT-TRANSMISSION

CADILLAC PASSENGER CAR .... 1982-87



**EM-2908**  
MOUNT-TRANSMISSION

CHRYSLER PASSENGER  
 CAR ..... 1998-04  
 DODGE PASSENGER CAR ..... 1998-04



**EM-2909#**  
MOUNT-ENGINE  
L & R Front

CADILLAC SPORT UTILITY ..... 2002-06  
 CHEVROLET SPORT UTILITY ... 2000-06  
 CHEVROLET TRUCK ..... 1999-10  
 GMC SPORT UTILITY ..... 2000-06  
 GMC TRUCK ..... 1999-07  
 HUMMER ..... 2003-07



**EM-2910\***  
MOUNT-ENGINE  
Front

FORD PASSENGER CAR ..... 1994-02  
 MAZDA PASSENGER CAR ..... 1994-96  
 MERCURY PASSENGER CAR ... 1994-99



**EM-2911**  
MOUNT-ENGINE  
Rear

FORD PASSENGER CAR ..... 1997-02  
 MERCURY PASSENGER CAR ... 1997-99



**EM-2912**  
MOUNT-ENGINE  
Rear

FORD PASSENGER CAR ..... 1997-02  
 MERCURY PASSENGER CAR ... 1997-99

\* = Hydraulic Mount, "S" suffix = solid replacement.

# = Available in the Westar Gold Line



# BUYER'S GUIDE

## NUMERICAL LISTING - ILLUSTRATIONS

 <p><b>EM-2913</b> <b>MOUNT-ENGINE</b> <b>RH Front</b></p> <p>DODGE TRUCK ..... 1987-96</p>	 <p><b>EM-2917</b> <b>MOUNT-ENGINE</b> <b>LH Front</b></p> <p>DODGE SPORT UTILITY ..... 1999-00 DODGE TRUCK ..... 1997-03</p>	 <p><b>EM-2921</b> <b>MOUNT-TRANSMISSION</b> <b>Manual</b></p> <p>AMERICAN MOTORS PASSENGER CAR ..... 1980-88</p> <p><b>MOUNT-TRANSMISSION</b> <b>Auto</b></p> <p>JEEP SPORT UTILITY ..... 1980-86</p>	 <p><b>EM-2924</b> <b>MOUNT-TRANSMISSION</b> <b>Rear</b></p> <p>CHEVROLET PASSENGER CAR ..... 1995-05</p> <p><b>MOUNT-TRANSMISSION</b> <b>LH Rear</b></p> <p>PONTIAC PASSENGER CAR ..... 1992-05</p>
 <p><b>EM-2914</b> <b>MOUNT-ENGINE</b> <b>LH Front</b></p> <p>DODGE TRUCK ..... 1987-96</p>	 <p><b>EM-2918</b> <b>MOUNT-ENGINE</b> <b>LH Front</b></p> <p>DODGE TRUCK ..... 1997-03</p>	 <p><b>EM-2922</b> <b>MOUNT-TRANSMISSION</b> <b>Manual</b></p> <p>CHEVROLET VAN ..... 1991-99 GMC VAN ..... 1991-99</p>	 <p><b>EM-2925</b> <b>MOUNT-TRANSMISSION</b> <b>Center</b></p> <p>CHRYSLER VAN ..... 2001-07 DODGE VAN ..... 2001-07</p>
 <p><b>EM-2915</b> <b>MOUNT-ENGINE</b> <b>RH Front</b></p> <p>FORD VAN ..... 1996-98</p>	 <p><b>EM-2919</b> <b>MOUNT-ENGINE</b> <b>L &amp; R Front</b></p> <p>JEEP SPORT UTILITY ..... 1997-99</p>	 <p><b>EM-2923</b> <b>MOUNT-TRANSMISSION</b> <b>Front</b></p> <p>CHEVROLET PASSENGER CAR ..... 1995-05</p> <p><b>MOUNT-TRANSMISSION</b> <b>LH Front</b></p> <p>OLDSMOBILE PASSENGER CAR ..... 1992-95</p> <p><b>MOUNT-TRANSMISSION</b></p> <p>PONTIAC PASSENGER CAR ..... 1992-05</p>	 <p><b>EM-2926*</b> <b>MOUNT-ENGINE</b> <b>RH Front</b></p> <p>CHRYSLER VAN ..... 2001-07 DODGE VAN ..... 2001-07</p>
 <p><b>EM-2916</b> <b>MOUNT-ENGINE</b> <b>LH Front</b></p> <p>JEEP SPORT UTILITY ..... 1998</p>	 <p><b>EM-2920</b> <b>MOUNT-ENGINE</b> <b>RH Front</b></p> <p>JEEP SPORT UTILITY ..... 1991-95</p>		

\* = Hydraulic Mount, "S" suffix = solid replacement.

# BUYER'S GUIDE

## NUMERICAL LISTING - ILLUSTRATIONS

 <p style="text-align: center;"><b>EM-2927</b> <b>MOUNT-TRANSMISSION</b> <b>LH Rear</b></p> <p>CHRYSLER VAN ..... 2001-07 DODGE VAN ..... 2001-07</p>	 <p style="text-align: center;"><b>EM-2930</b> <b>MOUNT-ENGINE</b> <b>LH Front</b></p> <p>FORD MEDIUM/HEAVY DUTY .... 1997-13 FORD VAN ..... 1997-13</p>	<p><b>EM-2933 (Continued)</b></p> <p>OLDSMOBILE PASSENGER CAR ..... 1999-04</p> <p style="text-align: center;"><b>MOUNT-ENGINE</b> <b>Front</b></p> <p>PONTIAC PASSENGER CAR ..... 1999-05</p> 	 <p style="text-align: center;"><b>EM-2938*</b> <b>MOUNT-ENGINE</b> <b>RH Front</b></p> <p>FORD PASSENGER CAR ..... 2000-04</p>
 <p style="text-align: center;"><b>EM-2928</b> <b>MOUNT-ENGINE</b> <b>Front</b></p> <p>CHRYSLER VAN ..... 2001-03 DODGE VAN ..... 2001-07</p> <p style="text-align: center;"><b>MOUNT-TRANSMISSION</b> <b>LH Front</b></p> <p>CHRYSLER VAN ..... 2001-07 DODGE VAN ..... 2001-07</p>	 <p style="text-align: center;"><b>EM-2931</b> <b>MOUNT-ENGINE</b> <b>RH Front</b></p> <p>FORD VAN ..... 1999-03</p>	<p style="text-align: center;"><b>EM-2934*</b> <b>MOUNT-ENGINE</b> <b>Front</b></p> <p>FORD PASSENGER CAR ..... 1996-99</p> <p style="text-align: center;"><b>MOUNT-ENGINE</b> <b>RH Front</b></p> <p>MERCURY PASSENGER CAR ... 1996-99</p> 	 <p style="text-align: center;"><b>EM-2939#</b> <b>Engine Torque Strut Mount</b> <b>Rear</b></p> <p>FORD PASSENGER CAR ..... 2000-07 FORD VAN ..... 2010-13</p>
 <p style="text-align: center;"><b>EM-2929</b> <b>MOUNT-ENGINE</b> <b>RH Front</b></p> <p>FORD MEDIUM/HEAVY DUTY .... 1997-13 FORD VAN ..... 1997-13</p>	 <p style="text-align: center;"><b>EM-2932*</b> <b>MOUNT-TRANSMISSION</b> <b>LH</b></p> <p>CADILLAC PASSENGER CAR .... 1997-02</p>	<p style="text-align: center;"><b>EM-2935</b> <b>MOUNT-ENGINE</b> <b>RH Front</b></p> <p>FORD TRUCK ..... 1999-11 MAZDA TRUCK ..... 1998-09</p> 	 <p style="text-align: center;"><b>EM-2940</b> <b>MOUNT-ENGINE</b> <b>LH Front</b></p> <p>FORD SPORT UTILITY ..... 1984-85 FORD TRUCK ..... 1983-85</p>
 <p style="text-align: center;"><b>EM-2933*</b> <b>MOUNT-ENGINE</b> <b>Front</b></p> <p>CHEVROLET PASSENGER CAR ..... 2001-03</p> <p style="text-align: center;"><b>MOUNT-ENGINE</b> <b>RH Front</b></p> <p style="text-align: center;"><b>(Continued Next Column)</b></p>	 <p style="text-align: center;"><b>EM-2936</b> <b>MOUNT-ENGINE</b> <b>RH Front</b></p> <p>FORD TRUCK ..... 1998-01</p>	 <p style="text-align: center;"><b>EM-2941</b> <b>MOUNT-ENGINE</b> <b>RH Front</b></p> <p>FORD SPORT UTILITY ..... 1984-85 FORD TRUCK ..... 1983-85</p>	

\* = Hydraulic Mount, "S" suffix = solid replacement.

# = Available in the Westar Gold Line

# BUYER'S GUIDE

## NUMERICAL LISTING - ILLUSTRATIONS

 <p style="text-align: center;"><b>EM-2942*</b> <b>MOUNT-ENGINE</b> <b>LH Front</b></p> <p>CHRYSLER PASSENGER CAR ..... 1998-04 DODGE PASSENGER CAR ..... 1998-04</p>	 <p style="text-align: center;"><b>EM-2945</b> <b>MOUNT-ENGINE</b> <b>Rear</b></p> <p>CHRYSLER PASSENGER CAR ..... 1998-00 DODGE PASSENGER CAR ..... 1999-00 PLYMOUTH PASSENGER CAR ..... 2000</p>	 <p style="text-align: center;"><b>EM-2949#</b> <b>MOUNT-ENGINE</b> <b>RH Front Lower</b></p> <p>CHRYSLER PASSENGER CAR ..... 2000-02 DODGE PASSENGER CAR ..... 2000-05 PLYMOUTH PASSENGER CAR ..... 2000-01</p> <p style="text-align: center;"><b>Engine Torque Strut Mount</b> <b>Front Lower</b></p> <p>CHRYSLER PASSENGER CAR ..... 2001-10</p>	 <p style="text-align: center;"><b>EM-2952</b> <b>MOUNT-ENGINE</b> <b>RH Rear</b></p> <p>BUICK PASSENGER CAR ..... 1988-91 CHEVROLET PASSENGER CAR ..... 1990-91 OLDSMOBILE PASSENGER CAR ..... 1988-91 PONTIAC PASSENGER CAR ..... 1988-91</p>
 <p style="text-align: center;"><b>EM-2943*</b> <b>MOUNT-ENGINE</b> <b>RH Front</b></p> <p>BUICK PASSENGER CAR ..... 1986-91</p> <p style="text-align: center;"><b>MOUNT-ENGINE</b> <b>Front</b></p> <p>OLDSMOBILE PASSENGER CAR ..... 1986-91</p>	 <p style="text-align: center;"><b>EM-2947</b> <b>MOUNT-ENGINE</b> <b>Rear</b></p> <p>CHRYSLER PASSENGER CAR ..... 2000-10 DODGE PASSENGER CAR ..... 2000-05 PLYMOUTH PASSENGER CAR ..... 2000-01</p>	 <p style="text-align: center;"><b>EM-2950</b> <b>MOUNT-TRANSMISSION</b></p> <p>CHEVROLET VAN ..... 1990-93 GMC VAN ..... 1990-93</p>	 <p style="text-align: center;"><b>EM-2953</b> <b>MOUNT-ENGINE</b> <b>LH Front</b></p> <p>DODGE TRUCK ..... 1990-96</p>
 <p style="text-align: center;"><b>EM-2944</b> <b>MOUNT-ENGINE</b> <b>RH Front</b></p> <p>DODGE TRUCK ..... 1987-90</p>	 <p style="text-align: center;"><b>EM-2948#</b> <b>MOUNT-ENGINE</b> <b>RH Front Upper</b></p> <p>CHRYSLER PASSENGER CAR ..... 2001-10 DODGE PASSENGER CAR ..... 2000-05</p> <p style="text-align: center;"><b>MOUNT-ENGINE</b> <b>LH Rear Upper</b></p> <p>CHRYSLER PASSENGER CAR ..... 2000-02 PLYMOUTH PASSENGER CAR ..... 2000-01</p>	 <p style="text-align: center;"><b>EM-2951</b> <b>MOUNT-TRANSMISSION</b> <b>RH</b></p> <p>CADILLAC PASSENGER CAR .... 1992-95</p>	 <p style="text-align: center;"><b>EM-2954</b> <b>MOUNT-TRANSMISSION</b> <b>Manual</b></p> <p>DODGE TRUCK ..... 1992-96</p>

\* = Hydraulic Mount, "S" suffix = solid replacement. # = Available in the Westar Gold Line

# BUYER'S GUIDE

## NUMERICAL LISTING - ILLUSTRATIONS

 <p><b>EM-2955</b> <b>MOUNT-ENGINE</b> <b>LH Front</b></p> <p>DODGE TRUCK ..... 1991-96</p>	 <p><b>EM-2958</b> <b>MOUNT-ENGINE</b> <b>Front</b></p> <p>CHRYSLER PASSENGER CAR ..... 1998-00 DODGE PASSENGER CAR ..... 1998-00 PLYMOUTH PASSENGER CAR ..... 1998-00</p>	 <p><b>EM-2961</b> <b>MOUNT-ENGINE</b> <b>RH Front</b></p> <p>DODGE TRUCK ..... 1991-96</p>	 <p><b>EM-2965</b> <b>MOUNT-TRANSMISSION</b> <b>Manual</b></p> <p>FORD PASSENGER CAR ..... 1986-87</p>
 <p><b>EM-2956</b> <b>MOUNT-TRANSMISSION</b> <b>Manual</b></p> <p>CHEVROLET TRUCK ..... 1994-97 GMC TRUCK ..... 1994-97 ISUZU TRUCK ..... 1996-97</p>	 <p><b>EM-2959</b> <b>MOUNT-ENGINE</b> <b>RH Front</b></p> <p>CHRYSLER VAN ..... 1996-00 DODGE VAN ..... 1996-00 PLYMOUTH VAN ..... 1996-00</p>	 <p><b>EM-2962</b> <b>MOUNT-ENGINE</b> <b>RH Front</b></p> <p>DODGE SPORT UTILITY ..... 1998-00 DODGE TRUCK ..... 1997-04</p>	 <p><b>EM-2967*</b> <b>MOUNT-ENGINE</b> <b>Front</b></p> <p>FORD PASSENGER CAR ..... 1993-95</p>
 <p><b>EM-2957</b> <b>MOUNT-TRANSMISSION</b> <b>Auto</b></p> <p>CHEVROLET TRUCK ..... 1994-03 <b>MOUNT-TRANSMISSION</b> <b>Manual</b></p> <p>GMC TRUCK ..... 1994-03 <b>MOUNT-TRANSMISSION</b> <b>Auto</b></p> <p>ISUZU TRUCK ..... 1996-00</p>	 <p><b>EM-2960</b> <b>MOUNT-TRANSMISSION</b> <b>LH Front</b></p> <p>CHRYSLER VAN ..... 1996-00 <b>MOUNT-TRANSMISSION</b></p> <p>DODGE VAN ..... 1996-04 <b>MOUNT-TRANSMISSION</b></p> <p>PLYMOUTH VAN ..... 1996-00</p>	 <p><b>EM-2963</b> <b>MOUNT-ENGINE</b> <b>LH Front</b></p> <p>DODGE SPORT UTILITY ..... 1998-00 DODGE TRUCK ..... 1997-04</p>	 <p><b>EM-2968*</b> <b>MOUNT-ENGINE</b> <b>Rear</b></p> <p>FORD PASSENGER CAR ..... 1993-95</p>
		 <p><b>EM-2964</b> <b>MOUNT-ENGINE</b> <b>RH Rear</b></p> <p>FORD PASSENGER CAR ..... 1989-95</p>	 <p><b>EM-2969</b> <b>MOUNT-TRANSMISSION</b> <b>Manual</b></p> <p>FORD TRUCK ..... 1994-96</p>

\* = Hydraulic Mount, "S" suffix = solid replacement.

# BUYER'S GUIDE

## NUMERICAL LISTING - ILLUSTRATIONS

 <p style="text-align: center;"><b>EM-2970</b> <b>MOUNT-TRANSMISSION</b> <b>Manual</b></p> <p>FORD MEDIUM/HEAVY DUTY ..... 1996</p> <p style="text-align: center;"><b>MOUNT-TRANSMISSION</b> <b>Auto</b></p> <p>FORD SPORT UTILITY ..... 1996 FORD TRUCK ..... 1996-97</p>	 <p style="text-align: center;"><b>EM-2973</b> <b>MOUNT-ENGINE</b> <b>RH Rear</b></p> <p>FORD PASSENGER CAR ..... 2000-07</p>	 <p style="text-align: center;"><b>EM-2977</b> <b>MOUNT-TRANSMISSION</b></p> <p>FORD VAN ..... 1997-98</p>	<p><b>EM-2980 (Continued)</b></p> <p>DODGE PASSENGER CAR ..... 1995-99 PLYMOUTH PASSENGER CAR ..... 1996-99</p>  <p style="text-align: center;"><b>EM-2981</b> <b>MOUNT-ENGINE</b> <b>LH Front</b></p> <p>DODGE TRUCK ..... 1987-96</p>
 <p style="text-align: center;"><b>EM-2971</b> <b>MOUNT-TRANSMISSION</b></p> <p>FORD MEDIUM/HEAVY DUTY .... 1999-07 FORD TRUCK ..... 1999-07 LINCOLN SPORT UTILITY ..... 2005-06</p>	 <p style="text-align: center;"><b>EM-2974*</b> <b>MOUNT-TRANSMISSION</b> <b>Auto</b></p> <p>FORD PASSENGER CAR ..... 2000-07</p> <p style="text-align: center;"><b>MOUNT-TRANSMISSION</b></p> <p>LINCOLN PASSENGER CAR ..... 2001-02 MERCURY PASSENGER CAR ... 2000-05</p>	 <p style="text-align: center;"><b>EM-2978</b> <b>MOUNT-ENGINE</b> <b>Front</b></p> <p>FORD PASSENGER CAR ..... 1995-00 MERCURY PASSENGER CAR ... 1995-97</p>	 <p style="text-align: center;"><b>EM-2982</b> <b>MOUNT-TRANSMISSION</b> <b>Manual</b></p> <p>DODGE VAN ..... 1992-93</p>
 <p style="text-align: center;"><b>EM-2972</b> <b>MOUNT-ENGINE</b> <b>LH Front</b></p> <p>FORD SPORT UTILITY ..... 1997-02 FORD TRUCK ..... 1997-04 LINCOLN SPORT UTILITY ..... 1998-02 LINCOLN TRUCK ..... 2002</p>	 <p style="text-align: center;"><b>EM-2975</b> <b>MOUNT-TRANSMISSION</b> <b>Auto</b></p> <p>CHRYSLER PASSENGER CAR ..... 2000-01 DODGE PASSENGER CAR ..... 2000-01 PLYMOUTH PASSENGER CAR ..... 2000-01</p>	 <p style="text-align: center;"><b>EM-2979</b> <b>MOUNT-ENGINE</b> <b>RH Front</b></p> <p>DODGE PASSENGER CAR ..... 1995-99 PLYMOUTH PASSENGER CAR ..... 1995-99</p>	 <p style="text-align: center;"><b>EM-2983</b> <b>MOUNT-ENGINE</b> <b>RH Front</b></p> <p>DODGE TRUCK ..... 1990-96</p>
		 <p style="text-align: center;"><b>EM-2980</b> <b>MOUNT-ENGINE</b> <b>Front</b></p> <p>CHRYSLER PASSENGER CAR ..... 1995-00</p> <p style="text-align: center;"><b>(Continued Next Column)</b></p>	

\* = Hydraulic Mount, "S" suffix = solid replacement.



# BUYER'S GUIDE

## NUMERICAL LISTING - ILLUSTRATIONS

 <p style="text-align: center;"><b>EM-2984</b> <b>MOUNT-TRANSMISSION</b> Center</p> <p>CHRYSLER VAN ..... 1996-00 <b>MOUNT-TRANSMISSION</b></p> <p>DODGE VAN ..... 1996-00 <b>MOUNT-TRANSMISSION</b></p> <p>PLYMOUTH VAN ..... 1996-00</p>	 <p style="text-align: center;"><b>EM-2987#</b> <b>MOUNT-ENGINE</b> RH Front</p> <p>BUICK PASSENGER CAR ..... 2005-09 BUICK SPORT UTILITY ..... 2002-07 BUICK VAN ..... 2005-07</p> <p style="text-align: center;"><b>MOUNT-ENGINE</b> Right</p> <p>CHEVROLET PASSENGER CAR ..... 2000-11</p> <p style="text-align: center;"><b>MOUNT-ENGINE</b> RH Front</p> <p>CHEVROLET VAN ..... 2003-07 PONTIAC PASSENGER CAR ..... 2004-08 PONTIAC SPORT UTILITY ..... 2001-05</p> <p style="text-align: center;"><b>MOUNT-ENGINE</b> LH Front</p> <p>PONTIAC VAN ..... 2005-06</p> <p style="text-align: center;"><b>MOUNT-ENGINE</b> Front</p> <p>SATURN VAN ..... 2005-07</p>	 <p style="text-align: center;"><b>EM-2990</b> <b>MOUNT-ENGINE</b> Rear</p> <p>BUICK PASSENGER CAR ..... 2008-09 CHEVROLET PASSENGER CAR ..... 2006-09</p> <p style="text-align: center;"><b>MOUNT-ENGINE</b> RH Rear</p> <p>OLDSMOBILE PASSENGER CAR ..... 1999-02</p> <p style="text-align: center;"><b>MOUNT-ENGINE</b> Rear</p> <p>PONTIAC PASSENGER CAR ..... 2005-08</p> <p style="text-align: center;"><b>MOUNT-TRANSMISSION</b></p> <p>BUICK PASSENGER CAR ..... 2008-09</p>	 <p style="text-align: center;"><b>EM-2993*</b> <b>MOUNT-ENGINE</b> L &amp; R Front</p> <p>CADILLAC PASSENGER CAR .... 2004-09 CHEVROLET PASSENGER CAR ..... 1997-10 PONTIAC PASSENGER CAR ..... 2004-06</p>
 <p style="text-align: center;"><b>EM-2985</b> <b>MOUNT-ENGINE</b> LH Rear</p> <p>MERCURY VAN ..... 1999-02 NISSAN VAN ..... 1999-02</p>	 <p style="text-align: center;"><b>EM-2988</b> <b>MOUNT-TRANSMISSION</b></p> <p>JEEP SPORT UTILITY ..... 1999-04</p>	 <p style="text-align: center;"><b>EM-2991</b> <b>MOUNT-TRANSMISSION</b> Manual</p> <p>DODGE SPORT UTILITY ..... 1998-99 DODGE TRUCK ..... 1997-03</p>	 <p style="text-align: center;"><b>EM-2994</b> <b>MOUNT-ENGINE</b> L &amp; R Front</p> <p>CHEVROLET TRUCK ..... 1999-06 GMC TRUCK ..... 1999-06</p>
 <p style="text-align: center;"><b>EM-2986#</b> <b>MOUNT-TRANSMISSION</b> Auto</p> <p>FORD PASSENGER CAR ..... 2000-11 <b>MOUNT-TRANSMISSION</b></p> <p>FORD VAN ..... 2010-13</p>	 <p style="text-align: center;"><b>EM-2989</b> <b>MOUNT-ENGINE</b> Front</p> <p>MERCURY VAN ..... 1999-02 NISSAN VAN ..... 1999-02</p>	 <p style="text-align: center;"><b>EM-2992</b> <b>MOUNT-TRANSMISSION</b> Auto</p> <p>DODGE SPORT UTILITY ..... 1999-03 DODGE TRUCK ..... 2000-04</p>	 <p style="text-align: center;"><b>EM-2995*</b> <b>MOUNT-ENGINE</b> L &amp; R Front</p> <p>FORD PASSENGER CAR ..... 1991-97 MERCURY PASSENGER CAR ... 1991-93</p>

\* = Hydraulic Mount, "S" suffix = solid replacement.

# = Available in the Westar Gold Line

# BUYER'S GUIDE

## NUMERICAL LISTING - ILLUSTRATIONS

 <p><b>EM-2996*</b> <b>MOUNT-ENGINE</b> <b>RH Front</b></p> <p>LINCOLN PASSENGER CAR ..... 1995-02</p>	 <p><b>EM-3000</b> <b>MOUNT-ENGINE</b> <b>LH Front</b></p> <p>FORD SPORT UTILITY ..... 1996-01 MERCURY SPORT UTILITY ..... 1997-01</p>	 <p><b>EM-3004</b> <b>MOUNT-ENGINE</b> <b>RH Front</b></p> <p>DODGE TRUCK ..... 1997-03</p>	 <p><b>EM-3008</b> <b>MOUNT-ENGINE</b> <b>RH Front</b></p> <p>JEEP SPORT UTILITY ..... 1999-04</p>
 <p><b>EM-2997</b> <b>MOUNT-ENGINE</b> <b>RH Front</b></p> <p>FORD PASSENGER CAR ..... 1994-95</p>	 <p><b>EM-3001</b> <b>MOUNT-ENGINE</b> <b>RH Front</b></p> <p>FORD PASSENGER CAR ..... 1996-04</p>	 <p><b>EM-3005</b> <b>MOUNT-ENGINE</b> <b>LH Front</b></p> <p>DODGE SPORT UTILITY ..... 2000-03 DODGE TRUCK ..... 2000-04</p>	 <p><b>EM-3009</b> <b>MOUNT-ENGINE</b> <b>LH Front</b></p> <p>JEEP SPORT UTILITY ..... 2002-05</p>
 <p><b>EM-2998</b> <b>MOUNT-ENGINE</b> <b>LH Front</b></p> <p>FORD PASSENGER CAR ..... 1994-95</p>	 <p><b>EM-3002</b> <b>MOUNT-ENGINE</b> <b>LH Front</b></p> <p>FORD PASSENGER CAR ..... 1996-04</p>	 <p><b>EM-3006</b> <b>MOUNT-ENGINE</b> <b>RH Front</b></p> <p>DODGE SPORT UTILITY ..... 2000-03 DODGE TRUCK ..... 2000-04</p>	 <p><b>EM-3010</b> <b>MOUNT-ENGINE</b> <b>RH Front</b></p> <p>JEEP SPORT UTILITY ..... 2002-05</p>
 <p><b>EM-2999</b> <b>MOUNT-ENGINE</b> <b>RH Front</b></p> <p>FORD SPORT UTILITY ..... 1996-01 MERCURY SPORT UTILITY ..... 1997-01</p>	 <p><b>EM-3003*</b> <b>MOUNT-ENGINE</b> <b>RH Front</b></p> <p>FORD PASSENGER CAR ..... 2000-04</p>	 <p><b>EM-3007</b> <b>MOUNT-TRANSMISSION</b> <b>Auto</b></p> <p>JEEP SPORT UTILITY ..... 2002-03</p>	 <p><b>EM-3011</b> <b>MOUNT-ENGINE</b> <b>Rear</b></p> <p>CHRYSLER PASSENGER CAR ..... 1995-00 DODGE PASSENGER CAR ..... 1995-99 PLYMOUTH PASSENGER CAR ..... 1996-99</p>

\* = Hydraulic Mount, "S" suffix = solid replacement.

# BUYER'S GUIDE

## NUMERICAL LISTING - ILLUSTRATIONS

 <p><b>EM-3012</b> <b>MOUNT-ENGINE</b> <b>LH Front</b></p> <p>JEEP SPORT UTILITY ..... 1999-04</p>	 <p><b>EM-3016</b> <b>MOUNT-TRANSMISSION</b></p> <p>JEEP SPORT UTILITY ..... 2002-05</p>	 <p><b>EM-3020*</b> <b>MOUNT-TRANSMISSION</b> <b>LH Front</b></p> <p>CADILLAC PASSENGER CAR ... 2000-05 OLDSMOBILE PASSENGER CAR ..... 2001-03</p>	 <p><b>EM-3023*</b> <b>MOUNT-ENGINE</b> <b>RH Front</b></p> <p>SATURN PASSENGER CAR ..... 2000-05</p>
 <p><b>EM-3013</b> <b>MOUNT-TRANSMISSION</b></p> <p>JEEP SPORT UTILITY ..... 1999-04</p>	 <p><b>EM-3017</b> <b>MOUNT-TRANSMISSION</b> <b>LH Rear</b></p> <p>CHRYSLER VAN ..... 1996-00 DODGE VAN ..... 1996-04 PLYMOUTH VAN ..... 1996-00</p>	 <p><b>EM-3021*</b> <b>MOUNT-ENGINE</b> <b>L &amp; R Front</b></p> <p>BUICK SPORT UTILITY ..... 2004-07 CHEVROLET SPORT UTILITY ... 2002-08 GMC SPORT UTILITY ..... 2002-09 ISUZU SPORT UTILITY ..... 2003-08 OLDSMOBILE SPORT UTILITY .. 2002-04 SAAB SUV ..... 2005-09</p>	 <p><b>EM-3024</b> <b>MOUNT-ENGINE</b> <b>RH Front</b></p> <p>FORD PASSENGER CAR ..... 2003-09 LINCOLN PASSENGER CAR ..... 2009 MERCURY PASSENGER CAR ... 2003-10</p>
 <p><b>EM-3014</b> <b>MOUNT-ENGINE</b> <b>RH Front</b></p> <p>JEEP SPORT UTILITY ..... 2002-05</p>	 <p><b>EM-3018</b> <b>MOUNT-TRANSMISSION</b></p> <p>JEEP SPORT UTILITY ..... 1999-04</p>	 <p><b>EM-3022*</b> <b>MOUNT-ENGINE</b> <b>RH Front</b></p> <p>SATURN PASSENGER CAR ..... 2000-03</p>	 <p><b>EM-3025</b> <b>MOUNT-ENGINE</b> <b>LH Front</b></p> <p>FORD PASSENGER CAR ..... 2003-09 LINCOLN PASSENGER CAR ..... 2009 MERCURY PASSENGER CAR ... 2003-10</p>
 <p><b>EM-3015</b> <b>MOUNT-ENGINE</b> <b>LH Front</b></p> <p>JEEP SPORT UTILITY ..... 2002-05</p>	 <p><b>EM-3019</b> <b>MOUNT-ENGINE</b> <b>LH Front</b></p> <p>JEEP SPORT UTILITY ..... 1999-04</p>		

\* = Hydraulic Mount, "S" suffix = solid replacement.



# BUYER'S GUIDE

## NUMERICAL LISTING - ILLUSTRATIONS

 <p style="text-align: center;"><b>EM-3026</b> <b>MOUNT-TRANSMISSION</b></p> <p>CHRYSLER PASSENGER CAR ..... 2003-10</p>	 <p style="text-align: center;"><b>EM-3029</b> <b>MOUNT-ENGINE LH Front</b></p> <p>FORD MEDIUM/HEAVY DUTY .... 1999-03 FORD TRUCK ..... 1999-03</p>	 <p style="text-align: center;"><b>EM-3033*</b> <b>MOUNT-ENGINE LH Front</b></p> <p>SATURN PASSENGER CAR ..... 2000-05</p>	<p><b>EM-3036 (Continued)</b></p> <p>DODGE TRUCK ..... 2000-04</p>  <p style="text-align: center;"><b>EM-3037</b> <b>MOUNT-ENGINE Rear</b></p> <p>FORD SPORT UTILITY ..... 2001-04 MAZDA SPORT UTILITY ..... 2001-04</p> <p style="text-align: center;"><b>MOUNT-TRANSMISSION Auto</b></p> <p>FORD SPORT UTILITY ..... 2001-04 MAZDA SPORT UTILITY ..... 2001-04</p>
 <p style="text-align: center;"><b>EM-3027</b> <b>MOUNT-TRANSMISSION</b></p> <p>BUICK SPORT UTILITY ..... 2004-07</p> <p style="text-align: center;"><b>MOUNT-TRANSMISSION Auto</b></p> <p>CHEVROLET SPORT UTILITY .... 2002-09</p> <p style="text-align: center;"><b>MOUNT-TRANSMISSION</b></p> <p>GMC SPORT UTILITY ..... 2002-07 ISUZU SPORT UTILITY ..... 2003-07 OLDSMOBILE SPORT UTILITY .. 2002-04 SAAB SUV ..... 2005-09</p>	 <p style="text-align: center;"><b>EM-3030</b> <b>MOUNT-ENGINE RH Front</b></p> <p>FORD MEDIUM/HEAVY DUTY .... 1999-03 FORD TRUCK ..... 1999-03</p>	 <p style="text-align: center;"><b>EM-3034</b> <b>MOUNT-ENGINE Front</b></p> <p>CHRYSLER PASSENGER CAR ..... 2001-06 DODGE PASSENGER CAR ..... 2001-06</p>	 <p style="text-align: center;"><b>EM-3038</b> <b>MOUNT-TRANSMISSION</b></p> <p>FORD PASSENGER CAR ..... 2003-09 LINCOLN PASSENGER CAR ..... 2003-09 MERCURY PASSENGER CAR ... 2003-10</p>
 <p style="text-align: center;"><b>EM-3028</b> <b>MOUNT-ENGINE LH Front</b></p> <p>CHEVROLET TRUCK ..... 1996-98 GMC TRUCK ..... 1996-98</p>	 <p style="text-align: center;"><b>EM-3031</b> <b>MOUNT-ENGINE Rear</b></p> <p>SATURN PASSENGER CAR ..... 2000-05</p>	 <p style="text-align: center;"><b>EM-3035</b> <b>MOUNT-ENGINE LH Front</b></p> <p>DODGE SPORT UTILITY ..... 2000-03 DODGE TRUCK ..... 2000-04</p>	 <p style="text-align: center;"><b>EM-3039</b> <b>MOUNT-ENGINE RH Front</b></p> <p>JEEP SPORT UTILITY ..... 1999-04</p>
 <p style="text-align: center;"><b>EM-3032</b> <b>MOUNT-TRANSMISSION Auto</b></p> <p>SATURN PASSENGER CAR ..... 2000-05</p>	 <p style="text-align: center;"><b>EM-3036</b> <b>MOUNT-ENGINE RH Front</b></p> <p>DODGE SPORT UTILITY ..... 2000-03</p> <p style="text-align: center;"><b>(Continued Next Column)</b></p>		

\* = Hydraulic Mount, "S" suffix = solid replacement.













# BUYER'S GUIDE

## NUMERICAL LISTING - ILLUSTRATIONS

 <p style="text-align: center;"><b>EM-3040</b> <b>MOUNT-TRANSMISSION</b> <b>LH Rear</b></p> <p>SATURN SUV ..... 2002-03</p>	<p><b>EM-3043 (Continued)</b> <b>MOUNT-TRANSMISSION</b> <b>LH Rear</b></p> <p>SATURN PASSENGER CAR ..... 2003-07</p>  <p style="text-align: center;"><b>EM-3044</b> <b>MOUNT-ENGINE</b> <b>RH Front</b></p> <p>CHEVROLET TRUCK ..... 1996-98 GMC TRUCK ..... 1996-98</p>	 <p style="text-align: center;"><b>EM-3047</b> <b>MOUNT-ENGINE</b> <b>LH Front</b></p> <p>FORD SPORT UTILITY ..... 2002-06 MERCURY SPORT UTILITY ..... 2002-05</p>	 <p style="text-align: center;"><b>EM-3050</b> <b>MOUNT-TRANSMISSION</b> <b>Manual</b></p> <p>CHRYSLER PASSENGER CAR ..... 2000-02 DODGE PASSENGER CAR ..... 2000-05 PLYMOUTH PASSENGER CAR ..... 2000-01</p>
 <p style="text-align: center;"><b>EM-3041</b> <b>MOUNT-TRANSMISSION</b> <b>LH Front</b></p> <p>SATURN PASSENGER CAR ..... 2003-04</p>	 <p style="text-align: center;"><b>EM-3045</b> <b>MOUNT-ENGINE</b> <b>LH Front</b></p> <p>CHEVROLET PASSENGER CAR ..... 1993-97 PONTIAC PASSENGER CAR ..... 1993-97</p>	 <p style="text-align: center;"><b>EM-3048</b> <b>MOUNT-ENGINE</b> <b>RH Front</b></p> <p>FORD SPORT UTILITY ..... 2002-10 MERCURY SPORT UTILITY ..... 2002-10</p>	 <p style="text-align: center;"><b>EM-3051</b> <b>MOUNT-TRANSMISSION</b></p> <p>JEEP SPORT UTILITY ..... 1999-04</p>
 <p style="text-align: center;"><b>EM-3042</b> <b>MOUNT-TRANSMISSION</b> <b>LH Front</b></p> <p>SATURN PASSENGER CAR ..... 2003-04</p>	 <p style="text-align: center;"><b>EM-3046</b> <b>MOUNT-ENGINE</b> <b>RH Front</b></p> <p>CHEVROLET PASSENGER CAR ..... 1993-97 PONTIAC PASSENGER CAR ..... 1993-97</p>	 <p style="text-align: center;"><b>EM-3049</b> <b>MOUNT-ENGINE</b> <b>Rear</b></p> <p>CHRYSLER PASSENGER CAR ..... 2001-06 DODGE PASSENGER CAR ..... 2001-06</p>	 <p style="text-align: center;"><b>EM-3052</b> <b>MOUNT-TRANSMISSION</b> <b>Manual</b></p> <p>JEEP SPORT UTILITY ..... 2002-03</p>
 <p style="text-align: center;"><b>EM-3043</b> <b>MOUNT-TRANSMISSION</b> <b>Rear</b></p> <p>CHEVROLET PASSENGER CAR ..... 2005-11 PONTIAC PASSENGER CAR ..... 2007-09</p> <p style="text-align: center;">(Continued Next Column)</p>			 <p style="text-align: center;"><b>EM-3053</b> <b>MOUNT-TRANSMISSION</b> <b>Auto</b></p> <p>JEEP SPORT UTILITY ..... 2002-03</p>

# BUYER'S GUIDE

## NUMERICAL LISTING - ILLUSTRATIONS

 <p><b>EM-3054</b> <b>MOUNT-TRANSMISSION</b> Auto</p> <p>JEEP SPORT UTILITY ..... 2004-05</p>	<p><b>EM-3057 (Continued)</b></p> <p>MAZDA SPORT UTILITY ..... 2001-04 <b>MOUNT-TRANSMISSION</b></p> <p>FORD SPORT UTILITY ..... 2001-04 MAZDA SPORT UTILITY ..... 2001-04</p>  <p><b>EM-3058</b> <b>MOUNT-TRANSMISSION</b> Auto</p> <p>OLDSMOBILE PASSENGER CAR ..... 1988-91 PONTIAC PASSENGER CAR ..... 1988-91</p>	 <p><b>EM-3061</b> <b>MOUNT-TRANSMISSION</b></p> <p>FORD SPORT UTILITY ..... 2002-05 <b>MOUNT-TRANSMISSION</b> Auto</p> <p>MERCURY SPORT UTILITY ..... 2002-05</p>	 <p><b>EM-3064</b> <b>MOUNT-ENGINE</b> L &amp; R Front</p> <p>CHEVROLET PASSENGER CAR ..... 1998-02 PONTIAC PASSENGER CAR ..... 1998-02</p>
 <p><b>EM-3055</b> <b>MOUNT-TRANSMISSION</b> Manual</p> <p>JEEP SPORT UTILITY ..... 2002-05</p>	 <p><b>EM-3059</b> <b>MOUNT-ENGINE</b> LH Front</p> <p>FORD VAN ..... 1997-03</p>	 <p><b>EM-3062</b> <b>MOUNT-TRANSMISSION</b></p> <p>FORD SPORT UTILITY ..... 2002-10 <b>MOUNT-TRANSMISSION</b> Auto</p> <p>MERCURY SPORT UTILITY ..... 2002-10</p>	 <p><b>EM-3065</b> <b>MOUNT-TRANSMISSION</b> Rear</p> <p>BUICK PASSENGER CAR ..... 1995-98 <b>MOUNT-TRANSMISSION</b> LH Rear</p> <p>OLDSMOBILE PASSENGER CAR ..... 1995-98</p>
 <p><b>EM-3056*</b> <b>MOUNT-ENGINE</b> RH Front</p> <p>FORD SPORT UTILITY ..... 2001-04 MAZDA SPORT UTILITY ..... 2001-04</p>	 <p><b>EM-3060</b> <b>MOUNT-ENGINE</b> RH Front</p> <p>FORD VAN ..... 1997-03</p>	 <p><b>EM-3063</b> <b>MOUNT-TRANSMISSION</b></p> <p>FORD PASSENGER CAR ..... 2002-05 JAGUAR ..... 2000-05 LINCOLN PASSENGER CAR ..... 2000-06</p>	 <p><b>EM-3066</b> <b>MOUNT-TRANSMISSION</b> Auto</p> <p>CHRYSLER SUV ..... 2007-09 <b>MOUNT-TRANSMISSION</b> Auto</p> <p>DODGE SPORT UTILITY ..... 2004-09 DODGE TRUCK ..... 2002-06</p>
 <p><b>EM-3057*</b> <b>MOUNT-ENGINE</b> Rear</p> <p>FORD SPORT UTILITY ..... 2001-04</p> <p><b>(Continued Next Column)</b></p>			

\* = Hydraulic Mount, "S" suffix = solid replacement.

# BUYER'S GUIDE

## NUMERICAL LISTING - ILLUSTRATIONS

 <p style="text-align: center;"><b>EM-3067</b> <b>MOUNT-ENGINE</b> <b>RH Front</b></p> <p>DODGE SPORT UTILITY ..... 1999-00 DODGE TRUCK ..... 1997-03</p>	 <p style="text-align: center;"><b>EM-3070</b> <b>MOUNT-TRANSMISSION</b> <b>LH Front</b></p> <p>CHEVROLET PASSENGER CAR ..... 2004-05 OLDSMOBILE PASSENGER CAR ..... 2002-04 PONTIAC PASSENGER CAR ..... 2002-05</p>	 <p style="text-align: center;"><b>EM-3073</b> <b>MOUNT-ENGINE</b> <b>LH Front</b></p> <p>DODGE TRUCK ..... 2002-05</p>	 <p style="text-align: center;"><b>EM-3076*</b> <b>MOUNT-ENGINE</b> <b>RH Front</b></p> <p>MERCURY VAN ..... 2004-07</p>
 <p style="text-align: center;"><b>EM-3068</b> <b>MOUNT-TRANSMISSION</b> <b>Rear</b></p> <p>CADILLAC PASSENGER CAR .... 1998-04 <b>MOUNT-TRANSMISSION</b> <b>LH Rear</b></p> <p>OLDSMOBILE PASSENGER CAR ... 1999</p>	 <p style="text-align: center;"><b>EM-3071*</b> <b>MOUNT-ENGINE</b> <b>LH Front</b></p> <p>LINCOLN PASSENGER CAR ..... 2003-08</p>	 <p style="text-align: center;"><b>EM-3074</b> <b>MOUNT-ENGINE</b> <b>RH Front</b></p> <p>DODGE TRUCK ..... 2002-05</p>	 <p style="text-align: center;"><b>EM-3076*</b> <b>MOUNT-ENGINE</b> <b>RH Rear</b></p> <p>FORD VAN ..... 2004-07</p>
 <p style="text-align: center;"><b>EM-3069</b> <b>MOUNT-TRANSMISSION</b> <b>Rear</b></p> <p>CHEVROLET SPORT UTILITY .... 2005-09 <b>MOUNT-TRANSMISSION</b> <b>LH Rear</b></p> <p>PONTIAC SPORT UTILITY ..... 2006-09</p>	 <p style="text-align: center;"><b>EM-3072*</b> <b>MOUNT-ENGINE</b> <b>RH Front</b></p> <p>LINCOLN PASSENGER CAR ..... 2003-08</p>	 <p style="text-align: center;"><b>EM-3075*</b> <b>MOUNT-ENGINE</b> <b>RH Front</b></p> <p>FORD VAN ..... 2004-07 <b>MOUNT-ENGINE</b> <b>LH Front</b></p> <p>MERCURY VAN ..... 2004-07</p>	 <p style="text-align: center;"><b>EM-3077*</b> <b>MOUNT-ENGINE</b> <b>L &amp; R Front</b></p> <p>JAGUAR ..... 2000-08 LINCOLN PASSENGER CAR ..... 2000-06</p>
			 <p style="text-align: center;"><b>EM-3078</b> <b>MOUNT-ENGINE</b> <b>LH Front</b></p> <p>FORD TRUCK ..... 2001-11 MAZDA TRUCK ..... 2001-09</p>

\* = Hydraulic Mount, "S" suffix = solid replacement.

# BUYER'S GUIDE

## NUMERICAL LISTING - ILLUSTRATIONS

 <p style="text-align: center;"><b>EM-3079*</b> <b>MOUNT-ENGINE</b> <b>RH Front</b></p> <p>FORD PASSENGER CAR ..... 2005-07 MERCURY PASSENGER CAR ... 2005-07</p>	 <p style="text-align: center;"><b>EM-3082</b> <b>MOUNT-TRANSMISSION</b> <b>Front</b></p> <p>CHEVROLET SPORT UTILITY ... 2005-09</p> <p style="text-align: center;"><b>MOUNT-TRANSMISSION</b> <b>LH Front</b></p> <p>PONTIAC SPORT UTILITY ..... 2006-09</p>	 <p style="text-align: center;"><b>EM-3085*</b> <b>MOUNT-ENGINE</b> <b>RH Front</b></p> <p>FORD PASSENGER CAR ..... 2002-04</p>	 <p style="text-align: center;"><b>EM-3088</b> <b>Engine Torque Strut Mount</b> <b>Front</b></p> <p>BUICK PASSENGER CAR ..... 1996-09 CHEVROLET PASSENGER CAR ..... 1998-05 OLDSMOBILE PASSENGER CAR ..... 1998-02 PONTIAC PASSENGER CAR ..... 2004-08</p>
 <p style="text-align: center;"><b>EM-3080*</b> <b>MOUNT-ENGINE</b> <b>LH Front</b></p> <p>FORD PASSENGER CAR ..... 2005-07 MERCURY PASSENGER CAR ... 2005-07</p> <p style="text-align: center;"><b>MOUNT-TRANSMISSION</b></p> <p>FORD PASSENGER CAR ..... 2005-07 MERCURY PASSENGER CAR ... 2005-07</p>	 <p style="text-align: center;"><b>EM-3083*</b> <b>MOUNT-ENGINE</b> <b>Front</b></p> <p>OLDSMOBILE PASSENGER CAR ... 1999</p> <p style="text-align: center;"><b>MOUNT-TRANSMISSION</b> <b>LH Front</b></p> <p>CADILLAC PASSENGER CAR .... 1998-04 OLDSMOBILE PASSENGER CAR ... 1999</p>	 <p style="text-align: center;"><b>EM-3086</b> <b>MOUNT-TRANSMISSION</b> <b>Rear</b></p> <p>CHEVROLET PASSENGER CAR ..... 2005-11 PONTIAC PASSENGER CAR ..... 2007-09</p> <p style="text-align: center;"><b>MOUNT-TRANSMISSION</b></p> <p>SATURN PASSENGER CAR ..... 2005-07</p>	 <p style="text-align: center;"><b>EM-3089</b> <b>MOUNT-ENGINE</b> <b>Rear</b></p> <p>CHRYSLER PASSENGER CAR ..... 2000 DODGE PASSENGER CAR ..... 1998-00 PLYMOUTH PASSENGER CAR ..... 1998-00</p>
 <p style="text-align: center;"><b>EM-3081</b> <b>MOUNT-TRANSMISSION</b> <b>Front</b></p> <p>CHEVROLET PASSENGER CAR ..... 2005-11</p> <p style="text-align: center;"><b>MOUNT-TRANSMISSION</b> <b>LH Front</b></p> <p>PONTIAC PASSENGER CAR ..... 2007-09 SATURN PASSENGER CAR ..... 2005-07</p>	 <p style="text-align: center;"><b>EM-3084*</b> <b>MOUNT-ENGINE</b> <b>Front</b></p> <p>CHRYSLER SUV ..... 2004-06</p> <p style="text-align: center;"><b>MOUNT-ENGINE</b> <b>Rear</b></p> <p>CHRYSLER SUV ..... 2004-06</p>	 <p style="text-align: center;"><b>EM-3087</b> <b>Engine Torque Strut Mount</b> <b>Rear Lower</b></p> <p>FORD PASSENGER CAR ..... 2008-11</p>	 <p style="text-align: center;"><b>EM-3090</b> <b>Engine Torque Strut Mount</b> <b>Front</b></p> <p>BUICK VAN ..... 2006-07 CHEVROLET PASSENGER CAR ..... 2006-11 PONTIAC PASSENGER CAR ..... 2005-08</p>

\* = Hydraulic Mount, "S" suffix = solid replacement.



# BUYER'S GUIDE

## NUMERICAL LISTING - ILLUSTRATIONS

 <p style="text-align: center;"><b>EM-3091</b> <b>MOUNT-ENGINE</b> <b>RH Front</b></p> <p>SATURN PASSENGER CAR ..... 2000-03</p>	 <p style="text-align: center;"><b>EM-3094</b> <b>MOUNT-TRANSMISSION</b> <b>LH Front</b></p> <p>CHEVROLET PASSENGER CAR ..... 2008</p> <p style="text-align: center;"><b>MOUNT-TRANSMISSION</b> <b>Rear</b></p> <p>CHEVROLET PASSENGER CAR ..... 2004-08 PONTIAC PASSENGER CAR ..... 2005-08 SATURN PASSENGER CAR ..... 2007-08</p>	 <p style="text-align: center;"><b>EM-3097</b> <b>MOUNT-ENGINE</b> <b>RH Front</b></p> <p>CHEVROLET PASSENGER CAR ..... 2004-10</p> <p style="text-align: center;"><b>MOUNT-ENGINE</b> <b>Right</b></p> <p>PONTIAC PASSENGER CAR ..... 2005-10</p> <p style="text-align: center;"><b>MOUNT-ENGINE</b> <b>Front</b></p> <p>SATURN PASSENGER CAR ..... 2007-09</p>	 <p style="text-align: center;"><b>EM-3102</b> <b>MOUNT-ENGINE</b> <b>LH Front</b></p> <p>CHEVROLET TRUCK ..... 2001-10</p> <p style="text-align: center;"><b>MOUNT-ENGINE</b> <b>Right</b></p> <p>GMC TRUCK ..... 2001-10</p>
 <p style="text-align: center;"><b>EM-3092</b> <b>MOUNT-TRANSMISSION</b> <b>Front</b></p> <p>SATURN PASSENGER CAR ..... 2005-07</p> <p style="text-align: center;"><b>MOUNT-TRANSMISSION</b> <b>Upper</b></p> <p>CHEVROLET PASSENGER CAR ..... 2005-10</p> <p style="text-align: center;"><b>MOUNT-TRANSMISSION</b> <b>Rear</b></p> <p>SATURN PASSENGER CAR ..... 2005-07</p>	 <p style="text-align: center;"><b>EM-3095</b> <b>Engine Torque Strut Mount</b> <b>Front</b></p> <p>CHRYSLER SUV ..... 2004-08</p>	 <p style="text-align: center;"><b>EM-3098</b> <b>MOUNT-TRANSMISSION</b> <b>Front</b></p> <p>CHEVROLET VAN ..... 2003-16 GMC VAN ..... 2003-16</p> <p style="text-align: center;"><b>MOUNT-TRANSMISSION</b></p> <p>CHEVROLET VAN ..... 2003-16</p>	 <p style="text-align: center;"><b>EM-3103</b> <b>MOUNT-ENGINE</b> <b>RH Front</b></p> <p>FORD PASSENGER CAR ..... 2003-13 FORD VAN ..... 2010-13 MAZDA PASSENGER CAR ..... 2004-13 MAZDA VAN ..... 2006-10</p>
 <p style="text-align: center;"><b>EM-3093</b> <b>MOUNT-ENGINE</b> <b>Front</b></p> <p>BUICK PASSENGER CAR ..... 2008-09 CHEVROLET PASSENGER CAR ..... 2006-09 OLDSMOBILE PASSENGER CAR ..... 1999-02 PONTIAC PASSENGER CAR ..... 2005-08</p>	 <p style="text-align: center;"><b>EM-3096</b> <b>MOUNT-TRANSMISSION</b> <b>Center</b></p> <p>CHEVROLET PASSENGER CAR ..... 2004-10 PONTIAC PASSENGER CAR ..... 2005-10 SATURN PASSENGER CAR ..... 2008</p>	 <p style="text-align: center;"><b>EM-3100</b> <b>Engine Torque Strut Mount</b> <b>Rear</b></p> <p>FORD PASSENGER CAR ..... 2003-07</p>	 <p style="text-align: center;"><b>EM-3104</b> <b>Engine Torque Strut Mount</b> <b>Front</b></p> <p>BUICK PASSENGER CAR ..... 2008-09 CHEVROLET PASSENGER CAR ..... 2006-11</p>

# BUYER'S GUIDE

## NUMERICAL LISTING - ILLUSTRATIONS

 <p style="text-align: center;"><b>EM-3105</b> Engine Torque Strut Mount Front</p> <p>FORD PASSENGER CAR ..... 2007-12 <b>Engine Torque Strut Front Right</b> MERCURY PASSENGER CAR ... 2007-11</p>	 <p style="text-align: center;"><b>EM-3108</b> MOUNT-ENGINE RH Front</p> <p>CHEVROLET PASSENGER CAR ..... 2005-11 PONTIAC PASSENGER CAR ..... 2007-08 <b>MOUNT-ENGINE Front</b> SATURN PASSENGER CAR ..... 2003-07 <b>MOUNT-ENGINE RH Front</b> SATURN SUV ..... 2002-07</p>	 <p style="text-align: center;"><b>EM-3111</b> Engine Torque Strut Mount Rear</p> <p>LINCOLN PASSENGER CAR ..... 1998-02</p>	 <p style="text-align: center;"><b>EM-3114</b> Engine Torque Strut Front Right</p> <p>CHEVROLET PASSENGER CAR ..... 2004-11 PONTIAC PASSENGER CAR ..... 2005-10 <b>Engine Torque Strut Mount Rear</b> PONTIAC PASSENGER CAR ..... 2009</p>
 <p style="text-align: center;"><b>EM-3106</b> MOUNT-TRANSMISSION</p> <p>FORD VAN ..... 2004-07 MERCURY VAN ..... 2004-07</p>	 <p style="text-align: center;"><b>EM-3109</b> MOUNT-ENGINE RH Front</p> <p>CHEVROLET PASSENGER CAR ..... 2005-11 PONTIAC PASSENGER CAR ..... 2007-08 <b>MOUNT-ENGINE Front</b> SATURN PASSENGER CAR ..... 2005-07 <b>MOUNT-ENGINE RH Front</b> SATURN SUV ..... 2002-07</p>	 <p style="text-align: center;"><b>EM-3112</b> MOUNT-TRANSMISSION Center</p> <p>CHEVROLET PASSENGER CAR ..... 2006-07 PONTIAC PASSENGER CAR ..... 2006-09</p>	 <p style="text-align: center;"><b>EM-3115</b> MOUNT-TRANSMISSION</p> <p>CHEVROLET PASSENGER CAR ..... 2004-08</p>
 <p style="text-align: center;"><b>EM-3107</b> Engine Torque Strut Mount Front</p> <p>FORD PASSENGER CAR ..... 2006-09 <b>Engine Torque Strut Front Right</b> LINCOLN PASSENGER CAR ..... 2006 MERCURY PASSENGER CAR ... 2006-09</p>	 <p style="text-align: center;"><b>EM-3110</b> MOUNT-ENGINE RH Front</p> <p>CHEVROLET SPORT UTILITY ... 2005-09 PONTIAC SPORT UTILITY ..... 2006-09 SATURN SUV ..... 2002-03</p>	 <p style="text-align: center;"><b>EM-3113</b> MOUNT-ENGINE Front</p> <p>CHEVROLET PASSENGER CAR ..... 2004-11 PONTIAC PASSENGER CAR ..... 2005-07 <b>MOUNT-TRANSMISSION</b> PONTIAC PASSENGER CAR ..... 2005-07</p>	 <p style="text-align: center;"><b>EM-3116</b> MOUNT-ENGINE Front</p> <p>PONTIAC PASSENGER CAR ..... 2006-09</p>

# BUYER'S GUIDE

## NUMERICAL LISTING - ILLUSTRATIONS

 <p style="text-align: center;"><b>EM-3117</b> <b>MOUNT-ENGINE</b> <b>Right</b></p> <p>CHEVROLET PASSENGER CAR ..... 2006-08</p> <p style="text-align: center;"><b>MOUNT-ENGINE</b> <b>RH Front</b></p> <p>PONTIAC PASSENGER CAR ..... 2006-10</p> <p style="text-align: center;"><b>MOUNT-ENGINE</b> <b>Front</b></p> <p>SATURN PASSENGER CAR ..... 2007-08</p>	 <p style="text-align: center;"><b>EM-3120</b> <b>MOUNT-ENGINE</b> <b>RH Front</b></p> <p>CHEVROLET TRUCK ..... 2004-12 GMC TRUCK ..... 2004-12</p>	 <p style="text-align: center;"><b>EM-3124</b> <b>MOUNT-TRANSMISSION</b> <b>Auto</b></p> <p>CHRYSLER PASSENGER CAR ..... 2002 DODGE PASSENGER CAR ..... 2001-06</p>	 <p style="text-align: center;"><b>EM-3128</b> <b>MOUNT-ENGINE</b> <b>RH Front</b></p> <p>CHEVROLET PASSENGER CAR ..... 2002-05 PONTIAC PASSENGER CAR ..... 2002-05</p>
 <p style="text-align: center;"><b>EM-3118</b> <b>MOUNT-ENGINE</b> <b>RH Front</b></p> <p>CHEVROLET PASSENGER CAR ..... 2009-12 PONTIAC PASSENGER CAR ..... 2009 SATURN PASSENGER CAR ..... 2009</p>	 <p style="text-align: center;"><b>EM-3121</b> <b>MOUNT-ENGINE</b> <b>LH Front</b></p> <p>CHEVROLET TRUCK ..... 2004-12 GMC TRUCK ..... 2004-12</p>	 <p style="text-align: center;"><b>EM-3125</b> <b>MOUNT-TRANSMISSION</b> <b>Manual</b></p> <p>CHEVROLET PASSENGER CAR ..... 1998-02 PONTIAC PASSENGER CAR ..... 1998-02</p>	 <p style="text-align: center;"><b>EM-3129</b> <b>MOUNT-ENGINE</b> <b>Right</b></p> <p>CHEVROLET PASSENGER CAR ..... 2004-05 OLDSMOBILE PASSENGER CAR ..... 2002-04 PONTIAC PASSENGER CAR ..... 2002-05</p>
 <p style="text-align: center;"><b>EM-3119</b> <b>MOUNT-TRANSMISSION</b> <b>Manual</b></p> <p>FORD PASSENGER CAR ..... 1998-00</p> <p style="text-align: center;"><b>MOUNT-TRANSMISSION</b> <b>Rear</b></p> <p>FORD PASSENGER CAR ..... 1995-00</p> <p style="text-align: center;"><b>MOUNT-TRANSMISSION</b> <b>Manual</b></p> <p>MERCURY PASSENGER CAR ... 1995-02</p>	 <p style="text-align: center;"><b>EM-3122</b> <b>MOUNT-TRANSMISSION</b></p> <p>CHEVROLET TRUCK ..... 2004-12 GMC TRUCK ..... 2004-12</p>	 <p style="text-align: center;"><b>EM-3126</b> <b>MOUNT-ENGINE</b> <b>LH Front</b></p> <p>BUICK PASSENGER CAR ..... 1997-99</p>	 <p style="text-align: center;"><b>EM-3130</b> <b>MOUNT-ENGINE</b> <b>RH Front</b></p> <p>DODGE PASSENGER CAR ..... 2007-12 JEEP SPORT UTILITY ..... 2007-16 MITSUBISHI PASSENGER CAR ..... 2008-16</p> <p style="text-align: center;"><b>MOUNT-ENGINE</b> <b>Right</b></p> <p>MITSUBISHI SPORT UTILITY .... 2011-16</p>
 <p style="text-align: center;"><b>EM-3123</b> <b>MOUNT-TRANSMISSION</b> <b>Auto</b></p> <p>CADILLAC PASSENGER CAR .... 2003-04</p>	 <p style="text-align: center;"><b>EM-3127</b> <b>MOUNT-TRANSMISSION</b> <b>Front</b></p> <p>BUICK PASSENGER CAR ..... 1995-98</p>		



# BUYER'S GUIDE

## NUMERICAL LISTING - ILLUSTRATIONS



**EM-3131**  
**MOUNT-ENGINE**  
**Front**

DODGE PASSENGER CAR ..... 2007-12  
 JEEP SPORT UTILITY ..... 2007-16  
 MITSUBISHI PASSENGER  
 CAR ..... 2008-16  
 MITSUBISHI SPORT UTILITY ..... 2011-16



**EM-3134**  
**MOUNT-TRANSMISSION**  
**Auto**

DODGE PASSENGER CAR ..... 2007-12  
**MOUNT-TRANSMISSION**  
**Manual**  
 JEEP SPORT UTILITY ..... 2007-13  
**MOUNT-TRANSMISSION**  
**Auto**

MITSUBISHI PASSENGER  
 CAR ..... 2008-16  
 MITSUBISHI SPORT UTILITY ..... 2008-16



**EM-3137**  
**MOUNT-TRANSMISSION**  
**Manual**

DODGE PASSENGER CAR ..... 2007-09  
 JEEP SPORT UTILITY ..... 2007-09  
 MITSUBISHI PASSENGER  
 CAR ..... 2008-16  
 MITSUBISHI SPORT UTILITY ..... 2011-16



**EM-3140**  
**Engine Torque Strut Mount**  
**Right**

BUICK PASSENGER CAR ..... 2006-11  
 CADILLAC PASSENGER CAR ..... 2006-11



**EM-3132**  
**MOUNT-ENGINE**  
**Rear**

DODGE PASSENGER CAR ..... 2007-09  
 MITSUBISHI PASSENGER  
 CAR ..... 2008-16  
 MITSUBISHI SPORT UTILITY ..... 2011-16



**EM-3135**  
**MOUNT-TRANSMISSION**  
**Center**

CHEVROLET PASSENGER  
 CAR ..... 2008-12  
 PONTIAC PASSENGER CAR ..... 2007-09  
 SATURN PASSENGER CAR ..... 2007-09



**EM-3138**  
**MOUNT-ENGINE**  
**L & R Front**

CHRYSLER PASSENGER  
 CAR ..... 2005-10  
 DODGE PASSENGER CAR ..... 2005-10



**EM-3141**  
**Engine Torque Strut Mount**  
**Right Upper**

BUICK SPORT UTILITY ..... 2009-17  
 CHEVROLET SPORT UTILITY ..... 2009-17  
 GMC SPORT UTILITY ..... 2009-17  
 SATURN SUV ..... 2009-10



**EM-3133**  
**Engine Torque Strut Mount**  
**Right Upper**

BUICK SPORT UTILITY ..... 2008  
 GMC SPORT UTILITY ..... 2007-08  
 SATURN SUV ..... 2007-08



**EM-3136**  
**MOUNT-TRANSMISSION**  
**Auto**

FORD TRUCK ..... 2004-08  
**MOUNT-TRANSMISSION**

LINCOLN TRUCK ..... 2006-08



**EM-3139**  
**Engine Torque Strut Mount**  
**Front**

BUICK PASSENGER CAR ..... 2006-11



**EM-3142**  
**Engine Torque Strut Mount**  
**Front**

FORD PASSENGER CAR ..... 2008-09  
 FORD SPORT UTILITY ..... 2009-12  
 LINCOLN SPORT UTILITY ..... 2010-13

**Engine Torque Strut Mount**  
**Rear**

FORD PASSENGER CAR ..... 2008-12  
 FORD SPORT UTILITY ..... 2011-14  
 LINCOLN PASSENGER CAR ..... 2009-11  
 LINCOLN SPORT UTILITY ..... 2011-14  
 MERCURY PASSENGER CAR ..... 2008-09







# BUYER'S GUIDE

## NUMERICAL LISTING - ILLUSTRATIONS

 <p style="text-align: center;"><b>EM-3143</b> <b>Engine Torque Strut Mount</b> <b>Right Upper</b></p> <p>BUICK SPORT UTILITY ..... 2008 GMC SPORT UTILITY ..... 2007-08 SATURN SUV ..... 2007-08</p>	 <p style="text-align: center;"><b>EM-3146</b> <b>MOUNT-ENGINE</b> <b>Rear</b></p> <p>BUICK PASSENGER CAR ..... 2006-08</p>	 <p style="text-align: center;"><b>EM-3149</b> <b>MOUNT-ENGINE</b> <b>L &amp; R Front</b></p> <p>CADILLAC PASSENGER CAR .... 2003-14 <b>MOUNT-ENGINE</b> <b>LH Front</b></p> <p>CADILLAC SPORT UTILITY ..... 2004-09 <b>MOUNT-ENGINE</b> <b>Rear</b></p> <p>BUICK PASSENGER CAR ..... 2009-11</p>	 <p style="text-align: center;"><b>EM-3152</b> <b>MOUNT-ENGINE</b> <b>Front</b></p> <p>CHRYSLER PASSENGER CAR ..... 2007-14 DODGE PASSENGER CAR ..... 2008-10</p>
 <p style="text-align: center;"><b>EM-3144</b> <b>Engine Torque Strut</b> <b>Front Left</b></p> <p>FORD SPORT UTILITY ..... 2007-10 <b>Engine Torque Strut Mount</b> <b>Rear</b></p> <p>LINCOLN SPORT UTILITY ..... 2007-10</p>	 <p style="text-align: center;"><b>EM-3147</b> <b>MOUNT-ENGINE</b> <b>Front</b></p> <p>CHRYSLER SUV ..... 2007-08 <b>MOUNT-ENGINE</b> <b>Rear</b></p> <p>CHRYSLER SUV ..... 2007-08</p>	 <p style="text-align: center;"><b>EM-3150</b> <b>MOUNT-ENGINE</b> <b>Right</b></p> <p>FORD TRUCK ..... 2004</p>	 <p style="text-align: center;"><b>EM-3153</b> <b>MOUNT-TRANSMISSION</b> <b>Auto</b></p> <p>BUICK PASSENGER CAR ..... 2006-11 <b>MOUNT-TRANSMISSION</b></p> <p>CADILLAC PASSENGER CAR .... 2006-11</p>
 <p style="text-align: center;"><b>EM-3145</b> <b>MOUNT-ENGINE</b> <b>Rear</b></p> <p>DODGE PASSENGER CAR ..... 2007-12 JEEP SPORT UTILITY ..... 2007-16 MITSUBISHI SPORT UTILITY ..... 2008-13</p>	 <p style="text-align: center;"><b>EM-3148</b> <b>MOUNT-ENGINE</b> <b>Front</b></p> <p>BUICK PASSENGER CAR ..... 2006-08</p>	 <p style="text-align: center;"><b>EM-3151</b> <b>MOUNT-ENGINE</b> <b>Left</b></p> <p>FORD TRUCK ..... 2004</p>	 <p style="text-align: center;"><b>EM-3154</b> <b>MOUNT-ENGINE</b> <b>Left</b></p> <p>CHEVROLET SPORT UTILITY .... 2008-09 <b>MOUNT-TRANSMISSION</b> <b>Center</b></p> <p>CHEVROLET SPORT UTILITY .... 2008-09 PONTIAC SPORT UTILITY ..... 2008-09</p>

# BUYER'S GUIDE

## NUMERICAL LISTING - ILLUSTRATIONS

 <p style="text-align: center;"><b>EM-3155</b> <b>MOUNT-ENGINE</b> <b>Rear</b></p> <p>CHRYSLER PASSENGER CAR ..... 2007-10 DODGE PASSENGER CAR ..... 2008-10</p>	 <p style="text-align: center;"><b>EM-3159</b> <b>MOUNT-TRANSMISSION</b> <b>Auto</b></p> <p>CADILLAC PASSENGER CAR .... 2004-07</p>	<p><b>EM-3162 (Continued)</b> CADILLAC PASSENGER CAR ..... 2004</p>  <p style="text-align: center;"><b>EM-3165</b> <b>MOUNT-ENGINE</b> <b>Front</b></p> <p>DODGE SPORT UTILITY ..... 2009-10</p>	 <p style="text-align: center;"><b>EM-3168</b> <b>MOUNT-ENGINE</b> <b>Rear</b></p> <p>CHRYSLER PASSENGER CAR ..... 2011-14 DODGE PASSENGER CAR ..... 2011-13</p> <p style="text-align: center;"><b>MOUNT-TRANSMISSION</b></p> <p>CHRYSLER PASSENGER CAR ..... 2007-10 DODGE PASSENGER CAR ..... 2008-09</p>
 <p style="text-align: center;"><b>EM-3156</b> <b>MOUNT-ENGINE</b> <b>Front</b></p> <p>CHRYSLER VAN ..... 2008-10 DODGE VAN ..... 2008-10 VOLKSWAGEN VAN ..... 2009-10</p>	 <p style="text-align: center;"><b>EM-3160</b> <b>MOUNT-ENGINE</b> <b>RH Front</b></p> <p>PONTIAC PASSENGER CAR ..... 2007-09</p> <p style="text-align: center;"><b>MOUNT-ENGINE</b> <b>LH Front</b></p> <p>SATURN PASSENGER CAR ..... 2007-10</p>	 <p style="text-align: center;"><b>EM-3166</b> <b>MOUNT-ENGINE</b> <b>Front</b></p> <p>BUICK PASSENGER CAR ..... 2006-11 CADILLAC PASSENGER CAR .... 2006-11</p>	 <p style="text-align: center;"><b>EM-3172</b> <b>MOUNT-TRANSMISSION</b></p> <p>CHEVROLET TRUCK ..... 2007-12 GMC TRUCK ..... 2007-12</p>
 <p style="text-align: center;"><b>EM-3157</b> <b>MOUNT-ENGINE</b> <b>Rear</b></p> <p>DODGE PASSENGER CAR ..... 2007-08 JEEP SPORT UTILITY ..... 2007-16 MITSUBISHI SPORT UTILITY ..... 2008-13</p>	 <p style="text-align: center;"><b>EM-3161</b> <b>MOUNT-TRANSMISSION</b></p> <p>PONTIAC PASSENGER CAR ..... 2007-09 SATURN PASSENGER CAR ..... 2007-10</p>	 <p style="text-align: center;"><b>EM-3167</b> <b>MOUNT-ENGINE</b> <b>RH Front</b></p> <p>CHRYSLER PASSENGER CAR ..... 2007-14 DODGE PASSENGER CAR ..... 2008-13</p>	 <p style="text-align: center;"><b>EM-3175</b> <b>MOUNT-ENGINE</b> <b>LH Front</b></p> <p>CHEVROLET VAN ..... 2003-14 GMC VAN ..... 2003-14</p>
 <p style="text-align: center;"><b>EM-3158</b> <b>MOUNT-ENGINE</b> <b>Front</b></p> <p>BUICK PASSENGER CAR ..... 2009-11</p>	 <p style="text-align: center;"><b>EM-3162</b> <b>MOUNT-TRANSMISSION</b> <b>Manual</b></p> <p style="text-align: center;">(Continued Next Column)</p>		

# BUYER'S GUIDE

## NUMERICAL LISTING - ILLUSTRATIONS

 <p><b>EM-3177</b> <b>MOUNT-ENGINE</b> <b>L &amp; R Front</b></p> <p>CHEVROLET VAN ..... 2003-12 GMC VAN ..... 2003-12</p>	 <p><b>EM-3190</b> <b>MOUNT-ENGINE</b> <b>L &amp; R Front</b></p> <p>DODGE VAN ..... 2003-06 FREIGHTLINER ..... 2003-06</p>	 <p><b>EM-3194</b> <b>MOUNT-TRANSMISSION</b> <b>Front</b></p> <p>BUICK PASSENGER CAR ..... 2010-17 CHEVROLET PASSENGER CAR ..... 2013-17</p> <p><b>MOUNT-TRANSMISSION</b></p> <p>CHEVROLET VAN ..... 2012-14</p>	 <p><b>EM-3197</b> <b>MOUNT-TRANSMISSION</b> <b>Front</b></p> <p>BUICK PASSENGER CAR ..... 2011-13 CADILLAC SPORT UTILITY ..... 2010-11</p>
 <p><b>EM-3179</b> <b>MOUNT-TRANSMISSION</b></p> <p>CHRYSLER PASSENGER CAR ..... 2003-08</p>	 <p><b>EM-3192</b> <b>MOUNT-ENGINE</b> <b>Front</b></p> <p>BUICK SPORT UTILITY ..... 2008 GMC SPORT UTILITY ..... 2007-08 SATURN SUV ..... 2007-08</p> <p><b>MOUNT-ENGINE</b> <b>Rear</b></p> <p>BUICK SPORT UTILITY ..... 2008 GMC SPORT UTILITY ..... 2007-08 SATURN SUV ..... 2007-08</p> <p><b>MOUNT-TRANSMISSION</b></p> <p>BUICK SPORT UTILITY ..... 2008</p>	 <p><b>EM-3195</b> <b>MOUNT-TRANSMISSION</b> <b>Front</b></p> <p>BUICK PASSENGER CAR ..... 2010-16 CADILLAC PASSENGER CAR ..... 2013-17 CADILLAC SPORT UTILITY ..... 2010-16 CHEVROLET PASSENGER CAR ..... 2013-18</p>	 <p><b>EM-3198</b> <b>MOUNT-ENGINE</b> <b>Right</b></p> <p>BUICK PASSENGER CAR ..... 2010-17 CHEVROLET PASSENGER CAR ..... 2013-17</p>
 <p><b>EM-3183</b> <b>MOUNT-ENGINE</b> <b>Right</b></p> <p>DODGE SPORT UTILITY ..... 2009-12</p>	 <p><b>EM-3193</b> <b>Engine Torque Strut Mount</b> <b>Rear</b></p> <p>FORD PASSENGER CAR ..... 2011-16</p>	 <p><b>EM-3196</b> <b>MOUNT-TRANSMISSION</b> <b>Rear</b></p> <p>BUICK PASSENGER CAR ..... 2010-17 CADILLAC PASSENGER CAR ..... 2013-17 CADILLAC SPORT UTILITY ..... 2010-16 CHEVROLET PASSENGER CAR ..... 2013-18</p>	 <p><b>EM-3199</b> <b>MOUNT-TRANSMISSION</b> <b>Center</b></p> <p>CHEVROLET PASSENGER CAR ..... 2014-17</p>
 <p><b>EM-3189</b> <b>MOUNT-TRANSMISSION</b></p> <p>DODGE VAN ..... 2003-06 FREIGHTLINER ..... 2003-06</p>	<p>FORD PASSENGER CAR ..... 2011-16</p>	 <p><b>EM-3200</b> <b>MOUNT-ENGINE</b> <b>Right</b></p> <p>BUICK PASSENGER CAR ..... 2010-15 CADILLAC PASSENGER CAR ..... 2013-17 CHEVROLET PASSENGER CAR ..... 2014-19</p>	<p>FORD PASSENGER CAR ..... 2011-16</p>

# BUYER'S GUIDE

## NUMERICAL LISTING - ILLUSTRATIONS

 <p style="text-align: center;"><b>EM-3201</b> <b>MOUNT-TRANSMISSION</b> Center</p> <p>BUICK PASSENGER CAR ..... 2011-13 <b>MOUNT-TRANSMISSION</b> CADILLAC SPORT UTILITY ..... 2010-11</p>	 <p style="text-align: center;"><b>EM-4002</b> <b>MOUNT-TRANSMISSION</b></p> <p>DODGE TRUCK ..... 2006-08</p>	 <p style="text-align: center;"><b>EM-4005</b> <b>MOUNT-ENGINE</b> RH Front</p> <p>FORD PASSENGER CAR ..... 1989-95</p>	 <p style="text-align: center;"><b>EM-4012</b> <b>MOUNT-ENGINE</b> Right</p> <p>CHRYSLER VAN ..... 2008-15 DODGE VAN ..... 2008-16 RAM VAN ..... 2012-15 VOLKSWAGEN VAN ..... 2011-14</p>
 <p style="text-align: center;"><b>EM-3202</b> <b>MOUNT-TRANSMISSION</b> Front</p> <p>CHEVROLET PASSENGER CAR ..... 2011-16</p>	 <p style="text-align: center;"><b>EM-4003</b> <b>MOUNT-ENGINE</b> Right</p> <p>CHRYSLER VAN ..... 2001-02 <b>MOUNT-ENGINE</b> RH Front DODGE VAN ..... 2001-02</p>	 <p style="text-align: center;"><b>EM-4006</b> <b>MOUNT-ENGINE</b> LH Front</p> <p>DODGE TRUCK ..... 2006-07</p>	 <p style="text-align: center;"><b>EM-4013</b> <b>MOUNT-TRANSMISSION</b></p> <p>CHRYSLER VAN ..... 2008-10 DODGE VAN ..... 2008-10 VOLKSWAGEN VAN ..... 2009-10</p>
 <p style="text-align: center;"><b>EM-4000</b> <b>MOUNT-ENGINE</b> LH Front</p> <p>CHEVROLET SPORT UTILITY ..... 2007-09 CHEVROLET TRUCK ..... 2007-13 GMC SPORT UTILITY ..... 2007-09 GMC TRUCK ..... 2007-13</p>	 <p style="text-align: center;"><b>EM-4004</b> <b>MOUNT-ENGINE</b> Right</p> <p>CHRYSLER VAN ..... 2003 <b>MOUNT-ENGINE</b> RH Front DODGE VAN ..... 2003-07</p>	 <p style="text-align: center;"><b>EM-4007</b> <b>MOUNT-ENGINE</b> RH Front</p> <p>DODGE TRUCK ..... 2006-07</p>	 <p style="text-align: center;"><b>EM-4015</b> <b>MOUNT-ENGINE</b> LH Front</p> <p>HUMMER ..... 2006-10</p>
 <p style="text-align: center;"><b>EM-4001</b> <b>MOUNT-ENGINE</b> Front</p> <p>HUMMER ..... 2002-06</p>	 <p style="text-align: center;"><b>EM-4011 (NEW)</b> <b>MOUNT-ENGINE</b> Right</p> <p>CHRYSLER VAN ..... 2008-10 DODGE VAN ..... 2008-10 VOLKSWAGEN VAN ..... 2009-10</p>	 <p style="text-align: center;"><b>EM-4016</b> <b>MOUNT-ENGINE</b> RH Front</p>	<p style="text-align: center;">(Continued Next Page)</p>



# BUYER'S GUIDE

## NUMERICAL LISTING - ILLUSTRATIONS

### EM-4016 (Continued)

HUMMER ..... 2006-10



**EM-4017**  
**MOUNT-ENGINE**  
**RH Front**

CHEVROLET SPORT UTILITY ..... 2007-09  
CHEVROLET TRUCK ..... 2007-13  
GMC SPORT UTILITY ..... 2007-09  
GMC TRUCK ..... 2007-13



**EM-4018**  
**MOUNT-ENGINE**  
**L & R Front**

DODGE TRUCK ..... 2003-07



**EM-4019**  
**MOUNT-ENGINE**  
**Rear**

FORD SPORT UTILITY ..... 2005-12  
MAZDA SPORT UTILITY ..... 2005-11  
MERCURY SPORT UTILITY ..... 2005-11



**EM-4021 (NEW)**  
**MOUNT-ENGINE**  
**Right**

FORD MEDIUM/HEAVY DUTY ..... 1999-04  
FORD SPORT UTILITY ..... 2000-05  
FORD TRUCK ..... 1999-04



**EM-4022**  
**MOUNT-ENGINE**  
**Left**

FORD MEDIUM/HEAVY DUTY ..... 1999-04  
FORD SPORT UTILITY ..... 2000-05  
FORD TRUCK ..... 1999-04



**EM-4023 (NEW)**  
**MOUNT-TRANSMISSION**

FORD MEDIUM/HEAVY DUTY ..... 2003-07  
FORD SPORT UTILITY ..... 2003-05  
FORD TRUCK ..... 2003-07



**EM-4024 (NEW)**  
**MOUNT-TRANSMISSION**

FORD MEDIUM/HEAVY DUTY ..... 2003-07  
FORD SPORT UTILITY ..... 2003-05  
FORD TRUCK ..... 2003-07



**EM-4025 (NEW)**  
**MOUNT-TRANSMISSION**

FORD TRUCK ..... 2005-08



**EM-4027**  
**MOUNT-TRANSMISSION**  
**Front**

CHEVROLET PASSENGER CAR ..... 2008-10  
PONTIAC PASSENGER CAR ..... 2007-10  
SATURN PASSENGER CAR ..... 2008-09



**EM-4028**  
**Engine Torque Strut Mount**  
**Bushing**  
**Upper**

(Continued Next Column)

### EM-4028 (Continued)

FORD PASSENGER CAR ..... 2005-07  
MERCURY PASSENGER CAR ... 2005-07



**EM-4029**  
**MOUNT-ENGINE**  
**L & R Front**

FORD PASSENGER CAR ..... 2005-16



**EM-4031 (NEW)**  
**MOUNT-ENGINE**  
**Left**

DODGE TRUCK ..... 2000-02



**EM-4033**  
**MOUNT-ENGINE**  
**Right**

FORD SPORT UTILITY ..... 2005-12  
**MOUNT-ENGINE**  
**Front**

MAZDA SPORT UTILITY ..... 2005-11  
MERCURY SPORT UTILITY ..... 2005-11

# BUYER'S GUIDE

## NUMERICAL LISTING - ILLUSTRATIONS

 <p style="text-align: center;"><b>EM-4034</b> <b>MOUNT-TRANSMISSION</b> <b>Auto</b></p> <p>FORD PASSENGER CAR ..... 2006-12 <b>MOUNT-TRANSMISSION</b></p> <p>LINCOLN PASSENGER CAR ..... 2006 <b>MOUNT-TRANSMISSION</b> <b>Manual</b></p> <p>MAZDA PASSENGER CAR ..... 2009-13 <b>MOUNT-TRANSMISSION</b> <b>Auto</b></p> <p>MERCURY PASSENGER CAR ... 2006-11</p>	 <p style="text-align: center;"><b>EM-4037</b> <b>MOUNT-ENGINE</b> <b>Front</b></p> <p>BUICK SPORT UTILITY ..... 2009-17 CHEVROLET SPORT UTILITY ... 2009-17 GMC SPORT UTILITY ..... 2009-17 SATURN SUV ..... 2009-10</p>	<p style="text-align: center;"><b>EM-4040 (Continued)</b></p> <p>MERCURY PASSENGER CAR ... 2008-09</p>  <p style="text-align: center;"><b>EM-4041</b> <b>MOUNT-ENGINE</b> <b>L &amp; R Front</b></p> <p>JEEP SPORT UTILITY ..... 2007-11</p>	 <p style="text-align: center;"><b>EM-4044</b> <b>MOUNT-ENGINE</b> <b>Right</b></p> <p>FORD PASSENGER CAR ..... 2006-09 LINCOLN PASSENGER CAR ..... 2006 MERCURY PASSENGER CAR ... 2006-09</p>
 <p style="text-align: center;"><b>EM-4035</b> <b>MOUNT-ENGINE</b> <b>Rear</b></p> <p>BUICK SPORT UTILITY ..... 2009-17 CHEVROLET SPORT UTILITY ... 2009-17 GMC SPORT UTILITY ..... 2009-17 SATURN SUV ..... 2009-10</p>	 <p style="text-align: center;"><b>EM-4038</b> <b>MOUNT-ENGINE</b> <b>Left</b></p> <p>FORD TRUCK ..... 2005-08 LINCOLN TRUCK ..... 2006-08</p>	 <p style="text-align: center;"><b>EM-4042</b> <b>MOUNT-ENGINE</b> <b>Rear</b></p> <p>CHRYSLER VAN ..... 2008-10 DODGE VAN ..... 2008-10 VOLKSWAGEN VAN ..... 2009-10</p>	 <p style="text-align: center;"><b>EM-4045</b> <b>MOUNT-TRANSMISSION</b> <b>Rear</b></p> <p>CHEVROLET PASSENGER CAR ..... 2008-12 PONTIAC PASSENGER CAR ..... 2008-10 SATURN PASSENGER CAR ..... 2009</p>
 <p style="text-align: center;"><b>EM-4036</b> <b>MOUNT-TRANSMISSION</b></p> <p>BUICK SPORT UTILITY ..... 2009-17 CHEVROLET SPORT UTILITY ... 2009-17 GMC SPORT UTILITY ..... 2009-17 SATURN SUV ..... 2009-10</p>	 <p style="text-align: center;"><b>EM-4039</b> <b>MOUNT-ENGINE</b> <b>Right</b></p> <p>FORD TRUCK ..... 2005-08 LINCOLN TRUCK ..... 2006-08</p>	 <p style="text-align: center;"><b>EM-4043</b> <b>MOUNT-TRANSMISSION</b> <b>Auto</b></p> <p>JEEP SPORT UTILITY ..... 2007-11</p>	 <p style="text-align: center;"><b>EM-4046</b> <b>MOUNT-TRANSMISSION</b> <b>Front</b></p> <p>CHEVROLET PASSENGER CAR ..... 2008-12 PONTIAC PASSENGER CAR ..... 2008-10 SATURN PASSENGER CAR ..... 2009</p>
 <p style="text-align: center;"><b>EM-4040</b> <b>MOUNT-TRANSMISSION</b> <b>Upper</b></p> <p>FORD PASSENGER CAR ..... 2008-19 FORD SPORT UTILITY ..... 2009-19 LINCOLN PASSENGER CAR ..... 2009-16 LINCOLN SPORT UTILITY ..... 2010-15</p> <p style="text-align: center;">(Continued Next Column)</p>	 <p style="text-align: center;"><b>EM-4047</b> <b>MOUNT-TRANSMISSION</b> <b>Center</b></p> <p>CHEVROLET PASSENGER CAR ..... 2004-10</p> <p style="text-align: center;">(Continued Next Page)</p>		

# BUYER'S GUIDE

## NUMERICAL LISTING - ILLUSTRATIONS

### EM-4047 (Continued)

PONTIAC PASSENGER CAR ..... 2007-10  
SATURN PASSENGER CAR ..... 2009



**EM-4049**  
**MOUNT-TRANSMISSION**  
**Front**

BUICK PASSENGER CAR ..... 2016-17  
**MOUNT-TRANSMISSION**

CHEVROLET PASSENGER  
CAR ..... 2011-16



**EM-4050**  
**MOUNT-ENGINE**  
**Front**

CHRYSLER VAN ..... 2011-15  
DODGE VAN ..... 2011-16  
RAM VAN ..... 2012-15  
VOLKSWAGEN VAN ..... 2011-14



**EM-4051**  
**Engine Torque Strut Mount**  
**Rear**

FORD SPORT UTILITY ..... 2005-12  
MERCURY SPORT UTILITY ..... 2006-11



**EM-4053 (NEW)**  
**MOUNT-TRANSMISSION**  
**Center**

CHEVROLET PASSENGER  
CAR ..... 2011-16



**EM-4054 (NEW)**  
**MOUNT-TRANSMISSION**  
**Center**

BUICK PASSENGER CAR ..... 2012-17  
**MOUNT-TRANSMISSION**

CHEVROLET PASSENGER  
CAR ..... 2011-16  
CHEVROLET VAN ..... 2012-14



**EM-4055**  
**Engine Torque Strut Mount**  
**Rear**

FORD PASSENGER CAR ..... 2010-19  
FORD SPORT UTILITY ..... 2010-19  
LINCOLN PASSENGER CAR ..... 2010-15  
LINCOLN SPORT UTILITY ..... 2010-15



**EM-4056**  
**Engine Torque Strut Mount**  
**Front**

FORD PASSENGER CAR ..... 2010-19

(Continued Next Column)

### EM-4056 (Continued)

FORD SPORT UTILITY ..... 2010-19  
LINCOLN PASSENGER CAR ..... 2010-15  
LINCOLN SPORT UTILITY ..... 2010-15



**EM-4057**  
**Engine Torque Strut Mount**  
**Front Lower**

FORD SPORT UTILITY ..... 2013-17  
**Engine Torque Strut Mount**  
**Rear Lower**

FORD PASSENGER CAR ..... 2012-18  
FORD VAN ..... 2014-17  
VOLVO PASSENGER CAR ..... 2004-11



**EM-4058**  
**Engine Torque Strut Mount**  
**Front**

FORD PASSENGER CAR ..... 2011-12  
MERCURY PASSENGER CAR ..... 2010-11



**EM-4059**  
**Engine Torque Strut Mount**  
**Front**

FORD PASSENGER CAR ..... 2010-12  
LINCOLN PASSENGER CAR ..... 2007-12



**EM-4060**  
**MOUNT-TRANSMISSION**  
**Auto**

DODGE MEDIUM/HEAVY  
DUTY ..... 2007-10  
**MOUNT-TRANSMISSION**

DODGE TRUCK ..... 2006-10  
**MOUNT-TRANSMISSION**  
**Manual**

RAM MEDIUM/HEAVY DUTY  
TRUCK ..... 2011-12  
**MOUNT-TRANSMISSION**  
**Auto**

RAM TRUCK ..... 2010-12  
STERLING MEDIUM/HEAVY  
DUTY TRUCK ..... 2008-10



**EM-4061 (NEW)**  
**MOUNT-TRANSMISSION**  
**Front**

CHEVROLET PASSENGER  
CAR ..... 2008-12  
PONTIAC PASSENGER CAR ..... 2007-09  
SATURN PASSENGER CAR ..... 2007-09



**EM-4062 (NEW)**  
**MOUNT-TRANSMISSION**  
**Rear**

CHEVROLET PASSENGER  
CAR ..... 2008-12  
PONTIAC PASSENGER CAR ..... 2007-09  
SATURN PASSENGER CAR ..... 2007-09



# BUYER'S GUIDE

## NUMERICAL LISTING - ILLUSTRATIONS

 <p><b>EM-4063</b> <b>MOUNT-TRANSMISSION</b> Rear</p> <p>SATURN SUV ..... 2008-10</p>	 <p><b>EM-4066 (NEW)</b> <b>Engine Torque Strut Mount</b> Upper</p> <p>FORD PASSENGER CAR ..... 2005-07 MERCURY PASSENGER CAR ... 2005-07</p>	 <p><b>EM-4069 (NEW)</b> <b>MOUNT-TRANSMISSION</b> Lower</p> <p>FORD PASSENGER CAR ..... 2013-14</p>	 <p><b>EM-4073</b> <b>MOUNT-ENGINE</b> L &amp; R Front</p> <p>CHEVROLET TRUCK ..... 2007-13 GMC TRUCK ..... 2007-13</p>
 <p><b>EM-4064</b> <b>MOUNT-TRANSMISSION</b> Center</p> <p>CHEVROLET SPORT UTILITY ... 2008-11</p> <p><b>MOUNT-TRANSMISSION</b> Upper</p> <p>SATURN SUV ..... 2008-10</p>	 <p><b>EM-4067 (NEW)</b> <b>MOUNT-TRANSMISSION</b> Auto</p> <p>FORD PASSENGER CAR ..... 2010-12</p> <p><b>MOUNT-TRANSMISSION</b></p> <p>LINCOLN PASSENGER CAR ..... 2011-12</p> <p><b>MOUNT-TRANSMISSION</b> Auto</p> <p>MERCURY PASSENGER CAR ... 2010-11</p>	 <p><b>EM-4070</b> <b>MOUNT-TRANSMISSION</b> Upper</p> <p>FORD PASSENGER CAR ..... 2013-14</p>	 <p><b>EM-4074 (NEW)</b> <b>MOUNT-ENGINE</b> Right</p> <p>FORD PASSENGER CAR ..... 2011-16 MAZDA PASSENGER CAR ..... 2011-14</p>
 <p><b>EM-4065 (NEW)</b> <b>Engine Torque Strut Mount</b> Upper</p> <p>FORD PASSENGER CAR ..... 2005-07 MERCURY PASSENGER CAR ... 2005-07</p>	 <p><b>EM-4068 (NEW)</b> <b>MOUNT-ENGINE</b> RH Front</p> <p>FORD PASSENGER CAR ..... 2013-15</p>	 <p><b>EM-4071</b> <b>MOUNT-ENGINE</b> LH Front</p> <p>FORD SPORT UTILITY ..... 2005-12 MAZDA SPORT UTILITY ..... 2005-11 MERCURY SPORT UTILITY ..... 2005-11</p>	 <p><b>EM-4076 (NEW)</b> <b>MOUNT-ENGINE</b> RH Front</p> <p>BUICK PASSENGER CAR ..... 2016-17</p> <p><b>MOUNT-ENGINE</b> Right</p> <p>CHEVROLET PASSENGER CAR ..... 2011-16</p>
		 <p><b>EM-4072 (NEW)</b> <b>MOUNT-ENGINE</b> Right</p> <p>CHEVROLET PASSENGER CAR ..... 2004-05</p>	

# BUYER'S GUIDE

## NUMERICAL LISTING - ILLUSTRATIONS

 <p style="text-align: center;"><b>EM-4077</b> <b>MOUNT-TRANSMISSION</b></p> <p>CHRYSLER VAN ..... 2011-15 DODGE VAN ..... 2011-17</p> <p style="text-align: center;"><b>MOUNT-TRANSMISSION</b> <b>Auto</b></p> <p>RAM VAN ..... 2012-15 VOLKSWAGEN VAN ..... 2011-14</p>	 <p style="text-align: center;"><b>EM-4080</b> <b>MOUNT-TRANSMISSION</b> <b>Rear</b></p> <p>BUICK PASSENGER CAR ..... 2012-17 CHEVROLET PASSENGER CAR ..... 2011-16</p> <p style="text-align: center;"><b>MOUNT-TRANSMISSION</b></p> <p>CHEVROLET VAN ..... 2012-14</p>	 <p style="text-align: center;"><b>EM-4084 (NEW)</b> <b>MOUNT-ENGINE</b> <b>LH Front</b></p> <p>DODGE TRUCK ..... 2003-07</p>	 <p style="text-align: center;"><b>EM-4088 (NEW)</b> <b>MOUNT-ENGINE</b> <b>LH Front</b></p> <p>DODGE TRUCK ..... 2002-05</p>
 <p style="text-align: center;"><b>EM-4078</b> <b>MOUNT-TRANSMISSION</b> <b>Rear</b></p> <p>CHEVROLET SPORT UTILITY ... 2008-09 PONTIAC SPORT UTILITY ..... 2008-09</p>	 <p style="text-align: center;"><b>EM-4081</b> <b>MOUNT-TRANSMISSION</b></p> <p>FORD SPORT UTILITY ..... 2007-14 LINCOLN SPORT UTILITY ..... 2007-15</p>	 <p style="text-align: center;"><b>EM-4085 (NEW)</b> <b>MOUNT-ENGINE</b> <b>RH Front</b></p> <p>DODGE TRUCK ..... 2003-07</p>	 <p style="text-align: center;"><b>EM-4089 (NEW)</b> <b>MOUNT-ENGINE</b> <b>RH Front</b></p> <p>DODGE TRUCK ..... 2002-05</p>
 <p style="text-align: center;"><b>EM-4079</b> <b>MOUNT-TRANSMISSION</b> <b>Front</b></p> <p>CHEVROLET SPORT UTILITY ... 2008-09 PONTIAC SPORT UTILITY ..... 2008-09</p>	 <p style="text-align: center;"><b>EM-4082</b> <b>MOUNT-ENGINE</b> <b>RH Front</b></p> <p>FORD PASSENGER CAR ..... 2008-11 FORD VAN ..... 2010-13</p>	 <p style="text-align: center;"><b>EM-4086 (NEW)</b> <b>MOUNT-ENGINE</b> <b>LH Front</b></p> <p>DODGE TRUCK ..... 2002-05</p>	 <p style="text-align: center;"><b>EM-4090 (NEW)</b> <b>MOUNT-ENGINE</b> <b>LH Front</b></p> <p>DODGE MEDIUM/HEAVY DUTY ..... 2007-10</p> <p style="text-align: center;"><b>MOUNT-ENGINE</b> <b>Left</b></p> <p>DODGE TRUCK ..... 2007-10</p> <p style="text-align: center;"><b>MOUNT-ENGINE</b> <b>LH Front</b></p> <p>RAM MEDIUM/HEAVY DUTY TRUCK ..... 2011-13 RAM TRUCK ..... 2010-12</p> <p style="text-align: center;"><b>MOUNT-ENGINE</b> <b>Left</b></p> <p>STERLING MEDIUM/HEAVY DUTY TRUCK ..... 2008-10</p>
 <p style="text-align: center;"><b>EM-4087 (NEW)</b> <b>MOUNT-ENGINE</b> <b>RH Front</b></p> <p>DODGE TRUCK ..... 2002-05</p>	 <p style="text-align: center;"><b>EM-4091 (NEW)</b> <b>MOUNT-ENGINE</b> <b>RH Front</b></p> <p>DODGE MEDIUM/HEAVY DUTY ..... 2008-10</p>	<p><b>(Continued Next Page)</b></p>	

# BUYER'S GUIDE

## NUMERICAL LISTING - ILLUSTRATIONS

### EM-4091 (Continued)

DODGE TRUCK ..... 2007-10  
 RAM MEDIUM/HEAVY DUTY TRUCK ..... 2011-13  
 RAM TRUCK ..... 2010-12

#### MOUNT-ENGINE Right

STERLING MEDIUM/HEAVY DUTY TRUCK ..... 2008-10



#### EM-4094 MOUNT-ENGINE Front

CHRYSLER PASSENGER CAR ..... 2007-14  
 CHRYSLER VAN ..... 2008-10  
 DODGE PASSENGER CAR ..... 2008-10  
 DODGE VAN ..... 2008-10  
 VOLKSWAGEN VAN ..... 2009-10



#### EM-4095 MOUNT-TRANSMISSION

FORD SPORT UTILITY ..... 2006-10



#### EM-4096 MOUNT-TRANSMISSION

HUMMER ..... 2006-10



#### EM-4097 MOUNT-ENGINE LH Front

FORD SPORT UTILITY ..... 2003-06  
 LINCOLN SPORT UTILITY ..... 2003-06



#### EM-4098 (NEW) MOUNT-ENGINE RH Front

FORD SPORT UTILITY ..... 2003  
 LINCOLN SPORT UTILITY ..... 2003



#### EM-4099 MOUNT-ENGINE RH Front

FORD SPORT UTILITY ..... 2004-06  
 LINCOLN SPORT UTILITY ..... 2004-06



#### EM-4100 MOUNT-ENGINE LH Front

JEEP SPORT UTILITY ..... 2005-09



#### EM-4101 MOUNT-ENGINE LH Front

DODGE SPORT UTILITY ..... 2007-11  
 JEEP SPORT UTILITY ..... 2008-12



#### EM-4102 DIFFERENTIAL MOUNT - FRONT

JEEP SPORT UTILITY ..... 2006-10



#### EM-4103 MOUNT-ENGINE LH Front

JEEP SPORT UTILITY ..... 2005-10



#### EM-4104 MOUNT-ENGINE RH Front

JEEP SPORT UTILITY ..... 2005-10



#### EM-4105 MOUNT-ENGINE RH Front

JEEP SPORT UTILITY ..... 2005-09



#### EM-4106 MOUNT-ENGINE LH Front

FORD SPORT UTILITY ..... 2006-10  
 MERCURY SPORT UTILITY ..... 2006-10



#### EM-4107 (NEW) MOUNT-TRANSMISSION

CHRYSLER PASSENGER CAR ..... 2009-14  
 DODGE PASSENGER CAR ..... 2009-14

#### MOUNT-TRANSMISSION Auto

DODGE SPORT UTILITY ..... 2009-18

# BUYER'S GUIDE

## NUMERICAL LISTING - ILLUSTRATIONS

 <p style="text-align: center;"><b>EM-4108</b> <b>MOUNT-TRANSMISSION</b> <b>Auto</b></p> <p>CHEVROLET VAN ..... 2003-14 GMC VAN ..... 2003-14</p>	 <p style="text-align: center;"><b>EM-4112</b> <b>MOUNT-ENGINE</b> <b>Right</b></p> <p>CHRYSLER PASSENGER CAR ..... 2011-14 DODGE PASSENGER CAR ..... 2011-14</p>	 <p style="text-align: center;"><b>EM-4115 (NEW)</b> <b>Engine Torque Strut Mount</b> <b>Rear</b></p> <p>CHEVROLET PASSENGER CAR ..... 2012-17</p>	 <p style="text-align: center;"><b>EM-4119 (NEW)</b> <b>MOUNT-TRANSMISSION</b> <b>Auto</b></p> <p>BUICK SPORT UTILITY ..... 2004</p> <p style="text-align: center;"><b>MOUNT-TRANSMISSION</b></p> <p>CHEVROLET TRUCK ..... 2005-06</p> <p style="text-align: center;"><b>MOUNT-TRANSMISSION</b> <b>Auto</b></p> <p>GMC SPORT UTILITY ..... 2005 SAAB SUV ..... 2005-09</p>
 <p style="text-align: center;"><b>EM-4109 (NEW)</b> <b>MOUNT-ENGINE</b> <b>Rear</b></p> <p>DODGE SPORT UTILITY ..... 2009-10</p>	 <p style="text-align: center;"><b>EM-4113</b> <b>MOUNT-ENGINE</b> <b>Front</b></p> <p>CHRYSLER PASSENGER CAR ..... 2011-14 DODGE PASSENGER CAR ..... 2011-14 DODGE SPORT UTILITY ..... 2011-16</p>	 <p style="text-align: center;"><b>EM-4116 (NEW)</b> <b>MOUNT-TRANSMISSION</b></p> <p>CHEVROLET PASSENGER CAR ..... 2012-16</p>	 <p style="text-align: center;"><b>EM-4120</b> <b>Engine Torque Strut Mount</b> <b>Front</b></p> <p>FORD SPORT UTILITY ..... 2012-15</p>
 <p style="text-align: center;"><b>EM-4110</b> <b>Engine Torque Strut Mount</b> <b>Rear Lower</b></p> <p>FORD PASSENGER CAR ..... 2012-18</p>	 <p style="text-align: center;"><b>EM-4114 (NEW)</b> <b>MOUNT-ENGINE</b> <b>Front</b></p> <p>CHEVROLET PASSENGER CAR ..... 2012-16</p>	 <p style="text-align: center;"><b>EM-4117</b> <b>MOUNT-TRANSMISSION</b> <b>Auto</b></p> <p>FORD SPORT UTILITY ..... 2005-12 MAZDA SPORT UTILITY ..... 2005-11</p> <p style="text-align: center;"><b>MOUNT-TRANSMISSION</b></p> <p>MERCURY SPORT UTILITY ..... 2005-11</p>	 <p style="text-align: center;"><b>EM-4121 (NEW)</b> <b>MOUNT-TRANSMISSION</b> <b>Upper</b></p> <p>FORD PASSENGER CAR ..... 2012-18 FORD SPORT UTILITY ..... 2013-19 FORD VAN ..... 2014-19</p> <p style="text-align: center;"><b>MOUNT-TRANSMISSION</b> <b>Auto</b></p> <p>LINCOLN SPORT UTILITY ..... 2015-18 VOLVO PASSENGER CAR ..... 2004-11</p>
 <p style="text-align: center;"><b>EM-4111 (NEW)</b> <b>MOUNT-TRANSMISSION</b> <b>Front</b></p> <p>CHEVROLET SPORT UTILITY .... 2010-17 GMC SPORT UTILITY ..... 2010-15</p>			



# BUYER'S GUIDE

## NUMERICAL LISTING - ILLUSTRATIONS

 <p style="text-align: center;"><b>EM-4122 (NEW)</b> <b>MOUNT-ENGINE</b> <b>Right</b></p> <p>SATURN PASSENGER CAR ..... 2008-09</p>	 <p style="text-align: center;"><b>EM-4126</b> <b>MOUNT-TRANSMISSION</b></p> <p>PONTIAC PASSENGER CAR ..... 2007-09 SATURN PASSENGER CAR ..... 2007-10</p>	 <p style="text-align: center;"><b>EM-4129</b> <b>MOUNT-TRANSMISSION</b> <b>Center</b></p> <p>CHEVROLET PASSENGER CAR ..... 2011-12</p>	 <p style="text-align: center;"><b>EM-4134 (NEW)</b> <b>MOUNT-TRANSMISSION</b> <b>Center</b></p> <p>CHEVROLET PASSENGER CAR ..... 2009-12 PONTIAC PASSENGER CAR ..... 2008-10 SATURN PASSENGER CAR ..... 2008-09</p>
 <p style="text-align: center;"><b>EM-4123 (NEW)</b> <b>MOUNT-ENGINE</b> <b>RH Front</b></p> <p>JEEP SPORT UTILITY ..... 2005-10</p>	 <p style="text-align: center;"><b>EM-4127</b> <b>MOUNT-TRANSMISSION</b></p> <p>CHRYSLER PASSENGER CAR ..... 2007-14 CHRYSLER VAN ..... 2008-10</p> <p style="text-align: center;"><b>MOUNT-TRANSMISSION</b> <b>Auto</b></p> <p>DODGE PASSENGER CAR ..... 2008-14 DODGE SPORT UTILITY ..... 2009-18</p> <p style="text-align: center;"><b>MOUNT-TRANSMISSION</b></p> <p>DODGE VAN ..... 2008-10 VOLKSWAGEN VAN ..... 2009-10</p>	 <p style="text-align: center;"><b>EM-4130 (NEW)</b> <b>Engine Torque Strut Mount</b> <b>Lower</b></p> <p>CHEVROLET PASSENGER CAR ..... 2013-15</p>	 <p style="text-align: center;"><b>EM-4135 (NEW)</b> <b>MOUNT-TRANSMISSION</b> <b>Rear</b></p> <p>CHEVROLET SPORT UTILITY .... 2010-17 GMC SPORT UTILITY ..... 2010-16</p>
 <p style="text-align: center;"><b>EM-4124 (NEW)</b> <b>MOUNT-TRANSMISSION</b></p> <p>FORD PASSENGER CAR ..... 2005-14</p>	 <p style="text-align: center;"><b>EM-4128 (NEW)</b> <b>MOUNT-TRANSMISSION</b> <b>Center</b></p> <p>BUICK PASSENGER CAR ..... 2011-17 CHEVROLET PASSENGER CAR ..... 2013-15</p>	 <p style="text-align: center;"><b>EM-4131 (NEW)</b> <b>MOUNT-TRANSMISSION</b> <b>Upper</b></p> <p>CHEVROLET PASSENGER CAR ..... 2013-15</p>	 <p style="text-align: center;"><b>EM-4137 (NEW)</b> <b>MOUNT-ENGINE</b> <b>Left</b></p> <p>FORD MEDIUM/HEAVY DUTY .... 2005-07 FORD TRUCK ..... 2005-07</p>
 <p style="text-align: center;"><b>EM-4125 (NEW)</b> <b>MOUNT-ENGINE</b> <b>Front</b></p> <p>FORD SPORT UTILITY ..... 2012-19</p>	 <p style="text-align: center;"><b>EM-4132 (NEW)</b> <b>MOUNT-ENGINE</b> <b>Rear</b></p> <p>CHRYSLER VAN ..... 2011-15 DODGE PASSENGER CAR ..... 2011-14 DODGE SPORT UTILITY ..... 2011-16 DODGE VAN ..... 2011-16 RAM VAN ..... 2012-15 VOLKSWAGEN VAN ..... 2011-14</p>		

# BUYER'S GUIDE

## NUMERICAL LISTING - ILLUSTRATIONS

 <p style="text-align: center;"><b>EM-4138 (NEW)</b> Engine Torque Strut Mount Rear</p> <p>FORD SPORT UTILITY ..... 2011-15</p>	 <p style="text-align: center;"><b>EM-4142 (NEW)</b> MOUNT-ENGINE RH Front</p> <p>FORD SPORT UTILITY ..... 2007-17 FORD TRUCK ..... 2009-18 LINCOLN SPORT UTILITY ..... 2007-17 LINCOLN TRUCK ..... 2010-14</p>	 <p style="text-align: center;"><b>EM-4147</b> MOUNT-TRANSMISSION</p> <p>FORD PASSENGER CAR ..... 1992-93</p> <p style="text-align: center;"><b>MOUNT-TRANSMISSION Auto</b></p> <p>LINCOLN PASSENGER CAR ..... 1991</p> <p style="text-align: center;"><b>MOUNT-TRANSMISSION</b></p> <p>MERCURY PASSENGER CAR ... 1992-93</p>	 <p style="text-align: center;"><b>EM-4151 (NEW)</b> MOUNT-TRANSMISSION Manual</p> <p>DODGE TRUCK ..... 2003-05</p>
 <p style="text-align: center;"><b>EM-4139 (NEW)</b> MOUNT-ENGINE RH Front</p> <p>FORD SPORT UTILITY ..... 2013-19</p>	 <p style="text-align: center;"><b>EM-4143 (NEW)</b> MOUNT-ENGINE LH Front</p> <p>FORD SPORT UTILITY ..... 2007-17 FORD TRUCK ..... 2009-18 LINCOLN SPORT UTILITY ..... 2007-17 LINCOLN TRUCK ..... 2010-14</p>	 <p style="text-align: center;"><b>EM-4149 (NEW)</b> MOUNT-ENGINE L &amp; R Front</p> <p>CHEVROLET PASSENGER CAR ..... 2010-15</p>	 <p style="text-align: center;"><b>EM-4152 (NEW)</b> MOUNT-ENGINE RH Front</p> <p>FORD PASSENGER CAR ..... 2014-17</p> <p style="text-align: center;"><b>MOUNT-ENGINE Right</b></p> <p>FORD SPORT UTILITY ..... 2013-17 FORD VAN ..... 2014-17</p>
 <p style="text-align: center;"><b>EM-4140 (NEW)</b> MOUNT-TRANSMISSION</p> <p>FORD SPORT UTILITY ..... 2011-17</p>	 <p style="text-align: center;"><b>EM-4146 (NEW)</b> Engine Torque Strut Mount Front</p> <p>FORD PASSENGER CAR ..... 2010-12 MERCURY PASSENGER CAR ... 2010-11</p>	 <p style="text-align: center;"><b>EM-4150 (NEW)</b> MOUNT-ENGINE L &amp; R Front</p> <p>CHRYSLER PASSENGER CAR ..... 2011-18 DODGE PASSENGER CAR ..... 2011-17</p>	 <p style="text-align: center;"><b>EM-4153 (NEW)</b> MOUNT-TRANSMISSION</p> <p>JEEP SPORT UTILITY ..... 2005-10</p>
 <p style="text-align: center;"><b>EM-4141 (NEW)</b> MOUNT-ENGINE Rear</p> <p>FORD PASSENGER CAR ..... 2005-07 MERCURY PASSENGER CAR ... 2005-07</p>			 <p style="text-align: center;"><b>EM-4154 (NEW)</b> MOUNT-TRANSMISSION</p> <p>FORD PASSENGER CAR ..... 2011-16</p>

# BUYER'S GUIDE

## NUMERICAL LISTING - ILLUSTRATIONS



**EM-4155 (NEW)**  
**MOUNT-ENGINE**  
**Front**

CHEVROLET SPORT UTILITY	.....	2010-15
GMC SPORT UTILITY	.....	2010-17
SATURN SUV	.....	2008-10



**EM-4156 (NEW)**  
**MOUNT-TRANSMISSION**  
**Auto**

CHEVROLET TRUCK	.....	2007-16
GMC TRUCK	.....	2011-16



**EM-4157 (NEW)**  
**MOUNT-TRANSMISSION**  
**Auto**

CHEVROLET TRUCK	.....	2011-16
-----------------	-------	---------



**EM-4158 (NEW)**  
**MOUNT-TRANSMISSION**  
**Center**

CHEVROLET PASSENGER CAR	.....	2005-11
-------------------------	-------	---------

(Continued Next Column)

**EM-4158 (Continued)**

PONTIAC PASSENGER CAR	.....	2007-09
SATURN PASSENGER CAR	.....	2005-07



**EM-4159 (NEW)**  
**MOUNT-TRANSMISSION**  
**Auto**

CHEVROLET TRUCK	.....	2011-16
GMC TRUCK	.....	2011-16



**EM-4160 (NEW)**  
**Engine Torque Strut Mount**  
**Front**

FORD PASSENGER CAR	.....	2005-07
MERCURY PASSENGER CAR	.....	2005-07



**EM-4161 (NEW)**  
**MOUNT-ENGINE**  
**Right**

CHEVROLET SPORT UTILITY	.....	2010-15
GMC SPORT UTILITY	.....	2010-15



**EM-4167 (NEW)**  
**MOUNT-ENGINE**  
**LH Front**

DODGE PASSENGER CAR	.....	2005-10
---------------------	-------	---------



**EM-4163 (NEW)**  
**MOUNT-ENGINE**  
**L & R Front**

CHEVROLET TRUCK	.....	2011-16
GMC TRUCK	.....	2011-16



**EM-4164 (NEW)**  
**Engine Torque Strut Mount**  
**Rear**

FORD PASSENGER CAR	.....	2011-14
--------------------	-------	---------



**EM-4166 (NEW)**  
**MOUNT-ENGINE**  
**Rear**

CHRYSLER PASSENGER CAR	.....	2007-10
DODGE PASSENGER CAR	.....	2008-10



**EM-4167 (NEW)**  
**MOUNT-ENGINE**  
**LH Front**

DODGE PASSENGER CAR	.....	2005-10
---------------------	-------	---------



**EM-4168 (NEW)**  
**MOUNT-ENGINE**  
**L & R Front**

CHRYSLER PASSENGER CAR	.....	2012-14
DODGE PASSENGER CAR	.....	2012-16
DODGE SPORT UTILITY	.....	2011-15
JEEP SPORT UTILITY	.....	2011-15



**EM-4169 (NEW)**  
**Engine Torque Strut Mount**  
**Front**

BUICK PASSENGER CAR	.....	1994-09
BUICK SPORT UTILITY	.....	2002-07
BUICK VAN	.....	2005-07
CHEVROLET PASSENGER CAR	.....	1995-11
CHEVROLET VAN	.....	1997-09
OLDSMOBILE PASSENGER CAR	.....	1994-02
OLDSMOBILE VAN	.....	1997-04
PONTIAC PASSENGER CAR	.....	1994-08
PONTIAC SPORT UTILITY	.....	2001-05
PONTIAC VAN	.....	1997-05
SATURN VAN	.....	2005-07



**EM-4171 (NEW)**  
**TRANSMISSION MOUNT**  
**BUSHING**  
**Front**

CHEVROLET PASSENGER CAR	.....	2005-11
CHEVROLET SPORT UTILITY	.....	2012-15
PONTIAC PASSENGER CAR	.....	2007-09
SATURN PASSENGER CAR	.....	2003-07

# BUYER'S GUIDE

## NUMERICAL LISTING - ILLUSTRATIONS

 <p style="text-align: center;"><b>EM-4172 (NEW)</b> <b>MOUNT-TRANSMISSION</b> <b>Auto</b></p> <p>DODGE SPORT UTILITY ..... 2011-17 JEEP SPORT UTILITY ..... 2011-16</p>	 <p style="text-align: center;"><b>EM-4175 (NEW)</b> <b>MOUNT-TRANSMISSION</b> <b>Front</b></p> <p>CHEVROLET SPORT UTILITY ... 2010-15 GMC SPORT UTILITY ..... 2010-16</p>	<p><b>EM-4178 (Continued)</b></p> <p>DODGE PASSENGER CAR ..... 2013-14 DODGE SPORT UTILITY ..... 2011-16</p>  <p style="text-align: center;"><b>EM-4179 (NEW)</b> <b>MOUNT-ENGINE</b> <b>RH Front</b></p> <p>CHRYSLER PASSENGER CAR ..... 2012-14</p> <p style="text-align: center;"><b>MOUNT-ENGINE</b> <b>Right</b></p> <p>DODGE SPORT UTILITY ..... 2011-16</p>	 <p style="text-align: center;"><b>EM-4182 (NEW)</b> <b>MOUNT-ENGINE</b> <b>Right</b></p> <p>JEEP SPORT UTILITY ..... 2007-11</p>
 <p style="text-align: center;"><b>EM-4173 (NEW)</b> <b>MOUNT-ENGINE</b> <b>LH Front</b></p> <p>CADILLAC SPORT UTILITY ..... 2015-16 CHEVROLET SPORT UTILITY ... 2015-16 CHEVROLET TRUCK ..... 2014-16 GMC SPORT UTILITY ..... 2015-16 GMC TRUCK ..... 2014-16</p>	 <p style="text-align: center;"><b>EM-4176 (NEW)</b> <b>MOUNT-TRANSMISSION</b> <b>Manual</b></p> <p>FORD TRUCK ..... 2008-10</p>	 <p style="text-align: center;"><b>EM-4180 (NEW)</b> <b>MOUNT-TRANSMISSION</b> <b>Center</b></p> <p>CHEVROLET SPORT UTILITY ... 2010-15 GMC SPORT UTILITY ..... 2010-16</p>	 <p style="text-align: center;"><b>EM-4183 (NEW)</b> <b>Engine Torque Strut Mount</b> <b>Lower</b></p> <p>CADILLAC PASSENGER CAR ... 2014-15 CHEVROLET PASSENGER CAR ..... 2011-15</p>
 <p style="text-align: center;"><b>EM-4174 (NEW)</b> <b>MOUNT-ENGINE</b> <b>RH Front</b></p> <p>CADILLAC SPORT UTILITY ..... 2015-16 CHEVROLET SPORT UTILITY ... 2015-16 CHEVROLET TRUCK ..... 2014-16 GMC SPORT UTILITY ..... 2015-16 GMC TRUCK ..... 2014-16</p>	 <p style="text-align: center;"><b>EM-4177 (NEW)</b> <b>MOUNT-TRANSMISSION</b> <b>Auto</b></p> <p>FORD TRUCK ..... 2011-16</p>	 <p style="text-align: center;"><b>EM-4181 (NEW)</b> <b>MOUNT-ENGINE</b> <b>Left</b></p> <p>JEEP SPORT UTILITY ..... 2007-11</p>	 <p style="text-align: center;"><b>EM-4184 (NEW)</b> <b>Engine Torque Strut Mount</b> <b>Rear</b></p> <p>FORD PASSENGER CAR ..... 2013-18 FORD SPORT UTILITY ..... 2015-17 LINCOLN PASSENGER CAR ..... 2013-18</p>
	 <p style="text-align: center;"><b>EM-4178 (NEW)</b> <b>MOUNT-TRANSMISSION</b> <b>Auto</b></p> <p>CHRYSLER PASSENGER CAR ..... 2011-14</p> <p style="text-align: center;"><b>MOUNT-TRANSMISSION</b> <b>Auto</b></p> <p style="text-align: center;">(Continued Next Column)</p>		



# BUYER'S GUIDE

## NUMERICAL LISTING - ILLUSTRATIONS

 <p style="text-align: center;"><b>EM-4185 (NEW)</b> <b>MOUNT-ENGINE</b> <b>LH Front</b></p> <p>JEEP SPORT UTILITY ..... 2005-10</p>	 <p style="text-align: center;"><b>EM-4190 (NEW)</b> <b>MOUNT-ENGINE</b> <b>Right</b></p> <p>FORD SPORT UTILITY ..... 2013-17</p>	<p><b>EM-4194 (Continued)</b> PONTIAC PASSENGER CAR ..... 2006-09</p>  <p style="text-align: center;"><b>EM-4195 (NEW)</b> <b>MOUNT-TRANSMISSION</b> <b>Front</b></p> <p>CHEVROLET PASSENGER CAR ..... 2006-07 PONTIAC PASSENGER CAR ..... 2006-09</p>	 <p style="text-align: center;"><b>EM-4200 (NEW)</b> <b>Engine Torque Strut Mount</b> <b>Lower</b></p> <p>FORD SPORT UTILITY ..... 2015-16 LINCOLN PASSENGER CAR ..... 2013-16 LINCOLN SPORT UTILITY ..... 2016</p>
<p style="text-align: center;"><b>EM-4186 (NEW)</b> <b>MOUNT-ENGINE</b> <b>Front</b></p> <p>CHRYSLER VAN ..... 2011-15 DODGE VAN ..... 2011-16 RAM VAN ..... 2012-15 VOLKSWAGEN VAN ..... 2011-14</p>	 <p style="text-align: center;"><b>EM-4192 (NEW)</b> <b>MOUNT-TRANSMISSION</b> <b>Center</b></p> <p>CHEVROLET SPORT UTILITY .... 2010-17 GMC SPORT UTILITY ..... 2010-15</p>	<p style="text-align: center;"><b>EM-4196 (NEW)</b> <b>MOUNT-TRANSMISSION</b> <b>Manual</b></p> <p>CHEVROLET TRUCK ..... 2015-18 <b>MOUNT-TRANSMISSION</b> <b>Auto</b></p> <p>GMC TRUCK ..... 2015-18</p>	 <p style="text-align: center;"><b>EM-4201 (NEW)</b> <b>MOUNT-ENGINE</b> <b>Rear</b></p> <p>DODGE SPORT UTILITY ..... 2009-16</p>
 <p style="text-align: center;"><b>EM-4187 (NEW)</b> <b>MOUNT-TRANSMISSION</b> <b>Auto</b></p> <p>FORD TRUCK ..... 2008-10</p>	 <p style="text-align: center;"><b>EM-4193 (NEW)</b> <b>Engine Torque Strut Mount</b> <b>Rear</b></p> <p>CHRYSLER PASSENGER CAR ..... 2015-16 JEEP SPORT UTILITY ..... 2014-16</p>	 <p style="text-align: center;"><b>EM-4198 (NEW)</b> <b>MOUNT-ENGINE</b> <b>Rear</b></p> <p>DODGE SPORT UTILITY ..... 2011-16</p>	 <p style="text-align: center;"><b>EM-4202 (NEW)</b> <b>Engine Torque Strut Mount</b> <b>Upper</b></p> <p>FORD SPORT UTILITY ..... 2015-16 LINCOLN PASSENGER CAR ..... 2013-16 LINCOLN SPORT UTILITY ..... 2016</p>
 <p style="text-align: center;"><b>EM-4189 (NEW)</b> <b>MOUNT-ENGINE</b> <b>Right</b></p> <p>CADILLAC PASSENGER CAR .... 2014-15 CHEVROLET PASSENGER CAR ..... 2011-15</p>	 <p style="text-align: center;"><b>EM-4194 (NEW)</b> <b>MOUNT-TRANSMISSION</b> <b>Rear</b></p> <p>CHEVROLET PASSENGER CAR ..... 2006-07 <b>(Continued Next Column)</b></p>	 <p style="text-align: center;"><b>EM-4199 (NEW)</b> <b>Engine Torque Strut Mount</b> <b>Lower</b></p> <p>FORD PASSENGER CAR ..... 2013-17</p>	<p style="text-align: center;"><b>EM-4203 (NEW)</b> <b>Engine Torque Strut Mount</b> <b>Rear</b></p> <p>DODGE PASSENGER CAR ..... 2013-16</p> <p style="text-align: center;"><b>EM-4205 (NEW)</b> <b>MOUNT-ENGINE</b> <b>RH Front</b></p> <p>FORD PASSENGER CAR ..... 2013-18 LINCOLN PASSENGER CAR ..... 2013-18</p>

# BUYER'S GUIDE

## NUMERICAL LISTING - ILLUSTRATIONS

 <p style="text-align: center;"><b>EM-4206 (NEW)</b> <b>MOUNT-TRANSMISSION</b> Front</p> <p>CHEVROLET PASSENGER CAR ..... 2004-12 PONTIAC PASSENGER CAR ..... 2005-10 SATURN PASSENGER CAR ..... 2007-09</p>	 <p style="text-align: center;"><b>EM-4211 (NEW)</b> <b>MOUNT-TRANSMISSION</b> Auto</p> <p>FORD VAN ..... 2015-17</p>	 <p style="text-align: center;"><b>EM-4215 (NEW)</b> <b>MOUNT-TRANSMISSION</b> Auto</p> <p>JEEP SPORT UTILITY ..... 2012-16</p>	 <p style="text-align: center;"><b>EM-4220 (NEW)</b> <b>MOUNT-ENGINE</b> Rear</p> <p>CHEVROLET PASSENGER CAR ..... 2012-16</p>
<p style="text-align: center;"><b>MOUNT-TRANSMISSION</b> Rear</p> <p>CHEVROLET PASSENGER CAR ..... 2004-12 PONTIAC PASSENGER CAR ..... 2005-10 SATURN PASSENGER CAR ..... 2007-09</p>  <p style="text-align: center;"><b>EM-4208 (NEW)</b> <b>MOUNT-ENGINE</b> Right</p> <p>FORD PASSENGER CAR ..... 2010-12 LINCOLN PASSENGER CAR ..... 2007-12</p>	 <p style="text-align: center;"><b>EM-4212 (NEW)</b> <b>MOUNT-ENGINE</b> Rear</p> <p>BUICK PASSENGER CAR ..... 2006-11 CADILLAC PASSENGER CAR ..... 2006-11</p>	<p style="text-align: center;"><b>MOUNT-ENGINE</b> L &amp; R Front</p> <p>FORD PASSENGER CAR ..... 2007-14</p>  <p style="text-align: center;"><b>EM-4217 (NEW)</b> <b>MOUNT-TRANSMISSION</b> Auto</p> <p>JEEP SPORT UTILITY ..... 2006-12</p>	 <p style="text-align: center;"><b>EM-4221 (NEW)</b> <b>MOUNT-ENGINE</b> Right</p> <p>FORD SPORT UTILITY ..... 2012-14</p>
 <p style="text-align: center;"><b>EM-4209 (NEW)</b> <b>MOUNT-ENGINE</b> RH Front</p> <p>FORD PASSENGER CAR ..... 2010-17 FORD SPORT UTILITY ..... 2010-16</p>	 <p style="text-align: center;"><b>EM-4213 (NEW)</b> <b>MOUNT-ENGINE</b> LH Front</p> <p>JEEP SPORT UTILITY ..... 2012-17</p>	 <p style="text-align: center;"><b>EM-4218 (NEW)</b> <b>MOUNT-TRANSMISSION</b> Manual</p> <p>CADILLAC PASSENGER CAR ..... 2013-17</p>	<p style="text-align: center;"><b>MOUNT-TRANSMISSION</b> Center</p> <p>BUICK PASSENGER CAR ..... 2010-16 CADILLAC PASSENGER CAR ..... 2013-17 CHEVROLET PASSENGER CAR ..... 2013-18</p>  <p style="text-align: center;"><b>EM-4224 (NEW)</b> <b>MOUNT-TRANSMISSION</b> Auto</p> <p>CADILLAC PASSENGER CAR ..... 2008-15</p>
<p style="text-align: center;"><b>MOUNT-ENGINE</b> Front</p> <p>LINCOLN PASSENGER CAR ..... 2013-15</p> <p style="text-align: center;"><b>MOUNT-ENGINE</b> RH Front</p> <p>LINCOLN SPORT UTILITY ..... 2010-15</p>	 <p style="text-align: center;"><b>EM-4214 (NEW)</b> <b>MOUNT-ENGINE</b> RH Front</p> <p>JEEP SPORT UTILITY ..... 2012-17</p>	<p style="text-align: center;"><b>MOUNT-TRANSMISSION</b></p> <p>CHEVROLET PASSENGER CAR ..... 2010-17</p>	<p style="text-align: center;"><b>MOUNT-TRANSMISSION</b></p> <p>CHEVROLET PASSENGER CAR ..... 2010-17</p>

# BUYER'S GUIDE

## NUMERICAL LISTING - ILLUSTRATIONS

 <p style="text-align: center;"><b>EM-4226 (NEW)</b> <b>MOUNT-TRANSMISSION</b> <b>Manual</b></p> <p>CHEVROLET PASSENGER CAR ..... 2010-15</p>	 <p style="text-align: center;"><b>EM-4229 (NEW)</b> <b>MOUNT-ENGINE</b> <b>Right</b></p> <p>FORD PASSENGER CAR ..... 2014-17            FORD SPORT UTILITY ..... 2013-17            FORD VAN ..... 2014-17            LINCOLN SPORT UTILITY ..... 2015-18</p>	 <p style="text-align: center;"><b>EM-4232 (NEW)</b> <b>MOUNT-ENGINE</b> <b>RH Front</b></p> <p>CHEVROLET TRUCK ..... 2009-12            GMC TRUCK ..... 2009-12</p>	 <p style="text-align: center;"><b>EM-4243 (NEW)</b> <b>MOUNT-ENGINE</b> <b>RH Front</b></p> <p>FIAT PASSENGER CAR ..... 2012-15</p>
 <p style="text-align: center;"><b>EM-4227 (NEW)</b> <b>Engine Torque Strut Mount</b> <b>Lower</b></p> <p>BUICK SPORT UTILITY ..... 2013-16            CHEVROLET PASSENGER CAR ..... 2012-16            CHEVROLET SPORT UTILITY ..... 2015-16</p>	 <p style="text-align: center;"><b>EM-4230 (NEW)</b> <b>MOUNT-TRANSMISSION</b> <b>Manual</b></p> <p>FORD PASSENGER CAR ..... 2011-16</p>	 <p style="text-align: center;"><b>EM-4234 (NEW)</b> <b>MOUNT-TRANSMISSION</b> <b>Center</b></p> <p>CHEVROLET PASSENGER CAR ..... 2013-16</p> <p style="text-align: center;"><b>EM-4237 (NEW)</b> <b>MOUNT-ENGINE</b> <b>Left</b></p> <p>CHEVROLET TRUCK ..... 2015-18            GMC TRUCK ..... 2015-18</p> <p style="text-align: center;"><b>EM-4238 (NEW)</b> <b>MOUNT-ENGINE</b> <b>Right</b></p> <p>CHEVROLET TRUCK ..... 2015-18            GMC TRUCK ..... 2015-18</p> <p style="text-align: center;"><b>EM-4239 (NEW)</b> <b>MOUNT-ENGINE</b> <b>Right</b></p> <p>DODGE PASSENGER CAR ..... 2013-16</p> <p style="text-align: center;"><b>EM-4240 (NEW)</b> <b>MOUNT-TRANSMISSION</b> <b>Auto</b></p> <p>DODGE PASSENGER CAR ..... 2013-16</p>	 <p style="text-align: center;"><b>EM-4248 (NEW)</b> <b>MOUNT-ENGINE</b> <b>L &amp; R Front</b></p> <p>CADILLAC PASSENGER CAR ..... 2008-14</p> <p style="text-align: center;"><b>EM-4249 (NEW)</b> <b>MOUNT-ENGINE</b> <b>LH Front</b></p> <p>CHEVROLET TRUCK ..... 2011-16            GMC TRUCK ..... 2011-16</p>
 <p style="text-align: center;"><b>EM-4228 (NEW)</b> <b>MOUNT-TRANSMISSION</b> <b>Auto</b></p> <p>DODGE SPORT UTILITY ..... 2014-17            JEEP SPORT UTILITY ..... 2014-17</p>	 <p style="text-align: center;"><b>EM-4231 (NEW)</b> <b>MOUNT-ENGINE</b> <b>LH Front</b></p> <p>CHEVROLET TRUCK ..... 2009-12            GMC TRUCK ..... 2009-12</p>	 <p style="text-align: center;"><b>EM-4241 (NEW)</b> <b>MOUNT-TRANSMISSION</b> <b>Auto</b></p> <p>CHEVROLET PASSENGER CAR ..... 2010-15</p>	 <p style="text-align: center;"><b>EM-4250 (NEW)</b> <b>MOUNT-ENGINE</b> <b>L &amp; R Front</b></p> <p>CHRYSLER PASSENGER CAR ..... 2005-10            DODGE PASSENGER CAR ..... 2006-10</p>

# BUYER'S GUIDE

## NUMERICAL LISTING - ILLUSTRATIONS

 <p style="text-align: center;"><b>EM-4251 (NEW)</b> <b>MOUNT-TRANSMISSION</b> Auto</p> <p>FORD PASSENGER CAR ..... 2013-17 FORD SPORT UTILITY ..... 2015-17 LINCOLN PASSENGER CAR ..... 2013-17</p> <hr/> <p style="text-align: center;"><b>EM-4252 (NEW)</b> <b>MOUNT-ENGINE</b> Front</p> <p>FORD PASSENGER CAR ..... 2013-17</p> <hr/> <p style="text-align: center;"><b>EM-4253 (NEW)</b> <b>MOUNT-TRANSMISSION</b></p> <p>GMC SPORT UTILITY ..... 2007-08 SATURN SUV ..... 2007-08</p> <hr/> <p style="text-align: center;"><b>EM-4254 (NEW)</b> <b>MOUNT-ENGINE</b> Front</p> <p>FORD PASSENGER CAR ..... 2013-17</p> <hr/>  <p style="text-align: center;"><b>EM-4255 (NEW)</b> <b>MOUNT-TRANSMISSION</b></p> <p>FORD PASSENGER CAR ..... 2010-12 LINCOLN PASSENGER CAR ..... 2007-12 MERCURY PASSENGER CAR ..... 2010-11</p> <hr/>  <p style="text-align: center;"><b>EM-4256 (NEW)</b> <b>MOUNT-ENGINE</b> Right</p> <p>FORD SPORT UTILITY ..... 2013-17 FORD VAN ..... 2014-16</p>	 <p style="text-align: center;"><b>EM-4258 (NEW)</b> <b>MOUNT-ENGINE</b> RH Front</p> <p>DODGE SPORT UTILITY ..... 2007-11 JEEP SPORT UTILITY ..... 2008-12</p> <hr/> <p style="text-align: center;"><b>EM-4261 (NEW)</b> <b>MOUNT-TRANSMISSION</b> Rear</p> <p>BUICK PASSENGER CAR ..... 2010-16 CADILLAC PASSENGER CAR ..... 2013-17 CADILLAC SPORT UTILITY ..... 2010-16 SAAB PASSENGER CAR ..... 2010-11</p> <hr/> <p style="text-align: center;"><b>EM-4264 (NEW)</b> <b>MOUNT-ENGINE</b> RH Front</p> <p>CHRYSLER PASSENGER CAR ..... 2015-17</p> <hr/> <p style="text-align: center;"><b>EM-4265 (NEW)</b> <b>MOUNT-ENGINE</b> RH Front</p> <p>CHRYSLER PASSENGER CAR ..... 2015-17 JEEP SPORT UTILITY ..... 2014-18</p> <hr/> <p style="text-align: center;"><b>EM-4266 (NEW)</b> <b>MOUNT-TRANSMISSION</b> Auto</p> <p>CHRYSLER PASSENGER CAR ..... 2015-17 JEEP SPORT UTILITY ..... 2014-18</p> <hr/> <p style="text-align: center;"><b>EM-4267 (NEW)</b> <b>MOUNT-TRANSMISSION</b> Upper</p> <p>CHEVROLET PASSENGER CAR ..... 2014-15</p> <hr/> <p style="text-align: center;"><b>EM-4268 (NEW)</b> <b>MOUNT-ENGINE</b> Left</p> <p>FORD SPORT UTILITY ..... 2003-05 FORD TRUCK ..... 2003-04</p> <hr/> <p style="text-align: center;"><b>EM-4269 (NEW)</b> <b>MOUNT-ENGINE</b> Right</p> <p>FORD SPORT UTILITY ..... 2003-05 FORD TRUCK ..... 2003-04</p> <hr/> <p style="text-align: center;"><b>EM-4270 (NEW)</b> <b>MOUNT-ENGINE</b> RH Front</p> <p>FORD SPORT UTILITY ..... 2015-18</p> <hr/> <p style="text-align: center;"><b>MOUNT-ENGINE</b> Right</p> <p>LINCOLN PASSENGER CAR ..... 2013-18</p> <p style="text-align: center;">(Continued Next Column)</p>	<p style="text-align: center;"><b>EM-4270 (Continued)</b></p> <p style="text-align: center;"><b>MOUNT-ENGINE</b> RH Front</p> <p>LINCOLN SPORT UTILITY ..... 2016-18</p> <hr/> <p style="text-align: center;"><b>EM-4274 (NEW)</b> <b>MOUNT-ENGINE</b> RH Front</p> <p>DODGE TRUCK ..... 2005-10</p> <hr/> <p style="text-align: center;"><b>EM-4275 (NEW)</b> <b>MOUNT-ENGINE</b> LH Front</p> <p>DODGE TRUCK ..... 2008-10 RAM TRUCK ..... 2011-12</p> <hr/> <p style="text-align: center;"><b>EM-4295 (NEW)</b> <b>Engine Torque Strut Mount</b> Rear Left</p> <p>BUICK PASSENGER CAR ..... 2018-19 CHEVROLET PASSENGER CAR ..... 2016-18</p> <hr/> <p style="text-align: center;"><b>EM-4298 (NEW)</b> <b>MOUNT-ENGINE</b> Front</p> <p>FORD SPORT UTILITY ..... 2013-19</p> <hr/>  <p style="text-align: center;"><b>EM-5020*</b> <b>MOUNT-ENGINE</b> L &amp; R Front</p> <p>CHRYSLER PASSENGER CAR ..... 1996-97 DODGE PASSENGER CAR ..... 1996-97</p> <hr/>  <p style="text-align: center;"><b>EM-5026*</b> <b>MOUNT-ENGINE</b> RH Front</p> <p>CHEVROLET PASSENGER CAR ..... 1995-02 PONTIAC PASSENGER CAR ..... 1995-02</p>	 <p style="text-align: center;"><b>EM-5028*</b> <b>MOUNT-ENGINE</b> RH Front</p> <p>CHEVROLET PASSENGER CAR ..... 1992-93</p> <hr/>  <p style="text-align: center;"><b>EM-5031*</b> <b>MOUNT-ENGINE</b> RH Front</p> <p>BUICK PASSENGER CAR ..... 1992-98 CHEVROLET PASSENGER CAR ..... 1992-96 OLDSMOBILE PASSENGER CAR ..... 1992-98 PONTIAC PASSENGER CAR ..... 1992-98</p> <hr/>  <p style="text-align: center;"><b>EM-5032</b> <b>MOUNT-TRANSMISSION</b> Rear</p> <p>CHEVROLET PASSENGER CAR ..... 1992-96</p>
--	--	---	--

\* = Hydraulic Mount, "S" suffix = solid replacement.



# BUYER'S GUIDE

## NUMERICAL LISTING - ILLUSTRATIONS

 <p style="text-align: center;"><b>EM-5033</b> <b>MOUNT-TRANSMISSION</b> <b>Front</b></p> <p>CHEVROLET PASSENGER CAR ..... 1992-96</p>	 <p style="text-align: center;"><b>EM-5063</b> <b>MOUNT-ENGINE</b> <b>LH Front</b></p> <p>FORD PASSENGER CAR ..... 1984-91 MERCURY PASSENGER CAR ... 1984-87</p>	 <p style="text-align: center;"><b>EM-5067</b> <b>MOUNT-ENGINE</b> <b>LH Front</b></p> <p>BMW PASSENGER CAR ..... 1966-76</p>	 <p style="text-align: center;"><b>EM-5074</b> <b>MOUNT-ENGINE</b> <b>RH Front</b></p> <p>BUICK PASSENGER CAR ..... 1997-99</p> <p style="text-align: center;"><b>MOUNT-ENGINE</b> <b>L &amp; R Front</b></p> <p>CHEVROLET TRUCK ..... 2006-08</p>
 <p style="text-align: center;"><b>EM-5042</b> <b>MOUNT-ENGINE</b> <b>Rear</b></p> <p>TOYOTA PASSENGER CAR ..... 1983-86</p>	 <p style="text-align: center;"><b>EM-5064</b> <b>MOUNT-ENGINE</b> <b>LH Front</b></p> <p>FORD PASSENGER CAR ..... 1986 MERCURY PASSENGER CAR ... 1984-87</p>	 <p style="text-align: center;"><b>EM-5068</b> <b>MOUNT-ENGINE</b> <b>RH Front</b></p> <p>BMW PASSENGER CAR ..... 1966-76</p>	 <p style="text-align: center;"><b>EM-5075</b> <b>MOUNT-TRANSMISSION</b> <b>Rear</b></p> <p>BUICK PASSENGER CAR ..... 1995-98</p> <p style="text-align: center;"><b>MOUNT-TRANSMISSION</b> <b>LH Rear</b></p> <p>OLDSMOBILE PASSENGER CAR ..... 1995-98</p>
 <p style="text-align: center;"><b>EM-5048*</b> <b>MOUNT-ENGINE</b> <b>L &amp; R Front</b></p> <p>LINCOLN PASSENGER CAR ..... 1993-98 MERCURY PASSENGER CAR ... 1994-97</p>	 <p style="text-align: center;"><b>EM-5065</b> <b>MOUNT-ENGINE</b> <b>LH Front</b></p> <p>FORD PASSENGER CAR ..... 1984-87 MERCURY PASSENGER CAR ... 1984-86</p>	 <p style="text-align: center;"><b>EM-5069</b> <b>MOUNT-ENGINE</b> <b>RH Front</b></p> <p>BMW PASSENGER CAR ..... 1985-87</p>	 <p style="text-align: center;"><b>EM-5078</b> <b>MOUNT-TRANSMISSION</b> <b>LH Rear</b></p> <p>CHEVROLET PASSENGER CAR ..... 1999-05 OLDSMOBILE PASSENGER CAR ..... 1997-04 PONTIAC PASSENGER CAR ..... 1999-05</p>
 <p style="text-align: center;"><b>EM-5052</b> <b>MOUNT-TRANSMISSION</b> <b>Auto</b></p> <p>DODGE PASSENGER CAR ..... 1995-99 PLYMOUTH PASSENGER CAR ..... 1995-99</p>		 <p style="text-align: center;"><b>EM-5070</b> <b>MOUNT-ENGINE</b> <b>LH Front</b></p> <p>BMW PASSENGER CAR ..... 1985-87</p>	

\* = Hydraulic Mount, "S" suffix = solid replacement.

# BUYER'S GUIDE

## NUMERICAL LISTING - ILLUSTRATIONS

 <p style="text-align: center;"><b>EM-5079</b> <b>MOUNT-TRANSMISSION</b> <b>LH Front</b></p> <p>CHEVROLET PASSENGER CAR ..... 1999-03 OLDSMOBILE PASSENGER CAR ..... 1997-04 PONTIAC PASSENGER CAR ..... 1999-05</p>	 <p style="text-align: center;"><b>EM-5083</b> <b>MOUNT-ENGINE</b> <b>RH Front</b></p> <p>CHRYSLER PASSENGER CAR ..... 1989</p>	 <p style="text-align: center;"><b>EM-5092</b> <b>MOUNT-ENGINE</b> <b>LH Front</b></p> <p>DODGE TRUCK ..... 1987-90</p>	 <p style="text-align: center;"><b>EM-5103</b> <b>MOUNT-TRANSMISSION</b> <b>Rear</b></p> <p>FORD PASSENGER CAR ..... 1994-97</p>
 <p style="text-align: center;"><b>EM-5080</b> <b>MOUNT-ENGINE</b> <b>RH Front Upper</b></p> <p>CHRYSLER PASSENGER CAR ..... 2001-07</p>	 <p style="text-align: center;"><b>EM-5085</b> <b>MOUNT-ENGINE</b> <b>Right</b></p> <p>CHRYSLER SUV ..... 2004-08</p>	 <p style="text-align: center;"><b>EM-5098</b> <b>MOUNT-ENGINE</b> <b>Rear</b></p> <p>EAGLE PASSENGER CAR ..... 1990-94 MITSUBISHI PASSENGER CAR ..... 1985-94 PLYMOUTH PASSENGER CAR ..... 1990-94</p>	 <p style="text-align: center;"><b>EM-5104</b> <b>MOUNT-TRANSMISSION</b> <b>Front</b></p> <p>FORD PASSENGER CAR ..... 1994-97</p>
 <p style="text-align: center;"><b>EM-5081</b> <b>MOUNT-ENGINE</b> <b>RH Front</b></p> <p>CHRYSLER PASSENGER CAR ..... 1995-99 DODGE PASSENGER CAR ..... 1995-99 EAGLE PASSENGER CAR ..... 1997-98</p>	 <p style="text-align: center;"><b>EM-5087</b> <b>MOUNT-TRANSMISSION</b></p> <p>DODGE PASSENGER CAR ..... 1963 PLYMOUTH PASSENGER CAR ..... 1960-65</p>	 <p style="text-align: center;"><b>EM-5101</b> <b>MOUNT-ENGINE</b> <b>Rear</b></p> <p>EAGLE PASSENGER CAR ..... 1990-94 MITSUBISHI PASSENGER CAR ..... 1990-94 PLYMOUTH PASSENGER CAR ..... 1992-94</p>	 <p style="text-align: center;"><b>EM-5105</b> <b>MOUNT-ENGINE</b> <b>RH Front</b></p> <p>FORD PASSENGER CAR ..... 1995-97 MERCURY PASSENGER CAR ... 1995-00</p>
 <p style="text-align: center;"><b>EM-5089</b> <b>MOUNT-ENGINE</b> <b>Front</b></p> <p>CHRYSLER PASSENGER CAR ..... 1995-00 DODGE PASSENGER CAR ..... 1995-00</p>	 <p style="text-align: center;"><b>EM-5106</b> <b>MOUNT-TRANSMISSION</b> <b>Front</b></p> <p>FORD PASSENGER CAR ..... 1995-00 MERCURY PASSENGER CAR ... 1995-02</p>		

# BUYER'S GUIDE

## NUMERICAL LISTING - ILLUSTRATIONS

 <p style="text-align: center;"><b>EM-5107</b> <b>MOUNT-TRANSMISSION</b> Rear</p> <p>FORD PASSENGER CAR ..... 1995-97 MERCURY PASSENGER CAR ... 1995-97</p>	<p><b>EM-5110 (Continued)</b> MAZDA PASSENGER CAR ..... 1993</p>  <p style="text-align: center;"><b>EM-5111</b> <b>MOUNT-TRANSMISSION</b> Manual</p> <p>FORD SPORT UTILITY ..... 1978-79 FORD TRUCK ..... 1979</p>	 <p style="text-align: center;"><b>EM-5141</b> <b>MOUNT-ENGINE</b> RH Front</p> <p>TOYOTA PASSENGER CAR ..... 2002-06 TOYOTA SPORT UTILITY ..... 2001-07</p>	 <p style="text-align: center;"><b>EM-5148</b> <b>MOUNT-ENGINE</b> RH Rear</p> <p>LINCOLN PASSENGER CAR ..... 1995-97</p>
 <p style="text-align: center;"><b>EM-5108</b> <b>MOUNT-ENGINE</b> RH Front</p> <p>FORD PASSENGER CAR ..... 1983-93 MERCURY PASSENGER CAR ..... 1984</p>	 <p style="text-align: center;"><b>EM-5121</b> <b>MOUNT-TRANSMISSION</b></p> <p>KIA PASSENGER CAR ..... 2004-06</p>	 <p style="text-align: center;"><b>EM-5142</b> <b>MOUNT-ENGINE</b> L &amp; R Front</p> <p>LEXUS PASSENGER CAR ..... 1998-10</p>	 <p style="text-align: center;"><b>EM-5152</b> <b>MOUNT-ENGINE</b> RH Front</p> <p>MAZDA PASSENGER CAR ..... 2003-08</p>
 <p style="text-align: center;"><b>EM-5109</b> <b>MOUNT-ENGINE</b> LH Front</p> <p>FORD PASSENGER CAR ..... 1983-93 MERCURY PASSENGER CAR ..... 1984</p>	 <p style="text-align: center;"><b>EM-5131</b> <b>MOUNT-ENGINE</b> RH Front</p> <p>INFINITI PASSENGER CAR ..... 1991-96</p>	 <p style="text-align: center;"><b>EM-5143</b> <b>MOUNT-ENGINE</b> L &amp; R Front</p> <p>LEXUS PASSENGER CAR ..... 1990-00</p>	 <p style="text-align: center;"><b>EM-5155</b> <b>MOUNT-ENGINE</b> Front</p> <p>FORD PASSENGER CAR ..... 1994-97 MAZDA PASSENGER CAR ..... 1994-00</p>
 <p style="text-align: center;"><b>EM-5110</b> <b>MOUNT-ENGINE</b> Front</p> <p>FORD PASSENGER CAR ..... 1993</p> <p><b>(Continued Next Column)</b></p>	 <p style="text-align: center;"><b>EM-5132</b> <b>MOUNT-ENGINE</b> Front</p> <p>INFINITI PASSENGER CAR ..... 1996-04 NISSAN PASSENGER CAR ..... 1996-03</p>	 <p style="text-align: center;"><b>EM-5144</b> <b>MOUNT-TRANSMISSION</b> Auto</p> <p>LEXUS PASSENGER CAR ..... 1990-95</p>	 <p style="text-align: center;"><b>EM-5156</b> <b>MOUNT-TRANSMISSION</b> Auto</p> <p>MAZDA PASSENGER CAR ..... 1988-89</p>

# BUYER'S GUIDE

## NUMERICAL LISTING - ILLUSTRATIONS

 <p><b>EM-5159</b> <b>MOUNT-ENGINE</b> <b>LH Front</b></p> <p>CHRYSLER PASSENGER CAR ..... 2001-05 DODGE PASSENGER CAR ..... 2001-05</p> <p><b>MOUNT-ENGINE</b> <b>Front</b></p> <p>MITSUBISHI PASSENGER CAR ..... 1999-05</p>	 <p><b>EM-5165</b> <b>MOUNT-TRANSMISSION</b> <b>Manual</b></p> <p>NISSAN PASSENGER CAR ..... 1974</p>	 <p><b>EM-5173</b> <b>MOUNT-ENGINE</b> <b>RH Front</b></p> <p>NISSAN SPORT UTILITY ..... 2002-07</p>	 <p><b>EM-5178</b> <b>MOUNT-ENGINE</b> <b>Bushing Kit</b></p> <p>CHRYSLER PASSENGER CAR ..... 1995-00 DODGE PASSENGER CAR ..... 1995-99 PLYMOUTH PASSENGER CAR ..... 1996-99</p>
 <p><b>EM-5162</b> <b>MOUNT-TRANSMISSION</b> <b>Auto</b></p> <p>NISSAN PASSENGER CAR ..... 1987-88</p>	 <p><b>EM-5166</b> <b>MOUNT-TRANSMISSION</b> <b>Manual</b></p> <p>NISSAN PASSENGER CAR ..... 1975-77</p>	 <p><b>EM-5174</b> <b>MOUNT-ENGINE</b> <b>Rear</b></p> <p>NISSAN SPORT UTILITY ..... 2005-07</p>	 <p><b>EM-5180</b> <b>MOUNT-TRANSMISSION</b> <b>Manual</b></p> <p>DODGE PASSENGER CAR ..... 1995-99 PLYMOUTH PASSENGER CAR ..... 1995-99</p>
 <p><b>EM-5163</b> <b>MOUNT-TRANSMISSION</b></p> <p>NISSAN PASSENGER CAR ..... 1979-82</p>	 <p><b>EM-5170</b> <b>Engine Torque Strut Mount</b> <b>Front</b></p> <p>NISSAN PASSENGER CAR ..... 1982-86</p>	 <p><b>EM-5175</b> <b>MOUNT-TRANSMISSION</b> <b>Auto</b></p> <p>NISSAN SPORT UTILITY ..... 2005-07</p>	 <p><b>EM-5181</b> <b>MOUNT-TRANSMISSION</b> <b>Manual</b></p> <p>PONTIAC PASSENGER CAR ..... 1988-90</p>
 <p><b>EM-5171</b> <b>MOUNT-ENGINE</b> <b>RH Front</b></p> <p>NISSAN PASSENGER CAR ..... 1987-89</p>	 <p><b>EM-5177</b> <b>Engine Torque Strut</b> <b>Front Left</b></p> <p>OLDSMOBILE PASSENGER CAR ..... 1988-89 PONTIAC PASSENGER CAR ..... 1988-90</p>		



# BUYER'S GUIDE

## NUMERICAL LISTING - ILLUSTRATIONS

 <p><b>EM-5182</b> <b>MOUNT-TRANSMISSION</b> PONTIAC PASSENGER CAR ..... 2004-06</p>	 <p><b>EM-5188</b> <b>MOUNT-TRANSMISSION</b> <b>RH</b> SUBARU PASSENGER CAR ..... 1992-99</p>	 <p><b>EM-5198</b> <b>MOUNT-ENGINE</b> <b>Front</b> TOYOTA PASSENGER CAR ..... 1993-97</p>	 <p><b>EM-5209</b> <b>MOUNT-TRANSMISSION</b> <b>Auto</b> TOYOTA SPORT UTILITY ..... 1996-97</p>
 <p><b>EM-5186</b> <b>MOUNT-TRANSMISSION</b> <b>Auto</b> SUBARU PASSENGER CAR ..... 1981-87 <b>MOUNT-TRANSMISSION</b> SUBARU SPORT UTILITY ..... 1984-87</p>	 <p><b>EM-5189</b> <b>MOUNT-TRANSMISSION</b> <b>LH</b> SUBARU PASSENGER CAR ..... 1992-99</p>	 <p><b>EM-5200</b> <b>MOUNT-ENGINE</b> <b>Rear</b> TOYOTA PASSENGER CAR ..... 1978-80</p>	 <p><b>EM-5213</b> <b>MOUNT-TRANSMISSION</b> VOLKSWAGEN VAN ..... 1982-03</p>
 <p><b>EM-5187</b> <b>Engine Torque Strut Mount</b> <b>Front</b> SUBARU PASSENGER CAR ..... 1992-98 SUBARU SPORT UTILITY ..... 2002-08</p>	 <p><b>EM-5190</b> <b>MOUNT-TRANSMISSION</b> <b>Manual</b> SUBARU PASSENGER CAR ..... 1993-97</p>	 <p><b>EM-5206</b> <b>Engine Torque Strut Mount</b> <b>Front</b> TOYOTA SPORT UTILITY ..... 2001-03</p>	 <p><b>EM-5214</b> <b>MOUNT-TRANSMISSION</b> VOLVO PASSENGER CAR ..... 1981-93</p>
 <p><b>EM-5191</b> <b>Engine Torque Strut Mount</b> <b>Front</b> SUBARU PASSENGER CAR ..... 1995-99 SUBARU SPORT UTILITY ..... 1998-01</p>	 <p><b>EM-5208</b> <b>MOUNT-ENGINE</b> <b>L &amp; R Front</b> TOYOTA SPORT UTILITY ..... 1981-82 TOYOTA TRUCK ..... 1981-82</p>	 <p><b>EM-5215</b> <b>MOUNT-ENGINE</b> <b>RH Front</b> VOLVO PASSENGER CAR ..... 1993-04</p>	

# BUYER'S GUIDE

## NUMERICAL LISTING - ILLUSTRATIONS

 <p><b>EM-5216</b> <b>MOUNT-TRANSMISSION</b> VOLVO PASSENGER CAR ..... 1996-04</p>	 <p><b>EM-5332</b> <b>MOUNT-TRANSMISSION</b> <b>Manual</b> INFINITI PASSENGER CAR ..... 1991-96</p>	 <p><b>EM-5350</b> <b>MOUNT-ENGINE</b> <b>RH Front</b> CHEVROLET TRUCK ..... 1994-03 GMC TRUCK ..... 1994-03 ISUZU TRUCK ..... 1996-00</p>	 <p><b>EM-5354</b> <b>MOUNT-ENGINE</b> <b>L &amp; R Front</b> CHEVROLET VAN ..... 2003-17 GMC VAN ..... 2003-17</p>
 <p><b>EM-5218</b> <b>MOUNT-ENGINE</b> <b>Rear</b> BMW PASSENGER CAR ..... 1978-84</p>	 <p><b>EM-5340</b> <b>MOUNT-ENGINE</b> <b>Front</b> BMW PASSENGER CAR ..... 1988-91</p>	 <p><b>EM-5352</b> <b>MOUNT-ENGINE</b> <b>RH Front</b> FORD PASSENGER CAR ..... 1998-00 MERCURY PASSENGER CAR ... 1998-02</p>	 <p><b>EM-5356</b> <b>MOUNT-ENGINE</b> <b>RH Front</b> TOYOTA VAN ..... 1998-03</p>
 <p><b>EM-5326</b> <b>RADIUS ARM BUSHING</b> <b>FRONT-RIGHT</b> HONDA PASSENGER CAR ..... 1992-93</p>	 <p><b>EM-5349</b> <b>MOUNT-ENGINE</b> <b>LH Rear</b> CHRYSLER PASSENGER CAR ..... 2001-05 DODGE PASSENGER CAR ..... 2001-05 MITSUBISHI PASSENGER CAR ..... 1999-05</p>	 <p><b>EM-5353</b> <b>MOUNT-ENGINE</b> <b>L &amp; R Front</b> CHEVROLET SPORT UTILITY ... 2001-06 CHEVROLET TRUCK ..... 2001-07 GMC SPORT UTILITY ..... 2001-06 GMC TRUCK ..... 2001-07</p>	 <p><b>EM-5358</b> <b>MOUNT-ENGINE</b> <b>RH Front</b> SUZUKI PASSENGER CAR ..... 1999-02</p>
 <p><b>EM-5329</b> <b>RADIUS ARM BUSHING</b> <b>FRONT-LEFT</b> HONDA PASSENGER CAR ..... 1992-93</p>			 <p><b>EM-5359</b> <b>MOUNT-ENGINE</b> <b>RH Front</b> SUZUKI PASSENGER CAR ..... 2004-07</p>

# BUYER'S GUIDE

## NUMERICAL LISTING - ILLUSTRATIONS

 <p style="text-align: center;"><b>EM-5362</b> <b>MOUNT-ENGINE</b> <b>RH Front</b></p> <p>MAZDA PASSENGER CAR ..... 2004-09 MAZDA VAN ..... 2006-10</p>	 <p style="text-align: center;"><b>EM-5372</b> <b>MOUNT-TRANSMISSION</b> <b>Auto</b></p> <p>SAAB PASSENGER CAR ..... 1994-02</p>	 <p style="text-align: center;"><b>EM-5376</b> <b>MOUNT-ENGINE</b> <b>Right</b></p> <p>HONDA PASSENGER CAR ..... 2003-05</p>	 <p style="text-align: center;"><b>EM-5379</b> <b>MOUNT-TRANSMISSION</b></p> <p>ACURA PASSENGER CAR ..... 1987-90</p>
 <p style="text-align: center;"><b>EM-5367</b> <b>MOUNT-ENGINE</b> <b>L &amp; R Front</b></p> <p>LEXUS PASSENGER CAR ..... 1992-00</p>	 <p style="text-align: center;"><b>EM-5373</b> <b>Engine Torque Strut Mount</b> <b>Rear</b></p> <p>SAAB PASSENGER CAR ..... 1986-98</p>	 <p style="text-align: center;"><b>EM-5377</b> <b>MOUNT-ENGINE</b> <b>RH Front</b></p> <p>FORD TRUCK ..... 2001-11 MAZDA TRUCK ..... 2001-09</p>	 <p style="text-align: center;"><b>EM-5380</b> <b>MOUNT-TRANSMISSION</b></p> <p>FORD PASSENGER CAR ..... 1999-04</p>
 <p style="text-align: center;"><b>EM-5370</b> <b>MOUNT-ENGINE</b> <b>L &amp; R Front</b></p> <p>TOYOTA SPORT UTILITY ..... 1975</p>	 <p style="text-align: center;"><b>EM-5374</b> <b>MOUNT-ENGINE</b> <b>RH Front</b></p> <p>MERCEDES-BENZ PASSENGER CAR ..... 1988-91</p>	 <p style="text-align: center;"><b>EM-5378</b> <b>MOUNT-TRANSMISSION</b> <b>Rear</b></p> <p>MAZDA PASSENGER CAR ..... 1983-87</p>	 <p style="text-align: center;"><b>EM-5382</b> <b>MOUNT-ENGINE</b> <b>Front</b></p> <p>ACURA PASSENGER CAR ..... 1987-90 HONDA PASSENGER CAR ..... 1986-89</p>
 <p style="text-align: center;"><b>EM-5371</b> <b>MOUNT-ENGINE</b> <b>Front Center</b></p> <p>HONDA PASSENGER CAR ..... 1986-89</p>	 <p style="text-align: center;"><b>EM-5375</b> <b>MOUNT-ENGINE</b> <b>RH Front</b></p> <p>MAZDA PASSENGER CAR ..... 2004-10</p>	 <p style="text-align: center;"><b>EM-5383</b> <b>MOUNT-TRANSMISSION</b> <b>Manual</b></p> <p>JEEP SPORT UTILITY ..... 1984-00</p>	











# BUYER'S GUIDE

## NUMERICAL LISTING - ILLUSTRATIONS

 <b>EM-5384</b> <b>MOUNT-ENGINE</b> <b>Front</b> TOYOTA PASSENGER CAR ..... 2000-04	 <b>EM-5392</b> <b>MOUNT-TRANSMISSION</b> <b>Auto</b> CHEVROLET VAN ..... 1994-95	 <b>EM-5398</b> <b>Engine Torque Strut</b> <b>Front Right</b> HYUNDAI PASSENGER CAR ..... 1986-89 MITSUBISHI PASSENGER CAR ..... 1987-89	 <b>EM-5403</b> <b>MOUNT-TRANSMISSION</b> LEXUS PASSENGER CAR ..... 1998-10
 <b>EM-5385</b> <b>MOUNT-TRANSMISSION</b> <b>Manual</b> ACURA PASSENGER CAR ..... 1990-93	 <b>EM-5394</b> <b>MOUNT-ENGINE</b> <b>L &amp; R Front</b> MERCEDES-BENZ PASSENGER CAR ..... 1996-97	 <b>EM-5399</b> <b>MOUNT-ENGINE</b> <b>L &amp; R Front</b> LEXUS PASSENGER CAR ..... 1993-97	 <b>EM-5404</b> <b>MOUNT-ENGINE</b> <b>L &amp; R Front</b> INFINITI SPORT UTILITY ..... 2004-11 NISSAN SPORT UTILITY ..... 2005-15 NISSAN TRUCK ..... 2004-14 NISSAN VAN ..... 2012-16
 <b>EM-5387</b> <b>MOUNT-ENGINE</b> <b>RH Front</b> NISSAN PASSENGER CAR ..... 1982-86	 <b>EM-5396</b> <b>MOUNT-ENGINE</b> <b>L &amp; R Front</b> VOLVO PASSENGER CAR ..... 1992-98	 <b>EM-5400</b> <b>MOUNT-TRANSMISSION</b> HONDA PASSENGER CAR ..... 1985-87	 <b>EM-5405</b> <b>MOUNT-ENGINE</b> <b>Front</b> NISSAN PASSENGER CAR ..... 2002-06
 <b>EM-5388</b> <b>MOUNT-ENGINE</b> <b>L &amp; R Rear</b> BUICK PASSENGER CAR ..... 1977-78	 <b>EM-5397</b> <b>MOUNT-ENGINE</b> <b>Front</b> SAAB PASSENGER CAR ..... 1981-88	 <b>EM-5401</b> <b>MOUNT-TRANSMISSION</b> <b>Manual</b> JEEP SPORT UTILITY ..... 1959-71	 <b>EM-5406</b> <b>MOUNT-TRANSMISSION</b> INFINITI SPORT UTILITY ..... 2004-13 NISSAN SPORT UTILITY ..... 2005-15 NISSAN TRUCK ..... 2004-14 NISSAN VAN ..... 2012-16

# BUYER'S GUIDE



## NUMERICAL LISTING - ILLUSTRATIONS

 <p style="text-align: center;"><b>EM-5407</b> <b>MOUNT-TRANSMISSION</b></p> <p>INFINITI SPORT UTILITY ..... 2004-13 NISSAN SPORT UTILITY ..... 2005-15 NISSAN TRUCK ..... 2004-14</p>	<p><b>EM-5422 (Continued)</b></p> <p>OLDSMOBILE PASSENGER CAR ..... 2002-04 PONTIAC PASSENGER CAR ..... 2002-05</p>  <p style="text-align: center;"><b>EM-5423</b> <b>MOUNT-ENGINE</b> <b>L &amp; R Front</b></p> <p>CHEVROLET SPORT UTILITY ... 2002-06 CHEVROLET TRUCK ..... 1999-10 GMC TRUCK ..... 1999-07</p>	 <p style="text-align: center;"><b>EM-5426</b> <b>MOUNT-ENGINE</b> <b>LH Front</b></p> <p>CHEVROLET TRUCK ..... 1994-03 GMC TRUCK ..... 1994-03 ISUZU TRUCK ..... 1996-00</p>	 <p style="text-align: center;"><b>EM-5432</b> <b>MOUNT-TRANSMISSION</b></p> <p>AUDI PASSENGER CAR ..... 1993-98</p>
 <p style="text-align: center;"><b>EM-5411</b> <b>MOUNT-ENGINE</b> <b>Rear</b></p> <p>NISSAN PASSENGER CAR ..... 2002-03</p>	 <p style="text-align: center;"><b>EM-5424</b> <b>MOUNT-ENGINE</b> <b>LH Front</b></p> <p>FORD SPORT UTILITY ..... 2000-05 FORD TRUCK ..... 1999-04</p>	 <p style="text-align: center;"><b>EM-5427</b> <b>MOUNT-ENGINE</b> <b>RH Front</b></p> <p>FORD PASSENGER CAR ..... 2008-17 FORD SPORT UTILITY ..... 2007-16</p>	 <p style="text-align: center;"><b>EM-5434</b> <b>MOUNT-ENGINE</b> <b>L &amp; R Front</b></p> <p>MERCEDES-BENZ PASSENGER CAR ..... 1999-11</p>
 <p style="text-align: center;"><b>EM-5420</b> <b>MOUNT-ENGINE</b> <b>Rear</b></p> <p>CHRYSLER PASSENGER CAR ..... 1995-99</p>	 <p style="text-align: center;"><b>EM-5425</b> <b>MOUNT-ENGINE</b> <b>RH Front</b></p> <p>FORD SPORT UTILITY ..... 2000-05 FORD TRUCK ..... 1999-04</p>	<p style="text-align: center;"><b>MOUNT-ENGINE</b> <b>Front</b></p> <p>LINCOLN PASSENGER CAR ..... 2009-15</p> <p style="text-align: center;"><b>MOUNT-ENGINE</b> <b>RH Front</b></p> <p>LINCOLN SPORT UTILITY ..... 2007-15 MERCURY PASSENGER CAR ... 2008-09</p>	 <p style="text-align: center;"><b>EM-5436</b> <b>MOUNT-ENGINE</b> <b>LH Front</b></p> <p>SAAB PASSENGER CAR ..... 1999-01</p>
 <p style="text-align: center;"><b>EM-5422</b> <b>MOUNT-TRANSMISSION</b> <b>LH Front</b></p> <p>CHEVROLET PASSENGER CAR ..... 2004-05</p> <p><b>(Continued Next Column)</b></p>	 <p style="text-align: center;"><b>EM-5428</b> <b>MOUNT-TRANSMISSION</b> <b>Manual</b></p> <p>JEEP SPORT UTILITY ..... 2000-01</p>	 <p style="text-align: center;"><b>EM-5437</b> <b>Engine Torque Strut Mount</b> <b>Rear</b></p> <p>SAAB PASSENGER CAR ..... 1999</p>	



# BUYER'S GUIDE

## NUMERICAL LISTING - ILLUSTRATIONS

 <p><b>EM-5439</b> <b>MOUNT-ENGINE</b> <b>Rear</b></p> <p>VOLVO PASSENGER CAR ..... 2000</p>	 <p><b>EM-5445</b> <b>MOUNT-ENGINE</b> <b>RH Rear</b></p> <p>VOLKSWAGEN PASSENGER CAR ..... 1993-97</p>	 <p><b>EM-5450</b> <b>MOUNT-TRANSMISSION</b> <b>LH Rear</b></p> <p>OLDSMOBILE PASSENGER CAR ..... 1974-78</p>	 <p><b>EM-5454</b> <b>MOUNT-ENGINE</b> <b>RH Front</b></p> <p>TOYOTA PASSENGER CAR ..... 1967-76</p>
 <p><b>EM-5440</b> <b>MOUNT-ENGINE</b> <b>LH Front</b></p> <p>FORD VAN ..... 1993-97</p> <p><b>MOUNT-ENGINE</b> <b>Rear</b></p> <p>VOLVO PASSENGER CAR ..... 2001-04</p>	 <p><b>EM-5446</b> <b>MOUNT-ENGINE</b> <b>Front</b></p> <p>VOLKSWAGEN VAN ..... 1992-97</p>	 <p><b>EM-5452</b> <b>MOUNT-TRANSMISSION</b> <b>Manual</b></p> <p>CHRYSLER PASSENGER CAR ..... 2003-04</p> <p>DODGE PASSENGER CAR ..... 2001-05</p> <p>MITSUBISHI PASSENGER CAR ..... 2000-05</p>	 <p><b>EM-5455</b> <b>MOUNT-ENGINE</b> <b>LH Front</b></p> <p>TOYOTA PASSENGER CAR ..... 1967-76</p>
 <p><b>EM-5441</b> <b>MOUNT-ENGINE</b> <b>Rear</b></p> <p>NISSAN SPORT UTILITY ..... 2003-07</p>	 <p><b>EM-5448</b> <b>MOUNT-ENGINE</b> <b>RH Front</b></p> <p>TOYOTA PASSENGER CAR ..... 1981-84</p>	 <p><b>EM-5453</b> <b>Engine Torque Strut</b> <b>Front Right</b></p> <p>HYUNDAI PASSENGER CAR ..... 1986-89</p> <p>MITSUBISHI PASSENGER CAR ..... 1987-89</p>	 <p><b>EM-5456</b> <b>MOUNT-TRANSMISSION</b></p> <p>TOYOTA PASSENGER CAR ..... 1967-76</p>
	 <p><b>EM-5449</b> <b>MOUNT-TRANSMISSION</b> <b>Auto</b></p> <p>HONDA PASSENGER CAR ..... 1996-00</p>		 <p><b>EM-5457</b> <b>MOUNT-TRANSMISSION</b> <b>LH</b></p> <p>SUZUKI PASSENGER CAR ..... 1985</p>

# BUYER'S GUIDE

## NUMERICAL LISTING - ILLUSTRATIONS

 <b>EM-5458</b> <b>MOUNT-TRANSMISSION</b> <b>LH Rear</b> SUZUKI TRUCK ..... 1987-88	 <b>EM-5462</b> <b>MOUNT-ENGINE</b> <b>RH Front</b> SAAB PASSENGER CAR ..... 1990-94	 <b>EM-5468</b> <b>MOUNT-ENGINE</b> <b>Center Front Lower</b> INFINITI PASSENGER CAR ..... 1991-96	 <b>EM-5476</b> <b>MOUNT-ENGINE</b> <b>L &amp; R Front</b> CHRYSLER PASSENGER CAR ..... 1974-78 DODGE PASSENGER CAR ..... 1974-78
 <b>EM-5459</b> <b>MOUNT-ENGINE</b> <b>Rear</b> VOLVO PASSENGER CAR ..... 1970-75	 <b>EM-5464</b> <b>MOUNT-ENGINE</b> <b>Front</b> TOYOTA SPORT UTILITY ..... 2001-03	 <b>EM-5471</b> <b>MOUNT-ENGINE</b> <b>Rear</b> ACURA PASSENGER CAR ..... 1997-99 HONDA PASSENGER CAR ..... 1995-97	 <b>EM-5481</b> <b>MOUNT-TRANSMISSION</b> <b>Manual</b> NISSAN PASSENGER CAR ..... 1987-89 NISSAN VAN ..... 1987-88
 <b>EM-5460</b> <b>MOUNT-ENGINE</b> <b>RH Front</b> SAAB PASSENGER CAR ..... 1981-88	 <b>EM-5465</b> <b>MOUNT-ENGINE</b> <b>Front</b> FORD PASSENGER CAR ..... 1949-52 FORD TRUCK ..... 1949-50	 <b>EM-5473</b> <b>MOUNT-ENGINE</b> <b>LH Front</b> TOYOTA PASSENGER CAR ..... 1971-79	 <b>EM-5482</b> <b>MOUNT-TRANSMISSION</b> KIA VAN ..... 2002-05
 <b>EM-5461</b> <b>MOUNT-ENGINE</b> <b>Front</b> SAAB PASSENGER CAR ..... 1990-94	 <b>EM-5467</b> <b>MOUNT-ENGINE</b> <b>L &amp; R Front</b> TOYOTA PASSENGER CAR ..... 1993-95	 <b>EM-5475</b> <b>MOUNT-TRANSMISSION</b> <b>Upper</b> CHEVROLET SPORT UTILITY .... 2005-06 PONTIAC SPORT UTILITY ..... 2006	 <b>EM-5483</b> <b>MOUNT-TRANSMISSION</b> <b>Front</b> SUZUKI TRUCK ..... 1987-88

# BUYER'S GUIDE

## NUMERICAL LISTING - ILLUSTRATIONS

 <p style="text-align: center;"><b>EM-5484</b> <b>MOUNT-ENGINE</b> <b>Rear</b></p> <p>VOLKSWAGEN VAN ..... 1982-84</p>	 <p style="text-align: center;"><b>EM-5489</b> <b>MOUNT-TRANSMISSION</b> <b>Auto</b></p> <p>SAAB PASSENGER CAR ..... 1986-98</p>	 <p style="text-align: center;"><b>EM-5493</b> <b>MOUNT-ENGINE</b> <b>Lower Rear</b></p> <p>VOLVO SPORT UTILITY ..... 2003-06</p>	 <p style="text-align: center;"><b>EM-5501</b> <b>MOUNT-TRANSMISSION</b> <b>Manual</b></p> <p>NISSAN PASSENGER CAR ..... 1987-88</p>
 <p style="text-align: center;"><b>EM-5485</b> <b>MOUNT-ENGINE</b> <b>Center Front</b></p> <p>AUDI PASSENGER CAR ..... 1988-05</p> <p style="text-align: center;"><b>MOUNT-ENGINE</b> <b>Center Front Lower</b></p> <p>VOLKSWAGEN PASSENGER CAR ..... 1998-05</p>	 <p style="text-align: center;"><b>EM-5490</b> <b>MOUNT-ENGINE</b> <b>Front</b></p> <p>SAAB PASSENGER CAR ..... 1990-98</p>	 <p style="text-align: center;"><b>EM-5494</b> <b>MOUNT-ENGINE</b> <b>Front</b></p> <p>VOLVO PASSENGER CAR ..... 2001-04</p>	 <p style="text-align: center;"><b>EM-5502</b> <b>MOUNT-ENGINE</b> <b>RH Front</b></p> <p>NISSAN PASSENGER CAR ..... 1993-99</p>
 <p style="text-align: center;"><b>EM-5487</b> <b>MOUNT-TRANSMISSION</b></p> <p>VOLVO PASSENGER CAR ..... 1994-97</p>	 <p style="text-align: center;"><b>EM-5491</b> <b>MOUNT-ENGINE</b> <b>L &amp; R Front</b></p> <p>BMW PASSENGER CAR ..... 1978-82</p>	 <p style="text-align: center;"><b>EM-5495</b> <b>MOUNT-ENGINE</b> <b>Front</b></p> <p>VOLVO PASSENGER CAR ..... 2000-04</p>	 <p style="text-align: center;"><b>EM-5510</b> <b>MOUNT-ENGINE</b> <b>LH Front</b></p> <p>HONDA PASSENGER CAR ..... 1989-91</p>
 <p style="text-align: center;"><b>EM-5488</b> <b>MOUNT-TRANSMISSION</b></p> <p>SAAB PASSENGER CAR ..... 1981-88</p>	 <p style="text-align: center;"><b>EM-5492</b> <b>MOUNT-ENGINE</b> <b>RH Front</b></p> <p>SAAB PASSENGER CAR ..... 1994-03</p>	 <p style="text-align: center;"><b>EM-5500</b> <b>MOUNT-ENGINE</b> <b>LH Front</b></p> <p>NISSAN PASSENGER CAR ..... 1986-89 NISSAN VAN ..... 1987-88</p>	 <p style="text-align: center;"><b>EM-5515</b> <b>MOUNT-TRANSMISSION</b> <b>Manual</b></p> <p>SUBARU PASSENGER CAR ..... 1990-15 SUBARU SPORT UTILITY ..... 1998-15</p>



# BUYER'S GUIDE

## NUMERICAL LISTING - ILLUSTRATIONS

 <p><b>EM-5517</b> <b>MOUNT-ENGINE</b> <b>LH Front</b></p> <p>AUDI PASSENGER CAR ..... 2002-08</p>	 <p><b>EM-5527</b> <b>MOUNT-ENGINE</b> <b>RH Front</b></p> <p>VOLKSWAGEN VAN ..... 1992-03</p>	 <p><b>EM-5551</b> <b>MOUNT-ENGINE</b> <b>LH Front</b></p> <p>FORD MEDIUM/HEAVY DUTY .... 2004-10 FORD VAN ..... 2004-10</p>	<p><b>EM-5556 (Continued)</b></p> <p>NISSAN TRUCK ..... 2000-04</p>  <p><b>EM-5561</b> <b>MOUNT-ENGINE</b> <b>Rear</b></p> <p>NISSAN PASSENGER CAR ..... 1990-96</p>
 <p><b>EM-5518</b> <b>MOUNT-ENGINE</b> <b>RH Rear</b></p> <p>VOLVO PASSENGER CAR ..... 2000</p>	 <p><b>EM-5528</b> <b>MOUNT-ENGINE</b> <b>Front Upper</b></p> <p>VOLVO PASSENGER CAR ..... 1998-09 VOLVO SPORT UTILITY ..... 2003-06</p>	 <p><b>EM-5553</b> <b>MOUNT-ENGINE</b> <b>RH Front</b></p> <p>VOLVO PASSENGER CAR ..... 1999-05 VOLVO SPORT UTILITY ..... 2003-05</p>	 <p><b>EM-5563</b> <b>MOUNT-TRANSMISSION</b></p> <p>MAZDA PASSENGER CAR ..... 1988-89</p>
 <p><b>EM-5521</b> <b>MOUNT-ENGINE</b> <b>Front</b></p> <p>FORD PASSENGER CAR ..... 1998-00 MERCURY PASSENGER CAR ... 1998-00</p>	 <p><b>EM-5530</b> <b>Engine Torque Strut Mount</b> <b>Lower</b></p> <p>VOLVO PASSENGER CAR ..... 2001-09 VOLVO SPORT UTILITY ..... 2003-06</p>	 <p><b>EM-5554</b> <b>MOUNT-TRANSMISSION</b> <b>Manual</b></p> <p>TOYOTA PASSENGER CAR ..... 2002-03</p>	 <p><b>EM-5574</b> <b>MOUNT-TRANSMISSION</b></p> <p>MITSUBISHI PASSENGER CAR ..... 1992-93</p>
 <p><b>EM-5526</b> <b>MOUNT-ENGINE</b> <b>Right</b></p> <p>KIA VAN ..... 2002-05</p>	 <p><b>EM-5533</b> <b>MOUNT-ENGINE</b> <b>RH Rear</b></p> <p>HYUNDAI PASSENGER CAR ..... 2003-08</p>	 <p><b>EM-5556</b> <b>MOUNT-TRANSMISSION</b> <b>Manual</b></p> <p>NISSAN SPORT UTILITY ..... 2000-04</p> <p><b>(Continued Next Column)</b></p>	 <p><b>EM-5575</b> <b>MOUNT-ENGINE</b> <b>Rear</b></p> <p>MITSUBISHI PASSENGER CAR ..... 1997-98</p>

# BUYER'S GUIDE

## NUMERICAL LISTING - ILLUSTRATIONS

 <p style="text-align: center;"><b>EM-5578</b> <b>MOUNT-ENGINE</b> <b>RH Front</b></p> <p>FORD MEDIUM/HEAVY DUTY ..... 2004-10 FORD VAN ..... 2004-10</p>	 <p style="text-align: center;"><b>EM-5587</b> <b>MOUNT-TRANSMISSION</b></p> <p>CHRYSLER PASSENGER CAR ..... 2005-18 DODGE PASSENGER CAR ..... 2005-18</p> <p style="text-align: center;"><b>MOUNT-TRANSMISSION</b> <b>Manual</b></p> <p>SRT ..... 2013-14</p>	 <p style="text-align: center;"><b>EM-5596</b> <b>MOUNT-ENGINE</b> <b>Front</b></p> <p>FORD PASSENGER CAR ..... 1995-97 MERCURY PASSENGER CAR ... 1995-97</p>	 <p style="text-align: center;"><b>EM-5599</b> <b>MOUNT-TRANSMISSION</b> <b>Auto</b></p> <p>SUBARU PASSENGER CAR ..... 1985-91</p>	
 <p style="text-align: center;"><b>EM-5582</b> <b>MOUNT-ENGINE</b> <b>RH Front</b></p> <p>CHEVROLET TRUCK ..... 2001-10</p> <p style="text-align: center;"><b>MOUNT-ENGINE</b> <b>Left</b></p> <p>GMC TRUCK ..... 2001-10</p>	 <p style="text-align: center;"><b>EM-5588</b> <b>MOUNT-ENGINE</b> <b>L &amp; R Front</b></p> <p>CHRYSLER PASSENGER CAR ..... 2005-10 DODGE PASSENGER CAR ..... 2005-10</p>	 <p style="text-align: center;"><b>EM-5597</b> <b>MOUNT-ENGINE</b> <b>LH Front</b></p> <p>SUBARU PASSENGER CAR ..... 1995</p> <p style="text-align: center;"><b>MOUNT-ENGINE</b> <b>Rear</b></p> <p>SUBARU PASSENGER CAR ..... 1990-95</p> <p style="text-align: center;"><b>MOUNT-TRANSMISSION</b> <b>Manual</b></p> <p>SUBARU PASSENGER CAR ..... 1992-95</p>	 <p style="text-align: center;"><b>EM-5600</b> <b>MOUNT-ENGINE</b> <b>RH Front</b></p> <p>SUBARU PASSENGER CAR ..... 1990-95</p>	
 <p style="text-align: center;"><b>EM-5583#</b> <b>MOUNT-ENGINE</b> <b>L &amp; R Front</b></p> <p>CADILLAC SPORT UTILITY ..... 2007-14 CHEVROLET SPORT UTILITY ... 2007-14 CHEVROLET TRUCK ..... 2007-13 GMC SPORT UTILITY ..... 2007-14 GMC TRUCK ..... 2007-13</p>	 <p style="text-align: center;"><b>EM-5591</b> <b>MOUNT-ENGINE</b> <b>LH Front</b></p> <p>CHEVROLET PASSENGER CAR ..... 1989-91 GEO PASSENGER CAR ..... 1989-94 PONTIAC PASSENGER CAR ..... 1989-94</p>	 <p style="text-align: center;"><b>EM-5598</b> <b>MOUNT-ENGINE</b> <b>L &amp; R Front</b></p> <p>SUBARU PASSENGER CAR ..... 1990-93</p>	 <p style="text-align: center;"><b>EM-5601</b> <b>MOUNT-ENGINE</b> <b>LH Front</b></p> <p>SUBARU PASSENGER CAR ..... 1990-94</p>	
				 <p style="text-align: center;"><b>EM-5602</b> <b>Engine Torque Strut Mount</b> <b>Front</b></p> <p>SUBARU PASSENGER CAR ..... 1985-94</p>

# = Available in the Westar Gold Line

# BUYER'S GUIDE

## NUMERICAL LISTING - ILLUSTRATIONS



**EM-5603**  
Engine Torque Strut Mount  
Front

SUBARU PASSENGER CAR ..... 1985-94  
SUBARU SPORT UTILITY ..... 1982-04



**EM-5610**  
MOUNT-TRANSMISSION  
Manual

HONDA SPORT UTILITY ..... 1998-02  
ISUZU SPORT UTILITY ..... 1998-04



**EM-5645**  
MOUNT-TRANSMISSION  
Center

SATURN PASSENGER CAR ..... 2003-04



**EM-5653**  
MOUNT-ENGINE  
L & R Front

TOYOTA PASSENGER CAR ..... 1990-92



**EM-5608**  
MOUNT-ENGINE  
Front

CHEVROLET PASSENGER  
CAR ..... 1998-01  
GEO PASSENGER CAR ..... 1992-97  
PONTIAC PASSENGER CAR ..... 1994-00



**EM-5612**  
MOUNT-ENGINE  
Front

SEAT PASSENGER CAR ..... 2001-02  
VOLKSWAGEN PASSENGER  
CAR ..... 1984-97



**EM-5646**  
MOUNT-ENGINE  
L & R Front

TOYOTA SPORT UTILITY ..... 2001-07  
TOYOTA TRUCK ..... 2000-06



**EM-5654**  
MOUNT-ENGINE  
RH Front

TOYOTA PASSENGER CAR ..... 2007-18



**EM-5609**  
MOUNT-TRANSMISSION  
Auto

HONDA SPORT UTILITY ..... 1998-02

**MOUNT-TRANSMISSION**

ISUZU SPORT UTILITY ..... 1998-04



**EM-5616**  
MOUNT-ENGINE  
Rear Upper

VOLVO PASSENGER CAR ..... 2009



**EM-5647**  
MOUNT-TRANSMISSION

TOYOTA PASSENGER CAR ..... 2004-09



**EM-5655**  
MOUNT-ENGINE  
Rear

INFINITI PASSENGER CAR ..... 2000-04



**EM-5617**  
MOUNT-ENGINE  
RH Front

SAAB PASSENGER CAR ..... 1994-03



**EM-5649**  
MOUNT-ENGINE  
L & R Front

LEXUS SPORT UTILITY ..... 2003-09  
TOYOTA SPORT UTILITY ..... 2003-09



**EM-5656**  
MOUNT-ENGINE  
RH Front

CHEVROLET VAN ..... 2015-17  
NISSAN PASSENGER CAR ..... 2007-14

**MOUNT-ENGINE  
Right**

NISSAN VAN ..... 2013-17

# BUYER'S GUIDE

## NUMERICAL LISTING - ILLUSTRATIONS

 <p><b>EM-5657</b> <b>MOUNT-TRANSMISSION</b> <b>Manual</b></p> <p>NISSAN PASSENGER CAR ..... 2000-06</p>	<p><b>EM-5660 (Continued)</b> <b>MOUNT-TRANSMISSION</b></p> <p>CHEVROLET PASSENGER CAR ..... 2005-13</p>  <p><b>EM-5661</b> <b>MOUNT-TRANSMISSION</b></p> <p>BUICK PASSENGER CAR ..... 2008-09 CHEVROLET PASSENGER CAR ..... 2006-09 PONTIAC PASSENGER CAR ..... 2005-08</p>  <p><b>EM-5662</b> <b>MOUNT-TRANSMISSION</b></p> <p>CADILLAC SPORT UTILITY ..... 2004-09</p>  <p><b>EM-5663</b> <b>MOUNT-TRANSMISSION</b></p> <p>CHEVROLET VAN ..... 2006-09 GMC VAN ..... 2006-09</p>	 <p><b>EM-5664</b> <b>MOUNT-TRANSMISSION</b></p> <p>CADILLAC SPORT UTILITY ..... 2007-09</p>  <p><b>EM-5665</b> <b>MOUNT-TRANSMISSION</b></p> <p>CADILLAC PASSENGER CAR .... 2006-09</p>  <p><b>EM-5669</b> <b>MOUNT-ENGINE</b> <b>RH Front</b></p> <p>VOLVO PASSENGER CAR ..... 1983-85</p>  <p><b>EM-5670</b> <b>MOUNT-ENGINE</b> <b>Front</b></p> <p>INFINITI PASSENGER CAR ..... 1996-04 NISSAN PASSENGER CAR ..... 1996-03</p>	 <p><b>EM-5672</b> <b>MOUNT-ENGINE</b> <b>Front</b></p> <p>NISSAN PASSENGER CAR ..... 2002-08 NISSAN SPORT UTILITY ..... 2003-07 NISSAN VAN ..... 2004-09</p>  <p><b>EM-5673</b> <b>MOUNT-ENGINE</b> <b>L &amp; R Front</b></p> <p>CHEVROLET PASSENGER CAR ..... 2009-10</p>  <p><b>EM-5675</b> <b>MOUNT-ENGINE</b> <b>Center Front</b></p> <p>AUDI PASSENGER CAR ..... 1992-97</p>  <p><b>EM-5682</b> <b>MOUNT-ENGINE</b> <b>RH Front</b></p> <p>CHEVROLET PASSENGER CAR ..... 1997-12</p>
<p><b>(Continued Next Column)</b></p>			

# BUYER'S GUIDE

## NUMERICAL LISTING - ILLUSTRATIONS

 <p style="text-align: center;"><b>EM-5689</b> <b>Engine Torque Strut Mount</b> <b>Upper</b></p> <p>HONDA PASSENGER CAR ..... 2006-11</p>	 <p style="text-align: center;"><b>EM-5694</b> <b>MOUNT-ENGINE</b> <b>LH Front</b></p> <p>BUICK SPORT UTILITY ..... 2005-07 CHEVROLET SPORT UTILITY ... 2005-09 GMC SPORT UTILITY ..... 2005-09 ISUZU SPORT UTILITY ..... 2005-06 SAAB SUV ..... 2005-09</p>	 <p style="text-align: center;"><b>EM-5734</b> <b>MOUNT-ENGINE</b> <b>L &amp; R Front</b></p> <p>MERCEDES-BENZ PASSENGER CAR ..... 2003-05</p>	 <p style="text-align: center;"><b>EM-5739</b> <b>Engine Torque Strut Mount</b> <b>Front</b></p> <p>MITSUBISHI PASSENGER CAR ..... 1983-88</p>	
 <p style="text-align: center;"><b>EM-5692</b> <b>MOUNT-ENGINE</b> <b>Front Lower</b></p> <p>DODGE PASSENGER CAR ..... 2003-05 <b>Engine Torque Strut Mount</b> CHRYSLER PASSENGER CAR ..... 2003-09</p>	 <p style="text-align: center;"><b>EM-5732</b> <b>MOUNT-ENGINE</b> <b>LH Front</b></p> <p>FORD TRUCK ..... 1997-04</p>	 <p style="text-align: center;"><b>EM-5736</b> <b>MOUNT-TRANSMISSION</b> <b>Manual</b></p> <p>TOYOTA PASSENGER CAR ..... 1995-99</p>	 <p style="text-align: center;"><b>EM-5741</b> <b>MOUNT-ENGINE</b> <b>Rear</b></p> <p>TOYOTA SPORT UTILITY ..... 2001-07 TOYOTA VAN ..... 2004-10</p>	
 <p style="text-align: center;"><b>EM-5693</b> <b>MOUNT-ENGINE</b> <b>RH Front</b></p> <p>BUICK SPORT UTILITY ..... 2005-07 CHEVROLET SPORT UTILITY ... 2005-09 GMC SPORT UTILITY ..... 2005-09 ISUZU SPORT UTILITY ..... 2005-06 SAAB SUV ..... 2005-09</p>	 <p style="text-align: center;"><b>EM-5733</b> <b>MOUNT-ENGINE</b> <b>RH Front</b></p> <p>CHEVROLET PASSENGER CAR ..... 1989-91 GEO PASSENGER CAR ..... 1989-91 PONTIAC PASSENGER CAR ..... 1989-91</p>	 <p style="text-align: center;"><b>EM-5737</b> <b>MOUNT-TRANSMISSION</b> <b>Manual</b></p> <p>MERCEDES-BENZ PASSENGER CAR ..... 1998-99</p>	 <p style="text-align: center;"><b>EM-5742</b> <b>MOUNT-ENGINE</b> <b>LH Front</b></p> <p>TOYOTA PASSENGER CAR ..... 2007-15 <b>MOUNT-ENGINE</b> <b>Front</b> TOYOTA SPORT UTILITY ..... 2009-15</p>	
		 <p style="text-align: center;"><b>EM-5738</b> <b>MOUNT-TRANSMISSION</b> <b>Front</b></p> <p>KIA PASSENGER CAR ..... 2001-05</p>		



# BUYER'S GUIDE

## NUMERICAL LISTING - ILLUSTRATIONS

 <p><b>EM-5743</b> <b>MOUNT-ENGINE</b> <b>RH Front</b></p> <p>TOYOTA PASSENGER CAR ..... 1990-93</p>	<p><b>EM-5747 (Continued)</b> VOLVO PASSENGER CAR ..... 1998-00</p>  <p><b>EM-5748</b> <b>MOUNT-ENGINE</b> <b>Rear</b></p> <p>NISSAN PASSENGER CAR ..... 2004-08</p>	 <p><b>EM-5752</b> <b>MOUNT-TRANSMISSION</b> <b>Auto</b></p> <p>TOYOTA PASSENGER CAR ..... 1993-98</p>	 <p><b>EM-5756</b> <b>MOUNT-ENGINE</b> <b>RH Front</b></p> <p>TOYOTA PASSENGER CAR ..... 1991-95</p>
 <p><b>EM-5744</b> <b>MOUNT-TRANSMISSION</b> <b>Front</b></p> <p>ACURA PASSENGER CAR ..... 2004-08</p>	 <p><b>EM-5749</b> <b>MOUNT-ENGINE</b> <b>Rear</b></p> <p>TOYOTA VAN ..... 1987-89</p>	 <p><b>EM-5753</b> <b>MOUNT-ENGINE</b> <b>Front</b></p> <p>TOYOTA PASSENGER CAR ..... 1994-99</p>	 <p><b>EM-5757</b> <b>MOUNT-TRANSMISSION</b> <b>Manual</b></p> <p>TOYOTA PASSENGER CAR ..... 2002-09</p>
 <p><b>EM-5746</b> <b>MOUNT-TRANSMISSION</b></p> <p>CHEVROLET PASSENGER CAR ..... 2008-09</p>	 <p><b>EM-5750</b> <b>Engine Torque Strut</b> <b>Front Right</b></p> <p>TOYOTA PASSENGER CAR ..... 2007-11</p>	 <p><b>EM-5754</b> <b>MOUNT-ENGINE</b> <b>L &amp; R Front</b></p> <p>TOYOTA TRUCK ..... 2005-06</p>	 <p><b>EM-5758</b> <b>Engine Torque Strut Mount</b> <b>Front</b></p> <p>TOYOTA PASSENGER CAR ..... 2000-03</p>
 <p><b>EM-5747</b> <b>MOUNT-ENGINE</b> <b>Rear</b> <b>MOUNT-TRANSMISSION</b></p> <p>VOLVO PASSENGER CAR ..... 1998-00</p>	 <p><b>EM-5751</b> <b>MOUNT-ENGINE</b> <b>Front</b></p> <p>TOYOTA PASSENGER CAR ..... 1991-95</p>	 <p><b>EM-5755</b> <b>MOUNT-ENGINE</b> <b>Rear</b></p> <p>TOYOTA SPORT UTILITY ..... 2001-03</p>	 <p><b>EM-5759</b> <b>MOUNT-ENGINE</b> <b>RH Front</b></p> <p>TOYOTA PASSENGER CAR ..... 2000-05</p>

(Continued Next Column)

# BUYER'S GUIDE

## NUMERICAL LISTING - ILLUSTRATIONS

 <p><b>EM-5761</b> <b>MOUNT-ENGINE</b> <b>Right</b></p> <p>TOYOTA PASSENGER CAR ..... 1990-92</p>	 <p><b>EM-5766</b> <b>MOUNT-ENGINE</b> <b>Right</b></p> <p>TOYOTA SPORT UTILITY ..... 2001-03</p>	 <p><b>EM-5770</b> <b>MOUNT-TRANSMISSION</b> <b>Auto</b></p> <p>NISSAN PASSENGER CAR ..... 1990-92</p>	 <p><b>EM-5774</b> <b>MOUNT-ENGINE</b> <b>Rear</b></p> <p>INFINITI PASSENGER CAR ..... 1998-99</p>
 <p><b>EM-5762</b> <b>MOUNT-ENGINE</b> <b>RH Front</b></p> <p>TOYOTA PASSENGER CAR ..... 1988-89</p>	 <p><b>EM-5767</b> <b>MOUNT-ENGINE</b> <b>Front</b></p> <p>TOYOTA PASSENGER CAR ..... 1991-95</p>	 <p><b>EM-5771</b> <b>MOUNT-TRANSMISSION</b> <b>Auto</b></p> <p>NISSAN PASSENGER CAR ..... 1991-92</p>	 <p><b>EM-5775</b> <b>MOUNT-TRANSMISSION</b> <b>Manual</b></p> <p>NISSAN PASSENGER CAR ..... 2002-06</p>
 <p><b>EM-5763</b> <b>MOUNT-ENGINE</b> <b>RH Front</b></p> <p>TOYOTA PASSENGER CAR ..... 1990-93</p>	 <p><b>EM-5768</b> <b>MOUNT-TRANSMISSION</b> <b>Manual</b></p> <p>LEXUS PASSENGER CAR ..... 1992-97</p>	 <p><b>EM-5772</b> <b>MOUNT-ENGINE</b> <b>Front</b></p> <p>NISSAN PASSENGER CAR ..... 2002-06</p>	 <p><b>EM-5776</b> <b>MOUNT-ENGINE</b> <b>LH Front</b></p> <p>INFINITI PASSENGER CAR ..... 2004-06 INFINITI SPORT UTILITY ..... 2003-08</p>
 <p><b>EM-5764</b> <b>MOUNT-ENGINE</b> <b>L &amp; R Front</b></p> <p>TOYOTA PASSENGER CAR ..... 1995-98</p>	 <p><b>EM-5769</b> <b>MOUNT-TRANSMISSION</b> <b>Auto</b></p> <p>LEXUS PASSENGER CAR ..... 1992-00 TOYOTA PASSENGER CAR ..... 1993-98</p>	 <p><b>EM-5773</b> <b>MOUNT-ENGINE</b> <b>RH Front</b></p> <p>NISSAN PASSENGER CAR ..... 2002-06</p>	 <p><b>EM-5777</b> <b>MOUNT-ENGINE</b> <b>LH Rear</b></p>

(Continued Next Page)

# BUYER'S GUIDE

## NUMERICAL LISTING - ILLUSTRATIONS

**EM-5777 (Continued)**

NISSAN PASSENGER CAR ..... 1992-94



**EM-5778**  
**MOUNT-TRANSMISSION**  
**RH**

NISSAN SPORT UTILITY ..... 1989  
NISSAN TRUCK ..... 1986-89



**EM-5779**  
**MOUNT-ENGINE**  
**LH Rear**

NISSAN PASSENGER CAR ..... 1989-94



**EM-5780**  
**MOUNT-TRANSMISSION**  
**RH**

NISSAN TRUCK ..... 1986-89



**EM-5781**  
**MOUNT-ENGINE**  
**RH Front**

NISSAN PASSENGER CAR ..... 2009-11



**EM-5782**  
**MOUNT-ENGINE**  
**RH Front**

NISSAN PASSENGER CAR ..... 2007-12



**EM-5783**  
**Engine Torque Strut Mount**  
**Rear**

MAZDA PASSENGER CAR ..... 2004-13  
MAZDA VAN ..... 2006-10



**EM-5784**  
**MOUNT-TRANSMISSION**  
**Upper**

ACURA PASSENGER CAR ..... 2009-12  
HONDA PASSENGER CAR ..... 2008-15



**EM-5785**  
**Engine Torque Strut Mount**  
**Rear**

HONDA PASSENGER CAR ..... 2009-14



**EM-5786**  
**MOUNT-ENGINE**  
**L & R Front**

HONDA PASSENGER CAR ..... 2000-09



**EM-5787**  
**MOUNT-ENGINE**  
**Right**

ACURA PASSENGER CAR ..... 2004-08  
HONDA PASSENGER CAR ..... 2003-07



**EM-5789**  
**MOUNT-ENGINE**  
**Front**

ACURA PASSENGER CAR ..... 2006-08



**EM-5790 (NEW)**  
**MOUNT-ENGINE**  
**Front**

ACURA PASSENGER CAR ..... 2004-08  
HONDA PASSENGER CAR ..... 2006-07



**EM-5792**  
**Engine Torque Strut Mount**  
**Rear**

HONDA PASSENGER CAR ..... 2009-14





**EM-5793**  
**MOUNT-ENGINE**  
**Front**

ACURA PASSENGER CAR ..... 2014-16  
ACURA SPORT UTILITY ..... 2013-16  
HONDA PASSENGER CAR ..... 2008-15  
HONDA VAN ..... 2008-17



# BUYER'S GUIDE

## NUMERICAL LISTING - ILLUSTRATIONS

 <p style="text-align: center;"><b>EM-5794</b> <b>MOUNT-TRANSMISSION</b> <b>Auto</b></p> <p>ACURA PASSENGER CAR ..... 2001-05 HONDA PASSENGER CAR ..... 2001-05</p>	 <p style="text-align: center;"><b>EM-5797</b> <b>MOUNT-TRANSMISSION</b></p> <p>MITSUBISHI SPORT UTILITY ..... 2003-06</p>	 <p style="text-align: center;"><b>EM-5801</b> <b>MOUNT-TRANSMISSION</b> <b>Manual</b></p> <p>LEXUS PASSENGER CAR ..... 2002-05</p>	 <p style="text-align: center;"><b>EM-5807</b> <b>MOUNT-TRANSMISSION</b></p> <p>TOYOTA SPORT UTILITY ..... 2001-04</p>
 <p style="text-align: center;"><b>EM-5795</b> <b>MOUNT-ENGINE</b> <b>Rear</b></p> <p>HONDA SPORT UTILITY ..... 2006-08 HONDA VAN ..... 2005-07</p>	 <p style="text-align: center;"><b>EM-5798</b> <b>MOUNT-ENGINE</b> <b>Right</b></p> <p>MITSUBISHI SPORT UTILITY ..... 2003-06</p>	 <p style="text-align: center;"><b>EM-5802</b> <b>MOUNT-ENGINE</b> <b>Right</b></p> <p>TOYOTA PASSENGER CAR ..... 1991-95</p>	 <p style="text-align: center;"><b>EM-5808</b> <b>MOUNT-TRANSMISSION</b></p> <p>TOYOTA SPORT UTILITY ..... 2001-04</p>
 <p style="text-align: center;"><b>EM-5796</b> <b>MOUNT-ENGINE</b> <b>Front</b></p> <p>MITSUBISHI PASSENGER CAR ..... 2004-06 MITSUBISHI SPORT UTILITY ..... 2003-06</p>	 <p style="text-align: center;"><b>EM-5799</b> <b>MOUNT-ENGINE</b> <b>Front</b></p> <p>TOYOTA PASSENGER CAR ..... 1991-95</p>	 <p style="text-align: center;"><b>EM-5804</b> <b>MOUNT-ENGINE</b> <b>Front</b></p> <p>LEXUS PASSENGER CAR ..... 1999-01</p>	 <p style="text-align: center;"><b>EM-5809</b> <b>MOUNT-TRANSMISSION</b></p> <p>LEXUS PASSENGER CAR ..... 1999-01</p>
 <p style="text-align: center;"><b>EM-5800</b> <b>MOUNT-ENGINE</b> <b>Front</b></p> <p>LEXUS SPORT UTILITY ..... 2004-06</p>	 <p style="text-align: center;"><b>EM-5805</b> <b>MOUNT-ENGINE</b> <b>RH Front</b></p> <p>TOYOTA PASSENGER CAR ..... 1991-95</p>	 <p style="text-align: center;"><b>EM-5810</b> <b>MOUNT-TRANSMISSION</b> <b>Auto</b></p> <p>TOYOTA PASSENGER CAR ..... 1988</p>	

# BUYER'S GUIDE

## NUMERICAL LISTING - ILLUSTRATIONS

 <p style="text-align: center;"><b>EM-5812</b> <b>MOUNT-ENGINE</b> <b>RH Front</b></p> <p>ISUZU SPORT UTILITY ..... 1998-03</p>	 <p style="text-align: center;"><b>EM-5817</b> <b>MOUNT-TRANSMISSION</b> <b>Auto</b></p> <p>NISSAN PASSENGER CAR ..... 2002-06</p>	 <p style="text-align: center;"><b>EM-5825</b> <b>MOUNT-TRANSMISSION</b> <b>Auto</b></p> <p>MITSUBISHI PASSENGER CAR ..... 2002-07</p>	 <p style="text-align: center;"><b>EM-5835</b> <b>Engine Torque Strut</b> <b>Front Right</b></p> <p>TOYOTA VAN ..... 2004-06</p>
 <p style="text-align: center;"><b>EM-5813</b> <b>MOUNT-ENGINE</b> <b>LH Front</b></p> <p>HONDA SPORT UTILITY ..... 2001-02 ISUZU SPORT UTILITY ..... 2001-04</p>	 <p style="text-align: center;"><b>EM-5818</b> <b>MOUNT-ENGINE</b> <b>Rear</b></p> <p>NISSAN PASSENGER CAR ..... 2002-06 NISSAN SPORT UTILITY ..... 2003-07 NISSAN VAN ..... 2004-09</p>	 <p style="text-align: center;"><b>EM-5827</b> <b>MOUNT-TRANSMISSION</b> <b>Manual</b></p> <p>TOYOTA PASSENGER CAR ..... 2006-17</p>	 <p style="text-align: center;"><b>EM-5837</b> <b>MOUNT-ENGINE</b> <b>Rear</b></p> <p>LEXUS SPORT UTILITY ..... 2004-09 TOYOTA SPORT UTILITY ..... 2004-07</p>
 <p style="text-align: center;"><b>EM-5814</b> <b>MOUNT-ENGINE</b> <b>RH Front</b></p> <p>HONDA SPORT UTILITY ..... 1998-00 ISUZU SPORT UTILITY ..... 1998-00</p>	 <p style="text-align: center;"><b>EM-5819</b> <b>MOUNT-ENGINE</b> <b>RH Front</b></p> <p>TOYOTA PASSENGER CAR ..... 1994-97</p>	 <p style="text-align: center;"><b>EM-5832</b> <b>MOUNT-ENGINE</b> <b>Right</b></p> <p>TOYOTA PASSENGER CAR ..... 2001-03</p>	 <p style="text-align: center;"><b>EM-5840</b> <b>MOUNT-ENGINE</b> <b>Front</b></p> <p>HONDA VAN ..... 2005-07</p>
 <p style="text-align: center;"><b>EM-5815</b> <b>MOUNT-TRANSMISSION</b></p> <p>NISSAN PASSENGER CAR ..... 1976-78</p>	<p style="text-align: center;"><b>EM-5820 (NEW)</b> <b>MOUNT-ENGINE</b> <b>LH Front</b></p> <p>MITSUBISHI SPORT UTILITY ..... 2000-04</p>	 <p style="text-align: center;"><b>EM-5834</b> <b>Engine Torque Strut</b> <b>Front Right</b></p> <p>TOYOTA PASSENGER CAR ..... 2007-14</p>	 <p style="text-align: center;"><b>EM-5842 (NEW)</b> <b>MOUNT-ENGINE</b> <b>Front</b></p> <p>LEXUS PASSENGER CAR ..... 2004-06</p> <p style="text-align: center;"><b>MOUNT-ENGINE</b> <b>LH Front</b></p> <p>TOYOTA PASSENGER CAR ..... 2004-06</p>









# BUYER'S GUIDE

## NUMERICAL LISTING - ILLUSTRATIONS

 <p><b>EM-5844</b> <b>MOUNT-ENGINE</b> <b>RH Rear</b></p> <p>MINI ..... 2002-04</p>	 <p><b>EM-5848 (NEW)</b> <b>MOUNT-ENGINE</b> <b>RH Lower</b></p> <p>VOLVO PASSENGER CAR ..... 2001-04</p>	 <p><b>EM-5857</b> <b>MOUNT-ENGINE</b> <b>Right</b></p> <p>MINI ..... 2008-13</p>	 <p><b>EM-5861</b> <b>Engine Torque Strut Mount</b> <b>Front</b></p> <p>LEXUS SPORT UTILITY ..... 2007-09</p>
 <p><b>EM-5846</b> <b>MOUNT-ENGINE</b> <b>Rear</b></p> <p>NISSAN PASSENGER CAR ..... 2000-01</p>	<p><b>EM-5851 (NEW)</b> <b>MOUNT-TRANSMISSION</b> <b>Manual</b></p> <p>TOYOTA PASSENGER CAR ..... 1998-02</p>  <p><b>EM-5855</b> <b>DIFFERENTIAL MOUNT</b></p> <p>AUDI PASSENGER CAR ..... 2002-11</p>	 <p><b>EM-5858</b> <b>MOUNT-TRANSMISSION</b></p> <p>MERCEDES-BENZ PASSENGER CAR ..... 2001-16 MERCEDES-BENZ SPORT UTILITY ..... 2010-15</p>	 <p><b>EM-5862 (NEW)</b> <b>MOUNT-TRANSMISSION</b> <b>Rear</b></p> <p>CHEVROLET PASSENGER CAR ..... 2008-10 PONTIAC PASSENGER CAR ..... 2007-10 SATURN PASSENGER CAR ..... 2008-09</p>
 <p><b>EM-5847 (NEW)</b> <b>MOUNT-ENGINE</b> <b>Left</b></p> <p>VOLVO PASSENGER CAR ..... 2001-04</p> <p><b>MOUNT-TRANSMISSION</b> <b>Auto</b></p> <p>VOLVO PASSENGER CAR ..... 1999-03</p>	 <p><b>EM-5856</b> <b>MOUNT-ENGINE</b> <b>Front</b></p> <p>MITSUBISHI PASSENGER CAR ..... 2008-15 MITSUBISHI SPORT UTILITY ..... 2007-13</p>	 <p><b>EM-5859</b> <b>MOUNT-ENGINE</b> <b>L &amp; R Front</b></p> <p>MERCEDES-BENZ PASSENGER CAR ..... 2008-16</p>	 <p><b>EM-5863</b> <b>MOUNT-TRANSMISSION</b></p> <p>MAZDA PASSENGER CAR ..... 2010-11</p>
		 <p><b>EM-5860</b> <b>Engine Torque Strut Mount</b> <b>Rear</b></p> <p>MINI ..... 2002-08</p>	 <p><b>EM-5864</b> <b>MOUNT-TRANSMISSION</b> <b>Auto</b></p> <p>MAZDA PASSENGER CAR ..... 2010-13 MAZDA VAN ..... 2012</p>

# BUYER'S GUIDE

## NUMERICAL LISTING - ILLUSTRATIONS

 <p><b>EM-5865</b> <b>MOUNT-ENGINE</b> <b>Right</b></p> <p>NISSAN PASSENGER CAR ..... 2007-13</p>	 <p><b>EM-5869</b> <b>MOUNT-ENGINE</b> <b>Front</b></p> <p>INFINITI SPORT UTILITY ..... 2013-18 NISSAN PASSENGER CAR ..... 2007-16 NISSAN SPORT UTILITY ..... 2009-16</p>	 <p><b>EM-5873</b> <b>MOUNT-ENGINE</b> <b>Front</b></p> <p>SUZUKI PASSENGER CAR ..... 2002-07</p>	 <p><b>EM-5877</b> <b>MOUNT-ENGINE</b> <b>L &amp; R Front</b></p> <p>BMW SPORT UTILITY ..... 2000-06</p>
 <p><b>EM-5866</b> <b>MOUNT-ENGINE</b> <b>Right</b></p> <p>INFINITI SPORT UTILITY ..... 2013-18 NISSAN PASSENGER CAR ..... 2013-16 NISSAN SPORT UTILITY ..... 2009-16 NISSAN VAN ..... 2011-15</p>	 <p><b>EM-5870</b> <b>MOUNT-ENGINE</b> <b>Rear</b></p> <p>NISSAN PASSENGER CAR ..... 2007-14</p>	 <p><b>EM-5874</b> <b>Engine Torque Strut</b> <b>Front Right</b></p> <p>TOYOTA VAN ..... 2004-06</p>	 <p><b>EM-5879</b> <b>MOUNT-ENGINE</b> <b>L &amp; R Front</b></p> <p>AUDI SPORTS UTILITY ..... 2007-16 VOLKSWAGEN SPORT UTILITY ..... 2004-17</p>
 <p><b>EM-5867</b> <b>MOUNT-ENGINE</b> <b>Right</b></p> <p>NISSAN PASSENGER CAR ..... 2007-16</p>	 <p><b>EM-5871</b> <b>DIFFERENTIAL MOUNT</b></p> <p>HONDA SPORT UTILITY ..... 2002-11</p>	 <p><b>EM-5875</b> <b>MOUNT-ENGINE</b> <b>Rear</b></p> <p>ACURA PASSENGER CAR ..... 2014-16 HONDA PASSENGER CAR ..... 2008-15</p>	 <p><b>EM-5880 (NEW)</b> <b>MOUNT-ENGINE</b> <b>RH Front</b></p> <p>KIA PASSENGER CAR ..... 2010-11</p>
 <p><b>EM-5868 (NEW)</b> <b>MOUNT-TRANSMISSION</b></p> <p>CHEVROLET PASSENGER CAR ..... 2004-10 SUZUKI PASSENGER CAR ..... 2004-08</p>	 <p><b>EM-5872</b> <b>MOUNT-ENGINE</b> <b>Front</b></p> <p>HONDA PASSENGER CAR ..... 2009-12</p>	 <p><b>EM-5876</b> <b>MOUNT-ENGINE</b> <b>Rear</b></p> <p>MITSUBISHI PASSENGER CAR ..... 2002-06</p>	 <p><b>EM-5881</b> <b>MOUNT-ENGINE</b> <b>LH Front</b></p> <p>HYUNDAI PASSENGER CAR ..... 2009-16</p>



# BUYER'S GUIDE

## NUMERICAL LISTING - ILLUSTRATIONS

 <p style="text-align: center;"><b>EM-5882</b> MOUNT-ENGINE RH Front</p> <p>HYUNDAI PASSENGER CAR ..... 2009-16</p>	 <p style="text-align: center;"><b>EM-5886</b> MOUNT-ENGINE L &amp; R Front</p> <p>BMW PASSENGER CAR ..... 2006-16</p>	 <p style="text-align: center;"><b>EM-5890</b> MOUNT-ENGINE Right</p> <p>BMW SPORT UTILITY ..... 2004-10</p>	 <p style="text-align: center;"><b>EM-5894</b> MOUNT-ENGINE RH Front</p> <p>LAND ROVER SPORT UTILITY .. 2006-09</p>
 <p style="text-align: center;"><b>EM-5883 (NEW)</b> MOUNT-ENGINE Front</p> <p>HYUNDAI SPORT UTILITY ..... 2010-12 KIA SPORT UTILITY ..... 2011-13</p>	 <p style="text-align: center;"><b>EM-5887</b> MOUNT-ENGINE RH Front</p> <p>BMW PASSENGER CAR ..... 2012-15 BMW SPORT UTILITY ..... 2013</p>	 <p style="text-align: center;"><b>EM-5891 (NEW)</b> MOUNT-TRANSMISSION Auto</p> <p>HONDA PASSENGER CAR ..... 2009-12</p>	 <p style="text-align: center;"><b>EM-5895</b> MOUNT-ENGINE LH Front</p> <p>LAND ROVER SPORT UTILITY .. 2003-05</p>
 <p style="text-align: center;"><b>EM-5884</b> MOUNT-ENGINE LH Front</p> <p>BMW PASSENGER CAR ..... 2004-11</p>	 <p style="text-align: center;"><b>EM-5888</b> MOUNT-ENGINE LH Front</p> <p>BMW PASSENGER CAR ..... 2012-15 BMW SPORT UTILITY ..... 2013</p>	 <p style="text-align: center;"><b>EM-5892</b> MOUNT-ENGINE L &amp; R Front</p> <p>LAND ROVER SPORT UTILITY .. 2006-12</p>	 <p style="text-align: center;"><b>EM-5896</b> MOUNT-ENGINE RH Front</p> <p>LAND ROVER SPORT UTILITY .. 2003-05</p>
 <p style="text-align: center;"><b>EM-5885</b> MOUNT-ENGINE RH Front</p> <p>BMW PASSENGER CAR ..... 2004-11</p>	 <p style="text-align: center;"><b>EM-5889</b> MOUNT-ENGINE Left</p> <p>BMW SPORT UTILITY ..... 2004-06</p>	 <p style="text-align: center;"><b>EM-5893</b> MOUNT-ENGINE LH Front</p> <p>LAND ROVER SPORT UTILITY .. 2006-09</p>	 <p style="text-align: center;"><b>EM-5898 (NEW)</b> MOUNT-TRANSMISSION Auto</p> <p>TOYOTA PASSENGER CAR ..... 2009-13</p>













# BUYER'S GUIDE

## NUMERICAL LISTING - ILLUSTRATIONS

 <p><b>EM-5900</b> <b>MOUNT-ENGINE</b> <b>Front</b></p> <p>TOYOTA SPORT UTILITY ..... 2009-13 TOYOTA VAN ..... 2004-12</p>	<p><b>EM-5903 (Continued)</b> HONDA SPORT UTILITY ..... 2006-08</p>  <p><b>EM-5904</b> <b>MOUNT-ENGINE</b> <b>Rear</b></p>	 <p><b>EM-5908</b> <b>MOUNT-TRANSMISSION</b> <b>Manual</b></p> <p>TOYOTA SPORT UTILITY ..... 1996-01</p>	 <p><b>EM-5912</b> <b>MOUNT-ENGINE</b> <b>Rear</b></p> <p>MITSUBISHI SPORT UTILITY ..... 2003-06</p>
 <p><b>EM-5901</b> <b>MOUNT-ENGINE</b> <b>RH Front</b></p> <p>TOYOTA SPORT UTILITY ..... 2008-16 TOYOTA TRUCK ..... 2007-16</p>	<p>HONDA VAN ..... 2008-10</p>  <p><b>EM-5905</b> <b>MOUNT-TRANSMISSION</b> <b>Manual</b></p>	 <p><b>EM-5909</b> <b>Engine Torque Strut Mount</b> <b>Rear</b></p> <p>MAZDA PASSENGER CAR ..... 2011-14</p>	 <p><b>EM-5913</b> <b>Engine Torque Strut Mount</b> <b>Upper</b></p> <p>ACURA SPORT UTILITY ..... 2007-12</p>
 <p><b>EM-5902</b> <b>MOUNT-ENGINE</b> <b>LH Front</b></p> <p>TOYOTA SPORT UTILITY ..... 2008-16 TOYOTA TRUCK ..... 2007-16</p>	<p>NISSAN PASSENGER CAR ..... 2007-12</p>  <p><b>EM-5906</b> <b>MOUNT-ENGINE</b> <b>RH Front</b></p>	 <p><b>EM-5910</b> <b>MOUNT-TRANSMISSION</b> <b>Manual</b></p> <p>TOYOTA TRUCK ..... 2005-15</p>	 <p><b>EM-5914</b> <b>MOUNT-TRANSMISSION</b></p> <p>NISSAN SPORT UTILITY ..... 2008-14 NISSAN VAN ..... 2011-14</p>
 <p><b>EM-5903</b> <b>MOUNT-ENGINE</b> <b>Front</b></p> <p>HONDA PASSENGER CAR ..... 2005-07</p> <p><b>(Continued Next Column)</b></p>	<p>HONDA PASSENGER CAR ..... 2006-11</p>  <p><b>EM-5907</b> <b>MOUNT-ENGINE</b> <b>Rear</b></p> <p>MITSUBISHI PASSENGER CAR ..... 1999-04</p>	 <p><b>EM-5911</b> <b>MOUNT-TRANSMISSION</b></p> <p>INFINITI PASSENGER CAR ..... 2004-10 INFINITI SPORT UTILITY ..... 2003-12</p>	 <p><b>EM-5915</b> <b>SUBFRAME MOUNT</b> <b>FRONT RIGHT</b></p> <p>ACURA PASSENGER CAR ..... 2004-14 HONDA PASSENGER CAR ..... 2003-17</p>

# BUYER'S GUIDE

## NUMERICAL LISTING - ILLUSTRATIONS

 <p><b>EM-5916</b> <b>MOUNT-ENGINE</b> <b>Right</b></p> <p>SCION PASSENGER CAR ..... 2005-10</p>	 <p><b>EM-5920 (NEW)</b> <b>MOUNT-TRANSMISSION</b></p> <p>TOYOTA TRUCK ..... 2005-06</p>	 <p><b>EM-5924</b> <b>MOUNT-ENGINE</b> <b>Rear</b></p> <p>MITSUBISHI PASSENGER CAR ..... 2008-15</p>	 <p><b>EM-5929</b> <b>MOUNT-ENGINE</b> <b>Front</b></p> <p>MITSUBISHI PASSENGER CAR ..... 1993-96</p>
 <p><b>EM-5917</b> <b>SUBFRAME MOUNT</b> <b>FRONT LEFT</b></p> <p>ACURA PASSENGER CAR ..... 2004-14 HONDA PASSENGER CAR ..... 2003-17</p>	 <p><b>EM-5921</b> <b>MOUNT-ENGINE</b> <b>L &amp; R Front</b></p> <p>LEXUS PASSENGER CAR ..... 1998-08</p>	 <p><b>EM-5925</b> <b>MOUNT-ENGINE</b> <b>Front</b></p> <p>HONDA VAN ..... 2008-10</p>	 <p><b>EM-5930</b> <b>MOUNT-TRANSMISSION</b> <b>Auto</b></p> <p>TOYOTA PASSENGER CAR ..... 2006-17</p>
 <p><b>EM-5918</b> <b>MOUNT-TRANSMISSION</b></p> <p>TOYOTA TRUCK ..... 2000-04</p>	 <p><b>EM-5922</b> <b>MOUNT-ENGINE</b> <b>Front</b></p> <p>MINI ..... 2004-08</p>	 <p><b>EM-5927</b> <b>MOUNT-ENGINE</b> <b>Right</b></p> <p>MITSUBISHI SPORT UTILITY ..... 2007-13</p>	 <p><b>EM-5931</b> <b>MOUNT-ENGINE</b> <b>Right</b></p> <p>CHEVROLET PASSENGER CAR ..... 2004-10 SUZUKI PASSENGER CAR ..... 2004-08</p>
 <p><b>EM-5919</b> <b>MOUNT-TRANSMISSION</b></p> <p>TOYOTA SPORT UTILITY ..... 2005-07</p>	 <p><b>EM-5923</b> <b>MOUNT-TRANSMISSION</b> <b>Manual</b></p> <p>MAZDA VAN ..... 2006-10</p>	 <p><b>EM-5928</b> <b>MOUNT-TRANSMISSION</b></p> <p>MITSUBISHI SPORT UTILITY ..... 2007-12</p>	 <p><b>EM-5932</b> <b>Engine Torque Strut Mount</b> <b>Right</b></p> <p>CHEVROLET PASSENGER CAR ..... 2004-10</p>

(Continued Next Page)

# BUYER'S GUIDE

## NUMERICAL LISTING - ILLUSTRATIONS

**EM-5932 (Continued)**

SUZUKI PASSENGER CAR ..... 2004-08



**EM-5933**  
Engine Torque Strut Mount  
Lower

CHEVROLET PASSENGER  
CAR ..... 2004-10  
SUZUKI PASSENGER CAR ..... 2004-08



**EM-5934**  
MOUNT-TRANSMISSION  
Manual

VOLKSWAGEN PASSENGER  
CAR ..... 2009-12



**EM-5935**  
MOUNT-TRANSMISSION  
Auto

VOLKSWAGEN PASSENGER  
CAR ..... 2009-14



**EM-5936**  
MOUNT-ENGINE  
Right

HYUNDAI PASSENGER CAR ..... 2009-10



**EM-5937**  
MOUNT-TRANSMISSION  
Auto

INFINITI PASSENGER CAR ..... 1996  
NISSAN PASSENGER CAR ..... 1995-01



**EM-5938**  
MOUNT-ENGINE  
Rear

NISSAN SPORT UTILITY ..... 2002-07



**EM-5940**  
MOUNT-ENGINE  
Right

TOYOTA SPORT UTILITY ..... 2006-08



**EM-5941**  
MOUNT-TRANSMISSION  
Auto

LEXUS PASSENGER CAR ..... 1998-05



**EM-5942**  
MOUNT-TRANSMISSION

LEXUS PASSENGER CAR ..... 1996-00



**EM-5943**  
Engine Torque Strut Mount  
Rear

MAZDA PASSENGER CAR ..... 2006-08



**EM-5944**  
Engine Torque Strut Mount  
Rear Lower

SCION PASSENGER CAR ..... 2008-14



**EM-5945**  
MOUNT-TRANSMISSION  
Auto

SUBARU PASSENGER CAR ..... 2012-15  
SUBARU SPORT UTILITY ..... 2013-15



**EM-5947**  
MOUNT-TRANSMISSION  
Manual

SAAB PASSENGER CAR ..... 1994-02



**EM-5948 (NEW)**  
MOUNT-TRANSMISSION

INFINITI PASSENGER CAR ..... 1990-96





**EM-5949**  
MOUNT-ENGINE  
Front

TOYOTA VAN ..... 2007-10



# BUYER'S GUIDE

## NUMERICAL LISTING - ILLUSTRATIONS

 <p><b>EM-5950</b> <b>MOUNT-TRANSMISSION</b> LEXUS PASSENGER CAR ..... 1993-97</p>	 <p><b>EM-5954</b> <b>Engine Torque Strut Mount Upper</b> ACURA PASSENGER CAR ..... 2013-15 HONDA SPORT UTILITY ..... 2012-16</p>	 <p><b>EM-5959</b> <b>MOUNT-ENGINE LH Front</b> SUBARU PASSENGER CAR ..... 2012-13 SUBARU SPORT UTILITY ..... 2013</p>	 <p><b>EM-5963</b> <b>MOUNT-TRANSMISSION Auto</b> LEXUS PASSENGER CAR ..... 2006-17</p>
 <p><b>EM-5951</b> <b>MOUNT-ENGINE Front</b> SUZUKI PASSENGER CAR ..... 2010-13</p>	 <p><b>EM-5956 (NEW)</b> <b>MOUNT-TRANSMISSION</b> ACURA SPORT UTILITY ..... 2010-15 HONDA VAN ..... 2011-16</p>	 <p><b>EM-5960</b> <b>MOUNT-ENGINE RH Front</b> SUBARU PASSENGER CAR ..... 2012-13 SUBARU SPORT UTILITY ..... 2013</p>	 <p><b>EM-5964</b> <b>MOUNT-ENGINE Right</b> TOYOTA SPORT UTILITY ..... 2006-12</p>
 <p><b>EM-5952</b> <b>MOUNT-ENGINE L &amp; R Front</b> LEXUS PASSENGER CAR ..... 2001-06</p>	 <p><b>EM-5957 (NEW)</b> <b>MOUNT-TRANSMISSION Rear</b> ACURA PASSENGER CAR ..... 2004-08</p>	 <p><b>EM-5961 (NEW)</b> <b>MOUNT-ENGINE Front</b> NISSAN SPORT UTILITY ..... 2003-07</p>	 <p><b>EM-5966 (NEW)</b> <b>MOUNT-ENGINE L &amp; R Front</b> AUDI PASSENGER CAR ..... 2008-10</p>
 <p><b>EM-5953</b> <b>MOUNT-ENGINE Right</b> NISSAN PASSENGER CAR ..... 2007-12 NISSAN SPORT UTILITY ..... 2008-13 RENAULT SPORT UTILITY ..... 2009-14</p>	 <p><b>EM-5958</b> <b>MOUNT-ENGINE Right</b> HONDA SPORT UTILITY ..... 2012-16</p>	 <p><b>EM-5962</b> <b>MOUNT-ENGINE Rear</b> NISSAN SPORT UTILITY ..... 2003-07</p>	 <p><b>EM-5967</b> <b>MOUNT-TRANSMISSION</b> LEXUS PASSENGER CAR ..... 2001-03</p>

# BUYER'S GUIDE

## NUMERICAL LISTING - ILLUSTRATIONS

 <p style="text-align: center;"><b>EM-5968</b> Engine Torque Strut Mount Lower</p> <p>NISSAN PASSENGER CAR ..... 2012-16</p>	<p><b>EM-5971 (Continued)</b> SUBARU SPORT UTILITY ..... 2009-10</p>  <p style="text-align: center;"><b>EM-5972 (NEW)</b> MOUNT-ENGINE L &amp; R Front</p> <p>MERCEDES-BENZ PASSENGER CAR ..... 2007-12 MERCEDES-BENZ SPORT UTILITY ..... 2006-12</p>	 <p style="text-align: center;"><b>EM-5975 (NEW)</b> MOUNT-TRANSMISSION Manual</p> <p>LEXUS PASSENGER CAR ..... 2006-12</p>	 <p style="text-align: center;"><b>EM-5979 (NEW)</b> MOUNT-ENGINE Right</p> <p>TOYOTA SPORT UTILITY ..... 2009-12</p>
 <p style="text-align: center;"><b>EM-5969</b> MOUNT-TRANSMISSION Manual</p> <p>NISSAN PASSENGER CAR ..... 2012-16</p>	 <p style="text-align: center;"><b>EM-5973</b> MOUNT-ENGINE Right</p> <p>SCION VAN ..... 2008-15</p>	 <p style="text-align: center;"><b>EM-5976</b> MOUNT-TRANSMISSION</p> <p>LEXUS PASSENGER CAR ..... 2004-06</p>	 <p style="text-align: center;"><b>EM-5980</b> MOUNT-TRANSMISSION Manual</p> <p>MITSUBISHI PASSENGER CAR ..... 2006-12</p>
 <p style="text-align: center;"><b>EM-5970</b> MOUNT-ENGINE Right</p> <p>LEXUS PASSENGER CAR ..... 2011-16 TOYOTA PASSENGER CAR ..... 2010-16</p>	 <p style="text-align: center;"><b>EM-5974 (NEW)</b> MOUNT-ENGINE Center Front Lower</p> <p>ACURA PASSENGER CAR ..... 1997-98</p>	 <p style="text-align: center;"><b>EM-5977 (NEW)</b> MOUNT-ENGINE Right</p> <p>TOYOTA SPORT UTILITY ..... 2009-12</p>	 <p style="text-align: center;"><b>EM-5981 (NEW)</b> MOUNT-TRANSMISSION Auto</p> <p>NISSAN SPORT UTILITY ..... 2002-07</p>
 <p style="text-align: center;"><b>EM-5971</b> MOUNT-ENGINE LH Front</p> <p>SUBARU PASSENGER CAR ..... 2005-09</p> <p style="text-align: center;"><b>EM-5971</b> MOUNT-ENGINE Left</p> <p>(Continued Next Column)</p>	 <p style="text-align: center;"><b>EM-5978</b> MOUNT-TRANSMISSION Upper</p> <p>ACURA PASSENGER CAR ..... 2007-08</p>	 <p style="text-align: center;"><b>EM-5982</b> MOUNT-ENGINE Right</p> <p>TOYOTA SPORT UTILITY ..... 2006-08</p>	

# BUYER'S GUIDE

## NUMERICAL LISTING - ILLUSTRATIONS

 <p style="text-align: center;"><b>EM-5983</b> <b>MOUNT-ENGINE</b> <b>RH Front</b></p> <p>SUBARU PASSENGER CAR ..... 2005-09 <b>MOUNT-ENGINE</b> <b>Right</b> SUBARU SPORT UTILITY ..... 2009-10</p>	 <p style="text-align: center;"><b>EM-5986</b> <b>MOUNT-ENGINE</b> <b>Rear</b></p> <p>SCION PASSENGER CAR ..... 2005-10</p>	 <p style="text-align: center;"><b>EM-5991 (NEW)</b> <b>MOUNT-ENGINE</b> <b>Front</b></p> <p>Lexus PASSENGER CAR ..... 2002-03</p>	<p><b>EM-5994 (Continued)</b> ACURA SPORT UTILITY ..... 2007-09</p>  <p style="text-align: center;"><b>EM-5995 (NEW)</b> <b>DIFFERENTIAL MOUNT</b></p> <p>HONDA SPORT UTILITY ..... 1997-01</p>
 <p style="text-align: center;"><b>EM-5984</b> <b>MOUNT-ENGINE</b> <b>Rear</b></p> <p>ACURA PASSENGER CAR ..... 2004-08</p>	 <p style="text-align: center;"><b>EM-5988</b> <b>MOUNT-ENGINE</b> <b>Rear</b></p> <p>SCION PASSENGER CAR ..... 2005-10</p>	 <p style="text-align: center;"><b>EM-5992</b> <b>MOUNT-ENGINE</b> <b>Right</b></p> <p>ACURA SPORT UTILITY ..... 2007-13</p>	 <p style="text-align: center;"><b>EM-5996</b> <b>MOUNT-TRANSMISSION</b> <b>Auto</b></p> <p>HYUNDAI PASSENGER CAR ..... 2011-14 <b>MOUNT-TRANSMISSION</b> KIA PASSENGER CAR ..... 2011-15</p>
 <p style="text-align: center;"><b>EM-5985 (NEW)</b> <b>Engine Torque Strut Mount</b> <b>Lower</b></p> <p>ACURA SPORT UTILITY ..... 2007-12</p>	 <p style="text-align: center;"><b>EM-5989 (NEW)</b> <b>MOUNT-TRANSMISSION</b></p> <p>SCION PASSENGER CAR ..... 2005-10</p>	 <p style="text-align: center;"><b>EM-5993</b> <b>MOUNT-ENGINE</b> <b>Right</b></p> <p>VOLVO PASSENGER CAR ..... 1998-07 VOLVO SPORT UTILITY ..... 2003-06</p>	 <p style="text-align: center;"><b>EM-5997 (NEW)</b> <b>MOUNT-TRANSMISSION</b> <b>Auto</b></p> <p>KIA PASSENGER CAR ..... 2010-13</p>
	 <p style="text-align: center;"><b>EM-5990</b> <b>MOUNT-TRANSMISSION</b> <b>Auto</b></p> <p>HONDA PASSENGER CAR ..... 2012-15</p>	 <p style="text-align: center;"><b>EM-5994</b> <b>MOUNT-TRANSMISSION</b> <b>Lower</b></p> <p>ACURA PASSENGER CAR ..... 2007-08 <b>MOUNT-TRANSMISSION</b></p> <p style="text-align: center;">(Continued Next Column)</p>	

# BUYER'S GUIDE

## NUMERICAL LISTING - ILLUSTRATIONS

 <p style="text-align: center;"><b>EM-5999 (NEW)</b> <b>MOUNT-ENGINE</b> <b>Rear</b></p> <p>KIA PASSENGER CAR ..... 2010-13</p>	 <p style="text-align: center;"><b>EM-7007</b> <b>MOUNT-TRANSMISSION</b> <b>Auto</b></p> <p>SUBARU PASSENGER CAR ..... 1992-96</p>	 <p style="text-align: center;"><b>EM-7010</b> <b>MOUNT-ENGINE</b> <b>L &amp; R Front</b></p> <p>TOYOTA TRUCK ..... 2005-15</p>	 <p style="text-align: center;"><b>EM-7015</b> <b>MOUNT-TRANSMISSION</b> <b>Auto</b></p> <p>SCION PASSENGER CAR ..... 2008-14</p>
 <p style="text-align: center;"><b>EM-7000</b> <b>MOUNT-TRANSMISSION</b> <b>Auto</b></p> <p>VOLKSWAGEN PASSENGER CAR ..... 1999-06</p>	 <p style="text-align: center;"><b>EM-7008 (NEW)</b> <b>MOUNT-ENGINE</b> <b>Front</b></p> <p>INFINITI PASSENGER CAR ..... 2007-18</p> <p style="text-align: center;"><b>MOUNT-ENGINE</b> <b>L &amp; R Front</b></p> <p>INFINITI SPORT UTILITY ..... 2008-17</p> <p style="text-align: center;"><b>MOUNT-ENGINE</b> <b>Front</b></p> <p>NISSAN PASSENGER CAR ..... 2009-19</p>	 <p style="text-align: center;"><b>EM-7011</b> <b>MOUNT-ENGINE</b> <b>Right</b></p> <p>TOYOTA SPORT UTILITY ..... 2004-05</p>	 <p style="text-align: center;"><b>EM-7016 (NEW)</b> <b>MOUNT-ENGINE</b> <b>Front</b></p> <p>TOYOTA PASSENGER CAR ..... 2012-17</p>
 <p style="text-align: center;"><b>EM-7004</b> <b>MOUNT-ENGINE</b> <b>Right</b></p> <p>MAZDA SPORT UTILITY ..... 2010-12</p>	 <p style="text-align: center;"><b>EM-7009 (NEW)</b> <b>Engine Torque Strut Mount</b> <b>Right</b></p> <p>NISSAN PASSENGER CAR ..... 2013-15</p> <p>NISSAN SPORT UTILITY ..... 2011-14</p>	 <p style="text-align: center;"><b>EM-7012 (NEW)</b> <b>MOUNT-TRANSMISSION</b> <b>Manual</b></p> <p>HONDA PASSENGER CAR ..... 2012-15</p>	 <p style="text-align: center;"><b>EM-7017</b> <b>MOUNT-TRANSMISSION</b> <b>Manual</b></p> <p>MITSUBISHI SPORT UTILITY ..... 1995-96</p>
 <p style="text-align: center;"><b>EM-7006</b> <b>MOUNT-ENGINE</b> <b>Rear</b></p> <p>KIA PASSENGER CAR ..... 2010-13</p>	 <p style="text-align: center;"><b>EM-7013 (NEW)</b> <b>Engine Torque Strut Mount</b> <b>Left</b></p> <p>NISSAN SPORT UTILITY ..... 2011-14</p>	 <p style="text-align: center;"><b>EM-7018 (NEW)</b> <b>MOUNT-ENGINE</b> <b>Right</b></p> <p>MAZDA SPORT UTILITY ..... 2007-12</p>	



# BUYER'S GUIDE

## NUMERICAL LISTING - ILLUSTRATIONS

 <p style="text-align: center;"><b>EM-7019 (NEW)</b> <b>MOUNT-ENGINE</b> <b>Right</b></p> <p>AUDI PASSENGER CAR ..... 2000-06 <b>MOUNT-ENGINE</b> <b>RH Front</b></p> <p>VOLKSWAGEN PASSENGER CAR ..... 2000-05</p>	 <p style="text-align: center;"><b>EM-7022 (NEW)</b> <b>MOUNT-TRANSMISSION</b> <b>Auto</b></p> <p>MAZDA PASSENGER CAR ..... 2011-14</p>	 <p style="text-align: center;"><b>EM-7025 (NEW)</b> <b>MOUNT-ENGINE</b> <b>Front</b></p> <p>BMW SPORT UTILITY ..... 2007-17</p>	 <p style="text-align: center;"><b>EM-7031 (NEW)</b> <b>Engine Torque Strut Mount</b> <b>Rear</b></p> <p>PORSCHE ..... 2011-16 PORSCHE SUV ..... 2003-10</p>
 <p style="text-align: center;"><b>EM-7020 (NEW)</b> <b>MOUNT-TRANSMISSION</b> <b>Auto</b></p> <p>MERCEDES-BENZ PASSENGER CAR ..... 2007</p> <p>MERCEDES-BENZ SPORT UTILITY ..... 2006-11</p>	 <p style="text-align: center;"><b>EM-7023 (NEW)</b> <b>MOUNT-TRANSMISSION</b></p> <p>ACURA SPORT UTILITY ..... 2007-12</p>	 <p style="text-align: center;"><b>EM-7027 (NEW)</b> <b>MOUNT-ENGINE</b> <b>Right</b></p> <p>TOYOTA SPORT UTILITY ..... 2008-13</p>	 <p style="text-align: center;"><b>EM-7034 (NEW)</b> <b>MOUNT-TRANSMISSION</b> <b>Auto</b></p> <p>HYUNDAI PASSENGER CAR ..... 2011-14</p>
 <p style="text-align: center;"><b>EM-7021</b> <b>MOUNT-ENGINE</b> <b>Right</b></p> <p>VOLKSWAGEN PASSENGER CAR ..... 2009-15</p>	 <p style="text-align: center;"><b>EM-7024 (NEW)</b> <b>Engine Torque Strut Mount</b> <b>Rear</b></p> <p>NISSAN SPORT UTILITY ..... 2017-18 <b>MOUNT-TRANSMISSION</b></p> <p>NISSAN PASSENGER CAR ..... 2013-17 <b>MOUNT-TRANSMISSION</b> <b>Manual</b></p> <p>NISSAN SPORT UTILITY ..... 2011-17</p>	 <p style="text-align: center;"><b>EM-7029 (NEW)</b> <b>MOUNT-ENGINE</b> <b>Rear</b></p> <p>SUZUKI PASSENGER CAR ..... 2007-13</p>	 <p style="text-align: center;"><b>EM-7035 (NEW)</b> <b>MOUNT-TRANSMISSION</b> <b>Manual</b></p> <p>HYUNDAI PASSENGER CAR ..... 2011-12</p>
 <p style="text-align: center;"><b>EM-7030</b> <b>MOUNT-ENGINE</b> <b>RH Front</b></p> <p>AUDI PASSENGER CAR ..... 2002-06</p>	 <p style="text-align: center;"><b>EM-7036 (NEW)</b> <b>MOUNT-ENGINE</b> <b>Right</b></p> <p>HYUNDAI SPORT UTILITY ..... 2003-06</p>		

# BUYER'S GUIDE

## NUMERICAL LISTING - ILLUSTRATIONS

<p><b>EM-7037 (NEW)</b> MOUNT-ENGINE Front</p> <p>KIA PASSENGER CAR ..... 2009-10</p> 	 <p><b>EM-7042</b> Engine Torque Strut Mount Upper</p> <p>SCION PASSENGER CAR ..... 2008-14</p>	 <p><b>EM-7046 (NEW)</b> MOUNT-TRANSMISSION Manual</p> <p>MAZDA PASSENGER CAR ..... 2011-14</p>	 <p><b>EM-7051</b> MOUNT-TRANSMISSION</p> <p>KIA SPORT UTILITY ..... 2007-11</p>
<p><b>EM-7038 (NEW)</b> MOUNT-ENGINE Front</p> <p>HONDA PASSENGER CAR ..... 2008-15</p> 	 <p><b>EM-7043</b> MOUNT-ENGINE L &amp; R Front</p> <p>AUDI PASSENGER CAR ..... 2005-08</p>	 <p><b>EM-7047 (NEW)</b> MOUNT-ENGINE RH Front</p> <p>AUDI PASSENGER CAR ..... 2002-08</p>	 <p><b>EM-7053 (NEW)</b> MOUNT-ENGINE Right</p> <p>LEXUS PASSENGER CAR ..... 2013-18 TOYOTA PASSENGER CAR ..... 2012-17</p>
<p><b>EM-7039</b> MOUNT-ENGINE Rear</p> <p>LEXUS SPORT UTILITY ..... 2004-09 TOYOTA SPORT UTILITY ..... 2004-10</p> 	<p><b>EM-7043</b> MOUNT-ENGINE L &amp; R Front</p> <p>AUDI PASSENGER CAR ..... 2005-08</p> <p><b>EM-7044 (NEW)</b> MOUNT-ENGINE Right</p> <p>FORD PASSENGER CAR ..... 2006-12 MAZDA PASSENGER CAR ..... 2009-13 MERCURY PASSENGER CAR ... 2006-11</p> 	 <p><b>EM-7048 (NEW)</b> MOUNT-ENGINE Rear</p> <p>SCION VAN ..... 2008-15</p>	 <p><b>EM-7054 (NEW)</b> MOUNT-TRANSMISSION</p> <p>TOYOTA PASSENGER CAR ..... 2012-17</p>
<p><b>EM-7041 (NEW)</b> Engine Torque Strut Front Right</p> <p>TOYOTA SPORT UTILITY ..... 2008-10</p> 	<p><b>EM-7049 (NEW)</b> MOUNT-TRANSMISSION Manual</p> <p>KIA PASSENGER CAR ..... 2010-13</p> 	 <p><b>EM-7055 (NEW)</b> Engine Torque Strut Mount Lower</p> <p>HONDA SPORT UTILITY ..... 2012-16</p>	

# BUYER'S GUIDE

## NUMERICAL LISTING - ILLUSTRATIONS

 <p><b>EM-7056 (NEW)</b> <b>MOUNT-TRANSMISSION</b> <b>Auto</b></p> <p>HYUNDAI SPORT UTILITY ..... 2010-13 KIA SPORT UTILITY ..... 2011-13</p>	 <p><b>EM-7060 (NEW)</b> <b>MOUNT-TRANSMISSION</b> <b>Auto</b></p> <p>HYUNDAI SPORT UTILITY ..... 2010-12 KIA SPORT UTILITY ..... 2011-13</p>	 <p><b>EM-7065 (NEW)</b> <b>Engine Torque Strut Mount</b> <b>Front Lower</b></p> <p>HYUNDAI PASSENGER CAR ..... 2012-16 KIA PASSENGER CAR ..... 2012-14</p>	 <p><b>EM-7072 (NEW)</b> <b>MOUNT-TRANSMISSION</b> <b>Auto</b></p> <p>NISSAN PASSENGER CAR ..... 2007-12</p>
 <p><b>EM-7057 (NEW)</b> <b>MOUNT-ENGINE</b> <b>Front</b></p> <p>HYUNDAI PASSENGER CAR ..... 2011-16</p> <p><b>MOUNT-TRANSMISSION</b> <b>Manual</b></p> <p>HYUNDAI PASSENGER CAR ..... 2012-17 KIA PASSENGER CAR ..... 2012-14</p>	 <p><b>EM-7061 (NEW)</b> <b>MOUNT-ENGINE</b> <b>Rear</b></p> <p>HYUNDAI SPORT UTILITY ..... 2010-12 KIA SPORT UTILITY ..... 2011-13</p>	 <p><b>EM-7066 (NEW)</b> <b>Engine Torque Strut Mount</b> <b>Front Lower</b></p> <p>HYUNDAI PASSENGER CAR ..... 2011-16 KIA PASSENGER CAR ..... 2010-16</p>	 <p><b>EM-7073 (NEW)</b> <b>MOUNT-ENGINE</b> <b>Front</b></p> <p>HONDA SPORT UTILITY ..... 2012-14</p>
 <p><b>EM-7058 (NEW)</b> <b>MOUNT-TRANSMISSION</b></p> <p>INFINITI PASSENGER CAR ..... 2006-15 INFINITI SPORT UTILITY ..... 2008-15</p>	 <p><b>EM-7062 (NEW)</b> <b>MOUNT-ENGINE</b> <b>Front</b></p> <p>HYUNDAI PASSENGER CAR ..... 2012-14 KIA PASSENGER CAR ..... 2012-16</p> <p><b>EM-7064 (NEW)</b> <b>MOUNT-ENGINE</b> <b>Front</b></p> <p>HYUNDAI PASSENGER CAR ..... 2011-19</p>	 <p><b>EM-7069 (NEW)</b> <b>MOUNT-ENGINE</b> <b>Right</b></p> <p>BMW PASSENGER CAR ..... 2004-10</p>	 <p><b>EM-7075 (NEW)</b> <b>MOUNT-ENGINE</b> <b>Rear</b></p> <p>VOLKSWAGEN PASSENGER CAR ..... 2006-15</p>
		 <p><b>EM-7070 (NEW)</b> <b>MOUNT-ENGINE</b> <b>Right</b></p> <p>NISSAN PASSENGER CAR ..... 2013 NISSAN SPORT UTILITY ..... 2011-14</p>	 <p><b>EM-7076 (NEW)</b> <b>MOUNT-TRANSMISSION</b> <b>Manual</b></p> <p>VOLKSWAGEN PASSENGER CAR ..... 2009-15</p>

# BUYER'S GUIDE

## NUMERICAL LISTING - ILLUSTRATIONS

 <p style="text-align: center;"><b>EM-7077 (NEW)</b> <b>MOUNT-ENGINE</b> <b>Rear</b></p> <p>LEXUS PASSENGER CAR ..... 2011-16 TOYOTA PASSENGER CAR ..... 2010-16</p>	 <p style="text-align: center;"><b>EM-7081 (NEW)</b> <b>Engine Torque Strut Mount</b> <b>Left</b></p> <p>NISSAN SPORT UTILITY ..... 2011-14</p>	 <p style="text-align: center;"><b>EM-7085 (NEW)</b> <b>MOUNT-TRANSMISSION</b> <b>Rear</b></p> <p>HONDA TRUCK ..... 2006-14</p>	 <p style="text-align: center;"><b>EM-7090 (NEW)</b> <b>MOUNT-TRANSMISSION</b> <b>Auto</b></p> <p>HYUNDAI PASSENGER CAR ..... 2011-17 KIA PASSENGER CAR ..... 2014-16</p>
 <p style="text-align: center;"><b>EM-7078 (NEW)</b> <b>MOUNT-ENGINE</b> <b>Rear</b></p> <p>TOYOTA SPORT UTILITY ..... 2006-12</p>	 <p style="text-align: center;"><b>EM-7082 (NEW)</b> <b>MOUNT-TRANSMISSION</b> <b>Manual</b></p> <p>NISSAN PASSENGER CAR ..... 2008-12</p>	 <p style="text-align: center;"><b>EM-7086 (NEW)</b> <b>Engine Torque Strut</b> <b>Front Right</b></p> <p>TOYOTA SPORT UTILITY ..... 2010-13</p>	 <p style="text-align: center;"><b>EM-7091 (NEW)</b> <b>MOUNT-ENGINE</b> <b>Front</b></p> <p>HYUNDAI PASSENGER CAR ..... 2011-14</p>
 <p style="text-align: center;"><b>EM-7079 (NEW)</b> <b>MOUNT-TRANSMISSION</b> <b>Auto</b></p> <p>TOYOTA TRUCK ..... 2011-15</p>	 <p style="text-align: center;"><b>EM-7083 (NEW)</b> <b>Engine Torque Strut Mount</b> <b>Right</b></p> <p>LEXUS SPORT UTILITY ..... 2010-15 TOYOTA SPORT UTILITY ..... 2011-15</p>	 <p style="text-align: center;"><b>EM-7087 (NEW)</b> <b>MOUNT-ENGINE</b> <b>Rear</b></p> <p>HYUNDAI PASSENGER CAR ..... 2011-14</p>	 <p style="text-align: center;"><b>EM-7092 (NEW)</b> <b>MOUNT-ENGINE</b> <b>Right</b></p> <p>HYUNDAI PASSENGER CAR ..... 2011-17 KIA PASSENGER CAR ..... 2011-15</p>
 <p style="text-align: center;"><b>EM-7080 (NEW)</b> <b>MOUNT-TRANSMISSION</b> <b>Auto</b></p> <p>NISSAN PASSENGER CAR ..... 2013-17</p>	 <p style="text-align: center;"><b>EM-7084 (NEW)</b> <b>Engine Torque Strut Mount</b> <b>Right</b></p> <p>LEXUS SPORT UTILITY ..... 2010-15</p>	 <p style="text-align: center;"><b>EM-7088 (NEW)</b> <b>MOUNT-ENGINE</b> <b>RH Front</b></p> <p>NISSAN PASSENGER CAR ..... 2012-15</p>	 <p style="text-align: center;"><b>EM-7093 (NEW)</b> <b>MOUNT-ENGINE</b> <b>Right</b></p> <p>HYUNDAI PASSENGER CAR ..... 2011-14</p>



# BUYER'S GUIDE

## NUMERICAL LISTING - ILLUSTRATIONS

 <p style="text-align: center;"><b>EM-7094 (NEW)</b> <b>MOUNT-ENGINE</b> <b>Rear</b></p> <p>ACURA PASSENGER CAR ..... 1997-99 HONDA PASSENGER CAR ..... 1995-97</p>	 <p style="text-align: center;"><b>EM-7105 (NEW)</b> <b>Engine Torque Strut Mount</b> <b>Lower</b></p> <p>HYUNDAI SPORT UTILITY ..... 2010-15 <b>Engine Torque Strut Mount</b> <b>Front</b></p> <p>KIA PASSENGER CAR ..... 2009-14 <b>Engine Torque Strut Mount</b> <b>Lower</b></p> <p>KIA SPORT UTILITY ..... 2011-16</p>	 <p style="text-align: center;"><b>EM-7111 (NEW)</b> <b>MOUNT-TRANSMISSION</b> <b>Auto</b></p> <p>HONDA SPORT UTILITY ..... 2012-16</p>	 <p style="text-align: center;"><b>EM-7115 (NEW)</b> <b>MOUNT-ENGINE</b> <b>Front</b></p> <p>NISSAN VAN ..... 2013-17 <b>MOUNT-TRANSMISSION</b> <b>Auto</b></p> <p>CHEVROLET VAN ..... 2015-17</p>
 <p style="text-align: center;"><b>EM-7096 (NEW)</b> <b>MOUNT-TRANSMISSION</b></p> <p>TOYOTA PASSENGER CAR ..... 1994-97</p>	 <p style="text-align: center;"><b>EM-7107 (NEW)</b> <b>MOUNT-ENGINE</b> <b>Rear</b></p> <p>TOYOTA SPORT UTILITY ..... 2006-12</p> <p style="text-align: center;"><b>EM-7108 (NEW)</b> <b>MOUNT-TRANSMISSION</b></p> <p>TOYOTA SPORT UTILITY ..... 2008-09 TOYOTA TRUCK ..... 2007-09</p>	 <p style="text-align: center;"><b>EM-7112 (NEW)</b> <b>MOUNT-TRANSMISSION</b> <b>L &amp; R</b></p> <p>HYUNDAI PASSENGER CAR ..... 2009-16</p>	 <p style="text-align: center;"><b>EM-7116 (NEW)</b> <b>Engine Torque Strut Mount</b> <b>Lower</b></p> <p>HONDA PASSENGER CAR ..... 2012-15</p> <p style="text-align: center;"><b>EM-7118 (NEW)</b> <b>MOUNT-TRANSMISSION</b> <b>Auto</b></p> <p>INFINITI PASSENGER CAR ..... 1996-02 NISSAN PASSENGER CAR ..... 1995-06 NISSAN SPORT UTILITY ..... 2002-07 RENAULT PASSENGER CAR ..... 2011-13</p>
 <p style="text-align: center;"><b>EM-7099 (NEW)</b> <b>MOUNT-ENGINE</b> <b>RH Front</b></p> <p>KIA PASSENGER CAR ..... 2014-16</p>	 <p style="text-align: center;"><b>EM-7110 (NEW)</b> <b>MOUNT-ENGINE</b> <b>Rear</b></p> <p>HYUNDAI SPORT UTILITY ..... 2010-12 KIA SPORT UTILITY ..... 2011-13</p>	 <p style="text-align: center;"><b>EM-7113 (NEW)</b> <b>MOUNT-ENGINE</b> <b>Front</b></p> <p>HYUNDAI PASSENGER CAR ..... 2007-10</p>	 <p style="text-align: center;"><b>EM-7119 (NEW)</b> <b>MOUNT-ENGINE</b> <b>RH Front</b></p> <p>NISSAN PASSENGER CAR ..... 1991-13</p> <p style="text-align: center;"><b>EM-7120 (NEW)</b> <b>Engine Torque Strut Mount</b> <b>Lower</b></p> <p>MERCEDES-BENZ PASSENGER CAR ..... 2013-16 MERCEDES-BENZ SPORT UTILITY ..... 2014-16</p>
 <p style="text-align: center;"><b>EM-7104 (NEW)</b> <b>MOUNT-ENGINE</b> <b>Right</b></p> <p>HYUNDAI SPORT UTILITY ..... 2010-13 KIA SPORT UTILITY ..... 2011-13</p>	 <p style="text-align: center;"><b>EM-7114 (NEW)</b> <b>MOUNT-TRANSMISSION</b> <b>Manual</b></p> <p>NISSAN PASSENGER CAR ..... 1991-98</p>	 <p style="text-align: center;"><b>EM-7120 (NEW)</b> <b>Engine Torque Strut Mount</b> <b>Lower</b></p> <p>MERCEDES-BENZ PASSENGER CAR ..... 2013-16 MERCEDES-BENZ SPORT UTILITY ..... 2014-16</p>	

# BUYER'S GUIDE

## NUMERICAL LISTING - ILLUSTRATIONS

 <p style="text-align: center;"><b>EM-7121 (NEW)</b> Engine Torque Strut Mount Upper</p> <p>MERCEDES-BENZ PASSENGER CAR ..... 2013-16 MERCEDES-BENZ SPORT UTILITY ..... 2014-16</p>	 <p style="text-align: center;"><b>EM-7124 (NEW)</b> MOUNT-ENGINE L &amp; R Front</p> <p>MERCEDES-BENZ PASSENGER CAR ..... 2011-13</p>	 <p style="text-align: center;"><b>EM-7128 (NEW)</b> MOUNT-ENGINE Right RH Front</p> <p>INFINITI PASSENGER CAR ..... 2014-15 INFINITI SPORT UTILITY ..... 2009-17</p>	 <p style="text-align: center;"><b>EM-7132 (NEW)</b> Engine Torque Strut Mount Bushing</p> <p>VOLVO PASSENGER CAR ..... 1998-04</p>
 <p style="text-align: center;"><b>EM-7122 (NEW)</b> MOUNT-ENGINE Right</p> <p>MERCEDES-BENZ PASSENGER CAR ..... 2013-19 MERCEDES-BENZ SPORT UTILITY ..... 2014-19</p>	 <p style="text-align: center;"><b>EM-7125 (NEW)</b> Engine Torque Strut Mount Rear</p> <p>MAZDA PASSENGER CAR ..... 2006-08</p>	 <p style="text-align: center;"><b>EM-7129 (NEW)</b> MOUNT-TRANSMISSION Upper</p> <p>ACURA PASSENGER CAR ..... 2015-16 HONDA PASSENGER CAR ..... 2013-17</p>	 <p style="text-align: center;"><b>EM-7134 (NEW)</b> MOUNT-ENGINE Right</p> <p>ACURA PASSENGER CAR ..... 2015-16 HONDA PASSENGER CAR ..... 2013-17</p>
 <p style="text-align: center;"><b>EM-7123 (NEW)</b> MOUNT-TRANSMISSION Auto</p> <p>MERCEDES-BENZ PASSENGER CAR ..... 2013-16 MERCEDES-BENZ SPORT UTILITY ..... 2014-16</p>	 <p style="text-align: center;"><b>EM-7126 (NEW)</b> Engine Torque Strut Mount Rear</p> <p>INFINITI SPORT UTILITY ..... 2014-15</p>	 <p style="text-align: center;"><b>EM-7130 (NEW)</b> MOUNT-ENGINE L &amp; R Front</p> <p>MERCEDES-BENZ PASSENGER CAR ..... 2001-05</p>	 <p style="text-align: center;"><b>EM-7138 (NEW)</b> MOUNT-TRANSMISSION Auto</p> <p>VOLKSWAGEN PASSENGER CAR ..... 2006-12</p>
 <p style="text-align: center;"><b>EM-7127 (NEW)</b> Engine Torque Strut Mount Rear</p> <p>HONDA PASSENGER CAR ..... 2015-19 HONDA SPORT UTILITY ..... 2016-18</p>	 <p style="text-align: center;"><b>EM-7139 (NEW)</b> MOUNT-ENGINE Front</p> <p>AUDI PASSENGER CAR ..... 2002-11</p>		

# BUYER'S GUIDE

## NUMERICAL LISTING - ILLUSTRATIONS

 <p><b>EM-7140 (NEW)</b> MOUNT-ENGINE RH Front</p> <p>AUDI PASSENGER CAR ..... 2005-11</p>	 <p><b>EM-7152 (NEW)</b> MOUNT-TRANSMISSION Auto</p> <p>NISSAN SPORT UTILITY ..... 2011-17</p>	 <p><b>EM-7156 (NEW)</b> MOUNT-ENGINE L &amp; R Front</p> <p>MERCEDES-BENZ PASSENGER CAR ..... 2008-14</p>	 <p><b>EM-7163 (NEW)</b> MOUNT-ENGINE RH Front</p> <p>KIA PASSENGER CAR ..... 2012-13</p>
 <p><b>EM-7145 (NEW)</b> MOUNT-ENGINE Front</p> <p>HONDA PASSENGER CAR ..... 2012-15</p>	 <p><b>EM-7153 (NEW)</b> MOUNT-ENGINE RH Front</p> <p>HYUNDAI PASSENGER CAR ..... 2010-12</p>	 <p><b>EM-7159 (NEW)</b> MOUNT-TRANSMISSION Auto</p> <p>DODGE VAN ..... 2007-09 FREIGHTLINER ..... 2007-16 MERCEDES-BENZ VAN ..... 2010-16</p>	 <p><b>EM-7168 (NEW)</b> Engine Torque Strut Mount Lower</p> <p>ACURA PASSENGER CAR ..... 2013-15 HONDA PASSENGER CAR ..... 2012-15</p>
 <p><b>EM-7148 (NEW)</b> MOUNT-ENGINE Front</p> <p>HONDA PASSENGER CAR ..... 2013-15</p>	 <p><b>EM-7154 (NEW)</b> MOUNT-TRANSMISSION Auto</p> <p>NISSAN SPORT UTILITY ..... 2011-17</p>	 <p><b>EM-7160 (NEW)</b> MOUNT-TRANSMISSION Manual</p> <p>HYUNDAI PASSENGER CAR ..... 2011-16 KIA PASSENGER CAR ..... 2014-17</p>	 <p><b>EM-7169 (NEW)</b> Engine Torque Strut Mount Upper</p> <p>ACURA PASSENGER CAR ..... 2013-15 HONDA PASSENGER CAR ..... 2012-15</p>
 <p><b>EM-7151 (NEW)</b> MOUNT-TRANSMISSION Manual</p> <p>KIA PASSENGER CAR ..... 2010-13</p>	 <p><b>EM-7155 (NEW)</b> MOUNT-ENGINE Rear</p> <p>ACURA PASSENGER CAR ..... 2015-16 HONDA PASSENGER CAR ..... 2013-17</p>		 <p><b>EM-7170 (NEW)</b> Engine Torque Strut Mount Lower</p> <p>ACURA PASSENGER CAR ..... 2013-15 HONDA PASSENGER CAR ..... 2012-15</p>

# BUYER'S GUIDE

## NUMERICAL LISTING - ILLUSTRATIONS

 <p style="text-align: center;"><b>EM-7171 (NEW)</b> Engine Torque Strut Mount Front</p> <p>INFINITI SPORT UTILITY ..... 2013-15 NISSAN PASSENGER CAR ..... 2013-17 NISSAN SPORT UTILITY ..... 2013-17</p>	 <p style="text-align: center;"><b>EM-7176 (NEW)</b> MOUNT-ENGINE Rear</p> <p>AUDI PASSENGER CAR ..... 2008-14 VOLKSWAGEN PASSENGER CAR ..... 2006-15</p>	<p style="text-align: center;"><b>EM-7183 (NEW)</b> MOUNT-ENGINE LH Front</p> <p>TOYOTA TRUCK ..... 2007-14</p> 	 <p style="text-align: center;"><b>EM-7187 (NEW)</b> MOUNT-ENGINE Rear</p> <p>HONDA SPORT UTILITY ..... 2009-15</p>
<p style="text-align: center;"><b>EM-7172 (NEW)</b> Engine Torque Strut Mount Rear</p> <p>MAZDA PASSENGER CAR ..... 2014-15 MAZDA SPORT UTILITY ..... 2014-15</p>	 <p style="text-align: center;"><b>EM-7177 (NEW)</b> MOUNT-TRANSMISSION Manual</p> <p>ACURA PASSENGER CAR ..... 2013-15 HONDA PASSENGER CAR ..... 2012-15</p>	<p style="text-align: center;"><b>EM-7184 (NEW)</b> MOUNT-ENGINE RH Front</p> <p>TOYOTA TRUCK ..... 2007-14</p> 	 <p style="text-align: center;"><b>EM-7188 (NEW)</b> MOUNT-ENGINE Front</p> <p>LEXUS SPORT UTILITY ..... 2006-15 TOYOTA SPORT UTILITY ..... 2006-16</p>
 <p style="text-align: center;"><b>EM-7174 (NEW)</b> Engine Torque Strut Mount Rear</p> <p>MAZDA PASSENGER CAR ..... 2009-13</p>	 <p style="text-align: center;"><b>EM-7178 (NEW)</b> MOUNT-TRANSMISSION Lower</p> <p>HONDA PASSENGER CAR ..... 2013-17</p>	<p style="text-align: center;"><b>EM-7185 (NEW)</b> MOUNT-ENGINE Rear</p> <p>TOYOTA SPORT UTILITY ..... 2011-16</p> 	 <p style="text-align: center;"><b>EM-7189 (NEW)</b> MOUNT-TRANSMISSION Auto</p> <p>LEXUS SPORT UTILITY ..... 2010-15 TOYOTA SPORT UTILITY ..... 2011-18</p>
 <p style="text-align: center;"><b>EM-7175 (NEW)</b> MOUNT-ENGINE Rear</p> <p>INFINITI SPORT UTILITY ..... 2013-18 NISSAN SPORT UTILITY ..... 2009-16 NISSAN VAN ..... 2011-15</p>	 <p style="text-align: center;"><b>EM-7179 (NEW)</b> MOUNT-ENGINE Front</p> <p>HONDA PASSENGER CAR ..... 2013-17</p>	<p style="text-align: center;"><b>EM-7186 (NEW)</b> MOUNT-ENGINE Front</p> <p>HONDA SPORT UTILITY ..... 2009-15</p> 	<p style="text-align: center;"><b>EM-7191 (NEW)</b> MOUNT-ENGINE L &amp; R Front</p> <p>AUDI PASSENGER CAR ..... 2013-16 AUDI SPORTS UTILITY ..... 2013-16</p>

# BUYER'S GUIDE

## NUMERICAL LISTING - ILLUSTRATIONS

 <p><b>EM-7192 (NEW)</b> Engine Torque Strut Mount Right</p> <p>TOYOTA VAN ..... 2015-19</p>	 <p><b>EM-7195 (NEW)</b> MOUNT-TRANSMISSION Auto</p> <p>BMW PASSENGER CAR ..... 2004-11</p>	 <p><b>EM-7202 (NEW)</b> MOUNT-TRANSMISSION Auto</p> <p>AUDI PASSENGER CAR ..... 2008-17</p>	 <p><b>EM-7224 (NEW)</b> MOUNT-TRANSMISSION Auto</p> <p>KIA SPORT UTILITY ..... 2014-16</p>
 <p><b>EM-7193 (NEW)</b> MOUNT-ENGINE LH Front</p> <p>INFINITI PASSENGER CAR ..... 2007-18</p> <p><b>EM-7194 (NEW)</b> MOUNT-TRANSMISSION Auto</p> <p>INFINITI SPORT UTILITY ..... 2008-18</p> <p>VOLVO PASSENGER CAR ..... 2001-08</p>	 <p><b>EM-7197 (NEW)</b> MOUNT-ENGINE LH Front</p> <p>TOYOTA SPORT UTILITY ..... 2008-09</p> <p>TOYOTA TRUCK ..... 2007-09</p>	 <p><b>EM-7204 (NEW)</b> Engine Torque Strut Mount Rear</p> <p>NISSAN SPORT UTILITY ..... 2014-18</p>	 <p><b>EM-7225 (NEW)</b> MOUNT-TRANSMISSION Auto</p> <p>HYUNDAI PASSENGER CAR ..... 2005</p>
 <p><b>EM-7198 (NEW)</b> MOUNT-ENGINE RH Front</p> <p>TOYOTA SPORT UTILITY ..... 2008-09</p> <p>TOYOTA TRUCK ..... 2007-09</p>	 <p><b>EM-7205 (NEW)</b> Engine Torque Strut Mount Front</p> <p>NISSAN SPORT UTILITY ..... 2014-18</p>	 <p><b>EM-7207 (NEW)</b> MOUNT-ENGINE Front</p> <p>HYUNDAI PASSENGER CAR ..... 2011</p>	 <p><b>EM-7229 (NEW)</b> MOUNT-ENGINE Rear</p> <p>ACURA SPORT UTILITY ..... 2007-13</p>
 <p><b>EM-7201 (NEW)</b> MOUNT-ENGINE Rear</p> <p>SCION PASSENGER CAR ..... 2011-16</p>	 <p><b>EM-7214 (NEW)</b> MOUNT-TRANSMISSION Auto</p> <p>HYUNDAI SPORT UTILITY ..... 2014-15</p>	 <p><b>EM-7221 (NEW)</b> MOUNT-TRANSMISSION Auto</p> <p>KIA PASSENGER CAR ..... 2014-17</p>	 <p><b>EM-7230 (NEW)</b> MOUNT-ENGINE RH Front</p> <p>MAZDA PASSENGER CAR ..... 2014-17</p> <p>MAZDA SPORT UTILITY ..... 2014-17</p>



# BUYER'S GUIDE

## NUMERICAL LISTING - ILLUSTRATIONS

 <p style="text-align: center;"><b>EM-7231 (NEW)</b> <b>MOUNT-TRANSMISSION</b> Lower</p> <p>HONDA PASSENGER CAR ..... 2013-17</p>	 <p style="text-align: center;"><b>EM-7236 (NEW)</b> <b>Engine Torque Strut Mount</b> Right</p> <p>TOYOTA VAN ..... 2015-19</p>	 <p style="text-align: center;"><b>EM-7242 (NEW)</b> <b>MOUNT-ENGINE</b> Right</p> <p>VOLVO PASSENGER CAR ..... 2007-16 VOLVO SPORT UTILITY ..... 2008-16</p>	 <p style="text-align: center;"><b>EM-7248 (NEW)</b> <b>MOUNT-ENGINE</b> L &amp; R Front</p> <p>SUBARU PASSENGER CAR ..... 2010-14 SUBARU SPORT UTILITY ..... 2010-14</p>
 <p style="text-align: center;"><b>EM-7232 (NEW)</b> <b>MOUNT-ENGINE</b> Rear</p> <p>TOYOTA SPORT UTILITY ..... 2013-18</p>	 <p style="text-align: center;"><b>EM-7238 (NEW)</b> <b>MOUNT-TRANSMISSION</b></p> <p>TOYOTA SPORT UTILITY ..... 2011-17 TOYOTA TRUCK ..... 2011-17</p>	 <p style="text-align: center;"><b>EM-7244 (NEW)</b> <b>MOUNT-ENGINE</b> Front</p> <p>TOYOTA SPORT UTILITY ..... 2001-03</p>	 <p style="text-align: center;"><b>EM-7249 (NEW)</b> <b>Engine Torque Strut Mount</b> Rear</p> <p>TOYOTA PASSENGER CAR ..... 2012-17</p>
 <p style="text-align: center;"><b>EM-7233 (NEW)</b> <b>MOUNT-ENGINE</b> Rear</p> <p>TOYOTA SPORT UTILITY ..... 2013-18</p>	 <p style="text-align: center;"><b>EM-7239 (NEW)</b> <b>MOUNT-ENGINE</b> RH Front</p> <p>MAZDA SPORT UTILITY ..... 2013-16</p>	 <p style="text-align: center;"><b>EM-7246 (NEW)</b> <b>MOUNT-TRANSMISSION</b> Auto</p> <p>SUBARU PASSENGER CAR ..... 2010-14 SUBARU SPORT UTILITY ..... 2010-14</p>	 <p style="text-align: center;"><b>EM-7251 (NEW)</b> <b>MOUNT-ENGINE</b> Right</p> <p>TOYOTA PASSENGER CAR ..... 2012-13</p>
 <p style="text-align: center;"><b>EM-7234 (NEW)</b> <b>MOUNT-TRANSMISSION</b> Auto</p> <p>INFINITI SPORT UTILITY ..... 2014-15 NISSAN SPORT UTILITY ..... 2013-16</p>	 <p style="text-align: center;"><b>EM-7241 (NEW)</b> <b>Engine Torque Strut Mount</b> Rear</p> <p>MAZDA PASSENGER CAR ..... 2011-14</p>	 <p style="text-align: center;"><b>EM-7247 (NEW)</b> <b>MOUNT-ENGINE</b> Center Lower</p> <p>SUBARU PASSENGER CAR ..... 2010-14 SUBARU SPORT UTILITY ..... 2010-14</p>	 <p style="text-align: center;"><b>EM-7253 (NEW)</b> <b>MOUNT-ENGINE</b> Front Center</p> <p>SUBARU PASSENGER CAR ..... 2010-12</p>
 <p style="text-align: center;"><b>EM-7235 (NEW)</b> <b>MOUNT-TRANSMISSION</b> Auto</p> <p>MAZDA PASSENGER CAR ..... 2014-18 MAZDA SPORT UTILITY ..... 2013-17</p>			

# BUYER'S GUIDE

## NUMERICAL LISTING - ILLUSTRATIONS

 <p style="text-align: center;"><b>EM-7254 (NEW)</b> <b>MOUNT-ENGINE</b> <b>LH Front</b></p> <p>SCION PASSENGER CAR ..... 2013-16 SUBARU PASSENGER CAR ..... 2013-17 SUBARU SPORT UTILITY ..... 2014-16 TOYOTA PASSENGER CAR ..... 2017</p>	 <p style="text-align: center;"><b>EM-7257 (NEW)</b> <b>MOUNT-ENGINE</b> <b>RH Front</b></p> <p>SUBARU PASSENGER CAR ..... 2000-04 SUBARU SPORT UTILITY ..... 2000-06</p>	 <p style="text-align: center;"><b>EM-7261 (NEW)</b> <b>MOUNT-TRANSMISSION</b> <b>Auto</b></p> <p>VOLKSWAGEN PASSENGER CAR ..... 2015-18</p>	 <p style="text-align: center;"><b>EM-7268 (NEW)</b> <b>MOUNT-ENGINE</b> <b>RH Front</b></p> <p>BMW PASSENGER CAR ..... 2016</p>
 <p style="text-align: center;"><b>EM-7255 (NEW)</b> <b>MOUNT-ENGINE</b> <b>RH Front</b></p> <p>SCION PASSENGER CAR ..... 2013-16 SUBARU PASSENGER CAR ..... 2013-17 SUBARU SPORT UTILITY ..... 2014-16 TOYOTA PASSENGER CAR ..... 2017</p>	 <p style="text-align: center;"><b>EM-7258 (NEW)</b> <b>MOUNT-ENGINE</b> <b>RH Front</b></p> <p>ACURA PASSENGER CAR ..... 2013-15 HONDA PASSENGER CAR ..... 2013-15</p>	 <p style="text-align: center;"><b>EM-7262 (NEW)</b> <b>MOUNT-ENGINE</b> <b>Rear</b></p> <p>VOLKSWAGEN PASSENGER CAR ..... 2011-17</p>	 <p style="text-align: center;"><b>EM-7270 (NEW)</b> <b>MOUNT-ENGINE</b> <b>Front Upper</b></p> <p>VOLKSWAGEN PASSENGER CAR ..... 2009-15</p>
 <p style="text-align: center;"><b>EM-7256 (NEW)</b> <b>MOUNT-ENGINE</b> <b>LH Front</b></p> <p>SUBARU PASSENGER CAR ..... 2000-04 SUBARU SPORT UTILITY ..... 2000-06</p>	 <p style="text-align: center;"><b>EM-7259 (NEW)</b> <b>MOUNT-TRANSMISSION</b> <b>Auto</b></p> <p>TOYOTA PASSENGER CAR ..... 2012-14</p>	 <p style="text-align: center;"><b>EM-7263 (NEW)</b> <b>MOUNT-TRANSMISSION</b> <b>Auto</b></p> <p>ACURA PASSENGER CAR ..... 2013-15</p>	 <p style="text-align: center;"><b>EM-7271 (NEW)</b> <b>MOUNT-TRANSMISSION</b> <b>Manual</b></p> <p>VOLKSWAGEN PASSENGER CAR ..... 2009-14</p>
 <p style="text-align: center;"><b>EM-7260 (NEW)</b> <b>MOUNT-TRANSMISSION</b> <b>Auto</b></p> <p>AUDI PASSENGER CAR ..... 2015-17</p>	 <p style="text-align: center;"><b>EM-7264 (NEW)</b> <b>MOUNT-TRANSMISSION</b> <b>Auto</b></p> <p>MAZDA PASSENGER CAR ..... 2009-13</p>	 <p style="text-align: center;"><b>EM-7272 (NEW)</b> <b>MOUNT-TRANSMISSION</b> <b>Auto</b></p> <p>AUDI PASSENGER CAR ..... 2009-14 VOLKSWAGEN PASSENGER CAR ..... 2009-16</p>	 <p style="text-align: center;"><b>EM-7275 (NEW)</b> <b>MOUNT-ENGINE</b> <b>Right</b></p> <p>VOLKSWAGEN PASSENGER CAR ..... 2015</p>

# BUYER'S GUIDE

## NUMERICAL LISTING - ILLUSTRATIONS

 <p style="text-align: center;"><b>EM-7277 (NEW)</b> <b>MOUNT-ENGINE</b> <b>LH Front</b></p> <p>BMW PASSENGER CAR ..... 2012-17 BMW SPORT UTILITY ..... 2013-17</p>	 <p style="text-align: center;"><b>EM-7281 (NEW)</b> <b>MOUNT-TRANSMISSION</b></p> <p>BMW SPORT UTILITY ..... 2007-17</p>	 <p style="text-align: center;"><b>EM-7287 (NEW)</b> <b>Engine Torque Strut Mount</b> <b>Front</b></p> <p>TOYOTA PASSENGER CAR ..... 1997-03</p>	<p style="text-align: center;"><b>EM-7325 (NEW)</b> <b>MOUNT-ENGINE</b> <b>RH Front</b></p> <p>MAZDA PASSENGER CAR ..... 2014-17 MAZDA SPORT UTILITY ..... 2014-17</p> <p style="text-align: center;"><b>EM-7333 (NEW)</b> <b>MOUNT-ENGINE</b> <b>Front</b></p> <p>INFINITI SPORT UTILITY ..... 2013-18 NISSAN SPORT UTILITY ..... 2009-16</p> <p style="text-align: center;"><b>EM-7335 (NEW)</b> <b>MOUNT-ENGINE</b> <b>Front</b></p> <p>LEXUS SPORT UTILITY ..... 2013-15</p>
 <p style="text-align: center;"><b>EM-7278 (NEW)</b> <b>MOUNT-ENGINE</b> <b>RH Front</b></p> <p>BMW PASSENGER CAR ..... 2012-17 BMW SPORT UTILITY ..... 2013-17</p>	 <p style="text-align: center;"><b>EM-7284 (NEW)</b> <b>MOUNT-ENGINE</b> <b>L &amp; R Front</b></p> <p>SUBARU PASSENGER CAR ..... 2013-16 SUBARU SPORT UTILITY ..... 2013-16</p>	<p style="text-align: center;"><b>EM-7289 (NEW)</b> <b>MOUNT-ENGINE</b> <b>Right</b></p> <p>HYUNDAI SPORT UTILITY ..... 2014-15</p> <p style="text-align: center;"><b>EM-7290 (NEW)</b> <b>MOUNT-ENGINE</b> <b>LH Front</b></p> <p>BMW PASSENGER CAR ..... 2010-18</p> <p style="text-align: center;"><b>EM-7294 (NEW)</b> <b>MOUNT-TRANSMISSION</b> <b>Auto</b></p> <p>NISSAN SPORT UTILITY ..... 2014-18</p>	 <p style="text-align: center;"><b>EM-8001</b> <b>MOUNT-ENGINE</b> <b>RH Front</b></p> <p>HONDA PASSENGER CAR ..... 1989-91</p> <p style="text-align: center;"><b>MOUNT-TRANSMISSION</b> <b>Auto</b></p> <p>HONDA PASSENGER CAR ..... 1988-91</p>
<p style="text-align: center;"><b>EM-7279 (NEW)</b> <b>MOUNT-TRANSMISSION</b> <b>Auto</b></p> <p>BMW PASSENGER CAR ..... 2012-17</p>  <p style="text-align: center;"><b>EM-7280 (NEW)</b> <b>MOUNT-TRANSMISSION</b> <b>Auto</b></p> <p>MERCEDES-BENZ PASSENGER CAR ..... 2007-17 MERCEDES-BENZ VAN ..... 2016-17</p>	 <p style="text-align: center;"><b>EM-7285 (NEW)</b> <b>MOUNT-TRANSMISSION</b> <b>Auto</b></p> <p>AUDI PASSENGER CAR ..... 2006-11</p> <p style="text-align: center;"><b>EM-7286 (NEW)</b> <b>MOUNT-ENGINE</b> <b>Rear</b></p> <p>INFINITI PASSENGER CAR ..... 1991-96</p>	<p style="text-align: center;"><b>EM-7296 (NEW)</b> <b>MOUNT-ENGINE</b> <b>Front</b></p> <p>HONDA PASSENGER CAR ..... 2015-19</p> <p style="text-align: center;"><b>EM-7300 (NEW)</b> <b>MOUNT-ENGINE</b> <b>Rear</b></p> <p>ACURA SPORT UTILITY ..... 2014-18 HONDA SPORT UTILITY ..... 2016-19 HONDA TRUCK ..... 2017-18</p> <p style="text-align: center;"><b>EM-7302 (NEW)</b> <b>MOUNT-ENGINE</b> <b>Front</b></p> <p>HONDA SPORT UTILITY ..... 2015-16</p> <p style="text-align: center;"><b>EM-7303 (NEW)</b> <b>MOUNT-ENGINE</b> <b>L &amp; R Front</b></p> <p>LEXUS PASSENGER CAR ..... 2006-15</p> <p style="text-align: center;"><b>EM-7307 (NEW)</b> <b>MOUNT-ENGINE</b> <b>Right</b></p> <p>SCION PASSENGER CAR ..... 2011-16</p> <p style="text-align: center;"><b>EM-7316 (NEW)</b> <b>MOUNT-ENGINE</b> <b>Rear</b></p> <p>NISSAN SPORT UTILITY ..... 2009-14</p>	 <p style="text-align: center;"><b>EM-8002</b> <b>MOUNT-TRANSMISSION</b> <b>Auto</b></p> <p>ACURA PASSENGER CAR ..... 1997-99</p> <p style="text-align: center;"><b>MOUNT-TRANSMISSION</b> <b>Manual</b></p> <p>HONDA PASSENGER CAR ..... 1990-97</p> <p style="text-align: center;"><b>MOUNT-TRANSMISSION</b> <b>Auto</b></p> <p>HONDA VAN ..... 1995-97 ISUZU VAN ..... 1996-99</p>



# BUYER'S GUIDE

## NUMERICAL LISTING - ILLUSTRATIONS

 <p style="text-align: center;"><b>EM-8004</b> <b>MOUNT-ENGINE</b> <b>Rear</b></p> <p>HONDA PASSENGER CAR ..... 1984-87 <b>MOUNT-TRANSMISSION</b> HONDA PASSENGER CAR ..... 1984-87 <b>MOUNT-TRANSMISSION</b> HONDA VAN ..... 1984-87</p>	 <p style="text-align: center;"><b>EM-8007</b> <b>MOUNT-ENGINE</b> <b>Rear</b></p> <p>HONDA PASSENGER CAR ..... 1988-91</p>	 <p style="text-align: center;"><b>EM-8011</b> <b>MOUNT-ENGINE</b> <b>Rear</b></p> <p>ACURA PASSENGER CAR ..... 1997-99 HONDA PASSENGER CAR ..... 1990-97 HONDA VAN ..... 1995-98 ISUZU VAN ..... 1996-99</p>	 <p style="text-align: center;"><b>EM-8016</b> <b>MOUNT-ENGINE</b> <b>LH Front</b></p> <p>HONDA PASSENGER CAR ..... 1990-93</p>
 <p style="text-align: center;"><b>EM-8005</b> <b>MOUNT-ENGINE</b> <b>L &amp; R Front</b></p> <p>HONDA PASSENGER CAR ..... 1985-88</p>	 <p style="text-align: center;"><b>EM-8008</b> <b>MOUNT-ENGINE</b> <b>Rear</b></p> <p>HONDA PASSENGER CAR ..... 1988-96</p>	 <p style="text-align: center;"><b>EM-8012</b> <b>MOUNT-ENGINE</b> <b>Front</b></p> <p>HONDA PASSENGER CAR ..... 1980-83</p>	 <p style="text-align: center;"><b>EM-8018</b> <b>MOUNT-ENGINE</b> <b>Front</b></p> <p>HONDA PASSENGER CAR ..... 1984-87 HONDA VAN ..... 1984-87</p>
 <p style="text-align: center;"><b>EM-8006</b> <b>MOUNT-ENGINE</b> <b>Rear</b></p> <p>HONDA PASSENGER CAR ..... 1988-91</p>	 <p style="text-align: center;"><b>EM-8009</b> <b>MOUNT-ENGINE</b> <b>Rear</b></p> <p>ACURA PASSENGER CAR ..... 1997-99 HONDA PASSENGER CAR ..... 1990-97</p>	 <p style="text-align: center;"><b>EM-8014</b> <b>MOUNT-ENGINE</b> <b>L &amp; R Front</b></p> <p>HONDA PASSENGER CAR ..... 1983-87</p>	 <p style="text-align: center;"><b>EM-8019</b> <b>MOUNT-ENGINE</b> <b>LH Front</b></p> <p>HONDA PASSENGER CAR ..... 1986-89</p>
 <p style="text-align: center;"><b>EM-8010</b> <b>MOUNT-ENGINE</b> <b>Rear</b></p> <p>ACURA PASSENGER CAR ..... 1994-01 HONDA PASSENGER CAR ..... 1992-00 HONDA SPORT UTILITY ..... 1998-01</p>	 <p style="text-align: center;"><b>EM-8012</b> <b>MOUNT-ENGINE</b> <b>Rear</b></p> <p>HONDA PASSENGER CAR ..... 1980-83</p>	 <p style="text-align: center;"><b>EM-8012</b> <b>MOUNT-ENGINE</b> <b>Lower</b></p> <p>HONDA PASSENGER CAR ..... 1980-83</p>	 <p style="text-align: center;"><b>EM-8018</b> <b>MOUNT-TRANSMISSION</b> <b>Manual</b></p> <p>ACURA PASSENGER CAR ..... 1986-89 HONDA PASSENGER CAR ..... 1984-87</p>
 <p style="text-align: center;"><b>EM-8010</b> <b>MOUNT-TRANSMISSION</b> <b>Auto</b></p> <p>HONDA PASSENGER CAR ..... 1984-85</p>	 <p style="text-align: center;"><b>EM-8012</b> <b>MOUNT-TRANSMISSION</b> <b>Manual</b></p> <p>HONDA PASSENGER CAR ..... 1984-85</p>	 <p style="text-align: center;"><b>EM-8018</b> <b>MOUNT-TRANSMISSION</b> <b>Auto</b></p> <p>ACURA PASSENGER CAR ..... 1986-89</p>	 <p style="text-align: center;"><b>EM-8019</b> <b>MOUNT-TRANSMISSION</b> <b>Manual</b></p> <p>HONDA PASSENGER CAR ..... 1984-87</p>

# BUYER'S GUIDE

## NUMERICAL LISTING - ILLUSTRATIONS

 <p><b>EM-8020</b> <b>MOUNT-ENGINE</b> <b>LH Front</b></p> <p>HONDA PASSENGER CAR ..... 1988-91</p>	 <p><b>EM-8024</b> <b>Engine Torque Strut Mount</b> <b>Front</b></p> <p>HONDA PASSENGER CAR ..... 1991-93</p>	 <p><b>EM-8030</b> <b>MOUNT-ENGINE</b> <b>RH Front</b></p> <p>HONDA PASSENGER CAR ..... 1988-91</p>	 <p><b>EM-8037</b> <b>MOUNT-ENGINE</b> <b>Rear</b></p> <p>ACURA PASSENGER CAR ..... 1993-98</p>
 <p><b>EM-8021</b> <b>MOUNT-ENGINE</b> <b>LH Front Upper</b></p> <p>HONDA PASSENGER CAR ..... 1992-97</p> <p><b>MOUNT-ENGINE</b> <b>LH Rear</b></p> <p>HONDA PASSENGER CAR ..... 1993-95</p>	 <p><b>EM-8025</b> <b>Engine Torque Strut Mount</b> <b>Front</b></p> <p>HONDA PASSENGER CAR ..... 1986-89</p>	 <p><b>EM-8031</b> <b>MOUNT-TRANSMISSION</b> <b>Lower</b></p> <p>HONDA PASSENGER CAR ..... 1980-87</p>	 <p><b>EM-8039</b> <b>MOUNT-ENGINE</b> <b>LH Front</b></p> <p>HYUNDAI PASSENGER CAR ..... 1990-94</p> <p>MITSUBISHI PASSENGER CAR ..... 1990-94</p> <p><b>MOUNT-TRANSMISSION</b> <b>Auto</b></p> <p>HYUNDAI PASSENGER CAR ..... 1991-92</p>
 <p><b>EM-8022</b> <b>MOUNT-TRANSMISSION</b> <b>Upper</b></p> <p>HONDA PASSENGER CAR ..... 1979-82</p>	 <p><b>EM-8026</b> <b>MOUNT-ENGINE</b> <b>Front</b></p> <p>ACURA PASSENGER CAR ..... 1997-99</p> <p>HONDA PASSENGER CAR ..... 1994-97</p> <p>HONDA VAN ..... 1995-98</p> <p>ISUZU VAN ..... 1996-99</p>	 <p><b>EM-8034</b> <b>MOUNT-ENGINE</b> <b>RH Front</b></p> <p>HONDA PASSENGER CAR ..... 1988-91</p> <p><b>MOUNT-TRANSMISSION</b> <b>Manual</b></p> <p>HONDA PASSENGER CAR ..... 1988-91</p>	 <p><b>EM-8040</b> <b>MOUNT-TRANSMISSION</b> <b>Auto</b></p> <p>HYUNDAI PASSENGER CAR ..... 1992-95</p>
	 <p><b>EM-8029</b> <b>Engine Torque Strut Mount</b> <b>Front</b></p> <p>HONDA PASSENGER CAR ..... 1973-79</p>		

# BUYER'S GUIDE

## NUMERICAL LISTING - ILLUSTRATIONS



**EM-8041**  
**MOUNT-ENGINE**  
**Rear**

HYUNDAI PASSENGER CAR ..... 1989-94



**EM-8047**  
**Engine Torque Strut Mount**  
**Front**

HYUNDAI PASSENGER CAR ..... 1990-94  
MITSUBISHI PASSENGER  
CAR ..... 1990-94



**EM-8053**  
**MOUNT-ENGINE**  
**LH Front**

ISUZU SPORT UTILITY ..... 1984-86  
ISUZU TRUCK ..... 1981-87



**EM-8059**  
**MOUNT-ENGINE**  
**Front**

MAZDA PASSENGER CAR ..... 1983-85



**EM-8042**  
**MOUNT-ENGINE**  
**Front**

HYUNDAI PASSENGER CAR ..... 1989-95



**EM-8048**  
**MOUNT-ENGINE**  
**LH Front**

CHEVROLET TRUCK ..... 1982  
ISUZU SPORT UTILITY ..... 1984-86  
ISUZU TRUCK ..... 1981-86



**EM-8054**  
**MOUNT-ENGINE**  
**RH Front**

ISUZU SPORT UTILITY ..... 1984-86  
ISUZU TRUCK ..... 1981-87



**EM-8060**  
**MOUNT-ENGINE**  
**RH Front**

DODGE PASSENGER CAR ..... 1989-90  
MAZDA PASSENGER CAR ..... 1981-89



**EM-8044**  
**MOUNT-ENGINE**  
**LH Front**

HYUNDAI PASSENGER CAR ..... 1989-91



**EM-8049**  
**MOUNT-ENGINE**  
**RH Front**

CHEVROLET TRUCK ..... 1982  
ISUZU SPORT UTILITY ..... 1984  
ISUZU TRUCK ..... 1981-86



**EM-8055**  
**MOUNT-ENGINE**  
**L & R Front**

MAZDA PASSENGER CAR ..... 1979-85



**EM-8061**  
**MOUNT-TRANSMISSION**  
**Manual**

MAZDA PASSENGER CAR ..... 1981-85



**EM-8045**  
**Engine Torque Strut**  
**Front Right**

HYUNDAI PASSENGER CAR ..... 1986-89  
MITSUBISHI PASSENGER  
CAR ..... 1987-89



**EM-8056**  
**MOUNT-ENGINE**  
**Front**

MAZDA PASSENGER CAR ..... 1981-82

# BUYER'S GUIDE

## NUMERICAL LISTING - ILLUSTRATIONS

 <p><b>EM-8062</b> <b>MOUNT-ENGINE</b> Front</p> <p>MAZDA PASSENGER CAR ..... 1995-98</p>	<p><b>EM-8068 (Continued)</b></p> <p>MAZDA PASSENGER CAR ..... 1986-91 <b>MOUNT-TRANSMISSION</b> Manual</p> <p>MAZDA PASSENGER CAR ..... 1986-91 <b>MOUNT-TRANSMISSION</b></p> <p>MERCURY PASSENGER CAR ... 1987-89</p>  <p><b>EM-8073</b> <b>MOUNT-ENGINE</b> Front</p> <p>FORD PASSENGER CAR ..... 1993-97 MAZDA PASSENGER CAR ..... 1993-02</p>	 <p><b>EM-8077</b> <b>MOUNT-ENGINE</b> Front</p> <p>MAZDA PASSENGER CAR ..... 1983-85</p>	 <p><b>EM-8082</b> <b>MOUNT-TRANSMISSION</b> Manual</p> <p>MAZDA PASSENGER CAR ..... 1983-85</p>
 <p><b>EM-8063</b> <b>MOUNT-TRANSMISSION</b> Auto</p> <p>MAZDA PASSENGER CAR ..... 1995-98</p>	 <p><b>EM-8074</b> <b>MOUNT-ENGINE</b> RH Front</p> <p>FORD PASSENGER CAR ..... 1993-97 MAZDA PASSENGER CAR ..... 1993-02</p>	 <p><b>EM-8078</b> <b>MOUNT-ENGINE</b> Rear</p> <p>MAZDA PASSENGER CAR ..... 1983-87</p>	 <p><b>EM-8083</b> <b>MOUNT-ENGINE</b> Front</p> <p>FORD PASSENGER CAR ..... 1989-92 MAZDA PASSENGER CAR ..... 1988-92</p>
 <p><b>EM-8065</b> <b>MOUNT-ENGINE</b> Front</p> <p>MAZDA PASSENGER CAR ..... 1986-89</p>	 <p><b>EM-8075</b> <b>MOUNT-ENGINE</b> Rear</p> <p>FORD PASSENGER CAR ..... 1993-97 MAZDA PASSENGER CAR ..... 1993-02 <b>MOUNT-TRANSMISSION</b> Upper</p> <p>FORD PASSENGER CAR ..... 1993</p>	 <p><b>EM-8079</b> <b>MOUNT-TRANSMISSION</b> Manual</p> <p>MAZDA TRUCK ..... 1972-84</p>	 <p><b>EM-8084</b> <b>MOUNT-ENGINE</b> L &amp; R Front</p> <p>MAZDA TRUCK ..... 1987-88</p>
 <p><b>EM-8068</b> <b>MOUNT-ENGINE</b> Rear</p> <p>MAZDA PASSENGER CAR ..... 1986-87 <b>MOUNT-TRANSMISSION</b> Front</p> <p>(Continued Next Column)</p>	 <p><b>EM-8080</b> <b>MOUNT-ENGINE</b> Front</p> <p>MAZDA PASSENGER CAR ..... 1983-87</p>	 <p><b>EM-8085</b> <b>MOUNT-ENGINE</b> Front</p> <p>FORD PASSENGER CAR ..... 1989-92 MAZDA PASSENGER CAR ..... 1988-92</p>	

# BUYER'S GUIDE

## NUMERICAL LISTING - ILLUSTRATIONS

 <p style="text-align: center;"><b>EM-8086</b> <b>MOUNT-ENGINE</b> <b>RH Front</b></p> <p>FORD PASSENGER CAR ..... 1989-92 MAZDA PASSENGER CAR ..... 1988-92</p>	<p><b>EM-8089 (Continued)</b> MAZDA PASSENGER CAR ..... 1988-89</p>  <p style="text-align: center;"><b>EM-8091</b> <b>MOUNT-TRANSMISSION</b> <b>Manual</b></p> <p>MAZDA PASSENGER CAR ..... 1986-87</p>	<p><b>EM-8095 (Continued)</b> MAZDA PASSENGER CAR ..... 1979-80 MAZDA TRUCK ..... 1972-76</p> <p style="text-align: center;"><b>MOUNT-TRANSMISSION</b> <b>Manual</b></p> <p>MAZDA PASSENGER CAR ..... 1979-85 MAZDA TRUCK ..... 1979-84 MAZDA PASSENGER CAR ..... 1984-85 MAZDA TRUCK ..... 1986-93</p>  <p style="text-align: center;"><b>EM-8096</b> <b>MOUNT-TRANSMISSION</b> <b>Auto</b></p> <p>DODGE SPORT UTILITY ..... 1987-88</p> <p>DODGE TRUCK ..... 1983-89</p> <p style="text-align: center;"><b>MOUNT-TRANSMISSION</b> <b>Auto</b></p> <p>MITSUBISHI SPORT UTILITY ..... 1983-89</p> <p style="text-align: center;"><b>MOUNT-TRANSMISSION</b> <b>Manual</b></p> <p>MITSUBISHI TRUCK ..... 1983-89</p>	 <p style="text-align: center;"><b>EM-8098</b> <b>MOUNT-ENGINE</b> <b>Front</b></p> <p>DODGE PASSENGER CAR ..... 1992-94 EAGLE PASSENGER CAR ..... 1992-96</p>
 <p style="text-align: center;"><b>EM-8087</b> <b>MOUNT-ENGINE</b> <b>Rear</b></p> <p>FORD PASSENGER CAR ..... 1989-92 MAZDA PASSENGER CAR ..... 1988-92</p>	 <p style="text-align: center;"><b>EM-8093</b> <b>MOUNT-ENGINE</b> <b>L &amp; R Front</b></p> <p>MAZDA VAN ..... 1989-95 SUZUKI SPORT UTILITY ..... 1996-98</p>	<p style="text-align: center;"><b>MOUNT-TRANSMISSION</b> <b>Manual</b></p> <p>MITSUBISHI TRUCK ..... 1983-89</p>	 <p style="text-align: center;"><b>EM-8099</b> <b>MOUNT-ENGINE</b> <b>RH Front</b></p> <p>DODGE PASSENGER CAR ..... 1992-94</p> <p style="text-align: center;"><b>MOUNT-TRANSMISSION</b> <b>Manual</b></p> <p>EAGLE PASSENGER CAR ..... 1996 MITSUBISHI PASSENGER CAR ..... 1993-96 PLYMOUTH PASSENGER CAR ..... 1993-94 DODGE PASSENGER CAR ..... 1993-94 EAGLE PASSENGER CAR ..... 1992-94 MITSUBISHI PASSENGER CAR ..... 1993-96</p>
 <p style="text-align: center;"><b>EM-8088</b> <b>MOUNT-ENGINE</b> <b>Rear</b></p> <p>FORD PASSENGER CAR ..... 1989-92 MAZDA PASSENGER CAR ..... 1988-92</p>	 <p style="text-align: center;"><b>EM-8094</b> <b>MOUNT-ENGINE</b> <b>L &amp; R Front</b></p> <p>MAZDA TRUCK ..... 1986-93</p>	 <p style="text-align: center;"><b>EM-8097</b> <b>MOUNT-ENGINE</b> <b>Front</b></p> <p>DODGE PASSENGER CAR ..... 1992-94 EAGLE PASSENGER CAR ..... 1992-93 MITSUBISHI PASSENGER CAR ..... 1993-94 PLYMOUTH PASSENGER CAR ..... 1993-94</p>	 <p style="text-align: center;"><b>EM-8100</b> <b>MOUNT-ENGINE</b> <b>Front</b></p> <p>DODGE PASSENGER CAR ..... 1993-94 MITSUBISHI PASSENGER CAR ..... 1993-96 MITSUBISHI VAN ..... 1992-93 PLYMOUTH PASSENGER CAR ..... 1992-94</p> <p style="text-align: center;"><b>MOUNT-ENGINE</b> <b>Rear</b></p> <p>DODGE PASSENGER CAR ..... 1992-94 EAGLE PASSENGER CAR ..... 1992-96 MITSUBISHI PASSENGER CAR ..... 1993-96</p>
 <p style="text-align: center;"><b>EM-8089</b> <b>MOUNT-TRANSMISSION</b> <b>Manual</b></p> <p>FORD PASSENGER CAR ..... 1989-92</p> <p style="text-align: center;">(Continued Next Column)</p>	 <p style="text-align: center;"><b>EM-8095</b> <b>MOUNT-ENGINE</b> <b>Rear</b></p> <p style="text-align: center;">(Continued Next Column)</p>	<p style="text-align: center;">(Continued Next Page)</p>	<p style="text-align: center;">(Continued Next Page)</p>



# BUYER'S GUIDE

## NUMERICAL LISTING - ILLUSTRATIONS

<p><b>EM-8100 (Continued)</b>            PLYMOUTH PASSENGER CAR ..... 1993-94</p>  <p style="text-align: center;"><b>EM-8101</b>  <b>MOUNT-ENGINE</b>  <b>Front</b></p> <p>MAZDA PASSENGER CAR ..... 1986-87</p>  <p style="text-align: center;"><b>EM-8102</b>  <b>MOUNT-ENGINE</b>  <b>Front</b></p> <p>EAGLE PASSENGER CAR ..... 1992-94            MITSUBISHI VAN ..... 1992            PLYMOUTH PASSENGER CAR ..... 1993-94</p> <p style="text-align: center;"><b>MOUNT-ENGINE</b>  <b>Rear</b></p> <p>DODGE PASSENGER CAR ..... 1989-90            EAGLE PASSENGER CAR ..... 1989-92            MITSUBISHI PASSENGER CAR ..... 1989-92            PLYMOUTH PASSENGER CAR ..... 1989-92</p>  <p style="text-align: center;"><b>EM-8103</b>  <b>MOUNT-ENGINE</b>  <b>Front</b></p> <p>DODGE PASSENGER CAR ..... 1985-88            EAGLE PASSENGER CAR ..... 1990-94            HYUNDAI PASSENGER CAR ..... 1990-94            MITSUBISHI PASSENGER CAR ..... 1985-94            PLYMOUTH PASSENGER CAR ..... 1985-94</p>	 <p style="text-align: center;"><b>EM-8104</b>  <b>MOUNT-ENGINE</b>  <b>Rear</b></p> <p>EAGLE PASSENGER CAR ..... 1990-94            MITSUBISHI PASSENGER CAR ..... 1990-94            PLYMOUTH PASSENGER CAR ..... 1990-94</p>  <p style="text-align: center;"><b>EM-8105</b>  <b>MOUNT-ENGINE</b>  <b>Front Upper</b></p> <p>MITSUBISHI PASSENGER CAR ..... 1984-88</p> <p style="text-align: center;"><b>MOUNT-ENGINE</b>  <b>Rear</b></p> <p>MITSUBISHI PASSENGER CAR ..... 1985-93</p>  <p style="text-align: center;"><b>EM-8106</b>  <b>MOUNT-TRANSMISSION</b>  <b>Manual</b></p> <p>MITSUBISHI PASSENGER CAR ..... 1989-93</p>	 <p style="text-align: center;"><b>EM-8107</b>  <b>MOUNT-ENGINE</b>  <b>Front</b></p> <p>DODGE PASSENGER CAR ..... 1989-92            EAGLE PASSENGER CAR ..... 1989-92            MITSUBISHI PASSENGER CAR ..... 1989-92            PLYMOUTH PASSENGER CAR ..... 1989-92</p> <p style="text-align: center;"><b>MOUNT-TRANSMISSION</b>  <b>Manual</b></p> <p>MITSUBISHI PASSENGER CAR ..... 1985-86</p>  <p style="text-align: center;"><b>EM-8108</b>  <b>MOUNT-ENGINE</b>  <b>RH Front</b></p> <p>DODGE PASSENGER CAR ..... 1989-92</p> <p style="text-align: center;"><b>MOUNT-ENGINE</b>  <b>LH Front</b></p> <p>EAGLE PASSENGER CAR ..... 1989-92            MITSUBISHI PASSENGER CAR ..... 1989-92</p> <p style="text-align: center;"><b>MOUNT-ENGINE</b>  <b>RH Front</b></p> <p>PLYMOUTH PASSENGER CAR ..... 1989-92</p> <p style="text-align: center;"><b>MOUNT-TRANSMISSION</b></p> <p>DODGE PASSENGER CAR ..... 1989-90</p>	 <p style="text-align: center;"><b>EM-8111</b>  <b>MOUNT-TRANSMISSION</b>  <b>Auto</b></p> <p>DODGE TRUCK ..... 1979-93            MITSUBISHI SPORT UTILITY ..... 1997-99            MITSUBISHI TRUCK ..... 1987-96</p>  <p style="text-align: center;"><b>EM-8114</b>  <b>MOUNT-ENGINE</b>  <b>L &amp; R Front</b></p> <p>NISSAN SPORT UTILITY ..... 1987-95            NISSAN TRUCK ..... 1986-95</p>  <p style="text-align: center;"><b>EM-8115</b>  <b>MOUNT-TRANSMISSION</b></p> <p>NISSAN PASSENGER CAR ..... 1971-73</p>  <p style="text-align: center;"><b>EM-8117</b>  <b>MOUNT-TRANSMISSION</b>  <b>Manual</b></p> <p>NISSAN PASSENGER CAR ..... 1975-77</p>
--	---	---	--





# BUYER'S GUIDE

## NUMERICAL LISTING - ILLUSTRATIONS

 <p><b>EM-8118</b> <b>MOUNT-ENGINE</b> <b>RH Front</b></p> <p>NISSAN PASSENGER CAR ..... 1982-86</p>	 <p><b>EM-8121</b> <b>MOUNT-TRANSMISSION</b> <b>Manual</b></p> <p>NISSAN PASSENGER CAR ..... 1982-92</p>	 <p><b>EM-8128</b> <b>MOUNT-TRANSMISSION</b> <b>Auto</b></p> <p>NISSAN PASSENGER CAR ..... 1987-90</p>	<p><b>EM-8133 (Continued)</b> NISSAN PASSENGER CAR ..... 1986-92</p>  <p><b>EM-8135</b> <b>MOUNT-ENGINE</b> <b>RH Front</b></p> <p>NISSAN PASSENGER CAR ..... 1982-86</p>
 <p><b>EM-8119</b> <b>MOUNT-ENGINE</b> <b>Rear</b></p> <p>NISSAN PASSENGER CAR ..... 1983-86</p> <p><b>MOUNT-TRANSMISSION</b> <b>Auto</b></p> <p>NISSAN PASSENGER CAR ..... 1982-85</p>	 <p><b>EM-8122</b> <b>MOUNT-ENGINE</b> <b>RH Front</b></p> <p>NISSAN PASSENGER CAR ..... 1991-13</p>	 <p><b>EM-8130</b> <b>MOUNT-ENGINE</b> <b>Front</b></p> <p>NISSAN PASSENGER CAR ..... 1991-13</p>	 <p><b>EM-8137</b> <b>Engine Torque Strut Mount</b> <b>Rear</b></p> <p>NISSAN PASSENGER CAR ..... 1987-89</p>
 <p><b>EM-8120</b> <b>Engine Torque Strut Mount</b> <b>Front</b></p> <p>NISSAN PASSENGER CAR ..... 1983</p>	 <p><b>EM-8124</b> <b>MOUNT-TRANSMISSION</b></p> <p>NISSAN SPORT UTILITY ..... 1987-95</p> <p><b>MOUNT-TRANSMISSION</b> <b>Auto</b></p> <p>NISSAN TRUCK ..... 1986-97</p>	 <p><b>EM-8132</b> <b>MOUNT-ENGINE</b> <b>Rear</b></p> <p>NISSAN PASSENGER CAR ..... 1991-00</p>	 <p><b>EM-8138</b> <b>MOUNT-ENGINE</b> <b>L &amp; R Front</b></p> <p>NISSAN PASSENGER CAR ..... 1976-84</p>
	 <p><b>EM-8125</b> <b>Engine Torque Strut Mount</b> <b>Front</b></p> <p>NISSAN PASSENGER CAR ..... 1986-92</p>	 <p><b>EM-8133</b> <b>Engine Torque Strut Mount</b> <b>Front</b></p> <p>NISSAN PASSENGER CAR ..... 1987-89</p> <p>NISSAN VAN ..... 1991-92</p> <p><b>Engine Torque Strut Mount</b> <b>Rear</b></p> <p>(Continued Next Column)</p>	 <p><b>EM-8140</b> <b>MOUNT-ENGINE</b> <b>RH Front</b></p> <p>NISSAN PASSENGER CAR ..... 1985-88</p>

# BUYER'S GUIDE

## NUMERICAL LISTING - ILLUSTRATIONS

 <p style="text-align: center;"><b>EM-8141</b> <b>MOUNT-ENGINE</b> <b>Rear</b></p> <p>NISSAN PASSENGER CAR ..... 1985-88</p>	 <p style="text-align: center;"><b>EM-8145</b> <b>MOUNT-ENGINE</b> <b>LH Front</b></p> <p>NISSAN TRUCK ..... 1981-83</p>	 <p style="text-align: center;"><b>EM-8150</b> <b>MOUNT-TRANSMISSION</b> <b>Auto</b></p> <p>NISSAN PASSENGER CAR ..... 1991-10</p>	 <p style="text-align: center;"><b>EM-8154</b> <b>MOUNT-ENGINE</b> <b>Rear</b></p> <p>NISSAN PASSENGER CAR ..... 1987-13</p>
 <p style="text-align: center;"><b>EM-8142</b> <b>Engine Torque Strut Mount</b> <b>Front</b></p> <p>NISSAN PASSENGER CAR ..... 1982-86</p> <p style="text-align: center;"><b>Engine Torque Strut Mount</b> <b>Rear</b></p> <p>NISSAN PASSENGER CAR ..... 1983</p>	 <p style="text-align: center;"><b>EM-8146</b> <b>MOUNT-ENGINE</b> <b>RH Front</b></p> <p>NISSAN TRUCK ..... 1981-83</p>	 <p style="text-align: center;"><b>EM-8151</b> <b>MOUNT-ENGINE</b> <b>Front</b></p> <p>NISSAN PASSENGER CAR ..... 1982-84</p> <p style="text-align: center;"><b>MOUNT-TRANSMISSION</b> <b>Auto</b></p> <p>NISSAN PASSENGER CAR ..... 1983-86</p>	 <p style="text-align: center;"><b>EM-8157</b> <b>MOUNT-ENGINE</b> <b>LH Front</b></p> <p>NISSAN TRUCK ..... 1983-86</p>
 <p style="text-align: center;"><b>EM-8144</b> <b>MOUNT-ENGINE</b> <b>RH Front</b></p> <p>NISSAN TRUCK ..... 1980</p>	 <p style="text-align: center;"><b>EM-8148</b> <b>MOUNT-TRANSMISSION</b> <b>Manual</b></p> <p>NISSAN PASSENGER CAR ..... 1991-13</p>	 <p style="text-align: center;"><b>EM-8152</b> <b>MOUNT-ENGINE</b> <b>Rear</b></p> <p>NISSAN PASSENGER CAR ..... 1987-13</p>	 <p style="text-align: center;"><b>EM-8160</b> <b>MOUNT-TRANSMISSION</b> <b>Manual</b></p> <p>SUZUKI SPORT UTILITY ..... 1985-95</p>
	 <p style="text-align: center;"><b>EM-8149</b> <b>MOUNT-TRANSMISSION</b> <b>Manual</b></p> <p>NISSAN PASSENGER CAR ..... 1991-99</p>		 <p style="text-align: center;"><b>EM-8161</b> <b>MOUNT-ENGINE</b> <b>L &amp; R Front</b></p> <p>SUZUKI SPORT UTILITY ..... 1985-95</p>



# BUYER'S GUIDE

## NUMERICAL LISTING - ILLUSTRATIONS

 <p><b>EM-8162</b> <b>MOUNT-ENGINE</b> <b>Front</b></p> <p>CHEVROLET PASSENGER CAR ..... 1985-86</p> <p><b>MOUNT-ENGINE</b> <b>L &amp; R Front</b></p> <p>TOYOTA PASSENGER CAR ..... 1981-85 TOYOTA SPORT UTILITY ..... 1984-98 TOYOTA TRUCK ..... 1988-99</p>	 <p><b>EM-8165</b> <b>MOUNT-TRANSMISSION</b> <b>Manual</b></p> <p>TOYOTA SPORT UTILITY ..... 1990-95 TOYOTA TRUCK ..... 1988-98</p>	 <p><b>EM-8169</b> <b>MOUNT-ENGINE</b> <b>Rear</b></p> <p>TOYOTA PASSENGER CAR ..... 1992-95</p>	 <p><b>EM-8174</b> <b>MOUNT-ENGINE</b> <b>Rear</b></p> <p>TOYOTA PASSENGER CAR ..... 1987-88</p>
 <p><b>EM-8163</b> <b>MOUNT-ENGINE</b> <b>RH Front</b></p> <p>TOYOTA PASSENGER CAR ..... 1981-84</p> <p><b>MOUNT-ENGINE</b> <b>L &amp; R Front</b></p> <p>TOYOTA SPORT UTILITY ..... 1981-90</p>	 <p><b>EM-8166</b> <b>MOUNT-ENGINE</b> <b>RH Front</b></p> <p>TOYOTA PASSENGER CAR ..... 1991-99</p>	 <p><b>EM-8170</b> <b>MOUNT-TRANSMISSION</b> <b>Manual</b></p> <p>TOYOTA PASSENGER CAR ..... 1991-95</p>	 <p><b>EM-8175</b> <b>MOUNT-TRANSMISSION</b> <b>Auto</b></p> <p>TOYOTA PASSENGER CAR ..... 1991-98</p>
 <p><b>EM-8164</b> <b>MOUNT-ENGINE</b> <b>L &amp; R Front</b></p> <p>TOYOTA SPORT UTILITY ..... 1988-00 TOYOTA TRUCK ..... 1988-04</p>	 <p><b>EM-8167</b> <b>MOUNT-ENGINE</b> <b>Rear</b></p> <p>TOYOTA PASSENGER CAR ..... 1991-99</p>	 <p><b>EM-8171</b> <b>MOUNT-ENGINE</b> <b>Rear</b></p> <p>TOYOTA PASSENGER CAR ..... 1991-94</p>	 <p><b>EM-8176</b> <b>MOUNT-TRANSMISSION</b> <b>Auto</b></p> <p>TOYOTA PASSENGER CAR ..... 1987-90</p>
 <p><b>EM-8168</b> <b>MOUNT-ENGINE</b> <b>Rear</b></p> <p>TOYOTA PASSENGER CAR ..... 1992-94</p>	 <p><b>EM-8173</b> <b>MOUNT-ENGINE</b> <b>Rear</b></p> <p>TOYOTA PASSENGER CAR ..... 1987-90</p>	 <p><b>EM-8177</b> <b>MOUNT-ENGINE</b> <b>Front</b></p> <p>GEO PASSENGER CAR ..... 1993-97 TOYOTA PASSENGER CAR ..... 1993-02</p>	

# BUYER'S GUIDE

## NUMERICAL LISTING - ILLUSTRATIONS

 <p style="text-align: center;"><b>EM-8178</b> <b>MOUNT-ENGINE</b> <b>RH Front</b></p> <p>GEO PASSENGER CAR ..... 1993-97 TOYOTA PASSENGER CAR ..... 1993-97</p>	<p><b>EM-8181 (Continued)</b> TOYOTA PASSENGER CAR ..... 1988-92 <b>MOUNT-TRANSMISSION</b></p> <hr/> <p>TOYOTA PASSENGER CAR ..... 1981-82</p>  <p style="text-align: center;"><b>EM-8183</b> <b>MOUNT-ENGINE</b> <b>RH Front</b></p> <p>GEO PASSENGER CAR ..... 1989-92 TOYOTA PASSENGER CAR ..... 1990-92</p>	 <p style="text-align: center;"><b>EM-8187</b> <b>MOUNT-ENGINE</b> <b>Rear</b></p> <p>GEO PASSENGER CAR ..... 1989-92 TOYOTA PASSENGER CAR ..... 1987-92</p>	 <p style="text-align: center;"><b>EM-8190</b> <b>MOUNT-TRANSMISSION</b> <b>Center</b></p> <p>TOYOTA PASSENGER CAR ..... 1989-92</p>
 <p style="text-align: center;"><b>EM-8179</b> <b>MOUNT-ENGINE</b> <b>Rear</b></p> <p>GEO PASSENGER CAR ..... 1993-97 TOYOTA PASSENGER CAR ..... 1993-97</p>	 <p style="text-align: center;"><b>EM-8185</b> <b>MOUNT-ENGINE</b> <b>Rear</b></p> <p>GEO PASSENGER CAR ..... 1989-92 TOYOTA PASSENGER CAR ..... 1988-92</p>	 <p style="text-align: center;"><b>EM-8188</b> <b>MOUNT-TRANSMISSION</b> <b>MOUNT-TRANSMISSION</b> <b>LH</b></p> <p>GEO PASSENGER CAR ..... 1989-92 TOYOTA PASSENGER CAR ..... 1988-92</p>	 <p style="text-align: center;"><b>EM-8191</b> <b>MOUNT-TRANSMISSION</b> <b>MOUNT-TRANSMISSION</b> <b>Manual</b></p> <p>GEO PASSENGER CAR ..... 1993-97 TOYOTA PASSENGER CAR ..... 1993-97</p>
 <p style="text-align: center;"><b>EM-8180</b> <b>MOUNT-ENGINE</b> <b>Front</b></p> <p>GEO PASSENGER CAR ..... 1989-97 TOYOTA PASSENGER CAR ..... 1988-92</p>	 <p style="text-align: center;"><b>EM-8186</b> <b>MOUNT-ENGINE</b> <b>Rear</b></p> <p>TOYOTA PASSENGER CAR ..... 1988-92</p>	 <p style="text-align: center;"><b>EM-8189</b> <b>MOUNT-ENGINE</b> <b>LH Front</b> <b>MOUNT-TRANSMISSION</b> <b>Manual</b></p> <p>TOYOTA PASSENGER CAR ..... 1984 TOYOTA PASSENGER CAR ..... 1984-91</p>	 <p style="text-align: center;"><b>EM-8192</b> <b>MOUNT-ENGINE</b> <b>LH Front</b> <b>MOUNT-ENGINE</b> <b>Front</b></p> <p>LEXUS PASSENGER CAR ..... 1990-91 TOYOTA PASSENGER CAR ..... 1988-91</p>
 <p style="text-align: center;"><b>EM-8181</b> <b>MOUNT-ENGINE</b> <b>Front</b></p> <p>GEO PASSENGER CAR ..... 1989-92</p> <p style="text-align: center;">(Continued Next Column)</p>			

# BUYER'S GUIDE

## NUMERICAL LISTING - ILLUSTRATIONS

 <p style="text-align: center;"><b>EM-8193</b> <b>MOUNT-ENGINE</b> <b>LH Front</b></p> <p>LEXUS PASSENGER CAR ..... 1990-91 <b>MOUNT-ENGINE</b> <b>Front</b></p> <hr/> <p>TOYOTA PASSENGER CAR ..... 1987-91</p>	 <p style="text-align: center;"><b>EM-8196</b> <b>MOUNT-ENGINE</b> <b>RH Front</b></p> <p>TOYOTA PASSENGER CAR ..... 1987-91</p>	 <p style="text-align: center;"><b>EM-8201</b> <b>Engine Torque Strut</b> <b>Front Right</b></p> <p>LEXUS PASSENGER CAR ..... 1992-96 <b>Engine Torque Strut Mount</b> <b>Front</b></p> <hr/> <p>TOYOTA PASSENGER CAR ..... 1992-96</p>	 <p style="text-align: center;"><b>EM-8206</b> <b>MOUNT-ENGINE</b> <b>RH Front</b></p> <p>DODGE PASSENGER CAR ..... 1993-94 <b>MOUNT-ENGINE</b> <b>LH Front</b></p> <hr/> <p>EAGLE PASSENGER CAR ..... 1993-96 <b>MOUNT-ENGINE</b> <b>RH Front</b></p> <hr/> <p>MITSUBISHI PASSENGER CAR ..... 1993-96 PLYMOUTH PASSENGER CAR ..... 1993-94</p>
 <p style="text-align: center;"><b>EM-8194</b> <b>MOUNT-ENGINE</b> <b>Front</b></p> <p>TOYOTA PASSENGER CAR ..... 1987-91</p>	 <p style="text-align: center;"><b>EM-8197</b> <b>MOUNT-ENGINE</b> <b>Rear</b></p> <p>LEXUS PASSENGER CAR ..... 1990-91 TOYOTA PASSENGER CAR ..... 1988-91</p>	 <p style="text-align: center;"><b>EM-8205</b> <b>MOUNT-ENGINE</b> <b>LH Front</b></p> <p>DODGE PASSENGER CAR ..... 1979-88 DODGE TRUCK ..... 1983-93 <b>MOUNT-ENGINE</b> <b>L &amp; R Front</b></p> <hr/> <p>MITSUBISHI SPORT UTILITY ..... 1992-94 <b>MOUNT-ENGINE</b> <b>LH Front</b></p> <hr/> <p>MITSUBISHI TRUCK ..... 1983-85 PLYMOUTH PASSENGER CAR ..... 1979-86 <b>MOUNT-ENGINE</b> <b>Rear</b></p> <hr/> <p>MITSUBISHI PASSENGER CAR ..... 1983-89 <b>MOUNT-TRANSMISSION</b> <b>Auto</b></p> <hr/> <p>MITSUBISHI PASSENGER CAR ..... 1987-88</p>	 <p style="text-align: center;"><b>EM-8207</b> <b>MOUNT-ENGINE</b> <b>RH Front</b></p> <p>LEXUS PASSENGER CAR ..... 1990-91 TOYOTA PASSENGER CAR ..... 1989-91</p>
 <p style="text-align: center;"><b>EM-8195</b> <b>MOUNT-ENGINE</b> <b>Front</b></p> <p>TOYOTA PASSENGER CAR ..... 1983-90 <b>MOUNT-TRANSMISSION</b> <b>Manual</b></p> <hr/> <p>TOYOTA PASSENGER CAR ..... 1987-88</p>	 <p style="text-align: center;"><b>EM-8198</b> <b>MOUNT-ENGINE</b> <b>Rear</b></p> <p>TOYOTA PASSENGER CAR ..... 1987-88</p>	 <p style="text-align: center;"><b>EM-8200</b> <b>Engine Torque Strut Mount</b> <b>Right</b></p> <p>TOYOTA PASSENGER CAR ..... 1992-01</p>	 <p style="text-align: center;"><b>EM-8208</b> <b>MOUNT-TRANSMISSION</b> <b>Center</b></p> <p>LEXUS PASSENGER CAR ..... 1990-91 <b>MOUNT-TRANSMISSION</b></p> <hr/> <p>TOYOTA PASSENGER CAR ..... 1987-91</p>

# BUYER'S GUIDE

## NUMERICAL LISTING - ILLUSTRATIONS

 <p><b>EM-8209</b> <b>MOUNT-ENGINE</b> <b>Rear</b></p> <p>TOYOTA PASSENGER CAR ..... 1992-96</p>	 <p><b>EM-8213</b> <b>MOUNT-ENGINE</b> <b>Front</b></p> <p>TOYOTA PASSENGER CAR ..... 1987-93</p>	 <p><b>EM-8221</b> <b>MOUNT-TRANSMISSION</b> <b>Auto</b></p> <p>AUDI PASSENGER CAR ..... 1973-87 VOLKSWAGEN PASSENGER CAR ..... 1974-81</p>	 <p><b>EM-8224</b> <b>MOUNT-ENGINE</b> <b>Front</b></p> <p>SEAT PASSENGER CAR ..... 2001-02 VOLKSWAGEN PASSENGER CAR ..... 1984-97</p>
 <p><b>EM-8210</b> <b>MOUNT-ENGINE</b> <b>L &amp; R Front</b></p> <p>TOYOTA PASSENGER CAR ..... 1984-87</p>	 <p><b>EM-8214</b> <b>MOUNT-ENGINE</b> <b>Rear</b></p> <p>TOYOTA PASSENGER CAR ..... 1983</p>	 <p><b>EM-8222</b> <b>MOUNT-ENGINE</b> <b>RH Front</b></p> <p>SEAT PASSENGER CAR ..... 2001-02 VOLKSWAGEN PASSENGER CAR ..... 1984-92</p>	<p><b>MOUNT-ENGINE</b> <b>LH Rear</b></p> <p>VOLKSWAGEN PASSENGER CAR ..... 1995-02</p>  <p><b>EM-8225</b> <b>MOUNT-ENGINE</b> <b>RH Front</b></p> <p>PONTIAC PASSENGER CAR ..... 1988-89</p>
 <p><b>EM-8211</b> <b>MOUNT-ENGINE</b> <b>Front</b></p> <p>TOYOTA PASSENGER CAR ..... 1983-87</p>	 <p><b>EM-8218</b> <b>MOUNT-TRANSMISSION</b></p> <p>TOYOTA PASSENGER CAR ..... 1986-89</p>	<p><b>MOUNT-ENGINE</b> <b>RH Rear</b></p> <p>VOLKSWAGEN PASSENGER CAR ..... 1984-97</p> <p><b>MOUNT-TRANSMISSION</b> <b>RH</b></p> <p>VOLKSWAGEN PASSENGER CAR ..... 1993-94</p>  <p><b>EM-8223</b> <b>MOUNT-TRANSMISSION</b> <b>Auto</b></p> <p>MAZDA PASSENGER CAR ..... 1990</p>	 <p><b>EM-8228</b> <b>MOUNT-ENGINE</b> <b>Rear</b></p> <p>HONDA PASSENGER CAR ..... 1996-97</p>
 <p><b>EM-8212</b> <b>MOUNT-ENGINE</b> <b>Front</b></p> <p>TOYOTA PASSENGER CAR ..... 1981-88</p>	 <p><b>EM-8220</b> <b>MOUNT-TRANSMISSION</b> <b>Auto</b></p> <p>TOYOTA PASSENGER CAR ..... 1984</p>		

# BUYER'S GUIDE

## NUMERICAL LISTING - ILLUSTRATIONS

 <p style="text-align: center;"><b>EM-8229</b> <b>MOUNT-ENGINE</b> <b>L &amp; R Front</b></p> <p>MERCEDES-BENZ PASSENGER CAR ..... 1974-91</p>	<p><b>EM-8232 (Continued)</b></p> <p style="text-align: center;"><b>MOUNT-ENGINE</b> <b>RH Front</b></p> <p>PLYMOUTH PASSENGER CAR ..... 1985-86</p> <p style="text-align: center;"><b>MOUNT-TRANSMISSION</b></p> <p>DODGE PASSENGER CAR ..... 1985-88 PLYMOUTH PASSENGER CAR ..... 1985-86</p>	 <p style="text-align: center;"><b>EM-8236</b> <b>MOUNT-ENGINE</b> <b>LH Rear</b></p> <p>VOLKSWAGEN PASSENGER CAR ..... 1990-92</p> <p style="text-align: center;"><b>MOUNT-TRANSMISSION</b> <b>Auto</b></p> <p>VOLKSWAGEN PASSENGER CAR ..... 1992-97</p> <p style="text-align: center;"><b>MOUNT-TRANSMISSION</b> <b>LH</b></p> <p>VOLKSWAGEN PASSENGER CAR ..... 1984-02</p>	 <p style="text-align: center;"><b>EM-8242</b> <b>MOUNT-ENGINE</b> <b>RH Front</b></p> <p>DODGE PASSENGER CAR ..... 1985-90 PLYMOUTH PASSENGER CAR ..... 1987-88</p> <p style="text-align: center;"><b>MOUNT-TRANSMISSION</b></p> <p>DODGE PASSENGER CAR ..... 1987-88</p> <p style="text-align: center;"><b>MOUNT-TRANSMISSION</b> <b>Manual</b></p> <p>PLYMOUTH PASSENGER CAR ..... 1987-88</p> <p>MITSUBISHI PASSENGER CAR ..... 1987-88</p> <p style="text-align: center;"><b>MOUNT-TRANSMISSION</b></p> <p>PLYMOUTH PASSENGER CAR ..... 1987-88</p>
 <p style="text-align: center;"><b>EM-8230</b> <b>MOUNT-TRANSMISSION</b></p> <p>MERCEDES-BENZ PASSENGER CAR ..... 1981-91</p>	 <p style="text-align: center;"><b>EM-8233</b> <b>MOUNT-ENGINE</b> <b>RH Front</b></p> <p>CHEVROLET PASSENGER CAR ..... 1985-88 TOYOTA PASSENGER CAR ..... 1983-87</p>	 <p style="text-align: center;"><b>EM-8238</b> <b>MOUNT-ENGINE</b> <b>RH Front</b></p> <p>DODGE PASSENGER CAR ..... 1993-94</p> <p style="text-align: center;"><b>MOUNT-ENGINE</b> <b>LH Front</b></p> <p>EAGLE PASSENGER CAR ..... 1993-96</p> <p style="text-align: center;"><b>MOUNT-ENGINE</b> <b>RH Front</b></p> <p>MITSUBISHI PASSENGER CAR ..... 1993-96 PLYMOUTH PASSENGER CAR ..... 1992-94</p>	 <p style="text-align: center;"><b>EM-8243</b> <b>MOUNT-TRANSMISSION</b> <b>Manual</b></p> <p>DODGE TRUCK ..... 1990-91 MITSUBISHI SPORT UTILITY ..... 1992-99</p>
 <p style="text-align: center;"><b>EM-8231</b> <b>MOUNT-ENGINE</b> <b>Front</b></p> <p>DODGE PASSENGER CAR ..... 1985-90</p>	 <p style="text-align: center;"><b>EM-8234</b> <b>MOUNT-ENGINE</b> <b>RH Front</b></p> <p>MAZDA PASSENGER CAR ..... 1986-89 MERCURY PASSENGER CAR ..... 1987-89</p> <p style="text-align: center;"><b>EM-8235</b> <b>MOUNT-ENGINE</b> <b>Front</b></p> <p>DODGE PASSENGER CAR ..... 1985-90</p> <p style="text-align: center;"><b>MOUNT-ENGINE</b> <b>L &amp; R Front</b></p> <p>DODGE SPORT UTILITY ..... 1989</p> <p style="text-align: center;"><b>MOUNT-ENGINE</b> <b>Front</b></p> <p>MITSUBISHI PASSENGER CAR ..... 1985-88 PLYMOUTH PASSENGER CAR ..... 1985-88</p>	 <p style="text-align: center;"><b>EM-8239</b> <b>MOUNT-ENGINE</b> <b>Front</b></p> <p>DODGE PASSENGER CAR ..... 1994 EAGLE PASSENGER CAR ..... 1994-96</p>	 <p style="text-align: center;"><b>EM-8244</b> <b>MOUNT-TRANSMISSION</b> <b>Manual</b></p> <p>DODGE TRUCK ..... 1990-93</p> <p style="text-align: center;"><b>MOUNT-TRANSMISSION</b> <b>Auto</b></p> <p>MITSUBISHI SPORT UTILITY ..... 1992-94</p>
<p><b>(Continued Next Column)</b></p>			



# BUYER'S GUIDE

## NUMERICAL LISTING - ILLUSTRATIONS

 <p style="text-align: center;"><b>EM-8248</b> <b>MOUNT-ENGINE</b> <b>Rear</b></p> <p>PLYMOUTH TRUCK ..... 1982 <b>MOUNT-TRANSMISSION</b> <b>Manual</b></p> <p>DODGE SPORT UTILITY ..... 1987-88 MITSUBISHI SPORT UTILITY ..... 1983-89 <b>MOUNT-TRANSMISSION</b></p> <p>MITSUBISHI TRUCK ..... 1983-86 DODGE TRUCK ..... 1982-89 <b>MOUNT-TRANSMISSION</b> <b>Manual</b></p> <p>MITSUBISHI TRUCK ..... 1983-86</p>	 <p style="text-align: center;"><b>EM-8255</b> <b>MOUNT-ENGINE</b> <b>LH Front</b></p> <p>HYUNDAI PASSENGER CAR ..... 1992-95</p>	 <p style="text-align: center;"><b>EM-8263</b> <b>MOUNT-TRANSMISSION</b> <b>Auto</b></p> <p>MAZDA PASSENGER CAR ..... 1981-82</p>	 <p style="text-align: center;"><b>EM-8270</b> <b>MOUNT-ENGINE</b> <b>Front Lower</b></p> <p>MITSUBISHI PASSENGER CAR ..... 1983-88 <b>MOUNT-ENGINE</b> <b>RH Front</b></p> <p>PLYMOUTH PASSENGER CAR ..... 1984-91</p>
 <p style="text-align: center;"><b>EM-8253</b> <b>MOUNT-ENGINE</b> <b>Front</b></p> <p>DODGE PASSENGER CAR ..... 1985-88 <b>MOUNT-ENGINE</b> <b>LH Front</b></p> <p>HYUNDAI PASSENGER CAR ..... 1995 <b>MOUNT-TRANSMISSION</b> <b>LH</b></p> <p>DODGE PASSENGER CAR ..... 2004-06</p>	 <p style="text-align: center;"><b>EM-8259</b> <b>MOUNT-ENGINE</b> <b>RH Front</b></p> <p>MAZDA PASSENGER CAR ..... 1983-85</p>	 <p style="text-align: center;"><b>EM-8266</b> <b>MOUNT-ENGINE</b> <b>Rear</b></p> <p>MITSUBISHI PASSENGER CAR ..... 1987-88</p>	 <p style="text-align: center;"><b>EM-8271</b> <b>MOUNT-ENGINE</b> <b>Rear</b></p> <p>MITSUBISHI PASSENGER CAR ..... 1983</p>
 <p style="text-align: center;"><b>EM-8254</b> <b>MOUNT-ENGINE</b> <b>RH Front</b></p> <p>HYUNDAI PASSENGER CAR ..... 1993-95</p>	 <p style="text-align: center;"><b>EM-8261</b> <b>MOUNT-ENGINE</b> <b>Rear</b></p> <p>MAZDA PASSENGER CAR ..... 1995-98</p>	 <p style="text-align: center;"><b>EM-8267</b> <b>MOUNT-ENGINE</b> <b>Rear</b></p> <p>DODGE PASSENGER CAR ..... 1985-88 MITSUBISHI PASSENGER CAR ..... 1985-88 PLYMOUTH PASSENGER CAR ..... 1985-88</p>	 <p style="text-align: center;"><b>EM-8272</b> <b>Engine Torque Strut Mount</b> <b>Front</b></p> <p>MITSUBISHI PASSENGER CAR ..... 1983-88</p>
 <p style="text-align: center;"><b>EM-8262</b> <b>MOUNT-ENGINE</b> <b>RH Front</b></p> <p>MAZDA PASSENGER CAR ..... 1986-87</p>			

# BUYER'S GUIDE

## NUMERICAL LISTING - ILLUSTRATIONS

 <p style="text-align: center;"><b>EM-8274</b> <b>MOUNT-TRANSMISSION</b> <b>Manual</b></p> <p>NISSAN PASSENGER CAR ..... 1989-90</p>	 <p style="text-align: center;"><b>EM-8278</b> <b>MOUNT-ENGINE</b> <b>RH Front</b></p> <p>TOYOTA PASSENGER CAR ..... 1987-90</p>	 <p style="text-align: center;"><b>EM-8282</b> <b>MOUNT-TRANSMISSION</b> <b>Manual</b></p> <p>CHEVROLET PASSENGER CAR ..... 1985-88</p>	<p><b>EM-8287 (Continued)</b> <b>MOUNT-TRANSMISSION</b></p> <p>SEAT PASSENGER CAR ..... 2001-02 VOLKSWAGEN PASSENGER CAR ..... 1984-02</p>  <p style="text-align: center;"><b>EM-8290</b> <b>MOUNT-ENGINE</b> <b>RH Front</b></p> <p>NISSAN PASSENGER CAR ..... 1991-93</p>
 <p style="text-align: center;"><b>EM-8276</b> <b>MOUNT-ENGINE</b> <b>L &amp; R Front</b></p> <p>NISSAN SPORT UTILITY ..... 1987-04 NISSAN TRUCK ..... 1986-04</p>	 <p style="text-align: center;"><b>EM-8279</b> <b>MOUNT-ENGINE</b> <b>L &amp; R Front</b></p> <p>TOYOTA PASSENGER CAR ..... 1980-86</p>	 <p style="text-align: center;"><b>EM-8283</b> <b>MOUNT-ENGINE</b> <b>Front</b></p> <p>CHEVROLET PASSENGER CAR ..... 1987-88 SUZUKI PASSENGER CAR ..... 1985</p>	 <p style="text-align: center;"><b>EM-8292</b> <b>MOUNT-ENGINE</b> <b>Front</b></p> <p>MITSUBISHI PASSENGER CAR ..... 1985-87</p> <p style="text-align: center;"><b>MOUNT-TRANSMISSION</b> <b>Auto</b></p> <p>MITSUBISHI PASSENGER CAR ..... 1984-88</p>
 <p style="text-align: center;"><b>EM-8277</b> <b>MOUNT-ENGINE</b> <b>Rear</b></p> <p>CHEVROLET PASSENGER CAR ..... 1998-00 GEO PASSENGER CAR ..... 1992-97 PONTIAC PASSENGER CAR ..... 1994-00 SUZUKI PASSENGER CAR ..... 1989-01</p> <p style="text-align: center;"><b>MOUNT-TRANSMISSION</b></p> <p>CHEVROLET PASSENGER CAR ..... 1989-01</p> <p style="text-align: center;"><b>MOUNT-TRANSMISSION</b> <b>Manual</b></p> <p>GEO PASSENGER CAR ..... 1989-97</p> <p style="text-align: center;"><b>MOUNT-TRANSMISSION</b></p> <p>SUZUKI PASSENGER CAR ..... 1992-94</p>	 <p style="text-align: center;"><b>EM-8280</b> <b>MOUNT-ENGINE</b> <b>L &amp; R Front</b></p> <p>TOYOTA SPORT UTILITY ..... 1967-80</p>	 <p style="text-align: center;"><b>EM-8284</b> <b>Engine Torque Strut Mount</b> <b>Rear</b></p> <p>NISSAN PASSENGER CAR ..... 1982-86</p>	 <p style="text-align: center;"><b>EM-8293</b> <b>Engine Torque Strut Mount</b> <b>Front</b></p> <p>HONDA PASSENGER CAR ..... 1979-81</p>
 <p style="text-align: center;"><b>EM-8281</b> <b>MOUNT-ENGINE</b> <b>LH Front</b></p> <p>MITSUBISHI PASSENGER CAR ..... 1990</p>	 <p style="text-align: center;"><b>EM-8287</b> <b>MOUNT-ENGINE</b> <b>RH Rear</b></p> <p>VOLKSWAGEN PASSENGER CAR ..... 1987-92</p> <p style="text-align: center;"><b>(Continued Next Column)</b></p>		

# BUYER'S GUIDE

## NUMERICAL LISTING - ILLUSTRATIONS

 <p style="text-align: center;"><b>EM-8294</b> <b>MOUNT-ENGINE</b> <b>Rear</b></p> <p>CHEVROLET PASSENGER CAR ..... 1985-91 GEO PASSENGER CAR ..... 1989-91 PONTIAC PASSENGER CAR ..... 1989-91 SUZUKI PASSENGER CAR ..... 1985</p>	 <p style="text-align: center;"><b>EM-8303</b> <b>MOUNT-ENGINE</b> <b>Rear</b></p> <p>NISSAN VAN ..... 1987-88</p> <p style="text-align: center;"><b>MOUNT-TRANSMISSION</b> <b>Auto</b></p> <p>NISSAN PASSENGER CAR ..... 1987-89</p>	 <p style="text-align: center;"><b>EM-8310</b> <b>MOUNT-ENGINE</b> <b>LH Front</b></p> <p>NISSAN TRUCK ..... 1980-85</p>	 <p style="text-align: center;"><b>EM-8317</b> <b>MOUNT-TRANSMISSION</b> <b>Auto</b></p> <p>NISSAN PASSENGER CAR ..... 1990</p>
 <p style="text-align: center;"><b>EM-8295</b> <b>MOUNT-ENGINE</b> <b>RH Front</b></p> <p>NISSAN PASSENGER CAR ..... 1989-90</p>	 <p style="text-align: center;"><b>EM-8304</b> <b>MOUNT-ENGINE</b> <b>RH Front</b></p> <p>NISSAN PASSENGER CAR ..... 1986-92</p>	 <p style="text-align: center;"><b>EM-8311</b> <b>MOUNT-ENGINE</b> <b>L &amp; R Front</b></p> <p>INFINITI SPORT UTILITY ..... 1997-00 NISSAN SPORT UTILITY ..... 1996-00</p>	 <p style="text-align: center;"><b>EM-8319</b> <b>MOUNT-ENGINE</b> <b>Rear</b></p> <p>NISSAN PASSENGER CAR ..... 1987-89</p>
 <p style="text-align: center;"><b>EM-8296</b> <b>MOUNT-ENGINE</b> <b>L &amp; R Front</b></p> <p>NISSAN PASSENGER CAR ..... 1989-98</p>	 <p style="text-align: center;"><b>EM-8307</b> <b>MOUNT-ENGINE</b> <b>RH Front</b></p> <p>NISSAN PASSENGER CAR ..... 1991-00</p>	 <p style="text-align: center;"><b>EM-8312</b> <b>MOUNT-TRANSMISSION</b> <b>Manual</b></p> <p>NISSAN PASSENGER CAR ..... 1986-90</p>	 <p style="text-align: center;"><b>EM-8322</b> <b>MOUNT-TRANSMISSION</b> <b>Auto</b></p> <p>INFINITI SPORT UTILITY ..... 2001-03</p> <p style="text-align: center;"><b>MOUNT-TRANSMISSION</b></p> <p>NISSAN SPORT UTILITY ..... 1996-04</p>
 <p style="text-align: center;"><b>EM-8300</b> <b>MOUNT-TRANSMISSION</b></p> <p>HONDA PASSENGER CAR ..... 1996-00 HONDA SPORT UTILITY ..... 1997-01</p>	 <p style="text-align: center;"><b>EM-8314</b> <b>MOUNT-TRANSMISSION</b> <b>Auto</b></p> <p>SUZUKI PASSENGER CAR ..... 1995-01</p>		













# BUYER'S GUIDE

## NUMERICAL LISTING - ILLUSTRATIONS

 <p style="text-align: center;"><b>EM-8323</b> <b>MOUNT-TRANSMISSION</b> <b>Manual</b></p> <p>NISSAN PASSENGER CAR ..... 1989-94</p>	<p><b>EM-8329 (Continued)</b> HONDA PASSENGER CAR ..... 1992-97</p>  <p style="text-align: center;"><b>EM-8330</b> <b>MOUNT-TRANSMISSION</b> <b>Auto</b></p> <p>ACURA PASSENGER CAR ..... 1994-01 HONDA PASSENGER CAR ..... 1992-93</p>	 <p style="text-align: center;"><b>EM-8348</b> <b>MOUNT-ENGINE</b> <b>Front</b></p> <p>TOYOTA PASSENGER CAR ..... 1984-89</p>	 <p style="text-align: center;"><b>EM-8352</b> <b>MOUNT-ENGINE</b> <b>RH Front</b></p> <p>ACURA SPORT UTILITY ..... 1996-99 HONDA SPORT UTILITY ..... 1996-97 ISUZU SPORT UTILITY ..... 1995-02</p>
 <p style="text-align: center;"><b>EM-8324</b> <b>MOUNT-ENGINE</b> <b>Rear</b></p> <p>NISSAN PASSENGER CAR ..... 1986-92</p>	 <p style="text-align: center;"><b>EM-8339</b> <b>MOUNT-ENGINE</b> <b>Front</b></p> <p>TOYOTA PASSENGER CAR ..... 1985-89</p>	 <p style="text-align: center;"><b>EM-8349</b> <b>MOUNT-ENGINE</b> <b>Rear</b></p> <p>HONDA PASSENGER CAR ..... 1989-91</p>	 <p style="text-align: center;"><b>EM-8353</b> <b>MOUNT-ENGINE</b> <b>L &amp; R Front</b></p> <p>LEXUS SPORT UTILITY ..... 1996-97 TOYOTA SPORT UTILITY ..... 1993-97</p>
 <p style="text-align: center;"><b>EM-8328</b> <b>MOUNT-TRANSMISSION</b> <b>Auto</b></p> <p>NISSAN TRUCK ..... 1990-97</p>	 <p style="text-align: center;"><b>EM-8344</b> <b>MOUNT-ENGINE</b> <b>L &amp; R Front</b></p> <p>TOYOTA PASSENGER CAR ..... 1989-92</p>	 <p style="text-align: center;"><b>EM-8351</b> <b>MOUNT-ENGINE</b> <b>LH Front</b></p> <p>ACURA SPORT UTILITY ..... 1996-99 HONDA SPORT UTILITY ..... 1996-00 ISUZU SPORT UTILITY ..... 1995-03</p>	 <p style="text-align: center;"><b>EM-8359</b> <b>MOUNT-ENGINE</b> <b>Front</b></p> <p>TOYOTA PASSENGER CAR ..... 1990-93</p>
 <p style="text-align: center;"><b>EM-8329</b> <b>MOUNT-TRANSMISSION</b> <b>Manual</b></p> <p>ACURA PASSENGER CAR ..... 1994-01</p> <p><b>(Continued Next Column)</b></p>			

# BUYER'S GUIDE

## NUMERICAL LISTING - ILLUSTRATIONS

 <p style="text-align: center;"><b>EM-8361</b> <b>MOUNT-ENGINE</b> <b>Front</b></p> <p>TOYOTA PASSENGER CAR ..... 1992-01</p>	 <p style="text-align: center;"><b>EM-8374</b> <b>MOUNT-TRANSMISSION</b> <b>Manual</b></p> <p>HONDA PASSENGER CAR ..... 1988-91</p>	 <p style="text-align: center;"><b>EM-8385</b> <b>MOUNT-ENGINE</b> <b>Rear</b></p> <p>TOYOTA PASSENGER CAR ..... 1986-93</p>	 <p style="text-align: center;"><b>EM-8393</b> <b>MOUNT-TRANSMISSION</b> <b>Manual</b></p> <p>TOYOTA SPORT UTILITY ..... 1985-92</p>
 <p style="text-align: center;"><b>EM-8363</b> <b>MOUNT-ENGINE</b> <b>Front</b></p> <p>TOYOTA PASSENGER CAR ..... 1987-90</p>	 <p style="text-align: center;"><b>EM-8375</b> <b>MOUNT-ENGINE</b> <b>Rear</b></p> <p>TOYOTA PASSENGER CAR ..... 1986-87</p>	 <p style="text-align: center;"><b>EM-8388</b> <b>MOUNT-TRANSMISSION</b> <b>Auto</b></p> <p>TOYOTA SPORT UTILITY ..... 1984-89</p>	 <p style="text-align: center;"><b>EM-8395</b> <b>MOUNT-TRANSMISSION</b></p> <p>LEXUS SPORT UTILITY ..... 1996-97 TOYOTA SPORT UTILITY ..... 1993-97</p>
 <p style="text-align: center;"><b>EM-8365</b> <b>MOUNT-ENGINE</b> <b>LH Front</b></p> <p>TOYOTA SPORT UTILITY ..... 1991-92</p>	 <p style="text-align: center;"><b>EM-8377</b> <b>MOUNT-TRANSMISSION</b> <b>Manual</b></p> <p>TOYOTA PASSENGER CAR ..... 1980-86</p>	 <p style="text-align: center;"><b>EM-8389</b> <b>MOUNT-TRANSMISSION</b></p> <p>TOYOTA TRUCK ..... 1981-88</p>	 <p style="text-align: center;"><b>EM-8398</b> <b>MOUNT-ENGINE</b> <b>Rear</b></p> <p>LEXUS PASSENGER CAR ..... 1992-96 TOYOTA PASSENGER CAR ..... 1992-01</p>
 <p style="text-align: center;"><b>EM-8368</b> <b>MOUNT-ENGINE</b> <b>RH Front</b></p> <p>TOYOTA PASSENGER CAR ..... 1984-86</p>	 <p style="text-align: center;"><b>EM-8384</b> <b>MOUNT-ENGINE</b> <b>Rear</b></p> <p>TOYOTA PASSENGER CAR ..... 1985-89</p>	 <p style="text-align: center;"><b>EM-8392</b> <b>MOUNT-TRANSMISSION</b> <b>Manual</b></p> <p>TOYOTA SPORT UTILITY ..... 1981-85</p>	 <p style="text-align: center;"><b>EM-8400</b> <b>MOUNT-ENGINE</b> <b>Rear</b></p> <p>TOYOTA PASSENGER CAR ..... 1984-85</p>

# BUYER'S GUIDE

## NUMERICAL LISTING - ILLUSTRATIONS

 <p style="text-align: center;"><b>EM-8401</b> <b>MOUNT-ENGINE</b> <b>Rear</b></p> <p>TOYOTA PASSENGER CAR ..... 1984-85</p>	 <p style="text-align: center;"><b>EM-8407</b> <b>MOUNT-ENGINE</b> <b>Rear</b></p> <p>TOYOTA PASSENGER CAR ..... 1986-89</p>	 <p style="text-align: center;"><b>EM-8415</b> <b>MOUNT-TRANSMISSION</b> <b>Auto</b></p> <p>GEO PASSENGER CAR ..... 1996-97 TOYOTA PASSENGER CAR ..... 1993-97</p>	<p><b>EM-8424 (Continued)</b></p> <p style="text-align: center;"><b>MOUNT-ENGINE</b> <b>Rear</b></p> <p>MAZDA PASSENGER CAR ..... 1981-85</p> <p style="text-align: center;"><b>MOUNT-TRANSMISSION</b> <b>Auto</b></p> <p>MAZDA PASSENGER CAR ..... 1986-87</p>
 <p style="text-align: center;"><b>EM-8402</b> <b>MOUNT-ENGINE</b> <b>RH Front</b></p> <p>HONDA PASSENGER CAR ..... 1984-87</p>	 <p style="text-align: center;"><b>EM-8411</b> <b>MOUNT-ENGINE</b> <b>Front</b></p> <p>HONDA PASSENGER CAR ..... 1988-91</p>	 <p style="text-align: center;"><b>EM-8418</b> <b>MOUNT-TRANSMISSION</b> <b>Manual</b></p> <p>TOYOTA PASSENGER CAR ..... 1995-99</p>	 <p style="text-align: center;"><b>EM-8425</b> <b>Engine Torque Strut Mount</b> <b>Front</b></p> <p>MAZDA PASSENGER CAR ..... 1981-85</p>
 <p style="text-align: center;"><b>EM-8404</b> <b>MOUNT-ENGINE</b> <b>LH Front</b></p> <p>ACURA PASSENGER CAR ..... 1997-99 HONDA PASSENGER CAR ..... 1994-97 HONDA VAN ..... 1995-98 ISUZU VAN ..... 1996-99</p>	 <p style="text-align: center;"><b>EM-8413</b> <b>MOUNT-ENGINE</b> <b>Rear</b></p> <p>TOYOTA PASSENGER CAR ..... 1990-93</p>	 <p style="text-align: center;"><b>EM-8422</b> <b>MOUNT-TRANSMISSION</b> <b>Auto</b></p> <p>TOYOTA PASSENGER CAR ..... 1988-91</p>	 <p style="text-align: center;"><b>EM-8427</b> <b>MOUNT-ENGINE</b> <b>RH Front</b></p> <p>NISSAN PASSENGER CAR ..... 1991-94</p>
 <p style="text-align: center;"><b>EM-8406</b> <b>MOUNT-ENGINE</b> <b>Rear</b></p> <p>TOYOTA PASSENGER CAR ..... 1987-88</p>	 <p style="text-align: center;"><b>EM-8414</b> <b>MOUNT-ENGINE</b> <b>Rear</b></p> <p>TOYOTA PASSENGER CAR ..... 1992-01</p>	 <p style="text-align: center;"><b>EM-8424</b> <b>MOUNT-ENGINE</b> <b>L &amp; R Front</b></p> <p>MAZDA PASSENGER CAR ..... 1986-91</p>	 <p style="text-align: center;"><b>EM-8430</b> <b>MOUNT-ENGINE</b> <b>L &amp; R Front</b></p> <p>TOYOTA PASSENGER CAR ..... 1980-82</p>
<p><b>(Continued Next Column)</b></p>			

# BUYER'S GUIDE

## NUMERICAL LISTING - ILLUSTRATIONS

 <p><b>EM-8431</b> <b>MOUNT-ENGINE</b> <b>Front</b></p> <p>HONDA PASSENGER CAR ..... 1988-97</p>	 <p><b>EM-8435</b> <b>MOUNT-ENGINE</b> <b>LH Front</b></p> <p>ACURA PASSENGER CAR ..... 1997-01</p> <p><b>MOUNT-ENGINE</b> <b>LH Front Lower</b></p> <p>HONDA PASSENGER CAR ..... 1992-00</p>	 <p><b>EM-8442</b> <b>MOUNT-ENGINE</b> <b>Front</b></p> <p>CHEVROLET PASSENGER CAR ..... 1985-88</p> <p>GEO PASSENGER CAR ..... 1989</p> <p>ISUZU PASSENGER CAR ..... 1985-89</p> <p>PONTIAC PASSENGER CAR ..... 1985-88</p>	 <p><b>EM-8456</b> <b>MOUNT-ENGINE</b> <b>Rear</b></p> <p>FORD PASSENGER CAR ..... 1993-97</p> <p>MAZDA PASSENGER CAR ..... 1993-02</p> <p><b>MOUNT-TRANSMISSION</b> <b>Upper</b></p> <p>FORD PASSENGER CAR ..... 1993</p>
 <p><b>EM-8432</b> <b>MOUNT-ENGINE</b> <b>Front</b></p> <p>ACURA PASSENGER CAR ..... 1997-99</p> <p>HONDA PASSENGER CAR ..... 1994-97</p>	 <p><b>EM-8438</b> <b>Engine Torque Strut</b> <b>Front Left</b></p> <p>CHEVROLET PASSENGER CAR ..... 1985-88</p> <p>ISUZU PASSENGER CAR ..... 1985-89</p>	 <p><b>EM-8445</b> <b>MOUNT-ENGINE</b> <b>LH Front</b></p> <p>HONDA SPORT UTILITY ..... 1994-95</p> <p>ISUZU SPORT UTILITY ..... 1992-95</p>	 <p><b>EM-8457</b> <b>MOUNT-TRANSMISSION</b> <b>Upper</b></p> <p>FORD PASSENGER CAR ..... 1994-97</p> <p><b>MOUNT-TRANSMISSION</b> <b>Manual</b></p> <p>MAZDA PASSENGER CAR ..... 1993-02</p>
 <p><b>EM-8434</b> <b>MOUNT-ENGINE</b> <b>Front</b></p> <p>ACURA PASSENGER CAR ..... 1997-01</p> <p><b>MOUNT-ENGINE</b> <b>RH Front</b></p> <p>HONDA PASSENGER CAR ..... 1992-95</p>	 <p><b>EM-8439</b> <b>MOUNT-ENGINE</b> <b>RH Front</b></p> <p>CHEVROLET PASSENGER CAR ..... 1985-88</p> <p>GEO PASSENGER CAR ..... 1989</p> <p>ISUZU PASSENGER CAR ..... 1989</p> <p>PONTIAC PASSENGER CAR ..... 1985-88</p> <p><b>MOUNT-TRANSMISSION</b> <b>Auto</b></p> <p>CHEVROLET PASSENGER CAR ..... 1985-88</p> <p>ISUZU PASSENGER CAR ..... 1985-89</p>	 <p><b>EM-8453</b> <b>MOUNT-ENGINE</b> <b>Rear</b></p> <p>MAZDA PASSENGER CAR ..... 1990-96</p>	 <p><b>EM-8460</b> <b>MOUNT-TRANSMISSION</b> <b>Auto</b></p> <p>MAZDA PASSENGER CAR ..... 1993-97</p>

# BUYER'S GUIDE

## NUMERICAL LISTING - ILLUSTRATIONS

 <p style="text-align: center;"><b>EM-8462</b> <b>MOUNT-TRANSMISSION</b> <b>Manual</b></p> <p>MAZDA PASSENGER CAR ..... 1988-92</p>	 <p style="text-align: center;"><b>EM-8485</b> <b>MOUNT-ENGINE</b> <b>Front</b></p> <p>TOYOTA PASSENGER CAR ..... 1992-96</p>	<p><b>EM-8490 (Continued)</b> SUZUKI PASSENGER CAR ..... 1985</p>  <p style="text-align: center;"><b>EM-8491</b> <b>MOUNT-ENGINE</b> <b>Front</b></p> <p>TOYOTA PASSENGER CAR ..... 1985-93</p>	<p><b>EM-8495 (Continued)</b> HONDA PASSENGER CAR ..... 1992-93</p>  <p style="text-align: center;"><b>EM-8497</b> <b>MOUNT-ENGINE</b> <b>RH Front</b></p> <p>HONDA PASSENGER CAR ..... 1988-91</p>
 <p style="text-align: center;"><b>EM-8466</b> <b>MOUNT-ENGINE</b> <b>LH Front</b></p> <p>MIITSUBISHI VAN ..... 1987-90</p>	 <p style="text-align: center;"><b>EM-8488</b> <b>MOUNT-ENGINE</b> <b>L &amp; R Front</b></p> <p>TOYOTA SPORT UTILITY ..... 1982-85 TOYOTA TRUCK ..... 1982-95</p>	 <p style="text-align: center;"><b>EM-8492</b> <b>MOUNT-ENGINE</b> <b>Rear</b></p> <p>TOYOTA PASSENGER CAR ..... 1984-85</p>	 <p style="text-align: center;"><b>EM-8499</b> <b>MOUNT-ENGINE</b> <b>LH Front</b></p> <p>HONDA SPORT UTILITY ..... 1996 ISUZU SPORT UTILITY ..... 1995-97</p>
 <p style="text-align: center;"><b>EM-8467</b> <b>MOUNT-ENGINE</b> <b>RH Front</b></p> <p>MIITSUBISHI VAN ..... 1987-90</p>	 <p style="text-align: center;"><b>EM-8489</b> <b>MOUNT-ENGINE</b> <b>Front</b></p> <p>CHEVROLET PASSENGER CAR ..... 1985-86 SUZUKI PASSENGER CAR ..... 1985</p>	 <p style="text-align: center;"><b>EM-8493</b> <b>MOUNT-ENGINE</b> <b>Rear</b></p> <p>TOYOTA PASSENGER CAR ..... 1984</p>	 <p style="text-align: center;"><b>EM-8502</b> <b>MOUNT-TRANSMISSION</b></p> <p>DODGE PASSENGER CAR ..... 1971-80 PLYMOUTH PASSENGER CAR ..... 1976-80</p>
 <p style="text-align: center;"><b>EM-8482</b> <b>MOUNT-ENGINE</b> <b>RH Front</b></p> <p>TOYOTA PASSENGER CAR ..... 1986</p>	 <p style="text-align: center;"><b>EM-8490</b> <b>MOUNT-TRANSMISSION</b> <b>Manual</b></p> <p style="text-align: center;">(Continued Next Column)</p>	 <p style="text-align: center;"><b>EM-8495</b> <b>MOUNT-TRANSMISSION</b> <b>Auto</b></p> <p style="text-align: center;">(Continued Next Column)</p>	

# BUYER'S GUIDE

## NUMERICAL LISTING - ILLUSTRATIONS

 <p style="text-align: center;"><b>EM-8503</b> <b>MOUNT-TRANSMISSION</b> <b>Manual</b></p> <p>DODGE PASSENGER CAR ..... 1980 <b>MOUNT-TRANSMISSION</b></p> <p>PLYMOUTH PASSENGER CAR ..... 1976-80 PLYMOUTH TRUCK ..... 1979-82</p>	 <p style="text-align: center;"><b>EM-8510</b> <b>MOUNT-TRANSMISSION</b> <b>Manual</b></p> <p>MITSUBISHI PASSENGER CAR ..... 1983-88 <b>MOUNT-TRANSMISSION</b> <b>Auto</b></p> <p>PLYMOUTH PASSENGER CAR ..... 1984-91</p>	 <p style="text-align: center;"><b>EM-8513</b> <b>MOUNT-ENGINE</b> <b>Front</b></p> <p>MAZDA PASSENGER CAR ..... 1995-98</p>	 <p style="text-align: center;"><b>EM-8517</b> <b>MOUNT-ENGINE</b> <b>Front</b></p> <p>CHEVROLET PASSENGER CAR ..... 1989-92 GEO PASSENGER CAR ..... 1989-97 <b>MOUNT-ENGINE</b> <b>LH Front</b></p> <p>PONTIAC PASSENGER CAR ..... 1989-94 <b>MOUNT-ENGINE</b> <b>Front</b></p> <p>SUZUKI PASSENGER CAR ..... 1989-01</p>
 <p style="text-align: center;"><b>EM-8506</b> <b>MOUNT-ENGINE</b> <b>Rear</b></p> <p>MITSUBISHI PASSENGER CAR ..... 1983</p>	 <p style="text-align: center;"><b>EM-8511</b> <b>MOUNT-ENGINE</b> <b>RH Front</b></p> <p>FORD PASSENGER CAR ..... 1990-93</p>	 <p style="text-align: center;"><b>EM-8514</b> <b>MOUNT-ENGINE</b> <b>RH Front</b></p> <p>CHEVROLET PASSENGER CAR ..... 1989-91 GEO PASSENGER CAR ..... 1989-91 <b>MOUNT-ENGINE</b> <b>Front</b></p> <p>MAZDA PASSENGER CAR ..... 1983-85 <b>MOUNT-ENGINE</b> <b>RH Front</b></p> <p>PONTIAC PASSENGER CAR ..... 1989-91</p>	 <p style="text-align: center;"><b>EM-8521</b> <b>Engine Torque Strut Mount</b> <b>Front</b></p> <p>CHEVROLET PASSENGER CAR ..... 1985-91 SUZUKI PASSENGER CAR ..... 1985</p>
 <p style="text-align: center;"><b>EM-8508</b> <b>MOUNT-TRANSMISSION</b> <b>Auto</b></p> <p>TOYOTA SPORT UTILITY ..... 1988-95 <b>MOUNT-TRANSMISSION</b> <b>Auto</b></p> <p>TOYOTA TRUCK ..... 1988-95</p>	 <p style="text-align: center;"><b>EM-8512</b> <b>MOUNT-TRANSMISSION</b> <b>Auto</b></p> <p>MAZDA PASSENGER CAR ..... 1979-85</p>	 <p style="text-align: center;"><b>EM-8516</b> <b>MOUNT-TRANSMISSION</b> <b>Auto</b></p> <p>FORD PASSENGER CAR ..... 1989-92 MAZDA PASSENGER CAR ..... 1988-92</p>	 <p style="text-align: center;"><b>EM-8522</b> <b>MOUNT-TRANSMISSION</b> <b>Auto</b></p> <p>SUZUKI PASSENGER CAR ..... 1985</p>



# BUYER'S GUIDE

## NUMERICAL LISTING - ILLUSTRATIONS

 <p style="text-align: center;"><b>EM-8524</b> Engine Torque Strut Mount Rear</p> <p>CHEVROLET PASSENGER CAR ..... 1985-91 SUZUKI PASSENGER CAR ..... 1985</p>	<p><b>EM-8539 (Continued)</b> ISUZU PASSENGER CAR ..... 1985-89</p>  <p style="text-align: center;"><b>EM-8542</b> MOUNT-ENGINE L &amp; R Front</p> <p>PLYMOUTH PASSENGER CAR ..... 1978-82</p> <p style="text-align: center;"><b>EM-8544</b> MOUNT-TRANSMISSION Manual</p> <p>DODGE PASSENGER CAR ..... 1978-79 PLYMOUTH PASSENGER CAR ..... 1979-82</p>  <p style="text-align: center;"><b>EM-8545</b> MOUNT-TRANSMISSION Auto</p> <p>DODGE PASSENGER CAR ..... 1980-84 PLYMOUTH PASSENGER CAR ..... 1978-84</p>	 <p style="text-align: center;"><b>EM-8548</b> MOUNT-TRANSMISSION Auto</p> <p>PLYMOUTH PASSENGER CAR ..... 1979-82</p>  <p style="text-align: center;"><b>EM-8552</b> MOUNT-TRANSMISSION Manual</p> <p>DODGE PASSENGER CAR ..... 1985-86 MITSUBISHI PASSENGER CAR ..... 1985-86 PLYMOUTH PASSENGER CAR ..... 1985-86</p>  <p style="text-align: center;"><b>EM-8553</b> MOUNT-ENGINE Front</p> <p>MITSUBISHI PASSENGER CAR ..... 1987-88</p>	 <p style="text-align: center;"><b>EM-8554</b> MOUNT-ENGINE Rear</p> <p>MITSUBISHI PASSENGER CAR ..... 1987-88</p>  <p style="text-align: center;"><b>EM-8556</b> MOUNT-ENGINE LH Front</p> <p>MITSUBISHI PASSENGER CAR ..... 1985</p> <p style="text-align: center;"><b>EM-8529</b> MOUNT-TRANSMISSION Manual</p> <p>LEXUS PASSENGER CAR ..... 1992-93 TOYOTA PASSENGER CAR ..... 1992-03</p>  <p style="text-align: center;"><b>EM-8539</b> Engine Torque Strut Front Left</p> <p>CHEVROLET PASSENGER CAR ..... 1985-88</p> <p style="text-align: center;">(Continued Next Column)</p>
 <p style="text-align: center;"><b>EM-8525</b> Engine Torque Strut Mount Front</p> <p>HONDA PASSENGER CAR ..... 1980-83</p>  <p style="text-align: center;"><b>EM-8529</b> MOUNT-TRANSMISSION Manual</p> <p>LEXUS PASSENGER CAR ..... 1992-93 TOYOTA PASSENGER CAR ..... 1992-03</p>  <p style="text-align: center;"><b>EM-8539</b> Engine Torque Strut Front Left</p> <p>CHEVROLET PASSENGER CAR ..... 1985-88</p> <p style="text-align: center;">(Continued Next Column)</p>	<p>PLYMOUTH PASSENGER CAR ..... 1978-82</p> <p style="text-align: center;"><b>EM-8542</b> MOUNT-ENGINE Rear</p> <p>PLYMOUTH PASSENGER CAR ..... 1981-84</p> <p style="text-align: center;"><b>EM-8544</b> MOUNT-TRANSMISSION Manual</p> <p>DODGE PASSENGER CAR ..... 1976-80 PLYMOUTH PASSENGER CAR ..... 1979-82</p>  <p style="text-align: center;"><b>EM-8544</b> MOUNT-TRANSMISSION Manual</p> <p>DODGE PASSENGER CAR ..... 1978-79 PLYMOUTH PASSENGER CAR ..... 1979-82</p>  <p style="text-align: center;"><b>EM-8545</b> MOUNT-TRANSMISSION Auto</p> <p>DODGE PASSENGER CAR ..... 1980-84 PLYMOUTH PASSENGER CAR ..... 1978-84</p>	 <p style="text-align: center;"><b>EM-8548</b> MOUNT-TRANSMISSION Auto</p> <p>PLYMOUTH PASSENGER CAR ..... 1979-82</p>  <p style="text-align: center;"><b>EM-8552</b> MOUNT-TRANSMISSION Manual</p> <p>DODGE PASSENGER CAR ..... 1985-86 MITSUBISHI PASSENGER CAR ..... 1985-86 PLYMOUTH PASSENGER CAR ..... 1985-86</p>  <p style="text-align: center;"><b>EM-8553</b> MOUNT-ENGINE Front</p> <p>MITSUBISHI PASSENGER CAR ..... 1987-88</p>	 <p style="text-align: center;"><b>EM-8554</b> MOUNT-ENGINE Rear</p> <p>MITSUBISHI PASSENGER CAR ..... 1987-88</p>  <p style="text-align: center;"><b>EM-8556</b> MOUNT-ENGINE LH Front</p> <p>MITSUBISHI PASSENGER CAR ..... 1985</p> <p style="text-align: center;"><b>EM-8529</b> MOUNT-TRANSMISSION Manual</p> <p>LEXUS PASSENGER CAR ..... 1992-93 TOYOTA PASSENGER CAR ..... 1992-03</p>  <p style="text-align: center;"><b>EM-8539</b> Engine Torque Strut Front Left</p> <p>CHEVROLET PASSENGER CAR ..... 1985-88</p> <p style="text-align: center;">(Continued Next Column)</p>

(Continued Next Page)

# BUYER'S GUIDE

## NUMERICAL LISTING - ILLUSTRATIONS

**EM-8559 (Continued)**

**MOUNT-ENGINE  
LH Front**

MITSUBISHI PASSENGER  
CAR ..... 1990-94

**MOUNT-ENGINE  
Front**

PLYMOUTH PASSENGER  
CAR ..... 1992-94



**EM-8560  
MOUNT-ENGINE  
LH Front**

HYUNDAI PASSENGER CAR ..... 1995



**EM-8563  
Engine Torque Strut Mount  
Rear**

MAZDA PASSENGER CAR ..... 1981-85



**EM-8566  
MOUNT-ENGINE  
L & R Front**

NISSAN TRUCK ..... 1970-85



**EM-8568  
MOUNT-ENGINE  
L & R Front**

CHEVROLET SPORT UTILITY ..... 1998  
GEO SPORT UTILITY ..... 1989-97  
PONTIAC PASSENGER CAR ..... 1994-97  
SUZUKI SPORT UTILITY ..... 1989-98



**EM-8571  
MOUNT-ENGINE  
RH Front**

TOYOTA SPORT UTILITY ..... 1991-92



**EM-8572  
MOUNT-TRANSMISSION  
Auto**

HONDA PASSENGER CAR ..... 1994-97



**EM-8574  
MOUNT-ENGINE  
Front**

HONDA PASSENGER CAR ..... 1984-85

(Continued Next Column)

**EM-8574 (Continued)**

**MOUNT-ENGINE  
Rear**

HONDA PASSENGER CAR ..... 1984-85



**EM-8575  
MOUNT-ENGINE  
Front**

ACURA PASSENGER CAR ..... 1994-01  
HONDA PASSENGER CAR ..... 1992-00

**MOUNT-ENGINE  
RH Front**

HONDA SPORT UTILITY ..... 1997-01

**MOUNT-TRANSMISSION  
Auto**

PLYMOUTH PASSENGER  
CAR ..... 1985-86



**EM-8576  
MOUNT-ENGINE  
LH Front**

ISUZU SPORT UTILITY ..... 1987-94  
ISUZU TRUCK ..... 1986-95



**EM-8577  
MOUNT-ENGINE  
L & R Front**

ISUZU TRUCK ..... 1987



**EM-8578  
MOUNT-ENGINE  
L & R Front**

MAZDA TRUCK ..... 1989-93



**EM-8579  
MOUNT-ENGINE  
RH Front**

ISUZU SPORT UTILITY ..... 1987-94  
ISUZU TRUCK ..... 1986-95



**EM-8582  
MOUNT-TRANSMISSION  
Auto**

DODGE PASSENGER CAR ..... 1993-94  
EAGLE PASSENGER CAR ..... 1993-96  
MITSUBISHI PASSENGER  
CAR ..... 1993-96  
PLYMOUTH PASSENGER  
CAR ..... 1993-94



# BUYER'S GUIDE

## NUMERICAL LISTING - ILLUSTRATIONS

 <p style="text-align: center;"><b>EM-8584</b> <b>MOUNT-ENGINE</b> <b>RH Front</b></p> <p>DODGE PASSENGER CAR ..... 1989-90</p> <p style="text-align: center;"><b>MOUNT-TRANSMISSION</b> <b>Auto</b></p> <p>DODGE PASSENGER CAR ..... 1989-92 EAGLE PASSENGER CAR ..... 1989-92 MITSUBISHI PASSENGER CAR ..... 1989-92 PLYMOUTH PASSENGER CAR ..... 1989-92</p>	<p><b>EM-8589 (Continued)</b> <b>MOUNT-TRANSMISSION</b></p> <p>VOLKSWAGEN PASSENGER CAR ..... 1990-94</p>  <p style="text-align: center;"><b>EM-8592</b> <b>MOUNT-TRANSMISSION</b> <b>Manual</b></p> <p>BMW PASSENGER CAR ..... 1966-83</p>	 <p style="text-align: center;"><b>EM-8595</b> <b>MOUNT-ENGINE</b> <b>LH Front</b></p> <p>HYUNDAI PASSENGER CAR ..... 1995-96</p>	 <p style="text-align: center;"><b>EM-8599</b> <b>MOUNT-ENGINE</b> <b>Front</b></p> <p>HYUNDAI PASSENGER CAR ..... 1992-94</p>
 <p style="text-align: center;"><b>EM-8586</b> <b>MOUNT-TRANSMISSION</b> <b>Auto</b></p> <p>CHEVROLET TRUCK ..... 1982</p> <p style="text-align: center;"><b>MOUNT-TRANSMISSION</b> <b>Auto</b></p> <p>HONDA SPORT UTILITY ..... 1994-97</p> <p style="text-align: center;"><b>MOUNT-TRANSMISSION</b> <b>Manual</b></p> <p>ISUZU SPORT UTILITY ..... 1984-00 ISUZU TRUCK ..... 1981-95</p>	 <p style="text-align: center;"><b>EM-8593</b> <b>MOUNT-TRANSMISSION</b> <b>Auto</b></p> <p>BMW PASSENGER CAR ..... 1966-76</p>	 <p style="text-align: center;"><b>EM-8596</b> <b>MOUNT-ENGINE</b> <b>Front</b></p> <p>HYUNDAI PASSENGER CAR ..... 1992-95</p>	 <p style="text-align: center;"><b>EM-8600</b> <b>MOUNT-ENGINE</b> <b>Front</b></p> <p>NISSAN PASSENGER CAR ..... 1987-94</p>
 <p style="text-align: center;"><b>EM-8589</b> <b>MOUNT-ENGINE</b> <b>RH Rear</b></p> <p>VOLKSWAGEN PASSENGER CAR ..... 1993-02</p> <p style="text-align: center;"><b>MOUNT-TRANSMISSION</b> <b>RH</b></p> <p>VOLKSWAGEN PASSENGER CAR ..... 1995-96</p> <p style="text-align: center;">(Continued Next Column)</p>	 <p style="text-align: center;"><b>EM-8594</b> <b>MOUNT-TRANSMISSION</b> <b>Manual</b></p> <p>BMW PASSENGER CAR ..... 1971-83</p>	 <p style="text-align: center;"><b>EM-8597</b> <b>MOUNT-ENGINE</b> <b>Front</b></p> <p>HYUNDAI PASSENGER CAR ..... 1995-98</p>	 <p style="text-align: center;"><b>EM-8601</b> <b>MOUNT-ENGINE</b> <b>LH Front</b></p> <p>NISSAN PASSENGER CAR ..... 1989-94</p> <p style="text-align: center;"><b>MOUNT-TRANSMISSION</b> <b>Auto</b></p> <p>NISSAN PASSENGER CAR ..... 1989-94</p>
		 <p style="text-align: center;"><b>EM-8598</b> <b>MOUNT-ENGINE</b> <b>Front</b></p> <p>HYUNDAI PASSENGER CAR ..... 1992-94</p>	

# BUYER'S GUIDE

## NUMERICAL LISTING - ILLUSTRATIONS

 <p style="text-align: center;"><b>EM-8602</b> MOUNT-ENGINE RH Rear</p> <p>NISSAN PASSENGER CAR ..... 1989-94</p>	 <p style="text-align: center;"><b>EM-8606</b> MOUNT-ENGINE RH Front</p> <p>KIA SPORT UTILITY ..... 1995-02</p>	 <p style="text-align: center;"><b>EM-8611</b> MOUNT-ENGINE Rear</p> <p>KIA PASSENGER CAR ..... 1994-97</p>	 <p style="text-align: center;"><b>EM-8616</b> MOUNT-ENGINE RH Front</p> <p>VOLKSWAGEN PASSENGER CAR ..... 1993-02</p> <p style="text-align: center;"><b>MOUNT-ENGINE RH Rear</b></p> <p>VOLKSWAGEN PASSENGER CAR ..... 1993-02</p>
 <p style="text-align: center;"><b>EM-8603</b> MOUNT-ENGINE LH Rear</p> <p>NISSAN PASSENGER CAR ..... 1989-94</p>	 <p style="text-align: center;"><b>EM-8607</b> MOUNT-ENGINE LH Front</p> <p>KIA SPORT UTILITY ..... 1995-02</p>	 <p style="text-align: center;"><b>EM-8612</b> MOUNT-ENGINE Rear</p> <p>KIA PASSENGER CAR ..... 1994-97</p>	 <p style="text-align: center;"><b>EM-8617</b> MOUNT-ENGINE Front</p> <p>VOLKSWAGEN PASSENGER CAR ..... 1993-02</p>
 <p style="text-align: center;"><b>EM-8604</b> MOUNT-TRANSMISSION Auto</p> <p>NISSAN PASSENGER CAR ..... 1985-88</p>	 <p style="text-align: center;"><b>EM-8608</b> MOUNT-TRANSMISSION Manual</p> <p>KIA SPORT UTILITY ..... 1995-02</p>	 <p style="text-align: center;"><b>EM-8614</b> Engine Torque Strut Mount Front</p> <p>ACURA PASSENGER CAR ..... 1986-90 HONDA PASSENGER CAR ..... 1982-89</p>	 <p style="text-align: center;"><b>EM-8619</b> MOUNT-ENGINE LH Front</p> <p>MITSUBISHI PASSENGER CAR ..... 1987-88</p>
 <p style="text-align: center;"><b>EM-8605</b> MOUNT-ENGINE Front</p> <p>NISSAN PASSENGER CAR ..... 1985-88</p>	 <p style="text-align: center;"><b>EM-8609</b> MOUNT-ENGINE RH Front</p> <p>KIA PASSENGER CAR ..... 1994-97 MAZDA PASSENGER CAR ..... 1990-96</p>	 <p style="text-align: center;"><b>EM-8615</b> Engine Torque Strut Mount Rear</p> <p>ACURA PASSENGER CAR ..... 1986-90 HONDA PASSENGER CAR ..... 1982-89</p>	<p style="text-align: center;"><b>MOUNT-TRANSMISSION Auto</b></p> <p>EAGLE PASSENGER CAR ..... 1992-96 MITSUBISHI PASSENGER CAR ..... 1993-96 PLYMOUTH PASSENGER CAR ..... 1993-94</p>

# BUYER'S GUIDE

## NUMERICAL LISTING - ILLUSTRATIONS

 <p><b>EM-8620</b> <b>MOUNT-ENGINE</b> <b>L &amp; R Front</b></p> <p>VOLVO PASSENGER CAR ..... 1983-85</p>	 <p><b>EM-8629</b> <b>MOUNT-TRANSMISSION</b></p> <p>MERCEDES-BENZ PASSENGER CAR ..... 1973-85</p>	 <p><b>EM-8639</b> <b>MOUNT-ENGINE</b> <b>Front</b></p> <p>TOYOTA PASSENGER CAR ..... 1990-93</p>	 <p><b>EM-8642</b> <b>MOUNT-TRANSMISSION</b> <b>Auto</b></p> <p>TOYOTA SPORT UTILITY ..... 1988-90</p>
 <p><b>EM-8621</b> <b>MOUNT-ENGINE</b> <b>LH Front</b></p> <p>ISUZU PASSENGER CAR ..... 1981-84</p>	 <p><b>EM-8630</b> <b>MOUNT-ENGINE</b> <b>LH Front</b></p> <p>MERCEDES-BENZ PASSENGER CAR ..... 1974-91</p>	 <p><b>EM-8640</b> <b>MOUNT-ENGINE</b> <b>RH Front</b></p> <p>SUBARU PASSENGER CAR ..... 1980-87</p>	 <p><b>EM-8643</b> <b>MOUNT-TRANSMISSION</b> <b>Auto</b></p> <p>TOYOTA PASSENGER CAR ..... 1988-92</p>
 <p><b>EM-8622</b> <b>MOUNT-ENGINE</b> <b>L &amp; R Front</b></p> <p>VOLVO PASSENGER CAR ..... 1987-95</p>	 <p><b>EM-8631</b> <b>MOUNT-TRANSMISSION</b></p> <p>MERCEDES-BENZ PASSENGER CAR ..... 1977-85</p>	 <p><b>EM-8640</b> <b>MOUNT-ENGINE</b> <b>Rear</b></p> <p>SUBARU PASSENGER CAR ..... 1980-87</p> <p><b>EM-8640</b> <b>MOUNT-ENGINE</b> <b>RH Front</b></p> <p>SUBARU PASSENGER CAR ..... 1985-89</p> <p><b>EM-8640</b> <b>MOUNT-ENGINE</b> <b>Rear</b></p> <p>SUBARU PASSENGER CAR ..... 1985-91</p> <p>SUBARU PASSENGER CAR ..... 1985-94</p>	 <p><b>EM-8644</b> <b>MOUNT-TRANSMISSION</b> <b>Auto</b></p> <p>LEXUS PASSENGER CAR ..... 1992-01</p> <p>TOYOTA PASSENGER CAR ..... 1993-04</p> <p><b>EM-8644</b> <b>MOUNT-TRANSMISSION</b> <b>Auto</b></p> <p>TOYOTA VAN ..... 1988-03</p>
 <p><b>EM-8623</b> <b>MOUNT-TRANSMISSION</b> <b>Manual</b></p> <p>AUDI PASSENGER CAR ..... 1975-80</p> <p>VOLKSWAGEN PASSENGER CAR ..... 1974-75</p>	 <p><b>EM-8632</b> <b>MOUNT-TRANSMISSION</b></p> <p>MERCEDES-BENZ PASSENGER CAR ..... 1986-93</p>	 <p><b>EM-8641</b> <b>MOUNT-ENGINE</b> <b>L &amp; R Front</b></p> <p>SUBARU PASSENGER CAR ..... 1979-94</p> <p>SUBARU SPORT UTILITY ..... 1978-80</p> <p><b>EM-8641</b> <b>MOUNT-ENGINE</b> <b>Rear</b></p> <p>SUBARU PASSENGER CAR ..... 1980-87</p>	

# BUYER'S GUIDE

## NUMERICAL LISTING - ILLUSTRATIONS

 <p><b>EM-8648</b> <b>MOUNT-TRANSMISSION</b> <b>Manual</b></p> <p>CHEVROLET PASSENGER CAR ..... 1985-88 TOYOTA PASSENGER CAR ..... 1985-87</p>	 <p><b>EM-8651</b> <b>MOUNT-TRANSMISSION</b> <b>Manual</b></p> <p>TOYOTA SPORT UTILITY ..... 1967-80</p>	 <p><b>EM-8655</b> <b>MOUNT-TRANSMISSION</b> <b>Auto</b></p> <p>DAIHATSU PASSENGER CAR ... 1989-92</p>	 <p><b>EM-8658</b> <b>Engine Torque Strut Mount</b> <b>Front</b></p> <p>CHEVROLET PASSENGER CAR ..... 1992 GEO PASSENGER CAR ..... 1995-97</p>
 <p><b>EM-8649</b> <b>MOUNT-ENGINE</b> <b>Rear</b></p> <p>TOYOTA VAN ..... 1984-88</p>	 <p><b>EM-8652</b> <b>MOUNT-ENGINE</b> <b>Front</b></p> <p>DAIHATSU PASSENGER CAR ... 1989-92</p>	 <p><b>EM-8656</b> <b>Engine Torque Strut Mount</b> <b>Front</b></p> <p>GEO SPORT UTILITY ..... 1996-97 SUZUKI SPORT UTILITY ..... 1996-98</p>	 <p><b>EM-8659</b> <b>MOUNT-ENGINE</b> <b>Rear</b></p> <p>SUZUKI PASSENGER CAR ..... 1989-94</p>
 <p><b>EM-8650</b> <b>MOUNT-TRANSMISSION</b> <b>Auto</b></p> <p>TOYOTA SPORT UTILITY ..... 1967-74</p>	 <p><b>EM-8653</b> <b>MOUNT-TRANSMISSION</b> <b>Manual</b></p> <p>DAIHATSU PASSENGER CAR ... 1989-92</p>	 <p><b>EM-8657</b> <b>Engine Torque Strut Mount</b> <b>Front</b></p> <p>CHEVROLET SPORT UTILITY ... 1998-00 GEO SPORT UTILITY ..... 1989-97 SUZUKI SPORT UTILITY ..... 1989-98</p>	 <p><b>EM-8660</b> <b>MOUNT-ENGINE</b> <b>Rear</b></p> <p>HONDA PASSENGER CAR ..... 1976-87</p>
	 <p><b>EM-8654</b> <b>MOUNT-ENGINE</b> <b>Rear</b></p> <p>DAIHATSU PASSENGER CAR ... 1989-92</p>		

# BUYER'S GUIDE

## NUMERICAL LISTING - ILLUSTRATIONS

 <p style="text-align: center;"><b>EM-8661</b> <b>MOUNT-ENGINE</b> <b>Front</b></p> <p>SUBARU PASSENGER CAR ..... 1980-87 <b>MOUNT-TRANSMISSION</b> <b>Auto</b> SUBARU PASSENGER CAR ..... 1979-80</p>	 <p style="text-align: center;"><b>EM-8664</b> <b>MOUNT-ENGINE</b> <b>Front</b></p> <p>VOLKSWAGEN PASSENGER CAR ..... 1995-02</p>	 <p style="text-align: center;"><b>EM-8668</b> <b>MOUNT-ENGINE</b> <b>Rear</b></p> <p>MITSUBISHI PASSENGER CAR ..... 1993-96</p>	 <p style="text-align: center;"><b>EM-8672</b> <b>MOUNT-ENGINE</b> <b>Rear</b></p> <p>HYUNDAI PASSENGER CAR ..... 1990-94 MITSUBISHI PASSENGER CAR ..... 1990-94</p>
 <p style="text-align: center;"><b>EM-8662</b> <b>MOUNT-ENGINE</b> <b>L &amp; R Front</b></p> <p>MERCEDES-BENZ PASSENGER CAR ..... 1977-95</p>	 <p style="text-align: center;"><b>EM-8665</b> <b>MOUNT-ENGINE</b> <b>Rear</b></p> <p>SUBARU PASSENGER CAR ..... 1980-94 SUBARU SPORT UTILITY ..... 1980-87 <b>MOUNT-TRANSMISSION</b> <b>L &amp; R</b> SUBARU PASSENGER CAR ..... 1976-87 SUBARU SPORT UTILITY ..... 1978-80 <b>MOUNT-TRANSMISSION</b> <b>Manual</b> SUBARU PASSENGER CAR ..... 1988-89</p>	 <p style="text-align: center;"><b>EM-8669</b> <b>MOUNT-TRANSMISSION</b> <b>Manual</b></p> <p>DODGE PASSENGER CAR ..... 1989-92 EAGLE PASSENGER CAR ..... 1989-92 MITSUBISHI PASSENGER CAR ..... 1989-92 PLYMOUTH PASSENGER CAR ..... 1989-92</p>	 <p style="text-align: center;"><b>EM-8674</b> <b>MOUNT-ENGINE</b> <b>RH Front</b></p> <p>HYUNDAI PASSENGER CAR ..... 1991-92 <b>MOUNT-TRANSMISSION</b> <b>Manual</b> HYUNDAI PASSENGER CAR ..... 1990-94 MITSUBISHI PASSENGER CAR ..... 1990-94</p>
 <p style="text-align: center;"><b>EM-8663</b> <b>MOUNT-ENGINE</b> <b>L &amp; R Front</b></p> <p>AUDI PASSENGER CAR ..... 1978-97 VOLKSWAGEN PASSENGER CAR ..... 1983-88</p>	 <p style="text-align: center;"><b>EM-8667</b> <b>MOUNT-ENGINE</b> <b>Front</b></p> <p>MITSUBISHI PASSENGER CAR ..... 1993-95</p>	 <p style="text-align: center;"><b>EM-8670</b> <b>MOUNT-ENGINE</b> <b>Front</b></p> <p>CHRYSLER PASSENGER CAR ..... 1995-99 DODGE PASSENGER CAR ..... 1995-99 EAGLE PASSENGER CAR ..... 1995-98 MITSUBISHI PASSENGER CAR ..... 1994-99</p>	 <p style="text-align: center;"><b>EM-8675</b> <b>MOUNT-ENGINE</b> <b>RH Front</b></p> <p>HYUNDAI PASSENGER CAR ..... 1991-92 <b>MOUNT-TRANSMISSION</b> <b>Auto</b> HYUNDAI PASSENGER CAR ..... 1990-94 MITSUBISHI PASSENGER CAR ..... 1990-94</p>



# BUYER'S GUIDE

## NUMERICAL LISTING - ILLUSTRATIONS

 <p><b>EM-8676</b> <b>MOUNT-ENGINE</b> <b>Front</b></p> <p>HYUNDAI PASSENGER CAR ..... 1995</p>	 <p><b>EM-8680</b> <b>MOUNT-ENGINE</b> <b>Front</b></p> <p>HYUNDAI PASSENGER CAR ..... 1992-95</p>	 <p><b>EM-8684</b> <b>MOUNT-TRANSMISSION</b> <b>Auto</b></p> <p>TOYOTA PASSENGER CAR ..... 1989-91</p>	 <p><b>EM-8687</b> <b>MOUNT-ENGINE</b> <b>Front</b></p> <p>EAGLE PASSENGER CAR ..... 1995-96 MITSUBISHI VAN ..... 1992</p>
 <p><b>EM-8677</b> <b>MOUNT-ENGINE</b> <b>Rear</b></p> <p>HYUNDAI PASSENGER CAR ..... 1995-96</p>	 <p><b>EM-8681</b> <b>MOUNT-ENGINE</b> <b>Rear</b></p> <p>INFINITI PASSENGER CAR ..... 1999-02 NISSAN PASSENGER CAR ..... 1990-01 NISSAN VAN ..... 1990-95</p>	 <p><b>EM-8685</b> <b>MOUNT-ENGINE</b> <b>LH Front</b></p> <p>MITSUBISHI VAN ..... 1992-94</p>	 <p><b>EM-8688</b> <b>MOUNT-ENGINE</b> <b>Front</b></p> <p>EAGLE PASSENGER CAR ..... 1996 MITSUBISHI VAN ..... 1992-95</p>
 <p><b>EM-8678</b> <b>MOUNT-TRANSMISSION</b> <b>Manual</b></p> <p>HYUNDAI PASSENGER CAR ..... 1995</p>	 <p><b>EM-8682</b> <b>MOUNT-ENGINE</b> <b>Front</b></p> <p>INFINITI PASSENGER CAR ..... 1999-02 NISSAN PASSENGER CAR ..... 1993-01</p>	 <p><b>EM-8686</b> <b>MOUNT-TRANSMISSION</b> <b>Manual</b></p> <p>DODGE PASSENGER CAR ..... 1993-94 EAGLE PASSENGER CAR ..... 1990-96 MITSUBISHI PASSENGER CAR ..... 1990-94 MITSUBISHI VAN ..... 1992 PLYMOUTH PASSENGER CAR ..... 1990-94</p>	 <p><b>EM-8689</b> <b>MOUNT-ENGINE</b> <b>LH Front</b></p> <p>EAGLE PASSENGER CAR ..... 1996</p>
 <p><b>EM-8679</b> <b>MOUNT-TRANSMISSION</b> <b>Auto</b></p> <p>HYUNDAI PASSENGER CAR ..... 1995</p>	 <p><b>EM-8683</b> <b>MOUNT-TRANSMISSION</b> <b>Manual</b></p> <p>NISSAN PASSENGER CAR ..... 1995-99</p>	<p><b>MOUNT-ENGINE</b> <b>Rear</b></p> <p>DODGE PASSENGER CAR ..... 1993-94 EAGLE PASSENGER CAR ..... 1996 MITSUBISHI VAN ..... 1992-95 PLYMOUTH PASSENGER CAR ..... 1992-94</p>	

# BUYER'S GUIDE

## NUMERICAL LISTING - ILLUSTRATIONS



**EM-8690**  
**MOUNT-ENGINE**  
**LH Front**

EAGLE PASSENGER CAR ..... 1992-96  
**MOUNT-ENGINE**  
**Front**

PLYMOUTH PASSENGER CAR ..... 1992  
**MOUNT-ENGINE**  
**Rear**

DODGE PASSENGER CAR ..... 1993-94  
EAGLE PASSENGER CAR ..... 1995-96  
MITSUBISHI VAN ..... 1992-95  
PLYMOUTH PASSENGER  
CAR ..... 1992-94



**EM-8691**  
**MOUNT-ENGINE**  
**Rear**

FORD PASSENGER CAR ..... 1994-97  
**MOUNT-TRANSMISSION**  
**Upper**

MAZDA PASSENGER CAR ..... 1994-97  
FORD PASSENGER CAR ..... 1994-97  
MAZDA PASSENGER CAR ..... 1998-02



**EM-8692**  
**MOUNT-ENGINE**  
**RH Front**

TOYOTA PASSENGER CAR ..... 1987-89



**EM-8693**  
**MOUNT-TRANSMISSION**

MAZDA VAN ..... 1989-98



**EM-8694**  
**Engine Torque Strut Mount**  
**Lower**

NISSAN PASSENGER CAR ..... 2005-10  
RENAULT PASSENGER CAR ..... 2010-15  
**MOUNT-TRANSMISSION**  
**Auto**

MITSUBISHI PASSENGER  
CAR ..... 1989-93



**EM-8695**  
**MOUNT-TRANSMISSION**  
**Auto**

MITSUBISHI SPORT UTILITY ..... 1994-03



**EM-8696**  
**MOUNT-ENGINE**  
**Rear**

MITSUBISHI TRUCK ..... 1991-94  
**MOUNT-TRANSFER CASE**

MITSUBISHI SPORT UTILITY ..... 1997-99  
**MOUNT-TRANSMISSION**  
**Manual**

MITSUBISHI VAN ..... 1992



**EM-8697**  
**Engine Torque Strut**  
**Front Right**

LEXUS PASSENGER CAR ..... 1997-01  
**Engine Torque Strut Mount**  
**Front**

TOYOTA PASSENGER CAR ..... 1997-03



**EM-8698**  
**Engine Torque Strut Mount**  
**Right**

TOYOTA PASSENGER CAR ..... 1997-01



**EM-8699**  
**MOUNT-ENGINE**  
**Rear**

LEXUS PASSENGER CAR ..... 1997-98  
TOYOTA PASSENGER CAR ..... 1997-03  
TOYOTA VAN ..... 1998-03



**EM-8700**  
**MOUNT-TRANSMISSION**  
**Auto**

EAGLE PASSENGER CAR ..... 1990-94  
MITSUBISHI PASSENGER  
CAR ..... 1990-94  
PLYMOUTH PASSENGER  
CAR ..... 1990-94



**EM-8701**  
**MOUNT-ENGINE**  
**Rear**

NISSAN PASSENGER CAR ..... 1991-98

# BUYER'S GUIDE

## NUMERICAL LISTING - ILLUSTRATIONS

 <p><b>EM-8704</b> <b>MOUNT-ENGINE</b> <b>RH Front</b></p> <p>NISSAN PASSENGER CAR ..... 1993-99</p>	 <p><b>EM-8710</b> <b>MOUNT-ENGINE</b> <b>Left</b></p> <p>HONDA SPORT UTILITY ..... 1998-01</p>	 <p><b>EM-8716</b> <b>MOUNT-ENGINE</b> <b>LH Front</b></p> <p>HYUNDAI PASSENGER CAR ..... 1992-93</p>	 <p><b>EM-8721</b> <b>MOUNT-ENGINE</b> <b>LH Front</b></p> <p>HYUNDAI PASSENGER CAR ..... 1997-98</p>
 <p><b>EM-8705</b> <b>MOUNT-TRANSMISSION</b> <b>Auto</b></p> <p>NISSAN PASSENGER CAR ..... 1993-01</p>	 <p><b>EM-8710</b> <b>MOUNT-ENGINE</b> <b>LH Rear Upper</b></p> <p>HONDA PASSENGER CAR ..... 1996-00</p>	 <p><b>EM-8717</b> <b>MOUNT-ENGINE</b> <b>LH Front</b></p> <p>HYUNDAI PASSENGER CAR ..... 1994-95</p>	 <p><b>EM-8722</b> <b>MOUNT-ENGINE</b> <b>RH Front</b></p> <p>HYUNDAI PASSENGER CAR ..... 1999-04 KIA PASSENGER CAR ..... 2001-06</p>
 <p><b>EM-8709</b> <b>MOUNT-ENGINE</b> <b>LH Front Lower</b></p> <p>ACURA PASSENGER CAR ..... 1994-01</p>	 <p><b>EM-8711</b> <b>MOUNT-ENGINE</b> <b>Front</b></p> <p>LEXUS PASSENGER CAR ..... 1994-96 TOYOTA PASSENGER CAR ..... 1994-96</p>	 <p><b>EM-8718</b> <b>MOUNT-ENGINE</b> <b>LH Front</b></p> <p>HYUNDAI PASSENGER CAR ..... 1994-95</p>	 <p><b>EM-8723</b> <b>MOUNT-ENGINE</b> <b>RH Front</b></p> <p>HYUNDAI PASSENGER CAR ..... 1999-05 KIA PASSENGER CAR ..... 2001-05</p>
 <p><b>EM-8709</b> <b>MOUNT-ENGINE</b> <b>LH Front</b></p> <p>HONDA SPORT UTILITY ..... 1997-01</p>	 <p><b>EM-8715</b> <b>MOUNT-ENGINE</b> <b>LH Front</b></p> <p>HYUNDAI PASSENGER CAR ..... 1996-99</p>	 <p><b>EM-8719</b> <b>MOUNT-ENGINE</b> <b>RH Front</b></p> <p>HYUNDAI PASSENGER CAR ..... 1996-01</p>	 <p><b>EM-8724</b> <b>MOUNT-TRANSMISSION</b> <b>Manual</b></p> <p>HYUNDAI PASSENGER CAR ..... 1998-99</p>



# BUYER'S GUIDE

## NUMERICAL LISTING - ILLUSTRATIONS

 <p style="text-align: center;"><b>EM-8725</b> <b>MOUNT-TRANSMISSION</b> Manual</p> <p>HYUNDAI PASSENGER CAR ..... 1996-97</p> <hr/> <p style="text-align: center;"><b>EM-8726</b> <b>MOUNT-TRANSMISSION</b> Auto</p> <p>HYUNDAI PASSENGER CAR ..... 1996-99</p>	 <p style="text-align: center;"><b>EM-8729</b> <b>MOUNT-TRANSMISSION</b> Manual</p> <p>HYUNDAI PASSENGER CAR ..... 1993-95</p> <hr/>  <p style="text-align: center;"><b>EM-8730</b> <b>MOUNT-TRANSMISSION</b> Manual</p> <p>HYUNDAI PASSENGER CAR ..... 1992-93</p> <hr/>  <p style="text-align: center;"><b>EM-8731</b> <b>MOUNT-TRANSMISSION</b> Manual</p> <p>HYUNDAI PASSENGER CAR ..... 1994-95</p> <hr/>  <p style="text-align: center;"><b>EM-8732</b> <b>MOUNT-TRANSMISSION</b> Auto</p> <p>(Continued Next Column)</p>	<p style="text-align: center;"><b>EM-8732 (Continued)</b></p> <p>HYUNDAI PASSENGER CAR ..... 1993-95</p> <hr/>  <p style="text-align: center;"><b>EM-8733</b> <b>MOUNT-TRANSMISSION</b> Manual</p> <p>HYUNDAI PASSENGER CAR ..... 1996-01</p> <hr/>  <p style="text-align: center;"><b>EM-8734</b> <b>MOUNT-TRANSMISSION</b> Auto</p> <p>HYUNDAI PASSENGER CAR ..... 1996-01</p> <hr/>  <p style="text-align: center;"><b>EM-8736</b> <b>MOUNT-ENGINE</b> LH Front</p> <p>HYUNDAI PASSENGER CAR ..... 1992-94</p> <hr/>  <p style="text-align: center;"><b>EM-8738</b> <b>MOUNT-TRANSMISSION</b> Manual</p> <p>(Continued Next Column)</p>	<p style="text-align: center;"><b>EM-8738 (Continued)</b></p> <p>HYUNDAI PASSENGER CAR ..... 1995-96</p> <hr/>  <p style="text-align: center;"><b>EM-8740</b> <b>MOUNT-ENGINE</b> LH Front</p> <p>HYUNDAI PASSENGER CAR ..... 1990-91</p> <hr/> <p style="text-align: center;"><b>EM-8741</b> <b>MOUNT-TRANSMISSION</b> Auto</p> <p>HYUNDAI PASSENGER CAR ..... 1995-98</p> <hr/>  <p style="text-align: center;"><b>EM-8742</b> <b>MOUNT-ENGINE</b> LH Front</p> <p>HYUNDAI PASSENGER CAR ..... 1992-94</p> <hr/> <p style="text-align: center;"><b>EM-8743</b> <b>MOUNT-ENGINE</b> RH Front</p> <p>MAZDA PASSENGER CAR ..... 1995-98</p>
---	---	--	--

# BUYER'S GUIDE

## NUMERICAL LISTING - ILLUSTRATIONS

 <p><b>EM-8743</b> <b>MOUNT-TRANSMISSION</b> Manual</p> <p>HYUNDAI PASSENGER CAR ..... 1999-01</p>	 <p><b>EM-8746</b> <b>MOUNT-ENGINE</b> Front</p> <p>HYUNDAI PASSENGER CAR ..... 1997-99</p>	 <p><b>EM-8750</b> <b>MOUNT-ENGINE</b> Front</p> <p>HYUNDAI PASSENGER CAR ..... 1996</p>	 <p><b>EM-8754</b> <b>MOUNT-TRANSMISSION</b> Manual</p> <p>HYUNDAI PASSENGER CAR ..... 1989-91</p>
 <p><b>EM-8744</b> <b>MOUNT-TRANSMISSION</b> Auto</p> <p>HYUNDAI PASSENGER CAR ..... 1999-01</p>	 <p><b>EM-8747</b> <b>MOUNT-ENGINE</b> Front</p> <p>HYUNDAI PASSENGER CAR ..... 1997-99</p>	 <p><b>EM-8751</b> <b>MOUNT-ENGINE</b> Rear</p> <p>HYUNDAI PASSENGER CAR ..... 1997-99</p>	 <p><b>EM-8755</b> <b>MOUNT-TRANSMISSION</b> Manual</p> <p>HYUNDAI PASSENGER CAR ..... 1992-94</p>
 <p><b>EM-8745</b> <b>MOUNT-TRANSMISSION</b> Auto</p> <p>HYUNDAI PASSENGER CAR ..... 1999-01</p>	 <p><b>EM-8748</b> <b>MOUNT-ENGINE</b> Front</p> <p>HYUNDAI PASSENGER CAR ..... 1996</p>	 <p><b>EM-8752</b> <b>MOUNT-ENGINE</b> Rear</p> <p>HYUNDAI PASSENGER CAR ..... 1993-95</p>	 <p><b>EM-8756</b> <b>MOUNT-TRANSMISSION</b> Auto</p> <p>HYUNDAI PASSENGER CAR ..... 1989-94</p>
		 <p><b>EM-8753</b> <b>MOUNT-ENGINE</b> Rear</p> <p>HYUNDAI PASSENGER CAR ..... 1993-95</p>	

# BUYER'S GUIDE

## NUMERICAL LISTING - ILLUSTRATIONS

 <p style="text-align: center;"><b>EM-8757</b> <b>MOUNT-TRANSMISSION</b> Auto</p> <p>HYUNDAI PASSENGER CAR ..... 1992-24</p>	<p><b>EM-8760 (Continued)</b> HYUNDAI PASSENGER CAR ..... 1993-95</p>  <p style="text-align: center;"><b>EM-8762</b> <b>MOUNT-ENGINE</b> Front</p> <p>HYUNDAI PASSENGER CAR ..... 1996-01</p>	 <p style="text-align: center;"><b>EM-8769</b> <b>MOUNT-ENGINE</b> Front</p> <p>HYUNDAI PASSENGER CAR ..... 1999-05 KIA PASSENGER CAR ..... 2001-05</p>	 <p style="text-align: center;"><b>EM-8772</b> <b>MOUNT-ENGINE</b> Rear</p> <p>HYUNDAI PASSENGER CAR ..... 1993-95</p>
 <p style="text-align: center;"><b>EM-8758</b> <b>MOUNT-TRANSMISSION</b></p> <p>HYUNDAI PASSENGER CAR ..... 1990-94</p>	 <p style="text-align: center;"><b>EM-8764</b> <b>MOUNT-ENGINE</b> Front</p> <p>HYUNDAI PASSENGER CAR ..... 1998-01</p>	 <p style="text-align: center;"><b>EM-8770</b> <b>MOUNT-ENGINE</b> Front</p> <p>HYUNDAI PASSENGER CAR ..... 2002-04 KIA PASSENGER CAR ..... 2001-06</p>	 <p style="text-align: center;"><b>EM-8774</b> <b>MOUNT-ENGINE</b> Rear</p> <p>HYUNDAI PASSENGER CAR ..... 1992-95</p>
 <p style="text-align: center;"><b>EM-8759</b> <b>MOUNT-ENGINE</b> Front</p> <p>HYUNDAI PASSENGER CAR ..... 1992-95</p>	 <p style="text-align: center;"><b>EM-8768</b> <b>MOUNT-ENGINE</b> Front</p> <p>HYUNDAI PASSENGER CAR ..... 1999-01</p>	 <p style="text-align: center;"><b>EM-8771</b> <b>MOUNT-ENGINE</b> Rear</p> <p>HYUNDAI PASSENGER CAR ..... 1992-95</p>	 <p style="text-align: center;"><b>EM-8775</b> <b>MOUNT-ENGINE</b> Rear</p> <p>HYUNDAI PASSENGER CAR ..... 1996-01</p>
 <p style="text-align: center;"><b>EM-8760</b> <b>MOUNT-ENGINE</b> Front</p> <p>(Continued Next Column)</p>			 <p style="text-align: center;"><b>EM-8778</b> <b>MOUNT-ENGINE</b> Rear</p> <p>HYUNDAI PASSENGER CAR ..... 1996-01</p>

# BUYER'S GUIDE

## NUMERICAL LISTING - ILLUSTRATIONS

 <p><b>EM-8780</b> <b>MOUNT-ENGINE</b> <b>Rear</b></p> <p>HYUNDAI PASSENGER CAR ..... 1995-96</p>	 <p><b>EM-8783</b> <b>MOUNT-ENGINE</b> <b>Rear</b></p> <p>HYUNDAI PASSENGER CAR ..... 1999-05 KIA PASSENGER CAR ..... 2001-06</p>	 <p><b>EM-8787</b> <b>MOUNT-ENGINE</b> <b>LH Front</b></p> <p>HYUNDAI PASSENGER CAR ..... 1997-98</p>	<p><b>EM-8790 (Continued)</b></p> <p>MITSUBISHI PASSENGER CAR ..... 1989-92</p> <div style="text-align: center; margin-top: 20px;">  </div> <p><b>EM-8791</b> <b>MOUNT-TRANSMISSION</b> <b>Manual</b></p> <p>HYUNDAI PASSENGER CAR ..... 1995-98</p>
 <p><b>EM-8781</b> <b>MOUNT-ENGINE</b> <b>Rear</b></p> <p>HYUNDAI PASSENGER CAR ..... 1995-98</p>	 <p><b>EM-8784</b> <b>MOUNT-ENGINE</b> <b>Rear</b></p> <p>HYUNDAI PASSENGER CAR ..... 2002-03 KIA PASSENGER CAR ..... 2001-05</p>	 <p><b>EM-8788</b> <b>MOUNT-ENGINE</b> <b>Front</b></p> <p>HYUNDAI PASSENGER CAR ..... 1997-98</p>	<div style="text-align: center; margin-top: 20px;">  </div> <p><b>EM-8792</b> <b>MOUNT-ENGINE</b> <b>LH Front</b></p> <p>EAGLE PASSENGER CAR ..... 1995-98</p> <p><b>MOUNT-ENGINE</b> <b>RH Front</b></p> <p>MITSUBISHI PASSENGER CAR ..... 1994-99</p>
 <p><b>EM-8782</b> <b>MOUNT-ENGINE</b> <b>Rear</b></p> <p>HYUNDAI PASSENGER CAR ..... 1997-98</p>	 <p><b>EM-8786</b> <b>MOUNT-ENGINE</b> <b>LH Front</b></p> <p>HYUNDAI PASSENGER CAR ..... 1995-96</p>	 <p><b>EM-8789</b> <b>MOUNT-TRANSMISSION</b></p> <p>HYUNDAI PASSENGER CAR ..... 1996-98</p>	<div style="text-align: center; margin-top: 20px;">  </div> <p><b>EM-8793</b> <b>MOUNT-TRANSMISSION</b> <b>Manual</b></p> <p>CHRYSLER PASSENGER CAR ..... 1995-99 DODGE PASSENGER CAR ..... 1995-99 EAGLE PASSENGER CAR ..... 1995-98 MITSUBISHI PASSENGER CAR ..... 1994-99</p>
		 <p><b>EM-8790</b> <b>MOUNT-ENGINE</b> <b>LH Front</b></p> <p>HYUNDAI PASSENGER CAR ..... 1997-98</p> <p><b>(Continued Next Column)</b></p>	

# BUYER'S GUIDE

## NUMERICAL LISTING - ILLUSTRATIONS

 <p><b>EM-8794</b> <b>MOUNT-ENGINE</b> <b>L &amp; R Front</b></p> <p>VOLVO PASSENGER CAR ..... 1989-92</p>	 <p><b>EM-8797</b> <b>MOUNT-TRANSMISSION</b> <b>Auto</b></p> <p>MITSUBISHI PASSENGER CAR ..... 1994-99</p>	 <p><b>EM-8800</b> <b>MOUNT-TRANSMISSION</b> <b>Auto</b></p> <p>VOLVO PASSENGER CAR ..... 1976-93</p>	<p><b>EM-8803 (Continued)</b></p> <p><b>MOUNT-ENGINE</b> <b>Rear</b></p> <p>HYUNDAI PASSENGER CAR ..... 1986-89            MITSUBISHI PASSENGER CAR ..... 1987-89            PLYMOUTH PASSENGER CAR ..... 1982-84</p>
 <p><b>EM-8795</b> <b>MOUNT-ENGINE</b> <b>Front</b></p> <p>TOYOTA PASSENGER CAR ..... 1997-01</p>	 <p><b>EM-8798</b> <b>MOUNT-ENGINE</b> <b>Rear</b></p> <p>CHRYSLER PASSENGER CAR ..... 1995-99            EAGLE PASSENGER CAR ..... 1997-98            MITSUBISHI PASSENGER CAR ..... 1994-99</p>	 <p><b>EM-8801</b> <b>MOUNT-ENGINE</b> <b>Front</b></p> <p>HONDA PASSENGER CAR ..... 1998-02</p>	 <p><b>EM-8804</b> <b>MOUNT-ENGINE</b> <b>Rear</b></p> <p>SUZUKI PASSENGER CAR ..... 1995-02</p>
 <p><b>EM-8796</b> <b>MOUNT-ENGINE</b> <b>Rear</b></p> <p>DODGE PASSENGER CAR ..... 1991-92            TOYOTA PASSENGER CAR ..... 1997-01</p>	 <p><b>EM-8799</b> <b>MOUNT-TRANSMISSION</b> <b>Auto</b></p> <p>HONDA PASSENGER CAR ..... 1998-99</p>	 <p><b>EM-8802</b> <b>Engine Torque Strut Mount</b> <b>Front</b></p> <p>HONDA PASSENGER CAR ..... 1982-83</p>	 <p><b>EM-8805</b> <b>MOUNT-ENGINE</b> <b>Rear</b></p> <p>SUZUKI PASSENGER CAR ..... 1995-00</p>
		 <p><b>EM-8803</b> <b>MOUNT-ENGINE</b> <b>Front Lower</b></p> <p>MITSUBISHI PASSENGER CAR ..... 1983</p> <p><b>MOUNT-ENGINE</b> <b>RH Front</b></p> <p>PLYMOUTH PASSENGER CAR ..... 1979-84</p> <p><b>(Continued Next Column)</b></p>	 <p><b>EM-8806</b> <b>MOUNT-ENGINE</b> <b>Front</b></p> <p>HONDA PASSENGER CAR ..... 1992-01</p>

# BUYER'S GUIDE

## NUMERICAL LISTING - ILLUSTRATIONS

 <p style="text-align: center;"><b>EM-8807</b> <b>MOUNT-ENGINE</b> <b>RH Front</b></p> <p>DODGE PASSENGER CAR ..... 1984-91 <b>MOUNT-TRANSMISSION</b> <b>Auto</b></p> <p>MITSUBISHI PASSENGER CAR ..... 1984-88 <b>MOUNT-TRANSMISSION</b> <b>Manual</b></p> <p>PLYMOUTH PASSENGER CAR ..... 1984-91</p>	 <p style="text-align: center;"><b>EM-8813</b> <b>MOUNT-ENGINE</b> <b>RH Front</b></p> <p>MAZDA PASSENGER CAR ..... 1992-93</p>	 <p style="text-align: center;"><b>EM-8817</b> <b>MOUNT-TRANSMISSION</b> <b>Manual</b></p> <p>MITSUBISHI PASSENGER CAR ..... 1997-07</p>	 <p style="text-align: center;"><b>EM-8820</b> <b>MOUNT-ENGINE</b> <b>LH Front</b></p> <p>EAGLE PASSENGER CAR ..... 1995-96 MITSUBISHI VAN ..... 1992-95 <b>MOUNT-ENGINE</b> <b>RH Front</b></p> <p>PLYMOUTH PASSENGER CAR ..... 1992-94</p>
 <p style="text-align: center;"><b>EM-8811</b> <b>MOUNT-ENGINE</b> <b>L &amp; R Front</b></p> <p>DAIHATSU SPORT UTILITY ..... 1990-92</p>	 <p style="text-align: center;"><b>EM-8814</b> <b>MOUNT-TRANSMISSION</b></p> <p>MAZDA VAN ..... 1989-98</p>	 <p style="text-align: center;"><b>EM-8818</b> <b>MOUNT-ENGINE</b> <b>Front</b></p> <p>EAGLE PASSENGER CAR ..... 1995-96 MITSUBISHI PASSENGER CAR ..... 1997-02 <b>MOUNT-ENGINE</b> <b>Rear</b></p> <p>DODGE PASSENGER CAR ..... 1993-94 PLYMOUTH PASSENGER CAR ..... 1993-94</p>	 <p style="text-align: center;"><b>EM-8821</b> <b>MOUNT-ENGINE</b> <b>Front</b></p> <p>EAGLE PASSENGER CAR ..... 1992-94 MITSUBISHI VAN ..... 1992 PLYMOUTH PASSENGER CAR ..... 1993-94</p>
 <p style="text-align: center;"><b>EM-8812</b> <b>MOUNT-TRANSMISSION</b> <b>Manual</b></p> <p>DAIHATSU SPORT UTILITY ..... 1990-92</p>	 <p style="text-align: center;"><b>EM-8816</b> <b>MOUNT-TRANSMISSION</b> <b>Auto</b></p> <p>MITSUBISHI PASSENGER CAR ..... 1997-02</p>	 <p style="text-align: center;"><b>EM-8819</b> <b>MOUNT-ENGINE</b> <b>Rear</b></p> <p>MITSUBISHI PASSENGER CAR ..... 1997-02</p>	 <p style="text-align: center;"><b>EM-8822</b> <b>MOUNT-TRANSMISSION</b> <b>Auto</b></p> <p>MITSUBISHI VAN ..... 1993-95 PLYMOUTH PASSENGER CAR ..... 1994</p>

# BUYER'S GUIDE

## NUMERICAL LISTING - ILLUSTRATIONS

 <p style="text-align: center;"><b>EM-8823</b> <b>MOUNT-ENGINE</b> Front</p> <p>ACURA PASSENGER CAR ..... 1990-93</p>	 <p style="text-align: center;"><b>EM-8828</b> <b>MOUNT-ENGINE</b> LH Front</p> <p>AUDI PASSENGER CAR ..... 1993-98</p>	 <p style="text-align: center;"><b>EM-8831</b> <b>MOUNT-TRANSMISSION</b></p> <p>AUDI PASSENGER CAR ..... 1988-91</p>	<p><b>EM-8835 (Continued)</b></p> <p>MERCEDES-BENZ PASSENGER CAR ..... 1990-99</p> 
 <p style="text-align: center;"><b>EM-8824</b> <b>MOUNT-ENGINE</b> Front</p> <p>ACURA PASSENGER CAR ..... 1994-01</p>	 <p style="text-align: center;"><b>EM-8829</b> <b>MOUNT-ENGINE</b> RH Front</p> <p>AUDI PASSENGER CAR ..... 1993-98</p>	 <p style="text-align: center;"><b>EM-8832</b> <b>MOUNT-ENGINE</b> L &amp; R Front</p> <p>MERCEDES-BENZ PASSENGER CAR ..... 1994-05</p>	<p style="text-align: center;"><b>EM-8836</b> <b>MOUNT-ENGINE</b> L &amp; R Front</p> <p>MERCEDES-BENZ PASSENGER CAR ..... 1987-93</p> 
 <p style="text-align: center;"><b>EM-8825</b> <b>MOUNT-TRANSMISSION</b></p> <p>CHEVROLET SPORT UTILITY .... 1998-04 GEO SPORT UTILITY ..... 1989-97 HONDA PASSENGER CAR ..... 1976-78 PONTIAC PASSENGER CAR ..... 1994-97 SUZUKI SPORT UTILITY ..... 1989-02</p>	 <p style="text-align: center;"><b>EM-8830</b> <b>MOUNT-ENGINE</b> Front Center</p> <p>AUDI PASSENGER CAR ..... 1996-01</p>	 <p style="text-align: center;"><b>EM-8834</b> <b>MOUNT-ENGINE</b> LH Front</p> <p>MERCEDES-BENZ PASSENGER CAR ..... 1990-97</p>	<p style="text-align: center;"><b>EM-8838</b> <b>MOUNT-ENGINE</b> L &amp; R Front</p> <p>MERCEDES-BENZ PASSENGER CAR ..... 1992-02</p> 
 <p style="text-align: center;"><b>EM-8826</b> <b>MOUNT-ENGINE</b> Rear</p> <p>CHEVROLET PASSENGER CAR ..... 1985-88 ISUZU PASSENGER CAR ..... 1985-89</p>	 <p style="text-align: center;"><b>EM-8835</b> <b>MOUNT-ENGINE</b> L &amp; R Front</p> <p>(Continued Next Column)</p>	<p style="text-align: center;"><b>EM-8843</b> <b>MOUNT-ENGINE</b> Front</p> <p>VOLKSWAGEN PASSENGER CAR ..... 1993-98</p>	

# BUYER'S GUIDE

## NUMERICAL LISTING - ILLUSTRATIONS

 <p style="text-align: center;"><b>EM-8845</b> <b>MOUNT-ENGINE</b> <b>Rear</b></p> <p>HONDA PASSENGER CAR ..... 1998-02</p>	<p><b>EM-8848 (Continued)</b></p> <p>TOYOTA PASSENGER CAR ..... 1994-95 TOYOTA SPORT UTILITY ..... 1996-00</p>  <p style="text-align: center;"><b>EM-8849</b> <b>MOUNT-ENGINE</b> <b>Rear</b></p> <p>HONDA PASSENGER CAR ..... 1998-02</p>	 <p style="text-align: center;"><b>EM-8852</b> <b>MOUNT-TRANSMISSION</b> <b>Manual</b></p> <p>TOYOTA PASSENGER CAR ..... 1994-99</p>	 <p style="text-align: center;"><b>EM-8856</b> <b>MOUNT-TRANSMISSION</b> <b>Manual</b></p> <p>TOYOTA SPORT UTILITY ..... 1996-97</p>
 <p style="text-align: center;"><b>EM-8846</b> <b>MOUNT-ENGINE</b> <b>RH Front</b></p> <p>NISSAN PASSENGER CAR ..... 1990-92</p>	 <p style="text-align: center;"><b>EM-8850</b> <b>MOUNT-ENGINE</b> <b>RH Front</b></p> <p>CHEVROLET PASSENGER CAR ..... 1998-02 TOYOTA PASSENGER CAR ..... 1998-02</p> <p style="text-align: center;"><b>MOUNT-TRANSMISSION</b> <b>Manual</b></p> <p>VOLKSWAGEN PASSENGER CAR ..... 1973-79</p>	 <p style="text-align: center;"><b>EM-8853</b> <b>MOUNT-ENGINE</b> <b>RH Front</b></p> <p>MITSUBISHI PASSENGER CAR ..... 1997-98</p>	 <p style="text-align: center;"><b>EM-8857</b> <b>MOUNT-TRANSMISSION</b></p> <p>VOLKSWAGEN PASSENGER CAR ..... 1971-04</p>
 <p style="text-align: center;"><b>EM-8847</b> <b>MOUNT-ENGINE</b> <b>Front</b></p> <p>TOYOTA SPORT UTILITY ..... 1996-00</p>	 <p style="text-align: center;"><b>EM-8851</b> <b>MOUNT-ENGINE</b> <b>Rear</b></p> <p>CHEVROLET PASSENGER CAR ..... 1998-02 TOYOTA PASSENGER CAR ..... 1998-02</p>	 <p style="text-align: center;"><b>EM-8854</b> <b>MOUNT-ENGINE</b> <b>RH Front</b></p> <p>TOYOTA SPORT UTILITY ..... 1996-00</p>	 <p style="text-align: center;"><b>EM-8858</b> <b>MOUNT-ENGINE</b> <b>Front</b></p> <p>INFINITI PASSENGER CAR ..... 1991-96</p>
 <p style="text-align: center;"><b>EM-8848</b> <b>MOUNT-ENGINE</b> <b>Front</b></p> <p style="text-align: center;">(Continued Next Column)</p>	 <p style="text-align: center;"><b>EM-8855</b> <b>MOUNT-ENGINE</b> <b>Rear</b></p> <p>TOYOTA SPORT UTILITY ..... 1996-00</p>	 <p style="text-align: center;"><b>EM-8859</b> <b>MOUNT-ENGINE</b> <b>Front</b></p> <p>HONDA PASSENGER CAR ..... 1992-96</p>	



# BUYER'S GUIDE

## NUMERICAL LISTING - ILLUSTRATIONS

 <p><b>EM-8860</b> <b>MOUNT-ENGINE</b> Front</p> <p>ACURA PASSENGER CAR ..... 1990-93</p>	 <p><b>EM-8865</b> <b>MOUNT-ENGINE</b> Front</p> <p>INFINITI PASSENGER CAR ..... 1996-97 NISSAN PASSENGER CAR ..... 1995-03</p>	 <p><b>EM-8869</b> <b>MOUNT-ENGINE</b> RH Front</p> <p>TOYOTA PASSENGER CAR ..... 1994-99</p>	 <p><b>EM-8872</b> <b>MOUNT-TRANSMISSION</b> Auto</p> <p>CHEVROLET PASSENGER CAR ..... 1998-02 TOYOTA PASSENGER CAR ..... 1998-02</p>
 <p><b>EM-8862</b> <b>MOUNT-TRANSMISSION</b></p> <p>MAZDA PASSENGER CAR ..... 1995-02</p>	 <p><b>EM-8866</b> <b>MOUNT-ENGINE</b> Rear</p> <p>INFINITI PASSENGER CAR ..... 1996-99 NISSAN PASSENGER CAR ..... 1995-03</p>	 <p><b>EM-8870</b> <b>MOUNT-ENGINE</b> Front</p> <p>CHEVROLET PASSENGER CAR ..... 1998-02 TOYOTA PASSENGER CAR ..... 1998-02</p>	 <p><b>EM-8873</b> <b>MOUNT-TRANSMISSION</b> Auto</p> <p>CHEVROLET PASSENGER CAR ..... 1998-02 TOYOTA PASSENGER CAR ..... 1998-02</p>
 <p><b>EM-8863</b> <b>MOUNT-TRANSMISSION</b></p> <p>MAZDA PASSENGER CAR ..... 1995-02</p>	 <p><b>EM-8867</b> <b>Engine Torque Strut Mount</b> Front</p> <p>MITSUBISHI PASSENGER CAR ..... 1984-88 PLYMOUTH PASSENGER CAR ..... 1989-90</p>	 <p><b>EM-8871</b> <b>MOUNT-ENGINE</b> Rear</p> <p>TOYOTA PASSENGER CAR ..... 1994-99</p>	 <p><b>EM-8874</b> <b>MOUNT-ENGINE</b> Front</p> <p>NISSAN PASSENGER CAR ..... 1990-92 NISSAN VAN ..... 1990-95</p>
 <p><b>EM-8864</b> <b>MOUNT-ENGINE</b> Front</p> <p>MAZDA PASSENGER CAR ..... 1997-00</p>	 <p><b>EM-8868</b> <b>MOUNT-ENGINE</b> L &amp; R Front</p> <p>MAZDA VAN ..... 1996-98</p>		

# BUYER'S GUIDE

## NUMERICAL LISTING - ILLUSTRATIONS

 <p style="text-align: center;"><b>EM-8875</b> <b>MOUNT-ENGINE</b> <b>RH Front</b></p> <p>DODGE PASSENGER CAR ..... 1985-88</p> <p style="text-align: center;"><b>MOUNT-TRANSMISSION</b> <b>Auto</b></p> <p>DODGE PASSENGER CAR ..... 1985-86 MITSUBISHI PASSENGER CAR ..... 1985-86</p>	 <p style="text-align: center;"><b>EM-8878</b> <b>MOUNT-ENGINE</b> <b>L &amp; R Front</b></p> <p>MITSUBISHI SPORT UTILITY ..... 1995-00</p>	 <p style="text-align: center;"><b>EM-8881</b> <b>MOUNT-TRANSMISSION</b> <b>Auto</b></p> <p>EAGLE PASSENGER CAR ..... 1992-96 MITSUBISHI VAN ..... 1992 PLYMOUTH PASSENGER CAR ..... 1992-93</p>	 <p style="text-align: center;"><b>EM-8884</b> <b>MOUNT-ENGINE</b> <b>RH Front</b></p> <p>MAZDA PASSENGER CAR ..... 1999-01</p>	
 <p style="text-align: center;"><b>EM-8876</b> <b>MOUNT-ENGINE</b> <b>L &amp; R Front</b></p> <p>MITSUBISHI SPORT UTILITY ..... 1994-99</p>	 <p style="text-align: center;"><b>EM-8879</b> <b>MOUNT-TRANSMISSION</b> <b>Auto</b></p> <p>MITSUBISHI PASSENGER CAR ..... 1997-02</p>	 <p style="text-align: center;"><b>EM-8882</b> <b>MOUNT-ENGINE</b> <b>Rear</b></p> <p>MAZDA PASSENGER CAR ..... 1999-03</p>	 <p style="text-align: center;"><b>EM-8885</b> <b>MOUNT-ENGINE</b> <b>Front</b></p> <p>MAZDA PASSENGER CAR ..... 1999-03</p>	
 <p style="text-align: center;"><b>EM-8877</b> <b>MOUNT-ENGINE</b> <b>RH Front</b></p> <p>MITSUBISHI PASSENGER CAR ..... 1997-02</p>	 <p style="text-align: center;"><b>EM-8880</b> <b>MOUNT-TRANSMISSION</b> <b>Manual</b></p> <p>MITSUBISHI PASSENGER CAR ..... 1997-02</p>	 <p style="text-align: center;"><b>EM-8883</b> <b>MOUNT-TRANSMISSION</b> <b>Auto</b></p> <p>TOYOTA PASSENGER CAR ..... 2000-05</p>	 <p style="text-align: center;"><b>EM-8886</b> <b>MOUNT-ENGINE</b> <b>Rear</b></p> <p>MAZDA PASSENGER CAR ..... 1999-01</p>	
 <p style="text-align: center;"><b>EM-8887</b> <b>MOUNT-TRANSMISSION</b> <b>MOUNT-TRANSMISSION</b> <b>Manual</b></p> <p>FORD VAN ..... 1986-87</p>				<p style="text-align: center;">(Continued Next Page)</p>

# BUYER'S GUIDE

## NUMERICAL LISTING - ILLUSTRATIONS

### EM-8887 (Continued)

NISSAN PASSENGER CAR ..... 1990-92

#### MOUNT-TRANSMISSION Auto

NISSAN VAN ..... 1990-95



### EM-8888 MOUNT-TRANSMISSION Manual

SCION PASSENGER CAR ..... 2004-06

SCION VAN ..... 2004-06

TOYOTA PASSENGER CAR ..... 2000-05



### EM-8889 MOUNT-ENGINE Rear

MAZDA PASSENGER CAR ..... 1999-03



### EM-8890 MOUNT-TRANSMISSION

SUZUKI PASSENGER CAR ..... 1995-02



### EM-8891 MOUNT-TRANSMISSION Manual

NISSAN PASSENGER CAR ..... 1995-00



### EM-8892 MOUNT-ENGINE RH Front

TOYOTA VAN ..... 1991-97



### EM-8893 MOUNT-ENGINE LH Front Lower

ACURA PASSENGER CAR ..... 1994-01



### EM-8894 MOUNT-ENGINE LH Front Upper

(Continued Next Column)

### EM-8894 (Continued)

ACURA PASSENGER CAR ..... 1994-01

HONDA PASSENGER CAR ..... 1994-97



### EM-8895 MOUNT-ENGINE Rear

ACURA PASSENGER CAR ..... 1990-93



### EM-8896 MOUNT-TRANSMISSION

ACURA PASSENGER CAR ..... 1997-99

HONDA PASSENGER CAR ..... 1995-97



### EM-8897 MOUNT-ENGINE Rear

ACURA PASSENGER CAR ..... 1997-01

HONDA SPORT UTILITY ..... 1997-01



### EM-8898 MOUNT-TRANSMISSION Front

ACURA PASSENGER CAR ..... 1999-03

ACURA SPORT UTILITY ..... 2001-02

HONDA PASSENGER CAR ..... 1998-02

HONDA SPORT UTILITY ..... 2003-05

HONDA VAN ..... 1999-06



### EM-8899 MOUNT-ENGINE LH Front

HONDA PASSENGER CAR ..... 1998-02



### EM-8900 MOUNT-ENGINE RH Front

HONDA PASSENGER CAR ..... 1995-97

# BUYER'S GUIDE

## NUMERICAL LISTING - ILLUSTRATIONS

 <p><b>EM-8901</b> <b>MOUNT-TRANSMISSION</b> <b>LH</b></p> <p>KIA SPORT UTILITY ..... 1995-02</p>	 <p><b>EM-8904</b> <b>MOUNT-ENGINE</b> <b>Front</b></p> <p>KIA PASSENGER CAR ..... 1998-04</p>	 <p><b>EM-8908</b> <b>MOUNT-ENGINE</b> <b>Rear</b></p> <p>KIA PASSENGER CAR ..... 1998-02</p>	<p><b>EM-8911 (Continued)</b> KIA PASSENGER CAR ..... 1998-00</p>  <p><b>EM-8912</b> <b>MOUNT-TRANSMISSION</b> <b>Auto</b></p> <p>KIA PASSENGER CAR ..... 1998-00</p>
 <p><b>EM-8902</b> <b>MOUNT-ENGINE</b> <b>RH Front</b></p> <p>KIA PASSENGER CAR ..... 1998-04</p>	 <p><b>EM-8905</b> <b>MOUNT-ENGINE</b> <b>Rear</b></p> <p>KIA PASSENGER CAR ..... 1998-04</p>	 <p><b>EM-8909</b> <b>MOUNT-ENGINE</b> <b>L &amp; R Front</b></p> <p>MAZDA PASSENGER CAR ..... 1990-05</p>	 <p><b>EM-8913</b> <b>MOUNT-ENGINE</b> <b>RH Front</b></p> <p>KIA PASSENGER CAR ..... 2001-02</p>
 <p><b>EM-8903</b> <b>MOUNT-ENGINE</b> <b>Front</b></p> <p>KIA PASSENGER CAR ..... 1994-97</p>	 <p><b>EM-8906</b> <b>MOUNT-ENGINE</b> <b>Front</b></p> <p>KIA PASSENGER CAR ..... 1998-04</p>	 <p><b>EM-8910</b> <b>MOUNT-TRANSMISSION</b> <b>Manual</b></p> <p>KIA PASSENGER CAR ..... 2000-04</p>	 <p><b>EM-8914</b> <b>MOUNT-ENGINE</b> <b>Front</b></p> <p>KIA PASSENGER CAR ..... 2001-05</p>
	 <p><b>EM-8907</b> <b>MOUNT-TRANSMISSION</b> <b>Auto</b></p> <p>KIA PASSENGER CAR ..... 2000-04</p>	 <p><b>EM-8911</b> <b>MOUNT-TRANSMISSION</b> <b>Manual</b></p> <p>(Continued Next Column)</p>	<p>KIA PASSENGER CAR ..... 2001-05</p> <p><b>MOUNT-ENGINE</b> <b>Rear</b></p> <p>KIA PASSENGER CAR ..... 2001-05</p>

# BUYER'S GUIDE

## NUMERICAL LISTING - ILLUSTRATIONS

 <p style="text-align: center;"><b>EM-8915</b> <b>MOUNT-TRANSMISSION</b> Auto</p> <p>DAEWOO PASSENGER CAR ..... 1999-02</p>	 <p style="text-align: center;"><b>EM-8919</b> <b>Engine Torque Strut Mount</b> Front</p> <p>DAEWOO PASSENGER CAR ..... 2000-02</p>	 <p style="text-align: center;"><b>EM-8925</b> <b>MOUNT-TRANSMISSION</b> Manual</p> <p>DAEWOO PASSENGER CAR ..... 2000-02</p>	 <p style="text-align: center;"><b>EM-8930</b> <b>MOUNT-TRANSMISSION</b> Manual</p> <p>DAEWOO PASSENGER CAR ..... 1999</p>
 <p style="text-align: center;"><b>EM-8916</b> <b>MOUNT-ENGINE</b> Front</p> <p>DAEWOO PASSENGER CAR ..... 1999-02</p>	 <p style="text-align: center;"><b>EM-8920</b> <b>MOUNT-ENGINE</b> Front</p> <p>DAEWOO PASSENGER CAR ..... 1999-02</p>	 <p style="text-align: center;"><b>EM-8926</b> <b>MOUNT-TRANSMISSION</b> Auto</p> <p>DAEWOO PASSENGER CAR ..... 2000-02</p>	 <p style="text-align: center;"><b>EM-8931</b> <b>MOUNT-TRANSMISSION</b> Auto</p> <p>DAEWOO PASSENGER CAR ..... 1999</p>
 <p style="text-align: center;"><b>EM-8917</b> <b>MOUNT-ENGINE</b> Rear</p> <p>DAEWOO PASSENGER CAR ..... 1999-02</p>	 <p style="text-align: center;"><b>EM-8921</b> <b>MOUNT-ENGINE</b> Rear</p> <p>DAEWOO PASSENGER CAR ..... 1999-02</p>	 <p style="text-align: center;"><b>EM-8928</b> <b>MOUNT-ENGINE</b> RH Front</p> <p>DAEWOO PASSENGER CAR ..... 1999-02</p>	 <p style="text-align: center;"><b>EM-8932</b> <b>Engine Torque Strut</b> Front Right</p> <p>HYUNDAI PASSENGER CAR ..... 1986-89 MITSUBISHI PASSENGER CAR ..... 1987-89</p>
 <p style="text-align: center;"><b>EM-8918</b> <b>MOUNT-ENGINE</b> RH Front</p> <p>DAEWOO PASSENGER CAR ..... 1999-02</p>	 <p style="text-align: center;"><b>EM-8923</b> <b>MOUNT-TRANSMISSION</b> Manual</p> <p>DAEWOO PASSENGER CAR ..... 1999-02</p>	 <p style="text-align: center;"><b>EM-8929</b> <b>MOUNT-ENGINE</b> RH Front</p> <p>DAEWOO PASSENGER CAR ..... 1999-02</p>	 <p style="text-align: center;"><b>EM-8933</b> <b>MOUNT-ENGINE</b> Front</p> <p>HYUNDAI PASSENGER CAR ..... 1986-89 MITSUBISHI PASSENGER CAR ..... 1987-89</p>

# BUYER'S GUIDE

## NUMERICAL LISTING - ILLUSTRATIONS

 <p><b>EM-8934</b> <b>MOUNT-TRANSMISSION</b> Auto</p> <p>HYUNDAI PASSENGER CAR ..... 1986-89 MITSUBISHI PASSENGER CAR ..... 1987-89</p>	 <p><b>EM-8937</b> <b>MOUNT-ENGINE</b> Rear</p> <p>HYUNDAI PASSENGER CAR ..... 2000-02</p>	 <p><b>EM-8940</b> <b>MOUNT-ENGINE</b> LH Front</p> <p>HYUNDAI PASSENGER CAR ..... 2001-05</p>	 <p><b>EM-8945</b> <b>MOUNT-ENGINE</b> Rear</p> <p>HYUNDAI PASSENGER CAR ..... 2001-08</p>
 <p><b>EM-8935</b> <b>MOUNT-ENGINE</b> Front</p> <p>HYUNDAI PASSENGER CAR ..... 2001-02</p>	 <p><b>EM-8938</b> <b>MOUNT-ENGINE</b> Front</p> <p>DODGE PASSENGER CAR ..... 2005-06</p> <p><b>MOUNT-TRANSMISSION</b> Manual</p> <p>HYUNDAI PASSENGER CAR ..... 2000-02</p>	 <p><b>EM-8941</b> <b>MOUNT-TRANSMISSION</b> Auto</p> <p>HYUNDAI PASSENGER CAR ..... 2001-02</p>	 <p><b>EM-8947</b> <b>MOUNT-TRANSMISSION</b> Manual</p> <p>HYUNDAI PASSENGER CAR ..... 2001-06</p>
 <p><b>EM-8936</b> <b>MOUNT-ENGINE</b> LH Front</p> <p>HYUNDAI PASSENGER CAR ..... 2000-02</p>	 <p><b>EM-8939</b> <b>MOUNT-TRANSMISSION</b> Auto</p> <p>HYUNDAI PASSENGER CAR ..... 2000-02</p>	 <p><b>EM-8943</b> <b>MOUNT-ENGINE</b> Front</p> <p>HYUNDAI PASSENGER CAR ..... 2001-08</p>	 <p><b>EM-8948</b> <b>MOUNT-ENGINE</b> Front</p> <p>HYUNDAI PASSENGER CAR ..... 2001-05 KIA PASSENGER CAR ..... 2004-06</p>
		 <p><b>EM-8944</b> <b>MOUNT-ENGINE</b> RH Front</p> <p>HYUNDAI PASSENGER CAR ..... 2001-06</p>	



# BUYER'S GUIDE

## NUMERICAL LISTING - ILLUSTRATIONS

 <p style="text-align: center;"><b>EM-8949</b> <b>MOUNT-ENGINE</b> <b>RH Front</b></p> <p>HYUNDAI PASSENGER CAR ..... 2001-05 KIA PASSENGER CAR ..... 2004-06</p>	 <p style="text-align: center;"><b>EM-8952</b> <b>MOUNT-ENGINE</b> <b>Front</b></p> <p>HYUNDAI SPORT UTILITY ..... 2001-06</p>	<p><b>EM-8955 (Continued)</b> HYUNDAI SPORT UTILITY ..... 2001-06</p>  <p style="text-align: center;"><b>EM-8956</b> <b>MOUNT-TRANSMISSION</b></p> <p>HYUNDAI SPORT UTILITY ..... 2001-06</p>	 <p style="text-align: center;"><b>EM-8959</b> <b>MOUNT-TRANSMISSION</b> <b>Auto</b></p> <p>INFINITI PASSENGER CAR ..... 1997-04 <b>MOUNT-TRANSMISSION</b></p> <p>NISSAN PASSENGER CAR ..... 2002-03</p>
 <p style="text-align: center;"><b>EM-8950</b> <b>MOUNT-ENGINE</b> <b>Rear</b></p> <p>HYUNDAI PASSENGER CAR ..... 2001-05 KIA PASSENGER CAR ..... 2004-06</p>	 <p style="text-align: center;"><b>EM-8953</b> <b>MOUNT-ENGINE</b> <b>Front</b></p> <p>HYUNDAI SPORT UTILITY ..... 2001-06</p>	 <p style="text-align: center;"><b>EM-8957</b> <b>MOUNT-TRANSMISSION</b></p> <p>HYUNDAI SPORT UTILITY ..... 2001-06</p>	 <p style="text-align: center;"><b>EM-8960</b> <b>MOUNT-ENGINE</b> <b>L &amp; R Front</b></p> <p>NISSAN SPORT UTILITY ..... 2000-04 NISSAN TRUCK ..... 1999-04</p>
 <p style="text-align: center;"><b>EM-8951</b> <b>MOUNT-TRANSMISSION</b></p> <p>HYUNDAI PASSENGER CAR ..... 2001-05</p>	 <p style="text-align: center;"><b>EM-8954</b> <b>MOUNT-ENGINE</b> <b>RH Front</b></p> <p>HYUNDAI SPORT UTILITY ..... 2001-06</p>	 <p style="text-align: center;"><b>EM-8958</b> <b>MOUNT-ENGINE</b> <b>Front</b></p> <p>HYUNDAI PASSENGER CAR ..... 2000-02</p>	 <p style="text-align: center;"><b>EM-8961</b> <b>MOUNT-ENGINE</b> <b>Rear</b></p> <p>NISSAN PASSENGER CAR ..... 1987-89</p>
	 <p style="text-align: center;"><b>EM-8955</b> <b>MOUNT-ENGINE</b> <b>Rear</b></p> <p style="text-align: center;">(Continued Next Column)</p>		

# BUYER'S GUIDE

## NUMERICAL LISTING - ILLUSTRATIONS











 <p><b>EM-8962</b> <b>MOUNT-ENGINE</b> <b>Front</b></p> <p>NISSAN PASSENGER CAR ..... 1985-88</p>	 <p><b>EM-8966</b> <b>MOUNT-ENGINE</b> <b>Front</b></p> <p>CHEVROLET PASSENGER CAR ..... 1998-02</p>	 <p><b>EM-8970</b> <b>MOUNT-TRANSMISSION</b> <b>Auto</b></p> <p>TOYOTA PASSENGER CAR ..... 1986-89</p>	 <p><b>EM-8974#</b> <b>MOUNT-ENGINE</b> <b>RH Front</b></p> <p>ACURA PASSENGER CAR ..... 1999-03 HONDA PASSENGER CAR ..... 1998-02 HONDA VAN ..... 1999-04</p>
 <p><b>EM-8963</b> <b>MOUNT-TRANSMISSION</b></p> <p>NISSAN PASSENGER CAR ..... 1984-89</p>	 <p><b>EM-8967</b> <b>MOUNT-ENGINE</b> <b>Front</b></p> <p>LEXUS PASSENGER CAR ..... 1997-01 TOYOTA PASSENGER CAR ..... 1997-03</p>	 <p><b>EM-8971</b> <b>MOUNT-TRANSMISSION</b> <b>Manual</b></p> <p>HONDA PASSENGER CAR ..... 1998-02</p>	 <p><b>EM-8975</b> <b>MOUNT-ENGINE</b> <b>Front</b></p> <p>ACURA PASSENGER CAR ..... 2001-05 HONDA PASSENGER CAR ..... 2001-05</p>
 <p><b>EM-8964</b> <b>MOUNT-TRANSMISSION</b></p> <p>NISSAN SPORT UTILITY ..... 2000-04</p> <p><b>EM-8964</b> <b>MOUNT-TRANSMISSION</b> <b>Auto</b></p> <p>NISSAN TRUCK ..... 1998-04</p>	 <p><b>EM-8968</b> <b>MOUNT-ENGINE</b> <b>Rear</b></p> <p>SCION PASSENGER CAR ..... 2004-06 SCION VAN ..... 2004-06 TOYOTA PASSENGER CAR ..... 2000-05</p>	 <p><b>EM-8973</b> <b>MOUNT-ENGINE</b> <b>Rear</b></p> <p>ACURA PASSENGER CAR ..... 2001-05 HONDA PASSENGER CAR ..... 2001-05</p>	 <p><b>EM-8976</b> <b>MOUNT-TRANSMISSION</b> <b>Manual</b></p> <p>GEO PASSENGER CAR ..... 1989 ISUZU PASSENGER CAR ..... 1989</p> <p><b>EM-8976</b> <b>MOUNT-TRANSMISSION</b></p> <p>PONTIAC PASSENGER CAR ..... 1985-88</p>
 <p><b>EM-8965</b> <b>MOUNT-ENGINE</b> <b>Front</b></p> <p>LEXUS PASSENGER CAR ..... 1992-93 TOYOTA PASSENGER CAR ..... 1992-93</p>			

# = Available in the Westar Gold Line



# BUYER'S GUIDE

## NUMERICAL LISTING - ILLUSTRATIONS

 <p style="text-align: center;"><b>EM-8977</b> <b>MOUNT-TRANSMISSION</b> Manual</p> <p>MAZDA PASSENGER CAR ..... 1999-01</p>	<p><b>EM-8980 (Continued)</b> ACURA PASSENGER CAR ..... 1990-93</p>  <p style="text-align: center;"><b>EM-8981</b> <b>MOUNT-ENGINE</b> LH Front</p> <p>ACURA PASSENGER CAR ..... 1990-93</p>	 <p style="text-align: center;"><b>EM-8984</b> <b>MOUNT-ENGINE</b> Rear</p> <p>ACURA PASSENGER CAR ..... 1997-99 HONDA PASSENGER CAR ..... 1990-97 HONDA VAN ..... 1995-98 ISUZU VAN ..... 1996-99</p>	 <p style="text-align: center;"><b>EM-8987</b> <b>MOUNT-TRANSMISSION</b> Auto</p> <p>HONDA PASSENGER CAR ..... 1988-91</p>
 <p style="text-align: center;"><b>EM-8978</b> <b>MOUNT-TRANSMISSION</b> Auto</p> <p>MAZDA PASSENGER CAR ..... 1999-03</p>	 <p style="text-align: center;"><b>EM-8982</b> <b>MOUNT-ENGINE</b> Left</p> <p>HONDA SPORT UTILITY ..... 1997-01</p>	 <p style="text-align: center;"><b>EM-8985</b> <b>MOUNT-TRANSMISSION</b></p> <p>VOLVO PASSENGER CAR ..... 1993-95</p>	 <p style="text-align: center;"><b>EM-8988</b> <b>MOUNT-ENGINE</b> Front</p> <p>ACURA PASSENGER CAR ..... 2001-05 HONDA PASSENGER CAR ..... 2001-05</p>
 <p style="text-align: center;"><b>EM-8979</b> <b>MOUNT-TRANSMISSION</b> Auto</p> <p>TOYOTA PASSENGER CAR ..... 1992-01</p>	 <p style="text-align: center;"><b>EM-8983</b> <b>MOUNT-TRANSMISSION</b> Auto</p> <p>HONDA PASSENGER CAR ..... 2000-02</p>	 <p style="text-align: center;"><b>EM-8986</b> <b>MOUNT-TRANSMISSION</b> Rear</p> <p>ACURA PASSENGER CAR ..... 1999-03</p>	 <p style="text-align: center;"><b>EM-8989</b> <b>MOUNT-TRANSMISSION</b></p> <p>TOYOTA TRUCK ..... 1998-04</p>
 <p style="text-align: center;"><b>EM-8980</b> <b>MOUNT-TRANSMISSION</b> Auto</p> <p>(Continued Next Column)</p>	<p style="text-align: center;"><b>EM-8984</b> <b>MOUNT-TRANSMISSION</b> LH Rear</p> <p>ACURA SPORT UTILITY ..... 2001-02</p> <p>HONDA PASSENGER CAR ..... 1998-02 HONDA SPORT UTILITY ..... 2003-05 HONDA VAN ..... 1999-04</p>		

# BUYER'S GUIDE

## NUMERICAL LISTING - ILLUSTRATIONS

 <p style="text-align: center;"><b>EM-8990</b> <b>MOUNT-TRANSMISSION</b></p> <p>TOYOTA SPORT UTILITY ..... 1996-02</p>	<p><b>EM-8993 (Continued)</b></p> <p>TOYOTA SPORT UTILITY ..... 1996-02 <b>MOUNT-TRANSMISSION</b></p> <p>TOYOTA TRUCK ..... 2000-06</p>	 <p style="text-align: center;"><b>EM-8997</b> <b>MOUNT-ENGINE</b> <b>L &amp; R Front</b></p> <p>AUDI PASSENGER CAR ..... 1996-08</p>	<p><b>EM-8999 (Continued)</b></p> <p style="text-align: center;"><b>MOUNT-TRANSMISSION</b> <b>Manual</b></p> <p>VOLKSWAGEN PASSENGER CAR ..... 1995-05</p>
 <p style="text-align: center;"><b>EM-8991</b> <b>MOUNT-TRANSMISSION</b></p> <p>LEXUS SPORT UTILITY ..... 1998-07 TOYOTA SPORT UTILITY ..... 1998-03</p>	 <p style="text-align: center;"><b>EM-8994</b> <b>MOUNT-ENGINE</b> <b>RH Front</b></p> <p>NISSAN PASSENGER CAR ..... 1996-01</p>	<p style="text-align: center;"><b>MOUNT-ENGINE</b> <b>RH Front</b></p> <p>VOLKSWAGEN PASSENGER CAR ..... 1995-05</p>	 <p style="text-align: center;"><b>EM-9000</b> <b>MOUNT-ENGINE</b> <b>Front</b></p> <p>VOLKSWAGEN PASSENGER CAR ..... 1992-98</p>
 <p style="text-align: center;"><b>EM-8992</b> <b>MOUNT-ENGINE</b> <b>RH Front</b></p> <p>ACURA PASSENGER CAR ..... 1993-98</p>	 <p style="text-align: center;"><b>EM-8995</b> <b>Engine Torque Strut Mount</b> <b>Front</b></p> <p>LEXUS SPORT UTILITY ..... 1999-03</p>	 <p style="text-align: center;"><b>EM-8998</b> <b>MOUNT-ENGINE</b> <b>LH Front</b></p> <p>AUDI PASSENGER CAR ..... 1997-04 VOLKSWAGEN PASSENGER CAR ..... 1995-05</p>	 <p style="text-align: center;"><b>EM-90000 (NEW)</b> <b>Engine Torque Strut Mount</b> <b>Lower</b></p> <p>NISSAN PASSENGER CAR ..... 2002-08 RENAULT PASSENGER CAR ..... 2003-10</p>
 <p style="text-align: center;"><b>EM-8993</b> <b>MOUNT-TRANSMISSION</b> <b>Manual</b></p> <p>(Continued Next Column)</p>	 <p style="text-align: center;"><b>EM-8996</b> <b>MOUNT-TRANSMISSION</b></p> <p>TOYOTA TRUCK ..... 1998-04</p>	 <p style="text-align: center;"><b>EM-8999</b> <b>MOUNT-ENGINE</b> <b>Center Front</b></p> <p>AUDI PASSENGER CAR ..... 2000-04 <b>MOUNT-TRANSMISSION</b> <b>Auto</b></p> <p>AUDI PASSENGER CAR ..... 1996-06 <b>MOUNT-TRANSMISSION</b> <b>RH</b></p> <p>VOLKSWAGEN PASSENGER CAR ..... 2001-04 <b>MOUNT-TRANSMISSION</b> <b>Auto</b></p> <p>AUDI PASSENGER CAR ..... 1996-05</p> <p>(Continued Next Column)</p>	 <p style="text-align: center;"><b>EM-90001 (NEW)</b> <b>MOUNT-TRANSMISSION</b> <b>Manual</b></p> <p>NISSAN PASSENGER CAR ..... 2002-09 RENAULT PASSENGER CAR ..... 2002-08 RENAULT VAN ..... 2008</p>

# BUYER'S GUIDE

## NUMERICAL LISTING - ILLUSTRATIONS

 <p style="text-align: center;"><b>EM-90002 (NEW)</b> <b>MOUNT-ENGINE</b> <b>RH Front</b></p> <p>CHEVROLET PASSENGER CAR ..... 1997-12 CHEVROLET TRUCK ..... 2012-15</p>	 <p style="text-align: center;"><b>EM-90008 (NEW)</b> <b>Engine Torque Strut Mount</b> <b>Rear</b></p> <p>FORD PASSENGER CAR ..... 2003-10</p>	 <p style="text-align: center;"><b>EM-90010 (NEW)</b> <b>MOUNT-ENGINE</b> <b>Right</b></p> <p>CHEVROLET PASSENGER CAR ..... 2000-08 CHEVROLET VAN ..... 2002-06</p>	 <p style="text-align: center;"><b>EM-90019 (NEW)</b> <b>MOUNT-ENGINE</b> <b>RH Front</b></p> <p>FORD PASSENGER CAR ..... 2001-08</p>
 <p style="text-align: center;"><b>EM-90003 (NEW)</b> <b>MOUNT-ENGINE</b> <b>Rear</b></p> <p>CHEVROLET PASSENGER CAR ..... 2002-08 CHEVROLET TRUCK ..... 2004-11</p>	 <p style="text-align: center;"><b>EM-90009 (NEW)</b> <b>MOUNT-ENGINE</b> <b>RH Front</b></p> <p>FORD PASSENGER CAR ..... 2003-10</p>	 <p style="text-align: center;"><b>EM-90011 (NEW)</b> <b>MOUNT-ENGINE</b> <b>Front</b></p> <p>CHEVROLET PASSENGER CAR ..... 2001-03 CHEVROLET VAN ..... 2002-06</p>	 <p style="text-align: center;"><b>EM-9002</b> <b>MOUNT-TRANSMISSION</b></p> <p>MERCEDES-BENZ PASSENGER CAR ..... 1992-96</p>
 <p style="text-align: center;"><b>EM-90004 (NEW)</b> <b>Engine Torque Strut Mount</b> <b>Lower</b></p> <p>NISSAN PASSENGER CAR ..... 2002-10 RENAULT PASSENGER CAR ..... 2003-10 RENAULT VAN ..... 2008</p>	 <p style="text-align: center;"><b>EM-9001</b> <b>MOUNT-ENGINE</b> <b>RH Front</b></p> <p>VOLKSWAGEN PASSENGER CAR ..... 1990-92</p>	 <p style="text-align: center;"><b>EM-90015 (NEW)</b> <b>MOUNT-TRANSMISSION</b> <b>Front Lower</b></p> <p>CHEVROLET PASSENGER CAR ..... 2002-08 CHEVROLET TRUCK ..... 2004-11</p>	 <p style="text-align: center;"><b>EM-90021 (NEW)</b> <b>MOUNT-ENGINE</b> <b>LH Front</b></p> <p>CHEVROLET PASSENGER CAR ..... 1994-12 CHEVROLET TRUCK ..... 2004-15</p>
 <p style="text-align: center;"><b>EM-90006 (NEW)</b> <b>MOUNT-ENGINE</b> <b>RH Rear</b></p> <p>CHEVROLET PASSENGER CAR ..... 2002-08 CHEVROLET TRUCK ..... 2004-11</p>	 <p style="text-align: center;"><b>EM-9001</b> <b>MOUNT-ENGINE</b> <b>RH Rear</b></p> <p>VOLKSWAGEN PASSENGER CAR ..... 1984-94</p>	 <p style="text-align: center;"><b>EM-90022 (NEW)</b> <b>MOUNT-ENGINE</b> <b>Rear</b></p> <p>NISSAN PASSENGER CAR ..... 1992-10</p>	 <p style="text-align: center;"><b>EM-9001</b> <b>MOUNT-TRANSMISSION</b> <b>RH</b></p> <p>VOLKSWAGEN PASSENGER CAR ..... 1993-94</p>

# BUYER'S GUIDE

## NUMERICAL LISTING - ILLUSTRATIONS

 <p style="text-align: center;"><b>EM-90027 (NEW)</b> Engine Torque Strut Mount Rear</p> <p>FORD PASSENGER CAR ..... 1998-00 FORD TRUCK ..... 2001-08</p>	 <p style="text-align: center;"><b>EM-9003</b> MOUNT-ENGINE L &amp; R Front</p> <p>BMW PASSENGER CAR ..... 1991-09</p>	 <p style="text-align: center;"><b>EM-90032 (NEW)</b> MOUNT-TRANSMISSION</p> <p>NISSAN VAN ..... 2003-08</p>	 <p style="text-align: center;"><b>EM-90037 (NEW)</b> MOUNT-TRANSMISSION Auto</p> <p>DODGE PASSENGER CAR ..... 2001-10</p>
 <p style="text-align: center;"><b>EM-90028 (NEW)</b> MOUNT-ENGINE Right</p> <p>FORD PASSENGER CAR ..... 1998-07 FORD TRUCK ..... 2001-08</p>	 <p style="text-align: center;"><b>EM-90030 (NEW)</b> MOUNT-TRANSMISSION Auto</p> <p>FORD PASSENGER CAR ..... 2003-10 FORD SPORT UTILITY ..... 2004-12</p>	 <p style="text-align: center;"><b>EM-90033 (NEW)</b> MOUNT-TRANSMISSION Auto</p> <p>DODGE PASSENGER CAR ..... 2005-10</p>	 <p style="text-align: center;"><b>EM-90038 (NEW)</b> MOUNT-ENGINE LH Front</p> <p>NISSAN VAN ..... 2000-08</p>
 <p style="text-align: center;"><b>EM-90029 (NEW)</b> MOUNT-TRANSMISSION LH</p> <p>FORD PASSENGER CAR ..... 1998-10 FORD TRUCK ..... 2001-08</p>	 <p style="text-align: center;"><b>EM-90031 (NEW)</b> MOUNT-TRANSMISSION Auto</p> <p>NISSAN PASSENGER CAR ..... 2002-08 RENAULT PASSENGER CAR ..... 2002-08</p>	 <p style="text-align: center;"><b>EM-90035 (NEW)</b> MOUNT-ENGINE L &amp; R Front</p> <p>TOYOTA VAN ..... 2006-18</p>	 <p style="text-align: center;"><b>EM-90039 (NEW)</b> MOUNT-ENGINE Rear</p> <p>NISSAN SPORT UTILITY ..... 2002-07</p>
		 <p style="text-align: center;"><b>EM-90036 (NEW)</b> Engine Torque Strut Mount Left</p> <p>NISSAN SPORT UTILITY ..... 2008-14 RENAULT SPORT UTILITY ..... 2009-14</p>	 <p style="text-align: center;"><b>EM-9004</b> MOUNT-ENGINE LH Front</p> <p>AUDI PASSENGER CAR ..... 1992-97</p>

# BUYER'S GUIDE

## NUMERICAL LISTING - ILLUSTRATIONS

 <p><b>EM-90040 (NEW)</b> <b>MOUNT-ENGINE</b> <b>Rear</b></p> <p>DODGE PASSENGER CAR ..... 2001-10</p>	 <p><b>EM-9008</b> <b>MOUNT-ENGINE</b> <b>Rear</b></p> <p>MAZDA PASSENGER CAR ..... 1995-02</p>	 <p><b>EM-9011</b> <b>MOUNT-TRANSMISSION</b> <b>Manual</b></p> <p>NISSAN SPORT UTILITY ..... 1997-02</p>	 <p><b>EM-9014</b> <b>MOUNT-ENGINE</b> <b>L &amp; R Front</b></p> <p>TOYOTA SPORT UTILITY ..... 1999-02 TOYOTA TRUCK ..... 2000-04</p>
 <p><b>EM-9005</b> <b>MOUNT-ENGINE</b> <b>RH Front</b></p> <p>AUDI PASSENGER CAR ..... 1992-97</p>	 <p><b>EM-9009</b> <b>MOUNT-ENGINE</b> <b>L &amp; R Front</b></p> <p>NISSAN PASSENGER CAR ..... 1984-89</p>	 <p><b>EM-9012</b> <b>MOUNT-ENGINE</b> <b>LH Front</b></p> <p>NISSAN SPORT UTILITY ..... 2000-04 NISSAN TRUCK ..... 1998-04</p>	 <p><b>EM-9015</b> <b>MOUNT-ENGINE</b> <b>RH Front</b></p> <p>SCION PASSENGER CAR ..... 2004-06 SCION VAN ..... 2004-06 TOYOTA PASSENGER CAR ..... 2000-05</p>
 <p><b>EM-9007</b> <b>MOUNT-ENGINE</b> <b>Front</b></p> <p>MAZDA PASSENGER CAR ..... 1995-02</p>	 <p><b>EM-9010</b> <b>MOUNT-ENGINE</b> <b>LH Front</b></p> <p>NISSAN PASSENGER CAR ..... 1989-94</p>	 <p><b>EM-9013</b> <b>MOUNT-ENGINE</b> <b>Rear</b></p> <p>TOYOTA PASSENGER CAR ..... 1994-99</p>	 <p><b>EM-9016</b> <b>MOUNT-ENGINE</b> <b>Left</b></p> <p>ACURA PASSENGER CAR ..... 2001-05</p>
 <p><b>EM-90071 (NEW)</b> <b>MOUNT-TRANSMISSION</b> <b>Auto</b></p> <p>TOYOTA VAN ..... 2007-18</p>	 <p><b>EM-9010</b> <b>MOUNT-ENGINE</b> <b>LH Front</b></p> <p>NISSAN PASSENGER CAR ..... 1989-91 NISSAN PASSENGER CAR ..... 1992-94</p>	 <p><b>EM-9013</b> <b>MOUNT-ENGINE</b> <b>Rear</b></p> <p>TOYOTA PASSENGER CAR ..... 1994-99</p>	 <p><b>EM-9016</b> <b>MOUNT-ENGINE</b> <b>LH Front</b></p> <p>HONDA PASSENGER CAR ..... 2001-05</p>



# BUYER'S GUIDE

## NUMERICAL LISTING - ILLUSTRATIONS

 <p><b>EM-9017</b> <b>MOUNT-ENGINE</b> <b>RH Front</b></p> <p>MAZDA PASSENGER CAR ..... 1995-02</p>	 <p><b>EM-9021</b> <b>MOUNT-ENGINE</b> <b>RH Front</b></p> <p>MAZDA PASSENGER CAR ..... 1995-02</p>	 <p><b>EM-9024</b> <b>MOUNT-ENGINE</b> <b>L &amp; R Front</b></p> <p>SUBARU PASSENGER CAR ..... 1993-11 SUBARU SPORT UTILITY ..... 2000-12</p>	 <p><b>EM-9027</b> <b>MOUNT-ENGINE</b> <b>Rear</b></p> <p>TOYOTA VAN ..... 1991-95</p>
 <p><b>EM-9018</b> <b>MOUNT-TRANSMISSION</b> <b>Manual</b></p> <p>TOYOTA TRUCK ..... 1998-04</p>	 <p><b>EM-9022</b> <b>MOUNT-ENGINE</b> <b>Front</b></p> <p>SUZUKI PASSENGER CAR ..... 1995-03</p>	 <p><b>EM-9025</b> <b>MOUNT-TRANSMISSION</b> <b>RH</b></p> <p>NISSAN PASSENGER CAR ..... 1984-88</p>	 <p><b>EM-9028</b> <b>MOUNT-TRANSMISSION</b> <b>Auto</b></p> <p>NISSAN PASSENGER CAR ..... 1982-86</p>
 <p><b>EM-9019</b> <b>MOUNT-ENGINE</b> <b>Rear</b></p> <p>TOYOTA PASSENGER CAR ..... 1991-94</p>	 <p><b>EM-9023</b> <b>MOUNT-ENGINE</b> <b>L &amp; R Front</b></p> <p>SUBARU PASSENGER CAR ..... 1995-05 SUBARU SPORT UTILITY ..... 1998-06</p>	 <p><b>EM-9026</b> <b>MOUNT-TRANSMISSION</b> <b>Auto</b></p> <p>TOYOTA SPORT UTILITY ..... 1998-00</p>	 <p><b>EM-9029</b> <b>MOUNT-ENGINE</b> <b>L &amp; R Front</b></p> <p>TOYOTA VAN ..... 1986-89</p>
 <p><b>EM-9020</b> <b>MOUNT-ENGINE</b> <b>Front</b></p> <p>NISSAN PASSENGER CAR ..... 1982-86</p>			 <p><b>EM-9030</b> <b>MOUNT-ENGINE</b> <b>RH Front</b></p>

(Continued Next Page)

# BUYER'S GUIDE

## NUMERICAL LISTING - ILLUSTRATIONS

### EM-9030 (Continued)

ACURA PASSENGER CAR ..... 1991-05



EM-9031

#### EM-9031 MOUNT-ENGINE RH Front

INFINITI PASSENGER CAR ..... 1996-04  
NISSAN PASSENGER CAR ..... 1997-03



EM-9032

#### EM-9032 MOUNT-TRANSMISSION Auto

TOYOTA VAN ..... 1991-95



EM-9033

#### EM-9033 MOUNT-ENGINE LH Front

NISSAN PASSENGER CAR ..... 1979-82



EM-9034

#### EM-9034 MOUNT-ENGINE L & R Front

TOYOTA PASSENGER CAR ..... 1986-89



EM-9035

#### EM-9035 MOUNT-TRANSMISSION Manual

INFINITI PASSENGER CAR ..... 1996-99  
NISSAN PASSENGER CAR ..... 1995-01



#### EM-9037 MOUNT-ENGINE Front

MITSUBISHI PASSENGER  
CAR ..... 1997-02



EM-9038

#### EM-9038 MOUNT-TRANSMISSION Auto

INFINITI SPORT UTILITY ..... 1997-00  
NISSAN SPORT UTILITY ..... 1997-00



EM-9039

#### EM-9039 MOUNT-ENGINE Rear

EAGLE PASSENGER CAR ..... 1995-98



EM-9040

#### EM-9040 MOUNT-ENGINE Rear

NISSAN PASSENGER CAR ..... 1982-86



EM-9041

#### EM-9041 MOUNT-TRANSMISSION Manual

NISSAN PASSENGER CAR ..... 1987-88



EM-9042

#### EM-9042 MOUNT-ENGINE Rear

NISSAN PASSENGER CAR ..... 1982-86



EM-9043

#### EM-9043 MOUNT-ENGINE RH Front

ACURA PASSENGER CAR ..... 1986-90



EM-9044

#### EM-9044 MOUNT-ENGINE L & R Front

NISSAN PASSENGER CAR ..... 1990-96

# BUYER'S GUIDE

## NUMERICAL LISTING - ILLUSTRATIONS

 <p style="text-align: center;"><b>EM-9045</b> <b>MOUNT-ENGINE</b> <b>L &amp; R Front</b></p> <p>VOLKSWAGEN PASSENGER CAR ..... 1975-93</p> <p style="text-align: center;"><b>MOUNT-ENGINE</b> <b>Front</b></p> <p>VOLKSWAGEN TRUCK ..... 1980-83</p>	 <p style="text-align: center;"><b>EM-9048</b></p> <p style="text-align: center;"><b>EM-9048</b> <b>MOUNT-ENGINE</b> <b>Front</b></p> <p>NISSAN PASSENGER CAR ..... 1992-94</p>	<p><b>EM-9051 (Continued)</b></p> <p>TOYOTA PASSENGER CAR ..... 1983-86</p>  <p style="text-align: center;"><b>EM-9053</b></p> <p style="text-align: center;"><b>EM-9053</b> <b>MOUNT-TRANSMISSION</b> <b>Auto</b></p> <p>TOYOTA PASSENGER CAR ..... 1983-86</p>	 <p style="text-align: center;"><b>EM-9056</b></p> <p style="text-align: center;"><b>EM-9056</b> <b>MOUNT-ENGINE</b> <b>LH Front</b></p> <p>EAGLE PASSENGER CAR ..... 1993-94</p> <p>MITSUBISHI PASSENGER CAR ..... 1990-94</p> <p>PLYMOUTH PASSENGER CAR ..... 1990-94</p>
 <p style="text-align: center;"><b>EM-9046</b></p> <p style="text-align: center;"><b>EM-9046</b> <b>MOUNT-TRANSMISSION</b></p> <p>AUDI PASSENGER CAR ..... 1978-92</p> <p>VOLKSWAGEN PASSENGER CAR ..... 1985-88</p>	 <p style="text-align: center;"><b>EM-9049</b></p> <p style="text-align: center;"><b>EM-9049</b> <b>MOUNT-TRANSMISSION</b> <b>LH</b></p> <p>NISSAN PASSENGER CAR ..... 1984-88</p>	 <p style="text-align: center;"><b>EM-9054</b></p> <p style="text-align: center;"><b>EM-9054</b> <b>MOUNT-TRANSMISSION</b> <b>Manual</b></p> <p>ACURA PASSENGER CAR ..... 1991-95</p>	 <p style="text-align: center;"><b>EM-9057</b></p> <p style="text-align: center;"><b>EM-9057</b> <b>MOUNT-ENGINE</b> <b>Front</b></p> <p>MITSUBISHI VAN ..... 1992-94</p> <p>PLYMOUTH PASSENGER CAR ..... 1993-94</p> <p style="text-align: center;"><b>MOUNT-ENGINE</b> <b>Rear</b></p> <p>DODGE PASSENGER CAR ..... 1992-94</p> <p>MITSUBISHI PASSENGER CAR ..... 1993-96</p>
 <p style="text-align: center;"><b>EM-9047</b></p> <p style="text-align: center;"><b>EM-9047</b> <b>MOUNT-ENGINE</b> <b>LH Front</b></p> <p>VOLVO PASSENGER CAR ..... 1985-90</p>	 <p style="text-align: center;"><b>EM-9050</b></p> <p style="text-align: center;"><b>EM-9050</b> <b>MOUNT-ENGINE</b> <b>L &amp; R Front</b></p> <p>LEXUS SPORT UTILITY ..... 1998-07</p> <p>TOYOTA SPORT UTILITY ..... 1998-07</p>	 <p style="text-align: center;"><b>EM-9055</b></p> <p style="text-align: center;"><b>EM-9055</b> <b>MOUNT-TRANSMISSION</b> <b>Manual</b></p> <p>ACURA PASSENGER CAR ..... 1997-99</p> <p>HONDA PASSENGER CAR ..... 1992-97</p>	 <p style="text-align: center;"><b>EM-9058</b></p> <p style="text-align: center;"><b>EM-9058</b> <b>MOUNT-TRANSMISSION</b> <b>Auto</b></p> <p>EAGLE PASSENGER CAR ..... 1995-98</p> <p>MITSUBISHI PASSENGER CAR ..... 1995-99</p>
<p><b>EM-9051</b></p> <p style="text-align: center;"><b>EM-9051</b> <b>MOUNT-ENGINE</b> <b>RH Front</b></p> <p style="text-align: center;">(Continued Next Column)</p>			



# BUYER'S GUIDE

## NUMERICAL LISTING - ILLUSTRATIONS

 <p style="text-align: right; margin-right: 10px;">EM-9059</p> <p style="text-align: center;"><b>EM-9059</b> <b>MOUNT-ENGINE</b> <b>Rear</b></p> <p>MITSUBISHI PASSENGER CAR ..... 1997-02</p>	 <p style="text-align: right; margin-right: 10px;">EM-9063</p> <p style="text-align: center;"><b>EM-9063</b> <b>MOUNT-TRANSMISSION</b></p> <p>TOYOTA VAN ..... 1994-97</p>	<p><b>EM-9066 (Continued)</b></p> <p>ACURA PASSENGER CAR ..... 2002-06 HONDA SPORT UTILITY ..... 2002-11</p>  <p style="text-align: right; margin-right: 10px;">EM-9067</p> <p style="text-align: center;"><b>EM-9067</b> <b>MOUNT-ENGINE</b> <b>Front Lower</b></p> <p>ACURA PASSENGER CAR ..... 1993-95</p>	 <p style="text-align: right; margin-right: 10px;">EM-9071</p> <p style="text-align: center;"><b>EM-9071</b> <b>MOUNT-ENGINE</b> <b>LH Front</b></p> <p>MITSUBISHI PASSENGER CAR ..... 1989-93</p>
 <p style="text-align: right; margin-right: 10px;">EM-9060</p> <p style="text-align: center;"><b>EM-9060</b> <b>MOUNT-TRANSFER CASE</b> <b>Right</b></p> <p>DODGE TRUCK ..... 1983-93</p>	 <p style="text-align: right; margin-right: 10px;">EM-9064</p> <p style="text-align: center;"><b>EM-9064</b> <b>MOUNT-TRANSMISSION</b> <b>Manual</b></p> <p>MAZDA PASSENGER CAR ..... 1992</p>	 <p style="text-align: right; margin-right: 10px;">EM-9068</p> <p style="text-align: center;"><b>EM-9068</b> <b>MOUNT-ENGINE</b> <b>RH Front</b></p> <p>MITSUBISHI PASSENGER CAR ..... 1999-02</p>	 <p style="text-align: right; margin-right: 10px;">EM-9072</p> <p style="text-align: center;"><b>EM-9072</b> <b>MOUNT-ENGINE</b> <b>RH Front</b></p> <p>MAZDA PASSENGER CAR ..... 1999-03</p>
 <p style="text-align: right; margin-right: 10px;">EM-9061</p> <p style="text-align: center;"><b>EM-9061</b> <b>MOUNT-TRANSMISSION</b> <b>Auto</b></p> <p>TOYOTA SPORT UTILITY ..... 1996-97</p>	 <p style="text-align: right; margin-right: 10px;">EM-9065</p> <p style="text-align: center;"><b>EM-9065</b> <b>MOUNT-ENGINE</b> <b>RH Rear</b></p> <p>VOLKSWAGEN PASSENGER CAR ..... 1992-98</p>	 <p style="text-align: right; margin-right: 10px;">EM-9070</p> <p style="text-align: center;"><b>EM-9070</b> <b>MOUNT-TRANSMISSION</b> <b>Auto</b></p> <p>DODGE TRUCK ..... 1990-93</p>	 <p style="text-align: right; margin-right: 10px;">EM-9073</p> <p style="text-align: center;"><b>EM-9073</b> <b>MOUNT-TRANSMISSION</b></p> <p>LEXUS SPORT UTILITY ..... 1999-03</p>
 <p style="text-align: right; margin-right: 10px;">EM-9062</p> <p style="text-align: center;"><b>EM-9062</b> <b>MOUNT-ENGINE</b> <b>RH Front</b></p> <p>VOLVO PASSENGER CAR ..... 1985-90</p>	 <p style="text-align: right; margin-right: 10px;">EM-9066</p> <p style="text-align: center;"><b>EM-9066</b> <b>MOUNT-ENGINE</b> <b>Front</b></p> <p style="text-align: center;">(Continued Next Column)</p>		

# BUYER'S GUIDE

## NUMERICAL LISTING - ILLUSTRATIONS

 <p><b>EM-9074</b> <b>MOUNT-TRANSMISSION</b> Auto</p> <p>SUBARU PASSENGER CAR ..... 1996-09 SUBARU SPORT UTILITY ..... 1998-13</p>	 <p><b>EM-9078</b> <b>MOUNT-ENGINE</b> Front</p> <p>EAGLE PASSENGER CAR ..... 1990-94 MITSUBISHI PASSENGER CAR ..... 1990-94 PLYMOUTH PASSENGER CAR ..... 1992-94</p>	 <p><b>EM-9081</b> <b>MOUNT-ENGINE</b> Front</p> <p>TOYOTA SPORT UTILITY ..... 2001-05</p>	 <p><b>EM-9084</b> <b>MOUNT-ENGINE</b> Rear</p> <p>ACURA PASSENGER CAR ..... 1986-89</p>
 <p><b>EM-9076</b> <b>MOUNT-ENGINE</b> Outer</p> <p>VOLKSWAGEN VAN ..... 1980-91</p>	 <p><b>EM-9079</b> <b>MOUNT-ENGINE</b> L &amp; R Front</p> <p>TOYOTA TRUCK ..... 2000-04</p>	 <p><b>EM-9082</b> <b>MOUNT-TRANSMISSION</b> Center Lower</p> <p>FORD PASSENGER CAR ..... 1993-97 MAZDA PASSENGER CAR ..... 1993-02</p>	 <p><b>EM-9085</b> <b>MOUNT-ENGINE</b> LH Front</p> <p>HONDA PASSENGER CAR ..... 1992-96</p>
 <p><b>EM-9077</b> <b>MOUNT-ENGINE</b> Front Center</p> <p>VOLKSWAGEN PASSENGER CAR ..... 1975-93 VOLKSWAGEN TRUCK ..... 1980-83</p>	 <p><b>EM-9080</b> <b>MOUNT-ENGINE</b> L &amp; R Front</p> <p>TOYOTA TRUCK ..... 1993-98</p>	 <p><b>EM-9083</b> <b>MOUNT-ENGINE</b> RH Front</p> <p>ACURA PASSENGER CAR ..... 1991-92</p>	 <p><b>EM-9086</b> <b>MOUNT-TRANSMISSION</b> Auto</p> <p>TOYOTA SPORT UTILITY ..... 1993-94 TOYOTA TRUCK ..... 1988-95</p>

# BUYER'S GUIDE

## NUMERICAL LISTING - ILLUSTRATIONS

 <p style="text-align: center;">EM-9087</p> <p style="text-align: center;"><b>EM-9087</b> <b>MOUNT-TRANSMISSION</b> <b>Center Lower</b></p> <p>FORD PASSENGER CAR ..... 1993-97 MAZDA PASSENGER CAR ..... 1993-02</p>	 <p style="text-align: center;">EM-9090</p> <p style="text-align: center;"><b>EM-9090</b> <b>MOUNT-TRANSMISSION</b> <b>Manual</b></p> <p>BMW PASSENGER CAR ..... 1978-87</p>	<p><b>EM-9093 (Continued)</b></p> <p>AUDI PASSENGER CAR ..... 1981-87 <b>MOUNT-TRANSMISSION</b></p> <p>VOLKSWAGEN PASSENGER CAR ..... 1987-08 VOLKSWAGEN TRUCK ..... 1999-07</p>  <p style="text-align: center;">EM-9094</p>	 <p style="text-align: center;">EM-9098</p> <p style="text-align: center;"><b>EM-9098</b> <b>MOUNT-TRANSMISSION</b> <b>Manual</b></p> <p>BMW PASSENGER CAR ..... 1984-91</p>
 <p style="text-align: center;">EM-9088</p> <p style="text-align: center;"><b>EM-9088</b> <b>MOUNT-TRANSMISSION</b> <b>Manual</b></p> <p>MITSUBISHI PASSENGER CAR ..... 2002-06</p>	 <p style="text-align: center;">EM-9091</p> <p style="text-align: center;"><b>EM-9091</b> <b>MOUNT-TRANSMISSION</b></p> <p>MERCEDES-BENZ PASSENGER CAR ..... 1993-96</p>	<p style="text-align: center;"><b>EM-9094</b> <b>MOUNT-ENGINE</b> <b>Front</b></p> <p>BMW PASSENGER CAR ..... 1984-87 <b>MOUNT-TRANSMISSION</b> <b>Auto</b></p> <p>BMW PASSENGER CAR ..... 1987-97</p>	 <p style="text-align: center;">EM-9099</p> <p style="text-align: center;"><b>EM-9099</b> <b>MOUNT-ENGINE</b> <b>L &amp; R Front</b></p> <p>BMW PASSENGER CAR ..... 1989-95</p>
 <p style="text-align: center;">EM-9089</p> <p style="text-align: center;"><b>EM-9089</b> <b>MOUNT-TRANSMISSION</b> <b>Manual</b></p> <p>AUDI PASSENGER CAR ..... 1986-97</p>	 <p style="text-align: center;">EM-9092</p> <p style="text-align: center;"><b>EM-9092</b> <b>MOUNT-ENGINE</b> <b>RH Front</b></p> <p>AUDI PASSENGER CAR ..... 1998-13 SEAT PASSENGER CAR ..... 2001-08 VOLKSWAGEN PASSENGER CAR ..... 1994-15</p>	 <p style="text-align: center;">EM-9095</p> <p style="text-align: center;"><b>EM-9095</b> <b>MOUNT-TRANSMISSION</b> <b>Auto</b></p> <p>BMW PASSENGER CAR ..... 1984-86</p>	 <p style="text-align: center;">EM-9100</p> <p style="text-align: center;"><b>EM-9100</b> <b>MOUNT-TRANSMISSION</b> <b>RH</b></p> <p>BMW PASSENGER CAR ..... 1989-00</p>
 <p style="text-align: center;">EM-9093</p> <p style="text-align: center;"><b>EM-9093</b> <b>MOUNT-TRANSMISSION</b> <b>Manual</b></p> <p>(Continued Next Column)</p>	 <p style="text-align: center;">EM-9096</p> <p style="text-align: center;"><b>EM-9096</b> <b>MOUNT-TRANSMISSION</b> <b>Manual</b></p> <p>BMW PASSENGER CAR ..... 1983-13</p>		

# BUYER'S GUIDE

## NUMERICAL LISTING - ILLUSTRATIONS

 <p style="text-align: center;">EM-9101</p> <p style="text-align: center;"><b>EM-9101</b> <b>MOUNT-TRANSMISSION</b></p> <p>AUDI PASSENGER CAR ..... 1998-01 SEAT PASSENGER CAR ..... 2001-06</p> <p style="text-align: center;"><b>MOUNT-TRANSMISSION</b> <b>Manual</b></p> <p>VOLKSWAGEN PASSENGER CAR ..... 1998-09</p>	 <p style="text-align: center;">EM-9104</p> <p style="text-align: center;"><b>EM-9104</b> <b>MOUNT-TRANSMISSION</b> <b>LH</b></p> <p>BMW PASSENGER CAR ..... 1991-00</p>	 <p style="text-align: center;">EM-9107</p> <p style="text-align: center;"><b>EM-9107</b> <b>MOUNT-TRANSMISSION</b> <b>Auto</b></p> <p>BMW PASSENGER CAR ..... 1984-91</p>	 <p style="text-align: center;">EM-9111</p> <p style="text-align: center;"><b>EM-9111</b> <b>MOUNT-ENGINE</b> <b>L &amp; R Front</b></p> <p>BMW PASSENGER CAR ..... 1984-85</p>
 <p style="text-align: center;">EM-9102</p> <p style="text-align: center;"><b>EM-9102</b> <b>MOUNT-TRANSMISSION</b> <b>Auto</b></p> <p>AUDI PASSENGER CAR ..... 1992-97</p>	 <p style="text-align: center;">EM-9105</p> <p style="text-align: center;"><b>EM-9105</b> <b>MOUNT-TRANSMISSION</b> <b>Manual</b></p> <p>BMW PASSENGER CAR ..... 1982-88</p>	 <p style="text-align: center;">EM-9108</p> <p style="text-align: center;"><b>EM-9108</b> <b>MOUNT-TRANSMISSION</b> <b>Auto</b></p> <p>NISSAN SPORT UTILITY ..... 1996</p>	 <p style="text-align: center;">EM-9113</p> <p style="text-align: center;"><b>EM-9113</b> <b>MOUNT-TRANSMISSION</b> <b>Manual</b></p> <p>TOYOTA SPORT UTILITY ..... 1987-95 TOYOTA TRUCK ..... 1989-95</p>
 <p style="text-align: center;">EM-9103</p> <p style="text-align: center;"><b>EM-9103</b> <b>MOUNT-TRANSMISSION</b> <b>Manual</b></p> <p>BMW PASSENGER CAR ..... 1997-03</p>	 <p style="text-align: center;">EM-9106</p> <p style="text-align: center;"><b>EM-9106</b> <b>MOUNT-TRANSMISSION</b> <b>LH</b></p> <p>VOLKSWAGEN PASSENGER CAR ..... 1998-05</p>	 <p style="text-align: center;">EM-9109</p> <p style="text-align: center;"><b>EM-9109</b> <b>MOUNT-ENGINE</b> <b>L &amp; R Front</b></p> <p>AUDI PASSENGER CAR ..... 1988-90 VOLKSWAGEN PASSENGER CAR ..... 1976-93</p>	 <p style="text-align: center;">EM-9114</p> <p style="text-align: center;"><b>EM-9114</b> <b>MOUNT-TRANSMISSION</b> <b>Manual</b></p> <p>TOYOTA PASSENGER CAR ..... 1985-87</p>
 <p style="text-align: center;">EM-9110</p> <p style="text-align: center;"><b>EM-9110</b> <b>MOUNT-ENGINE</b> <b>Rear</b></p> <p>ACURA PASSENGER CAR ..... 1987-88</p>	 <p style="text-align: center;">EM-9115</p> <p style="text-align: center;"><b>EM-9115</b> <b>MOUNT-TRANSMISSION</b> <b>Manual</b></p> <p>TOYOTA TRUCK ..... 1995-97</p>		

# BUYER'S GUIDE

## NUMERICAL LISTING - ILLUSTRATIONS

 <p style="text-align: center;"><b>EM-9116</b> <b>MOUNT-ENGINE</b> <b>Rear</b></p> <p>TOYOTA PASSENGER CAR ..... 1993-97</p>	 <p style="text-align: center;"><b>EM-9119</b> <b>MOUNT-ENGINE</b> <b>Rear</b></p> <p>TOYOTA PASSENGER CAR ..... 1987-93</p>	<p><b>EM-9122 (Continued)</b> TOYOTA PASSENGER CAR ..... 1985-86</p>  <p style="text-align: center;"><b>EM-9123</b> <b>MOUNT-TRANSMISSION</b> <b>Auto</b></p> <p>TOYOTA PASSENGER CAR ..... 1992-99</p>	 <p style="text-align: center;"><b>EM-9127</b> <b>MOUNT-ENGINE</b> <b>Rear</b></p> <p>TOYOTA PASSENGER CAR ..... 1989-91</p>
 <p style="text-align: center;"><b>EM-9117</b> <b>MOUNT-ENGINE</b> <b>RH Front</b></p> <p>TOYOTA PASSENGER CAR ..... 1988-89</p>	 <p style="text-align: center;"><b>EM-9120</b> <b>MOUNT-ENGINE</b> <b>L &amp; R Front</b></p> <p>TOYOTA TRUCK ..... 1993-98</p>	 <p style="text-align: center;"><b>EM-9124</b> <b>MOUNT-TRANSMISSION</b> <b>Manual</b></p> <p>TOYOTA PASSENGER CAR ..... 1987-90</p>	 <p style="text-align: center;"><b>EM-9128</b> <b>MOUNT-ENGINE</b> <b>RH Front</b></p> <p>HONDA PASSENGER CAR ..... 1989</p>
 <p style="text-align: center;"><b>EM-9118</b> <b>MOUNT-ENGINE</b> <b>Rear</b></p> <p>TOYOTA PASSENGER CAR ..... 1990-93</p>	 <p style="text-align: center;"><b>EM-9121</b> <b>MOUNT-TRANSMISSION</b> <b>Auto</b></p> <p>TOYOTA PASSENGER CAR ..... 1985-87</p>	 <p style="text-align: center;"><b>EM-9125</b> <b>MOUNT-TRANSMISSION</b> <b>Auto</b></p> <p>TOYOTA PASSENGER CAR ..... 1993-97</p>	 <p style="text-align: center;"><b>EM-9129</b> <b>MOUNT-ENGINE</b> <b>RH Front</b></p> <p>TOYOTA PASSENGER CAR ..... 1988-91</p>
	 <p style="text-align: center;"><b>EM-9122</b> <b>MOUNT-ENGINE</b> <b>Rear</b></p> <p style="text-align: center;">(Continued Next Column)</p>		 <p style="text-align: center;"><b>EM-9130</b> <b>MOUNT-ENGINE</b> <b>Rear</b></p> <p style="text-align: center;">(Continued Next Page)</p>

# BUYER'S GUIDE

## NUMERICAL LISTING - ILLUSTRATIONS

### EM-9130 (Continued)

MAZDA PASSENGER CAR ..... 1988-92



EM-9131

#### EM-9131 MOUNT-ENGINE RH Front

FORD PASSENGER CAR ..... 1989-92  
MAZDA PASSENGER CAR ..... 1990-94



EM-9133

#### EM-9133 MOUNT-ENGINE RH Front

SUZUKI PASSENGER CAR ..... 1989-94



EM-9134

#### EM-9134 MOUNT-ENGINE RH Front

NISSAN PASSENGER CAR ..... 1988-89



EM-9136

#### EM-9136 MOUNT-ENGINE LH Front Upper

HONDA PASSENGER CAR ..... 1992-97

#### MOUNT-ENGINE LH Rear

HONDA PASSENGER CAR ..... 1993-95



#### EM-9137 MOUNT-ENGINE Rear

HONDA PASSENGER CAR ..... 1990-01

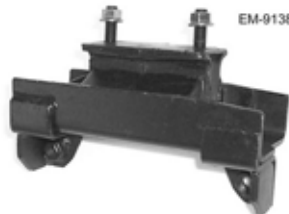

EM-9138

#### EM-9138 MOUNT-TRANSMISSION Manual

ISUZU SPORT UTILITY ..... 1984-86



#### EM-9139 MOUNT-ENGINE RH Front

HONDA SPORT UTILITY ..... 2002-06



EM-9140

#### EM-9140 MOUNT-ENGINE RH Front

HONDA SPORT UTILITY ..... 1994-95  
ISUZU SPORT UTILITY ..... 1991-95  
ISUZU TRUCK ..... 1991-94



EM-9141

#### EM-9141 MOUNT-ENGINE LH Front

HONDA SPORT UTILITY ..... 1994-95  
ISUZU SPORT UTILITY ..... 1991-95  
ISUZU TRUCK ..... 1991-94



EM-9142

#### EM-9142 MOUNT-TRANSMISSION

ACURA SPORT UTILITY ..... 1996-99

#### MOUNT-TRANSMISSION Auto

HONDA SPORT UTILITY ..... 1994-97

#### MOUNT-TRANSMISSION

ISUZU SPORT UTILITY ..... 1992-02



#### EM-9143 MOUNT-TRANSMISSION Auto

ISUZU SPORT UTILITY ..... 1989-94

#### MOUNT-TRANSMISSION

ISUZU TRUCK ..... 1986-94











EM-9144

#### EM-9144 MOUNT-ENGINE RH Front

HONDA SPORT UTILITY ..... 1994-95  
ISUZU SPORT UTILITY ..... 1992-95

# BUYER'S GUIDE













## NUMERICAL LISTING - ILLUSTRATIONS

 <p style="text-align: center;"><b>EM-9145</b> <b>MOUNT-ENGINE</b> <b>LH Front</b></p> <p>VOLVO PASSENGER CAR ..... 1993-04</p>	 <p style="text-align: center;"><b>EM-9148</b> <b>Engine Torque Strut</b> <b>Front Right</b></p> <p>TOYOTA PASSENGER CAR ..... 2002-08</p>	 <p style="text-align: center;"><b>EM-9151</b> <b>MOUNT-TRANSMISSION</b> <b>Front</b></p> <p>HONDA PASSENGER CAR ..... 2003-07</p>	<p><b>EM-9154 (Continued)</b></p> <p>MITSUBISHI PASSENGER CAR ..... 2004-07</p>  <p style="text-align: center;"><b>EM-9155</b> <b>MOUNT-ENGINE</b> <b>Rear</b></p> <p>PONTIAC PASSENGER CAR ..... 2003-07 TOYOTA PASSENGER CAR ..... 2003-08</p>
 <p style="text-align: center;"><b>EM-9146</b> <b>MOUNT-ENGINE</b> <b>Front</b></p> <p>LEXUS PASSENGER CAR ..... 1992-93 TOYOTA PASSENGER CAR ..... 1992-93</p>	 <p style="text-align: center;"><b>EM-9149</b> <b>MOUNT-ENGINE</b> <b>Rear</b></p> <p>ACURA PASSENGER CAR ..... 1999-03 HONDA PASSENGER CAR ..... 1998-02</p>	 <p style="text-align: center;"><b>EM-9152</b> <b>MOUNT-TRANSMISSION</b> <b>Rear</b></p> <p>ACURA PASSENGER CAR ..... 2004-08 HONDA PASSENGER CAR ..... 2003-07</p>	 <p style="text-align: center;"><b>EM-9156</b> <b>MOUNT-ENGINE</b> <b>RH Front</b></p> <p>SUZUKI PASSENGER CAR ..... 2002-07</p>
 <p style="text-align: center;"><b>EM-9147</b></p> <p style="text-align: center;"><b>EM-9147</b> <b>MOUNT-ENGINE</b> <b>LH Front</b></p> <p>EAGLE PASSENGER CAR ..... 1992-94</p> <p style="text-align: center;"><b>MOUNT-ENGINE</b> <b>RH Front</b></p> <p>PLYMOUTH PASSENGER CAR ..... 1992-94</p> <p style="text-align: center;"><b>MOUNT-TRANSMISSION</b> <b>Manual</b></p> <p>DODGE PASSENGER CAR ..... 1993-94</p>	 <p style="text-align: center;"><b>EM-9150</b> <b>MOUNT-ENGINE</b> <b>LH Front</b></p> <p>HONDA PASSENGER CAR ..... 1997-01</p>	 <p style="text-align: center;"><b>EM-9153</b> <b>MOUNT-ENGINE</b> <b>Rear</b></p> <p>MITSUBISHI SPORT UTILITY ..... 2003-06</p>	 <p style="text-align: center;"><b>EM-9157</b> <b>MOUNT-ENGINE</b> <b>Rear</b></p> <p>PONTIAC PASSENGER CAR ..... 2003-07 TOYOTA PASSENGER CAR ..... 2003-08</p>
 <p style="text-align: center;"><b>EM-9154</b> <b>MOUNT-ENGINE</b> <b>Rear</b></p> <p style="text-align: center;">(Continued Next Column)</p>			



# BUYER'S GUIDE













## NUMERICAL LISTING - ILLUSTRATIONS

 <p><b>EM-9158</b> <b>MOUNT-ENGINE</b> <b>Front</b></p> <p>PONTIAC PASSENGER CAR ..... 2003-07 SCION PASSENGER CAR ..... 2005-10 TOYOTA PASSENGER CAR ..... 2003-08</p>	 <p><b>EM-9161</b> <b>MOUNT-ENGINE</b> <b>Rear</b></p> <p>CHRYSLER PASSENGER CAR ..... 2001-05 DODGE PASSENGER CAR ..... 2001-05 MITSUBISHI PASSENGER CAR ..... 1994-05</p>	 <p><b>EM-9164</b> <b>MOUNT-ENGINE</b> <b>RH Front</b></p> <p>PONTIAC PASSENGER CAR ..... 2003-07 TOYOTA PASSENGER CAR ..... 2003-08</p>	 <p><b>EM-9167</b> <b>MOUNT-ENGINE</b> <b>Front</b></p> <p>NISSAN PASSENGER CAR ..... 2002-06</p>
 <p><b>EM-9159</b> <b>MOUNT-ENGINE</b> <b>Rear</b></p> <p>SUZUKI PASSENGER CAR ..... 2002-07</p>	 <p><b>EM-9162</b> <b>MOUNT-TRANSMISSION</b> <b>Auto</b></p> <p>CHRYSLER PASSENGER CAR ..... 2001-05 DODGE PASSENGER CAR ..... 2001-05 MITSUBISHI PASSENGER CAR ..... 1999-05</p>	 <p><b>EM-9165</b> <b>MOUNT-TRANSMISSION</b></p> <p>LEXUS PASSENGER CAR ..... 2002-06 LEXUS SPORT UTILITY ..... 2004-09</p> <p><b>MOUNT-TRANSMISSION</b> <b>Auto</b></p> <p>TOYOTA PASSENGER CAR ..... 2002-08 TOYOTA SPORT UTILITY ..... 2001-07 TOYOTA VAN ..... 2004-10</p>	 <p><b>EM-9168</b> <b>MOUNT-ENGINE</b> <b>Rear</b></p> <p>HONDA SPORT UTILITY ..... 2002-11</p>
 <p><b>EM-9160</b> <b>MOUNT-ENGINE</b> <b>Front</b></p> <p>CHRYSLER PASSENGER CAR ..... 2001-05 DODGE PASSENGER CAR ..... 2001-05 MITSUBISHI PASSENGER CAR ..... 1999-05</p>	 <p><b>EM-9163</b> <b>MOUNT-TRANSMISSION</b> <b>Auto</b></p> <p>PONTIAC PASSENGER CAR ..... 2003-07</p> <p><b>MOUNT-TRANSMISSION</b> <b>Manual</b></p> <p>TOYOTA PASSENGER CAR ..... 2003-08</p>	 <p><b>EM-9166</b> <b>MOUNT-ENGINE</b> <b>Rear</b></p> <p>NISSAN PASSENGER CAR ..... 2000-06</p>	 <p><b>EM-9169</b> <b>MOUNT-ENGINE</b> <b>LH Front</b></p> <p>ACURA PASSENGER CAR ..... 1992-93</p>
			 <p><b>EM-9170</b> <b>MOUNT-ENGINE</b> <b>Rear</b></p> <p style="text-align: right;">(Continued Next Page)</p>



# BUYER'S GUIDE

## NUMERICAL LISTING - ILLUSTRATIONS

<p><b>EM-9170 (Continued)</b>            MITSUBISHI PASSENGER            CAR ..... 2002-07</p>  <p style="text-align: center;"><b>EM-9171</b>  <b>MOUNT-ENGINE</b>  <b>RH Rear</b></p> <p>NISSAN PASSENGER CAR ..... 1992-94</p>  <p style="text-align: center;"><b>EM-9172</b>  <b>MOUNT-ENGINE</b>  <b>Front</b></p> <p>HONDA PASSENGER CAR ..... 1988</p>  <p style="text-align: center;"><b>EM-9173</b>  <b>MOUNT-ENGINE</b>  <b>Front</b></p> <p>LEXUS SPORT UTILITY ..... 1999-03</p>	 <p style="text-align: center;"><b>EM-9174</b>  <b>MOUNT-TRANSMISSION</b>  <b>Auto</b></p> <p>CHRYSLER PASSENGER            CAR ..... 1995-00</p> <p style="text-align: center;"><b>MOUNT-TRANSMISSION</b></p> <p>DODGE PASSENGER CAR ..... 1995-00            EAGLE PASSENGER CAR ..... 1995-98</p> <p style="text-align: center;"><b>MOUNT-TRANSMISSION</b>  <b>Manual</b></p> <p>MITSUBISHI PASSENGER            CAR ..... 1995-99</p>  <p style="text-align: center;"><b>EM-9175</b>  <b>MOUNT-ENGINE</b>  <b>Rear</b></p> <p>ACURA PASSENGER CAR ..... 2002-06            HONDA SPORT UTILITY ..... 2002-06</p>  <p style="text-align: center;"><b>EM-9176</b>  <b>MOUNT-TRANSMISSION</b>  <b>Auto</b></p> <p>NISSAN PASSENGER CAR ..... 1992-94</p>	 <p style="text-align: center;"><b>EM-9177</b>  <b>MOUNT-TRANSMISSION</b>  <b>Auto</b></p> <p>SUZUKI PASSENGER CAR ..... 2002-06</p>  <p style="text-align: center;"><b>EM-9178</b>  <b>MOUNT-ENGINE</b>  <b>Front</b></p> <p>ACURA PASSENGER CAR ..... 1997-99            HONDA PASSENGER CAR ..... 1995-97</p>  <p style="text-align: center;"><b>EM-9179</b>  <b>MOUNT-ENGINE</b>  <b>Rear</b></p> <p>LEXUS SPORT UTILITY ..... 1999-03</p>  <p style="text-align: center;"><b>EM-9180</b>  <b>MOUNT-ENGINE</b>  <b>L &amp; R Front</b></p> <p>INFINITI PASSENGER CAR ..... 2003-06            NISSAN PASSENGER CAR ..... 2003-09</p>	 <p style="text-align: center;"><b>EM-9181</b>  <b>MOUNT-ENGINE</b>  <b>Front</b></p> <p>MITSUBISHI PASSENGER            CAR ..... 2002-07</p>  <p style="text-align: center;"><b>EM-9182</b>  <b>MOUNT-ENGINE</b>  <b>RH Front</b></p> <p>MAZDA PASSENGER CAR ..... 2003-08</p>  <p style="text-align: center;"><b>EM-9183</b>  <b>MOUNT-TRANSMISSION</b>  <b>Auto</b></p> <p>HONDA PASSENGER CAR ..... 1997-01</p>
--	---	--	---

# BUYER'S GUIDE

## NUMERICAL LISTING - ILLUSTRATIONS

 <p style="text-align: center;"><b>EM-9184</b> <b>MOUNT-ENGINE</b> <b>RH Front</b></p> <p>CHRYSLER PASSENGER CAR ..... 2001-05 DODGE PASSENGER CAR ..... 2001-05 MITSUBISHI PASSENGER CAR ..... 1999-05</p>	 <p style="text-align: center;"><b>EM-9187</b> <b>MOUNT-ENGINE</b> <b>RH Front</b></p> <p>CHRYSLER PASSENGER CAR ..... 2001-05 DODGE PASSENGER CAR ..... 2001-05 MITSUBISHI PASSENGER CAR ..... 1999-05</p>	 <p style="text-align: center;"><b>EM-9190#</b> <b>MOUNT-ENGINE</b> <b>RH Front</b></p> <p>NISSAN PASSENGER CAR ..... 2002-06</p>	<p><b>EM-9193 (Continued)</b></p> <p>MITSUBISHI PASSENGER CAR ..... 1997-04</p>  <p style="text-align: center;"><b>EM-9194</b> <b>MOUNT-ENGINE</b> <b>Rear</b></p> <p>ACURA PASSENGER CAR ..... 2004-08 HONDA PASSENGER CAR ..... 2003-07</p>
 <p style="text-align: center;"><b>EM-9185</b> <b>MOUNT-ENGINE</b> <b>Front</b></p> <p>ACURA PASSENGER CAR ..... 1999 HONDA PASSENGER CAR ..... 1998-02</p>	 <p style="text-align: center;"><b>EM-9188</b> <b>MOUNT-ENGINE</b> <b>RH Front</b></p> <p>MITSUBISHI PASSENGER CAR ..... 2002-07</p>	 <p style="text-align: center;"><b>EM-9191</b> <b>MOUNT-ENGINE</b> <b>Front</b></p> <p>DODGE PASSENGER CAR ..... 1991-96 MITSUBISHI PASSENGER CAR ..... 1991-99</p>	 <p style="text-align: center;"><b>EM-9195</b> <b>Engine Torque Strut Mount</b> <b>Rear</b></p> <p>MAZDA PASSENGER CAR ..... 2003-05</p>
 <p style="text-align: center;"><b>EM-9186</b> <b>MOUNT-ENGINE</b> <b>L &amp; R Front</b></p> <p>MITSUBISHI SPORT UTILITY ..... 2001-06</p>	 <p style="text-align: center;"><b>EM-9189</b> <b>MOUNT-ENGINE</b> <b>RH Front</b></p> <p>MITSUBISHI PASSENGER CAR ..... 1997-04</p>	 <p style="text-align: center;"><b>EM-9192</b> <b>MOUNT-ENGINE</b> <b>Rear</b></p> <p>LEXUS SPORT UTILITY ..... 1999-03</p>	 <p style="text-align: center;"><b>EM-9196</b> <b>MOUNT-TRANSMISSION</b></p> <p>MAZDA PASSENGER CAR ..... 2004-09</p>
 <p style="text-align: center;"><b>EM-9193</b> <b>MOUNT-ENGINE</b> <b>Front</b></p> <p style="text-align: center;">(Continued Next Column)</p>	 <p style="text-align: center;"><b>EM-9197</b> <b>Engine Torque Strut Mount</b> <b>Front</b></p> <p>LEXUS PASSENGER CAR ..... 2002-06</p> <p style="text-align: center;">(Continued Next Page)</p>		

# = Available in the Westar Gold Line

# BUYER'S GUIDE

## NUMERICAL LISTING - ILLUSTRATIONS

**EM-9197 (Continued)**  
**Engine Torque Strut**  
**Front Right**

TOYOTA PASSENGER CAR ..... 2002-08



**EM-9198**  
**MOUNT-ENGINE**  
**RH Front**

EAGLE PASSENGER CAR ..... 1995-96  
 MITSUBISHI PASSENGER  
 CAR ..... 1995-99



**EM-9199**  
**MOUNT-TRANSMISSION**  
**Auto**

DODGE TRUCK ..... 1990-93  
 MITSUBISHI TRUCK ..... 1990-96



**EM-9200**  
**MOUNT-ENGINE**  
**Front**

NISSAN PASSENGER CAR ..... 2000-06



**EM-9201**  
**MOUNT-TRANSMISSION**

MITSUBISHI SPORT UTILITY ..... 2001-06



**EM-9202**  
**MOUNT-ENGINE**  
**Rear**

HONDA VAN ..... 1999-04



**EM-9203**  
**MOUNT-ENGINE**  
**RH Front**

MITSUBISHI PASSENGER  
 CAR ..... 1994-98



**EM-9204**  
**MOUNT-TRANSMISSION**  
**Manual**

ACURA PASSENGER CAR ..... 2001-05  
 HONDA PASSENGER CAR ..... 2001-05



**EM-9205**  
**MOUNT-TRANSMISSION**  
**Auto**

ACURA PASSENGER CAR ..... 2002-06

(Continued Next Column)

**EM-9205 (Continued)**

HONDA SPORT UTILITY ..... 2002-06



**EM-9206**  
**MOUNT-ENGINE**  
**LH Front**

EAGLE PASSENGER CAR ..... 1990-94  
 HYUNDAI PASSENGER CAR ..... 1992-94  
 MITSUBISHI PASSENGER  
 CAR ..... 1990-94  
 PLYMOUTH PASSENGER  
 CAR ..... 1990-94



**EM-9207**  
**MOUNT-ENGINE**  
**LH Front**

MITSUBISHI PASSENGER  
 CAR ..... 1989-92



**EM-9208**  
**MOUNT-ENGINE**  
**Rear**

AUDI PASSENGER CAR ..... 1998-06  
 SEAT PASSENGER CAR ..... 2001-08  
 VOLKSWAGEN PASSENGER  
 CAR ..... 1998-09



**EM-9209**  
**MOUNT-ENGINE**  
**Rear**

NISSAN PASSENGER CAR ..... 2002-06



**EM-9210**  
**Engine Torque Strut Mount**  
**Rear**

TOYOTA PASSENGER CAR ..... 2007-09



**EM-9211**  
**MOUNT-ENGINE**  
**Front**

TOYOTA PASSENGER CAR ..... 2002-08



**EM-9212**  
**MOUNT-ENGINE**  
**RH Front**

(Continued Next Page)

# BUYER'S GUIDE

## NUMERICAL LISTING - ILLUSTRATIONS

### EM-9212 (Continued)

LEXUS SPORT UTILITY ..... 2004-08  
 TOYOTA PASSENGER CAR ..... 2004-08

#### MOUNT-ENGINE Right

TOYOTA SPORT UTILITY ..... 2004-07  
 TOYOTA VAN ..... 2004-06

#### MOUNT-ENGINE RH Rear

LEXUS PASSENGER CAR ..... 2004-06



#### EM-9213 Engine Torque Strut Mount Upper

HONDA PASSENGER CAR ..... 2006-11



#### EM-9214 MOUNT-TRANSMISSION Rear

HONDA PASSENGER CAR ..... 2003-07



#### EM-9215 MOUNT-TRANSMISSION Front

ACURA PASSENGER CAR ..... 2004-06

#### MOUNT-TRANSMISSION

HONDA PASSENGER CAR ..... 2003-07



#### EM-9216 MOUNT-TRANSMISSION Auto

HONDA PASSENGER CAR ..... 2006-11



#### EM-9217 MOUNT-TRANSMISSION Auto

NISSAN PASSENGER CAR ..... 2000-06



#### EM-9218 Engine Torque Strut Mount Lower

HONDA PASSENGER CAR ..... 2006-11



#### EM-9219 MOUNT-TRANSMISSION Auto

NISSAN PASSENGER CAR ..... 2002-04  
 NISSAN VAN ..... 2004-06



#### EM-9220 MOUNT-TRANSMISSION Upper

ACURA PASSENGER CAR ..... 2004-08

#### MOUNT-TRANSMISSION Front Upper

HONDA PASSENGER CAR ..... 2003-07



#### EM-9221 Engine Torque Strut Mount Rear

MAZDA PASSENGER CAR ..... 2003-08



#### EM-9222 MOUNT-ENGINE Rear

MAZDA PASSENGER CAR ..... 2004-13  
 MAZDA VAN ..... 2006-10  
 VOLVO PASSENGER CAR ..... 2005-13



#### EM-9223# MOUNT-ENGINE Right

NISSAN PASSENGER CAR ..... 2002-08

#### MOUNT-ENGINE RH Front

NISSAN SPORT UTILITY ..... 2003-07  
 NISSAN VAN ..... 2004-09



#### EM-9224 MOUNT-TRANSMISSION Auto

INFINITI PASSENGER CAR ..... 1999-02

















#### EM-9225 MOUNT-TRANSMISSION Upper

HONDA PASSENGER CAR ..... 2003-07

# = Available in the Westar Gold Line

# BUYER'S GUIDE











## NUMERICAL LISTING - ILLUSTRATIONS

 <p style="text-align: center;"><b>EM-9226</b> Engine Torque Strut Mount Front</p> <p>TOYOTA VAN ..... 1998-03</p>	 <p style="text-align: center;"><b>EM-9230</b> MOUNT-TRANSMISSION</p> <p>NISSAN PASSENGER CAR ..... 2007-14</p>	 <p style="text-align: center;"><b>EM-9234</b> Engine Torque Strut Mount Front</p> <p>TOYOTA SPORT UTILITY ..... 2004-07</p>	 <p style="text-align: center;"><b>EM-9237</b> MOUNT-ENGINE MOUNT-ENGINE RH Front</p> <p>TOYOTA PASSENGER CAR ..... 2007-15</p> <p style="text-align: center;"><b>MOUNT-ENGINE Right</b></p> <p>TOYOTA SPORT UTILITY ..... 2009-15 TOYOTA VAN ..... 2011-12</p> <p style="text-align: center;"><b>MOUNT-ENGINE Rear</b></p> <p>TOYOTA SPORT UTILITY ..... 2014-16</p>
 <p style="text-align: center;"><b>EM-9227</b> Engine Torque Strut Front Right</p> <p>LEXUS SPORT UTILITY ..... 2004-06</p> <p style="text-align: center;"><b>Engine Torque Strut Mount Front</b></p> <p>TOYOTA SPORT UTILITY ..... 2001-07</p>	 <p style="text-align: center;"><b>EM-9231</b> Engine Torque Strut Front Right</p> <p>TOYOTA SPORT UTILITY ..... 2001-03</p>	 <p style="text-align: center;"><b>EM-9235</b> Engine Torque Strut Front Right</p> <p>TOYOTA SPORT UTILITY ..... 2001-03</p>	 <p style="text-align: center;"><b>EM-9238</b> MOUNT-ENGINE RH Front</p> <p>LEXUS PASSENGER CAR ..... 2007-12 LEXUS SPORT UTILITY ..... 2007-15 TOYOTA PASSENGER CAR ..... 2005-13 TOYOTA SPORT UTILITY ..... 2009-16 TOYOTA VAN ..... 2007-16</p>
 <p style="text-align: center;"><b>EM-9228</b> Engine Torque Strut Mount Rear</p> <p>CHEVROLET VAN ..... 2015-17 NISSAN PASSENGER CAR ..... 2007-14 NISSAN VAN ..... 2013-17</p>	 <p style="text-align: center;"><b>EM-9232</b> Engine Torque Strut Mount Right</p> <p>TOYOTA SPORT UTILITY ..... 2006-07</p> <p style="text-align: center;"><b>Engine Torque Strut Mount Rear</b></p> <p>LEXUS SPORT UTILITY ..... 2006-08</p>	 <p style="text-align: center;"><b>EM-9236</b> MOUNT-TRANSMISSION MOUNT-TRANSMISSION Auto</p> <p>LEXUS PASSENGER CAR ..... 2007-14 LEXUS SPORT UTILITY ..... 2010-15</p> <p>TOYOTA PASSENGER CAR ..... 2007-16 <b>MOUNT-TRANSMISSION</b></p> <p>TOYOTA SPORT UTILITY ..... 2009-16 TOYOTA VAN ..... 2011-16</p>	 <p style="text-align: center;"><b>EM-9239</b> MOUNT-ENGINE MOUNT-ENGINE RH Front</p> <p>LEXUS PASSENGER CAR ..... 2002-03 TOYOTA PASSENGER CAR ..... 2002-03</p> <p style="text-align: center;"><b>MOUNT-ENGINE Right</b></p> <p>TOYOTA SPORT UTILITY ..... 2001-03</p>
 <p style="text-align: center;"><b>EM-9229</b> MOUNT-ENGINE RH Front</p> <p>NISSAN PASSENGER CAR ..... 2000-06</p>	 <p style="text-align: center;"><b>EM-9233</b> Engine Torque Strut Mount Front</p> <p>TOYOTA SPORT UTILITY ..... 2004-07</p>		



# BUYER'S GUIDE

## NUMERICAL LISTING - ILLUSTRATIONS

 <p><b>EM-9240</b> <b>MOUNT-ENGINE</b> <b>L &amp; R Front</b></p> <p>CHEVROLET SPORT UTILITY .... 1999-04 SUZUKI SPORT UTILITY ..... 1999-06</p>	<p><b>EM-9244 (Continued)</b></p> <p>VOLVO SPORT UTILITY ..... 2003-06 <b>MOUNT-ENGINE</b> <b>Lower Rear</b></p> <p>VOLVO PASSENGER CAR ..... 1999-05 <b>MOUNT-ENGINE</b> <b>Rear</b></p> <p>VOLVO SPORT UTILITY ..... 2003-06</p> 	 <p><b>EM-9248</b> <b>MOUNT-ENGINE</b> <b>Rear</b></p> <p>NISSAN PASSENGER CAR ..... 2002-04 NISSAN SPORT UTILITY ..... 2003-07 NISSAN VAN ..... 2004-09</p>	 <p><b>EM-9252</b> <b>MOUNT-ENGINE</b> <b>Front</b></p> <p>NISSAN PASSENGER CAR ..... 2002-08 NISSAN SPORT UTILITY ..... 2003-07 NISSAN VAN ..... 2004-09</p>
 <p><b>EM-9241</b> <b>MOUNT-TRANSMISSION</b></p> <p>CHEVROLET SPORT UTILITY .... 1999-03 SUZUKI SPORT UTILITY ..... 1999-02</p>	<p><b>EM-9245</b> <b>MOUNT-TRANSMISSION</b> <b>Manual</b></p> <p>SEAT PASSENGER CAR ..... 2007-08 <b>MOUNT-TRANSMISSION</b> <b>Auto</b></p> <p>VOLKSWAGEN PASSENGER CAR ..... 2005-15</p>	 <p><b>EM-9249</b> <b>Engine Torque Strut Mount</b> <b>Rear Lower</b></p> <p>TOYOTA PASSENGER CAR ..... 2007-17</p>	 <p><b>EM-9253</b> <b>MOUNT-ENGINE</b> <b>Front</b></p> <p>DODGE PASSENGER CAR ..... 2004-06 HYUNDAI PASSENGER CAR ..... 2003-05</p>
 <p><b>EM-9242</b> <b>MOUNT-ENGINE</b> <b>RH Front</b></p> <p>SUZUKI PASSENGER CAR ..... 1995-00</p>	 <p><b>EM-9246</b> <b>Engine Torque Strut Mount</b> <b>Rear</b></p> <p>TOYOTA PASSENGER CAR ..... 2007-17</p>	 <p><b>EM-9250</b> <b>MOUNT-ENGINE</b> <b>Front</b></p> <p>HONDA PASSENGER CAR ..... 2007-08</p>	 <p><b>EM-9254</b> <b>MOUNT-ENGINE</b> <b>Rear</b></p> <p>DODGE PASSENGER CAR ..... 2005-06 HYUNDAI PASSENGER CAR ..... 2003-05</p>
 <p><b>EM-9244</b> <b>MOUNT-ENGINE</b> <b>L &amp; R Front</b></p> <p>VOLVO PASSENGER CAR ..... 1999-08 <b>MOUNT-ENGINE</b> <b>Front</b></p> <p><b>(Continued Next Column)</b></p>	 <p><b>EM-9247</b> <b>MOUNT-ENGINE</b> <b>Front</b></p> <p>ACURA PASSENGER CAR ..... 2004-08 HONDA PASSENGER CAR ..... 2003-07 HONDA VAN ..... 2005-07</p>	 <p><b>EM-9251</b> <b>MOUNT-ENGINE</b> <b>RH Front</b></p> <p>INFINITI PASSENGER CAR ..... 2000-01 NISSAN PASSENGER CAR ..... 2000-01</p>	













# BUYER'S GUIDE

## NUMERICAL LISTING - ILLUSTRATIONS

 <p style="text-align: center;"><b>EM-9255</b> <b>MOUNT-ENGINE</b> <b>RH Front</b></p> <p>DODGE PASSENGER CAR ..... 2005-06</p> <p style="text-align: center;"><b>MOUNT-ENGINE</b> <b>Front</b></p> <p>HYUNDAI PASSENGER CAR ..... 2003-05</p>	 <p style="text-align: center;"><b>EM-9258</b> <b>MOUNT-TRANSMISSION</b> <b>RH Rear</b></p> <p>AUDI PASSENGER CAR ..... 2000-07</p> <p style="text-align: center;"><b>MOUNT-TRANSMISSION</b> <b>L &amp; R</b></p> <p>VOLKSWAGEN PASSENGER CAR ..... 2001-05</p>	 <p style="text-align: center;"><b>EM-9261</b> <b>MOUNT-ENGINE</b> <b>Right</b></p> <p>AUDI PASSENGER CAR ..... 2004-06</p> <p style="text-align: center;"><b>MOUNT-ENGINE</b> <b>RH Front</b></p> <p>VOLKSWAGEN PASSENGER CAR ..... 1999-05</p>	 <p style="text-align: center;"><b>EM-9264</b> <b>SUBFRAME MOUNT</b> <b>FRONT LEFT</b></p> <p>VOLKSWAGEN PASSENGER CAR ..... 1999-05</p>
 <p style="text-align: center;"><b>EM-9256</b> <b>MOUNT-ENGINE</b> <b>Front</b></p> <p>NISSAN SPORT UTILITY ..... 2003-07</p>	 <p style="text-align: center;"><b>EM-9259</b> <b>MOUNT-ENGINE</b> <b>LH Front</b></p> <p>AUDI PASSENGER CAR ..... 2006-09</p> <p>VOLKSWAGEN PASSENGER CAR ..... 2005-14</p> <p style="text-align: center;"><b>SUBFRAME MOUNT</b> <b>FRONT LEFT</b></p> <p>AUDI PASSENGER CAR ..... 2006-16</p> <p>VOLKSWAGEN PASSENGER CAR ..... 2012-18</p>	 <p style="text-align: center;"><b>EM-9262</b> <b>MOUNT-TRANSMISSION</b> <b>Manual</b></p> <p>AUDI PASSENGER CAR ..... 2006-09</p> <p style="text-align: center;"><b>MOUNT-TRANSMISSION</b> <b>Auto</b></p> <p>SEAT PASSENGER CAR ..... 2005-06</p> <p style="text-align: center;"><b>MOUNT-TRANSMISSION</b></p> <p>VOLKSWAGEN PASSENGER CAR ..... 2006-10</p>	 <p style="text-align: center;"><b>EM-9265</b> <b>MOUNT-ENGINE</b> <b>L &amp; R Front</b></p> <p>MERCEDES-BENZ SPORT UTILITY ..... 1998-05</p>
 <p style="text-align: center;"><b>EM-9257</b> <b>MOUNT-ENGINE</b> <b>RH Front</b></p> <p>AUDI PASSENGER CAR ..... 2006-09</p> <p>VOLKSWAGEN PASSENGER CAR ..... 2005-14</p> <p style="text-align: center;"><b>SUBFRAME MOUNT</b> <b>FRONT RIGHT</b></p> <p>AUDI PASSENGER CAR ..... 2006-16</p> <p>VOLKSWAGEN PASSENGER CAR ..... 2012-18</p>	 <p style="text-align: center;"><b>EM-9260</b> <b>MOUNT-ENGINE</b> <b>Front Lower</b></p> <p>SEAT PASSENGER CAR ..... 2005-08</p> <p style="text-align: center;"><b>MOUNT-ENGINE</b> <b>LH Front Lower</b></p> <p>VOLKSWAGEN PASSENGER CAR ..... 2005-12</p> <p style="text-align: center;"><b>MOUNT-ENGINE</b> <b>Lower Rear</b></p> <p>AUDI PASSENGER CAR ..... 2006-13</p> <p>VOLKSWAGEN PASSENGER CAR ..... 2006-12</p>	 <p style="text-align: center;"><b>EM-9263</b> <b>MOUNT-ENGINE</b> <b>LH Front Upper</b></p> <p>AUDI PASSENGER CAR ..... 2006-13</p> <p style="text-align: center;"><b>MOUNT-ENGINE</b> <b>Front Upper</b></p> <p>SEAT PASSENGER CAR ..... 2005-08</p> <p style="text-align: center;"><b>MOUNT-ENGINE</b> <b>LH Front Upper</b></p> <p>VOLKSWAGEN PASSENGER CAR ..... 2005-12</p> <p style="text-align: center;"><b>MOUNT-ENGINE</b> <b>RH Rear</b></p> <p>VOLKSWAGEN PASSENGER CAR ..... 2005-06</p>	 <p style="text-align: center;"><b>EM-9266</b> <b>MOUNT-TRANSMISSION</b></p> <p>MERCEDES-BENZ PASSENGER CAR ..... 1984-96</p>
			 <p style="text-align: center;"><b>EM-9267</b> <b>MOUNT-TRANSMISSION</b></p> <p>MERCEDES-BENZ SPORT UTILITY ..... 1998-05</p>

# BUYER'S GUIDE

## NUMERICAL LISTING - ILLUSTRATIONS

 <p style="text-align: center;"><b>EM-9268</b> <b>MOUNT-TRANSMISSION</b></p> <p>CHRYSLER PASSENGER CAR ..... 2004-08 MERCEDES-BENZ PASSENGER CAR ..... 1996-14</p>	 <p style="text-align: center;"><b>EM-9271</b> <b>MOUNT-ENGINE</b> <b>LH Front</b></p> <p>BMW PASSENGER CAR ..... 1995-03</p>	 <p style="text-align: center;"><b>EM-9274</b> <b>MOUNT-ENGINE</b> <b>LH Front</b></p> <p>BMW PASSENGER CAR ..... 1993-97</p>	 <p style="text-align: center;"><b>EM-9278</b> <b>MOUNT-ENGINE</b> <b>RH Front</b></p> <p>MITSUBISHI PASSENGER CAR ..... 2004-09</p>
 <p style="text-align: center;"><b>EM-9269</b> <b>MOUNT-ENGINE</b> <b>L &amp; R Front</b></p> <p>MERCEDES-BENZ PASSENGER CAR ..... 1984-85</p>	 <p style="text-align: center;"><b>EM-9272</b> <b>MOUNT-ENGINE</b> <b>RH Front</b></p> <p>BMW PASSENGER CAR ..... 1995-03</p>	 <p style="text-align: center;"><b>EM-9275</b> <b>MOUNT-ENGINE</b> <b>L &amp; R Front</b></p> <p>BMW PASSENGER CAR ..... 1988-93</p>	 <p style="text-align: center;"><b>EM-9279</b> <b>MOUNT-ENGINE</b> <b>RH Front</b></p> <p>TOYOTA PASSENGER CAR ..... 2007-11</p>
 <p style="text-align: center;"><b>EM-9270</b> <b>MOUNT-ENGINE</b> <b>L &amp; R Front</b></p> <p>MERCEDES-BENZ PASSENGER CAR ..... 1984-85</p>	 <p style="text-align: center;"><b>EM-9273</b> <b>MOUNT-ENGINE</b> <b>RH Front</b></p> <p>BMW PASSENGER CAR ..... 1993-97</p>	 <p style="text-align: center;"><b>EM-9276</b> <b>MOUNT-ENGINE</b> <b>L &amp; R Front</b></p> <p>BMW PASSENGER CAR ..... 1997-03</p>	 <p style="text-align: center;"><b>EM-9280</b> <b>MOUNT-ENGINE</b> <b>Front</b></p> <p>HONDA PASSENGER CAR ..... 2006-11</p>
		 <p style="text-align: center;"><b>EM-9277</b> <b>MOUNT-ENGINE</b> <b>LH Front</b></p> <p>HONDA PASSENGER CAR ..... 2001-05</p>	



# BUYER'S GUIDE

## NUMERICAL LISTING - ILLUSTRATIONS

 <p style="text-align: center;"><b>EM-9281</b> <b>MOUNT-ENGINE</b> <b>RH Front</b></p> <p>MITSUBISHI PASSENGER CAR ..... 2004-12</p>	 <p style="text-align: center;"><b>EM-9284</b> <b>MOUNT-TRANSMISSION</b> <b>Auto</b></p> <p>SCION PASSENGER CAR ..... 2004-06 SCION VAN ..... 2004-06 TOYOTA PASSENGER CAR ..... 2001-03</p>	 <p style="text-align: center;"><b>EM-9288</b> <b>MOUNT-TRANSMISSION</b> <b>Auto</b></p> <p>INFINITI PASSENGER CAR ..... 1991-96</p>	<p><b>EM-9291 (Continued)</b> SAAB PASSENGER CAR ..... 1994-03</p>  <p style="text-align: center;"><b>EM-9292</b> <b>Engine Torque Strut Mount</b> <b>Front</b></p> <p>SAAB PASSENGER CAR ..... 2000-09</p>
 <p style="text-align: center;"><b>EM-9282</b> <b>MOUNT-ENGINE</b> <b>RH Front</b></p> <p>ACURA PASSENGER CAR ..... 2006-09 HONDA PASSENGER CAR ..... 2006-10</p>	 <p style="text-align: center;"><b>EM-9285</b> <b>MOUNT-TRANSMISSION</b> <b>Auto</b></p> <p>HONDA PASSENGER CAR ..... 2007-08</p>	 <p style="text-align: center;"><b>EM-9289</b> <b>MOUNT-ENGINE</b> <b>LH Rear</b></p> <p>SAAB PASSENGER CAR ..... 1990-98</p>	 <p style="text-align: center;"><b>EM-9293</b> <b>MOUNT-ENGINE</b> <b>Front</b></p> <p>SAAB PASSENGER CAR ..... 1986-89</p>
 <p style="text-align: center;"><b>EM-9283</b> <b>MOUNT-ENGINE</b> <b>Rear</b></p> <p>AUDI PASSENGER CAR ..... 2006-16 SEAT PASSENGER CAR ..... 2005-08 VOLKSWAGEN PASSENGER CAR ..... 2005-14</p>	 <p style="text-align: center;"><b>EM-9286</b> <b>MOUNT-TRANSMISSION</b> <b>Manual</b></p> <p>HONDA PASSENGER CAR ..... 2007-08</p>	 <p style="text-align: center;"><b>EM-9290</b> <b>Engine Torque Strut Mount</b> <b>Front</b></p> <p>SAAB PASSENGER CAR ..... 1999</p>  <p style="text-align: center;"><b>EM-9290</b> <b>Engine Torque Strut Mount</b> <b>Rear</b></p> <p>SAAB PASSENGER CAR ..... 1999</p>	 <p style="text-align: center;"><b>EM-9294</b> <b>MOUNT-ENGINE</b> <b>Rear</b></p> <p>SAAB PASSENGER CAR ..... 1986-89</p>
 <p style="text-align: center;"><b>EM-9287</b> <b>MOUNT-TRANSMISSION</b> <b>Manual</b></p> <p>AUDI PASSENGER CAR ..... 2005-07</p>	 <p style="text-align: center;"><b>EM-9291</b> <b>MOUNT-ENGINE</b> <b>Rear</b></p> <p style="text-align: center;">(Continued Next Column)</p>	 <p style="text-align: center;"><b>EM-9295</b> <b>MOUNT-TRANSMISSION</b> <b>Manual</b></p> <p>HYUNDAI PASSENGER CAR ..... 2003-05</p>	













# BUYER'S GUIDE

## NUMERICAL LISTING - ILLUSTRATIONS

 <p><b>EM-9296</b> <b>MOUNT-TRANSMISSION</b> <b>Auto</b></p> <p>HYUNDAI PASSENGER CAR ..... 2003-05</p>	 <p><b>EM-9299</b> <b>MOUNT-ENGINE</b> <b>RH Front</b></p> <p>ACURA SPORT UTILITY ..... 2003-06 HONDA SPORT UTILITY ..... 2005-08</p>	 <p><b>EM-9302</b> <b>Engine Torque Strut Mount</b> <b>Right Upper</b></p> <p>HONDA SPORT UTILITY ..... 2007-11</p>	 <p><b>EM-9306</b> <b>MOUNT-ENGINE</b> <b>Rear</b></p> <p>HYUNDAI SPORT UTILITY ..... 2005-09 KIA SPORT UTILITY ..... 2005-09</p>
 <p><b>EM-9297</b> <b>MOUNT-ENGINE</b> <b>RH Front</b></p> <p>ACURA PASSENGER CAR ..... 2004-08</p> <p><b>MOUNT-ENGINE</b> <b>Right</b></p> <p>HONDA PASSENGER CAR ..... 2003-07 HONDA PASSENGER CAR ..... 2003-07</p>	 <p><b>EM-9300</b> <b>MOUNT-ENGINE</b> <b>Rear</b></p> <p>ACURA SPORT UTILITY ..... 2001-06 HONDA SPORT UTILITY ..... 2003-08 HONDA TRUCK ..... 2006-14</p>	 <p><b>EM-9303</b> <b>Engine Torque Strut Mount</b> <b>Right Lower</b></p> <p>HONDA SPORT UTILITY ..... 2007-11</p>	 <p><b>EM-9307</b> <b>MOUNT-ENGINE</b> <b>Front</b></p> <p>HYUNDAI PASSENGER CAR ..... 2003-08</p>
 <p><b>EM-9298</b> <b>MOUNT-TRANSMISSION</b> <b>Rear</b></p> <p>ACURA SPORT UTILITY ..... 2003-06 HONDA SPORT UTILITY ..... 2006-08</p>	 <p><b>EM-9301</b> <b>MOUNT-TRANSMISSION</b> <b>Front</b></p> <p>ACURA SPORT UTILITY ..... 2003-06 HONDA SPORT UTILITY ..... 2006-08 HONDA TRUCK ..... 2006-08</p>	 <p><b>EM-9304</b> <b>MOUNT-TRANSMISSION</b></p> <p>MITSUBISHI PASSENGER CAR ..... 2004-12</p>	 <p><b>EM-9308</b> <b>MOUNT-TRANSMISSION</b></p> <p>HYUNDAI PASSENGER CAR ..... 2006-09 KIA PASSENGER CAR ..... 2006-09</p>
		 <p><b>EM-9305</b> <b>MOUNT-ENGINE</b> <b>Front</b></p> <p>MITSUBISHI PASSENGER CAR ..... 2004-12 MITSUBISHI SPORT UTILITY ..... 2004-11</p>	







# BUYER'S GUIDE

## NUMERICAL LISTING - ILLUSTRATIONS

 <p><b>EM-9309</b> <b>MOUNT-ENGINE</b> <b>Front Lower</b></p> <p>HYUNDAI PASSENGER CAR ..... 2006-11 KIA PASSENGER CAR ..... 2006-11</p>	 <p><b>EM-9312</b> <b>MOUNT-ENGINE</b> <b>Front</b></p> <p>KIA PASSENGER CAR ..... 2004-09</p>	 <p><b>EM-9315</b> <b>MOUNT-ENGINE</b> <b>Rear</b></p> <p>HYUNDAI SPORT UTILITY ..... 2007-12</p>	 <p><b>EM-9318</b> <b>MOUNT-ENGINE</b> <b>Rear</b></p> <p>HYUNDAI PASSENGER CAR ..... 2005-10</p>
 <p><b>EM-9310</b> <b>MOUNT-ENGINE</b> <b>Rear</b></p> <p>HYUNDAI PASSENGER CAR ..... 2006-11 KIA PASSENGER CAR ..... 2006-11</p>	 <p><b>EM-9313</b> <b>MOUNT-ENGINE</b> <b>Rear</b></p> <p>KIA PASSENGER CAR ..... 2004-09</p>	 <p><b>EM-9316</b> <b>MOUNT-ENGINE</b> <b>Rear</b></p> <p>HYUNDAI PASSENGER CAR ..... 2007-11</p>	 <p><b>EM-9319</b> <b>MOUNT-TRANSMISSION</b> <b>Manual</b></p> <p>KIA PASSENGER CAR ..... 2004-09</p>
 <p><b>EM-9311</b> <b>MOUNT-ENGINE</b> <b>Front</b></p> <p>KIA PASSENGER CAR ..... 2006-10</p>	 <p><b>EM-9314</b> <b>MOUNT-ENGINE</b> <b>Rear</b></p> <p>HYUNDAI PASSENGER CAR ..... 2003-08</p>	 <p><b>EM-9317</b> <b>MOUNT-ENGINE</b> <b>Front</b></p> <p>HYUNDAI PASSENGER CAR ..... 2005-17 KIA PASSENGER CAR ..... 2007-09</p>	 <p><b>EM-9320</b> <b>MOUNT-TRANSMISSION</b> <b>Auto</b></p> <p>KIA SPORT UTILITY ..... 2005-09</p>
			 <p><b>EM-9322</b> <b>MOUNT-ENGINE</b> <b>Front</b></p> <p style="text-align: right;">(Continued Next Page)</p>



# BUYER'S GUIDE

## NUMERICAL LISTING - ILLUSTRATIONS

<p><b>EM-9322 (Continued)</b>            HYUNDAI SPORT UTILITY ..... 2005-09            KIA SPORT UTILITY ..... 2005-09</p>  <p><b>EM-9323</b>  <b>MOUNT-ENGINE</b>  <b>Rear</b>            KIA PASSENGER CAR ..... 2005-10</p>	 <p><b>EM-9326</b>  <b>MOUNT-ENGINE</b>  <b>Rear</b>            KIA PASSENGER CAR ..... 2004-06</p>	 <p><b>EM-9330</b>  <b>MOUNT-ENGINE</b>  <b>Rear</b>            KIA PASSENGER CAR ..... 2007-09</p>	 <p><b>EM-9334</b>  <b>MOUNT-TRANSMISSION</b>            KIA PASSENGER CAR ..... 2006-10</p>
 <p><b>EM-9324</b>  <b>MOUNT-ENGINE</b>  <b>Front Upper</b>            HYUNDAI PASSENGER CAR ..... 2006-11            KIA PASSENGER CAR ..... 2006-11</p>	 <p><b>EM-9327</b>  <b>MOUNT-ENGINE</b>  <b>Rear Upper</b>            KIA PASSENGER CAR ..... 2004-09</p>	 <p><b>EM-9331</b>  <b>MOUNT-ENGINE</b>  <b>L &amp; R Front</b>            KIA SPORT UTILITY ..... 2003-06</p>	 <p><b>EM-9335</b>  <b>MOUNT-ENGINE</b>  <b>RH Front</b>            KIA PASSENGER CAR ..... 2005-10</p>
 <p><b>EM-9325</b>  <b>MOUNT-ENGINE</b>  <b>RH Front</b>            KIA PASSENGER CAR ..... 2004-09</p>	 <p><b>EM-9328</b>  <b>MOUNT-ENGINE</b>  <b>Front Upper</b>            KIA PASSENGER CAR ..... 2004-09</p>	 <p><b>EM-9332</b>  <b>MOUNT-ENGINE</b>  <b>RH Front</b>            KIA PASSENGER CAR ..... 2007-09</p>	 <p><b>EM-9336</b>  <b>MOUNT-TRANSMISSION</b>  <b>Manual</b>            KIA SPORT UTILITY ..... 2003-06</p>
 <p><b>EM-9329</b>  <b>MOUNT-ENGINE</b>  <b>L &amp; R Front</b>            KIA SPORT UTILITY ..... 2007-10</p>	 <p><b>EM-9333</b>  <b>MOUNT-TRANSMISSION</b>            KIA PASSENGER CAR ..... 2007-09</p>	 <p><b>EM-9337</b>  <b>MOUNT-TRANSMISSION</b>  <b>Auto</b>            KIA PASSENGER CAR ..... 2004-09</p>	

# BUYER'S GUIDE



## NUMERICAL LISTING - ILLUSTRATIONS

 <p style="text-align: center;"><b>EM-9338</b> <b>MOUNT-ENGINE</b> <b>Front</b></p> <p>HYUNDAI SPORT UTILITY ..... 2005-09 KIA SPORT UTILITY ..... 2005-09</p>	 <p style="text-align: center;"><b>EM-9341</b> <b>MOUNT-TRANSMISSION</b></p> <p>HYUNDAI SPORT UTILITY ..... 2007-12</p>	<p><b>EM-9344 (Continued)</b> HYUNDAI PASSENGER CAR ..... 2009-12</p>  <p style="text-align: center;"><b>EM-9345</b> <b>MOUNT-ENGINE</b> <b>RH Front</b></p> <p>HYUNDAI PASSENGER CAR ..... 2007-12 KIA PASSENGER CAR ..... 2010-13</p>	 <p style="text-align: center;"><b>EM-9348</b> <b>MOUNT-ENGINE</b> <b>Front</b></p> <p>HYUNDAI SPORT UTILITY ..... 2007-12</p>
 <p style="text-align: center;"><b>EM-9339</b> <b>MOUNT-TRANSMISSION</b></p> <p>HYUNDAI PASSENGER CAR ..... 2007-12</p>	 <p style="text-align: center;"><b>EM-9342</b> <b>MOUNT-TRANSMISSION</b></p> <p>KIA PASSENGER CAR ..... 2007-10</p>	 <p style="text-align: center;"><b>EM-9346</b> <b>MOUNT-ENGINE</b> <b>RH Front</b></p> <p>KIA PASSENGER CAR ..... 2003-05</p>	 <p style="text-align: center;"><b>EM-9349</b> <b>MOUNT-TRANSMISSION</b></p> <p>HYUNDAI VAN ..... 2007-08 KIA VAN ..... 2006-12</p>
 <p style="text-align: center;"><b>EM-9340</b> <b>MOUNT-ENGINE</b> <b>RH Front</b></p> <p>HYUNDAI PASSENGER CAR ..... 2006-11</p>	 <p style="text-align: center;"><b>EM-9343</b> <b>MOUNT-ENGINE</b> <b>RH Front</b></p> <p>HYUNDAI VAN ..... 2007-08 KIA VAN ..... 2006-09</p>	 <p style="text-align: center;"><b>EM-9347</b> <b>MOUNT-ENGINE</b> <b>Rear</b></p> <p>HYUNDAI VAN ..... 2007-08 KIA VAN ..... 2006-14</p>	 <p style="text-align: center;"><b>EM-9350</b> <b>MOUNT-TRANSMISSION</b></p> <p>HYUNDAI PASSENGER CAR ..... 2009</p>
 <p style="text-align: center;"><b>EM-9344</b> <b>MOUNT-ENGINE</b> <b>L &amp; R Front</b></p> <p style="text-align: center;">(Continued Next Column)</p>	 <p style="text-align: center;"><b>EM-9351</b> <b>MOUNT-ENGINE</b> <b>Front</b></p> <p>KIA VAN ..... 2002-05</p>		

















# BUYER'S GUIDE

## NUMERICAL LISTING - ILLUSTRATIONS

 <p><b>EM-9352</b> <b>MOUNT-ENGINE</b> <b>Rear</b></p> <p>HYUNDAI PASSENGER CAR ..... 2003-05</p>	 <p><b>EM-9355</b> <b>MOUNT-ENGINE</b> <b>RH Front</b></p> <p>HYUNDAI SPORT UTILITY ..... 2007-12</p>	 <p><b>EM-9359</b> <b>MOUNT-ENGINE</b> <b>Rear</b></p> <p>KIA VAN ..... 2002-05</p>	 <p><b>EM-9363</b> <b>MOUNT-ENGINE</b> <b>RH Front</b></p> <p>HYUNDAI PASSENGER CAR ..... 2009-10</p>
 <p><b>EM-9353</b> <b>MOUNT-ENGINE</b> <b>RH Front</b></p> <p>HYUNDAI PASSENGER CAR ..... 2005-11</p>	 <p><b>EM-9356</b> <b>MOUNT-TRANSMISSION</b></p> <p>HYUNDAI PASSENGER CAR ..... 2009-12</p>	 <p><b>EM-9360</b> <b>MOUNT-ENGINE</b> <b>Front</b></p> <p>KIA PASSENGER CAR ..... 2010-13</p>	 <p><b>EM-9364</b> <b>MOUNT-TRANSMISSION</b> <b>Manual</b></p> <p>HYUNDAI PASSENGER CAR ..... 2005-08</p>
 <p><b>EM-9354</b> <b>MOUNT-ENGINE</b> <b>Rear</b></p> <p>HYUNDAI PASSENGER CAR ..... 2006-17</p>	 <p><b>EM-9357</b> <b>MOUNT-ENGINE</b> <b>Front</b></p> <p>HYUNDAI PASSENGER CAR ..... 2009-12</p>	 <p><b>EM-9361</b> <b>MOUNT-TRANSMISSION</b> <b>Auto</b></p> <p>HYUNDAI PASSENGER CAR ..... 2006-10</p>	 <p><b>EM-9365</b> <b>MOUNT-ENGINE</b> <b>Rear</b></p> <p>HYUNDAI PASSENGER CAR ..... 1995-98</p>
	 <p><b>EM-9358</b> <b>MOUNT-ENGINE</b> <b>RH Front</b></p> <p>HYUNDAI PASSENGER CAR ..... 2003-06</p>	 <p><b>EM-9362</b> <b>MOUNT-ENGINE</b> <b>Front</b></p> <p>KIA PASSENGER CAR ..... 2006-09</p>	













# BUYER'S GUIDE

## NUMERICAL LISTING - ILLUSTRATIONS

 <p><b>EM-9366</b> <b>MOUNT-TRANSMISSION</b></p> <p>HYUNDAI PASSENGER CAR ..... 2003-08</p>	 <p><b>EM-9369</b> <b>MOUNT-TRANSMISSION</b> <b>Manual</b></p> <p>HYUNDAI PASSENGER CAR ..... 2005-08</p>	 <p><b>EM-9373</b> <b>MOUNT-TRANSMISSION</b> <b>Auto</b></p> <p>HYUNDAI PASSENGER CAR ..... 2002-05 KIA PASSENGER CAR ..... 2001-06</p>	 <p><b>EM-9376</b> <b>MOUNT-TRANSMISSION</b></p> <p>HYUNDAI PASSENGER CAR ..... 2001-08</p>
 <p><b>EM-9367</b> <b>MOUNT-TRANSMISSION</b> <b>Manual</b></p> <p>HYUNDAI PASSENGER CAR ..... 2002-05 KIA PASSENGER CAR ..... 2001-06</p>	 <p><b>EM-9370</b> <b>MOUNT-TRANSMISSION</b></p> <p>HYUNDAI PASSENGER CAR ..... 2006-10</p>	 <p><b>EM-9374</b> <b>MOUNT-TRANSMISSION</b> <b>Auto</b></p> <p>HYUNDAI SPORT UTILITY ..... 2005-09 KIA SPORT UTILITY ..... 2005-09</p>	 <p><b>EM-9377</b> <b>MOUNT-ENGINE</b> <b>Front</b></p> <p>HYUNDAI PASSENGER CAR ..... 2007-12</p>
 <p><b>EM-9368</b> <b>MOUNT-ENGINE</b> <b>RH Front</b></p> <p>HYUNDAI SPORT UTILITY ..... 2005-09 KIA SPORT UTILITY ..... 2005-09</p>	 <p><b>EM-9371</b> <b>MOUNT-ENGINE</b> <b>Front</b></p> <p>HYUNDAI SPORT UTILITY ..... 2003-06</p>	 <p><b>EM-9375</b> <b>MOUNT-ENGINE</b> <b>Front</b></p> <p>HYUNDAI VAN ..... 2007-08 KIA VAN ..... 2006-10</p>	 <p><b>EM-9378</b> <b>MOUNT-TRANSMISSION</b></p> <p>HYUNDAI SPORT UTILITY ..... 2005-08 KIA SPORT UTILITY ..... 2005-09</p>
	 <p><b>EM-9372</b> <b>MOUNT-ENGINE</b> <b>RH Front</b></p> <p>HYUNDAI PASSENGER CAR ..... 2003-08</p>		 <p><b>EM-9379</b> <b>MOUNT-ENGINE</b> <b>RH Front</b></p> <p>HYUNDAI PASSENGER CAR ..... 2006</p>

# BUYER'S GUIDE

## NUMERICAL LISTING - ILLUSTRATIONS

 <p style="text-align: center;"><b>EM-9380</b> <b>MOUNT-TRANSMISSION</b> <b>Manual</b></p> <p>HYUNDAI SPORT UTILITY ..... 2005-09 KIA SPORT UTILITY ..... 2005-09</p>	 <p style="text-align: center;"><b>EM-9383</b> <b>MOUNT-TRANSMISSION</b> <b>Auto</b></p> <p>MITSUBISHI PASSENGER CAR ..... 2004-06 MITSUBISHI SPORT UTILITY ..... 2004-11</p>	 <p style="text-align: center;"><b>EM-9386</b> <b>Engine Torque Strut Mount</b> <b>Lower</b></p> <p>ACURA PASSENGER CAR ..... 2006-10 HONDA PASSENGER CAR ..... 2006-10</p>	 <p style="text-align: center;"><b>EM-9390</b> <b>MOUNT-ENGINE</b> <b>Front</b></p> <p>TOYOTA PASSENGER CAR ..... 2014-17</p>
 <p style="text-align: center;"><b>EM-9381</b> <b>MOUNT-TRANSMISSION</b> <b>Auto</b></p> <p>HYUNDAI PASSENGER CAR ..... 2009-10</p>	 <p style="text-align: center;"><b>EM-9384</b> <b>MOUNT-TRANSMISSION</b> <b>LH</b></p> <p>CHRYSLER PASSENGER CAR ..... 2001-05 DODGE PASSENGER CAR ..... 2001-05 MITSUBISHI PASSENGER CAR ..... 1999-05</p>	 <p style="text-align: center;"><b>EM-9387</b> <b>MOUNT-TRANSMISSION</b></p> <p>MITSUBISHI PASSENGER CAR ..... 1997-04</p>	 <p style="text-align: center;"><b>EM-9391</b> <b>MOUNT-ENGINE</b> <b>Front</b></p> <p>PONTIAC PASSENGER CAR ..... 2009-10 TOYOTA PASSENGER CAR ..... 2009-13</p>
 <p style="text-align: center;"><b>EM-9382</b> <b>MOUNT-ENGINE</b> <b>Rear</b></p> <p>MITSUBISHI PASSENGER CAR ..... 2004-12</p>	 <p style="text-align: center;"><b>EM-9385</b> <b>Engine Torque Strut Mount</b> <b>Upper</b></p> <p>ACURA PASSENGER CAR ..... 2006-10 HONDA PASSENGER CAR ..... 2006-10</p>	 <p style="text-align: center;"><b>EM-9388</b> <b>Engine Torque Strut</b> <b>Front Right</b></p> <p>TOYOTA PASSENGER CAR ..... 2000-04</p>	 <p style="text-align: center;"><b>EM-9392</b> <b>MOUNT-ENGINE</b> <b>Rear</b></p> <p>CHRYSLER PASSENGER CAR ..... 1996-00 DODGE PASSENGER CAR ..... 1995-00</p>
		 <p style="text-align: center;"><b>EM-9389</b> <b>MOUNT-ENGINE</b> <b>RH Front</b></p> <p>ACURA SPORT UTILITY ..... 2001-02 HONDA SPORT UTILITY ..... 2003-04</p>	



# BUYER'S GUIDE

## NUMERICAL LISTING - ILLUSTRATIONS

 <p style="text-align: center;"><b>EM-9393</b> <b>MOUNT-ENGINE</b> <b>Rear</b></p> <p>TOYOTA SPORT UTILITY ..... 2001-05</p>	 <p style="text-align: center;"><b>EM-9396</b> <b>MOUNT-ENGINE</b> <b>Rear</b></p> <p>ACURA PASSENGER CAR ..... 2002-06 HONDA PASSENGER CAR ..... 2002-05</p>	<p><b>EM-9401 (Continued)</b></p> <p>VOLKSWAGEN PASSENGER CAR ..... 2006-15</p> <p style="text-align: center;"><b>MOUNT-ENGINE</b> <b>L &amp; R Rear</b></p> <p>VOLKSWAGEN PASSENGER CAR ..... 2009-15</p> 	 <p style="text-align: center;"><b>EM-9405</b> <b>MOUNT-ENGINE</b> <b>Right</b></p> <p>AUDI PASSENGER CAR ..... 2006-09 VOLKSWAGEN PASSENGER CAR ..... 2006-15</p>
 <p style="text-align: center;"><b>EM-9394</b> <b>MOUNT-ENGINE</b> <b>Rear</b></p> <p>CHRYSLER PASSENGER CAR ..... 1995-99 DODGE PASSENGER CAR ..... 1995-99 MITSUBISHI PASSENGER CAR ..... 1995-99</p>	 <p style="text-align: center;"><b>EM-9397</b> <b>MOUNT-TRANSMISSION</b></p> <p>HONDA SPORT UTILITY ..... 2007-11</p>	<p style="text-align: center;"><b>EM-9402</b> <b>MOUNT-ENGINE</b> <b>RH Front</b></p> <p>AUDI PASSENGER CAR ..... 2010-16</p> <p style="text-align: center;"><b>MOUNT-ENGINE</b> <b>Front</b></p> <p>VOLKSWAGEN PASSENGER CAR ..... 2009-11</p>	 <p style="text-align: center;"><b>EM-9406</b> <b>MOUNT-ENGINE</b> <b>LH Front</b></p> <p>AUDI PASSENGER CAR ..... 2006-11</p>
 <p style="text-align: center;"><b>EM-9395</b> <b>MOUNT-TRANSMISSION</b> <b>Auto</b></p> <p>INFINITI SPORT UTILITY ..... 2001-03 NISSAN SPORT UTILITY ..... 2001-04</p>	 <p style="text-align: center;"><b>EM-9400</b> <b>MOUNT-ENGINE</b> <b>Rear</b></p> <p>PONTIAC PASSENGER CAR ..... 2009-10 TOYOTA PASSENGER CAR ..... 2009-17</p>	<p style="text-align: center;"><b>EM-9403</b> <b>MOUNT-ENGINE</b> <b>L &amp; R Front</b></p> <p>AUDI PASSENGER CAR ..... 2005-08</p>	 <p style="text-align: center;"><b>EM-9407</b> <b>MOUNT-ENGINE</b> <b>RH Front</b></p> <p>AUDI PASSENGER CAR ..... 2006-11</p>
 <p style="text-align: center;"><b>EM-9401</b> <b>MOUNT-ENGINE</b> <b>L &amp; R Front</b></p> <p style="text-align: center;">(Continued Next Column)</p>	<p style="text-align: center;"><b>EM-9404</b> <b>MOUNT-ENGINE</b> <b>L &amp; R Front</b></p> <p>BMW PASSENGER CAR ..... 1986-92</p>		

# BUYER'S GUIDE

## NUMERICAL LISTING - ILLUSTRATIONS

 <p style="text-align: center;"><b>EM-9408</b> <b>MOUNT-ENGINE</b> <b>L &amp; R Front</b></p> <p>INFINITI SPORT UTILITY ..... 2001-03 NISSAN SPORT UTILITY ..... 2001-04</p>	 <p style="text-align: center;"><b>EM-9411</b> <b>MOUNT-ENGINE</b> <b>RH Front</b></p> <p>HONDA SPORT UTILITY ..... 2009-15 HONDA VAN ..... 2005-06</p>	<p><b>EM-9414 (Continued)</b> <b>MOUNT-TRANSMISSION</b> <b>Auto</b></p> <p>NISSAN SPORT UTILITY ..... 2003-07</p>  <p style="text-align: center;"><b>EM-9415</b> <b>MOUNT-ENGINE</b> <b>RH Front</b></p> <p>HONDA VAN ..... 2007-17</p>	 <p style="text-align: center;"><b>EM-9418</b> <b>MOUNT-ENGINE</b> <b>Rear</b></p> <p>PONTIAC PASSENGER CAR ..... 2003-06 TOYOTA PASSENGER CAR ..... 2003-06</p>
 <p style="text-align: center;"><b>EM-9409</b> <b>MOUNT-TRANSMISSION</b> <b>Front</b></p> <p>HONDA PASSENGER CAR ..... 2003-05</p>	 <p style="text-align: center;"><b>EM-9412</b> <b>MOUNT-ENGINE</b> <b>RH Front</b></p> <p>PONTIAC PASSENGER CAR ..... 2003-06 TOYOTA PASSENGER CAR ..... 2003-06</p>	 <p style="text-align: center;"><b>EM-9416</b> <b>MOUNT-ENGINE</b> <b>L &amp; R Front</b></p> <p>INFINITI PASSENGER CAR ..... 2003-06 INFINITI SPORT UTILITY ..... 2003-08</p>	 <p style="text-align: center;"><b>EM-9419</b> <b>MOUNT-ENGINE</b> <b>Front</b></p> <p>PONTIAC PASSENGER CAR ..... 2009-10 TOYOTA PASSENGER CAR ..... 2009-11</p>
 <p style="text-align: center;"><b>EM-9410</b> <b>MOUNT-TRANSMISSION</b> <b>MOUNT-TRANSMISSION</b> <b>Auto</b></p> <p>NISSAN PASSENGER CAR ..... 2004-06 NISSAN VAN ..... 2004-09</p>	 <p style="text-align: center;"><b>EM-9413</b> <b>MOUNT-ENGINE</b> <b>RH Front</b></p> <p>ACURA PASSENGER CAR ..... 2002-06 HONDA PASSENGER CAR ..... 2002-05</p>	 <p style="text-align: center;"><b>EM-9417</b> <b>MOUNT-TRANSMISSION</b> <b>Lower</b></p> <p>ACURA PASSENGER CAR ..... 2009-12 HONDA PASSENGER CAR ..... 2008-12</p>	 <p style="text-align: center;"><b>EM-9420</b> <b>MOUNT-TRANSMISSION</b></p> <p>TOYOTA SPORT UTILITY ..... 2001-05</p>
 <p style="text-align: center;"><b>EM-9414</b> <b>MOUNT-TRANSMISSION</b></p> <p>NISSAN PASSENGER CAR ..... 2007-08</p> <p style="text-align: center;">(Continued Next Column)</p>	 <p style="text-align: center;"><b>EM-9421</b> <b>MOUNT-ENGINE</b> <b>Rear</b></p> <p style="text-align: center;">(Continued Next Page)</p>		

# BUYER'S GUIDE

## NUMERICAL LISTING - ILLUSTRATIONS

### EM-9421 (Continued)

LEXUS PASSENGER CAR ..... 1999-01  
 TOYOTA PASSENGER CAR ..... 2000-03



**EM-9422**  
**Engine Torque Strut**  
**Front Left**

NISSAN PASSENGER CAR ..... 2007-14



**EM-9423**  
**MOUNT-TRANSMISSION**  
**Rear**

HONDA VAN ..... 2005-06



**EM-9424**  
**MOUNT-ENGINE**  
**Front**

ACURA PASSENGER CAR ..... 2002-06  
 HONDA PASSENGER CAR ..... 2002-05  
 HONDA SPORT UTILITY ..... 2002-05



**EM-9425**  
**MOUNT-TRANSMISSION**  
**Auto**

TOYOTA SPORT UTILITY ..... 2003-12



**EM-9426**  
**MOUNT-TRANSMISSION**  
**Front**

ACURA PASSENGER CAR ..... 2004-08  
 HONDA PASSENGER CAR ..... 2003-07



**EM-9427**  
**MOUNT-TRANSMISSION**  
**Rear**

HONDA VAN ..... 2007-10



**EM-9428**  
**MOUNT-TRANSMISSION**  
**Lower**

(Continued Next Column)

### EM-9428 (Continued)

ACURA PASSENGER CAR ..... 2009-12  
 HONDA PASSENGER CAR ..... 2008-15



**EM-9429**  
**MOUNT-TRANSMISSION**  
**Manual**

TOYOTA TRUCK ..... 2005-12



**EM-9430**  
**MOUNT-TRANSMISSION**  
**Auto**

TOYOTA TRUCK ..... 2005-12



**EM-9431**  
**MOUNT-ENGINE**  
**Rear**

HONDA VAN ..... 2005-10



**EM-9432**  
**MOUNT-ENGINE**  
**RH Front**

TOYOTA SPORT UTILITY ..... 2001-03



**EM-9433**  
**MOUNT-TRANSMISSION**  
**Manual**

ACURA PASSENGER CAR ..... 2002-06  
**MOUNT-TRANSMISSION**

HONDA PASSENGER CAR ..... 2002-05  
**MOUNT-TRANSMISSION**  
**Manual**

HONDA SPORT UTILITY ..... 2002-09



**EM-9434**  
**MOUNT-TRANSMISSION**  
**Rear**

HONDA PASSENGER CAR ..... 2003-07

# BUYER'S GUIDE

## NUMERICAL LISTING - ILLUSTRATIONS

 <p style="text-align: center;"><b>EM-9435</b> <b>MOUNT-TRANSMISSION</b> Front</p> <p>ACURA PASSENGER CAR ..... 2004-08</p>	 <p style="text-align: center;"><b>EM-9439</b> <b>MOUNT-TRANSMISSION</b> Lower</p> <p>ACURA PASSENGER CAR ..... 2010-12 HONDA PASSENGER CAR ..... 2008-12</p>	 <p style="text-align: center;"><b>EM-9442</b> <b>MOUNT-ENGINE</b> Front</p> <p>NISSAN PASSENGER CAR ..... 2002-06 NISSAN SPORT UTILITY ..... 2002-07</p>	 <p style="text-align: center;"><b>EM-9446</b> <b>MOUNT-ENGINE</b> Rear</p> <p>NISSAN PASSENGER CAR ..... 2007-13</p>
 <p style="text-align: center;"><b>EM-9436</b> <b>MOUNT-ENGINE</b> Rear</p> <p>PONTIAC PASSENGER CAR ..... 2009-10 TOYOTA PASSENGER CAR ..... 2010-11</p>	 <p style="text-align: center;"><b>EM-9440</b> <b>MOUNT-TRANSMISSION</b> Upper</p> <p>ACURA PASSENGER CAR ..... 2004-08</p>	 <p style="text-align: center;"><b>EM-9443</b> <b>MOUNT-ENGINE</b> LH Rear</p> <p>ACURA PASSENGER CAR ..... 2009-14 HONDA PASSENGER CAR ..... 2008-15</p>	 <p style="text-align: center;"><b>EM-9447</b> <b>MOUNT-ENGINE</b> RH Front</p> <p>PONTIAC PASSENGER CAR ..... 2009-10 TOYOTA PASSENGER CAR ..... 2009-11</p>
 <p style="text-align: center;"><b>EM-9437</b> <b>MOUNT-ENGINE</b> Rear</p> <p>HONDA PASSENGER CAR ..... 2007-08</p>	 <p style="text-align: center;"><b>EM-9441</b> <b>MOUNT-ENGINE</b> Front</p> <p>ACURA PASSENGER CAR ..... 2000-03 ACURA SPORT UTILITY ..... 2001-06 HONDA SPORT UTILITY ..... 2003-08 HONDA TRUCK ..... 2006-14 HONDA VAN ..... 1999-04</p>	 <p style="text-align: center;"><b>EM-9444</b> <b>Engine Torque Strut Mount</b> Front</p> <p>NISSAN PASSENGER CAR ..... 2007-13</p>	 <p style="text-align: center;"><b>EM-9448</b> <b>MOUNT-TRANSMISSION</b> Manual</p> <p>NISSAN PASSENGER CAR ..... 2007-12</p>
 <p style="text-align: center;"><b>EM-9438</b> <b>MOUNT-TRANSMISSION</b> Rear</p> <p>ACURA PASSENGER CAR ..... 2004-08 HONDA PASSENGER CAR ..... 2003-07</p>		 <p style="text-align: center;"><b>EM-9445</b> <b>MOUNT-ENGINE</b> RH Front</p> <p>HONDA SPORT UTILITY ..... 2003-06</p>	 <p style="text-align: center;"><b>EM-9449</b> <b>MOUNT-ENGINE</b> RH Front</p> <p>PONTIAC PASSENGER CAR ..... 2009-10 TOYOTA PASSENGER CAR ..... 2009-13</p>



# BUYER'S GUIDE

## NUMERICAL LISTING - ILLUSTRATIONS

 <p style="text-align: center;"><b>EM-9450</b> <b>MOUNT-TRANSMISSION</b> <b>Lower</b></p> <p>HONDA PASSENGER CAR ..... 2008-12</p>	 <p style="text-align: center;"><b>EM-9454</b> <b>Engine Torque Strut Mount</b> <b>Front</b></p> <p>TOYOTA PASSENGER CAR ..... 2004-09</p>	<p><b>EM-9457 (Continued)</b> HONDA PASSENGER CAR ..... 2008-15</p>  <p style="text-align: center;"><b>EM-9458</b> <b>MOUNT-TRANSMISSION</b> <b>Rear</b></p> <p>ACURA PASSENGER CAR ..... 2004-06</p>	 <p style="text-align: center;"><b>EM-9461</b> <b>MOUNT-ENGINE</b> <b>Left</b></p> <p>MAZDA VAN ..... 2002-06</p>
 <p style="text-align: center;"><b>EM-9451</b> <b>MOUNT-ENGINE</b> <b>Rear</b></p> <p>ACURA PASSENGER CAR ..... 2009-14 HONDA PASSENGER CAR ..... 2003-07</p>	 <p style="text-align: center;"><b>EM-9455</b> <b>Engine Torque Strut Mount</b> <b>Front</b></p> <p>TOYOTA PASSENGER CAR ..... 2001-03</p>	 <p style="text-align: center;"><b>EM-9459</b> <b>MOUNT-TRANSMISSION</b> <b>Lower</b></p> <p>ACURA PASSENGER CAR ..... 2009-14</p>	 <p style="text-align: center;"><b>EM-9462</b> <b>MOUNT-TRANSMISSION</b> <b>Auto</b></p> <p>PONTIAC PASSENGER CAR ..... 2009-10 TOYOTA PASSENGER CAR ..... 2009-10</p>
 <p style="text-align: center;"><b>EM-9452</b> <b>Engine Torque Strut Mount</b> <b>Rear</b></p> <p>NISSAN PASSENGER CAR ..... 2007-12 NISSAN SPORT UTILITY ..... 2008-13</p>	 <p style="text-align: center;"><b>EM-9456</b> <b>Engine Torque Strut Mount</b> <b>Left</b></p> <p>NISSAN PASSENGER CAR ..... 2007-12</p>	<p style="text-align: center;"><b>EM-9457 (Continued)</b> HONDA PASSENGER CAR ..... 2008-15</p>  <p style="text-align: center;"><b>EM-9457</b> <b>MOUNT-TRANSMISSION</b> <b>Upper</b></p> <p>HONDA PASSENGER CAR ..... 2008-15</p>	 <p style="text-align: center;"><b>EM-9463</b> <b>MOUNT-TRANSMISSION</b> <b>Upper</b></p> <p>ACURA PASSENGER CAR ..... 2009-14</p>
 <p style="text-align: center;"><b>EM-9453</b> <b>Engine Torque Strut Mount</b> <b>Left</b></p> <p>NISSAN PASSENGER CAR ..... 2007-12 NISSAN SPORT UTILITY ..... 2008-13</p>	 <p style="text-align: center;"><b>EM-9457</b> <b>MOUNT-ENGINE</b> <b>RH Front</b></p> <p>ACURA PASSENGER CAR ..... 2009-14</p>	<p style="text-align: center;"><b>EM-9460</b> <b>MOUNT-TRANSMISSION</b> <b>Auto</b></p> <p>NISSAN PASSENGER CAR ..... 2007-12</p>	 <p style="text-align: center;"><b>EM-9464</b> <b>MOUNT-TRANSMISSION</b></p> <p>INFINITI PASSENGER CAR ..... 2002-08 INFINITI SPORT UTILITY ..... 2003-08 NISSAN PASSENGER CAR ..... 2003-09</p>
<p><b>(Continued Next Column)</b></p>			

















# BUYER'S GUIDE

## NUMERICAL LISTING - ILLUSTRATIONS

 <p style="text-align: center;"><b>EM-9465</b> <b>MOUNT-TRANSMISSION</b> <b>Auto</b></p> <p>NISSAN PASSENGER CAR ..... 2007-12</p>	 <p style="text-align: center;"><b>EM-9469</b> <b>MOUNT-ENGINE</b> <b>RH Front</b></p> <p>MAZDA PASSENGER CAR ..... 2000-02</p>	 <p style="text-align: center;"><b>EM-9473</b> <b>MOUNT-TRANSMISSION</b> <b>Auto</b></p> <p>HONDA SPORT UTILITY ..... 2003-09</p>	 <p style="text-align: center;"><b>EM-9477</b> <b>MOUNT-ENGINE</b> <b>Front</b></p> <p>TOYOTA SPORT UTILITY ..... 2001-07</p>
 <p style="text-align: center;"><b>EM-9466</b> <b>MOUNT-ENGINE</b> <b>Front</b></p> <p>MAZDA PASSENGER CAR ..... 2001-02</p>	 <p style="text-align: center;"><b>EM-9470</b> <b>MOUNT-TRANSMISSION</b> <b>Auto</b></p> <p>HONDA PASSENGER CAR ..... 2001-05</p>	 <p style="text-align: center;"><b>EM-9474</b> <b>MOUNT-TRANSMISSION</b> <b>Manual</b></p> <p>CHEVROLET PASSENGER CAR ..... 1998-02 TOYOTA PASSENGER CAR ..... 1998-02</p>	 <p style="text-align: center;"><b>EM-9478</b> <b>MOUNT-ENGINE</b> <b>LH Front</b></p> <p>MAZDA PASSENGER CAR ..... 1998-02</p>
 <p style="text-align: center;"><b>EM-9467</b> <b>MOUNT-ENGINE</b> <b>Right</b></p> <p>ACURA PASSENGER CAR ..... 2010-14 HONDA PASSENGER CAR ..... 2008-15</p>	 <p style="text-align: center;"><b>EM-9471</b> <b>MOUNT-TRANSMISSION</b> <b>Auto</b></p> <p>NISSAN PASSENGER CAR ..... 2002-06</p>	 <p style="text-align: center;"><b>EM-9475</b> <b>MOUNT-ENGINE</b> <b>RH Front</b></p> <p>TOYOTA PASSENGER CAR ..... 2002-03</p>	 <p style="text-align: center;"><b>EM-9479</b> <b>MOUNT-TRANSMISSION</b> <b>Manual</b></p> <p>HONDA PASSENGER CAR ..... 2003-05</p>
 <p style="text-align: center;"><b>EM-9468</b> <b>MOUNT-ENGINE</b> <b>Front</b></p> <p>MAZDA VAN ..... 2000-06</p>	 <p style="text-align: center;"><b>EM-9472</b> <b>MOUNT-ENGINE</b> <b>Rear</b></p> <p>MAZDA VAN ..... 2000-06</p>	 <p style="text-align: center;"><b>EM-9476</b> <b>MOUNT-ENGINE</b> <b>Rear</b></p> <p>MAZDA PASSENGER CAR ..... 1994-97</p>	 <p style="text-align: center;"><b>EM-9480</b> <b>MOUNT-ENGINE</b> <b>Rear</b></p> <p>MAZDA PASSENGER CAR ..... 1998-00</p>

















# BUYER'S GUIDE

## NUMERICAL LISTING - ILLUSTRATIONS

 <p style="text-align: center;"><b>EM-9481</b> <b>MOUNT-ENGINE</b> <b>Rear</b></p> <p>MAZDA PASSENGER CAR ..... 1998-00</p>	 <p style="text-align: center;"><b>EM-9485</b> <b>MOUNT-ENGINE</b> <b>Rear</b></p> <p>CHRYSLER PASSENGER CAR ..... 2003-04 DODGE PASSENGER CAR ..... 2001-05 MITSUBISHI PASSENGER CAR ..... 2000-05</p>	 <p style="text-align: center;"><b>EM-9490</b> <b>MOUNT-TRANSMISSION</b></p> <p>HONDA PASSENGER CAR ..... 2000-09</p>	 <p style="text-align: center;"><b>EM-9495</b> <b>MOUNT-TRANSMISSION</b> <b>Auto</b></p> <p>TOYOTA PASSENGER CAR ..... 1994-99</p>
 <p style="text-align: center;"><b>EM-9482</b> <b>MOUNT-TRANSMISSION</b> <b>Manual</b></p> <p>NISSAN SPORT UTILITY ..... 2005-14 NISSAN TRUCK ..... 2005-15</p>	 <p style="text-align: center;"><b>EM-9487</b> <b>Engine Torque Strut Mount</b> <b>Lower</b></p> <p>HONDA PASSENGER CAR ..... 2006-11</p>	 <p style="text-align: center;"><b>EM-9491</b> <b>MOUNT-ENGINE</b> <b>Rear</b></p> <p>PONTIAC PASSENGER CAR ..... 2009-10 TOYOTA PASSENGER CAR ..... 2009-11</p>	 <p style="text-align: center;"><b>EM-9496</b> <b>MOUNT-ENGINE</b> <b>RH Front</b></p> <p>HONDA SPORT UTILITY ..... 2007-11</p>
 <p style="text-align: center;"><b>EM-9483</b> <b>MOUNT-ENGINE</b> <b>L &amp; R Front</b></p> <p>NISSAN TRUCK ..... 2005-18</p>	 <p style="text-align: center;"><b>EM-9488</b> <b>MOUNT-ENGINE</b> <b>Front</b></p> <p>ACURA PASSENGER CAR ..... 2009-14 HONDA PASSENGER CAR ..... 2009-15</p>	 <p style="text-align: center;"><b>EM-9492</b> <b>Engine Torque Strut Mount</b> <b>Rear</b></p> <p>TOYOTA PASSENGER CAR ..... 2002-06</p>	 <p style="text-align: center;"><b>EM-9497</b> <b>MOUNT-ENGINE</b> <b>Front</b></p> <p>SCION VAN ..... 2008-15 TOYOTA SPORT UTILITY ..... 2006-18</p>
 <p style="text-align: center;"><b>EM-9484</b> <b>MOUNT-ENGINE</b> <b>Front</b></p> <p>TOYOTA PASSENGER CAR ..... 2000-05</p>	 <p style="text-align: center;"><b>EM-9489</b> <b>MOUNT-ENGINE</b> <b>Rear</b></p> <p>MITSUBISHI PASSENGER CAR ..... 2008-15</p>	 <p style="text-align: center;"><b>EM-9494</b> <b>MOUNT-TRANSMISSION</b></p> <p>TOYOTA SPORT UTILITY ..... 2003-12 TOYOTA TRUCK ..... 2005-12</p>	 <p style="text-align: center;"><b>EM-9498</b> <b>MOUNT-ENGINE</b> <b>Front</b></p> <p>TOYOTA SPORT UTILITY ..... 2009-18</p>

# BUYER'S GUIDE

















## NUMERICAL LISTING - ILLUSTRATIONS

 <p><b>EM-9499</b> <b>MOUNT-TRANSMISSION</b></p> <p>TOYOTA SPORT UTILITY ..... 2003-09</p>	 <p><b>EM-9506</b> <b>MOUNT-ENGINE</b> <b>L &amp; R Front</b></p> <p>NISSAN SPORT UTILITY ..... 2005-12 NISSAN TRUCK ..... 2005-12 NISSAN VAN ..... 2012-13</p>	 <p><b>EM-9511</b> <b>MOUNT-TRANSMISSION</b></p> <p>LEXUS SPORT UTILITY ..... 2003-07 TOYOTA SPORT UTILITY ..... 2003-09</p>	 <p><b>EM-9515</b> <b>MOUNT-TRANSMISSION</b></p> <p>TOYOTA TRUCK ..... 1995-04</p>
 <p><b>EM-9500</b> <b>MOUNT-TRANSMISSION</b> <b>Manual</b></p> <p>TOYOTA TRUCK ..... 2005-15</p>	 <p><b>EM-9507</b> <b>Engine Torque Strut Mount</b> <b>Rear</b></p> <p>MAZDA SPORT UTILITY ..... 2007-09</p>	 <p><b>EM-9512</b> <b>MOUNT-TRANSMISSION</b></p> <p>HONDA SPORT UTILITY ..... 2009-14 HONDA VAN ..... 2011-13</p>	 <p><b>EM-9516</b> <b>MOUNT-TRANSMISSION</b> <b>Upper</b></p> <p>HONDA PASSENGER CAR ..... 2008-12</p>
 <p><b>EM-9502</b> <b>MOUNT-ENGINE</b> <b>Rear</b></p> <p>TOYOTA SPORT UTILITY ..... 2004-05</p>	 <p><b>EM-9509</b> <b>MOUNT-ENGINE</b> <b>Front</b></p> <p>TOYOTA SPORT UTILITY ..... 2006-12</p>	 <p><b>EM-9513</b> <b>MOUNT-ENGINE</b> <b>Rear</b></p> <p>TOYOTA SPORT UTILITY ..... 2006-12</p>	 <p><b>EM-9517</b> <b>MOUNT-TRANSMISSION</b> <b>Manual</b></p> <p>NISSAN PASSENGER CAR ..... 1993-97</p>
 <p><b>EM-9504</b> <b>Engine Torque Strut Mount</b> <b>Front</b></p> <p>TOYOTA PASSENGER CAR ..... 2002-03</p>	 <p><b>EM-9510</b> <b>MOUNT-ENGINE</b> <b>Rear</b></p> <p>MITSUBISHI PASSENGER CAR ..... 2006-12 MITSUBISHI SPORT UTILITY ..... 2004-11</p>	 <p><b>EM-9514</b> <b>MOUNT-ENGINE</b> <b>Front</b></p> <p>LEXUS PASSENGER CAR ..... 2011-16 TOYOTA PASSENGER CAR ..... 2010-16</p>	 <p><b>EM-9518</b> <b>MOUNT-ENGINE</b> <b>Rear</b></p> <p>TOYOTA SPORT UTILITY ..... 2006-12</p>



















# BUYER'S GUIDE

## NUMERICAL LISTING - ILLUSTRATIONS

 <p><b>EM-9519</b> <b>MOUNT-TRANSMISSION</b></p> <p>TOYOTA SPORT UTILITY ..... 2008-09 TOYOTA TRUCK ..... 2007-09</p>	 <p><b>EM-9525</b> <b>MOUNT-ENGINE</b> <b>RH Front</b></p> <p>PONTIAC PASSENGER CAR ..... 2003-06 TOYOTA PASSENGER CAR ..... 2000-06</p>	 <p><b>EM-9531</b> <b>MOUNT-ENGINE</b> <b>Right</b></p> <p>NISSAN PASSENGER CAR ..... 2000-01</p>	 <p><b>EM-9537</b> <b>MOUNT-TRANSMISSION</b></p> <p>MAZDA SPORT UTILITY ..... 2007-14</p>
 <p><b>EM-9520</b> <b>MOUNT-TRANSMISSION</b></p> <p>NISSAN SPORT UTILITY ..... 2005-14 NISSAN TRUCK ..... 2005-15</p>	 <p><b>EM-9526</b> <b>MOUNT-TRANSMISSION</b> <b>Auto</b></p> <p>MAZDA PASSENGER CAR ..... 2007-09</p>	 <p><b>EM-9534</b> <b>MOUNT-TRANSMISSION</b> <b>Manual</b></p> <p>MAZDA PASSENGER CAR ..... 2010-13</p>	 <p><b>EM-9538</b> <b>Engine Torque Strut</b> <b>Front Right</b></p> <p>TOYOTA SPORT UTILITY ..... 2008-10</p>
 <p><b>EM-9522</b> <b>MOUNT-TRANSMISSION</b></p> <p>TOYOTA SPORT UTILITY ..... 2008-17 TOYOTA TRUCK ..... 2007-17</p>	 <p><b>EM-9527</b> <b>MOUNT-TRANSMISSION</b></p> <p>MAZDA VAN ..... 2000-06</p>	 <p><b>EM-9535</b> <b>Engine Torque Strut Mount</b> <b>Rear</b></p> <p>TOYOTA PASSENGER CAR ..... 2005-07</p>	 <p><b>EM-9539</b> <b>MOUNT-TRANSMISSION</b></p> <p>MAZDA PASSENGER CAR ..... 2003-08</p>
 <p><b>EM-9523</b> <b>MOUNT-TRANSMISSION</b></p> <p>TOYOTA TRUCK ..... 2007-13</p>	 <p><b>EM-9530</b> <b>MOUNT-TRANSMISSION</b> <b>Front</b></p> <p>HONDA VAN ..... 2007-10</p>	 <p><b>EM-9536</b> <b>MOUNT-TRANSMISSION</b> <b>Auto</b></p> <p>MAZDA PASSENGER CAR ..... 2003-08</p>	 <p><b>EM-9541</b> <b>MOUNT-TRANSMISSION</b></p> <p>TOYOTA PASSENGER CAR ..... 2000-05</p>













# BUYER'S GUIDE

## NUMERICAL LISTING - ILLUSTRATIONS

 <p><b>EM-9542</b> <b>MOUNT-ENGINE</b> <b>Front</b></p> <p>HONDA PASSENGER CAR ..... 2006-10</p>	 <p><b>EM-9546</b> <b>Engine Torque Strut</b> <b>Front Right</b></p> <p>TOYOTA VAN ..... 2007-10</p>	 <p><b>EM-9550</b> <b>MOUNT-TRANSMISSION</b> <b>Auto</b></p> <p>TOYOTA SPORT UTILITY ..... 2006-12</p>	 <p><b>EM-9554</b> <b>MOUNT-ENGINE</b> <b>LH Rear</b></p> <p>HONDA PASSENGER CAR ..... 2008-15</p>
 <p><b>EM-9543</b> <b>MOUNT-TRANSMISSION</b> <b>Manual</b></p> <p>TOYOTA TRUCK ..... 2005-06</p>	 <p><b>EM-9547</b> <b>MOUNT-ENGINE</b> <b>Rear</b></p> <p>NISSAN PASSENGER CAR ..... 2002-06</p>	 <p><b>EM-9551</b> <b>Engine Torque Strut Mount</b> <b>Rear</b></p> <p>INFINITI SPORT UTILITY ..... 2013-15 NISSAN PASSENGER CAR ..... 2008-17 NISSAN SPORT UTILITY ..... 2013-17</p>	 <p><b>EM-9558</b> <b>MOUNT-TRANSMISSION</b></p> <p>AUDI PASSENGER CAR ..... 2005-11</p>
 <p><b>EM-9544</b> <b>MOUNT-ENGINE</b> <b>Rear</b></p> <p>NISSAN PASSENGER CAR ..... 2007-11</p>	 <p><b>EM-9548</b> <b>MOUNT-ENGINE</b> <b>Rear</b></p> <p>NISSAN VAN ..... 2004-08</p>	 <p><b>EM-9552</b> <b>MOUNT-TRANSMISSION</b> <b>Auto</b></p> <p>SUBARU SPORT UTILITY ..... 2003-06</p>	 <p><b>EM-9559</b> <b>Engine Torque Strut Mount</b> <b>Front</b></p> <p>SUBARU SPORT UTILITY ..... 2003-06</p> <p><b>Engine Torque Strut Mount</b> <b>Rear</b></p> <p>SUBARU PASSENGER CAR ..... 2000-09 SUBARU SPORT UTILITY ..... 2005-14</p>
 <p><b>EM-9545</b> <b>Engine Torque Strut Mount</b> <b>Right</b></p> <p>NISSAN PASSENGER CAR ..... 2008-17</p> <p><b>Engine Torque Strut Mount</b> <b>Front</b></p> <p>NISSAN SPORT UTILITY ..... 2013-14</p>	 <p><b>EM-9549</b> <b>MOUNT-TRANSMISSION</b></p> <p>TOYOTA SPORT UTILITY ..... 2006-12</p>	 <p><b>EM-9553</b> <b>Engine Torque Strut Mount</b> <b>Rear</b></p> <p>HONDA PASSENGER CAR ..... 2006-11</p>	 <p><b>EM-9560</b> <b>MOUNT-TRANSMISSION</b> <b>Auto</b></p> <p>SUBARU PASSENGER CAR ..... 2005-09 SUBARU SPORT UTILITY ..... 2005-14</p>

# BUYER'S GUIDE

## NUMERICAL LISTING - ILLUSTRATIONS

 <p><b>EM-9562</b> <b>MOUNT-ENGINE</b> <b>L &amp; R Front</b></p> <p>MERCEDES-BENZ PASSENGER CAR ..... 1998-12</p>	 <p><b>EM-9573</b> <b>MOUNT-ENGINE</b> <b>Rear</b></p> <p>NISSAN PASSENGER CAR ..... 2002-06</p>	 <p><b>EM-9577</b> <b>MOUNT-TRANSMISSION</b> <b>Manual</b></p> <p>NISSAN PASSENGER CAR ..... 2002-04</p>	 <p><b>EM-9588</b> <b>Engine Torque Strut</b> <b>Front Right</b></p> <p>TOYOTA PASSENGER CAR ..... 2010-17</p>
 <p><b>EM-9566</b> <b>MOUNT-TRANSMISSION</b> <b>Manual</b></p> <p>SUBARU PASSENGER CAR ..... 2007-09 SUBARU SPORT UTILITY ..... 2005-09</p>	 <p><b>EM-9574</b> <b>MOUNT-ENGINE</b> <b>Rear</b></p> <p>TOYOTA PASSENGER CAR ..... 2000-05</p>	 <p><b>EM-9579</b> <b>Engine Torque Strut Mount</b> <b>Lower</b></p> <p>VOLVO PASSENGER CAR ..... 1999-05 VOLVO SPORT UTILITY ..... 2003-05</p>	 <p><b>EM-9589</b> <b>MOUNT-TRANSMISSION</b> <b>Manual</b></p> <p>NISSAN PASSENGER CAR ..... 2002-03</p>
 <p><b>EM-9570</b> <b>MOUNT-TRANSMISSION</b> <b>Center</b></p> <p>SUBARU PASSENGER CAR ..... 1990-94</p>	 <p><b>EM-9575</b> <b>MOUNT-TRANSMISSION</b> <b>Manual</b></p> <p>NISSAN PASSENGER CAR ..... 2004-06</p>	 <p><b>EM-9580</b> <b>MOUNT-ENGINE</b> <b>Rear Upper</b></p> <p>VOLVO PASSENGER CAR ..... 1999-05 VOLVO SPORT UTILITY ..... 2003-05</p>	 <p><b>EM-9590 (NEW)</b> <b>MOUNT-ENGINE</b> <b>Rear</b></p> <p>LEXUS SPORT UTILITY ..... 2004-09 TOYOTA SPORT UTILITY ..... 2009-15</p>
 <p><b>EM-9572</b> <b>MOUNT-ENGINE</b> <b>Front</b></p> <p>TOYOTA PASSENGER CAR ..... 2002-03</p>	 <p><b>EM-9576</b> <b>MOUNT-TRANSMISSION</b> <b>Auto</b></p> <p>TOYOTA PASSENGER CAR ..... 2002-03</p>	 <p><b>EM-9587</b> <b>Engine Torque Strut Mount</b> <b>Rear</b></p> <p>TOYOTA VAN ..... 2011-14</p>	 <p><b>EM-9591 (NEW)</b> <b>MOUNT-ENGINE</b> <b>Rear</b></p> <p>TOYOTA SPORT UTILITY ..... 2001-15 TOYOTA VAN ..... 2004-16</p>

# BUYER'S GUIDE

## NUMERICAL LISTING - ILLUSTRATIONS

 <p style="text-align: center;"><b>EM-9593</b> Engine Torque Strut Mount Right</p> <p>TOYOTA PASSENGER CAR ..... 2009-15 TOYOTA SPORT UTILITY ..... 2009-15</p>	 <p style="text-align: center;"><b>EM-9601</b> Engine Torque Strut Mount Rear</p> <p>LEXUS PASSENGER CAR ..... 2007-15</p>	 <p style="text-align: center;"><b>EM-9617</b> MOUNT-TRANSMISSION</p> <p>HONDA PASSENGER CAR ..... 2006-11</p>	 <p style="text-align: center;"><b>ST-10002 (NEW)</b> STRUT MOUNT Front</p> <p>MERCEDES-BENZ PASSENGER CAR ..... 2003-09</p>
 <p style="text-align: center;"><b>EM-9594</b> MOUNT-TRANSMISSION Front</p> <p>HONDA TRUCK ..... 2009-14</p>	 <p style="text-align: center;"><b>EM-9610</b> Engine Torque Strut Mount Right</p> <p>TOYOTA PASSENGER CAR ..... 2009-13 TOYOTA SPORT UTILITY ..... 2009-13</p>	 <p style="text-align: center;"><b>EM-9619</b> MOUNT-TRANSMISSION Auto</p> <p>TOYOTA SPORT UTILITY ..... 2010</p>	 <p style="text-align: center;"><b>ST-10003 (NEW)</b> STRUT MOUNT Front</p> <p>AUDI PASSENGER CAR ..... 2005-11</p>
 <p style="text-align: center;"><b>EM-9595</b> Engine Torque Strut Mount Rear</p> <p>TOYOTA VAN ..... 2011-14</p>	 <p style="text-align: center;"><b>EM-9612</b> Engine Torque Strut Mount Rear Lower</p> <p>SCION PASSENGER CAR ..... 2008-14</p>	 <p style="text-align: center;"><b>EM-9634</b> MOUNT-ENGINE Rear</p> <p>INFINITI PASSENGER CAR ..... 2000-04</p>	 <p style="text-align: center;"><b>ST-10004 (NEW)</b> STRUT MOUNT Front</p> <p>BUICK PASSENGER CAR ..... 2012-19 BUICK SPORT UTILITY ..... 2013-19 CHEVROLET PASSENGER CAR ..... 2011-16 CHEVROLET SPORT UTILITY ..... 2013-19</p>
 <p style="text-align: center;"><b>EM-9599</b> MOUNT-ENGINE L &amp; R Front</p> <p>TOYOTA SPORT UTILITY ..... 2003-14 TOYOTA TRUCK ..... 2005-11</p>	 <p style="text-align: center;"><b>EM-9613</b> MOUNT-TRANSMISSION Auto</p> <p>SUZUKI SPORT UTILITY ..... 2006-11</p>	 <p style="text-align: center;"><b>ST-10000 (NEW)</b> STRUT MOUNT Front</p> <p>BMW SPORT UTILITY ..... 2007-14</p>	

# BUYER'S GUIDE

## NUMERICAL LISTING - ILLUSTRATIONS



**ST-10005 (NEW)**  
**STRUT MOUNT**  
Front

MERCEDES-BENZ PASSENGER CAR ..... 2006-11



**ST-10006 (NEW)**  
**STRUT MOUNT**  
Front

MERCEDES-BENZ PASSENGER CAR ..... 2010-15



**ST-10007 (NEW)**  
**STRUT MOUNT**  
Front

MERCEDES-BENZ PASSENGER CAR ..... 2008-15



**ST-10008 (NEW)**  
**STRUT MOUNT**  
Rear

AUDI PASSENGER CAR ..... 2008-15

(Continued Next Column)

**ST-10008 (Continued)**

AUDI SPORTS UTILITY .....	2009-15
BMW PASSENGER CAR .....	1999-03
PORSCHE SUV .....	2015



**ST-10009 (NEW)**  
**STRUT MOUNT**  
Rear

BMW PASSENGER CAR ..... 1999-03



**ST-10010 (NEW)**  
**STRUT MOUNT**  
Front

MERCEDES-BENZ PASSENGER CAR ..... 2008-18

MERCEDES-BENZ SPORT UTILITY ..... 2009-18



**ST-10011 (NEW)**  
**STRUT MOUNT**  
Front

SMART ..... 2008-14



**ST-10012 (NEW)**  
**STRUT MOUNT**  
Front

AUDI PASSENGER CAR ..... 2008-15

AUDI SPORTS UTILITY ..... 2009-15



**ST-1901**  
**STRUT MOUNT**  
Front

FORD PASSENGER CAR ..... 1984-94

MERCURY PASSENGER CAR ... 1984-94



**ST-1902**  
**STRUT MOUNT**  
Front

FORD PASSENGER CAR ..... 1986-95

MERCURY PASSENGER CAR ... 1986-95



**ST-1903**  
**STRUT MOUNT**  
Front

(Continued Next Column)

**ST-1903 (Continued)**

AUDI PASSENGER CAR .....	1973-79
TOYOTA TRUCK .....	1980-83
VOLKSWAGEN PASSENGER CAR .....	1974-93
VOLKSWAGEN TRUCK .....	1980-83



**ST-1904**  
**STRUT MOUNT**  
Front

VOLKSWAGEN PASSENGER CAR ..... 1985-95



**ST-1905**  
**STRUT MOUNT**  
Front

CHRYSLER PASSENGER CAR ..... 1982

DODGE PASSENGER CAR ..... 1978-90

DODGE TRUCK ..... 1982-84

PLYMOUTH PASSENGER CAR ..... 1978-90



**ST-1906**  
**STRUT MOUNT**  
Front

CHRYSLER PASSENGER CAR ..... 1983

DODGE PASSENGER CAR ..... 1983

PLYMOUTH PASSENGER CAR ..... 1983



# BUYER'S GUIDE

## NUMERICAL LISTING - ILLUSTRATIONS

 <p style="text-align: center;"><b>ST-1907</b> <b>STRUT MOUNT</b> Front</p> <p>CHRYSLER PASSENGER CAR ..... 1984-86 DODGE PASSENGER CAR ..... 1984-86 DODGE VAN ..... 1984-85 PLYMOUTH PASSENGER CAR ..... 1984-86 PLYMOUTH VAN ..... 1984-85</p>	 <p style="text-align: center;"><b>ST-1910</b> <b>STRUT MOUNT</b> Front</p> <p>TOYOTA PASSENGER CAR ..... 1982-87</p>	 <p style="text-align: center;"><b>ST-1916</b> <b>STRUT MOUNT</b> Front</p> <p>FORD PASSENGER CAR ..... 1981-85 MERCURY PASSENGER CAR ... 1983-85</p>	 <p style="text-align: center;"><b>ST-1923</b> <b>STRUT MOUNT</b> Front</p> <p>CHEVROLET PASSENGER CAR ..... 1982-92 PONTIAC PASSENGER CAR ..... 1982-92</p>
 <p style="text-align: center;"><b>ST-1908</b> <b>STRUT MOUNT</b> Front</p> <p>CHRYSLER PASSENGER CAR ..... 1986-95 CHRYSLER VAN ..... 1990-95 DODGE PASSENGER CAR ..... 1986-95 DODGE VAN ..... 1986-95 PLYMOUTH PASSENGER CAR ..... 1986-95 PLYMOUTH VAN ..... 1986-95</p>	 <p style="text-align: center;"><b>ST-1911</b> <b>STRUT MOUNT</b> Front</p> <p>TOYOTA PASSENGER CAR ..... 1984-87</p>	 <p style="text-align: center;"><b>ST-1921</b> <b>STRUT MOUNT</b> Front</p> <p>BUICK PASSENGER CAR ..... 1988-96 CHEVROLET PASSENGER CAR ..... 1990-01 OLDSMOBILE PASSENGER CAR ..... 1988-97 PONTIAC PASSENGER CAR ..... 1988-96</p>	 <p style="text-align: center;"><b>ST-1924</b> <b>STRUT MOUNT</b> Front</p> <p>CHEVROLET PASSENGER CAR ..... 1982-92 PONTIAC PASSENGER CAR ..... 1982-92</p>
 <p style="text-align: center;"><b>ST-1909</b> <b>STRUT MOUNT</b> Front</p> <p>TOYOTA PASSENGER CAR ..... 1982-87</p>	 <p style="text-align: center;"><b>ST-1912</b> <b>STRUT MOUNT</b> Front</p> <p>TOYOTA PASSENGER CAR ..... 1984-87</p>	 <p style="text-align: center;"><b>ST-1922</b> <b>STRUT MOUNT</b> Front</p> <p>BUICK PASSENGER CAR ..... 1990-99 CADILLAC PASSENGER CAR ... 1991-93 OLDSMOBILE PASSENGER CAR ..... 1990-99 PONTIAC PASSENGER CAR ..... 1990-99</p>	 <p style="text-align: center;"><b>ST-1925</b> <b>STRUT MOUNT</b> Front</p> <p>FORD PASSENGER CAR ..... 1978-04 MERCURY PASSENGER CAR ... 1978-86</p>
 <p style="text-align: center;"><b>ST-1913</b> <b>STRUT MOUNT</b> Front</p> <p>BUICK PASSENGER CAR ..... 1982-91 CADILLAC PASSENGER CAR ... 1982-88 CHEVROLET PASSENGER CAR ..... 1982-91 OLDSMOBILE PASSENGER CAR ..... 1982-91 PONTIAC PASSENGER CAR ..... 1982-91</p>			

# BUYER'S GUIDE

## NUMERICAL LISTING - ILLUSTRATIONS



**ST-1926**  
**STRUT MOUNT**  
Front

FORD PASSENGER CAR ..... 1986-95  
LINCOLN PASSENGER CAR ..... 1988-94  
MERCURY PASSENGER CAR ... 1986-95



**ST-1927**  
**STRUT MOUNT**  
Front

FORD PASSENGER CAR ..... 1984-94  
MERCURY PASSENGER CAR ... 1984-94



**ST-1928**  
**STRUT MOUNT**  
Front

BUICK PASSENGER CAR ..... 1985-96  
CADILLAC PASSENGER CAR .... 1987-02  
OLDSMOBILE PASSENGER  
CAR ..... 1985-99  
PONTIAC PASSENGER CAR ..... 1987-99



**ST-1929**  
**STRUT MOUNT**  
Front

CHEVROLET PASSENGER  
CAR ..... 1987-94  
PONTIAC PASSENGER CAR ..... 1987-94



**ST-1930**  
**STRUT MOUNT**  
Front

MAZDA PASSENGER CAR ..... 1981-89  
MERCURY PASSENGER CAR ... 1987-89



**ST-1932**  
**STRUT MOUNT**  
Front

CHEVROLET PASSENGER  
CAR ..... 1985-88  
GEO PASSENGER CAR ..... 1989  
ISUZU PASSENGER CAR ..... 1985-89  
PONTIAC PASSENGER CAR ..... 1985-88



**ST-1933**  
**STRUT MOUNT**  
Front

(Continued Next Column)

**ST-1933 (Continued)**

HONDA PASSENGER CAR ..... 1982-85



**ST-1934**  
**STRUT MOUNT**  
Front

BUICK PASSENGER CAR ..... 1982-96  
CHEVROLET PASSENGER  
CAR ..... 1982-90  
CHEVROLET VAN ..... 1990-96  
OLDSMOBILE PASSENGER  
CAR ..... 1982-96  
OLDSMOBILE VAN ..... 1990-96  
PONTIAC PASSENGER CAR ..... 1982-91  
PONTIAC VAN ..... 1990-96



**ST-1937**  
**STRUT MOUNT**  
Front

DODGE PASSENGER CAR ..... 1977-84  
HYUNDAI PASSENGER CAR ..... 1986-89  
MITSUBISHI PASSENGER  
CAR ..... 1987-88  
PLYMOUTH PASSENGER  
CAR ..... 1976-84



**ST-1938**  
**STRUT MOUNT**  
Front

HYUNDAI PASSENGER CAR ..... 1990-95  
MITSUBISHI PASSENGER  
CAR ..... 1989-94



**ST-1939**  
**STRUT MOUNT**  
Front

ACURA PASSENGER CAR ..... 1986-89  
HONDA PASSENGER CAR ..... 1984-87



**ST-1940**  
**STRUT MOUNT**  
Front

ACURA PASSENGER CAR ..... 1986-14  
CHRYSLER PASSENGER  
CAR ..... 1995-06  
DODGE PASSENGER CAR ..... 1995-06  
HONDA PASSENGER CAR ..... 1983-08  
HONDA SPORT UTILITY ..... 1997-01  
HONDA VAN ..... 1995-98  
ISUZU VAN ..... 1996-99  
PLYMOUTH PASSENGER  
CAR ..... 1996-00

**STRUT MOUNT**  
Rear

ACURA PASSENGER CAR ..... 1990-14  
CHRYSLER PASSENGER  
CAR ..... 2001-06  
DODGE PASSENGER CAR ..... 2001-06  
HONDA PASSENGER CAR ..... 1988-08  
HONDA SPORT UTILITY ..... 1997-14  
HONDA VAN ..... 1995-98  
ISUZU VAN ..... 1996-99



**ST-1941**  
**STRUT MOUNT**  
Front

VOLKSWAGEN PASSENGER  
CAR ..... 1973-93

# BUYER'S GUIDE

## NUMERICAL LISTING - ILLUSTRATIONS

 <p style="text-align: center;"><b>ST-1942 STRUT MOUNT Front</b></p> <p>AUDI PASSENGER CAR ..... 1980-88 VOLKSWAGEN PASSENGER CAR ..... 1982-88</p>	<p><b>ST-1946 (Continued)</b></p> <p>OLDSMOBILE PASSENGER CAR ..... 1992-94 PONTIAC PASSENGER CAR ..... 1992-94</p>  <p style="text-align: center;"><b>ST-1947 STRUT MOUNT Front</b></p> <p>INFINITI PASSENGER CAR ..... 1990-92 NISSAN PASSENGER CAR ..... 1970-94</p>	 <p style="text-align: center;"><b>ST-1951 STRUT MOUNT Rear</b></p> <p>BUICK PASSENGER CAR ..... 1984-98 CADILLAC PASSENGER CAR .... 1984-88 CHEVROLET PASSENGER CAR ..... 1984-96 CHEVROLET VAN ..... 1990-96 OLDSMOBILE PASSENGER CAR ..... 1984-98 OLDSMOBILE VAN ..... 1990-96 PONTIAC PASSENGER CAR ..... 1984-98 PONTIAC VAN ..... 1990-96</p>	 <p style="text-align: center;"><b>ST-1954 STRUT MOUNT Rear</b></p> <p>FORD PASSENGER CAR ..... 1986-07 MERCURY PASSENGER CAR ... 1986-05</p>
 <p style="text-align: center;"><b>ST-1943 STRUT MOUNT Front</b></p> <p>CHEVROLET PASSENGER CAR ..... 1985-88 TOYOTA PASSENGER CAR ..... 1983-88</p>	 <p style="text-align: center;"><b>ST-1948 STRUT MOUNT Front</b></p> <p>NISSAN PASSENGER CAR ..... 1985-89 <b>STRUT MOUNT</b> TOYOTA PASSENGER CAR ..... 1978-82</p>	 <p style="text-align: center;"><b>ST-1952 STRUT MOUNT Rear</b></p> <p>DODGE PASSENGER CAR ..... 1978-90 PLYMOUTH PASSENGER CAR ..... 1978-90</p>	 <p style="text-align: center;"><b>ST-1955 STRUT MOUNT Rear</b></p> <p>FORD PASSENGER CAR ..... 1984-94 MERCURY PASSENGER CAR ... 1984-94</p>
 <p style="text-align: center;"><b>ST-1944 STRUT MOUNT Front</b></p> <p>LEXUS PASSENGER CAR ..... 1990-91 TOYOTA PASSENGER CAR ..... 1987-91 TOYOTA VAN ..... 1991-97</p>	 <p style="text-align: center;"><b>ST-1950 STRUT MOUNT Front</b></p> <p>SATURN PASSENGER CAR ..... 1991-02</p>	 <p style="text-align: center;"><b>ST-1953 STRUT MOUNT Rear</b></p> <p>BUICK PASSENGER CAR ..... 1985-99 CADILLAC PASSENGER CAR .... 1985-93 OLDSMOBILE PASSENGER CAR ..... 1985-99 PONTIAC PASSENGER CAR ..... 1987-99</p>	 <p style="text-align: center;"><b>ST-1956 STRUT MOUNT Rear</b></p> <p>FORD PASSENGER CAR ..... 1981-90 MERCURY PASSENGER CAR ... 1981-87</p>
 <p style="text-align: center;"><b>ST-1946 STRUT MOUNT Front</b></p> <p>BUICK PASSENGER CAR ..... 1992-94 CHEVROLET PASSENGER CAR ..... 1992-94 <b>(Continued Next Column)</b></p>	 <p style="text-align: center;"><b>ST-1958 STRUT MOUNT Rear</b></p> <p>CHEVROLET PASSENGER CAR ..... 1985-88 TOYOTA PASSENGER CAR ..... 1983-91</p>	 <p style="text-align: center;"><b>ST-1958 STRUT MOUNT Rear</b></p> <p>CHEVROLET PASSENGER CAR ..... 1985-88 TOYOTA PASSENGER CAR ..... 1983-91</p>	 <p style="text-align: center;"><b>ST-1958 STRUT MOUNT Rear</b></p> <p>CHEVROLET PASSENGER CAR ..... 1985-88 TOYOTA PASSENGER CAR ..... 1983-91</p>



# BUYER'S GUIDE

## NUMERICAL LISTING - ILLUSTRATIONS



**ST-1959**  
**STRUT MOUNT**  
**Rear**

MAZDA PASSENGER CAR ..... 1981-89  
MERCURY PASSENGER CAR ... 1987-93



**ST-1963**  
**STRUT MOUNT**  
**Rear**

FORD PASSENGER CAR ..... 1991-03  
MAZDA PASSENGER CAR ..... 1990-95  
MERCURY PASSENGER CAR ... 1991-99



**ST-1967**  
**STRUT MOUNT**  
**Front**

TOYOTA PASSENGER CAR ..... 1983-88



**ST-1971**  
**STRUT MOUNT**  
**Front**

FORD PASSENGER CAR ..... 1980-86  
LINCOLN PASSENGER CAR ..... 1982-92  
MERCURY PASSENGER CAR ... 1980-86



**ST-1960**  
**STRUT MOUNT**  
**Rear**

FORD PASSENGER CAR ..... 1989-92  
MAZDA PASSENGER CAR ..... 1988-92



**ST-1964**  
**STRUT MOUNT**  
**Rear**

SATURN PASSENGER CAR ..... 1991-02



**ST-1968**  
**STRUT MOUNT**  
**Front**

TOYOTA PASSENGER CAR ..... 1970-84



**ST-1973**  
**STRUT MOUNT**  
**Front**

BUICK PASSENGER CAR ..... 1985-90  
CADILLAC PASSENGER CAR .... 1987-90  
OLDSMOBILE PASSENGER  
CAR ..... 1985-90  
PONTIAC PASSENGER CAR ..... 1987-90



**ST-1961**  
**STRUT MOUNT**  
**Rear**

ACURA PASSENGER CAR ..... 1986-03  
HONDA PASSENGER CAR ..... 1979-07



**ST-1965**  
**STRUT MOUNT**  
**Rear**

BMW PASSENGER CAR ..... 1984-02



**ST-1969**  
**STRUT MOUNT**  
**Front**

TOYOTA PASSENGER CAR ..... 1987-90



**ST-1974**  
**STRUT MOUNT**  
**Front**

FORD PASSENGER CAR ..... 1987-88  
MERCURY PASSENGER CAR ... 1987-88



**ST-1962**  
**STRUT MOUNT**  
**Rear**

LEXUS PASSENGER CAR ..... 1990-91  
TOYOTA PASSENGER CAR ..... 1987-91



**ST-1966**  
**STRUT MOUNT**  
**Rear**

VOLKSWAGEN PASSENGER  
CAR ..... 1975-02



**ST-1970**  
**STRUT MOUNT**  
**Front**

FORD PASSENGER CAR ..... 1989-97  
MERCURY PASSENGER CAR ... 1989-97



**ST-1975**  
**STRUT MOUNT**  
**Front**

NISSAN PASSENGER CAR ..... 1990-99

# BUYER'S GUIDE

## NUMERICAL LISTING - ILLUSTRATIONS

 <p style="text-align: center;"><b>ST-1976 STRUT MOUNT Front</b></p> <p>HYUNDAI PASSENGER CAR ..... 1989-94            MITSUBISHI VAN ..... 1992-95            PLYMOUTH PASSENGER            CAR ..... 1992-94</p>	 <p style="text-align: center;"><b>ST-1979 STRUT MOUNT Front</b></p> <p>TOYOTA PASSENGER CAR ..... 1986-93</p>	 <p style="text-align: center;"><b>ST-1983 STRUT MOUNT Front</b></p> <p>TOYOTA PASSENGER CAR ..... 1995-99</p>	<p><b>ST-1986 (Continued)</b></p> <p>OLDSMOBILE PASSENGER            CAR ..... 1988-97</p>  <p style="text-align: center;"><b>ST-1987 STRUT MOUNT Front</b></p> <p>CHEVROLET PASSENGER            CAR ..... 1989-01            GEO PASSENGER CAR ..... 1989-97            PONTIAC PASSENGER CAR ..... 1989-00            SUZUKI PASSENGER CAR ..... 1989-01</p>
 <p style="text-align: center;"><b>ST-1977 STRUT MOUNT Front</b></p> <p>DODGE PASSENGER CAR ..... 1989-92            EAGLE PASSENGER CAR ..... 1989-92            HYUNDAI PASSENGER CAR ..... 1992-95            MITSUBISHI PASSENGER            CAR ..... 1989-92            PLYMOUTH PASSENGER            CAR ..... 1989-92</p>	 <p style="text-align: center;"><b>ST-1980 STRUT MOUNT Front</b></p> <p>CHRYSLER PASSENGER            CAR ..... 1993-97            DODGE PASSENGER CAR ..... 1993-97            EAGLE PASSENGER CAR ..... 1993-97</p>	 <p style="text-align: center;"><b>ST-1984 STRUT MOUNT Rear</b></p> <p>TOYOTA PASSENGER CAR ..... 1987-95</p>	 <p style="text-align: center;"><b>ST-1988 STRUT MOUNT Rear</b></p> <p>CHEVROLET PASSENGER            CAR ..... 1989-01            GEO PASSENGER CAR ..... 1989-97            PONTIAC PASSENGER CAR ..... 1989-91            SUZUKI PASSENGER CAR ..... 1989-01</p>
 <p style="text-align: center;"><b>ST-1978 STRUT MOUNT Rear</b></p> <p>CHRYSLER PASSENGER            CAR ..... 1993-97            DODGE PASSENGER CAR ..... 1993-97            EAGLE PASSENGER CAR ..... 1993-97</p>	 <p style="text-align: center;"><b>ST-1981 STRUT MOUNT Front</b></p> <p>VOLVO PASSENGER CAR ..... 1975-93</p>	 <p style="text-align: center;"><b>ST-1985 STRUT MOUNT Front</b></p> <p>AUDI PASSENGER CAR ..... 1980-94</p>	 <p style="text-align: center;"><b>ST-1989 STRUT MOUNT Rear</b></p> <p>NISSAN PASSENGER CAR ..... 1991-95</p>
 <p style="text-align: center;"><b>ST-1986 STRUT MOUNT Front</b></p> <p style="text-align: center;">(Continued Next Column)</p>			

# BUYER'S GUIDE

## NUMERICAL LISTING - ILLUSTRATIONS

 <p style="text-align: center;"><b>ST-1990</b> <b>STRUT MOUNT</b> Front</p> <p>BUICK PASSENGER CAR ..... 1986-89 CADILLAC PASSENGER CAR ..... 1986 OLDSMOBILE PASSENGER CAR ..... 1986-89</p>	 <p style="text-align: center;"><b>ST-1993</b> <b>STRUT MOUNT</b> Front</p> <p>TOYOTA PASSENGER CAR ..... 1975-85</p>	 <p style="text-align: center;"><b>ST-1999</b> <b>STRUT MOUNT</b> Front</p> <p>FORD PASSENGER CAR ..... 1989-92 MAZDA PASSENGER CAR ..... 1988-92</p>	 <p style="text-align: center;"><b>ST-2903</b> <b>STRUT MOUNT</b> Front</p> <p>BMW PASSENGER CAR ..... 1977-83</p>
 <p style="text-align: center;"><b>ST-1991</b> <b>STRUT MOUNT</b> Front</p> <p>CADILLAC PASSENGER CAR .... 1985-86</p>	 <p style="text-align: center;"><b>ST-1994</b> <b>STRUT MOUNT</b> Front</p> <p>CHEVROLET SPORT UTILITY .... 1989-98 GEO SPORT UTILITY ..... 1989-97 GMC SPORT UTILITY ..... 1989-91 PONTIAC PASSENGER CAR ..... 1994-97 SUZUKI SPORT UTILITY ..... 1989-98</p>	 <p style="text-align: center;"><b>ST-2901</b> <b>STRUT MOUNT</b> Rear</p> <p>CHEVROLET PASSENGER CAR ..... 1998-02 GEO PASSENGER CAR ..... 1989-97 TOYOTA PASSENGER CAR ..... 1988-02</p>	 <p style="text-align: center;"><b>ST-2904</b> <b>STRUT MOUNT</b> Front</p> <p>BMW PASSENGER CAR ..... 1982-95</p>
 <p style="text-align: center;"><b>ST-1992</b> <b>STRUT MOUNT</b> Front</p> <p>DODGE PASSENGER CAR ..... 1971-80 PLYMOUTH PASSENGER CAR ..... 1976-84</p>	 <p style="text-align: center;"><b>ST-1995</b> <b>STRUT MOUNT</b> Front</p> <p>PONTIAC PASSENGER CAR ..... 1988-93</p>	 <p style="text-align: center;"><b>ST-2902</b> <b>STRUT MOUNT</b> Front</p> <p>MERCEDES-BENZ PASSENGER CAR ..... 1984-96</p>	 <p style="text-align: center;"><b>ST-2905</b> <b>STRUT MOUNT</b> Front</p> <p>BMW PASSENGER CAR ..... 1991-02</p>
 <p style="text-align: center;"><b>ST-1996</b> <b>STRUT MOUNT</b> Front</p> <p>TOYOTA PASSENGER CAR ..... 1974-79</p>	 <p style="text-align: center;"><b>ST-2906</b> <b>STRUT MOUNT</b> Front</p> <p>VOLKSWAGEN PASSENGER CAR ..... 1992-02</p>		

# BUYER'S GUIDE

## NUMERICAL LISTING - ILLUSTRATIONS

 <p style="text-align: center;"><b>ST-2907</b> <b>STRUT MOUNT</b> Front</p> <p>DODGE PASSENGER CAR ..... 1995-99 PLYMOUTH PASSENGER CAR ..... 1995-99</p>	<p><b>ST-2910 (Continued)</b></p> <p>FORD VAN ..... 1995-03</p>  <p style="text-align: center;"><b>ST-2911</b> <b>STRUT MOUNT</b> Front</p> <p>VOLVO PASSENGER CAR ..... 1983-98</p>	 <p style="text-align: center;"><b>ST-2915</b> <b>STRUT MOUNT</b> Front</p> <p>HYUNDAI PASSENGER CAR ..... 1995-99</p>	<p><b>ST-2918 (Continued)</b></p> <p>PLYMOUTH PASSENGER CAR ..... 1987-90</p>  <p style="text-align: center;"><b>ST-2919</b> <b>STRUT MOUNT</b> Front</p> <p>MAZDA PASSENGER CAR ..... 1990-97</p>
 <p style="text-align: center;"><b>ST-2908</b> <b>STRUT MOUNT</b> Rear</p> <p>DODGE PASSENGER CAR ..... 1995-99 PLYMOUTH PASSENGER CAR ..... 1995-99</p>	 <p style="text-align: center;"><b>ST-2912</b> <b>STRUT MOUNT</b> Front</p> <p>TOYOTA PASSENGER CAR ..... 1985-92</p>	 <p style="text-align: center;"><b>ST-2916</b> <b>STRUT MOUNT</b> Rear</p> <p>PONTIAC PASSENGER CAR ..... 1984-88</p>	<p>MAZDA PASSENGER CAR ..... 1990-97</p> <p style="text-align: center;"><b>STRUT MOUNT</b> Rear</p> <p>MAZDA PASSENGER CAR ..... 1990-97</p>  <p style="text-align: center;"><b>ST-2920</b> <b>STRUT MOUNT</b> Front</p> <p>EAGLE PASSENGER CAR ..... 1990-94 MITSUBISHI PASSENGER CAR ..... 1990-94 PLYMOUTH PASSENGER CAR ..... 1990-94</p>
 <p style="text-align: center;"><b>ST-2909</b> <b>STRUT MOUNT</b> Front</p> <p>RENAULT PASSENGER CAR ..... 1983-87</p>	 <p style="text-align: center;"><b>ST-2913</b> <b>STRUT MOUNT</b> Front</p> <p>SUBARU PASSENGER CAR ..... 1985-94</p>	 <p style="text-align: center;"><b>ST-2917</b> <b>STRUT MOUNT</b> Front</p> <p>DODGE PASSENGER CAR ..... 1985-86 MITSUBISHI PASSENGER CAR ..... 1985-86 PLYMOUTH PASSENGER CAR ..... 1985-86</p>	 <p style="text-align: center;"><b>ST-2921</b> <b>STRUT MOUNT</b> Front</p> <p>MAZDA VAN ..... 1989-98</p>
 <p style="text-align: center;"><b>ST-2910</b> <b>STRUT MOUNT</b> Front</p> <p>(Continued Next Column)</p>	 <p style="text-align: center;"><b>ST-2914</b> <b>STRUT MOUNT</b> Front</p> <p>HYUNDAI PASSENGER CAR ..... 1995-98 MITSUBISHI PASSENGER CAR ..... 1992-03</p>	 <p style="text-align: center;"><b>ST-2918</b> <b>STRUT MOUNT</b> Front</p> <p>DODGE PASSENGER CAR ..... 1987-90 EAGLE PASSENGER CAR ..... 1989-92 MITSUBISHI PASSENGER CAR ..... 1987-88</p> <p>(Continued Next Column)</p>	

# BUYER'S GUIDE

## NUMERICAL LISTING - ILLUSTRATIONS



**ST-2922**  
**STRUT MOUNT**  
Front

FORD PASSENGER CAR ..... 1993-97  
**STRUT MOUNT**  
KIA PASSENGER CAR ..... 1998-01  
**STRUT MOUNT**  
MAZDA PASSENGER CAR ..... 1993-97



**ST-2923**  
**STRUT MOUNT**  
Front

CHRYSLER PASSENGER CAR ..... 1995-00  
DODGE PASSENGER CAR ..... 1995-00  
EAGLE PASSENGER CAR ..... 1995-98  
HYUNDAI PASSENGER CAR ..... 1999-05  
KIA PASSENGER CAR ..... 2001-06  
MITSUBISHI PASSENGER CAR ..... 1994-99

**STRUT MOUNT**  
Rear

CHRYSLER PASSENGER CAR ..... 1995-05  
DODGE PASSENGER CAR ..... 1989-05  
EAGLE PASSENGER CAR ..... 1989-98  
HYUNDAI PASSENGER CAR ..... 1992-05  
MITSUBISHI PASSENGER CAR ..... 1985-05  
MITSUBISHI VAN ..... 1992-95  
PLYMOUTH PASSENGER CAR ..... 1990-94



**ST-2924**  
**STRUT MOUNT**  
Front

SUBARU PASSENGER CAR ..... 1990-14  
SUBARU SPORT UTILITY ..... 1998-14



**ST-2925**  
**STRUT MOUNT**  
Front

AUDI PASSENGER CAR ..... 1978-79



**ST-2926**  
**STRUT MOUNT**  
Front

LEXUS PASSENGER CAR ..... 1992-94  
TOYOTA PASSENGER CAR ..... 1992-94



**ST-2927**  
**STRUT MOUNT**  
Rear

TOYOTA PASSENGER CAR ..... 1992-96



**ST-2928**  
**STRUT MOUNT**  
Front

ACURA PASSENGER CAR ..... 1991-95



**ST-2929**  
**STRUT MOUNT**  
Front

DODGE PASSENGER CAR ..... 1990-92  
EAGLE PASSENGER CAR ..... 1988-92



**ST-2930**  
**STRUT MOUNT**  
Front

BUICK PASSENGER CAR ..... 1995-97  
OLDSMOBILE PASSENGER CAR ..... 1995-97



**ST-2931**  
**STRUT MOUNT**  
Front

SUBARU PASSENGER CAR ..... 1980-89  
SUBARU SPORT UTILITY ..... 1983-87



**ST-2932**  
**STRUT MOUNT**  
Front

GEO PASSENGER CAR ..... 1990-93  
ISUZU PASSENGER CAR ..... 1990-93



**ST-2933**  
**STRUT MOUNT**  
Front

CHEVROLET PASSENGER CAR ..... 1985-88  
PONTIAC PASSENGER CAR ..... 1985-88  
SUZUKI TRUCK ..... 1985-88



**ST-2934**  
**STRUT MOUNT**  
Front

MAZDA PASSENGER CAR ..... 1979-85



**ST-2935**  
**STRUT MOUNT**  
Front

FORD PASSENGER CAR ..... 1989-92  
MAZDA PASSENGER CAR ..... 1988-92

# BUYER'S GUIDE

## NUMERICAL LISTING - ILLUSTRATIONS

 <p style="text-align: center;"><b>ST-2936</b> <b>STRUT MOUNT</b> Front</p> <p>FORD PASSENGER CAR ..... 1991-96 MAZDA PASSENGER CAR ..... 1990-95 MERCURY PASSENGER CAR ... 1991-96</p>	 <p style="text-align: center;"><b>ST-2939</b> <b>STRUT MOUNT</b> Front</p> <p>MAZDA PASSENGER CAR ..... 1983-87</p>	 <p style="text-align: center;"><b>ST-2942</b> <b>STRUT MOUNT</b> Rear</p> <p>MAZDA PASSENGER CAR ..... 1983-85</p>	<p><b>ST-2945 (Continued)</b></p> <p>PLYMOUTH VAN ..... 1995-00</p>  <p style="text-align: center;"><b>ST-2946</b> <b>STRUT MOUNT</b> Rear</p> <p>CHRYSLER PASSENGER CAR ..... 1995-00 DODGE PASSENGER CAR ..... 1995-00 PLYMOUTH PASSENGER CAR ..... 1996-00</p>
 <p style="text-align: center;"><b>ST-2937</b> <b>STRUT MOUNT</b> Front</p> <p>NISSAN PASSENGER CAR ..... 1983-92</p>  <p style="text-align: center;"><b>STRUT MOUNT</b> Rear</p> <p>NISSAN PASSENGER CAR ..... 1987-92</p>	 <p style="text-align: center;"><b>ST-2940</b> <b>STRUT MOUNT</b> Front</p> <p>FORD PASSENGER CAR ..... 1988-97</p>	 <p style="text-align: center;"><b>ST-2943</b> <b>STRUT MOUNT</b> Rear</p> <p>MAZDA PASSENGER CAR ..... 1983-85</p>	 <p style="text-align: center;"><b>ST-2947</b> <b>STRUT MOUNT</b> Front</p> <p>CHEVROLET PASSENGER CAR ..... 1993-02 PONTIAC PASSENGER CAR ..... 1993-02</p>
 <p style="text-align: center;"><b>ST-2938</b> <b>STRUT MOUNT</b> Front</p> <p>NISSAN PASSENGER CAR ..... 1991-99</p>	 <p style="text-align: center;"><b>ST-2941</b> <b>STRUT MOUNT</b> Rear</p> <p>BUICK PASSENGER CAR ..... 1988-96 CHEVROLET PASSENGER CAR ..... 1990-94 OLDSMOBILE PASSENGER CAR ..... 1988-97 PONTIAC PASSENGER CAR ..... 1988-96</p>	 <p style="text-align: center;"><b>ST-2944</b> <b>STRUT MOUNT</b> Front</p> <p>FORD PASSENGER CAR ..... 1996-07 MERCURY PASSENGER CAR ... 1996-05</p>	 <p style="text-align: center;"><b>ST-2948</b> <b>STRUT MOUNT</b> Front</p> <p>CHEVROLET PASSENGER CAR ..... 1993-02 PONTIAC PASSENGER CAR ..... 1993-02</p>
		 <p style="text-align: center;"><b>ST-2945</b> <b>STRUT MOUNT</b> Front</p> <p>CHRYSLER VAN ..... 1995-00 DODGE VAN ..... 1995-00</p> <p style="text-align: center;">(Continued Next Column)</p>	

# BUYER'S GUIDE

## NUMERICAL LISTING - ILLUSTRATIONS



**ST-2949**  
**STRUT MOUNT**  
**Rear**

CHEVROLET PASSENGER CAR ..... 1995-05  
PONTIAC PASSENGER CAR ..... 1995-05



**ST-2952**  
**STRUT MOUNT**  
**Rear**

FORD PASSENGER CAR ..... 1993-97  
MAZDA PASSENGER CAR ..... 1993-99



**ST-2956**  
**STRUT MOUNT**  
**Rear**

BMW PASSENGER CAR ..... 1986-94



**ST-2960**  
**STRUT MOUNT**  
**Front**

MAZDA PASSENGER CAR ..... 1988-89



**ST-2950**  
**STRUT MOUNT**  
**Rear**

HONDA PASSENGER CAR ..... 1988-91



**ST-2953**  
**STRUT MOUNT**  
**Front**

FORD PASSENGER CAR ..... 1995-00  
MERCURY PASSENGER CAR ..... 1995-02



**ST-2957**  
**STRUT MOUNT**  
**Rear**

TOYOTA PASSENGER CAR ..... 1990-99



**ST-2961**  
**STRUT MOUNT**  
**Front**

CHRYSLER PASSENGER CAR ..... 1987-89  
DODGE PASSENGER CAR ..... 1984-86  
MITSUBISHI PASSENGER CAR ..... 1983-89  
PLYMOUTH PASSENGER CAR ..... 1984-86



**ST-2951**  
**STRUT MOUNT**  
**Rear**

FORD PASSENGER CAR ..... 1993-97  
MAZDA PASSENGER CAR ..... 1993-99



**ST-2954**  
**STRUT MOUNT**  
**Rear**

FORD PASSENGER CAR ..... 1995-00  
MERCURY PASSENGER CAR ..... 1995-00



**ST-2958**  
**STRUT MOUNT**  
**Front**

DODGE PASSENGER CAR ..... 1993-95  
EAGLE PASSENGER CAR ..... 1993-96  
MITSUBISHI PASSENGER CAR ..... 1993-96  
PLYMOUTH PASSENGER CAR ..... 1993-94



**ST-2962**  
**STRUT MOUNT**  
**Rear**

CHRYSLER PASSENGER CAR ..... 1987-89  
DODGE PASSENGER CAR ..... 1984-86  
MITSUBISHI PASSENGER CAR ..... 1983-89  
PLYMOUTH PASSENGER CAR ..... 1984-86



**ST-2955**  
**STRUT MOUNT**  
**Front**

DODGE PASSENGER CAR ..... 1991-96  
MITSUBISHI PASSENGER CAR ..... 1991-99



**ST-2959**  
**STRUT MOUNT**  
**Rear**

GEO PASSENGER CAR ..... 1990-93  
ISUZU PASSENGER CAR ..... 1990-93

# BUYER'S GUIDE

## NUMERICAL LISTING - ILLUSTRATIONS



**ST-2963**  
**STRUT MOUNT**  
Front

DODGE PASSENGER CAR ..... 1981-83  
PLYMOUTH PASSENGER  
CAR ..... 1981-83



**ST-2964**  
**STRUT MOUNT**  
Rear

HYUNDAI PASSENGER CAR ..... 1989-98



**ST-2965**  
**STRUT MOUNT**  
Front

BUICK PASSENGER CAR ..... 1990-93  
CADILLAC PASSENGER CAR ..... 1987-02  
OLDSMOBILE PASSENGER  
CAR ..... 1990-92



**ST-2966**  
**STRUT MOUNT**  
Rear

MAZDA PASSENGER CAR ..... 1988-91



**ST-2967**  
**STRUT MOUNT**  
Rear

ACURA PASSENGER CAR ..... 1986-88



**ST-2968**  
**STRUT MOUNT**  
Rear

BUICK PASSENGER CAR ..... 1997-09  
CHEVROLET PASSENGER  
CAR ..... 1995-14  
OLDSMOBILE PASSENGER  
CAR ..... 1998-02  
PONTIAC PASSENGER CAR ..... 1997-08



**ST-2969**  
**STRUT MOUNT**  
Rear

BUICK PASSENGER CAR ..... 1997-09  
CHEVROLET PASSENGER  
CAR ..... 1995-14  
OLDSMOBILE PASSENGER  
CAR ..... 1998-02  
PONTIAC PASSENGER CAR ..... 1997-08



**ST-2970**  
**STRUT MOUNT**  
Front

MAZDA PASSENGER CAR ..... 1999-05

**STRUT MOUNT**  
Rear

FORD PASSENGER CAR ..... 1988-97  
MAZDA PASSENGER CAR ..... 1999-05



**ST-2971**  
**STRUT MOUNT**  
Rear

BUICK PASSENGER CAR ..... 1986-93  
CADILLAC PASSENGER CAR ..... 1986-93  
OLDSMOBILE PASSENGER  
CAR ..... 1986-92



**ST-2972**  
**STRUT MOUNT**  
Front

BUICK PASSENGER CAR ..... 1998-05  
CADILLAC PASSENGER CAR ..... 1998-05  
OLDSMOBILE PASSENGER  
CAR ..... 1998-03  
PONTIAC PASSENGER CAR ..... 2000-05



**ST-2973**  
**STRUT MOUNT**  
Front

BUICK PASSENGER CAR ..... 1997-09

**STRUT MOUNT**

BUICK SPORT UTILITY ..... 2002-07

BUICK VAN ..... 2005-07

**STRUT MOUNT**

CHEVROLET PASSENGER  
CAR ..... 2000-13

**STRUT MOUNT**

CHEVROLET VAN ..... 1997-09

**STRUT MOUNT**

OLDSMOBILE PASSENGER  
CAR ..... 1998-02

**STRUT MOUNT**

OLDSMOBILE VAN ..... 1997-04

**STRUT MOUNT**

PONTIAC PASSENGER CAR ..... 1997-08

**STRUT MOUNT**

PONTIAC SPORT UTILITY ..... 2001-05

PONTIAC VAN ..... 1997-09

SATURN VAN ..... 2005-07



**ST-2974**  
**STRUT MOUNT**  
Front

MAZDA PASSENGER CAR ..... 1986-91



# BUYER'S GUIDE

## NUMERICAL LISTING - ILLUSTRATIONS



**ST-2975**  
**STRUT MOUNT**  
Rear

MAZDA PASSENGER CAR ..... 1986-91



**ST-2976**  
**STRUT MOUNT**  
Front

MERCURY PASSENGER CAR ... 1991-93



**ST-2977**  
**STRUT MOUNT**  
Front

MITSUBISHI PASSENGER  
CAR ..... 1985-93



**ST-2978**  
**STRUT MOUNT**  
Rear

(Continued Next Column)

**ST-2978 (Continued)**

NISSAN PASSENGER CAR ..... 1990-99



**ST-2979**  
**STRUT MOUNT**  
Front

NISSAN PASSENGER CAR ..... 1989-98



**ST-2980**  
**STRUT MOUNT**  
Rear

NISSAN PASSENGER CAR ..... 1989-98



**ST-2981**  
**STRUT MOUNT**  
Rear

NISSAN PASSENGER CAR ..... 1993-01



**ST-2982**  
**STRUT MOUNT**  
Rear

NISSAN PASSENGER CAR ..... 1985-94  
NISSAN VAN ..... 1990-94



**ST-2983**  
**STRUT MOUNT**  
Rear

NISSAN PASSENGER CAR ..... 1985-94  
NISSAN VAN ..... 1990-94



**ST-2984**  
**STRUT MOUNT**  
Front

HYUNDAI PASSENGER CAR ..... 1996-06  
KIA PASSENGER CAR ..... 2004-09



**ST-2985**  
**STRUT MOUNT**  
Front

NISSAN PASSENGER CAR ..... 1990-96



**ST-2986**  
**STRUT MOUNT**  
Rear

TOYOTA PASSENGER CAR ..... 1995-99



**ST-2987**  
**STRUT MOUNT**  
Front

SAAB PASSENGER CAR ..... 1986-98

# BUYER'S GUIDE

## NUMERICAL LISTING - ILLUSTRATIONS

 <p style="text-align: center;"><b>ST-2988 STRUT MOUNT Rear</b></p> <p>TOYOTA PASSENGER CAR ..... 1989-92</p>	 <p style="text-align: center;"><b>ST-2991 STRUT MOUNT Rear</b></p> <p>ACURA PASSENGER CAR ..... 1991-95</p>	 <p style="text-align: center;"><b>ST-2994 STRUT MOUNT Front</b></p> <p>BUICK PASSENGER CAR ..... 1988-96 CHEVROLET PASSENGER CAR ..... 1990-01 OLDSMOBILE PASSENGER CAR ..... 1988-97 PONTIAC PASSENGER CAR ..... 1988-96</p>	 <p style="text-align: center;"><b>ST-2998 STRUT MOUNT Rear</b></p> <p>BUICK PASSENGER CAR ..... 1995-11 CADILLAC PASSENGER CAR ..... 1998-11 OLDSMOBILE PASSENGER CAR ..... 1995-03 PONTIAC PASSENGER CAR ..... 2000-05</p>
 <p style="text-align: center;"><b>ST-2989 STRUT MOUNT Front</b></p> <p>MERCURY VAN ..... 1993-02</p> <p style="text-align: center;"><b>ST-2990 STRUT MOUNT</b></p> <p>NISSAN PASSENGER CAR ..... 1989-94</p> <p style="text-align: center;"><b>ST-2990 STRUT MOUNT</b></p> <p>NISSAN VAN ..... 1990-02</p>	 <p style="text-align: center;"><b>ST-2992 STRUT MOUNT Front</b></p> <p>CHEVROLET SPORT UTILITY .... 1988-99 CHEVROLET TRUCK ..... 1988-99 GMC SPORT UTILITY ..... 1988-99 GMC TRUCK ..... 1991-99 OLDSMOBILE SPORT UTILITY .. 1991-99</p>	 <p style="text-align: center;"><b>ST-2995 STRUT MOUNT Front</b></p> <p>BUICK PASSENGER CAR ..... 1988-96 CHEVROLET PASSENGER CAR ..... 1990-01 OLDSMOBILE PASSENGER CAR ..... 1988-97 PONTIAC PASSENGER CAR ..... 1988-96</p>	 <p style="text-align: center;"><b>ST-2999 STRUT MOUNT Front</b></p> <p>CHEVROLET PASSENGER CAR ..... 1997-05 OLDSMOBILE PASSENGER CAR ..... 1997-04 PONTIAC PASSENGER CAR ..... 1999-05</p>
 <p style="text-align: center;"><b>ST-2990 STRUT MOUNT Rear</b></p> <p>VOLKSWAGEN PASSENGER CAR ..... 1990-97</p>	 <p style="text-align: center;"><b>ST-2993 STRUT MOUNT Front</b></p> <p>DODGE VAN ..... 1986-94</p>	 <p style="text-align: center;"><b>ST-2997 STRUT MOUNT Rear</b></p> <p>LINCOLN PASSENGER CAR ..... 1988-94</p>	 <p style="text-align: center;"><b>ST-3900 STRUT MOUNT Rear</b></p> <p>CHEVROLET PASSENGER CAR ..... 1997-05 OLDSMOBILE PASSENGER CAR ..... 1997-04 PONTIAC PASSENGER CAR ..... 1999-05</p>

# BUYER'S GUIDE

## NUMERICAL LISTING - ILLUSTRATIONS



**ST-3901**  
**STRUT MOUNT**  
Front

CHRYSLER PASSENGER CAR ..... 1998-04  
DODGE PASSENGER CAR ..... 1998-04



**ST-3902**  
**STRUT MOUNT**  
Rear

CHRYSLER PASSENGER CAR ..... 1998-04  
DODGE PASSENGER CAR ..... 1998-04



**ST-3903**  
**STRUT MOUNT**  
Front

LEXUS PASSENGER CAR ..... 1997-03  
LEXUS SPORT UTILITY ..... 1999-03  
TOYOTA PASSENGER CAR ..... 1997-04  
TOYOTA VAN ..... 1998-03



**ST-3904**  
**STRUT MOUNT**  
Rear

LEXUS PASSENGER CAR ..... 1997-06

**STRUT MOUNT**

LEXUS SPORT UTILITY ..... 1999-03

**STRUT MOUNT**

TOYOTA PASSENGER CAR ..... 1997-06

**STRUT MOUNT**

TOYOTA SPORT UTILITY ..... 2001-03



**ST-3905**  
**STRUT MOUNT**  
Front

FORD PASSENGER CAR ..... 1989-92  
MAZDA PASSENGER CAR ..... 1988-92



**ST-3906**  
**STRUT MOUNT**  
Front

LEXUS PASSENGER CAR ..... 1997-03  
LEXUS SPORT UTILITY ..... 1999-03  
TOYOTA PASSENGER CAR ..... 1997-04  
TOYOTA VAN ..... 1998-03



**ST-3907**  
**STRUT MOUNT**  
Front

MAZDA PASSENGER CAR ..... 1995-98



**ST-3908**  
**STRUT MOUNT**  
Rear

MAZDA PASSENGER CAR ..... 1995-98



**ST-3909**  
**STRUT MOUNT**  
Rear

MAZDA PASSENGER CAR ..... 1995-98



**ST-3910**  
**STRUT MOUNT**  
Front

INFINITI PASSENGER CAR ..... 1993-99  
NISSAN PASSENGER CAR ..... 1995-99



**ST-3911**  
**STRUT MOUNT**  
Front

INFINITI PASSENGER CAR ..... 1991-02

**STRUT MOUNT**

**Rear**

INFINITI PASSENGER CAR ..... 1990-05  
NISSAN PASSENGER CAR ..... 1995-99



**ST-3912**  
**STRUT MOUNT**  
Front

AUDI PASSENGER CAR ..... 1992-97













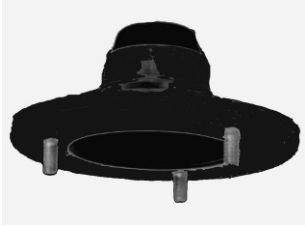

**ST-3913**  
**STRUT MOUNT**  
Rear

AUDI PASSENGER CAR ..... 1989-97

# BUYER'S GUIDE

## NUMERICAL LISTING - ILLUSTRATIONS

 <p><b>ST-3914</b> <b>STRUT MOUNT</b> <b>Front</b></p> <p>BMW SPORT UTILITY ..... 2000-06</p>	 <p><b>ST-3917</b> <b>STRUT MOUNT</b> <b>Front</b></p> <p>BMW PASSENGER CAR ..... 1995-99</p>	 <p><b>ST-3921</b> <b>STRUT MOUNT</b> <b>Rear</b></p> <p>BMW PASSENGER CAR ..... 1996-03</p>	 <p><b>ST-3924</b> <b>STRUT MOUNT</b> <b>Rear</b></p> <p>CHRYSLER PASSENGER CAR ..... 2000-02 DODGE PASSENGER CAR ..... 2000-05 PLYMOUTH PASSENGER CAR ..... 2000-01</p>
 <p><b>ST-3915</b> <b>STRUT MOUNT</b> <b>Rear</b></p> <p>BMW PASSENGER CAR ..... 1988-95</p>	 <p><b>ST-3918</b> <b>STRUT MOUNT</b> <b>Front</b></p> <p>BMW PASSENGER CAR ..... 1996-13 BMW SPORT UTILITY ..... 2004-10</p>	 <p><b>ST-3922</b> <b>STRUT MOUNT</b> <b>Front</b></p> <p>BMW PASSENGER CAR ..... 1993-01</p>	 <p><b>ST-3926</b> <b>STRUT MOUNT</b> <b>Front</b></p> <p>CHRYSLER PASSENGER CAR ..... 2000-09 DODGE PASSENGER CAR ..... 2000-05 PLYMOUTH PASSENGER CAR ..... 2000-01</p>
 <p><b>ST-3916</b> <b>STRUT MOUNT</b> <b>Front</b></p> <p>BMW PASSENGER CAR ..... 1995-99</p>	 <p><b>ST-3919</b> <b>STRUT MOUNT</b> <b>Front</b></p> <p>BMW PASSENGER CAR ..... 1997-03</p>	 <p><b>ST-3923</b> <b>STRUT MOUNT</b> <b>Rear</b></p> <p>BMW SPORT UTILITY ..... 2000-05</p>	 <p><b>ST-3928</b> <b>STRUT MOUNT</b> <b>Front</b></p> <p>FORD PASSENGER CAR ..... 2000-07</p>
	 <p><b>ST-3920</b> <b>STRUT MOUNT</b> <b>Rear</b></p> <p>BMW PASSENGER CAR ..... 1993-03</p>		

# BUYER'S GUIDE

## NUMERICAL LISTING - ILLUSTRATIONS

 <p style="text-align: center; margin-top: 10px;"><b>ST-3929</b> <b>STRUT MOUNT</b> Rear</p> <p>CADILLAC PASSENGER CAR ..... 1994-02</p>	 <p style="text-align: center; margin-top: 10px;"><b>ST-3935</b> <b>STRUT MOUNT</b> Rear</p> <p>HYUNDAI PASSENGER CAR ..... 1996-08 HYUNDAI SPORT UTILITY ..... 2005-10 KIA PASSENGER CAR ..... 2004-09 KIA SPORT UTILITY ..... 2005-10</p>	 <p style="text-align: center; margin-top: 10px;"><b>ST-3938</b> <b>STRUT MOUNT</b> Front</p> <p>HYUNDAI PASSENGER CAR ..... 2000-05</p>	 <p style="text-align: center; margin-top: 10px;"><b>ST-3941</b> <b>STRUT MOUNT</b> Rear</p> <p>KIA PASSENGER CAR ..... 1995-01</p>
 <p style="text-align: center; margin-top: 10px;"><b>ST-3930</b> <b>STRUT MOUNT</b> Front</p> <p>CADILLAC PASSENGER CAR ..... 1994-97</p>	 <p style="text-align: center; margin-top: 10px;"><b>ST-3936</b> <b>STRUT MOUNT</b> Rear</p> <p>HYUNDAI PASSENGER CAR ..... 1996-08 HYUNDAI SPORT UTILITY ..... 2005-10 KIA PASSENGER CAR ..... 2004-09 KIA SPORT UTILITY ..... 2005-10</p>	 <p style="text-align: center; margin-top: 10px;"><b>ST-3939</b> <b>STRUT MOUNT</b> Rear</p> <p>DAIHATSU PASSENGER CAR ... 1988-92 HYUNDAI PASSENGER CAR ..... 1995-05</p>	 <p style="text-align: center; margin-top: 10px;"><b>ST-3942</b> <b>STRUT MOUNT</b> Front</p> <p>KIA PASSENGER CAR ..... 1995-97</p>
 <p style="text-align: center; margin-top: 10px;"><b>ST-3932</b> <b>STRUT MOUNT</b> Front</p> <p>CADILLAC PASSENGER CAR ..... 1997-01 PONTIAC PASSENGER CAR ..... 2004-09</p>	 <p style="text-align: center; margin-top: 10px;"><b>ST-3937</b> <b>STRUT MOUNT</b> Rear</p> <p>HYUNDAI PASSENGER CAR ..... 1999-00</p>	 <p style="text-align: center; margin-top: 10px;"><b>ST-3940</b> <b>STRUT MOUNT</b> Rear</p> <p>KIA PASSENGER CAR ..... 1995-01</p>	 <p style="text-align: center; margin-top: 10px;"><b>ST-3943</b> <b>STRUT MOUNT</b> Front</p> <p>MAZDA PASSENGER CAR ..... 1990-91</p>
 <p style="text-align: center; margin-top: 10px;"><b>ST-3933</b> <b>STRUT MOUNT</b> Front</p> <p>CHEVROLET PASSENGER CAR ..... 1993-02 PONTIAC PASSENGER CAR ..... 1993-02</p>			

# BUYER'S GUIDE

## NUMERICAL LISTING - ILLUSTRATIONS

 <p><b>ST-3944</b> <b>STRUT MOUNT</b> Front</p> <p>MERCEDES-BENZ PASSENGER CAR ..... 1994-02</p>	 <p><b>ST-3947</b> <b>STRUT MOUNT</b> Front</p> <p>MITSUBISHI PASSENGER CAR ..... 1997-02</p>	 <p><b>ST-3951</b> <b>STRUT MOUNT</b> Front</p> <p>NISSAN PASSENGER CAR ..... 1984-89</p>	<p><b>ST-3958 (Continued)</b> INFINITI PASSENGER CAR ..... 1997-05</p>  <p><b>ST-3959</b> <b>STRUT MOUNT</b> Front</p> <p>SAAB PASSENGER CAR ..... 1999-08</p>
 <p><b>ST-3945</b> <b>STRUT MOUNT</b> Front</p> <p>MITSUBISHI PASSENGER CAR ..... 1997</p>	 <p><b>ST-3948</b> <b>STRUT MOUNT</b> Front</p> <p>MITSUBISHI PASSENGER CAR ..... 1983-88</p>	 <p><b>ST-3954</b> <b>STRUT MOUNT</b> Front</p> <p>INFINITI SPORT UTILITY ..... 1997-03 NISSAN SPORT UTILITY ..... 1996-04</p>	 <p><b>ST-3960</b> <b>STRUT MOUNT</b> Front</p> <p>SAAB PASSENGER CAR ..... 1994-98</p>
 <p><b>ST-3946</b> <b>STRUT MOUNT</b> Front</p> <p>MITSUBISHI PASSENGER CAR ..... 1989-90</p>	 <p><b>ST-3949</b> <b>STRUT MOUNT</b> Front</p> <p>NISSAN PASSENGER CAR ..... 1984-88</p>	 <p><b>ST-3957</b> <b>STRUT MOUNT</b> Front</p> <p>NISSAN PASSENGER CAR ..... 2000-01</p>	 <p><b>ST-3961</b> <b>STRUT MOUNT</b> Front</p> <p>SAAB PASSENGER CAR ..... 1999-02</p>
 <p><b>ST-3950</b> <b>STRUT MOUNT</b> Front</p> <p>NISSAN PASSENGER CAR ..... 2000-06</p>	 <p><b>ST-3958</b> <b>STRUT MOUNT</b> Front</p> <p>(Continued Next Column)</p>	 <p><b>ST-3962</b> <b>STRUT MOUNT</b> Rear</p> <p>VOLKSWAGEN PASSENGER CAR ..... 1985-02</p>	



# BUYER'S GUIDE

## NUMERICAL LISTING - ILLUSTRATIONS

 <p style="text-align: center;">ST-3964</p> <p style="text-align: center;"><b>ST-3964 STRUT MOUNT Front</b></p> <p>FORD PASSENGER CAR ..... 1993-97 MAZDA PASSENGER CAR ..... 1993-02</p>	 <p style="text-align: center;">ST-3967</p> <p style="text-align: center;"><b>ST-3967 STRUT MOUNT Front</b></p> <p>FORD PASSENGER CAR ..... 1986-95 MERCURY PASSENGER CAR ... 1986-95</p>	 <p style="text-align: center;">ST-3970</p> <p style="text-align: center;"><b>ST-3970 STRUT MOUNT Front</b></p> <p>BUICK PASSENGER CAR ..... 1995-98 CHEVROLET PASSENGER CAR ..... 1994-96 OLDSMOBILE PASSENGER CAR ..... 1995-98 PONTIAC PASSENGER CAR ..... 1995-98</p>	 <p style="text-align: center;">ST-3973</p> <p style="text-align: center;"><b>ST-3973 STRUT MOUNT Front</b></p> <p>BUICK PASSENGER CAR ..... 1990-99 CADILLAC PASSENGER CAR .... 1991-93 OLDSMOBILE PASSENGER CAR ..... 1990-99 PONTIAC PASSENGER CAR ..... 1990-99 PONTIAC SPORT UTILITY ..... 2001-05</p>
 <p style="text-align: center;">ST-3965</p> <p style="text-align: center;"><b>ST-3965 STRUT MOUNT Front</b></p> <p>FORD PASSENGER CAR ..... 1991-96 MERCURY PASSENGER CAR ... 1991-96</p>	 <p style="text-align: center;">ST-3968</p> <p style="text-align: center;"><b>ST-3968 STRUT MOUNT Front</b></p> <p>FORD PASSENGER CAR ..... 1996-07 MERCURY PASSENGER CAR ... 1996-05</p>	 <p style="text-align: center;">ST-3971</p> <p style="text-align: center;"><b>ST-3971 STRUT MOUNT Front</b></p> <p>BUICK PASSENGER CAR ..... 1984-96 CHEVROLET PASSENGER CAR ..... 1984-90 CHEVROLET VAN ..... 1990-96 OLDSMOBILE PASSENGER CAR ..... 1984-96 OLDSMOBILE VAN ..... 1990-96 PONTIAC PASSENGER CAR ..... 1984-91 PONTIAC VAN ..... 1990-96</p>	 <p style="text-align: center;">ST-3974</p> <p style="text-align: center;"><b>ST-3974 STRUT MOUNT Front</b></p> <p>BUICK PASSENGER CAR ..... 1985-90 CADILLAC PASSENGER CAR .... 1985-90 OLDSMOBILE PASSENGER CAR ..... 1985-90 PONTIAC PASSENGER CAR ..... 1987-90</p>
 <p style="text-align: center;">ST-3966</p> <p style="text-align: center;"><b>ST-3966 STRUT MOUNT Rear</b></p> <p>FORD PASSENGER CAR ..... 1984-94 MERCURY PASSENGER CAR ... 1984-94</p>	 <p style="text-align: center;">ST-3969</p> <p style="text-align: center;"><b>ST-3969 STRUT MOUNT Front</b></p> <p>BUICK PASSENGER CAR ..... 1982-91 CADILLAC PASSENGER CAR .... 1982-88 CHEVROLET PASSENGER CAR ..... 1982-94 OLDSMOBILE PASSENGER CAR ..... 1982-91 PONTIAC PASSENGER CAR ..... 1982-94</p>	 <p style="text-align: center;">ST-3972</p> <p style="text-align: center;"><b>ST-3972 STRUT MOUNT Front</b></p> <p>BUICK PASSENGER CAR ..... 1990-94 CHEVROLET PASSENGER CAR ..... 1992-94 OLDSMOBILE PASSENGER CAR ..... 1992-94 PONTIAC PASSENGER CAR ..... 1992-94</p>	 <p style="text-align: center;">ST-3975</p> <p style="text-align: center;"><b>ST-3975 STRUT MOUNT Front</b></p> <p>CHRYSLER VAN ..... 1995-00 DODGE VAN ..... 1995-00 PLYMOUTH VAN ..... 1995-00</p>

# BUYER'S GUIDE

## NUMERICAL LISTING - ILLUSTRATIONS

 <p style="text-align: center;"><b>ST-3976</b></p> <p style="text-align: center;"><b>ST-3976</b> <b>STRUT MOUNT</b> <b>Front</b></p> <p>DODGE PASSENGER CAR ..... 1995-99 PLYMOUTH PASSENGER CAR ..... 1995-99</p>	 <p style="text-align: center;"><b>ST-3980</b></p> <p style="text-align: center;"><b>ST-3980</b> <b>STRUT MOUNT</b> <b>Front</b></p> <p>CHRYSLER PASSENGER CAR ..... 1986-95 CHRYSLER VAN ..... 1990-95 DODGE PASSENGER CAR ..... 1986-95 DODGE VAN ..... 1986-95 PLYMOUTH PASSENGER CAR ..... 1986-95 PLYMOUTH VAN ..... 1986-95</p>	 <p style="text-align: center;"><b>ST-3984</b></p> <p style="text-align: center;"><b>ST-3984</b> <b>STRUT MOUNT</b> <b>Rear</b></p> <p>SUBARU PASSENGER CAR ..... 1985-94</p>	 <p style="text-align: center;"><b>ST-3988</b></p> <p style="text-align: center;"><b>ST-3988</b> <b>STRUT MOUNT</b> <b>Rear</b></p> <p>SUBARU PASSENGER CAR ..... 1995-96</p>
 <p style="text-align: center;"><b>ST-3977</b></p> <p style="text-align: center;"><b>ST-3977</b> <b>STRUT MOUNT</b> <b>Front</b></p> <p>CHRYSLER PASSENGER CAR ..... 1993-97 DODGE PASSENGER CAR ..... 1993-97 EAGLE PASSENGER CAR ..... 1993-97</p>	 <p style="text-align: center;"><b>ST-3982</b></p> <p style="text-align: center;"><b>ST-3982</b> <b>STRUT MOUNT</b> <b>Rear</b></p> <p>HONDA PASSENGER CAR ..... 1992-01</p>	 <p style="text-align: center;"><b>ST-3985</b></p> <p style="text-align: center;"><b>ST-3985</b> <b>STRUT MOUNT</b> <b>Rear</b></p> <p>SUBARU PASSENGER CAR ..... 1985-91</p>	 <p style="text-align: center;"><b>ST-3989</b></p> <p style="text-align: center;"><b>ST-3989</b> <b>STRUT MOUNT</b> <b>Rear</b></p> <p>SUBARU PASSENGER CAR ..... 1995-96</p>
 <p style="text-align: center;"><b>ST-3978</b></p> <p style="text-align: center;"><b>ST-3978</b> <b>STRUT MOUNT</b> <b>Front</b></p> <p>VOLVO PASSENGER CAR ..... 1993-07 VOLVO SPORT UTILITY ..... 2003-14</p>	 <p style="text-align: center;"><b>ST-3983</b></p> <p style="text-align: center;"><b>ST-3983</b> <b>STRUT MOUNT</b> <b>Rear</b></p> <p>SUBARU PASSENGER CAR ..... 1992-01</p>	 <p style="text-align: center;"><b>ST-3986</b></p> <p style="text-align: center;"><b>ST-3986</b> <b>STRUT MOUNT</b> <b>Rear</b></p> <p>SUBARU PASSENGER CAR ..... 1995-03 SUBARU SPORT UTILITY ..... 1998-02</p>	 <p style="text-align: center;"><b>ST-3990</b></p> <p style="text-align: center;"><b>ST-3990</b> <b>STRUT MOUNT</b> <b>Front</b></p> <p>TOYOTA PASSENGER CAR ..... 1991-95</p>
		 <p style="text-align: center;"><b>ST-3987</b></p> <p style="text-align: center;"><b>ST-3987</b> <b>STRUT MOUNT</b> <b>Rear</b></p> <p>SUBARU PASSENGER CAR ..... 1995-03 SUBARU SPORT UTILITY ..... 1998-02</p>	 <p style="text-align: center;"><b>ST-3991</b></p> <p style="text-align: center;"><b>ST-3991</b> <b>STRUT MOUNT</b> <b>Front</b></p> <p>LEXUS PASSENGER CAR ..... 1995-96 TOYOTA PASSENGER CAR ..... 1995-96</p>



# BUYER'S GUIDE

## NUMERICAL LISTING - ILLUSTRATIONS

 <p style="text-align: center;"><b>ST-3992</b> <b>STRUT MOUNT</b> Front</p> <p>TOYOTA PASSENGER CAR ..... 1994-99</p>	 <p style="text-align: center;"><b>ST-3997</b> <b>STRUT MOUNT</b> Front</p> <p>LEXUS PASSENGER CAR ..... 1993-08</p>	 <p style="text-align: center;"><b>ST-4900</b> <b>STRUT MOUNT</b> Front</p> <p>TOYOTA SPORT UTILITY ..... 1996-02</p>	 <p style="text-align: center;"><b>ST-4905</b> <b>STRUT MOUNT</b> Front</p> <p>AUDI PASSENGER CAR ..... 2000-06 VOLKSWAGEN PASSENGER CAR ..... 1998-10</p>
 <p style="text-align: center;"><b>ST-3993</b> <b>STRUT MOUNT</b> Rear</p> <p>TOYOTA PASSENGER CAR ..... 1986-93</p>	 <p style="text-align: center;"><b>ST-3998</b> <b>STRUT MOUNT</b> Front</p> <p>LEXUS PASSENGER CAR ..... 1990-94</p>	 <p style="text-align: center;"><b>ST-4902</b> <b>STRUT MOUNT</b> Rear</p> <p>LEXUS PASSENGER CAR ..... 1992-00 TOYOTA PASSENGER CAR ..... 1994-98</p>	 <p style="text-align: center;"><b>ST-4906</b> <b>STRUT MOUNT</b> Rear</p> <p>VOLKSWAGEN PASSENGER CAR ..... 1987-93</p>
 <p style="text-align: center;"><b>ST-3994</b> <b>STRUT MOUNT</b> Front</p> <p>TOYOTA PASSENGER CAR ..... 1986-93</p>	 <p style="text-align: center;"><b>ST-3999</b> <b>STRUT MOUNT</b> Rear</p> <p>LEXUS PASSENGER CAR ..... 1995-00</p>	 <p style="text-align: center;"><b>ST-4903</b> <b>STRUT MOUNT</b> Front</p> <p>VOLVO PASSENGER CAR ..... 1993-07 VOLVO SPORT UTILITY ..... 2003-14</p>	 <p style="text-align: center;"><b>ST-4907</b> <b>STRUT MOUNT</b> Rear</p> <p>AUDI PASSENGER CAR ..... 1996-06 VOLKSWAGEN PASSENGER CAR ..... 1982-88</p>
 <p style="text-align: center;"><b>ST-3995</b> <b>STRUT MOUNT</b> Front</p> <p>TOYOTA SPORT UTILITY ..... 1996-05</p>	 <p style="text-align: center;"><b>ST-4904</b> <b>STRUT MOUNT</b> Rear</p> <p>VOLVO PASSENGER CAR ..... 1993-04</p>	 <p style="text-align: center;"><b>ST-4908</b> <b>STRUT MOUNT</b> Front</p>	<p style="text-align: center;">(Continued Next Page)</p>

# BUYER'S GUIDE

## NUMERICAL LISTING - ILLUSTRATIONS

### ST-4908 (Continued)

AUDI PASSENGER CAR ..... 1996-07  
VOLKSWAGEN PASSENGER  
CAR ..... 1998-00



**ST-4909**  
**STRUT MOUNT**  
Rear

AUDI PASSENGER CAR ..... 1997-04  
VOLKSWAGEN PASSENGER  
CAR ..... 1998-05



**ST-4910**  
**SHOCK REAR**

AUDI PASSENGER CAR ..... 2000-06

SEAT PASSENGER CAR ..... 2001-19

VOLKSWAGEN PASSENGER  
CAR ..... 1998-10



**ST-4911**  
**STRUT MOUNT**  
Front

LINCOLN PASSENGER CAR ..... 1997-02



**ST-4912**  
**STRUT MOUNT**  
Front

BUICK PASSENGER CAR ..... 1995-98  
CHEVROLET PASSENGER  
CAR ..... 1995-99  
OLDSMOBILE PASSENGER  
CAR ..... 1995-98  
PONTIAC PASSENGER CAR ..... 1995-99



**ST-4913**  
**STRUT MOUNT**  
Front

FORD PASSENGER CAR ..... 1997-03  
MERCURY PASSENGER CAR ... 1997-99

**STRUT MOUNT**  
Rear

AUDI PASSENGER CAR ..... 1995-97



**ST-4915**  
**STRUT MOUNT**  
Front

SATURN PASSENGER CAR ..... 2000-05



**ST-4916**  
**STRUT MOUNT**  
Front

CHRYSLER PASSENGER  
CAR ..... 1986-95  
CHRYSLER VAN ..... 1990-95  
DODGE PASSENGER CAR ..... 1986-95  
DODGE VAN ..... 1986-95  
PLYMOUTH PASSENGER  
CAR ..... 1986-95  
PLYMOUTH VAN ..... 1986-95



**ST-4918**  
**STRUT MOUNT**  
Rear

LEXUS PASSENGER CAR ..... 1990-94



**ST-4919**  
**STRUT MOUNT**  
Front

CHEVROLET PASSENGER  
CAR ..... 2000-05  
PONTIAC PASSENGER CAR ..... 1999-05



**ST-4920**  
**STRUT MOUNT**  
Front

FORD PASSENGER CAR ..... 1989-97  
MERCURY PASSENGER CAR ... 1989-97



**ST-4921**  
**STRUT MOUNT**  
Front

CHRYSLER VAN ..... 1995-00  
DODGE VAN ..... 1995-00  
PLYMOUTH VAN ..... 1995-00



**ST-4922**  
**STRUT MOUNT**  
Front

FORD PASSENGER CAR ..... 1997-03

**STRUT MOUNT**  
Rear

FORD PASSENGER CAR ..... 1991-96  
MERCURY PASSENGER CAR ... 1991-99

# BUYER'S GUIDE

## NUMERICAL LISTING - ILLUSTRATIONS

 <p style="text-align: center;"><b>ST-4923</b> <b>STRUT MOUNT</b> Front</p> <p>BUICK PASSENGER CAR ..... 1985-90 CADILLAC PASSENGER CAR .... 1985-90 OLDSMOBILE PASSENGER CAR ..... 1985-90 PONTIAC PASSENGER CAR ..... 1987-90</p>	 <p style="text-align: center;"><b>ST-4927</b> <b>STRUT MOUNT</b> Rear</p> <p>FORD PASSENGER CAR ..... 2000-11</p>	<p style="text-align: center;"><b>ST-4934 (Continued)</b></p> <p>SUBARU SPORT UTILITY ..... 2000-09</p>  <p style="text-align: center;"><b>ST-4935</b> <b>STRUT MOUNT</b> Front</p> <p>PONTIAC PASSENGER CAR ..... 2003-08 TOYOTA PASSENGER CAR ..... 2000-08</p>	 <p style="text-align: center;"><b>ST-4938</b> <b>STRUT MOUNT</b> Front</p> <p>FORD SPORT UTILITY ..... 2001-12 MAZDA SPORT UTILITY ..... 2001-11 MERCURY SPORT UTILITY ..... 2005-11</p>
 <p style="text-align: center;"><b>ST-4924</b> <b>STRUT MOUNT</b> Front</p> <p>BUICK PASSENGER CAR ..... 1983-91 CADILLAC PASSENGER CAR .... 1983-88 CHEVROLET PASSENGER CAR ..... 1983-91 OLDSMOBILE PASSENGER CAR ..... 1983-91 PONTIAC PASSENGER CAR ..... 1982-91</p>	 <p style="text-align: center;"><b>ST-4932</b> <b>STRUT MOUNT</b> Front</p> <p>CHEVROLET SPORT UTILITY .... 1999-04 SUZUKI SPORT UTILITY ..... 1999-06</p>	 <p style="text-align: center;"><b>ST-4936</b> <b>STRUT MOUNT</b> Front</p> <p>FORD PASSENGER CAR ..... 1997-03 MERCURY PASSENGER CAR ... 1997-99</p>	 <p style="text-align: center;"><b>ST-4939</b> <b>STRUT MOUNT</b> Front</p> <p>CHEVROLET PASSENGER CAR ..... 1995-05 PONTIAC PASSENGER CAR ..... 1999-05</p>
 <p style="text-align: center;"><b>ST-4925</b> <b>STRUT MOUNT</b> Front</p> <p>BUICK PASSENGER CAR ..... 1990-99 CADILLAC PASSENGER CAR .... 1991-93 OLDSMOBILE PASSENGER CAR ..... 1990-99 PONTIAC PASSENGER CAR ..... 1990-99</p>	 <p style="text-align: center;"><b>ST-4933</b> <b>STRUT MOUNT</b> Front</p> <p>CHEVROLET SPORT UTILITY .... 1999-02 SUZUKI SPORT UTILITY ..... 1999-02</p>	 <p style="text-align: center;"><b>ST-4937</b> <b>STRUT MOUNT</b> Front</p> <p>FORD PASSENGER CAR ..... 1996-07 MERCURY PASSENGER CAR ... 1996-05</p>	 <p style="text-align: center;"><b>ST-4940</b> <b>STRUT MOUNT</b> Front</p> <p>CHEVROLET PASSENGER CAR ..... 1995-05 PONTIAC PASSENGER CAR ..... 1995-05</p>
 <p style="text-align: center;"><b>ST-4934</b> <b>STRUT MOUNT</b> Rear</p> <p>SUBARU PASSENGER CAR ..... 2000-09</p> <p style="text-align: center;">(Continued Next Column)</p>	 <p style="text-align: center;"><b>ST-4941</b> <b>STRUT MOUNT</b> Rear</p> <p>BUICK PASSENGER CAR ..... 1997-05</p> <p style="text-align: center;">(Continued Next Page)</p>		

# BUYER'S GUIDE

## NUMERICAL LISTING - ILLUSTRATIONS

### ST-4941 (Continued)

CHEVROLET PASSENGER CAR ..... 2000-13  
 PONTIAC PASSENGER CAR ..... 1997-03



ST-4942

#### ST-4942 STRUT MOUNT Front

BUICK PASSENGER CAR ..... 1997-05  
 BUICK SPORT UTILITY ..... 2002-07  
 BUICK VAN ..... 2005-07  
 CHEVROLET PASSENGER CAR ..... 2000-13  
 CHEVROLET VAN ..... 1997-09  
 OLDSMOBILE VAN ..... 1997-04  
 PONTIAC PASSENGER CAR ..... 1997-03  
 PONTIAC SPORT UTILITY ..... 2001-05  
 PONTIAC VAN ..... 1997-09  
 SATURN VAN ..... 2005-07



ST-4943

#### ST-4943 STRUT MOUNT Front

BUICK PASSENGER CAR ..... 1997-05  
 BUICK SPORT UTILITY ..... 2002-07  
 BUICK VAN ..... 2005-07  
 CHEVROLET PASSENGER CAR ..... 2000-13  
 CHEVROLET VAN ..... 1997-09  
 OLDSMOBILE VAN ..... 1997-04  
 PONTIAC PASSENGER CAR ..... 1997-03  
 PONTIAC SPORT UTILITY ..... 2001-05  
 PONTIAC VAN ..... 1997-09  
 SATURN VAN ..... 2005-07



#### ST-4944 STRUT MOUNT Front

(Continued Next Column)

### ST-4944 (Continued)

CHEVROLET PASSENGER CAR ..... 1997-05  
 OLDSMOBILE PASSENGER CAR ..... 1997-04  
 PONTIAC PASSENGER CAR ..... 1999-05



ST-4945

#### ST-4945 STRUT MOUNT Front

CHEVROLET PASSENGER CAR ..... 1997-05  
 OLDSMOBILE PASSENGER CAR ..... 1997-04  
 PONTIAC PASSENGER CAR ..... 1999-05



ST-4948

#### ST-4948 STRUT MOUNT Rear

DODGE PASSENGER CAR ..... 1995-99  
 PLYMOUTH PASSENGER CAR ..... 1995-99



ST-4949

#### ST-4949 STRUT MOUNT Front

FORD VAN ..... 1995-03



ST-4950

#### ST-4950 STRUT MOUNT Front

LEXUS PASSENGER CAR ..... 1995-03  
 TOYOTA PASSENGER CAR ..... 1995-03



#### ST-4951 STRUT MOUNT Front

LEXUS PASSENGER CAR ..... 1995-03  
 TOYOTA PASSENGER CAR ..... 1995-03



ST-4952

#### ST-4952 STRUT MOUNT Rear

LEXUS PASSENGER CAR ..... 1992-96  
 TOYOTA PASSENGER CAR ..... 1992-96



#### ST-4953 STRUT MOUNT Rear

LEXUS PASSENGER CAR ..... 1992-03

(Continued Next Column)

### ST-4953 (Continued)

TOYOTA PASSENGER CAR ..... 1992-03



ST-4954

#### ST-4954 STRUT MOUNT Front

MAZDA PASSENGER CAR ..... 1998-02



#### ST-4955 STRUT MOUNT Rear

NISSAN PASSENGER CAR ..... 2000-06



ST-4956

#### ST-4956 STRUT MOUNT Front

DODGE PASSENGER CAR ..... 2000-05



ST-4957

#### ST-4957 STRUT MOUNT Front

CHRYSLER PASSENGER CAR ..... 2001-05  
 DODGE PASSENGER CAR ..... 2001-05  
 HYUNDAI SPORT UTILITY ..... 2001-10

(Continued Next Page)

# BUYER'S GUIDE

## NUMERICAL LISTING - ILLUSTRATIONS

### ST-4957 (Continued)

MITSUBISHI PASSENGER CAR ..... 1999-05



ST-4958

### ST-4958 STRUT MOUNT Front

MAZDA VAN ..... 2000-06



ST-4962

### ST-4962 STRUT MOUNT Front

CHEVROLET PASSENGER CAR ..... 1993-02  
ISUZU SPORT UTILITY ..... 2003-08  
PONTIAC PASSENGER CAR ..... 1993-02



ST-4965

### ST-4965 STRUT MOUNT Rear

AUDI PASSENGER CAR ..... 2001-07



ST-4966

### ST-4966 STRUT MOUNT Rear

BMW PASSENGER CAR ..... 2000-06



ST-4968

### ST-4968 STRUT MOUNT Front

BUICK SPORT UTILITY ..... 2004-07  
CHEVROLET SPORT UTILITY ..... 2002-09  
CHEVROLET TRUCK ..... 2004-06  
GMC SPORT UTILITY ..... 2002-08  
ISUZU SPORT UTILITY ..... 2003-08  
OLDSMOBILE SPORT UTILITY ..... 2002-04  
SAAB SUV ..... 2005-09



ST-4970

### ST-4970 STRUT MOUNT Front

FORD TRUCK ..... 2004-08  
LINCOLN TRUCK ..... 2006-08



ST-4971

### ST-4971 STRUT MOUNT Front

FORD VAN ..... 2004-07  
MERCURY VAN ..... 2004-07



ST-4972

### ST-4972 STRUT MOUNT Front

FORD PASSENGER CAR ..... 2002-05  
JAGUAR ..... 2000-05  
LINCOLN PASSENGER CAR ..... 2000-06

### STRUT MOUNT Rear

FORD PASSENGER CAR ..... 2002-05  
JAGUAR ..... 2000-05  
LINCOLN PASSENGER CAR ..... 2000-06



ST-4973

### ST-4973 STRUT MOUNT Rear

FORD SPORT UTILITY ..... 2003-06



ST-4974

### ST-4974 STRUT MOUNT Front

FORD SPORT UTILITY ..... 2003-06



ST-4975

### ST-4975 STRUT MOUNT Front

ACURA SPORT UTILITY ..... 2001-06  
HONDA SPORT UTILITY ..... 2003-08  
HONDA VAN ..... 1999-04



ST-4976

### ST-4976 STRUT MOUNT Front

ACURA PASSENGER CAR ..... 1996-04



ST-4977

### ST-4977 STRUT MOUNT Rear

ACURA PASSENGER CAR ..... 1996-04



ST-4979

### ST-4979 STRUT MOUNT Rear

INFINITI PASSENGER CAR ..... 2000-04  
NISSAN PASSENGER CAR ..... 2000-03



# BUYER'S GUIDE

## NUMERICAL LISTING - ILLUSTRATIONS

 <p style="text-align: center;"><b>ST-4980</b> <b>STRUT MOUNT</b> Front</p> <p>KIA PASSENGER CAR ..... 2001-02</p>	 <p style="text-align: center;"><b>ST-4985</b> <b>STRUT MOUNT</b> Rear</p> <p>NISSAN PASSENGER CAR ..... 2002-08</p>	<p><b>ST-4989 (Continued)</b></p> <p>TOYOTA PASSENGER CAR ..... 2002-08 TOYOTA SPORT UTILITY ..... 2001-07 TOYOTA VAN ..... 2004-08</p>  <p style="text-align: center;"><b>ST-4990</b> <b>STRUT MOUNT</b> Rear</p> <p>PONTIAC PASSENGER CAR ..... 2003-10 SCION PASSENGER CAR ..... 2005-10 TOYOTA PASSENGER CAR ..... 2000-17</p>	 <p style="text-align: center;"><b>ST-4993</b> <b>STRUT MOUNT</b> Rear</p> <p>HONDA PASSENGER CAR ..... 1990-97</p>
 <p style="text-align: center;"><b>ST-4981</b> <b>STRUT MOUNT</b> Front</p> <p>KIA SPORT UTILITY ..... 1995-02</p>	 <p style="text-align: center;"><b>ST-4987</b> <b>STRUT MOUNT</b> Rear</p> <p>SATURN PASSENGER CAR ..... 2000-05</p>	 <p style="text-align: center;"><b>ST-4991</b> <b>STRUT MOUNT</b> Rear</p> <p>MAZDA PASSENGER CAR ..... 1999-03</p>	 <p style="text-align: center;"><b>ST-4994</b> <b>STRUT MOUNT</b> Rear</p> <p>MAZDA PASSENGER CAR ..... 1999-03</p>
 <p style="text-align: center;"><b>ST-4983</b> <b>STRUT MOUNT</b> Front</p> <p>MAZDA PASSENGER CAR ..... 1999-03</p>	 <p style="text-align: center;"><b>ST-4988</b> <b>STRUT MOUNT</b> Front</p> <p>SCION PASSENGER CAR ..... 2004-05 SCION VAN ..... 2004-06 TOYOTA PASSENGER CAR ..... 2000-05</p>	 <p style="text-align: center;"><b>ST-4991</b> <b>STRUT MOUNT</b> Front</p> <p>TOYOTA PASSENGER CAR ..... 2001-03</p>	 <p style="text-align: center;"><b>ST-4995</b> <b>STRUT MOUNT</b> Rear</p> <p>MAZDA PASSENGER CAR ..... 1999-03</p>
 <p style="text-align: center;"><b>ST-4984</b> <b>STRUT MOUNT</b> Front</p> <p>MAZDA PASSENGER CAR ..... 1999-03</p>	 <p style="text-align: center;"><b>ST-4989</b> <b>STRUT MOUNT</b> Front</p> <p>LEXUS PASSENGER CAR ..... 2004-06 LEXUS SPORT UTILITY ..... 2004-06</p>	 <p style="text-align: center;"><b>ST-4992</b> <b>STRUT MOUNT</b> Front</p> <p>AUDI PASSENGER CAR ..... 2007 VOLKSWAGEN PASSENGER CAR ..... 2001-05</p>	 <p style="text-align: center;"><b>ST-4995</b> <b>STRUT MOUNT</b> Rear</p> <p>MAZDA PASSENGER CAR ..... 1999-03</p>
 <p style="text-align: center;"><b>ST-4984</b> <b>STRUT MOUNT</b> Front</p> <p>MITSUBISHI SPORT UTILITY ..... 2001-03</p>	 <p style="text-align: center;"><b>ST-4989</b> <b>STRUT MOUNT</b> Front</p> <p>LEXUS PASSENGER CAR ..... 2004-06 LEXUS SPORT UTILITY ..... 2004-06</p>	 <p style="text-align: center;"><b>ST-4992</b> <b>STRUT MOUNT</b> Front</p> <p>AUDI PASSENGER CAR ..... 2007 VOLKSWAGEN PASSENGER CAR ..... 2001-05</p>	 <p style="text-align: center;"><b>ST-4996</b> <b>STRUT MOUNT</b> Front</p> <p>ACURA PASSENGER CAR ..... 2005-06 HONDA PASSENGER CAR ..... 2002-05</p>
<p><b>(Continued Next Column)</b></p>			

# BUYER'S GUIDE

## NUMERICAL LISTING - ILLUSTRATIONS

 <p style="text-align: center;"><b>ST-4997</b> <b>STRUT MOUNT</b> Front</p> <p>ACURA PASSENGER CAR ..... 2005-06 HONDA PASSENGER CAR ..... 2002-05</p>	 <p style="text-align: center;"><b>ST-5901</b> <b>STRUT MOUNT</b> Front</p> <p>HONDA PASSENGER CAR ..... 1990-97</p>	 <p style="text-align: center;"><b>ST-5905</b> <b>STRUT MOUNT</b> Front</p> <p>BMW PASSENGER CAR ..... 2003-06</p>	 <p style="text-align: center;"><b>ST-5909</b> <b>STRUT MOUNT</b> Front</p> <p>CHEVROLET PASSENGER CAR ..... 2004-12 PONTIAC PASSENGER CAR ..... 2005-10 SATURN PASSENGER CAR ..... 2007-09</p>
 <p style="text-align: center;"><b>ST-4998</b> <b>STRUT MOUNT</b> Rear</p> <p>MAZDA PASSENGER CAR ..... 2000-02</p>	 <p style="text-align: center;"><b>ST-5902</b> <b>STRUT MOUNT</b> Front</p> <p>DODGE SPORT UTILITY ..... 2007-11 JEEP SPORT UTILITY ..... 2002-12</p>	 <p style="text-align: center;"><b>ST-5906</b> <b>STRUT MOUNT</b> Front</p> <p>CHEVROLET PASSENGER CAR ..... 2004-11 PONTIAC PASSENGER CAR ..... 2005-09 SUZUKI PASSENGER CAR ..... 2004-08</p>	 <p style="text-align: center;"><b>ST-5910</b> <b>STRUT MOUNT</b> Front</p> <p>CADILLAC SPORT UTILITY ..... 2007-14 CHEVROLET SPORT UTILITY ..... 2007-13 CHEVROLET TRUCK ..... 2007-13 GMC SPORT UTILITY ..... 2007-14 GMC TRUCK ..... 2007-14</p>
 <p style="text-align: center;"><b>ST-4999</b> <b>STRUT MOUNT</b> Rear</p> <p>MAZDA PASSENGER CAR ..... 2000-02</p>	 <p style="text-align: center;"><b>ST-5903</b> <b>STRUT MOUNT</b> Front</p> <p>DODGE SPORT UTILITY ..... 2007-11 JEEP SPORT UTILITY ..... 2002-12</p>	 <p style="text-align: center;"><b>ST-5907</b> <b>STRUT MOUNT</b> Front</p> <p>CHEVROLET PASSENGER CAR ..... 2005-11 PONTIAC PASSENGER CAR ..... 2005-09</p>	 <p style="text-align: center;"><b>ST-5911</b> <b>STRUT MOUNT</b> Front</p> <p>CHRYSLER SUV ..... 2004-08 CHRYSLER VAN ..... 2001-07 DODGE VAN ..... 2001-07</p>
 <p style="text-align: center;"><b>ST-5900</b> <b>STRUT MOUNT</b> Front</p> <p>TOYOTA PASSENGER CAR ..... 2000-05</p>	 <p style="text-align: center;"><b>ST-5904</b> <b>STRUT MOUNT</b> Front</p> <p>HONDA SPORT UTILITY ..... 2009-15 HONDA VAN ..... 2005-17</p>	 <p style="text-align: center;"><b>ST-5908</b> <b>STRUT MOUNT</b> Front</p> <p>CHEVROLET PASSENGER CAR ..... 2004-12 PONTIAC PASSENGER CAR ..... 2005-10 SATURN PASSENGER CAR ..... 2007-09</p>	 <p style="text-align: center;"><b>ST-5912</b> <b>STRUT MOUNT</b> Front</p> <p>CHEVROLET PASSENGER CAR ..... 1998-02 GEO PASSENGER CAR ..... 1989-97 TOYOTA PASSENGER CAR ..... 1988-02</p>

# BUYER'S GUIDE

## NUMERICAL LISTING - ILLUSTRATIONS

 <p><b>ST-5913</b> <b>STRUT MOUNT</b> Front</p> <p>DODGE TRUCK ..... 2005-09</p>	 <p><b>ST-5917</b> <b>STRUT MOUNT</b> Front</p> <p>MAZDA PASSENGER CAR ..... 2003-04</p>	 <p><b>ST-5921</b> <b>STRUT MOUNT</b> Front</p> <p>MERCURY VAN ..... 1993-98</p>	 <p><b>ST-5925</b> <b>STRUT MOUNT</b> Front</p> <p>KIA PASSENGER CAR ..... 2001-05</p>
 <p><b>ST-5914</b> <b>STRUT MOUNT</b> Front</p> <p>DODGE TRUCK ..... 2006-08</p>	 <p><b>ST-5918</b> <b>STRUT MOUNT</b> Front</p> <p>FORD PASSENGER CAR ..... 2006-12 LINCOLN PASSENGER CAR ..... 2006-12 MAZDA PASSENGER CAR ..... 2005-08 MERCURY PASSENGER CAR ... 2006-11</p>	 <p><b>ST-5922</b> <b>STRUT MOUNT</b> Front</p> <p>JEEP SPORT UTILITY ..... 2005-10</p>	 <p><b>ST-5926</b> <b>STRUT MOUNT</b> Front</p> <p>KIA PASSENGER CAR ..... 2001-05</p>
 <p><b>ST-5915</b> <b>STRUT MOUNT</b> Front</p> <p>FORD PASSENGER CAR ..... 2005-10 MERCURY PASSENGER CAR ... 2005-07</p>	 <p><b>ST-5919</b> <b>STRUT MOUNT</b> Front</p> <p>HONDA PASSENGER CAR ..... 1992-95</p>	 <p><b>ST-5923</b> <b>STRUT MOUNT</b> Front</p> <p>KIA PASSENGER CAR ..... 2004-06</p>	 <p><b>ST-5927</b> <b>STRUT MOUNT</b> Front</p> <p>KIA SPORT UTILITY ..... 2003-06</p>
 <p><b>ST-5916</b> <b>STRUT MOUNT</b> Front</p> <p>HYUNDAI PASSENGER CAR ..... 2003-08</p>	 <p><b>ST-5920</b> <b>STRUT MOUNT</b> Front</p> <p>HONDA PASSENGER CAR ..... 1990-93</p>	 <p><b>ST-5924</b> <b>STRUT MOUNT</b> Front</p> <p>MERCURY VAN ..... 1993-98</p>	 <p><b>ST-5929</b> <b>STRUT MOUNT</b> Rear</p> <p>LAND ROVER SPORT UTILITY .. 2002-05</p>
		 <p><b>ST-5923</b> <b>STRUT MOUNT</b> Rear</p> <p>KIA PASSENGER CAR ..... 2004-06</p>	



# BUYER'S GUIDE

## NUMERICAL LISTING - ILLUSTRATIONS

 <p style="text-align: center;"><b>ST-5930</b> <b>STRUT MOUNT</b> Rear</p> <p>LEXUS PASSENGER CAR ..... 1998-05</p>	 <p style="text-align: center;"><b>ST-5935</b> <b>STRUT MOUNT</b> Rear</p> <p>LEXUS PASSENGER CAR ..... 2001-06</p>	 <p style="text-align: center;"><b>ST-5938</b> <b>STRUT MOUNT</b> Front</p> <p>LEXUS PASSENGER CAR ..... 1992-00</p>	<p><b>ST-5941 (Continued)</b></p> <p>MITSUBISHI PASSENGER CAR ..... 1992-96</p>  <p style="text-align: center;"><b>ST-5942</b> <b>STRUT MOUNT</b> Rear</p> <p>MITSUBISHI PASSENGER CAR ..... 1997-03</p>
 <p style="text-align: center;"><b>ST-5931</b> <b>STRUT MOUNT</b> Rear</p> <p>LEXUS PASSENGER CAR ..... 1993-97</p>	 <p style="text-align: center;"><b>ST-5936</b> <b>STRUT MOUNT</b> Rear</p> <p>LEXUS SPORT UTILITY ..... 2004-06 TOYOTA SPORT UTILITY ..... 2004-07</p>	 <p style="text-align: center;"><b>ST-5939</b> <b>STRUT MOUNT</b> Rear</p> <p>NISSAN PASSENGER CAR ..... 1995-99</p>	 <p style="text-align: center;"><b>ST-5943</b> <b>STRUT MOUNT</b> Front</p> <p>MITSUBISHI PASSENGER CAR ..... 2002-06</p>
 <p style="text-align: center;"><b>ST-5932</b> <b>STRUT MOUNT</b> Front</p> <p>LEXUS PASSENGER CAR ..... 2001-05</p>	 <p style="text-align: center;"><b>ST-5937</b> <b>STRUT MOUNT</b> Rear</p> <p>LEXUS SPORT UTILITY ..... 2004-06 TOYOTA SPORT UTILITY ..... 2004-07</p>	 <p style="text-align: center;"><b>ST-5940</b> <b>STRUT MOUNT</b> Rear</p> <p>LEXUS PASSENGER CAR ..... 2002-08</p>	 <p style="text-align: center;"><b>ST-5944</b> <b>STRUT MOUNT</b> Front</p> <p>MITSUBISHI PASSENGER CAR ..... 2002-07</p>
 <p style="text-align: center;"><b>ST-5933</b> <b>STRUT MOUNT</b> Front</p> <p>LEXUS PASSENGER CAR ..... 1995-00</p>	 <p style="text-align: center;"><b>ST-5934</b> <b>STRUT MOUNT</b> Front</p> <p>LEXUS PASSENGER CAR ..... 2001-06</p>	 <p style="text-align: center;"><b>ST-5941</b> <b>STRUT MOUNT</b> Rear</p> <p style="text-align: center;">(Continued Next Column)</p>	

# BUYER'S GUIDE

## NUMERICAL LISTING - ILLUSTRATIONS

			
<p><b>ST-5945</b> <b>STRUT MOUNT</b> <b>Rear</b></p> <p>MITSUBISHI PASSENGER CAR ..... 2002-07</p>	<p><b>ST-5948</b> <b>STRUT MOUNT</b> <b>Front</b></p> <p>SATURN PASSENGER CAR ..... 2003-07</p>	<p><b>ST-5951</b> <b>STRUT MOUNT</b> <b>Front</b></p> <p>SUZUKI PASSENGER CAR ..... 1995-07</p>	<p><b>ST-5954</b> <b>STRUT MOUNT</b> <b>Front</b></p> <p>CHRYSLER PASSENGER CAR ..... 1993-97 DODGE PASSENGER CAR ..... 1993-97 EAGLE PASSENGER CAR ..... 1993-97</p>
			
<p><b>ST-5946</b> <b>STRUT MOUNT</b> <b>Front</b></p> <p>VOLKSWAGEN PASSENGER CAR ..... 1993-98</p>	<p><b>ST-5949</b> <b>STRUT MOUNT</b> <b>Front</b></p> <p>SATURN SUV ..... 2002-07</p>	<p><b>ST-5952</b> <b>STRUT MOUNT</b> <b>Rear</b></p> <p>SUZUKI PASSENGER CAR ..... 1995-99</p>	<p><b>ST-5955</b> <b>STRUT MOUNT</b> <b>Rear</b></p> <p>CHRYSLER PASSENGER CAR ..... 1993-97 DODGE PASSENGER CAR ..... 1993-97 EAGLE PASSENGER CAR ..... 1993-97</p>
			
<p><b>ST-5947</b> <b>STRUT MOUNT</b> <b>Front</b></p> <p>TOYOTA PASSENGER CAR ..... 1993-02</p>	<p><b>ST-5950</b> <b>STRUT MOUNT</b> <b>Rear</b></p> <p>SUBARU PASSENGER CAR ..... 2004-07 SUBARU SPORT UTILITY ..... 2003-08</p>	<p><b>ST-5953</b> <b>STRUT MOUNT</b> <b>Rear</b></p> <p>SUZUKI PASSENGER CAR ..... 2000-07</p>	<p><b>ST-5956</b> <b>STRUT MOUNT</b> <b>Rear</b></p> <p>HONDA PASSENGER CAR ..... 1992-95</p>

# BUYER'S GUIDE

## NUMERICAL LISTING - ILLUSTRATIONS

 <p style="text-align: center;"><b>ST-5957</b> <b>STRUT MOUNT</b> Front</p> <p>TOYOTA PASSENGER CAR ..... 2000-09</p>	<p><b>ST-5960 (Continued)</b> TOYOTA PASSENGER CAR ..... 1993-02</p>  <p style="text-align: center;"><b>ST-5961</b> <b>STRUT MOUNT</b> Rear</p> <p>TOYOTA PASSENGER CAR ..... 1993-02</p>	 <p style="text-align: center;"><b>ST-5964</b> <b>STRUT MOUNT</b> Rear</p> <p>FORD PASSENGER CAR ..... 1996-07 MERCURY PASSENGER CAR ... 1986-95</p>	 <p style="text-align: center;"><b>ST-5967</b> <b>STRUT MOUNT</b> Front</p> <p>CHRYSLER PASSENGER CAR ..... 2005-14 DODGE PASSENGER CAR ..... 2005-14</p>
 <p style="text-align: center;"><b>ST-5958</b> <b>STRUT MOUNT</b> Front</p> <p>VOLVO PASSENGER CAR ..... 2000</p>	 <p style="text-align: center;"><b>ST-5962</b> <b>STRUT MOUNT</b> Front</p> <p>NISSAN PASSENGER CAR ..... 1995-99</p>	 <p style="text-align: center;"><b>ST-5965</b> <b>STRUT MOUNT</b> Front</p> <p>FORD PASSENGER CAR ..... 1986-95 MERCURY PASSENGER CAR ... 1986-95</p>	 <p style="text-align: center;"><b>ST-5968 (NEW)</b> <b>STRUT MOUNT</b> Front</p> <p>CHRYSLER PASSENGER CAR ..... 2005-14 DODGE PASSENGER CAR ..... 2005-14</p>
 <p style="text-align: center;"><b>ST-5959</b> <b>STRUT MOUNT</b> Front</p> <p>VOLVO PASSENGER CAR ..... 2000-04</p>	 <p style="text-align: center;"><b>ST-5963</b> <b>STRUT MOUNT</b> Rear</p> <p>VOLKSWAGEN PASSENGER CAR ..... 1993-98</p>	 <p style="text-align: center;"><b>ST-5966</b> <b>STRUT MOUNT</b> Front</p> <p>CHRYSLER PASSENGER CAR ..... 2005-14 DODGE PASSENGER CAR ..... 2005-14</p>	 <p style="text-align: center;"><b>ST-5969</b> <b>STRUT MOUNT</b> Rear</p> <p>CHRYSLER PASSENGER CAR ..... 2005-10 DODGE PASSENGER CAR ..... 2005-10</p>
 <p style="text-align: center;"><b>ST-5960</b> <b>STRUT MOUNT</b> Front</p> <p>(Continued Next Column)</p>			

# BUYER'S GUIDE

## NUMERICAL LISTING - ILLUSTRATIONS

 <p><b>ST-5970</b> <b>STRUT MOUNT</b> Rear</p> <p>CHRYSLER PASSENGER CAR ..... 2005-14 DODGE PASSENGER CAR ..... 2005-14</p>	 <p><b>ST-5973</b> <b>STRUT MOUNT</b> Rear</p> <p>CHRYSLER PASSENGER CAR ..... 1998-04 DODGE PASSENGER CAR ..... 1998-04</p>	 <p><b>ST-5977</b> <b>STRUT MOUNT</b> Rear</p> <p>HONDA PASSENGER CAR ..... 1992-00</p>	 <p><b>ST-5980</b> <b>STRUT MOUNT</b> Front</p> <p>CHEVROLET SPORT UTILITY .... 2005-06 PONTIAC SPORT UTILITY ..... 2006</p>
 <p><b>ST-5971</b> <b>STRUT MOUNT</b> Front</p> <p>CHRYSLER VAN ..... 2001-07 DODGE VAN ..... 2001-07</p>	 <p><b>ST-5974</b> <b>STRUT MOUNT</b> Rear</p> <p>HONDA PASSENGER CAR ..... 1994-97</p>	 <p><b>ST-5978</b> <b>STRUT MOUNT</b> Front</p> <p>NISSAN PASSENGER CAR ..... 1995-99</p>	 <p><b>ST-5981</b> <b>STRUT MOUNT</b> Rear</p> <p>CHEVROLET PASSENGER CAR ..... 2004-11 PONTIAC PASSENGER CAR ..... 2005-09 SUZUKI PASSENGER CAR ..... 2004-08</p>
 <p><b>ST-5972</b> <b>STRUT MOUNT</b> Front</p> <p>CHRYSLER VAN ..... 2001-07 DODGE VAN ..... 2001-07</p>	 <p><b>ST-5975</b> <b>STRUT MOUNT</b> Rear</p> <p>HONDA PASSENGER CAR ..... 1994-97</p>	 <p><b>ST-5979</b> <b>STRUT MOUNT</b> Rear</p> <p>NISSAN PASSENGER CAR ..... 1995-99</p>	 <p><b>ST-5982</b> <b>STRUT MOUNT</b> Rear</p> <p>CHRYSLER PASSENGER CAR ..... 1998-04 DODGE PASSENGER CAR ..... 1998-04</p>
	 <p><b>ST-5976</b> <b>STRUT MOUNT</b> Front</p> <p>HONDA PASSENGER CAR ..... 1992-00</p>		

# BUYER'S GUIDE

## NUMERICAL LISTING - ILLUSTRATIONS

 <p><b>ST-5983</b> <b>STRUT MOUNT</b> Front</p> <p>HYUNDAI PASSENGER CAR ..... 2006-11 KIA PASSENGER CAR ..... 2007-09</p>	 <p><b>ST-5986</b> <b>STRUT MOUNT</b> Front</p> <p>HONDA PASSENGER CAR ..... 1998-02</p>	 <p><b>ST-5989</b> <b>STRUT MOUNT</b> Front</p> <p>CHRYSLER PASSENGER CAR ..... 1998-04 DODGE PASSENGER CAR ..... 1998-04</p>	 <p><b>ST-5993</b> <b>STRUT MOUNT</b> Front</p> <p>HONDA PASSENGER CAR ..... 1998-02</p>
 <p><b>ST-5984</b> <b>STRUT MOUNT</b> Rear</p> <p>HYUNDAI PASSENGER CAR ..... 2006-11 KIA PASSENGER CAR ..... 2007-11</p>	 <p><b>ST-5987</b> <b>STRUT MOUNT</b> Rear</p> <p>HONDA PASSENGER CAR ..... 1998-02</p>	 <p><b>ST-5990</b> <b>STRUT MOUNT</b> Rear</p> <p>KIA PASSENGER CAR ..... 2001-06</p>	 <p><b>ST-5994</b> <b>STRUT MOUNT</b> Rear</p> <p>HONDA PASSENGER CAR ..... 1998-02</p>
 <p><b>ST-5985</b> <b>STRUT MOUNT</b> Front</p> <p>NISSAN PASSENGER CAR ..... 2003-08</p>	 <p><b>ST-5988</b> <b>STRUT MOUNT</b> Front</p> <p>CHRYSLER PASSENGER CAR ..... 1998-04 DODGE PASSENGER CAR ..... 1998-04</p>	 <p><b>ST-5992</b> <b>STRUT MOUNT</b> Front</p> <p>CHRYSLER PASSENGER CAR ..... 2000-02 DODGE PASSENGER CAR ..... 2000-05</p>	 <p><b>ST-5995</b> <b>STRUT MOUNT</b> Rear</p> <p>NISSAN PASSENGER CAR ..... 1993-99</p>

# BUYER'S GUIDE

## NUMERICAL LISTING - ILLUSTRATIONS

 <p style="text-align: center;"><b>ST-5996</b> <b>STRUT MOUNT</b> Front</p> <p>NISSAN PASSENGER CAR ..... 1991-99</p> <p style="text-align: center;"><b>STRUT MOUNT</b> Rear</p> <p>NISSAN PASSENGER CAR ..... 1991-01</p>	 <p style="text-align: center;"><b>ST-6915</b> <b>STRUT MOUNT</b> Rear</p> <p>ACURA PASSENGER CAR ..... 1986-90 HONDA PASSENGER CAR ..... 1984-93 HONDA VAN ..... 1984-87</p>	 <p style="text-align: center;"><b>ST-6919</b> <b>STRUT MOUNT</b> Front</p> <p>ACURA PASSENGER CAR ..... 2001-06 HONDA PASSENGER CAR ..... 2001-05 HONDA SPORT UTILITY ..... 2002-11</p>	<p><b>ST-6922 (Continued)</b></p> <p>SATURN SUV ..... 2006-07</p>  <p style="text-align: center;"><b>ST-6923</b> <b>STRUT MOUNT</b> Front</p> <p>FORD SPORT UTILITY ..... 2002-05 MERCURY SPORT UTILITY ..... 2002-05</p>
 <p style="text-align: center;"><b>ST-5997</b> <b>STRUT MOUNT</b> Front</p> <p>LEXUS PASSENGER CAR ..... 1992-94 TOYOTA PASSENGER CAR ..... 1992-94</p>	 <p style="text-align: center;"><b>ST-6916</b> <b>STRUT MOUNT</b> Rear</p> <p>ACURA PASSENGER CAR ..... 1990-03 HONDA PASSENGER CAR ..... 1989-97</p>	 <p style="text-align: center;"><b>ST-6920</b> <b>STRUT MOUNT</b> Front</p> <p>ACURA PASSENGER CAR ..... 2001-06 HONDA PASSENGER CAR ..... 2001-05 HONDA SPORT UTILITY ..... 2002-11</p>	 <p style="text-align: center;"><b>ST-6924</b> <b>STRUT MOUNT</b> Front</p> <p>FORD SPORT UTILITY ..... 2002-05 MERCURY SPORT UTILITY ..... 2002-05</p>
 <p style="text-align: center;"><b>ST-6914</b> <b>STRUT MOUNT</b> Front</p> <p>INFINITI PASSENGER CAR ..... 2000-04 NISSAN PASSENGER CAR ..... 2000-08 NISSAN SPORT UTILITY ..... 2003-07 NISSAN VAN ..... 2004-09</p>	 <p style="text-align: center;"><b>ST-6917</b> <b>STRUT MOUNT</b> Rear</p> <p>CHRYSLER PASSENGER CAR ..... 2001-06 DODGE PASSENGER CAR ..... 2001-06</p>	 <p style="text-align: center;"><b>ST-6921</b> <b>STRUT MOUNT</b> Front</p> <p>SATURN SUV ..... 2006-07</p>	 <p style="text-align: center;"><b>ST-6925</b> <b>STRUT MOUNT</b> Rear</p> <p>FORD SPORT UTILITY ..... 2002-05 MERCURY SPORT UTILITY ..... 2002-05</p>
 <p style="text-align: center;"><b>ST-6918</b> <b>STRUT MOUNT</b> Front</p> <p>FORD SPORT UTILITY ..... 2002-05 MERCURY SPORT UTILITY ..... 2002-05</p>	 <p style="text-align: center;"><b>ST-6922</b> <b>STRUT MOUNT</b> Front</p> <p style="text-align: center;">(Continued Next Column)</p>		



# BUYER'S GUIDE

## NUMERICAL LISTING - ILLUSTRATIONS

 <p style="text-align: center;"><b>ST-6926</b> <b>STRUT MOUNT</b> Rear</p> <p>FORD SPORT UTILITY ..... 2002-05 MERCURY SPORT UTILITY ..... 2002-05</p>	 <p style="text-align: center;"><b>ST-6929</b> <b>STRUT MOUNT</b> Front</p> <p>NISSAN PASSENGER CAR ..... 1993-99</p>	<p><b>ST-6932 (Continued)</b> FORD PASSENGER CAR ..... 2000-05</p>  <p style="text-align: center;"><b>ST-6934</b> <b>STRUT MOUNT</b> Front</p> <p>MERCEDES-BENZ PASSENGER CAR ..... 2001-05</p>	 <p style="text-align: center;"><b>ST-6937</b> <b>STRUT MOUNT</b> Front</p> <p>LEXUS PASSENGER CAR ..... 1992-94 TOYOTA PASSENGER CAR ..... 1992-94</p>
 <p style="text-align: center;"><b>ST-6927</b> <b>STRUT MOUNT</b> Rear</p> <p>FORD SPORT UTILITY ..... 2002-05 MERCURY SPORT UTILITY ..... 2002-05</p>	 <p style="text-align: center;"><b>ST-6930</b> <b>STRUT MOUNT</b> Rear</p> <p>NISSAN PASSENGER CAR ..... 1993-99</p>	 <p style="text-align: center;"><b>ST-6935</b> <b>STRUT MOUNT</b> Front</p> <p>LEXUS PASSENGER CAR ..... 2004-09 TOYOTA PASSENGER CAR ..... 2004-11</p>	 <p style="text-align: center;"><b>ST-6938</b> <b>STRUT MOUNT</b> Front</p> <p>CHRYSLER PASSENGER CAR ..... 2001-05 DODGE PASSENGER CAR ..... 2001-05 MITSUBISHI PASSENGER CAR ..... 1997-05</p>
 <p style="text-align: center;"><b>ST-6928</b> <b>STRUT MOUNT</b> Front</p> <p>SATURN PASSENGER CAR ..... 1991-02</p>	 <p style="text-align: center;"><b>ST-6931</b> <b>STRUT MOUNT</b> Rear</p> <p>NISSAN PASSENGER CAR ..... 1993-99</p>	 <p style="text-align: center;"><b>ST-6936</b> <b>STRUT MOUNT</b> Front</p> <p>LEXUS PASSENGER CAR ..... 1990-91 PONTIAC PASSENGER CAR ..... 2003-08 TOYOTA PASSENGER CAR ..... 1987-08</p>	 <p style="text-align: center;"><b>ST-6939</b> <b>STRUT MOUNT</b> Rear</p> <p>HYUNDAI PASSENGER CAR ..... 1996-01</p>
 <p style="text-align: center;"><b>ST-6932</b> <b>STRUT MOUNT</b> Front</p> <p>(Continued Next Column)</p>	<p style="text-align: center;"><b>ST-6932</b> <b>STRUT MOUNT</b> Rear</p> <p>LEXUS PASSENGER CAR ..... 1997-05 SUBARU PASSENGER CAR ..... 2002-03</p>	<p style="text-align: center;"><b>ST-6936</b> <b>STRUT MOUNT</b> Rear</p> <p>HYUNDAI PASSENGER CAR ..... 1997-05 SUBARU PASSENGER CAR ..... 2002-03</p>	

# BUYER'S GUIDE

## NUMERICAL LISTING - ILLUSTRATIONS

			
<p><b>ST-6940</b> STRUT MOUNT Front</p>	<p><b>ST-6943</b> STRUT MOUNT Front</p>	<p><b>ST-6946</b> STRUT MOUNT Front</p>	<p><b>ST-6949</b> STRUT MOUNT Rear</p>
<p>MAZDA PASSENGER CAR ..... 1995-98</p>	<p>HYUNDAI PASSENGER CAR ..... 1996-01</p>	<p>SUBARU PASSENGER CAR ..... 1992-99 SUBARU SPORT UTILITY ..... 1998-02</p>	<p>ACURA PASSENGER CAR ..... 1997-03 HONDA PASSENGER CAR ..... 1998-02</p>
			
<p><b>ST-6941</b> STRUT MOUNT Front</p>	<p><b>ST-6944</b> STRUT MOUNT Front</p>	<p><b>ST-6947</b> STRUT MOUNT Front</p>	<p><b>ST-6950</b> STRUT MOUNT Front</p>
<p>VOLVO PASSENGER CAR ..... 1999-07</p>	<p>BMW PASSENGER CAR ..... 1992-00</p>	<p>TOYOTA PASSENGER CAR ..... 1995-99</p>	<p>ACURA PASSENGER CAR ..... 2004-14 HONDA PASSENGER CAR ..... 2003-07</p>
			
<p><b>ST-6942</b> STRUT MOUNT Front</p>	<p><b>ST-6945</b> STRUT MOUNT Front</p>	<p><b>ST-6948</b> STRUT MOUNT Rear</p>	<p><b>ST-6951</b> STRUT MOUNT Rear</p>
<p>MAZDA PASSENGER CAR ..... 1999-03</p>	<p>NISSAN PASSENGER CAR ..... 2002-08</p>	<p>HYUNDAI PASSENGER CAR ..... 2001-06</p>	<p>ACURA PASSENGER CAR ..... 2004-08 HONDA PASSENGER CAR ..... 2003-07</p>



# BUYER'S GUIDE

## NUMERICAL LISTING - ILLUSTRATIONS

 <p><b>ST-6952 STRUT MOUNT Rear</b></p> <p>SUBARU PASSENGER CAR ..... 1990-01</p>	 <p><b>ST-6956 STRUT MOUNT Front</b></p> <table style="width: 100%; border-collapse: collapse;"> <tr> <td>CHEVROLET SPORT UTILITY ....</td> <td>2007-17</td> </tr> <tr> <td>GMC SPORT UTILITY .....</td> <td>2010-16</td> </tr> <tr> <td>PONTIAC SPORT UTILITY .....</td> <td>2007-09</td> </tr> <tr> <td>SATURN SUV .....</td> <td>2008-10</td> </tr> <tr> <td>SUZUKI SPORT UTILITY .....</td> <td>2007-09</td> </tr> </table>	CHEVROLET SPORT UTILITY ....	2007-17	GMC SPORT UTILITY .....	2010-16	PONTIAC SPORT UTILITY .....	2007-09	SATURN SUV .....	2008-10	SUZUKI SPORT UTILITY .....	2007-09	 <p><b>ST-6959 STRUT MOUNT Rear</b></p> <table style="width: 100%; border-collapse: collapse;"> <tr> <td>CHRYSLER PASSENGER CAR .....</td> <td>2007-14</td> </tr> <tr> <td>DODGE PASSENGER CAR .....</td> <td>2007-14</td> </tr> <tr> <td>JEEP SPORT UTILITY .....</td> <td>2007-16</td> </tr> </table>	CHRYSLER PASSENGER CAR .....	2007-14	DODGE PASSENGER CAR .....	2007-14	JEEP SPORT UTILITY .....	2007-16	 <p><b>ST-6962 STRUT MOUNT Front</b></p> <table style="width: 100%; border-collapse: collapse;"> <tr> <td>FORD PASSENGER CAR .....</td> <td>2008-11</td> </tr> <tr> <td>FORD SPORT UTILITY .....</td> <td>2007-10</td> </tr> <tr> <td>LINCOLN SPORT UTILITY .....</td> <td>2007-10</td> </tr> <tr> <td>MERCURY PASSENGER CAR ...</td> <td>2008-09</td> </tr> </table>	FORD PASSENGER CAR .....	2008-11	FORD SPORT UTILITY .....	2007-10	LINCOLN SPORT UTILITY .....	2007-10	MERCURY PASSENGER CAR ...	2008-09
CHEVROLET SPORT UTILITY ....	2007-17																										
GMC SPORT UTILITY .....	2010-16																										
PONTIAC SPORT UTILITY .....	2007-09																										
SATURN SUV .....	2008-10																										
SUZUKI SPORT UTILITY .....	2007-09																										
CHRYSLER PASSENGER CAR .....	2007-14																										
DODGE PASSENGER CAR .....	2007-14																										
JEEP SPORT UTILITY .....	2007-16																										
FORD PASSENGER CAR .....	2008-11																										
FORD SPORT UTILITY .....	2007-10																										
LINCOLN SPORT UTILITY .....	2007-10																										
MERCURY PASSENGER CAR ...	2008-09																										
 <p><b>ST-6953 STRUT MOUNT Front</b></p> <p>BMW PASSENGER CAR ..... 1994-01</p>	 <p><b>ST-6957 STRUT MOUNT Rear</b></p> <p>CHRYSLER PASSENGER CAR ..... 1996-00</p>	 <p><b>ST-6960 STRUT MOUNT Front</b></p> <table style="width: 100%; border-collapse: collapse;"> <tr> <td>CHRYSLER VAN .....</td> <td>2008-15</td> </tr> <tr> <td>DODGE VAN .....</td> <td>2008-15</td> </tr> <tr> <td>RAM VAN .....</td> <td>2012-15</td> </tr> <tr> <td>VOLKSWAGEN VAN .....</td> <td>2009-12</td> </tr> </table>	CHRYSLER VAN .....	2008-15	DODGE VAN .....	2008-15	RAM VAN .....	2012-15	VOLKSWAGEN VAN .....	2009-12	 <p><b>ST-6963 STRUT MOUNT Front</b></p> <table style="width: 100%; border-collapse: collapse;"> <tr> <td>FORD SPORT UTILITY .....</td> <td>2007-18</td> </tr> <tr> <td>FORD TRUCK .....</td> <td>2009-18</td> </tr> </table>	FORD SPORT UTILITY .....	2007-18	FORD TRUCK .....	2009-18												
CHRYSLER VAN .....	2008-15																										
DODGE VAN .....	2008-15																										
RAM VAN .....	2012-15																										
VOLKSWAGEN VAN .....	2009-12																										
FORD SPORT UTILITY .....	2007-18																										
FORD TRUCK .....	2009-18																										
 <p><b>ST-6955 STRUT MOUNT Rear</b></p> <p>CHRYSLER PASSENGER CAR ..... 2001-06</p>	 <p><b>ST-6958 STRUT MOUNT Front</b></p> <table style="width: 100%; border-collapse: collapse;"> <tr> <td>CHRYSLER PASSENGER CAR .....</td> <td>2007-14</td> </tr> <tr> <td>DODGE PASSENGER CAR .....</td> <td>2008-14</td> </tr> </table>	CHRYSLER PASSENGER CAR .....	2007-14	DODGE PASSENGER CAR .....	2008-14	 <p><b>ST-6961 STRUT MOUNT Front</b></p> <p>FORD PASSENGER CAR ..... 2006-12</p>	 <p><b>ST-6964 STRUT MOUNT Front</b></p> <table style="width: 100%; border-collapse: collapse;"> <tr> <td>ACURA PASSENGER CAR .....</td> <td>2006-18</td> </tr> <tr> <td>HONDA PASSENGER CAR .....</td> <td>2006-11</td> </tr> </table>	ACURA PASSENGER CAR .....	2006-18	HONDA PASSENGER CAR .....	2006-11																
CHRYSLER PASSENGER CAR .....	2007-14																										
DODGE PASSENGER CAR .....	2008-14																										
ACURA PASSENGER CAR .....	2006-18																										
HONDA PASSENGER CAR .....	2006-11																										
		 <p><b>ST-6965 STRUT MOUNT Front</b></p> <p>HONDA PASSENGER CAR ..... 2007-12</p>																									

# BUYER'S GUIDE

## NUMERICAL LISTING - ILLUSTRATIONS

 <p style="text-align: center;"><b>ST-6966</b> <b>STRUT MOUNT</b> Front</p> <p>ACURA SPORT UTILITY ..... 2007-12 HONDA SPORT UTILITY ..... 2007-14</p>	 <p style="text-align: center;"><b>ST-6970</b> <b>STRUT MOUNT</b> Front</p> <p>HYUNDAI PASSENGER CAR ..... 2006-11</p>	 <p style="text-align: center;"><b>ST-6975</b> <b>STRUT MOUNT</b> Front</p> <p>KIA PASSENGER CAR ..... 2006-11</p>	 <p style="text-align: center;"><b>ST-6981</b> <b>SHOCK MOUNT</b> REAR</p> <p>FORD PASSENGER CAR ..... 2012-18 FORD SPORT UTILITY ..... 2013-18 LINCOLN SPORT UTILITY ..... 2015-19</p>
 <p style="text-align: center;"><b>ST-6967</b> <b>STRUT MOUNT</b> Front</p> <p>HYUNDAI PASSENGER CAR ..... 2007-12</p>	 <p style="text-align: center;"><b>ST-6971</b> <b>STRUT MOUNT</b> Rear</p> <p>HYUNDAI PASSENGER CAR ..... 2006-11 KIA PASSENGER CAR ..... 2006-11</p>	 <p style="text-align: center;"><b>ST-6976</b> <b>STRUT MOUNT</b> Front</p> <p>KIA PASSENGER CAR ..... 2006-11</p>	 <p style="text-align: center;"><b>ST-6982</b> <b>STRUT MOUNT</b> Front</p> <p>MAZDA PASSENGER CAR ..... 2004-12</p>
 <p style="text-align: center;"><b>ST-6968</b> <b>STRUT MOUNT</b> Front</p> <p>HYUNDAI SPORT UTILITY ..... 2007-09 HYUNDAI VAN ..... 2007-08</p>	 <p style="text-align: center;"><b>ST-6973</b> <b>STRUT MOUNT</b> Front</p> <p>KIA PASSENGER CAR ..... 2006-11</p>	 <p style="text-align: center;"><b>ST-6977</b> <b>STRUT MOUNT</b> Front</p> <p>KIA VAN ..... 2002-05</p>	 <p style="text-align: center;"><b>ST-6983</b> <b>STRUT MOUNT</b> Rear</p> <p>MAZDA PASSENGER CAR ..... 2004-12</p>
 <p style="text-align: center;"><b>ST-6969</b> <b>STRUT MOUNT</b> Front</p> <p>HYUNDAI PASSENGER CAR ..... 2006-11</p>	 <p style="text-align: center;"><b>ST-6974</b> <b>STRUT MOUNT</b> Front</p> <p>KIA PASSENGER CAR ..... 2006-11</p>	 <p style="text-align: center;"><b>ST-6980</b> <b>STRUT MOUNT</b> Front</p> <p>MAZDA PASSENGER CAR ..... 2004-12 MAZDA VAN ..... 2006-14 VOLVO PASSENGER CAR ..... 2004-12</p>	 <p style="text-align: center;"><b>ST-6983</b> <b>STRUT MOUNT</b> Front</p> <p>MINI ..... 2002-06</p>

# BUYER'S GUIDE

## NUMERICAL LISTING - ILLUSTRATIONS

 <p style="text-align: center;"><b>ST-6984</b> <b>STRUT MOUNT</b> Rear</p> <p>MINI ..... 2002-06</p>	 <p style="text-align: center;"><b>ST-6988</b> <b>STRUT MOUNT</b> Front</p> <p>Lexus Passenger Car ..... 2011-17 Scion Passenger Car ..... 2016 Scion Van ..... 2008-15 Toyota Sport Utility ..... 2006-08</p>	 <p style="text-align: center;"><b>ST-6995</b> <b>STRUT MOUNT</b> Front</p> <p>Chrysler Passenger Car ..... 2005-14 Dodge Passenger Car ..... 2005-14</p>	 <p style="text-align: center;"><b>ST-6999</b> <b>STRUT MOUNT</b> Rear</p> <p>Ford Passenger Car ..... 2005-09 Mercury Passenger Car ... 2008-09</p>
 <p style="text-align: center;"><b>ST-6985</b> <b>STRUT MOUNT</b> Front</p> <p>SAAB Passenger Car ..... 2003-11</p>	 <p style="text-align: center;"><b>ST-6989</b> <b>STRUT MOUNT</b> Front</p> <p>Scion Passenger Car ..... 2008-14 Toyota Passenger Car ..... 2007-13</p>	 <p style="text-align: center;"><b>ST-6996</b> <b>STRUT MOUNT</b> Rear</p> <p>Ford Passenger Car ..... 2005-07 Mercury Passenger Car ... 2005-07</p>	 <p style="text-align: center;"><b>ST-7900</b> <b>STRUT MOUNT</b> Rear</p> <p>Ford Passenger Car ..... 2005-09 Mercury Passenger Car ... 2005-09</p>
 <p style="text-align: center;"><b>ST-6986</b> <b>STRUT MOUNT</b> Front</p> <p>Lexus Passenger Car ..... 2007-12 Toyota Passenger Car ..... 2006-12 Toyota Sport Utility ..... 2008-13</p>	 <p style="text-align: center;"><b>ST-6990</b> <b>STRUT MOUNT</b> Rear</p> <p>Volvo Passenger Car ..... 2000-04</p>	 <p style="text-align: center;"><b>ST-6997</b> <b>STRUT MOUNT</b> Rear</p> <p>Ford Passenger Car ..... 2005-07 Mercury Passenger Car ... 2005-07</p>	 <p style="text-align: center;"><b>ST-7901</b> <b>STRUT MOUNT</b> Rear</p> <p>Ford Passenger Car ..... 2005-09 Mercury Passenger Car ... 2005-09</p>
 <p style="text-align: center;"><b>ST-6987</b> <b>STRUT MOUNT</b> Front</p> <p>Scion Passenger Car ..... 2011-16 Toyota Passenger Car ..... 2010-15 Toyota Sport Utility ..... 2006-12</p>	 <p style="text-align: center;"><b>ST-6994 (NEW)</b> <b>STRUT MOUNT</b> Front</p> <p>Ford Van ..... 2004-07</p>	 <p style="text-align: center;"><b>ST-6998</b> <b>STRUT MOUNT</b> Rear</p> <p>Ford Passenger Car ..... 2005-09 Mercury Passenger Car ... 2008-09</p>	 <p style="text-align: center;"><b>ST-7902</b> <b>STRUT MOUNT</b> Front</p> <p>Nissan Passenger Car ..... 2002-06</p>

# BUYER'S GUIDE

## NUMERICAL LISTING - ILLUSTRATIONS

			
<p><b>ST-7903</b> <b>STRUT MOUNT</b> Front</p>	<p><b>ST-7906</b> <b>STRUT MOUNT</b> Front</p>	<p><b>ST-7909</b> <b>STRUT MOUNT</b> Front</p>	<p><b>ST-7912</b> <b>STRUT MOUNT</b> Rear</p>
<p>NISSAN PASSENGER CAR ..... 2002-06</p>	<p>FORD SPORT UTILITY ..... 2001-12 MAZDA SPORT UTILITY ..... 2001-11 MERCURY SPORT UTILITY ..... 2005-11</p>	<p>CHEVROLET PASSENGER CAR ..... 2005-10 PONTIAC PASSENGER CAR ..... 2005-06</p>	<p>CHRYSLER PASSENGER CAR ..... 1996-00</p>
			
<p><b>ST-7904</b> <b>STRUT MOUNT</b> Front</p>	<p><b>ST-7907</b> <b>STRUT MOUNT</b> Front</p>	<p><b>ST-7910</b> <b>STRUT MOUNT</b> Front</p>	<p><b>ST-7913</b> <b>STRUT MOUNT</b> Rear</p>
<p>NISSAN PASSENGER CAR ..... 2002-06</p>	<p>FORD SPORT UTILITY ..... 2001-12 MAZDA SPORT UTILITY ..... 2001-11 MERCURY SPORT UTILITY ..... 2005-11</p>	<p>CHEVROLET PASSENGER CAR ..... 2005-10 PONTIAC PASSENGER CAR ..... 2005-06</p>	<p>CHRYSLER PASSENGER CAR ..... 1996-00</p>
			
<p><b>ST-7905</b> <b>STRUT MOUNT</b> Front</p>	<p><b>ST-7908</b> <b>STRUT MOUNT</b> Front</p>	<p><b>ST-7911</b> <b>STRUT MOUNT</b> Rear</p>	<p><b>ST-7914 (NEW)</b> <b>STRUT MOUNT</b> Rear</p>
<p>FORD SPORT UTILITY ..... 2001-12 MAZDA SPORT UTILITY ..... 2001-11 MERCURY SPORT UTILITY ..... 2005-11</p>	<p>CHEVROLET PASSENGER CAR ..... 2005-10 PONTIAC PASSENGER CAR ..... 2005-06</p>	<p>CHRYSLER PASSENGER CAR ..... 2001-06 DODGE PASSENGER CAR ..... 2001-06</p>	<p>HONDA PASSENGER CAR ..... 2001-05 HONDA SPORT UTILITY ..... 2002-11</p>

# BUYER'S GUIDE

## NUMERICAL LISTING - ILLUSTRATIONS

 <p><b>ST-7915</b> STRUT MOUNT Rear</p> <p>HONDA PASSENGER CAR ..... 2001-05</p>	 <p><b>ST-7920</b> STRUT MOUNT Front</p> <p>HONDA VAN ..... 1999-04</p>	<p><b>ST-7923 (Continued)</b> TOYOTA SPORT UTILITY ..... 2008-17 TOYOTA TRUCK ..... 2007-16</p>  <p><b>ST-7924</b> STRUT MOUNT Front</p> <p>TOYOTA TRUCK ..... 2007-16</p>	 <p><b>ST-7927 (NEW)</b> STRUT MOUNT Front</p> <p>TOYOTA TRUCK ..... 1995-04</p>
 <p><b>ST-7916</b> STRUT MOUNT Front</p> <p>HONDA PASSENGER CAR ..... 2001-05</p>	 <p><b>ST-7921</b> STRUT MOUNT Front</p> <p>TOYOTA TRUCK ..... 2005-15</p>	 <p><b>ST-7925</b> STRUT MOUNT Front</p> <p>TOYOTA TRUCK ..... 2000-06</p>	 <p><b>ST-7928</b> STRUT MOUNT Front</p> <p>NISSAN SPORT UTILITY ..... 2005-11 NISSAN TRUCK ..... 2005-11</p>
<p><b>ST-7917 (NEW)</b> STRUT MOUNT Front</p> <p>HONDA PASSENGER CAR ..... 2002-05</p>	 <p><b>ST-7922</b> STRUT MOUNT Front</p> <p>TOYOTA SPORT UTILITY ..... 2003-11</p>	 <p><b>ST-7926</b> STRUT MOUNT Front</p> <p>TOYOTA TRUCK ..... 2000-06</p>	 <p><b>ST-7929</b> STRUT MOUNT Front</p> <p>NISSAN SPORT UTILITY ..... 2005-11 NISSAN TRUCK ..... 2005-11</p>
 <p><b>ST-7919 (NEW)</b> STRUT MOUNT Front</p> <p>HONDA VAN ..... 1999-04</p>	 <p><b>ST-7923</b> STRUT MOUNT Front</p> <p>(Continued Next Column)</p>		



# BUYER'S GUIDE

## NUMERICAL LISTING - ILLUSTRATIONS

 <p><b>ST-7930</b> STRUT MOUNT Front</p> <p>DODGE TRUCK ..... 2009-10</p>	 <p><b>ST-7934</b> STRUT MOUNT Rear</p> <p>FORD SPORT UTILITY ..... 2007-18</p>	 <p><b>ST-7937</b> STRUT MOUNT Front</p> <p>FORD SPORT UTILITY ..... 2006-10 MERCURY SPORT UTILITY ..... 2006-10</p>	 <p><b>ST-7940</b> STRUT MOUNT Rear</p> <p>FORD SPORT UTILITY ..... 2006-10 MERCURY SPORT UTILITY ..... 2006-10</p>
 <p><b>ST-7931</b> STRUT MOUNT Front</p> <p>DODGE TRUCK ..... 2009-10</p>	 <p><b>ST-7935</b> STRUT MOUNT Rear</p> <p>FORD SPORT UTILITY ..... 2007-18</p>	 <p><b>ST-7938</b> STRUT MOUNT Front</p> <p>FORD SPORT UTILITY ..... 2006-10 MERCURY SPORT UTILITY ..... 2006-10</p>	 <p><b>ST-7941</b> STRUT MOUNT Rear</p> <p>FORD SPORT UTILITY ..... 2006-10 MERCURY SPORT UTILITY ..... 2006-10</p>
 <p><b>ST-7932</b> STRUT MOUNT Front</p> <p>NISSAN SPORT UTILITY ..... 2005-15 NISSAN TRUCK ..... 2004-15</p>	 <p><b>ST-7936</b> STRUT MOUNT Rear</p> <p>FORD SPORT UTILITY ..... 2007-18</p>	 <p><b>ST-7939</b> STRUT MOUNT Front</p> <p>FORD SPORT UTILITY ..... 2006-10 MERCURY SPORT UTILITY ..... 2006-10</p>	 <p><b>ST-7942</b> STRUT MOUNT Front</p> <p>CADILLAC SPORT UTILITY ..... 2007-14 CHEVROLET SPORT UTILITY ..... 2007-13 CHEVROLET TRUCK ..... 2007-13 GMC SPORT UTILITY ..... 2007-14 GMC TRUCK ..... 2007-14</p>
 <p><b>ST-7933</b> STRUT MOUNT Front</p> <p>NISSAN SPORT UTILITY ..... 2005-15 NISSAN TRUCK ..... 2004-15</p>			

# BUYER'S GUIDE

## NUMERICAL LISTING - ILLUSTRATIONS

 <p style="text-align: center;"><b>ST-7943</b> <b>STRUT MOUNT</b> Front</p> <p>SCION PASSENGER CAR ..... 2005-10</p>	 <p style="text-align: center;"><b>ST-7947</b> <b>STRUT MOUNT</b> Rear</p> <p>AUDI PASSENGER CAR ..... 2006-13 VOLKSWAGEN PASSENGER CAR ..... 2005-19</p>	<p><b>ST-7950 (Continued)</b> KIA PASSENGER CAR ..... 2006-11</p>  <p style="text-align: center;"><b>ST-7951</b> <b>STRUT MOUNT</b> Front</p> <p>KIA PASSENGER CAR ..... 2005-09</p>	 <p style="text-align: center;"><b>ST-7955</b> <b>STRUT MOUNT</b> Front</p> <p>HONDA PASSENGER CAR ..... 2006-15</p>
 <p style="text-align: center;"><b>ST-7944</b> <b>STRUT MOUNT</b> Front</p> <p>FORD PASSENGER CAR ..... 2003-11 LINCOLN PASSENGER CAR ..... 2003-09 MERCURY PASSENGER CAR ... 2003-11</p>	 <p style="text-align: center;"><b>ST-7948</b> <b>STRUT MOUNT</b> Front</p> <p>FORD PASSENGER CAR ..... 2005-10 FORD SPORT UTILITY ..... 2007-10 LINCOLN SPORT UTILITY ..... 2007-10 MERCURY PASSENGER CAR ... 2005-07</p>	<p>KIA PASSENGER CAR ..... 2004-09</p>  <p style="text-align: center;"><b>ST-7952</b> <b>STRUT MOUNT</b> Front</p> <p>HYUNDAI SPORT UTILITY ..... 2007-09</p>	 <p style="text-align: center;"><b>ST-7956</b> <b>STRUT MOUNT</b> Front</p> <p>HONDA PASSENGER CAR ..... 2006-15</p>
 <p style="text-align: center;"><b>ST-7945</b> <b>STRUT MOUNT</b> Front</p> <p>FORD PASSENGER CAR ..... 2003-11 LINCOLN PASSENGER CAR ..... 2003-09 MERCURY PASSENGER CAR ... 2003-11</p>	 <p style="text-align: center;"><b>ST-7949</b> <b>STRUT MOUNT</b> Front</p> <p>AUDI PASSENGER CAR ..... 2006-15 VOLKSWAGEN PASSENGER CAR ..... 2005-19</p>	 <p style="text-align: center;"><b>ST-7953</b> <b>STRUT MOUNT</b> Front</p> <p>HYUNDAI PASSENGER CAR ..... 2007-12 KIA PASSENGER CAR ..... 2006-11</p>	 <p style="text-align: center;"><b>ST-7957</b> <b>STRUT MOUNT</b> Front</p> <p>ACURA PASSENGER CAR ..... 2006-11 HONDA PASSENGER CAR ..... 2006-15</p>
 <p style="text-align: center;"><b>ST-7946</b> <b>STRUT MOUNT</b> Rear</p> <p>VOLVO PASSENGER CAR ..... 1999-07</p>	 <p style="text-align: center;"><b>ST-7950</b> <b>STRUT MOUNT</b> Front</p> <p>HYUNDAI PASSENGER CAR ..... 2006-11</p> <p style="text-align: center;"><b>(Continued Next Column)</b></p>	 <p style="text-align: center;"><b>ST-7954</b> <b>STRUT MOUNT</b> Front</p> <p>KIA VAN ..... 2002-05</p>	 <p style="text-align: center;"><b>ST-7958</b> <b>STRUT MOUNT</b> Front</p> <p>ACURA PASSENGER CAR ..... 1995-04</p>

# BUYER'S GUIDE

## NUMERICAL LISTING - ILLUSTRATIONS

 <p><b>ST-7959</b> <b>STRUT MOUNT</b> Rear</p> <p>LEXUS PASSENGER CAR ..... 2007-12 TOYOTA PASSENGER CAR ..... 2006-12</p>	 <p><b>ST-7963</b> <b>STRUT MOUNT</b> Front</p> <p>MITSUBISHI PASSENGER CAR ..... 2002-06</p>	 <p><b>ST-7967</b> <b>STRUT MOUNT</b> Front</p> <p>BMW PASSENGER CAR ..... 2007-13</p>	 <p><b>ST-7974 (NEW)</b> <b>STRUT MOUNT</b> Front</p> <p>BMW PASSENGER CAR ..... 2001-06</p>
 <p><b>ST-7960</b> <b>STRUT MOUNT</b> Rear</p> <p>LEXUS PASSENGER CAR ..... 2007-12 TOYOTA PASSENGER CAR ..... 2006-12</p>	 <p><b>ST-7964</b> <b>STRUT MOUNT</b> Front</p> <p>MITSUBISHI PASSENGER CAR ..... 2002-05 MITSUBISHI SPORT UTILITY ..... 2003-06</p>	 <p><b>ST-7968</b> <b>STRUT MOUNT</b> Rear</p> <p>ACURA PASSENGER CAR ..... 1996-04</p>	 <p><b>ST-7975 (NEW)</b> <b>STRUT MOUNT</b> Front</p> <p>BMW PASSENGER CAR ..... 2001-06</p>
 <p><b>ST-7961</b> <b>STRUT MOUNT</b> Rear</p> <p>LEXUS PASSENGER CAR ..... 1993-97</p>	 <p><b>ST-7965</b> <b>STRUT MOUNT</b> Front</p> <p>MITSUBISHI PASSENGER CAR ..... 2004-12</p>	 <p><b>ST-7969</b> <b>STRUT MOUNT</b> Rear</p> <p>MINI ..... 2002-06</p>	 <p><b>ST-7976</b> <b>STRUT MOUNT</b> Front</p> <p>HONDA PASSENGER CAR ..... 2003-07</p>
 <p><b>ST-7962</b> <b>STRUT MOUNT</b> Rear</p> <p>MITSUBISHI PASSENGER CAR ..... 2002-07</p>	 <p><b>ST-7966</b> <b>STRUT MOUNT</b> Front</p> <p>MITSUBISHI PASSENGER CAR ..... 2008-17</p>	 <p><b>ST-7973 (NEW)</b> <b>STRUT MOUNT</b> Front</p> <p>BMW PASSENGER CAR ..... 2001-06</p>	 <p><b>ST-7977</b> <b>STRUT MOUNT</b> Front</p> <p>HONDA PASSENGER CAR ..... 2003-07</p>



# BUYER'S GUIDE

## NUMERICAL LISTING - ILLUSTRATIONS

**ST-7978**  
**STRUT MOUNT**  
**Front**  
 INFINITI SPORT UTILITY ..... 1999-01  
 NISSAN SPORT UTILITY ..... 1999-01



**ST-7979 (NEW)**  
**STRUT MOUNT**  
**Front**  
 INFINITI SPORT UTILITY ..... 1999-01  
 NISSAN SPORT UTILITY ..... 1999-01



**ST-7980 (NEW)**  
**STRUT MOUNT**  
**Front**  
 INFINITI SPORT UTILITY ..... 1999-01  
 NISSAN SPORT UTILITY ..... 1999-01



**ST-7981 (NEW)**  
**STRUT MOUNT**  
**Front**  
 PONTIAC PASSENGER CAR ..... 2003-08  
 TOYOTA PASSENGER CAR ..... 2003-08



**ST-7982 (NEW)**  
**STRUT MOUNT**  
**Front**  
 PONTIAC PASSENGER CAR ..... 2003-08  
 TOYOTA PASSENGER CAR ..... 2003-08



**ST-7983**  
**STRUT MOUNT**  
**Front**  
 ACURA SPORT UTILITY ..... 2007-13  
 HONDA TRUCK ..... 2006-14



**ST-7984 (NEW)**  
**STRUT MOUNT**  
**Front**  
 BMW PASSENGER CAR ..... 2007-13



**ST-7985**  
**STRUT MOUNT**  
**Rear**  
 BMW PASSENGER CAR ..... 2007-13



**ST-7986**  
**STRUT MOUNT**  
**Front**  
 BUICK SPORT UTILITY ..... 2008-16  
 CHEVROLET SPORT UTILITY ..... 2009-16  
 GMC SPORT UTILITY ..... 2007-16  
 SATURN SUV ..... 2007-10



**ST-7987 (NEW)**  
**STRUT MOUNT**  
**Front**  
 BUICK PASSENGER CAR ..... 2010-13  
 CHEVROLET PASSENGER CAR ..... 2013



**ST-7988**  
**STRUT MOUNT**  
**Rear**  
 BUICK PASSENGER CAR ..... 2010-13  
 SAAB PASSENGER CAR ..... 2010-11



**ST-7989**  
**STRUT MOUNT**  
**Rear**  
 BUICK PASSENGER CAR ..... 2010-13  
 SAAB PASSENGER CAR ..... 2010-11



**ST-7990**  
**STRUT MOUNT**  
**Rear**  
 CHEVROLET PASSENGER CAR ..... 2004-12  
 PONTIAC PASSENGER CAR ..... 2005-10  
 SATURN PASSENGER CAR ..... 2007-09



**ST-7991**  
**STRUT MOUNT**  
**Front**  
 BUICK PASSENGER CAR ..... 2011-13  
 CHEVROLET PASSENGER CAR ..... 2010-13

**ST-7992**  
**STRUT MOUNT**  
**Rear**  
 CHEVROLET PASSENGER CAR ..... 2010-13

# BUYER'S GUIDE

## NUMERICAL LISTING - ILLUSTRATIONS

 <p><b>ST-7993</b> <b>STRUT MOUNT</b> Rear</p> <p>CHRYSLER PASSENGER CAR ..... 1995-06 DODGE PASSENGER CAR ..... 1995-06 EAGLE PASSENGER CAR ..... 1995-98 MITSUBISHI PASSENGER CAR ..... 1994-99</p>	 <p><b>ST-7996</b> <b>STRUT MOUNT</b> Front</p> <p>FORD PASSENGER CAR ..... 2011-18 FORD SPORT UTILITY ..... 2013-16 MAZDA PASSENGER CAR ..... 2011-16</p>	 <p><b>ST-7999 (NEW)</b> <b>STRUT MOUNT</b> Front</p> <p>FORD PASSENGER CAR ..... 2008-11 LINCOLN PASSENGER CAR ..... 2010-11 LINCOLN SPORT UTILITY ..... 2010-11 MERCURY PASSENGER CAR ... 2008-09</p>	 <p><b>ST-8905</b> <b>STRUT MOUNT</b> Rear</p> <p>KIA PASSENGER CAR ..... 2001-04</p>
 <p><b>ST-7994</b> <b>STRUT MOUNT</b> Front</p> <p>DODGE PASSENGER CAR ..... 2007-12 JEEP SPORT UTILITY ..... 2007-16</p>	 <p><b>ST-7997</b> <b>STRUT MOUNT</b> Rear</p> <p>FORD PASSENGER CAR ..... 2011-18 MAZDA PASSENGER CAR ..... 2011-16</p>	 <p><b>ST-8900</b> <b>STRUT MOUNT</b> Front</p> <p>FORD VAN ..... 2010-13</p>	 <p><b>ST-8907</b> <b>STRUT MOUNT</b> Front</p> <p>MAZDA SPORT UTILITY ..... 2007-14</p>
 <p><b>ST-7995 (NEW)</b> <b>STRUT MOUNT</b> Rear</p> <p>DODGE SPORT UTILITY ..... 2009-15</p>	 <p><b>ST-7998 (NEW)</b> <b>STRUT MOUNT</b> Rear</p> <p>FORD PASSENGER CAR ..... 2005-09 MERCURY PASSENGER CAR ... 2005-09</p>	 <p><b>ST-8903</b> <b>STRUT MOUNT</b> Front</p> <p>KIA PASSENGER CAR ..... 2001-04</p>	 <p><b>ST-8908</b> <b>STRUT MOUNT</b> Rear</p> <p>MAZDA PASSENGER CAR ..... 1997-00</p>
		 <p><b>ST-8904</b> <b>STRUT MOUNT</b> Rear</p> <p>KIA PASSENGER CAR ..... 2001-04</p>	 <p><b>ST-8909</b> <b>STRUT MOUNT</b> Rear</p> <p>MAZDA PASSENGER CAR ..... 1995</p>

# BUYER'S GUIDE

## NUMERICAL LISTING - ILLUSTRATIONS

 <p><b>ST-8910</b> STRUT MOUNT Front</p> <p>MINI ..... 2007-17</p>	 <p><b>ST-8914</b> STRUT MOUNT Front</p> <p>NISSAN PASSENGER CAR ..... 2007-12</p>	 <p><b>ST-8918</b> STRUT MOUNT Rear</p> <p>SUBARU SPORT UTILITY ..... 2006-14</p>	 <p><b>ST-8922</b> STRUT MOUNT Rear</p> <p>TOYOTA PASSENGER CAR ..... 2000-05</p>
 <p><b>ST-8911 (NEW)</b> STRUT MOUNT Rear</p> <p>BMW SPORT UTILITY ..... 2016-18 MINI ..... 2007-18</p>	 <p><b>ST-8915</b> STRUT MOUNT Front</p> <p>NISSAN PASSENGER CAR ..... 2007-12</p>	 <p><b>ST-8919 (NEW)</b> STRUT MOUNT Front</p> <p>SUZUKI SPORT UTILITY ..... 2006-13</p>	 <p><b>ST-8923</b> STRUT MOUNT Rear</p> <p>AUDI PASSENGER CAR ..... 2008-15 VOLKSWAGEN PASSENGER CAR ..... 2009-15</p>
 <p><b>ST-8912</b> STRUT MOUNT Front</p> <p>MITSUBISHI PASSENGER CAR ..... 2008-17 MITSUBISHI SPORT UTILITY ..... 2007-19</p>	 <p><b>ST-8916</b> STRUT MOUNT Front</p> <p>NISSAN PASSENGER CAR ..... 2007-18 NISSAN SPORT UTILITY ..... 2008-12</p>	 <p><b>ST-8920 (NEW)</b> STRUT MOUNT Rear</p> <p>TOYOTA SPORT UTILITY ..... 2008-13</p>	 <p><b>ST-8924</b> STRUT MOUNT Rear</p> <p>BUICK PASSENGER CAR ..... 2011-13</p>
 <p><b>ST-8913</b> STRUT MOUNT Front</p> <p>NISSAN PASSENGER CAR ..... 2007-14</p>	 <p><b>ST-8917</b> STRUT MOUNT Front</p> <p>NISSAN PASSENGER CAR ..... 2007-18 NISSAN SPORT UTILITY ..... 2008-12</p>	 <p><b>ST-8921 (NEW)</b> STRUT MOUNT Rear</p> <p>TOYOTA SPORT UTILITY ..... 2008-13</p>	 <p><b>ST-8925</b> STRUT MOUNT Rear</p> <p>BUICK PASSENGER CAR ..... 2011-13</p>

# BUYER'S GUIDE

## NUMERICAL LISTING - ILLUSTRATIONS

 <p><b>ST-8926</b> <b>STRUT MOUNT</b> Front</p> <p>SUBARU PASSENGER CAR ..... 2005-13 SUBARU SPORT UTILITY ..... 2005-13</p>	 <p><b>ST-8930 (NEW)</b> <b>STRUT MOUNT</b> Front</p> <p>HYUNDAI PASSENGER CAR ..... 2000-05</p>	 <p><b>ST-8934 (NEW)</b> <b>STRUT MOUNT</b> Front</p> <p>MAZDA PASSENGER CAR ..... 1999-03</p>	 <p><b>ST-8941 (NEW)</b> <b>STRUT MOUNT WASHER</b> Front Upper</p> <p>VOLVO PASSENGER CAR ..... 1993-07 VOLVO SPORT UTILITY ..... 2003-07</p>
 <p><b>ST-8927 (NEW)</b> <b>STRUT BUMPER</b> Front</p> <p>CHRYSLER PASSENGER CAR ..... 1998-04 DODGE PASSENGER CAR ..... 1998-04</p>	 <p><b>ST-8931 (NEW)</b> <b>STRUT MOUNT</b> Front</p> <p>HYUNDAI PASSENGER CAR ..... 1997-06 KIA PASSENGER CAR ..... 2005-09</p>	 <p><b>ST-8937 (NEW)</b> <b>STRUT MOUNT</b> Front</p> <p>HYUNDAI SPORT UTILITY ..... 2005-10 KIA SPORT UTILITY ..... 2005-10</p>	 <p><b>ST-8942</b> <b>STRUT MOUNT</b> Front</p> <p>PONTIAC PASSENGER CAR ..... 2009-10 TOYOTA PASSENGER CAR ..... 2009-17</p>
 <p><b>ST-8928 (NEW)</b> <b>STRUT MOUNT SPACER</b> Front</p> <p>FORD VAN ..... 1995-03</p>	 <p><b>ST-8932 (NEW)</b> <b>STRUT MOUNT</b> Front</p> <p>HYUNDAI PASSENGER CAR ..... 2001-06</p>	 <p><b>ST-8938 (NEW)</b> <b>STRUT MOUNT</b> Front</p> <p>HYUNDAI SPORT UTILITY ..... 2005-10 KIA SPORT UTILITY ..... 2005-10</p>	 <p><b>ST-8943 (NEW)</b> <b>STRUT MOUNT</b> Rear</p> <p>CHRYSLER PASSENGER CAR ..... 2007-14 DODGE PASSENGER CAR ..... 2008-14 DODGE SPORT UTILITY ..... 2009-15 JEEP SPORT UTILITY ..... 2007-16</p>
 <p><b>ST-8929 (NEW)</b> <b>STRUT MOUNT</b> Front</p> <p>HYUNDAI PASSENGER CAR ..... 2000-05</p>	 <p><b>ST-8933 (NEW)</b> <b>STRUT MOUNT</b> Front</p> <p>MAZDA PASSENGER CAR ..... 1999-03</p>	 <p><b>ST-8939</b> <b>STRUT MOUNT</b> Rear</p> <p>HYUNDAI PASSENGER CAR ..... 1997-05</p>	



# BUYER'S GUIDE

## NUMERICAL LISTING - ILLUSTRATIONS

 <p style="text-align: center;"><b>ST-8944 (NEW)</b> <b>STRUT MOUNT</b> Front</p> <p>MITSUBISHI PASSENGER CAR ..... 2004-12 MITSUBISHI SPORT UTILITY ..... 2004-11</p>	 <p style="text-align: center;"><b>ST-8950 (NEW)</b> <b>STRUT MOUNT</b> Rear</p> <p>HYUNDAI PASSENGER CAR ..... 1996-06</p>	 <p style="text-align: center;"><b>ST-8954</b> <b>STRUT MOUNT</b> Front</p> <p>CHEVROLET SPORT UTILITY .... 2005-06 PONTIAC SPORT UTILITY ..... 2006</p>	<p><b>ST-8957 (Continued)</b> NISSAN PASSENGER CAR ..... 2000-03</p>  <p style="text-align: center;"><b>ST-8958 (NEW)</b> <b>STRUT MOUNT</b> Front</p> <p>CHRYSLER SUV ..... 2004-08</p>
 <p style="text-align: center;"><b>ST-8946</b> <b>STRUT MOUNT</b> Front</p> <p>SUZUKI PASSENGER CAR ..... 2004-08</p>	 <p style="text-align: center;"><b>ST-8951 (NEW)</b> <b>STRUT BUMPER</b> Rear Lower</p> <p>MAZDA PASSENGER CAR ..... 1999-03</p>	 <p style="text-align: center;"><b>ST-8955 (NEW)</b> <b>STRUT MOUNT</b> Front</p> <p>INFINITI PASSENGER CAR ..... 2000-04 NISSAN PASSENGER CAR ..... 2000-03</p>	 <p style="text-align: center;"><b>ST-8959</b> <b>STRUT MOUNT</b> Front</p> <p>CHRYSLER SUV ..... 2004-08</p>
<p style="text-align: center;"><b>ST-8947 (NEW)</b> <b>STRUT MOUNT</b> Rear</p> <p>SUZUKI PASSENGER CAR ..... 2004-08</p>	 <p style="text-align: center;"><b>ST-8952 (NEW)</b> <b>STRUT MOUNT</b> Front</p> <p>SATURN PASSENGER CAR ..... 2003-07</p>	 <p style="text-align: center;"><b>ST-8956 (NEW)</b> <b>STRUT MOUNT</b> Front</p> <p>INFINITI PASSENGER CAR ..... 2000-04 NISSAN PASSENGER CAR ..... 2000-03</p>	 <p style="text-align: center;"><b>ST-8960</b> <b>STRUT MOUNT</b> Front</p> <p>CHRYSLER SUV ..... 2004-08</p>
 <p style="text-align: center;"><b>ST-8948</b> <b>STRUT MOUNT</b> Front</p> <p>BUICK PASSENGER CAR ..... 2006-11 CADILLAC PASSENGER CAR .... 2006-11</p>	 <p style="text-align: center;"><b>ST-8949</b> <b>STRUT MOUNT</b> Front</p> <p>JEEP SPORT UTILITY ..... 2005-10</p>	 <p style="text-align: center;"><b>ST-8953</b> <b>STRUT MOUNT</b> Front</p> <p>SATURN PASSENGER CAR ..... 2003-07</p>	 <p style="text-align: center;"><b>ST-8961 (NEW)</b> <b>STRUT MOUNT</b> Front</p> <p>FORD PASSENGER CAR ..... 2012-18</p>
 <p style="text-align: center;"><b>ST-8949</b> <b>STRUT MOUNT</b> Front</p> <p>JEEP SPORT UTILITY ..... 2005-10</p>	 <p style="text-align: center;"><b>ST-8953</b> <b>STRUT MOUNT</b> Front</p> <p>SATURN PASSENGER CAR ..... 2003-07</p>	 <p style="text-align: center;"><b>ST-8957 (NEW)</b> <b>STRUT MOUNT</b> Front</p> <p>INFINITI PASSENGER CAR ..... 2000-04</p> <p style="text-align: center;">(Continued Next Column)</p>	 <p style="text-align: center;"><b>ST-8961 (NEW)</b> <b>STRUT MOUNT</b> Front</p> <p>FORD PASSENGER CAR ..... 2012-18</p> <p style="text-align: center;">(Continued Next Page)</p>

# BUYER'S GUIDE

## NUMERICAL LISTING - ILLUSTRATIONS

### ST-8961 (Continued)

FORD SPORT UTILITY ..... 2013-18  
 FORD VAN ..... 2014-19  
 LINCOLN SPORT UTILITY ..... 2015-19



**ST-8962 (NEW)**  
**CONTROL ARM BUSHING**  
 Front

DODGE TRUCK ..... 2009-10  
 RAM TRUCK ..... 2010-18



**ST-8965**  
**STRUT MOUNT**  
 Rear

LEXUS PASSENGER CAR ..... 2007-12  
 TOYOTA PASSENGER CAR ..... 2006-12



**ST-8966**  
**STRUT MOUNT**  
 Rear

LEXUS PASSENGER CAR ..... 2007-12  
 TOYOTA PASSENGER CAR ..... 2006-12



**ST-8967**  
**STRUT MOUNT**  
 Front

JAGUAR ..... 2002-08



**ST-8968**  
**STRUT MOUNT**  
 Front

FORD PASSENGER CAR ..... 2008-11



**ST-8969 (NEW)**  
**STRUT MOUNT**  
 Front

DODGE PASSENGER CAR ..... 2007-12



**ST-8970 (NEW)**  
**STRUT MOUNT**  
 Front

DODGE PASSENGER CAR ..... 2007-12



**ST-8971**  
**STRUT MOUNT**  
 Front

DODGE PASSENGER CAR ..... 2007-12  
 DODGE SPORT UTILITY ..... 2009-15  
 DODGE VAN ..... 2008-12



**ST-8972**  
**STRUT MOUNT**  
 Rear

CHRYSLER PASSENGER CAR ..... 2007-14  
 DODGE PASSENGER CAR ..... 2007-14  
 DODGE SPORT UTILITY ..... 2009-15  
 JEEP SPORT UTILITY ..... 2007-16



**ST-8973 (NEW)**  
**STRUT MOUNT**  
 Rear

DODGE PASSENGER CAR ..... 2007-12



**ST-8975**  
**STRUT MOUNT**  
 Front

NISSAN SPORT UTILITY ..... 2003-07



**ST-8976**  
**STRUT MOUNT**  
 Front

HYUNDAI PASSENGER CAR ..... 2000-05



**ST-8977 (NEW)**  
**STRUT MOUNT WASHER**  
 Front Lower

HYUNDAI PASSENGER CAR ..... 2000-05



**ST-8978 (NEW)**  
**STRUT MOUNT**  
 Front

HYUNDAI PASSENGER CAR ..... 2000-05

# BUYER'S GUIDE

## NUMERICAL LISTING - ILLUSTRATIONS

 <p style="text-align: center;"><b>ST-8979 (NEW)</b> STRUT MOUNT Front</p> <p>HYUNDAI SPORT UTILITY ..... 2001-06</p>	 <p style="text-align: center;"><b>ST-8983 (NEW)</b> STRUT MOUNT Front</p> <p>DODGE SPORT UTILITY ..... 2009-15</p>	 <p style="text-align: center;"><b>ST-8990 (NEW)</b> STRUT MOUNT Rear</p> <p>TOYOTA PASSENGER CAR ..... 2009-13</p>	 <p style="text-align: center;"><b>ST-8994 (NEW)</b> STRUT MOUNT Front</p> <p>MAZDA PASSENGER CAR ..... 2009-13</p>
 <p style="text-align: center;"><b>ST-8980 (NEW)</b> STRUT MOUNT Front</p> <p>HYUNDAI SPORT UTILITY ..... 2001-06</p>	 <p style="text-align: center;"><b>ST-8984 (NEW)</b> STRUT MOUNT Front</p> <p>DODGE SPORT UTILITY ..... 2009-15</p>	<p style="text-align: center;"><b>ST-8991</b> STRUT MOUNT Rear</p> <p>CADILLAC PASSENGER CAR ..... 2003</p> 	 <p style="text-align: center;"><b>ST-8997 (NEW)</b> STRUT MOUNT Front</p> <p>HYUNDAI PASSENGER CAR ..... 2011-17 KIA PASSENGER CAR ..... 2011-17</p>
 <p style="text-align: center;"><b>ST-8981 (NEW)</b> STRUT MOUNT Front</p> <p>HYUNDAI SPORT UTILITY ..... 2001-06</p>	 <p style="text-align: center;"><b>ST-8988</b> STRUT MOUNT Rear</p> <p>TOYOTA PASSENGER CAR ..... 2003-08</p>	<p style="text-align: center;"><b>ST-8992</b> STRUT MOUNT Rear</p> <p>BMW SPORT UTILITY ..... 2004-10</p> 	<p style="text-align: center;"><b>ST-8998 (NEW)</b> STRUT MOUNT Front</p> <p>NISSAN SPORT UTILITY ..... 2009-14 NISSAN VAN ..... 2011-14</p> 
 <p style="text-align: center;"><b>ST-8982 (NEW)</b> STRUT MOUNT Front</p> <p>DODGE VAN ..... 2008-12</p>	 <p style="text-align: center;"><b>ST-8989</b> STRUT MOUNT Rear</p> <p>TOYOTA PASSENGER CAR ..... 2003-08</p>	<p style="text-align: center;"><b>ST-8993 (NEW)</b> SHOCK MOUNT REAR</p> <p>BUICK PASSENGER CAR ..... 2012-19 CADILLAC PASSENGER CAR ..... 2014-16 CHEVROLET PASSENGER CAR ..... 2011-16</p>	<p style="text-align: center;"><b>ST-8999</b> STRUT MOUNT Rear</p> <p>DODGE SPORT UTILITY ..... 2011-15 JEEP SPORT UTILITY ..... 2011-13</p> 

# BUYER'S GUIDE

## NUMERICAL LISTING - ILLUSTRATIONS

 <p><b>ST-98000 (NEW)</b> STRUT MOUNT Front</p> <p>FORD PASSENGER CAR ..... 1998-07</p> <p><b>ST-98001 (NEW)</b> STRUT MOUNT Front</p> <p>FORD PASSENGER CAR ..... 2003-10 FORD SPORT UTILITY ..... 2004-12</p> <p><b>ST-98002 (NEW)</b> STRUT MOUNT Front</p> <p>NISSAN PASSENGER CAR ..... 2002-10 RENAULT PASSENGER CAR ..... 2002-10 RENAULT VAN ..... 2007-09</p>	 <p><b>ST-98005 (NEW)</b> STRUT MOUNT Front</p> <p>CHEVROLET PASSENGER CAR ..... 2000-08 CHEVROLET TRUCK ..... 2004-11 CHEVROLET VAN ..... 2002-06</p>  <p><b>ST-9901 (NEW)</b> STRUT MOUNT Front</p> <p>BUICK PASSENGER CAR ..... 2006-11 CADILLAC PASSENGER CAR ..... 2006-11</p>  <p><b>ST-9902 (NEW)</b> STRUT MOUNT WASHER Front Lower</p> <p>HYUNDAI PASSENGER CAR ..... 2006-10</p>	 <p><b>ST-9903 (NEW)</b> STRUT MOUNT Front</p> <p>MAZDA PASSENGER CAR ..... 2003-04</p>  <p><b>ST-9904 (NEW)</b> STRUT MOUNT Front</p> <p>NISSAN PASSENGER CAR ..... 2007-13</p>  <p><b>ST-9905 (NEW)</b> STRUT MOUNT Front</p> <p>FORD SPORT UTILITY ..... 2011-13</p>  <p><b>ST-9906 (NEW)</b> STRUT MOUNT Front</p> <p>FORD PASSENGER CAR ..... 2011-14 FORD SPORT UTILITY ..... 2011-15 LINCOLN SPORT UTILITY ..... 2011-15</p>	 <p><b>ST-9907 (NEW)</b> STRUT MOUNT Rear</p> <p>AUDI PASSENGER CAR ..... 1997-04</p>  <p><b>ST-9908 (NEW)</b> STRUT MOUNT Rear</p> <p>BMW PASSENGER CAR ..... 2004-17</p>  <p><b>ST-9909 (NEW)</b> STRUT MOUNT Front</p> <p>CADILLAC PASSENGER CAR ..... 2013-16</p>  <p><b>ST-9910 (NEW)</b> STRUT MOUNT Rear</p> <p>CADILLAC PASSENGER CAR ..... 2013-16</p>
---	---	---	---



# BUYER'S GUIDE

## NUMERICAL LISTING - ILLUSTRATIONS



**ST-9911 (NEW)**  
**STRUT MOUNT**  
Rear

CADILLAC PASSENGER CAR ..... 2013-16



**ST-9912 (NEW)**  
**STRUT MOUNT**  
Rear

ACURA PASSENGER CAR ..... 2015-17  
HONDA PASSENGER CAR ..... 2013-14



**ST-9913 (NEW)**  
**STRUT MOUNT**  
Front

TOYOTA TRUCK ..... 2005-13



**ST-9914 (NEW)**  
**STRUT MOUNT**  
Front

FORD PASSENGER CAR ..... 2008-11  
FORD SPORT UTILITY ..... 2009  
LINCOLN PASSENGER CAR ..... 2010-11

(Continued Next Column)

**ST-9914 (Continued)**

LINCOLN SPORT UTILITY ..... 2010-11  
MERCURY PASSENGER CAR ... 2008-09



**ST-9915 (NEW)**  
**STRUT MOUNT**  
Front

FORD PASSENGER CAR ..... 2012  
FORD SPORT UTILITY ..... 2012  
LINCOLN PASSENGER CAR ..... 2012  
LINCOLN SPORT UTILITY ..... 2012



**ST-9916 (NEW)**  
**STRUT MOUNT**  
Front

FORD PASSENGER CAR ..... 2013-19  
FORD SPORT UTILITY ..... 2013-19  
LINCOLN PASSENGER CAR ..... 2013-16  
LINCOLN SPORT UTILITY ..... 2013-19



**ST-9917 (NEW)**  
**STRUT MOUNT**  
Front

ACURA PASSENGER CAR ..... 2009-14  
HONDA PASSENGER CAR ..... 2008-15



**ST-9918 (NEW)**  
**STRUT MOUNT**  
Front

ACURA PASSENGER CAR ..... 2009-14  
HONDA PASSENGER CAR ..... 2008-15

**ST-9920 (NEW)**  
**STRUT MOUNT**  
Rear

HONDA SPORT UTILITY ..... 2003-11



**ST-9921 (NEW)**  
**STRUT MOUNT**  
Front

CHEVROLET TRUCK ..... 2004-12  
GMC TRUCK ..... 2004-12



**ST-9922 (NEW)**  
**STRUT MOUNT**  
Front

ACURA PASSENGER CAR ..... 2009-14  
HONDA PASSENGER CAR ..... 2008-15



**ST-9923 (NEW)**  
**STRUT MOUNT**  
Front

BUICK SPORT UTILITY ..... 2008-16  
CHEVROLET SPORT UTILITY ... 2009-16  
GMC SPORT UTILITY ..... 2007-16  
SATURN SUV ..... 2007-10



**ST-9924 (NEW)**  
**STRUT MOUNT**  
Front

BUICK SPORT UTILITY ..... 2008-16  
CHEVROLET SPORT UTILITY ... 2009-16  
GMC SPORT UTILITY ..... 2007-16  
SATURN SUV ..... 2007-10



**ST-9925 (NEW)**  
**STRUT MOUNT**  
Front

NISSAN PASSENGER CAR ..... 2007-12

# BUYER'S GUIDE

## NUMERICAL LISTING - ILLUSTRATIONS

	<p><b>ST-9931 (Continued)</b>            SCION PASSENGER CAR ..... 2005-10            TOYOTA PASSENGER CAR ..... 2010-15            TOYOTA SPORT UTILITY ..... 2009-12</p>		
<p><b>ST-9927 (NEW)</b>  <b>STRUT MOUNT</b>  <b>Front</b></p> <p>HONDA SPORT UTILITY ..... 2003-11</p>		<p><b>ST-9940 (NEW)</b>  <b>STRUT MOUNT</b>  <b>Front</b></p> <p>TOYOTA SPORT UTILITY ..... 1996-05</p>	<p><b>ST-9946 (NEW)</b>  <b>STRUT MOUNT</b>  <b>Rear</b></p> <p>HONDA SPORT UTILITY ..... 2007-11</p>
	<p><b>ST-9937 (NEW)</b>  <b>STRUT MOUNT</b>  <b>Front</b></p> <p>HYUNDAI PASSENGER CAR ..... 2006-11            KIA PASSENGER CAR ..... 2006-11</p>		
<p><b>ST-9929 (NEW)</b>  <b>STRUT MOUNT</b>  <b>Front</b></p> <p>FORD PASSENGER CAR ..... 2006-12            LINCOLN PASSENGER CAR ..... 2007-12            MAZDA PASSENGER CAR ..... 2005-08            MERCURY PASSENGER CAR ..... 2006-11</p>		<p><b>ST-9942 (NEW)</b>  <b>STRUT MOUNT</b>  <b>Front</b></p> <p>LEXUS PASSENGER CAR ..... 2013-15            LEXUS SPORT UTILITY ..... 2004-15            TOYOTA SPORT UTILITY ..... 2004-13</p>	<p><b>ST-9947 (NEW)</b>  <b>STRUT MOUNT</b>  <b>Rear</b></p> <p>CHRYSLER PASSENGER CAR ..... 2001-05            DODGE PASSENGER CAR ..... 2001-05            EAGLE PASSENGER CAR ..... 1995-98            MITSUBISHI PASSENGER CAR ..... 1995-05</p>
	<p><b>ST-9938 (NEW)</b>  <b>STRUT MOUNT</b>  <b>Front</b></p> <p>HYUNDAI PASSENGER CAR ..... 2006-11            KIA PASSENGER CAR ..... 2006-11</p>		
<p><b>ST-9930 (NEW)</b>  <b>STRUT MOUNT</b>  <b>Front</b></p> <p>HONDA SPORT UTILITY ..... 2003-11</p>		<p><b>ST-9943 (NEW)</b>  <b>STRUT MOUNT</b>  <b>Front</b></p> <p>LEXUS SPORT UTILITY ..... 2004-15            TOYOTA SPORT UTILITY ..... 2004-13</p>	<p><b>ST-9948 (NEW)</b>  <b>STRUT MOUNT</b>  <b>Front</b></p> <p>HYUNDAI PASSENGER CAR ..... 2007-12</p>
	<p><b>ST-9939 (NEW)</b>  <b>STRUT MOUNT</b>  <b>Front</b></p> <p>TOYOTA SPORT UTILITY ..... 1996-05</p>		
<p><b>ST-9931 (NEW)</b>  <b>STRUT MOUNT</b>  <b>Front</b></p> <p>LEXUS PASSENGER CAR ..... 2010-12</p> <p><b>(Continued Next Column)</b></p>		<p><b>ST-9945 (NEW)</b>  <b>STRUT MOUNT</b>  <b>Front</b></p> <p>HONDA PASSENGER CAR ..... 2006-11</p>	

# BUYER'S GUIDE

## NUMERICAL LISTING - ILLUSTRATIONS

			
<p><b>ST-9949 (NEW)</b> STRUT MOUNT Front</p>	<p><b>ST-9959 (NEW)</b> STRUT MOUNT Rear</p>	<p><b>ST-9977 (NEW)</b> STRUT MOUNT Front</p>	<p><b>ST-9998 (NEW)</b> STRUT MOUNT Front</p>
<p>HYUNDAI PASSENGER CAR ..... 2007-12</p>	<p>HONDA SPORT UTILITY ..... 2007-11</p>	<p>HONDA VAN ..... 2005-07</p>	<p>KIA PASSENGER CAR ..... 2006-11</p>
			
<p><b>ST-9955 (NEW)</b> STRUT MOUNT Front</p>	<p><b>ST-9962 (NEW)</b> STRUT MOUNT Front</p>	<p><b>ST-9978 (NEW)</b> STRUT MOUNT Front</p>	<p><b>ST-9999 (NEW)</b> STRUT MOUNT Front</p>
<p>TOYOTA PASSENGER CAR ..... 2009-15</p>	<p>SCION PASSENGER CAR ..... 2005-10 TOYOTA PASSENGER CAR ..... 2003-09</p>	<p>HONDA VAN ..... 2005-07</p>	<p>KIA PASSENGER CAR ..... 2006-10</p>
			
<p><b>ST-9956 (NEW)</b> STRUT MOUNT Front</p>	<p><b>ST-9969 (NEW)</b> STRUT MOUNT Rear</p>	<p><b>ST-9988 (NEW)</b> STRUT MOUNT Front</p>	
<p>TOYOTA PASSENGER CAR ..... 2003-13</p>	<p>CHRYSLER PASSENGER CAR ..... 2001-05 DODGE PASSENGER CAR ..... 2001-05 MITSUBISHI PASSENGER CAR ..... 1999-05</p>	<p>DODGE PASSENGER CAR ..... 2013-16</p>	
			
<p><b>ST-9957 (NEW)</b> STRUT MOUNT Front</p>		<p><b>ST-9989 (NEW)</b> STRUT MOUNT Front</p>	
<p>TOYOTA PASSENGER CAR ..... 2009-13</p>		<p>DODGE PASSENGER CAR ..... 2013-16</p>	

# CROSS REFERENCE

Mfg Part No	Our Part	Mfg Part No	Our Part	Mfg Part No	Our Part	Mfg Part No	Our Part
ANCHOR		ANCHOR (cont.)		ANCHOR (cont.)		ANCHOR (cont.)	
2007	EM-2007	2250	EM-2250	2329	EM-2329	2406	EM-2406
2009	EM-2009	2253	EM-2253	2330	EM-2330	2407	EM-2407
2010	EM-2010	2254	EM-2254	2331	EM-2331	2408	EM-2408
2014	EM-2014	2255	EM-2255	2332	EM-2332	2409	EM-2409
2018	EM-2018	2256	EM-2256	2333	EM-2333	2410	EM-2410
2039	EM-2039	2257	EM-2257	2334	EM-2250	2413	EM-2413
2040	EM-2040	2258	EM-2253	2335	EM-2335	2414	EM-2414
2041	EM-2041	2261	EM-2261	2336	EM-2336	2415	EM-2415
2048	EM-2048	2262	EM-2262	2337	EM-2337	2417	EM-2417
2050	EM-2050	2263	EM-2263	2338	EM-2338	2418	EM-2418
2053	EM-2053	2264	EM-2264	2339	EM-2339	2419	EM-2419
2057	EM-2057	2265	EM-2265	2340	EM-2340	2420	EM-2420
2060	EM-2060	2266	EM-2266	2341	EM-2341	2421	EM-2421
2070	EM-2070	2267	EM-2267	2344	EM-2344	2424	EM-2424
2073	EM-2073	2268	EM-2268	2345	EM-2345	2425	EM-2425
2091	EM-2091	2270	EM-2270	2346	EM-2346	2426	EM-2426
2092	EM-2092	2271	EM-2271	2347	EM-2347	2427	EM-2427
2107	EM-2107	2272	EM-2272	2348	EM-2348	2428	EM-2428
2108	EM-2108	2273	EM-2296	2349	EM-2349	2429	EM-2429
2110	EM-2110	2274	EM-2274	2350	EM-2350	2433	EM-2433
2119	EM-2119	2275	EM-2275	2351	EM-2351	2434	EM-2434
2120	EM-2120	2276	EM-2276	2353	EM-2353	2435	EM-2436
2121	EM-2121	2277	EM-2277	2356	EM-2356	2436	EM-2436
2122	EM-2122	2278	EM-2278	2357	EM-2357	2437	EM-2437
2123	EM-2123	2279	EM-2279	2358	EM-2358	2438	EM-2438
2124	EM-2124	2280	EM-2280	2359	EM-2359	2439	EM-2439
2125	EM-2125	2281	EM-2281	2360	EM-2360	2440	EM-2440
2126	EM-2126	2282	EM-2282	2361	EM-2349	2441	EM-2441
2127	EM-2127	2283	EM-2283	2362	EM-2362	2442	EM-2442
2141	EM-2141	2284	EM-2284	2363	EM-2363	2444	EM-2444
2142	EM-2142	2285	EM-2285	2364	EM-2364	2445	EM-2445
2143	EM-2143	2286	EM-2257	2365	EM-2365	2446	EM-2446
2150	EM-2150	2286	EM-2286	2366	EM-2525	2447	EM-2447
2162	EM-2162	2287	EM-2287	2367	EM-2367	2448	EM-2448
2163	EM-2163	2288	EM-2288	2368	EM-2368	2449	EM-2449
2167	EM-2167	2289	EM-2289	2369	EM-2369	2450	EM-2451
2170	EM-2170	2290	EM-2290	2370	EM-2370	2451	EM-2451
2171	EM-2171	2291	EM-2291	2371	EM-2371	2452	EM-2452
2172	EM-2172	2292	EM-2292	2372	EM-2372	2453	EM-2453
2204	EM-2204	2293	EM-2293	2373	EM-2373	2454	EM-2454
2205	EM-2205	2294	EM-2294	2374	EM-2374	2455	EM-2600
2206	EM-2206	2295	EM-2295	2375	EM-2375	2456	EM-2456
2215	EM-2268	2296	EM-2296	2376	EM-2376	2457	EM-2457
2216	EM-2216	2297	EM-2297	2377	EM-2370	2458	EM-2458
2217	EM-2217	2298	EM-2298	2378	EM-2378	2459	EM-2459
2218	EM-2218	2299	EM-2299	2379	EM-2379	2460	EM-2460
2219	EM-2219	2300	EM-2512	2380	EM-2328	2461	EM-2461
2220	EM-2220	2301	EM-2301	2381	EM-2381	2462	EM-2462
2221	EM-2221	2302	EM-2302	2382	EM-2382	2463	EM-2463
2222	EM-2222	2303	EM-2303	2383	EM-2382	2464	EM-2464
2223	EM-2223	2304	EM-2304	2384	EM-2384	2465	EM-2436
2225	EM-2225	2305	EM-2305	2385	EM-2385	2466	EM-2466
2226	EM-2226	2306	EM-2306	2386	EM-2387	2467	EM-2467
2227	EM-2227	2307	EM-2307	2387	EM-2387	2468	EM-2469
2228	EM-2228	2309	EM-2309	2388	EM-2388	2469	EM-2469
2231	EM-2231	2310	EM-2310	2389	EM-2389	2470	EM-2470
2234	EM-2234	2311	EM-2311	2390	EM-2389	2471	EM-2471
2235	EM-2235	2314	EM-2369	2391	EM-2391	2472	EM-2472
2236	EM-2349	2316	EM-2316	2392	EM-2392	2473	EM-2473
2238	EM-2238	2317	EM-2317	2393	EM-2393	2474	EM-2474
2240	EM-2240	2319	EM-2319	2394	EM-2394	2475	EM-2549
2241	EM-2241	2320	EM-2320	2395	EM-2395	2476	EM-2550
2242	EM-2242	2321	EM-2321	2396	EM-2396	2477	EM-2477
2244	EM-2287	2323	EM-2323	2400	EM-2400	2478	EM-2381
2245	EM-2142	2324	EM-2324	2401	EM-2401	2479	EM-2457
2246	EM-2142	2325	EM-2325	2402	EM-2402	2480	EM-2458
2247	EM-2240	2326	EM-2326	2403	EM-2403	2481	EM-2457
2248	EM-2241	2327	EM-2327	2404	EM-2404	2482	EM-2457
2249	EM-2249	2328	EM-2328	2405	EM-2405	2483	EM-2458

# CROSS REFERENCE

Mfg Part No	Our Part	Mfg Part No	Our Part	Mfg Part No	Our Part	Mfg Part No	Our Part
<b>ANCHOR (cont.)</b>		<b>ANCHOR (cont.)</b>		<b>ANCHOR (cont.)</b>		<b>ANCHOR (cont.)</b>	
2484	EM-2458	2551SR	EM-2551S	2641	EM-2641	2711SR	EM-2711S
2485	EM-2458	2552	EM-2551	2642	EM-2642	2712	EM-2712
2486	EM-2458	2552SR	EM-2551S	2643	EM-2643	2712SR	EM-2712S
2487	EM-2487	2553	EM-2553	2644	EM-2644	2713	EM-2713
2488	EM-2488	2553SR	EM-2553S	2645	EM-2645	2714	EM-2714
2489	EM-2489	2554	EM-2551	2646	EM-2646	2715	EM-2715
2490	EM-2490	2554SR	EM-2551S	2647	EM-2646	2716	EM-2716
2491	EM-2491	2555	EM-2555	2648	EM-2815	2717	EM-2717
2492	EM-2492	2555SR	EM-2555S	2649	EM-2649	2717SR	EM-2717S
2493	EM-2493	2556	EM-2556	2650	EM-2650	2718	EM-2718
2494	EM-2494	2556SR	EM-2556S	2651	EM-2651	2719	EM-2719
2495	EM-2495	2557	EM-2557	2652	EM-2652	2720	EM-2720
2496	EM-2496	2558	EM-2558	2653	EM-2653	2721	EM-2721
2497	EM-2497	2559	EM-2559	2654	EM-2654	2722	EM-2722
2498	EM-2498	2560	EM-2557	2655	EM-2655	2723	EM-2723
2499	EM-2499	2561	EM-2528	2656	EM-2656	2724	EM-2724
2500	EM-2500	2562	EM-2562	2657	EM-2657	2725	EM-2725
2501	EM-2501	2563	EM-2563	2658	EM-2658	2726	EM-2726
2502	EM-2502	2564	EM-2564	2659	EM-2659	2727	EM-2727
2503	EM-2503	2565	EM-2565	2660	EM-2660	2728	EM-2728
2504	EM-2504	2566	EM-2566	2660SR	EM-2660S	2730	EM-2730
2505	EM-2505	2567	EM-2567	2661	EM-2661	2731	EM-2731
2506	EM-2506	2568	EM-2568	2661SR	EM-2661S	2732	EM-2731
2507	EM-2395	2569	EM-2569	2662	EM-2662	2733	EM-2733
2508	EM-2508	2570	EM-2570	2663	EM-2663	2734	EM-2734
2509	EM-2436	2571	EM-2571	2664	EM-2664	2735	EM-2735
2510	EM-2510	2572	EM-2572	2665	EM-2665	2736	EM-2736
2511	EM-2466	2573	EM-2528	2666	EM-2639	2737	EM-2737
2512	EM-2512	2600	EM-2600	2667	EM-2667	2738	EM-2738
2513	EM-2513	2601	EM-2601	2668	EM-2668	2739	EM-2739
2514	EM-2515	2602	EM-2601	2669	EM-2657	2740	EM-2740
2515	EM-2515	2603	EM-2601	2670	EM-2658	2741	EM-2741
2516	EM-2394	2604	EM-2601	2671	EM-2671	2742	EM-2742
2517	EM-2292	2605	EM-2601	2672	EM-2394	2743	EM-2743
2518	EM-2501	2606	EM-2601	2673	EM-2673	2744	EM-2744
2519	EM-2500	2607	EM-2601	2674	EM-2674	2745	EM-2745
2520	EM-2501	2608	EM-2601	2675	EM-2675	2746	EM-2746
2521	EM-2500	2609	EM-2609	2676	EM-2676	2747	EM-2747
2522	EM-2501	2610	EM-2538	2677	EM-2677	2748	EM-2748
2523	EM-2500	2611	EM-2538	2678	EM-2678	2749	EM-2749
2524	EM-2524	2612	EM-2538	2679	EM-2679	2750	EM-2750
2525	EM-2525	2613	EM-2538	2680	EM-2680	2751	EM-2751
2526	EM-2528	2614	EM-2601	2681	EM-2681	2752	EM-2752
2527	EM-2528	2615	EM-2615	2682	EM-2682	2753	EM-2753
2528	EM-2528	2616	EM-2616	2683	EM-2683	2754	EM-2754
2529	EM-2497	2617	EM-2617	2684	EM-2684	2755	EM-2755
2530	EM-2388	2618	EM-2618	2685	EM-2685	2756	EM-2756
2531	EM-2531	2619	EM-2619	2686	EM-2686	2759	EM-2759
2532	EM-2532	2620	EM-2620	2687	EM-2687	2760	EM-2760
2533	EM-2533	2621	EM-2621	2688	EM-2688	2761	EM-2761
2534	EM-2534	2622	EM-2622	2689	EM-2689	2762	EM-2762
2535	EM-2436	2623	EM-2623	2690	EM-2690	2763	EM-2763
2536	EM-2536	2624	EM-2624	2691	EM-2691	2764	EM-2764
2537	EM-2537	2625	EM-2625	2692	EM-2692	2765	EM-2765
2538	EM-2538	2626	EM-2626	2693	EM-2693	2766	EM-2766
2539	EM-2538	2627	EM-2627	2694	EM-2812	2767	EM-2767
2540	EM-2538	2628	EM-2628	2695	EM-2813	2768	EM-2768
2541	EM-2538	2629	EM-2629	2696	EM-2696	2769	EM-2769
2542	EM-2538	2630	EM-2630	2696SR	EM-2696S	2770	EM-2770
2543	EM-2543	2631	EM-2631	2697	EM-2697	2771	EM-2771
2544	EM-2531	2632	EM-2632	2697SR	EM-2697S	2772	EM-2772
2545	EM-2457	2633	EM-2633	2698	EM-2698	2773	EM-2773
2546	EM-2458	2634	EM-2634	2698SR	EM-2698S	2774	EM-2774
2547	EM-2457	2635	EM-2635	2707	EM-2707	2775	EM-2775
2548	EM-2548	2636	EM-2636	2707SR	EM-2707S	2776	EM-2776
2548SR	EM-2548S	2637	EM-2637	2708	EM-2708	2777	EM-2777
2549	EM-2549	2638	EM-2638	2709	EM-2709	2778	EM-2778
2550	EM-2550	2639	EM-2639	2710	EM-2710	2779	EM-2779
2551	EM-2551	2640	EM-2640	2711	EM-2711	2780	EM-2780

# CROSS REFERENCE

Mfg Part No	Our Part	Mfg Part No	Our Part	Mfg Part No	Our Part	Mfg Part No	Our Part
<b>ANCHOR (cont.)</b>		<b>ANCHOR (cont.)</b>		<b>ANCHOR (cont.)</b>		<b>ANCHOR (cont.)</b>	
2781	EM-2781	2836SR	EM-2836S	2893SR	EM-2893S	2947	EM-2947
2782	EM-2782	2837	EM-2837	2894	EM-2894	2948	EM-2948
2783	EM-2783	2837SR	EM-2837S	2894SR	EM-2894S	2949	EM-2949
2784	EM-2784	2838	EM-2838	2895	EM-2895	2950	EM-2950
2785	EM-2785	2838SR	EM-2838S	2895SR	EM-2895S	2951	EM-2951
2786	EM-2786	2839	EM-2839	2896	EM-2896	2952	EM-2952
2787	EM-2351	2840	EM-2840	2896SR	EM-2896S	2953	EM-2953
2788	EM-2788	2840SR	EM-2840S	2897	EM-2897	2954	EM-2954
2788SR	EM-2788S	2841	EM-2841	2897SR	EM-2897S	2955	EM-2955
2789	EM-2789	2841SR	EM-2841S	2898	EM-2898	2956	EM-2956
2789SR	EM-2789S	2842	EM-2842	2899	EM-2899	2957	EM-2957
2790	EM-2790	2842SR	EM-2842S	2900	EM-2900	2958	EM-2958
2790SR	EM-2790S	2843	EM-2843	2901	EM-2901	2959	EM-2959
2791	EM-2791	2844	EM-2844	2902	EM-2902	2960	EM-2960
2791SR	EM-2791S	2845	EM-2845	2902SR	EM-2902S	2961	EM-2961
2792	EM-2792	2846	EM-2846	2903	EM-2903	2962	EM-2962
2792SR	EM-2792S	2847	EM-2847	2903SR	EM-2903S	2963	EM-2963
2793	EM-2793	2848	EM-2848	2904	EM-2904	2964	EM-2964
2794	EM-2794	2849	EM-2849	2905	EM-2905	2965	EM-2965
2795	EM-2795	2850	EM-2850	2906	EM-2906	2966	EM-2966
2795SR	EM-2795S	2851	EM-2851	2906SR	EM-2906S	2967	EM-2967
2796	EM-2796	2852	EM-2852	2907	EM-2907	2967SR	EM-2967S
2796SR	EM-2796S	2853	EM-2853	2908	EM-2908	2968	EM-2968
2797	EM-2797	2854	EM-2854	2909	EM-2909	2968SR	EM-2968S
2798	EM-2798	2855	EM-2855	2910	EM-2910	2969	EM-2969
2799	EM-2799	2856	EM-2856	2910SR	EM-2910S	2970	EM-2970
2800	EM-2800	2857	EM-2857	2911	EM-2911	2971	EM-2971
2801	EM-2801	2858	EM-2858	2912	EM-2912	2972	EM-2972
2802	EM-2802	2859	EM-2859	2913	EM-2913	2973	EM-2973
2803	EM-2803	2859SR	EM-2859S	2914	EM-2914	2974	EM-2974
2803SR	EM-2803S	2860	EM-2860	2915	EM-2915	2974SR	EM-2974S
2804	EM-2804	2861	EM-2861	2916	EM-2916	2975	EM-2975
2805	EM-2805	2862	EM-2862	2917	EM-2917	2977	EM-2977
2806	EM-2806	2863	EM-2863	2918	EM-2918	2978	EM-2978
2807	EM-2807	2864	EM-2864	2919	EM-2919	2979	EM-2979
2808	EM-2808	2865	EM-2865	2920	EM-2920	2980	EM-2980
2809	EM-2809	2866	EM-2866	2921	EM-2921	2981	EM-2981
2810	EM-2810	2867	EM-2867	2922	EM-2922	2982	EM-2982
2811	EM-2811	2868	EM-2868	2923	EM-2923	2983	EM-2983
2812	EM-2812	2869	EM-2869	2924	EM-2924	2984	EM-2984
2812SR	EM-2812S	2870	EM-2870	2925	EM-2925	2985	EM-2985
2813	EM-2813	2871	EM-2871	2926	EM-2926	2986	EM-2986
2813SR	EM-2813S	2872	EM-2872	2926SR	EM-2926S	2987	EM-2987
2814	EM-2814	2873	EM-2873	2927	EM-2927	2987SR	EM-2987S
2815	EM-2815	2874	EM-2874	2928	EM-2928	2988	EM-2988
2816	EM-2816	2875	EM-2875	2929	EM-2929	2989	EM-2989
2817	EM-2817	2876	EM-2876	2930	EM-2930	2990	EM-2990
2818	EM-2818	2876SR	EM-2876S	2931	EM-2931	2991	EM-2991
2819	EM-2819	2877	EM-2877	2932	EM-2932	2992	EM-2992
2820	EM-2820	2878	EM-2878	2932SR	EM-2932S	2993	EM-2993
2821	EM-2821	2879	EM-2879	2933	EM-2933	2993SR	EM-2993S
2821SR	EM-2821S	2879SR	EM-2879S	2933SR	EM-2933S	2994	EM-2994
2822	EM-2822	2880	EM-2880	2934	EM-2934	2995	EM-2995
2823	EM-2823	2880SR	EM-2880S	2934SR	EM-2934S	2995SR	EM-2995S
2823SR	EM-2823S	2881	EM-2881	2935	EM-2935	2996	EM-2996
2824	EM-2824	2882	EM-2882	2936	EM-2936	2996SR	EM-2996S
2824SR	EM-2824S	2883	EM-2883	2937	EM-2853	2997	EM-2997
2825	EM-2825	2884	EM-2884	2938	EM-2938	2998	EM-2998
2826	EM-2826	2885	EM-2885	2938SR	EM-2938S	2999	EM-2999
2827	EM-2827	2886	EM-2886	2939	EM-2939	3000	EM-3000
2828	EM-2828	2887	EM-2887	2940	EM-2940	3001	EM-3001
2829	EM-2829	2888	EM-2888	2941	EM-2941	3002	EM-3002
2830	EM-2830	2889	EM-2889	2942	EM-2942	3003	EM-3003
2831	EM-2831	2890	EM-2890	2942SR	EM-2942S	3003SR	EM-3003S
2832	EM-2832	2890SR	EM-2890S	2943	EM-2943	3004	EM-3004
2833	EM-2833	2891	EM-2891	2943SR	EM-2943S	3005	EM-3005
2834	EM-2834	2892	EM-2892	2944	EM-2944	3006	EM-3006
2835	EM-2835	2892SR	EM-2892S	2945	EM-2945	3007	EM-3007
2836	EM-2836	2893	EM-2893	2946	EM-2946	3008	EM-3008

# CROSS REFERENCE

Mfg Part No	Our Part	Mfg Part No	Our Part	Mfg Part No	Our Part	Mfg Part No	Our Part
<b>ANCHOR (cont.)</b>		<b>ANCHOR (cont.)</b>		<b>ANCHOR (cont.)</b>		<b>ANCHOR (cont.)</b>	
3009	EM-3009	3071	EM-3071	3132	EM-3132	3201	EM-3201
3010	EM-3010	3071SR	EM-3071S	3133	EM-3133	3202	EM-3202
3011	EM-3011	3072	EM-3072	3134	EM-3134	3203	EM-4034
3012	EM-3012	3072SR	EM-3072S	3135	EM-3135	3204	EM-5377
3013	EM-3013	3073	EM-3073	3136	EM-3136	3205	EM-4040
3014	EM-3014	3074	EM-3074	3137	EM-3137	3206	EM-4038
3015	EM-3015	3075	EM-3075	3138	EM-3138	3207	EM-4039
3016	EM-3016	3075SR	EM-3075S	3139	EM-3139	3208	EM-4035
3017	EM-3017	3076	EM-3076	3140	EM-3140	3209	EM-4037
3018	EM-3018	3076SR	EM-3076S	3141	EM-3141	3210	EM-4033
3019	EM-3019	3077	EM-3077	3142	EM-3142	3211	EM-5583
3020	EM-3020	3077SR	EM-3077S	3143	EM-3143	3212	EM-4045
3020SR	EM-3020S	3078	EM-3078	3144	EM-3144	3213	EM-4046
3021	EM-3021	3079	EM-3079	3145	EM-3145	3214	EM-4057
3021SR	EM-3021S	3079SR	EM-3079S	3146	EM-3146	3215	EM-4019
3022	EM-3022	3080	EM-3080	3147	EM-3147	3216	EM-4146
3022SR	EM-3022S	3080SR	EM-3080S	3148	EM-3148	3217	EM-4050
3023	EM-3023	3081	EM-3081	3149	EM-3149	3218	EM-4055
3023SR	EM-3023S	3082	EM-3082	3150	EM-3150	3219	EM-4056
3024	EM-3024	3083	EM-3083	3151	EM-3151	3220	EM-4059
3025	EM-3025	3083SR	EM-3083S	3152	EM-3152	3221	EM-4044
3026	EM-3026	3084	EM-3084	3153	EM-3153	3222	EM-4071
3027	EM-3027	3084SR	EM-3084S	3154	EM-3154	3223	EM-4076
3028	EM-3028	3085	EM-3085	3155	EM-3155	3224	EM-4072
3029	EM-3029	3085SR	EM-3085S	3156	EM-3156	3225	EM-4053
3030	EM-3030	3086	EM-3086	3157	EM-3157	3226	EM-4054
3031	EM-3031	3087	EM-3087	3158	EM-3158	3227	EM-4077
3032	EM-3032	3088	EM-3088	3159	EM-3159	3228	EM-4013
3033	EM-3033	3089	EM-3089	3160	EM-3160	3229	EM-4078
3033SR	EM-3033S	3090	EM-3090	3161	EM-3161	3230	EM-4079
3034	EM-3034	3091	EM-3091	3162	EM-3162	3231	EM-4073
3035	EM-3035	3092	EM-3092	3163	EM-5587	3232	EM-4000
3036	EM-3036	3093	EM-3093	3164	EM-5380	3233	EM-3142
3037	EM-3037	3094	EM-3094	3165	EM-3165	3234	EM-4080
3038	EM-3038	3095	EM-3095	3166	EM-3166	3235	EM-4081
3039	EM-3039	3096	EM-3096	3167	EM-3167	3236	EM-4119
3040	EM-3040	3097	EM-3097	3168	EM-3168	3237	EM-4120
3041	EM-3041	3098	EM-3098	3169	EM-5692	3238	EM-4121
3042	EM-3042	3100	EM-3100	3170	EM-5588	3239	EM-4122
3043	EM-3043	3102	EM-3102	3171	EM-4002	3240	EM-4129
3044	EM-3044	3103	EM-3103	3172	EM-3172	3241	EM-4106
3045	EM-3045	3104	EM-3104	3173	EM-5424	3242	EM-4061
3046	EM-3046	3105	EM-3105	3174	EM-5425	3243	EM-4185
3047	EM-3047	3106	EM-3106	3175	EM-3175	3244	EM-4124
3048	EM-3048	3107	EM-3107	3176	EM-5353	3245	EM-4027
3049	EM-3049	3108	EM-3108	3177	EM-3177	3246	EM-4107
3050	EM-3050	3109	EM-3109	3178	EM-5354	3247	EM-4125
3051	EM-3051	3110	EM-3110	3179	EM-3179	3248	EM-4062
3052	EM-3052	3111	EM-3111	3180	EM-5427	3249	EM-4156
3053	EM-3053	3112	EM-3112	3181	EM-5085	3250	EM-4029
3054	EM-3054	3113	EM-3113	3182	EM-4028	3251	EM-5694
3055	EM-3055	3114	EM-3114	3183	EM-3183	3252	EM-5693
3056	EM-3056	3115	EM-3115	3184	EM-5659	3253	EM-4074
3056SR	EM-3056S	3116	EM-3116	3185	EM-5660	3254	EM-4018
3057	EM-3057	3117	EM-3117	3186	EM-4012	3255	EM-4138
3057SR	EM-3057S	3118	EM-3118	3187	EM-5661	3256	EM-4132
3058	EM-3058	3119	EM-3119	3188	EM-5428	3257	EM-4153
3059	EM-3059	3120	EM-3120	3189	EM-3189	3258	EM-4117
3060	EM-3060	3121	EM-3121	3190	EM-3190	3259	EM-4154
3061	EM-3061	3122	EM-3122	3191	EM-4036	3260	EM-4108
3062	EM-3062	3123	EM-3123	3192	EM-3192	3261	EM-4164
3063	EM-3063	3124	EM-3124	3193	EM-3193	3262	EM-4150
3064	EM-3064	3125	EM-3125	3194	EM-3194	3263	EM-4155
3065	EM-3065	3126	EM-3126	3195	EM-3195	3264	EM-4159
3066	EM-3066	3127	EM-3127	3196	EM-3196	3265	EM-4049
3067	EM-3067	3128	EM-3128	3197	EM-3197	3266	EM-4221
3068	EM-3068	3129	EM-3129	3198	EM-3198	3267	EM-4134
3069	EM-3069	3130	EM-3130	3199	EM-3199	3268	EM-4047
3070	EM-3070	3131	EM-3131	3200	EM-3200	3269	EM-4135

# CROSS REFERENCE

Mfg Part No	Our Part	Mfg Part No	Our Part	Mfg Part No	Our Part	Mfg Part No	Our Part
<b>ANCHOR (cont.)</b>		<b>ANCHOR (cont.)</b>		<b>ANCHOR (cont.)</b>		<b>ANCHOR (cont.)</b>	
3270	EM-4218	3342	EM-4253	6066	DS-6066	8023	EM-8024
3271	EM-4114	3343	EM-4181	6067	DS-6500	8024	EM-8024
3272	EM-4220	3344	EM-4182	6068	DS-6068	8025	EM-8025
3273	EM-4139	3345	EM-4167	6069	DS-6069	8026	EM-8026
3274	EM-4113	3346	EM-4183	6071	DS-6071	8027	EM-8575
3275	EM-4173	3347	EM-4205	6072	DS-6072	8028	EM-8435
3276	EM-4174	3348	EM-4254	6073	DS-5225	8029	EM-8029
3277	EM-4123	3349	EM-4237	6074	DS-5227	8030	EM-8030
3279	EM-4161	3350	EM-4238	6075	DS-5223	8031	EM-8031
3280	EM-4168	3351	EM-4255	6076	DS-6076	8032	EM-8021
3281	EM-4115	3352	EM-4256	6077	DS-6077	8033	EM-8010
3282	EM-4116	3353	EM-4128	6078	DS-6078	8034	EM-8034
3283	EM-4224	3354	EM-4104	6079	DS-6079	8035	EM-8431
3284	EM-4024	3355	EM-4101	6080	DS-6505	8036	EM-8012
3285	EM-7044	3356	EM-4103	6080	DS-6507	8037	EM-8037
3286	EM-4225	3357	EM-4102	6081	DS-6504	8037SR	EM-8037
3287	EM-4226	3358	EM-4258	6081	DS-6506	8038	EM-8103
3288	EM-4160	3359	EM-4231	6082	DS-5229	8039	EM-8039
3289	EM-4163	3360	EM-4232	6083	DS-5228	8040	EM-8040
3290	EM-4249	3363	EM-4261	6084	DS-5230	8041	EM-8041
3291	EM-4158	3364	EM-4239	6085	DS-6085	8042	EM-8042
3292	EM-5475	3365	EM-4189	6086	DS-6086	8043	EM-8042
3293	EM-4227	3366	EM-4067	6087	DS-6095	8044	EM-8044
3294	EM-4230	3370	EM-4130	6088	DS-5236	8045	EM-8045
3295	EM-4149	3371	EM-4142	6089	DS-6517	8046	EM-8100
3296	EM-4241	3372	EM-4143	6091	DS-6510	8047	EM-8047
3297	EM-4172	3375	EM-7115	6092	DS-6092	8048	EM-8048
3298	EM-4228	3376	EM-4060	6093	DS-6509	8049	EM-8049
3299	EM-4043	3378	EM-4264	6094	DS-6501	8050	EM-8586
3300	EM-4040	3379	EM-4265	6096	DS-6042	8051	EM-8576
3301	EM-4175	3380	EM-4266	6099	DS-6519	8052	EM-8579
3302	EM-4111	3383	EM-5551	6100	DS-6072	8053	EM-8053
3303	EM-4223	3384	EM-5578	6102	DS-5235	8054	EM-8054
3304	EM-4229	3385	EM-4240	6103	DS-6524	8055	EM-8055
3305	EM-4209	3389	EM-4295	6104	DS-6503	8056	EM-8056
3306	EM-4208	3392	EM-4298	6106	DS-6531	8057	EM-8068
3307	EM-4192	3401	EM-4267	6107	DS-6502	8058	EM-8095
3308	EM-4193	3402	EM-4131	6109	DS-6516	8059	EM-8059
3309	EM-4194	3403	EM-4137	6111	DS-6533	8060	EM-8060
3310	EM-4195	3405	EM-4268	6112	DS-6534	8061	EM-8061
3311	EM-4196	3406	EM-4269	6113	DS-6535	8062	EM-8062
3312	EM-4100	3407	EM-4270	6114	DS-6536	8063	EM-8063
3313	EM-4105	3409	EM-4090	6130	DS-5232	8064	EM-2651
3315	EM-4250	3410	EM-4091	6133	DS-6024	8065	EM-8065
3316	EM-4176	3412	EM-4088	6136	DS-6511	8066	EM-8609
3317	EM-4177	3414	EM-4087	6137	DS-6512	8068	EM-8068
3319	EM-4211	3416	EM-4274	8000	EM-8018	8069	EM-8063
3320	EM-4212	3418	EM-4275	8001	EM-8001	8070	EM-2815
3321	EM-4213	3421	EM-4084	8002	EM-8002	8071	EM-8063
3322	EM-4214	3422	EM-4085	8003	EM-8329	8073	EM-8073
3323	EM-4215	3426	EM-4086	8004	EM-8004	8074	EM-8074
3324	EM-4216	6027	DS-6027	8005	EM-8005	8075	EM-8075
3325	EM-4217	6028	DS-6028	8006	EM-8006	8076	EM-8080
3326	EM-4198	6035	DS-6035	8007	EM-8007	8077	EM-8077
3327	EM-4251	6038	DS-6038	8008	EM-8008	8078	EM-8078
3328	EM-4248	6039	DS-6038	8009	EM-8009	8079	EM-8079
3329	EM-4184	6040	DS-6040	8010	EM-8010	8080	EM-8080
3330	EM-4199	6048	DS-6048	8011	EM-8011	8081	EM-8082
3331	EM-4031	6049	DS-6049	8012	EM-8012	8082	EM-8082
3332	EM-4200	6050	DS-6050	8013	EM-8014	8083	EM-8083
3333	EM-4201	6051	DS-6051	8014	EM-8014	8084	EM-8084
3334	EM-4178	6052	DS-6052	8015	EM-8016	8085	EM-8085
3335	EM-4179	6053	DS-6053	8016	EM-8016	8086	EM-8086
3336	EM-4252	6056	DS-6056	8017	EM-8021	8087	EM-8087
3337	EM-4202	6061	DS-6061	8018	EM-8018	8088	EM-8088
3338	EM-4203	6062	DS-6062	8019	EM-8019	8089	EM-8089
3339	EM-4180	6063	DS-6063	8020	EM-8020	8090	EM-8516
3340	EM-4140	6064	DS-6064	8021	EM-8021	8091	EM-8091
3341	EM-4110	6065	DS-6065	8022	EM-8022	8092	EM-8080



# CROSS REFERENCE

Mfg Part No	Our Part	Mfg Part No	Our Part	Mfg Part No	Our Part	Mfg Part No	Our Part
<b>ANCHOR (cont.)</b>		<b>ANCHOR (cont.)</b>		<b>ANCHOR (cont.)</b>		<b>ANCHOR (cont.)</b>	
8093	EM-8093	8166	EM-8166	8238	EM-8238	8308	EM-8307
8094	EM-8094	8167	EM-8167	8239	EM-8239	8309	EM-8427
8095	EM-8095	8168	EM-8168	8240	EM-8431	8310	EM-8310
8096	EM-8096	8169	EM-8169	8241	EM-8073	8311	EM-8311
8097	EM-8097	8170	EM-8170	8242	EM-8242	8312	EM-8312
8098	EM-8098	8171	EM-8171	8243	EM-8243	8313	EM-8312
8099	EM-8099	8172	EM-8278	8244	EM-8244	8314	EM-8314
8100	EM-8100	8173	EM-8173	8245	EM-8424	8315	EM-8149
8101	EM-8101	8174	EM-8174	8246	EM-8517	8316	EM-8312
8102	EM-8102	8175	EM-8175	8247	EM-8004	8317	EM-8317
8103	EM-8103	8176	EM-8176	8248	EM-8248	8318	DS-8318
8104	EM-8104	8177	EM-8177	8249	EM-8031	8319	EM-8319
8105	EM-8105	8178	EM-8178	8250	EM-8014	8320	EM-8149
8106	EM-8106	8179	EM-8179	8251	EM-8014	8321	EM-8133
8107	EM-8107	8180	EM-8180	8252	EM-8019	8322	EM-8322
8108	EM-8108	8181	EM-8181	8253	EM-8253	8323	EM-8323
8109	EM-8103	8182	EM-8211	8254	EM-8254	8324	EM-8324
8111	EM-8111	8183	EM-8183	8255	EM-8255	8325	EM-8324
8112	EM-8100	8184	EM-8183	8256	EM-8586	8326	EM-8324
8113	EM-8065	8185	EM-8185	8257	EM-8586	8327	EM-8324
8114	EM-8114	8186	EM-8186	8258	EM-8586	8328	EM-8328
8115	EM-8115	8187	EM-8187	8259	EM-8259	8329	EM-8329
8116	EM-8132	8188	EM-8188	8260	EM-8424	8330	EM-8330
8117	EM-8117	8189	EM-8189	8261	EM-8261	8331	EM-8130
8118	EM-8118	8190	EM-8190	8262	EM-8262	8332	EM-8130
8119	EM-8119	8191	EM-8191	8263	EM-8263	8335	EM-8178
8120	EM-8120	8192	EM-8192	8264	EM-8080	8336	EM-8194
8121	EM-8121	8193	EM-8193	8265	EM-8094	8337	EM-8278
8122	EM-8122	8194	EM-8194	8266	EM-8266	8338	EM-8278
8123	EM-8124	8195	EM-8195	8267	EM-8267	8339	EM-8339
8124	EM-8124	8196	EM-8196	8268	EM-8103	8340	EM-8180
8125	EM-8125	8197	EM-8197	8269	EM-8584	8341	EM-9055
8126	EM-8304	8198	EM-8198	8270	EM-8270	8343	EM-8164
8127	EM-8133	8199	EM-8485	8271	EM-8271	8344	EM-8344
8128	EM-8128	8200	EM-8200	8272	EM-8272	8345	EM-8002
8129	EM-8304	8201	EM-8201	8273	EM-8324	8346	EM-8194
8130	EM-8130	8205	EM-8205	8274	EM-8274	8347	EM-8002
8131	EM-8125	8206	EM-8206	8275	EM-8312	8348	EM-8348
8132	EM-8132	8207	EM-8207	8276	EM-8276	8349	EM-8349
8133	EM-8133	8208	EM-8208	8277	EM-8277	8350	EM-8348
8134	EM-8133	8209	EM-8209	8278	EM-8278	8351	EM-8351
8135	EM-8135	8210	EM-8210	8279	EM-8279	8352	EM-8352
8137	EM-8137	8211	EM-8211	8280	EM-8280	8353	EM-8353
8138	EM-8138	8212	EM-8212	8281	EM-8281	8354	EM-8344
8139	EM-2740	8213	EM-8213	8282	EM-8282	8355	EM-8195
8140	EM-8140	8214	EM-8214	8283	EM-8283	8356	EM-8195
8141	EM-8141	8218	EM-8218	8284	EM-8284	8357	EM-8193
8142	EM-8142	8219	EM-8211	8285	EM-8142	8358	EM-8213
8143	EM-8310	8220	EM-8220	8286	EM-8181	8359	EM-8359
8144	EM-8144	8221	EM-8221	8287	EM-8287	8360	EM-8014
8145	EM-8145	8221SR	EM-8221	8288	EM-8411	8361	EM-8361
8146	EM-8146	8222	EM-8222	8289	EM-8431	8361SR	EM-8361
8147	EM-8303	8223	EM-8223	8290	EM-8290	8362	EM-8485
8148	EM-8148	8224	EM-8224	8291	EM-8619	8363	EM-8363
8149	EM-8149	8224SR	EM-8224	8292	EM-8292	8364	EM-8166
8150	EM-8150	8225	EM-8225	8293	EM-8293	8365	EM-8365
8151	EM-8151	8226	EM-8102	8294	EM-8294	8366	EM-8207
8152	EM-8152	8227	EM-8223	8295	EM-8295	8367	EM-8368
8153	EM-8137	8228	EM-8228	8296	EM-8296	8368	EM-8368
8154	EM-8154	8229	EM-8229	8298	EM-8304	8369	EM-8482
8155	EM-8132	8230	EM-8230	8299	EM-8001	8370	EM-8190
8156	EM-8324	8231	EM-8231	8300	EM-8300	8371	EM-8201
8157	EM-8157	8232	EM-8232	8301	EM-8304	8372	EM-8208
8160	EM-8160	8233	EM-8233	8302	EM-8304	8373	EM-8014
8161	EM-8161	8234	EM-8234	8303	EM-8303	8374	EM-8374
8162	EM-8162	8235	EM-8235	8304	EM-8304	8375	EM-8375
8163	EM-8163	8236	EM-8236	8305	EM-2406	8376	EM-8167
8164	EM-8164	8236SR	EM-8236	8306	EM-8034	8377	EM-8377
8165	EM-8165	8237	EM-8224	8307	EM-8307	8378	EM-8214

# CROSS REFERENCE

Mfg Part No	Our Part	Mfg Part No	Our Part	Mfg Part No	Our Part	Mfg Part No	Our Part
<b>ANCHOR (cont.)</b>		<b>ANCHOR (cont.)</b>		<b>ANCHOR (cont.)</b>		<b>ANCHOR (cont.)</b>	
8379	EM-8375	8452	EM-8586	8525	EM-8525	8597	EM-8597
8380	EM-8179	8453	EM-8453	8526	EM-8576	8598	EM-8598
8381	EM-2409	8454	EM-8609	8527	EM-8314	8599	EM-8599
8382	EM-2690	8455	EM-8073	8528	EM-8197	8600	EM-8600
8384	EM-8384	8456	EM-8456	8529	EM-8529	8601	EM-8601
8385	EM-8385	8457	EM-8457	8530	DS-8531	8602	EM-8602
8386	EM-8187	8458	EM-8073	8531	DS-8531	8603	EM-8603
8388	EM-8388	8459	EM-8073	8532	DS-8532	8604	EM-8604
8389	EM-8389	8460	EM-8460	8533	DS-8533	8605	EM-8605
8390	EM-8389	8461	EM-8075	8535	DS-8535	8606	EM-8606
8392	EM-8392	8462	EM-8462	8536	EM-8005	8607	EM-8607
8393	EM-8393	8463	EM-8087	8537	EM-8402	8608	EM-8608
8394	EM-8393	8464	EM-8086	8538	DS-8538	8609	EM-8609
8395	EM-8395	8465	EM-8516	8539	EM-8539	8610	EM-2815
8396	EM-8197	8466	EM-8466	8540	EM-8803	8611	EM-8611
8397	EM-8197	8467	EM-8467	8541	EM-8803	8612	EM-8612
8398	EM-8398	8468	DS-8468	8542	EM-8542	8613	EM-8612
8399	EM-8398	8469	DS-8469	8543	EM-8544	8614	EM-8614
8400	EM-8400	8470	DS-8470	8544	EM-8544	8615	EM-8615
8401	EM-8401	8471	DS-8471	8545	EM-8545	8616	EM-8616
8402	EM-8402	8472	DS-8472	8546	EM-8548	8617	EM-8617
8404	EM-8404	8473	DS-8473	8547	EM-8548	8618	EM-8236
8405	EM-8197	8474	DS-8474	8548	EM-8548	8619	EM-8619
8406	EM-8406	8475	DS-8475	8549	DS-8549	8620	EM-8620
8407	EM-8407	8477	EM-8075	8550	DS-8550	8621	EM-8621
8408	EM-8385	8478	EM-8055	8551	DS-8551	8622	EM-8622
8409	EM-8385	8479	EM-8142	8552	EM-8552	8622SR	EM-8622
8410	EM-8197	8480	EM-8304	8553	EM-8553	8623	EM-8623
8411	EM-8411	8481	EM-8192	8554	EM-8554	8624	EM-8594
8412	EM-8413	8482	EM-8482	8555	EM-8103	8626	DS-8626
8413	EM-8413	8483	EM-8368	8556	EM-8556	8627	DS-8627
8414	EM-8414	8484	EM-8348	8557	EM-8107	8628	EM-8229
8415	EM-8415	8485	EM-8485	8558	EM-8205	8629	EM-8629
8416	EM-8175	8485SR	EM-8485	8559	EM-8559	8630	EM-8630
8417	EM-8175	8487	EM-8197	8560	EM-8560	8631	EM-8631
8418	EM-8418	8488	EM-8488	8561	EM-8068	8632	EM-8632
8419	EM-8191	8489	EM-8489	8562	EM-8095	8633	EM-8230
8420	EM-8643	8490	EM-8490	8563	EM-8563	8634	DS-8634
8421	EM-8415	8491	EM-8491	8565	DS-8565	8635	DS-8635
8422	EM-8422	8492	EM-8492	8566	EM-8566	8636	DS-8636
8423	EM-8021	8493	EM-8493	8567	EM-8124	8637	EM-8224
8424	EM-8424	8494	EM-8400	8568	EM-8568	8637SR	EM-8224
8425	EM-8425	8495	EM-8495	8569	EM-8568	8638	EM-8663
8426	EM-8034	8496	EM-8008	8571	EM-8571	8639	EM-8639
8427	EM-8427	8497	EM-8497	8572	EM-8572	8640	EM-8640
8428	EM-8120	8499	EM-8499	8573	EM-8010	8641	EM-8641
8429	EM-8177	8501	EM-2731	8574	EM-8574	8642	EM-8642
8430	EM-8430	8502	EM-8502	8575	EM-8575	8643	EM-8643
8431	EM-8431	8503	EM-8503	8576	EM-8576	8644	EM-8644
8432	EM-8432	8505	EM-2731	8577	EM-8577	8645	EM-8389
8433	EM-8435	8506	EM-8506	8578	EM-8578	8646	EM-8196
8434	EM-8434	8507	EM-8507	8579	EM-8579	8647	EM-8164
8435	EM-8435	8508	EM-8508	8580	EM-8055	8648	EM-8648
8436	EM-8435	8509	DS-8509	8581	EM-8512	8649	EM-8649
8437	EM-8435	8510	EM-8510	8582	EM-8582	8650	EM-8650
8438	EM-8438	8511	EM-8511	8584	EM-8584	8651	EM-8651
8439	EM-8439	8512	EM-8512	8585	EM-8205	8652	EM-8652
8440	EM-8439	8513	EM-8513	8586	EM-8586	8653	EM-8653
8441	EM-8586	8514	EM-8514	8587	DS-8587	8654	EM-8654
8442	EM-8442	8515	EM-8078	8588	DS-8588	8655	EM-8655
8443	EM-8586	8516	EM-8516	8589	EM-8589	8656	EM-8656
8444	EM-8579	8517	EM-8517	8589SR	EM-8589	8657	EM-8657
8445	EM-8445	8518	EM-8282	8590	EM-8663	8658	EM-8658
8446	EM-8579	8519	EM-8282	8591	DS-8591	8659	EM-8659
8447	EM-8576	8520	EM-8490	8592	EM-8592	8660	EM-8660
8448	EM-8586	8521	EM-8521	8593	EM-8593	8661	EM-8661
8449	EM-8586	8522	EM-8522	8594	EM-8594	8662	EM-8662
8450	EM-8586	8523	EM-8524	8595	EM-8595	8662SR	EM-8662
8451	EM-8352	8524	EM-8524	8596	EM-8596	8663	EM-8663

# CROSS REFERENCE

Mfg Part No	Our Part	Mfg Part No	Our Part	Mfg Part No	Our Part	Mfg Part No	Our Part
<b>ANCHOR (cont.)</b>		<b>ANCHOR (cont.)</b>		<b>ANCHOR (cont.)</b>		<b>ANCHOR (cont.)</b>	
8663SR	EM-8663	8734	EM-8734	8802	EM-8802	8862	EM-8862
8664	EM-8664	8736	EM-8736	8803	EM-8803	8863	EM-8863
8665	EM-8665	8737	EM-8044	8804	EM-8804	8864	EM-8864
8666	EM-8165	8738	EM-8738	8805	EM-8805	8865	EM-8865
8667	EM-8667	8739	EM-8738	8806	EM-8806	8866	EM-8866
8668	EM-8668	8740	EM-8740	8807	EM-8807	8867	EM-8867
8669	EM-8669	8741	EM-8741	8808	EM-8681	8868	EM-8868
8670	EM-8670	8742	EM-8742	8809	EM-8296	8869	EM-8869
8672	EM-8672	8743	EM-8743	8810	EM-8296	8870	EM-8870
8673	EM-8672	8744	EM-8744	8810SR	EM-8296	8871	EM-8871
8674	EM-8674	8745	EM-8745	8811	EM-8811	8872	EM-8872
8675	EM-8675	8746	EM-8746	8812	EM-8812	8873	EM-8873
8676	EM-8676	8747	EM-8747	8813	EM-8813	8874	EM-8874
8677	EM-8677	8748	EM-8748	8814	EM-8814	8875	EM-8875
8678	EM-8678	8749	EM-8788	8815	EM-8093	8876	EM-8876
8679	EM-8679	8750	EM-8750	8816	EM-8816	8877	EM-8877
8680	EM-8680	8751	EM-8751	8817	EM-8817	8878	EM-8878
8681	EM-8681	8752	EM-8752	8818	EM-8818	8879	EM-8879
8682	EM-8682	8753	EM-8753	8819	EM-8819	8880	EM-8880
8683	EM-8683	8754	EM-8754	8820	EM-8820	8881	EM-8881
8684	EM-8684	8755	EM-8755	8821	EM-8821	8882	EM-8882
8685	EM-8685	8756	EM-8756	8822	EM-8822	8883	EM-8883
8686	EM-8686	8757	EM-8757	8823	EM-8823	8884	EM-8884
8687	EM-8687	8758	EM-8758	8824	EM-8824	8885	EM-8885
8688	EM-8688	8759	EM-8759	8825	EM-8825	8886	EM-8886
8689	EM-8689	8760	EM-8760	8826	EM-8826	8887	EM-8887
8690	EM-8690	8761	EM-8042	8827	EM-8663	8888	EM-8888
8691	EM-8691	8762	EM-8762	8828	EM-8828	8889	EM-8889
8692	EM-8692	8763	EM-8762	8828SR	EM-8828	8890	EM-8890
8693	EM-8693	8764	EM-8764	8829	EM-8829	8891	EM-8891
8694	EM-8694	8765	EM-8788	8829SR	EM-8829	8892	EM-8892
8695	EM-8695	8766	EM-8597	8830	EM-8830	8893	EM-8893
8696	EM-8696	8767	EM-8597	8831	EM-8831	8894	EM-8894
8697	EM-8697	8768	EM-8768	8832	EM-8832	8895	EM-8895
8698	EM-8698	8769	EM-8769	8832SR	EM-8832	8896	EM-8896
8699	EM-8699	8770	EM-8770	8833	EM-8832	8897	EM-8897
8700	EM-8700	8771	EM-8771	8834	EM-8834	8898	EM-8898
8701	EM-8701	8772	EM-8772	8834SR	EM-8834	8899	EM-8899
8703	EM-2855	8773	EM-8774	8835	EM-8835	8900	EM-8900
8704	EM-8704	8774	EM-8774	8835SR	EM-8835	8901	EM-8901
8705	EM-8705	8775	EM-8775	8836	EM-8836	8902	EM-8902
8706	EM-2856	8776	EM-8775	8836SR	EM-8836	8903	EM-8903
8707	EM-2857	8777	EM-8778	8837	EM-8834	8904	EM-8904
8708	EM-2854	8778	EM-8778	8837SR	EM-8834	8905	EM-8905
8709	EM-8709	8779	EM-8778	8838	EM-8838	8906	EM-8906
8710	EM-8710	8780	EM-8780	8838SR	EM-8838	8907	EM-8907
8711	EM-8711	8781	EM-8781	8839	EM-8832	8908	EM-8908
8712	EM-8041	8782	EM-8782	8840	EM-8832	8909	EM-8909
8713	EM-8041	8783	EM-8783	8841	EM-8616	8910	EM-8910
8714	EM-8042	8784	EM-8784	8842	EM-8616	8911	EM-8911
8715	EM-8715	8785	EM-8783	8843	EM-8843	8912	EM-8912
8716	EM-8716	8786	EM-8786	8844	EM-8616	8913	EM-8913
8717	EM-8717	8787	EM-8787	8845	EM-8845	8914	EM-8914
8718	EM-8718	8788	EM-8788	8846	EM-8846	8915	EM-8915
8719	EM-8719	8789	EM-8789	8847	EM-8847	8916	EM-8916
8720	EM-8719	8790	EM-8790	8848	EM-8848	8917	EM-8917
8721	EM-8721	8791	EM-8791	8849	EM-8849	8918	EM-8918
8722	EM-8722	8792	EM-8792	8850	EM-8850	8918SR	EM-8918
8723	EM-8723	8793	EM-8793	8851	EM-8851	8919	EM-8919
8724	EM-8724	8794	EM-8794	8852	EM-8852	8920	EM-8920
8725	EM-8725	8795	EM-8795	8853	EM-8853	8921	EM-8921
8726	EM-8726	8795SR	EM-8795	8854	EM-8854	8922	EM-8921
8727	EM-8727	8796	EM-8796	8855	EM-8855	8923	EM-8923
8728	EM-8728	8796SR	EM-8796	8856	EM-8856	8924	EM-8923
8729	EM-8729	8797	EM-8797	8857	EM-8857	8925	EM-8925
8730	EM-8730	8798	EM-8798	8858	EM-8858	8926	EM-8926
8731	EM-8731	8799	EM-8799	8859	EM-8859	8927	EM-8921
8732	EM-8732	8800	EM-8800	8860	EM-8860	8928	EM-8928
8733	EM-8733	8801	EM-8801	8861	EM-8460	8928SR	EM-8928

# CROSS REFERENCE

Mfg Part No	Our Part	Mfg Part No	Our Part	Mfg Part No	Our Part	Mfg Part No	Our Part
<b>ANCHOR (cont.)</b>		<b>ANCHOR (cont.)</b>		<b>ANCHOR (cont.)</b>		<b>ANCHOR (cont.)</b>	
8929	EM-8929	8994	EM-8994	9050	EM-9050	9113	EM-9113
8929SR	EM-8929	8995	EM-8995	9051	EM-9051	9114	EM-9114
8930	EM-8930	8996	EM-8996	9052	EM-9018	9115	EM-9115
8931	EM-8931	8997	EM-8997	9053	EM-9053	9116	EM-9116
8932	EM-8932	8997SR	EM-8997	9054	EM-9054	9117	EM-9117
8933	EM-8933	8998	EM-8998	9055	EM-9055	9118	EM-9118
8934	EM-8934	8998SR	EM-8998	9056	EM-9056	9119	EM-9119
8935	EM-8935	8999	EM-8999	9057	EM-9057	9120	EM-9120
8936	EM-8936	9000	EM-9000	9058	EM-9058	9121	EM-9121
8937	EM-8937	9001	EM-9001	9059	EM-9059	9122	EM-9122
8938	EM-8938	9001SR	EM-9001	9060	EM-9060	9123	EM-9123
8939	EM-8939	9002	EM-9002	9061	EM-9061	9124	EM-9124
8940	EM-8940	9003	EM-9003	9062	EM-9062	9125	EM-9125
8941	EM-8941	9003SR	EM-9003	9063	EM-9063	9126	EM-2910
8942	EM-8943	9004	EM-9004	9064	EM-9064	9127	EM-9127
8943	EM-8943	9004SR	EM-9004	9065	EM-9065	9128	EM-9128
8944	EM-8944	9005	EM-9005	9065SR	EM-9065	9128SR	EM-9128
8945	EM-8945	9005SR	EM-9005	9066	EM-9066	9129	EM-9129
8946	EM-8945	9006	EM-8795	9067	EM-9067	9130	EM-9130
8947	EM-8947	9006SR	EM-8795	9068	EM-9068	9131	EM-9131
8948	EM-8948	9007	EM-9007	9069	EM-8261	9132	EM-2649
8949	EM-8949	9007SR	EM-9007	9070	EM-9070	9133	EM-9133
8950	EM-8950	9008	EM-9008	9071	EM-9071	9134	EM-9134
8951	EM-8951	9008SR	EM-9008	9072	EM-9072	9135	EM-8681
8952	EM-8952	9009	EM-9009	9073	EM-9073	9136	EM-9136
8953	EM-8953	9010	EM-9010	9074	EM-9074	9137	EM-9137
8954	EM-8954	9011	EM-9011	9075	EM-8895	9138	EM-9138
8954SR	EM-8954	9012	EM-9012	9076	EM-9076	9139	EM-9139
8955	EM-8955	9013	EM-9013	9077	EM-9077	9140	EM-9140
8956	EM-8956	9014	EM-9014	9078	EM-9078	9141	EM-9141
8957	EM-8957	9015	EM-9015	9079	EM-9079	9142	EM-9142
8958	EM-8958	9016	EM-9016	9080	EM-9080	9143	EM-9143
8959	EM-8959	9017	EM-9017	9081	EM-9081	9144	EM-9144
8960	EM-8960	9017SR	EM-9017	9082	EM-9082	9145	EM-9145
8961	EM-8961	9018	EM-9018	9083	EM-9083	9145SR	EM-9145
8962	EM-8962	9019	EM-9019	9083SR	EM-9083	9146	EM-9146
8963	EM-8963	9020	EM-9020	9084	EM-9084	9146SR	EM-9146
8964	EM-8964	9021	EM-9021	9085	EM-9085	9147	EM-9147
8965	EM-8965	9021SR	EM-9021	9086	EM-9086	9148	EM-9148
8965SR	EM-8965	9022	EM-9022	9087	EM-9087	9149	EM-9149
8966	EM-8966	9023	EM-9023	9088	EM-9088	9150	EM-9150
8967	EM-8967	9024	EM-9024	9089	EM-9089	9151	EM-9151
8968	EM-8968	9025	EM-9025	9090	EM-9090	9152	EM-9152
8969	EM-8644	9026	EM-9026	9091	EM-9091	9153	EM-9153
8970	EM-8970	9027	EM-9027	9092	EM-9092	9154	EM-9154
8971	EM-8971	9028	EM-9028	9092SR	EM-9092	9155	EM-9155
8972	EM-8008	9029	EM-9029	9093	EM-9093	9156	EM-9156
8973	EM-8973	9030	EM-9030	9094	EM-9094	9157	EM-9157
8974	EM-8974	9031	EM-9031	9095	EM-9095	9158	EM-9158
8975	EM-8975	9032	EM-9032	9096	EM-9096	9159	EM-9159
8976	EM-8976	9033	EM-9033	9097	EM-9003	9160	EM-9160
8977	EM-8977	9034	EM-9034	9097SR	EM-9003	9161	EM-9161
8978	EM-8978	9035	EM-9035	9098	EM-9098	9162	EM-9162
8979	EM-8979	9036	EM-2985	9099	EM-9099	9163	EM-9163
8980	EM-8980	9037	EM-9037	9100	EM-9100	9164	EM-9164
8981	EM-8981	9038	EM-9038	9101	EM-9101	9165	EM-9165
8982	EM-8982	9039	EM-9039	9101SR	EM-9101	9165SR	EM-9165
8983	EM-8983	9040	EM-9040	9102	EM-9102	9166	EM-9166
8984	EM-8984	9041	EM-9041	9103	EM-9103	9167	EM-9167
8984SR	EM-8984	9042	EM-9042	9104	EM-9104	9168	EM-9168
8985	EM-8985	9043	EM-9043	9105	EM-9105	9169	EM-9169
8986	EM-8986	9043SR	EM-9043	9106	EM-9106	9170	EM-9170
8987	EM-8987	9044	EM-9044	9107	EM-9107	9171	EM-9171
8988	EM-8988	9044SR	EM-9044	9108	EM-9108	9172	EM-9172
8989	EM-8989	9045	EM-9045	9109	EM-9109	9173	EM-9173
8990	EM-8990	9046	EM-9046	9110	EM-9110	9174	EM-9174
8991	EM-8991	9047	EM-9047	9110SR	EM-9110	9175	EM-9175
8992	EM-8992	9048	EM-9048	9111	EM-9111	9176	EM-9176
8993	EM-8993	9049	EM-9049	9112	EM-2410	9177	EM-9177

# CROSS REFERENCE

Mfg Part No	Our Part	Mfg Part No	Our Part	Mfg Part No	Our Part	Mfg Part No	Our Part
<b>ANCHOR (cont.)</b>		<b>ANCHOR (cont.)</b>		<b>ANCHOR (cont.)</b>		<b>ANCHOR (cont.)</b>	
9178	EM-9178	9247	EM-9247	9316	EM-9316	9385	EM-9385
9179	EM-9179	9248	EM-9248	9317	EM-9317	9386	EM-9386
9180	EM-9180	9249	EM-9249	9318	EM-9318	9387	EM-9387
9181	EM-9181	9250	EM-9250	9319	EM-9319	9388	EM-9388
9182	EM-9182	9251	EM-9251	9320	EM-9320	9389	EM-9389
9183	EM-9183	9252	EM-9252	9321	EM-9321	9390	EM-9390
9184	EM-9184	9253	EM-9253	9322	EM-9322	9391	EM-9391
9185	EM-9185	9254	EM-9254	9323	EM-9323	9392	EM-9392
9186	EM-9186	9255	EM-9255	9324	EM-9324	9393	EM-9393
9187	EM-9187	9256	EM-9256	9325	EM-9325	9394	EM-9394
9188	EM-9188	9257	EM-9257	9326	EM-9326	9395	EM-9395
9189	EM-9189	9258	EM-9258	9327	EM-9327	9396	EM-9396
9190	EM-9190	9259	EM-9259	9328	EM-9328	9397	EM-9397
9191	EM-9191	9260	EM-9260	9329	EM-9329	9398	EM-9066
9192	EM-9192	9261	EM-9261	9330	EM-9330	9399	EM-9168
9193	EM-9193	9262	EM-9262	9331	EM-9331	9400	EM-9400
9194	EM-9194	9263	EM-9263	9332	EM-9332	9401	EM-9401
9195	EM-9195	9264	EM-9264	9333	EM-9333	9402	EM-9402
9196	EM-9196	9265	EM-9265	9334	EM-9334	9403	EM-9403
9197	EM-9197	9266	EM-9266	9335	EM-9335	9404	EM-9404
9198	EM-9198	9267	EM-9267	9336	EM-9336	9405	EM-9405
9199	EM-9199	9268	EM-9268	9337	EM-9337	9406	EM-9406
9200	EM-9200	9269	EM-9269	9338	EM-9338	9407	EM-9407
9201	EM-9201	9270	EM-9270	9339	EM-9339	9408	EM-9408
9202	EM-9202	9271	EM-9271	9340	EM-9340	9409	EM-9409
9203	EM-9203	9272	EM-9272	9341	EM-9341	9410	EM-9410
9204	EM-9204	9273	EM-9273	9342	EM-9342	9411	EM-9411
9205	EM-9205	9274	EM-9274	9343	EM-9343	9412	EM-9412
9206	EM-9206	9275	EM-9275	9344	EM-9344	9413	EM-9413
9207	EM-9207	9276	EM-9276	9345	EM-9345	9414	EM-9414
9208	EM-9208	9277	EM-9277	9346	EM-9346	9415	EM-9415
9209	EM-9209	9278	EM-9278	9347	EM-9347	9416	EM-9416
9210	EM-9210	9279	EM-9279	9348	EM-9348	9417	EM-9417
9211	EM-9211	9280	EM-9280	9349	EM-9349	9418	EM-9418
9212	EM-9212	9281	EM-9281	9350	EM-9350	9419	EM-9419
9213	EM-9213	9282	EM-9282	9351	EM-9351	9420	EM-9420
9214	EM-9214	9283	EM-9283	9352	EM-9352	9421	EM-9421
9215	EM-9215	9284	EM-9284	9353	EM-9353	9422	EM-9422
9216	EM-9216	9285	EM-9285	9354	EM-9354	9423	EM-9423
9217	EM-9217	9286	EM-9286	9355	EM-9355	9424	EM-9424
9218	EM-9218	9287	EM-9287	9356	EM-9356	9425	EM-9425
9219	EM-9219	9288	EM-9288	9357	EM-9357	9426	EM-9426
9220	EM-9220	9289	EM-9289	9358	EM-9358	9427	EM-9427
9221	EM-9221	9290	EM-9290	9359	EM-9359	9428	EM-9428
9222	EM-9222	9291	EM-9291	9360	EM-9360	9429	EM-9429
9223	EM-9223	9292	EM-9292	9361	EM-9361	9430	EM-9430
9224	EM-9224	9293	EM-9293	9362	EM-9362	9431	EM-9431
9225	EM-9225	9294	EM-9294	9363	EM-9363	9432	EM-9432
9226	EM-9226	9295	EM-9295	9364	EM-9364	9433	EM-9433
9227	EM-9227	9296	EM-9296	9365	EM-9365	9434	EM-9434
9228	EM-9228	9297	EM-9297	9366	EM-9366	9435	EM-9435
9229	EM-9229	9298	EM-9298	9367	EM-9367	9436	EM-9436
9230	EM-9230	9299	EM-9299	9368	EM-9368	9437	EM-9437
9231	EM-9231	9300	EM-9300	9369	EM-9369	9438	EM-9438
9232	EM-9232	9301	EM-9301	9370	EM-9370	9439	EM-9439
9233	EM-9233	9302	EM-9302	9371	EM-9371	9440	EM-9440
9234	EM-9234	9303	EM-9303	9372	EM-9372	9441	EM-9441
9235	EM-9235	9304	EM-9304	9373	EM-9373	9442	EM-9442
9236	EM-9236	9305	EM-9305	9374	EM-9374	9443	EM-9443
9237	EM-9237	9306	EM-9306	9375	EM-9375	9444	EM-9444
9238	EM-9238	9307	EM-9307	9376	EM-9376	9445	EM-9445
9239	EM-9239	9308	EM-9308	9377	EM-9377	9446	EM-9446
9240	EM-9240	9309	EM-9309	9378	EM-9378	9447	EM-9447
9241	EM-9241	9310	EM-9310	9379	EM-9379	9448	EM-9448
9242	EM-9242	9311	EM-9311	9380	EM-9380	9449	EM-9449
9243	EM-9240	9312	EM-9312	9381	EM-9381	9450	EM-9450
9244	EM-9244	9313	EM-9313	9382	EM-9382	9451	EM-9451
9245	EM-9245	9314	EM-9314	9383	EM-9383	9452	EM-9452
9246	EM-9246	9315	EM-9315	9384	EM-9384	9453	EM-9453

# CROSS REFERENCE

Mfg Part No	Our Part	Mfg Part No	Our Part	Mfg Part No	Our Part	Mfg Part No	Our Part
<b>ANCHOR (cont.)</b>		<b>ANCHOR (cont.)</b>		<b>ANCHOR (cont.)</b>		<b>ANCHOR (cont.)</b>	
9454	EM-9454	9523	EM-9523	9592	EM-5772	9660	EM-5971
9455	EM-9455	9524	EM-5656	9593	EM-9593	9661	EM-5903
9456	EM-9456	9525	EM-9525	9594	EM-9594	9662	EM-5904
9457	EM-9457	9526	EM-9526	9595	EM-9595	9663	EM-5921
9458	EM-9458	9527	EM-9527	9596	EM-5494	9664	EM-5972
9459	EM-9459	9528	EM-5404	9597	EM-5440	9665	EM-7000
9460	EM-9460	9529	EM-5411	9598	EM-5750	9667	EM-5956
9461	EM-9461	9530	EM-9530	9599	EM-9599	9668	EM-5940
9462	EM-9462	9531	EM-9531	9600	EM-5649	9669	EM-5973
9463	EM-9463	9532	EM-5132	9601	EM-9601	9670	EM-5966
9464	EM-9464	9533	EM-5785	9602	EM-5872	9671	EM-5968
9465	EM-9465	9534	EM-9534	9603	EM-5142	9672	EM-5974
9466	EM-9466	9535	EM-9535	9604	EM-5485	9673	EM-5975
9467	EM-9467	9536	EM-9536	9605	EM-5437	9674	EM-5985
9468	EM-9468	9537	EM-9537	9606	EM-5213	9675	EM-5970
9469	EM-9469	9538	EM-9538	9607	EM-5445	9676	EM-5744
9470	EM-9470	9539	EM-9539	9608	EM-5527	9677	EM-5976
9471	EM-9471	9540	EM-5864	9609	EM-5612	9678	EM-5969
9472	EM-9472	9541	EM-9541	9610	EM-9610	9679	EM-5916
9473	EM-9473	9542	EM-9542	9611	EM-5957	9680	EM-5742
9474	EM-9474	9543	EM-9543	9612	EM-9612	9681	EM-5967
9475	EM-9475	9544	EM-9544	9613	EM-9613	9682	EM-5886
9476	EM-9476	9545	EM-9545	9614	EM-5943	9683	EM-5877
9477	EM-9477	9546	EM-9546	9615	EM-5944	9684	EM-5144
9478	EM-9478	9547	EM-9547	9616	EM-5191	9685	EM-5964
9479	EM-9479	9548	EM-9548	9617	EM-9617	9686	EM-5977
9480	EM-9480	9549	EM-9549	9618	EM-5942	9687	EM-5978
9481	EM-9481	9550	EM-9550	9619	EM-9619	9688	EM-5979
9482	EM-9482	9551	EM-9551	9620	EM-5406	9689	EM-5840
9483	EM-9483	9552	EM-9552	9621	EM-5905	9690	EM-5994
9484	EM-9484	9553	EM-9553	9622	EM-5866	9691	EM-5980
9485	EM-9485	9554	EM-9554	9623	EM-5941	9692	EM-5902
9486	EM-5689	9555	EM-5189	9624	EM-5906	9693	EM-5901
9487	EM-9487	9556	EM-5599	9625	EM-5867	9694	EM-5900
9488	EM-9488	9557	EM-5188	9626	EM-5657	9695	EM-5792
9489	EM-9489	9558	EM-9558	9627	EM-5876	9696	EM-5875
9490	EM-9490	9559	EM-9559	9628	EM-5924	9697	EM-5986
9491	EM-9491	9560	EM-9560	9629	EM-5907	9698	EM-5758
9492	EM-9492	9561	EM-9559	9630	EM-5356	9699	EM-7013
9493	EM-5155	9562	EM-9562	9631	EM-5796	9701	EM-5988
9494	EM-9494	9563	EM-5515	9632	EM-5783	9702	EM-5530
9495	EM-9495	9564	EM-8974	9633	EM-5670	9703	EM-5993
9496	EM-9496	9565	EM-5874	9634	EM-5655	9704	EM-5930
9497	EM-9497	9566	EM-9566	9634	EM-9634	9705	EM-7021
9498	EM-9498	9567	EM-5835	9635	EM-5908	9706	EM-7047
9499	EM-9499	9568	EM-7007	9636	EM-5909	9707	EM-5757
9500	EM-9500	9569	EM-5825	9637	EM-5982	9708	EM-7022
9501	EM-5349	9570	EM-9570	9638	EM-5910	9709	EM-5983
9502	EM-9502	9571	EM-5332	9639	EM-5856	9710	EM-7023
9503	EM-5781	9572	EM-9572	9640	EM-5556	9711	EM-7046
9504	EM-9504	9573	EM-9573	9641	EM-5911	9712	EM-7024
9505	EM-5646	9574	EM-9574	9642	EM-5912	9713	EM-5672
9506	EM-9506	9575	EM-9575	9643	EM-5526	9714	EM-5818
9507	EM-9507	9576	EM-9576	9644	EM-5403	9715	EM-5989
9508	EM-5384	9577	EM-9577	9645	EM-5859	9716	EM-5885
9509	EM-9509	9578	EM-5553	9646	EM-5860	9717	EM-7009
9510	EM-9510	9579	EM-9579	9647	EM-5452	9718	EM-5923
9511	EM-9511	9580	EM-9580	9648	EM-5754	9719	EM-7069
9512	EM-9512	9581	EM-5358	9649	EM-5963	9720	EM-7077
9513	EM-9513	9582	EM-5782	9650	EM-5601	9721	EM-7078
9514	EM-9514	9583	EM-5143	9651	EM-5913	9722	EM-7107
9515	EM-9515	9584	EM-5436	9652	EM-5819	9723	EM-7079
9516	EM-9516	9585	EM-5432	9653	EM-5600	9724	EM-7091
9517	EM-9517	9586	EM-5489	9654	EM-5877	9725	EM-7108
9518	EM-9518	9587	EM-9587	9655	EM-5884	9726	EM-7080
9519	EM-9519	9588	EM-9588	9656	EM-9096	9727	EM-5528
9520	EM-9520	9589	EM-9589	9657	EM-5795	9728	EM-7081
9521	EM-5407	9590	EM-9590	9658	EM-7019	9729	EM-5883
9522	EM-9522	9591	EM-9591	9659	EM-5914	9730	EM-5962

# CROSS REFERENCE

Mfg Part No	Our Part	Mfg Part No	Our Part	Mfg Part No	Our Part	Mfg Part No	Our Part
<b>ANCHOR (cont.)</b>		<b>ANCHOR (cont.)</b>		<b>ANCHOR (cont.)</b>		<b>ANCHOR (cont.)</b>	
9731	EM-5961	9811	EM-7174	9883	EM-7072	701927	ST-1927
9732	EM-5861	9812	EM-7155	9885	EM-7148	701928	ST-1928
9733	EM-7082	9813	EM-7235	9886	EM-7262	701929	ST-1929
9734	EM-5827	9814	EM-7194	9887	EM-7076	701930	ST-1930
9735	EM-7083	9815	EM-7073	9888	EM-7268	701932	ST-1932
9736	EM-7084	9816	EM-7176	9889	EM-7271	701933	ST-1933
9737	EM-5793	9817	EM-7075	9890	EM-7272	701934	ST-1934
9738	EM-5846	9818	EM-7070	9893	EM-4243	701937	ST-1937
9739	EM-5647	9819	EM-7192	9896	EM-7239	701938	ST-1938
9740	EM-7085	9820	EM-7246	9897	EM-7134	701939	ST-1939
9741	EM-7086	9821	EM-7178	9898	EM-5915	701940	ST-1940
9742	EM-5990	9822	EM-7236	9899	EM-5917	701941	ST-1941
9743	EM-7168	9823	EM-7249	9900	EM-7263	701942	ST-1942
9744	EM-7169	9824	EM-7286	9901	EM-7012	701943	ST-1943
9745	EM-5495	9825	EM-7253	9902	EM-7294	701944	ST-1944
9747	EM-7171	9826	EM-7287	9905	EM-7104	701946	ST-1946
9748	EM-7116	9827	EM-7284	9906	EM-7242	701947	ST-1947
9749	EM-7172	9828	EM-7088	9908	EM-5889	701948	ST-1948
9750	EM-7170	9829	EM-7018	9909	EM-5890	701950	ST-1950
9751	EM-7060	9830	EM-7230	9910	EM-7244	701951	ST-1951
9752	EM-7087	9831	EM-7264	9911	EM-7275	701952	ST-1952
9753	EM-7160	9832	EM-7255	9912	EM-7285	701953	ST-1953
9754	EM-7110	9833	EM-7031	9913	EM-7281	701954	ST-1954
9755	EM-5996	9834	EM-7254	9914	EM-7280	701955	ST-1955
9757	EM-7035	9835	EM-7256	9915	EM-7195	701956	ST-1956
9758	EM-7090	9836	EM-7257	9916	EM-7279	701958	ST-1958
9759	EM-7034	9837	EM-7159	9917	EM-7260	701959	ST-1959
9760	EM-7105	9838	EM-7265	9920	EM-7270	701960	ST-1960
9761	EM-7065	9839	EM-7038	9921	EM-5886	701961	ST-1961
9764	EM-7151	9840	EM-5958	9922	EM-7278	701962	ST-1962
9765	EM-5880	9841	EM-7258	9923	EM-5879	701963	ST-1963
9766	EM-7092	9842	EM-7179	9924	EM-7156	701964	ST-1964
9769	EM-5945	9843	EM-7016	9925	EM-7202	701965	ST-1965
9770	EM-5775	9844	EM-7186	9926	EM-7277	701966	ST-1966
9771	EM-5773	9845	EM-7187	9927	EM-7261	701967	ST-1967
9772	EM-7041	9846	EM-7184	9929	EM-7030	701968	ST-1968
9773	EM-7231	9847	EM-7247	9941	EM-7290	701969	ST-1969
9774	EM-7008	9848	EM-7183	9945	EM-7296	701970	ST-1970
9775	EM-5922	9849	EM-7266	9953	EM-7189	701971	ST-1971
9776	EM-7201	9850	EM-7197	9955	EM-7188	701973	ST-1973
9777	EM-7232	9851	EM-7198	9959	EM-7048	701974	ST-1974
9779	EM-7056	9852	EM-5858	9964	EM-7300	701975	ST-1975
9780	EM-5121	9853	EM-7130	9966	EM-7302	701976	ST-1976
9782	EM-7061	9854	EM-7248	9968	EM-7316	701977	ST-1977
9783	EM-5999	9855	EM-7267	9969	EM-7303	701978	ST-1978
9784	EM-7112	9856	EM-5953	9991	EM-7333	701979	ST-1979
9785	EM-5997	9857	EM-7204	9992	EM-5949	701980	ST-1980
9785	EM-7049	9858	EM-7205	9993	EM-7335	701981	ST-1981
9789	EM-5881	9859	EM-7193	10015	EM-7307	701983	ST-1983
9790	EM-5882	9860	EM-7152	701901	ST-1901	701984	ST-1984
9791	EM-7049	9861	EM-7125	701902	ST-1902	701985	ST-1985
9792	EM-7241	9862	EM-7126	701903	ST-1903	701986	ST-1986
9793	EM-7233	9863	EM-7127	701904	ST-1904	701987	ST-1987
9795	EM-7234	9864	EM-5951	701905	ST-1905	701988	ST-1988
9796	EM-5954	9865	EM-7259	701906	ST-1906	701989	ST-1989
9797	EM-7062	9866	EM-7120	701907	ST-1907	701990	ST-1990
9798	EM-7055	9867	EM-7121	701908	ST-1908	701991	ST-1991
9799	EM-7229	9868	EM-7122	701909	ST-1909	701992	ST-1992
9800	EM-5847	9869	EM-7123	701910	ST-1910	701993	ST-1993
9801	EM-7096	9870	EM-7251	701911	ST-1911	701994	ST-1994
9802	EM-7111	9871	EM-7250	701912	ST-1912	701995	ST-1995
9803	EM-5925	9872	EM-7128	701913	ST-1913	701996	ST-1996
9804	EM-7094	9874	EM-7129	701916	ST-1916	701999	ST-1999
9805	EM-7191	9877	EM-5654	701921	ST-1921	702901	ST-2901
9806	EM-7175	9878	EM-5952	701922	ST-1922	702902	ST-2902
9807	EM-5870	9879	EM-5871	701923	ST-1923	702903	ST-2903
9808	EM-5869	9880	EM-7124	701924	ST-1924	702904	ST-2904
9809	EM-5865	9881	EM-7145	701925	ST-1925	702905	ST-2905
9810	EM-7177	9882	EM-7238	701926	ST-1926	702906	ST-2906

# CROSS REFERENCE

Mfg Part No	Our Part	Mfg Part No	Our Part	Mfg Part No	Our Part	Mfg Part No	Our Part
<b>ANCHOR (cont.)</b>		<b>ANCHOR (cont.)</b>		<b>ANCHOR (cont.)</b>		<b>ANCHOR (cont.)</b>	
702907	ST-2907	702976	ST-2976	703949	ST-3949	704934	ST-4934
702908	ST-2908	702977	ST-2977	703950	ST-3950	704935	ST-4935
702909	ST-2909	702978	ST-2978	703951	ST-3951	704936	ST-4936
702910	ST-2910	702979	ST-2979	703954	ST-3954	704937	ST-4937
702911	ST-2911	702980	ST-2980	703957	ST-3957	704938	ST-4938
702912	ST-2912	702981	ST-2981	703958	ST-3958	704939	ST-4939
702913	ST-2913	702982	ST-2982	703959	ST-3959	704940	ST-4940
702914	ST-2914	702983	ST-2983	703960	ST-3960	704941	ST-4941
702915	ST-2915	702984	ST-2984	703961	ST-3961	704942	ST-4942
702916	ST-2916	702985	ST-2985	703962	ST-3962	704943	ST-4943
702917	ST-2917	702986	ST-2986	703964	ST-3964	704944	ST-4944
702918	ST-2918	702987	ST-2987	703965	ST-3965	704945	ST-4945
702919	ST-2919	702988	ST-2988	703966	ST-3966	704948	ST-4948
702920	ST-2920	702989	ST-2989	703967	ST-3967	704949	ST-4949
702921	ST-2921	702990	ST-2990	703968	ST-3968	704950	ST-4950
702922	ST-2922	702991	ST-2991	703969	ST-3969	704951	ST-4951
702923	ST-2923	702992	ST-2992	703970	ST-3970	704952	ST-4952
702924	ST-2924	702993	ST-2993	703971	ST-3971	704953	ST-4953
702925	ST-2925	702994	ST-2994	703972	ST-3972	704954	ST-4954
702926	ST-2926	702995	ST-2995	703973	ST-3973	704955	ST-4955
702927	ST-2927	702997	ST-2997	703974	ST-3974	704956	ST-4956
702928	ST-2928	702998	ST-2998	703975	ST-3975	704957	ST-4957
702929	ST-2929	702999	ST-2999	703976	ST-3976	704958	ST-4958
702930	ST-2930	703900	ST-3900	703977	ST-3977	704959	ST-6919
702931	ST-2931	703901	ST-3901	703978	ST-3978	704960	ST-6920
702932	ST-2932	703902	ST-3902	703980	ST-3980	704962	ST-4962
702933	ST-2933	703903	ST-3903	703982	ST-3982	704965	ST-4965
702934	ST-2934	703904	ST-3904	703983	ST-3983	704966	ST-4966
702935	ST-2935	703905	ST-3905	703984	ST-3984	704968	ST-4968
702936	ST-2936	703906	ST-3906	703985	ST-3985	704970	ST-4970
702937	ST-2937	703907	ST-3907	703986	ST-3986	704971	ST-4971
702938	ST-2938	703908	ST-3908	703987	ST-3987	704972	ST-4972
702939	ST-2939	703909	ST-3909	703988	ST-3988	704973	ST-4973
702940	ST-2940	703910	ST-3910	703989	ST-3989	704974	ST-4974
702941	ST-2941	703911	ST-3911	703990	ST-3990	704975	ST-4975
702942	ST-2942	703912	ST-3912	703991	ST-3991	704976	ST-4976
702943	ST-2943	703913	ST-3913	703992	ST-3992	704977	ST-4977
702944	ST-2944	703914	ST-3914	703993	ST-3993	704978	ST-6914
702945	ST-2945	703915	ST-3915	703994	ST-3994	704979	ST-4979
702946	ST-2946	703916	ST-3916	703995	ST-3995	704980	ST-4980
702947	ST-2947	703917	ST-3917	703997	ST-3997	704981	ST-4981
702948	ST-2948	703918	ST-3918	703998	ST-3998	704983	ST-4983
702949	ST-2949	703919	ST-3919	703999	ST-3999	704984	ST-4984
702950	ST-2950	703920	ST-3920	704900	ST-4900	704985	ST-4985
702951	ST-2951	703921	ST-3921	704902	ST-4902	704987	ST-4987
702952	ST-2952	703922	ST-3922	704903	ST-4903	704988	ST-4988
702953	ST-2953	703923	ST-3923	704904	ST-4904	704989	ST-4989
702954	ST-2954	703924	ST-3924	704905	ST-4905	704990	ST-4990
702955	ST-2955	703925	ST-5911	704906	ST-4906	704991	ST-4991
702956	ST-2956	703926	ST-3926	704907	ST-4907	704992	ST-4992
702957	ST-2957	703928	ST-3928	704908	ST-4908	704993	ST-4993
702958	ST-2958	703929	ST-3929	704909	ST-4909	704994	ST-4994
702959	ST-2959	703930	ST-3930	704910	ST-4910	704995	ST-4995
702960	ST-2960	703932	ST-3932	704911	ST-4911	704996	ST-4996
702961	ST-2961	703933	ST-3933	704912	ST-4912	704997	ST-4997
702962	ST-2962	703935	ST-3935	704913	ST-4913	704998	ST-4998
702963	ST-2963	703936	ST-3936	704915	ST-4915	704999	ST-4999
702964	ST-2964	703937	ST-3937	704916	ST-4916	705900	ST-5900
702965	ST-2965	703938	ST-3938	704918	ST-4918	705901	ST-5901
702966	ST-2966	703939	ST-3939	704919	ST-4919	705902	ST-5902
702967	ST-2967	703940	ST-3940	704920	ST-4920	705903	ST-5903
702968	ST-2968	703941	ST-3941	704921	ST-4921	705904	ST-5904
702969	ST-2969	703942	ST-3942	704922	ST-4922	705905	ST-5905
702970	ST-2970	703943	ST-3943	704923	ST-4923	705906	ST-5906
702971	ST-2971	703944	ST-3944	704924	ST-4924	705907	ST-5907
702972	ST-2972	703945	ST-3945	704925	ST-4925	705908	ST-5908
702973	ST-2973	703946	ST-3946	704927	ST-4927	705909	ST-5909
702974	ST-2974	703947	ST-3947	704932	ST-4932	705910	ST-5910
702975	ST-2975	703948	ST-3948	704933	ST-4933	705911	ST-5911



# CROSS REFERENCE

Mfg Part No	Our Part	Mfg Part No	Our Part	Mfg Part No	Our Part	Mfg Part No	Our Part
<b>ANCHOR (cont.)</b>		<b>ANCHOR (cont.)</b>		<b>ANCHOR (cont.)</b>		<b>ANCHOR (cont.)</b>	
705912	ST-5912	705982	ST-5982	706970	ST-6970	707946	ST-7946
705913	ST-5913	705983	ST-5983	706971	ST-6971	707947	ST-7947
705914	ST-5914	705984	ST-5984	706973	ST-6973	707948	ST-7948
705915	ST-5915	705985	ST-5985	706974	ST-6974	707949	ST-7949
705916	ST-5916	705986	ST-5986	706975	ST-6975	707950	ST-7950
705917	ST-5917	705987	ST-5987	706976	ST-6976	707951	ST-7951
705918	ST-5918	705988	ST-5988	706977	ST-6977	707952	ST-7952
705919	ST-5919	705989	ST-5989	706980	ST-6980	707953	ST-7953
705920	ST-5920	705990	ST-5990	706981	ST-6981	707954	ST-7954
705921	ST-5921	705992	ST-5992	706982	ST-6982	707955	ST-7955
705922	ST-5922	705993	ST-5993	706983	ST-6983	707956	ST-7956
705923	ST-5923	705994	ST-5994	706984	ST-6984	707957	ST-7957
705924	ST-5924	705995	ST-5995	706985	ST-6985	707958	ST-7958
705925	ST-5925	705996	ST-5996	706986	ST-6986	707959	ST-7959
705926	ST-5926	705997	ST-5997	706987	ST-6987	707960	ST-7960
705927	ST-5927	706914	ST-6914	706988	ST-6988	707961	ST-7961
705929	ST-5929	706915	ST-6915	706989	ST-6989	707962	ST-7962
705930	ST-5930	706916	ST-6916	706990	ST-6990	707963	ST-7963
705931	ST-5931	706917	ST-6917	706994	ST-6994	707964	ST-7964
705932	ST-5932	706918	ST-6918	706995	ST-6995	707965	ST-7965
705933	ST-5933	706919	ST-6919	706996	ST-6996	707966	ST-7966
705934	ST-5934	706920	ST-6920	706997	ST-6997	707967	ST-7967
705935	ST-5935	706921	ST-6921	706998	ST-6998	707968	ST-7968
705936	ST-5936	706922	ST-6922	706999	ST-6999	707969	ST-7969
705937	ST-5937	706923	ST-6923	707900	ST-7900	707972	ST-7972
705938	ST-5938	706924	ST-6924	707901	ST-7901	707973	ST-7973
705939	ST-5939	706925	ST-6925	707902	ST-7902	707974	ST-7974
705940	ST-5940	706926	ST-6926	707903	ST-7903	707975	ST-7975
705941	ST-5941	706927	ST-6927	707904	ST-7904	707976	ST-7976
705942	ST-5942	706928	ST-6928	707905	ST-7905	707977	ST-7977
705943	ST-5943	706929	ST-6929	707906	ST-7906	707978	ST-7978
705944	ST-5944	706930	ST-6930	707907	ST-7907	707979	ST-7979
705945	ST-5945	706931	ST-6931	707908	ST-7908	707980	ST-7980
705946	ST-5946	706932	ST-6932	707909	ST-7909	707981	ST-7981
705947	ST-5947	706934	ST-6934	707910	ST-7910	707982	ST-7982
705948	ST-5948	706935	ST-6935	707911	ST-7911	707983	ST-7983
705949	ST-5949	706936	ST-6936	707912	ST-7912	707984	ST-7984
705950	ST-5950	706937	ST-6937	707913	ST-7913	707985	ST-7985
705951	ST-5951	706938	ST-6938	707914	ST-7914	707986	ST-7986
705952	ST-5952	706939	ST-6939	707915	ST-7915	707987	ST-7987
705953	ST-5953	706940	ST-6940	707916	ST-7916	707988	ST-7988
705954	ST-5954	706941	ST-6941	707917	ST-7917	707989	ST-7989
705955	ST-5955	706942	ST-6942	707919	ST-7919	707990	ST-7990
705956	ST-5956	706943	ST-6943	707920	ST-7920	707991	ST-7991
705957	ST-5957	706944	ST-6944	707921	ST-7921	707992	ST-7992
705958	ST-5958	706945	ST-6945	707922	ST-7922	707993	ST-7993
705959	ST-5959	706946	ST-6946	707923	ST-7923	707994	ST-7994
705960	ST-5960	706947	ST-6947	707924	ST-7924	707995	ST-7995
705961	ST-5961	706948	ST-6948	707925	ST-7925	707996	ST-7996
705962	ST-5962	706949	ST-6949	707926	ST-7926	707997	ST-7997
705963	ST-5963	706950	ST-6950	707927	ST-7927	707998	ST-7998
705964	ST-5964	706951	ST-6951	707928	ST-7928	707999	ST-7999
705965	ST-5965	706952	ST-6952	707929	ST-7929	708900	ST-8900
705966	ST-5966	706953	ST-6953	707930	ST-7930	708903	ST-8903
705967	ST-5967	706955	ST-6955	707931	ST-7931	708904	ST-8904
705968	ST-5968	706956	ST-6956	707932	ST-7932	708905	ST-8905
705969	ST-5969	706957	ST-6957	707933	ST-7933	708907	ST-8907
705970	ST-5970	706958	ST-6958	707934	ST-7934	708908	ST-8908
705971	ST-5971	706959	ST-6959	707935	ST-7935	708909	ST-8909
705972	ST-5972	706960	ST-6960	707936	ST-7936	708910	ST-8910
705973	ST-5973	706961	ST-6961	707937	ST-7937	708911	ST-8911
705974	ST-5974	706962	ST-6962	707938	ST-7938	708912	ST-8912
705975	ST-5975	706963	ST-6963	707939	ST-7939	708913	ST-8913
705976	ST-5976	706964	ST-6964	707940	ST-7940	708914	ST-8914
705977	ST-5977	706965	ST-6965	707941	ST-7941	708915	ST-8915
705978	ST-5978	706966	ST-6966	707942	ST-7942	708916	ST-8916
705979	ST-5979	706967	ST-6967	707943	ST-7943	708917	ST-8917
705980	ST-5980	706968	ST-6968	707944	ST-7944	708918	ST-8918
705981	ST-5981	706969	ST-6969	707945	ST-7945	708919	ST-8919

# CROSS REFERENCE

Mfg Part No	Our Part	Mfg Part No	Our Part	Mfg Part No	Our Part	Mfg Part No	Our Part
<b>ANCHOR (cont.)</b>		<b>ANCHOR (cont.)</b>		<b>AUTO7 (cont.)</b>		<b>BECK ARNLEY (cont.)</b>	
708920	ST-8920	709902	ST-9902	810-0505	EM-8913	104-0724	EM-8280
708921	ST-8921	709903	ST-9903	810-0508	EM-8907	104-0732	EM-2407
708922	ST-8922	709904	ST-9904	810-0515	EM-8905	104-0757	EM-2408
708923	ST-8923	709906	ST-9906	810-0517	EM-8902	104-0765	EM-2409
708924	ST-8924	709907	ST-9907	810-0520	EM-8908	104-0773	EM-2690
708925	ST-8925	709908	ST-9908	810-0523	EM-8906	104-0781	EM-8651
708926	ST-8926	709909	ST-9909	810-0537	EM-8904	104-0799	EM-8650
708927	ST-8927	709910	ST-9910	810-0541	EM-8608	104-0803	EM-2167
708928	ST-8928	709911	ST-9911	810-0560	EM-3113	104-0804	EM-2419
708929	ST-8929	709912	ST-9912	810-0580	EM-9325	104-0805	EM-2418
708930	ST-8930	709913	ST-9913	810-0581	EM-9331	104-0809	EM-2293
708931	ST-8931	709914	ST-9914	810-0594	EM-9338	104-0810	EM-8857
708932	ST-8932	709915	ST-9915	810-0597	EM-9362	104-0814	EM-8430
708933	ST-8933	709916	ST-9916	810-0602	EM-8948	104-0816	EM-8279
708934	ST-8934	709917	ST-9917	810-0611	EM-9326	104-0817	EM-2406
708937	ST-8937	709918	ST-9918	810-0616	EM-9353	104-0818	EM-2406
708938	ST-8938	709920	ST-9920	810-0617	EM-8948	104-0823	EM-2409
708939	ST-8939	709921	ST-9921	810-0622	EM-9335	104-0825	EM-2690
708941	ST-8941	709922	ST-9922	810-0628	EM-9375	104-0827	EM-2403
708942	ST-8942	709923	ST-9923	810-0632	EM-9344	104-0828	EM-2401
708943	ST-8943	709924	ST-9924	810-0638	EM-9309	104-0829	EM-2533
708946	ST-8946	709925	ST-9925	810-0639	EM-9371	104-0831	EM-2405
708947	ST-8947	709927	ST-9927	810-0654	EM-9317	104-0832	EM-2740
708948	ST-8948	709929	ST-9929	810-0655	EM-9343	104-0834	EM-2742
708949	ST-8949	709930	ST-9930	810-0666	EM-9313	104-0835	EM-2741
708950	ST-8950	709931	ST-9931	810-0680	EM-9354	104-0837	EM-8566
708951	ST-8951	709937	ST-9937	810-0681	EM-9347	104-0838	EM-8138
708952	ST-8952	709938	ST-9938	810-0685	EM-3114	104-0840	EM-2404
708953	ST-8953	709939	ST-9939	810-0687	EM-3113	104-0841	EM-2456
708954	ST-8954	709940	ST-9940	810-0693	EM-5526	104-0844	EM-8310
708955	ST-8955	709942	ST-9942	820-0012	EM-8910	104-0845	EM-2400
708956	ST-8956	709943	ST-9943	820-0080	EM-9366	104-0847	EM-2681
708957	ST-8957	709945	ST-9945	820-0081	EM-9376	104-0850	EM-2487
708958	ST-8958	709946	ST-9946	820-0083	EM-9376	104-0851	EM-2487
708959	ST-8959	709947	ST-9947	820-0086	EM-9374	104-0852	EM-2488
708960	ST-8960	709948	ST-9948	820-0108	EM-9373	104-0856	EM-2731
708961	ST-8961	709949	ST-9949	820-0140	EM-9337	104-0863	EM-8272
708962	ST-8962	709955	ST-9955	820-0161	EM-8950	104-0864	EM-8502
708965	ST-8965	709956	ST-9956	820-0208	EM-9336	104-0865	EM-8503
708966	ST-8966	709957	ST-9957	820-0219	EM-9352	104-0866	EM-2730
708967	ST-8967	709959	ST-9959	820-0282	EM-3115	104-0870	EM-8803
708968	ST-8968	709962	ST-9962	820-0283	EM-3114	104-0873	EM-8095
708969	ST-8969	709969	ST-9969	820-0291	EM-9320	104-0874	EM-8424
708970	ST-8970	709977	ST-9977	820-0294	EM-8956	104-0875	EM-8055
708971	ST-8971	709978	ST-9978	820-0300	EM-9319	104-0876	EM-8055
708972	ST-8972	709988	ST-9988	820-0310	EM-9370	104-0877	EM-8061
708973	ST-8973	709989	ST-9989	820-0318	EM-9318	104-0881	EM-2562
708975	ST-8975	709998	ST-9998	820-0332	EM-5482	104-0882	EM-8054
708976	ST-8976	709999	ST-9999	<b>BECK ARNLEY</b>		104-0883	EM-8424
708977	ST-8977	<b>ARNOTT</b>		101-3523	EM-8615	104-0884	EM-8055
708978	ST-8978			101-3674	EM-8539	104-0885	EM-8060
708979	ST-8979	M-2296	ST-4908	101-3790	EM-8614	104-0887	EM-2563
708980	ST-8980	<b>AUTO7</b>		101-4019	DS-8474	104-0888	EM-8053
708981	ST-8981	810-0061	EM-9359	101-4247	DS-8473	104-0898	EM-2567
708982	ST-8982	810-0163	EM-9346	101-4265	DS-8591	104-0902	EM-8230
708983	ST-8983	810-0172	EM-8784	101-4267	EM-8047	104-0907	EM-2407
708984	ST-8984	810-0186	EM-9368	101-7362	DS-6042	104-0909	EM-8389
708988	ST-8988	810-0198	EM-8945	101-8100	DS-6024	104-0910	EM-2532
708989	ST-8989	810-0199	EM-8722	101-8152	DS-6514	104-0911	EM-2449
708990	ST-8990	810-0203	EM-8949	104-0088	EM-2427	104-0912	EM-2451
708991	ST-8991	810-0209	EM-8945	104-0096	EM-2424	104-0913	EM-2451
708992	ST-8992	810-0240	EM-8955	104-0102	EM-8662	104-0915	EM-2680
708993	ST-8993	810-0251	EM-8768	104-0211	EM-2425	104-0916	EM-8135
708994	ST-8994	810-0253	EM-8943	104-0237	EM-2735	104-0919	EM-9040
708995	ST-10004	810-0256	EM-8952	104-0245	EM-2736	104-0920	EM-8604
708997	ST-8997	810-0341	EM-8606	104-0559	EM-2425	104-0923	EM-8117
708998	ST-8998	810-0342	EM-8607	104-0609	EM-2426	104-0928	EM-2489
708999	ST-8999	810-0500	EM-9351	104-0617	EM-2429	104-0929	EM-8118
709901	ST-9901	810-0503	EM-8914	104-0641	EM-2428	104-0930	EM-8121

# CROSS REFERENCE

Mfg Part No	Our Part	Mfg Part No	Our Part	Mfg Part No	Our Part	Mfg Part No	Our Part
<b>BECK ARNLEY (cont.)</b>		<b>BECK ARNLEY (cont.)</b>		<b>BECK ARNLEY (cont.)</b>		<b>BECK ARNLEY (cont.)</b>	
104-0930	EM-8151	104-1076	EM-8197	104-1147	EM-8002	104-1234	EM-5098
104-0931	EM-8146	104-1078	EM-8102	104-1147	EM-8329	104-1235	EM-8576
104-0932	EM-8145	104-1079	EM-8108	104-1148	EM-8002	104-1237	EM-9065
104-0935	EM-8119	104-1080	EM-8107	104-1148	EM-8024	104-1238	EM-5467
104-0937	EM-8641	104-1081	EM-2673	104-1149	EM-8019	104-1240	EM-9034
104-0958	EM-8210	104-1083	EM-8292	104-1150	EM-2451	104-1243	EM-8981
104-0959	EM-8279	104-1084	EM-8103	104-1150	EM-8014	104-1245	EM-8860
104-0961	EM-8212	104-1085	EM-8111	104-1151	EM-9046	104-1249	EM-8166
104-0964	EM-8213	104-1086	EM-8205	104-1153	EM-8600	104-1250	EM-8711
104-0967	EM-8214	104-1087	EM-2718	104-1154	EM-8602	104-1253	EM-8644
104-0968	EM-2685	104-1088	EM-8304	104-1154	EM-8603	104-1256	EM-9189
104-0970	EM-2690	104-1089	EM-8304	104-1156	EM-8005	104-1257	EM-5575
104-0978	EM-2417	104-1090	EM-8133	104-1156	EM-8019	104-1266	EM-8895
104-0982	EM-9045	104-1091	EM-8133	104-1157	EM-8019	104-1271	EM-8167
104-0990	EM-8229	104-1093	EM-8149	104-1158	EM-8014	104-1273	EM-8056
104-0996	EM-8229	104-1094	EM-8963	104-1159	EM-8011	104-1275	EM-8617
104-1003	EM-8230	104-1095	EM-8130	104-1159	EM-8016	104-1276	EM-9000
104-1016	EM-8800	104-1095	EM-8310	104-1163	EM-5468	104-1277	EM-8107
104-1021	EM-8224	104-1096	EM-8193	104-1165	EM-8311	104-1278	EM-8552
104-1022	EM-8222	104-1096	EM-8198	104-1166	EM-9038	104-1281	EM-8586
104-1023	EM-2421	104-1096	EM-8385	104-1167	EM-8236	104-1282	EM-8586
104-1030	EM-8224	104-1097	EM-8435	104-1167	EM-8287	104-1284	EM-8167
104-1031	EM-8142	104-1097	EM-8575	104-1167	EM-8589	104-1286	EM-8174
104-1031	EM-8284	104-1100	EM-8037	104-1172	EM-8228	104-1287	EM-8073
104-1032	EM-8620	104-1102	EM-8133	104-1173	EM-9137	104-1290	EM-8086
104-1033	EM-8622	104-1103	EM-8125	104-1174	EM-8002	104-1292	EM-2643
104-1034	EM-8119	104-1103	EM-8304	104-1174	EM-8011	104-1293	EM-2641
104-1034	EM-8142	104-1105	EM-5453	104-1176	EM-8276	104-1296	EM-5974
104-1036	EM-8103	104-1106	EM-8034	104-1177	EM-8681	104-1300	EM-9048
104-1038	EM-2684	104-1108	EM-8004	104-1178	EM-5131	104-1314	EM-8554
104-1040	EM-8045	104-1108	EM-8018	104-1179	EM-8296	104-1315	EM-8105
104-1041	EM-8047	104-1109	EM-8010	104-1181	EM-8323	104-1316	EM-8082
104-1042	EM-8039	104-1110	EM-8021	104-1182	EM-8323	104-1318	EM-2675
104-1043	EM-8044	104-1111	EM-8042	104-1183	EM-8124	104-1319	EM-8026
104-1044	EM-8211	104-1112	EM-8085	104-1184	EM-8323	104-1320	EM-9060
104-1045	EM-8042	104-1113	EM-8007	104-1185	EM-8124	104-1321	EM-9071
104-1047	EM-8080	104-1113	EM-8431	104-1187	EM-8114	104-1322	EM-8467
104-1048	EM-8080	104-1114	EM-8154	104-1188	EM-8266	104-1323	EM-8696
104-1049	EM-2653	104-1114	EM-8304	104-1191	EM-8005	104-1324	EM-8100
104-1050	EM-2655	104-1115	EM-8435	104-1192	EM-8259	104-1324	EM-8238
104-1051	EM-8453	104-1115	EM-8575	104-1193	EM-8059	104-1325	EM-8097
104-1052	EM-2815	104-1117	EM-2639	104-1194	EM-8104	104-1326	EM-8099
104-1053	EM-2651	104-1118	EM-8094	104-1195	EM-8021	104-1327	EM-8619
104-1054	EM-8065	104-1119	EM-8079	104-1196	EM-8078	104-1328	EM-8206
104-1055	EM-2658	104-1119	EM-8091	104-1198	EM-5398	104-1329	EM-8244
104-1056	EM-2656	104-1120	EM-8160	104-1199	EM-8103	104-1331	EM-8816
104-1057	EM-8166	104-1121	EM-8095	104-1200	EM-8166	104-1332	EM-9029
104-1058	EM-2654	104-1122	EM-8255	104-1200	EM-8177	104-1333	EM-8681
104-1059	EM-2688	104-1124	EM-8040	104-1200	EM-8363	104-1335	EM-8705
104-1060	EM-8233	104-1126	EM-8130	104-1202	EM-8189	104-1336	EM-9024
104-1061	EM-8220	104-1127	EM-8088	104-1205	EM-8406	104-1337	EM-9023
104-1063	EM-8189	104-1127	EM-8089	104-1210	EM-8175	104-1338	EM-5187
104-1063	EM-8375	104-1128	EM-8122	104-1211	EM-8166	104-1341	EM-8068
104-1063	EM-8492	104-1128	EM-8427	104-1212	EM-9019	104-1342	EM-8586
104-1065	EM-8140	104-1129	EM-8001	104-1213	EM-8176	104-1343	EM-8087
104-1065	EM-8605	104-1130	EM-8008	104-1217	EM-8183	104-1343	EM-8516
104-1066	EM-8604	104-1130	EM-8024	104-1219	EM-8137	104-1344	EM-8075
104-1067	EM-8140	104-1131	EM-8086	104-1220	EM-8603	104-1345	EM-8075
104-1067	EM-8141	104-1131	EM-8087	104-1221	EM-8601	104-1346	EM-8073
104-1068	EM-8140	104-1132	EM-8083	104-1222	EM-8093	104-1346	EM-8457
104-1068	EM-8141	104-1134	EM-8218	104-1226	EM-8568	104-1347	EM-8456
104-1069	EM-8173	104-1135	EM-8016	104-1228	EM-8609	104-1348	EM-9087
104-1071	EM-8132	104-1138	EM-8595	104-1229	EM-8287	104-1349	EM-8193
104-1071	EM-8149	104-1142	EM-8623	104-1229	EM-8431	104-1350	EM-8190
104-1072	EM-8125	104-1143	EM-8006	104-1230	EM-8287	104-1351	EM-8164
104-1073	EM-8125	104-1144	EM-2719	104-1230	EM-8411	104-1355	EM-8508
104-1073	EM-8128	104-1145	EM-8018	104-1230	EM-8431	104-1356	EM-9055
104-1074	EM-8132	104-1145	EM-8411	104-1233	EM-8576	104-1357	EM-8001
104-1075	EM-9009	104-1146	EM-8002	104-1233	EM-8579	104-1358	EM-8034

# CROSS REFERENCE

Mfg Part No	Our Part	Mfg Part No	Our Part	Mfg Part No	Our Part	Mfg Part No	Our Part
<b>BECK ARNLEY (cont.)</b>		<b>BECK ARNLEY (cont.)</b>		<b>BECK ARNLEY (cont.)</b>		<b>BECK ARNLEY (cont.)</b>	
104-1359	EM-8312	104-1440	EM-8041	104-1545	EM-8944	104-1626	EM-2641
104-1361	EM-8068	104-1441	EM-9008	104-1547	EM-8944	104-1627	EM-9031
104-1362	EM-8185	104-1442	EM-8806	104-1548	EM-9372	104-1628	EM-8404
104-1363	EM-8175	104-1444	EM-9007	104-1549	EM-9368	104-1629	EM-8150
104-1365	EM-8418	104-1445	EM-8209	104-1550	EM-8721	104-1631	EM-8352
104-1366	EM-8021	104-1446	EM-8102	104-1551	EM-8790	104-1632	EM-2985
104-1367	EM-8643	104-1447	EM-8242	104-1552	EM-8790	104-1633	EM-2989
104-1369	EM-8181	104-1449	EM-8170	104-1554	EM-8722	104-1634	EM-8801
104-1370	EM-8180	104-1450	EM-8864	104-1555	EM-8723	104-1635	EM-8849
104-1371	EM-8186	104-1451	EM-9017	104-1556	EM-8951	104-1636	EM-9139
104-1372	EM-8183	104-1452	EM-8122	104-1557	EM-8678	104-1638	EM-8975
104-1373	EM-8187	104-1453	EM-8682	104-1559	EM-8938	104-1639	EM-9066
104-1374	EM-8190	104-1454	EM-8893	104-1560	EM-8727	104-1640	EM-8845
104-1375	EM-8200	104-1455	EM-8824	104-1562	EM-8679	104-1641	EM-8896
104-1376	EM-8171	104-1456	EM-9143	104-1563	EM-8938	104-1642	EM-8900
104-1377	EM-8175	104-1459	EM-9055	104-1564	EM-8939	104-1643	EM-9085
104-1378	EM-8208	104-1460	EM-8863	104-1565	EM-8941	104-1644	EM-8988
104-1379	EM-8004	104-1461	EM-8862	104-1566	EM-8956	104-1645	EM-9003
104-1380	EM-8432	104-1462	EM-8909	104-1567	EM-8956	104-1646	EM-9145
104-1381	EM-8328	104-1463	EM-8008	104-1568	EM-8957	104-1647	EM-9003
104-1382	EM-8445	104-1464	EM-8497	104-1571	EM-9364	104-1648	EM-8699
104-1383	EM-9144	104-1466	EM-8351	104-1572	EM-9366	104-1649	EM-8398
104-1384	EM-2420	104-1467	EM-8888	104-1573	EM-5533	104-1650	EM-8529
104-1386	EM-8516	104-1468	EM-5198	104-1574	EM-8947	104-1651	EM-8608
104-1387	EM-8389	104-1469	EM-8457	104-1575	EM-9376	104-1652	EM-8913
104-1388	EM-8662	104-1472	EM-8300	104-1576	EM-9369	104-1653	EM-9351
104-1390	EM-8162	104-1473	EM-8330	104-1577	EM-8791	104-1654	EM-8606
104-1391	EM-8597	104-1475	EM-8764	104-1578	EM-8791	104-1655	EM-8607
104-1392	EM-8098	104-1476	EM-8762	104-1579	EM-8741	104-1656	EM-8914
104-1393	EM-8517	104-1478	EM-8778	104-1580	EM-8741	104-1657	EM-5738
104-1395	EM-8201	104-1479	EM-8719	104-1581	EM-8789	104-1658	EM-8906
104-1398	EM-8191	104-1480	EM-8719	104-1582	EM-8743	104-1659	EM-8904
104-1399	EM-8319	104-1481	EM-8734	104-1583	EM-9367	104-1660	EM-5494
104-1400	EM-8188	104-1482	EM-8733	104-1584	EM-8744	104-1661	EM-8997
104-1401	EM-8825	104-1489	EM-8717	104-1585	EM-9373	104-1662	EM-5372
104-1402	EM-9096	104-1498	EM-9125	104-1586	EM-8745	104-1663	EM-5947
104-1403	EM-9096	104-1500	EM-8161	104-1587	EM-8951	104-1664	EM-5216
104-1404	EM-9094	104-1505	EM-8568	104-1588	EM-8683	104-1665	EM-8973
104-1406	EM-8979	104-1507	EM-8582	104-1589	EM-8062	104-1666	EM-8935
104-1408	EM-8187	104-1508	EM-8984	104-1590	EM-8513	104-1667	EM-5155
104-1409	EM-8462	104-1509	EM-8009	104-1591	EM-8261	104-1668	EM-8964
104-1409	EM-9130	104-1510	EM-8898	104-1592	EM-8074	104-1669	EM-8848
104-1411	EM-5332	104-1512	EM-8995	104-1593	EM-8578	104-1670	EM-5617
104-1412	EM-9288	104-1513	EM-9073	104-1594	EM-8693	104-1671	EM-9229
104-1413	EM-8681	104-1514	EM-8691	104-1595	EM-8659	104-1672	EM-9271
104-1414	EM-5462	104-1515	EM-8460	104-1596	EM-8307	104-1673	EM-9274
104-1416	EM-8235	104-1516	EM-8846	104-1597	EM-2855	104-1674	EM-9273
104-1418	EM-8239	104-1517	EM-2856	104-1598	EM-8322	104-1675	EM-9272
104-1418	EM-8582	104-1518	EM-8398	104-1599	EM-8964	104-1676	EM-8178
104-1419	EM-8277	104-1520	EM-8796	104-1600	EM-8884	104-1677	EM-8850
104-1420	EM-9275	104-1521	EM-8697	104-1601	EM-9018	104-1679	EM-8870
104-1421	EM-9099	104-1522	EM-9079	104-1602	EM-8261	104-1680	EM-8832
104-1422	EM-8662	104-1523	EM-8985	104-1603	EM-8882	104-1681	EM-9106
104-1423	EM-8361	104-1524	EM-8980	104-1604	EM-2854	104-1682	EM-5528
104-1424	EM-8485	104-1525	EM-8801	104-1605	EM-8572	104-1683	EM-8968
104-1425	EM-8795	104-1527	EM-8670	104-1606	EM-8885	104-1685	EM-8872
104-1426	EM-8179	104-1528	EM-9074	104-1607	EM-8866	104-1686	EM-9168
104-1427	EM-8194	104-1529	EM-7007	104-1608	EM-8704	104-1687	EM-9205
104-1428	EM-8231	104-1530	EM-8746	104-1609	EM-9011	104-1688	EM-9166
104-1428	EM-8553	104-1531	EM-8747	104-1611	EM-2857	104-1689	EM-8974
104-1429	EM-8200	104-1534	EM-8680	104-1612	EM-8868	104-1690	EM-8997
104-1432	EM-8179	104-1535	EM-8751	104-1613	EM-9108	104-1691	EM-9059
104-1433	EM-8375	104-1538	EM-8752	104-1614	EM-8978	104-1692	EM-8967
104-1434	EM-8243	104-1539	EM-8676	104-1616	EM-2639	104-1693	EM-9184
104-1435	EM-8063	104-1540	EM-8936	104-1618	EM-8977	104-1694	EM-9165
104-1436	EM-8209	104-1541	EM-8253	104-1621	EM-2639	104-1695	EM-9148
104-1437	EM-5191	104-1542	EM-8940	104-1622	EM-9015	104-1696	EM-8937
104-1438	EM-8435	104-1543	EM-8954	104-1623	EM-8740	104-1697	EM-8945
104-1439	EM-8100	104-1544	EM-7036	104-1625	EM-9035	104-1698	EM-8945

# CROSS REFERENCE

Mfg Part No	Our Part	Mfg Part No	Our Part	Mfg Part No	Our Part	Mfg Part No	Our Part
<b>BECK ARNLEY (cont.)</b>		<b>BECK ARNLEY (cont.)</b>		<b>BECK ARNLEY (cont.)</b>		<b>BECK ARNLEY (cont.)</b>	
104-1699	EM-9306	104-1775	EM-8681	104-1847	EM-9185	104-1925	EM-9239
104-1700	EM-9322	104-1776	EM-9195	104-1848	EM-7010	104-1926	EM-9441
104-1701	EM-9338	104-1777	EM-5769	104-1849	EM-9072	104-1927	EM-8529
104-1703	EM-9374	104-1778	EM-9149	104-1850	EM-9170	104-1928	EM-5407
104-1704	EM-8783	104-1779	EM-5375	104-1851	EM-3057	104-1929	EM-9471
104-1705	EM-8783	104-1780	EM-3056	104-1853	EM-8878	104-1930	EM-9248
104-1707	EM-8769	104-1781	EM-3057	104-1854	EM-8696	104-1931	EM-9149
104-1708	EM-8768	104-1782	EM-9167	104-1856	EM-9186	104-1932	EM-9573
104-1710	EM-8902	104-1783	EM-5817	104-1857	EM-9153	104-1933	EM-8353
104-1711	EM-8907	104-1784	EM-9223	104-1858	EM-9359	104-1934	EM-9420
104-1712	EM-9200	104-1785	EM-9161	104-1859	EM-5526	104-1935	EM-5921
104-1713	EM-8830	104-1786	EM-9305	104-1860	EM-5482	104-1936	EM-5399
104-1714	EM-8855	104-1787	EM-5797	104-1861	EM-5188	104-1937	EM-9539
104-1715	EM-9092	104-1788	EM-5452	104-1862	EM-5189	104-1938	EM-9539
104-1716	EM-9101	104-1789	EM-8792	104-1863	EM-9160	104-1939	EM-9345
104-1717	EM-9188	104-1790	EM-9161	104-1864	EM-9110	104-1940	EM-9324
104-1718	EM-9217	104-1791	EM-5825	104-1865	EM-9442	104-1941	EM-9344
104-1719	EM-8851	104-1792	EM-9203	104-1866	EM-9304	104-1942	EM-9339
104-1720	EM-8805	104-1793	EM-9088	104-1867	EM-9382	104-1943	EM-9324
104-1721	EM-8805	104-1794	EM-8793	104-1868	EM-9261	104-1944	EM-9348
104-1722	EM-9159	104-1795	EM-8797	104-1869	EM-9092	104-1945	EM-9338
104-1723	EM-9177	104-1796	EM-9187	104-1870	EM-8224	104-1946	EM-9317
104-1724	EM-9156	104-1798	EM-5159	104-1871	EM-8997	104-1947	EM-9310
104-1725	EM-9155	104-1799	EM-8798	104-1873	EM-9291	104-1948	EM-9306
104-1726	EM-9162	104-1800	EM-5349	104-1874	EM-9293	104-1949	EM-9377
104-1727	EM-9158	104-1801	EM-9211	104-1875	EM-9294	104-1950	EM-9316
104-1728	EM-9107	104-1802	EM-9515	104-1876	EM-5396	104-1951	EM-9318
104-1729	EM-8832	104-1803	EM-9079	104-1878	EM-9562	104-1952	EM-9411
104-1730	EM-8832	104-1804	EM-9389	104-1879	EM-9258	104-1953	EM-9415
104-1731	EM-9276	104-1805	EM-5908	104-1880	EM-8999	104-1954	EM-5881
104-1732	EM-8616	104-1806	EM-8353	104-1882	EM-9100	104-1955	EM-5882
104-1733	EM-9182	104-1807	EM-8990	104-1883	EM-9384	104-1956	EM-9432
104-1734	EM-9190	104-1808	EM-9081	104-1884	EM-9058	104-1957	EM-9371
104-1735	EM-9202	104-1809	EM-9211	104-1885	EM-9058	104-1958	EM-9477
104-1736	EM-9164	104-1810	EM-8996	104-1886	EM-9198	104-1959	EM-5757
104-1737	EM-9163	104-1811	EM-9297	104-1887	EM-9247	104-1960	EM-5742
104-1738	EM-8955	104-1812	EM-8899	104-1888	EM-9451	104-1961	EM-9466
104-1739	EM-8952	104-1813	EM-5367	104-1889	EM-9247	104-1962	EM-9469
104-1740	EM-8953	104-1814	EM-9300	104-1890	EM-9213	104-1963	EM-9476
104-1741	EM-8616	104-1815	EM-5356	104-1891	EM-9487	104-1964	EM-9441
104-1742	EM-8832	104-1816	EM-5143	104-1892	EM-9216	104-1965	EM-5384
104-1743	EM-8958	104-1817	EM-5142	104-1893	EM-5689	104-1966	EM-9462
104-1744	EM-8943	104-1818	EM-8162	104-1894	EM-9280	104-1967	EM-9441
104-1745	EM-8783	104-1819	EM-9120	104-1895	EM-9215	104-1968	EM-5900
104-1746	EM-8783	104-1820	EM-8192	104-1896	EM-9220	104-1969	EM-9385
104-1747	EM-8838	104-1821	EM-5741	104-1897	EM-9247	104-1970	EM-9248
104-1748	EM-5434	104-1822	EM-2410	104-1898	EM-5405	104-1970	EM-9547
104-1749	EM-9003	104-1823	EM-9163	104-1900	EM-5775	104-1971	EM-9431
104-1750	EM-9180	104-1824	EM-9125	104-1901	EM-9201	104-1972	EM-5670
104-1751	EM-8698	104-1825	EM-8165	104-1902	EM-8797	104-1973	EM-8284
104-1752	EM-9092	104-1826	EM-8993	104-1903	EM-5750	104-1974	EM-9445
104-1753	EM-9470	104-1827	EM-8395	104-1904	EM-9249	104-1975	EM-9408
104-1754	EM-8865	104-1828	EM-5891	104-1905	EM-5930	104-1976	EM-9165
104-1755	EM-9208	104-1829	EM-9502	104-1906	EM-5827	104-1977	EM-5553
104-1757	EM-9268	104-1830	EM-3078	104-1908	EM-2650	104-1979	EM-9254
104-1758	EM-9091	104-1831	EM-2851	104-1909	EM-9541	104-1980	EM-5892
104-1759	EM-9104	104-1832	EM-3037	104-1910	EM-9150	104-1981	EM-9329
104-1760	EM-9100	104-1834	EM-9515	104-1911	EM-9137	104-1982	EM-3132
104-1761	EM-9204	104-1835	EM-8068	104-1912	EM-9183	104-1983	EM-3134
104-1764	EM-8983	104-1836	EM-9014	104-1913	EM-8691	104-1984	EM-9265
104-1766	EM-8836	104-1837	EM-9225	104-1915	EM-5672	104-1985	EM-8832
104-1767	EM-8832	104-1839	EM-9299	104-1916	EM-8986	104-1986	EM-9267
104-1768	EM-9289	104-1840	EM-9197	104-1918	EM-9245	104-1988	EM-9267
104-1769	EM-5490	104-1841	EM-9050	104-1919	EM-4117	104-1989	EM-9265
104-1770	EM-5489	104-1842	EM-9277	104-1920	EM-4019	104-1991	EM-9208
104-1771	EM-5528	104-1843	EM-9194	104-1921	EM-8845	104-1992	EM-5809
104-1772	EM-8838	104-1844	EM-8990	104-1922	EM-5471	104-1993	EM-5495
104-1773	EM-8838	104-1845	EM-8710	104-1923	EM-8010	104-1994	EM-8871
104-1774	EM-5141	104-1846	EM-8889	104-1924	EM-9393	104-1995	EM-9180

# CROSS REFERENCE

Mfg Part No	Our Part	Mfg Part No	Our Part	Mfg Part No	Our Part	Mfg Part No	Our Part
<b>BECK ARNLEY (cont.)</b>		<b>BECK ARNLEY (cont.)</b>		<b>BECK ARNLEY (cont.)</b>		<b>CAR QUEST</b>	
104-1996	EM-9164	104-2072	EM-9513	104-2155	EM-9355	31-1000	EM-2376
104-1997	EM-9209	104-2075	EM-5867	104-2156	EM-5883	31-1001	EM-2369
104-1999	EM-9280	104-2077	EM-9498	104-2157	EM-9315	31-1003	EM-2525
104-2000	EM-7138	104-2079	EM-5871	104-2158	EM-9320	31-1004	EM-2720
104-2000	EM-9092	104-2080	EM-7090	104-2160	EM-9313	31-1005	EM-2721
104-2001	EM-8982	104-2081	EM-7057	104-2161	EM-9325	31-1007	EM-2615
104-2002	EM-5894	104-2082	EM-7207	104-2162	EM-5999	31-1008	EM-2616
104-2003	EM-5893	104-2083	EM-9354	104-2163	EM-7163	31-1009	EM-2618
104-2004	EM-9421	104-2084	EM-9380	104-2164	EM-7056	31-1026	EM-3026
104-2005	EM-9247	104-2085	EM-9353	104-2165	EM-9332	31-2007	EM-2007
104-2006	EM-5818	104-2086	EM-7062	104-2166	EM-7104	31-2009	EM-2009
104-2007	EM-9247	104-2088	EM-5996	104-2167	EM-9331	31-2010	EM-2010
104-2008	EM-9185	104-2089	EM-7092	104-2168	EM-9300	31-2039	EM-2039
104-2009	EM-5773	104-2090	EM-9330	104-2169	EM-9457	31-2040	EM-2040
104-2010	EM-9262	104-2093	EM-7087	104-2170	EM-8877	31-2048	EM-2048
104-2011	EM-9403	104-2094	EM-9361	104-2171	EM-5968	31-2050	EM-2050
104-2012	EM-9406	104-2095	EM-9370	104-2172	EM-9428	31-2060	EM-2060
104-2013	EM-9407	104-2096	EM-9375	104-2173	EM-8781	31-2070	EM-2070
104-2014	EM-9282	104-2097	EM-8910	104-2174	EM-5872	31-2073	EM-2073
104-2015	EM-9285	104-2098	EM-9311	104-2175	EM-9279	31-2107	EM-2107
104-2016	EM-9286	104-2102	EM-7105	104-2176	EM-9205	31-2108	EM-2108
104-2017	EM-9386	104-2104	EM-7065	104-2177	EM-9506	31-2119	EM-2119
104-2018	EM-9397	104-2105	EM-9181	104-2178	EM-8869	31-2121	EM-2121
104-2019	EM-9437	104-2106	EM-9214	104-2179	EM-9413	31-2122	EM-2122
104-2020	EM-9443	104-2107	EM-5793	104-2180	EM-8959	31-2123	EM-2123
104-2021	EM-9488	104-2108	EM-9152	104-2181	EM-9424	31-2124	EM-2124
104-2022	EM-9496	104-2109	EM-7060	104-2183	EM-5902	31-2125	EM-2125
104-2023	EM-9542	104-2110	EM-9313	104-2184	EM-5901	31-2126	EM-2126
104-2024	EM-9457	104-2111	EM-9344	104-2185	EM-9595	31-2127	EM-2127
104-2025	EM-9459	104-2112	EM-9319	104-2186	EM-9588	31-2141	EM-2141
104-2027	EM-9178	104-2113	EM-9363	104-2187	EM-9504	31-2142	EM-2142
104-2028	EM-9599	104-2114	EM-9580	104-2188	EM-9468	31-2142HD	EM-2267
104-2029	EM-5910	104-2115	EM-9579	104-2189	EM-7070	31-2143	EM-2143
104-2030	EM-9430	104-2117	EM-9340	104-2190	EM-9576	31-2150	EM-2150
104-2031	EM-9499	104-2118	EM-5152	104-2191	EM-9414	31-2162	EM-2162
104-2032	EM-9425	104-2119	EM-9444	104-2192	EM-9445	31-2163	EM-2163
104-2033	EM-9429	104-2120	EM-9446	104-2193	EM-9473	31-2167	EM-2167
104-2034	EM-9500	104-2121	EM-5865	104-2194	EM-9175	31-2168	EM-2293
104-2035	EM-9511	104-2122	EM-9514	104-2195	EM-9302	31-2170	EM-2170
104-2036	EM-9494	104-2123	EM-5362	104-2196	EM-9221	31-2172	EM-2172
104-2037	EM-5649	104-2124	EM-9194	104-2197	EM-9452	31-2204	EM-2204
104-2038	EM-9236	104-2125	EM-8905	104-2198	EM-9433	31-2205	EM-2205
104-2039	EM-9535	104-2126	EM-8908	104-2199	EM-5672	31-2206	EM-2206
104-2040	EM-9538	104-2127	EM-9458	104-2200	EM-5904	31-2217	EM-2217
104-2041	EM-9238	104-2128	EM-5655	104-2206	EM-9222	31-2218	EM-2218
104-2042	EM-9447	104-2129	EM-9554	104-2207	EM-9228	31-2219	EM-2219
104-2043	EM-9491	104-2130	EM-9467	104-2224	EM-5886	31-2220	EM-2220
104-2044	EM-9419	104-2131	EM-9439	104-2225	EM-5647	31-2221	EM-2221
104-2045	EM-9400	104-2132	EM-9211	104-2226	EM-8783	31-2222	EM-2222
104-2046	EM-9449	104-2133	EM-8997	104-2227	EM-7264	31-2223	EM-2223
104-2047	EM-5173	104-2134	EM-9403	104-2228	EM-8992	31-2224	EM-2378
104-2048	EM-5411	104-2135	EM-9223	104-2229	EM-9067	31-2225	EM-2225
104-2049	EM-5847	104-2136	EM-7153	104-2243	EM-9483	31-2226	EM-2226
104-2050	EM-9431	104-2137	EM-9337	104-2244	EM-9456	31-2227	EM-2227
104-2051	EM-5403	104-2138	EM-5582	104-2248	EM-9560	31-2228	EM-2228
104-2052	EM-5940	104-2140	EM-9332	104-2279	EM-5973	31-2231	EM-2231
104-2053	EM-5782	104-2141	EM-9342	104-2283	EM-7048	31-2234	EM-2234
104-2054	EM-9460	104-2142	EM-7110	104-2327	EM-9179	31-2235	EM-2235
104-2057	EM-9465	104-2143	EM-5997	104-2329	EM-5977	31-2239HD	EM-2282
104-2058	EM-5656	104-2145	EM-9333	104-2335	EM-9523	31-2240	EM-2240
104-2059	EM-5982	104-2146	EM-9334	104-2337	EM-5970	31-2241	EM-2241
104-2060	EM-9219	104-2147	EM-9308	104-2340	EM-9434	31-2243HD	EM-2284
104-2061	EM-9390	104-2148	EM-5880	104-2344	EM-5989	31-2244	EM-2287
104-2063	EM-9016	104-2149	EM-9362	104-2345	EM-5967	31-2244HD	EM-2287
104-2064	EM-9230	104-2150	EM-9310	104-2346	EM-4033	31-2245	EM-2327
104-2067	EM-5404	104-2151	EM-9255	104-2348	EM-7057	31-2250	EM-2242
104-2068	EM-9497	104-2152	EM-9360	104-2351	EM-7249	31-2255	EM-2349
104-2069	EM-9448	104-2153	EM-9352			31-2265	EM-2250
104-2071	EM-9550	104-2154	EM-9311			31-2266	EM-2272

# CROSS REFERENCE

Mfg Part No	Our Part	Mfg Part No	Our Part	Mfg Part No	Our Part	Mfg Part No	Our Part
<b>CAR QUEST (cont.)</b>		<b>CAR QUEST (cont.)</b>		<b>CAR QUEST (cont.)</b>		<b>CAR QUEST (cont.)</b>	
31-2267	EM-2338	31-2389	EM-2359	31-2918	EM-2918	31-2980	EM-2980
31-2268	EM-2304	31-2390	EM-2470	31-2919	EM-2919	31-2981	EM-2981
31-2271	EM-2321	31-2391	EM-2374	31-2920	EM-2920	31-2982	EM-2982
31-2273	EM-2254	31-2393	EM-2326	31-2921	EM-2921	31-2983	EM-2983
31-2274	EM-2256	31-2511	EM-2466	31-2922	EM-2922	31-2984	EM-2984
31-2275	EM-2255	31-2537	EM-2537	31-2923	EM-2923	31-2985	EM-2985
31-2276	EM-2350	31-2538	EM-2538	31-2924	EM-2924	31-2986	EM-2986
31-2280	EM-2534	31-2868	EM-2868	31-2925	EM-2925	31-2987	EM-2987S
31-2281	EM-2262	31-2869	EM-2869	31-2926	EM-2926S	31-2987HY	EM-2987
31-2284	EM-2253	31-2870	EM-2870	31-2926HY	EM-2926	31-2988	EM-2988
31-2286	EM-2333	31-2871	EM-2871	31-2927	EM-2927	31-2989	EM-2989
31-2288	EM-2290	31-2872	EM-2872	31-2928	EM-2928	31-2990	EM-2990
31-2289	EM-2289	31-2873	EM-2873	31-2929	EM-2929	31-2991	EM-2991
31-2293	EM-2264	31-2874	EM-2874	31-2930	EM-2930	31-2992	EM-2992
31-2295	EM-2351	31-2875	EM-2875	31-2931	EM-2931	31-2993	EM-2993S
31-2296	EM-2266	31-2876	EM-2876S	31-2932	EM-2932S	31-2993HY	EM-2993
31-2304	EM-2263	31-2876HY	EM-2876	31-2932HY	EM-2932	31-2994	EM-2994
31-2305	EM-2281	31-2878	EM-2878	31-2933	EM-2933S	31-2995	EM-2995S
31-2308	EM-2267	31-2879	EM-2879S	31-2933HY	EM-2933	31-2995HY	EM-2995
31-2308HD	EM-2267	31-2879HY	EM-2879	31-2934	EM-2934S	31-2996	EM-2996S
31-2313	EM-2261	31-2880	EM-2880S	31-2934HY	EM-2934	31-2996HY	EM-2996
31-2315	EM-2309	31-2880HY	EM-2880	31-2935	EM-2935	31-2997	EM-2997
31-2316	EM-2277	31-2881	EM-2881	31-2936	EM-2936	31-2998	EM-2998
31-2317	EM-2275	31-2882	EM-2882	31-2938	EM-2938S	31-2999	EM-2999
31-2319	EM-2301	31-2883	EM-2883	31-2938HY	EM-2938	31-3000	EM-2303
31-2322	EM-2283	31-2884	EM-2884	31-2939	EM-2939	31-3002	EM-3002
31-2323	EM-2317	31-2885	EM-2885	31-2940	EM-2940	31-3003	EM-3003S
31-2327	EM-2310	31-2886	EM-2886	31-2941	EM-2941	31-3003HY	EM-3003
31-2328	EM-2403	31-2887	EM-2887	31-2942	EM-2942S	31-3004	EM-2373
31-2331	EM-2271	31-2888	EM-2888	31-2942HY	EM-2942	31-3005	EM-3005
31-2332	EM-2270	31-2889	EM-2889	31-2943	EM-2943S	31-3006	EM-3006
31-2334	EM-2297	31-2890	EM-2890S	31-2943HY	EM-2943	31-3007	EM-3007
31-2335	EM-2298	31-2890HY	EM-2890	31-2944	EM-2944	31-3008	EM-3008
31-2336	EM-2299	31-2892	EM-2892S	31-2945	EM-2945	31-3009	EM-2340
31-2338	EM-2305	31-2892HY	EM-2892	31-2947	EM-2947	31-3010	EM-3010
31-2339	EM-2306	31-2893	EM-2893S	31-2948	EM-2948	31-3011	EM-3011
31-2342	EM-2257	31-2893HY	EM-2893	31-2949	EM-2949	31-3014	EM-2339
31-2343	EM-2268	31-2894	EM-2894S	31-2950	EM-2950	31-3015	EM-2341
31-2344	EM-2279	31-2894HY	EM-2894	31-2951	EM-2951	31-3017	EM-2363
31-2345	EM-2316	31-2895	EM-2895S	31-2952	EM-2952	31-3018	EM-2346
31-2346	EM-2296	31-2895HY	EM-2895	31-2953	EM-2953	31-3019	EM-2348
31-2350	EM-2265	31-2896	EM-2896S	31-2954	EM-2954	31-3020	EM-2384
31-2352	EM-2311	31-2896HY	EM-2896	31-2955	EM-2955	31-3021	EM-2382
31-2353	EM-2288	31-2897	EM-2897S	31-2956	EM-2956	31-3022	EM-2387
31-2356	EM-2512	31-2897HY	EM-2897	31-2957	EM-2957	31-3024	EM-2394
31-2357	EM-2323	31-2898	EM-2898	31-2958	EM-2958	31-3025	EM-2360
31-2358	EM-2324	31-2899	EM-2899	31-2959	EM-2959	31-3026	EM-2379
31-2359	EM-2325	31-2900	EM-2900	31-2960	EM-2960	31-3030	EM-2381
31-2361	EM-2292	31-2901	EM-2901	31-2961	EM-2961	31-3033	EM-2436
31-2363	EM-2291	31-2902	EM-2902S	31-2962	EM-2962	31-3034	EM-2436
31-2365	EM-2320	31-2902HY	EM-2902	31-2963	EM-2963	31-3036	EM-2391
31-2366	EM-2295	31-2903	EM-2903S	31-2964	EM-2964	31-3037	EM-2531
31-2367	EM-2328	31-2903HY	EM-2903	31-2965	EM-2965	31-3038	EM-2395
31-2370	EM-2370	31-2904	EM-2904	31-2966	EM-2966	31-3042	EM-2446
31-2372	EM-2329	31-2905	EM-2905	31-2967	EM-2967S	31-3045	EM-2370
31-2373	EM-2722	31-2906	EM-2987S	31-2967HY	EM-2967	31-3046	EM-2370
31-2374	EM-2351	31-2906HY	EM-2987	31-2968	EM-2968S	31-3048	EM-2471
31-2375	EM-2345	31-2907	EM-2907	31-2968HY	EM-2968	31-3049	EM-2362
31-2377	EM-2353	31-2908	EM-2908	31-2969	EM-2969	31-3054	EM-2364
31-2378	EM-2331	31-2909	EM-2909	31-2970	EM-2970	31-3055	EM-2365
31-2379	EM-2332	31-2910	EM-2910S	31-2971	EM-2971	31-3056	EM-2368
31-2380	EM-2375	31-2910HY	EM-2910	31-2972	EM-2972	31-3057	EM-2367
31-2381	EM-2356	31-2911	EM-2911	31-2973	EM-2973	31-3058	EM-2723
31-2382	EM-2357	31-2912	EM-2912	31-2974	EM-2974S	31-3059	EM-2724
31-2384	EM-2344	31-2913	EM-2913	31-2974HY	EM-2974	31-3060	EM-2409
31-2385	EM-2337	31-2914	EM-2914	31-2975	EM-2975	31-3062	EM-2406
31-2386	EM-2335	31-2915	EM-2915	31-2977	EM-2977	31-3063	EM-2400
31-2387	EM-2336	31-2916	EM-2916	31-2978	EM-2978	31-3064	EM-2405
31-2388	EM-2358	31-2917	EM-2917	31-2979	EM-2979	31-3065	EM-2404

# CROSS REFERENCE

Mfg Part No	Our Part	Mfg Part No	Our Part	Mfg Part No	Our Part	Mfg Part No	Our Part
<b>CAR QUEST (cont.)</b>		<b>CAR QUEST (cont.)</b>		<b>CAR QUEST (cont.)</b>		<b>CAR QUEST (cont.)</b>	
31-3066	EM-2414	31-3201	EM-2600	31-3444	EM-2510	31-3548	EM-2601
31-3067	EM-2419	31-3202	EM-2730	31-3446	EM-2496	31-3549	EM-2623
31-3068	EM-2418	31-3203	EM-2731	31-3447	EM-2543	31-3550	EM-2622
31-3069	EM-2417	31-3204	EM-2731	31-3450	EM-2492	31-3551	EM-2687
31-3071	EM-2424	31-3206	EM-2733	31-3454	EM-2528	31-3552	EM-2686
31-3072	EM-2426	31-3208	EM-2734	31-3455	EM-2396	31-3553	EM-2644
31-3073	EM-2428	31-3234	EM-2469	31-3456	EM-2494	31-3554	EM-2645
31-3074	EM-2425	31-3245	EM-2493	31-3458	EM-2548S	31-3555	EM-2646
31-3075	EM-2415	31-3276	EM-2401	31-3458HY	EM-2548	31-3556	EM-2646
31-3076	EM-2389	31-3277	EM-2421	31-3459	EM-2495	31-3557	EM-2640
31-3077	EM-2457	31-3278	EM-2456	31-3460	EM-2755	31-3558	EM-2641
31-3078	EM-2458	31-3279	EM-2533	31-3461	EM-2756	31-3559	EM-2642
31-3080	EM-2420	31-3280	EM-2532	31-3464	EM-2382	31-3560	EM-2643
31-3081	EM-2372	31-3281	EM-2410	31-3465	EM-2549	31-3561	EM-2652
31-3082	EM-2385	31-3282	EM-2429	31-3466	EM-2550	31-3562	EM-2620
31-3083	EM-2437	31-3283	EM-2449	31-3467	EM-2549	31-3563	EM-2637
31-3084	EM-2438	31-3285	EM-2451	31-3468	EM-2550	31-3564	EM-2638
31-3086	EM-2388	31-3286	EM-2452	31-3469	EM-2497	31-3565	EM-2564
31-3088	EM-2462	31-3287	EM-2735	31-3500	EM-2280	31-3566	EM-2621
31-3089	EM-2453	31-3288	EM-2736	31-3501	EM-2330	31-3568	EM-2649
31-3090	EM-2454	31-3291	EM-2737	31-3502	EM-2570	31-3569	EM-2650
31-3091	EM-2389	31-3292	EM-2738	31-3503	EM-2661S	31-3570	EM-2651
31-3093	EM-2467	31-3293	EM-2739	31-3503HY	EM-2661	31-3571	EM-2665
31-3095	EM-2505	31-3297	EM-2680	31-3504	EM-2571	31-3572	EM-2717S
31-3096	EM-2466	31-3300	EM-2740	31-3505	EM-2572	31-3572HY	EM-2717
31-3097	EM-2393	31-3302	EM-2681	31-3506	EM-2569	31-3573	EM-2660S
31-3099	EM-2531	31-3305	EM-2741	31-3507	EM-2568	31-3573HY	EM-2660
31-3103	EM-2472	31-3306	EM-2742	31-3508	EM-2627	31-3574	EM-2691
31-3108	EM-2436	31-3307	EM-2488	31-3509	EM-2759	31-3575	EM-2671
31-3112	EM-2491	31-3308	EM-2487	31-3510	EM-2628	31-3576	EM-2761
31-3113	EM-2490	31-3310	EM-2407	31-3511	EM-2617	31-3577	EM-2708
31-3120	EM-2567	31-3315	EM-2743	31-3512	EM-2625	31-3578	EM-2762
31-3121	EM-2562	31-3316	EM-2744	31-3513	EM-2624	31-3579	EM-2763
31-3122	EM-2563	31-3317	EM-2745	31-3515	EM-2629	31-3580	EM-2764
31-3136	EM-2439	31-3318	EM-2408	31-3516	EM-2626	31-3581	EM-2765
31-3137	EM-2440	31-3320	EM-2746	31-3517	EM-2553S	31-3582	EM-2766
31-3138	EM-2441	31-3322	EM-2690	31-3517HY	EM-2553	31-3584	EM-2667
31-3139	EM-2442	31-3325	EM-2489	31-3518	EM-2555S	31-3585	EM-2668
31-3141	EM-2444	31-3327	EM-2747	31-3518HY	EM-2555	31-3586	EM-2710
31-3142	EM-2445	31-3328	EM-2748	31-3519	EM-2633	31-3587	EM-2653
31-3144	EM-2502	31-3375	EM-2749	31-3520	EM-2557	31-3588	EM-2654
31-3145	EM-2448	31-3386	EM-2750	31-3521	EM-2639	31-3589	EM-2655
31-3147	EM-2433	31-3387	EM-2751	31-3522	EM-2557	31-3591	EM-2656
31-3148	EM-2434	31-3392	EM-2619	31-3523	EM-2632	31-3592	EM-2657
31-3152	EM-2774	31-3394	EM-2565	31-3524	EM-2609	31-3593	EM-2658
31-3153	EM-2775	31-3395	EM-2566	31-3525	EM-2551S	31-3594	EM-2767
31-3159	EM-2503	31-3396	EM-2752	31-3525HY	EM-2551	31-3595	EM-2768
31-3160	EM-2504	31-3397	EM-2753	31-3526	EM-2551S	31-3596	EM-2769
31-3161	EM-2776	31-3401	EM-2754	31-3526HY	EM-2551	31-3597	EM-2711S
31-3166	EM-2500	31-3408	EM-2458	31-3527	EM-2551S	31-3597HY	EM-2711
31-3167	EM-2501	31-3409	EM-2457	31-3527HY	EM-2551	31-3598	EM-2770
31-3170	EM-2459	31-3411	EM-2457	31-3528	EM-2556S	31-3600	EM-2771
31-3171	EM-2460	31-3412	EM-2682	31-3528HY	EM-2556	31-3601	EM-2676
31-3172	EM-2461	31-3413	EM-2683	31-3529	EM-2630	31-3602	EM-2664
31-3175	EM-2501	31-3414	EM-2558	31-3530	EM-2684	31-3603	EM-2663
31-3177	EM-2501	31-3415	EM-2559	31-3531	EM-2760	31-3604	EM-2692
31-3178	EM-2500	31-3418	EM-2696S	31-3532	EM-2685	31-3605	EM-2662
31-3179	EM-2501	31-3418HY	EM-2696	31-3533	EM-2636	31-3606	EM-2674
31-3180	EM-2500	31-3419	EM-2631	31-3533	EM-2635	31-3607	EM-2688
31-3182	EM-2725	31-3425	EM-2497	31-3538	EM-2600	31-3608	EM-2772
31-3183	EM-2726	31-3426	EM-2498	31-3539	EM-2499	31-3609	EM-2707S
31-3187	EM-2464	31-3429	EM-2513	31-3540	EM-2601	31-3609HY	EM-2707
31-3188	EM-2463	31-3434	EM-2515	31-3541	EM-2601	31-3610	EM-2677
31-3189	EM-2679	31-3436	EM-2474	31-3542	EM-2601	31-3611	EM-2678
31-3190	EM-2727	31-3437	EM-2473	31-3543	EM-2601	31-3613	EM-2773
31-3191	EM-2728	31-3438	EM-2506	31-3544	EM-2601	31-3614	EM-2777
31-3192	EM-2536	31-3439	EM-2524	31-3545	EM-2601	31-3616	EM-2778
31-3195	EM-2458	31-3440	EM-2477	31-3546	EM-2601	31-3617	EM-2548S
31-3200	EM-2447	31-3442	EM-2381	31-3547	EM-2601	31-3617HY	EM-2548



# CROSS REFERENCE

Mfg Part No	Our Part	Mfg Part No	Our Part	Mfg Part No	Our Part	Mfg Part No	Our Part
<b>CAR QUEST (cont.)</b>		<b>CAR QUEST (cont.)</b>		<b>CAR QUEST (cont.)</b>		<b>CAR QUEST (cont.)</b>	
31-3617HY	EM-2779	31-3679HY	EM-2698	31-5285	EM-3025	31-8046	EM-8100
31-3618	EM-2780	31-3680	EM-2789S	31-5322	EM-3087	31-8047	EM-8047
31-3619	EM-2781	31-3680HY	EM-2789	31-5327	EM-5423	31-8048	EM-8048
31-3621	EM-2782	31-3681	EM-2790S	31-5353HY	EM-3147	31-8049	EM-8049
31-3622	EM-2783	31-3681HY	EM-2790	31-5358	EM-2927	31-8050	EM-8586
31-3624	EM-2784	31-3682	EM-2788S	31-5365	EM-5583	31-8051	EM-8576
31-3625	EM-2785	31-3682HY	EM-2788	31-5374	EM-3086	31-8052	EM-8579
31-3626	EM-2786	31-3683	EM-2394	31-5376	EM-3100	31-8053	EM-8053
31-3629	EM-2639	31-3935	EM-2825	31-5379	EM-3105	31-8054	EM-8054
31-3630	EM-2673	31-3936	EM-2826	31-5382	EM-3098	31-8055	EM-8055
31-3631	EM-2675	31-3937	EM-2827	31-5390	EM-2548	31-8056	EM-8056
31-3632	EM-2693	31-3938	EM-2828	31-5401	EM-5660	31-8057	EM-8068
31-3633	EM-2697S	31-3939	EM-2829	31-5406	EM-5692	31-8058	EM-8095
31-3633HY	EM-2697	31-3940	EM-2830	31-5417	EM-3145	31-8059	EM-8059
31-3634	EM-2709	31-3941	EM-2831	31-6793	EM-5738	31-8060	EM-8060
31-3635	EM-2712S	31-3942	EM-2832	31-6958	EM-5485	31-8061	EM-8061
31-3635HY	EM-2712	31-3943	EM-2833	31-7117	EM-9373	31-8062	EM-8062
31-3636	EM-2713	31-3945	EM-2835	31-7127	EM-9254	31-8063	EM-8063
31-3638	EM-2715	31-3946	EM-2836S	31-7147	EM-9353	31-8065	EM-8065
31-3639	EM-2716	31-3946HY	EM-2836	31-7306	EM-5132	31-8066	EM-8609
31-3640	EM-2718	31-3947	EM-2837S	31-7341	EM-9209	31-8068	EM-8068
31-3642	EM-2719	31-3947HY	EM-2837	31-7349	EM-5672	31-8071	EM-8063
31-3643	EM-2634	31-3948	EM-2838S	31-7358	EM-5818	31-8073	EM-8073
31-3644	EM-2791S	31-3948HY	EM-2838	31-7358	EM-9248	31-8074	EM-8074
31-3644HY	EM-2791	31-3950	EM-2840S	31-8000	EM-8018	31-8075	EM-8075
31-3645	EM-2792S	31-3950HY	EM-2840	31-8001	EM-8001	31-8076	EM-8080
31-3645HY	EM-2792	31-3951	EM-2841S	31-8002	EM-8002	31-8077	EM-8077
31-3646	EM-2793	31-3951HY	EM-2841	31-8003	EM-8329	31-8078	EM-8078
31-3647	EM-2794	31-3952	EM-2842S	31-8004	EM-8004	31-8079	EM-8079
31-3648	EM-2795S	31-3952HY	EM-2842	31-8005	EM-8005	31-8080	EM-8080
31-3648HY	EM-2795	31-3953	EM-2843	31-8006	EM-8006	31-8081	EM-8082
31-3649	EM-2796S	31-3954	EM-2844	31-8007	EM-8007	31-8082	EM-8082
31-3649HY	EM-2796	31-3955	EM-2845	31-8008	EM-8008	31-8083	EM-8083
31-3650	EM-2797	31-3956	EM-2846	31-8009	EM-8009	31-8084	EM-8084
31-3651	EM-2798	31-3957	EM-2847	31-8010	EM-8010	31-8085	EM-8085
31-3652	EM-2799	31-3958	EM-2848	31-8011	EM-8011	31-8086HY	EM-8086
31-3653	EM-2800	31-3959	EM-2849	31-8012	EM-8012	31-8087	EM-8087
31-3654	EM-2801	31-3960	EM-2854	31-8013	EM-8014	31-8088	EM-8088
31-3655	EM-2802	31-3961	EM-2855	31-8014	EM-8014	31-8089	EM-8089
31-3656	EM-2803S	31-3962	EM-2857	31-8015	EM-8016	31-8090	EM-8516
31-3656HY	EM-2803	31-3963	EM-2850	31-8016	EM-8016	31-8091	EM-8091
31-3657	EM-2804	31-3964	EM-2851	31-8017	EM-8021	31-8092	EM-8080
31-3658	EM-2805	31-3965	EM-2852	31-8018	EM-8018	31-8093HY	EM-8093
31-3659	EM-2806	31-3966	EM-2853	31-8019	EM-8019	31-8094	EM-8094
31-3660	EM-2807	31-3967	EM-2856	31-8020	EM-8020	31-8095	EM-8095
31-3661	EM-2808	31-3968	EM-2858	31-8021	EM-8021	31-8096	EM-8096
31-3662	EM-2809	31-3969	EM-2859S	31-8022	EM-8022	31-8097	EM-8097
31-3663	EM-2810	31-3969HY	EM-2859	31-8023	EM-8024	31-8098	EM-8098
31-3664	EM-2817	31-3970	EM-2860	31-8024	EM-8024	31-8099	EM-8099
31-3665	EM-2812S	31-3971	EM-2861	31-8025	EM-8025	31-8100	EM-8100
31-3665HY	EM-2812	31-3972	EM-2862	31-8026	EM-8026	31-8101	EM-8101
31-3666	EM-2813S	31-3973	EM-2863	31-8027	EM-8575	31-8102	EM-8102
31-3666HY	EM-2813	31-3974	EM-2864	31-8028	EM-8435	31-8103	EM-8103
31-3667	EM-2814	31-3976	EM-2866	31-8029	EM-8029	31-8104	EM-8104
31-3668	EM-2815	31-3977	EM-2867	31-8031	EM-8031	31-8105	EM-8105
31-3669	EM-2816	31-3978	EM-3000	31-8032	EM-8021	31-8106	EM-8106
31-3670	EM-2817	31-3979	EM-3001	31-8033	EM-8010	31-8107	EM-8107
31-3671	EM-2818	31-3980	EM-3004	31-8034	EM-8034	31-8108	EM-8108
31-3672	EM-2819	31-3981	EM-3009	31-8035	EM-8431	31-8109	EM-8103
31-3673	EM-2820	31-4205	EM-9227	31-8036	EM-8012	31-8111	EM-8111
31-3674	EM-2821S	31-4301	EM-9217	31-8037HY	EM-8037	31-8112	EM-8100
31-3674HY	EM-2821	31-4320	EM-9422	31-8038	EM-8103	31-8113	EM-8065
31-3675	EM-2822	31-4323	EM-5656	31-8039	EM-8039	31-8114	EM-8114
31-3676	EM-2823S	31-4524	EM-9215	31-8040	EM-8040	31-8115	EM-8115
31-3676HY	EM-2823	31-4532	EM-9298	31-8041	EM-8041	31-8116	EM-8132
31-3677	EM-2824S	31-4536	EM-9303	31-8042	EM-8042	31-8117	EM-8117
31-3677HY	EM-2824	31-4541	EM-9250	31-8043	EM-8042	31-8118	EM-8118
31-3678	EM-2657	31-4627	EM-9278	31-8044	EM-8044	31-8119	EM-8119
31-3679	EM-2698S	31-4630	EM-9383	31-8045	EM-8045	31-8120	EM-8120

# CROSS REFERENCE

Mfg Part No	Our Part	Mfg Part No	Our Part	Mfg Part No	Our Part	Mfg Part No	Our Part
CAR QUEST (cont.)		CAR QUEST (cont.)		CAR QUEST (cont.)		CAR QUEST (cont.)	
31-8121	EM-8121	31-8194	EM-8194	31-8269	EM-8584	31-8343	EM-8164
31-8122	EM-8122	31-8195	EM-8195	31-8270	EM-8270	31-8344	EM-8344
31-8123	EM-8124	31-8196	EM-8196	31-8271	EM-8271	31-8345	EM-8002
31-8124	EM-8124	31-8197	EM-8197	31-8272	EM-8272	31-8346	EM-8194
31-8125	EM-8125	31-8198	EM-8198	31-8273	EM-8324	31-8347	EM-8002
31-8126	EM-8304	31-8199	EM-8485	31-8274	EM-8274	31-8348	EM-8348
31-8127	EM-8133	31-8200	EM-8200	31-8275	EM-8312	31-8349	EM-8349
31-8128	EM-8128	31-8201	EM-8201	31-8276	EM-8276	31-8350	EM-8348
31-8129	EM-8304	31-8205	EM-8205	31-8277	EM-8277	31-8351	EM-8351
31-8130	EM-8130	31-8206	EM-8206	31-8278	EM-8278	31-8352	EM-8352
31-8131	EM-8125	31-8207	EM-8207	31-8279	EM-8279	31-8353	EM-8353
31-8132	EM-8132	31-8208	EM-8208	31-8280	EM-8280	31-8354	EM-8344
31-8133	EM-8133	31-8209	EM-8209	31-8281	EM-8281	31-8355	EM-8195
31-8134	EM-8133	31-8210	EM-8210	31-8282	EM-8282	31-8356	EM-8195
31-8135	EM-8135	31-8211	EM-8211	31-8283	EM-8283	31-8357	EM-8193
31-8137	EM-8137	31-8212	EM-8212	31-8284	EM-8284	31-8358	EM-8213
31-8138	EM-8138	31-8213	EM-8213	31-8285	EM-8142	31-8359	EM-8359
31-8139	EM-2740	31-8214	EM-8214	31-8286	EM-8181	31-8360	EM-8014
31-8140	EM-8140	31-8218	EM-8218	31-8287	EM-8287	31-8361	EM-8361
31-8141	EM-8141	31-8219	EM-8211	31-8288	EM-8411	31-8362	EM-8485
31-8142	EM-8142	31-8220	EM-8220	31-8289	EM-8431	31-8363	EM-8363
31-8143	EM-8310	31-8221	EM-8221	31-8290	EM-8290	31-8364	EM-8166
31-8144	EM-8144	31-8222	EM-8222	31-8291	EM-8619	31-8365	EM-8365
31-8145	EM-8145	31-8223	EM-8223	31-8292	EM-8292	31-8366	EM-8207
31-8146	EM-8146	31-8224HY	EM-8224	31-8293	EM-8293	31-8367	EM-8368
31-8147	EM-8303	31-8225	EM-8225	31-8294	EM-8294	31-8368	EM-8368
31-8148	EM-8148	31-8226	EM-8102	31-8295	EM-8295	31-8369	EM-8482
31-8149	EM-8149	31-8227	EM-8223	31-8296	EM-8296	31-8370	EM-8190
31-8150	EM-8150	31-8228	EM-8228	31-8298	EM-8304	31-8371	EM-8201
31-8151	EM-8151	31-8229	EM-8229	31-8299	EM-8001	31-8372	EM-8208
31-8152	EM-8152	31-8230	EM-8230	31-8300	EM-8300	31-8373	EM-8014
31-8153	EM-8137	31-8231	EM-8231	31-8301	EM-8304	31-8374	EM-8374
31-8154	EM-8154	31-8232	EM-8232	31-8302	EM-8304	31-8375	EM-8375
31-8155	EM-8132	31-8233	EM-8233	31-8303	EM-8303	31-8376	EM-8167
31-8156	EM-8324	31-8234	EM-8234	31-8304	EM-8304	31-8377	EM-8377
31-8157	EM-8157	31-8235	EM-8235	31-8305	EM-2406	31-8378	EM-8214
31-8160	EM-8160	31-8236	EM-8236	31-8306	EM-8034	31-8379	EM-8375
31-8161	EM-8161	31-8237	EM-8224	31-8307	EM-8307	31-8380	EM-8179
31-8163	EM-8163	31-8238	EM-8238	31-8308	EM-8307	31-8381	EM-2409
31-8164	EM-8164	31-8239	EM-8239	31-8309	EM-8427	31-8382	EM-2690
31-8165	EM-8165	31-8240	EM-8431	31-8310	EM-8310	31-8384	EM-8384
31-8166	EM-8166	31-8241	EM-8073	31-8311	EM-8311	31-8385	EM-8385
31-8167	EM-8167	31-8242	EM-8242	31-8312	EM-8312	31-8386	EM-8187
31-8168	EM-8168	31-8243	EM-8243	31-8313	EM-8312	31-8387	EM-8389
31-8169	EM-8169	31-8244	EM-8244	31-8314	EM-8314	31-8389	EM-8389
31-8170	EM-8170	31-8245	EM-8424	31-8315	EM-8149	31-8390	EM-8389
31-8171	EM-8171	31-8246	EM-8517	31-8316	EM-8312	31-8392	EM-8392
31-8172	EM-8278	31-8247	EM-8004	31-8317	EM-8317	31-8393	EM-8393
31-8173	EM-8173	31-8248	EM-8248	31-8318	DS-8318	31-8394	EM-8393
31-8174	EM-8174	31-8249	EM-8031	31-8319	EM-8319	31-8395	EM-8395
31-8175	EM-8175	31-8250	EM-8014	31-8320	EM-8149	31-8396	EM-8197
31-8176	EM-8176	31-8251	EM-8014	31-8321	EM-8133	31-8397	EM-8197
31-8177	EM-8177	31-8252	EM-8019	31-8322	EM-8322	31-8398	EM-8398
31-8178	EM-8178	31-8253	EM-8253	31-8323	EM-8323	31-8399	EM-8398
31-8179	EM-8179	31-8254	EM-8254	31-8324	EM-8324	31-8400	EM-8400
31-8180	EM-8180	31-8255	EM-8255	31-8325	EM-8324	31-8401	EM-8401
31-8181	EM-8181	31-8256	EM-8586	31-8326	EM-8324	31-8402	EM-8402
31-8182	EM-8211	31-8257	EM-8586	31-8327	EM-8324	31-8404	EM-8404
31-8183	EM-8183	31-8258	EM-8586	31-8328	EM-8328	31-8405	EM-8197
31-8184	EM-8183	31-8259	EM-8259	31-8329	EM-8329	31-8406	EM-8406
31-8185	EM-8185	31-8260	EM-8424	31-8330	EM-8330	31-8407	EM-8407
31-8186	EM-8186	31-8261	EM-8261	31-8331	EM-8130	31-8408	EM-8385
31-8187	EM-8187	31-8262	EM-8262	31-8332	EM-8130	31-8409	EM-8385
31-8188	EM-8188	31-8263	EM-8263	31-8335	EM-8178	31-8410	EM-8197
31-8189	EM-8189	31-8264	EM-8080	31-8336	EM-8194	31-8411	EM-8411
31-8190	EM-8190	31-8265	EM-8094	31-8337	EM-8278	31-8412	EM-8413
31-8191	EM-8191	31-8266	EM-8266	31-8338	EM-8278	31-8413	EM-8413
31-8192	EM-8192	31-8267	EM-8267	31-8339	EM-8339	31-8414	EM-8414
31-8193	EM-8193	31-8268	EM-8103	31-8340	EM-8180	31-8415	EM-8415

# CROSS REFERENCE

Mfg Part No	Our Part	Mfg Part No	Our Part	Mfg Part No	Our Part	Mfg Part No	Our Part
<b>CAR QUEST (cont.)</b>		<b>CAR QUEST (cont.)</b>		<b>CAR QUEST (cont.)</b>		<b>CAR QUEST (cont.)</b>	
31-8416	EM-8175	31-8488	EM-8488	31-8561	EM-8068	31-8635	DS-8635
31-8417	EM-8175	31-8489	EM-8489	31-8562	EM-8095	31-8636	DS-8636
31-8418	EM-8418	31-8490	EM-8490	31-8563	EM-8563	31-8638HY	EM-8663
31-8419	EM-8191	31-8491	EM-8491	31-8565	DS-8565	31-8639	EM-8639
31-8420	EM-8643	31-8492	EM-8492	31-8566	EM-8566	31-8640	EM-8640
31-8421	EM-8415	31-8493	EM-8493	31-8567	EM-8124	31-8641	EM-8641
31-8422	EM-8422	31-8494	EM-8400	31-8568	EM-8568	31-8642	EM-8642
31-8423	EM-8021	31-8495	EM-8495	31-8569	EM-8568	31-8643	EM-8643
31-8424	EM-8424	31-8496	EM-8008	31-8571	EM-8571	31-8644	EM-8644
31-8425	EM-8425	31-8497	EM-8497	31-8572	EM-8572	31-8645	EM-8389
31-8426	EM-8034	31-8499	EM-8499	31-8573	EM-8010	31-8646	EM-8196
31-8427	EM-8427	31-8501	EM-2731	31-8574	EM-8574	31-8647	EM-8164
31-8428	EM-8120	31-8502	EM-8502	31-8575	EM-8575	31-8648	EM-8648
31-8429	EM-8177	31-8503	EM-8503	31-8576	EM-8576	31-8649	EM-8649
31-8430	EM-8430	31-8505	EM-2731	31-8577	EM-8577	31-8650	EM-8650
31-8431	EM-8431	31-8506	EM-8506	31-8578	EM-8578	31-8651	EM-8651
31-8433	EM-8435	31-8507	EM-8507	31-8579	EM-8579	31-8652	EM-8652
31-8434	EM-8434	31-8508	EM-8508	31-8580	EM-8055	31-8653	EM-8653
31-8435	EM-8435	31-8509	DS-8509	31-8581	EM-8512	31-8654	EM-8654
31-8436	EM-8435	31-8510	EM-8510	31-8582	EM-8582	31-8655	EM-8655
31-8437	EM-8435	31-8511	EM-8511	31-8584	EM-8584	31-8656	EM-8656
31-8438	EM-8438	31-8512	EM-8512	31-8585	EM-8205	31-8657	EM-8657
31-8439	EM-8439	31-8513	EM-8513	31-8586	EM-8586	31-8658	EM-8658
31-8440	EM-8439	31-8514	EM-8514	31-8587	DS-8587	31-8659	EM-8659
31-8441	EM-8586	31-8515	EM-8078	31-8588	DS-8588	31-8660	EM-8660
31-8442	EM-8442	31-8516	EM-8516	31-8589	EM-8589	31-8661	EM-8661
31-8443	EM-8586	31-8517	EM-8517	31-8590HY	EM-8663	31-8662HY	EM-8662
31-8444	EM-8579	31-8518	EM-8282	31-8591	DS-8591	31-8663HY	EM-8663
31-8445	EM-8445	31-8519	EM-8282	31-8592	EM-8592	31-8664	EM-8664
31-8446	EM-8579	31-8520	EM-8490	31-8593	EM-8593	31-8665	EM-8665
31-8447	EM-8576	31-8521	EM-8521	31-8594	EM-8594	31-8666	EM-8165
31-8448	EM-8586	31-8522	EM-8522	31-8595	EM-8595	31-8667	EM-8667
31-8449	EM-8586	31-8523	EM-8524	31-8596	EM-8596	31-8668	EM-8668
31-8450	EM-8586	31-8524	EM-8524	31-8597	EM-8597	31-8669	EM-8669
31-8451	EM-8352	31-8525	EM-8525	31-8598	EM-8598	31-8670	EM-8670
31-8452	EM-8586	31-8526	EM-8576	31-8599	EM-8599	31-8672	EM-8672
31-8453	EM-8453	31-8527	EM-8314	31-8600	EM-8600	31-8673	EM-8672
31-8454	EM-8609	31-8528	EM-8197	31-8601	EM-8601	31-8674	EM-8674
31-8455	EM-8073	31-8529	EM-8529	31-8602	EM-8602	31-8675	EM-8675
31-8456	EM-8456	31-8530	DS-8531	31-8603	EM-8603	31-8676	EM-8676
31-8457	EM-8457	31-8531	DS-8531	31-8604	EM-8604	31-8677	EM-8677
31-8458	EM-8073	31-8532	DS-8532	31-8605	EM-8605	31-8678	EM-8678
31-8459	EM-8073	31-8533	DS-8533	31-8606	EM-8606	31-8679	EM-8679
31-8460	EM-8460	31-8535	DS-8535	31-8607	EM-8607	31-8680	EM-8680
31-8461	EM-8075	31-8536	EM-8005	31-8608	EM-8608	31-8681	EM-8681
31-8462	EM-8462	31-8537	EM-8402	31-8609	EM-8609	31-8682	EM-8682
31-8463	EM-8087	31-8538	DS-8538	31-8611	EM-8611	31-8683	EM-8683
31-8464	EM-8086	31-8539	EM-8539	31-8612	EM-8612	31-8684	EM-8684
31-8465	EM-8516	31-8540	EM-8803	31-8613	EM-8612	31-8685	EM-8685
31-8466	EM-8466	31-8541	EM-8803	31-8614	EM-8614	31-8686	EM-8686
31-8467	EM-8467	31-8542	EM-8542	31-8615	EM-8615	31-8687	EM-8687
31-8468	DS-8468	31-8543	EM-8544	31-8616	EM-8616	31-8688	EM-8688
31-8469	DS-8469	31-8544	EM-8544	31-8617	EM-8617	31-8689	EM-8689
31-8470	DS-8470	31-8545	EM-8545	31-8618	EM-8236	31-8690	EM-8690
31-8471	DS-8471	31-8546	EM-8548	31-8619	EM-8619	31-8691	EM-8691
31-8472	DS-8472	31-8547	EM-8548	31-8620	EM-8620	31-8692	EM-8692
31-8473	DS-8473	31-8548	EM-8548	31-8621	EM-8621	31-8693	EM-8693
31-8474	DS-8474	31-8549	DS-8549	31-8622HY	EM-8622	31-8694	EM-8694
31-8475	DS-8475	31-8550	DS-8550	31-8623	EM-8623	31-8695	EM-8695
31-8477	EM-8075	31-8551	DS-8551	31-8624	EM-8594	31-8696	EM-8696
31-8478	EM-8055	31-8552	EM-8552	31-8626	DS-8626	31-8697	EM-8697
31-8479	EM-8142	31-8553	EM-8553	31-8627	DS-8627	31-8698	EM-8698
31-8480	EM-8304	31-8554	EM-8554	31-8628	EM-8229	31-8699	EM-8699
31-8481	EM-8192	31-8555	EM-8103	31-8629	EM-8629	31-8700	EM-8700
31-8482	EM-8482	31-8556	EM-8556	31-8630	EM-8630	31-8701	EM-8701
31-8483	EM-8368	31-8557	EM-8107	31-8631	EM-8631	31-8703	EM-2855
31-8484	EM-8348	31-8558	EM-8205	31-8632	EM-8632	31-8704	EM-8704
31-8485	EM-8485	31-8559	EM-8559	31-8633	EM-8230	31-8705	EM-8705
31-8487	EM-8197	31-8560	EM-8560	31-8634	DS-8634	31-8706	EM-2856

# CROSS REFERENCE

Mfg Part No	Our Part	Mfg Part No	Our Part	Mfg Part No	Our Part	Mfg Part No	Our Part
<b>CAR QUEST (cont.)</b>		<b>CAR QUEST (cont.)</b>		<b>CAR QUEST (cont.)</b>		<b>CAR QUEST (cont.)</b>	
31-8707	EM-2857	31-8778	EM-8778	31-8847	EM-8847	31-8916	EM-8916
31-8709	EM-8709	31-8779	EM-8778	31-8848	EM-8848	31-8917	EM-8917
31-8710	EM-8710	31-8780	EM-8780	31-8849	EM-8849	31-8918	EM-8918
31-8711	EM-8711	31-8781	EM-8781	31-8850	EM-8850	31-8919	EM-8919
31-8712	EM-8041	31-8782	EM-8782	31-8851	EM-8851	31-8920	EM-8920
31-8713	EM-8041	31-8783	EM-8783	31-8852	EM-8852	31-8921	EM-8921
31-8714	EM-8042	31-8784	EM-8784	31-8853	EM-8853	31-8922	EM-8921
31-8715	EM-8715	31-8785	EM-8783	31-8854	EM-8854	31-8923	EM-8923
31-8716	EM-8716	31-8786	EM-8786	31-8855	EM-8855	31-8924	EM-8923
31-8717	EM-8717	31-8787	EM-8787	31-8856	EM-8856	31-8925	EM-8925
31-8718	EM-8718	31-8788	EM-8788	31-8857	EM-8857	31-8926	EM-8926
31-8719	EM-8719	31-8789	EM-8789	31-8858	EM-8858	31-8927	EM-8921
31-8720	EM-8719	31-8790	EM-8790	31-8859	EM-8859	31-8928	EM-8928
31-8721	EM-8721	31-8791	EM-8791	31-8860	EM-8860	31-8929	EM-8929
31-8722	EM-8722	31-8792	EM-8792	31-8861	EM-8460	31-8930	EM-8930
31-8723	EM-8723	31-8793	EM-8793	31-8862	EM-8862	31-8931	EM-8931
31-8724	EM-8724	31-8794	EM-8794	31-8863	EM-8863	31-8932	EM-8932
31-8725	EM-8725	31-8795	EM-8795	31-8864	EM-8864	31-8933	EM-8933
31-8726	EM-8726	31-8796	EM-8796	31-8865	EM-8865	31-8934	EM-8934
31-8727	EM-8727	31-8797	EM-8797	31-8866	EM-8866	31-8935	EM-8935
31-8728	EM-8728	31-8798	EM-8798	31-8867	EM-8867	31-8936	EM-8936
31-8729	EM-8729	31-8799	EM-8799	31-8868	EM-8868	31-8937	EM-8937
31-8730	EM-8730	31-8800	EM-8800	31-8869	EM-8869	31-8938	EM-8938
31-8731	EM-8731	31-8801	EM-8801	31-8870	EM-8870	31-8939	EM-8939
31-8732	EM-8732	31-8802	EM-8802	31-8871	EM-8871	31-8940	EM-8940
31-8733	EM-8733	31-8803	EM-8803	31-8872	EM-8872	31-8941	EM-8941
31-8734	EM-8734	31-8804	EM-8804	31-8873	EM-8873	31-8942	EM-8943
31-8736	EM-8736	31-8805	EM-8805	31-8874	EM-8874	31-8943	EM-8943
31-8737	EM-8044	31-8806	EM-8806	31-8875	EM-8875	31-8944	EM-8944
31-8738	EM-8738	31-8807	EM-8807	31-8876	EM-8876	31-8945	EM-8945
31-8739	EM-8738	31-8808	EM-8681	31-8877	EM-8877	31-8946	EM-8945
31-8740	EM-8740	31-8809	EM-8296	31-8878	EM-8878	31-8947	EM-8947
31-8741	EM-8741	31-8810	EM-8296	31-8879	EM-8879	31-8948	EM-8948
31-8742	EM-8742	31-8811	EM-8811	31-8880	EM-8880	31-8949	EM-8949
31-8743	EM-8743	31-8812	EM-8812	31-8881	EM-8881	31-8950	EM-8950
31-8744	EM-8744	31-8813	EM-8813	31-8882	EM-8882	31-8951	EM-8951
31-8745	EM-8745	31-8814	EM-8814	31-8883	EM-8883	31-8952	EM-8952
31-8746	EM-8746	31-8815	EM-8093	31-8884	EM-8884	31-8953	EM-8953
31-8747	EM-8747	31-8816	EM-8816	31-8885	EM-8885	31-8954	EM-8954
31-8748	EM-8748	31-8817	EM-8817	31-8886	EM-8886	31-8954HY	EM-8954
31-8749	EM-8788	31-8818	EM-8818	31-8887	EM-8887	31-8955	EM-8955
31-8750	EM-8750	31-8819	EM-8819	31-8888	EM-8888	31-8956	EM-8956
31-8751	EM-8751	31-8820	EM-8820	31-8889	EM-8889	31-8957	EM-8957
31-8752	EM-8752	31-8821	EM-8821	31-8890	EM-8890	31-8958	EM-8958
31-8753	EM-8753	31-8822	EM-8822	31-8891	EM-8891	31-8959	EM-8959
31-8754	EM-8754	31-8823	EM-8823	31-8892	EM-8892	31-8960	EM-8960
31-8755	EM-8755	31-8824	EM-8824	31-8893	EM-8893	31-8961	EM-8961
31-8756	EM-8756	31-8825	EM-8825	31-8894	EM-8894	31-8962	EM-8962
31-8757	EM-8757	31-8826	EM-8826	31-8895	EM-8895	31-8963	EM-8963
31-8758	EM-8758	31-8827HY	EM-8663	31-8896	EM-8896	31-8964	EM-8964
31-8759	EM-8759	31-8828HY	EM-8828	31-8897	EM-8897	31-8965	EM-8965
31-8760	EM-8760	31-8829HY	EM-8829	31-8898	EM-8898	31-8966	EM-8966
31-8761	EM-8042	31-8830	EM-8830	31-8899	EM-8899	31-8967	EM-8967
31-8762	EM-8762	31-8831	EM-8831	31-8900	EM-8900	31-8967HY	EM-8967
31-8763	EM-8762	31-8832HY	EM-8832	31-8901	EM-8901	31-8968	EM-8968
31-8764	EM-8764	31-8833HY	EM-8832	31-8902	EM-8902	31-8969	EM-8644
31-8765	EM-8788	31-8834HY	EM-8834	31-8903	EM-8903	31-8970	EM-8970
31-8766	EM-8597	31-8835HY	EM-8835	31-8904	EM-8904	31-8971	EM-8971
31-8767	EM-8597	31-8836HY	EM-8836	31-8905	EM-8905	31-8972	EM-8008
31-8768	EM-8768	31-8837HY	EM-8834	31-8906	EM-8906	31-8973	EM-8973
31-8769	EM-8769	31-8838HY	EM-8838	31-8907	EM-8907	31-8974	EM-8974
31-8770	EM-8770	31-8839HY	EM-8832	31-8908	EM-8908	31-8975	EM-8975
31-8771	EM-8771	31-8840HY	EM-8832	31-8909	EM-8909	31-8976	EM-8976
31-8772	EM-8772	31-8841	EM-8616	31-8910	EM-8910	31-8977	EM-8977
31-8773	EM-8774	31-8842	EM-8616	31-8911	EM-8911	31-8978	EM-8978
31-8774	EM-8774	31-8843	EM-8843	31-8912	EM-8912	31-8979	EM-8979
31-8775	EM-8775	31-8844	EM-8616	31-8913	EM-8913	31-8980	EM-8980
31-8776	EM-8775	31-8845	EM-8845	31-8914	EM-8914	31-8981	EM-8981
31-8777	EM-8778	31-8846	EM-8846	31-8915	EM-8915	31-8982	EM-8982

# CROSS REFERENCE

Mfg Part No	Our Part	Mfg Part No	Our Part	Mfg Part No	Our Part	Mfg Part No	Our Part
<b>CAR QUEST (cont.)</b>		<b>CAR QUEST (cont.)</b>		<b>CAR QUEST (cont.)</b>		<b>CAR QUEST (cont.)</b>	
31-8983	EM-8983	31-9052	EM-9018	31-9122	EM-9122	31-9194	EM-2600
31-8984HY	EM-8984	31-9053	EM-9053	31-9123	EM-9123	31-9195	EM-2457
31-8985	EM-8985	31-9054	EM-9054	31-9124	EM-9124	31-9195	EM-2469
31-8986	EM-8986	31-9055	EM-9055	31-9125	EM-9125	31-9196	EM-2470
31-8987	EM-8987	31-9056	EM-9056	31-9126	EM-2910	31-9197	EM-2458
31-8988	EM-8988	31-9057	EM-9057	31-9127	EM-9127	31-9198	EM-2457
31-8989	EM-8989	31-9058	EM-9058	31-9128HY	EM-9128	31-9199	EM-2503
31-8990	EM-8990	31-9059	EM-9059	31-9129HY	EM-9129	31-9200	EM-2504
31-8991	EM-8991	31-9060	EM-9060	31-9130	EM-9130	31-9201	EM-2500
31-8992	EM-8992	31-9061	EM-9061	31-9131	EM-9131	31-9202	EM-2550
31-8993	EM-8993	31-9062	EM-9062	31-9132	EM-2649	31-9203	EM-2551S
31-8994	EM-8994	31-9063	EM-9063	31-9133	EM-9133	31-9204	EM-2562
31-8995	EM-8995	31-9064	EM-9064	31-9134	EM-9134	31-9205	EM-2563
31-8996	EM-8996	31-9065HY	EM-9065	31-9135	EM-8681	31-9206	EM-2538
31-8997HY	EM-8997	31-9066	EM-9066	31-9136	EM-9136	31-9207	EM-8225
31-8998HY	EM-8998	31-9067	EM-9067	31-9137	EM-9137	31-9208	EM-2660
31-8999	EM-8999	31-9068	EM-9068	31-9138	EM-9138	31-9209	EM-2717S
31-9000	EM-9000	31-9069	EM-8261	31-9139	EM-9139	31-9210	EM-2351
31-9001HY	EM-9001	31-9070	EM-9070	31-9140	EM-9140	31-9211	EM-8239
31-9002	EM-9002	31-9071	EM-9071	31-9141	EM-9141	31-9212	EM-2681
31-9003HY	EM-9003	31-9072	EM-9072	31-9142	EM-9142	31-9213	EM-8568
31-9004HY	EM-9004	31-9073	EM-9073	31-9143	EM-9143	31-9214	EM-8100
31-9005HY	EM-9005	31-9074	EM-9074	31-9144	EM-9144	31-9215	EM-8073
31-9006HY	EM-8795	31-9075	EM-8895	31-9145HY	EM-9145	31-9216	EM-2326
31-9007HY	EM-9007	31-9076	EM-9076	31-9147	EM-9147	31-9217	EM-3006
31-9008HY	EM-9008	31-9077	EM-9077	31-9148	EM-2835	31-9218	EM-2912
31-9009HY	EM-9009	31-9078	EM-9078	31-9149	EM-2696S	31-9220	EM-8107
31-9010	EM-9010	31-9079	EM-9079	31-9150	EM-8104	31-9221	EM-8100
31-9011	EM-9011	31-9080	EM-9080	31-9151	EM-2709	31-9222	EM-8238
31-9012	EM-9012	31-9081	EM-9081	31-9152	EM-2803S	31-9223	EM-8456
31-9013	EM-9013	31-9082	EM-9082	31-9153	EM-8010	31-9225	EM-8584
31-9014	EM-9014	31-9083HY	EM-9083	31-9154	EM-8100	31-9226	EM-8691
31-9015	EM-9015	31-9084	EM-9084	31-9155	EM-2959	31-9227	EM-8188
31-9016	EM-9016	31-9085	EM-9085	31-9156	EM-2902	31-9228	EM-3048
31-9017HY	EM-9017	31-9086	EM-9086	31-9157	EM-2903	31-9229	EM-2819
31-9018	EM-9018	31-9087	EM-9087	31-9158	EM-8239	31-9230	EM-2876
31-9019	EM-9019	31-9088	EM-9088	31-9159	EM-2493	31-9231HY	EM-2836
31-9020	EM-9020	31-9089	EM-9089	31-9160	EM-2829	31-9232HY	EM-2804
31-9021HY	EM-9021	31-9090	EM-9090	31-9161	EM-2838	31-9233	EM-2893
31-9022	EM-9022	31-9091	EM-9091	31-9162	EM-2859	31-9234	EM-2837S
31-9023	EM-9023	31-9092HY	EM-9092	31-9163	EM-2007	31-9237	EM-2073
31-9024	EM-9024	31-9093	EM-9093	31-9164	EM-2050	31-9238	EM-2126
31-9025	EM-9025	31-9094	EM-9094	31-9165	EM-2091	31-9239	EM-2127
31-9026	EM-9026	31-9095	EM-9095	31-9166	EM-2092	31-9240	EM-2268
31-9027	EM-9027	31-9096	EM-9096	31-9167	EM-2110	31-9241	EM-2171
31-9028	EM-9028	31-9097HY	EM-9003	31-9168	EM-2120	31-9242	EM-2216
31-9029	EM-9029	31-9098	EM-9098	31-9169	EM-2142	31-9243	EM-2217
31-9030	EM-9030	31-9099	EM-9099	31-9171	EM-2218	31-9244	EM-2349
31-9031	EM-9031	31-9100	EM-9100	31-9172	EM-2238	31-9245	EM-2253
31-9032	EM-9032	31-9101HY	EM-9101	31-9173	EM-2287	31-9246	EM-2288
31-9033	EM-9033	31-9102	EM-9102	31-9174	EM-2250	31-9247	EM-2294
31-9034	EM-9034	31-9103	EM-9103	31-9175	EM-2270	31-9248	EM-2302
31-9035	EM-9035	31-9104	EM-9104	31-9176	EM-2271	31-9249	EM-2307
31-9036	EM-2985	31-9105	EM-9105	31-9178	EM-2296	31-9250	EM-2372
31-9037	EM-9037	31-9106	EM-9106	31-9179	EM-2275	31-9251	EM-2349
31-9038	EM-9038	31-9107	EM-9107	31-9180	EM-2276	31-9252	EM-2525
31-9039	EM-9039	31-9108	EM-9108	31-9181	EM-2277	31-9253	EM-2374
31-9040	EM-9040	31-9109	EM-9109	31-9182	EM-2279	31-9254	EM-2388
31-9041	EM-9041	31-9110HY	EM-9110	31-9183	EM-2303	31-9255	EM-2392
31-9042	EM-9042	31-9111	EM-9111	31-9184	EM-2319	31-9256	EM-2471
31-9043HY	EM-9043	31-9112	EM-2410	31-9185	EM-2328	31-9257	EM-2508
31-9044HY	EM-9044	31-9113	EM-9113	31-9186	EM-2356	31-9259	EM-2565
31-9045	EM-9045	31-9114	EM-9114	31-9187	EM-2357	31-9260	EM-2712
31-9046	EM-9046	31-9115	EM-9115	31-9188	EM-2367	31-9261	EM-2750
31-9047	EM-9047	31-9116	EM-9116	31-9189	EM-2368	31-9262	EM-2751
31-9048	EM-9048	31-9117	EM-9117	31-9190	EM-2370	31-9263	EM-2730
31-9049	EM-9049	31-9118	EM-9118	31-9191	EM-2387	31-9264	EM-2857
31-9050	EM-9050	31-9120	EM-9120	31-9192	EM-2395	31-9265	EM-2858
31-9051	EM-9051	31-9121	EM-9121	31-9193	EM-2436	31-9267	EM-2884

# CROSS REFERENCE

Mfg Part No	Our Part	Mfg Part No	Our Part	Mfg Part No	Our Part	Mfg Part No	Our Part	
<b>CAR QUEST (cont.)</b>		<b>CAR QUEST (cont.)</b>		<b>CAR QUEST (cont.)</b>		<b>DEA / MRC (cont.)</b>		
31-9268	EM-8503	35-9334	EM-8663	33-10483	EM-4097	AM332	EM-90000	
31-9269	EM-8544	35-9335	EM-8639	33-10509	EM-4022	AM352	EM-90001	
31-9270	DS-6051	35-9336	EM-8828	33-10583	EM-5741	AM353	EM-90031	
33-5364	EM-2949	35-9337	EM-8829	33-10749	EM-9507	A2007	EM-2007	
33-7139	EM-9312	35-9338	EM-8832	33-10750	EM-9507	A2009	EM-2009	
33-8341	EM-9055	35-9339	EM-8834	33-10772	EM-2884	A2010	EM-2010	
33-9146HY	EM-9146	35-9340	EM-8834	33-10773	EM-3151	A2014	EM-2014	
35-6027	DS-6027	35-9341	EM-8836	33-10774	EM-3150	A2018	EM-2018	
35-6028	DS-6028	35-9342	EM-8834	33-10776	EM-3136	A2039	EM-2039	
35-6035	DS-6035	35-9343	EM-8838	33-10777	EM-3151	A2040	EM-2040	
35-6036	DS-6056	35-9344	EM-8832	33-10778	EM-3150	A2041	EM-2041	
35-6047	DS-6038	35-9345	EM-8193	33-10863	EM-9426	A2048	EM-2048	
35-6049	DS-6040	35-9346	EM-2409	33-10888	EM-5957	A2050	EM-2050	
35-6050	DS-6048	35-9348	EM-8063	33-10936	EM-4044	A2053	EM-2053	
35-6051	DS-6049	35-9349	EM-2742	33-10972	EM-5994	A2055	EM-5465	
35-6053	DS-6051	35-9350	EM-8644	33-11067	EM-9445	A2057	EM-2057	
35-6055	DS-6052	35-9351	EM-8277	33-11185	EM-5862	A2060	EM-2060	
35-6058	DS-6053	35-9352	EM-8041	33-11186	EM-4027	A2070	EM-2070	
35-6061	DS-6061	35-9353	EM-8303	33-11187	EM-5515	A2073	EM-2073	
35-6062	DS-6062	35-9354	EM-8140	33-11191	EM-4047	A2091	EM-2091	
35-9277	EM-8402	35-9355	EM-8140	33-11218	EM-4095	A2092	EM-2092	
35-9278	EM-8497	35-9356	EM-8374	33-11481	EM-4134	A2107	EM-2107	
35-9279	EM-8662	35-9357	EM-9095	33-11518	EM-3135	A2108	EM-2108	
35-9280	EM-8266	35-9358	EM-8593	33-11685	EM-4017	A2110	EM-2110	
35-9281	EM-8979	35-9359	EM-2487	33-11686	EM-9428	A2119	EM-2119	
35-9282	EM-8485	35-9360	EM-2487	33-11687	EM-9459	A2120	EM-2120	
35-9283	EM-8485	35-9362	EM-8214	33-11688	EM-4000	A2121	EM-2121	
35-9284	EM-8303	35-9363	EM-8018	33-11688	EM-4001	A2122	EM-2122	
35-9286	EM-2406	35-9364	EM-8151	33-11689	EM-4019	A2123	EM-2123	
35-9288	EM-8012	35-9365	EM-8218	33-11690	EM-9417	A2124	EM-2124	
35-9289	EM-2681	35-9366	EM-8222	33-11691	EM-9459	A2125	EM-2125	
35-9292	EM-8803	35-9367	EM-8586	33-11700	EM-5793	A2126	EM-2126	
35-9293	EM-8200	35-9368	EM-8586	33-11704	EM-4062	A2127	EM-2127	
35-9294	EM-8208	35-9369	EM-8236	33-11705	EM-4061	A2141	EM-2141	
35-9295	EM-8643	35-9370	EM-8672	33-11708	EM-5875	A2142	EM-2142	
35-9296	EM-8175	35-9371	EM-9060	33-11813	EM-4049	A2143	EM-2143	
35-9297	EM-8209	35-9374	EM-8614	33-12004	EM-3087	A2150	EM-2150	
35-9298	EM-8681	33-10009	EM-9205	33-12575	EM-4072	A2162	EM-2162	
35-9299	EM-8006	33-10066	EM-5984	37-10018	DS-6066	A2163	EM-2163	
35-9300	EM-8665	33-10080	EM-9247	37-10110	DS-6079	A2167	EM-2167	
35-9302	EM-2744	33-10082	EM-5840	37-10114	DS-6501	A2170	EM-2170	
35-9303	EM-8255	33-10085	EM-5795	37-10116	DS-6502	A2171	EM-2171	
35-9304	EM-8122	33-10126	EM-9527	37-10122	DS-6516	A2172	EM-2172	
35-9305	EM-8078	33-10133	EM-3037	37-10123	DS-6500	A2201	EM-5401	
35-9306	EM-8292	33-10149	EM-5734	37-10124	DS-6079	A2204	EM-2204	
35-9307	EM-5067	33-10189	EM-5844	<b>CARDONE</b>			A2205	EM-2205
35-9309	EM-8055	33-10197	EM-5846	4J4002M	ST-4908	A2206	EM-2206	
35-9310	EM-8259	33-10281	EM-5847	<b>DEA / MRC</b>			A2215	EM-2268
35-9311	EM-8512	33-10292	EM-5672	AM001	EM-90037	A2216	EM-2216	
35-9312	EM-8079	33-10293	EM-5132	AM002	EM-90040	A2217	EM-2217	
35-9314	EM-8224	33-10294	EM-5818	AM002	EM-90040	A2218	EM-2218	
35-9315	EM-9000	33-10295	EM-5647	AM013	EM-90033	A2219	EM-2219	
35-9316	EM-9004	33-10296	EM-5649	AM120	EM-90019	A2220	EM-2220	
35-9317	EM-9005	33-10297	EM-5835	AM152	EM-90027	A2221	EM-2221	
35-9318	EM-8593	33-10298	EM-9599	AM156	EM-90029	A2222	EM-2222	
35-9320	EM-8138	33-10300	EM-5837	AM158	EM-90028	A2223	EM-2223	
35-9321	EM-8402	33-10301	EM-9494	AM159	EM-90030	A2225	EM-2225	
35-9322	EM-8435	33-10302	EM-9420	AM160	EM-90008	A2226	EM-2226	
35-9323	EM-8103	33-10305	EM-9299	AM169	EM-90009	A2227	EM-2227	
35-9324	EM-8132	33-10306	EM-9427	AM200	EM-90011	A2228	EM-2228	
35-9325	EM-8119	33-10307	EM-9423	AM205	EM-90010	A2231	EM-2231	
35-9326	EM-8641	33-10308	EM-3096	AM206	EM-90003	A2234	EM-2234	
35-9327	EM-8641	33-10309	EM-4018	AM207	EM-90006	A2235	EM-2235	
35-9328	EM-8209	33-10310	EM-9313	AM222	EM-90015	A2236	EM-2349	
35-9329	EM-8270	33-10311	EM-9454	AM233	EM-5682	A2238	EM-2238	
35-9330	EM-8164	33-10312	EM-5861	AM247	EM-90021	A2239	EM-2282	
35-9331	EM-8349	33-10312	EM-9546	AM305	EM-90004	A2240	EM-2240	
35-9332	EM-8213	33-10313	EM-9538	AM308	EM-90038	A2241	EM-2241	
35-9333	EM-8283	33-10389	EM-5851	AM309	EM-90032	A2242	EM-2242	

# CROSS REFERENCE

Mfg Part No	Our Part	Mfg Part No	Our Part	Mfg Part No	Our Part	Mfg Part No	Our Part
DEA / MRC (cont.)		DEA / MRC (cont.)		DEA / MRC (cont.)		DEA / MRC (cont.)	
A2244	EM-2287	A2323	EM-2323	A2402	EM-2402	A2479	EM-2457
A2245	EM-2142	A2324	EM-2324	A2403	EM-2403	A2480	EM-2458
A2246	EM-2142	A2325	EM-2325	A2404	EM-2404	A2481	EM-2457
A2247	EM-2240	A2326	EM-2326	A2405	EM-2405	A2482	EM-2457
A2248	EM-2241	A2327	EM-2327	A2406	EM-2406	A2483	EM-2458
A2249	EM-2249	A2328	EM-2328	A2407	EM-2407	A2484	EM-2458
A2250	EM-2250	A2329	EM-2329	A2408	EM-2408	A2485	EM-2458
A2253	EM-2253	A2330	EM-2330	A2409	EM-2409	A2486	EM-2458
A2254	EM-2254	A2331	EM-2331	A2410	EM-2410	A2487	EM-2487
A2255	EM-2255	A2332	EM-2332	A2411	EM-9076	A2488	EM-2488
A2256	EM-2256	A2333	EM-2333	A2413	EM-2413	A2489	EM-2489
A2257	EM-2257	A2334	EM-2250	A2414	EM-2414	A2490	EM-2490
A2258	EM-2253	A2335	EM-2335	A2415	EM-2415	A2491	EM-2491
A2261	EM-2261	A2336	EM-2336	A2417	EM-2417	A2492	EM-2492
A2262	EM-2262	A2337	EM-2337	A2418	EM-2418	A2493	EM-2493
A2263	EM-2263	A2338	EM-2338	A2419	EM-2419	A2494	EM-2494
A2264	EM-2264	A2339	EM-2339	A2420	EM-2420	A2495	EM-2495
A2265	EM-2265	A2340	EM-2340	A2421	EM-2421	A2496	EM-2496
A2266	EM-2266	A2341	EM-2341	A2424	EM-2424	A2497	EM-2497
A2267	EM-2267	A2344	EM-2344	A2425	EM-2425	A2498	EM-2498
A2268	EM-2268	A2345	EM-2345	A2426	EM-2426	A2499	EM-2499
A2268C	EM-2268	A2346	EM-2346	A2427	EM-2427	A2500	EM-2500
A2270	EM-2270	A2347	EM-2347	A2428	EM-2428	A2501	EM-2501
A2271	EM-2271	A2348	EM-2348	A2429	EM-2429	A2502	EM-2502
A2272	EM-2272	A2349	EM-2349	A2433	EM-2433	A2503	EM-2503
A2273	EM-2274	A2350	EM-2350	A2434	EM-2434	A2504	EM-2504
A2274	EM-2274	A2351	EM-2351	A2435	EM-2436	A2505	EM-2505
A2275	EM-2275	A2353	EM-2353	A2436	EM-2436	A2506	EM-2506
A2276	EM-2276	A2356	EM-2356	A2437	EM-2437	A2507	EM-2395
A2277	EM-2277	A2357	EM-2357	A2438	EM-2438	A2508	EM-2508
A2278	EM-2278	A2358	EM-2358	A2439	EM-2439	A2509	EM-2436
A2279	EM-2279	A2359	EM-2359	A2440	EM-2440	A2510	EM-2510
A2280	EM-2280	A2360	EM-2360	A2441	EM-2441	A2511	EM-2466
A2281	EM-2281	A2361	EM-2349	A2442	EM-2442	A2512	EM-2512
A2282	EM-2282	A2362	EM-2362	A2444	EM-2444	A2513	EM-2513
A2283	EM-2283	A2363	EM-2363	A2445	EM-2445	A2514	EM-2515
A2284	EM-2284	A2364	EM-2364	A2446	EM-2446	A2515	EM-2515
A2285	EM-2285	A2365	EM-2365	A2447	EM-2447	A2516	EM-2394
A2286	EM-2286	A2366	EM-2525	A2448	EM-2448	A2517	EM-2292
A2287	EM-2287	A2367	EM-2367	A2449	EM-2449	A2518	EM-2501
A2288	EM-2288	A2368	EM-2368	A2450	EM-2451	A2519	EM-2500
A2289	EM-2289	A2369	EM-2369	A2451	EM-2451	A2520	EM-2501
A2290	EM-2290	A2370	EM-2370	A2452	EM-2452	A2521	EM-2500
A2291	EM-2291	A2371	EM-2371	A2453	EM-2453	A2522	EM-2501
A2292	EM-2292	A2372	EM-2372	A2454	EM-2454	A2523	EM-2500
A2293	EM-2293	A2373	EM-2373	A2455	EM-2600	A2524	EM-2524
A2294	EM-2294	A2374	EM-2374	A2456	EM-2456	A2525	EM-2525
A2295	EM-2295	A2375	EM-2375	A2457	EM-2457	A2526	EM-2528
A2296	EM-2296	A2376	EM-2376	A2458	EM-2458	A2527	EM-2528
A2297	EM-2297	A2377	EM-2370	A2459	EM-2459	A2528	EM-2528
A2298	EM-2298	A2378	EM-2378	A2460	EM-2460	A2529	EM-2497
A2299	EM-2299	A2379	EM-2379	A2461	EM-2461	A2530	EM-2388
A2300	EM-2512	A2381	EM-2381	A2462	EM-2462	A2531	EM-2531
A2301	EM-2301	A2382	EM-2382	A2463	EM-2463	A2532	EM-2532
A2302	EM-2302	A2383	EM-2382	A2464	EM-2464	A2533	EM-2533
A2303	EM-2303	A2384	EM-2384	A2465	EM-2436	A2534	EM-2534
A2304	EM-2304	A2385	EM-2385	A2466	EM-2466	A2535	EM-2436
A2305	EM-2305	A2387	EM-2387	A2467	EM-2467	A2536	EM-2536
A2306	EM-2306	A2388	EM-2388	A2468	EM-2469	A2537	EM-2537
A2307	EM-2307	A2389	EM-2389	A2469	EM-2469	A2538	EM-2538
A2309	EM-2309	A2390	EM-2389	A2470	EM-2470	A2539	EM-2538
A2310	EM-2310	A2391	EM-2391	A2471	EM-2471	A2540	EM-2538
A2311	EM-2311	A2392	EM-2392	A2472	EM-2472	A2541	EM-2538
A2314	EM-2369	A2393	EM-2393	A2473	EM-2473	A2542	EM-2538
A2316	EM-2316	A2394	EM-2394	A2474	EM-2474	A2543	EM-2543
A2317	EM-2317	A2395	EM-2395	A2475	EM-2549	A2544	EM-2531
A2319	EM-2319	A2396	EM-2396	A2476	EM-2550	A2545	EM-2457
A2320	EM-2320	A2400	EM-2400	A2477	EM-2477	A2546	EM-2458
A2321	EM-2321	A2401	EM-2401	A2478	EM-2381	A2547	EM-2458

# CROSS REFERENCE

Mfg Part No	Our Part	Mfg Part No	Our Part	Mfg Part No	Our Part	Mfg Part No	Our Part
DEA / MRC (cont.)		DEA / MRC (cont.)		DEA / MRC (cont.)		DEA / MRC (cont.)	
A2548	EM-2548S	A2636	EM-2636	A2707HY	EM-2707	A2776	EM-2776
A2548HY	EM-2548	A2637	EM-2637	A2708	EM-2708	A2777	EM-2777
A2549	EM-2549	A2638	EM-2638	A2709	EM-2709	A2778	EM-2778
A2550	EM-2550	A2639	EM-2639	A2710	EM-2710	A2779HY	EM-2779
A2551	EM-2551S	A2640	EM-2640	A2711	EM-2711S	A2780	EM-2780
A2551HY	EM-2551	A2641	EM-2641	A2711HY	EM-2711	A2781	EM-2781
A2552	EM-2551S	A2642	EM-2642	A2712	EM-2712S	A2782	EM-2782
A2552HY	EM-2551	A2643	EM-2643	A2712HY	EM-2712	A2783	EM-2783
A2553	EM-2553S	A2644	EM-2644	A2713	EM-2713	A2784	EM-2784
A2553HY	EM-2553	A2645	EM-2645	A2714	EM-2714	A2785	EM-2785
A2554	EM-2551S	A2646	EM-2646	A2715	EM-2715	A2786	EM-2786
A2554HY	EM-2551	A2647	EM-2646	A2716	EM-2716	A2787	EM-2351
A2555	EM-2555S	A2648	EM-2815	A2717	EM-2717S	A2788	EM-2788S
A2555HY	EM-2555	A2649	EM-2649	A2717HY	EM-2717	A2788HY	EM-2788
A2556	EM-2556S	A2650	EM-2650	A2718	EM-2718	A2789	EM-2789S
A2556HY	EM-2556	A2651	EM-2651	A2719	EM-2719	A2789HY	EM-2789
A2557	EM-2557	A2652	EM-2652	A2720	EM-2720	A2790	EM-2790S
A2558	EM-2558	A2653	EM-2653	A2721	EM-2721	A2790HY	EM-2790
A2559	EM-2559	A2654	EM-2654	A2722	EM-2722	A2791	EM-2791S
A2560	EM-2557	A2655	EM-2655	A2723	EM-2723	A2791HY	EM-2791
A2561	EM-2528	A2656	EM-2656	A2724	EM-2724	A2792	EM-2792S
A2562	EM-2562	A2657	EM-2657	A2725	EM-2725	A2792HY	EM-2792
A2563	EM-2563	A2658	EM-2658	A2726	EM-2726	A2793	EM-2793
A2564	EM-2564	A2659	EM-2659	A2727	EM-2727	A2794	EM-2794
A2565	EM-2565	A2660	EM-2660S	A2728	EM-2728	A2795	EM-2795S
A2566	EM-2566	A2660HY	EM-2660	A2730	EM-2730	A2795HY	EM-2795
A2567	EM-2567	A2661	EM-2661S	A2731	EM-2731	A2796	EM-2796S
A2568	EM-2568	A2661HY	EM-2661	A2732	EM-2731	A2796HY	EM-2796
A2569	EM-2569	A2662	EM-2662	A2733	EM-2733	A2797	EM-2797
A2570	EM-2570	A2663	EM-2663	A2734	EM-2734	A2798	EM-2798
A2571	EM-2571	A2664	EM-2664	A2735	EM-2735	A2799	EM-2799
A2572	EM-2572	A2665	EM-2665	A2736	EM-2736	A2800	EM-2800
A2573	EM-2528	A2666	EM-2639	A2737	EM-2737	A2801	EM-2801
A2600	EM-2600	A2667	EM-2667	A2738	EM-2738	A2802	EM-2802
A2601	EM-2601	A2668	EM-2668	A2739	EM-2739	A2803	EM-2803S
A2602	EM-2601	A2669	EM-2657	A2740	EM-2740	A2803HY	EM-2803
A2603	EM-2601	A2670	EM-2658	A2741	EM-2741	A2804	EM-2804
A2604	EM-2601	A2671	EM-2671	A2742	EM-2742	A2805	EM-2805
A2605	EM-2601	A2672	EM-2394	A2743	EM-2743	A2806	EM-2806
A2606	EM-2601	A2673	EM-2673	A2744	EM-2744	A2807	EM-2807
A2607	EM-2601	A2674	EM-2674	A2745	EM-2745	A2808	EM-2808
A2608	EM-2601	A2675	EM-2675	A2746	EM-2746	A2809	EM-2809
A2609	EM-2609	A2676	EM-2676	A2747	EM-2747	A2810	EM-2810
A2610	EM-2538	A2677	EM-2677	A2748	EM-2748	A2811	EM-2811
A2611	EM-2538	A2678	EM-2678	A2749	EM-2749	A2812	EM-2812S
A2612	EM-2538	A2679	EM-2679	A2750	EM-2750	A2812HY	EM-2812
A2613	EM-2538	A2680	EM-2680	A2751	EM-2751	A2813	EM-2813S
A2614	EM-2601	A2681	EM-2681	A2752	EM-2752	A2813HY	EM-2813
A2615	EM-2615	A2682	EM-2682	A2753	EM-2753	A2814	EM-2814
A2616	EM-2616	A2683	EM-2683	A2754	EM-2754	A2815	EM-2815
A2617	EM-2617	A2684	EM-2684	A2755	EM-2755	A2816	EM-2816
A2618	EM-2618	A2685	EM-2685	A2756	EM-2756	A2817	EM-2817
A2619	EM-2619	A2686	EM-2686	A2759	EM-2759	A2818	EM-2818
A2620	EM-2620	A2687	EM-2687	A2760	EM-2760	A2818HD	EM-2818
A2621	EM-2621	A2688	EM-2688	A2761	EM-2761	A2819	EM-2819
A2622	EM-2622	A2689	EM-2689	A2762	EM-2762	A2820	EM-2820
A2623	EM-2623	A2690	EM-2690	A2763	EM-2763	A2821	EM-2821S
A2624	EM-2624	A2691	EM-2691	A2764	EM-2764	A2821HY	EM-2821
A2625	EM-2625	A2692	EM-2692	A2765	EM-2765	A2822	EM-2822
A2626	EM-2626	A2693	EM-2693	A2766	EM-2766	A2823	EM-2823S
A2627	EM-2627	A2694HY	EM-2812	A2767	EM-2767	A2823HY	EM-2823
A2628	EM-2628	A2695HY	EM-2813	A2768	EM-2768	A2824	EM-2824S
A2629	EM-2629	A2696	EM-2696S	A2769	EM-2769	A2824HY	EM-2824
A2630	EM-2630	A2696HY	EM-2696	A2770	EM-2770	A2825	EM-2825
A2631	EM-2631	A2697	EM-2697S	A2771	EM-2771	A2826	EM-2826
A2632	EM-2632	A2697HY	EM-2697	A2772	EM-2772	A2827	EM-2827
A2633	EM-2633	A2698	EM-2698S	A2773	EM-2773	A2828	EM-2828
A2634	EM-2634	A2698HY	EM-2698	A2774	EM-2774	A2829	EM-2829
A2635	EM-2635	A2707	EM-2707S	A2775	EM-2775	A2830	EM-2830



# CROSS REFERENCE

Mfg Part No	Our Part	Mfg Part No	Our Part	Mfg Part No	Our Part	Mfg Part No	Our Part
DEA / MRC (cont.)		DEA / MRC (cont.)		DEA / MRC (cont.)		DEA / MRC (cont.)	
A2831	EM-2831	A2890HY	EM-2890	A2947	EM-2947	A3010	EM-3010
A2832	EM-2832	A2892	EM-2892S	A2948	EM-2948	A3011	EM-3011
A2833	EM-2833	A2892HY	EM-2892	A2949	EM-2949	A3014	EM-3014
A2834	EM-2834	A2893	EM-2893S	A2950	EM-2950	A3019	EM-3019
A2835	EM-2835	A2893HY	EM-2893	A2951	EM-2951	A3022	EM-3022
A2836	EM-2836S	A2894	EM-2894S	A2952	EM-2952	A3023	EM-3023
A2836HY	EM-2836	A2894HY	EM-2894	A2953	EM-2953	A3026	EM-3026
A2837	EM-2837S	A2895	EM-2895S	A2954	EM-2954	A3027	EM-3027
A2837HY	EM-2837	A2895HY	EM-2895	A2955	EM-2955	A3031	EM-3031
A2838	EM-2838S	A2896	EM-2896S	A2956	EM-2956	A3032	EM-3032
A2838HY	EM-2838	A2896HY	EM-2896	A2957	EM-2957	A3033	EM-3033
A2839	EM-2839	A2897	EM-2897S	A2958	EM-2958	A3034	EM-3034
A2840	EM-2840S	A2897HY	EM-2897	A2959	EM-2959	A3039	EM-3039
A2840HY	EM-2840	A2898	EM-2898	A2960	EM-2960	A3040	EM-3040
A2841	EM-2841S	A2899	EM-2899	A2961	EM-2961	A3041	EM-3041
A2841HY	EM-2841	A2900	EM-2900	A2962	EM-2962	A3042	EM-3042
A2842	EM-2842S	A2901	EM-2901	A2963	EM-2963	A3043	EM-3043
A2842HY	EM-2842	A2902	EM-2902S	A2964	EM-2964	A3044	EM-3044
A2843	EM-2843	A2902HY	EM-2902	A2965	EM-2965	A3047	EM-3047
A2844	EM-2844	A2903	EM-2903S	A2966	EM-2966	A3049	EM-3049
A2845	EM-2845	A2903HY	EM-2903	A2967	EM-2967S	A3052	EM-3052
A2846	EM-2846	A2904	EM-2904	A2967HY	EM-2967	A3054	EM-3054
A2847	EM-2847	A2905	EM-2905	A2968	EM-2968S	A3055	EM-3055
A2848	EM-2848	A2906	EM-2987	A2968HY	EM-2968	A3065	EM-3065
A2849	EM-2849	A2907	EM-2907	A2969	EM-2969	A3069	EM-3069
A2850	EM-2850	A2908	EM-2908	A2970	EM-2970	A3075HY	EM-3075
A2851	EM-2851	A2909	EM-2909	A2971	EM-2971	A3076HY	EM-3076
A2852	EM-2852	A2910	EM-2910S	A2972	EM-2972	A3078	EM-3078
A2853	EM-2853	A2910HY	EM-2910	A2973	EM-2973	A3079HY	EM-3079
A2854	EM-2854	A2911	EM-2911	A2974	EM-2974S	A3080HY	EM-3080
A2855	EM-2855	A2912	EM-2912	A2974HY	EM-2974	A3081	EM-3081
A2856	EM-2856	A2913	EM-2913	A2975	EM-2975	A3082	EM-3082
A2857	EM-2857	A2914	EM-2914	A2977	EM-2977	A3085HY	EM-3085
A2858	EM-2858	A2915	EM-2915	A2978	EM-2978	A3415	EM-5063
A2859	EM-2859S	A2916	EM-2916	A2979	EM-2979	A3416	EM-5064
A2859HY	EM-2859	A2917	EM-2917	A2980	EM-2980	A3417	EM-5065
A2860	EM-2860	A2918	EM-2918	A2981	EM-2981	A4000	EM-5518
A2861	EM-2861	A2919	EM-2919	A2982	EM-2982	A4001	EM-5528
A2862	EM-2862	A2920	EM-2920	A2983	EM-2983	A4002	EM-5553
A2863	EM-2863	A2921	EM-2921	A2984	EM-2984	A4003	EM-9244
A2864	EM-2864	A2922	EM-2922	A2985	EM-2985	A4004	EM-9580
A2866	EM-2866	A2923	EM-2923	A2986	EM-2986	A4005	EM-5734
A2867	EM-2867	A2924	EM-2924	A2987	EM-2987S	A4006	EM-9579
A2868	EM-2868	A2925	EM-2925	A2987HY	EM-2987	A4007	EM-5747
A2869	EM-2869	A2926	EM-2926S	A2988	EM-2988	A4008	EM-5877
A2870	EM-2870	A2926HY	EM-2926	A2989	EM-2989	A4009	EM-5877
A2871	EM-2871	A2927	EM-2927	A2990	EM-2990	A4010	EM-5884
A2872	EM-2872	A2928	EM-2928	A2991	EM-2991	A4011	EM-5885
A2873	EM-2873	A2929	EM-2929	A2992	EM-2992	A4012	EM-5886
A2873HY	EM-2873	A2930	EM-2930	A2993	EM-2993S	A4013	EM-5887
A2874	EM-2874	A2931	EM-2931	A2993HY	EM-2993	A4014	EM-5888
A2875	EM-2875	A2932	EM-2932S	A2994	EM-2994	A4015	EM-5889
A2876	EM-2876S	A2932HY	EM-2932	A2995	EM-2995	A4016	EM-5890
A2876HY	EM-2876	A2933	EM-2933	A2996	EM-2996S	A4017	EM-5859
A2878	EM-2878	A2934	EM-2934S	A2996HY	EM-2996	A4018	EM-5892
A2879	EM-2879S	A2934HY	EM-2934	A2997	EM-2997	A4019	EM-5893
A2879HY	EM-2879	A2935	EM-2935	A2998	EM-2998	A4020	EM-5894
A2880	EM-2880S	A2936	EM-2936	A2999	EM-2999	A4021	EM-5895
A2880HY	EM-2880	A2938	EM-2938S	A3000	EM-3000	A4022	EM-5896
A2881	EM-2881	A2938HY	EM-2938	A3001	EM-3001	A4023	EM-7130
A2882	EM-2882	A2939	EM-2939	A3002	EM-3002	A4026	EM-5922
A2883	EM-2883	A2940	EM-2940	A3003	EM-3003S	A4027	EM-7025
A2884	EM-2884	A2941	EM-2941	A3003HY	EM-3003	A4028	EM-5947
A2885	EM-2885	A2942	EM-2942S	A3004	EM-3004	A4029	EM-3189
A2886	EM-2886	A2942HY	EM-2942	A3005	EM-3005	A4030	EM-3190
A2887	EM-2887	A2943	EM-2943S	A3006	EM-3006	A4032	EM-5860
A2888	EM-2888	A2943HY	EM-2943	A3007	EM-3007	A4033	EM-7020
A2889	EM-2889	A2944	EM-2944	A3008	EM-3008	A4038	EM-5993
A2890	EM-2890S	A2945	EM-2945	A3009	EM-3009	A4041	EM-7194

# CROSS REFERENCE

Mfg Part No	Our Part	Mfg Part No	Our Part	Mfg Part No	Our Part	Mfg Part No	Our Part
DEA / MRC (cont.)		DEA / MRC (cont.)		DEA / MRC (cont.)		DEA / MRC (cont.)	
A4043	EM-9096	A4258	EM-5874	A4328	EM-5772	A4430	EM-7022
A4045	EM-5972	A4259	EM-9538	A4329	EM-5773	A4431	EM-7044
A4046	EM-7265	A4260	EM-9599	A4330	EM-5774	A4433	EM-7239
A4051	EM-7069	A4261	EM-9590	A4331	EM-9471	A4435	EM-5943
A4058	EM-7159	A4262	EM-7039	A4332	EM-5776	A4438	EM-7235
A4062	EM-7156	A4263	EM-9494	A4333	EM-5777	A4439	EM-7172
A4064	EM-7132	A4265	EM-9420	A4334	EM-5778	A4440	EM-7018
A4066	EM-5844	A4266	EM-9546	A4335	EM-5779	A4441	EM-7264
A4070	EM-7242	A4267	EM-5901	A4336	EM-9448	A4500	EM-9137
A4074	EM-7280	A4268	EM-9599	A4338	EM-5780	A4501	EM-8374
A4090	EM-7290	A4269	EM-9210	A4339	EM-9446	A4502	EM-5400
A4200	EM-9192	A4270	EM-5900	A4340	EM-9465	A4503	EM-5376
A4201	EM-9179	A4271	EM-9436	A4341	EM-5948	A4504	EM-9168
A4202	EM-9173	A4272	EM-7010	A4342	EM-9471	A4505	EM-9150
A4203	EM-9211	A4273	EM-9421	A4343	EM-9482	A4506	EM-9205
A4204	EM-9148	A4274	EM-5750	A4344	EM-9506	A4507	EM-9149
A4205	EM-9227	A4275	EM-9500	A4345	EM-9456	A4508	EM-9175
A4206	EM-5206	A4276	EM-5751	A4346	EM-7072	A4508	EM-9396
A4207	EM-9165	A4277	EM-5752	A4347	EM-5781	A4509	EM-9152
A4208	EM-8164	A4278	EM-5819	A4348	EM-5782	A4510	EM-9151
A4209	EM-9231	A4279	EM-5753	A4349	EM-9483	A4511	EM-9204
A4210	EM-9235	A4280	EM-5754	A4350	EM-9444	A4512	EM-5385
A4211	EM-5141	A4281	EM-5755	A4351	EM-9452	A4513	EM-9183
A4212	EM-9212	A4282	EM-5756	A4352	EM-9453	A4514	EM-9169
A4213	EM-5448	A4283	EM-5757	A4353	EM-5865	A4515	EM-5449
A4214	EM-5198	A4284	EM-5741	A4354HY	EM-5867	A4516	EM-9194
A4215	EM-9388	A4285	EM-5758	A4355HY	EM-5869	A4517	EM-9297
A4216	EM-9226	A4286	EM-5759	A4356HY	EM-5870	A4518	EM-9202
A4217	EM-8189	A4287	EM-9239	A4357	EM-9577	A4519	EM-9441
A4218	EM-9163	A4288	EM-9236	A4359	EM-9589	A4520	EM-9172
A4219	EM-9484	A4289	EM-5761	A4360	EM-7013	A4521	EM-9178
A4220	EM-9155	A4290	EM-5762	A4361	EM-5969	A4522	EM-9128
A4221	EM-9164	A4291	EM-7011	A4362	EM-9228	A4522HY	EM-9128
A4222	EM-9053	A4292	EM-5763	A4363	EM-7294	A4523	EM-9300
A4223	EM-9053	A4293	EM-5764	A4364	EM-7204	A4524	EM-9215
A4224	EM-5399	A4294	EM-5143	A4365HY	EM-5866	A4525	EM-9214
A4225	EM-5384	A4295	EM-9237	A4366	EM-7205	A4526HY	EM-9247
A4226	EM-9492	A4296	EM-5766	A4368	EM-7008	A4527HY	EM-9451
A4227	EM-8365	A4297	EM-5767	A4369	EM-7128	A4528	EM-9433
A4228	EM-8401	A4298	EM-5768	A4370	EM-7193	A4529	EM-5471
A4229	EM-5356	A4299	EM-5769	A4371HY	EM-7175	A4530	EM-9280
A4230	EM-9157	A4300	EM-8994	A4400	EM-8909	A4531	EM-9301
A4231	EM-5653	A4301	EM-9217	A4401	EM-9469	A4532	EM-9298
A4232	EM-5467	A4302	EM-9180	A4402	EM-5375	A4533	EM-9299
A4233	EM-8200	A4303	EM-9176	A4403	EM-5362	A4534	EM-9218
A4234	EM-5367	A4304	EM-9171	A4404	EM-9196	A4535	EM-9302
A4235HY	EM-5921	A4305	EM-9229	A4405	EM-9222	A4536	EM-9303
A4236	EM-9197	A4307	EM-7080	A4406	EM-9466	A4537	EM-9285
A4237	EM-9249	A4308	EM-9228	A4407	EM-9461	A4538	EM-9286
A4238	EM-9279	A4309	EM-7115	A4408	EM-9468	A4539	EM-9277
A4239HY	EM-5842	A4310	EM-5468	A4409	EM-9527	A4540	EM-9282
A4240	EM-9234	A4311	EM-8682	A4410	EM-9472	A4541	EM-9250
A4241	EM-9233	A4312	EM-9230	A4411	EM-5909	A4542	EM-9225
A4242	EM-9232	A4313	EM-5405	A4413	EM-8074	A4543	EM-9213
A4243	EM-9284	A4314	EM-5556	A4414	EM-5923	A4544	EM-9220
A4244	EM-9246	A4315	EM-8887	A4415	EM-7043	A4545	EM-9205
A4245	EM-5403	A4316	EM-5770	A4416	EM-5563	A4546	EM-9216
A4246	EM-5647	A4317	EM-9442	A4417	EM-5658	A4547	EM-9487
A4247	EM-5554	A4318	EM-9228	A4418	EM-5783	A4548	EM-5689
A4248	EM-9454	A4319	EM-5561	A4419	EM-9507	A4549	EM-9424
A4249	EM-5749	A4320	EM-9422	A4420	EM-9534	A4550	EM-5510
A4250	EM-5649	A4321	EM-9414	A4421	EM-5864	A4551	EM-9299
A4251	EM-9541	A4322EL	EM-5655	A4422	EM-5863	A4552	EM-9437
A4252	EM-8643	A4323	EM-5656	A4423	EM-9536	A4553	EM-9431
A4253	EM-5646	A4324	EM-5657	A4424	EM-9539	A4554	EM-7038
A4254	EM-5654	A4325	EM-9248	A4425	EM-9537	A4555	EM-9411
A4255	EM-9546	A4325EL	EM-5748	A4427	EM-7046	A4557	EM-9427
A4256	EM-7041	A4326	EM-9573	A4428	EM-7241	A4558	EM-9530
A4257	EM-5835	A4327	EM-5771	A4429	EM-4074	A4559	EM-9423

# CROSS REFERENCE

Mfg Part No	Our Part	Mfg Part No	Our Part	Mfg Part No	Our Part	Mfg Part No	Our Part
DEA / MRC (cont.)		DEA / MRC (cont.)		DEA / MRC (cont.)		DEA / MRC (cont.)	
A4561	EM-9459	A4634	EM-8243	A5182	EM-3029	A5292	EM-3057
A4562	EM-9490	A4635	EM-5575	A5183	EM-3030	A5293	EM-3037
A4563	EM-5785	A4637	EM-9207	A5198	EM-3053	A5294	EM-2944
A4564	EM-5786	A4638	EM-5927	A5199	EM-3035	A5295	EM-3047
A4565	EM-9488	A4639	EM-9304	A5200	EM-2972	A5296	EM-3048
A4566	EM-5787	A4640	EM-5796	A5203	EM-5103	A5297	EM-3062
A4567	EM-9413	A4641	EM-5797	A5204	EM-5104	A5298	EM-3061
A4568	EM-5789	A4642	EM-5798	A5205	EM-5177	A5299	EM-3084
A4570	EM-9443	A4643	EM-5928	A5207	EM-5105	A5300	EM-5182
A4572	EM-9457	A4644	EM-5857	A5208	EM-5383	A5301	EM-3050
A4573	EM-9445	A4645	EM-5876	A5209	EM-5107	A5302HY	EM-3020
A4574	EM-5792	A4646	EM-9088	A5211	EM-2960	A5303	EM-3036
A4575	EM-5793	A4647	EM-5929	A5212	EM-5052	A5304	EM-3056
A4575EL	EM-5793	A4648	EM-5856	A5213	EM-2899	A5305	EM-5085
A4577	EM-9439	A4649	EM-5924	A5214	EM-2977	A5306	EM-3095
A4579	EM-9473	A4653	EM-5912	A5215	EM-2915	A5308	EM-3129
A4580	EM-9479	A4655	EM-7017	A5216	EM-2931	A5309	EM-3088
A4581	EM-9409	A4700	EM-8920	A5217	EM-3002	A5310	EM-5380
A4582	EM-9434	A4701	EM-8916	A5218	EM-3001	A5311	EM-3046
A4583	EM-5795	A4702	EM-8925	A5219B	EM-5106	A5312	EM-3103
A4583EL	EM-5795	A4703	EM-8930	A5221	EM-5732	A5313	EM-3028
A4584	EM-9428	A4704	EM-8923	A5223	EM-5079	A5314	EM-3064
A4585	EM-9617	A4705	EM-8919	A5224	EM-2896	A5315	EM-5422
A4587	EM-9415	A4706	EM-8915	A5225	EM-2895	A5316	EM-5350
A4588	EM-9385	A4707	EM-8921	A5227	EM-2995	A5317HY	EM-5352
A4589	EM-9386	A4708	EM-8917	A5228	EM-2961	A5318	EM-3124
A4590	EM-9435	A4709	EM-8923	A5229	EM-5181	A5319	EM-3070
A4591	EM-5915	A4711	EM-8918	A5231	EM-2952	A5320	EM-3045
A4592	EM-9450	A4901	EM-7043	A5232	EM-2902	A5322	EM-3087
A4593	EM-9440	A4909	EM-7176	A5233	EM-3017	A5323HY	EM-3093
A4594	EM-9438	A4911	EM-7075	A5234	EM-3068	A5324	EM-3110
A4595	EM-9496	A4912HY	EM-7191	A5235	EM-3083	A5325	EM-5475
A4596	EM-9426	A4919	EM-7268	A5236	EM-5075	A5326	EM-5377
A4597	EM-9417	A4920	EM-7202	A5237	EM-5074	A5327	EM-5423
A4598	EM-9397	A5003HY	EM-2943	A5238	EM-3059	A5329	EM-5551
A4599HY	EM-5984	A5006	EM-2959	A5239	EM-3060	A5330	EM-5578
A4600	EM-9174	A5007	EM-2964	A5240	EM-5089	A5338	EM-5424
A4601	EM-5081	A5009	EM-2911	A5241	EM-2958	A5339	EM-5425
A4602	EM-9184	A5011	EM-2940	A5242	EM-2974	A5341	EM-5426
A4603	EM-5159	A5012	EM-2941	A5243	EM-2973	A5342	EM-5427
A4604	EM-9394	A5013	EM-2912	A5248	EM-2939	A5346	EM-5428
A4605	EM-8685	A5017	EM-5067	A5251	EM-5080	A5347	EM-3128
A4606	EM-9188	A5018	EM-5068	A5253	EM-3063	A5348	EM-5476
A4607	EM-9154	A5020	EM-5087	A5254	EM-3077	A5350HY	EM-3113
A4608	EM-9153	A5021	EM-5392	A5260	EM-3050	A5351	EM-3115
A4610	EM-9485	A5024	EM-5148	A5261	EM-5078	A5353HY	EM-3147
A4611	EM-9384	A5024HY	EM-5148	A5263	EM-3104	A5354HY	EM-3097
A4612	EM-9162	A5026	EM-5473	A5265	EM-3067	A5355	EM-3094
A4613	EM-5420	A5028	EM-2901	A5271	EM-3038	A5356HY	EM-3096
A4614	EM-5349	A5029	EM-2900	A5272	EM-3071	A5357	EM-5659
A4615	EM-9186	A5030	EM-2945	A5273	EM-3072	A5358	EM-2927
A4616	EM-9187	A5031	EM-2920	A5274	EM-5026	A5359	EM-5582
A4617	EM-9170	A5034	EM-5450	A5275	EM-5031S	A5360	EM-3102
A4618	EM-9189	A5035	EM-5388	A5276	EM-5032	A5361	EM-2928
A4619	EM-9191	A5095	EM-5111	A5277	EM-5033	A5362	EM-2947
A4620	EM-9193	A5101	EM-9064	A5278	EM-5028	A5363	EM-2947
A4621	EM-9161	A5102	EM-5353	A5279	EM-5381	A5364	EM-2949
A4622	EM-5452	A5103	EM-2620	A5280	EM-3016	A5365	EM-5583
A4623	EM-8792	A5104	EM-2817	A5281	EM-3013	A5366	EM-3121
A4624	EM-9305	A5106	EM-5083	A5282	EM-3012	A5367	EM-3122
A4625	EM-9199	A5109	EM-5354	A5283	EM-5180	A5368	EM-5645
A4626	EM-9201	A5117	EM-5108	A5284	EM-3015	A5369	EM-3116
A4627	EM-9278	A5118	EM-5109	A5285	EM-3025	A5370	EM-3117
A4628	EM-9281	A5123	EM-8068	A5286	EM-3024	A5371	EM-3089
A4629	EM-9382	A5132	EM-3125	A5287	EM-3018	A5372	EM-3090
A4630	EM-9383	A5137	EM-3021	A5288	EM-3051	A5373	EM-3123
A4631	EM-9387	A5151	EM-2979	A5289	EM-3074	A5374	EM-3086
A4632	EM-9206	A5169	EM-2910	A5290	EM-3073	A5375	EM-3119
A4633	EM-5574	A5181	EM-2951	A5291	EM-3066	A5376	EM-3100

# CROSS REFERENCE

Mfg Part No	Our Part	Mfg Part No	Our Part	Mfg Part No	Our Part	Mfg Part No	Our Part
DEA / MRC (cont.)		DEA / MRC (cont.)		DEA / MRC (cont.)		DEA / MRC (cont.)	
A5378	EM-3114	A5448	EM-4002	A5528	EM-4102	A5632	EM-4107
A5379	EM-3105	A5449	EM-4003	A5529	EM-4103	A5633	EM-4135
A5380	EM-3106	A5450	EM-4004	A5530	EM-3195	A5634	EM-4125
A5381	EM-3107	A5451	EM-4005	A5532	EM-3199	A5635	EM-4138
A5382	EM-3098	A5452	EM-4006	A5533	EM-4021	A5638	EM-4176
A5384	EM-3108	A5453	EM-4007	A5534	EM-4112	A5639	EM-4243
A5385	EM-3109	A5454HY	EM-3160	A5535	EM-3200	A5640	EM-4226
A5386HY	EM-3112	A5455HY	EM-3149	A5536	EM-3197	A5642	EM-4160
A5387	EM-3140	A5456HY	EM-3148	A5537	EM-3198	A5649	EM-4157
A5388	EM-5587	A5458HY	EM-4036	A5538	EM-3201	A5651	EM-4115
A5389	EM-5588	A5459	EM-3161	A5539	EM-3179	A5652	EM-4185
A5390	EM-3138	A5460HY	EM-3160	A5540	EM-4128	A5655	EM-4177
A5391	EM-5521	A5461	EM-3162	A5541	EM-4104	A5657	EM-4142
A5392	EM-3091	A5462	EM-4126	A5542	EM-4186	A5663HY	EM-4139
A5393	EM-2993	A5463	EM-9489	A5543	EM-4107	A5663HY	EM-4298
A5394	EM-5591	A5464	EM-4041	A5545	EM-4053	A5665	EM-4050
A5395	EM-3092	A5465	EM-3155	A5546	EM-4110	A5671	EM-4213
A5396	EM-3111	A5466	EM-3159	A5547	EM-4258	A5674	EM-4239
A5397	EM-3120	A5468	EM-4096	A5548HY	EM-4035	A5676	EM-4223
A5398	EM-3118	A5469	EM-3168	A5549HY	EM-4037	A5677	EM-4195
A5399	EM-5596	A5470	EM-4016	A5550	EM-4105	A5678	EM-4194
A5400	EM-5673	A5471	EM-4015	A5551	EM-4113	A5681	EM-4237
A5401	EM-5660	A5472	EM-4206	A5553	EM-4155	A5682	EM-4238
A5402	EM-5661	A5473	EM-4044	A5556	EM-4146	A5686	EM-4179
A5403	EM-5662	A5474	EM-4034	A5558	EM-4023	A5687	EM-4178
A5404	EM-5663	A5475	EM-4100	A5559	EM-4141	A5707	EM-4175
A5405	EM-5664	A5476	EM-3157	A5560	EM-4241	A5710	EM-4252
A5406	EM-5692	A5478	EM-4060	A5561	EM-4225	A5712	EM-4220
A5407	EM-5665	A5479	EM-4049	A5562	EM-4111	A5716	EM-4249
A5408	EM-5693	A5480	EM-4011	A5563	EM-4049	A5720	EM-4189
A5409	EM-5694	A5481	EM-4071	A5566	EM-4074	A5731	EM-4143
A5410	EM-4018	A5482	EM-4012	A5568	EM-4055	A5732	EM-4214
A5411	EM-4051	A5485	EM-3136	A5569	EM-4056	A5733	EM-4215
A5412	EM-4019	A5486	EM-3183	A5570	EM-4059	A5734	EM-4140
A5413	EM-3151	A5487	EM-3165	A5571	EM-4208	A5738	EM-4174
A5414	EM-3150	A5488	EM-4172	A5572	EM-4058	A5739	EM-4173
A5415	EM-3130	A5489	EM-4127	A5572	EM-4146	A5740	EM-4067
A5416	EM-3131	A5490	EM-4022	A5573	EM-4167	A5750	EM-4228
A5417	EM-3145	A5491HY	EM-3166	A5575	EM-4124	A5822	EM-4240
A5418	EM-3134	A5492HY	EM-3158	A5576	EM-4106	A5823	EM-4240
A5419	EM-3137	A5493	EM-4013	A5577	EM-4077	A6001	DS-8468
A5420	EM-3152	A5494	EM-4043	A5581	EM-4073	A6002	DS-8587
A5421	EM-3154	A5495	EM-4082	A5583	EM-4034	A6003	DS-8532
A5422	EM-3177	A5497	EM-4101	A5584	EM-2984	A6004	DS-8588
A5423	EM-3132	A5499HY	EM-4253	A5585	EM-4122	A6005	DS-8474
A5424	EM-3136	A5500	EM-3202	A5589	EM-4132	A6006	DS-8473
A5425	EM-3142	A5501	EM-3194	A5590	EM-4027	A6007	DS-8549
A5426	EM-3143	A5502	EM-3196	A5592	EM-4190	A6008	DS-8470
A5427	EM-3127	A5503	EM-4045	A5593	EM-4256	A6009	DS-8473
A5428	EM-3133	A5504	EM-4046	A5594	EM-4047	A6010	DS-8591
A5429	EM-4040	A5505	EM-4079	A5596	EM-4227	A6011	DS-8469
A5430	EM-4076	A5506	EM-4078	A5598	EM-4134	A6012	DS-8471
A5431	EM-3144	A5507	EM-3193	A5599	EM-4028	A6013	DS-8475
A5432	EM-4000	A5510	EM-4054	A5603	EM-4251	A6014	DS-8509
A5433	EM-4095	A5511	EM-4267	A5605	EM-4081	A6015	DS-8535
A5434	EM-3126	A5514	EM-3026	A5606	EM-4184	A6016	DS-8550
A5435	EM-4061	A5515	EM-4154	A5609	EM-4156	A6017	DS-8551
A5436	EM-4062	A5516	EM-4072	A5611	EM-4168	A6019	DS-8565
A5437	EM-3146	A5517	EM-3175	A5612	EM-4121	A6020	DS-8626
A5438	EM-3139	A5518	EM-4038	A5614	EM-4120	A6021	DS-8634
A5439	EM-3153	A5519	EM-4039	A5615	EM-4123	A6022	DS-8635
A5440	EM-4017	A5520	EM-4057	A5616	EM-4068	A6023	DS-8636
A5441	EM-4117	A5521	EM-4130	A5618	EM-4064	A6024	DS-6024
A5442HY	EM-5746	A5522	EM-4150	A5620	EM-4153	A6025	DS-8627
A5443	EM-3167	A5523	EM-4029	A5621	EM-4168	A6027	DS-6027
A5444	EM-3141	A5524	EM-4065	A5623	EM-4216	A6028	DS-6028
A5445	EM-4094	A5525	EM-4042	A5625	EM-4116	A6029	DS-5230
A5446	EM-4033	A5526	EM-4151	A5630	EM-4149	A6030	DS-5223
A5447	EM-4001	A5527	EM-4109	A5631	EM-4152	A6031	DS-5234

# CROSS REFERENCE

Mfg Part No	Our Part	Mfg Part No	Our Part	Mfg Part No	Our Part	Mfg Part No	Our Part
DEA / MRC (cont.)		DEA / MRC (cont.)		DEA / MRC (cont.)		DEA / MRC (cont.)	
A6031	DS-6031	A6132	EM-8599	A6218	EM-8210	A6292	EM-8392
A6032	DS-5235	A6133	EM-8598	A6219	EM-8186	A6293	EM-8214
A6034	DS-6509	A6134	EM-8041	A6220	EM-8185	A6294	EM-2748
A6035	DS-6035	A6135	EM-8786	A6221	EM-9117	A6295	EM-8375
A6037	DS-6037	A6136	EM-8790	A6222	EM-8193	A6297	EM-8492
A6038	DS-6038	A6137	EM-8759	A6223	EM-8188	A6298	EM-8395
A6039	DS-5236	A6138	EM-8596	A6224	EM-5810	A6299	EM-8393
A6040	DS-6040	A6139	EM-8676	A6225	EM-8187	A6301	EM-8303
A6042	DS-6042	A6140	EM-8680	A6226	EM-8187	A6302	EM-8137
A6048	DS-6048	A6142	EM-8103	A6227	EM-8180	A6303	EM-8125
A6049	DS-6049	A6142IN	EM-8553	A6228	EM-8183	A6304	EM-8133
A6050	DS-6050	A6143	EM-8042	A6230	EM-8192	A6305	EM-8142
A6051	DS-6051	A6144	EM-8741	A6231	EM-8194	A6306	EM-8284
A6052	DS-6052	A6145	EM-8738	A6232	EM-8201	A6307	EM-8154
A6053	DS-6053	A6146	EM-8764	A6233	EM-8190	A6308	EM-8304
A6056	DS-6056	A6147	EM-8762	A6234	EM-8190	A6309	EM-8304
A6061	DS-6061	A6148	EM-8780	A6235	EM-8200	A6310	EM-8304
A6062	DS-6062	A6149	EM-8781	A6236	EM-8422	A6311	EM-8148
A6063	DS-6063	A6150	EM-8932	A6237	EM-8430	A6312	EM-8149
A6064	DS-6064	A6151	EM-8672	A6238	EM-8344	A6313	EM-8427
A6065	DS-6065	A6152	EM-8752	A6239	EM-8175	A6314	EM-8133
A6066	DS-6066	A6153	EM-8677	A6240	EM-8171	A6315	EM-8135
A6067	DS-6079	A6154	EM-8751	A6241	EM-8166	A6316	EM-5170
A6068	DS-6068	A6156	EM-8736	A6242	EM-8179	A6318	EM-8137
A6069	DS-8538	A6157	EM-8721	A6243	EM-9116	A6320	EM-8604
A6070	DS-5227	A6158	EM-8255	A6244	EM-8170	A6321	EM-8605
A6071	DS-5225	A6160	EM-8254	A6245	EM-8176	A6323	EM-8140
A6072	DS-5234	A6161	EM-8734	A6246	EM-8361	A6324	EM-8701
A6085	DS-6511	A6162	EM-8941	A6246HY	EM-8361	A6325	EM-8132
A6086	DS-6512	A6163	EM-8044	A6247	EM-8414	A6326	EM-8128
A6087	DS-6500	A6164	EM-8936	A6248	EM-8208	A6329	EM-9040
A6089	DS-6076	A6165	EM-8674	A6249	EM-8363	A6330	EM-8141
A6091	DS-6072	A6166	EM-8675	A6250	EM-8166	A6331	EM-8130
A6092	DS-6077	A6167	EM-8678	A6251	EM-8398	A6333	EM-8118
A6093	DS-6085	A6169	EM-8719	A6252	EM-8711	A6334	EM-9049
A6094	DS-5229	A6170	EM-8595	A6253	EM-8209	A6335	EM-9025
A6095	DS-6095	A6171	EM-8775	A6254	EM-9146	A6336	EM-5171
A6097	DS-6078	A6172	EM-8756	A6255	EM-8162	A6338	EM-8600
A6099	DS-6099	A6176	EM-8742	A6256	EM-8979	A6339	EM-8601
A6100	EM-8803	A6178	EM-8745	A6257	EM-8644	A6340	EM-8602
A6101	EM-8744	A6179	EM-8746	A6258	EM-8191	A6341	EM-8603
A6103	EM-8747	A6180	EM-8748	A6259	EM-8415	A6342	EM-8704
A6104	EM-8715	A6181	EM-8937	A6260	EM-8178	A6343	EM-8705
A6105	EM-8716	A6182	EM-8940	A6261	EM-8177	A6344	EM-8114
A6106	EM-8717	A6185	EM-8935	A6264	EM-8278	A6344HY	EM-8114
A6107	EM-8718	A6186	EM-9296	A6265	EM-8279	A6345	EM-8682
A6108	EM-8722	A6187	EM-8791	A6267	EM-5454	A6346	EM-8681
A6109	EM-8723	A6188	EM-8743	A6268	EM-8212	A6347	EM-8124
A6110	EM-8938	A6189	EM-8750	A6270	EM-8165	A6348	EM-8276
A6112	EM-8726	A6190	EM-8753	A6271	EM-8168	A6349	EM-8324
A6112	EM-8939	A6191	EM-8754	A6272	EM-8169	A6350	EM-8295
A6113	EM-8727	A6192	EM-8755	A6273	EM-8174	A6351	EM-8121
A6114	EM-8728	A6193	EM-8757	A6274	EM-8508	A6352	EM-8151
A6115	EM-8729	A6194	EM-8758	A6275	EM-8207	A6353	EM-8566
A6116	EM-8730	A6195	EM-8790	A6276	EM-8213	A6354	EM-8312
A6117	EM-8731	A6196	EM-8944	A6277	EM-8485	A6355	EM-8296
A6118	EM-8732	A6198	EM-8957	A6277HY	EM-8485	A6356	EM-8138
A6119	EM-8733	A6199	EM-8956	A6278	EM-8375	A6357	EM-8310
A6121	EM-8934	A6204	EM-8648	A6279	EM-8488	A6358	EM-8152
A6122	EM-8045	A6206	EM-5042	A6280	EM-5370	A6359	EM-5165
A6123	EM-5453	A6208	EM-8173	A6281	EM-8280	A6360	EM-8117
A6124	EM-5398	A6209	EM-8218	A6282	EM-8163	A6361	EM-8119
A6125	EM-8044	A6210	EM-8189	A6283	EM-5455	A6363	EM-9033
A6126	EM-8039	A6211	EM-8195	A6284	EM-8181	A6364	EM-9033
A6127	EM-8047	A6213	EM-8233	A6285	EM-8377	A6365	EM-8145
A6128	EM-8040	A6214	EM-2410	A6286	EM-8389	A6368	EM-5163
A6129	EM-8253	A6215	EM-8181	A6288	EM-5200	A6369	EM-5387
A6130	EM-8255	A6216	EM-8197	A6290	EM-5456	A6371	EM-9038
A6131	EM-8597	A6217	EM-8198	A6291	EM-8650	A6372	EM-8961

# CROSS REFERENCE

Mfg Part No	Our Part	Mfg Part No	Our Part	Mfg Part No	Our Part	Mfg Part No	Our Part
DEA / MRC (cont.)		DEA / MRC (cont.)		DEA / MRC (cont.)		DEA / MRC (cont.)	
A6373	EM-5162	A6458	EM-8234	A6530	EM-8432	A6603	EM-8292
A6374	EM-8963	A6460	EM-8074	A6531	EM-8002	A6604	EM-8107
A6375	EM-8323	A6461	EM-8516	A6532	EM-5329	A6605	EM-8102
A6377	EM-8276	A6462	EM-8457	A6533	EM-9136	A6606	EM-8205
A6379	EM-8150	A6463	EM-8691	A6534	EM-8021	A6607	EM-8238
A6380	EM-8115	A6464	EM-8978	A6535	EM-8614	A6608	EM-8206
A6381	EM-7001	A6465	EM-8977	A6536	EM-8615	A6609	EM-5098
A6381	EM-8322	A6466	EM-8263	A6537	EM-8802	A6610	EM-8105
A6382	EM-8311	A6467	EM-8578	A6538	EM-8025	A6611	EM-8102
A6383	EM-8307	A6468	EM-5156	A6539	EM-8293	A6612	EM-8582
A6384	EM-8144	A6469	EM-8095	A6540	EM-8029	A6613	EM-8099
A6385	EM-8157	A6470	EM-8062	A6541	EM-5326	A6614	EM-8467
A6386	EM-8962	A6471	EM-8063	A6542	EM-9055	A6615	EM-8466
A6387	EM-8310	A6473	EM-9007	A6543	EM-5379	A6616	EM-8098
A6388	EM-8317	A6474	EM-8814	A6544	EM-8009	A6617	EM-8242
A6389	EM-5481	A6475	EM-8813	A6545	EM-8411	A6618	EM-8272
A6390	EM-9042	A6476	EM-9476	A6546	EM-9084	A6618IN	EM-5739
A6391	EM-9028	A6477	EM-9130	A6547	EM-8011	A6619	EM-8267
A6392	EM-9010	A6478	EM-8425	A6548	EM-8349	A6621	EM-8097
A6394	EM-8683	A6479	EM-8884	A6549	EM-8404	A6622	EM-8100
A6398	EM-8122	A6480	EM-5155	A6550	EM-8572	A6623	EM-8106
A6403	EM-8693	A6481	EM-9072	A6551	EM-8330	A6624	EM-8584
A6404	EM-8460	A6482	EM-8863	A6552	EM-8974	A6625	EM-8104
A6405	EM-8075	A6483	EM-8864	A6553	EM-8525	A6626	EM-8696
A6406	EM-8516	A6484	EM-8868	A6554	EM-9067	A6627	EM-8248
A6407	EM-8055	A6485	EM-8882	A6555	EM-8992	A6628	EM-8243
A6409	EM-8083	A6486	EM-8885	A6556	EM-8710	A6629	EM-8502
A6410	EM-8078	A6487	EM-9008	A6557	EM-8228	A6630	EM-8503
A6411	EM-8055	A6488	EM-8886	A6559	EM-8806	A6633	EM-8235
A6412	EM-8424	A6489	EM-8563	A6560	EM-9030	A6634	EM-8108
A6413	EM-8056	A6490	EM-8424	A6561	EM-8980	A6635	EM-8667
A6414	EM-8060	A6491	EM-9131	A6562	EM-9054	A6636	EM-8507
A6415	EM-8061	A6492	EM-9021	A6563	EM-8824	A6637	EM-8552
A6416	EM-8424	A6493	EM-9017	A6564	EM-8845	A6638	EM-8271
A6417	EM-8059	A6494	EM-9182	A6565	EM-8572	A6640	EM-8270
A6418	EM-8065	A6495	EM-5152	A6566	EM-9085	A6641	EM-8686
A6419	EM-8082	A6496	EM-9221	A6567	EM-5382	A6642	EM-8096
A6420	EM-8514	A6497	EM-9195	A6568	EM-8896	A6643	EM-8879
A6421	EM-8077	A6498	EM-5110	A6569	EM-8971	A6644	EM-8619
A6422	EM-8080	A6499	EM-5378	A6570	EM-8799	A6645	EM-8506
A6423	EM-8512	A6500	EM-8031	A6571	EM-8894	A6646	EM-8510
A6424	EM-8094	A6501	EM-8018	A6572	EM-8801	A6647	EM-9181
A6425	EM-8095	A6502	EM-8435	A6573	EM-8823	A6648	EM-9203
A6427	EM-8080	A6503	EM-8007	A6574	EM-8849	A6649	EM-8542
A6428	EM-8091	A6504	EM-8020	A6575	EM-8574	A6650	EM-8545
A6429	EM-8078	A6505	EM-8021	A6576	EM-8709	A6651	EM-8548
A6432	EM-8609	A6506	EM-8010	A6577	EM-8895	A6652	EM-8556
A6433	EM-8513	A6507	EM-8431	A6578	EM-8900	A6654	EM-8559
A6433HY	EM-8513	A6509	EM-8002	A6579	EM-8986	A6655	EM-8668
A6434	EM-8740	A6510	EM-8014	A6581	EM-5371	A6656	EM-8669
A6436	EM-8261	A6512	EM-8016	A6582	EM-8898	A6657	EM-8670
A6437	EM-8516	A6513	EM-8004	A6583	EM-8899	A6658	EM-9071
A6438	EM-8068	A6514	EM-8019	A6584	EM-8983	A6659	EM-8689
A6440	EM-9087	A6515	EM-8037	A6585	EM-8982	A6660	EM-8688
A6442	EM-8084	A6515HY	EM-8037	A6586	EM-8981	A6661	EM-8690
A6444	EM-8062	A6516	EM-8006	A6587	EM-8984	A6662	EM-8798
A6445	EM-9082	A6517	EM-8034	A6588	EM-8973	A6663	EM-8687
A6446	EM-8456	A6518	EM-8001	A6589	EM-8975	A6664	EM-8619
A6447	EM-8862	A6519	EM-8024	A6590	EM-8660	A6665	EM-8232
A6448	EM-8079	A6520	EM-8575	A6591	EM-9016	A6666	EM-8235
A6450	EM-8462	A6521	EM-8005	A6592	EM-9185	A6667	EM-8244
A6451	EM-8089	A6522	EM-8402	A6593	EM-9043	A6668	EM-9147
A6452	EM-8085	A6523	EM-8660	A6594	EM-9110	A6669	EM-8818
A6453	EM-8086	A6524	EM-8329	A6595	EM-8988	A6670	EM-8817
A6454	EM-8088	A6525	EM-8008	A6596	EM-9139	A6671	EM-8797
A6455	EM-9240	A6526	EM-8300	A6597	EM-9066	A6672	EM-8793
A6455HY	EM-9240	A6527	EM-8005	A6598	EM-8987	A6673	EM-8792
A6456	EM-8087	A6528	EM-8026	A6599	EM-9083	A6674	EM-8685
A6457	EM-8073	A6529	EM-8497	A6600	EM-2731	A6675	EM-8807

# CROSS REFERENCE

Mfg Part No	Our Part	Mfg Part No	Our Part	Mfg Part No	Our Part	Mfg Part No	Our Part
DEA / MRC (cont.)		DEA / MRC (cont.)		DEA / MRC (cont.)		DEA / MRC (cont.)	
A6676	EM-8820	A6764	EM-8910	A6850	EM-8586	A6935	EM-9208
A6677	EM-8700	A6765	EM-8908	A6851	EM-8976	A6936	EM-9261
A6678	EM-8821	A6766	EM-8907	A6852	EM-8445	A6937	EM-7030
A6679	EM-8695	A6767	EM-8906	A6853	EM-9144	A6938	EM-7076
A6680	EM-8853	A6768	EM-8904	A6854	EM-8049	A6950	EM-9045
A6681	EM-8111	A6769	EM-8905	A6855	EM-8054	A6951	EM-9109
A6682	EM-8867	A6770	EM-9359	A6856	EM-8053	A6952	EM-9093
A6683	EM-8875	A6771	EM-9351	A6857	EM-8049	A6953HY	EM-5445
A6684	EM-8876	A6772	EM-9331	A6858	EM-8048	A6954HY	EM-5446
A6685	EM-8877	A6773	EM-5121	A6859	EM-8586	A6955	EM-5484
A6686	EM-8878	A6774	EM-5482	A6860	EM-8439	A6957	EM-5675
A6687	EM-9056	A6775	EM-5526	A6861	EM-8442	A6958	EM-5485
A6688	EM-9037	A6776	EM-9337	A6862	EM-8579	A6959HY	EM-9245
A6689	EM-8881	A6777	EM-9334	A6863	EM-8576	A6960HY	EM-9262
A6690	EM-9060	A6778	EM-9342	A6864	EM-8576	A6961	EM-5432
A6691	EM-9057	A6779	EM-9330	A6865	EM-8438	A6962	EM-9283
A6692	EM-9070	A6780	EM-9311	A6866	EM-8577	A6964	EM-9257
A6693	EM-8694	A6781	EM-7007	A6867	EM-9142	A6965	EM-9259
A6694	EM-8822	A6791	EM-8812	A6868	EM-9140	A6966	EM-9260
A6695	EM-5101	A6793	EM-8914	A6870	EM-8351	A6967	EM-9287
A6696	EM-9078	A6795	EM-8811	A6871	EM-8499	A6968	EM-5612
A6697	EM-9068	A6796	EM-8655	A6872	EM-8539	A6969	EM-7270
A6698	EM-9058	A6797	EM-8654	A6873	EM-8621	A6969	EM-9263
A6699	EM-9160	A6798	EM-8653	A6874	EM-8586	A6970	EM-9264
A6700	EM-8665	A6799	EM-8652	A6875	EM-8352	A6971	EM-5527
A6701	EM-5186	A6800	EM-8160	A6877	EM-9138	A6972	EM-9092
A6702	EM-8641	A6801	EM-8283	A6878	EM-9143	A6973	EM-9092
A6703	EM-5187	A6802	EM-8161	A6879	EM-9141	A6974	EM-5517
A6704	EM-8640	A6803	EM-8659	A6880	EM-5733	A6975	EM-9258
A6706	EM-8661	A6804	EM-8489	A6882	EM-5609	A6976	EM-9406
A6707	EM-9560	A6805	EM-5457	A6883	EM-5610	A6977	EM-9407
A6708	EM-5188	A6806	EM-8568	A6883	EM-8586	A6978	EM-9401
A6709	EM-9024	A6807	EM-8825	A6884	EM-5812	A6979	EM-5855
A6710	EM-5189	A6808	EM-8277	A6885	EM-5813	A6980	EM-9403
A6712	EM-9023	A6809	EM-8517	A6886	EM-5814	A6981	EM-9402
A6713	EM-5190	A6810	EM-5483	A6900	EM-8224	A6982	EM-5934
A6714	EM-9074	A6811	EM-8524	A6901	EM-8236	A6983	EM-7138
A6716	EM-5191	A6812	EM-8314	A6902	EM-8222	A6984	EM-5935
A6717	EM-5597	A6813	EM-8568	A6903HY	EM-8224	A6985	EM-9558
A6718	EM-5598	A6814	EM-8517	A6904	EM-8221	A6987	EM-5879
A6719	EM-5599	A6815	EM-8656	A6905	EM-8857	A6988	EM-7139
A6721	EM-5600	A6816	EM-8657	A6906	EM-8589	A6989	EM-7031
A6722	EM-5601	A6817	EM-8294	A6907	EM-8287	A6995	EM-7271
A6723	EM-9559	A6818	EM-8658	A6908	EM-9000	A6996	EM-7140
A6724	EM-9552	A6819	EM-8282	A6909	EM-8663	A7000	EM-8794
A6725	EM-5602	A6820	EM-8521	A6910	EM-8616	A7001	EM-8800
A6726	EM-5603	A6821	EM-8804	A6911	EM-9004	A7002	EM-8620
A6727	EM-5515	A6822	EM-8093	A6912	EM-8623	A7004	EM-5459
A6728	EM-7253	A6823	EM-9242	A6912	EM-9077	A7005	EM-8622
A6729	EM-7248	A6824	EM-9022	A6913	EM-8663	A7006	EM-5214
A6730	EM-5983	A6825	EM-8890	A6914	EM-8663	A7007	EM-9145
A6731	EM-5971	A6826	EM-5458	A6915	EM-8617	A7008	EM-9111
A6732	EM-5960	A6827	EM-8568	A6916	EM-9046	A7009	EM-9062
A6733	EM-5959	A6828	EM-5358	A6917	EM-8829	A7010	EM-9047
A6734	EM-7257	A6829	EM-5359	A6918	EM-8831	A7011	EM-9094
A6735	EM-7256	A6830	EM-5951	A6919	EM-8830	A7012	EM-5069
A6738	EM-7246	A6833	EM-9613	A6920	EM-8828	A7013	EM-8985
A6750	EM-8912	A6834	EM-7029	A6921	EM-9005	A7014	EM-5669
A6752	EM-8612	A6835	EM-8522	A6922	EM-8998	A7015	EM-5737
A6753	EM-8611	A6836	EM-9156	A6923	EM-9106	A7016	EM-5616
A6754	EM-9346	A6837	EM-9159	A6924	EM-8999	A7017	EM-9095
A6755	EM-8911	A6838	EM-9177	A6925	EM-9102	A7018	EM-8594
A6756	EM-8902	A6839	EM-9241	A6926	EM-8997	A7019	EM-8593
A6757	EM-8914	A6840	EM-5608	A6927	EM-9065	A7020	EM-9099
A6759	EM-8913	A6841	EM-5931	A6929	EM-9092	A7021	EM-9003
A6760	EM-8606	A6842	EM-5932	A6930	EM-9101	A7022	EM-5218
A6761	EM-8607	A6843	EM-5868	A6932	EM-9001	A7023	EM-5216
A6762	EM-8608	A6844	EM-5933	A6933	EM-5213	A7024	EM-9002
A6763	EM-8901	A6845	EM-5873	A6934	EM-9076	A7025	EM-9105

# CROSS REFERENCE

Mfg Part No	Our Part	Mfg Part No	Our Part	Mfg Part No	Our Part	Mfg Part No	Our Part
DEA / MRC (cont.)		DEA / MRC (cont.)		DEA / MRC (cont.)		DEA / MRC (cont.)	
A7026	EM-9096	A7101	EM-9376	A7169	EM-9344	A7249	EM-8692
A7028	EM-9098	A7102	EM-8953	A7170	EM-7087	A7250	EM-5208
A7029	EM-5215	A7103	EM-8787	A7171	EM-9370	A7251	EM-9034
A7030	EM-9099	A7104	EM-8789	A7172	EM-5533	A7252	EM-8213
A7031	EM-9404	A7105	EM-8788	A7174	EM-9350	A7253	EM-8965
A7032	EM-9271	A7106	EM-8784	A7175	EM-9348	A7254	EM-8851
A7033	EM-9272	A7107	EM-8782	A7176	EM-9335	A7255	EM-8869
A7034	EM-9273	A7108	EM-8786	A7177	EM-9323	A7256	EM-8870
A7035	EM-8592	A7109	EM-8950	A7178	EM-9362	A7257	EM-8871
A7036	EM-5396	A7110	EM-8597	A7179	EM-9313	A7258	EM-8872
A7037	EM-5487	A7111	EM-8949	A7179	EM-9319	A7259	EM-8873
A7038	EM-5397	A7112	EM-9307	A7180	EM-9329	A7260	EM-8883
A7039	EM-5488	A7113	EM-8955	A7181	EM-9332	A7261	EM-8967
A7040	EM-5460	A7114	EM-8948	A7182	EM-9333	A7262	EM-8651
A7041	EM-5461	A7115	EM-8947	A7183	EM-9343	A7263	EM-8892
A7042	EM-5462	A7116	EM-8945	A7184	EM-9347	A7264	EM-8966
A7043	EM-9293	A7117	EM-9373	A7185	EM-9357	A7265	EM-9019
A7044	EM-9294	A7118	EM-8943	A7187	EM-9371	A7267	EM-8993
A7045	EM-5489	A7119	EM-8783	A7188	EM-9363	A7268	EM-9013
A7046	EM-5490	A7120	EM-8952	A7189	EM-5738	A7269	EM-8359
A7047	EM-5372	A7121	EM-8951	A7190	EM-5880	A7270	EM-8639
A7048	EM-9294	A7122	EM-9367	A7191	EM-5881	A7271	EM-9081
A7049	EM-5373	A7123	EM-9366	A7192	EM-5882	A7272	EM-8385
A7050	EM-8229	A7124	EM-8954	A7194	EM-7153	A7273	EM-9014
A7051	EM-8230	A7125	EM-9314	A7195	EM-7060	A7274	EM-8996
A7054	EM-8630	A7126	EM-9255	A7196	EM-5883	A7275	EM-8989
A7055	EM-8629	A7127	EM-9254	A7197	EM-5996	A7276	EM-9073
A7056	EM-8632	A7128	EM-8944	A7199	EM-9320	A7277	EM-9032
A7057	EM-8631	A7129	EM-8769	A7200	EM-8167	A7278	EM-9027
A7058	EM-8662	A7130	EM-9253	A7201	EM-8970	A7279	EM-8990
A7060	EM-8832	A7131	EM-9380	A7202	EM-8339	A7280	EM-8991
A7061	EM-8838	A7132	EM-9374	A7203	EM-8348	A7281	EM-9018
A7062	EM-8836	A7133	EM-9378	A7204	EM-8353	A7282	EM-9026
A7063	EM-8834	A7134	EM-9336	A7205	EM-8571	A7283	EM-9050
A7064	EM-5394	A7135	EM-7051	A7206	EM-8384	A7284	EM-9018
A7066	EM-9100	A7136	EM-9324	A7207	EM-9119	A7285	EM-9063
A7067	EM-9104	A7137	EM-9338	A7208	EM-8995	A7286	EM-9079
A7068	EM-9090	A7138	EM-9322	A7211	EM-8368	A7287	EM-9114
A7069	EM-9091	A7139	EM-9312	A7213	EM-8164	A7288	EM-9015
A7070	EM-9107	A7140	EM-9306	A7214	EM-8164	A7289	EM-5464
A7071	EM-9274	A7141	EM-9306	A7216	EM-9086	A7291	EM-9115
A7072HY	EM-9562	A7142	EM-9326	A7217	EM-9122	A7292	EM-9118
A7073	EM-5434	A7143	EM-9368	A7219	EM-8796	A7293	EM-9123
A7074	EM-5340	A7144	EM-9325	A7220	EM-8407	A7294	EM-5144
A7075	EM-9276	A7145	EM-9295	A7222	EM-8196	A7295	EM-9061
A7075HY	EM-9276	A7146	EM-9372	A7223	EM-9129	A7296	EM-5143
A7076	EM-5491	A7147	EM-9353	A7224	EM-8413	A7297	EM-5142
A7077	EM-5374	A7148	EM-9345	A7225	EM-8163	A7298	EM-9113
A7078	EM-9269	A7149	EM-9375	A7226	EM-8418	A7299	EM-9477
A7079	EM-9270	A7150	EM-9355	A7226IN	EM-5736	A7300	EM-8274
A7081	EM-9289	A7151	EM-9340	A7227	EM-8482	A7301	EM-9020
A7082	EM-5492	A7152	EM-9308	A7228	EM-8968	A7302	EM-8866
A7083	EM-9291	A7153	EM-9354	A7229	EM-9029	A7303	EM-8959
A7084	EM-5530	A7154	EM-9364	A7231	EM-8649	A7304	EM-9031
A7085	EM-9290	A7155	EM-9339	A7232	EM-8175	A7305	EM-8865
A7086	EM-9292	A7156	EM-9341	A7233	EM-8848	A7306	EM-5132
A7087	EM-5436	A7157	EM-9361	A7234	EM-8855	A7306EL	EM-5670
A7088	EM-5437	A7157	EM-9381	A7237	EM-8385	A7307	EM-5500
A7089	EM-9265	A7158	EM-9349	A7238	EM-8698	A7308	EM-8874
A7091HY	EM-5493	A7159	EM-9309	A7239	EM-8697	A7309	EM-8887
A7092	EM-5439	A7160	EM-9377	A7240	EM-5209	A7310	EM-8858
A7093HY	EM-9244	A7161	EM-7113	A7241	EM-8795	A7311	EM-8846
A7094	EM-5440	A7162	EM-9317	A7242	EM-8699	A7312	EM-5131
A7095	EM-9267	A7163	EM-5936	A7243	EM-8850	A7313	EM-5937
A7096	EM-5494	A7164	EM-9310	A7244	EM-8529	A7314	EM-9200
A7097	EM-5495	A7165	EM-9313	A7245	EM-8852	A7315	EM-9166
A7098	EM-9268	A7166	EM-9315	A7246	EM-9432	A7316	EM-5166
A7099	EM-5617	A7167	EM-9316	A7247	EM-8856	A7317	EM-5815
A7100	EM-8768	A7168	EM-9318	A7248	EM-8684	A7318	EM-9012



# CROSS REFERENCE

Mfg Part No	Our Part	Mfg Part No	Our Part	Mfg Part No	Our Part	Mfg Part No	Our Part
DEA / MRC (cont.)		DEA / MRC (cont.)		DEA / MRC (cont.)		DEA / MRC (cont.)	
A7319	EM-8964	A7386	EM-7171	A62051	EM-9523	A65046	EM-5744
A7320	EM-2985	A7389	EM-7058	A62052HY	EM-9175	A65047	EM-7169
A7321	EM-9251	A7391HY	EM-7316	A62053	EM-9514	A65048	EM-7116
A7322	EM-9011	A7394	EM-7333	A62055HY	EM-9525	A65050	EM-7170
A7323HY	EM-9009	A8224	EM-8224	A62056	EM-9550	A65052	EM-5954
A7324	EM-9044	A8799	EM-8799	A62057	EM-9509	A65053	EM-5958
A7325	EM-9048	A9022	ST-2936	A62058	EM-9593	A65054	EM-7134
A7326	EM-9134	A42001	EM-7201	A62059	EM-9412	A65055	EM-7073
A7327	EM-5332	A42002	EM-7232	A62060	EM-9601	A65056	EM-7012
A7328	EM-9288	A42003	EM-7233	A62061	EM-8854	A65057	EM-5956
A7329	EM-8891	A42006	EM-5975	A62062	EM-9588	A65058	EM-9397
A7330	EM-9035	A42013	EM-5832	A62063	EM-9158	A65069	EM-7111
A7331	EM-9108	A42016	EM-7238	A62064	EM-9549	A65070	EM-7055
A7332	EM-8960	A42032	EM-7192	A62065	EM-5963	A65071	EM-7178
A7332HY	EM-8960	A42033	EM-7236	A62066	EM-9576	A65079	EM-9389
A7333	EM-9442	A42050	EM-9514	A62067	EM-7048	A65081	EM-7302
A7334	EM-8964	A60013	DS-6504	A62068	EM-7015	A65083	EM-7177
A7335	EM-5173	A60048	DS-6519	A62069	EM-9497	A65095	EM-7296
A7336	EM-5174	A60082	DS-5226	A62071	EM-5973	A71001	EM-7092
A7337	EM-5175	A62001	EM-5799	A62072	EM-5964	A71003	EM-7006
A7338	EM-5411	A62002	EM-5743	A62075	EM-7042	A71004	EM-7062
A7339	EM-8681	A62003	EM-5800	A62076	EM-9511	A71005	EM-7049
A7340	EM-9167	A62004	EM-5801	A62078	EM-9535	A71006	EM-5997
A7341	EM-9209	A62005	EM-5802	A62079	EM-9574	A71008	EM-7151
A7342	EM-9190	A62006	EM-9197	A62080HY	EM-7188	A71009	EM-7056
A7343	EM-5817	A62007	EM-5804	A62081	EM-7053	A71011	EM-7034
A7344	EM-5938	A62008	EM-5805	A62083HY	EM-5982	A71012	EM-7035
A7345	EM-5501	A62009	EM-5742	A62086	EM-7054	A71013	EM-9360
A7346	EM-5502	A62010	EM-9393	A62088	EM-5910	A71014	EM-7036
A7347	EM-9219	A62010	EM-9502	A62089	EM-5970	A71015	EM-7091
A7348	EM-9223	A62011	EM-9418	A62090	EM-9610	A71017	EM-5999
A7349	EM-9252	A62012	EM-9497	A62092	EM-5902	A71018	EM-7110
A7349EL	EM-5672	A62013	EM-5807	A62095	EM-9522	A71020	EM-7066
A7350	EM-9575	A62014	EM-5808	A62097	EM-5908	A71021	EM-7105
A7351	EM-9410	A62015	EM-9391	A62098	EM-5952	A71022	EM-7037
A7352	EM-5905	A62016	EM-9504	A62099	EM-7303	A71026	EM-7112
A7353	EM-9256	A62017	EM-5809	A65001HY	EM-5872	A71028	EM-7207
A7353EL	EM-5961	A62018	EM-9425	A65002	EM-9458	A71029	EM-7090
A7354	EM-5441	A62019	EM-8493	A65003	EM-9467	A71030	EM-7163
A7354EL	EM-5962	A62020	EM-9430	A65004	EM-9463	A71031	EM-7090
A7355	EM-5404	A62021	EM-9429	A65005	EM-9470	A71032	EM-7057
A7356	EM-5406	A62022	EM-9390	A65006	EM-9473	A71040	EM-7151
A7357	EM-5407	A62023	EM-9449	A65007	EM-5794	A71047	EM-7064
A7358	EM-9248	A62024	EM-9447	A65008	EM-9301	A71048	EM-7104
A7358EL	EM-5818	A62025	EM-5834	A65009	EM-5995	A71054	EM-7061
A7359	EM-9464	A62026	EM-9525	A65010	EM-5871	A71057	EM-7160
A7360	EM-9416	A62027	EM-9400	A65011	EM-9554	A71065	EM-7099
A7361	EM-9460	A62028	EM-9419	A65012	EM-5891	A71067	EM-7221
A7362	EM-9551	A62029	EM-9455	A65014	EM-9542	A71069	EM-7289
A7363	EM-9545	A62030	EM-9491	A65015	EM-9512	A71070	EM-7214
A7364	EM-9544	A62031	EM-9462	A65016	EM-5992	A71081	EM-7093
A7365	EM-9531	A62032	EM-5827	A65017EL	EM-5904	A71082	EM-7224
A7366	EM-9520	A62033	EM-9158	A65018	EM-5957	A71086	EM-7225
A7367	EM-9517	A62034	EM-5861	A65019	EM-5906	A72004HY	EM-7016
A7368	EM-7088	A62035	EM-5949	A65020	EM-9215	A72005	EM-7266
A7368HY	EM-7088	A62036HY	EM-7027	A65021	EM-5990	A72007	EM-5919
A7369	EM-5968	A62037HY	EM-5916	A65022	EM-5994	A72010	EM-5986
A7370	EM-5953	A62038	EM-9498	A65023HY	EM-5925	A72011	EM-5988
A7371HY	EM-7008	A62039	EM-5898	A65025	EM-5917	A72014	EM-7078
A7372	EM-5914	A62040	EM-9543	A65026EL	EM-5840	A72015	EM-7107
A7373EL	EM-5846	A62041	EM-9499	A65027EL	EM-5903	A72016	EM-5967
A7374	EM-5981	A62042	EM-9015	A65027HY	EM-5903	SP4921	ST-4921
A7375	EM-5911	A62044	EM-5930	A65028EL	EM-5875	SP4924	ST-4924
A7376	EM-7009	A62045	EM-9595	A65029	EM-9553	SP4937	ST-4937
A7379	EM-7081	A62046	EM-9518	A65030	EM-9280	SP4950	ST-4950
A7380	EM-7070	A62047	EM-9519	A65031HY	EM-7148	SP4954	ST-4954
A7381	EM-9551	A62048HY	EM-5991	A65037	EM-5978	SP4958	ST-4958
A7382	EM-7024	A62049HY	EM-5940	A65040	EM-7155	SP4978	ST-6914
A7383	EM-7234	A62050	EM-9513	A65043	EM-7168	SP4980	ST-4980

# CROSS REFERENCE

Mfg Part No	Our Part	Mfg Part No	Our Part	Mfg Part No	Our Part	Mfg Part No	Our Part
DEA / MRC (cont.)		DEA / MRC (cont.)		DEA / MRC (cont.)		DEA / MRC (cont.)	
SP4999	ST-4999	SP7589	ST-2920	SP7690	ST-1961	SP9050	ST-5951
SP5907	ST-5907	SP7591	ST-1971	SP7692	ST-1939	SP9055	ST-3949
SP5908	ST-5908	SP7591	ST-1974	SP7693	ST-3939	SP9056	ST-1989
SP5909	ST-5909	SP7592	ST-1916	SP7694	ST-2984	SP9058	ST-3951
SP5922	ST-5922	SP7593	ST-1970	SP7695	ST-3935	SP9059	ST-3911
SP5924	ST-5924	SP7595	ST-1954	SP7696	ST-3936	SP9061	ST-2938
SP5930	ST-5930	SP7597	ST-1960	SP7697	ST-2914	SP9063	ST-3910
SP5965	ST-5965	SP7599	ST-1956	SP7698	ST-2964	SP9064	ST-1947
SP5971	ST-5971	SP7600	ST-1901	SP7700	ST-4919	SP9065	ST-2985
SP5974	ST-5974	SP7601	ST-1902	SP7702	ST-6920	SP9069	ST-2982
SP5975	ST-5975	SP7602	ST-2953	SP7703	ST-6919	SP9070	ST-2983
SP5976	ST-5976	SP7603	ST-2970	SP7705	ST-4955	SP9071	ST-2981
SP5977	ST-5977	SP7605	ST-1925	SP7706	ST-4996	SP9073	ST-1948
SP5979	ST-5979	SP7606	ST-2910	SP7706	ST-4997	SP9074	ST-1975
SP7500	ST-1951	SP7607	ST-1927	SP7707	ST-4990	SP9075	ST-2980
SP7501	ST-1908	SP7608	ST-1902	SP7708	ST-3908	SP9076	ST-2989
SP7502	ST-1905	SP7610	ST-2944	SP7709	ST-3909	SP9077	ST-2979
SP7503	ST-1906	SP7611	ST-1955	SP7710	ST-5902	SP9078	ST-2937
SP7504	ST-1907	SP7614	ST-1926	SP7711	ST-5903	SP9081	ST-2929
SP7508	ST-2925	SP7616	ST-3928	SP7712	ST-4952	SP9082	ST-2909
SP7509	ST-1985	SP7617	ST-1930	SP7713	ST-4989	SP9083	ST-1964
SP7510	ST-1903	SP7618	ST-2940	SP7714	ST-4927	SP9084	ST-2998
SP7511	ST-1904	SP7619	ST-2954	SP7715	ST-4938	SP9088	ST-3960
SP7516	ST-1942	SP7620	ST-2952	SP7716	ST-4971	SP9090	ST-2987
SP7517	ST-2903	SP7621	ST-2951	SP7717	ST-4943	SP9092	ST-3961
SP7518	ST-2905	SP7623	ST-2935	SP7718	ST-4953	SP9093	ST-3905
SP7519	ST-1950	SP7624	ST-2976	SP7718	ST-6935	SP9094	ST-2994
SP7522	ST-1913	SP7625	ST-2932	SP7719	ST-2914	SP9095	ST-3962
SP7527	ST-1929	SP7627	ST-2901	SP7720	ST-4966	SP9096	ST-3905
SP7529	ST-1953	SP7629	ST-2959	SP7721	ST-4983	SP9097	ST-2995
SP7531	ST-1968	SP7630	ST-1987	SP7722	ST-4985	SP9098	ST-3964
SP7532	ST-1967	SP7631	ST-1994	SP7723	ST-4981	SP9099	ST-3965
SP7533	ST-1969	SP7632	ST-1988	SP7724	ST-5943	SP9101	ST-3967
SP7534	ST-1911	SP7633	ST-2971	SP7725	ST-4975	SP9102	ST-3968
SP7535	ST-1996	SP7634	ST-1934	SP7729	ST-8914	SP9103	ST-3969
SP7536	ST-1943	SP7635	ST-1946	SP9000	ST-1932	SP9104	ST-3970
SP7537	ST-1912	SP7636	ST-4912	SP9004	ST-2942	SP9105	ST-3971
SP7538	ST-1944	SP7638	ST-2972	SP9006	ST-3907	SP9106	ST-2993
SP7539	ST-1993	SP7640	ST-2973	SP9007	ST-2943	SP9107	ST-3972
SP7540	ST-1992	SP7642	ST-2968	SP9008	ST-2919	SP9108	ST-3973
SP7542	ST-1910	SP7642	ST-2969	SP9009	ST-1999	SP9109	ST-3974
SP7543	ST-1909	SP7646	ST-2941	SP9011	ST-2960	SP9110	ST-3975
SP7544	ST-1983	SP7647	ST-2965	SP9012	ST-2966	SP9111	ST-3976
SP7545	ST-2904	SP7649	ST-3929	SP9014	ST-2975	SP9112	ST-3977
SP7546	ST-2903	SP7651	ST-1973	SP9015	ST-2906	SP9114	ST-3978
SP7547	ST-1930	SP7651	ST-1991	SP9016	ST-2921	SP9115	ST-5997
SP7550	ST-1976	SP7652	ST-1922	SP9018	ST-2974	SP9116	ST-3980
SP7551	ST-1938	SP7654	ST-3900	SP9019	ST-1959	SP9117	ST-3982
SP7552	ST-1937	SP7656	ST-1990	SP9020	ST-1963	SP9119	ST-1952
SP7553	ST-1995	SP7657	ST-1924	SP9021	ST-2934	SP9120	ST-2924
SP7555	ST-1977	SP7658	ST-1923	SP9022	ST-2936	SP9121	ST-2933
SP7557	ST-2905	SP7659	ST-2947	SP9023	ST-4913	SP9126	ST-2913
SP7558	ST-2963	SP7660	ST-2948	SP9025	ST-2939	SP9127	ST-2931
SP7559	ST-2915	SP7661	ST-2999	SP9027	ST-2922	SP9130	ST-3983
SP7560	ST-1933	SP7663	ST-1921	SP9028	ST-6977	SP9132	ST-3993
SP7561	ST-8915	SP7665	ST-2992	SP9029	ST-2902	SP9133	ST-3994
SP7562	ST-2904	SP7668	ST-1986	SP9030	ST-3944	SP9135	ST-2957
SP7563	ST-2956	SP7669	ST-1928	SP9031	ST-2962	SP9137	ST-2988
SP7565	ST-1965	SP7676	ST-2916	SP9032	ST-3945	SP9143	ST-3903
SP7570	ST-1981	SP7677	ST-2930	SP9034	ST-2961	SP9144	ST-3906
SP7572	ST-8928	SP7679	ST-3933	SP9035	ST-2923	SP9145	ST-3995
SP7573	ST-1978	SP7680	ST-2949	SP9036	ST-2917	SP9146	ST-3904
SP7574	ST-2908	SP7682	ST-6915	SP9037	ST-2918	SP9147	ST-3997
SP7576	ST-3901	SP7683	ST-6916	SP9038	ST-2918	SP9151	ST-4900
SP7578	ST-2907	SP7684	ST-2928	SP9041	ST-3946	SP9154	ST-2986
SP7582	ST-2945	SP7686	ST-2967	SP9043	ST-3947	SP9156	ST-1979
SP7583	ST-3902	SP7687	ST-2991	SP9045	ST-2977	SP9158	ST-1958
SP7584	ST-2946	SP7688	ST-2950	SP9047	ST-2955	SP9159	ST-2912
SP7587	ST-1980	SP7689	ST-1940	SP9048	ST-2958	SP9160	ST-2926

# CROSS REFERENCE

Mfg Part No	Our Part	Mfg Part No	Our Part	Mfg Part No	Our Part	Mfg Part No	Our Part
<b>DEA / MRC (cont.)</b>		<b>DORMAN (cont.)</b>		<b>DORMAN (cont.)</b>		<b>DORMAN (cont.)</b>	
SP9161	ST-2927	665-016	ST-1947	665-344	ST-2912	665-645	ST-2977
SP9164	ST-3991	665-017	ST-1965	665-345	ST-2913	665-650	ST-2999
SP9165	ST-1984	665-019	ST-1986	665-346	ST-2915	665-653	ST-2974
SP9166	ST-1962	665-023	ST-2938	665-347	ST-2916	665-800	ST-1905
SP9168	ST-2911	665-024	ST-1985	665-348	ST-2922	665-801	ST-1934
SP9169	ST-4903	665-025	ST-1988	665-349	ST-2924	665-802	ST-1922
SP9170	ST-4905	665-026	ST-1989	665-351	ST-2927	665-803	ST-1923
SP9174	ST-2990	665-028	ST-1994	665-352	ST-2928	665-804	ST-1924
SP9175	ST-1941	665-029	ST-2923	665-353	ST-2931	665-807	ST-1990
SP9176	ST-4908	665-030	ST-2925	665-354	ST-2932	665-809	ST-2954
SP9177	ST-1966	665-031	ST-2933	665-355	ST-2934	665-810	ST-2973
SP9178	ST-4965	665-032	ST-2964	665-356	ST-2929	665-812	ST-2972
SP9179	ST-4910	665-033	ST-2990	665-357	ST-2957	934-220	DS-8472
SP9182	ST-4994	665-035	ST-2971	665-358	ST-2959	934-404	DS-5228
SP9183	ST-4995	665-039	ST-2986	665-359	ST-2958	934-601	DS-6077
SP9188	ST-5911	665-200	ST-1951	665-360	ST-2960	934-610	DS-6503
SP9193	ST-4911	665-202	ST-1921	665-361	ST-2962	<b>EAGLE BHP</b>	
SP9196	ST-3937	665-203	ST-1952	665-362	ST-2966	GJL339060	EM-7230
SP9199	ST-3938	665-204	ST-1953	665-363	ST-2950	1000R	EM-2980
SP9201	ST-3950	665-205	ST-1925	665-364	ST-2945	1001R	EM-3011
SP9202	ST-4979	665-206	ST-1932	665-365	ST-2946	1008R	EM-90037
SP9204	ST-3954	665-207	ST-2918	665-366	ST-2953	1012	EM-2975
SP9207	ST-3957	665-208	ST-2906	665-367	ST-2956	1015	EM-8690
SP9208	ST-3959	665-209	ST-2917	665-370	ST-2987	1017	EM-2949
SP9209	ST-3954	665-214	ST-2998	665-371	ST-2982	1018	EM-5080
SP9210	ST-4987	665-300	ST-1908	665-372	ST-2983	1019	EM-2909
SP9211	ST-4915	665-301	ST-1904	665-373	ST-2981	1020	EM-2994
SP9213	ST-4956	665-302	ST-1906	665-380	ST-2926	1023	EM-2959
SP9216	ST-4904	665-303	ST-1903	665-381	ST-2991	1023R	EM-2844
SP9230	ST-5952	665-304	ST-1926	665-386	ST-3903	1025	EM-2911
SP9233	ST-4968	665-305	ST-1959	665-387	ST-3906	1026	EM-2912
SP9236	ST-4976	665-306	ST-1930	665-600	ST-1907	1027	EM-2901
SP9238	ST-5919	665-306	ST-2976	665-601	ST-1913	1027R	EM-4169
SP9247	ST-4977	665-307	ST-1948	665-602	ST-1955	1028	EM-2900
SP9253	ST-5939	665-308	ST-1964	665-603	ST-1954	1030H	EM-2910
SP9270	ST-7993	665-309	ST-1916	665-604	ST-1927	1031	EM-2948
SP9271	ST-5942	665-310	ST-1943	665-605	ST-1929	1032	EM-2960
SP9275	ST-5900	665-311	ST-2936	665-606	ST-2935	1032R	EM-2849
4173833	ST-7994	665-312	ST-1937	665-607	ST-1933	1033	EM-3017
4713062	ST-5912	665-313	ST-1967	665-608	ST-1960	1034	EM-8689
4713085	ST-1970	665-314	ST-1909	665-610	ST-1944	1035R	EM-2924
4713155	ST-2924	665-315	ST-1910	665-611	ST-1946	1036R	EM-2923
4713290	ST-3987	665-316	ST-1963	665-612	ST-1974	1037	EM-2931
4713291	ST-3986	665-317	ST-1969	665-613	ST-1976	1037B	EM-2931
4713531	ST-4958	665-318	ST-1968	665-614	ST-1977	1040	EM-2958
4713572	ST-5909	665-319	ST-1911	665-615	ST-1978	1041H	EM-2938
4713573	ST-5908	665-320	ST-1912	665-616	ST-1979	1042	EM-2977
4713600	ST-7990	665-321	ST-1938	665-617	ST-1980	1043	EM-2915
4713916	ST-6960	665-322	ST-1970	665-618	ST-2920	1044	EM-2939
4713922	ST-8982	665-323	ST-2939	665-619	ST-2908	1046	EM-90000
4713923	ST-8971	665-324	ST-2940	665-620	ST-2911	1048H	EM-3003
<b>DORMAN</b>		665-325	ST-1975	665-621	ST-2914	1049	EM-2947
523-103	ST-7946	665-326	ST-1981	665-622	ST-2921	1051	EM-2984
663-451	ST-2992	665-327	ST-1983	665-623	ST-2930	1051R	EM-2845
665-001	ST-1901	665-328	ST-1984	665-624	ST-2943	1052	EM-2925
665-002	ST-1902	665-329	ST-1987	665-625	ST-2942	1053	EM-2986
665-003	ST-1928	665-330	ST-1992	665-626	ST-2951	1054H	EM-9092
665-004	ST-1958	665-331	ST-1993	665-627	ST-2952	1055	EM-9101
665-006	ST-1956	665-332	ST-1995	665-628	ST-2963	1058H	EM-8513
665-006	ST-2995	665-333	ST-1996	665-629	ST-2955	1059	EM-8074
665-007	ST-1941	665-334	ST-2919	665-630	ST-2961	1068	EM-8178
665-008	ST-1942	665-335	ST-2907	665-631	ST-2944	1069	EM-8740
665-009	ST-1940	665-337	ST-1999	665-632	ST-2947	1070	EM-5612
665-010	ST-1961	665-338	ST-2902	665-633	ST-2948	1073	EM-2832
665-011	ST-1966	665-339	ST-2903	665-634	ST-2949	1074H	EM-2840
665-012	ST-1950	665-340	ST-2904	665-639	ST-2979	1076H	EM-2890
665-013	ST-1939	665-341	ST-2905	665-640	ST-2989	1077	EM-8261
665-014	ST-2937	665-342	ST-2909	665-641	ST-2984	1080	EM-8577
665-015	ST-1962	665-343	ST-2910	665-642	ST-3900	1082	EM-8262

# CROSS REFERENCE

Mfg Part No	Our Part	Mfg Part No	Our Part	Mfg Part No	Our Part	Mfg Part No	Our Part
<b>EAGLE BHP (cont.)</b>		<b>EAGLE BHP (cont.)</b>		<b>EAGLE BHP (cont.)</b>		<b>EAGLE BHP (cont.)</b>	
1089	EM-90001	1210	EM-8253	1324	EM-9187	1466	EM-8062
1092H	EM-2896	1212	EM-90011	1327	EM-3073	1488	EM-8658
1093H	EM-2895	1215	EM-9190	1328	EM-3074	1489	EM-8161
1097	EM-8711	1216	EM-9167	1329	EM-3066	1500	DS-8473
1098H	EM-2926	1217	EM-9219	1332	EM-9263	1502	DS-8551
1100	EM-90027	1220	EM-90015	1333	EM-9260	1504	DS-8470
1101	EM-90002	1221H	EM-9149	1334	EM-9283	1505	DS-8474
1103	EM-90028	1222H	EM-9185	1335	EM-8819	1506	DS-8471
1107R	EM-90040	1224H	EM-2717	1336	EM-9262	1507	DS-8549
1108	EM-9093	1225	EM-8974	1337	EM-9245	1508	DS-5234
1109	EM-90006	1226	EM-8975	1341H	EM-8998	1510	DS-8473
1110	EM-90003	1227	EM-8973	1342	EM-9106	1511	DS-8475
1112	EM-90004	1228	EM-9204	1343	EM-8999	1512	DS-6062
1113	EM-2956	1229	EM-9152	1349	EM-8964	1513	DS-6061
1114	EM-2957	1230	EM-9151	1351	EM-9422	1514	DS-6035
1115	EM-2927	1231H	EM-9247	1352	EM-9228	1515	DS-6049
1117	EM-2928	1232H	EM-9194	1353	EM-9223	1516	DS-6038
1123	EM-2658	1233H	EM-9297	1354	EM-9256	1520	DS-6056
1129	EM-9208	1235R	EM-7118	1355	EM-5441	1522	DS-6092
1130	EM-3034	1236	EM-5426	1356	EM-9066	1523	DS-6068
1131	EM-3049	1237	EM-5350	1357V	EM-9139	1527	DS-5230
1132	EM-2628	1241	EM-2835	1358	EM-9168	1530	DS-8471
1133H	EM-2836	1242	EM-8792	1360	EM-8352	1531	DS-8471
1134	EM-2899	1243H	EM-3103	1364	EM-2988	1532	DS-8469
1135H	EM-8967	1244	EM-3037	1365	EM-3051	1533	DS-5225
1138	EM-2933	1245H	EM-3056	1366	EM-3019	1536	DS-6521
1138H	EM-2933	1246	EM-3057	1367	EM-3039	1539	DS-6511
1140	EM-90029	1252	EM-3088	1368	EM-3012	1540	DS-6512
1141L	EM-90038	1254	EM-2932	1369	EM-3008	1556H	EM-5656
1147H	EM-2903	1255	EM-2870	1370	EM-3018	1557	EM-9230
1149	EM-2962	1256	EM-2917	1371	EM-3013	1560	EM-8586
1150H	EM-9016	1257H	EM-3021	1373	EM-3009	1562H	EM-3150
1151H	EM-2942	1258	EM-3027	1374	EM-3010	1563H	EM-3151
1152H	EM-2837	1259	EM-9184	1375	EM-3016	1566H	EM-5527
1153H	EM-2838	1262	EM-2918	1376	EM-3015	1567H	EM-9092
1154	EM-2712	1265	EM-2963	1377	EM-3014	1568	EM-5213
1155	EM-8801	1266	EM-3067	1378	EM-3053	1569H	EM-8845
1156	EM-90030	1267	EM-2954	1379	EM-3052	1569S	EM-8845
1157	EM-90008	1269	EM-3006	1380	EM-3007	1570	EM-90033
1158	EM-90009	1272	EM-2992	1381	EM-3055	1571	EM-90019
1159	EM-5424	1273	EM-2991	1389	EM-9209	1572	EM-9205
1160	EM-5425	1274R	EM-3005	1391	EM-9252	1574	EM-8990
1161	EM-90031	1277	EM-9162	1391EL	EM-5672	1578H	EM-5782
1162	EM-8001	1278	EM-3025	1393	EM-8866	1579H	EM-3167
1163	EM-8007	1279	EM-3024	1396	EM-5404	1582R	EM-4094
1165	EM-8133	1280	EM-3038	1397	EM-9011	1585	EM-3131
1166	EM-8166	1281H	EM-3085	1400	EM-9442	1589H	EM-3096
1168H	EM-8662	1282	EM-2904	1401	EM-5173	1590	EM-3094
1171	EM-8670	1283	EM-2905	1402	EM-5174	1591	EM-5659
1174H	EM-8836	1284	EM-3002	1402R	EM-2910	1596	EM-9241
1178	EM-8987	1285	EM-3001	1402R	EM-90039	1599	EM-9222
1179H	EM-8997	1286	EM-2973	1405EL	EM-5818	1600	EM-9196
1180H	EM-9001	1287H	EM-2967	1405S	EM-9248	1601	EM-3157
1182	EM-9009	1288	EM-9229	1407R	EM-8398	1602	EM-3134
1183	EM-9010	1289H	EM-3075	1408	EM-8697	1604	EM-9202
1184	EM-9019	1290H	EM-3076	1409	EM-8529	1605H	EM-9441
1185	EM-8988	1291	EM-2989	1414	EM-5407	1610	EM-3168
1187	EM-9058	1294	EM-2930	1415	EM-5406	1610R	EM-4127
1189	EM-9063	1295	EM-2929	1419H	EM-9092	1611	EM-9225
1197	EM-9131	1298	EM-2972	1420	EM-9410	1612H	EM-9280
1198	EM-8568	1301	EM-2834	1421	EM-2971	1612HR	EM-9280
1199	EM-90010	1304	EM-3047	1422	EM-4002	1613	EM-9216
1200H	EM-2993	1305	EM-3048	1431	EM-8170	1614	EM-5689
1201	EM-90032	1306	EM-3062	1434	EM-9014	1615	EM-9487
1202	EM-2908	1307	EM-3061	1436	EM-9081	1617	EM-9250
1205	EM-8938	1308	EM-3000	1452	EM-9148	1618	EM-9437
1206	EM-9255	1309	EM-2999	1462	EM-9476	1619	EM-9286
1207	EM-8935	1310	EM-3078	1464	EM-9082	1621H	EM-5931
1209	EM-8937	1313	EM-2936	1465	EM-9087	1622	EM-5932

# CROSS REFERENCE

Mfg Part No	Our Part	Mfg Part No	Our Part	Mfg Part No	Our Part	Mfg Part No	Our Part
<b>EAGLE BHP (cont.)</b>		<b>EAGLE BHP (cont.)</b>		<b>EAGLE BHP (cont.)</b>		<b>EAGLE BHP (cont.)</b>	
1623	EM-5868	1715	EM-2167	2394	EM-2394	2711	EM-2711
1624	EM-3113	1736	EM-2282	2400	EM-2681	2713	EM-2713
1625	EM-3114	1757	EM-2288	2406	EM-2406	2715	EM-2715
1626	EM-3115	1762	EM-2512	2407	EM-2407	2730	EM-2730
1627	EM-9214	1782	EM-2292	2408	EM-2408	2731	EM-2731
1628H	EM-9496	1786	EM-2742	2409	EM-2409	2732	EM-2731
1629	EM-9302	1794	EM-2533	2439	EM-2439	2759	EM-2759
1630	EM-9303	1796	EM-2469	2441	EM-2441	2766	EM-2766
1631	EM-9397	1797	EM-2329	2442	EM-2442	2771	EM-2771
1632	EM-5871	1798	EM-2448	2444	EM-2444	2774	EM-2774
1633	EM-3122	1800	EM-2742	2445	EM-2445	2775	EM-2775
1636	EM-9448	1802	EM-2489	2460	EM-2460	2778	EM-2778
1639	EM-2437	1805	EM-8857	2473	EM-2473	2780	EM-2780
1640	EM-2438	1809	EM-2491	2490	EM-2490	2781	EM-2781
1641	EM-8983	1810	EM-2600	2528	EM-2528	2782	EM-2782
1642	EM-3190	1814	EM-2472	2537	EM-2537	2785	EM-2785
1643	EM-3189	1817	EM-8119	2543	EM-2543	2786	EM-2786
1644H	EM-9015	1824	EM-8310	2549	EM-2549	2788H	EM-2788
1646	EM-8968	1830	EM-8142	2550	EM-2550	2789H	EM-2789
1647	EM-8899	1831	EM-8284	2555	EM-2555	2790H	EM-2790
1648H	EM-9488	1832	EM-2420	2556	EM-2556	2791H	EM-2791
1649H	EM-9457	1833	EM-2417	2559	EM-2559	2792H	EM-2792
1650	EM-9443	1834	EM-2456	2562	EM-2562	2793	EM-2793
1651HR	EM-9459	1835	EM-2414	2563	EM-2563	2794	EM-2794
1652	EM-9484	1837	EM-2467	2568	EM-2568	2795H	EM-2795
1653H	EM-9164	1839	EM-2466	2570	EM-2570	2797	EM-2797
1654	EM-9157	1845	EM-2388	2572	EM-2572	2798	EM-2798
1655	EM-9163	1847	EM-2457	2609	EM-2609	2799	EM-2799
1656	EM-3082	1864	EM-2396	2620	EM-2620	2800	EM-2800
1656R	EM-3082	1867	EM-9045	2622	EM-2622	2801	EM-2801
1657	EM-3069	1868	EM-2493	2625	EM-2625	2802	EM-2802
1657R	EM-3069	1870R	EM-2665	2626	EM-2626	2803H	EM-2803
1662	EM-5078	1874	EM-2558	2627	EM-2627	2803K	EM-2803S
1663H	EM-5867	1879	EM-2290	2635	EM-2635	2804	EM-2804
1664	EM-9545	1880	EM-2289	2636	EM-2636	2806	EM-2806
1665H	EM-5865	1881	EM-2661	2637	EM-2637	2807	EM-2807
1666	EM-9446	1881H	EM-2661	2638	EM-2638	2808	EM-2808
1668	EM-9551	1884	EM-2696	2639	EM-2639	2809	EM-2809
1669	EM-9460	1884H	EM-2696	2640	EM-2640	2812	EM-2812
1671	EM-9309	1894	EM-2624	2641	EM-2641	2812H	EM-2812
1672	EM-9324	1896X	EM-2884	2642	EM-2642	2813	EM-2813
1672H	EM-9324	1897	EM-2564	2643	EM-2643	2813H	EM-2813
1673	EM-9310	1900	EM-2421	2644	EM-2644	2814	EM-2814
1674	EM-9308	1901	EM-8133	2645	EM-2645	2817	EM-2817
1675	EM-4018	1902	EM-8125	2646	EM-2646	2818	EM-2818
1676	EM-4060	1911	EM-2811	2648	EM-2815	2819R	EM-2819
1677	EM-5587	1912	EM-2830	2648R	EM-2815	2820	EM-2820
1680	EM-3098	1913	EM-2829	2649	EM-2649	2821	EM-2821
1681	EM-3090	1919	EM-2852	2650	EM-2650	2822	EM-2822
1682	EM-3104	1929	EM-2656	2651	EM-2651	2823	EM-2823
1683H	EM-3093	1934	EM-90021	2652	EM-2652	2824	EM-2824
1684	EM-2990	1935	EM-2657	2653	EM-2653	2825	EM-2825
1685H	EM-4044	2268	EM-2268	2659	EM-2659	2826	EM-2826
1686	EM-3107	2287	EM-2287	2660H	EM-2660	2827	EM-2827
1687	EM-4034	2328	EM-2328	2662	EM-2662	2828	EM-2828
1687R	EM-4034	2331	EM-2331	2663	EM-2663	2831	EM-2831
1689H	EM-3106	2332	EM-2332	2664	EM-2664	2833	EM-2833
1690H	EM-3108	2341	EM-2341	2665	EM-2665	2839	EM-2839
1691H	EM-3109	2351	EM-2351	2672	EM-2394	2841	EM-2841
1692	EM-3081	2354X	EM-2617	2674	EM-2674	2841H	EM-2841
1692R	EM-4171	2360	EM-2360	2677	EM-2677	2842	EM-2842
1693	EM-3086	2379	EM-2379	2678	EM-2678	2843	EM-2843
1695H	EM-3110	2381	EM-2381	2681	EM-2681	2850	EM-2850
1696	EM-5085	2382	EM-2382	2685	EM-2685	2851	EM-2851
1697	EM-3129	2383	EM-2382	2688	EM-2688	2853	EM-2853
1698H	EM-3117	2384	EM-2384	2690	EM-2690	2854	EM-2854
1699H	EM-3118	2385	EM-2385	2697H	EM-2697	2855	EM-2855
1700H	EM-3116	2387	EM-2387	2707	EM-2707	2856	EM-2856
1704	EM-2378	2391	EM-2391	2709	EM-2709	2857	EM-2857

# CROSS REFERENCE

Mfg Part No	Our Part	Mfg Part No	Our Part	Mfg Part No	Our Part	Mfg Part No	Our Part
<b>EAGLE BHP (cont.)</b>		<b>EAGLE BHP (cont.)</b>		<b>EAGLE BHP (cont.)</b>		<b>EAGLE BHP (cont.)</b>	
2858	EM-2858	3464H	EM-9279	3555H	EM-5798	3679	EM-9411
2859	EM-2859	3465	EM-9249	3556	EM-5796	3688H	EM-8944
2860	EM-2860	3466	EM-9246	3558	EM-9542	3689H	EM-8832
2861	EM-2861	3468	EM-90035	3559	EM-9386	3690H	EM-5394
2862	EM-2862	3470	EM-9497	3560	EM-9385	3691H	EM-5859
2863	EM-2863	3471H	EM-5982	3562	EM-9268	3693H	EM-9271
2864	EM-2864	3472	EM-9513	3564	EM-9265	3694H	EM-9272
2868	EM-2868	3473	EM-9549	3565	EM-9267	3695H	EM-9003
2869	EM-2869	3474	EM-3026	3566H	EM-9145	3697H	EM-5884
2872	EM-2872	3475	EM-2997	3567H	EM-5215	3698H	EM-5885
2874	EM-2874	3476H	EM-3084	3568	EM-5216	3701H	EM-5886
2875	EM-5078	3477	EM-2998	3570	EM-9022	3702H	EM-5892
2875R	EM-2875	3478	EM-3202	3571	EM-3050	3703H	EM-5894
2876H	EM-2876	3479	EM-4049	3573H	EM-5654	3704H	EM-5894
2877	EM-2622	3480H	EM-4076	3577	EM-3141	3705H	EM-5893
2878	EM-2878	3482	EM-4129	3578H	EM-4035	3706H	EM-5894
2879	EM-2879	3483R	EM-4080	3579H	EM-4036	3707H	EM-5879
2880	EM-2880	3486	EM-4130	3580H	EM-4037	3708	EM-9442
2881	EM-2881	3489	EM-3193	3581	EM-3133	3709	EM-9170
2882	EM-2882	3490	EM-4154	3582H	EM-4149	3710	EM-4091
2883	EM-2883	3491H	EM-5872	3584	EM-4226	3710R	EM-4006
3014H	EM-7300	3493	EM-5792	3585	EM-4241	3711	EM-4090
3041	EM-4196	3494	EM-3156	3587	EM-5968	3716	EM-5935
3082	EM-7279	3495H	EM-4012	3588H	EM-7088	3717	EM-5860
3083H	EM-7316	3497	EM-4013	3593	EM-9156	3718	EM-5922
3152	EM-5775	3498	EM-9452	3594	EM-9432	3719	EM-5844
3172	EM-5975	3499	EM-90036	3603	EM-9304	3721H	EM-5877
3417	EM-9197	3499	EM-9453	3604H	EM-3147	3723	EM-3159
3418	EM-9212	3500H	EM-5953	3605H	EM-5694	3724	EM-3162
3419	EM-9213	3501	EM-5943	3606H	EM-5693	3726	EM-3160
3420	EM-9218	3503	EM-7072	3607	EM-5380	3731	EM-9579
3421H	EM-9451	3504	EM-3028	3608	EM-3070	3732	EM-9580
3422H	EM-9211	3505	EM-3040	3609	EM-3046	3744	EM-3100
3423H	EM-9182	3506	EM-3041	3610	EM-4143	3745	EM-3087
3424	EM-3168	3507	EM-3042	3614	EM-4095	3746	EM-3105
3424R	EM-4127	3508	EM-3044	3618	EM-4227	3747	EM-3111
3425	EM-9215	3509H	EM-3079	3621H	EM-3149	3748	EM-3125
3426	EM-9220	3510H	EM-3020	3622H	EM-3154	3749	EM-3126
3427H	EM-5793	3511H	EM-3022	3623	EM-5428	3750	EM-3127
3428H	EM-5875	3512H	EM-3023	3625	EM-9305	3752	EM-9160
3429	EM-9428	3513	EM-3031	3626	EM-9159	3753	EM-9394
3430H	EM-9282	3514	EM-3032	3628	EM-9177	3754	EM-9394
3430HR	EM-9282	3515	EM-3033	3629	EM-5424	3755	EM-5452
3431	EM-9221	3515H	EM-3033	3630	EM-5425	3756	EM-9531
3432	EM-9285	3516H	EM-3071	3631H	EM-4039	3757	EM-5144
3433	EM-9300	3517H	EM-3072	3632H	EM-3151	3758	EM-5188
3434	EM-9301	3518H	EM-3077	3637	EM-9477	3759	EM-5190
3435	EM-9298	3519H	EM-3080	3638	EM-9455	3760	EM-5191
3436	EM-9384	3520H	EM-3083	3640H	EM-5152	3761	EM-5121
3439	EM-4061	3521H	EM-9188	3641	EM-9507	3763H	EM-9329
3440	EM-4062	3522	EM-5876	3642	EM-9281	3764	EM-9068
3441	EM-3128	3523H	EM-4155	3644	EM-4022	3765	EM-8879
3442	EM-3177	3524	EM-8696	3646	EM-3060	3766	EM-8877
3443H	EM-5583	3525	EM-8111	3647	EM-3059	3767	EM-9203
3444	EM-5354	3527	EM-5933	3648	EM-3063	3768	EM-9373
3446H	EM-4033	3527R	EM-5933	3649R	EM-3065	3769	EM-8769
3447	EM-4071	3530H	EM-4064	3650	EM-8872	3770	EM-8768
3448	EM-4019	3532H	EM-4155	3651	EM-8873	3771	EM-9318
3449H	EM-9467	3537H	EM-5949	3657	EM-8850	3772	EM-8754
3450HR	EM-9459	3540	EM-3137	3662H	EM-3092	3773	EM-8755
3451	EM-4117	3541	EM-9283	3667	EM-8395	3776	EM-8719
3453	EM-9539	3543	EM-9078	3668	EM-9483	3777	EM-8734
3454	EM-5349	3544	EM-3144	3670	EM-5785	3779	EM-8947
3455H	EM-5588	3545	EM-9423	3672	EM-9433	3780	EM-8945
3456	EM-3095	3547H	EM-5904	3673	EM-3119	3781H	EM-9345
3460H	EM-5475	3548	EM-5377	3674	EM-9599	3783	EM-9316
3461H	EM-9506	3550	EM-8817	3675	EM-9050	3785	EM-8904
3462	EM-9482	3551	EM-9181	3676	EM-9494	3786	EM-8906
3463	EM-9520	3554H	EM-9465	3678	EM-3064	3787	EM-8905

# CROSS REFERENCE

Mfg Part No	Our Part	Mfg Part No	Our Part	Mfg Part No	Our Part	Mfg Part No	Our Part
<b>EAGLE BHP (cont.)</b>		<b>EAGLE BHP (cont.)</b>		<b>EAGLE BHP (cont.)</b>		<b>EAGLE BHP (cont.)</b>	
3788	EM-8908	3868H	EM-9348	3942	EM-8907	4249	EM-9452
3789	EM-8943	3869	EM-9315	3943	EM-9359	4250	EM-7013
3790	EM-8948	3869H	EM-9315	3944	EM-9351	4254	EM-4121
3791	EM-8890	3870	EM-9322	3945	EM-8856	4256	EM-3195
3792	EM-8952	3871	EM-9374	3946	EM-9414	4257H	EM-4116
3793	EM-8953	3872	EM-9380	3948H	EM-4074	4258	EM-4103
3794H	EM-9368	3873	EM-9311	3949	EM-7241	4259	EM-4100
3795	EM-9338	3874	EM-9024	3953	EM-4040	4261	EM-4104
3796	EM-9306	3875	EM-9314	3955	EM-5647	4266	EM-5990
3797	EM-9366	3876	EM-9336	3956	EM-9599	4267	EM-9487
3798	EM-8914	3877	EM-9320	3957	EM-9417	4269	EM-7073
3799	EM-9346	3878H	EM-9332	3960H	EM-5890	4273H	EM-4243
3800H	EM-9344	3879	EM-9330	3961H	EM-5889	4277	EM-4000
3801	EM-9191	3879H	EM-9330	3962H	EM-5660	4278H	EM-4074
3802	EM-8884	3880	EM-9333	3963H	EM-3166	4278HR	EM-4074
3803	EM-8886	3881H	EM-9335	3964H	EM-3153	4283	EM-5912
3804	EM-9469	3882	EM-9334	3965H	EM-5661	4289	EM-9456
3805H	EM-9007	3883	EM-9342	3966H	EM-3158	4290	EM-9464
3806H	EM-9008	3884	EM-9341	3967H	EM-3146	4291	EM-5864
3807	EM-8457	3885H	EM-9375	3968	EM-3139	4292	EM-8856
3808	EM-9186	3886	EM-9347	3970	EM-3179	4293	EM-9587
3809	EM-8695	3888	EM-9364	3971H	EM-2995	4294	EM-9588
3810	EM-9030	3889H	EM-9372	3972	EM-4028	4295	EM-4079
3811	EM-9435	3890	EM-9413	3973	EM-3142	4296	EM-4078
3812H	EM-9178	3892	EM-9277	3974	EM-4040	4297H	EM-7009
3813	EM-8900	3893H	EM-8982	3975	EM-9058	4298H	EM-9576
3814	EM-9150	3894	EM-5783	3976	EM-9539	4299	EM-9504
3814H	EM-9150	3895	EM-9466	3977	EM-9383	4300	EM-9541
3815	EM-9183	3896	EM-9461	3978	EM-8878	4301	EM-4046
3816	EM-8894	3897	EM-8965	3979	EM-8947	4302	EM-4045
3818	EM-8996	3898	EM-9472	3981	EM-9242	4303	EM-5990
3819H	EM-9261	3900H	EM-5384	3983	EM-8993	4304H	EM-5916
3820	EM-9420	3901H	EM-8795	3984	EM-9425	4305H	EM-5742
3821	EM-9061	3902H	EM-8796	3985	EM-8991	4306	EM-5834
3822	EM-8353	3903	EM-5750	3986	EM-8989	4309	EM-5914
3823	EM-9438	3904	EM-5757	3988	EM-8388	4316	EM-4240
3824	EM-9434	3905	EM-8870	3989	EM-2633	4318	EM-9518
3825	EM-3140	3906H	EM-5356	3990	EM-9554	4319H	EM-9447
3826	EM-9418	3907H	EM-5900	3993	EM-8744	4321	EM-9419
3827	EM-9436	3908	EM-5835	3994	EM-8746	4322H	EM-9449
3828	EM-9388	3909	EM-9546	3995	EM-8747	4325H	EM-2974
3830	EM-3123	3910	EM-9231	3996	EM-8748	4326	EM-5908
3831	EM-3177	3911	EM-9235	3997	EM-8750	4327	EM-8132
3832H	EM-9244	3912	EM-9227	3998	EM-8751	4328	EM-3074
3833	EM-5358	3913	EM-5206	3999	EM-8757	4329	EM-3073
3834	EM-5526	3914	EM-9538	4200	EM-8758	4331	EM-9077
3835	EM-5482	3915	EM-9233	4202	EM-8791	4332H	EM-4029
3836	EM-8869	3916	EM-9234	4203	EM-8804	4333	EM-4102
3837H	EM-5375	3918	EM-9161	4205	EM-8883	4334	EM-4153
3838H	EM-5362	3919	EM-9278	4206	EM-8944	4336	EM-4123
3839	EM-8163	3920	EM-9174	4208	EM-8122	4337	EM-4185
3842H	EM-5143	3921	EM-9201	4209	EM-9017	4340	EM-8228
3843	EM-8743	3922H	EM-5427	4210	EM-9019	4346	EM-8992
3844	EM-8783	3923	EM-3132	4211	EM-9189	4347	EM-4135
3847H	EM-9340	3924	EM-8722	4212	EM-9253	4348	EM-4111
3848	EM-9361	3925	EM-8784	4214	EM-9295	4356R	EM-4041
3849H	EM-9363	3926	EM-9323	4215	EM-9296	4359H	EM-7187
3851	EM-9370	3927	EM-8723	4217	EM-8896	4360H	EM-7186
3852	EM-9361	3928	EM-8913	4224	EM-4258	4366	EM-5905
3853	EM-9339	3929	EM-5738	4225	EM-4101	4367	EM-4172
3854	EM-8775	3931	EM-9378	4229H	EM-3148	4368	EM-9550
3857	EM-8911	3932	EM-3124	4235	EM-8995	4369	EM-7107
3858	EM-9313	3934	EM-9173	4236	EM-9514	4370	EM-7078
3860	EM-9312	3935	EM-9180	4237	EM-9454	4370	EM-9518
3861H	EM-9325	3936	EM-8711	4238H	EM-5970	4371	EM-9509
3862	EM-9326	3937	EM-9437	4239	EM-9498	4372H	EM-5964
3864	EM-9362	3938	EM-8978	4241	EM-5647	4373	EM-7238
3865	EM-8949	3939	EM-8977	4244	EM-5981	4374	EM-5902
3866	EM-8950	3941	EM-8912	4248	EM-5353	4374	EM-7183

# CROSS REFERENCE

Mfg Part No	Our Part	Mfg Part No	Our Part	Mfg Part No	Our Part	Mfg Part No	Our Part
<b>EAGLE BHP (cont.)</b>		<b>EAGLE BHP (cont.)</b>		<b>EAGLE BHP (cont.)</b>		<b>EAGLE BHP (cont.)</b>	
4375	EM-5901	4519	EM-7172	5043	ST-1934	5249	ST-4927
4375	EM-7184	4520	EM-7235	5046	ST-1973	5250	ST-5902
4376	EM-9522	4521HR	EM-7230	5048	ST-2901	5251	ST-5903
4377	EM-8849	4524H	EM-5840	5050	ST-1940	5252	ST-5922
4379	EM-4142	4525H	EM-5795	5051	ST-1961	5254	ST-1966
4381	EM-4138	4529	EM-9427	5059	ST-2938	5255	ST-5914
4382H	EM-4139	4530	EM-3092	5060	ST-4915	5256	ST-98004
4383	EM-4140	4531	EM-9215	5061	ST-1964	5257	ST-6989
4389H	EM-4168	4532H	EM-9572	5064	ST-1958	5258	ST-98005
4390	EM-8824	4533	EM-9343	5068	ST-1954	5259	ST-5906
4391	EM-5528	4544	EM-4182	5070	ST-1978	5260	ST-5981
4392	EM-9287	4545	EM-4181	5072	ST-2965	5263	ST-4955
4393	EM-9601	4548H	EM-5781	5076	ST-1975	5264	ST-4973
4394H	EM-5786	4550	EM-5752	5078	ST-1983	5267	ST-6964
4396H	EM-4205	4551	EM-9560	5081	ST-2932	5267K	ST-6964
4399H	EM-7044	4552	EM-5769	5093	ST-2954	5269	ST-10004
4403	EM-8981	4553	EM-5768	5095	ST-4912	5270	ST-6965
4404	EM-8980	4556	EM-4016	5096	ST-2968	5270K	ST-6965
4405	EM-9067	4557	EM-4015	5103	ST-2982	5271	ST-6971
4406	EM-9054	4558	EM-3030	5113	ST-3910	5276	ST-4985
4407	EM-9461	4559	EM-3029	5124	ST-2998	5279	ST-7996
4408	EM-9079	4560	EM-9470	5125	ST-3903	5282	ST-8900
4409	EM-9074	4570	EM-9552	5139	ST-3902	5285	ST-3928
4410	EM-8882	4573H	EM-5983	5143	ST-2953	5296	ST-3995
4413	EM-8978	4574H	EM-5971	5144	ST-2910	5304	ST-5917
4417	EM-9153	4577	EM-9232	5149	ST-1994	5305	ST-5918
4419	EM-9390	4578H	EM-9527	5151	ST-2947	5308	ST-6987
4420	EM-9537	4582H	EM-7000	5153	ST-4919	5312	ST-8998
4421	EM-3165	4583	EM-9544	5162	ST-2906	5322	ST-3918
4422H	EM-3183	4584	EM-5951	5175	ST-4916	5324	ST-3923
4424	EM-5411	4588H	EM-4190	5184	ST-4900	5326	ST-7949
4425	EM-4110	4590H	EM-4053	5186	ST-4905	5329	ST-4984
4426	EM-5530	4593H	EM-5973	5196	ST-2907	5330	ST-8992
4427	EM-5993	4595	EM-7048	5198	ST-4910	5339	ST-1923
4430H	EM-3200	4609	EM-4050	5200	ST-3962	5341	ST-2956
4431	EM-3197	4636	EM-5945	5201	ST-3928	5343	ST-1950
4432	EM-3196	4643	EM-9519	5202	ST-98000	5344	ST-3978
4433	EM-3201	4658H	EM-4265	5203	ST-98001	5345	ST-4972
4433H	EM-3201	4685H	EM-7025	5205	ST-98002	5347	ST-4954
4434	EM-4128	4728	EM-7195	5207	ST-4927	5348	ST-1979
4435	EM-3199	4737	EM-4055	5208	ST-3950	5356	ST-4957
4435H	EM-3199	4770H	EM-4125	5210	ST-8917	5358	ST-2924
4436	EM-9426	4808H	EM-5903	5211	ST-8916	5371	ST-8912
4443	EM-9573	4865	EM-4087	5216	ST-4936	5374	ST-8949
4444	EM-9444	4866	EM-4086	5218	ST-4990	5405	ST-9916
4446	EM-3043	4929H	EM-4238	5219	ST-2972	5418	ST-5916
4450H	EM-9236	4957H	EM-7290	5220	ST-5913	5425	ST-3939
4452	EM-5741	4961	EM-7031	5221	ST-3906	5433	ST-6973
4454H	EM-7053	4984H	EM-4097	5225	ST-3903	5434	ST-6974
4457	EM-90071	4987	EM-4267	5226	ST-5908	5471	ST-6985
4462	EM-7024	4988	EM-4131	5227	ST-5909	6121	EM-8934
4463	DS-6514	5000	ST-1905	5229	ST-3900	6122	EM-8045
4464H	EM-5882	5003	ST-1908	5230	ST-4968	6127	EM-8047
4465H	EM-5881	5004	ST-1951	5231	ST-4975	6131	EM-8597
4466H	EM-7153	5005	ST-1927	5232	ST-4989	6134	EM-8041
4467	EM-8971	5007	ST-1913	5233	ST-4996	6143	EM-8042
4468	EM-9473	5010	ST-1903	5234	ST-4997	6206	EM-5042
4469H	EM-9445	5011	ST-1904	5235	ST-4919	6211	EM-8195
4471H	EM-9445	5013	ST-1913	5236	ST-3957	6215	EM-8181
4474	EM-9511	5016	ST-2941	5238	ST-3926	6216	EM-8197
4475	EM-9535	5018	ST-1955	5239	ST-2908	6217	EM-8198
4476	EM-9593	5022	ST-1921	5240	ST-2938	6219	EM-8186
4478	EM-9558	5028	ST-1926	5241	ST-3928	6220	EM-8185
4481	EM-5515	5030	ST-2935	5242	ST-3924	6221	EM-9117
4485	EM-7234	5031	ST-2937	5243	ST-7949	6222	EM-8193
4496	EM-9072	5032	ST-1959	5244	ST-5910	6225	EM-8187
4498	EM-8955	5033	ST-2937	5245	ST-98003	6227	EM-8180
4501H	EM-5966	5035	ST-1925	5247	ST-4970	6230	EM-8192
4518H	EM-7239	5038	ST-1975	5248	ST-4932	6231	EM-8194



# CROSS REFERENCE

Mfg Part No	Our Part	Mfg Part No	Our Part	Mfg Part No	Our Part	Mfg Part No	Our Part
<b>EAGLE BHP (cont.)</b>		<b>EAGLE BHP (cont.)</b>		<b>EAGLE BHP (cont.)</b>		<b>GABRIEL (cont.)</b>	
6232	EM-8201	6507	EM-8431	6688	EM-8148	142082	ST-1901
6233	EM-8190	6509	EM-8002	6691	EM-2805	142083	ST-1902
6234	EM-8190	6510	EM-8014	6692	EM-8224	142084	ST-1913
6235	EM-8200	6512	EM-8016	6693	EM-8236	142087	ST-1910
6239	EM-8175	6519	EM-8024	6694	EM-90022	142088	ST-1909
6242	EM-8179	6520	EM-8575	6695	EM-2810	142089	ST-1912
6243	EM-9116	6524	EM-8329	6704R	EM-2978	142090	ST-1911
6246	EM-8361	6525	EM-8008	6706	EM-2873	142091	ST-1903
6248	EM-8208	6526	EM-8300	6712R	EM-2632	142092	ST-1904
6253	EM-8209	6528	EM-8026	6713	EM-2889	142103	ST-1954
6256	EM-8979	6529	EM-8497	6713R	EM-5105	142108	ST-1913
6257	EM-8644	6530	EM-8432	6714R	EM-2887	142131	ST-2941
6261	EM-8177	6531	EM-8002	6715R	EM-2888	142132	ST-1953
6261X	EM-5198	6533	EM-9136	6804	EM-8489	142133	ST-1955
6274	EM-8508	6534	EM-8021	6806	EM-8568	142134	ST-1943
6275	EM-8207	6536	EM-8615	6807	EM-8825	142135	ST-1965
6277	EM-8485	6544H	EM-8009	6808	EM-8277	142136	ST-1941
6286	EM-8389	6545	EM-8411	6811	EM-8524	142141	ST-1921
6295	EM-8375	6547H	EM-8011	6814	EM-8517	142142	ST-1921
6308	EM-8304	6549	EM-8404	6819	EM-8282	142143	ST-1921
6309	EM-8304	6550	EM-8572	6825	EM-8890	142144	ST-1921
6310	EM-8304	6556	EM-8710	6857	EM-8049	142145	ST-1923
6318	EM-8137	6579	EM-8986	6858	EM-8048	142146	ST-1924
6320	EM-8604	6582	EM-8898	6862	EM-8579	142148	ST-1929
6323	EM-8140	6587H	EM-8984	6863	EM-8576	142150	ST-6915
6330	EM-8141	6589	EM-8586	6867	EM-9142	142173	ST-1952
6340	EM-8602	6602	EM-8205	6870	EM-8351	142182	ST-1926
6342	EM-8704	6606	EM-8205	6871	EM-8499	142183	ST-1930
6342R	EM-5502	6625	EM-8104	6906	EM-8589	142184	ST-2940
6343	EM-8705	6632	EM-2513	6907	EM-8287	142185	ST-2935
6344	EM-8114	6632X	EM-2508	7200	EM-8167	142189	ST-1959
6345	EM-8682	6632Y	EM-2393	7213	EM-8164	142190	ST-1963
6346	EM-8681	6633H	EM-2548	7214	EM-8164	142191	ST-2939
6347	EM-8124	6634	EM-2615	7219	EM-8209	142192	ST-2937
6348	EM-8276	6637	EM-8553	7226	EM-8418	142193	ST-1944
6350R	EM-8295	6638	EM-2477	7233	EM-8848	142194	ST-1981
6355	EM-8296	6640	EM-2436	7233X	EM-8848	142195	ST-1942
6371	EM-9038	6642	EM-2720	7234	EM-8855	142196	ST-1960
6377	EM-8276	6643	EM-2616	7238	EM-8698	142197	ST-1925
6379	EM-8150	6644X	EM-2618	7241	EM-8795	142198	ST-1927
6381	EM-8322	6645	EM-2621	7254	EM-8851	142217	ST-2904
6382	EM-8311	6646	EM-2538	7269	EM-8359	142218	ST-1980
6383	EM-8307	6647	EM-2492	7303	EM-8959	142219	ST-2920
6390	EM-9042	6653	EM-2340	7304	EM-9031	142220	ST-1971
6398	EM-8122	6654	EM-8152	7305	EM-8865	142220	ST-1974
6398R	EM-7119	6655	EM-2601	7306EL	EM-5670	142221	ST-1956
6398R	EM-8083	6658H	EM-8224	7311	EM-8846	142222	ST-1970
6410	EM-8078	6659	EM-8222	7314	EM-9200	142223	ST-1934
6419	EM-8082	6660	EM-8236	7315	EM-9166	142224	ST-1946
6424	EM-8094	6662	EM-8616	7318	EM-9012	142225	ST-1973
6425	EM-8095	6663	EM-8236	7319	EM-8964	142225	ST-1991
6428	EM-8091	6665	EM-8118	7320	EM-2985	142226	ST-1922
6437	EM-8516	6668	EM-2824S	7321	EM-9251	142227	ST-1928
6442	EM-8084	6669	EM-2979	7323	EM-5773	142228	ST-2901
6447	EM-8862	6669R	EM-2847	7324	EM-9415	142229	ST-2901
6452	EM-8085	6670	EM-5052	7325	EM-9431	142230	ST-1940
6453	EM-8086	6670R	EM-2848	7327	EM-8162	142231	ST-1961
6454	EM-8088	6671	EM-5180	7328	EM-9228	142232	ST-1933
6456	EM-8087	6672	EM-2512	7330	EM-9500	142233	ST-1939
6457	EM-9478	6674	EM-2812	7331	EM-9165	142234	ST-1938
6461	EM-8516	6675	EM-2813	7332	EM-9226	142235	ST-1932
6463	EM-8691	6676	EM-2718	7517	DS-6516	142236	ST-2922
6467	EM-9240	6677	EM-2719	62009	EM-5742	142237	ST-2919
6467H	EM-9240	6678	EM-7114	6705R9	EM-2886	142238	ST-2918
6474	EM-8814	6682	EM-2867	<b>GABRIEL</b>		142239	ST-2918
6500	EM-8031	6683	EM-2846	141578	ST-1905	142240	ST-1977
6502	EM-8435	6684	EM-8130	141579	ST-1906	142241	ST-1947
6505	EM-8021	6685	EM-8149	141580	ST-1907	142242	ST-1948
6506	EM-8010	6686	EM-8427	141974	ST-1951	142243	ST-2938

# CROSS REFERENCE

Mfg Part No	Our Part	Mfg Part No	Our Part	Mfg Part No	Our Part	Mfg Part No	Our Part
<b>GABRIEL (cont.)</b>		<b>GABRIEL (cont.)</b>		<b>GABRIEL (cont.)</b>		<b>GABRIEL (cont.)</b>	
142244	ST-1950	142415	ST-2915	142569	ST-3905	142831	ST-2992
142245	ST-1964	142416	ST-2942	142570	ST-3905	142832	ST-2936
142246	ST-1968	142417	ST-2943	142571	ST-3964	142832	ST-4913
142247	ST-1967	142418	ST-2934	142572	ST-3982	142834	ST-5997
142248	ST-1969	142419	ST-2923	142573	ST-3962	142836	ST-2926
142249	ST-1958	142420	ST-2917	142621	ST-2903	142836	ST-3991
142250	ST-1962	142421	ST-3947	142622	ST-2987	142837	ST-3904
142251	ST-1941	142422	ST-2955	142623	ST-2938	142838	ST-4900
142252	ST-1966	142423	ST-1947	142624	ST-1992	142839	ST-1985
142253	ST-1937	142425	ST-2989	142625	ST-2984	142840	ST-2907
142254	ST-1954	142426	ST-2982	142626	ST-3939	142841	ST-2945
142266	ST-1980	142427	ST-2983	142640	ST-2972	142842	ST-1980
142292	ST-1978	142428	ST-2981	142641	ST-3940	142843	ST-2953
142293	ST-1987	142430	ST-2979	142642	ST-3941	142844	ST-1927
142294	ST-1994	142431	ST-2989	142643	ST-3942	142845	ST-2944
142295	ST-1988	142432	ST-2929	142644	ST-2975	142846	ST-1926
142296	ST-1995	142433	ST-2909	142645	ST-2974	142847	ST-2940
142297	ST-2965	142434	ST-2933	142646	ST-2978	142849	ST-2941
142298	ST-1990	142435	ST-1944	142646	ST-2980	142850	ST-1933
142299	ST-1986	142436	ST-2986	142647	ST-2998	142851	ST-3907
142300	ST-6916	142437	ST-2912	142649	ST-3903	142852	ST-1999
142301	ST-1976	142438	ST-2926	142650	ST-3906	142853	ST-2960
142302	ST-1989	142439	ST-2927	142651	ST-4905	142854	ST-2936
142303	ST-1975	142440	ST-2911	142652	ST-4908	142855	ST-2939
142304	ST-1944	142441	ST-4906	142653	ST-4909	142856	ST-2922
142305	ST-1979	142442	ST-4907	142654	ST-4910	142857	ST-3947
142306	ST-1984	142443	ST-2990	142734	ST-1985	142858	ST-1947
142307	ST-1983	142444	ST-2906	142734	ST-3912	142858	ST-3949
142309	ST-1916	142521	ST-3913	142735	ST-2904	142859	ST-3951
142310	ST-2963	142522	ST-2956	142735	ST-3915	142860	ST-2989
142311	ST-1993	142523	ST-2946	142736	ST-3901	142861	ST-2937
142312	ST-1996	142524	ST-1928	142737	ST-2976	142862	ST-2989
142316	ST-2992	142525	ST-2973	142738	ST-2970	142880	ST-1908
142317	ST-2932	142526	ST-2973	142740	ST-3943	142930	ST-3928
142318	ST-2950	142527	ST-2965	142741	ST-2985	142931	ST-5911
142320	ST-2914	142527	ST-3930	142742	ST-1994	142932	ST-3926
142321	ST-2964	142528	ST-3929	142742	ST-2994	142933	ST-1908
142322	ST-1999	142529	ST-2930	142743	ST-2995	142935	ST-3938
142323	ST-2966	142530	ST-1922	142744	ST-3965	142936	ST-3950
142324	ST-2960	142531	ST-1946	142744	ST-4936	142937	ST-6914
142325	ST-2921	142531	ST-2999	142745	ST-1955	142938	ST-3954
142326	ST-2902	142532	ST-3900	142745	ST-3966	142939	ST-2981
142327	ST-2962	142533	ST-2969	142746	ST-3967	142939	ST-3957
142328	ST-2961	142534	ST-2991	142747	ST-3968	142940	ST-4916
142329	ST-2958	142535	ST-2984	142748	ST-1946	142941	ST-4904
142330	ST-2924	142535	ST-3935	142748	ST-3970	142942	ST-4987
142334	ST-2959	142536	ST-2984	142749	ST-3971	142943	ST-4915
142335	ST-1932	142536	ST-3936	142750	ST-1946	142949	ST-4979
142335	ST-2913	142538	ST-2921	142750	ST-3972	142992	ST-4927
142336	ST-2957	142539	ST-3945	142751	ST-1922	143028	ST-2918
142392	ST-2925	142540	ST-2977	142751	ST-3973	143028	ST-2934
142393	ST-2908	142541	ST-3947	142752	ST-3974	143030	ST-1940
142396	ST-2946	142542	ST-2977	142753	ST-3975	143031	ST-1940
142397	ST-2953	142543	ST-2977	142754	ST-3976	143032	ST-1940
142399	ST-2910	142546	ST-3910	142755	ST-3977	143035	ST-4919
142401	ST-2944	142547	ST-3911	142756	ST-3901	143036	ST-2994
142402	ST-2954	142549	ST-2931	142757	ST-3985	143037	ST-2995
142403	ST-2952	142550	ST-3983	142758	ST-3993	143067	ST-2941
142404	ST-2951	142551	ST-3987	142759	ST-3994	143071	ST-2968
142405	ST-2971	142552	ST-3986	142760	ST-2988	143072	ST-2969
142406	ST-1946	142553	ST-3988	142761	ST-2967	143073	ST-2968
142407	ST-2968	142554	ST-3989	142762	ST-1913	143073	ST-2969
142408	ST-2947	142555	ST-3990	142762	ST-3969	143074	ST-2968
142409	ST-2948	142559	ST-3992	142763	ST-3984	143074	ST-2969
142410	ST-2916	142561	ST-2926	142803	ST-2935	143082	ST-3918
142411	ST-2930	142562	ST-2960	142825	ST-3916	143083	ST-3922
142412	ST-3933	142566	ST-2936	142826	ST-3917	143084	ST-3914
142413	ST-2949	142567	ST-2993	142827	ST-3901	143087	ST-4957
142414	ST-2928	142568	ST-3980	142828	ST-3902	143088	ST-5943

# CROSS REFERENCE

Mfg Part No	Our Part	Mfg Part No	Our Part	Mfg Part No	Our Part	Mfg Part No	Our Part
<b>GABRIEL (cont.)</b>		<b>GABRIEL (cont.)</b>		<b>HAYDEN (cont.)</b>		<b>HAYDEN (cont.)</b>	
143089	ST-5948	143317	ST-4973	31-1003	EM-2525	31-2271	EM-2321
143090	ST-4915	143318	ST-6918	31-1004	EM-2720	31-2273	EM-2254
143091	ST-2973	143319	ST-6927	31-1007	EM-2615	31-2274	EM-2256
143093	ST-4935	143320	ST-7912	31-1008	EM-2616	31-2275	EM-2255
143094	ST-4990	143321	ST-6917	31-1009	EM-2618	31-2276	EM-2350
143112	ST-4998	143322	ST-3950	31-2007	EM-2007	31-2281	EM-2262
143113	ST-4999	143323	ST-5907	31-2009	EM-2009	31-2284	EM-2253
143116	ST-8908	143324	ST-5914	31-2010	EM-2010	31-2286	EM-2333
143139	ST-3983	143325	ST-4900	31-2039	EM-2039	31-2287	EM-2257
143140	ST-4934	143335	ST-5969	31-2040	EM-2040	31-2288	EM-2290
143191	ST-4903	143336	ST-6958	31-2048	EM-2048	31-2289	EM-2289
143193	ST-4991	143337	ST-6959	31-2050	EM-2050	31-2293	EM-2264
143194	ST-4988	143339	ST-7923	31-2060	EM-2060	31-2295	EM-2351
143195	ST-5900	143341	ST-5915	31-2070	EM-2070	31-2296	EM-2266
143196	ST-4902	143342	ST-5983	31-2073	EM-2073	31-2304	EM-2263
143197	ST-4918	143343	ST-6988	31-2107	EM-2107	31-2305	EM-2281
143198	ST-3999	143344	ST-7949	31-2108	EM-2108	31-2308	EM-2267
143199	ST-3998	143345	ST-7947	31-2119	EM-2119	31-2308HD	EM-2267
143200	ST-3997	143349	ST-8946	31-2121	EM-2121	31-2312	EM-2238
143201	ST-5957	143353	ST-6919	31-2122	EM-2122	31-2312	EM-2274
143202	ST-4989	143353	ST-6920	31-2123	EM-2123	31-2313	EM-2261
143204	ST-4932	143354	ST-5909	31-2124	EM-2124	31-2315	EM-2309
143205	ST-5950	143355	ST-5908	31-2125	EM-2125	31-2316	EM-2277
143206	ST-3961	143356	ST-7944	31-2126	EM-2126	31-2317	EM-2275
143207	ST-3960	143358	ST-7932	31-2127	EM-2127	31-2319	EM-2301
143208	ST-3959	143359	ST-7932	31-2141	EM-2141	31-2322	EM-2283
143209	ST-4955	143360	ST-7937	31-2142	EM-2142	31-2323	EM-2317
143210	ST-3958	143361	ST-7940	31-2142HD	EM-2267	31-2327	EM-2310
143214	ST-4985	143363	ST-5980	31-2142HDL	EM-2278	31-2328	EM-2402
143218	ST-4954	143364	ST-5922	31-2143	EM-2143	31-2328	EM-2403
143219	ST-4983	143365	ST-6980	31-2150	EM-2150	31-2331	EM-2271
143220	ST-3909	143366	ST-7986	31-2162	EM-2162	31-2332	EM-2270
143221	ST-4995	143367	ST-3995	31-2163	EM-2163	31-2334	EM-2297
143222	ST-3908	143368	ST-5949	31-2167	EM-2167	31-2335	EM-2298
143223	ST-4994	143369	ST-5966	31-2168	EM-2293	31-2336	EM-2299
143224	ST-5917	143375	ST-5981	31-2170	EM-2170	31-2338	EM-2305
143226	ST-5927	143377	ST-8914	31-2172	EM-2172	31-2339	EM-2306
143227	ST-4980	143378	ST-8915	31-2204	EM-2204	31-2342	EM-2286
143228	ST-4981	143379	ST-7928	31-2205	EM-2205	31-2343	EM-2268
143231	ST-6920	143381	ST-6973	31-2206	EM-2206	31-2344	EM-2279
143233	ST-4997	143382	ST-6974	31-2217	EM-2217	31-2345	EM-2316
143235	ST-4977	143383	ST-7922	31-2218	EM-2218	31-2346	EM-2296
143236	ST-4976	143385	ST-5913	31-2219	EM-2219	31-2350	EM-2265
143239	ST-5906	143386	ST-5984	31-2220	EM-2220	31-2352	EM-2311
143240	ST-3932	143387	ST-5937	31-2221	EM-2221	31-2353	EM-2288
143241	ST-4968	143388	ST-5936	31-2222	EM-2222	31-2353	EM-2531
143242	ST-4972	143389	ST-7930	31-2223	EM-2223	31-2356	EM-2512
143244	ST-4974	143390	ST-6996	31-2224	EM-2378	31-2357	EM-2323
143246	ST-4971	143391	ST-6997	31-2225	EM-2225	31-2357	EM-2357
143248	ST-4970	143392	ST-5918	31-2226	EM-2226	31-2358	EM-2324
143253	ST-4938	143394	ST-5945	31-2227	EM-2227	31-2359	EM-2325
143255	ST-5903	143397	ST-5916	31-2228	EM-2228	31-2361	EM-2292
143256	ST-3924	143400	ST-7997	31-2231	EM-2231	31-2363	EM-2291
143259	ST-3923	143404	ST-6983	31-2234	EM-2234	31-2365	EM-2320
143262	ST-3921	143406	ST-7943	31-2235	EM-2235	31-2366	EM-2295
143263	ST-3920	143408	ST-5930	31-2239HD	EM-2282	31-2367	EM-2328
143264	ST-6919	143412	ST-6982	31-2240	EM-2240	31-2370	EM-2294
143264	ST-6920	143415	ST-6962	31-2241	EM-2241	31-2372	EM-2329
143265	ST-4996	143418	ST-5953	31-2243HD	EM-2284	31-2373	EM-2722
143266	ST-5902	143419	ST-5923	31-2244	EM-2287	31-2375	EM-2345
143267	ST-4958	143421	ST-5959	31-2244HD	EM-2287	31-2377	EM-2353
143277	ST-1975	143422	ST-6990	31-2245	EM-2327	31-2378	EM-2331
143278	ST-1944	143423	ST-6955	31-2250	EM-2242	31-2379	EM-2332
143279	ST-1979	143425	ST-7990	31-2255	EM-2349	31-2380	EM-2375
143280	ST-5912	143458	ST-6977	31-2255	EM-2369	31-2381	EM-2356
143281	ST-5912	143474	ST-8993	31-2265	EM-2250	31-2384	EM-2344
143305	ST-5904	<b>HAYDEN</b>		31-2266	EM-2272	31-2385	EM-2337
143315	ST-4975	31-1000	EM-2376	31-2267	EM-2338	31-2386	EM-2335
143316	ST-5910	31-1001	EM-2369	31-2268	EM-2304	31-2387	EM-2336

# CROSS REFERENCE

Mfg Part No	Our Part	Mfg Part No	Our Part	Mfg Part No	Our Part	Mfg Part No	Our Part
<b>HAYDEN (cont.)</b>		<b>HAYDEN (cont.)</b>		<b>HAYDEN (cont.)</b>		<b>HAYDEN (cont.)</b>	
31-2388	EM-2358	31-3086	EM-2388	31-3282	EM-2429	31-3502	EM-2570
31-2389	EM-2359	31-3088	EM-2462	31-3283	EM-2449	31-3503HY	EM-2661
31-2390	EM-2470	31-3089	EM-2453	31-3284	EM-2451	31-3503SLD	EM-2661S
31-2391	EM-2374	31-3090	EM-2454	31-3285	EM-2451	31-3504	EM-2571
31-2393	EM-2326	31-3091	EM-2389	31-3286	EM-2452	31-3505	EM-2572
31-2511	EM-2466	31-3093	EM-2467	31-3297	EM-2680	31-3506	EM-2569
31-2534	EM-2534	31-3095	EM-2505	31-3300	EM-2740	31-3506	EM-2663
31-2537	EM-2537	31-3096	EM-2466	31-3302	EM-2681	31-3507	EM-2568
31-2538	EM-2538	31-3097	EM-2393	31-3305	EM-2741	31-3508	EM-2627
31-2539	EM-2538	31-3097	EM-2508	31-3306	EM-2742	31-3510	EM-2628
31-2540	EM-2538	31-3099	EM-2531	31-3307	EM-2488	31-3511	EM-2617
31-2541	EM-2538	31-3103	EM-2472	31-3308	EM-2487	31-3512	EM-2625
31-2542	EM-2538	31-3108	EM-2436	31-3310	EM-2407	31-3513	EM-2624
31-3000	EM-2303	31-3112	EM-2491	31-3315	EM-2743	31-3515	EM-2629
31-3004	EM-2373	31-3113	EM-2490	31-3316	EM-2744	31-3516	EM-2626
31-3006	EM-2512	31-3120	EM-2567	31-3317	EM-2745	31-3517HY	EM-2553
31-3009	EM-2340	31-3121	EM-2562	31-3318	EM-2408	31-3517SLD	EM-2553S
31-3014	EM-2339	31-3121	EM-2774	31-3320	EM-2746	31-3518HY	EM-2555
31-3015	EM-2341	31-3122	EM-2563	31-3322	EM-2690	31-3518SLD	EM-2555S
31-3017	EM-2363	31-3136	EM-2439	31-3325	EM-2489	31-3519	EM-2633
31-3018	EM-2346	31-3137	EM-2440	31-3325	EM-2489	31-3519	EM-2633
31-3019	EM-2348	31-3138	EM-2441	31-3375	EM-2749	31-3520	EM-2557
31-3020	EM-2384	31-3139	EM-2442	31-3386	EM-2750	31-3521	EM-2639
31-3021	EM-2382	31-3141	EM-2442	31-3387	EM-2751	31-3523	EM-2632
31-3022	EM-2387	31-3142	EM-2444	31-3392	EM-2619	31-3523	EM-2634
31-3024	EM-2394	31-3142	EM-2445	31-3392	EM-2619	31-3523	EM-2634
31-3025	EM-2360	31-3144	EM-2502	31-3394	EM-2565	31-3524	EM-2609
31-3026	EM-2379	31-3145	EM-2448	31-3395	EM-2566	31-3525HY	EM-2551
31-3030	EM-2381	31-3147	EM-2433	31-3396	EM-2752	31-3525SLD	EM-2551S
31-3033	EM-2436	31-3148	EM-2434	31-3397	EM-2753	31-3526HY	EM-2551
31-3034	EM-2436	31-3153	EM-2775	31-3401	EM-2754	31-3526SLD	EM-2551S
31-3036	EM-2391	31-3159	EM-2503	31-3408	EM-2458	31-3527HY	EM-2551
31-3037	EM-2392	31-3160	EM-2504	31-3409	EM-2457	31-3527SLD	EM-2551S
31-3038	EM-2395	31-3161	EM-2776	31-3410	EM-2458	31-3528HY	EM-2556
31-3042	EM-2446	31-3165	EM-2458	31-3411	EM-2457	31-3529	EM-2630
31-3045	EM-2370	31-3166	EM-2500	31-3412	EM-2682	31-3529	EM-2630
31-3046	EM-2370	31-3167	EM-2501	31-3412	EM-2682	31-3530	EM-2684
31-3046	EM-2371	31-3168	EM-2457	31-3413	EM-2683	31-3531	EM-2760
31-3048	EM-2471	31-3170	EM-2459	31-3414	EM-2558	31-3532	EM-2685
31-3049	EM-2362	31-3171	EM-2460	31-3415	EM-2559	31-3535	EM-2636
31-3054	EM-2364	31-3172	EM-2461	31-3418	EM-2696S	31-3536	EM-2635
31-3055	EM-2365	31-3175	EM-2501	31-3419	EM-2631	31-3538	EM-2600
31-3056	EM-2368	31-3176	EM-2500	31-3425	EM-2497	31-3538	EM-2600
31-3057	EM-2367	31-3177	EM-2501	31-3426	EM-2498	31-3539	EM-2499
31-3058	EM-2723	31-3178	EM-2500	31-3429	EM-2513	31-3540	EM-2601
31-3059	EM-2724	31-3179	EM-2501	31-3429	EM-2515	31-3541	EM-2601
31-3060	EM-2409	31-3180	EM-2500	31-3434	EM-2515	31-3542	EM-2601
31-3062	EM-2406	31-3182	EM-2725	31-3436	EM-2474	31-3543	EM-2601
31-3062	EM-2406	31-3183	EM-2726	31-3437	EM-2473	31-3544	EM-2601
31-3063	EM-2400	31-3187	EM-2464	31-3438	EM-2506	31-3545	EM-2601
31-3064	EM-2405	31-3188	EM-2463	31-3439	EM-2524	31-3546	EM-2601
31-3065	EM-2404	31-3189	EM-2679	31-3440	EM-2477	31-3547	EM-2601
31-3066	EM-2414	31-3190	EM-2727	31-3442	EM-2381	31-3548	EM-2601
31-3067	EM-2419	31-3191	EM-2728	31-3444	EM-2510	31-3549	EM-2623
31-3068	EM-2418	31-3192	EM-2536	31-3446	EM-2496	31-3550	EM-2622
31-3069	EM-2417	31-3195	EM-2458	31-3447	EM-2543	31-3551	EM-2687
31-3071	EM-2424	31-3199	EM-2728	31-3450	EM-2492	31-3552	EM-2686
31-3072	EM-2426	31-3200	EM-2447	31-3450	EM-2492	31-3552	EM-2688
31-3073	EM-2428	31-3201	EM-2600	31-3453	EM-2528	31-3553	EM-2644
31-3074	EM-2425	31-3202	EM-2730	31-3454	EM-2528	31-3554	EM-2645
31-3075	EM-2415	31-3203	EM-2731	31-3455	EM-2396	31-3555	EM-2646
31-3076	EM-2389	31-3204	EM-2731	31-3456	EM-2494	31-3556	EM-2646
31-3077	EM-2457	31-3204	EM-2731	31-3458HY	EM-2548	31-3557	EM-2640
31-3078	EM-2458	31-3208	EM-2734	31-3458SLD	EM-2548S	31-3558	EM-2641
31-3080	EM-2420	31-3208	EM-2734	31-3459	EM-2495	31-3559	EM-2642
31-3081	EM-2372	31-3234	EM-2469	31-3460	EM-2755	31-3560	EM-2643
31-3082	EM-2385	31-3245	EM-2493	31-3461	EM-2756	31-3561	EM-2652
31-3083	EM-2437	31-3276	EM-2401	31-3464	EM-2382	31-3562	EM-2620
31-3084	EM-2438	31-3277	EM-2421	31-3464	EM-2382	31-3562	EM-2620
		31-3278	EM-2456	31-3467	EM-2549	31-3563	EM-2637
		31-3279	EM-2533	31-3468	EM-2550	31-3564	EM-2638
		31-3280	EM-2532	31-3469	EM-2497	31-3565	EM-2564
		31-3281	EM-2410	31-3500	EM-2280	31-3566	EM-2621
				31-3501	EM-2330	31-3568	EM-2649

# CROSS REFERENCE

Mfg Part No	Our Part	Mfg Part No	Our Part	Mfg Part No	Our Part	Mfg Part No	Our Part
<b>HAYDEN (cont.)</b>		<b>HUMMER (cont.)</b>		<b>KYB (cont.)</b>		<b>KYB (cont.)</b>	
31-3569	EM-2650	15113134	EM-2638	SM5057	ST-1922	SM5131	ST-3980
31-3570	EM-2651	15171918	EM-2638	SM5058	ST-1940	SM5132	ST-3962
31-3571	EM-2665	15226251	EM-2909	SM5059	ST-1961	SM5133	ST-2927
31-3572HY	EM-2717	15236456	EM-4015	SM5060	ST-1938	SM5135	ST-2908
31-3572SLD	EM-2717S	15683966	EM-2638	SM5061	ST-2918	SM5136	ST-2907
31-3573HY	EM-2660	15750514	EM-2638	SM5062	ST-2918	SM5137	ST-2946
31-3573SLD	EM-2660S	15804744	EM-4096	SM5063	ST-1977	SM5138	ST-2953
31-3574	EM-2691	15840277	EM-2638	SM5064	ST-1947	SM5139	ST-2970
31-3575	EM-2671	15840278	EM-2638	SM5065	ST-1948	SM5140	ST-2954
31-3576	EM-2761	15925797	EM-4016	SM5067	ST-1967	SM5141	ST-2976
31-3577	EM-2708	25746056	EM-2638	SM5068	ST-1969	SM5142	ST-4912
31-3578	EM-2762	<b>INTERNATIONAL (IHC)</b>		SM5069	ST-1958	SM5143	ST-2973
31-3579	EM-2763	879849R92	DS-6052	SM5070	ST-1966	SM5144	ST-2968
31-3580	EM-2764	<b>KYB</b>		SM5072	ST-2920	SM5144	ST-2969
31-3581	EM-2765	SM1043	ST-1942	SM5073	ST-1946	SM5145	ST-3900
31-3582	EM-2766	SM5001	ST-1905	SM5074	ST-2901	SM5146	ST-2999
31-3584	EM-2667	SM5002	ST-1906	SM5075	ST-2901	SM5147	ST-2949
31-3585	EM-2668	SM5003	ST-1908	SM5076	ST-2922	SM5148	ST-3939
31-3586	EM-2710	SM5004	ST-1907	SM5077	ST-2919	SM5149	ST-2915
31-3587	EM-2653	SM5005	ST-1902	SM5078	ST-1950	SM5150	ST-3907
31-3588	EM-2654	SM5006	ST-1901	SM5079	ST-1964	SM5151	ST-2921
31-3589	EM-2655	SM5007	ST-1913	SM5080	ST-2903	SM5151	ST-6977
31-3591	EM-2656	SM5010	ST-1951	SM5081	ST-2932	SM5152	ST-3947
31-3592	EM-2657	SM5011	ST-1903	SM5082	ST-1994	SM5153	ST-2938
31-3593	EM-2658	SM5012	ST-1904	SM5083	ST-1986	SM5154	ST-2978
31-3594	EM-2767	SM5013	ST-1965	SM5084	ST-2902	SM5154	ST-2980
31-3595	EM-2768	SM5014	ST-1955	SM5085	ST-1989	SM5155	ST-3965
31-3596	EM-2769	SM5016	ST-2941	SM5086	ST-1979	SM5155	ST-4936
31-3597HY	EM-2711	SM5017	ST-1953	SM5087	ST-2957	SM5156	ST-3967
31-3598	EM-2770	SM5018	ST-1952	SM5088	ST-1984	SM5157	ST-3975
31-3600	EM-2771	SM5019	ST-1943	SM5089	ST-1983	SM5158	ST-3976
31-3601	EM-2676	SM5020	ST-1911	SM5090	ST-1944	SM5159	ST-3993
31-3602	EM-2664	SM5021	ST-1912	SM5091	ST-2923	SM5160	ST-3994
31-3604	EM-2692	SM5022	ST-1910	SM5091	ST-6990	SM5161	ST-3990
31-3605	EM-2662	SM5023	ST-1909	SM5092	ST-2911	SM5162	ST-3995
31-3606	EM-2674	SM5023	ST-1910	SM5093	ST-2952	SM5163	ST-2986
31-3608	EM-2772	SM5024	ST-1941	SM5094	ST-2951	SM5164	ST-3992
31-3609	EM-2707S	SM5026	ST-1973	SM5096	ST-2955	SM5165	ST-4903
31-3610	EM-2677	SM5027	ST-1924	SM5097	ST-3951	SM5167	ST-3901
31-3611	EM-2678	SM5028	ST-1923	SM5098	ST-2989	SM5168	ST-3902
31-3613	EM-2773	SM5029	ST-1921	SM5099	ST-2982	SM5169	ST-3928
31-3614	EM-2777	SM5030	ST-1921	SM5100	ST-2983	SM5170	ST-4913
31-3616	EM-2778	SM5033	ST-1929	SM5101	ST-2979	SM5172	ST-3960
31-3617HY	EM-2548	SM5034	ST-1942	SM5102	ST-2989	SM5173	ST-5997
31-3618	EM-2780	SM5035	ST-1960	SM5103	ST-2987	SM5174	ST-3991
31-3619	EM-2781	SM5036	ST-1925	SM5104	ST-1944	SM5175	ST-3904
31-3621	EM-2782	SM5037	ST-1927	SM5105	ST-2959	SM5176	ST-3998
31-3623	EM-2709	SM5038	ST-1926	SM5106	ST-1975	SM5177	ST-3999
31-3624	EM-2784	SM5039	ST-1930	SM5107	ST-2981	SM5178	ST-4918
31-3625	EM-2785	SM5040	ST-2940	SM5108	ST-2933	SM5179	ST-3903
31-3626	EM-2786	SM5041	ST-2935	SM5109	ST-2958	SM5180	ST-3906
35-6027	DS-6027	SM5042	ST-2992	SM5110	ST-1980	SM5181	ST-4905
35-6028	DS-6028	SM5043	ST-1934	SM5111	ST-1978	SM5182	ST-4910
35-6035	DS-6035	SM5044	ST-2936	SM5112	ST-2945	SM5183	ST-3912
35-6036	DS-6056	SM5045	ST-1959	SM5113	ST-2944	SM5184	ST-4900
35-6047	DS-6038	SM5046	ST-1963	SM5114	ST-1990	SM5186	ST-4902
35-6049	DS-6040	SM5047	ST-2939	SM5115	ST-2921	SM5187	ST-1970
35-6050	DS-6048	SM5048	ST-2937	SM5116	ST-2910	SM5188	ST-1987
35-6051	DS-6049	SM5049	ST-1944	SM5117	ST-2968	SM5189	ST-1988
35-6053	DS-6051	SM5050	ST-1981	SM5117	ST-2969	SM5190	ST-2916
35-6054	DS-6050	SM5052	ST-1985	SM5118	ST-2947	SM5191	ST-2928
35-6055	DS-6052	SM5053	ST-2904	SM5119	ST-2948	SM5192	ST-2991
35-6058	DS-6053	SM5054	ST-1971	SM5120	ST-3913	SM5193	ST-2984
<b>HUMMER</b>		SM5055	ST-1954	SM5121	ST-2956	SM5194	ST-2914
12339179	EM-4001	SM5056	ST-1934	SM5122	ST-3910	SM5195	ST-1976
14049626	EM-2638			SM5123	ST-3911	SM5196	ST-2985
15022551	EM-2638			SM5126	ST-2926	SM5197	ST-2990
15031704	EM-2638			SM5130	ST-2993	SM5198	ST-3924
15041508	EM-2909			SM5130	ST-4916	SM5199	ST-3926

# CROSS REFERENCE

Mfg Part No	Our Part	Mfg Part No	Our Part	Mfg Part No	Our Part	Mfg Part No	Our Part
<b>KYB (cont.)</b>		<b>KYB (cont.)</b>		<b>KYB (cont.)</b>		<b>KYB (cont.)</b>	
SM5200	ST-3937	SM5290	ST-4977	SM5385	ST-2926	SM5474	ST-4991
SM5201	ST-3938	SM5291	ST-2950	SM5386	ST-5902	SM5475	ST-4903
SM5202	ST-3957	SM5292	ST-1933	SM5387	ST-5903	SM5476	ST-7990
SM5203	ST-3954	SM5293	ST-1939	SM5388	ST-4957	SM5477	ST-5925
SM5205	ST-3997	SM5294	ST-2964	SM5389	ST-5911	SM5478	ST-5926
SM5206	ST-4927	SM5295	ST-4957	SM5390	ST-4938	SM5479	ST-8903
SM5211	ST-4975	SM5297	ST-1932	SM5395	ST-4968	SM5480	ST-8904
SM5213	ST-4955	SM5298	ST-2942	SM5398	ST-2969	SM5481	ST-8905
SM5214	ST-4934	SM5299	ST-2943	SM5399	ST-2968	SM5483	ST-5948
SM5215	ST-4935	SM5300	ST-1999	SM5400	ST-1940	SM5484	ST-5949
SM5216	ST-3950	SM5301	ST-2960	SM5401	ST-1940	SM5485	ST-4950
SM5217	ST-4979	SM5302	ST-2966	SM5402	ST-4996	SM5486	ST-5920
SM5218	ST-3957	SM5303	ST-2974	SM5402	ST-4997	SM5488	ST-5952
SM5220	ST-4904	SM5304	ST-2934	SM5403	ST-6920	SM5489	ST-5953
SM5225	ST-2994	SM5305	ST-2936	SM5405	ST-3909	SM5490	ST-5932
SM5226	ST-2995	SM5306	ST-3943	SM5406	ST-3908	SM5491	ST-5936
SM5227	ST-3968	SM5307	ST-2939	SM5407	ST-4999	SM5492	ST-5937
SM5228	ST-3970	SM5308	ST-2922	SM5408	ST-4998	SM5493	ST-7946
SM5229	ST-3971	SM5310	ST-2962	SM5409	ST-6914	SM5510	ST-5913
SM5230	ST-3973	SM5311	ST-3945	SM5410	ST-4921	SM5511	ST-5922
SM5231	ST-3977	SM5312	ST-2963	SM5411	ST-4923	SM5512	ST-6917
SM5232	ST-3940	SM5313	ST-2961	SM5412	ST-4925	SM5513	ST-5907
SM5233	ST-3941	SM5314	ST-4984	SM5415	ST-5965	SM5517	ST-5923
SM5234	ST-3942	SM5315	ST-1992	SM5417	ST-5992	SM5519	ST-6923
SM5236	ST-4908	SM5316	ST-2917	SM5418	ST-4919	SM5521	ST-5924
SM5237	ST-4909	SM5317	ST-2918	SM5418	ST-4940	SM5522	ST-5960
SM5239	ST-3935	SM5319	ST-3946	SM5420	ST-4945	SM5523	ST-5961
SM5240	ST-3936	SM5322	ST-3949	SM5422	ST-5950	SM5525	ST-5974
SM5242	ST-2977	SM5324	ST-3910	SM5423	ST-4989	SM5526	ST-5975
SM5243	ST-3983	SM5326	ST-2989	SM5427	ST-4983	SM5527	ST-5976
SM5244	ST-3987	SM5327	ST-2937	SM5428	ST-5917	SM5528	ST-5977
SM5245	ST-3986	SM5328	ST-3958	SM5430	ST-4922	SM5529	ST-5979
SM5246	ST-3988	SM5330	ST-2929	SM5431	ST-4924	SM5530	ST-5910
SM5247	ST-3989	SM5331	ST-2909	SM5432	ST-5972	SM5531	ST-5914
SM5249	ST-1985	SM5332	ST-4987	SM5434	ST-5971	SM5532	ST-6955
SM5250	ST-3920	SM5333	ST-4915	SM5437	ST-4943	SM5533	ST-5969
SM5251	ST-3921	SM5334	ST-2998	SM5438	ST-4944	SM5534	ST-5970
SM5252	ST-3922	SM5335	ST-3959	SM5440	ST-4941	SM5535	ST-5966
SM5253	ST-3923	SM5340	ST-3961	SM5441	ST-4951	SM5536	ST-4973
SM5254	ST-3914	SM5343	ST-3905	SM5442	ST-7925	SM5537	ST-5904
SM5255	ST-2905	SM5344	ST-4956	SM5443	ST-6983	SM5539	ST-6968
SM5256	ST-3915	SM5346	ST-3964	SM5444	ST-6984	SM5540	ST-5918
SM5257	ST-4966	SM5347	ST-3966	SM5444	ST-8911	SM5542	ST-5985
SM5258	ST-3916	SM5348	ST-3969	SM5444	ST-8913	SM5543	ST-5939
SM5259	ST-3917	SM5349	ST-3972	SM5447	ST-5909	SM5554	ST-5921
SM5260	ST-3918	SM5350	ST-3974	SM5448	ST-4971	SM5556	ST-5954
SM5261	ST-3919	SM5351	ST-3978	SM5451	ST-5906	SM5557	ST-5955
SM5266	ST-5911	SM5360	ST-3982	SM5452	ST-5981	SM5563	ST-5933
SM5268	ST-1916	SM5361	ST-2924	SM5453	ST-4981	SM5564	ST-5938
SM5269	ST-1956	SM5362	ST-3984	SM5454	ST-4980	SM5565	ST-5934
SM5270	ST-1927	SM5363	ST-3985	SM5455	ST-5927	SM5566	ST-5935
SM5271	ST-1926	SM5364	ST-2913	SM5456	ST-4995	SM5567	ST-7949
SM5273	ST-2940	SM5365	ST-2931	SM5457	ST-4994	SM5568	ST-2973
SM5274	ST-2935	SM5366	ST-4932	SM5458	ST-4958	SM5569	ST-6927
SM5275	ST-2971	SM5367	ST-4933	SM5459	ST-4954	SM5570	ST-7908
SM5276	ST-2972	SM5369	ST-1996	SM5460	ST-5942	SM5571	ST-7910
SM5277	ST-2941	SM5370	ST-1993	SM5461	ST-5944	SM5573	ST-6950
SM5278	ST-1995	SM5371	ST-1968	SM5463	ST-4949	SM5574	ST-6937
SM5279	ST-2965	SM5372	ST-3992	SM5464	ST-4948	SM5575	ST-6952
SM5280	ST-1929	SM5373	ST-2988	SM5465	ST-4920	SM5576	ST-5989
SM5281	ST-1973	SM5374	ST-2912	SM5466	ST-4937	SM5577	ST-5993
SM5281	ST-1991	SM5375	ST-1962	SM5467	ST-4942	SM5578	ST-5994
SM5282	ST-3930	SM5376	ST-2906	SM5468	ST-4952	SM5579	ST-5988
SM5283	ST-4919	SM5376	ST-4906	SM5469	ST-4953	SM5580	ST-7930
SM5284	ST-1928	SM5377	ST-4907	SM5470	ST-5951	SM5581	ST-8900
SM5285	ST-3932	SM5378	ST-2906	SM5471	ST-5908	SM5584	ST-5986
SM5286	ST-2930	SM5380	ST-4992	SM5472	ST-5900	SM5585	ST-5987
SM5288	ST-2967	SM5381	ST-4985	SM5473	ST-4988	SM5589	ST-6980
SM5289	ST-4976	SM5382	ST-4990	SM5473	ST-4998	SM5590	ST-5973

# CROSS REFERENCE

Mfg Part No	Our Part	Mfg Part No	Our Part	Mfg Part No	Our Part	Mfg Part No	Our Part
<b>KYB (cont.)</b>		<b>KYB (cont.)</b>		<b>MONROE (cont.)</b>		<b>MONROE (cont.)</b>	
SM5591	ST-5982	SM5678	ST-8943	901937	ST-1937	902914	ST-2914
SM5592	ST-6943	SM5679	ST-6960	901938	ST-1938	902915	ST-2915
SM5592	ST-7951	SM5680	ST-5902	901939	ST-1939	902916	ST-2916
SM5594	ST-5995	SM5682	ST-5968	901940	ST-1940	902917	ST-2917
SM5596	ST-5929	SM5683	ST-5967	901941	ST-1941	902918	ST-2918
SM5597	ST-5930	SM5684	ST-8999	901942	ST-1942	902919	ST-2919
SM5598	ST-6947	SM5686	ST-3933	901943	ST-1943	902920	ST-2920
SM5599	ST-6942	SM5687	ST-7915	901944	ST-1944	902921	ST-2921
SM5600	ST-6944	SM5689	ST-3939	901946	ST-1946	902922	ST-2922
SM5601	ST-7994	SM5690	ST-6975	901947	ST-1947	902923	ST-2923
SM5602	ST-6918	SM5692	ST-8907	901948	ST-1948	902924	ST-2924
SM5603	ST-6997	SM5694	ST-6934	901950	ST-1950	902925	ST-2925
SM5604	ST-6996	SM5698	ST-7928	901951	ST-1951	902926	ST-2926
SM5605	ST-7901	SM5705	ST-7955	901952	ST-1952	902927	ST-2927
SM5606	ST-7900	SM5706	ST-7956	901953	ST-1953	902928	ST-2928
SM5607	ST-8968	SM5707	ST-7957	901954	ST-1954	902929	ST-2929
SM5608	ST-5980	SM5710	ST-7945	901955	ST-1955	902930	ST-2930
SM5609	ST-8948	SM5711	ST-7941	901956	ST-1956	902931	ST-2931
SM5610	ST-7987	SM5713	ST-6949	901958	ST-1958	902932	ST-2932
SM5610	ST-7991	SM5715	ST-7960	901959	ST-1959	902933	ST-2933
SM5611	ST-7983	SM5717	ST-7942	901960	ST-1960	902934	ST-2934
SM5612	ST-7983	SM5718	ST-7904	901961	ST-1961	902935	ST-2935
SM5615	ST-6964	SM5719	ST-7959	901962	ST-1962	902936	ST-2936
SM5616	ST-7976	SM5720	ST-8919	901963	ST-1963	902937	ST-2937
SM5617	ST-5984	SM5721	ST-8946	901964	ST-1964	902938	ST-2938
SM5618	ST-5983	SM5722	ST-8965	901965	ST-1965	902939	ST-2939
SM5619	ST-6981	SM5722	ST-8966	901966	ST-1966	902940	ST-2940
SM5620	ST-6982	SM5727	ST-6963	901967	ST-1967	902941	ST-2941
SM5622	ST-8915	SM5728	ST-6956	901968	ST-1968	902942	ST-2942
SM5623	ST-8914	SM5737	ST-7923	901969	ST-1969	902943	ST-2943
SM5624	ST-8917	SM5741	ST-5943	901970	ST-1970	902944	ST-2944
SM5625	ST-8916	SM5745	ST-7953	901971	ST-1971	902945	ST-2945
SM5630	ST-6945	SM5746	ST-6948	901973	ST-1973	902946	ST-2946
SM5631	ST-6938	SM5754	ST-7934	901974	ST-1974	902947	ST-2947
SM5632	ST-6951	SM5755	ST-6962	901975	ST-1975	902948	ST-2948
SM5633	ST-5996	SM5756	ST-6962	901976	ST-1976	902949	ST-2949
SM5636	ST-7977	SM5762	ST-7935	901977	ST-1977	902950	ST-2950
SM5637	ST-6986	SM5778	ST-8918	901978	ST-1978	902951	ST-2951
SM5638	ST-8942	SM5782	ST-8947	901979	ST-1979	902952	ST-2952
SM5639	ST-6988	SM5803	ST-8998	901980	ST-1980	902953	ST-2953
SM5640	ST-7922	SM5936	ST-2969	901981	ST-1981	902954	ST-2954
SM5641	ST-6989	<b>MONROE</b>		901983	ST-1983	902955	ST-2955
SM5645	ST-7947	901901	ST-1901	901984	ST-1984	902956	ST-2956
SM5651	ST-7989	901902	ST-1902	901985	ST-1985	902957	ST-2957
SM5651	ST-8925	901903	ST-1903	901986	ST-1986	902958	ST-2958
SM5652	ST-7988	901904	ST-1904	901987	ST-1987	902959	ST-2959
SM5652	ST-8924	901905	ST-1905	901988	ST-1988	902960	ST-2960
SM5653	ST-7986	901906	ST-1906	901989	ST-1989	902961	ST-2961
SM5654	ST-6965	901907	ST-1907	901990	ST-1990	902962	ST-2962
SM5655	ST-6966	901908	ST-1908	901991	ST-1991	902963	ST-2963
SM5656	ST-6971	901909	ST-1909	901992	ST-1992	902964	ST-2964
SM5657	ST-8912	901910	ST-1910	901993	ST-1993	902965	ST-2965
SM5658	ST-6987	901911	ST-1911	901994	ST-1994	902966	ST-2966
SM5660	ST-8910	901912	ST-1912	901995	ST-1995	902967	ST-2967
SM5661	ST-5916	901913	ST-1913	901996	ST-1996	902968	ST-2968
SM5662	ST-6974	901916	ST-1916	901999	ST-1999	902969	ST-2969
SM5663	ST-6973	901921	ST-1921	902901	ST-2901	902970	ST-2970
SM5664	ST-8926	901922	ST-1922	902902	ST-2902	902971	ST-2971
SM5665	ST-6987	901923	ST-1923	902903	ST-2903	902972	ST-2972
SM5668	ST-6967	901924	ST-1924	902904	ST-2904	902973	ST-2973
SM5670	ST-6969	901925	ST-1925	902905	ST-2905	902974	ST-2974
SM5670	ST-6970	901926	ST-1926	902906	ST-2906	902975	ST-2975
SM5670	ST-6975	901927	ST-1927	902907	ST-2907	902976	ST-2976
SM5670	ST-6976	901928	ST-1928	902908	ST-2908	902977	ST-2977
SM5671	ST-6976	901929	ST-1929	902909	ST-2909	902978	ST-2978
SM5677	ST-6958	901930	ST-1930	902910	ST-2910	902979	ST-2979
SM5677	ST-8984	901932	ST-1932	902911	ST-2911	902980	ST-2980
SM5678	ST-6959	901933	ST-1933	902912	ST-2912	902981	ST-2981
SM5678	ST-7995	901934	ST-1934	902913	ST-2913	902982	ST-2982

# CROSS REFERENCE

Mfg Part No	Our Part	Mfg Part No	Our Part	Mfg Part No	Our Part	Mfg Part No	Our Part
<b>MONROE (cont.)</b>		<b>MONROE (cont.)</b>		<b>MONROE (cont.)</b>		<b>MONROE (cont.)</b>	
902983	ST-2983	903960	ST-3960	904941	ST-4941	905919	ST-5919
902984	ST-2984	903961	ST-3961	904942	ST-4942	905920	ST-5920
902985	ST-2985	903962	ST-3962	904943	ST-4943	905921	ST-5921
902986	ST-2986	903964	ST-3964	904944	ST-4944	905922	ST-5922
902987	ST-2987	903965	ST-3965	904945	ST-4945	905923	ST-5923
902988	ST-2988	903966	ST-3966	904948	ST-4948	905924	ST-5924
902989	ST-2989	903967	ST-3967	904949	ST-4949	905925	ST-5925
902990	ST-2990	903968	ST-3968	904950	ST-4950	905926	ST-5926
902991	ST-2991	903969	ST-3969	904951	ST-4951	905927	ST-5927
902992	ST-2992	903970	ST-3970	904952	ST-4952	905929	ST-5929
902993	ST-2993	903971	ST-3971	904953	ST-4953	905930	ST-5930
902994	ST-2994	903972	ST-3972	904954	ST-4954	905931	ST-5931
902995	ST-2995	903973	ST-3973	904955	ST-4955	905932	ST-5932
902997	ST-2997	903974	ST-3974	904956	ST-4956	905933	ST-5933
902998	ST-2998	903975	ST-3975	904957	ST-4957	905934	ST-5934
902999	ST-2999	903976	ST-3976	904958	ST-4958	905935	ST-5935
903900	ST-3900	903977	ST-3977	904959	ST-6919	905936	ST-5936
903901	ST-3901	903978	ST-3978	904960	ST-6920	905937	ST-5937
903902	ST-3902	903980	ST-3980	904962	ST-4962	905938	ST-5938
903903	ST-3903	903982	ST-3982	904965	ST-4965	905939	ST-5939
903904	ST-3904	903983	ST-3983	904966	ST-4966	905940	ST-5940
903905	ST-3905	903984	ST-3984	904968	ST-4968	905941	ST-5941
903906	ST-3906	903985	ST-3985	904970	ST-4970	905942	ST-5942
903907	ST-3907	903986	ST-3986	904971	ST-4971	905943	ST-5943
903908	ST-3908	903987	ST-3987	904972	ST-4972	905944	ST-5944
903909	ST-3909	903988	ST-3988	904973	ST-4973	905945	ST-5945
903910	ST-3910	903989	ST-3989	904974	ST-4974	905946	ST-5946
903911	ST-3911	903990	ST-3990	904975	ST-4975	905947	ST-5947
903912	ST-3912	903991	ST-3991	904976	ST-4976	905948	ST-5948
903913	ST-3913	903992	ST-3992	904977	ST-4977	905949	ST-5949
903914	ST-3914	903993	ST-3993	904978	ST-6914	905950	ST-5950
903915	ST-3915	903994	ST-3994	904979	ST-4979	905951	ST-5951
903916	ST-3916	903995	ST-3995	904980	ST-4980	905952	ST-5952
903917	ST-3917	903997	ST-3997	904981	ST-4981	905953	ST-5953
903918	ST-3918	903998	ST-3998	904983	ST-4983	905954	ST-5954
903919	ST-3919	903999	ST-3999	904984	ST-4984	905955	ST-5955
903920	ST-3920	904900	ST-4900	904985	ST-4985	905956	ST-5956
903921	ST-3921	904902	ST-4902	904987	ST-4987	905957	ST-5957
903922	ST-3922	904903	ST-4903	904988	ST-4988	905958	ST-5958
903923	ST-3923	904904	ST-4904	904989	ST-4989	905959	ST-5959
903924	ST-3924	904905	ST-4905	904990	ST-4990	905960	ST-5960
903925	ST-5911	904906	ST-4906	904991	ST-4991	905961	ST-5961
903926	ST-3926	904907	ST-4907	904992	ST-4992	905962	ST-5962
903928	ST-3928	904908	ST-4908	904993	ST-4993	905963	ST-5963
903929	ST-3929	904909	ST-4909	904994	ST-4994	905964	ST-5964
903930	ST-3930	904910	ST-4910	904995	ST-4995	905965	ST-5965
903932	ST-3932	904911	ST-4911	904996	ST-4996	905966	ST-5966
903933	ST-3933	904912	ST-4912	904997	ST-4997	905967	ST-5967
903935	ST-3935	904913	ST-4913	904998	ST-4998	905968	ST-5968
903936	ST-3936	904915	ST-4915	904999	ST-4999	905969	ST-5969
903937	ST-3937	904916	ST-4916	905900	ST-5900	905970	ST-5970
903938	ST-3938	904918	ST-4918	905901	ST-5901	905971	ST-5971
903939	ST-3939	904919	ST-4919	905902	ST-5902	905972	ST-5972
903940	ST-3940	904920	ST-4920	905903	ST-5903	905973	ST-5973
903941	ST-3941	904921	ST-4921	905904	ST-5904	905974	ST-5974
903942	ST-3942	904922	ST-4922	905905	ST-5905	905975	ST-5975
903943	ST-3943	904923	ST-4923	905906	ST-5906	905976	ST-5976
903944	ST-3944	904924	ST-4924	905907	ST-5907	905977	ST-5977
903945	ST-3945	904925	ST-4925	905908	ST-5908	905978	ST-5978
903946	ST-3946	904927	ST-4927	905909	ST-5909	905979	ST-5979
903947	ST-3947	904932	ST-4932	905910	ST-5910	905980	ST-5980
903948	ST-3948	904933	ST-4933	905911	ST-5911	905981	ST-5981
903949	ST-3949	904934	ST-4934	905912	ST-5912	905982	ST-5982
903950	ST-3950	904935	ST-4935	905913	ST-5913	905983	ST-5983
903951	ST-3951	904936	ST-4936	905914	ST-5914	905984	ST-5984
903954	ST-3954	904937	ST-4937	905915	ST-5915	905985	ST-5985
903957	ST-3957	904938	ST-4938	905916	ST-5916	905986	ST-5986
903958	ST-3958	904939	ST-4939	905917	ST-5917	905987	ST-5987
903959	ST-3959	904940	ST-4940	905918	ST-5918	905988	ST-5988



# CROSS REFERENCE

Mfg Part No	Our Part	Mfg Part No	Our Part	Mfg Part No	Our Part	Mfg Part No	Our Part
<b>MONROE (cont.)</b>		<b>MONROE (cont.)</b>		<b>MONROE (cont.)</b>		<b>MONROE (cont.)</b>	
905989	ST-5989	906980	ST-6980	907953	ST-7953	908927	ST-8927
905990	ST-5990	906981	ST-6981	907954	ST-7954	908928	ST-8928
905992	ST-5992	906982	ST-6982	907955	ST-7955	908929	ST-8929
905993	ST-5993	906983	ST-6983	907956	ST-7956	908930	ST-8930
905994	ST-5994	906984	ST-6984	907957	ST-7957	908931	ST-8931
905995	ST-5995	906985	ST-6985	907958	ST-7958	908932	ST-8932
905996	ST-5996	906986	ST-6986	907959	ST-7959	908933	ST-8933
905997	ST-5997	906987	ST-6987	907960	ST-7960	908934	ST-8934
906914	ST-6914	906988	ST-6988	907961	ST-7961	908937	ST-8937
906915	ST-6915	906989	ST-6989	907962	ST-7962	908938	ST-8938
906916	ST-6916	906990	ST-6990	907963	ST-7963	908939	ST-8939
906917	ST-6917	906994	ST-6994	907964	ST-7964	908941	ST-8941
906918	ST-6918	906995	ST-6995	907965	ST-7965	908942	ST-8942
906919	ST-6919	906996	ST-6996	907966	ST-7966	908943	ST-8943
906920	ST-6920	906997	ST-6997	907967	ST-7967	908946	ST-8946
906921	ST-6921	906998	ST-6998	907968	ST-7968	908947	ST-8947
906922	ST-6922	906999	ST-6999	907969	ST-7969	908948	ST-8948
906923	ST-6923	907900	ST-7900	907972	ST-7972	908949	ST-8949
906924	ST-6924	907901	ST-7901	907973	ST-7973	908950	ST-8950
906925	ST-6925	907902	ST-7902	907974	ST-7974	908951	ST-8951
906926	ST-6926	907903	ST-7903	907975	ST-7975	908952	ST-8952
906927	ST-6927	907904	ST-7904	907976	ST-7976	908953	ST-8953
906928	ST-6928	907905	ST-7905	907977	ST-7977	908954	ST-8954
906929	ST-6929	907906	ST-7906	907978	ST-7978	908955	ST-8955
906930	ST-6930	907907	ST-7907	907979	ST-7979	908956	ST-8956
906931	ST-6931	907908	ST-7908	907980	ST-7980	908957	ST-8957
906932	ST-6932	907909	ST-7909	907981	ST-7981	908958	ST-8958
906934	ST-6934	907910	ST-7910	907982	ST-7982	908959	ST-8959
906935	ST-6935	907911	ST-7911	907983	ST-7983	908960	ST-8960
906936	ST-6936	907912	ST-7912	907984	ST-7984	908961	ST-8961
906937	ST-6937	907913	ST-7913	907985	ST-7985	908962	ST-8962
906938	ST-6938	907914	ST-7914	907986	ST-7986	908965	ST-8965
906939	ST-6939	907915	ST-7915	907987	ST-7987	908966	ST-8966
906940	ST-6940	907916	ST-7916	907988	ST-7988	908967	ST-8967
906941	ST-6941	907917	ST-7917	907989	ST-7989	908968	ST-8968
906942	ST-6942	907919	ST-7919	907990	ST-7990	908969	ST-8969
906943	ST-6943	907920	ST-7920	907991	ST-7991	908970	ST-8970
906944	ST-6944	907921	ST-7921	907992	ST-7992	908971	ST-8971
906945	ST-6945	907922	ST-7922	907993	ST-7993	908972	ST-8972
906946	ST-6946	907923	ST-7923	907994	ST-7994	908973	ST-8973
906947	ST-6947	907924	ST-7924	907995	ST-7995	908975	ST-8975
906948	ST-6948	907925	ST-7925	907996	ST-7996	908976	ST-8976
906949	ST-6949	907926	ST-7926	907997	ST-7997	908977	ST-8977
906950	ST-6950	907927	ST-7927	907998	ST-7998	908978	ST-8978
906951	ST-6951	907928	ST-7928	907999	ST-7999	908979	ST-8979
906952	ST-6952	907929	ST-7929	908900	ST-8900	908980	ST-8980
906953	ST-6953	907930	ST-7930	908903	ST-8903	908981	ST-8981
906955	ST-6955	907931	ST-7931	908904	ST-8904	908982	ST-8982
906956	ST-6956	907932	ST-7932	908905	ST-8905	908983	ST-8983
906957	ST-6957	907933	ST-7933	908907	ST-8907	908984	ST-8984
906958	ST-6958	907934	ST-7934	908908	ST-8908	908988	ST-8988
906959	ST-6959	907935	ST-7935	908909	ST-8909	908989	ST-8989
906960	ST-6960	907936	ST-7936	908910	ST-8910	908990	ST-8990
906961	ST-6961	907937	ST-7937	908911	ST-8911	908991	ST-8991
906962	ST-6962	907938	ST-7938	908912	ST-8912	908992	ST-8992
906963	ST-6963	907939	ST-7939	908913	ST-8913	908993	ST-8993
906964	ST-6964	907940	ST-7940	908914	ST-8914	908994	ST-8994
906965	ST-6965	907941	ST-7941	908915	ST-8915	908995	ST-10004
906966	ST-6966	907942	ST-7942	908916	ST-8916	908997	ST-8997
906967	ST-6967	907943	ST-7943	908917	ST-8917	908998	ST-8998
906968	ST-6968	907944	ST-7944	908918	ST-8918	908999	ST-8999
906969	ST-6969	907945	ST-7945	908919	ST-8919	909901	ST-9901
906970	ST-6970	907946	ST-7946	908920	ST-8920	909902	ST-9902
906971	ST-6971	907947	ST-7947	908921	ST-8921	909903	ST-9903
906973	ST-6973	907948	ST-7948	908922	ST-8922	909904	ST-9904
906974	ST-6974	907949	ST-7949	908923	ST-8923	909905	ST-9905
906975	ST-6975	907950	ST-7950	908924	ST-8924	909906	ST-9906
906976	ST-6976	907951	ST-7951	908925	ST-8925	909907	ST-9907
906977	ST-6977	907952	ST-7952	908926	ST-8926	909908	ST-9908

# CROSS REFERENCE

Mfg Part No	Our Part	Mfg Part No	Our Part	Mfg Part No	Our Part	Mfg Part No	Our Part
<b>MONROE (cont.)</b>		<b>MOOG (cont.)</b>		<b>MOOG (cont.)</b>		<b>MOOG (cont.)</b>	
909909	ST-9909	K6443	ST-2992	K8628	ST-1916	K9656	ST-1944
909910	ST-9910	K6444	ST-1922	K8630	ST-1926	K9662	ST-1981
909911	ST-9911	K6446	ST-1934	K8632	ST-1970	K9668	ST-2911
909912	ST-9912	K6448	ST-1973	K8634	ST-1925	K9670	ST-2925
909913	ST-9913	K6448	ST-1991	K8636	ST-1954	K9671	ST-6916
909914	ST-9914	K6450	ST-2965	K8638	ST-1927	K9679	ST-2933
909915	ST-9915	K6456	ST-1986	K8640	ST-1971	K9681	ST-1992
909916	ST-9916	K6458	ST-1990	K8640	ST-1974	K9683	ST-2919
909917	ST-9917	K6491	ST-2901	K8646	ST-1963	K9685	ST-2902
909918	ST-9918	K6510	ST-2901	K8677	ST-2910	K9686	ST-2903
909920	ST-9920	K6513	ST-2971	K8693	ST-1999	K9687	ST-2915
909921	ST-9921	K6514	ST-3929	K8694	ST-2951	K9689	ST-2964
909922	ST-9922	K6515	ST-3932	K8696	ST-2952	K9690	ST-2957
909923	ST-9923	K6516	ST-2947	K8697	ST-2936	K9691	ST-2959
909924	ST-9924	K6517	ST-2948	K8741	ST-2953	K9692	ST-2958
909925	ST-9925	K6518	ST-2949	K8742	ST-2944	K9693	ST-2960
909927	ST-9927	K6519	ST-3900	K8743	ST-2954	K9694	ST-2962
909929	ST-9929	K6520	ST-2999	K8775	ST-2970	K9695	ST-2966
909930	ST-9930	K6521	ST-2973	K8795	ST-2976	K9697	ST-2950
909931	ST-9931	K6573	ST-3933	K8796	ST-2989	K9701	ST-2942
909937	ST-9937	K6632	ST-2994	K8803	ST-3905	K9703	ST-2943
909938	ST-9938	K6633	ST-2995	K8993	ST-3905	K9704	ST-1975
909939	ST-9939	K6634	ST-3969	K8994	ST-3964	K9705	ST-2901
909940	ST-9940	K6635	ST-3970	K8995	ST-4936	K9706	ST-1976
909942	ST-9942	K6636	ST-3971	K8996	ST-3966	K9707	ST-2912
909943	ST-9943	K6637	ST-3972	K8997	ST-3967	K9708	ST-1977
909945	ST-9945	K6656	ST-4987	K8998	ST-3968	K9709	ST-2922
909946	ST-9946	K6657	ST-4915	K9390	ST-2963	K9710	ST-1979
909947	ST-9947	K6681	ST-4919	K9392	ST-1937	K9711	ST-2926
909948	ST-9948	K6702	ST-4968	K9394	ST-1903	K9713	ST-2927
909949	ST-9949	K6703	ST-4923	K9443	ST-6915	K9714	ST-1983
909955	ST-9955	K6704	ST-4925	K9476	ST-1947	K9715	ST-2920
909956	ST-9956	K6706	ST-4940	K9478	ST-1958	K9716	ST-1984
909957	ST-9957	K6707	ST-4939	K9480	ST-1939	K9717	ST-2921
909959	ST-9959	K6708	ST-4945	K9488	ST-1943	K9718	ST-1985
909962	ST-9962	K6725	ST-4944	K9492	ST-1940	K9719	ST-2955
909969	ST-9969	K7150	ST-1906	K9498	ST-1961	K9720	ST-1987
909977	ST-9977	K7171	ST-1952	K9506	ST-1962	K9721	ST-2961
909978	ST-9978	K7175	ST-1908	K9549	ST-2904	K9722	ST-1988
909988	ST-9988	K7179	ST-1905	K9555	ST-2905	K9723	ST-2937
909989	ST-9989	K7182	ST-1907	K9557	ST-2913	K9724	ST-1989
909998	ST-9998	K7200	ST-1978	K9559	ST-2924	K9725	ST-2935
909999	ST-9999	K7202	ST-1980	K9560	ST-1911	K9727	ST-2940
<b>MOOG</b>		K7215	ST-2907	K9561	ST-2928	K9728	ST-1993
K3152	ST-2909	K7216	ST-2908	K9562	ST-1912	K9729	ST-2939
K3189	ST-5902	K7226	ST-2923	K9563	ST-2931	K9730	ST-1994
K3190	ST-5903	K7227	ST-2929	K9564	ST-1909	K9731	ST-2938
K5321	ST-2930	K7254	ST-3901	K9565	ST-2932	K9732	ST-1995
K5322	ST-2916	K7259	ST-2945	K9566	ST-1910	K9734	ST-1996
K5337	ST-2972	K7260	ST-2946	K9569	ST-2934	K9762	ST-2990
K5339	ST-3930	K7333	ST-2993	K9579	ST-2918	K9773	ST-3939
K5341	ST-2998	K7334	ST-3975	K9583	ST-2906	K9774	ST-2986
K5343	ST-3973	K7335	ST-3976	K9585	ST-2917	K9775	ST-3911
K5344	ST-3974	K7336	ST-3977	K9591	ST-2914	K9777	ST-2956
K5346	ST-4924	K7338	ST-3980	K9592	ST-1904	K9778	ST-3915
K5349	ST-4943	K7372	ST-3924	K9622	ST-1941	K9779	ST-2987
K5350	ST-4941	K7374	ST-5911	K9624	ST-1965	K9780	ST-2982
K6353	ST-1951	K7375	ST-3926	K9628	ST-1942	K9783	ST-2983
K6373	ST-1913	K7380	ST-3902	K9632	ST-1966	K9784	ST-2981
K6394	ST-2941	K7381	ST-4956	K9634	ST-1930	K9785	ST-3907
K6404	ST-1953	K7456	ST-4957	K9636	ST-1959	K9786	ST-3910
K6406	ST-1929	K7458	ST-4921	K9638	ST-1938	K9787	ST-3983
K6410	ST-1921	K7459	ST-5992	K9640	ST-1948	K9788	ST-3992
K6412	ST-1923	K7475	ST-5971	K9642	ST-1967	K9789	ST-3991
K6414	ST-1924	K7477	ST-5972	K9644	ST-1968	K9790	ST-2979
K6436	ST-1928	K8466	ST-1901	K9646	ST-1969	K9794	ST-2984
K6438	ST-1950	K8520	ST-1902	K9648	ST-1932	K9795	ST-3945
K6440	ST-1964	K8586	ST-1955	K9650	ST-1933	K9796	ST-3947
K6442	ST-1946	K8626	ST-1956	K9652	ST-1960	K9797	ST-2977

# CROSS REFERENCE

Mfg Part No	Our Part	Mfg Part No	Our Part	Mfg Part No	Our Part	Mfg Part No	Our Part
MOOG (cont.)		MOOG (cont.)		MOOG (cont.)		MOOG (cont.)	
K9798	ST-3987	K90231	ST-3984	K160007	ST-8903	K160146	ST-5994
K9799	ST-3986	K90232	ST-3985	K160008	ST-8904	K160147	ST-5988
K9800	ST-3988	K90233	ST-3993	K160009	ST-8905	K160194	ST-8992
K9801	ST-3989	K90234	ST-3994	K160010	ST-5941	K160197	ST-7994
K9843	ST-4906	K90235	ST-2988	K160012	ST-5948	K160198	ST-6918
K9844	ST-3913	K90236	ST-3903	K160014	ST-4950	K160200	ST-8900
K9845	ST-3949	K90237	ST-3906	K160019	ST-7907	K160201	ST-6997
K9847	ST-3990	K90238	ST-3995	K160020	ST-6932	K160201	ST-6999
K9848	ST-2991	K90240	ST-4903	K160023	ST-5920	K160202	ST-6996
K9849	ST-3948	K90241	ST-4905	K160025	ST-5952	K160202	ST-6998
K9850	ST-3943	K90242	ST-4907	K160026	ST-5953	K160203	ST-7901
K9851	ST-3951	K90243	ST-4908	K160027	ST-5932	K160204	ST-7900
K9904	ST-5912	K90244	ST-4909	K160031	ST-7946	K160205	ST-8968
K10117	ST-2968	K90245	ST-4910	K160049	ST-5913	K160210	ST-5980
K10118	ST-2969	K90267	ST-3916	K160050	ST-5922	K160213	ST-8948
K16012	ST-6952	K90268	ST-3917	K160051	ST-6917	K160214	ST-7987
K80030	ST-4911	K90269	ST-3918	K160052	ST-5907	K160214	ST-7991
K80031	ST-3928	K90270	ST-3919	K160056	ST-5923	K160215	ST-5986
K80032	ST-4913	K90271	ST-3920	K160058	ST-8949	K160216	ST-5987
K80051	ST-4927	K90272	ST-3921	K160069	ST-6923	K160217	ST-7983
K80143	ST-4938	K90273	ST-3922	K160070	ST-7937	K160222	ST-6964
K80146	ST-5964	K90274	ST-3944	K160074	ST-5924	K160223	ST-7976
K80147	ST-5965	K90276	ST-3959	K160075	ST-5947	K160224	ST-5984
K80218	ST-4970	K90278	ST-3960	K160076	ST-5960	K160225	ST-5983
K80221	ST-4922	K90281	ST-3961	K160077	ST-5961	K160228	ST-6980
K80902	ST-6983	K90282	ST-5997	K160078	ST-5963	K160229	ST-6981
K80903	ST-6984	K90285	ST-3904	K160080	ST-5974	K160230	ST-6982
K80903	ST-8911	K90286	ST-3997	K160081	ST-5975	K160233	ST-8915
K80904	ST-4972	K90287	ST-3998	K160082	ST-5976	K160234	ST-8914
K80905	ST-4971	K90288	ST-3999	K160083	ST-5977	K160235	ST-8916
K80907	ST-5906	K90289	ST-4918	K160084	ST-5978	K160236	ST-8917
K80908	ST-5981	K90290	ST-4900	K160085	ST-5979	K160241	ST-6985
K80909	ST-4981	K90292	ST-4902	K160087	ST-5946	K160242	ST-5973
K80910	ST-4980	K90293	ST-3914	K160088	ST-7993	K160243	ST-5982
K80911	ST-5927	K90294	ST-3923	K160089	ST-5930	K160244	ST-6945
K80912	ST-4995	K90295	ST-3937	K160090	ST-5940	K160245	ST-6938
K80913	ST-4994	K90296	ST-3938	K160091	ST-5905	K160247	ST-6947
K80914	ST-4958	K90298	ST-3950	K160092	ST-5914	K160248	ST-6942
K80915	ST-4954	K90299	ST-4979	K160093	ST-6955	K160249	ST-6943
K80916	ST-5942	K90301	ST-3954	K160094	ST-5969	K160249	ST-7951
K80917	ST-5944	K90304	ST-3957	K160094	ST-5970	K160250	ST-6944
K80919	ST-4949	K90307	ST-4904	K160096	ST-5966	K160251	ST-6935
K80920	ST-4948	K90322	ST-4966	K160097	ST-4973	K160252	ST-6931
K80921	ST-4920	K90323	ST-4975	K160098	ST-5910	K160253	ST-6930
K80922	ST-4937	K90326	ST-4955	K160099	ST-5904	K160254	ST-6951
K80923	ST-4942	K90327	ST-4932	K160101	ST-6968	K160256	ST-5996
K80924	ST-4952	K90328	ST-4933	K160102	ST-5929	K160258	ST-5995
K80925	ST-4953	K90329	ST-4934	K160103	ST-5917	K160262	ST-7977
K80927	ST-4962	K90330	ST-4935	K160103	ST-5918	K160263	ST-6986
K80928	ST-5900	K90412	ST-4992	K160105	ST-5985	K160264	ST-7943
K80929	ST-4988	K90449	ST-6920	K160106	ST-5962	K160264	ST-8942
K80930	ST-4991	K90648	ST-4996	K160107	ST-5939	K160265	ST-6988
K90212	ST-3912	K90648	ST-4997	K160118	ST-5921	K160267	ST-6989
K90214	ST-2967	K90649	ST-6919	K160120	ST-5954	K160269	ST-5959
K90215	ST-3935	K90651	ST-3909	K160121	ST-5955	K160271	ST-7947
K90216	ST-3936	K90652	ST-3908	K160127	ST-5931	K160273	ST-8923
K90217	ST-3940	K90653	ST-4999	K160128	ST-5933	K160288	ST-8910
K90218	ST-3941	K90654	ST-4998	K160129	ST-5938	K160292	ST-8925
K90219	ST-3942	K90655	ST-6914	K160130	ST-5934	K160293	ST-7988
K90220	ST-2975	K90657	ST-5950	K160131	ST-5935	K160293	ST-7989
K90221	ST-2974	K90658	ST-4989	K160132	ST-7949	K160293	ST-8924
K90222	ST-6977	K90721	ST-4983	K160135	ST-6927	K160294	ST-7986
K90225	ST-3946	K90724	ST-5945	K160137	ST-7910	K160295	ST-6965
K90226	ST-2985	K90725	ST-4951	K160139	ST-6940	K160296	ST-6966
K90227	ST-2978	K160002	ST-5909	K160140	ST-6950	K160297	ST-5916
K90227	ST-2980	K160003	ST-5908	K160141	ST-6937	K160301	ST-6971
K90228	ST-3962	K160004	ST-7990	K160143	ST-6936	K160302	ST-6973
K90229	ST-3978	K160005	ST-5925	K160144	ST-5989	K160303	ST-6974
K90230	ST-3982	K160006	ST-5926	K160145	ST-5993	K160305	ST-8912

# CROSS REFERENCE

Mfg Part No	Our Part	Mfg Part No	Our Part	Mfg Part No	Our Part	Mfg Part No	Our Part
<b>MOOG (cont.)</b>		<b>McQuay (cont.)</b>		<b>McQuay (cont.)</b>		<b>McQuay (cont.)</b>	
K160313	ST-8926	SM7049	ST-1940	SM7142	ST-2915	SM7258	ST-3911
K160314	ST-6987	SM7050	ST-1961	SM7143	ST-2934	SM7260	ST-2931
K160317	ST-4985	SM7052	ST-1939	SM7144	ST-2923	SM7261	ST-3983
K160318	ST-6959	SM7053	ST-6915	SM7145	ST-2917	SM7262	ST-3987
K160318	ST-7995	SM7054	ST-1938	SM7146	ST-2929	SM7263	ST-2998
K160318	ST-8973	SM7055	ST-1937	SM7147	ST-2909	SM7263	ST-3986
K160319	ST-6960	SM7056	ST-1932	SM7148	ST-2933	SM7264	ST-3988
K160320	ST-8982	SM7058	ST-1959	SM7149	ST-2912	SM7265	ST-3989
K160321	ST-8971	SM7059	ST-1963	SM7151	ST-2927	SM7266	ST-3990
K160321	ST-8972	SM7062	ST-2919	SM7152	ST-2911	SM7270	ST-3992
K160322	ST-7911	SM7065	ST-1977	SM7153	ST-2906	SM7276	ST-2972
K160328	ST-7944	SM7067	ST-1947	SM7154	ST-2946	SM7277	ST-3940
K160330	ST-7940	SM7068	ST-1948	SM7159	ST-2954	SM7278	ST-3941
K160331	ST-6963	SM7070	ST-1950	SM7160	ST-2952	SM7279	ST-3942
K160333	ST-6956	SM7071	ST-1964	SM7161	ST-2951	SM7280	ST-2975
K160341	ST-5943	SM7072	ST-1952	SM7164	ST-2971	SM7281	ST-2974
K160352	ST-7953	SM7073	ST-1911	SM7165	ST-4912	SM7282	ST-2978
K160353	ST-6948	SM7074	ST-1912	SM7167	ST-2947	SM7282	ST-2980
K160361	ST-5951	SM7075	ST-1909	SM7168	ST-2948	SM7287	ST-3903
K1650362	ST-7923	SM7076	ST-1910	SM7170	ST-2949	SM7288	ST-3906
<b>MOTORCRAFT</b>		SM7077	ST-1968	SM7173	ST-2984	SM7289	ST-4905
AD1066	ST-9914	SM7078	ST-1967	SM7174	ST-2942	SM7291	ST-4909
AD1084	ST-9905	SM7079	ST-1969	SM7175	ST-2943	SM7297	ST-3912
AD1095	ST-9915	SM7080	ST-1944	SM7177	ST-2955	SM7298	ST-3915
AD1100	ST-9906	SM7081	ST-1943	SM7181	ST-2982	SM7300	ST-2976
AD1134	ST-9916	SM7082	ST-1958	SM7182	ST-2983	SM7301	ST-2970
<b>McQuay</b>		SM7083	ST-1962	SM7183	ST-2981	SM7302	ST-1927
SM6030	ST-1905	SM7084	ST-1981	SM7185	ST-2979	SM7303	ST-3932
SM6031	ST-1907	SM7086	ST-1966	SM7187	ST-2987	SM7306	ST-2967
SM6032	ST-1906	SM7087	ST-1941	SM7189	ST-2986	SM7307	ST-3907
SM6033	ST-1908	SM7099	ST-1978	SM7190	ST-4906	SM7310	ST-2985
SM6076	ST-1903	SM7100	ST-1916	SM7191	ST-4907	SM7311	ST-2994
SM6077	ST-1904	SM7102	ST-1987	SM7192	ST-2990	SM7312	ST-2995
SM6084	ST-1951	SM7103	ST-1994	SM7197	ST-1985	SM7313	ST-4936
SM6091	ST-1913	SM7104	ST-1988	SM7198	ST-1980	SM7316	ST-3968
SM6092	ST-1934	SM7105	ST-2932	SM7199	ST-2945	SM7320	ST-3972
SM7000	ST-1901	SM7106	ST-2959	SM7200	ST-2907	SM7321	ST-3973
SM7003	ST-1942	SM7107	ST-1995	SM7201	ST-2953	SM7322	ST-3974
SM7004	ST-2903	SM7108	ST-2965	SM7202	ST-1927	SM7327	ST-3978
SM7005	ST-2905	SM7109	ST-1990	SM7203	ST-2944	SM7328	ST-3984
SM7006	ST-2904	SM7110	ST-1986	SM7204	ST-1926	SM7329	ST-3985
SM7007	ST-1965	SM7111	ST-2950	SM7209	ST-1933	SM7330	ST-3993
SM7012	ST-2920	SM7112	ST-2914	SM7210	ST-1999	SM7332	ST-2988
SM7013	ST-1971	SM7113	ST-2964	SM7211	ST-2918	SM7335	ST-3916
SM7013	ST-1974	SM7116	ST-2966	SM7213	ST-2922	SM7336	ST-3917
SM7014	ST-1960	SM7117	ST-2921	SM7214	ST-2960	SM7337	ST-3918
SM7015	ST-1956	SM7118	ST-2902	SM7215	ST-2935	SM7338	ST-3919
SM7016	ST-1925	SM7119	ST-2962	SM7216	ST-2936	SM7339	ST-3920
SM7019	ST-1930	SM7120	ST-2963	SM7217	ST-2937	SM7340	ST-3921
SM7022	ST-1970	SM7121	ST-2961	SM7218	ST-2938	SM7341	ST-3922
SM7024	ST-1954	SM7122	ST-1992	SM7219	ST-2939	SM7342	ST-3901
SM7025	ST-1955	SM7123	ST-2958	SM7220	ST-2940	SM7343	ST-3902
SM7026	ST-1902	SM7124	ST-1976	SM7224	ST-2989	SM7344	ST-3928
SM7027	ST-2901	SM7125	ST-1989	SM7226	ST-3913	SM7346	ST-4913
SM7028	ST-2901	SM7126	ST-1975	SM7227	ST-2956	SM7358	ST-3904
SM7029	ST-1929	SM7127	ST-2924	SM7228	ST-2993	SM7360	ST-3998
SM7030	ST-1946	SM7128	ST-2913	SM7233	ST-3964	SM7361	ST-3999
SM7033	ST-1929	SM7129	ST-1996	SM7236	ST-2973	SM7362	ST-4918
SM7036	ST-1973	SM7130	ST-1993	SM7237	ST-3930	SM7365	ST-4902
SM7036	ST-1991	SM7131	ST-1979	SM7238	ST-3929	SM7366	ST-3914
SM7037	ST-1922	SM7132	ST-1984	SM7241	ST-2999	SM7366	ST-3924
SM7038	ST-1924	SM7133	ST-1983	SM7242	ST-3900	SM7367	ST-3923
SM7039	ST-1923	SM7134	ST-2957	SM7243	ST-2968	SM7370	ST-5911
SM7040	ST-1921	SM7136	ST-2925	SM7243	ST-2969	SM7371	ST-3926
SM7043	ST-2992	SM7137	ST-2908	SM7244	ST-2991	SM7380	ST-3954
SM7044	ST-1928	SM7138	ST-2910	SM7246	ST-3935	SM7405	ST-4934
SM7046	ST-1934	SM7139	ST-2916	SM7247	ST-3936	SM7406	ST-4935
SM7048	ST-1953	SM7140	ST-2930	SM7254	ST-2977	SM7411	ST-4919
		SM7141	ST-2928	SM7257	ST-3910	SM7440	ST-2997

# CROSS REFERENCE

Mfg Part No	Our Part	Mfg Part No	Our Part	Mfg Part No	Our Part	Mfg Part No	Our Part
<b>McQuay (cont.)</b>		<b>NAPA (cont.)</b>		<b>NAPA (cont.)</b>		<b>NAPA (cont.)</b>	
SM7474	ST-3939	9024	EM-9024	905906	ST-5906	602-1139	EM-2222
<b>NAPA</b>		9026	EM-9026	905907	ST-5907	602-1140	EM-2223
HB209KF	DS-6062	9032	EM-9032	905909	ST-5909	602-1144	EM-2271
HB88107E	DS-6056	9035	EM-9035	905911	ST-5911	602-1145	EM-2270
HB88508	DS-6038	9045	EM-9045	905912	ST-5912	602-1147	EM-2255
HB88515	DS-6064	9046	EM-9046	905948	ST-5948	602-1148	EM-2256
HB88526	DS-6053	9054	EM-9054	90-6919	ST-6919	602-1149	EM-2291
HB88532	DS-6063	9056	EM-9056	90-6920	ST-6920	602-1151	EM-2257
HB128030	DS-8474	9067	EM-9067	907972	ST-3901	602-1151	EM-2286
HB138010	DS-8469	9068	EM-9068	602-1006	EM-2384	602-1152	EM-2287
HB138030	DS-8532	9072	EM-9072	602-1009	EM-2387	602-1153	EM-2333
8163	EM-8163	9074	EM-9074	602-1015	EM-2014	602-1154	EM-2240
8170	EM-8170	9081	EM-9081	602-1017	EM-2385	602-1155	EM-2241
8230	EM-8230	9085	EM-9085	602-1020	EM-2040	602-1156	EM-2226
8351	EM-8351	9094	EM-9094	602-1021	EM-2039	602-1157	EM-2254
8374	EM-8374	9096	EM-9096	602-1023	EM-2057	602-1158	EM-2320
8384	EM-8384	9123	EM-9123	602-1026	EM-2219	602-1159	EM-2281
8434	EM-8434	9129	EM-9129	602-1027	EM-2053	602-1161	EM-2280
8457	EM-8457	9145	EM-9145	602-1028	EM-2381	602-1162	EM-2330
8489	EM-8489	303918	ST-3918	602-1030	EM-2091	602-1165	EM-2263
8572	EM-8572	505908	ST-5908	602-1034	EM-2107	602-1167	EM-2284
8688	EM-8688	901925	ST-1925	602-1035	EM-2108	602-1168	EM-2289
8722	EM-8722	901940	ST-1940	602-1038	EM-2110	602-1169	EM-2290
8734	EM-8734	901943	ST-1943	602-1039	EM-2120	602-1170	EM-2265
8764	EM-8764	901944	ST-1944	602-1040	EM-2119	602-1174	EM-2340
8769	EM-8769	901950	ST-1950	602-1041	EM-2121	602-1174	EM-2512
8770	EM-8770	901961	ST-1961	602-1044	EM-2122	602-1175	EM-2296
8783	EM-8783	901965	ST-1965	602-1045	EM-2123	602-1177	EM-2009
8784	EM-8784	901979	ST-1979	602-1046	EM-2124	602-1178	EM-2010
8793	EM-8793	902902	ST-2902	602-1047	EM-2125	602-1179	EM-2292
8800	EM-8800	902906	ST-2906	602-1050	DS-6027	602-1180	EM-2375
8847	EM-8847	902911	ST-2911	602-1054	EM-2142	602-1182	EM-2351
8848	EM-8848	902923	ST-2923	602-1058	EM-2141	602-1189	EM-2217
8854	EM-8854	902926	ST-2926	602-1059	EM-2204	602-1189	EM-2515
8862	EM-8862	902927	ST-2927	602-1061	EM-2206	602-1190	EM-2218
8877	EM-8877	902936	ST-2936	602-1063	EM-2364	602-1193	EM-2444
8879	EM-8879	902938	ST-2938	602-1064	EM-2365	602-1194	EM-2445
8896	EM-8896	902944	ST-2944	602-1066	EM-2162	602-1195	EM-2345
8909	EM-8909	902945	ST-2945	602-1067	EM-2163	602-1196	EM-2311
8912	EM-8912	902948	ST-2948	602-1068	EM-2170	602-1213	EM-2301
8913	EM-8913	902968	ST-2968	602-1069	EM-2172	602-1214	EM-2302
8914	EM-8914	902973	ST-2973	602-1078	EM-2150	602-1217	EM-2297
8920	EM-8920	902984	ST-2984	602-1086	EM-2319	602-1218	EM-2298
8935	EM-8935	902989	ST-2989	602-1087	DS-6028	602-1221	EM-2305
8937	EM-8937	902999	ST-2999	602-1090	EM-2309	602-1227	EM-2369
8943	EM-8943	903900	ST-3900	602-1091	EM-2316	602-1231	EM-2357
8944	EM-8944	903903	ST-3903	602-1094	EM-2350	602-1232	EM-2356
8945	EM-8945	903904	ST-3904	602-1102	EM-2462	602-1235	EM-2331
8947	EM-8947	903906	ST-3906	602-1104	EM-2267	602-1236	EM-2332
8948	EM-8948	903910	ST-3910	602-1105	EM-2231	602-1237	EM-2327
8949	EM-8949	903911	ST-3911	602-1106	EM-2267	602-1238	EM-2344
8950	EM-8950	903928	ST-3928	602-1107	EM-2283	602-1239	EM-2358
8951	EM-8951	903933	ST-3933	602-1108	EM-2282	602-1240	EM-2359
8952	EM-8952	903947	ST-3947	602-1109	EM-2261	602-1242	EM-2335
8954	EM-8954	903950	ST-3950	602-1110	EM-2275	602-1243	EM-2336
8955	EM-8955	903954	ST-3954	602-1114	EM-2234	602-1250	EM-2363
8956	EM-8956	903978	ST-3978	602-1115	EM-2235	602-1251	EM-2395
8970	EM-8970	903995	ST-3995	602-1116	EM-2264	602-1252	EM-2371
8980	EM-8980	904903	ST-4903	602-1118	EM-2250	602-1253	EM-2370
8981	EM-8981	904905	ST-4905	602-1119	EM-2328	602-1254	EM-2341
8989	EM-8989	904913	ST-4913	602-1121	EM-2272	602-1255	EM-2400
8995	EM-8995	904915	ST-4915	602-1122	EM-2277	602-1258	EM-2424
8996	EM-8996	904957	ST-4957	602-1127	EM-2267	602-1259	EM-2426
8998	EM-8998	904968	ST-4968	602-1127	EM-2285	602-1260	EM-2367
8999	EM-8999	904975	ST-4975	602-1130	EM-2266	602-1262	EM-2414
9012	EM-9012	904989	ST-4989	602-1132	EM-2225	602-1263	EM-2417
9013	EM-9013	904994	ST-4994	602-1133	EM-2220	602-1264	EM-2415
9019	EM-9019	904996	ST-4996	602-1134	EM-2221	602-1265	EM-2329
9021	EM-9021	904997	ST-4997	602-1138	EM-2242	602-1266	EM-2600

# CROSS REFERENCE

Mfg Part No	Our Part	Mfg Part No	Our Part	Mfg Part No	Our Part	Mfg Part No	Our Part
NAPA (cont.)		NAPA (cont.)		NAPA (cont.)		NAPA (cont.)	
602-1268	EM-2376	602-1527	EM-2728	602-1647	EM-2717	602-1725	EM-2789
602-1280	EM-2562	602-1528	EM-2682	602-1648	EM-2711	602-1726	EM-2790
602-1281	EM-2563	602-1529	EM-2683	602-1649	EM-2661	602-1727	EM-2791
602-1284	EM-2439	602-1530	EM-2407	602-1650	EM-2555	602-1728	EM-2792
602-1285	EM-2440	602-1531	EM-2406	602-1651	EM-2764	602-1729	EM-2795
602-1286	EM-2441	602-1532	EM-2458	602-1652	EM-2765	602-1730	EM-2796
602-1287	EM-2442	602-1534	EM-2458	602-1653	EM-2710	602-1731	EM-2801
602-1288	EM-2502	602-1535	EM-2457	602-1654	EM-2767	602-1732	EM-2803
602-1297	EM-2457	602-1536	EM-2458	602-1655	EM-2768	602-1733	EM-2812
602-1298	EM-2458	602-1537	EM-2457	602-1657	EM-2677	602-1734	EM-2793
602-1300	EM-2396	602-1538	EM-2501	602-1658	EM-2678	602-1735	EM-2794
602-1310	EM-2609	602-1539	EM-2500	602-1663	EM-2018	602-1736	EM-2802
602-1311	EM-2825	602-1541	EM-2538	602-1664	EM-2287	602-1737	EM-2804
602-1313	EM-2872	602-1546	EM-2491	602-1665	EM-2276	602-1738	EM-2805
602-1321	EM-8200	602-1550	EM-2548	602-1666	EM-2303	602-1739	EM-2806
602-1322	EM-8137	602-1552	EM-2538	602-1667	EM-2304	602-1740	EM-2807
602-1323	EM-8142	602-1555	EM-2600	602-1669	EM-2786	602-1741	EM-2808
602-1324	EM-2533	602-1556	EM-2326	602-1670	EM-2402	602-1742	EM-2809
602-1325	EM-2532	602-1557	EM-2505	602-1671	EM-2403	602-1743	EM-2819
602-1334	EM-2565	602-1558	EM-2472	602-1672	EM-2427	602-1744	EM-2798
602-1340	EM-2619	602-1559	EM-2501	602-1673	EM-2381	602-1745	EM-2799
602-1343	EM-2744	602-1560	EM-2500	602-1674	EM-2662	602-1746	EM-2814
602-1345	EM-2681	602-1563	EM-2627	602-1675	EM-2658	602-1747	EM-2797
602-1346	EM-2469	602-1565	EM-2569	602-1676	EM-2673	602-1748	EM-8025
602-1350	EM-2429	602-1566	EM-2571	602-1677	EM-2674	602-1749	EM-8024
602-1355	EM-2615	602-1567	EM-2572	602-1678	EM-2676	602-1750	EM-8697
602-1356	EM-2616	602-1569	EM-2501	602-1679	EM-2680	602-1751	EM-8698
602-1357	EM-2623	602-1570	EM-2501	602-1680	EM-2685	602-1752	EM-9153
602-1358	EM-2626	602-1571	EM-2500	602-1681	EM-2686	602-1753	EM-9154
602-1361	EM-2629	602-1572	EM-2564	602-1682	EM-2687	602-1754	EM-9155
602-1362	EM-2630	602-1573	EM-2551	602-1683	EM-2688	602-1755	EM-9156
602-1363	EM-2635	602-1574	EM-2551	602-1684	EM-2689	602-1756	EM-9157
602-1364	EM-2636	602-1575	EM-2553	602-1685	EM-2697	602-1757	EM-9158
602-1365	EM-2637	602-1576	EM-2551	602-1686	EM-2698	602-1758	EM-9159
602-1369	EM-2493	602-1578	EM-2559	602-1687	EM-2708	602-1759	EM-9160
602-1370	EM-2436	602-1580	EM-2458	602-1688	EM-2709	602-1760	EM-9161
602-1373	EM-2436	602-1581	EM-2621	602-1689	EM-2713	602-1761	EM-9164
602-1375	EM-2421	602-1582	EM-2640	602-1691	EM-2716	602-1762	EM-8209
602-1376	EM-2456	602-1583	EM-2641	602-1692	EM-2718	602-1763	EM-8682
602-1377	EM-2446	602-1584	EM-2642	602-1693	EM-2722	602-1764	EM-8801
602-1379	EM-2436	602-1585	EM-2643	602-1694	EM-2723	602-1765	EM-8849
602-1380	EM-2437	602-1586	EM-2644	602-1695	EM-2724	602-1766	EM-8851
602-1381	EM-2438	602-1587	EM-2645	602-1696	EM-2726	602-1767	EM-8960
602-1382	EM-2433	602-1588	EM-2646	602-1698	EM-2733	602-1769	EM-8968
602-1383	EM-2434	602-1589	EM-2646	602-1699	EM-2736	602-1770	EM-8973
602-1384	EM-2449	602-1590	EM-2649	602-1700	EM-2737	602-1771	EM-8975
602-1387	EM-2447	602-1591	EM-2650	602-1701	EM-2738	602-1772	EM-8795
602-1389	EM-2382	602-1592	EM-2651	602-1702	EM-2740	602-1773	EM-9014
602-1390	EM-2382	602-1593	EM-2652	602-1703	EM-2743	602-1774	EM-9016
602-1391	EM-2459	602-1594	EM-2654	602-1704	EM-2745	602-1775	EM-9136
602-1392	EM-2460	602-1595	EM-2655	602-1705	EM-2749	602-1776	EM-9139
602-1393	EM-2461	602-1596	EM-2656	602-1706	EM-2755	602-1778	EM-4073
602-1483	EM-2506	602-1597	EM-2657	602-1707	EM-2756	602-1780	EM-5423
602-1484	EM-2524	602-1598	EM-2658	602-1708	EM-2396	602-1781	EM-5903
602-1486	EM-2496	602-1599	EM-2338	602-1709	EM-2763	602-1782	EM-5783
602-1488	EM-2473	602-1623	EM-2401	602-1710	EM-2776	602-1783	EM-5426
602-1489	EM-2474	602-1628	EM-2451	602-1711	EM-2777	602-1784	EM-5840
602-1490	EM-2477	602-1629	EM-2536	602-1712	EM-2778	602-1785	EM-5528
602-1493	EM-2490	602-1631	EM-2747	602-1713	EM-2780	602-1786	EM-4113
602-1501	EM-2550	602-1634	EM-2731	602-1714	EM-2781	602-1788	EM-4074
602-1502	EM-2549	602-1635	EM-2731	602-1715	EM-2782	602-1789	EM-8133
602-1503	EM-2550	602-1638	EM-2696	602-1716	EM-2785	602-1800	EM-8039
602-1506	EM-2558	602-1639	EM-2725	602-1717	EM-2351	602-1801	EM-8041
602-1514	EM-2323	602-1640	EM-2750	602-1718	EM-2775	602-1802	EM-8042
602-1515	EM-2324	602-1641	EM-2735	602-1719	EM-2413	602-1803	EM-8042
602-1516	EM-2325	602-1642	EM-2684	602-1720	EM-2748	602-1804	EM-8044
602-1517	EM-2326	602-1643	EM-2812	602-1721	EM-2774	602-1805	EM-8053
602-1524	EM-2503	602-1644	EM-2692	602-1722	EM-2404	602-1806	EM-8068
602-1526	EM-2727	602-1645	EM-2660	602-1723	EM-2405	602-1807	EM-8059

# CROSS REFERENCE

Mfg Part No	Our Part	Mfg Part No	Our Part	Mfg Part No	Our Part	Mfg Part No	Our Part
<b>NAPA (cont.)</b>		<b>NAPA (cont.)</b>		<b>NAPA (cont.)</b>		<b>NAPA (cont.)</b>	
602-1808	EM-2651	602-1882	EM-8406	602-1973	EM-2844	602-2059	EM-2853
602-1809	EM-8065	602-1883	EM-8177	602-1974	EM-2846	602-2060	EM-2938
602-1811	EM-8073	602-1884	EM-8430	602-1975	EM-2847	602-2061	EM-2940
602-1812	EM-8078	602-1885	EM-8605	602-1976	EM-2849	602-2062	EM-2941
602-1813	EM-8080	602-1886	EM-8600	602-1977	EM-2854	602-2063	EM-2942
602-1814	EM-8083	602-1887	EM-8568	602-1978	EM-2855	602-2064	EM-2943
602-1815	EM-8084	602-1888	EM-8574	602-1979	EM-8004	602-2065	EM-2944
602-1816	EM-8085	602-1890	EM-8576	602-1980	EM-8026	602-2066	EM-2945
602-1817	EM-8086	602-1891	EM-8431	602-1982	EM-8037	602-2067	EM-2947
602-1818	EM-8087	602-1892	EM-8407	602-1984	EM-8068	602-2068	EM-2948
602-1819	EM-8088	602-1893	EM-8276	602-1985	EM-8093	602-2069	EM-2949
602-1820	EM-8080	602-1894	EM-8212	602-1986	EM-8097	602-2070	EM-2952
602-1821	EM-8100	602-1895	EM-8151	602-1987	EM-8114	602-2071	EM-2953
602-1822	EM-8102	602-1897	EM-8094	602-1990	EM-8166	602-2072	EM-2955
602-1823	EM-8103	602-1898	EM-8007	602-1991	EM-8171	602-2073	EM-2958
602-1824	EM-8104	602-1899	EM-8018	602-1992	EM-8179	602-2074	EM-2959
602-1825	EM-8105	602-1900	EM-2451	602-1993	EM-8196	602-2075	EM-2961
602-1826	EM-8107	602-1901	EM-8014	602-1995	EM-8207	602-2076	EM-2962
602-1827	EM-8103	602-1902	EM-8002	602-1996	EM-8235	602-2077	EM-2963
602-1828	EM-8065	602-1903	EM-8005	602-1998	EM-8253	602-2078	EM-2964
602-1829	EM-8118	602-1904	EM-8517	602-1999	EM-8304	602-2079	EM-2967
602-1830	EM-8119	602-1905	EM-8001	602-2005	EM-8402	602-2080	EM-2972
602-1831	EM-8125	602-1906	EM-8006	602-2007	EM-8485	602-2081	EM-2973
602-1832	EM-8133	602-1909	EM-8047	602-2009	EM-8584	602-2082	EM-2978
602-1833	EM-8125	602-1910	EM-8122	602-2010	EM-8596	602-2083	EM-2979
602-1834	EM-8133	602-1911	EM-8132	602-2011	EM-8602	602-2084	EM-2980
602-1835	EM-8135	602-1912	EM-8152	602-2012	EM-8603	602-2085	EM-2899
602-1836	EM-8140	602-1913	EM-8164	602-2013	EM-8609	602-2086	EM-2981
602-1837	EM-8141	602-1914	EM-8187	602-2014	EM-8622	602-2087	EM-2983
602-1839	EM-8161	602-1917	EM-8234	602-2015	EM-8224	602-2088	EM-2985
602-1840	EM-2407	602-1921	EM-8310	602-2016	EM-8672	602-2089	EM-2987
602-1841	EM-8278	602-1923	EM-8411	602-2018	EM-8680	602-2090	EM-2989
602-1842	EM-8173	602-1925	EM-8566	602-2020	EM-2869	602-2091	EM-2990
602-1843	EM-8177	602-1926	EM-8578	602-2021	EM-2876	602-2092	EM-2993
602-1844	EM-8178	602-1927	EM-8579	602-2022	EM-2622	602-2093	EM-2994
602-1845	EM-8180	602-1928	EM-2939	602-2023	EM-2878	602-2094	EM-2995
602-1846	EM-8181	602-1929	EM-2968	602-2024	EM-2883	602-2095	EM-2996
602-1847	EM-8211	602-1939	EM-3011	602-2025	EM-2885	602-2096	EM-2997
602-1848	EM-8183	602-1940	EM-8614	602-2026	EM-2886	602-2097	EM-2998
602-1849	EM-8183	602-1941	EM-8615	602-2027	EM-2889	602-2098	EM-2999
602-1850	EM-8185	602-1942	EM-8427	602-2028	EM-2890	602-2099	EM-3000
602-1851	EM-8186	602-1943	EM-2894	602-2029	EM-2892	602-2100	EM-3001
602-1852	EM-8192	602-1944	EM-2896	602-2032	EM-2900	602-2101	EM-3002
602-1853	EM-8193	602-1945	EM-3012	602-2033	EM-2901	602-2102	EM-3003
602-1854	EM-8194	602-1946	EM-3014	602-2034	EM-2902	602-2103	EM-3004
602-1855	EM-8195	602-1947	EM-3015	602-2035	EM-2903	602-2104	EM-3005
602-1856	EM-8197	602-1948	EM-3019	602-2036	EM-2904	602-2105	EM-3006
602-1857	EM-8198	602-1950	EM-2866	602-2037	EM-2905	602-2106	EM-3008
602-1858	EM-8210	602-1951	EM-8201	602-2038	EM-2987	602-2107	EM-3009
602-1859	EM-8211	602-1953	EM-2850	602-2039	EM-2909	602-2108	EM-3010
602-1860	EM-8213	602-1954	EM-2851	602-2040	EM-2910	602-2109	EM-8008
602-1861	EM-2678	602-1955	EM-2853	602-2041	EM-2911	602-2110	EM-8010
602-1862	EM-8222	602-1956	EM-2856	602-2042	EM-2912	602-2111	EM-8011
602-1863	EM-8224	602-1957	EM-2859	602-2043	EM-2913	602-2112	EM-8021
602-1864	EM-8229	602-1958	EM-2860	602-2044	EM-2914	602-2113	EM-8074
602-1865	EM-8233	602-1959	EM-2861	602-2045	EM-2915	602-2114	EM-8075
602-1866	EM-8224	602-1960	EM-2867	602-2046	EM-2916	602-2116	EM-8167
602-1867	EM-8239	602-1961	EM-2827	602-2047	EM-2917	602-2117	EM-8296
602-1868	EM-8259	602-1962	EM-2829	602-2048	EM-2918	602-2118	EM-8361
602-1869	EM-8278	602-1963	EM-2830	602-2049	EM-2919	602-2119	EM-8404
602-1870	EM-8279	602-1964	EM-2831	602-2050	EM-2920	602-2121	EM-8435
602-1871	EM-8282	602-1965	EM-2832	602-2051	EM-2926	602-2122	EM-8456
602-1872	EM-8283	602-1966	EM-2833	602-2052	EM-2929	602-2123	DS-8471
602-1873	EM-8307	602-1967	EM-2834	602-2053	EM-2930	602-2124	EM-8491
602-1875	EM-8178	602-1968	EM-2835	602-2054	EM-2931	602-2125	EM-8513
602-1876	EM-8278	602-1969	EM-2836	602-2055	EM-2933	602-2126	EM-8612
602-1878	EM-8348	602-1970	EM-2838	602-2056	EM-2934	602-2127	EM-8617
602-1879	EM-8363	602-1971	EM-2841	602-2057	EM-2935	602-2130	EM-8164
602-1881	EM-8197	602-1972	EM-2842	602-2058	EM-2936	602-2131	EM-8662

# CROSS REFERENCE

Mfg Part No	Our Part	Mfg Part No	Our Part	Mfg Part No	Our Part	Mfg Part No	Our Part
NAPA (cont.)		NAPA (cont.)		NAPA (cont.)		NAPA (cont.)	
602-2132	EM-8677	602-2201	EM-8432	602-2271	EM-3073	602-2340	EM-9279
602-2133	EM-8687	602-2202	EM-8497	602-2272	EM-3074	602-2341	EM-9280
602-2134	EM-8692	602-2203	EM-8524	602-2273	EM-3075	602-2342	EM-9281
602-2135	EM-8699	602-2204	EM-8575	602-2274	EM-3076	602-2343	EM-9282
602-2136	EM-8701	602-2205	EM-8616	602-2275	EM-3077	602-2344	EM-9283
602-2137	EM-8710	602-2206	EM-8658	602-2276	EM-3078	602-2345	EM-9288
602-2138	EM-8711	602-2207	EM-8670	602-2277	EM-3079	602-2346	EM-9289
602-2139	EM-8740	602-2208	EM-8690	602-2278	EM-3084	602-2347	EM-9290
602-2140	EM-8597	602-2209	EM-8709	602-2279	EM-3085	602-2348	EM-9291
602-2141	EM-8774	602-2210	EM-8792	602-2280	EM-9182	602-2349	EM-9292
602-2142	EM-8781	602-2211	EM-8819	602-2281	EM-9192	602-2350	EM-9293
602-2143	EM-8788	602-2212	EM-8823	602-2282	EM-9194	602-2351	EM-9294
602-2144	EM-8795	602-2213	EM-8824	602-2283	EM-9195	602-2352	EM-9299
602-2145	EM-8796	602-2214	EM-8616	602-2284	EM-3083	602-2353	EM-9300
602-2146	EM-8798	602-2215	EM-8344	602-2285	EM-3088	602-2354	EM-9302
602-2147	EM-8803	602-2216	EM-8691	602-2286	EM-3089	602-2356	EM-3087
602-2148	EM-8806	602-2217	EM-3022	602-2287	EM-3090	602-2357	EM-3091
602-2149	EM-8681	602-2218	EM-3023	602-2288	EM-3093	602-2358	EM-3095
602-2150	EM-8818	602-2219	EM-3024	602-2289	EM-3097	602-2360	EM-3100
602-2151	EM-8820	602-2220	EM-3025	602-2290	EM-3102	602-2362	EM-3107
602-2152	EM-8845	602-2221	EM-3028	602-2291	EM-3103	602-2363	EM-3108
602-2153	EM-8846	602-2222	EM-3029	602-2292	EM-3104	602-2364	EM-3109
602-2154	EM-8850	602-2223	EM-3030	602-2293	EM-3105	602-2365	EM-3110
602-2155	EM-5131	602-2224	EM-3031	602-2294	EM-3111	602-2366	EM-3113
602-2155	EM-8858	602-2225	EM-3033	602-2295	EM-3121	602-2367	EM-3114
602-2156	EM-8860	602-2226	EM-3034	602-2296	EM-9196	602-2368	EM-3116
602-2157	EM-8864	602-2227	EM-3035	602-2297	EM-9197	602-2369	EM-3117
602-2158	EM-8865	602-2228	EM-3036	602-2298	EM-9078	602-2370	EM-3118
602-2159	EM-8866	602-2229	EM-3037	602-2299	EM-9208	602-2371	EM-3120
602-2160	EM-8870	602-2230	EM-3039	602-2300	EM-9211	602-2372	EM-9198
602-2161	EM-8874	602-2231	EM-3044	602-2301	EM-5141	602-2373	EM-9200
602-2162	EM-8893	602-2232	EM-3045	602-2301	EM-9212	602-2374	EM-9202
602-2163	EM-8894	602-2233	EM-3046	602-2302	EM-9223	602-2375	EM-9203
602-2164	EM-8895	602-2233	EM-3064	602-2303	EM-9226	602-2376	EM-9207
602-2165	EM-8897	602-2234	EM-3047	602-2304	EM-9227	602-2377	EM-9209
602-2166	EM-8899	602-2235	EM-3048	602-2305	EM-9228	602-2378	EM-9210
602-2167	EM-8906	602-2236	EM-3049	602-2306	EM-9231	602-2379	EM-9213
602-2168	EM-8908	602-2237	EM-3056	602-2307	EM-9232	602-2380	EM-9218
602-2169	EM-8921	602-2238	EM-3059	602-2308	EM-9233	602-2381	EM-9221
602-2170	EM-8961	602-2239	EM-3060	602-2309	EM-9234	602-2382	EM-9228
602-2171	EM-8962	602-2240	EM-3067	602-2310	EM-9235	602-2383	EM-9246
602-2172	EM-8965	602-2241	EM-9149	602-2311	EM-9237	602-2384	EM-9248
602-2173	EM-8974	602-2242	EM-9150	602-2312	EM-9238	602-2385	EM-9250
602-2174	EM-8984	602-2243	EM-9166	602-2313	EM-9239	602-2386	EM-9265
602-2175	EM-8988	602-2244	EM-9167	602-2314	EM-9240	602-2387	EM-9277
602-2176	EM-8994	602-2245	EM-9168	602-2315	EM-9242	602-2388	EM-5787
602-2177	EM-9003	602-2246	EM-9169	602-2316	EM-9240	602-2388	EM-9297
602-2178	EM-9007	602-2247	EM-9170	602-2318	EM-9247	602-2389	EM-9303
602-2179	EM-9008	602-2248	EM-9171	602-2319	EM-9249	602-2390	EM-9305
602-2180	EM-9009	602-2249	EM-9172	602-2320	EM-9251	602-2392	EM-9307
602-2181	EM-9022	602-2250	EM-9173	602-2321	EM-9252	602-2393	EM-9309
602-2182	EM-9023	602-2251	EM-9175	602-2322	EM-9253	602-2394	EM-9310
602-2183	EM-9043	602-2252	EM-9178	602-2323	EM-9254	602-2395	EM-9311
602-2184	EM-9044	602-2253	EM-9179	602-2324	EM-9255	602-2396	EM-9312
602-2185	EM-8261	602-2254	EM-9180	602-2325	EM-9256	602-2397	EM-9313
602-2186	EM-8895	602-2255	EM-9181	602-2326	EM-9257	602-2398	EM-9314
602-2187	EM-9083	602-2256	EM-9184	602-2327	EM-9259	602-2400	EM-9316
602-2188	EM-2649	602-2257	EM-9185	602-2328	EM-9260	602-2401	EM-9317
602-2189	EM-8681	602-2258	EM-9186	602-2329	EM-9261	602-2402	EM-9318
602-2190	EM-9137	602-2259	EM-9187	602-2330	EM-9263	602-2403	EM-9317
602-2192	EM-8009	602-2260	EM-9188	602-2331	EM-9269	602-2404	EM-9322
602-2193	EM-8030	602-2261	EM-9189	602-2332	EM-9270	602-2405	EM-9323
602-2194	EM-8100	602-2262	EM-9190	602-2333	EM-9271	602-2406	EM-9324
602-2195	EM-8169	602-2263	EM-9191	602-2334	EM-9272	602-2407	EM-9325
602-2196	EM-8349	602-2264	EM-9193	602-2335	EM-9273	602-2408	EM-9326
602-2197	EM-8359	602-2267	EM-3021	602-2336	EM-9274	602-2409	EM-9327
602-2198	EM-8385	602-2268	EM-3064	602-2337	EM-9275	602-2410	EM-9328
602-2199	EM-8398	602-2269	EM-3072	602-2338	EM-9276	602-2411	EM-9329
602-2200	EM-8413	602-2270	EM-3071	602-2339	EM-9278	602-2412	EM-9330



# CROSS REFERENCE

Mfg Part No	Our Part	Mfg Part No	Our Part	Mfg Part No	Our Part	Mfg Part No	Our Part
NAPA (cont.)		NAPA (cont.)		NAPA (cont.)		NAPA (cont.)	
602-2413	EM-9331	602-2487	EM-9385	602-2556	EM-9487	602-2643	EM-9497
602-2413	EM-9331	602-2488	EM-9386	602-2557	EM-9488	602-2644	EM-9498
602-2414	EM-9332	602-2489	EM-9388	602-2558	EM-9489	602-2645	EM-5349
602-2415	EM-9335	602-2490	EM-9389	602-2559	EM-9491	602-2646	EM-9502
602-2416	EM-9338	602-2491	EM-9391	602-2560	EM-9492	602-2647	EM-5781
602-2417	EM-9340	602-2492	EM-9392	602-2561	EM-5155	602-2648	EM-9504
602-2419	EM-9344	602-2493	EM-9393	602-2562	EM-9496	602-2649	EM-5646
602-2420	EM-9345	602-2494	EM-9394	602-2563	EM-5553	602-2650	EM-9506
602-2421	EM-9346	602-2495	EM-9396	602-2564	EM-9580	602-2651	EM-9507
602-2423	EM-9348	602-2496	EM-9066	602-2565	EM-5399	602-2652	EM-5384
602-2425	EM-9352	602-2497	EM-9168	602-2566	EM-5356	602-2653	EM-9509
602-2426	EM-9353	602-2498	EM-9400	602-2567	EM-5367	602-2654	EM-9510
602-2427	EM-9354	602-2499	EM-9401	602-2568	EM-5921	602-2655	EM-9513
602-2428	EM-9355	602-2500	EM-9402	602-2569	EM-5649	602-2656	EM-9514
602-2429	EM-9357	602-2501	EM-9403	602-2570	EM-5837	602-2657	EM-9518
602-2430	EM-9358	602-2502	EM-9404	602-2571	EM-7039	602-2658	EM-5656
602-2431	EM-9359	602-2503	EM-9405	602-2572	EM-5655	602-2659	EM-9525
602-2432	EM-9360	602-2504	EM-9406	602-2573	EM-9248	602-2660	EM-9526
602-2433	EM-9362	602-2505	EM-9407	602-2576	EM-5375	602-2661	EM-5404
602-2434	EM-9363	602-2506	EM-9408	602-2580	EM-5798	602-2662	EM-5411
602-2435	EM-9365	602-2507	EM-9411	602-2581	EM-5857	602-2663	EM-9531
602-2436	EM-9368	602-2508	EM-9412	602-2582	EM-5876	602-2664	EM-5132
602-2438	EM-9372	602-2509	EM-9413	602-2583	EM-5148	602-2665	EM-5785
602-2439	EM-9375	602-2510	EM-9415	602-2584	EM-5353	602-2666	EM-9535
602-2440	EM-9377	602-2511	EM-9416	602-2585	EM-5354	602-2667	EM-9537
602-2441	EM-9379	602-2512	EM-9418	602-2586	EM-5104	602-2668	EM-5834
602-2442	EM-9382	602-2513	EM-9419	602-2588	EM-5074	602-2668	EM-9538
602-2444	EM-8681	602-2514	EM-9421	602-2589	EM-5352	602-2669	EM-9542
602-2445	EM-8704	602-2515	EM-9422	602-2592	EM-5578	602-2670	EM-9544
602-2446	EM-8885	602-2516	EM-9424	602-2595	EM-5427	602-2671	EM-9545
602-2447	EM-8902	602-2517	EM-9431	602-2596	EM-2928	602-2672	EM-9546
602-2448	EM-2985	602-2518	EM-9432	602-2597	EM-2947	602-2673	EM-9547
602-2449	EM-9031	602-2519	EM-9436	602-2598	EM-5588	602-2674	EM-9548
602-2450	EM-8150	602-2520	EM-9437	602-2599	EM-2993	602-2675	EM-9551
602-2451	EM-8959	602-2521	EM-9441	602-2601	EM-5692	602-2676	EM-9553
602-2452	EM-8882	602-2522	EM-9442	602-2602	EM-5693	602-2677	EM-9554
602-2453	EM-8997	602-2523	EM-9443	602-2603	EM-5694	602-2705	EM-4028
602-2454	EM-8778	602-2524	EM-9444	602-2605	EM-4017	602-2706	EM-4038
602-2455	EM-9116	602-2525	EM-9445	602-2606	EM-4000	602-2707	EM-4039
602-2456	EM-8277	602-2526	EM-9446	602-2607	EM-5152	602-2708	EM-5583
602-2457	EM-8855	602-2527	EM-9447	602-2608	EM-8021	602-2709	EM-5424
602-2458	EM-8992	602-2528	EM-9449	602-2609	EM-5326	602-2710	EM-5425
602-2459	EM-9015	602-2529	EM-9451	602-2610	EM-8568	602-2711	EM-3175
602-2460	EM-8978	602-2530	EM-3152	602-2611	EM-5358	602-2713	EM-5085
602-2461	EM-8982	602-2531	EM-3154	602-2612	EM-5445	602-2714	EM-3183
602-2462	EM-8884	602-2532	EM-3156	602-2613	EM-5446	602-2715	EM-4012
602-2463	EM-8871	602-2533	EM-3157	602-2614	EM-5485	602-2716	EM-3190
602-2464	EM-9092	602-2534	EM-9452	602-2615	EM-5612	602-2717	EM-3193
602-2465	EM-8002	602-2535	EM-9453	602-2616	EM-5527	602-2718	EM-3198
602-2466	EM-8832	602-2536	EM-9454	602-2617	EM-5616	602-2719	EM-3200
602-2468	EM-3128	602-2537	EM-9455	602-2621	EM-5436	602-2720	EM-5377
602-2469	EM-3129	602-2538	EM-9456	602-2622	EM-5494	602-2721	EM-4035
602-2470	EM-3130	602-2539	EM-9457	602-2623	EM-5495	602-2722	EM-5859
602-2471	EM-3131	602-2540	EM-9458	602-2624	EM-5143	602-2723	EM-4033
602-2472	EM-3132	602-2541	EM-9461	602-2625	EM-5142	602-2724	EM-4057
602-2473	EM-3133	602-2542	EM-9466	602-2626	EM-5441	602-2725	EM-4019
602-2474	EM-3138	602-2543	EM-9467	602-2629	EM-9579	602-2726	EM-4146
602-2475	EM-3139	602-2544	EM-9468	602-2630	EM-5835	602-2728	EM-4055
602-2476	EM-3140	602-2545	EM-9469	602-2632	EM-5191	602-2729	EM-4056
602-2477	EM-3141	602-2546	EM-9475	602-2633	EM-5437	602-2730	EM-4095
602-2478	EM-3142	602-2547	EM-9476	602-2634	EM-5673	602-2731	EM-4044
602-2479	EM-3143	602-2548	EM-9477	602-2635	EM-3158	602-2732	EM-4071
602-2480	EM-3145	602-2549	EM-9478	602-2636	EM-3160	602-2733	EM-5599
602-2481	EM-3146	602-2550	EM-9480	602-2637	EM-3165	602-2734	EM-9559
602-2482	EM-3147	602-2551	EM-9481	602-2638	EM-3166	602-2735	EM-5959
602-2483	EM-3148	602-2552	EM-9483	602-2639	EM-3167	602-2737	EM-8974
602-2484	EM-3149	602-2553	EM-9484	602-2640	EM-3168	602-2738	EM-5874
602-2485	EM-3150	602-2554	EM-9485	602-2641	EM-5692	602-2739	EM-9572
602-2486	EM-3151	602-2555	EM-5689	602-2642	EM-5588	602-2740	EM-9573

# CROSS REFERENCE

Mfg Part No	Our Part	Mfg Part No	Our Part	Mfg Part No	Our Part	Mfg Part No	Our Part
NAPA (cont.)		NAPA (cont.)		NAPA (cont.)		NAPA (cont.)	
602-2741	EM-9574	612-1574	EM-2551S	620-1094	EM-2391	620-1246	EM-2721
602-2745	EM-5782	612-1576	EM-2551S	620-1097	EM-2393	620-1247	EM-2730
602-2747	EM-9588	612-1638	EM-2696S	620-1097	EM-2508	620-1248	EM-2734
602-2749	EM-9591	612-1645	EM-2660S	620-1097	EM-2531	620-1249	EM-2741
602-2750	EM-5772	612-1648	EM-2711S	620-1100	EM-2464	620-1251	EM-2759
602-2751	EM-9593	612-1649	EM-2661S	620-1101	EM-2448	620-1252	EM-2760
602-2752	EM-9595	612-1650	EM-2555S	620-1102	EM-2467	620-1253	EM-2766
602-2755	EM-5750	612-1685	EM-2697S	620-1103	EM-2466	620-1254	EM-2771
602-2756	EM-9601	612-1686	EM-2698S	620-1105	EM-2742	620-1255	EM-2772
602-2757	EM-9610	612-1687	EM-5742	620-1106	EM-2487	620-1256	EM-2773
602-2758	EM-9612	612-1688	EM-9599	620-1107	EM-2392	620-1257	EM-2548
602-2759	EM-9613	612-1689	EM-5872	620-1108	EM-2389	620-1258	EM-2783
602-2761	EM-5944	612-1690	EM-5906	620-1109	EM-2497	620-1259	EM-2784
602-2762	EM-5866	6121690	EM-5906	620-1110	EM-2557	620-1260	EM-2671
602-2763	EM-5924	612-1691	EM-5867	620-1111	EM-2556	620-1261	EM-2394
602-2764	EM-5907	612-1692	EM-5982	620-1114	EM-2557	620-1262	EM-2639
602-2765	EM-5796	612-1693	EM-5601	620-1121	EM-2620	620-1263	EM-2813
602-2766	EM-5783	612-1694	EM-5600	620-1122	EM-2639	620-1264	EM-2452
602-2767	EM-5670	612-1696	EM-5940	620-1123	EM-2815	620-1265	EM-8604
602-2768	EM-5909	612-1697	EM-5973	620-1124	EM-2653	620-1267	EM-8516
602-2769	EM-5856	612-1698	EM-5970	620-1141	EM-9161	620-1268	EM-8303
602-2770	EM-5912	612-1725	EM-2789S	620-1141	EM-9162	620-1269	EM-8208
602-2771	EM-9351	612-1726	EM-2790S	620-1142	EM-9163	620-1270	EM-8124
602-2772	EM-5859	612-1727	EM-2791S	620-1184	EM-2488	620-1271	EM-8188
602-2773	EM-5860	612-1728	EM-2792S	620-1185	EM-2489	620-1272	EM-8176
602-2774	EM-5754	612-1729	EM-2795S	620-1186	EM-2495	620-1273	EM-8160
602-2775	EM-5913	612-1730	EM-2796S	620-1189	EM-2513	620-1274	EM-8128
602-2776	EM-5819	612-1732	EM-2803S	620-1194	EM-2537	620-1276	EM-8082
602-2777	EM-5877	612-1733	EM-2812S	620-1197	EM-2570	620-1277	EM-8019
602-2778	EM-5884	612-1957	EM-2859S	620-1198	EM-2628	620-1278	EM-8022
602-2779	EM-5795	612-1969	EM-2836S	620-1200	EM-2617	620-1279	EM-8020
602-2780	EM-7019	620-1010	EM-2362	620-1201	EM-2618	620-1280	EM-8016
602-2781	EM-5903	620-1012	EM-2048	620-1202	EM-2622	620-1281	EM-8031
602-2782	EM-5904	620-1013	EM-2050	620-1203	EM-2624	620-1283	EM-8091
602-2783	EM-5972	620-1020	EM-2268	620-1204	EM-2625	620-1284	EM-8095
602-2784	EM-5966	620-1023	EM-2294	620-1205	EM-2631	620-1285	EM-8175
602-2785	EM-5968	620-1024	EM-2378	620-1206	EM-2632	620-1286	EM-8190
602-2786	EM-5974	620-1026	EM-2360	620-1207	EM-2633	620-1287	EM-8209
602-2787	EM-5985	620-1030	EM-2295	620-1208	EM-2634	620-1288	EM-2410
602-2788	EM-5916	620-1031	EM-2268	620-1209	EM-2638	620-1289	EM-8424
602-2789	EM-8164	620-1032	EM-2369	620-1212	EM-2409	620-1293	EM-2852
602-2793	EM-8685	620-1034	EM-2293	620-1214	EM-2746	620-1294	EM-2858
602-2794	EM-5108	620-1037	EM-2317	620-1219	EM-2679	620-1295	EM-2862
602-2795	EM-5109	620-1040	EM-2253	620-1220	EM-2739	620-1296	EM-2863
602-2796	EM-5105	620-1041	EM-2353	620-1221	EM-2667	620-1297	EM-2864
602-2797	EM-5350	620-1043	EM-2534	620-1222	EM-2668	620-1298	EM-2822
602-2798	EM-8062	620-1045	EM-2337	620-1223	EM-2769	620-1300	EM-8106
602-2799	EM-9351	620-1046	EM-2374	620-1224	EM-2770	620-1301	EM-8111
602-2801	EM-8967	620-1052	EM-2346	620-1225	EM-2707	620-1302	EM-8150
602-2802	EM-5464	620-1056	EM-2471	620-1226	EM-2349	620-1303	EM-8191
602-2803	EM-5173	620-1058	EM-2372	620-1227	EM-2306	620-1304	EM-8236
602-2804	EM-8120	620-1059	EM-2167	620-1228	EM-2307	620-1305	EM-8323
602-2805	EM-8960	620-1063	EM-2419	620-1229	EM-2762	620-1309	EM-8063
602-2806	EM-5052	620-1064	EM-2418	620-1230	EM-2348	620-1310	EM-8529
602-2807	EM-2910	620-1065	EM-2420	620-1231	EM-2408	620-1311	EM-8586
602-2808	EM-5748	620-1068	EM-2428	620-1232	EM-2499	620-1312	EM-8601
602-2809	EM-5672	620-1069	EM-2425	620-1233	EM-2659	620-1313	EM-2815
602-2810	DS-8549	620-1070	EM-2394	620-1234	EM-2663	620-1314	EM-2908
602-2812	DS-8469	620-1071	EM-2373	620-1235	EM-2664	620-1315	EM-2921
602-2813	DS-8470	620-1072	EM-2453	620-1236	EM-2665	620-1316	EM-2922
602-2815	DS-8473	620-1073	EM-2454	620-1237	EM-2657	620-1317	EM-2923
602-2816	DS-8472	620-1075	EM-2310	620-1238	EM-2675	620-1318	EM-2924
602-2818	DS-8532	620-1076	EM-2525	620-1239	EM-2690	620-1319	EM-2925
602-2819	DS-8551	620-1077	EM-2410	620-1240	EM-2691	620-1320	EM-2927
602-2820	DS-8587	620-1086	EM-2463	620-1241	EM-2693	620-1321	EM-2928
602-2821	DS-8468	620-1087	EM-2601	620-1242	EM-2712	620-1322	EM-2932
602-2822	DS-8591	620-1090	EM-2379	620-1243	EM-2715	620-1324	EM-2960
602-2829	EM-4082	620-1091	EM-2388	620-1244	EM-2719	620-1325	EM-2950
612-1550	EM-2548S	620-1092	EM-2389	620-1245	EM-2720	620-1326	EM-2951

# CROSS REFERENCE

Mfg Part No	Our Part	Mfg Part No	Our Part	Mfg Part No	Our Part	Mfg Part No	Our Part
NAPA (cont.)		NAPA (cont.)		NAPA (cont.)		NAPA (cont.)	
620-1327	EM-2954	620-1505	EM-2543	620-1598	EM-9177	620-1667	EM-9308
620-1328	EM-2956	620-1521	EM-2567	620-1599	EM-9183	620-1668	EM-9319
620-1329	EM-2957	620-1525	EM-2826	620-1600	EM-3020	620-1670	EM-9333
620-1330	EM-2960	620-1526	EM-2828	620-1601	EM-3063	620-1671	EM-9334
620-1331	EM-2965	620-1527	EM-2837	620-1602	EM-3065	620-1672	EM-9336
620-1332	EM-2966	620-1528	EM-2638	620-1603	EM-3070	620-1673	EM-9337
620-1334	EM-2969	620-1529	EM-2840	620-1604	EM-3080	620-1674	EM-9339
620-1335	EM-2970	620-1530	EM-2843	620-1605	EM-3081	620-1675	EM-9341
620-1336	EM-2971	620-1531	EM-2845	620-1606	EM-3082	620-1676	EM-9342
620-1337	EM-2974	620-1532	EM-2848	620-1607	EM-3092	620-1677	EM-9349
620-1338	EM-2975	620-1533	EM-2857	620-1608	EM-3096	620-1678	EM-9350
620-1339	EM-2624	620-1536	EM-2788	620-1609	EM-3106	620-1679	EM-9356
620-1340	EM-2977	620-1537	EM-2813	620-1610	EM-3119	620-1680	EM-9361
620-1341	EM-2907	620-1538	EM-2821	620-1611	EM-3122	620-1681	EM-9364
620-1342	EM-2982	620-1539	EM-2823	620-1612	EM-3123	620-1682	EM-9366
620-1343	EM-2984	620-1540	EM-2824	620-1613	EM-3124	620-1683	EM-9367
620-1344	EM-2986	620-1541	EM-2800	620-1614	EM-9199	620-1684	EM-9369
620-1345	EM-2988	620-1542	EM-2810	620-1615	EM-9205	620-1685	EM-9370
620-1346	EM-2991	620-1543	EM-2817	620-1616	EM-9219	620-1686	EM-9373
620-1347	EM-2992	620-1544	EM-2815	620-1617	EM-9224	620-1687	EM-9374
620-1348	EM-3007	620-1545	EM-2816	620-1618	EM-9230	620-1688	EM-9376
620-1349	EM-2897	620-1546	EM-2817	620-1619	EM-9241	620-1690	EM-9380
620-1349	EM-2897S	620-1547	EM-2818	620-1620	EM-9245	620-1691	EM-9381
620-1350	EM-8063	620-1548	EM-2820	620-1621	EM-9262	620-1692	EM-9383
620-1351	EM-8329	620-1549	EM-2822	620-1622	EM-9264	620-1693	EM-9384
620-1352	EM-8330	620-1550	EM-8103	620-1623	EM-9266	620-1695	EM-3125
620-1355	EM-8907	620-1551	EM-8045	620-1624	EM-9267	620-1696	EM-3126
620-1356	EM-9082	620-1552	EM-8095	620-1625	EM-9268	620-1697	EM-3127
620-1357	EM-9086	620-1553	EM-2815	620-1626	EM-8883	620-1698	EM-3134
620-1358	EM-9087	620-1554	EM-8080	620-1626	EM-9284	620-1699	EM-3135
620-1359	EM-8034	620-1555	EM-8077	620-1627	EM-9286	620-1700	EM-3136
620-1360	EM-8300	620-1556	EM-8079	620-1628	EM-9287	620-1701	EM-3137
620-1361	EM-8328	620-1557	EM-8121	620-1629	EM-9295	620-1702	EM-3144
620-1362	EM-8460	620-1558	EM-8130	620-1630	EM-9296	620-1703	EM-9387
620-1363	EM-8684	620-1559	EM-8214	620-1631	EM-8165	620-1704	EM-9390
620-1364	EM-8693	620-1560	EM-8238	620-1632	EM-9055	620-1705	EM-9395
620-1365	EM-8694	620-1561	EM-8312	620-1633	EM-8799	620-1706	EM-9397
620-1366	EM-8700	620-1562	EM-2568	620-1634	EM-8872	620-1707	EM-9409
620-1367	EM-8705	620-1566	EM-8324	620-1635	EM-8873	620-1708	EM-9410
620-1368	EM-8797	620-1567	EM-2690	620-1636	EM-8888	620-1709	EM-9414
620-1369	EM-8825	620-1568	EM-8422	620-1637	EM-8898	620-1710	EM-9417
620-1370	EM-3013	620-1569	EM-2898	620-1638	EM-8971	620-1711	EM-9420
620-1371	EM-3016	620-1570	EM-2868	620-1639	EM-8979	620-1712	EM-9423
620-1372	EM-3017	620-1571	EM-2870	620-1640	EM-8983	620-1713	EM-9425
620-1373	EM-3018	620-1572	EM-2871	620-1641	EM-8986	620-1714	EM-9426
620-1374	EM-8415	620-1573	EM-2873	620-1642	EM-8993	620-1715	EM-9427
620-1375	EM-8643	620-1574	EM-2874	620-1643	EM-9018	620-1716	EM-9428
620-1376	EM-8644	620-1575	EM-2875	620-1644	EM-9101	620-1717	EM-9429
620-1377	EM-9142	620-1576	EM-2879	620-1645	EM-9113	620-1718	EM-9430
620-1378	EM-3026	620-1577	EM-2880	620-1647	EM-3086	620-1719	EM-9433
620-1379	EM-3027	620-1578	EM-2881	620-1648	EM-3094	620-1720	EM-9434
620-1380	EM-3032	620-1579	EM-2882	620-1649	EM-3098	620-1721	EM-9435
620-1381	EM-3038	620-1580	EM-2884	620-1650	EM-3112	620-1722	EM-9438
620-1382	EM-3040	620-1581	EM-2887	620-1651	EM-3115	620-1723	EM-9439
620-1383	EM-3041	620-1582	EM-2888	620-1652	EM-9201	620-1724	EM-9440
620-1384	EM-3042	620-1583	EM-2638	620-1653	EM-9204	620-1725	EM-9448
620-1385	EM-3043	620-1585	EM-2893	620-1654	EM-9214	620-1726	EM-9450
620-1386	EM-3050	620-1586	EM-2895	620-1655	EM-9215	620-1727	EM-3153
620-1387	EM-3051	620-1587	EM-3061	620-1656	EM-9216	620-1728	EM-3155
620-1388	EM-3052	620-1588	EM-3062	620-1657	EM-9217	620-1729	EM-9459
620-1389	EM-3053	620-1589	EM-3066	620-1658	EM-9220	620-1730	EM-9460
620-1390	EM-3054	620-1590	EM-3068	620-1659	EM-9222	620-1731	EM-9462
620-1391	EM-3055	620-1591	EM-3069	620-1660	EM-9225	620-1732	EM-9463
620-1392	EM-3057	620-1592	EM-9148	620-1661	EM-9236	620-1733	EM-9464
620-1393	EM-3058	620-1593	EM-9151	620-1662	EM-9258	620-1734	EM-9465
620-1481	EM-2498	620-1594	EM-9152	620-1663	EM-9285	620-1735	EM-5794
620-1482	EM-2497	620-1595	EM-9165	620-1664	EM-9298	620-1735	EM-9470
620-1496	EM-2528	620-1596	EM-9174	620-1665	EM-9301	620-1736	EM-9471
620-1497	EM-2492	620-1597	EM-9176	620-1666	EM-9304	620-1737	EM-9472

# CROSS REFERENCE

Mfg Part No	Our Part	Mfg Part No	Our Part	Mfg Part No	Our Part	Mfg Part No	Our Part
<b>NAPA (cont.)</b>		<b>NAPA (cont.)</b>		<b>NAPA (cont.)</b>		<b>PIONEER (cont.)</b>	
620-1738	EM-9473	620-1817	EM-5428	622-1536	EM-2788S	601004	EM-2952
620-1739	EM-9474	620-1819	EM-4036	622-1537	EM-2813S	601006	EM-8402
620-1740	EM-9479	620-1820	EM-3192	622-1538	EM-2821S	601007	EM-8104
620-1741	EM-9482	620-1821	EM-3194	622-1539	EM-2823S	601008	EM-2804
620-1742	EM-9490	620-1823	EM-3196	622-1540	EM-2824S	601010	EM-8103
620-1743	EM-9494	620-1824	EM-3197	642-1743	EM-5426	601013	EM-8568
620-1744	EM-9495	620-1825	EM-3199	642-1759	EM-5159	601016	EM-2615
620-1745	EM-5518	620-1826	EM-3201	6422039	EM-2909G	601021	EM-8191
620-1746	EM-5403	620-1827	EM-3202	6422257	EM-8974G	601023	EM-8186
620-1747	EM-5647	620-1828	EM-4034	6422561	EM-2949G	601025	EM-8230
620-1748	EM-5657	620-1829	EM-4045	642-3000	EM-5026	601026	EM-8933
620-1749	EM-5449	620-1830	EM-4046	642-3001	EM-5031	601032	EM-5383
620-1750	EM-9205	620-1831	EM-5189	642-3021	EM-5362	601033	EM-2709
620-1751	EM-5452	620-1832	EM-5188	644-1575	EM-5079	601035	EM-8228
620-1752	EM-5928	620-1833	EM-9558	644-1616	EM-5817	601036	EM-8497
620-1753	EM-2620	620-1834	EM-9560	644-3001	EM-5078	601038	EM-2836
620-1754	EM-5103	620-1836	EM-9566	650-1184	EM-2714	601042	EM-2812S
620-1755	EM-5383	620-1837	EM-7007	8631968	EM-5216	601044	EM-2791
620-1757	EM-5033	620-1839	EM-9570	864-9597	EM-5528	601045	EM-2803S
620-1758	EM-5182	620-1840	EM-5332	914-1042	EM-5530	601046	EM-5026
620-1760	EM-5475	620-1841	EM-9575	<b>PIONEER</b>		601048	EM-8662
620-1762	EM-5659	620-1842	EM-9577	A2834	EM-2834	601052	EM-8236
620-1763	EM-2927	620-1843	EM-9589	A2835	EM-2835	601055	EM-8266
620-1764	EM-5660	620-1844	EM-9594	A4000	EM-5518	601058	EM-8897
620-1765	EM-5661	620-1845	EM-5957	A4310	EM-5468	601059	EM-8238
620-1766	EM-5662	620-1846	EM-9617	A4622	EM-5452	601060	EM-8100
620-1767	EM-5663	620-1847	EM-9619	A5338	EM-5424	601061	EM-8206
620-1768	EM-5664	620-1848	EM-5905	A5339	EM-5425	601063	EM-8178
620-1769	EM-5665	620-1849	EM-5908	A5341	EM-5426	601064	EM-8211
620-1770	EM-4040	620-1850	EM-5910	A5346	EM-5428	601068	EM-8213
620-1773	EM-5190	620-1851	EM-5556	A5347	EM-3128	601071	EM-8195
620-1774	EM-5121	620-1852	EM-5911	A5348	EM-5476	601072	EM-8361
620-1775	EM-5609	620-1853	EM-5963	A6953HY	EM-5445	601074	EM-8278
620-1777	EM-5432	620-1854	EM-9096	A7084	EM-5530	601075	EM-8166
620-1778	EM-5737	620-1855	EM-5914	A7087	EM-5436	601076	EM-8233
620-1779	EM-5489	620-1856	EM-7000	A7088	EM-5437	601080	EM-8375
620-1780	EM-5440	620-1858	EM-5956	A7092	EM-5439	601081	EM-8171
620-1781	EM-5144	620-1859	EM-5975	MB518393	EM-8281	601082	EM-8492
620-1782	EM-5406	620-1860	EM-5744	600000	EM-9000	601083	EM-8187
620-1786	EM-3159	620-1861	EM-5976	600001	EM-3001	601084	EM-8179
620-1787	EM-3161	620-1862	EM-5969	600012	EM-9012	601089	EM-8979
620-1788	EM-3162	620-1863	EM-5967	600013	EM-9013	601090	EM-8151
620-1789	EM-5587	620-2305	EM-9229	600014	EM-9014	601092	EM-8274
620-1790	EM-5380	620-2408	EM-8388	600015	EM-9015	601097	EM-8065
620-1791	EM-9499	620-2409	EM-5107	600016	EM-9016	601098	EM-8234
620-1792	EM-9500	620-2411	EM-5075	600019	EM-9019	601102	EM-9082
620-1793	EM-9511	620-2412	EM-5080	600022	EM-9022	601105	EM-8209
620-1794	EM-9512	620-2413	EM-3050	600024	EM-9024	601112	EM-2803
620-1795	EM-9515	620-2414	EM-5078	600031	EM-9031	601114	EM-8485
620-1796	EM-9516	620-2415	EM-5213	600424	EM-8424	601118	EM-8485
620-1797	EM-9517	620-2416	EM-8964	600841	EM-2841S	601120	EM-8795
620-1798	EM-9519	620-2417	EM-5175	600869	EM-2869	601129	EM-2789S
620-1799	EM-9520	620-2419	EM-5206	600878	EM-2878	601138	EM-8164
620-1800	EM-5407	620-2431	EM-9351	600883	EM-2883	601141	EM-8389
620-1801	EM-9522	620-2448	EM-4171	600885	EM-2885	601143	EM-9055
620-1802	EM-9523	620-2449	EM-8189	600886	EM-2886	601146	EM-2690
620-1803	EM-9527	620-2450	EM-4054	600888	EM-2888	601147	EM-8157
620-1804	EM-9530	620-2451	EM-4061	600889	EM-2889	601151	EM-8456
620-1805	EM-9534	620-2452	EM-4062	600906	EM-8906	601154	EM-8859
620-1806	EM-9536	620-2453	EM-4060	600908	EM-8908	601155	EM-8010
620-1807	EM-9539	620-2454	EM-4013	600909	EM-8909	601157	EM-8239
620-1808	EM-5864	620-2455	EM-3026	600914	EM-8914	601160	EM-8363
620-1809	EM-9541	620-2456	EM-7022	600916	EM-8916	601161	EM-8179
620-1810	EM-9543	620-2480	EM-5000	600917	EM-8917	601163	EM-9041
620-1811	EM-9549	620-2481	EM-5917	600919	EM-8919	601169	EM-8619
620-1812	EM-9550	620-2482	EM-9515	600920	EM-8920	601179	EM-2862
620-1813	EM-9552	622-1111	EM-2556S	600921	EM-8921	601185	EM-2829
620-1814	EM-3172	622-1225	EM-2707S	600922	EM-8921	601205	EM-2850
620-1815	EM-4002	622-1242	EM-2712S	600927	EM-8921	601206	EM-2851

# CROSS REFERENCE

Mfg Part No	Our Part	Mfg Part No	Our Part	Mfg Part No	Our Part	Mfg Part No	Our Part
<b>PIONEER (cont.)</b>		<b>PIONEER (cont.)</b>		<b>PIONEER (cont.)</b>		<b>PIONEER (cont.)</b>	
601207	EM-2852	602278	EM-2278	602406	EM-2406	602535	EM-2436
601208	EM-2853	602279	EM-2279	602407	EM-2407	602536	EM-2536
601209	EM-2856	602280	EM-2280	602413	EM-2413	602540	EM-2538
601211	EM-2859S	602281	EM-2281	602414	EM-2414	602546	EM-2458
601218	EM-2866	602282	EM-2282	602415	EM-2415	602547	EM-2457
602007	EM-2007	602283	EM-2283	602417	EM-2417	602548	EM-2548S
602009	EM-2009	602284	EM-2284	602418	EM-2418	602549	EM-2549
602010	EM-2010	602285	EM-2267	602419	EM-2419	602550	EM-2550
602040	EM-2040	602286	EM-2257	602421	EM-2421	602551	EM-2551S
602041	EM-2041	602287	EM-2287	602424	EM-2424	602552	EM-2551S
602048	EM-2048	602289	EM-2289	602426	EM-2426	602553	EM-2553S
602050	EM-2050	602290	EM-2290	602427	EM-2427	602554	EM-2551S
602053	EM-2053	602291	EM-2291	602429	EM-2429	602555	EM-2555S
602091	EM-2091	602292	EM-2292	602433	EM-2433	602558	EM-2558
602092	EM-2092	602296	EM-2296	602434	EM-2434	602559	EM-2559
602107	EM-2107	602297	EM-2297	602435	EM-2436	602562	EM-2562
602108	EM-2108	602298	EM-2298	602436	EM-2436	602563	EM-2563
602110	EM-2110	602301	EM-2301	602437	EM-2437	602564	EM-2564
602120	EM-2120	602303	EM-2303	602438	EM-2438	602569	EM-2569
602122	EM-2122	602304	EM-2304	602439	EM-2439	602571	EM-2571
602123	EM-2123	602309	EM-2309	602440	EM-2440	602572	EM-2572
602141	EM-2141	602316	EM-2316	602441	EM-2441	602600	EM-2600
602142	EM-2142	602319	EM-2319	602442	EM-2442	602610	EM-2538
602150	EM-2150	602323	EM-2323	602444	EM-2444	602611	EM-2538
602167	EM-2167	602324	EM-2324	602445	EM-2445	602615	EM-2615
602170	EM-2170	602325	EM-2325	602446	EM-2446	602616	EM-2616
602204	EM-2204	602326	EM-2326	602447	EM-2447	602621	EM-2621
602205	EM-2205	602328	EM-2328	602449	EM-2449	602623	EM-2623
602215	EM-2268	602329	EM-2329	602450	EM-2451	602626	EM-2626
602218	EM-2218	602330	EM-2330	602451	EM-2451	602626	EM-2926S
602219	EM-2219	602331	EM-2331	602455	EM-2600	602627	EM-2627
602220	EM-2220	602332	EM-2332	602456	EM-2456	602629	EM-2629
602221	EM-2221	602333	EM-2333	602458	EM-2458	602630	EM-2630
602222	EM-2222	602335	EM-2335	602459	EM-2459	602635	EM-2635
602223	EM-2223	602336	EM-2336	602460	EM-2460	602636	EM-2636
602225	EM-2225	602338	EM-2338	602461	EM-2461	602637	EM-2637
602226	EM-2226	602341	EM-2341	602462	EM-2462	602640	EM-2640
602227	EM-2227	602344	EM-2344	602465	EM-2436	602641	EM-2641
602228	EM-2228	602350	EM-2350	602469	EM-2469	602642	EM-2642
602231	EM-2231	602351	EM-2351	602470	EM-2470	602643	EM-2643
602234	EM-2234	602356	EM-2356	602472	EM-2472	602644	EM-2644
602235	EM-2235	602357	EM-2357	602473	EM-2473	602645	EM-2645
602238	EM-2238	602358	EM-2358	602474	EM-2474	602646	EM-2646
602240	EM-2240	602359	EM-2359	602477	EM-2477	602649	EM-2649
602241	EM-2241	602363	EM-2363	602479	EM-2457	602650	EM-2650
602244	EM-2287	602364	EM-2364	602480	EM-2458	602651	EM-2651
602245	EM-2142	602365	EM-2365	602481	EM-2457	602652	EM-2652
602246	EM-2142	602367	EM-2367	602483	EM-2458	602654	EM-2654
602248	EM-2241	602368	EM-2368	602484	EM-2458	602655	EM-2655
602249	EM-2267	602369	EM-2369	602493	EM-2493	602656	EM-2656
602250	EM-2250	602370	EM-2370	602496	EM-2496	602658	EM-2658
602254	EM-2254	602371	EM-2371	602500	EM-2500	602660	EM-2660S
602255	EM-2255	602375	EM-2375	602501	EM-2501	602661	EM-2661S
602256	EM-2256	602376	EM-2376	602502	EM-2502	602670	EM-2658
602257	EM-2257	602380	EM-2328	602503	EM-2503	602673	EM-2673
602261	EM-2261	602381	EM-2381	602504	EM-2504	602674	EM-2674
602262	EM-2262	602382	EM-2382	602505	EM-2505	602676	EM-2676
602263	EM-2263	602383	EM-2382	602506	EM-2506	602677	EM-2677
602264	EM-2264	602384	EM-2384	602507	EM-2395	602678	EM-2678
602265	EM-2265	602385	EM-2385	602509	EM-2436	602680	EM-2680
602266	EM-2266	602386	EM-2387	602518	EM-2501	602681	EM-2681
602267	EM-2267	602387	EM-2387	602519	EM-2500	602682	EM-2682
602270	EM-2270	602395	EM-2395	602520	EM-2501	602683	EM-2683
602271	EM-2271	602400	EM-2400	602521	EM-2500	602684	EM-2684
602273	EM-2296	602401	EM-2401	602522	EM-2501	602686	EM-2686
602274	EM-2274	602402	EM-2402	602523	EM-2500	602687	EM-2687
602275	EM-2275	602403	EM-2403	602524	EM-2524	602688	EM-2688
602276	EM-2276	602404	EM-2404	602532	EM-2532	602689	EM-2689
602277	EM-2277	602405	EM-2405	602533	EM-2533	602692	EM-2692

# CROSS REFERENCE

Mfg Part No	Our Part	Mfg Part No	Our Part	Mfg Part No	Our Part	Mfg Part No	Our Part
<b>PIONEER (cont.)</b>		<b>PIONEER (cont.)</b>		<b>PIONEER (cont.)</b>		<b>PIONEER (cont.)</b>	
602697	EM-2697	602845	EM-8579	603000	EM-3000	605327	EM-5423
602708	EM-2708	602846	EM-2845	603002	EM-3002	605338	EM-5424
602709	EM-2709	602847	EM-8643	603004	EM-3004	605341	EM-5426
602710	EM-2710	602848	EM-8175	603005	EM-3005	605359	EM-3102
602711	EM-2711	602849	EM-8170	603006	EM-3006	605389	EM-5588
602713	EM-2713	602850	EM-8414	603008	EM-3008	605406	EM-5692
602717	EM-2717S	602855	EM-8568	603009	EM-3009	605415	EM-3130
602718	EM-2718	602856	EM-8568	603010	EM-3010	605417	EM-3145
602722	EM-2722	602857	EM-8197	603011	EM-3011	605440	EM-4017
602723	EM-2723	602858	EM-8414	603156	EM-3156	605445	EM-4094
602724	EM-2724	602859	EM-8602	603183	EM-3183	605446	EM-4033
602725	EM-2725	602860	EM-8681	603186	EM-4012	605487	EM-3165
602726	EM-2726	602862	EM-8006	603198	EM-3198	605551	EM-4113
602727	EM-2727	602863	EM-8100	603200	EM-3200	605961	EM-5959
602728	EM-2728	602866	EM-8119	603206	EM-4038	606128	EM-8040
602731	EM-2731	602868	EM-8603	603207	EM-4039	606129	EM-8677
602732	EM-2731	602878	EM-8242	603231	EM-4073	606130	EM-8255
602733	EM-2733	602883	EM-8073	603305	EM-2741	606131	EM-8595
602735	EM-2735	602884	EM-8021	604001	EM-5528	606133	EM-8598
602736	EM-2736	602889	EM-8016	604017	EM-5859	606138	EM-8596
602737	EM-2737	602893	EM-8349	604200	EM-9121	606139	EM-8676
602738	EM-2738	602894	EM-8021	604201	EM-9179	606140	EM-8680
602740	EM-2740	602904	EM-2904	604208	EM-8164	606307	EM-8154
602743	EM-2743	602905	EM-2905	604213	EM-5448	606310	EM-8304
602744	EM-2744	602909	EM-2909	604219	EM-9484	606313	EM-8122
602745	EM-2745	602911	EM-2911	604220	EM-9155	606331	EM-8130
602747	EM-2747	602912	EM-2912	604228	EM-8401	606400	EM-8063
602748	EM-2748	602913	EM-2913	604278	EM-5819	606401	EM-8609
602749	EM-2749	602914	EM-2914	604302	EM-9416	606408	EM-8648
602754	EM-2754	602915	EM-2915	604305	EM-9229	606409	EM-8083
602755	EM-2755	602916	EM-2916	604319	EM-2835	606410	EM-8077
602756	EM-2756	602917	EM-2917	604324	EM-2832	606444	EM-8062
602763	EM-2763	602918	EM-2918	604402	EM-5375	606452	EM-8085
602764	EM-2764	602919	EM-2919	604418	EM-5783	606453	EM-8086
602765	EM-2765	602920	EM-2920	604502	EM-5400	606500	EM-8012
602767	EM-2767	602929	EM-2929	604504	EM-9168	606507	EM-8431
602768	EM-2768	602930	EM-2930	604505	EM-9150	606514	EM-8019
602774	EM-2774	602931	EM-2931	604518	EM-9202	606521	EM-8005
602775	EM-2775	602935	EM-2935	604519	EM-9441	606523	EM-8008
602776	EM-2776	602936	EM-2936	604555	EM-9411	606567	EM-5382
602777	EM-2777	602939	EM-2939	604565	EM-9488	606581	EM-5371
602785	EM-2785	602940	EM-2940	604570	EM-9443	606603	EM-8292
602786	EM-2786	602941	EM-2941	604605	EM-8685	606604	EM-8107
602787	EM-2351	602944	EM-2944	604605	EM-9147	606610	EM-8559
602791	EM-2791	602945	EM-2945	604607	EM-9154	606611	EM-8108
602792	EM-2731	602947	EM-2947	604608	EM-9153	606614	EM-8467
602793	EM-2793	602948	EM-2948	604621	EM-9161	606615	EM-8466
602794	EM-2794	602949	EM-2949	604624	EM-9305	606699	EM-9160
602801	EM-2801	602953	EM-2953	605091	EM-8622	606700	EM-8091
602802	EM-2802	602955	EM-2955	605102	EM-5353	606717	EM-5597
602805	EM-2805	602958	EM-2958	605109	EM-5354	606718	EM-5598
602806	EM-2806	602959	EM-2959	605117	EM-5108	606771	EM-9351
602807	EM-2807	602961	EM-2961	605118	EM-5109	606772	EM-8055
602808	EM-2808	602962	EM-2962	605142	EM-8104	606773	EM-8055
602809	EM-2809	602963	EM-2963	605183	EM-3030	606775	EM-9351
602813	EM-8103	602964	EM-2964	605199	EM-3035	606776	EM-8060
602816	EM-8045	602972	EM-2972	605204	EM-5104	606777	EM-9337
602823	EM-8100	602978	EM-2978	605207	EM-5105	606784	EM-8512
602825	EM-8200	602979	EM-2979	605238	EM-3059	606785	EM-8094
602826	EM-8208	602980	EM-2980	605280	EM-3024	606786	EM-8079
602827	EM-8600	602981	EM-2981	605282	EM-3012	606823	EM-9242
602829	EM-8224	602983	EM-2983	605284	EM-3015	606828	EM-5358
602832	EM-8026	602985	EM-2985	605285	EM-3025	606900	EM-8236
602834	EM-2834	602989	EM-2989	605286	EM-3024	606912	EM-4071
602834	EM-8097	602990	EM-2990	605289	EM-3074	606923	EM-5796
602838	EM-8601	602994	EM-2994	605312	EM-3103	606940	EM-9599
602839	EM-8445	602997	EM-2997	605316	EM-5350	606949	EM-5909
602842	EM-8430	602998	EM-2998	605324	EM-3110	607012	EM-5069
602843	EM-8344	602999	EM-2999	605326	EM-5377	607019	EM-8593

# CROSS REFERENCE

Mfg Part No	Our Part	Mfg Part No	Our Part	Mfg Part No	Our Part	Mfg Part No	Our Part
<b>PIONEER (cont.)</b>		<b>PIONEER (cont.)</b>		<b>PIONEER (cont.)</b>		<b>PIONEER (cont.)</b>	
607033	EM-8163	608080	EM-8080	608242	EM-8242	608447	EM-8576
607088	EM-5437	608084	EM-8084	608253	EM-8253	608451	EM-8352
607092	EM-8566	608085	EM-8085	608254	EM-8254	608456	EM-8456
607097	EM-5495	608087	EM-8087	608259	EM-8259	608461	EM-8075
607110	EM-8788	608088	EM-8088	608260	EM-8424	608481	EM-8192
607119	EM-8783	608092	EM-8080	608261	EM-8261	608482	EM-8482
607123	EM-9366	608093	EM-8093	608262	EM-8262	608483	EM-8368
607126	EM-9255	608097	EM-8097	608266	EM-8266	608484	EM-8348
607127	EM-9352	608098	EM-8098	608267	EM-8267	608485	EM-8485
607130	EM-9253	608100	EM-8100	608270	EM-8270	608488	EM-8488
607162	EM-8144	608101	EM-8101	608271	EM-8271	608489	EM-8489
607177	EM-9323	608102	EM-8102	608276	EM-8276	608491	EM-8491
607188	EM-8103	608103	EM-8103	608277	EM-8277	608493	EM-8493
607250	EM-5208	608104	EM-8104	608279	EM-8279	608494	EM-8400
607261	EM-8967	608105	EM-8105	608281	EM-8281	608496	EM-8008
607272	EM-8385	608107	EM-8107	608282	EM-8282	608499	EM-8499
607289	EM-5464	608112	EM-8100	608283	EM-8283	608501	EM-2731
607299	EM-9477	608114	EM-8114	608286	EM-8181	608502	EM-8502
607306	EM-5132	608116	EM-8132	608287	EM-8287	608505	EM-2731
607312	EM-8858	608118	EM-8118	608294	EM-8294	608513	EM-8513
607314	EM-9200	608119	EM-8119	608296	EM-8296	608514	EM-8514
607321	EM-9251	608120	EM-8120	608298	EM-8304	608517	EM-8517
607327	EM-5332	608122	EM-8122	608305	EM-2406	608523	EM-8524
607328	EM-9288	608125	EM-8125	608307	EM-8307	608526	EM-8576
607333	EM-9442	608133	EM-8133	608310	EM-8310	608527	EM-8314
607335	EM-5173	608135	EM-8135	608311	EM-8311	608537	EM-8402
607338	EM-5411	608138	EM-8138	608319	EM-8319	608539	EM-8539
608002	EM-8002	608139	EM-2740	608324	EM-8324	608553	EM-8553
608004	EM-8804	608140	EM-8140	608331	EM-8130	608554	EM-8554
608007	EM-8007	608143	EM-8310	608332	EM-8130	608555	EM-8103
608008	EM-8008	608145	EM-8145	608339	EM-8339	608556	EM-8556
608009	EM-8009	608146	EM-8146	608340	EM-8180	608560	EM-8560
608011	EM-8011	608147	EM-8303	608343	EM-8164	608561	EM-8068
608013	EM-8014	608161	EM-8161	608344	EM-8344	608568	EM-8568
608014	EM-8014	608164	EM-8164	608348	EM-8348	608569	EM-8568
608017	EM-8021	608166	EM-8166	608349	EM-8349	608571	EM-8571
608018	EM-8018	608167	EM-8167	608350	EM-8348	608574	EM-8574
608020	EM-8020	608168	EM-8168	608351	EM-8351	608576	EM-8576
608022	EM-8181	608169	EM-8169	608352	EM-8352	608577	EM-8577
608024	EM-8024	608173	EM-8173	608353	EM-8353	608578	EM-8578
608025	EM-8025	608174	EM-8174	608355	EM-8195	608579	EM-8579
608026	EM-8026	608177	EM-8177	608358	EM-8213	608585	EM-8205
608027	EM-8575	608178	EM-8178	608359	EM-8359	608590	EM-8663
608028	EM-8435	608179	EM-8179	608360	EM-8014	608597	EM-8597
608032	EM-8021	608180	EM-8180	608362	EM-8485	608599	EM-8599
608033	EM-8010	608182	EM-8211	608365	EM-8365	608602	EM-8602
608034	EM-8034	608183	EM-8183	608368	EM-8368	608605	EM-8605
608038	EM-8103	608185	EM-8185	608375	EM-8375	608606	EM-8606
608039	EM-8039	608194	EM-8194	608378	EM-8214	608607	EM-8607
608041	EM-8041	608195	EM-8195	608380	EM-8179	608609	EM-8609
608042	EM-8042	608196	EM-8196	608384	EM-8384	608611	EM-8611
608043	EM-8042	608205	EM-8205	608385	EM-8385	608612	EM-8612
608044	EM-8044	608206	EM-8424	608396	EM-8197	608616	EM-8616
608046	EM-8100	608207	EM-8207	608398	EM-8398	608617	EM-8617
608048	EM-8048	608209	EM-8209	608399	EM-8398	608620	EM-8620
608049	EM-8049	608210	EM-8210	608400	EM-8400	608621	EM-8621
608051	EM-8576	608211	EM-8211	608401	EM-8401	608630	EM-8630
608052	EM-8579	608212	EM-8212	608402	EM-8402	608638	EM-8663
608053	EM-8053	608213	EM-8213	608404	EM-8404	608639	EM-8639
608054	EM-8054	608222	EM-8222	608406	EM-8406	608640	EM-8640
608056	EM-8056	608225	EM-8225	608407	EM-8407	608641	EM-8641
608057	EM-8068	608226	EM-8102	608411	EM-8411	608647	EM-8164
608059	EM-8059	608229	EM-8229	608413	EM-8413	608652	EM-8652
608062	EM-8062	608231	EM-8231	608434	EM-8434	608654	EM-8654
608073	EM-8073	608233	EM-8233	608435	EM-8435	608659	EM-8659
608074	EM-8074	608235	EM-8235	608437	EM-8435	608660	EM-8660
608075	EM-8075	608237	EM-8224	608442	EM-8442	608661	EM-8661
608076	EM-8080	608238	EM-8238	608444	EM-8579	608664	EM-8664
608078	EM-8078	608239	EM-8239	608445	EM-8445	608665	EM-8665

# CROSS REFERENCE

Mfg Part No	Our Part	Mfg Part No	Our Part	Mfg Part No	Our Part	Mfg Part No	Our Part
PIONEER (cont.)		PIONEER (cont.)		PIONEER (cont.)		PIONEER (cont.)	
608667	EM-8667	608786	EM-8786	608878	EM-8878	609018	EM-2854
608668	EM-8668	608787	EM-8787	608882	EM-8882	609019	EM-2855
608670	EM-8670	608788	EM-8788	608884	EM-8884	609023	EM-9023
608681	EM-8681	608790	EM-8790	608885	EM-8885	609027	EM-9027
608682	EM-8682	608792	EM-8792	608886	EM-8886	609029	EM-9029
608685	EM-8685	608794	EM-8794	608889	EM-8889	609030	EM-9030
608687	EM-8687	608795	EM-8795	608892	EM-8892	609031	EM-2819
608688	EM-8688	608796	EM-8796	608893	EM-8893	609033	EM-9033
608689	EM-8689	608797	EM-8797	608894	EM-8894	609034	EM-9034
608690	EM-8690	608798	EM-8798	608895	EM-8895	609036	EM-2985
608691	EM-8691	608801	EM-8801	608897	EM-8897	609037	EM-9037
608692	EM-8692	608802	EM-8802	608899	EM-8899	609039	EM-9039
608699	EM-8699	608803	EM-8803	608900	EM-8900	609040	EM-9040
608701	EM-8701	608804	EM-8804	608902	EM-8902	609041	EM-9041
608703	EM-2855	608805	EM-8805	608903	EM-8903	609042	EM-9042
608704	EM-8704	608806	EM-8806	608904	EM-8904	609045	EM-9045
608706	EM-2856	608807	EM-8807	608905	EM-8905	609047	EM-9047
608707	EM-2857	608808	EM-8808	608906	EM-8193	609048	EM-9048
608709	EM-8709	608809	EM-8296	608907	EM-8198	609050	EM-9050
608710	EM-8710	608810	EM-8296	608909	EM-8192	609051	EM-9051
608711	EM-8711	608811	EM-8811	608911	EM-8197	609056	EM-9056
608712	EM-8041	608813	EM-8813	608913	EM-2409	609057	EM-9057
608713	EM-8041	608814	EM-8814	608919	EM-8188	609059	EM-9059
608714	EM-8042	608818	EM-8818	608932	EM-8932	609062	EM-9062
608715	EM-8715	608819	EM-8819	608935	EM-8935	609066	EM-9066
608716	EM-8716	608820	EM-8820	608936	EM-8936	609067	EM-9067
608717	EM-8717	608821	EM-8821	608937	EM-8937	609068	EM-9068
608718	EM-8718	608823	EM-8823	608940	EM-8940	609069	EM-8261
608719	EM-8719	608824	EM-8824	608942	EM-8943	609071	EM-9071
608720	EM-8719	608826	EM-8826	608943	EM-8943	609072	EM-9072
608721	EM-8721	608827	EM-8663	608944	EM-8944	609075	EM-8895
608722	EM-8722	608828	EM-8828	608945	EM-8945	609076	EM-9076
608723	EM-8723	608829	EM-8829	608946	EM-8945	609077	EM-9077
608736	EM-8736	608830	EM-8830	608948	EM-8948	609078	EM-9078
608737	EM-8044	608832	EM-8832	608949	EM-8949	609079	EM-9079
608742	EM-8742	608833	EM-8832	608950	EM-8950	609080	EM-9080
608746	EM-8746	608834	EM-8834	608952	EM-8952	609081	EM-9081
608747	EM-8747	608835	EM-8835	608953	EM-8953	609084	EM-9084
608748	EM-8748	608836	EM-8836	608955	EM-8955	609085	EM-9085
608749	EM-8788	608837	EM-8834	608958	EM-8958	609099	EM-9099
608750	EM-8750	608838	EM-8838	608960	EM-8960	609109	EM-9109
608751	EM-8751	608839	EM-8832	608961	EM-8961	609111	EM-9111
608752	EM-8752	608840	EM-8832	608962	EM-8962	609117	EM-9117
608753	EM-8753	608841	EM-8616	608966	EM-8966	609118	EM-9118
608759	EM-8759	608842	EM-8616	608968	EM-8968	609119	EM-9119
608760	EM-8760	608843	EM-8843	608970	EM-8970	609120	EM-9120
608762	EM-8762	608844	EM-8616	608973	EM-8973	609122	EM-9122
608763	EM-8762	608845	EM-8845	608974	EM-8974	609126	EM-2910
608764	EM-8764	608846	EM-8846	608975	EM-8975	609127	EM-9127
608765	EM-8788	608847	EM-8847	608976	EM-8976	609130	EM-9130
608766	EM-8597	608848	EM-8848	608979	EM-8025	609131	EM-9131
608768	EM-8768	608849	EM-8849	608981	EM-8981	609132	EM-2649
608769	EM-8769	608850	EM-8850	608982	EM-8982	609133	EM-9133
608770	EM-8770	608851	EM-8851	608988	EM-8988	609134	EM-9134
608771	EM-8771	608853	EM-8853	608992	EM-8992	609135	EM-8681
608772	EM-8772	608854	EM-8854	608994	EM-8994	609136	EM-9136
608773	EM-8774	608855	EM-8855	609000	EM-2825	609137	EM-9137
608774	EM-8774	608860	EM-8860	609001	EM-2827	609139	EM-9139
608775	EM-8775	608864	EM-8864	609003	EM-2830	609140	EM-9140
608776	EM-8775	608865	EM-8865	609004	EM-2831	609141	EM-9141
608777	EM-8778	608866	EM-8866	609005	EM-2833	609144	EM-9144
608778	EM-8778	608868	EM-8868	609007	EM-2844	609185	EM-2876
608779	EM-8778	608869	EM-8869	609008	EM-2846	609389	EM-9389
608780	EM-8780	608870	EM-8870	609008	EM-2849	609412	EM-9412
608781	EM-8781	608871	EM-8871	609009	EM-2847	609544	EM-9544
608782	EM-8782	608874	EM-8874	609012	EM-5052	609556	EM-5599
608783	EM-8783	608875	EM-8875	609014	EM-2860	609564	EM-8974
608784	EM-8784	608876	EM-8876	609015	EM-2861	609568	EM-7019
608785	EM-8783	608877	EM-8877	609017	EM-2867	609572	EM-9572



# CROSS REFERENCE

Mfg Part No	Our Part	Mfg Part No	Our Part	Mfg Part No	Our Part	Mfg Part No	Our Part
<b>PIONEER (cont.)</b>		<b>PIONEER (cont.)</b>		<b>PIONEER (cont.)</b>		<b>PIONEER (cont.)</b>	
609573	EM-9573	612993	EM-2993	620901	EM-8901	622348	EM-2348
609574	EM-9574	612995	EM-2995	620910	EM-8910	622349	EM-2349
609592	EM-5772	612996	EM-2996	620915	EM-8915	622353	EM-2353
609624	EM-5906	613003	EM-3003	621007	EM-8632	622360	EM-2360
609628	EM-5924	614202	EM-9173	621008	EM-8963	622361	EM-2349
609639	EM-5856	614203	EM-9211	621018	EM-8619	622362	EM-2362
609642	EM-5912	614212	EM-9212	621019	EM-8244	622366	EM-2525
609648	EM-5754	614325	EM-5748	621022	EM-8300	622372	EM-2372
609650	EM-5601	614507	EM-9149	621024	EM-8063	622373	EM-2373
609654	EM-5877	614527	EM-9451	621027	EM-8002	622374	EM-2374
609655	EM-5884	614583	EM-5795	621029	EM-8460	622378	EM-2378
609661	EM-5903	615024	EM-5148	621035	EM-2818	622379	EM-2379
609664	EM-5972	615137	EM-3021	621040	EM-2826	622388	EM-2388
609668	EM-5940	615235	EM-3083	621041	EM-2828	622389	EM-2389
609669	EM-5973	615272	EM-3071	621042	EM-2837S	622390	EM-2389
609672	EM-5974	615273	EM-3072	621044	EM-2845	622391	EM-2391
609675	EM-5970	615275	EM-5031S	621045	EM-2848	622392	EM-2392
609676	EM-5744	615278	EM-5028	621046	EM-2849	622393	EM-2393
609679	EM-5916	615413	EM-3151	621048	EM-2863	622394	EM-2394
611014	EM-2892	615414	EM-3150	621049	EM-2864	622408	EM-2408
611038	EM-2836	615443	EM-3167	621050	EM-2870	622409	EM-2409
611047	EM-7064	615456	EM-3148	622014	EM-2014	622410	EM-2410
611107	EM-8605	616254	EM-8207	622039	EM-2039	622420	EM-2420
611108	EM-2795	616592	EM-9185	622057	EM-2057	622425	EM-2425
611110	EM-2859	616999	EM-5840	622060	EM-2060	622428	EM-2428
611114	EM-8485	617064	EM-5394	622070	EM-2070	622448	EM-2448
611180	EM-2841	617128	EM-8944	622073	EM-2073	622452	EM-2452
611191	EM-2838	617349	EM-5672	622119	EM-2119	622453	EM-2453
612548	EM-2548	617923	EM-4074	622121	EM-2121	622454	EM-2454
612551	EM-2551	618037	EM-8037	622124	EM-2124	622463	EM-2463
612552	EM-2551	618224	EM-8224	622125	EM-2125	622464	EM-2464
612553	EM-2553	618662	EM-8662	622126	EM-2126	622466	EM-2466
612554	EM-2551	618663	EM-8663	622127	EM-2127	622467	EM-2467
612555	EM-2555	618918	EM-8918	622143	EM-2268	622471	EM-2471
612660	EM-2660	618928	EM-8928	622162	EM-2162	622487	EM-2487
612661	EM-2661	618929	EM-8929	622163	EM-2163	622488	EM-2488
612694	EM-2812	618954	EM-8954	622171	EM-2171	622489	EM-2489
612697	EM-2697	618965	EM-8965	622172	EM-2172	622494	EM-2494
612698	EM-2698	618984	EM-8984	622206	EM-2206	622495	EM-2495
612711	EM-2711	618997	EM-8997	622216	EM-2216	622497	EM-2497
612717	EM-2717	618998	EM-8998	622217	EM-2217	622498	EM-2498
612788	EM-2788	619001	EM-9001	622236	EM-2349	622499	EM-2499
612789	EM-2789	619003	EM-9003	622242	EM-2242	622508	EM-2508
612790	EM-2790	619004	EM-9004	622253	EM-2253	622510	EM-2510
612791	EM-2791	619005	EM-9005	622258	EM-2253	622511	EM-2466
612792	EM-2792	619006	EM-8795	622268	EM-2268	622512	EM-2512
612795	EM-2795	619007	EM-9007	622272	EM-2272	622513	EM-2513
612796	EM-2796	619008	EM-9008	622288	EM-2288	622514	EM-2515
612803	EM-2803	619009	EM-9009	622293	EM-2293	622515	EM-2515
612804	EM-2804	619017	EM-9017	622294	EM-2294	622525	EM-2525
612812	EM-2812	619021	EM-9021	622295	EM-2295	622529	EM-2497
612813	EM-2813	619043	EM-9043	622299	EM-2299	622530	EM-2388
612890	EM-2890	619044	EM-9044	622302	EM-2302	622531	EM-2531
612894	EM-2894	619065	EM-9065	622305	EM-2305	622534	EM-2534
612896	EM-2896	619083	EM-9083	622306	EM-2306	622537	EM-2537
612902	EM-2902	619092	EM-9092	622307	EM-2307	622543	EM-2543
612903	EM-2903	619097	EM-9003	622310	EM-2310	622544	EM-2531
612906	EM-2987	619110	EM-9110	622311	EM-2311	622556	EM-2556S
612910	EM-2910	619128	EM-9128	622314	EM-2349	622557	EM-2557
612926	EM-2926	619129	EM-9129	622317	EM-2317	622565	EM-2565
612933	EM-2933	619145	EM-9145	622320	EM-2320	622566	EM-2566
612934	EM-2934	619146	EM-9146	622321	EM-2321	622567	EM-2567
612938	EM-2938	619238	EM-9238	622327	EM-2327	622568	EM-2568
612942	EM-2942	619265	EM-5867	622337	EM-2337	622570	EM-2570
612943	EM-2943	619662	EM-5904	622339	EM-2339	622601	EM-2601
612967	EM-2967	619670	EM-5966	622340	EM-2340	622602	EM-2601
612968	EM-2968	619680	EM-5742	622345	EM-2345	622603	EM-2601
612973	EM-2973	620081	EM-4171	622346	EM-2346	622607	EM-2601
612987	EM-2987	620263	EM-8263	622347	EM-2347	622608	EM-2601

# CROSS REFERENCE

Mfg Part No	Our Part	Mfg Part No	Our Part	Mfg Part No	Our Part	Mfg Part No	Our Part
<b>PIONEER (cont.)</b>		<b>PIONEER (cont.)</b>		<b>PIONEER (cont.)</b>		<b>PIONEER (cont.)</b>	
622614	EM-2601	622817	EM-2394	624546	EM-9216	627793	EM-8857
622617	EM-2617	622817	EM-2817	624600	EM-9174	627911	EM-4117
622618	EM-2618	622818	EM-2818	625020	EM-5087	627919	EM-4013
622619	EM-2619	622819	EM-2819	625021	EM-5392	627920	EM-3026
622620	EM-2620	622820	EM-2820	625095	EM-5111	627937	EM-7022
622622	EM-2622	622822	EM-2822	625123	EM-8068	628001	EM-8001
622624	EM-2624	622823	EM-2823S	625152	EM-8462	628004	EM-8004
622625	EM-2625	622828	EM-8644	625203	EM-5103	628020	EM-8014
622628	EM-2628	622831	EM-8111	625209	EM-5107	628022	EM-8022
622631	EM-2631	622835	EM-8124	625219	EM-5106	628031	EM-8031
622632	EM-2632	622840	EM-8659	625233	EM-3017	628036	EM-8012
622633	EM-2633	622845	EM-2730	625236	EM-5075	628050	EM-8586
622634	EM-2634	622847	EM-8388	625251	EM-5080	628061	EM-8061
622638	EM-2638	622857	EM-2857	625253	EM-3063	628063	EM-8063
622639	EM-2639	622858	EM-2858	625260	EM-3050	628068	EM-8068
622648	EM-2815	622868	EM-2868	625261	EM-5078	628079	EM-8079
622653	EM-2653	622882	EM-2882	625271	EM-3038	628082	EM-8082
622657	EM-2657	622884	EM-2884	625276	EM-5032	628089	EM-8089
622659	EM-2659	622898	EM-2898	625279	EM-5381	628095	EM-8095
622663	EM-2663	622907	EM-2907	625280	EM-3016	628096	EM-8096
622664	EM-2664	622908	EM-2908	625281	EM-3013	628099	EM-8099
622665	EM-2665	622921	EM-2921	625283	EM-5180	628106	EM-8106
622666	EM-2639	622922	EM-2922	625287	EM-3018	628111	EM-8111
622667	EM-2667	622923	EM-2923	625288	EM-3051	628115	EM-8115
622668	EM-2668	622924	EM-2924	625298	EM-3061	628117	EM-8117
622669	EM-2657	622925	EM-2925	625301	EM-3050	628121	EM-8121
622671	EM-2671	622927	EM-2927	625305	EM-5085	628128	EM-8128
622672	EM-2394	622928	EM-2928	625346	EM-5428	628148	EM-8148
622675	EM-2675	622946	EM-2960	625380	EM-3106	628149	EM-8149
622679	EM-2679	622950	EM-2950	625435	EM-4061	628151	EM-8151
622685	EM-2685	622951	EM-2951	625436	EM-4062	628152	EM-8152
622690	EM-2690	622954	EM-2954	625448	EM-4002	628160	EM-8160
622691	EM-2691	622956	EM-2956	625461	EM-3162	628165	EM-8165
622693	EM-2693	622957	EM-2957	625478	EM-4060	628175	EM-8175
622695	EM-2813	622960	EM-2960	626120	EM-8672	628189	EM-8189
622696	EM-2696S	622965	EM-2965	626121	EM-8934	628190	EM-8190
622707	EM-2707S	622966	EM-2966	626134	EM-8041	628191	EM-8191
622712	EM-2712	622969	EM-2969	626208	EM-8176	628208	EM-8208
622715	EM-2715	622970	EM-2970	626209	EM-8218	628218	EM-8218
622719	EM-2719	622971	EM-2971	626320	EM-8604	628220	EM-8220
622720	EM-2720	622975	EM-2975	626322	EM-8141	628221	EM-8221
622721	EM-2721	622977	EM-2977	626324	EM-8149	628222	EM-8222
622730	EM-2730	622982	EM-2982	626325	EM-8150	628223	EM-8223
622734	EM-2734	622984	EM-2984	626330	EM-8141	628232	EM-8232
622739	EM-2739	622986	EM-2986	626450	EM-8516	628236	EM-8236
622742	EM-2742	622988	EM-2988	626508	EM-8374	628241	EM-8073
622746	EM-2746	622991	EM-2991	626543	EM-5379	628243	EM-8243
622750	EM-2750	622992	EM-2992	626681	EM-8111	628244	EM-8244
622751	EM-2751	623000	EM-5000	626702	EM-8641	628245	EM-8424
622752	EM-2752	623007	EM-3007	626704	EM-8640	628248	EM-8248
622753	EM-2753	623041	EM-3041	626708	EM-5188	628256	EM-8586
622759	EM-2759	623082	EM-3082	626710	EM-5189	628257	EM-8586
622760	EM-2760	623175	EM-3175	626713	EM-5190	628258	EM-8586
622762	EM-2762	623191	EM-4036	626750	EM-8912	628280	EM-8280
622766	EM-2766	623196	EM-3196	626799	EM-8652	628293	EM-8293
622769	EM-2769	623203	EM-4034	626838	EM-9177	628295	EM-8295
622770	EM-2770	623226	EM-4054	626933	EM-5213	628299	EM-8001
622771	EM-2771	623227	EM-4077	626985	EM-9558	628300	EM-8300
622772	EM-2772	624108	EM-2871	626987	EM-5879	628303	EM-8303
622773	EM-2773	624113	EM-2843	626989	EM-7031	628306	EM-8034
622778	EM-2778	624120	EM-2873	627061	EM-8544	628312	EM-8312
622783	EM-2783	624130	EM-8898	627117	EM-9373	628313	EM-8312
622784	EM-2784	624275	EM-9500	627122	EM-9367	628314	EM-8314
622797	EM-2797	624509	EM-9152	627165	EM-8214	628317	EM-8317
622800	EM-2800	624510	EM-9151	627334	EM-8964	628320	EM-8149
622810	EM-2810	624525	EM-9214	627337	EM-5175	628322	EM-8322
622811	EM-2817	624531	EM-9301	627351	EM-9410	628323	EM-8323
622815	EM-2815	624532	EM-9289	627357	EM-5407	628328	EM-8328
622816	EM-2816	624538	EM-9286	627509	EM-8512	628329	EM-8329

# CROSS REFERENCE

Mfg Part No	Our Part	Mfg Part No	Our Part	Mfg Part No	Our Part	Mfg Part No	Our Part
<b>PIONEER (cont.)</b>		<b>PIONEER (cont.)</b>		<b>PIONEER (cont.)</b>		<b>PIONEER (cont.)</b>	
628330	EM-8330	628674	EM-8674	628913	EM-8913	629098	EM-9098
628341	EM-9055	628675	EM-8675	628915	EM-2874	629100	EM-9100
628345	EM-8002	628678	EM-8678	628923	EM-8923	629102	EM-9102
628347	EM-8002	628679	EM-8679	628924	EM-8923	629103	EM-9103
628377	EM-8377	628683	EM-8683	628925	EM-8925	629104	EM-9104
628387	EM-8389	628684	EM-8684	628926	EM-8926	629105	EM-9105
628389	EM-8389	628686	EM-8686	628930	EM-8930	629106	EM-9106
628392	EM-8392	628693	EM-8693	628931	EM-8931	629107	EM-9107
628393	EM-8393	628694	EM-8694	628934	EM-8934	629108	EM-9108
628395	EM-8395	628695	EM-8695	628938	EM-8938	629112	EM-2410
628415	EM-8415	628696	EM-8696	628939	EM-8939	629113	EM-9113
628418	EM-8418	628700	EM-8700	628941	EM-8941	629114	EM-9114
628419	EM-8191	628705	EM-8705	628947	EM-8947	629115	EM-9115
628420	EM-8643	628724	EM-8724	628951	EM-8951	629121	EM-9121
628421	EM-8415	628725	EM-8725	628956	EM-8956	629123	EM-9123
628422	EM-8422	628726	EM-8726	628957	EM-8957	629124	EM-9124
628427	EM-8427	628727	EM-8727	628959	EM-8959	629125	EM-9125
628439	EM-8439	628728	EM-8728	628964	EM-8964	629138	EM-9138
628440	EM-8439	628729	EM-8729	628971	EM-8971	629142	EM-9142
628441	EM-8586	628730	EM-8730	628977	EM-8977	629143	EM-9143
628448	EM-8586	628731	EM-8731	628978	EM-8978	629147	EM-9147
628452	EM-8586	628732	EM-8732	628979	EM-8979	629428	EM-9428
628457	EM-8457	628733	EM-8733	628980	EM-8980	629560	EM-9560
628460	EM-8460	628734	EM-8734	628983	EM-8983	629568	EM-7007
628490	EM-8490	628738	EM-8738	628985	EM-8985	629570	EM-9570
628495	EM-8495	628739	EM-8738	628986	EM-8986	629611	EM-5957
628503	EM-8503	628740	EM-8740	628987	EM-8987	629617	EM-9617
628506	EM-8506	628741	EM-8741	628989	EM-8989	629619	EM-9619
628507	EM-8507	628743	EM-8743	628990	EM-8990	629621	EM-5905
628508	EM-8508	628744	EM-8744	628991	EM-8991	629635	EM-5908
628510	EM-8510	628745	EM-8745	628993	EM-8993	629638	EM-5910
628511	EM-8511	628754	EM-8754	628996	EM-8996	629641	EM-5911
628512	EM-8512	628755	EM-8755	629000	EM-2881	629649	EM-5963
628516	EM-8516	628756	EM-8756	629002	EM-9002	629667	EM-5956
628519	EM-8282	628757	EM-8757	629010	EM-9010	629673	EM-5975
628522	EM-8522	628758	EM-8758	629011	EM-9011	629677	EM-5976
628529	EM-8529	628789	EM-8789	629015	EM-2887	629678	EM-5969
628542	EM-8542	628791	EM-8791	629018	EM-9018	629681	EM-5967
628544	EM-8544	628793	EM-8793	629025	EM-9025	632396	EM-2396
628545	EM-8545	628799	EM-8799	629026	EM-9026	632490	EM-2490
628552	EM-8552	628800	EM-8800	629028	EM-9028	632491	EM-2491
628562	EM-8095	628812	EM-8812	629032	EM-9032	632492	EM-2492
628572	EM-8572	628816	EM-8816	629035	EM-9035	632526	EM-2528
628582	EM-8582	628817	EM-8817	629038	EM-9038	632527	EM-2528
628584	EM-8584	628822	EM-8822	629046	EM-9046	632528	EM-2528
628586	EM-8586	628825	EM-8825	629049	EM-9049	632561	EM-2528
628589	EM-8589	628831	EM-8831	629052	EM-9018	632573	EM-2528
628592	EM-8592	628852	EM-8852	629053	EM-9053	632609	EM-2609
628593	EM-8593	628856	EM-8856	629054	EM-9054	632662	EM-2662
628594	EM-8594	628857	EM-8857	629055	EM-9055	632716	EM-2716
628604	EM-8290	628862	EM-8862	629058	EM-9058	632761	EM-2761
628608	EM-8608	628863	EM-8863	629060	EM-9060	632780	EM-2780
628618	EM-8236	628872	EM-8872	629061	EM-9061	632781	EM-2781
628623	EM-8623	628873	EM-8873	629063	EM-9063	632782	EM-2782
628624	EM-8594	628879	EM-8879	629064	EM-9064	632798	EM-2798
628629	EM-8629	628880	EM-8880	629070	EM-9070	632799	EM-2799
628631	EM-8631	628881	EM-8881	629073	EM-9073	632814	EM-2814
628633	EM-8230	628883	EM-8883	629074	EM-9074	632815	EM-8200
628634	DS-8634	628887	EM-8887	629082	EM-9082	632817	DS-8538
628642	EM-8642	628888	EM-8888	629086	EM-9086	632826	EM-8045
628644	EM-8644	628890	EM-8890	629087	EM-9087	632872	EM-2872
628648	EM-8648	628891	EM-8891	629088	EM-9088	632899	EM-2899
628649	EM-8649	628896	EM-8896	629089	EM-9089	632900	EM-2900
628650	EM-8650	628898	EM-8898	629090	EM-9090	632901	EM-2901
628651	EM-8651	628907	EM-8907	629091	EM-9091	633182	EM-4028
628653	EM-8653	628910	EM-2875	629093	EM-9093	633214	EM-4057
628655	EM-8655	628910	EM-8910	629094	EM-9094	633216	EM-4146
628669	EM-8669	628911	EM-8911	629095	EM-9095	633218	EM-4055
628673	EM-8672	628912	EM-8912	629096	EM-9096	633219	EM-4056

# CROSS REFERENCE

Mfg Part No	Our Part	Mfg Part No	Our Part	Mfg Part No	Our Part	Mfg Part No	Our Part
<b>PIONEER (cont.)</b>		<b>PIONEER (cont.)</b>		<b>SEALED POWER (cont.)</b>		<b>SEALED POWER (cont.)</b>	
633220	EM-4095	648469	DS-8469	270-2070	EM-2070	270-2291	EM-2291
634206	EM-5206	648470	DS-8470	270-2107	EM-2107	270-2292	EM-2292
634210	EM-9235	648471	DS-8471	270-2119	EM-2119	270-2294	EM-2294
634240	EM-9234	648472	DS-8472	270-2121	EM-2121	270-2295	EM-2295
634258	EM-5874	648473	DS-8473	270-2122	EM-2122	270-2296	EM-2296
634318	EM-9228	648474	DS-8474	270-2123	EM-2123	270-2297	EM-2297
634350	EM-9444	648475	DS-8475	270-2124	EM-2124	270-2298	EM-2298
634536	EM-9303	648509	DS-8509	270-2125	EM-2125	270-2299	EM-2299
635306	EM-3095	648530	DS-8531	270-2141	EM-2141	270-2300	EM-2512
635322	EM-3087	648531	DS-8531	270-2142	EM-2142	270-2301	EM-2301
635372	EM-3090	648532	DS-8532	270-2162	EM-2162	270-2303	EM-2303
635396	EM-3111	648533	DS-8533	270-2163	EM-2163	270-2304	EM-2304
635438	EM-3139	648535	DS-8535	270-2170	EM-2170	270-2305	EM-2305
636124	EM-5398	648549	DS-8549	270-2172	EM-2172	270-2306	EM-2306
636304	EM-8133	648550	DS-8550	270-2204	EM-2204	270-2309	EM-2309
636318	EM-8133	648551	DS-8551	270-2205	EM-2205	270-2310	EM-2310
636519	EM-8024	648563	EM-8563	270-2206	EM-2206	270-2311	EM-2311
636703	EM-5187	648565	DS-8565	270-2219	EM-2219	270-2316	EM-2316
636740	EM-8615	648587	DS-8587	270-2220	EM-2220	270-2317	EM-2317
636741	EM-8614	648588	DS-8588	270-2221	EM-2221	270-2320	EM-2320
638045	EM-8045	648591	DS-8591	270-2222	EM-2222	270-2323	EM-2323
638047	EM-8047	648627	DS-8627	270-2223	EM-2223	270-2324	EM-2324
638137	EM-8137	648635	DS-8635	270-2225	EM-2225	270-2325	EM-2325
638142	EM-8142	648636	DS-8636	270-2226	EM-2226	270-2326	EM-2326
638153	EM-8133	658029	EM-8029	270-2227	EM-2227	270-2327	EM-2327
638201	EM-8201	658272	EM-8272	270-2228	EM-2228	270-2327	EM-2349
638284	EM-8284	658438	EM-8438	270-2231	EM-2231	270-2328	EM-2328
638428	EM-8120	658521	EM-8521	270-2234	EM-2234	270-2330	EM-2330
638479	EM-8142	658524	EM-8524	270-2235	EM-2235	270-2331	EM-2331
638697	EM-8697	658525	EM-8525	270-2238	EM-2238	270-2332	EM-2332
638698	EM-8698	658548	EM-8548	270-2240	EM-2240	270-2333	EM-2333
638867	EM-8867	658614	EM-8614	270-2241	EM-2241	270-2335	EM-2335
638995	EM-8995	658656	EM-8656	270-2242	EM-2242	270-2336	EM-2336
639020	EM-9020	658657	EM-8657	270-2244	EM-2287	270-2337	EM-2337
639532	EM-5132	658658	EM-8658	270-2245	EM-2142	270-2338	EM-2338
639545	EM-9545	662714	EM-2714	270-2249	EM-2267	270-2339	EM-2339
639559	EM-9559	666901	EM-8236	270-2250	EM-2250	270-2340	EM-2340
639588	EM-9588	671004	EM-2893	270-2254	EM-2254	270-2341	EM-2341
639593	EM-9593	671006	EM-2879	270-2255	EM-2255	270-2344	EM-2344
639595	EM-9595	671038	EM-2842	270-2256	EM-2256	270-2345	EM-2345
639601	EM-9601	671042	EM-2837	270-2257	EM-2257	270-2346	EM-2346
639610	EM-9610	672556	EM-2556	270-2261	EM-2261	270-2348	EM-2348
639612	EM-9612	672696	EM-2696	270-2261	EM-2296	270-2349	EM-2349
639613	EM-9613	672707	EM-2707	270-2262	EM-2262	270-2349	EM-2369
639615	EM-5944	672712	EM-2712	270-2263	EM-2263	270-2350	EM-2350
639632	EM-5783	672779	EM-2779	270-2264	EM-2264	270-2351	EM-2351
639651	EM-5913	672821	EM-2821	270-2265	EM-2265	270-2353	EM-2353
639671	EM-5968	672823	EM-2823	270-2266	EM-2266	270-2357	EM-2357
639674	EM-5985	672824	EM-2824	270-2267	EM-2267	270-2358	EM-2358
639798	EM-7055	672880	EM-2880	270-2268	EM-2268	270-2359	EM-2359
644223	EM-9053	672895	EM-2895	270-2268	EM-2534	270-2360	EM-2360
646027	DS-6027	672897	EM-2897	270-2270	EM-2270	270-2362	EM-2362
646028	DS-6028	672932	EM-2932	270-2271	EM-2271	270-2363	EM-2363
646035	DS-6035	672974	EM-2974	270-2272	EM-2272	270-2364	EM-2364
646038	DS-6038	674202	EM-2840	270-2275	EM-2275	270-2365	EM-2365
646040	DS-6040	674207	EM-9165	270-2277	EM-2277	270-2367	EM-2367
646048	DS-6048	674211	EM-5141	270-2278	EM-2278	270-2368	EM-2368
646049	DS-6049	675225	EM-2895	270-2279	EM-2279	270-2369	EM-2369
646051	DS-6051	678999	EM-8999	270-2280	EM-2280	270-2370	EM-2370
646052	DS-6052	679101	EM-9101	270-2281	EM-2281	270-2372	EM-2347
646053	DS-6053	909653	EM-5600	270-2282	EM-2282	270-2372	EM-2372
646056	DS-6056	<b>SEALED POWER</b>		270-2283	EM-2283	270-2373	EM-2373
646061	DS-6061	270-2009	EM-2009	270-2284	EM-2284	270-2374	EM-2374
646062	DS-6062	270-2010	EM-2010	270-2285	EM-2267	270-2375	EM-2375
646085	DS-6511	270-2039	EM-2039	270-2286	EM-2257	270-2376	EM-2376
646086	DS-6512	270-2040	EM-2040	270-2287	EM-2287	270-2377	EM-2370
648318	DS-8318	270-2048	EM-2048	270-2288	EM-2288	270-2377	EM-2371
648425	EM-8425	270-2050	EM-2050	270-2289	EM-2289	270-2378	EM-2378
648468	DS-8468	270-2060	EM-2060	270-2290	EM-2290	270-2379	EM-2379

# CROSS REFERENCE

Mfg Part No	Our Part	Mfg Part No	Our Part	Mfg Part No	Our Part	Mfg Part No	Our Part
<b>SEALED POWER (cont.)</b>		<b>SEALED POWER (cont.)</b>		<b>SEALED POWER (cont.)</b>		<b>SEALED POWER (cont.)</b>	
270-2381	EM-2381	270-2485	EM-2505	270-2647	EM-2741	270-2755	EM-2636
270-2384	EM-2384	270-2487	EM-2501	270-2649	EM-2488	270-2756	EM-2635
270-2385	EM-2385	270-2488	EM-2472	270-2650	EM-2487	270-2757	EM-2642
270-2387	EM-2387	270-2493	EM-2470	270-2652	EM-2775	270-2758	EM-2643
270-2388	EM-2388	270-2494	EM-2458	270-2655	EM-2759	270-2759	EM-2641
270-2389	EM-2389	270-2495	EM-2457	270-2656	EM-2449	270-2760	EM-2646
270-2390	EM-2389	270-2496	EM-2458	270-2658	EM-2451	270-2761	EM-2645
270-2391	EM-2391	270-2497	EM-2457	270-2659	EM-2452	270-2762	EM-2640
270-2392	EM-2446	270-2498	EM-2453	270-2660	EM-2743	270-2763	EM-2646
270-2393	EM-2437	270-2499	EM-2454	270-2664	EM-2489	270-2764	EM-2644
270-2394	EM-2438	270-2500	EM-2108	270-2668	EM-2748	270-2765	EM-2632
270-2395	EM-2433	270-2501	EM-2253	270-2675	EM-2739	270-2765	EM-2634
270-2396	EM-2434	270-2503	EM-2490	270-2677	EM-2751	270-2766	EM-2638
270-2398	EM-2436	270-2504	EM-2491	270-2684	EM-2549	270-2767	EM-2621
270-2400	EM-2382	270-2505	EM-2492	270-2684	EM-2550	270-2768	EM-2637
270-2401	EM-2457	270-2506	EM-2497	270-2685	EM-2549	270-2769	EM-2555
270-2403	EM-2444	270-2507	EM-2495	270-2685	EM-2550	270-2770	EM-2551
270-2404	EM-2445	270-2508	EM-2497	270-2686	EM-2548	270-2801	EM-2405
270-2405	EM-2448	270-2509	EM-2498	270-2687	EM-2543	270-2834	EM-2679
270-2406	EM-2441	270-2510	EM-2494	270-2688	EM-2558	270-2838	EM-2466
270-2407	EM-2442	270-2511	EM-2477	270-2692	EM-2382	270-2850	EM-2720
270-2408	EM-2439	270-2512	EM-2524	270-2699	EM-2537	270-2851	EM-2268
270-2409	EM-2440	270-2513	EM-2436	270-2700	EM-2458	270-2854	EM-2738
270-2410	EM-2502	270-2515	EM-2393	270-2702	EM-2538	270-2856	EM-2682
270-2411	EM-2396	270-2515	EM-2508	270-2704	EM-2538	270-2857	EM-2683
270-2412	EM-2395	270-2516	EM-2436	270-2707	EM-2538	270-2858	EM-2559
270-2413	EM-2329	270-2517	EM-2510	270-2708	EM-2601	270-2861	EM-2696S
270-2414	EM-2531	270-2518	EM-2513	270-2709	EM-2601	270-2861H	EM-2696
270-2415	EM-2464	270-2520	EM-2515	270-2710	EM-2601	270-2862	EM-2381
270-2416	EM-2467	270-2521	EM-2394	270-2711	EM-2601	270-2865	EM-2661
270-2420	EM-2447	270-2524	EM-2528	270-2712	EM-2601	270-2873	EM-2684
270-2421	EM-2600	270-2525	EM-2528	270-2713	EM-2551	270-2875	EM-2685
270-2422	EM-2733	270-2526	EM-2569	270-2714	EM-2556	270-2878	EM-2499
270-2424	EM-2734	270-2527	EM-2571	270-2715	EM-2568	270-2879	EM-2687
270-2425	EM-2493	270-2528	EM-2570	270-2716	EM-2601	270-2880	EM-2686
270-2426	EM-2469	270-2529	EM-2572	270-2717	EM-2601	270-2881	EM-2665
270-2428	EM-2471	270-2600	EM-2400	270-2718	EM-2601	270-2882	EM-2717
270-2429	EM-2723	270-2601	EM-2401	270-2719	EM-2601	270-2883	EM-2660
270-2430	EM-2724	270-2603	EM-2403	270-2720	EM-2553	270-2884	EM-2691
270-2431	EM-2466	270-2604	EM-2404	270-2721	EM-2538	270-2885	EM-2671
270-2432	EM-2496	270-2606	EM-2406	270-2722	EM-2538	270-2886	EM-2761
270-2434	EM-2462	270-2607	EM-2407	270-2723	EM-2620	270-2887	EM-2708
270-2435	EM-2503	270-2608	EM-2408	270-2724	EM-2626	270-2888	EM-2762
270-2437	EM-2776	270-2609	EM-2409	270-2725	EM-2630	270-2889	EM-2763
270-2441	EM-2501	270-2610	EM-2690	270-2726	EM-2629	270-2890	EM-2764
270-2442	EM-2500	270-2614	EM-2414	270-2727	EM-2551	270-2891	EM-2765
270-2445	EM-2459	270-2615	EM-2415	270-2729	EM-2627	270-2892	EM-2766
270-2446	EM-2460	270-2618	EM-2418	270-2730	EM-2600	270-2894	EM-2667
270-2447	EM-2461	270-2619	EM-2419	270-2731	EM-2615	270-2895	EM-2668
270-2448	EM-2501	270-2620	EM-2420	270-2732	EM-2616	270-2896	EM-2710
270-2449	EM-2500	270-2621	EM-2421	270-2733	EM-2617	270-2897	EM-2653
270-2452	EM-2501	270-2622	EM-2293	270-2734	EM-2618	270-2898	EM-2654
270-2453	EM-2500	270-2623	EM-2167	270-2735	EM-2609	270-2899	EM-2655
270-2455	EM-2725	270-2624	EM-2424	270-2736	EM-2557	270-2900	EM-2656
270-2456	EM-2726	270-2625	EM-2425	270-2737	EM-2564	270-2901	EM-2657
270-2457	EM-2474	270-2626	EM-2426	270-2738	EM-2557	270-2902	EM-2658
270-2458	EM-2463	270-2628	EM-2428	270-2739	EM-2624	270-2903	EM-2767
270-2459	EM-2727	270-2629	EM-2429	270-2740	EM-2652	270-2904	EM-2768
270-2461	EM-2536	270-2630	EM-2456	270-2742	EM-2525	270-2905	EM-2769
270-2462	EM-2458	270-2631	EM-2533	270-2743	EM-2628	270-2906	EM-2711
270-2466	EM-2749	270-2632	EM-2532	270-2744	EM-2625	270-2907	EM-2770
270-2468	EM-2750	270-2633	EM-2417	270-2747	EM-2651	270-2908	EM-2771
270-2470	EM-2619	270-2634	EM-2410	270-2748	EM-2649	270-2909	EM-2676
270-2471	EM-2566	270-2635	EM-2730	270-2749	EM-2650	270-2910	EM-2664
270-2472	EM-2565	270-2636	EM-2731	270-2750	EM-2623	270-2911	EM-2663
270-2475	EM-2754	270-2637	EM-2731	270-2751	EM-2622	270-2912	EM-2692
270-2479	EM-2473	270-2640	EM-2680	270-2752	EM-2639	270-2913	EM-2662
270-2481	EM-2392	270-2642	EM-2740	270-2753	EM-2631	270-2914	EM-2674
270-2484	EM-2506	270-2644	EM-2681	270-2754	EM-2633	270-2915	EM-2688

# CROSS REFERENCE

Mfg Part No	Our Part	Mfg Part No	Our Part	Mfg Part No	Our Part	Mfg Part No	Our Part
<b>SEALED POWER (cont.)</b>		<b>SEALED POWER (cont.)</b>		<b>SEALED POWER (cont.)</b>		<b>SEALED POWER (cont.)</b>	
270-2916	EM-2772	270-3052	EM-8059	270-3126	EM-8140	270-3203	EM-8228
270-2917	EM-2707	270-3053	EM-8060	270-3127	EM-8141	270-3204	EM-8229
270-2919	EM-2677	270-3054	EM-8061	270-3128	EM-8142	270-3205	EM-8230
270-2920	EM-2678	270-3055	EM-8062	270-3129	EM-8303	270-3206	EM-8231
270-2921	EM-2773	270-3056	EM-8063	270-3130	EM-8148	270-3207	EM-8232
270-2922	EM-2777	270-3058	EM-8065	270-3131	EM-8149	270-3208	EM-8233
270-2923	EM-2788	270-3059	EM-8609	270-3132	EM-8150	270-3209	EM-8234
270-2924	EM-2697	270-3061	EM-8068	270-3133	EM-8151	270-3210	EM-8103
270-2925	EM-2712	270-3063	EM-8063	270-3134	EM-8152	270-3211	EM-8236
270-2926	EM-2548	270-3065	EM-8073	270-3135	EM-8137	270-3212	EM-8224
270-2927	EM-2778	270-3066	EM-8074	270-3136	EM-8154	270-3213	EM-8238
270-2928	EM-2785	270-3067	EM-8075	270-3137	EM-8132	270-3214	EM-8239
270-2929	EM-2693	270-3068	EM-8080	270-3138	EM-8157	270-3215	EM-8073
270-2930	EM-2718	270-3069	EM-8077	270-3139	EM-8160	270-3216	EM-8242
270-2931	EM-2782	270-3070	EM-8078	270-3140	EM-8161	270-3217	EM-8244
270-2932	EM-2786	270-3071	EM-8080	270-3142	EM-8163	270-3218	EM-8424
270-2933	EM-2713	270-3072	EM-8082	270-3143	EM-8164	270-3219	EM-8517
270-3000	EM-8018	270-3073	EM-8082	270-3144	EM-8165	270-3220	EM-8004
270-3001	EM-8001	270-3074	EM-8083	270-3145	EM-8166	270-3221	EM-8248
270-3002	EM-8002	270-3075	EM-8084	270-3146	EM-8167	270-3222	EM-8031
270-3003	EM-8004	270-3076	EM-8085	270-3147	EM-8168	270-3223	EM-8014
270-3004	EM-8005	270-3077	EM-8086	270-3148	EM-8169	270-3224	EM-8014
270-3005	EM-8006	270-3078	EM-8087	270-3149	EM-8170	270-3225	EM-8019
270-3006	EM-8007	270-3079	EM-8088	270-3150	EM-8171	270-3226	EM-8253
270-3007	EM-8008	270-3080	EM-8089	270-3151	EM-8278	270-3227	EM-8254
270-3008	EM-8009	270-3081	EM-8516	270-3152	EM-8173	270-3228	EM-8255
270-3009	EM-8010	270-3082	EM-8091	270-3153	EM-8174	270-3229	EM-8586
270-3010	EM-8011	270-3083	EM-8080	270-3155	EM-8176	270-3230	EM-8586
270-3011	EM-2451	270-3084	EM-8093	270-3156	EM-8177	270-3231	EM-8259
270-3012	EM-8014	270-3085	EM-8094	270-3157	EM-8178	270-3232	EM-8261
270-3013	EM-8014	270-3086	EM-8095	270-3158	EM-8179	270-3233	EM-8262
270-3014	EM-8016	270-3087	EM-8096	270-3159	EM-8180	270-3234	EM-8080
270-3015	EM-8016	270-3088	EM-8097	270-3160	EM-8181	270-3235	EM-8094
270-3016	EM-8021	270-3089	EM-8098	270-3161	EM-8211	270-3236	EM-8266
270-3017	EM-8018	270-3090	EM-8099	270-3162	EM-8183	270-3237	EM-8103
270-3018	EM-8019	270-3091	EM-8100	270-3163	EM-8183	270-3238	EM-8584
270-3019	EM-8020	270-3092	EM-8060	270-3164	EM-8185	270-3239	EM-8270
270-3020	EM-8021	270-3093	EM-8102	270-3165	EM-8186	270-3240	EM-8324
270-3021	EM-8022	270-3094	EM-8103	270-3166	EM-8187	270-3241	EM-8274
270-3022	EM-8024	270-3095	EM-8104	270-3167	EM-8188	270-3242	EM-8312
270-3023	EM-8024	270-3096	EM-8105	270-3168	EM-8190	270-3244	EM-8277
270-3024	EM-8025	270-3097	EM-8106	270-3169	EM-8191	270-3245	EM-8278
270-3025	EM-8026	270-3098	EM-8107	270-3170	EM-8192	270-3246	EM-8279
270-3026	EM-8575	270-3099	EM-8108	270-3171	EM-8193	270-3247	EM-8282
270-3027	EM-8435	270-3100	EM-8103	270-3172	EM-8194	270-3248	EM-8283
270-3028	EM-8026	270-3102	EM-8111	270-3173	EM-8195	270-3249	EM-8284
270-3029	EM-8031	270-3103	EM-8100	270-3174	EM-8196	270-3250	EM-8142
270-3030	EM-8021	270-3104	EM-8065	270-3175	EM-8197	270-3251	EM-8181
270-3031	EM-8010	270-3105	EM-8114	270-3176	EM-8198	270-3252	EM-8619
270-3032	EM-8034	270-3106	EM-8132	270-3177	EM-8485	270-3253	EM-8293
270-3033	EM-8431	270-3107	EM-8118	270-3178	EM-8200	270-3254	EM-8294
270-3034	EM-2451	270-3108	EM-8119	270-3179	EM-8201	270-3255	EM-8295
270-3035	EM-8037	270-3109	EM-8120	270-3183	EM-8205	270-3256	EM-8296
270-3036	EM-8103	270-3110	EM-8121	270-3184	EM-8206	270-3258	EM-8001
270-3037	EM-8039	270-3111	EM-8122	270-3185	EM-8207	270-3259	EM-8300
270-3038	EM-8040	270-3112	EM-8124	270-3186	EM-8208	270-3260	EM-8304
270-3039	EM-8041	270-3113	EM-8124	270-3187	EM-8209	270-3261	EM-8303
270-3040	EM-8042	270-3114	EM-8125	270-3188	EM-8210	270-3262	EM-8304
270-3041	EM-8042	270-3115	EM-8304	270-3189	EM-8211	270-3263	EM-8034
270-3042	EM-8044	270-3116	EM-8133	270-3190	EM-8212	270-3264	EM-8307
270-3043	EM-8045	270-3117	EM-8128	270-3191	EM-8213	270-3265	EM-8307
270-3044	EM-8047	270-3118	EM-8304	270-3195	EM-8218	270-3266	EM-8310
270-3045	EM-8586	270-3119	EM-8130	270-3196	EM-8211	270-3267	EM-8311
270-3046	EM-8053	270-3120	EM-8125	270-3197	EM-8220	270-3268	EM-8312
270-3047	EM-8054	270-3121	EM-8132	270-3198	EM-8221	270-3269	EM-8312
270-3048	EM-8055	270-3122	EM-8133	270-3199	EM-8222	270-3270	EM-8314
270-3049	EM-8056	270-3123	EM-8133	270-3200	EM-8224	270-3271	EM-8149
270-3050	EM-8068	270-3124	EM-8135	270-3201	EM-8225	270-3272	EM-8312
270-3051	EM-8095	270-3125	EM-8137	270-3202	EM-8102	270-3273	EM-8317

# CROSS REFERENCE

Mfg Part No	Our Part	Mfg Part No	Our Part	Mfg Part No	Our Part	Mfg Part No	Our Part
<b>SEALED POWER (cont.)</b>		<b>SEALED POWER (cont.)</b>		<b>SEALED POWER (cont.)</b>		<b>SEALED POWER (cont.)</b>	
270-3274	EM-8319	270-3348	EM-8411	270-3427	EM-8524	270-3513	EM-8656
270-3275	EM-8149	270-3349	EM-8413	270-3428	EM-8314	270-3514	EM-8657
270-3276	EM-8133	270-3350	EM-8413	270-3429	EM-8197	270-3515	EM-8658
270-3277	EM-8322	270-3351	EM-8209	270-3430	EM-8529	270-3516	EM-8659
270-3278	EM-8323	270-3352	EM-8415	270-3437	EM-8005	270-3517	EM-8662
270-3279	EM-8324	270-3353	EM-8175	270-3438	EM-8402	270-3518	EM-8663
270-3280	EM-8324	270-3354	EM-8175	270-3440	EM-8544	270-3519	EM-8664
270-3281	EM-8324	270-3355	EM-8418	270-3443	EM-8560	270-3520	EM-8665
270-3282	EM-8328	270-3356	EM-8191	270-3444	EM-8068	270-3521	EM-8165
270-3283	EM-8329	270-3357	EM-8643	270-3445	EM-8095	270-3522	EM-8667
270-3284	EM-8330	270-3358	EM-8415	270-3448	EM-8566	270-3523	EM-8668
270-3285	EM-8130	270-3359	EM-8422	270-3449	EM-8568	270-3524	EM-8669
270-3286	EM-8130	270-3360	EM-8021	270-3450	EM-8568	270-3525	EM-8670
270-3289	EM-8178	270-3361	EM-8424	270-3452	EM-8572	270-3527	EM-8672
270-3290	EM-8278	270-3363	EM-8034	270-3453	EM-8010	270-3528	EM-8672
270-3291	EM-8278	270-3364	EM-8427	270-3454	EM-8574	270-3529	EM-8674
270-3292	EM-8180	270-3365	EM-8177	270-3455	EM-8575	270-3530	EM-8675
270-3293	EM-9055	270-3366	EM-8430	270-3456	EM-8576	270-3531	EM-8676
270-3295	EM-8164	270-3367	EM-8431	270-3457	EM-8578	270-3532	EM-8677
270-3296	EM-8344	270-3369	EM-8435	270-3458	EM-8579	270-3533	EM-8678
270-3297	EM-8002	270-3370	EM-8434	270-3459	EM-8055	270-3534	EM-8679
270-3298	EM-8194	270-3371	EM-8435	270-3460	EM-8582	270-3535	EM-8680
270-3299	EM-8002	270-3372	EM-8435	270-3462	EM-8584	270-3536	EM-2789
270-3300	EM-8348	270-3373	EM-8435	270-3463	EM-8205	270-3537	EM-2790
270-3301	EM-8349	270-3374	EM-8438	270-3464	EM-8586	270-3538	EM-2791
270-3302	EM-8348	270-3375	EM-8439	270-3466	EM-8589	270-3539	EM-2792
270-3303	EM-8351	270-3376	EM-8586	270-3467	EM-8663	270-3540	EM-2793
270-3304	EM-8352	270-3377	EM-8442	270-3469	EM-8596	270-3541	EM-2794
270-3305	EM-8353	270-3378	EM-8586	270-3470	EM-8599	270-3542	EM-2795
270-3306	EM-8344	270-3379	EM-8579	270-3471	EM-8600	270-3543	EM-2796
270-3307	EM-8195	270-3380	EM-8445	270-3472	EM-8601	270-3544	EM-2798
270-3308	EM-8193	270-3381	EM-8579	270-3473	EM-8602	270-3545	EM-2799
270-3309	EM-8213	270-3382	EM-8576	270-3474	EM-8603	270-3546	EM-2800
270-3310	EM-8359	270-3383	EM-8586	270-3475	EM-8604	270-3547	EM-2801
270-3311	EM-8014	270-3384	EM-8586	270-3476	EM-8605	270-3548	EM-2802
270-3312	EM-8361	270-3385	EM-8586	270-3477	EM-8606	270-3549	EM-2803
270-3313	EM-8485	270-3386	EM-8352	270-3478	EM-8607	270-3550	EM-2804
270-3314	EM-8363	270-3387	EM-8586	270-3479	EM-8608	270-3551	EM-2805
270-3315	EM-8166	270-3388	EM-8063	270-3480	EM-8609	270-3552	EM-2806
270-3316	EM-8207	270-3389	EM-8609	270-3482	EM-8611	270-3553	EM-2807
270-3317	EM-8482	270-3390	EM-8456	270-3483	EM-8612	270-3554	EM-2808
270-3318	EM-8190	270-3391	EM-8457	270-3484	EM-8612	270-3555	EM-2809
270-3319	EM-8201	270-3392	EM-8073	270-3485	EM-8614	270-3556	EM-2810
270-3320	EM-8208	270-3393	EM-8073	270-3486	EM-8615	270-3557	EM-2817
270-3321	EM-8014	270-3394	EM-8460	270-3487	EM-8616	270-3558	EM-2812
270-3322	EM-8374	270-3395	EM-8075	270-3488	EM-8617	270-3559	EM-2813
270-3323	EM-8375	270-3396	EM-8516	270-3489	EM-8236	270-3560	EM-2814
270-3324	EM-8377	270-3397	EM-8466	270-3490	EM-8619	270-3561	EM-2815
270-3325	EM-8375	270-3398	EM-8467	270-3491	EM-8620	270-3562	EM-2816
270-3326	EM-8179	270-3406	EM-8075	270-3492	EM-8622	270-3563	EM-2817
270-3327	EM-2690	270-3407	EM-8142	270-3494	EM-8629	270-3564	EM-2818
270-3329	EM-8384	270-3408	EM-8304	270-3495	EM-8630	270-3565	EM-2819
270-3330	EM-8385	270-3409	EM-8192	270-3496	EM-8631	270-3566	EM-2820
270-3331	EM-8187	270-3410	EM-8485	270-3497	EM-8632	270-3567	EM-2821
270-3332	EM-8389	270-3411	EM-8197	270-3498	EM-8230	270-3568	EM-2822
270-3333	EM-8389	270-3412	EM-8490	270-3499	EM-8224	270-3569	EM-2823
270-3334	EM-8389	270-3413	EM-8491	270-3500	EM-8663	270-3570	EM-2824
270-3336	EM-8197	270-3414	EM-8492	270-3501	EM-8639	<b>SKF</b>	
270-3337	EM-8197	270-3415	EM-8400	270-3502	EM-8641	HB106-FF	DS-6061
270-3338	EM-8398	270-3416	EM-8495	270-3503	EM-8643	HB206FF	DS-6035
270-3339	EM-8398	270-3417	EM-8008	270-3504	EM-8644	HB88107E	DS-6056
270-3340	EM-8402	270-3418	EM-8497	270-3505	EM-8389	HB88506	DS-6071
270-3341	EM-8404	270-3419	EM-8499	270-3506	EM-8196	HB88506	DS-6099
270-3342	EM-8197	270-3420	EM-8508	270-3507	EM-8164	HB88508	DS-6038
270-3343	EM-8406	270-3422	EM-8511	270-3508	EM-8648	HB88509	DS-6040
270-3344	EM-8407	270-3423	EM-8513	270-3509	EM-8649	HB88510	DS-6048
270-3345	EM-8385	270-3424	EM-8078	270-3510	EM-8652	HB88512A	DS-6049
270-3346	EM-8385	270-3425	EM-8516	270-3511	EM-8653	HB88514	DS-6531
270-3347	EM-8197	270-3426	EM-8517	270-3512	EM-8654	HB88515	DS-6064

# CROSS REFERENCE

Mfg Part No	Our Part	Mfg Part No	Our Part	Mfg Part No	Our Part	Mfg Part No	Our Part
<b>SKF (cont.)</b>							
HB88518 .....	DS-6502						
HB88529 .....	DS-6536						
HB88530 .....	DS-6079						
HB88532 .....	DS-6063						
HB88540 .....	DS-6510						
HB88547 .....	DS-6516						
HB88550 .....	DS-6533						
HB88553 .....	DS-6535						
HB88554 .....	DS-6078						
HB88557 .....	DS-6534						
HB88560 .....	DS-6092						
HB1280-20 .....	DS-8472						
HB1380-50 .....	DS-5225						
HB1380-75 .....	DS-5226						
HB1680-20 .....	DS-5224						
HB2380-40 .....	DS-5227						
HB2780-20 .....	DS-8627						
HB2800-60 .....	DS-6024						
<b>SPICER</b>							
213075 .....	DS-6516						
<b>TIMKEN</b>							
HB2 .....	DS-6051						
HB3 .....	DS-6052						
HB6 .....	DS-8474						
HB10 .....	DS-8532						
HB12 .....	DS-8472						
HB14 .....	DS-5224						
HB26 .....	DS-5225						
HB28 .....	DS-5226						
HB31 .....	DS-5227						
HB106FF .....	DS-6061						
HB206FF .....	DS-6035						
HB1004 .....	DS-6072						
HB4010A .....	DS-6071						
HB4016A .....	DS-6510						
HB4019A .....	DS-6099						
HB4021 .....	DS-6509						
HB4025A .....	DS-6502						
HB55809 .....	DS-6040						
HB88107E .....	DS-6056						
HB88508 .....	DS-6038						
HB88510 .....	DS-6048						
HB88512A .....	DS-6049						
HB88514 .....	DS-6531						
HB88515 .....	DS-6064						
HB88554 .....	DS-6078						
HB88560 .....	DS-6092						