



United Pacific

ANTIQUE

2018 New Product Collection



HOW TO ORDER

To order from United Pacific Industries, you must be an authorized dealer, distributor or OEM.



United Pacific partnered with Maxluder Brothers for the 2018 SEMA Show, to build this custom '74 Ford Bronco using our steel replacement panels and LED lighting.



The official vehicle of this year's Street Rodder Road Tour is this custom 1932 Ford Truck, designed and built by Hot Rod's by Dean using United Pacific's 1932 Ford Truck body cab, door shells, parts and accessories.

QUALITY

With over 30 years of experience in the automotive aftermarket industry, United Pacific Industries understands the rigors and stresses that our products are subjected to on the road. It is our mission to provide our customers with products of superior quality and reliability. In achieving this goal, United Pacific only partners with manufacturing facilities that conforms to our quality control requirements and standards. Our manufacturing partners meet or exceed ISO-9001 requirements. In addition, United Pacific's manufacturing partners must be equipped on site to perform the following quality assurance tests and maintain a track record of consistent quality and low product failure rate.

- Aging Test
- Air Tight Test
- Dust Test
- Flux Test
- Photometric Test
- Pull Force Test
- Rain Test
- Salt Spray Test
- Shock Test
- Temperature Test
- Humidity Test
- Vibration Test

Furthermore, our internal quality control structure allows us to function as the final quality control station prior to shipping. With the assistance of 3D computer technology, United Pacific can adhere to strict quality control standards during prototype creation and the production process. Our engineers and technicians perform a battery of tests to ensure that our products meet the demands of today's drivers and our goal to be first in quality.

INNOVATION

Known as the leader in innovation, United Pacific is dedicated to be the first to bring new and exciting products to the market. United Pacific's global expertise allows us to search the globe for new ideas and concepts. Not only do we search the globe for new products, United Pacific invest a significant amount of resources into our own research and development efforts. With the assistance of advance 3D scanning technology, our engineers and designers can acquire accurate and precise data in seconds. The 3D data allows United Pacific to verify designs, perform quality assurance tests, and reverse engineer with unprecedented speed and accuracy. Digital inspection contributes to the early detection of shape problems, provides rapid feedback on design, and eliminates unnecessary work in downstream processes. Our rapid prototyping facility permits us to have a concept-to-shelf time of less than 5 months. In addition, United Pacific's 3D printing capabilities permit our designers to have physical models of their design concepts in hours. The physical models allow our designers and marketing staff to evaluate and test the viability of different design ideas. Our rapid prototyping facility allow United Pacific to compress design cycles, improve manufacturing planning, shorten concept-to-shelf time, most importantly, generate new and innovative products.

DESIGN

Located near some of the nation's most progressive automotive design centers, United Pacific established the UP Design Studio in 2002 to consolidate our position as the design leader in the automotive industry. UP Design Studio utilizes the latest generation of computer aided design (CAD) and studio/graphic software. The design studio is equipped with the newest computers and rapid prototyping systems. In addition, UP Design Studio is staffed by graduates from the nation's most prestigious design colleges. Unlike our competitors, United Pacific's design and manufacturing capabilities mean that we carry more new and original items than our competitors. The establishment of the design studio will enable us to generate even more new products with significant shorter concept-to-shelf time. The reduction in development cost mean that we can develop products utilizing design based development processes. Design based product development allows United Pacific to create new product concepts based on designs incorporating driver demands and needs instead of economic considerations. United Pacific's emphasis on design distinguishes and positions us ahead of our competitors.



WARRANTY

With LED (Light Emitting Diodes) rated at 100,000 hours of operation and solid-state construction, United Pacific's LED lights are extremely reliable and durable. Purchase with confidence, United Pacific offers a complete line of LED lighting products with extended or limited lifetime warranties. Please see the warranty policy page for more details.

INVENTORY AND SHIPPING

United Pacific carries over 20,000 items in our California distribution center. No other company in the heavy duty trucking industry can match United Pacific in the variety and range of in-stock inventories. With an order fill rate of over 98.5%, United Pacific is the largest and most reliable supplier in the industry. Our shipping department ships 96.8% of all orders within 24 hours and 98.9% within 48 hours. United Pacific's vast inventory and prompt shipping has made United Pacific the only source for our customer's chrome and lighting needs.



HARD AT WORK FOR THE ENVIRONMENT



United Pacific
132,000 sq ft
Distribution Center
Long Beach, CA

- 100%** reduction in potable water used for landscaping
- 40%** reduction in total energy use due to high-efficiency mechanical and lighting systems
- 82%** of construction waste was diverted from landfills

LEED ACCOMPLISHMENTS

Sustainable Sites

- On-site bicycle storage, showers and changing areas for company employees.
- Preferred parking for low-emitting, fuel-efficient and carpool vehicles.
- Stormwater is infiltrated on-site and treated to remove contaminants to reduce environmental impact on local waterways.

Water Efficiency

- In addition to using reclaimed water, drought-tolerant plants and a high-efficiency irrigation system were installed to reduce the use of potable water for irrigation by 100%.

Energy and Atmosphere

- Efficient HVAC equipment and a lighting system with daylight controls reduces energy consumption by over 30%.
- Enhanced commission verifies that the building's energy and water-related systems are performing as intended by the initial design.

Indoor Environmental Quality

- Building ventilation systems was designed to provide enhanced levels of fresh outside air to building occupants.
- Interior finishes (plants, sealants, adhesives, coatings, carpet systems and composite wood) were selected with low levels of volatile organic compounds (VOCs) to reduce indoor air contamination.



NEW ITEMS

December 2018



WIDE ANGLE OPTICS



Available with LED Turn Signal

Mustang LED Mirror



Exterior Mirror for 1964.5-66 Ford Mustang

- Original fit for 1964.5-66 Ford Mustang
- Chrome die cast mirror arm and head
- Right hand available with convex mirror for wide angle visibility
- Available with led turn signal arrow for safety and visibility when changing lanes
- Mounting pad and mounting screws included

F646601	L/H & R/H	1 Pc. / Color Box
110174	L/H w/LED Turn Signal	1 Pc. / Color Box
110175	R/H w/Convex Mirror	1 Pc. / Color Box
110176	R/H w/Convex Mirror & LED Turn Signal	1 Pc. / Color Box

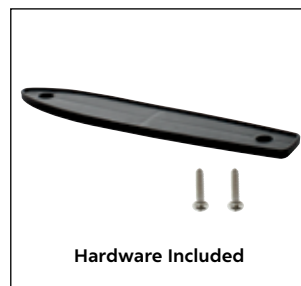

NEW COLOR PACKAGING

*LED Turn Signal for Auxiliary/Off-Road Only. Early 1964-65 Mustang with Single Dashboard Turn Indicator Will Require Modification of the Indicator Bulb



110292



110293

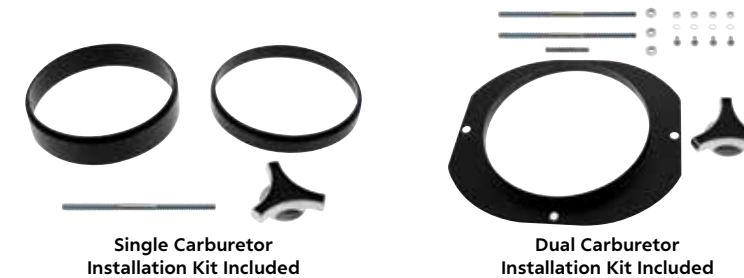

Single Carburetor Installation Kit Included

Dual Carburetor Installation Kit Included

Oval Aluminum Air Cleaner - with Mustang Script

- Complete assembly with top, base & air filter element
- Measures 21" long, 10" wide, 2-1/4" tall (2-3/8" tall at carb flange)
- Includes die cast chrome plated 3-wing nut & mounting hardware

110292 Single 4-Barrel - 1 Pc. / Box

110293 Double 4-Barrel - 1 Pc. / Box



Door Striker Kit for 1966-67 Ford Bronco - Also Fits 64-66 Mustang

- Heavy duty steel reproduction of the original striker
- Round latch stud
- Includes one shim and two 5/16 - 18 screws
- Fits both the left or right hand side

110476 66-67 Bronco - 1 Kit / Bag

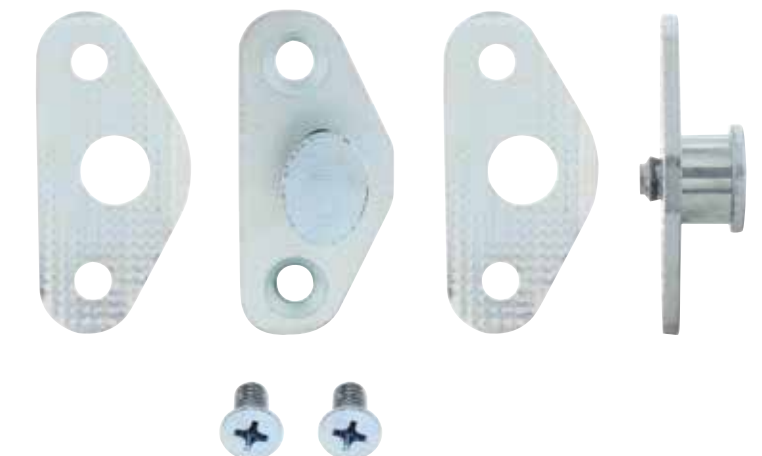

Door Striker Kit for 1968-77 Ford Bronco

- Heavy duty steel reproduction of the original striker
- Original style oval latch stud
- Includes two shims and two 5/16 - 18 screws
- Fits both the left or right hand side

110477 68-77 Bronco - 1 Kit / Bag

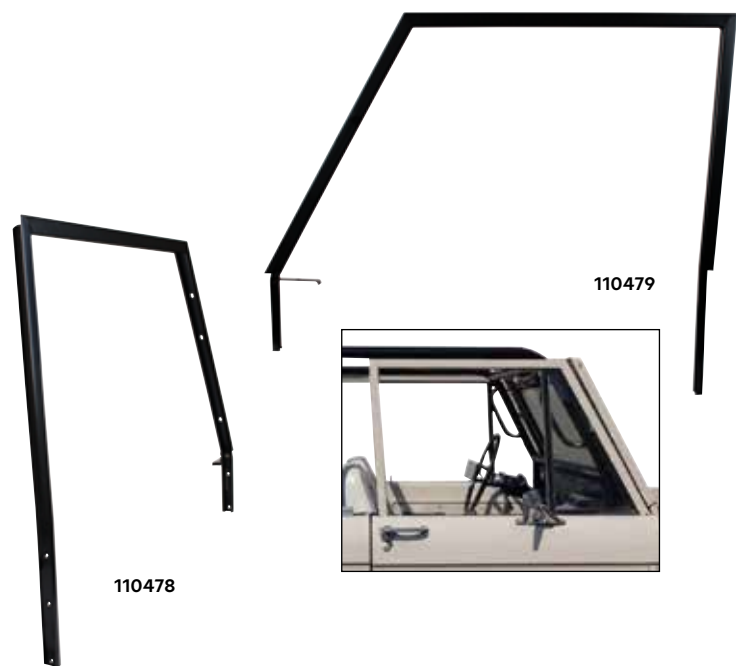

110479

110478

Black Door Window Frame for 1966-77 Ford Bronco

- Excellent steel reproduction with original 196-68 removable frame style
- Black EDP coated
- Thread plated welded to frame for easy mounting to door shell
- OEM #: c6tz-9722220-a / c6tz-9722221-a
- Sold individually, please specify LH or RH side

110478 R/H - 1 Pc. / Box

110479 L/H - 1 Pc. / Box



High Power H4 LED Bulb with Fan

- 23W low beam application, 25W high beam application
- 1800 Lumen low beam output
- 2400 Lumen high beam output
- Includes driver/controller for easy installation, replaces any h4 bulb. Driver/controller is approximately 2 3/16" L x 7/8" W x 5/8" H

36512 1 Pair / Color Box



NEW COLOR PACKAGING

COMPETITION SERIES



1,020 LUMENS

10v-30v MULTIPLE VOLTAGE

12 High Power LED 7" Combo Light Bar

- 12 High power LED combo light
- 4 inner LEDs (spot) / 8 outer LEDs (flood)
- 12 V application, IP 67 rated
- 3 Year Warranty

36599 1 Pc. / Color Box



United Pacific Banner

- United Pacific Banner - 48" x 36"

99053 1 Pc. / Bulk

NEW ITEMS

February 2018



Deluxe Heavy Duty Vehicle Positioning Jack

- Ideal for moving vehicles in garages, workshops and areas with limited space
- Hydraulic ram and pump provides easy lifting action
- Accommodates most automotive tires up to 12" wide
- Steel frame construction with steel tire rollers, 1500 lb. Capacity
- 6000 Lb. Total vehicle capacity with 4 jacks
- High quality polyurethane casters for floor protection from damage (2 with toe locks)
- Sold 1 per box, two jacks are needed per axle
- Optional storage cart available: item # 98998

98999 1 Pc. / Color Box

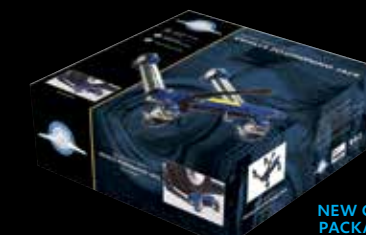

NEW COLOR PACKAGING

Storage Cart for Vehicle Positioning Jacks

- Secure and store up to 4 vehicle positioning jacks
- Four hard rubber 360 degree swivel ball bearing wheels for easy maneuvering
- Positioning jack available separately: item # 98999

98998 1 Pc. / Box

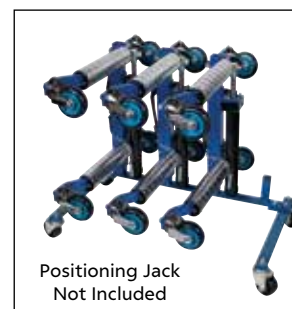
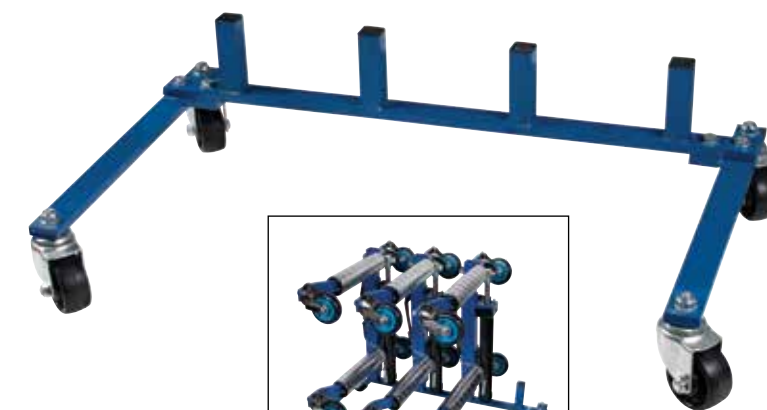
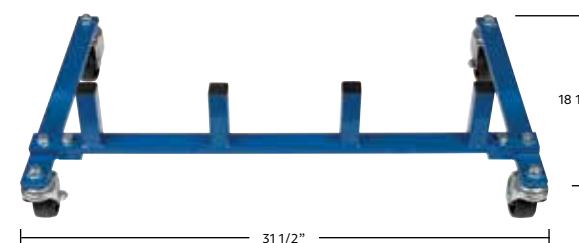

Positioning Jack Not Included



36 White LED Back-Up Light for 1971 Chevelle SS & Malibu

- 36 Super bright LEDs, complete with polycarbonate lens and stainless steel trim
- Epoxy coated, fully sealed electronics
- Easy electrical connection with 1156 plug, no modification to vehicle
- **Lifetime Warranty**

CBL7101LED-L L/H - 1 Pc. / Card

CBL7101LED-R R/H - 1 Pc. / Card



36 White LED Back-Up Light for 1972 Chevelle SS & Malibu

- 36 Super bright LEDs, complete with polycarbonate lens and stainless steel trim
- Epoxy coated, fully sealed electronics
- Easy electrical connection with 1156 plug, no modification to vehicle
- **Lifetime Warranty**

CBL7201LED-L L/H - 1 Pc. / Card

CBL7201LED-R R/H - 1 Pc. / Card



LED Back-Up Light for 1957 Chevy

- 28 Super bright LEDs, complete with polycarbonate lens
- Epoxy coated, fully sealed electronics
- Easy electrical connection with 1156 plug, no modification to vehicle
- **Lifetime Warranty**

110221 1 Pc. / Card



Vent Window Assembly for 1966-77 Ford Bronco

- Beautifully chrome plated
- Fully assembled and ready to install
- Sold individually, please specify L/H or R/H

110218 R/H - 1 Pc. / Box

110219 L/H - 1 Pc. / Box



46 Red LED Tail Light for 1971 Chevelle SS & Malibu

- 46 Super bright LEDs, complete with polycarbonate lens and stainless steel trim
- Dual function with tail light and bright stop/turn signal
- Epoxy coated, fully sealed electronics
- Easy electrical connection with 1157 plug, no modification to vehicle
- Recommended upgrade under dash flasher to 90652 led flasher
- **Lifetime Warranty**

CTL7101LED-L L/H - 1 Pc. / Card

CTL7101LED-R R/H - 1 Pc. / Card



46 Red LED Tail Light for 1972 Chevelle SS & Malibu

- 46 Super bright LEDs, complete with polycarbonate lens and stainless steel trim
- Dual function with tail light and bright stop/turn signal
- Epoxy coated, fully sealed electronics
- Easy electrical connection with 1157 plug, no modification to vehicle
- Recommended upgrade under dash flasher to 90652 led flasher
- **Lifetime Warranty**

CTL7201LED-L L/H - 1 Pc. / Card

CTL7201LED-R R/H - 1 Pc. / Card



Car Gas Tank Cover 1933-34 Ford Passenger

- High quality 20 gauge stamped steel with wire beaded edge as original
- Features all of the original contour detail & mounting holes except gas neck hole & bumper bracket holes
- Coated in black EDP

B24035 1 Pc. / Box

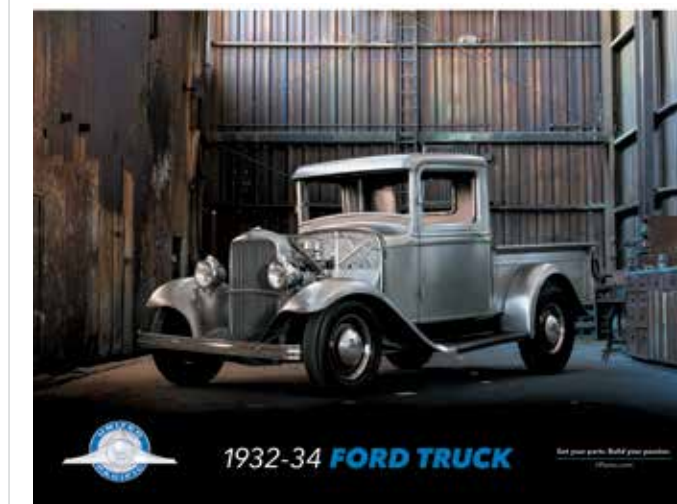

United Pacific 32 Ford Truck Poster

- Beautiful photography of our new 1932-34 Ford truck product line
- Dimension approximately = 24" W x 18" L

99112 1 Pc. / Bulk

NEW ITEMS

March 2018



Door Shells for 1966-67 Ford Bronco

- Die stamped with high quality 20 gauge sheet metal
- Features all of the original 66-67 contour detail
- Black EDP coated
- Sold individually, please specify L/H or R/H

110370 66-67 R/H - 1 Pc. / Box

110371 66-67 L/H - 1 Pc. / Box

Door Shells for 1968-77 Ford Bronco

- Die stamped with high quality 20 gauge sheet metal
- Features all of the original 68-77 contour detail
- Black EDP coated
- Sold Individually, Please Specify L/H or R/H

110372 68-77 R/H - 1 Pc. / Box

110373 68-77 L/H - 1 Pc. / Box



Firewall Kit for 1966-77 Ford Bronco

- Made with excellent quality 18 gauge sheet metal
- Features all original 1966 contour detail and cutouts
- Coated with weldable primer
- Kit includes: left & right kick panel, left & right dash panel, upper & lower dash panel, cowl lower panel
- User assembly is required
- Oversize freight policy

110535 1 Kit / Box



Firewall Assembly for 1966-77 Ford Bronco

- Die stamped with high quality 18 gauge sheet metal
- Features all original 1966 contour detail and cutouts
- Coated with weldable primer
- Fully assembled for quick drop in restorations
- Oversize freight policy

110369 1 Pc. / Box



Extended Eleanor Style All Steel Hood for 1967 Ford Mustang

- All-Steel "Eleanor" Style Hood which is extra long at the front to match up with the Eleanor/Shelby style nose for those converting over to the "Eleanor" style Mustang
- This is not a bolt-on stock replacement hood and you must have the Eleanor/Shelby style extended nose for this hood to fit properly
- Can also be used on 1968 Mustang if 1967 extended nose is used
- Black EDP coated
- Oversize freight policy

110648 1 Pc. / Box



Rear View

Eleanor Style Fiberglass Front Valance for 1967-68 Ford Mustang

- High Quality Fiberglass Construction
- Accurate Reproduction with All Original Contour Detail and Cutouts
- Iconic Eleanor Style
- Oversize Freight Policy

110650 1 Pc. / Box



Shelby Style Quarter Panel Side Scoop - Upper Pair for 1967-68 Ford Mustang Fastback

- Die stamped with high quality sheet metal
- Features accurate contour detail
- As original, has mounting studs for easy installation
- Fits 1967-68 Fastback only
- Sold in pairs

110651 1 Pair / Box



Shelby Style Quarter Panel Side Scoop - Lower Pair for 1967-68 Ford Mustang

- Die stamped with high quality sheet metal
- Features accurate contour detail
- As original, has mounting studs for easy installation
- Great upgrade for any 1967-68 Mustang
- Fits all 1967-68 Fastback, Convertible and Coupe
- Also fits "California Special" Mustang
- Sold in pairs

110652 1 Pair / Box



Chrome Mirror for Chevy / GMC Full Size Truck and Van

- Exterior rectangular rear view mirror
- Includes mounting pad and mounting hardware
- Can be used for L/H or R/H

60050 1 Kit / Box



Glove Box Door Kit for 1955-59 Chevy & GMC 2nd Series Truck

- Excellent steel reproduction with high quality 22 gauge sheet metal
- Heavy gauge arm brackets with 10-32 tapped holes for easy installation
- 10-24 Caged nuts for quick hinge mounting
- Quality steel hinge with pre-installed springs
- 10-32 & 10-24 Screws included
- Black EDP coated

110338 1 Pc. / Box



Chrome Headlamp Bezels for 1963 Chevy Truck

- Beautifully chrome plated with triple plating process
- #8 Oval head sheet metal screws included
- Sold in pair

110429 1 Pair / Box

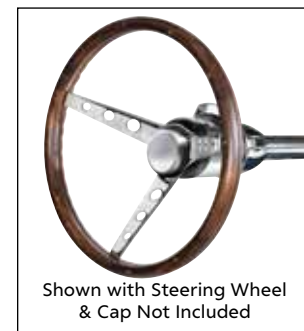

Shown with Steering Wheel & Cap Not Included



NEW COLOR PACKAGING

Steering Wheel Hub Adapter Kit for GM

- Use with all 3-bolt mount steering wheels
- Fits wide variety of gm vehicles 1949-1980
- Includes splined hub, horn contact plate and hardware
- Horn button cap sold separately

110314 1 Pc. / Box



6 High Power LED 6418 / 6461 36 mm Light Bulb (2 Pack)

- Festoon style light bulb with 6 high power micro SMD LEDs
- Specially designed LED bulb projects light 160 degrees

36591 Amber - 2 Pcs. / Card

36592 Blue - 2 Pcs. / Card

36593 Red - 2 Pcs. / Card

36594 White - 2 Pcs. / Card



8 High Power LED 211-2 Light Bulb (2 Pack)

- 211-2 Festoon style light bulb with 8 high power micro SMD LEDs
- Specially designed LED bulb projects light 160 degrees

36595 Amber - 2 Pcs. / Card

36596 Blue - 2 Pcs. / Card

36597 Red - 2 Pcs. / Card

36598 White - 2 Pcs. / Card

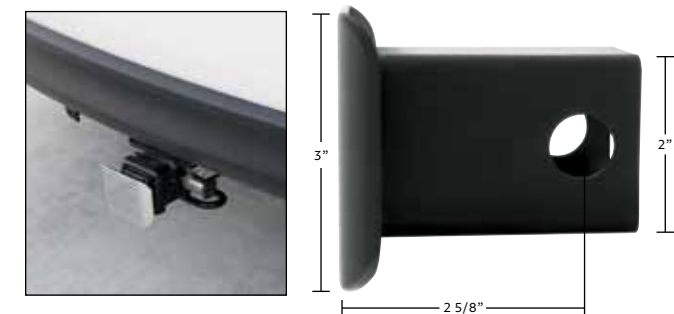

2" Hitch Cover

- Fits standard 2" x 2" tow hitch receivers
- Mounts in place with standard locking hitch pin & clip (sold separately)
- Keep out dirt and debris, super clean look

77007 Chrome - 1 Pc. / Card

77008 Black - 1 Pc. / Card

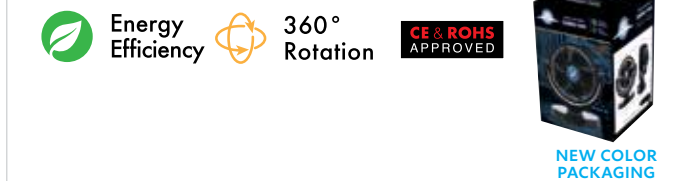

NEW COLOR PACKAGING

Mini Cooling Turbo Fan

- Complete and ready to install in cars, trucks, vans, motor homes, boats or recreation vehicles
- 360° rotation, universal positioning
- Improve vehicle ventilation, air circulation, and window de-misting
- Easy installation, double sided tape included
- Built-in car charger head
- Comes with fuse inside the plug
- 12V DC input/0.33 Amps, total power consumption: 4w
- Noise: <45db
- Power cord length: 10 feet

40847 1 Pc. / Color Box

NEW ITEMS

April 2018



18 GAL Tin Sheet Fuel Tank for 1947-55 Chevy & GMC 1st Series Truck

- Die stamped with Ni-Terne treated steel sheet
- Has all original contour detail and mounting holes
- Machine welded for an even and complete seal

110687 1 Pc. / Box

18 GAL Tin Sheet Fuel Tank for 1955-59 Chevy & GMC 2nd Series Truck

- Die stamped with Ni-Terne treated steel sheet
- Has all original contour detail and mounting holes
- Machine welded for an even and complete seal

110688 1 Pc. / Box

20 GAL Tin Sheet Fuel Tank without EVAP for 1967-72 Chevy & GMC C/K Series Truck

- Die stamped with Ni-Terne treated steel sheet
- Has all original contour detail and mounting holes
- Machine welded for an even and complete seal
- For truck models without EVAP

110685 1 Pc. / Box

20 GAL Tin Sheet Fuel Tank with EVAP for 1970-72 Chevy & GMC C/K Series Truck

- Die stamped with Ni-Terne treated steel sheet
- Has all original contour detail and mounting holes
- Machine welded for an even and complete seal
- For truck models with EVAP

110686 1 Pc. / Box

16 GAL Steel Zinc Plated Fuel Tank for 1973-81 Chevy & GMC C/K Series Truck

- Die stamped with Ni-Terne treated steel sheet
- Has all original contour detail and mounting holes
- Machine welded for an even and complete seal

110683 1 Pc. / Box



20 GAL Fuel Tank with Drain Plug for 1969 Ford Mustang

- Made with corrosion resistant stainless steel sheet
- Die stamped with all original contour and mounting holes
- Machine welded to ensure proper seal
- Stainless steel drain plug pre-installed
- OEM #: C9ZZ-9002-A

110680 1 Pc. / Box



22 GAL Fuel Tank with Drain Plug for 1970 Ford Mustang

- Made with corrosion resistant stainless steel sheet
- Die stamped with all original contour and mounting holes
- Machine welded to ensure proper seal
- Stainless steel drain plug pre-installed
- For Mustang models without EVAP
- OEM #: D0ZZ-9002-A

110682 1 Pc. / Box

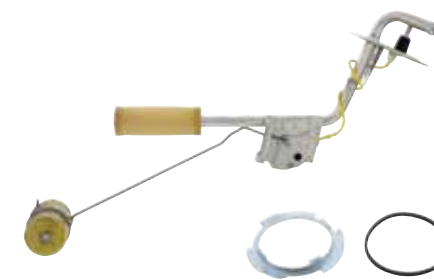

Fuel Tank Sending Unit for 1970 Ford Mustang

- Made with corrosion resistant stainless steel sheet
- Brass float just like the original
- Resistance output: 8.5 - 77 Ohms
- Includes rubber seal, stainless steel lock ring, and strainer
- OEM #: D0WY-9275-A

110667 1 Pc. / Box



Door Latch Striker Plates for 1967-72 Chevy & GMC Truck

- Excellent reproduction of the original design
- Zinc plated, sold in pair

110223 1 Pair / Box

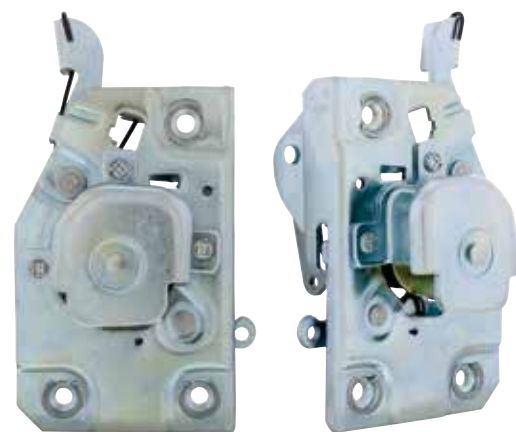

Truck Door Latch for 1967-72 Chevy & GMC

- Precision stampings with original design mechanism
- Zinc plated. LH & RH sold individually
- Fits pickup and suburban
- Mounting hardware not included

110262 R/H - 1 Pc. / Bulk

110263 L/H - 1 Pc. / Bulk



Battery Hold-Down Frame for 1947-55 Chevy & GMC Truck

- Excellent reproduction of the original design
- Die-stamped steel black painted

110470 1 Pc. / Box



Battery Hold-Down Bracket for 1958-66 Chevy & GMC Truck

- 304 High grade stainless steel

110473 1 Pc. / Box



3 LED Dual Function Mini Auxiliary/Utility Light w/ Bezel

- 3 LED mini dual function clearance marker light with stainless steel bezel
- Requires 3/4" diameter hole for installation
- Fits panels and bumpers up to 1/4" thick. Includes plastic backing washer when mounting on thin body panels

36600 Amber LED /Amber Lens - 1 Pc. / Card

36601 Red LED /Red Lens - 1 Pc. / Card

36602 Amber LED /Clear Lens - 1 Pc. / Card

36603 Red LED /Clear Lens - 1 Pc. / Card



LED Flasher w/Reverse Polarity Base & Extension Wires

- 12 Volt, 20 amp maximum
- Solves turn signal problems, such as hyper flashing, no flashing, or burnt out bulb indication when using led lights and bulbs
- Includes polarity reversing base & extension wires

90649 1 Set / Card



Multi-Color High Power LED Rock Light

- Multi-color high power LEDs for easy navigation when rock crawling
- Plays millions of colors of light with music from smart phone
- Control & dim lights with rgb remote app.
- Cree LEDs in a waterproof and aluminum housing
- Mounting pads & spacers, screws and instructions included
- Supports most iPhone, iPad and Android smartphones

36604 1 Kit / Color Box





Chrome Spike Nut Cover for 1999 - 2004 Ford F-Series

- Fits 1999-2004 Ford F-Series truck models with original steel wheel hubcap
- Spike accessory is sized to fit the push-on simulated lug nut on OE steel wheel hubcap
- Spike is quality molded plastic with beautiful long lasting chrome plating

10718B 1 Pc. / BULK



Chrome 3 Skull Shift Knob

- Ultra high quality chrome finish
- Universal hex screw mount design, includes mounting hardware, adapters, & hex ranch

70708 1 Pc. / Card



United Pacific '32 Truck T-Shirt

- Gray color

99104M	Medium - 1 Pc. / Bulk
99104L	Large - 1 Pc. / Bulk
99104XL	X-Large - 1 Pc. / Bulk
99104XXL	XX-Large - 1 Pc. / Bulk

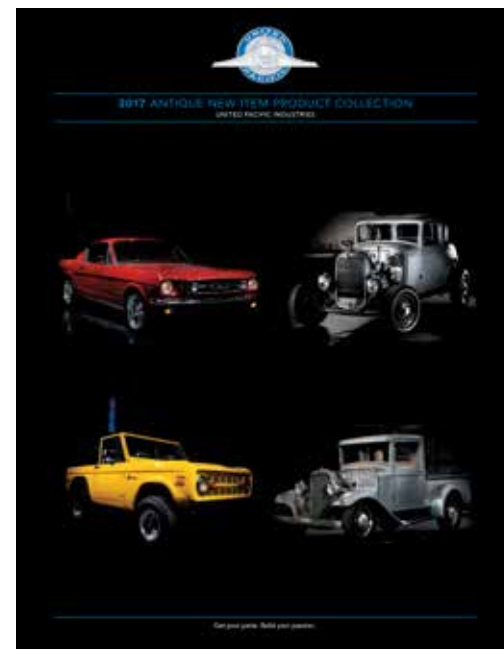

2017 New Item Product Collection Catalog Item # ANF1217

Available Now!

NEW ITEMS

May 2018



44 LED Tail Light Insert Board for 1951 Ford Passenger Car

- Super bright LED circuit board installs behind existing lens
- Dual function with tail light & bright stop/turn signal
- For use on 12 volt vehicles only (not 6 volt)
- Easy electrical connection with 1157 plug, no modification to vehicle
- Recommended upgrade under dash flasher to 90652 led flasher
- Not for use with blue dots

110128	LED Tail Light Insert Board - 1 Pc. / Card
F5103	Lens Gasket - 1 Pair / Bulk
F5101	Tail Light Lens - 1 Pc. / Card



Load Resistor Kit, Solves LED Issue, 50 Watt/6 OHM

- For LED turn signal lights or led license plate lights
- Eliminate LED turn signal problems, such as hyper flashing, no flashing, or burnt out bulb indication
- Simulates the load of an incandescent bulb to solve most LED issues
- Aluminum housing with proprietary heat management allows installation in most locations
- Kit includes two load resistors and 4 connectors

34235 2 Pcs. / Color Box



Mirror Bundles



3" Peep Mirror

- Convex peep mirror with wide angle optics for R/H side
- Polished stainless steel mirror head & chrome plated arm
- Includes mounting pad and hex wrench for installation
- Bundle includes: C5001-1 & C5001-1CVX Pre-packed in one box for shipping

110741 1 Pair / Box



4" Peep Mirror

- Convex Peep Mirror with Wide Angle Optics for R/H Side
- Polished Stainless Steel Mirror Head & Chrome Plated Arm
- Includes Mounting Pad and Hex Wrench for Installation
- Bundle includes: C5001 & C5001-CVX Pre-Packed in One Box for Shipping

110742 1 Pair / Box



4" Peep Mirror with LED Turn Signal

- Convex peep mirror with wide angle optics for R/H side
- Red 7 LED arrow hidden inside mirror glass, 12 volt
- Polished stainless steel mirror head & chrome plated arm
- Includes mounting pad and hex wrench for installation
- Bundle includes: C5001-LED & C5001-CVXLED pre-packed in one box for shipping

110743 1 Pair / Box



Exterior Mirror for 1955-57 Chevy Passenger Car

- Convex Peep Mirror with Wide Angle Optics for R/H Side
- Polished Stainless Steel Mirror Head & Chrome Plated Arm
- Includes Mounting Pad and Hex Wrench for Installation
- Bundle Includes: C555728 & C555728-CVX Pre-Packed in One Box for Shipping

110745 1 Pair / Box



Exterior Mirror with LED Turn Signal for 1955-57 Chevy Passenger Car

- Convex peep mirror with wide angle optics for R/H side
- Red 7 led arrow hidden inside mirror glass
- Polished stainless steel mirror head & chrome plated arm
- Includes mounting pad and hex wrench for installation
- Bundle includes: C555728-LED & C555728-LEDCVX pre-packed in one box for shipping

110746 1 Pair / Box



Exterior Mirror with Bowtie Logo for 1965-66 Chevy Passenger Car

- Convex Peep Mirror with Wide Angle Optics for R/H Side
- Full Size Mirror Housing with Chevy Bowtie Logo
- Polished Stainless Steel Mirror Head & Chrome Plated Arm
- Includes Mounting Pad and Hex Wrench for Installation
- GM Restoration Licensed Product
- Bundle Includes: C656601 & C656602 Pre-Packed in One Box for Shipping

110747 1 Pair / Box

LED Tail Light Bundle



23 LED Tail Light with LED Blue Dot for 1940-53 Chevy & GMC Truck & 1937-38 Chevy Passenger Car

- Dual function with tail light and bright stop/turn signal
- Blue dot can be controlled independently with additional wiring
- Lefthand includes 6 super white LEDs for license plate light
- Complete with polycarbonate lens
- Epoxy coated, fully sealed electronics
- Solid state circuit boards are designed for 7.7-14.0 VDC
- Bundle includes: CTL4053LED-LBD & CTL4053LED-RBD pre-packed in one box for shipping

110750 1 Pair / Box

NEW ITEMS

June 2018

MUSTANG 1964 1/2 to 1970



110629



110630

Complete Door Glass Assembly for 1967-68 Ford Mustang Fastback

- Heavy 16 gauge stamped channel with riveted track rollers
- Polished stainless steel upper glass frame
- Available with crystal clear non-tinted tempered window glass or original style green tinted tempered window glass
- Fully assembled from factory for a quick and straight forward replacement
- Sold individually, please specify L/H or R/H

110628	R/H Clear - 1 Pc. / Box
110629	L/H Clear - 1 Pc. / Box
110630	R/H Tint - 1 Pc. / Box
110631	L/H Tint - 1 Pc. / Box



110621



110622

Complete Door Glass Assembly for 1967-68 Ford Mustang Coupe

- Heavy 16 gauge stamped channel with riveted track rollers
- Polished stainless steel upper glass frame
- Available with crystal clear non-tinted tempered window glass or original style green tinted tempered window glass
- Fully assembled from factory for a quick and straight forward replacement
- Sold individually, please specify L/H or R/H

110620	R/H Clear - 1 Pc. / Box
110621	L/H Clear - 1 Pc. / Box
110622	R/H Tint - 1 Pc. / Box <i>Coming Soon</i>
110623	L/H Tint - 1 Pc. / Box



110625

110626

Complete Door Glass Assembly for 1967-68 Ford Mustang Convertible

- Heavy 16 gauge stamped channel with riveted track rollers
- Polished stainless steel upper glass frame
- Available with crystal clear non-tinted tempered window glass or original style green tinted tempered window glass
- Fully assembled from factory for a quick and straight forward replacement
- Sold individually, please specify L/H or R/H

110624	R/H Clear - 1 Pc. / Box	
110625	L/H Clear - 1 Pc. / Box	
110626	R/H Tint - 1 Pc. / Box	Coming Soon
110627	L/H Tint - 1 Pc. / Box	Coming Soon

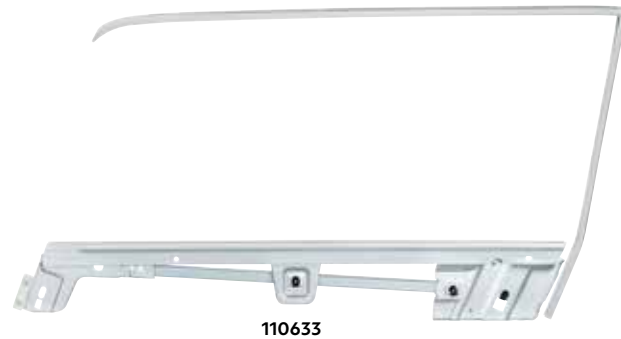

110633



110635

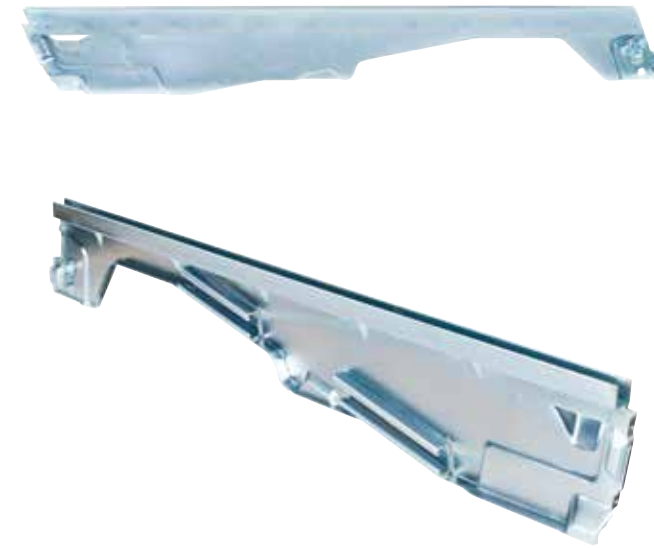

Door Glass Channel for 1964.5-66 Ford Mustang

- High quality 20 gauge steel
- Accurate reproduction with all original contour detail and cutouts
- Sold individually, please specify L/H or R/H

110618	R/H - 1 Pc. / Box
110619	L/H - 1 Pc. / Box



Complete Door Glass Assembly for 1969-70 Ford Mustang Coupe & Convertible

- Heavy 16 gauge stamped channel with riveted track rollers
- Crystal clear non-tinted glass cut to original shape
- Fully assembled from factory for a quick and straight forward replacement
- Sold individually, please specify L/H or R/H

110640	R/H - 1 Pc. / Box	Coming Soon
110641	L/H - 1 Pc. / Box	



Quarter Window Assembly with Clear Glass for 1967-68 Ford Mustang Coupe

- Heavy 16 gauge stamped steel window track with mounting hardware
- Crystal clear non-tinted glass tempered glass
- Beautifully polished stainless steel window frame with weatherstrip
- Fully assembled from factory for a quick and straight forward replacement
- Sold individually, please specify L/H or R/H

110644	R/H - 1 Pc. / Box
110645	L/H - 1 Pc. / Box

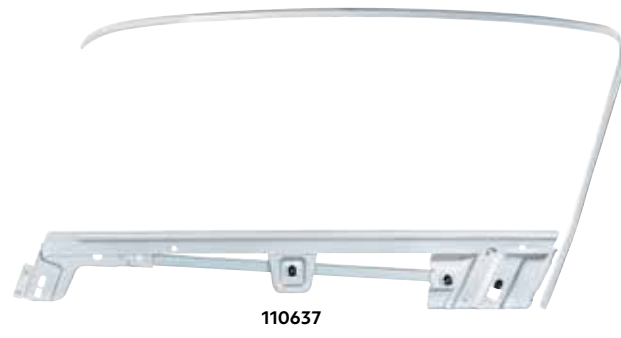

110637

Door Glass Frame Kit for 1967-68 Ford Mustang

- Heavy 16 gauge stamped channel with riveted track rollers
- Polished stainless steel upper glass frame
- Sold individually, please specify L/H or R/H

110632	R/H Coupe - 1 Pc. / Box
110633	L/H Coupe - 1 Pc. / Box
110634	R/H Convertible - 1 Pc. / Box
110635	L/H Convertible - 1 Pc. / Box
110636	R/H Fastback - 1 Pc. / Box
110637	L/H Fastback - 1 Pc. / Box

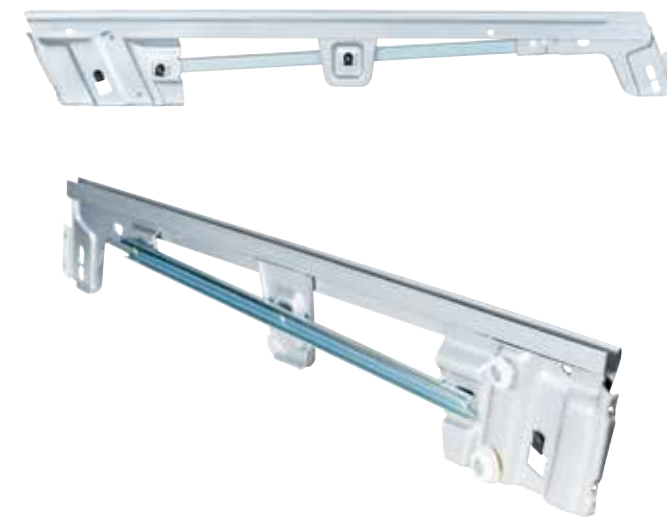

Door Glass Channel for 1967-68 Ford Mustang Coupe, Convertible, & Fastback

- Heavy 16 gauge stamped channel with riveted track rollers
- Sold individually, please specify L/H or R/H

110638	R/H - 1 Pc. / Box
110639	L/H - 1 Pc. / Box



110488



110489

Rear Valance for 1964.5-66 Ford Mustang

- High quality 19 gauge sheet metal
- Black EDP coated
- Includes license plate mounting bracket with mounting holes
- Available with backup light cutouts only or backup & dual exhaust cutouts for Mustang GT

110488	Backup Light Cutouts - 1 Pc. / Box
110489	Backup Light & Exhaust Cutouts - 1 Pc. / Box



A-Pillar Hinge Jamb Post for 1966-67 Ford Bronco

- Exact duplicate of the factory OEM door pillar
- Has heavy duty hinge backing plates with 5/16-18 thread exactly like the original design
- Coated in weldable primer
- OEM #: C6TZ-9602501-A/C6TZ-9602500-A
- Sold individually, please specify L/H or R/H

110233	L/H - 1 Pc. / Box
110234	R/H - 1 Pc. / Box



A-Pillar Hinge Jamb Post for 1968-77 Ford Bronco

- Excellent quality 17 gauge sheet metal coated with weldable primer
- Three 5/16-18 square nuts installed for easy fender mounting
- Features two caged door hinge mounting plates with 5/16-18 threaded holes
- Original style steel fender liner panel included
- Sold individually, please specify L/H or R/H

110509	R/H - 1 Pc. / Box
110510	L/H - 1 Pc. / Box



Bumper Bolt Set for 1966-77 Ford Bronco & 1964.5-70 Ford Mustang

- Highly polished 1" long 7/16-14 carriage bolt to match that beautifully polished front and rear bumper
- Includes spring wave washers and serrated 7/16-14 flange locknuts
- Two extra 5/16-18 polished carriage bolts and nuts for the Mustang front bumper

110536	1 Set / Card
---------------	--------------



Door Striker Mounting Nut Plate Kit for 1932 Ford Closed Car

- High quality 20 gauge retainer bracket
- 12-24 D-nuts installed on a 19 gauge bracket
- Each kit comes with 2 retainers and 2 d-nut brackets
- All parts are coated in black EDP

B20123-1	1 Set / Bulk
-----------------	--------------



110512 110511

B-Pillar Reinforcement for 1966-77 Ford Bronco

- Stamped heavy 16 gauge sheet metal
- Coated in weldable primer
- Sold individually, please specify L/H or R/H

110511	L/H - 1 Pc. / Bulk
110512	R/H - 1 Pc. / Bulk



Front Floor Pan Assembly for 1968-77 Ford Bronco

- Fully assembled with spot welds to ensure proper structural integrity
- Each heavy duty steel panel is die stamped with all original contour and mounting detail
- Has all of the original cutouts such as fuel tank selector switch
- Coated in weldable primer

110504	1 Pc. / Box
---------------	-------------



Upper Hinge Has Original 12-24 Mirror Thread

Door Hinge Set for 1932-34 Ford Truck

- All mounting holes and threads fully machined & ready to install
- Precision cast stainless steel for strength & durability
- Includes stainless hinge pins and steel black oxide 5/16-24 hinge screws & washers
- One set required per door, fits L/H & R/H

B21010	Fits L/H & R/H - 1 Set / Box
---------------	------------------------------



Door Hinge Set for 1932 Closed Car (Exc. 3W)

- Fits front doors of 5 Window Coupe, Tudor, Fordor, Sport Coupe, B400 and Victoria
- All mounting holes and threads fully machined & ready to install
- Precision cast stainless steel for strength and durability
- Includes special threaded backing plates to mount hinge on door side
- Includes stainless hinge pins and steel black oxide 5/16-24 hinge screws & washers
- One set required per door, does not fit 3-Window Coupe

B20010	R/H - 1 Set / Box
B20011	L/H - 1 Set / Box



Stainless 3" x 10" Radiator Overflow Tank

- Show quality polished stainless steel tank
- Polished aluminum filler cap with o-ring seal
- Holds 2 1/4 pints
- Includes stainless mounting brackets, hardware, and instructions
- Universal application fits most classic cars, trucks and hot rods

A6132 1 Pc. / Color Box



2,400 LUMENS **5w X 9** HIGH POWER **12v-24v** MULTIPLE VOLTAGE

9 High Power LED Driving/Work Light with Side LED - Spot/Flood Light

- 6 LEDs at front - spot light and 3 LEDs at side - flood light
- Stainless steel mounting bracket and hardware
- Operates on 12V-24V, draws 2.8 Amps at 12V
- **3 years warranty**

36509 1 Pair / Color Box



Exterior Mirror for 1970-72 Chevy & GMC Truck

- Polished stainless steel mirror head & chrome plated arm
- Includes mounting pad, mounting bracket and screws
- Bundle includes: C707201 & C707202 pre-packed in one box for shipping

110748 1 Pair / Box



Exterior Mirror with LED Turn Signal for 1970-72 Chevy & GMC Truck

- Red 9 LED arrow hidden inside mirror glass (hidden when off)
- Polished stainless steel mirror head and chrome plated arm
- Includes mounting pad, mounting bracket and screws
- Easy hookup, just route wire through door jamb and connect to front turn signal wires under dash near steering column
- Correct for 1970-72, but can be used to update 1967-69 trucks
- Bundle includes: C707201-LED & C707202-LED pre-packed in one box for shipping

110749 1 Pair / Box



All American Series 6 Gauge Set

- 3 3/8" Speedo & Tach, 2 1/8" Fuel (240-33), oil, temp, & volts
- Stainless high step bezel with curved glass lens
- Available in black gauge face or nickel gauge face
- Includes all sending units except fuel sending unit

110752 **Black Gauge Face - 1 Set / Box**

110023 **Nickel Gauge Face - 1 Set / Box**

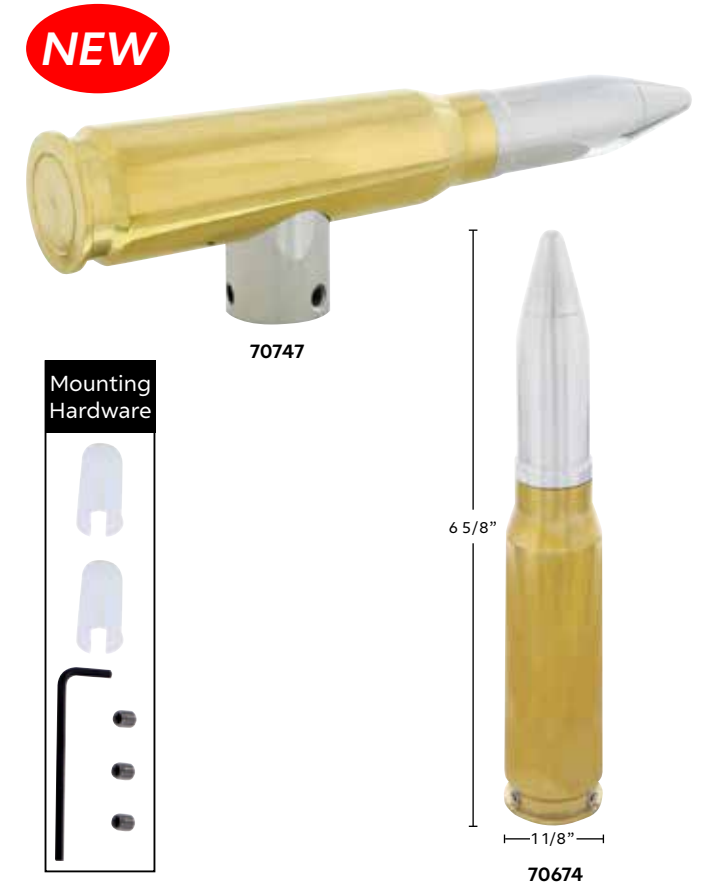

50 Caliber Bullet Shift Knob

- Ultra high quality finish
- Heavy duty solid brass construction ensures strength & durability
- Universal hex screw mount design, includes mounting hardware
- Available in t-handle or vertical design

70747 **T-Handle - 1 Pc. / Card**

70674 **Vertical - 1 Pc. / Card**



Load Resistor Kit, Solves LED Issue, 50 Watt/6 OHM

- 50W 6Ohm LED load resistors for LED turn signal lights or LED license plate lights
- Eliminate LED turn signal problems, such as hyper flashing, no flashing, or burnt out bulb indication
- Simulates the load of an incandescent bulb to solve most led issues
- Aluminum housing with proprietary heat management allows installation in most locations
- Kit includes two load resistors and 4 connectors

34235 2 Pcs. / Color Box

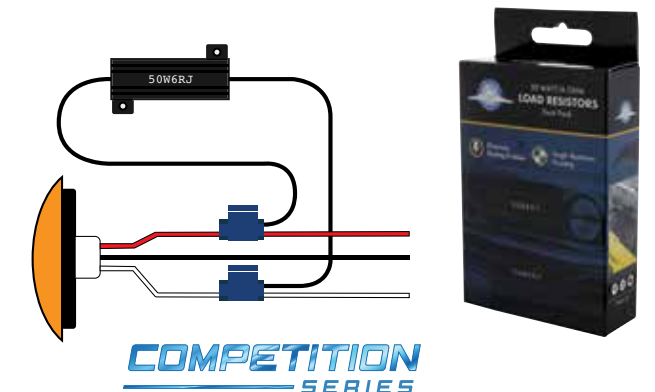

NEW ITEMS

July 2018



Original Style Stainless Steel Grille Insert for 1932 Ford Passenger Car

- Die stamped 304 polished stainless steel
- Desirable version with the separate outer surround trim
- Available with crank hole or without crank hole

B20340 with Crank Hole - 1 Pc. / Box

B20341 without Crank Hole - 1 Pc. / Box

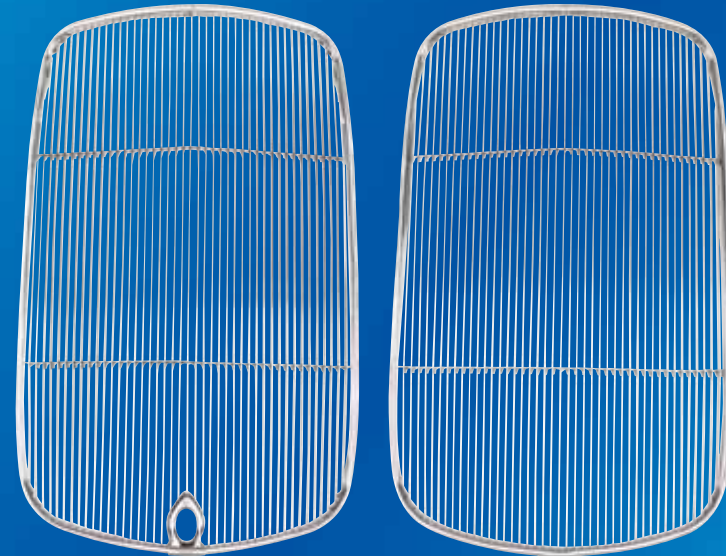

B20340

B20341



Original Style Steel Splash Apron For 1932 Ford Passenger Car & Truck

- Excellent quality 19 gauge sheet metal
- Die stamped with original contour detail
- Including all mounting holes and 1/4-20 d-nuts installed exactly like the original design
- Black EDP coated
- OEM #: B-16527

B20322 1 Pc. / Box



Interior Sun Visor Assembly for 1932 Ford Closed Car

- Deluxe version with polished stainless steel adjustable bracket
- Includes ready-to-use black textured fiberboard visor with original edge detail
- Uses removable hardware for easy disassembly if you choose to upholster
- Sold each

B20151 1 Pc. / Box



Battery Hold-Down Frame for 1955-57 Chevy & GMC Truck

- Excellent reproduction of the original design
- Fits group-24 battery size
- Die-stamped steel black painted

110471 1 Pc. / Bulk



Battery Hold-Down Bracket for 1958-66 Chevy & GMC Truck

- Anti-corrosive vinyl plastisol coating

110472 1 Pc. / Bulk



Battery Hold-Down Frame for 1947-55 Chevy & GMC Truck

- Excellent reproduction of the original design
- Die-stamped steel black painted

110470 1 Pc. / Box



Battery Hold-Down Bracket for 1958-66 Chevy & GMC Truck

- 304 High grade stainless steel

110473 1 Pc. / Box





Chrome Headlamp Bezel Set for 1955-57 Chevy Truck

- Includes seals
- Sold in set

110705 1 Set / Box



Fuel Sending Unit for 1973-75 Chevy & GMC Truck

- Made with corrosion resistant stainless steel
- RH tank, 1 outlet
- Brass float just like the original
- Includes rubber seal, stainless steel lock ring, and strainer
- OEM #: 6429439

110676 1 Pc. / Box



Fuel Sending Unit for 1980-89 Chevy & GMC Truck

- Made with corrosion resistant stainless steel
- LH tank, 3 outlets
- Brass float just like the original
- Includes rubber seal, stainless steel lock ring, and strainer
- OEM #: 25002010

110675 1 Pc. / Box



Fuel Sending Unit for 1980-89 Chevy & GMC Truck

- Made with corrosion resistant stainless steel
- RH tank, 3 outlets
- Brass float just like the original
- Includes rubber seal, stainless steel lock ring, and strainer
- OEM #: 25002007

110671 1 Pc. / Box



Fuel Sending Unit for 1973-79 Chevy & GMC Truck

- Made with corrosion resistant stainless steel
- LH tank, 2 outlets
- Brass float just like the original
- Includes rubber seal, stainless steel lock ring, and strainer
- OEM #: 25000612

110674 1 Pc. / Box



Fuel Sending Unit for 1973-79 Chevy & GMC Truck

- Made with corrosion resistant stainless steel
- RH tank, 2 outlets
- Brass float just like the original
- Includes rubber seal, stainless steel lock ring, and strainer
- OEM #: 25000610

110670 1 Pc. / Box



Fuel Sending Unit for 1980-84 Chevy & GMC Truck

- Made with corrosion resistant stainless steel
- LH tank, 2 outlets
- Brass float just like the original
- Includes rubber seal, stainless steel lock ring, and strainer
- OEM #: 25002009

110673 1 Pc. / Box



Fuel Sending Unit for 1973-79 Chevy & GMC Truck - 6 cyl

- Made with corrosion resistant stainless steel
- RH tank, 3 outlets
- Brass float just like the original
- Includes rubber seal, stainless steel lock ring, and strainer
- OEM #: 25000611

110672 1 Pc. / Box



Headlamp Bracket for 2007-2016 Jeep Wrangler

- Sold individually, please specify L/H or R/H side
- OEM #: 55078149AC

110585	L/H - 1 Pc. / Box
110586	R/H - 1 Pc. / Box



Chrome Art-Deco Nude Lady Grab Handle

- Unique avant-garde design
- Quality die cast & beautifully chrome plated
- Traditionally used for classic big rig trucks
- Also perfect for doors, cabinets, knobs, mancave, garage
- Mounting hole center to center distance is 11-1/2"
- Includes stainless mounting screws, lock nuts and hex wrench for trucks
- Mounting screws for doors & cabinets not included

C5036-3	1 Pc. / Box
----------------	-------------

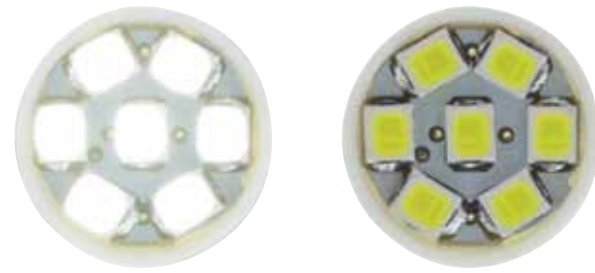

7 White LED 912/921 Bulb

- 912/921 Bulb with 7 micros LEDs
- 912/921 Wedge base, also fits 194 socket

36504	2 Pcs. / Card
--------------	---------------

34
LUMENS



High Power LED 4" x 6" Rectangular Headlight

- Available with 9-white led daytime running light or 9-amber LED auxiliary light
- Waterproof die cast housing and polycarbonate lens provide maximum protection and durability
- OEM fit, plug into existing wiring harness
- Sold each, please specify low beam or high beam

31150	Low Beam with Amber Auxiliary Light - 1 Pc. / Color Box
31151	High Beam with Amber Auxiliary Light - 1 Pc. / Color Box
31152	Low Beam with Daytime Running Light - 1 Pc. / Color Box
31153	High Beam with Daytime Running Light - 1 Pc. / Color Box



5 3/4" Motorcycle Headlight - Bottom Mount

- Headlight housing available separately: Item #32051 (Chrome) / #32052 (Black)

Item #	Bottom Mount Motorcycle Headlight		
	Housing	Bulb	Bulb Type
32787	32051 (Chrome)	S2005LED	Crystal Headlight w/Amber LED Auxiliary/Utility Light
32788	32052 (Black)	S2005LED	Crystal Headlight w/Amber LED Auxiliary/Utility Light
32791	32051 (Chrome)	31386	Crystal Headlight
32792	32052 (Black)	31386	Crystal Headlight
32795	32051 (Chrome)	31259	9 LED Headlight w/Amber LED Position Light Bar
32796	32052 (Black)	31259	9 LED Headlight w/Amber LED Position Light Bar
32799	32051 (Chrome)	31267	9 LED Headlight w/White LED Position Light Bar
32800	32052 (Black)	31267	9 LED Headlight w/White LED Position Light Bar
32803	32051 (Chrome)	31201	8 High Power LED Silver Headlight
32804	32052 (Black)	31201	8 High Power LED Silver Headlight
32807	32051 (Chrome)	31202	8 High Power LED Black Headlight
32808	32052 (Black)	31202	8 High Power LED Black Headlight



Headlight Bulbs



S2005LED



31386



31259



31267



31201



31202

5 3/4" Motorcycle Headlight - Side Mount

- Headlight housing available separately: Item #32051 (Chrome) / #32052 (Black)

Item #	Side Mount Motorcycle Headlight		
	Housing	Bulb	Bulb Type
32789	32051 (Chrome)	S2005LED	Crystal Headlight w/Amber LED Auxiliary/Utility Light
32790	32052 (Black)	S2005LED	Crystal Headlight w/Amber LED Auxiliary/Utility Light
32793	32051 (Chrome)	31386	Crystal Headlight
32794	32052 (Black)	31386	Crystal Headlight
32797	32051 (Chrome)	31259	9 LED Headlight w/Amber LED Position Light Bar
32798	32052 (Black)	31259	9 LED Headlight w/Amber LED Position Light Bar
32801	32051 (Chrome)	31267	9 LED Headlight w/White LED Position Light Bar
32802	32052 (Black)	31267	9 LED Headlight w/White LED Position Light Bar
32805	32051 (Chrome)	31201	8 High Power LED Silver Headlight
32806	32052 (Black)	31201	8 High Power LED Silver Headlight
32809	32051 (Chrome)	31202	8 High Power LED Black Headlight
32810	32052 (Black)	31202	8 High Power LED Black Headlight

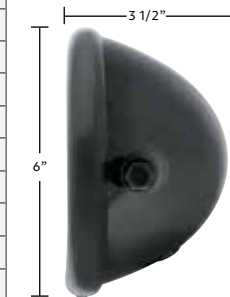

5 3/4" Motorcycle Headlight Housing Only

- Available with chrome or black housing

32051	Chrome / Bottom Mount - 1 Pc. / Box
32052	Black / Bottom Mount - 1 Pc. / Box
32053	Chrome / Side Mount - 1 Pc. / Box
32054	Black / Side Mount - 1 Pc. / Box

NEW ITEMS

July 2018



110583

110584



Includes Foam Gaskets & Mounting Hardware



Billet Aluminum Tail Light Bezels for 1966-77 Ford Bronco

- CNC milled out of single solid aluminum block
- Durable anodized for a tough off-road look
- Stainless steel extended length socket head screws included for use with original tail light lens mounting holes
- Includes foam gaskets to prevent scratches to the tail light panel
- Sold as set

110583 Clear Anodized - 1 Set / Color Box
110584 Satin Black Anodized - 1 Set / Color Box

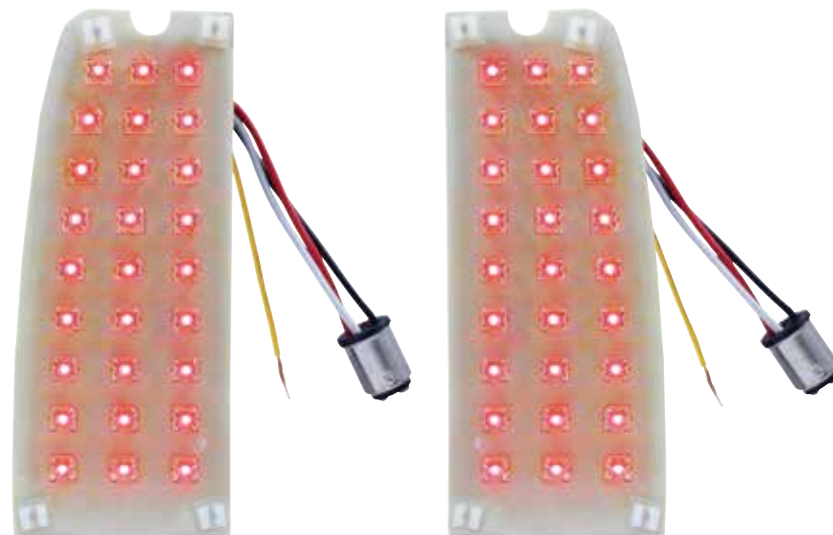

27 LED Sequential Tail Light Retrofit for 1967-77 Ford Bronco & 1967-72 Ford Truck

- Super bright LED circuit board installs behind existing lens
- Dual function with tail light & bright stop/turn signal
- Features sequential operation with selector switch to select sequential function ON/OFF
- Features sequential once brake attention function
- Easy electrical connection with 1157 plug, no modification to vehicle
- Requires united pacific LED turn signal flasher, item # 90652



SEQUENTIAL
F · L · A · S · H

(((BRAKE ATTENTION)))

110497 1 Pair / Card



110366

110367

Front Inner Wheel Tub for 1966-77 Ford Bronco

- High quality 18 gauge stamped steel reproduction
- Features all original design and tough spot welded construction
- Popular 1973-75 design works best with most steering setups and aftermarket power brake setup
- Coated with weldable primer
- Sold individually, please specify L/H or R/H side

110366 R/H - 1 Pc. / Box
110367 L/H - 1 Pc. / Box



Front Wheel Tub to Radiator Core Support & Body Mount Brace Set for 1966-77 Ford Bronco (3/Set)

- Heavy duty 14 gauge sheet metal.
- Wheel tub braces with radiator core supports with frame mounts spot welded exactly like the original design
- Features mounting holes for battery tray installation
- Coated with weldable primer

110368 3 Pcs. Set / Box



Fuel Sending Unit for 1966-76 Ford Bronco

- Made with corrosion resistant stainless steel
- Brass float just like the original
- Includes rubber seal, stainless steel lock ring, and strainer

110664 1 Pc. / Box



Battery Tray for 1966-77 Ford Bronco

- Excellent reproduction of the original design
- Die-stamped steel black painted

110557 1 Pc. / Bulk



Battery Hold-Down Bracket for 1966-69 Ford Bronco & 1967-70 Ford Mustang

- Anti-corrosive vinyl plastisol coating

110522 1 Pc. / Bulk



Auxiliary Fuel Tank Sending Unit for 1966-77 Ford Bronco

- Made with corrosion resistant stainless steel
- Brass float just like the original
- Includes rubber seal, stainless steel lock ring, and strainer

110665 1 Pc. / Box



Battery Hold-Down "J" Bolt Set for 1966-77 Ford Bronco & 1967-70 Ford Mustang

- Anti-corrosive coating
- Zinc plated

110523 1 Pair / Bulk

NEW ITEMS

July 2018



110601



110605



110602



110606

Complete Door Glass Assembly for 1965-66 Ford Mustang Fastback

- Heavy 16 gauge steel channel with all of the original detail and mounting holes
- Highly polished stainless steel glass frame
- Available with crystal clear non-tinted tempered window glass or original style green tinted tempered window glass
- Factory assembled with high quality rubber seal
- Exactly like the original design for a straight forward replacement
- Sold individually, please specify L/H or R/H side

110600	R/H Clear - 1 Pc. / Box
110601	L/H Clear - 1 Pc. / Box
110602	R/H Tint - 1 Pc. / Box
110603	L/H Tint - 1 Pc. / Box

Complete Door Glass Assembly for 1965-66 Ford Mustang Convertible

- Heavy 16 gauge steel channel with all of the original detail and mounting holes
- Highly polished stainless steel glass frame
- Available with crystal clear non-tinted tempered window glass or original style green tinted tempered window glass
- Factory assembled with high quality rubber seal
- Exactly like the original design for a straight forward replacement
- Sold individually, please specify L/H or R/H side

110604	R/H Clear - 1 Pc. / Box
110605	L/H Clear - 1 Pc. / Box
110606	R/H Tint - 1 Pc. / Box
110607	L/H Tint - 1 Pc. / Box



110610



10609

Complete Door Glass Assembly for 1965-66 Ford Mustang Coupe

- Heavy 16 gauge steel channel with all of the original detail and mounting holes
- Highly polished stainless steel glass frame
- Available with crystal clear non-tinted tempered window glass or original style green tinted tempered window glass
- Factory assembled with high quality rubber seal
- Exactly like the original design for a straight forward replacement
- Sold individually, please specify L/H or R/H side

110608	R/H Clear - 1 Pc. / Box
110609	L/H Clear - 1 Pc. / Box
110610	R/H Tint - 1 Pc. / Box
110611	L/H Tint - 1 Pc. / Box



110622



110621

Complete Door Glass Assembly for 1967-68 Ford Mustang Coupe

- Heavy 16 gauge stamped channel with riveted track rollers
- Polished stainless steel upper glass frame
- Available with crystal clear non-tinted tempered window glass or original style green tinted tempered window glass
- Fully assembled from factory for a quick and straight forward replacement
- Sold individually, please specify L/H or R/H side

110620	R/H Clear - 1 Pc. / Box
110621	L/H Clear - 1 Pc. / Box
110622	R/H Tint - 1 Pc. / Box
110623	L/H Tint - 1 Pc. / Box



110630



110629

Complete Door Glass Assembly for 1967-68 Ford Mustang Fastback

- Heavy 16 gauge stamped channel with riveted track rollers
- Polished stainless steel upper glass frame
- Available with crystal clear non-tinted tempered window glass or original style green tinted tempered window glass
- Fully assembled from factory for a quick and straight forward replacement
- Sold individually, please specify L/H or R/H side

110628	R/H Clear - 1 Pc. / Box
110629	L/H Clear - 1 Pc. / Box
110630	R/H Tint - 1 Pc. / Box
110631	L/H Tint - 1 Pc. / Box



110626



110625

Complete Door Glass Assembly for 1967-68 Ford Mustang Convertible

- Heavy 16 gauge stamped channel with riveted track rollers
- Polished stainless steel upper glass frame
- Available with crystal clear non-tinted tempered window glass or original style green tinted tempered window glass
- Fully assembled from factory for a quick and straight forward replacement
- Sold individually, please specify L/H or R/H side

110624	R/H Clear - 1 Pc. / Box
110625	L/H Clear - 1 Pc. / Box
110626	R/H Tint - 1 Pc. / Box <i>Coming Soon</i>
110627	L/H Tint - 1 Pc. / Box <i>Coming Soon</i>



110613



110637



110615



110635



110617



110633

Door Glass Frame & Channel Kit for 1965-66 Ford Mustang

- Beautiful chrome finish door glass frame
- Heavy duty gauge steel channel with all of the original detail and mounting holes
- TEK screws included for mounting the frame to channel
- Sold individually, please specify L/H or R/H side

110612	R/H Fastback - 1 Pc. / Box
110613	L/H Fastback - 1 Pc. / Box
110614	R/H Convertible - 1 Pc. / Box
110615	L/H Convertible - 1 Pc. / Box
110616	R/H Coupe - 1 Pc. / Box
110617	L/H Coupe - 1 Pc. / Box

Door Glass Frame & Channel Kit for 1967-68 Ford Mustang

- Heavy 16 gauge stamped channel with riveted track rollers
- Polished stainless steel upper glass frame
- Sold individually, please specify L/H or R/H side

110636	R/H Fastback - 1 Pc. / Box
110637	L/H Fastback - 1 Pc. / Box
110634	R/H Convertible - 1 Pc. / Box
110635	L/H Convertible - 1 Pc. / Box
110632	R/H Coupe - 1 Pc. / Box
110633	L/H Coupe - 1 Pc. / Box



Quarter Window Assembly with Clear Glass for 1967-68 Ford Mustang Coupe

- Heavy 16 gauge stamped steel window track with mounting hardware
- Crystal clear non-tinted glass tempered glass
- Beautifully polished stainless steel window frame with weatherstrip
- Fully assembled from factory for a quick and straight forward replacement
- Sold individually, please specify L/H or R/H side

110644	R/H - 1 Pc. / Box
110645	L/H - 1 Pc. / Box <i>Coming Soon</i>



110647



110646

Quarter Window Assembly with Clear Glass for 1969-70 Ford Mustang Fastback

- Quality crystal clear untinted tempered glass
- High quality chrome window glass frame with rubber seal
- Upper and lower pivot arm with mounting brackets included
- Show quality chrome plated handle with steel braided safety wire and mounting bracket
- Sold individually, please specify L/H or R/H side

110646	R/H - 1 Pc. / Box
110647	L/H - 1 Pc. / Box



110488



110489

Rear Valance for 1964.5-66 Ford Mustang

- High quality 19 gauge sheet metal
- Black EDP coated
- Includes license plate mounting bracket with mounting holes
- Available with backup light cutouts only or backup & dual exhaust cutouts for Mustang GT

110488	Backup Light Cutouts - 1 Pc. / Box
110489	Backup Light & Exhaust Cutouts - 1 Pc. / Box



110493



110490

Rear Valance for 1967-68 Ford Mustang

- High quality 19 gauge sheet metal
- Feature all of the original contour detail
- License plate bracket with mounting holes spot welded from factory
- Includes the mounting tabs on the back of the Valance for easy installation
- Straight forward backup light installation with existing light cutout and mounting holes
- Black EDP coated
- Available with backup light cutouts only or backup & dual exhaust cutouts for Mustang GT

110493	Backup Light Cutouts - 1 Pc. / Box
110490	Backup Light & Exhaust Cutouts - 1 Pc. / Box



110494



110498

Rear Valance for 1969-70 Ford Mustang

- High quality 19 gauge sheet metal
- Feature all of the original contour detail
- License plate bracket with mounting holes spot welded from factory
- Includes the mounting tabs on the back of the valance for easy installation
- Straight forward backup light installation with existing light cutout and mounting holes
- Black EDP coated
- Available with backup light cutouts only or backup & dual exhaust cutouts for Mustang GT

110494 Backup Light Cutouts - 1 Pc. / Box

110498 Backup Light & Exhaust Cutouts - 1 Pc. / Box



67 Shelby Style Tail Light Panel for 1967-68 Ford Mustang

- Quality 19 gauge sheet metal reproduction
- Feature the iconic 1967 Shelby GT style tail light cutout
- Includes cutout for the trunk lock cylinder and fuel filler neck
- Correctly timed fuel cap mounting holes to make sure the emblem is nice and straight
- Black EDP coated

110653 1 Pc. / Box

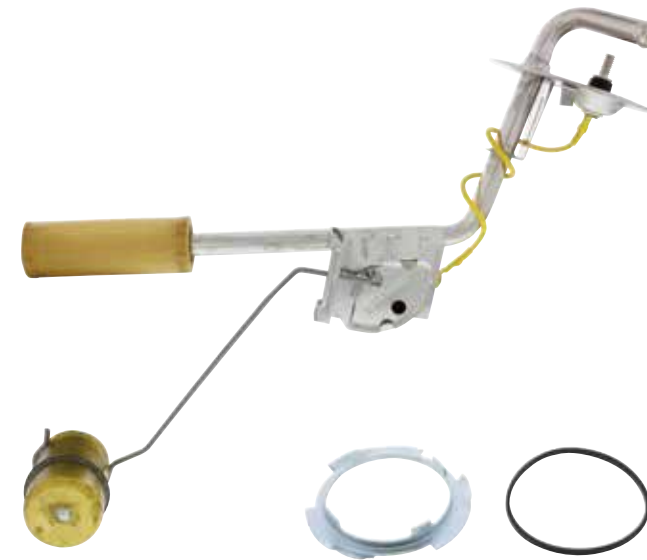

Fuel Sending Unit for 1964-68 Ford Mustang

- Made with corrosion resistant stainless steel
- Brass float just like the original
- Includes rubber seal, stainless steel lock ring, and strainer

110669 1 Pc. / Box



16 GAL Fuel Tank with Drain Plug for 1964-68 Ford Mustang

- Made with corrosion resistant stainless steel sheet
- Die stamped with all original contour and mounting holes
- Machine welded to ensure proper seal
- Stainless steel drain plug pre-installed
- OEM #: C5ZZ-9002-D

110678 1 Pc. / Box

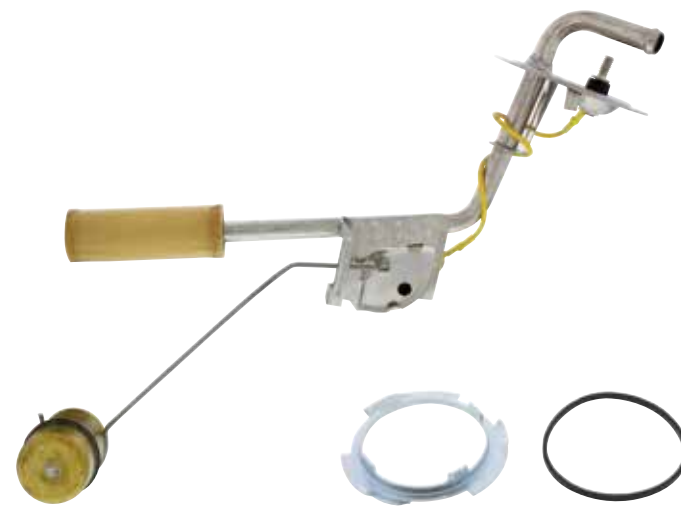

Fuel Sending Unit for 1969 Ford Mustang

- Made with corrosion resistant stainless steel
- Brass float just like the original
- Includes rubber seal, stainless steel lock ring, and strainer

110666 1 Pc. / Box

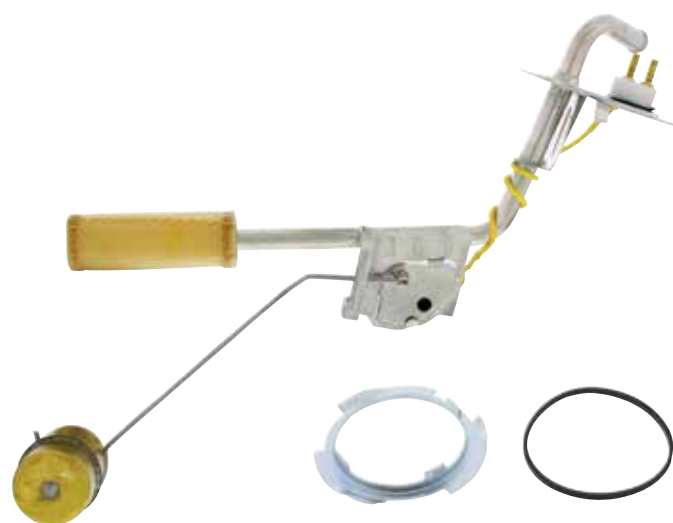

Fuel Sending Unit for 1971-73 Ford Mustang

- Made with corrosion resistant stainless steel
- Brass float just like the original
- Includes rubber seal, stainless steel lock ring, and strainer

110668 1 Pc. / Box



Chrome Interior Rear View Mirror Bracket for 1968-69 Ford Mustang

- Highly detailed die casting with chrome plating
- Includes mirror head mounting screw

110710 1 Pc. / Box



Battery Hold-Down Bracket for 1966-69 Ford Bronco & 1967-70 Ford Mustang

- Anti-corrosive coating

110522 1 Pc. / Bulk



Battery Hold-Down "J" Bolt Set for 1966-77 Ford Bronco & 1967-70 Ford Mustang

- Anti-corrosive coating

110523 1 Pair / Bulk

NEW ITEMS

August 2018

1932-34 Ford Truck

Cab Back for 1932-33 Ford Truck

- Exact replica of original die stamped cab back
- Fits 1934, does not have the 1934 large reveal on back
- Precision punched carriage bolt holes to OE specification for cab back wood mounting
- Black EDP coated
- Oversize freight policy

B21051 1 Pc. / Box



Mustang Parts

Chrome Front Bumper for 1967-68 Ford Mustang

- Made with heavy gauge sheet metal
- Features all original contour and detail
- Precision punched square mounting bolt holes for easy and quick installation
- Show ready chrome plating finish

110484 1 Pc. / Box



Chrome Front Bumper for 1969-70 Ford Mustang

- Made with heavy gauge sheet metal
- Features all original contour and detail
- Precision punched square mounting bolt holes for easy and quick installation
- Show ready chrome plating finish

110485 1 Pc. / Box



Hub Cap for 1968-69 Ford Mustang

- Highly polished stainless steel with black outer ring
- Also fits 1968-69 Ford Fairlane, Torino, and 1968-69 Mercury Montego, and Comet
- Sold each

A6047 1 Pc. / Box



Hub Cap for 1968-69 Ford Mustang

- Highly polished stainless steel
- Red "GT" lettering with black outer ring
- Also fits 1968-69 Ford Fairlane, Torino, and 1968-69 Mercury Montego, and Comet
- Sold each

A6046 1 Pc. / Box

Ford Parts

Shoebox Gauge for 1949-50 Ford - Kilometers

- Direct fit into the stock dashboard using factory holes with the included mounting hardware

110769 1 Pc. / Box



Universal Products



19 High Power LED Work Light with Side LED

- 19 high power 1.5W LEDs with spot & flood function for exceptional performance
- Flip bracket mount fits both driver's & passenger's side
- Operates on 9V-30V, draws 1.75 Amps at 12V
- 3 year warranty

36505 1 Pc. / Color Box

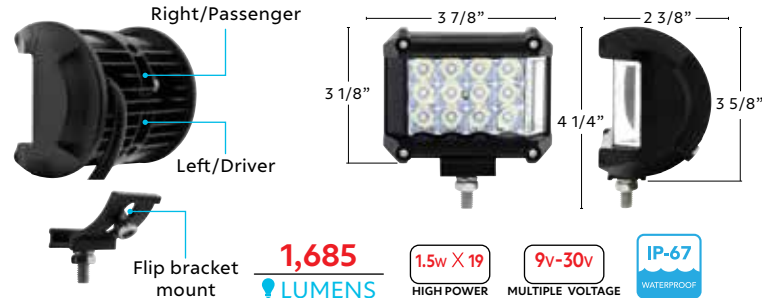

Spike Nut Cover for Chevy & GMC Full Size Pickup

- Fits many 2003-15 Chevrolet & GMC truck models with original steel wheel hubcap
- Spike nut cover is sized to fit the twist-on simulated lug nut on OE steel wheel hubcap
- Available in chrome and black
- Spike covers sold each. **Hubcap not included**

10349B Black - 1 Pc. / Bulk (New)
10351B Chrome - 1 Pc. / Bulk



Steering Wheel Spinner

- Fits 1 1/8" to 1 5/8" diameter steering wheel grips
- Classic design intended to reduce effort and fatigue
- Not recommended for padded steering wheels

70092 1 Pc. / Card

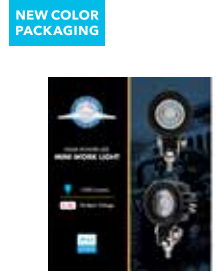

High Power LED Mini Work Light

- High power 10W Cree LED with spot function
- Operates on 9V-30V, draws 0.5 Amps at 12V
- 3 year warranty

36506 1 Pc. / Color Box

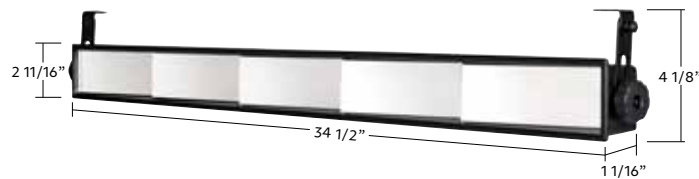

Panoramic 5-Panel Rearview Mirror

- 5-panel mirror design provides wider rear view
- Easy installation in most cars, trucks & power sports vehicles
- Mounting hardware & instruction included
- May interfere with sun visors on some applications
- Recommended for performance & off-road vehicles

60051 1 Pc. / Color Box



Black Day/Night Interior Rearview Mirror Assembly - Flat Type Mount

- Convenient day/night feature
- Available in 8" & 10"

60052 8" - 1 Pc. / Box
60053 10" - 1 Pc. / Box



50" x 60" Flannel Fleece Comfort Blanket

- Ultra soft and lightweight
- Wrinkle/fade/shrink resistant
- 100% microfiber polyester
- Machine washable

99113 Navy Blue - 1 Pc. / Card
99114 Scarlet Red - 1 Pc. / Card
99115 Ash Black - 1 Pc. / Card
99116 Olive Green - 1 Pc. / Card

Motorcycle Parts



Motorcycle Rubber Grip Set

- High quality molded rubber provides comfortable grip
- Old school dirt track look in 4 colors, sold in pairs
- Available for 7/8" or 1" handlebar, twist grip side has larger ID

52000 Black 1"/1-1/8" (25/28mm) - 1 Pair / Color Box
52001 Red 1"/1-1/8" (25/28mm) - 1 Pair / Color Box
52002 White 1"/1-1/8" (25/28mm) - 1 Pair / Color Box
52003 Natural 1"/1-1/8" (25/28mm) - 1 Pair / Color Box
52004 Black 7/8"/1" (22/25mm) - 1 Pair / Color Box
52005 Red 7/8"/1" (22/25mm) - 1 Pair / Color Box
52006 White 7/8"/1" (22/25mm) - 1 Pair / Color Box
52007 Natural 7/8"/1" (22/25mm) - 1 Pair / Color Box

NEW ITEMS

August 2018



Front Fender for 1966-77 Ford Bronco

- Die stamped with high quality sheet metal
- Features all original fender curvature and mounting pattern
- Black EDP coated
- Sold individually, please specify left or right hand side

110463

L/H - 1 Pc. / Box

110464

R/H - 1 Pc. / Box



Black EDP Hood with W/S U-Bolt Holes, Washer Holes, & Vents for 1966-77 Ford Bronco

- Die stamped with high quality 18 gauge sheet metal
- Uses the early 66-69 style hood rod prop location
- Pre-drilled fold-down windshield u-bolt mounting holes with reinforcement center brace
- Also has air box vent openings and washer mounting holes
- Black EDP coated

110460 1 Pc. / Box



Black EDP Hood with Vents for 1966-77 Ford Bronco

- Die stamped with high quality 18 gauge sheet metal
- Uses the early 66-69 style hood rod prop location
- Has air box vent openings
- Black EDP coated

110461 1 Pc. / Box



Black EDP Hood with Washer Holes & Vents for 1966-77 Ford Bronco

- Die stamped with high quality 18 gauge sheet metal
- Uses the early 70-77 style hood rod prop location
- Has air box vent openings and washer mounting holes
- Black EDP coated

110462 1 Pc. / Box



110465



110466

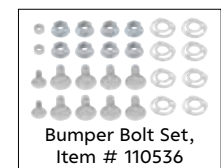

Front/Rear Bumper for 1966-77 Ford Bronco

- Made with heavy gauge sheet metal
- Can be used as the front or the rear
- Features all original square shaped mounting holes
- Available in chrome and black finish

110465

Chrome - 1 Pc. / Box

110466

Black - 1 Pc. / Box



B-Pillar Door Jamb for 1966-67 Ford Bronco

- Excellent stamped 17 gauge sheet metal
- Features all original contour and detail
- Caged striker mounting plate with 5/16-18 tapped holes
- Includes upper pillar post extension
- Coated with weldable primer
- Sold individually, please specify LH or RH side

110474 L/H - 1 Pc. / Box
110475 R/H - 1 Pc. / Box

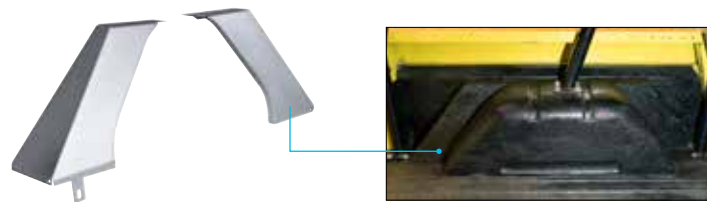

Tank Filler Guard Set for 1966-76 Ford Bronco

- Made with high quality sheet metal
- Has identical curvature and detail exactly like the original design
- Coated in weldable primer for easy attachment to wheel house and inner quarter panel
- A set includes the front and the back guard

110331 1 Pc. / Box



1973-77 Style Dash Panel with Single DIN Radio Cutout for 1966-77 Ford Bronco

- Die stamped with quality 20 gauge sheet metal
- Features the later 73-77 original style contour and component cutouts
- Single DIN radio cutout for easy installation of modern head units
- Coated with weldable primer

110502 1 Pc. / Box



B-Pillar Door Jamb for 1968-77 Ford Bronco

- Excellent sheetmetal reproduction of the door b-Pillar jamb post with all of the original contour detail
- Die stamped with 18 gauge steel, coated in weldable primer
- Includes door latch striker plate, striker plate shims, striker plate screws & upper corner filler strip
- Sold individually, please specify LH or RH side
- OEM number: C8TZ-9628161-A

110354 L/H - 1 Pc. / Box
110355 R/H - 1 Pc. / Box



Air Vent Box Gasket for 1966-77 Ford Bronco

- Made of highly durable black foam material
- Air vent box available separately, item #: 110239

110095 1 Pc. / Bulk

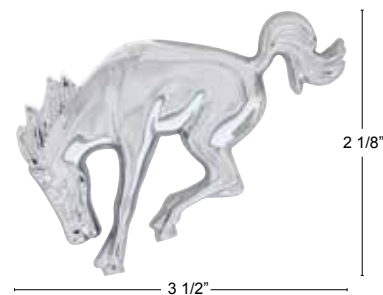

Chrome Bucking Bronco Emblem

- Easy installation
- Double sided tape included for easy installation

50130 1 Pc. / Card



NEW ITEMS

August 2018

Chevy Trucks Parts & Accessories



Black EDP Front Bumper for 1947-55 Chevy & GMC Truck

- Die stamped with heavy gauge sheet metal
- Features identical curvature exactly like the original design
- Precision punched square carriage bolt holes for straight forward installation
- With black EDP coated finish

110729 1 Pc. / Box



Black EDP Rear Bumper for 1947-53 Chevy & GMC Truck

- Die stamped with heavy gauge sheet metal
- Features identical curvature exactly like the original design
- Precision punched square carriage bolt holes for straight forward installation
- Black EDP coated

110730 1 Pc. / Box



Black EDP Front Bumper for 1960-62 Chevy & GMC Truck

- Die stamped with heavy gauge sheet metal
- Features all the original contour and detail
- Precision punched square carriage Bolt holes for straight forward installation
- Pre-drilled license plate mounting holes
- Black EDP coated

110721 1 Pc. / Box



Black EDP Front Bumper for 1963-66 Chevy & GMC Truck

- Die stamped with heavy gauge sheet metal
- Features all the original contour and detail
- Precision punched square carriage bolt holes for straight forward installation
- Pre-drilled license plate mounting holes
- Black EDP coated

110722 1 Pc. / Box



Black EDP Rear Bumper for 1963-66 Chevy & GMC Truck

- Die stamped with heavy gauge sheet metal
- Features all the original contour and detail
- License plate recess and mounting bracket mounting holes
- Precision punched square carriage bolt holes for straight forward installation
- Black EDP coated

110725 1 Pc. / Box



Black EDP Front Bumper for 1967-70 Chevy Truck & 1967-68 GMC Truck

- Die stamped with heavy gauge sheet metal
- Features all the original contour and detail
- Precision punched square carriage bolt holes for straight forward installation
- Pre-drilled license plate mounting holes
- Black EDP coated

110718 1 Pc. / Box



Black EDP Rear Bumper for 1967-87 Chevy & GMC Fleetside Truck

- Die stamped with heavy gauge sheet metal
- Features all the original contour and detail
- License plate recess with mounting holes
- Precision punched square carriage bolt holes for straight forward installation
- Black EDP coated

110733 1 Pc. / Box



Black EDP Front Bumper with Parking Light Recesses for 1967-72 GMC Truck

- Die stamped with heavy gauge sheet metal
- Features all the original contour and later style's parking light clearance recesses
- Precision punched square carriage bolt holes for straight forward installation
- Pre-drilled license plate mounting holes
- Black EDP coated

110719 1 Pc. / Box



Black EDP Front Bumper for 1971-72 Chevy Truck

- Die stamped with heavy gauge sheet metal
- Features all the original contour and detail
- Parking light pockets with mounting flanges
- Precision punched square carriage bolt holes for straight forward installation
- Pre-drilled license plate mounting holes
- Black EDP coated

110720 1 Pc. / Box



Chevy & GMC Tail Light Socket Wiring Boot with Rubber Conduit

- Identical design as the 1954-59 Chevy & GMC stepside truck's wiring
- Excellent universal tail light wiring boot for all hot rod & restoration projects
- Total length is 21-1/2"
- Sold each

C545504-2 1 Pc. / Bulk

NEW ITEMS

September 2018

Sequential Tail Light, Parts & Accessories for Ford, Chevy & GMC Truck



DOT & SAE APPROVED

Sequential Tail Light

38 Red LED Sequential Tail Light for 1953-56 Ford Truck

- Super bright red LED with fully sealed epoxy coated electronics
- Selector switch to control sequential function off, direction left, or direction right
- Also features a brake attention option with a sequential-once function
- 1157 double connector with offset pins, plugs into existing tail lamp socket
- Requires use of United Pacific LED turn signal flasher, item number: 90652 or 90649
- Sold individually, please specify left or right hand side



««« SEQUENTIAL F · L · A · S · H »»» (((BRAKE ATTENTION)))

110144	L/H - 1 Pc. / Card
110145	R/H - 1 Pc. / Card



DOT & SAE APPROVED



««« SEQUENTIAL F · L · A · S · H »»» (((BRAKE ATTENTION)))

40 Red LED Sequential Tail Light for 1960-66 Chevy & GMC Fleetside Truck

- Super bright red LED with fully sealed epoxy coated electronics
- Selector switch to control sequential function off, direction left, or direction right
- Also features a brake attention option with a sequential-once function
- 1157 double connector with offset pins, plugs into existing tail lamp socket
- Requires use of United Pacific LED turn signal flasher, item number: 90652 or 90649

110199 1 Pc. / Card

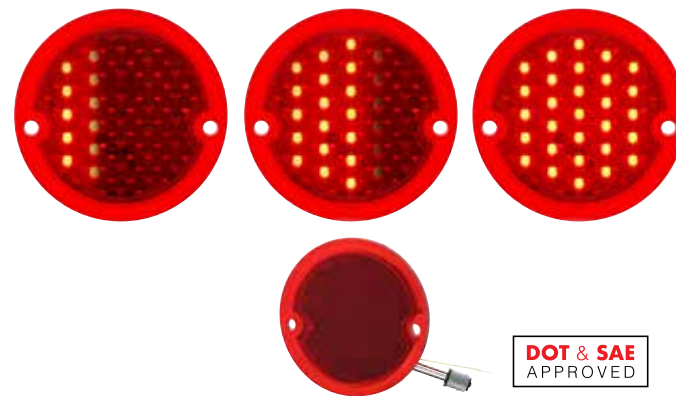

DOT & SAE APPROVED



««« SEQUENTIAL F · L · A · S · H »»» (((BRAKE ATTENTION)))

29 Red LED Sequential Tail Light for 1954-59 Chevy & GMC Truck

- Super bright red LED with fully sealed epoxy coated electronics
- Selector switch to control sequential function off, direction left, or direction right
- Also features a brake attention option with a sequential-once function
- 1157 double connector with offset pins, plugs into existing tail lamp socket
- Requires use of United Pacific LED turn signal flasher, item number: 90652 or 90649

110405 1 Pc. / Card

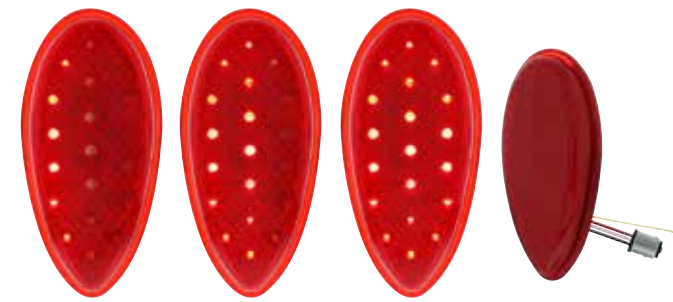

DOT & SAE APPROVED



««« SEQUENTIAL F · L · A · S · H »»» (((BRAKE ATTENTION)))

19 Red LED Sequential Tail Light for 1938-39 Ford Passenger Car

- Super bright red LED with fully sealed epoxy coated electronics
- Selector switch to control sequential function off, direction left, or direction right
- Also features a brake attention option with a sequential-once function
- 1157 double connector with offset pins, plugs into existing tail lamp socket
- Requires use of United Pacific LED turn signal flasher, item number: 90652 or 90649

110253 1 Pc. / Card



DOT & SAE APPROVED



««« SEQUENTIAL F · L · A · S · H »»» (((BRAKE ATTENTION)))

19 Red LED Sequential Tail Light Assembly for 1938-39 Ford Passenger Car

- Super bright red LED with fully sealed epoxy coated electronics
- Black powder coated housing, stainless steel rim
- Selector switch to control sequential function off, direction left, or direction right
- Also features a brake attention option with a sequential-once function
- 1157 double connector with offset pins, plugs into existing tail lamp socket
- Requires use of United Pacific LED turn signal flasher, item number: 90652 or 90649

110796 1 Pc. / Card

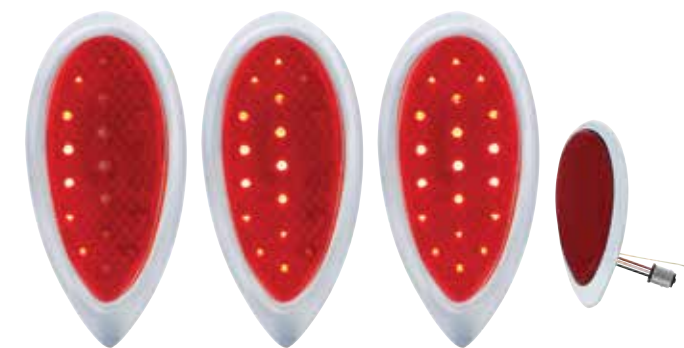

DOT & SAE APPROVED



««« SEQUENTIAL F · L · A · S · H »»» (((BRAKE ATTENTION)))

19 Red LED Sequential Tail Light with Chrome Flush Mount Bezel for 1938-39 Ford Passenger Car

- Super bright red LED with fully sealed epoxy coated electronics
- Chrome flush mount bezel
- Selector switch to control sequential function off, direction left, or direction right
- Also features a brake attention option with a sequential-once function
- 1157 double connector with offset pins, plugs into existing tail lamp socket
- Requires use of United Pacific LED turn signal flasher, item number: 90652 or 90649

110797 1 Pc. / Card

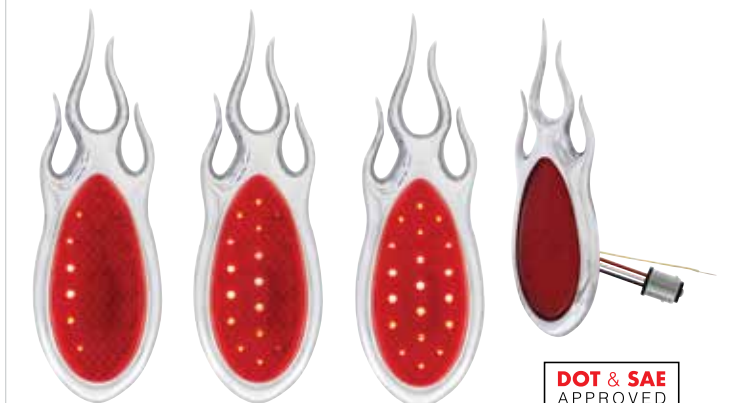

DOT & SAE APPROVED



««« SEQUENTIAL F · L · A · S · H »»» (((BRAKE ATTENTION)))

1938-39 Ford Car Style LED Sequential Tail Light with Chrome Flame Bezel

- Super bright red LED with fully sealed epoxy coated electronics
- Chrome plastic flame light bezel
- Selector switch to control sequential function off, direction left, or direction right
- Also features a brake attention option with a sequential-once function
- 1157 double connector with offset pins, plugs into existing tail lamp socket
- Can be use as auxiliary light or motorcycle tail light.
- Requires use of United Pacific LED turn signal flasher, item number: 90652 or 90649

110798 1 Pc. / Card

1932-34 Ford Truck



B21004



B21005



Dash Panel for 1932-34 Ford Truck

- Die stamped with high quality 18 gauge sheetmetal
- Features all of the original contour and mounting detail
- Precision punched center oval opening for original style dash tunnel
- Reinforced steering column mounting holes
- Black EDP coated
- Available with or without center hole

B21004 With Center Hole - 1 Pc. / Box

B21005 Without Center Hole - 1 Pc. / Box

1932-34 Ford Car



Rear Fender for 1933-34 Ford Passenger Car

- Die stamped with high quality 20 gauge sheetmetal
- Features all of the original contour and mounting detail
- Beautiful edge bead with inner reinforcement rod just like the original design
- Black EDP coated
- Sold individually, please specify left or right hand side

B24033 L/H - 1 Pc. / Box

B24034 R/H - 1 Pc. / Box



Front Fender Brace For 1932 Ford Passenger Car & Truck

- Made of heavy duty 11 gauge steel
- Exact curvature as the original for easy installation
- Features all of the mounting holes for chassis, fender, and headlight bar
- Black EDP coated

B20330 1 Pc. / Bulk

1964.5-70 Ford Mustang



Chrome Front Bumper for 1967-68 Ford Mustang

- Made with heavy gauge sheet metal
- Features all original contour and detail
- Precision punched square mounting bolt holes for easy and quick installation
- Show ready chrome plating finish

110484 1 Pc. / Box



Chrome Rear Bumper for 1967-68 Ford Mustang

- Made of heavy duty 13 gauge steel
- Beautifully chrome plated with triple plating process
- Features all the original contour and detail
- Precision punched square carriage bolt holes for straight forward installation

110487 1 Pc. / Box



Chrome Front Bumper for 1964.5-66 Ford Mustang

- Made of heavy duty 13 gauge steel
- Beautifully chrome plated with triple plating process
- Features all the original contour and detail
- Precision punched square carriage bolt holes for straight forward installation

110483 1 Pc. / Box



Door Glass Mounting Bracket & Guide Kit for 1969-70 Ford Mustang

- Heavy duty 13 gauge steel mounting brackets
- High quality 14 gauge steel regulator guide brackets
- Accurate reproduction with all original contour detail and cutouts
- Mounting hardware included
- Sold individually, please specify left or right hand side

110642 R/H - 1 Set / Box

110643 L/H - 1 Set / Box

1954-59 Chevy Truck

Painted Rear Bumper Fits Stepside For 1955-59 Chevy & GMC Truck

- Made of heavy duty 12 steel
- Features all the original contour and detail
- Precision punched square carriage bolt holes for straight forward installation
- Mounting holes and recess for license plate bracket
- Black powder coated finish



110726 1 Pc. / Box

Painted Front Bumper For 1955-59 Chevy & GMC Truck

- Made of heavy duty 12 steel
- Features all the original contour and detail
- Precision punched square carriage bolt holes for straight forward installation
- Feature recess for the license plate
- Black powder coated finish



110728 1 Pc. / Box

Painted Rear Bumper For 1954-55 Chevy & GMC Truck

- Made of heavy duty 12 steel
- Features all the original contour and detail
- Precision punched square carriage bolt holes for straight forward installation
- Black powder coated finish



110731 1 Pc. / Box

Ford Parts



Firewall Support Brackets For 1948-52 Ford Truck (4Pcs/Set)

- Die stamped with high quality 14 & 16 gauge sheetmetal
- Identical shape and size exactly like the original design
- Features all of the original designed strengthening ribs
- Finished with United Pacific Classic-Coat® weldable primer

110734 1 Set / Box

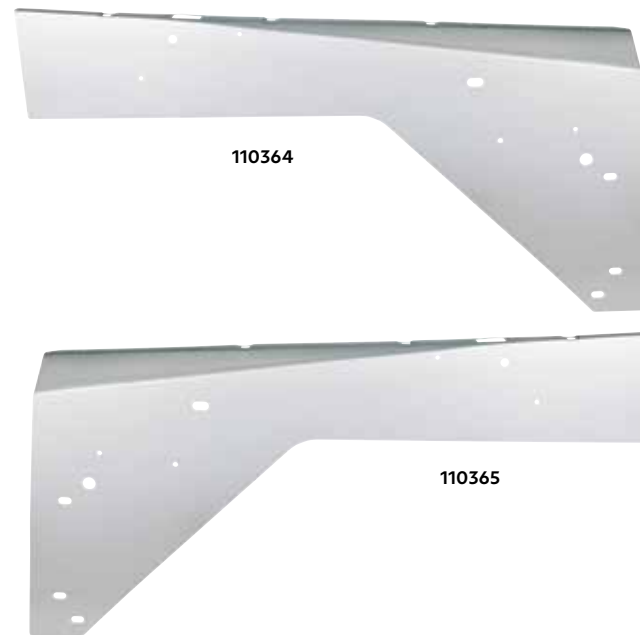

Fender Apron for 1966-77 Ford Bronco

- Die stamped with high quality 19 gauge sheetmetal
- Features all of the original contour and mounting detail
- Coated with weldable primer for easy body attachment
- Sold individually, please specify left or right hand side

110364 R/H - 1 Pc. / Bulk

110365 L/H - 1 Pc. / Bulk

Chevy Parts

CHEVROLET

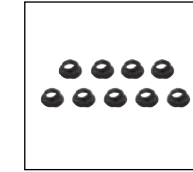

Chrome "Chevrolet" Hood Letter Emblem Set for 1967-68 Chevrolet Truck

- Beautiful chrome plated die cast
- Identical mounting stud location exactly like the original design for easy replacement
- Speed nuts included
- OEM GM # 3892085
- GM Restoration licensed product

110057 1 Pc. / Card



Cargo Light Mounting Pad for 1969-72 Chevy & GMC Truck

- Rubber mounting pad only
- Made of high quality durable black rubber

110149 1 Pc. / Bulk



Incandescent Tail Light Lens for 1953 Chevy Passenger Car

- High quality plastic injection molded red polycarbonate lens
- exactly like the original design with painted base
- Marked with "guide R1-53" and "5943406" script
- OEM number 5943406
- GM restoration licensed product

C4007 1 Pc. / Bulk



Incandescent Tail Light Lens with Blue Dot for 1953 Chevy Passenger Car

- High quality plastic injection molded red polycarbonate lens
- Blue dot with chrome ring installed

C4007-1 1 Pc. / Bulk

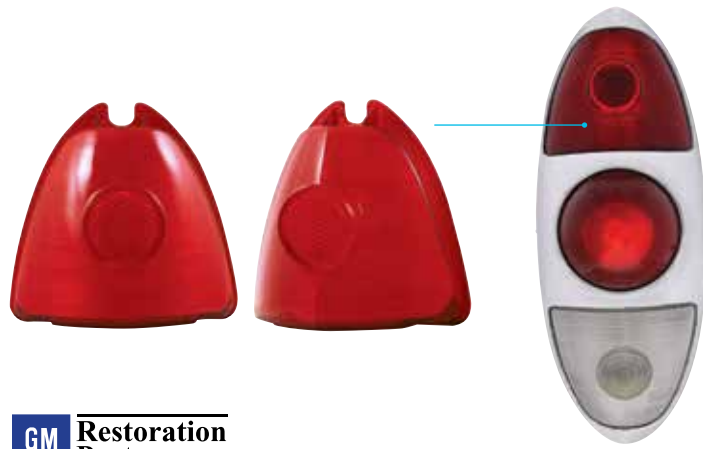

Incandescent Upper Outer Tail Light Lens for 1953 Chevy Passenger Car

- High quality plastic injection molded red polycarbonate lens
- Exactly like the original design with raised center reflector
- Marked with "guide RI-53" & "5943403" script
- OEM number 5943403
- GM restoration licensed product

C4006 1 Pc. / Bulk

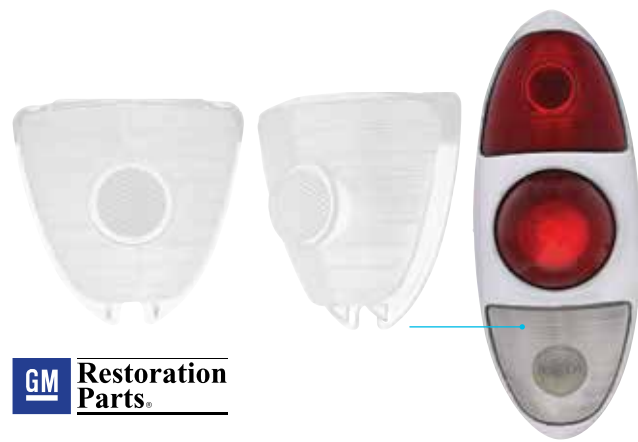

Incandescent Backup Lens for 1953 Chevy Passenger Car

- High quality plastic injection molded clear polycarbonate lens
- Exactly like the original design with raised center reflector
- Marked with "guide RI-53" & "5943404" script
- OEM number 5943404
- GM restoration licensed product

C4027 1 Pc. / Bulk

Light Bulb

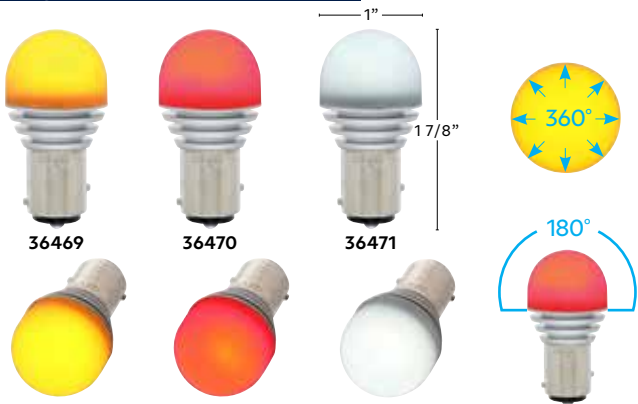

High Power 1157 LED Bulb

- Dual function LED bulb: high 275 lumens/low 150 lumens
- 360° glow design
- Long life sealed design

36469 Amber - 1 Pc. / Card
36470 Red - 1 Pc. / Card
36471 White - 1 Pc. / Card



Xenon White 9007 Halogen Bulb

- 12V 9007 halogen bulb
- Hi/Low function
- High beam 100 watt/low beam 80 watt

39132 1 Pair / Clamshell

Chrome Small 4 Trumpet Air Horn

- Extra loud air horn in compact size
- Universal application, perfect for all vehicles
- Deluxe chrome finish
- Mounting hardware included
- Technical specifications:
 - Height of the 4 horns: 9 3/8" & 11 7/8"
 - Dia of the 4 horns: 3 5/8"
 - Horn Base: 5 3/8" x 6 1/8"
 - Solenoid valve voltage: 12VDC
 - Decibel Rating: 130db ± 10db

46155 1 Pc. / Color Box



Jeep Wrangler Parts



Headlight Assembly for 1997-2006 Jeep Wrangler

- Excellent OEM style headlight bracket: item number 110383/110384
- Includes 7" quartz halogen sealed beam bulb - UP item number 30356
- Sold individually, please specify left or right hand side

110799 L/H - 1 Pc. / Card
110800 R/H - 1 Pc. / Card



Headlight Bracket for 1997-2006 Jeep Wrangler

- Excellent OEM style headlight bracket for the 1997-2006 Jeep Wrangler
- Plastic injection molded high quality durable plastic material
- Sold individually, please specify left or right hand side

110383 L/H - 1 Pc. / Card
110384 R/H - 1 Pc. / Card

Display for 4" x 6" DOT Headlight

- Attractive counter top display with interactive push buttons
- Ready to use, requires 110V outlet
- Creates customer demand to drive sales

99124 1 Pc. / Box



Display for 4" x 6" Rectangular Light

- Attractive counter top display with interactive push buttons
- Ready to use, requires 110V outlet
- Creates customer demand to drive sales

99125 1 Pc. / Box



Headlight Assembly for 2007-2016 Jeep Wrangler

- Excellent OEM style headlight bracket: item number 110383/110384
- Includes 7" H4 quartz halogen crystal headlight bulb - UP item number: 31387
- Sold individually, please specify left or right hand side

110801 L/H - 1 Pc. / Card
110802 R/H - 1 Pc. / Card



Headlamp Bracket for 2007-2016 Jeep Wrangler

- Sold individually, please specify L/H or R/H side
- OEM #: 55078149AC

110585 L/H - 1 Pc. / Box
110586 R/H - 1 Pc. / Box

NEW ITEMS

October 2018

Parts & Accessories for Ford, Chevy Truck & Mustang



B21075

B21076



Cowl Top for 1932-34 Ford Truck

- High quality 18 gauge die-stamped sheet metal reproduction
- Identical curvature as the original
- Feature windshield opening flange and cowl band channel
- Coated With United Pacific Classic-Coat® weldable primer
- Cowl vent inner drain base sold separately

B21075	with Vent Opening - 1 Pc. / Box
B21076	without Vent Opening - 1 Pc. / Box



Cowl Side Panel for 1932-34 Ford Truck

- Made with high quality 18 gauge die-stamped sheet metal
- Identical curvature as the original
- Feature windshield pillar to factory seam with original style lead-fill valley for roof attachment
- Precision machine cut door hinge notches
- Coated With United Pacific Classic-Coat® weldable primer
- Sold individually, please specify L/H or R/H side

B21077	L/H - 1 Pc. / Box
B21078	R/H - 1 Pc. / Box

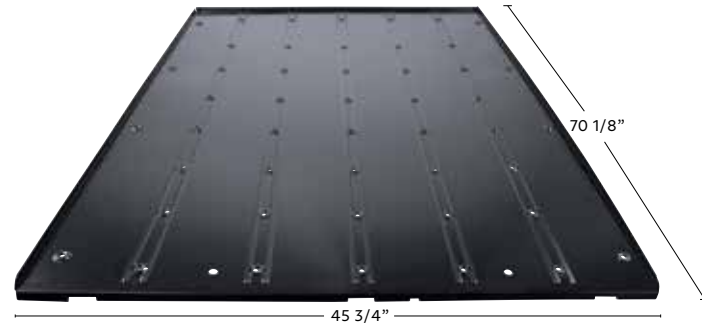

Truck Bed Floor for 1932 Ford Truck

- High quality reproduction of the original 1932 bed floor with strengthening ribs in 18 gauge steel
- Features original style countersink holes for bed floor mounting screws
- Black EDP coated
- Truck freight only

B21510	1 Pc. / Bulk
--------	--------------



Cowl Inner Braces for 1932 Ford Truck

- Excellent sheet metal reproduction
- Identical curvature as the original
- Feature mounting hole and pass-through for vacuum line
- Machine punched rivet holes for straight forward installation to A-Pillar and Cowl Band
- Sold as pair

B21079	1 Pair / Box
--------	--------------



Lower Rear B-Pillar Braces for 1932-34 Ford Truck

- Heavy duty sheet metal reproduction
- Identical design as the original
- Machine punched rivet holes for straight forward installation to B-Pillar and Rear Floor Panel
- Black EDP coated
- Sold as pair

B21027	1 Pair / Box
--------	--------------

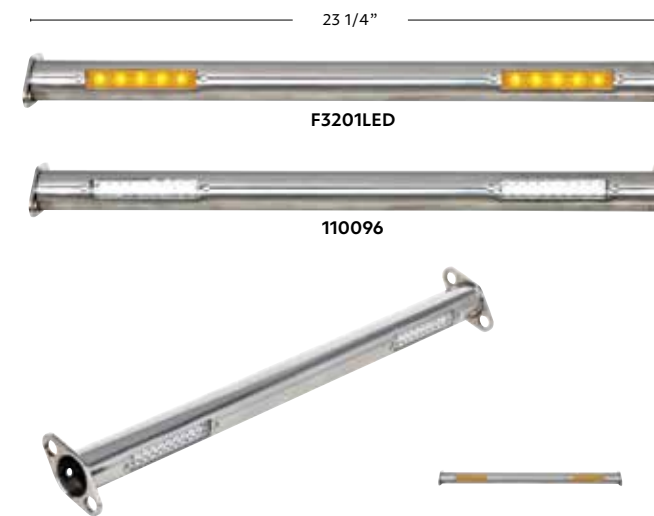

LED Front Spreader Bar for 1932 Ford Car & Truck

- Now available with white LED running lights. Amber version is available for turn signal.
- Polished stainless steel spreader bar with hidden welds
- Wires exit on each side near mounting flange, and can be easily hidden along inside frame rail
- Solid state circuit board engineered for any 12VDC system
- Includes polished stainless steel button head bolts with stainless nylock nuts

110096	With White Running Lights - 1 Pc. / Box
F3201LED	With Amber Turn Signals - 1 Pc. / Box

1966-77 Ford Bronco



Chrome "FORD" Grille Letter Set for 1966-77 Ford Bronco

- High quality die cast & chrome plated with gloss red inlay
- 8 speed nuts included
- Excellent upgrade for all 1966-77 Ford Broncos
- Official licensed product by Ford Motor Company

110482	1 Set / Card
--------	--------------

1967-68 Ford Mustang



Eleanor Style Fiberglass Trunk Lid for 1967-68 Ford Mustang Fastback

- Fiberglass outer skin with steel inner skeleton
- Identical design as the original
- Will require Eleanor style quarter panel extensions, sold separately

110654 1 Pc. / Box



Black Steel Low Rise Eleanor Style Hood for 1967-68 Ford Mustang with 67 Shelby Front End

- All-steel "Eleanor" style hood which is extra long at the front to match up with the Eleanor/Shelby style nose for those converting over to the "Eleanor" style Mustang
- This is NOT a bolt-on stock replacement hood and you must have the Eleanor/Shelby Style Extended Nose for This Hood to Fit Properly
- Black EDP coated
- Oversize freight policy

110648 1 Pc. / Box

Chevy Parts



Fiberglass Nose Panel for 1967-68 Ford Mustang Coupe/Convertible/Fastback - Eleanor Style

- Excellent reproduction of Iconic Eleanor Mustang
- Feature two recesses on the bottom for lower grille round lights
- Require 1967 Shelby style hood, will not work with stock length Mustang hoods

110649 1 Pc. / Box



White Painted Grille for 1957 Chevy Truck

- Excellent steel reproduction of the original truck grille
- 5/16-18 nuts pre-welded to grille for easy and quick installation
- Powdered coated with original factory color look

110390 1 Pc. / Box



29 Red LED Sequential Tail Light for 1954-59 Chevy & GMC Truck with Black Housing

- Super bright red LED with fully sealed epoxy coated electronics
- Selector switch to control sequential function off, direction left, or direction right
- Also features a brake attention option with a sequential-once function
- 1157 double connector with offset pins, plugs into existing tail lamp socket
- Requires use of United Pacific LED turn signal flasher, item number: 90652 or 90649
- DOT & SAE Approved

110767 1 Pc. / Box

LED 3rd Brake Light



33009



33010



33013

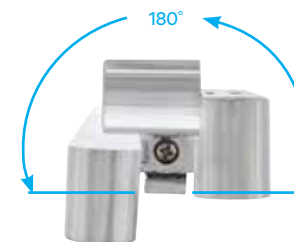

10 LED 3rd Brake Light with Adjustable Pedestal Base

- Designed with adjustable base mount for inside rear window installation
- Available with split LED function for lefthand & righthand turn signal
- Available with running light and brake light
- Base swivels 180° for multiple application

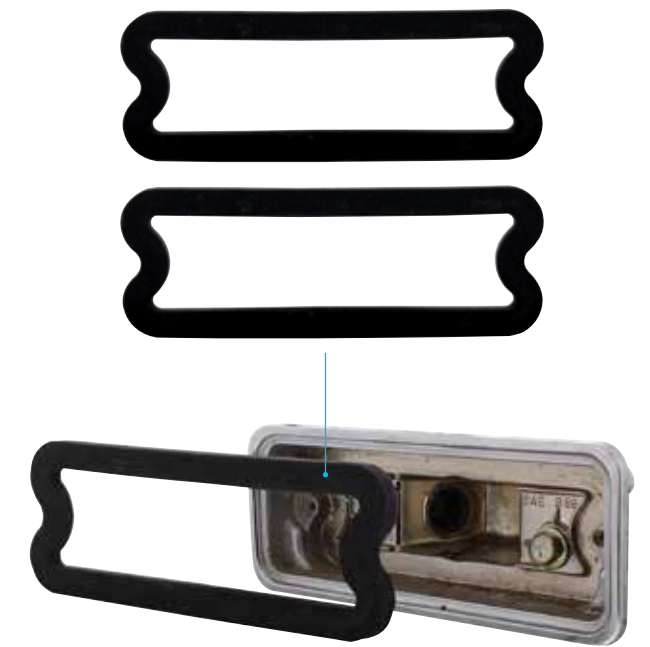

Backup Lens Gasket Set for 1969-72 Chevy Camino

- Made of high durability foam material
- Precision cut to exactly shape as the original for a tight seal

110459 1 Pair / Bulk



Split Dual Function Versions:

33010 Split Function Red LED/Red Lens - 1 Pc. / Card

Regular Dual Function:

33009 Dual Function Red LED/Red Lens - 1 Pc. / Card

33013 Dual Function Red LED/Clear Lens - 1 Pc. / Card

Universal Products



2" Hitch Cover

- Fits standard 2" x 2" tow hitch receivers
- Mounts in place with standard hitch pin & clip (Sold separately 77051)
- Keeps dirt and debris out of hitch receiver and gives a Super Clean Look
- Corrosion resistant, made of high quality plastic polymer

77007 Chrome - 1 Pc. / Card

77008 Black - 1 Pc. / Card

Light Bulb



High Power 1156 LED Bulb

- Single function LED bulb with maximum 275 lumens
- 360° surround illumination, 180° front illumination
- Long life sealed design

36465 Amber - 1 Pc. / Card

36466 Red - 1 Pc. / Card

36467 White - 1 Pc. / Card

LED Headlight



Technical Specification

Low Beam Application	High Beam Application
12V 1.2A / 24V 0.6A	12V 1.3A / 24V 1.0A
1,000 Lumens	2,000 Lumens

7" High Power LED Headlight with LED Position Light Bar

- High power led headlight with 2 LED position light bar for powerful performance
- Dual function headlight: low beam & high beam
- Aluminum housing with proprietary heat management provides maximum protection for long-lasting performance
- Solid state design resists shock and vibration
- Easy connection, fits OEM housing or fender, plugs into existing wiring harness, position light requires additional wiring
- DOT/SAE headlight approved

31200 1 Pc. / Color Box



High Power 9006/HB4 LED Bulb

- 20W low beam application
- 4500 lumen output
- Forced convection design with cooling fan and heat sink, to increase service life
- Includes driver/controller for easy installation, made to fit most 9006/HB4 bulb
- Driver/controller is approximately 2 1/4" L x 15/16" W x 5/8" H

36513 1 Pair / Color Box

NEW ITEMS

November & December 2018

Parts & Accessories for Ford, Chevy Truck & Mustang

1932 Ford 5W & Roadster



Rear Fender for 1932 Ford 5W Coupe & Roadster

- Quality stamped steel, exactly like the original design
- Made of excellent 20 gauge sheetmetal
- Fender edge bead with steel inner wire
- Precision punched quarter panel mounting holes
- Includes mounting holes for frame horn cover
- Black EDP coated
- Sold individually, please specify left or right hand side

B20333 L/H - 1 Pc. / Box

B20334 R/H - 1 Pc. / Box



1932-34 Ford Truck



Upper Door A-Pillar Cover for 1932-34 Ford Truck

- Die stamp quality 19 gauge sheetmetal
- Accurate reproduction of the original to cover the corner of A-pillar and roof
- Finished with United Pacific Classic-Coat® weldable primer
- Sold individually, please specify L/H or R/H side

B21121 L/H - 1 Pc. / Bulk

B21122 R/H - 1 Pc. / Bulk



Inner Lower A-Pillar Reinforcement for 1932-34 Ford Truck

- Heavy duty 13 gauge steel reproduction
- Die stamp with special attention to all detail to match the original
- Features square carriage bolt holes for chassis & floor installation
- Spot welding pass-thru holes for OE style A-Pillar mounting
- Center strengthening rib exactly like the original
- Black EDP coated
- Sold individually, please specify L/H or R/H side

B21129 L/H - 1 Pc. / Bulk

B21130 R/H - 1 Pc. / Bulk

For Ford Bronco



13 Gal Main Fuel Tank for 1966-77 Ford Bronco

- Die stamped with Ni-Terne treated steel sheet
- Approximately 13-gallon fuel capacity
- Precision notched fuel tank strap recesses for better positioning during installation
- Includes locking ring and o-ring

110561 1 Pc. / Box



Grille without Logo for 1969-77 Ford Bronco

- Die stamped with high quality 17 gauge sheet metal
- Feature all of the original contour detail and mounting brackets for the larger round signal lights
- Smooth design to keep that clean front end look
- Black powder coated finish
- Headlight adjusters included

110515 1 Pc. / Box

For Ford Truck



Door Check Arm for 1948-52 Ford Truck

- Original style with durable rubber stop
- Includes solid rivet and cotter pin
- Fits both L/H & R/H

110790 1 Pc. / Box



Aluminum Cab Back Molding with for 1967-72 Ford Truck

- Quality aluminum extrusion
- 66-3/4" overall length when assembled
- Highly polished face to a show ready chrome finish
- Corner end pieces not included
- Mounting hardware included

110026 1 Set / Box



18' Roll of Fender Flare Welting for 1966-77 Ford Bronco

- Welting mounts between the flare and the body to provide a finished edge
- 3/16" bead, 1 1/4" wide, 1/16" thick
- Heat & UV resistant black PVC material
- Each 18' roll is enough for 2 Bronco flares
- Requires 2 sets for a full Bronco

110539 1 Roll / Bulk



Tailgate Still Plate for 1978-86 Ford Bronco

- Quality aluminum extrusion
- Clear anodized finish
- Machine drilled mounting hole with countersink
- Mounting hardware included

110791 1 Pc. / Box

1964.5-68 Ford Mustang



Racing Style Fiberglass Front Valance with Light Cutout for 1964.5-66 Ford Mustang

- High quality sheet molded compound
- Accurate reproduction with all original contour detail
- Feature racing style design front parking light cutouts

110491 1 Pc. / Box



Racing Style Fiberglass Front Valance with Light Cutout for 1967-68 Ford Mustang

- High quality sheet molded compound
- Accurate reproduction with all original contour detail
- Feature racing style design front parking light cutouts

110492 1 Pc. / Box



Eleanor Style Quarter Panel Extensions/End Caps for 1967-68 Ford Mustang Fastback

- Made of high quality sheet molded compound
- Matte black painted finish
- Each side has 3 overmolded mounting studs
- Mounting hardware included

110655 1 Pair / Box

Eleanor Style Fiberglass Trunk Lid for 1967-68 Ford Mustang Fastback

- Fiberglass outer skin with steel inner skeleton
- Identical design as the original
- Will require Eleanor style quarter panel extensions, sold separately

110654 1 Pc. / Box



Vent Window Assembly for 1964.5-66 Ford Mustang

- Highly polished stainless steel glass frame
- Factory assembled with high quality rubber seal
- Exactly like the original design for a straight forward replacement
- Period correct chrome vent window handle
- Includes door glass channel with felt
- Available with crystal clear non-tinted tempered window glass or original style green tinted tempered window glass
- Sold individually, please specify L/H or R/H side

110778 R/H Clear - 1 Pc. / Box
110779 L/H Clear - 1 Pc. / Box
110780 R/H Tint - 1 Pc. / Box
110781 L/H Tint - 1 Pc. / Box



Vent Window Assembly for 1967 Ford Mustang

- Highly polished stainless steel glass frame
- Factory assembled with high quality rubber seal
- Exactly like the original design for a straight forward replacement
- Period correct chrome vent window handle
- Includes door glass channel with felt
- Available with crystal clear non-tinted tempered window glass or original style green tinted tempered window glass
- Sold individually, please specify L/H or R/H side

110782 R/H Clear - 1 Pc. / Box
110783 L/H Clear - 1 Pc. / Box
110784 R/H Tint - 1 Pc. / Box
110785 L/H Tint - 1 Pc. / Box

Chevy & GMC Trucks



Black Painted Running Board for 1947-54 Chevy & GMC Shortbed Truck

- Excellent quality 18 gauge sheetmetal
- Ribbed style just like original
- Underside retainer brackets pre-welded for easy installation
- Painted black to help protect against rust during installation and shipment
- Sold individually, please specify L/H or R/H side

170471 L/H - 1 Pc. / Box
170472 R/H - 1 Pc. / Box



Bedside Step for 1955-66 Chevy & GMC Shortbed Truck

- High quality 17 gauge steel reproduction
- Ribbed style just like original
- Precision punched square carriage mounting bolt holes
- Painted black to help protect against rust
- Sold individually, please specify L/H or R/H side

170551 L/H - 1 Pc. / Box
170552 R/H - 1 Pc. / Box



Bedside Step for 1955-66 Chevy & GMC Truck Longbed Truck with 7-1/2 Foot Bed

- High quality 17 gauge steel reproduction
- Ribbed style just like original
- Precision punched square carriage mounting bolt holes
- Painted black to help protect against rust
- Sold individually, please specify L/H or R/H side

170553 L/H - 1 Pc. / Bulk
170554 R/H - 1 Pc. / Bulk



Black Painted Rear Bumper for 1960-62 Chevy & GMC Fleetside Truck

- Die stamped with heavy 12 gauge sheet metal
- Features identical curvature exactly like the original design
- 4 precision punched square carriage bolt holes for straight forward installation
- 2 square carriage bolt holes for license plate bracket
- Painted black to help protect against rust

110724 1 Pc. / Box

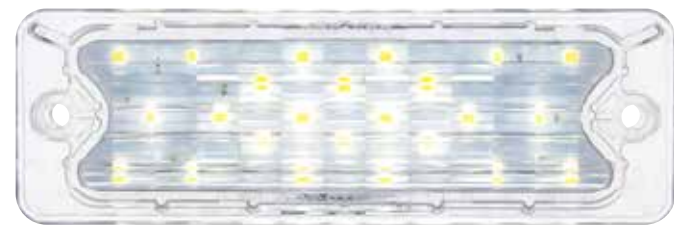

24 White LED Back-Up Light for 1969-72 Chevy El Camino

- 1156 single contact, straight pins
- Epoxy coated, fully sealed electronics
- Easy installation, fits existing bezel and housing
- Solid state circuit boards are designed at 7.7-14.0 VDC

110458 1 Set / Card



29 Red LED Sequential Tail Light for 1954-59 Chevy & GMC Truck with Housing

- Super bright red LED with fully sealed epoxy coated electronics
- Selector switch to control sequential function off, direction left, or direction right
- Also features a brake attention option with a sequential-once function
- 1157 double connector with offset pins, plugs into existing tail lamp socket
- Requires use of United Pacific LED turn signal flasher, item number: 90652 or 90649
- Available with stainless and black housing
- DOT & SAE approved

110767 **Black** - 1 Pc. / Box

110768 **Stainless** - 1 Pc. / Box



Backup Light Housing Gasket for 1969 Chevy Camaro

- Made of high durability foam material
- Precision cut to exact shape as the original for a tight seal

110451 1 Pair / Bulk



29 Red LED Tail Light for 1954-59 Chevy & GMC Truck with Housing

- Super bright red LED with fully sealed epoxy coated electronics
- 1157 double connector with offset pins, plugs into existing tail lamp socket
- Requires use of United Pacific LED turn signal flasher, item number: 90652 or 90649
- Available with stainless and black housing
- DOT & SAE Approved

110765 **Black** - 1 Pc. / Box

110766 **Stainless** - 1 Pc. / Box



31458

31459

Technical Specification

Low Beam Application	High Beam Application
900 Lumens	1,300 Lumens
25 Watt / 5700K	25 Watt / 5700K

High Power LED 7" Headlight with LED Turn Signal/Position Light Bar

- High power LED headlight with LED turn signal/position light bar for powerful performance
- Aluminum housing with proprietary head management provides maximum protection for long-lasting performance
- Solid state design resists shock and vibration
- Easy connection, fits OEM housing or fender, plugs into existing wiring harness, position light requires additional wiring
- DOT/SAE headlight approved

31458 **Turn Signal & Amber Position Light Bar** - 1 Pc. / Color Box

31459 **White Position Light Bar** - 1 Pc. / Color Box



Rear License Plate Bracket w/Light for 1954-59 Chevy Truck

- Die stamped with high quality 17 gauge sheet metal
- Original style license plate light with quality glass & metal enclosure
- Single positive lead wire with quick connector pre-installed for easy electrical hookup
- Original style large riveted license plate bracket
- Black EDP coated

110770 1 Pc. / Bulk



31168

31237



Technical Specification

Low Beam Application		
12 - 24V DC Input	0.35 Amps / 8.5 Watt	FMVSS108

High Power LED 4" x 6" Rectangular Headlight with 6 LED Position Lights

- 1 high power LED headlight with 6 LED position light
- Available in single function white LED and dual function amber LED
- Die cast aluminum housing provides maximum protection from the elements
- Solid state design resists shock and vibration
- Improve visibility with light output that is closer to the color temperature of daylight

31168 **White LED/Single Function** - 1 Pc. / Color Box

31237 **Amber LED/Dual Function** - 1 Pc. / Color Box



Rear License Plate Bracket w/Light for 1960-66 Chevy Truck

- Die stamped with high quality 17 gauge sheet metal
- Original style license plate light with quality glass enclosure
- Single positive lead wire with quick connector pre-installed for easy electrical hookup
- Precision cut bumper and license plate mounting holes
- Black rubber insert help reduce rattling noise from license plate
- Black EDP coated

110771 1 Pc. / Bulk

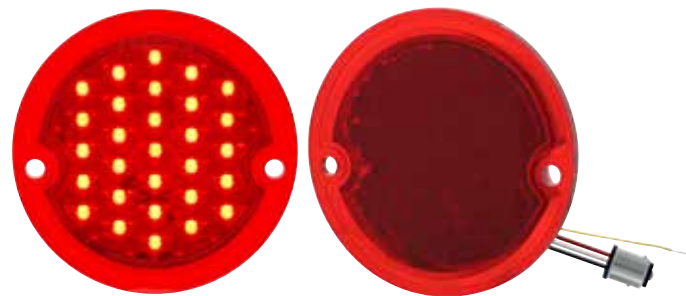

29 Red LED Tail Light for 1954-59 Chevy & GMC Truck

- Super bright red LED with fully sealed epoxy coated electronics
- 1157 double connector with offset pins, plugs into existing tail lamp socket
- Requires use of United Pacific LED turn signal flasher, item number: 90652 or 90649

110404 1 Pc. / Card

Universal Products



34103

34102



License Plate Light Lens for 1990-2004 Ford Truck

- OEM style with mounting tabs for easy installation
- High quality plastic housing in chrome plated with triple chrome plating process or painted black finish
- OEM number: F67Z-13550-AA/ F67Z-13550-A

34102 **Chrome** - 1 Pc. / Card
34103 **Black** - 1 Pc. / Card



Sending Unit Available:

- 110675
- 110671
- 110673

16 GAL Zinc Plated Fuel Tank for 1982-86 Chevy & GMC Shortbed Truck

- Die stamped with Ni-Terne treated steel sheet
- Has all original contour detail and mounting holes
- Machine welded for an even and complete seal

110684 1 Pc. / Box



Chrome "Lead Sled" Script Emblem

- Chrome diecast "Lead Sled" script emblem
- Easy installation with 5 studs, mounting clips included

110709 1 Pc. / Card

Merchandising



United Pacific Analog Neon Wall Clock

- Nostalgic blue neon light design
- Chrome plate outer bezel
- Clock face features beautiful shot of the UPI's 1932 5-Window Coupe built by Roy Brizio, and customized UPI sponsored Cascadia

99049 1 Pc. / Color Box



12 Blanket Bin Box Display - 50" x 60" Flannel Fleece Comfort Blanket

- Includes 3 each of the following
- 99113 - Navy blue blanket
- 99114 - Red blanket
- 99115 - Ash black blanket
- 99116 - Green blanket

99133 1 Set / Bulk



9 High Power LED Work Light Bin Box Display

- Includes 4 each of the following
- 36617 - 9 high power round led work light
- 36618 - 9 high power square led work light

99134 1 Set / Bulk



United Pacific Metal Cooler Box

- Retro style 1940's-1950's metal picnic cooler
- Beautiful blue painted steel exterior with chrome plated carrying handle and corner protectors
- Aluminum lined interior keeps contents cool and fresh
- Convenient built-in bottle opener on side
- Great counter display for retail stores, man cave, RV, etc.

99118 1 Pc. / Box



1966-77 Ford Bronco Product Catalog Item # ACBR01



The Official 1932-34 Ford Truck & 1932 5 Window Coupe Product Catalog, Item # AC3209



United Pacific Ford Bronco Poster Item # 99130



United Pacific 32 Ford Truck Poster Item # 99112

Available Now!

PRODUCT INDEX

ITEM #	PAGE #	ITEM #	PAGE #	ITEM #	PAGE #	ITEM #	PAGE #
31150	33	36513	67	110145	55	110477	6
31151	33	36591	14	110149	60	110478	7
31152	33	36592	14	110174	5	110479	7
31153	33	36593	14	110175	5	110482	64
31168	74	36594	14	110176	5	110483	58
31200	67	36595	14	110199	55	110484	46, 58
31237	74	36596	14	110218	10	110485	46
31458	74	36597	14	110219	10	110487	58
31459	74	36598	14	110221	10	110488	24, 42
32051	34	36599	7	110223	17	110489	24, 42
32052	34	36600	18	110233	25	110490	42
32053	34	36601	18	110234	25	110491	70
32054	34	36602	18	110253	56	110492	70
32787	34	36603	18	110262	17	110493	42
32788	34	36604	18	110263	17	110494	43
32789	34	39132	61	110292	6	110497	35
32790	34	40847	14	110293	6	110498	43
32791	34	46155	62	110314	13	110502	51
32792	34	50130	51	110331	51	110504	25
32793	34	52000	48	110338	13	110509	25
32794	34	52001	48	110354	51	110510	25
32795	34	52002	48	110355	51	110511	25
32796	34	52003	48	110364	59	110512	25
32797	34	52004	48	110365	59	110515	69
32798	34	52005	48	110366	36	110522	37, 44
32799	34	52006	48	110367	36	110523	37, 44
32800	34	52007	48	110368	36	110535	11
32801	34	60050	13	110369	11	110536	26
32802	34	60051	47	110370	11	110539	69
32803	34	60052	47	110371	11	110557	37
32804	34	60053	47	110372	11	110561	69
32805	34	70092	48	110373	11	110583	36
32806	34	70674	28	110383	62	110584	36
32807	34	70708	19	110384	62	110585	33, 62
32808	34	90649	18	110390	65	110586	33, 62
32809	34	98998	8	110404	75	110600	38
32810	34	99049	76	110405	55	110601	38
33009	66	99053	7	110429	13	110602	38
33010	66	99112	10	110451	73	110603	38
33013	66	99113	48	110458	73	110604	38
34102	75	99114	48	110459	66	110605	38
34103	75	99115	48	110460	50	110606	38
34235	20	99116	48	110461	50	110607	38
34235	28	99118	76	110462	50	110608	39
36465	67	99124	61	110463	49	110609	39
36466	67	99125	61	110464	49	110610	39
36467	67	99133	76	110465	50	110611	39
36469	61	99134	76	110466	50	110612	41
36470	61	110023	28	110470	17, 30	110613	41
36471	61	110026	70	110471	30	110614	41
36504	33	110057	60	110472	30	110615	41
36505	47	110095	51	110473	17, 30	110616	41
36506	47	110096	64	110474	51	110617	41
36509	27	110128	20	110475	51	110618	24
36512	7	110144	55	110476	6	110619	24

PRODUCT INDEX

ITEM #	PAGE #	ITEM #	PAGE #	ITEM #	PAGE #	ITEM #	PAGE #
110620	22, 40	110682	16	110799	62	CBL7101LED-R	9
110621	22, 40	110683	15	110800	62	CBL7201LED-L	9
110622	22, 40	110684	75	110801	62	CBL7201LED-R	9
110623	22, 40	110685	15	110802	62	CTL7101LED-L	9
110624	22, 40	110686	15	170471	72	CTL7101LED-R	9
110625	22, 40	110687	15	170472	72	CTL7201LED-L	9
110626	22, 40	110688	15	170551	72	CTL7201LED-R	9
110627	22, 40	110705	31	170552	72	F3201LED	64
110628	22, 39	110709	75	170553	72	F5101	20
110629	22, 39	110710	44	170554	72	F5103	20
110630	22, 39	110718	54	10349B	48	F646601	5
110631	22, 39	110719	54	10351B	48		
110632	23, 41	110720	54	10718B	19		
110633	23, 41	110721	53	99104L	19		
110634	23, 41	110722	53	99104M	19		
110635	23, 41	110724	72	99104XL	19		
110636	23, 41	110725	54	99104XXL	19		
110637	23, 41	110726	59	A6046	46		
110638	24	110728	59	A6047	46		
110639	24	110729	53	A6132	27		
110640	24	110730	53	B20010	26		
110641	24	110731	59	B20011	26		
110642	58	110733	54	B20123-1	26		
110643	58	110734	59	B20151	29		
110644	23	110741	21	B20322	29		
110644	42	110742	21	B20330	57		
110645	23	110743	21	B20333	68		
110645	42	110745	21	B20334	68		
110646	42	110746	21	B20340	29		
110647	42	110747	21	B20341	29		
110648	12	110748	27	B21004	57		
110648	65	110749	27	B21005	57		
110649	65	110750	21	B21010	26		
110650	12	110752	28	B21027	64		
110651	12	110765	73	B21051	45		
110652	12	110766	73	B21075	63		
110653	43	110767	66	B21076	63		
110654	65	110767	73	B21077	63		
110654	71	110768	73	B21078	63		
110655	71	110769	46	B21079	64		
110664	37	110770	74	B21121	68		
110665	37	110771	74	B21122	68		
110666	43	110778	71	B21129	68		
110667	16	110779	71	B21130	68		
110668	43	110780	71	B21510	63		
110669	44	110781	71	B24033	57		
110670	31	110782	71	B24034	57		
110671	32	110783	71	B24035	10		
110672	32	110784	71	C4006	61		
110673	32	110785	71	C4007	60		
110674	31	110790	70	C4007-1	60		
110675	32	110791	69	C4027	61		
110676	31	110796	56	C5036-3	33		
110678	44	110797	56	C545504-2	54		
110680	16	110798	56	CBL7101LED-L	9		



[Learn more about custom and factory headlights we have.](#)