



FOR THE ADVENTURE...

AND EVERY DAY  
IN BETWEEN

# SKYJACKER® SUSPENSIONS

## Table of Contents

Skyjacker® SkyArmor Plus Warranty.....	2	Jeep.....	10
Skyjacker® FMVSS No. 126 .....	3	Chevrolet/GMC/GM .....	44
Skyjacker® Shock Options .....	4	Dodge .....	50
Skyjacker® Steering Stabilizers .....	6	Ford.....	56
Skyjacker® Adjustable Control Arms .....	7	Toyota .....	66
Skyjacker® Product Features .....	8	Nissan .....	72



**Skyjacker® is proud to announce a new SkyArmor Plus Warranty that is offered with qualified suspension lift kits. SkyArmor Plus is another reason when you ride with Skyjacker® you ride with the best.**

**What is the SkyArmor Plus program?** SkyArmor Plus is a Factory Supplemental Limited Warranty offered as an additional feature of Qualified Skyjacker® suspension kits. SkyArmor may provide for repair or replacement of failure drive train components your OEM warrantor may refuse to cover. (See SkyArmor Plus terms for covered components, exclusions and limitations). Your Skyjacker® Limited Warranty continues to cover your Skyjacker® suspension kit. (See Skyjacker® limited Warranty terms).

**How much does SkyArmor Plus cost?** There is no additional cost. It is our way of supporting your choice and loyalty of our products.

**How can I apply for the SkyArmor Plus Program?** First, buy a Qualified Skyjacker® suspension kit by February 1, 2017 and have it properly installed by an approved independent dealer or shop. Second, complete and send in an application card, describing your vehicle, your suspension and confirming coverage under your OEM drive train Limited Warranty. Our warrantor, Sky Armor Plus, LLC will confirm your application meets program requirements and notify you of acceptance.

**Is there a waiting period to apply for the SkyArmor Plus Program?** Make your application when your Qualified Skyjacker® suspension is installed. In fairness, however, we don't cover pre-existing problems or failures. Meaning there is a sixty day (60) waiting period from installation to when your application may be accepted and coverage begin. (See SkyArmor Plus terms for covered components, exclusions and limitations).

**Is the SkyArmor Plus Program for new and used vehicles?** YES, so long as you are the original purchaser of the Qualified Skyjacker suspension, the kit is properly installed by an approved independent dealer or shop and your new or used vehicle has remaining coverage under your OEM drive train Limited Warranty.

**How long is my vehicle covered?** When your application is accepted your new or used vehicle is, subject to terms of the SkyArmor program, covered from sixty (60) days after installation until the earlier of: (1.) expiration of the original OEM drive train limited warranty covering the vehicle, (2.) 100,000 miles from date of new vehicle purchase or lease, (3.) five (5) years from the original in-service date of the vehicle upon which the Skyjacker® Qualified Kit is originally installed. (See SkyArmor Plus terms for covered components, additional exclusions and limitations).

**If I sell my vehicle, is the SkyArmor Plus Program transferrable?** YES. Upon written request to Sky Armor, LLC. Again, to be fair, Sky Armor may ask for verification of remaining OEM drive train warranty and acceptable proof of vehicle condition, service and maintenance history.

**Will the SkyArmor Plus program cover my vehicle if I install a qualified suspension?** Most of the OEM's current suspension designs are sophisticated and tied into sensitive vehicle stability controls. For this reason, even if you are a good wrench, we recommend installation by a qualified dealer and shop. At this time SkyArmor Plus coverage is only available for qualified Skyjacker® suspension kits properly installed by an approved independent dealer or shop.

**SkyArmor Plus is another reason when you ride with Skyjacker® you ride with the best.** This summary is not intended to cover or modify all the terms, limitations and exclusions of the program. We worked hard to keep the actual Supplemental Limited Warranty terms available, fair and easy to understand. So, if you have questions start there first.



**Recently the National Highway Traffic Safety Administration (NHTSA) established the Federal Motor Vehicle Safety Standard (FMVSS) No. 126** requiring all new passenger vehicles under 10,000 lbs GVWR include an electronic stability control (ESC) system as standard equipment. FMVSS No. 126 tests new vehicle ESC systems through a series of evasive lane-change maneuvers at highway speeds to ensure the driver can maintain control in critical driving situations. The idea behind the mandate is to reduce the risk of rollover crashes among passenger vehicles. Effective August 2012 this law requires aftermarket products to be compliant with these same standards.

We have a number of our lift kits tested to prove compliance with the FMVSS 126 mandate. These tests measure with great accuracy how the vehicle reacts after modification and was done to ensure Skyjacker products work in harmony with the Electronic Stability Control (ESC). Through SEMA and the advanced testing by Link Engineering that involves robotic steering and outrigger equipment we have demonstrated our compliance with this safety standard and are proud to announce we have passed the rigorous FMVSS 126 physical testing.



# SKYJACKER SUSPENSIONS BLACKMAX

Black MAX twin tube shock absorbers have increased fluid capacity and utilize “foam-cell” technology. When the shock is working hard and gets hot, the foam-cell insert compresses to compensate for oil expansion which maintains consistent MAX Performance throughout the operating temperature range of the shock. The foam-cell design also eliminates air inside the shock which allows for mounting in any direction. Arc-welded end mounts and select specific valving give the Black MAX shock absorber MAX value.

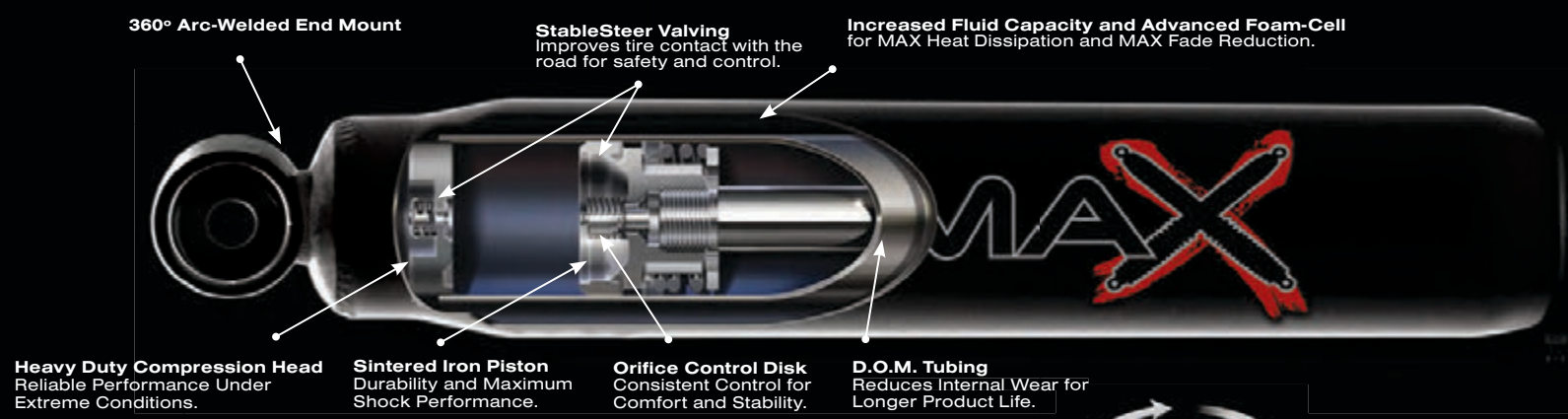

- **Advanced Foam-Cell Technology**
- **Vehicle Specific Multi-Stage Valving**
- **Increased Fluid Capacity for MAX Heat Dissipation**
- **360° Arc-Welded End Mount**
- **180° Directional Mounting**
- **Twin Tube Construction**
- **Chrome Plated Shaft**
- **Sintered Iron Piston**
- **Black Boot Incl.**
- **Limited Lifetime Warranty**

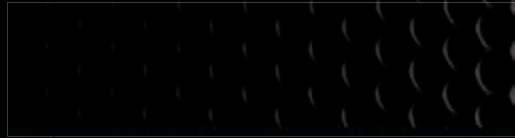

# SKYJACKER SUSPENSIONS Steering Stabilizers

**Skyjacker® Steering Stabilizer** A steering stabilizer is a dampening shock for your steering system. It dampens out the harshness of the highway, the 'shimmy' from running the additional weight of larger tires & wheels and places control back into the driver's hands. Stabilizers also reduce the fatigue of the driver on a personal level by reducing the amount of physical strength it takes to guide those larger tires on and off the road. Changing the weak stock unit for a better performing replacement or adding dual steering stabilizers is an inexpensive but worthy investment.



### Replacement Shock Boots

Skyjacker® offers replacement shock boots in a variety of colors.



**Skyjacker's adjustable lower control arms for Jeep JK** feature a vulcanized rubber bushing at the frame and flex joints at the axle. The vulcanized rubber bushing provide superior vibration dampening, while the Currie Johnny Joint® provides 30 degrees of misalignment. You can rest assured we have the right components to give you the most articulation! Skyjacker® Flex Joints features a bushing that is made with a high density tough 88 urethane that encases the inner ball. This durable material stands up in all weather conditions! The special ball insert is heat treated steel which offers unparalleled strength. The joint is lubricated with a zerk fitting on the outer shell and the outer shell is also heat treated steel. The retaining washers in the rod end are machined out of 4340 chrome moly and feature a snap ring safety machined into the face of them to protect the snap ring from coming out.

This new combination of a rubber bushing which provides a smooth quiet ride on the street and the rock solid reputation of the Currie Johnny joint will give you peace of mind out on the trail and in any terrain.



# SKYJACKER<sup>®</sup> SUSPENSIONS Product Features

## SOFRIDE<sup>®</sup> LEAF SPRINGS Featured in Systems

Skyjacker<sup>®</sup> Softride<sup>®</sup> springs are individually shot-peened with hard steel pellets at very high velocities. This shot-peening compresses the surface of the steel thereby increasing the tensile strength of the spring. Without this shot-peening procedure, the maximum wheel travel and ride quality could not be achieved without sacrificing the life of the spring. Softride<sup>®</sup> springs use 'bolt' style spring clips, eliminating friction. Other spring designs use the 'cinch' style bend clips which bend tightly over the spring leafs causing binding and friction. Skyjacker<sup>®</sup> Softride<sup>®</sup> springs are a tapered spring creating more flex at the leaf ends. This tapering distributes loads more evenly over a greater area and reduces the tendency for one leaf to dig into the leaf above it. Rear Softride<sup>®</sup> springs are used to complete the 'SYSTEM' in a Skyjacker<sup>®</sup> suspension lift.



## BLOCKS AND U-BOLTS Featured in Kits

The Skyjacker<sup>®</sup> U-Bolts are e-coated for corrosion resistance. These U-Bolts are offered in various shapes and sizes such as square, round, and semi-round in lengths ranging from 1.75" - 19". The Blocks used in Skyjacker<sup>®</sup> Kits are Ductile iron with fixed center pins. They are also tapered to correct pinion angle and prevent driveline vibrations. Available in 1.25, 2, 3.5, 4.5 & 5.5 inches. Rear Block & U-Bolt Kits are usually used to make a 'KIT' in a Skyjacker<sup>®</sup> suspension lift. But a 'KIT' could also be a combination of Blocks & U-Bolts or Add-a-Leafs.

### SKYJACKER<sup>®</sup> BLOCKS

- Ductile iron • Fixed Center Pin • Tapered



## ADD-A-LEAFS SPRINGS Featured in Kits

Skyjacker<sup>®</sup> offers a diverse selection of front and rear Add-a-Leafs. Skyjacker<sup>®</sup> Add-A-Leafs insert directly into your factory leaf spring providing lift and added strength. Softride<sup>®</sup> Add-a-Leafs are shot-peened with hard steel pellets at very high velocities. This shot-peening compresses the surface of the steel thereby increasing the tensile strength of the leaf. Without this shot-peening procedure, the maximum wheel travel and ride quality could not be achieved without sacrificing the life of the leaf.

The Skyjacker<sup>®</sup> Add-a-Leafs are pre-drilled for the center pin. Pin location varies with each application. Most have long tapered ends for a progressive affect and ride comfort. Rear Add-A-Leafs are sometimes used to make a 'KIT' in a Skyjacker<sup>®</sup> suspension lift. But it could also be a combination of Blocks & U-Bolts AND Add-a-Leafs.



## SKYJACKER<sup>®</sup> STEERING COMPONENTS

Skyjacker<sup>®</sup> knows the importance of steering correction after lifting a vehicle and we have an extensive line of steering components to prove it. From drag links to a variety of steering arms, Skyjacker<sup>®</sup> has the steering components to steer you straight.





## SKYJACKER® SPACER KITS

Spacer Kits are in high demand and produce optimum results for the amount of money spent. Specifically designed for an array of vehicles, these Spacer Kits add 2-2.5" of lift to the struts or coil springs. Skyjacker® offers Poly Value Kits with polyurethane spacers & powder coated steel fabricated units like for the Honda Ridgeline. They include all the parts & hardware necessary to bolt-on this simple, but effective lift. No cutting or welding is involved and standard tools get the job done.



## ASSORTED POLYURETHANE

Skyjacker® carries a very large line of Polyurethane products to fit your vehicle's needs. The list includes Bump Stops, Bushings, Cab Mount Kits, Clearance Kits, and an array of Bushings (Spring Eye, Frame Shackle, Radius Arm, Track Bar, Caster) for various applications, makes and models. Polyurethane is a superior material that has a higher load-bearing capacity and can better resist the dynamic torque-like twisting and turning forces of suspension components as they go through their normal operation/travel movements. It is also an improved sound/vibration dampening material.

## STAINLESS STEEL BRAIDED BRAKELINES

Skyjacker® has gone to 'extended lengths' to accommodate our four wheeling friends and to improve your 4x4s braking performance. All have been tried and tested in some of the most severe conditions four wheeling has to offer in virtually every corner of the world. They all passed the test and are proven in their quality of engineering, workmanship and finish. Skyjacker® brake lines conform to all federal requirements of FMVSS106, making them D.O.T. Certified and T.U.V. Approved in Germany.

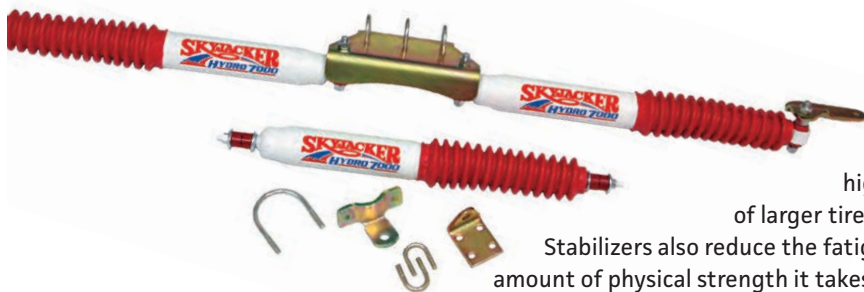

## STEERING STABILIZERS

A steering stabilizer is a dampening shock for your steering system. It dampens out the harshness of the highway, the 'shimmy' from running the additional weight of larger tires & wheels and places control back into the driver's hands.

Stabilizers also reduce the fatigue of the driver on a personal level by reducing the amount of physical strength it takes to guide those larger tires on and off the road. Changing the weak stock unit for a better performing replacement or adding dual steering stabilizers is an inexpensive but worthy investment.

## JEEP CONTROL ARMS \ LINKS

**Standard Link Control arms** are fitted with rubber bushings (RB) on both ends of each link. **Value Flex Control arms** are fitted with greasable polyurethane bushings on one end and a NG rebuildable rod end on the other. **Rock Ready® Series long arm links** are 80% longer than stock, fitted with NG rebuildable rod ends with "Pivot Plus" inserts for maximum rotation.



# JT



**2020 Gladiator JT DUAL RATE-LONG TRAVEL** systems offer the best of both worlds whether for On-Road use or Off-Road use. The 1st spring rate offers an exceptional highway ride & will expand when off-roading during articulation to keep the tires in contact with the ground much longer & the coils remain in the upper coil bucket even at full drop unlike linear rate coils. The 2nd rate, lower coils, only engage after compression past the 1st rate & allows consistent control & stability during body roll & heavy off-road suspension movement. Unique left & right coil spring utilized like OE & long travel front and rear Skyjacker shocks are length fitted to offer the maximum extension allowable for full articulation to complete this system. **GLADIATOR REAR COILS** have an added feature of the 2nd stage being variable rate helping control loads through the suspension travel for activities like overlanding and towing.



**2.5" GLADIATOR SYSTEM**



**3.5" GLADIATOR SYSTEM**



**4.5" GLADIATOR SYSTEM**

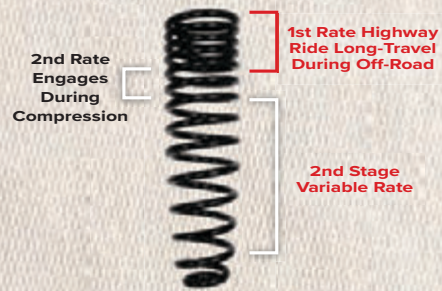

2nd Rate Engages During Compression

1st Rate Highway Ride Long-Travel During Off-Road

2nd Stage Variable Rate

**2-STAGE VARIABLE RATE REAR COILS**



### 2020 Gladiator JT 4 Door 4WD (Rubicon & NON-Rubicon Models)

Kit Ref #	Description	Qty	Part #
<b>GLADIATOR JT 4 Door 4WD Polyurethane Spacer &amp; Value Kits (Rubicon &amp; NON-Rubicon Models)</b>			
JTFPS75	3/4" Front Poly Spacer, pair	1	JKFPS75
G250MSB	2.5" Front & 1" Rear Metal Spacer Kit w/ Front & Rear Sway Bar End Links & Shock Extensions	1	G250MSB
G25MSFB	2.5" Front Metal Spacer Kit	1	G25MSFB
<b>GLADIATOR JT 4 Door 4WD Dual Rate-Long Travel (NON-Rubicon Models)</b>			
G250PBLT	2.5" Dual Rate-Long Travel Kit, with 1" Rear Coil Spacers, includes (4) Black MAX Shocks	1	G250PBLT
G250PMLT	2.5" Dual Rate-Long Travel Kit, with 1" Rear Coil Spacers, includes (4) M95 Monotube Shocks	1	G250PMLT
G251PBLT	2.5" Dual Rate-Long Travel System, with 1.5" Rear Coils, includes (4) Black MAX Shocks	1	G251PBLT
G251PMLT	2.5" Dual Rate-Long Travel System, with 1.5" Rear Coils, includes (4) M95 Monotube Shocks	1	G251PMLT
G350PBLT	3.5" Dual Rate-Long Travel Kit, with 2" Rear Coil Spacers, includes (4) Black MAX Shocks	1	G350PBLT
G350PMLT	3.5" Dual Rate-Long Travel Kit, with 2" Rear Coil Spacers, includes (4) Long Travel M95 Shocks	1	G350PMLT
G351KBLT	3.5" Dual Rate-Long Travel System, with 2" Rear Coils, includes (4) Black MAX Shocks	1	G351KBLT
G351KMLT	3.5" Dual Rate-Long Travel System, with 2" Rear Coils, includes (4) Long Travel M95 Shocks	1	G351KMLT
G452KBLT	4.5" Main Comp Box	1	G452LT
	(4) Black MAX Shocks	1	G45B
G452KMLT	4.5" Main Comp Box	1	G452LT
	(4) Monotube Shocks	1	G45M
<b>GLADIATOR JT 4 Door 4WD Dual Rate-Long Travel (RUBICON Models)</b>			
G250RPBLT	2.5" Dual Rate-Long Travel Kit, with 1" Rear Coil Spacers, includes (4) Black MAX Shocks	1	G250RPBLT
G250RPMLT	2.5" Dual Rate-Long Travel Kit, with 1" Rear Coil Spacers, includes (4) M95 Monotube Shocks	1	G250RPMLT
G251RPBLT	2.5" Dual Rate-Long Travel System, with 1" Rear Coils, includes (4) Black MAX Shocks	1	G251RPBLT
G251RPMLT	2.5" Dual Rate-Long Travel System, with 1" Rear Coils, includes (4) M95 Monotube Shocks	1	G251RPMLT
G350RPBLT	3.5" Dual Rate-Long Travel Kit, with 2" Rear Coil Spacers, includes (4) Black MAX Shocks	1	G350RPBLT
G350RPMLT	3.5" Dual Rate-Long Travel Kit, with 2" Rear Coil Spacers, includes (4) Long Travel M95 Shocks	1	G350RPMLT
G351RKBLT	3.5" Dual Rate-Long Travel System, with 2" Rear Coils, includes (4) Black MAX Shocks	1	G351RKBLT
G351RKMLT	3.5" Dual Rate-Long Travel System, with 2" Rear Coils, includes (4) Long Travel M95 Shocks	1	G351RKMLT
G452RKBLT	4.5" Main Comp Box	1	G452RLT
	(4) Black MAX Shocks	1	G45B
G452RKMLT	4.5" Main Comp Box	1	G452RLT
	(4) Monotube Shocks	1	G45M
Gladiator JT Options	1" Rear Upper Coil Spacers, Pair	1	G10MSR
	2" Rear Upper Coil Spacers, Pair	1	G20MSR
	Adjustable Front Track Bar JL/JT	1	JLFTBA18
	Adjustable Rear Track Bar JT	1	JTGRTBA20
	Front Lower Adjustable Control Arms JL/JT, pair	1	JLL24F-SX
	Front Upper Adjustable Control Arms JL/JT, pair	1	JLULF26-SX
	Rear Lower Adjustable Control Arms JT, pair	1	GLL24R-SX
	Rear Upper Adjustable Control Arms JT, pair	1	GULR24-SX
	Front Outboard Shock Mounting Brackets JL/JT	1	JLOSM
	Front Double Disconnect Sway Bar End Links JL/JT 2-3"	1	SBE4238
	Front Double Disconnect Sway Bar End Links JL/JT 3.5-6"	1	SBE4258
	HD OEM Replacement Steering Damper, White	1	7008
	HD OEM Replacement Steering Damper, Black	1	8008
	HD OEM Replacement Steering Damper, Silver	1	9008
	Dual Steering Damper Kit, White	1	7208
	Dual Steering Damper Kit, Black	1	8208
	Dual Steering Damper Kit, Silver	1	9208

# JL



**2018-20 JL DUAL RATE-LONG TRAVEL** suspension offers you the best of both worlds! Dual Rate means the 1st Rate offers both an exceptional highway ride & LONG TRAVEL as those coils EXPAND during articulation which allows suspension droop to keep the tires in the contact with the ground much longer. The 2nd Rate, lower coils, only engage when the suspension compresses past the 1st rate. The 2nd rate allows consistent control & stability during heavy off-road suspension movement.



**1-1.5" Dual Rate-Long Travel**



**2-2.5" Dual Rate-Long Travel**



**3.5-4" Dual Rate-Long Travel**

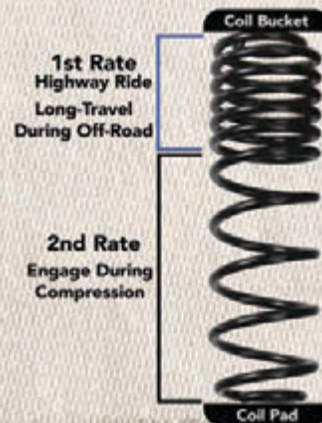

## 2018-2020 Wrangler JL 4 Door 4WD (Rubicon & NON-Rubicon Models)

Kit Ref #	Description	Qty	Part #
<b>WRANGLER JL 4 Door 4WD Polyurethane Spacer &amp; Value Kits (Rubicon &amp; NON-Rubicon Models)</b>			
JLFPS75	3/4" Front Poly Spacer	1	JLFPS75
JLRPS75	3/4" Rear Poly Spacer	1	JLRPS75
JL25MSB	2.5" Front & 2" Rear Coil Spacers	1	JL25MSB
LOWJL025PB	2-2.5 Drop System (Sport/Sahara Only) w/ 4 Black MAX Shocks	1	LOWJL025PB
<b>WRANGLER JL 4 Door 4WD Dual Rate-Long Travel (NON-Rubicon Models)</b>			
JL15BPBLT	1-1.5" Dual Rate-Long Travel Coil Springs & Shocks, includes (4) Long Travel Black MAX Shocks	1	JL15BPBLT
JL15BPMLT	1-1.5" Dual Rate-Long Travel Coil Springs & Shocks, includes (4) Long Travel M95 Shocks	1	JL15BPMLT
JL25BPBLT	2-2.5" Dual Rate-Long Travel Coil Springs & Shocks, includes (4) Long Travel Black MAX Shocks	1	JL25BPBLT
JL25BPMLT	2-2.5" Dual Rate-Long Travel Coil Springs & Shocks, includes (4) Long Travel M95 Shocks	1	JL25BPMLT
JL40BPBLT	3.5-4" Dual Rate-Long Travel Coil Springs & Shocks, includes (4) Long Travel Black MAX Shocks	1	JL40BPBLT
JL40BPMLT	3.5-4" Dual Rate-Long Travel Coil Springs & Shocks, includes (4) Long Travel M95 Shocks	1	JL40BPMLT
<b>WRANGLER JL 4 Door 4WD Dual Rate-Long Travel (RUBICON Models)</b>			
JL15RBPBLT	1-1.5" Dual Rate-Long Travel Coil Springs & Shocks, includes (4) Long Travel Black MAX Shocks	1	JL15RBPBLT
JL15RBPMLT	1-1.5" Dual Rate-Long Travel Coil Springs & Shocks, includes (4) Long Travel M95 Shocks	1	JL15RBPMLT
JL25RBPBLT	2-2.5" Dual Rate-Long Travel Coil Springs & Shocks, includes (4) Long Travel Black MAX Shocks	1	JL25RBPBLT
JL25RBPMLT	2-2.5" Dual Rate-Long Travel Coil Springs & Shocks, includes (4) Long Travel M95 Shocks	1	JL25RBPMLT
JL40RBPBLT	3.5-4" Dual Rate-Long Travel Coil Springs & Shocks, includes (4) Long Travel Black MAX Shocks	1	JL40RBPBLT
JL40RBPMLT	3.5-4" Dual Rate-Long Travel Coil Springs & Shocks, includes (4) Long Travel M95 Shocks	1	JL40RBPMLT
<b>Wrangler JL Options</b>	<b>OEM HD Replacement Steering Damper - White</b>	1	7008
	<b>OEM HD Replacement Steering Damper - Black</b>	1	8008
	<b>OEM HD Replacement Steering Damper - Silver</b>	1	9008
	<b>Dual Steering Damper Kit - White</b>	1	7208
	<b>Dual Steering Damper Kit - Black</b>	1	8208
	<b>Dual Steering Damper Kit - Silver</b>	1	9208
	<b>Front &amp; Rear Lower Standard Heavy Duty Links, 1-4" Lift (Set)</b>	1	JL24LL
	<b>Front &amp; Rear Lower Adjustable Flex Links, 1-6" Lift (Set)</b>	1	JL24LLX
	<b>Front Lower Adjustable Flex Links, 1-6" Lift (Pair)</b>	1	JLL24F-SX
	<b>Rear Lower Adjustable Flex Links, 1-6" Lift (Pair)</b>	1	JLL24R-SX
	<b>Front Upper Adjustable Flex Links, 1-6" Lift (Pair)</b>	1	JLULF26-SX
	<b>Rear Upper Adjustable Flex Links, 1-6" Lift (Pair)</b>	1	JLULR26-SX
	<b>Front Adjustable Track Bar, 0-6" Lift</b>	1	JLFTBA18
	<b>Rear Adjustable Track Bar, 2-6" Lift</b>	1	JLRTBA18
	<b>Front Track Bar Brace</b>	1	JLFBRC18
	<b>Front Sway Bar Double Disconnect Extended End Links, 2-3" Lift</b>	1	SBE4238
	<b>Front Sway Bar Double Disconnect Extended End Links, 3.5-6" Lift</b>	1	SBE4258
	<b>Tailgate Saver Support System &amp; Spare Tire Relocation Kit</b>	1	TGSSTR2
	<b>JL Front Outboard Shock Mounting Brackets</b>	1	JLOSM



# JL



## 3.5-6" ADJUSTABLE COIL-OVER SYSTEM:

### Features & Benefits

- Direct bolt on (NO cutting or welding)
- Can be returned to stock
- Adjustable ride height
- Increased articulation (12" travel front and rear)
- Adjustable secondary spring rate engagement
- Made in the USA
- Lifetime guaranteed coil spring
- Purchased as kit or coil-over upgrade



JL36SLSK-SX



JLFTBA18



JLRTBA18



SBE4238



SBE4258



JLFBRC18



JL24LL



JLL24R-SX



JL24LLX



JLULF26-SX



JLULR26-SX



## 2018-2020 Wrangler JL 2 Door 4WD (Rubicon & NON-Rubicon Models)

Kit Ref #	Description	Qty	Part #
<b>WRANGLER JL 2 Door 4WD Polyurethane Spacer &amp; Value Kits (Rubicon &amp; NON-Rubicon Models)</b>			
JLFPS75	3/4" Front Poly Spacer	1	JLFPS75
JLRPS75	3/4" Rear Poly Spacer	1	JLRPS75
JL25MSB	2.5" Front & 2" Rear Coil Spacers	1	JL25MSB
LOWJLO25PB	2-2.5 Drop System (Sport/Sahara Only) w/ 4 Black MAX Shocks	1	LOWJLO25PB
<b>WRANGLER JL 2 Door 4WD Dual Rate-Long Travel (NON-Rubicon Models)</b>			
JL20BPBLT	2-2.5" Dual Rate-Long Travel Coil Springs & Shocks, includes (4) Long Travel Black MAX Shocks	1	JL20BPBLT
JL20BPMLT	2-2.5" Dual Rate-Long Travel Coil Springs & Shocks, includes (4) Long Travel M95 Shocks	1	JL20BPMLT
JL35BPBLT	3.5-4" Dual Rate-Long Travel Coil Springs & Shocks, includes (4) Long Travel Black MAX Shocks	1	JL35BPBLT
JL35BPMLT	3.5-4" Dual Rate-Long Travel Coil Springs & Shocks, includes (4) Long Travel M95 Shocks	1	JL35BPMLT
<b>WRANGLER JL 2 Door 4WD Dual Rate-Long Travel (RUBICON Models)</b>			
JL20RBPBLT	2-2.5" Dual Rate-Long Travel Coil Springs & Shocks, includes (4) Long Travel Black MAX Shocks	1	JL20RBPBLT
JL20RBPMLT	2-2.5" Dual Rate-Long Travel Coil Springs & Shocks, includes (4) Long Travel M95 Shocks	1	JL20RBPMLT
JL35RBPBLT	3.5-4" Dual Rate-Long Travel Coil Springs & Shocks, includes (4) Long Travel Black MAX Shocks	1	JL35RBPBLT
JL35RBPMLT	3.5-4" Dual Rate-Long Travel Coil Springs & Shocks, includes (4) Long Travel M95 Shocks	1	JL35RBPMLT
<b>Wrangler JL Options</b>	<b>OEM HD Replacement Steering Damper - White</b>	1	7008
	<b>OEM HD Replacement Steering Damper - Black</b>	1	8008
	<b>OEM HD Replacement Steering Damper - Silver</b>	1	9008
	<b>Dual Steering Damper Kit - White</b>	1	7208
	<b>Dual Steering Damper Kit - Black</b>	1	8208
	<b>Dual Steering Damper Kit - Silver</b>	1	9208
	<b>Front &amp; Rear Lower Standard Heavy Duty Links, 1-4" Lift (Set)</b>	1	JL24LL
	<b>Front &amp; Rear Lower Adjustable Flex Links, 1-6" Lift (Set)</b>	1	JL24LLX
	<b>Front Lower Adjustable Flex Links, 1-6" Lift (Pair)</b>	1	JLL24F-SX
	<b>Rear Lower Adjustable Flex Links, 1-6" Lift (Pair)</b>	1	JLL24R-SX
	<b>Front Upper Adjustable Flex Links, 1-6" Lift (Pair)</b>	1	JLULF26-SX
	<b>Rear Upper Adjustable Flex Links, 1-6" Lift (Pair)</b>	1	JLULR26-SX
	<b>Front Adjustable Track Bar, 0-6" Lift</b>	1	JLFTBA18
	<b>Rear Adjustable Track Bar, 2-6" Lift</b>	1	JLRTBA18
	<b>Front Track Bar Brace</b>	1	JLFBRC18
	<b>Front Sway Bar Double Disconnect Extended End Links, 2-3" Lift</b>	1	SBE4238
	<b>Front Sway Bar Double Disconnect Extended End Links, 3.5-6" Lift</b>	1	SBE4258
	<b>Tailgate Saver Support System &amp; Spare Tire Relocation Kit</b>	1	TGSSTR2
	<b>JL Front Outboard Shock Mounting Brackets</b>	1	JLOSM



# JK



## SKYJACKER SUSPENSIONS

### Skyjacker® Coil-Over Features & Benefits

- Direct bolt on
- Returnable to stock
- Adjustable ride height
- Increased articulation
- Adjustable secondary spring rate engagement
- Vehicle specific tuned shocks
- Improved stability
- Optional air bump stops
- Made in the USA
- Lifetime guaranteed coil spring
- Purchased as kit or coil-over box upgrade for current Skyjacker® Suspension!



**Skyjacker® is proud to announce our new bolt in Skyjacker® Coil-Overs that are tuned and tested by with application specific valving for maximum performance on and off-road. This new series of Coil-Overs can be purchased as kit or just get the Coil-Over box upgrade for your current Skyjacker® Suspension!**

<b>4.5" -6" Coil-Over Kits with Lower Arms Jeep 2DR &amp; 4DR Wrangler &amp; Unlimited 2007-18 - Suggested Tire Size 33" - 37"</b>				
<b>JK60SLSK-SX</b>	Wrangler JK Front Coil-Over Shocks & Coil-Over Spring Box	1	JK62FLS	4,5,6,7
	Wrangler JK Front Coil-Over Component Box	1	JK62FLSB	
	Rear Coil-Over Shocks & Coil Spring Box	1	JK62RLS	
	Rear Coil-Over Component Box	1	JK62RLSB	
	Front & Rear Adjustable Lower Flex Control Arm Links w/Currie Rod Ends 2.5-4" Lift	1	JK24LLX	
	Front Adjustable Track Bar 0-7"	1	JKFTBA717	
<b>3.5" -4.5" Coil-Over Kits with Lower Arms Jeep 2DR &amp; 4DR Wrangler &amp; Unlimited 2007-18 - Suggested Tire Size 33" - 37"</b>				
<b>JK40SLSK-SX</b>	Wrangler JK Front Coil-Over Shocks & Coil-Over Spring Box	1	JK62FLS	4,5,6,7
	Wrangler JK Front Coil-Over Component Box	1	JK62FLSB	
	Rear Coil-Over Shocks & Coil Spring Box	1	JK62RLS	
	Rear Coil-Over Component Box	1	JK42RLSB	
	Front & Rear Adjustable Lower Flex Control Arm Links w/Currie Rod End 2.5-4" Lift	1	JK24LLX	
	Front Adjustable Track Bar 2-7"	1	JKFTBA717	
<b>4.5" -6" Long Arm Coil-Over Kits Jeep 2DR &amp; 4DR Wrangler &amp; Unlimited 2007-18 - Suggested Tire Size 33" - 37"</b>				
<b>JK64LLSK-SX</b>	Wrangler JK Front Coil-Over Shocks & Coil-Over Spring Box	1	JK62FLS	4,5,6,7
	Wrangler JK Front Coil-Over Component Box	1	JK62FLSB	
	Rear Coil-Over Shocks & Coil Spring Box	1	JK62RLS	
	Rear Coil-Over Component Box	1	JK62RLSB	
	Wrangler JK Long Arm Box 4-7"	1	JK46LA-SX	
	Front Adjustable Track Bar 0-7"	1	JKFTBA717	
<b>3.5" -4.5" Long Arm Coil-Over Kits Jeep 2DR &amp; 4DR Wrangler &amp; Unlimited 2007-18 - Suggested Tire Size 33" - 37"</b>				
<b>JK44LLSK-SX</b>	Wrangler JK Front Coil-Over Shocks & Coil-Over Spring Box	1	JK62FLS	4,5,6,7
	Wrangler JK Front Coil-Over Component Box	1	JK62FLSB	
	Rear Coil-Over Shocks & Coil Spring Box	1	JK62RLS	
	Rear Coil-Over Component Box	1	JK42RLSB	
	Wrangler JK Long Arm Box 4-7"	1	JK46LA-SX	
	Front Adjustable Track Bar 2-7"	1	JKFTBA717	
<b>Notes</b>	<b>4)</b> Steering Stabilizers available to match all shock colors <b>5)</b> Exhaust Spacer/Modification JK36ESK required 2012-18 <b>6)</b> 2 Door Models require After market CV Driveshaft <b>7)</b> 2 Door Models may require Rear Upper Adjustable Control Arms JKULR26-SX			
<b>Options</b>	Optional Front Air Bump Stop	1	JKLSAB	
	Optional Rear Air Bump Stop	1	JKLSABR	



# JK



Dual Rate-Long Travel suspension offers you the best of both worlds! The 1st Rate offers an exceptional highway ride & LONG TRAVEL as those coils EXPAND during articulation which allows suspension droop to keep the tires in contact with the ground much longer. The 2nd Rate, lower coils, only engage when the suspension compresses past the 1st rate. The 2nd rate allows consistent control & stability during heavy off-road suspension movement.

## Jeep Wrangler 2 Door & 4 Door - 2WD & 4WD 2007-2018

Kit Ref #	Description	Qty	Part #	Front Shock	Rear Shock	Note
<b>2" Front, 2" Rear Poly Spacer Kit Jeep 2DR &amp; 4DR Wrangler / Wrangler Unlimited 2007-18 - Suggested Tire Size 33" - 34"</b>						
JK20	2" Lift Poly Spacer Kit, Choose Shocks	1	JK20			
	<b>Select Shock Option F&amp;R Shocks (2) each of desired Series</b>					
	<b>Hydro Series Shock with Red Boot, White</b>	2		H7035	H7037	4
	<b>Nitro Series Gas Shock with Red Boot, White</b>	2		N8035	N8037	4
	<b>Black MAX Performance Shock with Black Boot, Black</b>	2		B8535	B8537	4
<b>M95 Monotube Performance Shock, Silver</b>	2		M9535	M9537	4	
<b>2" Front, 3/4" Rear Poly Spacer Leveling Kit Jeep 2DR &amp; 4DR Wrangler / Wrangler Unlimited 2007-18 - Suggested Tire Size 33" - 34"</b>						
JK23	2" Front, 3/4" Rear Lift Poly Spacer Kit, Choose Shocks	1	JK23			
	<b>Select Shock Option F&amp;R Shocks (2) each of desired Series</b>					
	<b>Hydro Series Shock with Red Boot, White</b>	2		H7035	H7037	4
	<b>Nitro Series Gas Shock with Red Boot, White</b>	2		N8035	N8037	4
	<b>Black MAX Performance Shock with Black Boot, Black</b>	2		B8535	B8537	4
<b>M95 Monotube Performance Shock, Silver</b>	2		M9535	M9537	4	



# Jeep

## Jeep JK 2 Door & 4 Door - 2WD & 4WD 2007-2018

Kit Ref #	Description	Qty	Part #	Note
<b>2-2.5" Dual Rate-Long Travel Series 4DR Wrangler 2007-18 (FVMSS 126 Safety Compliant)</b>				
JK25BPBLT	2-2.5" Dual Rate-Long Travel, Complete System, <b>includes (4) Black MAX shocks</b>	1	JK25BPBLT	2
JK25BPMLT	2-2.5" Dual Rate-Long Travel, Complete System, <b>includes (4) M95 Monotube</b>	1	JK25BPMLT	2
<b>2.5" Dual Rate Long Travel Systems Jeep 4DR Wrangler Unlimited 2007-18 (FVMSS 126 Safety Compliant)</b>				
JK25BPHLT	2.5" Dual Rate-Long Travel, Complete System, <b>includes (4) Hydro shocks</b>	1	JK25BPHLT	2
JK25BPNTL	2.5" Dual Rate-Long Travel, Complete System, <b>includes (4) Nitro shocks</b>	1	JK25BPNTL	2
JK25BPBLT	2.5" Dual Rate-Long Travel, Complete System, <b>includes (4) Black MAX shocks</b>	1	JK25BPBLT	2,4
JK2500BPMLT	2.5" Dual Rate-Long Travel, Complete System, <b>includes (4) M95 Monotube</b>	1	JK2500BPMLT	2
<b>4" Dual Rate Long Travel Systems 4DR Jeep Wrangler Unlimited 2007-18 (FVMSS 126 Safety Compliant)</b>				
JK40BPHLT	4" Dual Rate-Long Travel, Complete Kit, <b>includes (4) Hydro shocks &amp; ADJUSTABLE FRONT TRACK BAR</b>	1	JK40BPHLT	2,3,4,5
JK40BPNTL	4" Dual Rate-Long Travel, Complete Kit, <b>includes (4) Nitro shocks &amp; ADJUSTABLE FRONT TRACK BAR</b>	1	JK40BPNTL	2,3,4,5
JK40BPBLT	4" Dual Rate-Long Travel, Complete Kit, <b>includes (4) Black MAX shocks &amp; ADJUSTABLE FRONT TRACK BAR</b>	1	JK40BPBLT	2,3,4,5
JK40BPMLT	4" Dual Rate-Long Travel, Complete Kit, <b>includes (4) M95 Monotube &amp; ADJUSTABLE FRONT TRACK BAR</b>	1	JK400BPMLT	2,3,4,5
<b>2-2.5" Dual Rate-Long Travel Series 2DR Wrangler 2007-18 (FVMSS 126 Safety Compliant)</b>				
JK20BPHLT	2-2.5" Dual Rate-Long Travel, Complete System, <b>includes (4) Hydro shocks</b>	1	JK20BPHLT	2
JK20BPNTL	2-2.5" Dual Rate-Long Travel, Complete System, <b>includes (4) Nitro shocks</b>	1	JK20BPNTL	2
JK20BPBLT	2-2.5" Dual Rate-Long Travel, Complete System, <b>includes (4) Black MAX shocks</b>	1	JK20BPBLT	2
JK20BPMLT	2-2.5" Dual Rate-Long Travel, Complete System, <b>includes (4) M95 Monotube</b>	1	JK20BPMLT	2
<b>3.5-4" Dual Rate-Long Travel Series 2DR Wrangler 2007-18 (FVMSS 126 Safety Compliant)</b>				
JK35BPHLT	3.5-4" Dual Rate-Long Travel, Complete System, <b>includes (4) Hydro shocks</b>	1	JK35BPHLT	2
JK35BPNTL	3.5-4" Dual Rate-Long Travel, Complete System, <b>includes (4) Nitro shocks</b>	1	JK35BPNTL	2
JK35BPBLT	3.5-4" Dual Rate-Long Travel, Complete System, <b>includes (4) Black MAX shocks</b>	1	JK35BPBLT	2
JK35BPMLT	3.5-4" Dual Rate-Long Travel, Complete System, <b>includes (4) M95 Monotube</b>	1	JK35BPMLT	2
<b>Notes</b>	<b>2) Control Arm Upgrades - Heavy Duty Lower Links add JKLL24, Adjustable Lower Flex Links add JK24LLX 3) Long Arm Upgrade add JK46LA-SX 4) Steering Stabilizers available to match 5) Exhaust Spacer/Modification JK36ESK required 2012-18 Models</b>			

Additional Jeep applications available. See pages 156-179.



**JK40BPMLT**

3.5-4" DUAL RATE-LONG TRAVEL SYSTEM



**JK20**



**JK25BPBLT**

2-2.5" DUAL RATE-LONG TRAVEL SYSTEM



### Jeep Wrangler 2 Door & 4 Door - 2WD & 4WD 2007-2018

Kit Ref #	Description	Qty	Part #	Front Shock	Rear Shock	Note	
<b>4" 4 Door - 5" 2 Door Rock Ready Long Arm Kit Jeep Wrangler / Unlimited JK Suggested Tire Size 35"- 37"</b>							
<b>JK40LAK-SX</b>	Wrangler JK Long Arm Box 4-7"	1	JK46LA-SX			5	
	Wrangler JK Long Arm Box 4-5"	1	JK45LA				
	Wrangler JK Dual Rate- Long Travel 4-5" Front Coils, Pair	1	JKU40FDR				
	Wrangler JK Dual Rate-Long Travel 4-5" Rear Coils, Pair	1	JKU40RDR				
	<b>Adjustable Front Track Bar</b>	1	JKFTBA717				
	<b>Select a Shock Option F&amp;R Shocks (2) each of desired Shock Series</b>						
	<b>Hydro Series Shock with Red Boot, White</b>	2		H7065	H7067	4	
	<b>Nitro Series Gas Shock with Red Boot, White</b>	2		N8065	N8067	4	
	<b>Black MAX Performance Shock with Black Boot, Black</b>	2		B8565	B8567	4	
<b>M95 Monotube Performance Shock, Silver</b>	2		M9565	M9567	4		
<b>6" 4 Door - 7" 2 Door Rock Ready Long Arm Kit Jeep Wrangler / Unlimited JK Suggested Tire Size 36"- 38"</b>							
<b>JK60LAK-SX</b>	Wrangler JK Long Arm Box 4-7"	1	JK46LA-SX			5	
	Wrangler JK Long Arm Box 4-5"	1	JK60LA				
	Wrangler JK Dual Rate Long Travel Front Coils 6-7"	1	JK60FDR				
	Wrangler JK Dual Rate Long Travel Rear Coils 6-7"	1	JK60RDR				
	<b>Adjustable Front Track Bar</b>	1	JKFTBA717				
	<b>Select a Shock Option F&amp;R Shocks (2) each of desired Shock Series</b>						
	<b>Hydro Series Shock with Red Boot, White</b>	2		H7075	H7087	4	
	<b>Nitro Series Gas Shock with Red Boot, White</b>	2		N8075	N8087	4	
	<b>Black MAX Performance Shock with Black Boot, Black</b>	2		B8575	B8587	4	
<b>M95 Monotube Performance Shock, Silver</b>	2		M9575	M9587	4		
<b>Notes</b>	<b>2) Control Arm Upgrades - Heavy Duty Lower Links add JKLL24, Adjustable Lower Flex Links add JK24LLX 3) Long Arm Upgrade add JK46LA-SX 4) Steering Stabilizers available to match 5) Exhaust Spacer/Modification JK36ESK required 2012-18 Models 6) 2 Door Models require After market CV Driveshaft 7) 2 Door Models require Upper Adjustable Control Arms JKULR26-SX 8) Requires Adjustable Front Track Bar JKFTBA717 9) Requires Front &amp; Rear Adjustable Lower Control JK24LLX</b>						

Additional Jeep applications available. See pages 156-179.



JK40LAK-SX  
JK60LAK-SX



# Jeep

### Options Jeep Wrangler & Wrangler & Unlimited 2007-2018

<b>JK62FLSBO</b> (3.5-6" JK Front Coil-Over Upgrade)	Wrangler JK Front Coil-Over Upgrade Shocks & Coil-Over Spring Box	1	JK62FLS	8,9
	Wrangler JK Front Coil-Over Upgrade Component Box	1	JK62FLSB	8,9
<b>JK42RLSBO</b> (3.5-4.5" JK Rear Coil-Over Upgrade)	Wrangler JK Rear Coil-Over Upgrade Shocks & Coil-Over Spring Box	1	JK62RLS	6,7
	Wrangler JK Rear Coil-Over Upgrade Component Box	1	JK42RLSB	6,7
<b>JK62RLSBO</b> (4.5-6" JK Rear Coil-Over Upgrade)	Wrangler JK Rear Coil-Over Upgrade Shocks & Coil-Over Spring Box	1	JK62RLS	6,7
	Wrangler JK Rear Coil-Over Upgrade Component Box	1	JK62RLSB	6,7
<b>Wrangler JK Options</b>	<b>Spare Tire Relocation Kit</b>	1	STRJK212	
	<b>Spare Tire Support Kit (See page 22-23)</b>	1	TGSJK1	
	<b>Combo Relocation &amp; Support Kit (Includes STRJK212 &amp; TGSJK1)</b>	1	TGSSTR1	
	<b>Heavy Duty DUAL LOAD Ball Joint Kit (See page 25)</b>	1	JK2717B	
	<b>Front &amp; Rear Heavy Duty Lower Control Arm Links 2.5-5" Lift</b>	1	JKLL24	
	<b>Front &amp; Rear Adjustable Lower Flex Control Arm Links w/ Flex Rod Ends 2.5-6" Lift</b>	1	JK24LLX	
	<b>Long Arm Upgrade 3.5-6" Lift Long Arm Upgrade 3.5-6" Lift</b>	1	JK46LA-SX	
	<b>Front Upper Adjustable Control Arms, 2-6" lift</b>	1	JKULF26-SX	
	<b>Rear Upper Adjustable Control Arms, 2-6" lift</b>	1	JKULR26-SX	
	<b>Front Adjustable Track Bar 0-7"</b>		JKFTBA717	
	<b>Rear Adjustable Track Bar 2-7"</b>	1	JKRTBA717	
	<b>Dual Steering Stabilizer Kit, WHITE</b>	1	7203 or 7204	
	<b>Dual Steering Stabilizer Kit, Black MAX</b>	1	8203 or 8204	
	<b>Dual Steering Stabilizer Kit, SILVER</b>	1	9203 or 9204	
	<b>OEM Steering Stabilizer Kit, WHITE w/Red Boot</b>	1	7003	
	<b>OEM Steering Stabilizer Kit, Black MAX w/Black Boot</b>	1	8003	
	<b>OEM Steering Stabilizer Kit, SILVER w/Black Boot</b>	1	9003	
	<b>Front Coil Spring Isolator Pads 3/4", Pair</b>		JKFPS75	
	<b>Rear Coil Spring Isolator Pads 3/4", Pair</b>		JKRPS75	
	<b>Grab Handles, 3" BLACK</b>		RRGH30RP-K	
	<b>Grab Handles, 3" RED</b>		RRGH30RP-R	
	<b>Control arm Cam Bolt Kit pair</b>		CAM700	
	<b>Optional Front Air Bump Stop</b>		JKLSAB	

Additional Jeep applications available. See pages 156-179.



JKFTBA717



JK717DL



JK24LLX



JK717TR

# SKYJACKER SUSPENSIONS

## Spare Tire Support Relocation Kit



Part # TGSJK1



Part # STRJK212

Part # TGSJK1

Combo Kit # TGSSTR1





## Skyjacker Tailgate Saver Vibration Results Comparison

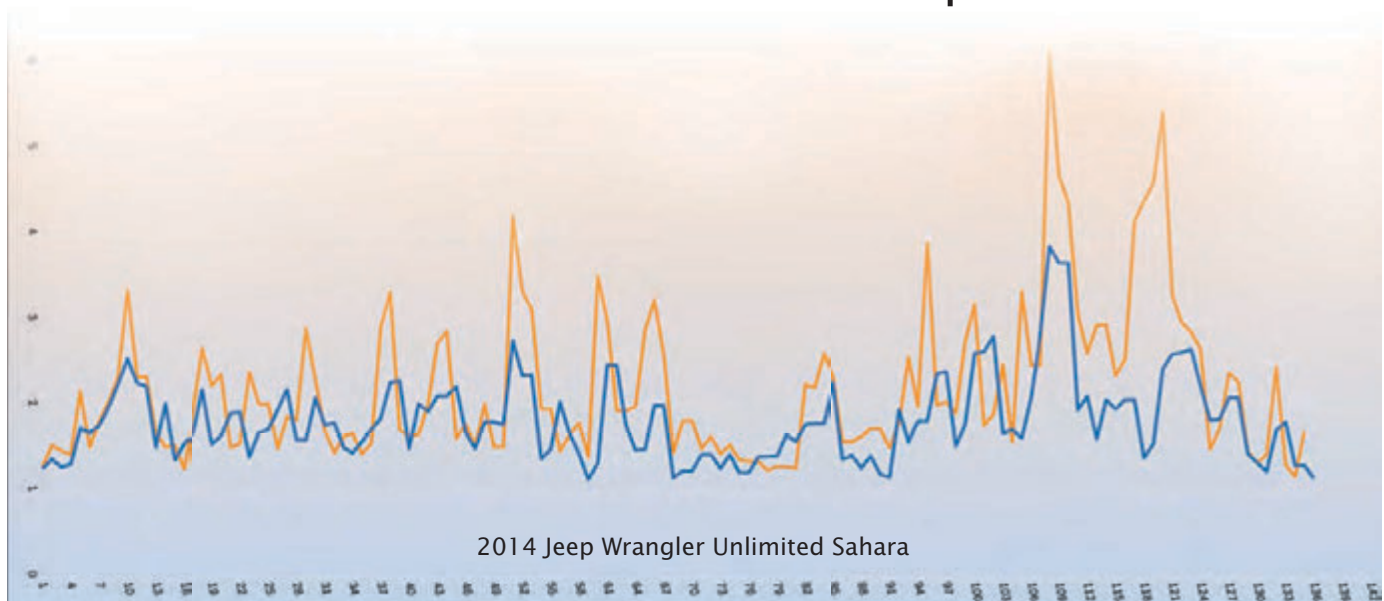

**Without  
Tailgate Saver**

**With  
Tailgate Saver**

- Supports Spare Tire Reducing Vibration and Noise
- Reducing Load and Force on Tailgate to Prevent Cracking
- Engineered to Work with Existing Tailgate Using Spare Tire Adapter/Spacer
- Works with Factory Rear Bumper and Many Aftermarket Rear Bumpers
- Works with and without Trailer Hitch or Tow Hook
- Completely Adjustable for 33"-38" Tires and Wheel Backspacing of 4"-5.5"
- Easy Installation Uses Existing Holes and Requires No Drilling
- Powder Coated Black with Stainless Hardware and Anti-Friction Wear Pad



## The Skyjacker® Rock Ready® heavy duty tie rod and drag link system



JK717DL



JK717TR

The Skyjacker® Rock Ready® heavy duty steering system for all Jeep Wrangler JK models features 1 3/4" diameter .281 wall 1026 DOM tie rod and drag link tubes, 1 1/4" threaded forged steel greasable tie rod ends, as well as a new steering stabilizer bracket. The massive tie rod cartridges thread into the tie rod end body, so they may be replaced without purchasing the entire rod end which saves cost. The same threaded tie rod cartridge is used at all 4 points so only one spare would have to be carried. Tie rod and drag link tubes feature wrench flats machined into them for ease of adjustment. This unit is a direct replacement for the OEM parts. No modifications or machining to any part of the vehicle is necessary. Tie rod and drag links can be purchased as a set or individually.

If a flipped draglink is desired, the tie rod cartridge may be unscrewed from the rod end body and screwed in from the other side. **NOTE: Flipping the drag link will require retapering the tie rod end hole from the top side of the knuckle.**





# Jeep

## Skyjacker® Rock Ready® ball joint load distribution design



**JK2717B**  
**JD302B**

**Upper Ball Joint**, USA-made tapered roller bearing carries axial and radial loads. Polyurethane wipe seal prevents contamination - mounted internally to prevent tearing and friction between knuckle and ball joint face

**Lower Ball Joint**, HEXAD Grease System - 6 equally spaced grease grooves evenly distributes grease; With every turn of the wheel, grease is spread in between the two wear surfaces

**32MM** powdered metal bearing replaces the undersized OE plastic bearing, increasing load carrying capacity

Allows clearance for RCV axles without modification

**MADE IN THE USA**

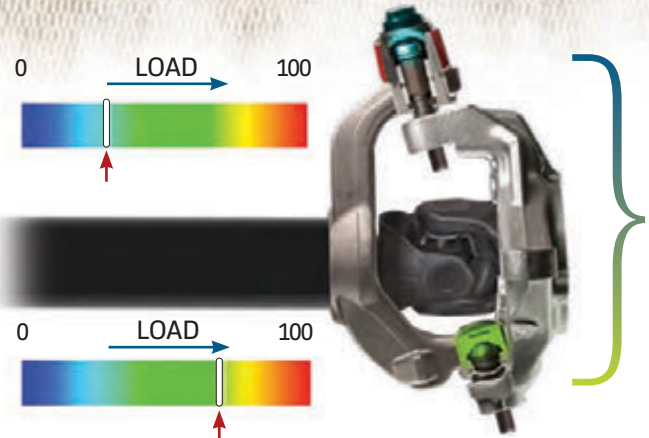
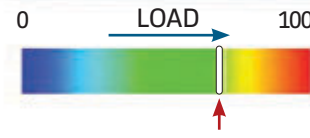
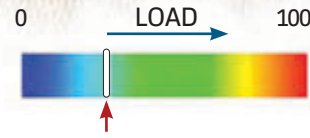

The Skyjacker® Rock Ready® ball joint design shares the load between both the lower and upper ball joints significantly lengthening the life of both joints.

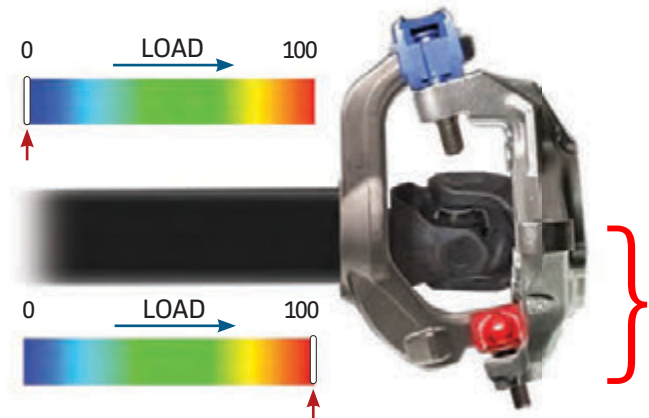
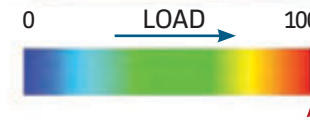
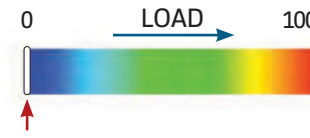

The OE ball joint design consist of a weight carrying lower ball joint and a follower upper ball joint. In this design the lower ball joint carries the full weight and road force of the Jeep and the upper ball joint is only a pivot point that controls lateral movement.

## Heavy Duty Load Carrying Upper Ball Joint

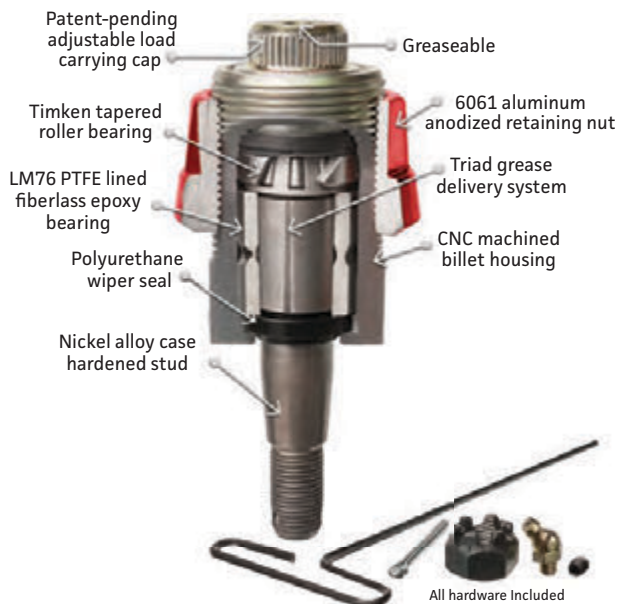

- Patent-pending adjustable load carrying cap
  - Greaseable
  - Timken tapered roller bearing
  - 6061 aluminum anodized retaining nut
  - LM76 PTFE lined fiberlass epoxy bearing
  - Triad grease delivery system
  - Polyurethane wiper seal
  - CNC machined billet housing
  - Nickel alloy case hardened stud
- All hardware Included

## Heavy Duty Lower Ball Joint



- HEXAD grease delivery system
  - CNC machined billet housing
  - Hardened steel retaining bearing with grease grooves
  - Greaseable
  - Replaceable low profile dust boot
  - 32mm powdered metal load-carrying bearing
  - Nickel alloy case hardened stud
- All hardware Included

# TJ



## Jeep Wrangler TJ 1997-2006

Kit Ref #	Description	Qty	Part #	Front Shock	Back Shock	Note
<b>2.5" Dual Rate-Long Travel System Jeep Wrangler TJ &amp; Wrangler Unlimited LJ 1997-2006</b>						
TJ25BPHLT	2.5" Dual Rate-LongTravel System with <b>Hydro Shocks</b>	1	TJ25BPHLT			
TJ25BPNLT	2.5" Dual Rate-LongTravel System with <b>Nitro Shocks</b>	1	TJ25BPNLT			
TJ25BPBLT	2.5" Dual Rate-LongTravel System with <b>Black MAX Shocks</b>	1	TJ25BPBLT			
TJ25BPMLT	2.5" Dual Rate-LongTravel System with <b>Monotube Shocks</b>	1	TJ25BPMLT			
<b>4" Dual Rate-Long Travel System Jeep Wrangler TJ 1997-02</b>						
TJ401BPHLT	4" Dual Rate-LongTravel System with <b>Hydro Shocks</b>	1	TJ401BPHLT			
TJ401BPNLT	4" Dual Rate-LongTravel System with <b>Nitro Shocks</b>	1	TJ401BPNLT			
TJ401BPBLT	4" Dual Rate-LongTravel System with <b>Black MAX Shocks</b>	1	TJ401BPBLT			
TJ401BPMLT	4" Dual Rate-LongTravel System with <b>Monotube Shocks</b>	1	TJ401BPMLT			
<b>4" Dual Rate-Long Travel System Jeep Wrangler TJ &amp; Wrangler Unlimited LJ 2003-06</b>						
TJ403BPHLT	4" Dual Rate-LongTravel System with <b>Hydro Shocks</b>	1	TJ403BPHLT			
TJ403BPNLT	4" Dual Rate-LongTravel System with <b>Nitro Shocks</b>	1	TJ403BPNLT			
TJ403BPBLT	4" Dual Rate-LongTravel System with <b>Black MAX Shocks</b>	1	TJ403BPBLT			
TJ403BPMLT	4" Dual Rate-LongTravel System with <b>Monotube Shocks</b>	1	TJ403BPMLT			



TJ25BPBLT



TJ401BPBLT



## Jeep Wrangler TJ 1997-2006

Kit Ref #	Description	Qty	Part #	Front Shock	Back Shock		
<b>2" Poly Spacer Kit Jeep Wrangler TJ &amp; Wrangler Unlimited LJ 1997-06 - Suggested Tire Size - 32"</b>							
TJ20	2" Kit Poly Spacer Kit Front & Rear	1	TJ20				
	<b>Select a Shock Option F&amp;R Shocks (2) each of desired Shock Series</b>						
	<b>Hydro</b> Series Shock with Red Boot, <b>White</b>	2		H7016	H7018		
	<b>Nitro</b> Series Gas Shock with Red Boot, <b>White</b>	2		N8016	N8018		
	<b>Black MAX</b> Performance Shock with Black Boot, <b>Black</b>	2		B8516	B8518		
	<b>M95</b> Monotube Performance Shock, <b>Silver</b>	2		M9516	M9518		
<b>3" Kit No Lower Link Arms Jeep Wrangler TJ &amp; Wrangler Unlimited LJ 1997-06 - Suggested Tire Size - 31"-33"</b>							
TJ30BPH	3" Jeep Wrangler, <b>includes (4) Hydro shocks</b>	1	TJ30BPH	Incl.	Incl.		
<b>4" Dual Rate-Long Travel System 1997-02 Jeep Wrangler TJ - Suggested Tire Size - 33"</b>							
TJ401BPHLT	4" Jeep Wrangler w/ Dual Rate-Long Travel Coils, <b>includes (4) Hydro shocks</b>	1	TJ401BPHLT				
TJ401BPFLT	4" Jeep Wrangler w/ Dual Rate-Long Travel Coils, <b>includes (4) Nitro shocks</b>	1	TJ401BPFLT				
TJ401BPBLT	4" Jeep Wrangler w/ Dual Rate-Long Travel Coils, <b>includes (4) Black MAX shocks</b>	1	TJ401BPBLT				
TJ401BPMLT	4" Jeep Wrangler w/ Dual Rate-Long Travel Coils, <b>includes (4) M95 Monotube</b>	1	TJ401BPMLT				
<b>4" Dual Rate-Long Travel System 2003-06 Jeep Wrangler TJ &amp; Wrangler Unlimited LJ - Suggested Tire Size - 33"</b>							
TJ403BPHLT	4" Jeep Wrangler w/ Dual Rate-Long Travel Coils, <b>includes (4) Hydro shocks</b>	1	TJ403BPHLT				
TJ403BPFLT	4" Jeep Wrangler w/ Dual Rate-Long Travel Coils, <b>includes (4) Nitro shocks</b>	1	TJ403BPFLT				
TJ403BPBLT	4" Jeep Wrangler w/ Dual Rate-Long Travel Coils, <b>includes (4) Black MAX shocks</b>	1	TJ403BPBLT				
TJ403BPMLT	4" Jeep Wrangler w/ Dual Rate-Long Travel Coils, <b>includes (4) M95 Monotube</b>	1	TJ403BPMLT				
<b>Jeep Wrangler TJ 1997-2006 Rock Ready Long Arm Kits</b>							
Kit Ref #	Description	Qty	Part #	Front Shock	Rear Shock	Note	
<b>4" Rock Ready 1 Long Arm Lower Adjustable Control Arms - Suggested Tire Size - 36"</b>							
TJ40RR1K	4" Rock Ready 1 Long Arm Adjustable, Main Box 1	1	TJ40RRX			10,11,12	
	4" Rock Ready 1 Long Arm Adjustable, Main Box 2	1	TJ40XRR1				
	4" Dual Rate-Long Travel Front Coils, Pair	1	TJ40FDR				
	4" Dual Rate-Long Travel Rear Coils, Pair	1	TJ40RDR				
	<b>Select a Shock Option F&amp;R Shocks (2) each of desired Shock Series</b>						
		<b>Hydro</b> Series Shock, White with Red Boot	2		H7049	H7063	
		<b>Nitro</b> Series Gas Shock, White with Red Boot	2		N8049	N8063	
		<b>Black MAX</b> Performance Shock, Black with Black Boot	2		B8549	B8563	
		<b>M95</b> Monotube Performance Shock, <b>Silver</b>	2		M9549	M9563	
Additional Jeep applications available. See pages 156-179.							

# TJ



## Jeep Wrangler TJ 1997-2006 Rock Ready Long Arm Kits

Kit Ref #	Description	Qty	Part #	Front Shock	Rear Shock	Note	
<b>6" Rock Ready 1 Long Arm Lower Adjustable Control Arms - Suggested Tire Size - 36"</b>							
TJ60RR1LTK	6" Rock Ready 1 Long Arm Adjustable, Main Box 1	1	TJ68RRX			10,11,12	
	6" Rock Ready 1 Long Arm Adjustable, Main Box 2	1	TJ60RR1				
	6" Dual Rate-Long Travel Front Coils, Pair	1	TJ60FDR				
	6" Dual Rate-Long Travel Rear Coils, Pair	1	TJ60RDR				
	<b>Select a Shock Option F&amp;R Shocks (2) each of desired Shock Series</b>						
	<b>Hydro</b> Series Shock, White with Red Boot	2		H7049	H7063		
	<b>Nitro</b> Series Gas Shock, White with Red Boot	2		N8049	N8063		
	<b>Black MAX</b> Performance Shock, Black with Black Boot	2		B8549	B8563		
<b>M95</b> Monotube Performance Shock, <b>Silver</b>	2		M9549	M9563			
<b>6" Rock Ready 2 Long Arm Upper &amp; Lower Adjustable Control Arms - Suggested Tire Size - 36"</b>							
TJ60RR2LTK	6" Rock Ready 2 Long Arm Adjustable, Main Box 1	1	TJ68RRX			10,11,12	
	6" Rock Ready 2 Long Arm Adjustable, Main Box 2	1	TJ60X2				
	6" Dual Rate-Long Travel Front Coils, Pair	1	TJ60FDR				
	6" Dual Rate-Long Travel Rear Coils, Pair	1	TJ60RDR				
	<b>Select a Shock Option F&amp;R Shocks (2) each of desired Shock Series</b>						
	<b>Hydro</b> Series Shock, White with Red Boot	2		H7049	H7063		
	<b>Nitro</b> Series Gas Shock, White with Red Boot	2		N8049	N8063		
	<b>Black MAX</b> Performance Shock, Black with Black Boot	2		B8549	B8563		
<b>M95</b> Monotube Performance Shock, <b>Silver</b>	2		M9549	M9563			
<b>Notes</b>	<b>10)</b> Optional 1997-06 High Clearance Skid add SP176 *97-02 order SPS28M Mount. 03-06 Auto Only <b>11)</b> Non Rubicon Models Requires Slip Yoke Eliminator RR231 and CV Driveshaft TJRS <b>12)</b> Exhaust Modifications to Crossover Pipe required						

Additional Jeep applications available. See pages 156-179.





### Options Jeep Wrangler & Wrangler & Unlimited 1997-2006

Kit Ref #	Description	Qty	Part #	Note
<b>Wrangler TJ Options</b>	Heavy Duty DUAL LOAD Ball Joint Kit <b>(See page 29)</b>	1	JD302B	<b>NEW!</b>
	OEM Steering Stabilizer Kit, <b>WHITE</b> w/Red Boot	1	7009	
	OEM Steering Stabilizer Kit, <b>Black MAX</b> w/Black Boot	1	8009	
	OEM Steering Stabilizer Kit, <b>SILVER</b> w/Black Boot	1	9009	
	Dual Steering Stabilizer Kit, <b>WHITE</b> w/Red Boot	1	7219	
	Dual Steering Stabilizer Kit, <b>Black MAX</b> w/Black Boot	1	8219	
	Dual Steering Stabilizer Kit, <b>SILVER</b> w/Black Boot	1	9219	
	Long Arm Upgrade 3.5-6" Lift Jeep Wrangler 1997-2006	1	TJ40RRX	11,12
	High Clearance Transfer Case Skid Plate (03-06 TJ Models)	1	SP176	10
	Upper Front & Rear Adjustable Control Arm Jeep Wrangler TJ LJ 1997-2006	1	JUL48SFX	
	Slip Yoke Eliminator	1	RR231	
	CV Driveshaft 2003-06 Auto & 6cyl with Dana 35 rear axle & OEM Skid	1	TJRS	
	CV Driveshaft 1997-03 5 Speed Manual & 6cyl Dana 35 rear axle & OEM Skid	1	TJRS	
	Front Upper Adjustable Control Arms	1	JULF24-FX	
	Rear Upper Adjustable Control Arms	1	JULR24-SX	
	Control Arm Cam Bolt Kit pair	1	CAM500	
	Extended Poly Bump stop Front or Rear 1997-06 Wrangler TJ LJ 2.5" pair	1	BP50	
	Bump stop extensions 2" Front or Rear coil pad mount 1997-06 Wrangler TJ LJ	1	BPS20	
	Bump stop extensions 3" Front or Rear coil pad mount 1997-06 Wrangler TJ LJ	1	BPS30	
	3/4" Coil Spring Isolator Pads, Pair 1997-06 Wrangler TJ LJ	1	SIP275	
	Rock Ready Steering Box Skid Plate 1997-06 Wrangler TJ LJ	1	RRSP20	
	NP231 Transfer Case Shifter Relocation Bracket 1997-06 Wrangler TJ LJ	1	JSRB231A	
	Front Stainless Steel DOT Brake Lines 4"-8" Lift/Pair 1997-06 Wrangler TJ LJ	1	FBL44	
	Rear Stainless Steel DOT Brake Line 4"-8" Lift/Single 1997-06 Wrangler TJ LJ	1	RBL98	
	High Capacity Trans Pan w/Drain Plug 1987-02 Wrangler with 999 Auto	1	OPA999	
	Heavy Duty Tie Rod Tube 1997-06 Wrangler TJ LJ	1	TR300	
	Rear Shock Relocation Bracket Jeep Wrangler TJ Only 1997-2006	1	TJRSB10	
	Rock Lock Front Selectable Front Sway Bar	1	JFSBA10	
<b>Notes</b>	<b>10)</b> Optional 1997-06 High Clearance Skid add SP176 *97-02 order SPS28M Mount. 03-06 Auto Only <b>11)</b> Non Rubicon Models Requires Slip Yoke Eliminator RR231 and CV Driveshaft TJRS <b>12)</b> Exhaust Modifications to Crossover Pipe required			



FBL44



JD302B



RRSP20



OPA999



SP176



TJRS



RR231



JSRB231A



CAM500

# XJ



# Jeep



Shown in red for display only.



**4.5", 6" and 8" Rock Ready® Cherokee XJ System Skyjacker® Suspensions** offers Jeep Cherokee XJ owners the ultimate in suspension technology. Whether you're twisting it up on the Red Rock of Moab or conquering the South American jungles of Peru, this is the suspension system you need.

## Jeep Wrangler XJ 1984-2001

Kit Ref #	Description	Qty	Part #	Front Shock	Back Shock	Note
<b>JEOP Cherokee XJ Dual Rate-Long Travel Systems</b>						
JC301BPHLT	3" Dual Rate-Long Travel Kit w/ Hydro Shocks	1	JC301BPHLT			<b>NEW!</b>
JC301BPNLT	3" Dual Rate-Long Travel Kit w/ Nitro Shocks	1	JC301BPNLT			<b>NEW!</b>
JC301BPBLT	3" Dual Rate-Long Travel Kit w/ Black MAX Shocks	1	JC301BPBLT			<b>NEW!</b>
JC301BPMLT	3" Dual Rate-Long Travel Kit w/ Monotube Shocks	1	JC301BPMLT			<b>NEW!</b>
JC3158KSBLT	3" Dual Rate-Long Travel System w/ Rear Springs & Black MAX Shocks	1	JC3158KSBLT			<b>NEW!</b>
JC3158KSMLT	3" Dual Rate-Long Travel System w/ Rear Springs & Monotube Shocks	1	JC3158KSMLT			<b>NEW!</b>

## Jeep Cherokee XJ 1984-2001

Kit Ref #	Description	Qty	Part #	Front Shock	Rear Shock	Note
<b>2" Kit Poly Spacer Rear 1" Lift Shackles - Suggested Tire Size - 30"</b>						
<b>XJ20</b>	2" Poly Front with Rear 1" Lift Shackles	1	XJ20			
	<b>Select a Shock Option F&amp;R Shocks (2) each of desired Shock Series</b>					
	<b>Hydro</b> Series Shock, White with Red Boot	2		H7016	H7018	
	<b>Nitro</b> Series Gas Shock, White with Red Boot	2		N8016	N8018	
	<b>Black MAX</b> Performance Shock, Black with Black Boot	2		B8516	B8518	
<b>M95</b> Monotube Performance Shock, <b>Silver</b>	2		M9516	M9518		
<b>3" Kit, Sport Series Add-A-Leaf, No Control Arms with Hydro Shocks - Suggested Tire Size - 31"</b>						
<b>JC301BH</b>	3" Coils, Rear Add-A-Leafs, No Arms, includes (4) Hydro shocks	1	JC301BH	Incl.	Incl.	
<b>3" Kit, Dual Rate-Long Travel, Rear Leaf Springs, No Control Arms with Monotube Shocks with Chrysler 8.25 Axle - Suggested Tire Size - 31"</b>						
<b>JC301BPHLT</b>	3" Dual Rate-Long Travel Kit w/ Hydro Shocks	1	JC301BPHLT	Incl.	Incl.	<b>NEW!</b>
<b>JC301BPNTLT</b>	3" Dual Rate-Long Travel Kit w/ Nitro Shocks	1	JC301BPNTLT	Incl.	Incl.	<b>NEW!</b>
<b>JC301BPBLT</b>	3" Dual Rate-Long Travel Kit w/ Black MAX Shocks	1	JC301BPBLT	Incl.	Incl.	<b>NEW!</b>
<b>JC301BPMLT</b>	3" Dual Rate-Long Travel Kit w/ Monotube Shocks	1	JC301BPMLT	Incl.	Incl.	<b>NEW!</b>
<b>3" Kit, Dual Rate-Long Travel, Rear Leaf Springs, No Control Arms with Black MAX Shocks - Suggested Tire Size - 31"</b>						
<b>JC3158KSBLT</b>	3" Coils, Rear Leaf Springs, No Arms, (4) Black MAX shocks	1	JC3158SBLT	Incl.	Incl.	
	Rear Leaf Springs Cherokee	2	JC25RSB			
<b>JC3158KSMLT</b>	3" Coils, Rear Leaf Springs, No Arms, (4) Monotube shocks	1	JC3158SMLT	Incl.	Incl.	
	Rear Leaf Springs Cherokee	2	JC25RSB			
<b>4.5" Kit, Dual Rate-Long Travel System, Add-A-Leaf - Suggested Tire Size - 31"</b>						
<b>JC451KHLT</b>	4.5" Dual Rate-Long Travel Kit w/ Hydro Shocks	1	JC451KHLT	Incl.	Incl.	<b>NEW!</b>
<b>JC451KNLT</b>	4.5" Dual Rate-Long Travel Kit w/ Nitro Shocks	1	JC451KNLT	Incl.	Incl.	<b>NEW!</b>
<b>JC451KBLT</b>	4.5" Dual Rate-Long Travel Kit w/ Black MAX Shocks	1	JC451KBLT	Incl.	Incl.	<b>NEW!</b>
<b>JC451KMLT</b>	4.5" Dual Rate-Long Travel Kit w/ Monotube Shocks	1	JC451KMLT	Incl.	Incl.	<b>NEW!</b>
<b>4.5" Kit, Dual Rate-Long Travel, w/Rear Springs /Shackle Adjustable Flex Arms - Suggested Tire Size - 32"</b>						
<b>JC4558KSBLT</b>	4.5" Dual Rate-Long Comp Box w/ Black MAX Shocks	1	JC4558SB	Incl.	Incl.	<b>NEW!</b>
	4.5" Dual Rate-Long Front Coils, Pair	1	JC45FDR			<b>NEW!</b>
	Rear Leaf Springs Cherokee	2	JC25RSB			
<b>JC4558KSMLT</b>	4.5" Dual Rate-Long Comp Box w/ Monotube Shocks	1	JC4558SBM	Incl.	Incl.	<b>NEW!</b>
	4.5" Dual Rate-Long Front Coils, Pair	1	JC45FDR			<b>NEW!</b>
	Rear Leaf Springs Cherokee	2	JC25RSB			
<b>6" Kit, Dual Rate-Long Travel, w/Rear Springs /Shackle Adjustable Flex Arms - Suggested Tire Size - 33"</b>						
<b>JC6058KSBLT</b>	6" Dual Rate-Long Main Comp Box	1	JC48RRX			<b>NEW!</b>
	6" Comp Box 2 w/ Black MAX Shocks	1	JC6058SB	Incl.	Incl.	<b>NEW!</b>
	6" Dual Rate-Long Front Coils, Pair	1	JC60FDR			<b>NEW!</b>
	Rear Leaf Springs Cherokee	2	JC55RSB			
<b>JC6058KSMLT</b>	6" Dual Rate-Long Main Comp Box	1	JC48RRX			<b>NEW!</b>
	6" Comp Box 2 w/ Monotube Shocks	1	JC6058SM	Incl.	Incl.	<b>NEW!</b>
	6" Dual Rate-Long Front Coils, Pair	1	JC60FDR			<b>NEW!</b>
	Rear Leaf Springs Cherokee	2	JC55RSB			
<b>Notes</b>	<b>16)</b> Transfer Case Lowering Kit Required <b>17)</b> Requires Slip Yoke Eliminator RR231 and CV Driveshaft					



JC301BH



JD302B



JC3158KSBLT

# XJ



## Jeep Cherokee XJ 1984-2001

Kit Ref #	Description	Qty	Part #	Front Shock	Rear Shock	Note
<b>4.5 -8" Rock Ready 2 Dual Rate-Long Travel, w/Rear Springs /Shackle Adjustable Flex Arms (Dana 35 Rear Axle)</b>						
JC4552LTKS	4.5-8" Dual Rate-Long Main Comp Box	1	JC48RRX			<b>NEW!</b>
	4.5" Comp Box 2	1	JC405XS2			<b>NEW!</b>
	4.5" Dual Rate-Long Front Coils, Pair	1	JC45FDR			<b>NEW!</b>
	Rear Leaf Springs Cherokee	2	JC25RSB			
JC6052LTKS	4.5-8" Dual Rate-Long Main Comp Box	1	JC48RRX			<b>NEW!</b>
	6" Comp Box 2	1	JC605XS2			<b>NEW!</b>
	6" Dual Rate-Long Front Coils, Pair	1	JC60FDR			<b>NEW!</b>
	Rear Leaf Springs Cherokee	2	JC55RSB			
JC8052LTKS	4.5-8" Dual Rate-Long Main Comp Box	1	JC48RRX			<b>NEW!</b>
	8" Comp Box 2	1	JC805XS2			<b>NEW!</b>
	8" Dual Rate-Long Front Coils, Pair	1	JC80FDR			<b>NEW!</b>
	Rear Leaf Springs Cherokee	2	JC75RSB			
<b>Notes</b>	<b>All Shock Options Sold Separately</b>					
<b>4.5 -8" Rock Ready 2 Dual Rate-Long Travel, w/Rear Springs /Shackle Adjustable Flex Arms (Chrysler 8.25 Rear Axle)</b>						
JC4582LTKS	4.5-8" Dual Rate-Long Main Comp Box	1	JC48RRX			<b>NEW!</b>
	4.5" Comp Box 2	1	JC408XS2			<b>NEW!</b>
	4.5" Dual Rate-Long Front Coils, Pair	1	JC45FDR			<b>NEW!</b>
	Rear Leaf Springs Cherokee	2	JC25RSB			
JC6082LTKS	4.5-8" Dual Rate-Long Main Comp Box	1	JC48RRX			<b>NEW!</b>
	6" Comp Box 2	1	JC608XS2			<b>NEW!</b>
	6" Dual Rate-Long Front Coils, Pair	1	JC60FDR			<b>NEW!</b>
	Rear Leaf Springs Cherokee	2	JC55RSB			
JC8082LTKS	4.5-8" Dual Rate-Long Main Comp Box	1	JC48RRX			<b>NEW!</b>
	8" Comp Box 2	1	JC808XS2			<b>NEW!</b>
	8" Dual Rate-Long Front Coils, Pair	1	JC80FDR			<b>NEW!</b>
	Rear Leaf Springs Cherokee	2	JC75RSB			
<b>Notes</b>	<b>All Shock Options Sold Separately</b>					
<b>Options Jeep Cherokee 1984-2001</b>						
<b>Jeep Cherokee Options</b>	Heavy Duty DUAL LOAD Ball Joint Kit <b>(See page 25)</b>	1	JD302B			
	Transfer Case Lowering Kit (Short Arm/OE Arm Kits)	1	TCL30			
	Transfer Case Lowering Kit (Long Arm Kits)	1	TCL32			
	3/4" Coil Spring Isolator Pads, Pair	1	SIP275			
	Lower Fixed Control Arms pair	1	TJLL24			
	OEM Steering Stabilizer Kit, WHITE w/Red Boot	1	7009			
	OEM Steering Stabilizer Kit, Black MAX w/Black Boot	1	8009			
	OEM Steering Stabilizer Kit, SILVER w/Black Boot	1	9009			
	Rear Shackles 1/2" Lift Jeep Cherokee 1988-2001	1	SH130			
	Heavy Duty Tie Rod Tube (1991 - 2001 Models)	1	TR300			
	Slip Yoke Eliminator Kit (1984 - 2001 Models with NP231 Transfer Case)	1	RR231			

Additional Jeep applications available. See pages 156-179.





# Jeep



**4.5" Jeep Cherokee Standard Kits & Systems Skyjacker® Suspensions** offers a 4.5" Kit with rear Add-A-Leafs, or a 4.5" System with Softride® rear springs. Both Kits feature Softride® front coil springs, track bar relocation bracket, greaseable lower control arms and 2-stage rear Softride® leaf springs.



JC4558KSMLT



JC451KBLT



TR300



JD302B



TCL30

# YJ

**2" and 4" Systems** These versatile Systems consist of front and rear Softride® multi-leaf springs and e-coated U-Bolts. The 4" features rear track bar brackets. The 2" and 4" systems are the perfect lifts for the less extreme off road driver. Complete your YJ today by ordering one of these versatile systems.



**2.5" and 4" Military Wrap** You will want to utilize the performance of the Double Military Wrap Leaf Springs to gain torque control, main leaf protection and exceptional ride quality. These durable, long lasting units have larger spring eyes at both ends. These larger eyes contain larger bushings designed for strength & longevity.





### Jeep Wrangler YJ 1987-1995

Kit Ref #	Description	Qty	Part #	Front Shock	Rear Shock	Note
<b>2.5" Kit Includes Hydro Shocks &amp; Sport Series Leaf Springs - Suggested Tire Size - 31"</b>						
YJ21BKH	Front Leaf Spring 2.5"	2	YJ20FSB			
	Rear Leaf Spring 2.5"	2	YJ20RSB			
	2.5" Component Box, includes (4) Hydro shocks	1	YJ21BH	Incl.	Incl.	
<b>4" Kit Includes Hydro Shocks &amp; Sport Series Leaf Springs - Suggested Tire Size - 33"</b>						
YJ41BKH	Front Leaf Spring 4"	2	YJ40FSB			18, 20
	Rear Leaf Spring 4"	2	YJ40RSB			
	4" Component Box, T-Case Lowering Kit, Front Sway Bar Extended Links, Front & Rear Track Bar Extension Brackets, includes (4) Hydro shocks	1	YJ41BH	Incl.	Incl.	
<b>2.5" Kit Softride® Series Leaf Springs - Suggested Tire Size - 31"</b>						
YJ20K	Front Leaf Spring 2.5"	2	YJ20FS			
	Rear Leaf Spring 2.5"	2	YJ20RS			
	2.5" Component Box	1	YJ20			
	<b>Select a Shock Option F&amp;R Shocks (2) each of desired Shock Series</b>					
	<b>Hydro Series Shock with Red Boot, White</b>	2		H7056	H7023	
	<b>Nitro Series Gas Shock with Red Boot, White</b>	2		N8056	N8023	
	<b>Black MAX Performance Shock with Black Boot, Black</b>	2		B8556	B8523	
<b>M95 Monotube Performance Shock, Silver</b>	2		M9556	M9523		
<b>4" Kit Softride® Series Leaf Springs - Suggested Tire Size - 33"</b>						
YJ40K	Front Leaf Spring 4"	2	YJ40FS			18,19,20
	Rear Leaf Spring 4"	2	YJ40RS			
	4" Component Box	1	YJ40			
	<b>Select a Shock Option F&amp;R Shocks (2) each of desired Shock Series</b>					
	<b>Hydro Series Shock with Red Boot, White</b>	2		H7059	H7088	
	<b>Nitro Series Gas Shock with Red Boot, White</b>	2		N8059	N8088	
	<b>Black MAX Performance Shock with Black Boot, Black</b>	2		B8559	B8588	
<b>M95 Monotube Performance Shock, Silver</b>	2		M9559	M9588		

Additional Jeep applications available. See pages 158-179.

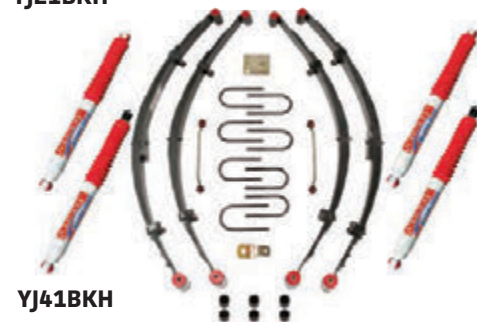
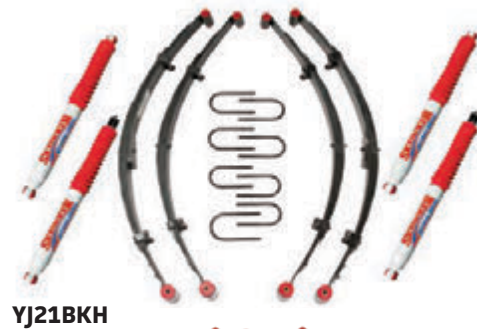

# YJ



**Jeep Wrangler 1987-95 YJ 2.5" Rock Ready Military Wrap Series Leaf Springs - Suggested Tire Size - 31"**

YJ25K	Front Leaf Spring 2.5"	2	YJ25FS		
	Rear Leaf Spring 2.5"	2	YJ25RS		
	2.5" Component Box	1	YJ25		
	<b>Select a Shock Option F&amp;R Shocks (2) each of desired Shock Series</b>				
	<b>Hydro Series Shock with Red Boot, White</b>	2		H7056	H7023
	<b>Nitro Series Gas Shock with Red Boot, White</b>	2		N8056	N8023
	<b>Black MAX Performance Shock, with Black Boot, Black</b>	2		B8556	B8523
	<b>M95 Monotube Performance Shock, Silver</b>	2		M9556	M9523



YJ5LK





Jeep Wrangler YJ 1987-1995					
Kit Ref #	Description	Qty	Part #	Front Shock	Rear Shock
<b>4" Kit Rock Ready Military Wrap Series Leaf Springs - Suggested Tire Size - 33"</b>					
YJ45K	Front Leaf Spring 4"	2	YJ45FS		
	Rear Leaf Spring 4"	2	YJ45RS		
	4" Component Box	1	YJ45		
	<b>Select a Shock Option F&amp;R Shocks (2) each of desired Shock Series</b>				
	<b>Hydro Series Shock with Red Boot, White</b>	2		H7059	H7088
	<b>Nitro Series Gas Shock with Red Boot, White</b>	2		N8059	N8088
	<b>Black MAX Performance Shock, with Black Boot, Black</b>	2		B8559	B8588
<b>M95 Monotube Performance Shock, Silver</b>	2		M9559	M9588	
<b>6" Kit with Mono-linear Single Leaf Springs - Suggested Tire Size - 35"</b>					
YJ60M	6" Lift Mono-linear Complete Kit Box	1	YJ60M		
	<b>Select a Shock Option F&amp;R Shocks (2) each of desired Shock Series</b>				
	<b>Hydro Series Shock with Red Boot, White</b>	2		H7059	H7088
	<b>Nitro Series Gas Shock with Red Boot, White</b>	2		N8059	N8088
	<b>Black MAX Performance Shock, with Black Boot, Black</b>	2		B8559	B8588
<b>M95 Monotube Performance Shock, Silver</b>	2		M9559	M9588	
<b>Notes</b>	<b>17)</b> Requires Slip Yoke Eliminator RR231 & CV Driveshaft <b>18)</b> YJ5LK 5th Link Traction Bar Recommended <b>19)</b> Transfer Case Lower Kit Required <b>20)</b> Drop Pitman Part #JA750 Required				
<b>Options Jeep Wrangler YJ 1987-95</b>					
Jeep Wrangler YJ 1987-95 Options	Heavy Duty DUAL LOAD Ball Joint Kit <b>(See page 21)</b>	1	JD302B		
	Drop Pitman Arm 4" lift Power Steering	1	JA750		
	OEM Steering Stabilizer <b>White</b> w/Red Boot	1	7009		
	OEM Steering Stabilizer <b>Black MAX</b> w/Black Boot	1	8009		
	OEM Steering Stabilizer Kit, <b>Silver</b> w/Black Boot	1	9009		
	Dual Steering Stabilizer Kit, <b>White</b> w/Red Boots	1	7200		
	Dual Steering Stabilizer <b>Black MAX</b> w/Black Boots	1	8200		
	Dual Steering Stabilizer <b>Silver</b> w/Black Boots	1	9200		
	Front & Rear Complete Frame Shackle Bushings Wrangler YJ 1987-95	1	SE3YJ		
	1" Lift Shackles Front Greasable Wrangler YJ 1987-95	1	SH2545F		
	1" Lift Shackles Rear Greasable Wrangler YJ 1987-95	1	SH2545R		
	High Capacity Transmission Pan w/Drain Plug 1987-95 Wrangler w/999 Auto	1	OPA999		
	Traction Bar 5th Link w/Cross member 1987-95 Wrangler	1	YJ5LK		
Traction Bar 5th Link w/o "NO" Cross member 1987-95 Wrangler	1	TB500K			
Additional Jeep applications available. See pages 156-179.					



**NEW!**  
**JD302B**



**SH2545R**



**SH2545F**

# CJ

**2" & 4" Systems for the '55-'86 Jeep CJ**  
Many CJ owners will say the CJ is the only Jeep. Well Skyjacker® has designed the BEST rated springs for these true believers. These Softride® first-rate systems are the perfect way to transform your daily driver into the Conquering Jeep (CJ) you need it to be.





Jeep CJ5, CJ7, CJ8 1955-1986							
Kit Ref #	Description	Qty	Part #	Front Shock	Rear Shock	Note	
<b>2.5" 76-86 CJ w/Hydro Shocks &amp; Sport Series Leaf Springs - Suggested Tire Size - 31"</b>							
J21BKH	Front Leaf Spring 2.5"	2	J20FSB			20	
	Rear Leaf Spring 2.5"	2	J20RSB				
	2.5" Component Box, includes (4) Hydro shocks	1	J21BH	Incl.	Incl.		
<b>4" 76-86 CJ w/Hydro Shocks &amp; Sport Series Leaf Springs - Suggested Tire Size - 33"</b>							
J41BKH	Front Leaf Spring 4"	2	J40FSB			20	
	Rear Leaf Spring 4"	2	J40RSB				
	4" Component Box, includes (4) Hydro shocks	1	J41BH	Incl.	Incl.		
<b>2.5" 76-86 CJ Softride® Series Leaf Springs - Suggested Tire Size - 31"</b>							
J20K	Front Leaf Spring 2.5"	2	J20FS			20	
	Rear Leaf Spring 2.5"	2	J20RS				
	Component Box, 2.5"	1	J24				
	<b>Select a Shock Option F&amp;R Shocks (2) each of desired Shock Series</b>						
	<b>Hydro Series Shock with Red Boot, White</b>	2		H7012	H7023		
	<b>Nitro Series Gas Shock with Red Boot, White</b>	2		N8012	N8023		
	<b>Black MAX Performance Shock with Black Boot, Black</b>	2		B8512	B8523		
	<b>M95 Monotube Performance Shock, Silver</b>	2		M9512	M9523		
<b>4" 76-86 CJ Softride® Series Leaf Springs - Suggested Tire Size - 33"</b>							
J40K	Front Leaf Spring 4"	2	J40FS			20	
	Rear Leaf Spring 4"	2	J40RS				
	Component Box, 4"	1	J24				
	<b>Select a Shock Option F&amp;R Shocks (2) each of desired Shock Series</b>						
	<b>Hydro Series Shock with Red Boot, White</b>	2		H7023	H7058		
	<b>Nitro Series Gas Shock with Red Boot, White</b>	2		N8023	N8058		
	<b>Black MAX Performance Shock with Black Boot, Black</b>	2		B8523	B8558		
	<b>M95 Monotube Performance Shock, Silver</b>	2		M9523	M9558		
<b>2.5" 55-75 CJ Softride® Series Leaf Springs - Suggested Tire Size - 31"</b>							
J32K	Front Leaf Spring 2.5"	2	J32FS			20	
	Rear Leaf Spring 2.5"	2	J32RS				
	Component Box, 2.5"	1	J34				
	<b>Select Shock Option F&amp;R Shocks (2) each of desired Shock Series</b>						
	<b>Hydro Series Shock with Red Boot, White</b>	2		H7023	H7023		
	<b>Nitro Series Gas Shock with Red Boot, White</b>	2		N8023	N8023		
	<b>Black MAX Performance Shock with Black Boot, Black</b>	2		B8523	B8523		
	<b>M95 Monotube Performance Shock, Silver</b>	2		M9523	M9523		
<b>Notes</b>	20) CJ8 Scrambler Models require rear fitted leaves, see page 237						
Additional Jeep applications available. See pages 156-179.							

J41BKH



J34K

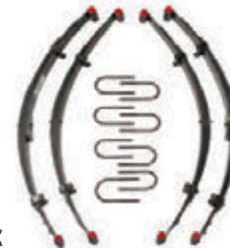

## Jeep CJ5, CJ7, CJ8 1955-1986

Kit Ref #	Description	Qty	Part #	Front Shock	Rear Shock	Note	
<b>4" 55-75 CJ Softride® Series Leaf Springs - Suggested Tire Size - 33"</b>							
<b>J34K</b>	Front Leaf Spring 4"	2	J34FS				
	Rear Leaf Spring 4"	2	J34RS				
	Component Box, 4"	1	J34				
	<b>Select Shock Option F&amp;R Shocks (2) each of desired Shock Series</b>						
	<b>Hydro</b> Series Shock with Red Boot, <b>White</b>	2		H7058	H7058		
	<b>Nitro</b> Series Gas Shock with Red Boot, <b>White</b>	2		N8058	N8058		
	<b>Black MAX</b> Performance Shock with Black Boot, <b>Black</b>	2		B8558	B8558		
<b>M95</b> Monotube Performance Shock, <b>Silver</b>	2		M9558	M9558			
<b>Notes</b>	20) CJ8 Scrambler Models require Rear fitted leaves, see page 237						

### Options Jeep Wrangler CJ 1955-86 / 93-98 Grand Cherokee ZJ

<b>Jeep Options</b>	Heavy Duty DUAL LOAD Ball Joint Kit 1993-98 Grand Cherokee ZJ <b>(See page 25)</b>	1	JD302B			<b>NEW!</b>
	Drop Pitman Arm 4" lift <b>Power</b> Steering 1976-86	1	JA250			
	Drop Pitman Arm 4" lift <b>Manual</b> Steering 1976-86	1	JA150			
	Drop Pitman Arm 4" lift <b>Power</b> Steering 1972-75	1	JA550			
	Drop Pitman Arm 4" lift <b>Manual</b> Steering 1972-75	1	JA650			
	Drop Pitman Arm 2" lift <b>Power</b> Steering 1972-75	1	JA552			
	Drop Pitman Arm 2" lift <b>Manual</b> Steering 1972-75	1	JA652			
	OEM Steering Stabilizer Kit, <b>WHITE</b> w/Red Boot 1976-86 CJ	1	7001			
	Dual Steering Stabilizer Kit, <b>WHITE</b> w/Red Boots 1976-86 CJ	1	7200			
	OEM Steering Stabilizer Kit, <b>Black MAX</b> w/Black Boot 1976-86 CJ	1	8001			
	Dual Steering Stabilizer Kit, <b>Black MAX</b> w/Blacks Boot 1976-86 CJ	1	8200			
	OEM Steering Stabilizer Kit, <b>SILVER</b> w/Black Boot 1976-86 CJ	1	9001			
	Dual Steering Stabilizer Kit, <b>SILVER</b> w/Black Boots 1976-86 CJ	1	9200			
	OEM Steering Stabilizer, <b>WHITE</b> w/Red Boot 1993-98 Grand Cherokee ZJ	1	7009			
	OEM Steering Stabilizer, <b>Black MAX</b> w/Red Boot 1993-98 Grand Cherokee ZJ	1	8009			
	OEM Steering Stabilizer, <b>SILVER</b> w/Black Boot 1993-98 Grand Cherokee ZJ	1	9009			
	Front & Rear Complete Frame Shackle Bushings Wrangler CJ 1976-86	1	SE4CJ			
	Front & Rear Complete Frame Shackle Bushings CJ 1955-75	1	SE34J			

Additional Jeep applications available. See pages 156-179.



**JD302B**



**JA250**



**TCL151**



**TCL35**



# Grand Cherokee

# Jeep



## Jeep Grand Cherokee 1993-2010 / Jeep Commander 2006-2010

Kit Ref #	Description	Qty	Part #	Front Shock	Rear Shock	Note
<b>2" Poly Spacer Kit - Jeep Grand Cherokee WK 2005-10, Jeep Commander 2006-10 - Suggested Tire Size - 30"- 30.5"</b>						
WK20	2" Poly Spacer Kit Front & Rear	1	WK20			
	<b>Select Shock Option F&amp;R Shocks (2) each of desired Series</b>					
	<b>Hydro Series Shock with Red Boot, White</b>	2			H7088	
	<b>Nitro Series Gas Shock with Red Boot, White</b>	2			N8088	
	<b>Black MAX Performance Shock with Black Boot, Black</b>	2			B8588	
<b>M95 Monotube Performance Shock, Silver</b>	2			M9558		
<b>2" Poly Spacer Kit - Jeep Grand Cherokee WJ 1999-2004 - Suggested Tire Size - 31"</b>						
WJ20	2" Poly Spacer Kit Front & Rear	1	WJ20			
	<b>Select Shock Option F&amp;R Shocks (2) each of desired Shock Series</b>					
	<b>Hydro Series Shock with Red Boot, White</b>	2		H7016	H7044	
	<b>Nitro Series Gas Shock with Red Boot, White</b>	2		N8016	N8044	
	<b>Black MAX Performance Shock with Black Boot, Black</b>	2		B8516	B8544	
<b>M95 Monotube Performance Shock, Silver</b>	2		M9516	M9544		
<b>2" Poly Spacer Kit - Jeep Grand Cherokee ZJ 1993-98 - Suggested Tire Size - 31"</b>						
ZJ20	2" Poly Spacer Kit Front & Rear	1	ZJ20			
	<b>Select Shock Option F&amp;R Shocks (2) each of desired Shock Series</b>					
	<b>Hydro Series Shock with Red Boot, White</b>	2		H7016	H7023	
	<b>Nitro Series Gas Shock with Red Boot, White</b>	2		N8016	N8023	
	<b>Black MAX Performance Shock with Black Boot, Black</b>	2		B8516	B8523	
<b>M95 Monotube Performance Shock, Silver</b>	2		M9516	M9523		
<b>3" Kit - Jeep Grand Cherokee ZJ 1993-98 - Suggested Tire Size - 31"</b>						
GC301K	Front Coil Springs Pair	1	JC30F			
	Rear Coil Springs Pair	1	GC20R			
	Component Box 3"	1	GC30			
	<b>Select Shock Option F&amp;R Shocks (2) each of desired Shock Series</b>					
	<b>Hydro Series Shock with Red Boot, White</b>	2		H7016	H7023	
	<b>Nitro Series Gas Shock with Red Boot, White</b>	2		N8016	N8023	
<b>Black MAX Performance Shock with Black Boot, Black</b>	2		B8516	B8523		
<b>M95 Monotube Performance Shock, Silver</b>	2		M9516	M9523		



ZJ20



GC301K



WJ20

# Liberty



Jeep Liberty KK & KJ 2002-2012						
Kit Ref #	Description	Qty	Part #	Front Shock	Rear Shock	Note
<b>2.5-3" Jeep Liberty KK 2008-12 - Suggested Tire Size - 31"</b>						
LIB258K	Component Box, 2.5-3" Front	1	LIB250			
	2-2.5" Rear Coils Springs Pair	1	LIB208R			
	<b>Select Shock Option F&amp;R Shocks (2) each of desired Shock Series</b>					
	<b>Hydro</b> Series Shock with Red Boot, <b>White</b>	2			H7088	
	<b>Nitro</b> Series Gas Shock with Red Boot, <b>White</b>	2			N8088	
	<b>Black MAX</b> Performance Shock with Black Boot, <b>Black</b>	2			B8588	
<b>M95</b> Monotube Performance Shock, <b>Silver</b>	2			M9558		
<b>2.5-3" Jeep Liberty KJ 2002-07 - Suggested Tire Size - 31"</b>						
LIB250K	Component Box, 2.5-3" Front	1	LIB250			
	2-2.5" Rear Coils Springs Pair	1	LIB25R			
	<b>Select Shock Option F&amp;R Shocks (2) each of desired Shock Series</b>					
	<b>Hydro</b> Series Shock with Red Boot, <b>White</b>	2			H7088	
	<b>Nitro</b> Series Gas Shock with Red Boot, <b>White</b>	2			N8088	
	<b>Black MAX</b> Performance Shock with Black Boot, <b>Black</b>	2			B8588	
<b>M95</b> Monotube Performance Shock, <b>Silver</b>	2			M9558		
<b>2" Poly Spacer Kit, Jeep Liberty KK 2008-12 - Suggested Tire Size - 30"-30.5"</b>						
KKN25	2" Poly Spacer Kit, Front & Rear	1	KKN25			
	<b>Select Shock Option F&amp;R Shocks (2) each of desired Shock Series</b>					
	<b>Hydro</b> Series Shock with Red Boot, <b>White</b>	2			H7088	
	<b>Nitro</b> Series Gas Shock with Red Boot, <b>White</b>	2			N8088	
	<b>Black MAX</b> Performance Shock with Black Boot, <b>Black</b>	2			B8588	
	<b>M95</b> Monotube Performance Shock, <b>Silver</b>	2			M9558	
<b>2" Poly Spacer Kit, Jeep Liberty KJ 2002-07 - Suggested Tire Size - 30"-30.5"</b>						
KJ25	2" Poly Spacer Kit, Front & Rear	1	KJ25			
	<b>Select Shock Option F&amp;R Shocks (2) each of desired Shock Series</b>					
	<b>Hydro</b> Series Shock with Red Boot, <b>White</b>	2			H7088	
	<b>Nitro</b> Series Gas Shock with Red Boot, <b>White</b>	2			N8088	
	<b>Black MAX</b> Performance Shock with Black Boot, <b>Black</b>	2			B8588	
	<b>M95</b> Monotube Performance Shock, <b>Silver</b>	2			M9558	
Additional Jeep applications available. See pages 156-179.						

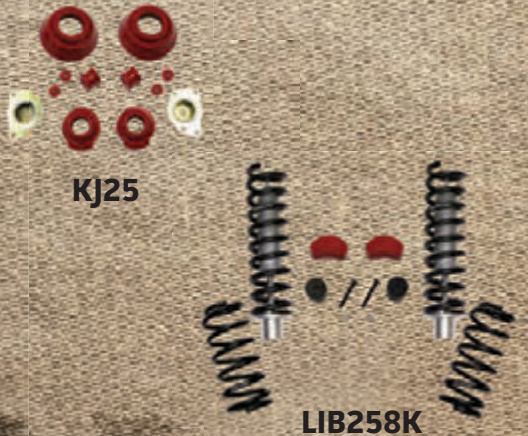

# Wagoneer

# Jeep



JP40K



JP40KS

Kit Ref #	Description	Qty	Part #	Front Shock	Rear Shock	Note
<b>4" Jeep Cherokee, Wagoneer, Full Size 1984-1991 Front Leaf Springs, Rear Blocks - Suggested Tire Size - 35"</b>						
JP45K	Front Leaf Springs, 4"	2	JP40FS			
	Component Kit Box, 4"	1	JP45			
	Jeep Full Size Pitman Arm Required	1	JA350			23
	<b>Select Shock Option F&amp;R Shocks (2) each of desired Shock Series</b>					
	<b>Hydro Series Shock with Red Boot, White</b>	2		H7088	H7088	
	<b>Nitro Series Gas Shock with Red Boot, White</b>	2		N8088	N8088	
	<b>Black MAX Performance Shock with Black Boot, Black</b>	2		B8588	B8588	
<b>M95 Monotube Performance Shock, Silver</b>	2		M9558	M9558		
<b>4" Jeep Cherokee, Wagoneer, Full Size 1984-1991 Front Leaf Springs &amp; Rear Leaf Springs - Suggested Tire Size - 35"</b>						
JP45KS	Front Leaf Springs, 4"	2	JP40FS			
	Rear Leaf Springs, 4"	2	JP40RS			
	System Box, 4"	1	JP45S			
	Jeep Full Size Pitman Arm Required	1	JA350			23
	<b>Select Shock Option F&amp;R Shocks (2) each of desired Shock Series</b>					
	<b>Hydro Series Shock with Red Boot, White</b>	2		H7088	H7088	
	<b>Nitro Series Gas Shock with Red Boot, White</b>	2		N8088	N8088	
<b>Black MAX Performance Shock with Black Boot, Black</b>	2		B8588	B8588		
<b>M95 Monotube Performance Shock, Silver</b>	2		M9558	M9558		
<b>4" Jeep J10/J20 Full Size 1974-83 Front Leaf Springs, Rear Blocks - Suggested Tire Size - 35"</b>						
JP40K	Front Leaf Springs, 4"	2	JP40FS			
	Component Kit Box, 4"	1	JP40			
	Jeep Full Size Pitman Arm Required	1	JA350			23
	<b>Select Shock Option F&amp;R Shocks (2) each of desired Shock Series</b>					
	<b>Hydro Series Shock with Red Boot, White</b>	2		H7088	H7088	
	<b>Nitro Series Gas Shock with Red Boot, White</b>	2		N8088	N8088	
	<b>Black MAX Performance Shock with Black Boot, Black</b>	2		B8588	B8588	
<b>M95 Monotube Performance Shock, Silver</b>	2		M9558	M9558		
<b>4" Jeep J10/J20 Full Size 1974-83 Front Leaf Springs &amp; Rear Leaf Springs - Suggested Tire Size - 35"</b>						
JP40KS	Front Leaf Springs, 4"	2	JP40FS			
	Rear Leaf Springs, 4"	2	JP40RS			24
	System Box, 4"	1	JP40S			
	Jeep Full Size Pitman Arm Required	1	JA350			23
	<b>Select Shock Option F&amp;R Shocks (2) each of desired Shock Series</b>					
	<b>Hydro Series Shock with Red Boot, White</b>	2		H7088	H7088	
	<b>Nitro Series Gas Shock with Red Boot, White</b>	2		N8088	N8088	
<b>Black MAX Performance Shock with Black Boot, Black</b>	2		B8588	B8588		
<b>M95 Monotube Performance Shock, Silver</b>	2		M9558	M9558		
<b>Notes</b>	<b>23) Power Steering Models Only 24) 74-75 Models MUST have 131" Wheel Base &amp; 7,200 lb. GVWR or More for Rear Springs to fit.</b>					



# 1500



•C14350PB

•All Shock Options Available

Skyjacker's new 100% bolt-on Control Arm kits heights. These easy to install & mild lifts allow you to clear up to 33" tall tires on your GMC/Chevrolet. Whether you're an everyday pavement pounder or mild-to-wild off-roader set your ride apart with quality and durability.

### Chevrolet/GMC 1500 Pickup 2014-2020

Kit Ref #	Description	Qty	Part #	Front Shock	Rear Shock	Note
<b>Chevrolet/GMC 1500 4WD - 2007-2020 - 2" Leveling Kits</b>						
<b>C1420LMSA</b>	2" Leveling Kit, Mounts Below Struts	1	C1420LMSA			
<b>C720MS</b>	2" Leveling Kit, Mounts Above Struts	1	C720MS			
<b>Chevrolet/GMC 1500 4WD - 2017-18 - Control Arm Kits</b>						
<b>C17350PAH</b>	3.5" - 4" Upper Control Arm Lift Kit with <b>Hydro</b> 7000 Rear Shocks	1	C17350PAH			1,3
<b>C17350PAN</b>	3.5" - 4" Upper Control Arm Lift Kit with <b>Nitro</b> 8000 Rear Shocks	1	C17350PAN			1,3
<b>C17350PAB</b>	3.5" - 4" Upper Control Arm Lift Kit with <b>Black Max</b> B8500 Rear Shocks	1	C17350PAB			1,3
<b>C17350PAM</b>	3.5" - 4" Upper Control Arm Lift Kit with <b>Monotube</b> M9500 Rear Shocks	1	C17350PAM			1,3
<b>Chevrolet/GMC 1500 4WD - 2014-16 - Control Arm Kits (ALUMINUM OR STAMPED STEEL CONTROL ARMS)</b>						
<b>C14350PAH</b>	3.5" - 4" Upper Control Arm Lift Kit with <b>Hydro</b> 7000 Rear Shocks	1	C14350PAH			1,3
<b>C14350PAN</b>	3.5" - 4" Upper Control Arm Lift Kit with <b>Nitro</b> 8000 Rear Shocks	1	C14350PAN			1,3
<b>C14350PAB</b>	3.5" - 4" Upper Control Arm Lift Kit with <b>Black Max</b> B8500 Rear Shocks	1	C14350PAB			1,3
<b>C14350PAM</b>	3.5" - 4" Upper Control Arm Lift Kit with <b>Monotube</b> M9500 Rear Shocks	1	C14350PAM			1,3
<b>Chevrolet/GMC 1500 4WD - 2014-16 - Control Arm Kits (CAST STEEL CONTROL ARMS)</b>						
<b>C14350PH</b>	3.5" - 4" Upper Control Arm Lift Kit with <b>Hydro</b> 7000 Rear Shocks	1	C14350PH			1,3
<b>C14350PN</b>	3.5" - 4" Upper Control Arm Lift Kit with <b>Nitro</b> 8000 Rear Shocks	1	C14350PN			1,3
<b>C14350PB</b>	3.5" - 4" Upper Control Arm Lift Kit with <b>Black Max</b> B8500 Rear Shocks	1	C14350PB			1,3
<b>C14350PM</b>	3.5" - 4" Upper Control Arm Lift Kit with <b>Monotube</b> M9500 Rear Shocks	1	C14350PM			1,3

### Chevrolet/GMC SUV 2015-2020

Kit Ref #	Description	Qty	Part #	Front Shock	Rear Shock	Note
<b>Chevrolet/GMC 1500 Suburban, Tahoe, Yukon, Yukon XL - 2015-19 - Control Arm Kits (ALUMINUM OR STAMPED STEEL CONTROL ARMS)</b>						
<b>C15350VA</b>	3.5" - 4" Upper Control Arm Lift Kit with <b>Rear Shock Brackets</b>	1	C15350VA			1,2
<b>Chevrolet/GMC 1500 Suburban, Tahoe, Yukon, Yukon XL - 2015-16 - Control Arm Kits (CAST STEEL CONTROL ARMS)</b>						
<b>C15350V</b>	3.5" - 4" Upper Control Arm Lift Kit with <b>Rear Shock Brackets</b>	1	C15350V			1,2

**Notes**

1) Does not fit All Wheel Drive models 2) Does not fit Auto Ride or Auto Leveling  
3) Does not fit GMC Denali models with magnetic ride control

Chevrolet/GMC 1500 4WD - Models Built May 2016 - 2018 - (Equipped with STAMPED STEEL A-ARMS Only) - Models Built 2014 - April 2016 - ( Equipped with ALUMINUM KNUCKLES Only)							
4" Front Strut Spacer Lift with Rear Blocks							
C14460APK	Comp Box, Stamped Steel A-Arms or Aluminum Knuckles 4"	1	C14461AAL			2, 23, 32	
	Comp Box Strut Spacers 4"	1	C14460SP				
	Comp Box 4" Rear	1	C7361PR				
	<b>Select Required Shock Option (2) each of desired Series</b>						
		<b>Hydro Series Shock with Red Boot, White</b>	2			H7017	
		<b>Black MAX Performance Shock with Black Boot, Black</b>	2			B8517	
		<b>M95 Monotube Performance Shock, Silver</b>	2			M9517	
	<b>Nitro Series Gas Shock with Red Boot, White</b>	2			N8017		
Chevrolet/GMC 1500 4WD - Models Built May 2016 - 2018 - (Equipped with STAMPED STEEL A-ARMS Only) - Models Built 2014 - April 2016 - ( Equipped with ALUMINUM KNUCKLES Only)							
6-7" Front Strut Spacer Lift with Rear Blocks							
C14660APK	Comp Box, Stamped Steel A-Arms or Aluminum Knuckles 6"	1	C14661AAL			2, 23, 32	
	Comp Box Strut Spacer 6-7"	1	C14660SP				
	Comp Box 6" Rear	1	C14661PR				
	<b>Select Required Shock Option (2) each of desired Series</b>						
		<b>Hydro Series Shock with Red Boot, White</b>	2			H7036	
		<b>Black MAX Performance Shock with Black Boot, Black</b>	2			B8536	
		<b>M95 Monotube Performance Shock, Silver</b>	2			M9536	
	<b>Nitro Series Gas Shock with Red Boot, White</b>	2			N8036		
Chevrolet/GMC 1500 4WD - 2014 - April 2016 - 4" Front Strut Spacer Lift with Rear Blocks (models equipped with OE CAST STEEL Knuckles Only)							
C14460PK	Comp Box CAST STEEL Knuckles 4"	1	C14461A			1, 23, 32	
	Comp Box Strut Spacers 4"	1	C14460SP				
	Comp Box 4" Rear	1	C7361PR				
	<b>Select Required Shock Option (2) each of desired Series</b>						
		<b>Hydro Series Shock with Red Boot, White</b>	2			H7017	
		<b>Black MAX Performance Shock with Black Boot, Black</b>	2			B8517	
		<b>M95 Monotube Performance Shock, Silver</b>	2			M9517	
	<b>Nitro Series Gas Shock with Red Boot, White</b>	2			N8017		
Chevrolet/GMC 1500 4WD - 2014 - April 2016 - 6-7" Front Strut Spacer Lift with Rear Blocks (models equipped with OE CAST STEEL Knuckles Only)							
C14660PK	Comp Box CAST STEEL Knuckles 6"	1	C14661A			1, 3, 23, 32, 33	
	Comp Box Strut Spacers 6-7"	1	C14660SP				
	Comp Box 6" Rear	1	C14661PR				
	<b>Select Required Shock Option (2) each of desired Series</b>						
		<b>Hydro Series Shock with Red Boot, White</b>	2			H7036	
		<b>Black MAX Performance Shock with Black Boot, Black</b>	2			B8536	
		<b>M95 Monotube Performance Shock, White</b>	2			M9536	
	<b>Nitro Series Gas Shock with Red Boot, White</b>	2			N8036		
Notes	<b>1)</b> Works "Only" on vehicles equipped with OE STEEL A-Arms <b>2)</b> Works "Only" on models equipped with Aluminum or stamped steel A-Arms <b>3)</b> OEM Wheels work with exception of 18", OEM 18" Wheels require wheel spacers # WSP655 <b>10)</b> Models with factory 18"/20" wheels must run 18"/20" wheels when changing to aftermarket wheels. <b>14)</b> Coil-Over upgrade for installed 6" kits <b>23)</b> Rear Replacement Leaf options available, see GM Master Pages 76-101 <b>32)</b> Wheel/Tire fitment requirements page 244-245 <b>33)</b> If driver line vibration occurs order front drive shaft part #GM10146DS						



# 1500



GM may have redesigned the newer 1500, but Skyjacker® has released two new suspension lift kits that redefine this all new setup. The 4 & 6" kits include CNC Machined Steering knuckles, front & rear crossmembers, 1-piece differential skid plate, 4-link relocation brackets and replacement variable rate Softride® rear coil springs.



Skyjacker's 6" suspension lift system for the '07-'18 GM K1500 is the ultimate in performance, comfort, and stability for these popular vehicles. Skyjacker's adjustable Performance Struts provide the best ride possible and achieve a full 6" of lift in the front. This complete system features heavy-duty front and rear crossmembers along with the necessary differential drop brackets. Replacement CNC machined ductile iron steering knuckles are Incl. and maintain the correct steering geometry, so there is no need for modifications to the factory steering assembly.

## Chevrolet/GMC 1500 Pickup 2007-2020

Kit Ref #	Description	Qty	Part #	Front Shock	Rear Shock	Note
<b>Chevrolet/GMC 4WD 1500 - 2007-2020 - 2" Leveling</b>						
<b>C1420LMSA</b>	2" Leveling Kit Below Strut Mount	1	C1420LMSA			32
<b>C720MS</b>	2" Leveling Kit Above Strut Spacer	1	C720MS			32
<b>Chevrolet/GMC 4WD 1500 - 2007-13 - Control Arm Kit</b>						
<b>C7350PH</b>	3.5" - 4" Upper Control Arm Lift Kit with <b>Hydro</b> 7000 Rear Shocks	1	C7350PH			1,3
<b>C7350PN</b>	3.5" - 4" Upper Control Arm Lift Kit with <b>Nitro</b> 8000 Rear Shocks	1	C7350PN			1,3
<b>C7350PB</b>	3.5" - 4" Upper Control Arm Lift Kit with <b>Black Max</b> B8500 Rear Shocks	1	C7350PB			1,3
<b>C7350PM</b>	3.5" - 4" Upper Control Arm Lift Kit with <b>Monotube</b> M9500 Rear Shocks	1	C7350PM			1,3
<b>Chevrolet/GMC 1500 Avalanche, Suburban, Tahoe, Yukon, Yukon XL - 2007-14 - Control Arm Kit</b>						
<b>C7350V</b>	3.5" - 4" Upper Control Arm Lift Kit with <b>Rear Shock Brackets</b>	1	C7350V			1,2
<b>Notes</b>	<b>1)</b> Does not fit All Wheel Drive models <b>2)</b> Does not fit Auto Ride or Auto Leveling <b>3)</b> Does not fit GMC Denali models with magnetic rider control					



# 1500



Chevrolet/GMC 4WD 1500 - 2007-13 - 4" Front Strut Spacer Lift with Rear Blocks							
<b>C7360PK</b>	Comp Box Main 4"	1	C7361A			10, 23, 32	
	Comp Box Strut Spacer 4"	1	C7360SP				
	Comp Box 4" Rear	1	C7361PR				
	<b>Select Required Shock Option (2) each of desired Series</b>						
	<b>Hydro Series Shock with Red Boot, White</b>	2			H7017		
	<b>Black MAX Performance Shock with Black Boot, Black</b>	2			B8517		
	<b>M95 Monotube Performance Shock, Silver</b>	2			M9517		
<b>Nitro Series Gas Shock with Red Boot, White</b>	2			N8017			
Chevrolet/GMC 4WD 1500 - 2007-13 - 6" Front Strut Spacer Lift with Rear Blocks							
<b>C7660PK</b>	Comp Box Main 6"	1	C7661A			10, 23, 32	
	Comp Box Strut Spacer 6"	1	C7660SP				
	Comp Box 6" Rear	1	C7661PR				
	<b>Select Required Shock Option (2) each of desired Series</b>						
	<b>Hydro Series Shock with Red Boot, White</b>	2			H7036		
	<b>Black MAX Performance Shock with Black Boot, Black</b>	2			B8536		
	<b>M95 Monotube Performance Shock, Silver</b>	2			M9536		
<b>Nitro Series Gas Shock with Red Boot, White</b>	2			N8036			

Chevrolet/GMC Colorado/Canyon - 2004-2020						
Colorado/Canyon 4WD/2WD - 2015-2020 - 1" or 2" Leveling Kit						
<b>CC12MS</b>	Colorado Canyon Leveling Kit	1	CC12MS			<b>NEW!</b>
Colorado/Canyon 4WD/2WD - 2004-12 - 2" Leveling Kit (fits models equipped with OE Torsion bars only)						
<b>C104KE</b>	Colorado Canyon Leveling Kit Torsion Keys	1	C104KE			11, 13, 32
Colorado/Canyon 4WD - 2004-12 - 4" Lift with Rear Add-a-Leaf (fits models equipped with OE Torsion bars only)						
<b>CC409K</b>	Component Box 4WD 4"	1	CC409			11, 13, 23, 32, 33
	Add-A-Leaf Rear	1	RCC25			
Colorado/Canyon 2WD - 2004-12 - 4" Lift with Rear Add-a-Leaf (fits models equipped with OE Torsion bars only)						
<b>CC429K</b>	Component Box 2WD 4"	1	CC429			11, 13, 23, 32, 33
	Add-A-Leaf Rear	1	RCC25			
<b>Select Required Shock Option F&amp;R Shocks (2) each of desired Series</b>						
	<b>Hydro Series Shock with Red Boot, White</b>	2		H7040	H7084	
	<b>Black MAX Performance Shock with Black Boot, Black</b>	2		B8540	B8584	
	<b>Nitro Series Gas Shock with Red Boot, White</b>	2		N8040	N8084	
Chevrolet/GMC 4WD 1500 - 2007-12 - Chevrolet/GMC 4WD Colorado/Canyon						
<b>Notes</b>	<b>10)</b> OEM Wheels can be used. <b>11)</b> Can "NOT" reuse OE Wheels, requires 4.75" Back Spacing, see wheel and tire fitments in rear of catalog <b>12)</b> Fits vehicles equipped with OE Torsion Bar front suspensions <b>13)</b> Fits 4WD ONLY, See Master catalog pages for 2WD applications <b>23)</b> Rear Replacement Leaf options available, see GM Master Pages 74-99 <b>32)</b> See Wheel & Tire fitment requirements page 244-245 <b>33)</b> Rear leaf springs available - Order (2) CCR25S instead of RCC25					
NOTE: Many additional applications and Steering Stabilizers available. See GM Chevrolet Master Pages 76-101						

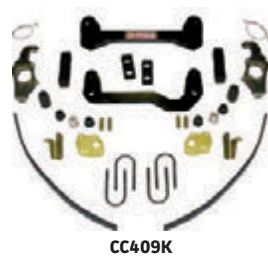



# 2500HD 3500HD

## Chevrolet/GMC 2500HD/3500HD 4WD Pickup 2011-2019

Kit Ref #	Description	Qty	Part #	Front Shock	Rear Shock	Note
<b>Chevrolet/GMC 4WD 2500-3500HD - 2011-19 - 2" Leveling</b>						
<b>C115KE</b>	2" Torsion Keys 2500HD (Shock Extensions Incl.)	1	C115KE			7, 32,33
<b>Option</b>	2" Block and U-Bolt Kit	1	BUK2789			
<b>Chevrolet/GMC 4WD/2WD 2500HD-3500HD - 2011-19 - Control Arm Kits</b>						
<b>C11350PH</b>	3" - 3.5" Upper Control Arm Lift Kit with <b>Hydro</b> 7000 Rear Shocks	1	C11350PH			33
<b>C11350PN</b>	3" - 3.5" Upper Control Arm Lift Kit with <b>Nitro</b> 8000 Rear Shocks	1	C11350PN			33
<b>C11350PB</b>	3" - 3.5" Upper Control Arm Lift Kit with <b>Black Max</b> B8500 Rear Shocks	1	C11350PB			33
<b>C11350PM</b>	3" - 3.5" Upper Control Arm Lift Kit with <b>Monotube</b> M9500 Rear Shocks	1	C11350PM			33
<b>Chevrolet/GMC 4WD 2500HD - 2011-2019 - 6" - Lift Rear Blocks with Torsion Bar Lowered</b>						
<b>C11680K</b>	Main Component Box, 6"	1	C1168A			4, 5, 8, 9, 23, 32
	Component Box 2500HD, 6-7"	1	C1178B			
	Front & Rear Shock Box	1	C1178N		Incl.	
<b>Chevrolet/GMC 4WD 2500HD - 2011-2019 - 7" Lift - Rear Blocks with Torsion Bar raised</b>						
<b>C11781K</b>	Main Component Box, 7"	1	C1178A			4, 6, 8, 9, 23, 32
	Component Box 2500HD, 6-7"	1	C1178B			
	Raised Torsion Bar Box	1	C1178TR			
	Front & Rear Shock Box	1	C1178N		Incl.	
<b>Chevrolet/GMC 4WD 3500HD - 2011-2019 - 6" Lift - Rear Blocks with Torsion Bar Lowered</b>						
<b>C11680KH</b>	Main Component Box, 6"	1	C1168A			4, 5, 8, 9, 23
	Component Box 3500HD, 6-7"	1	C1178BH			
	Front & Rear Shock Box	1	C1178N		Incl.	
<b>Chevrolet/GMC 4WD 3500HD - 2011-2019 with Torsion Bar Raised</b>						
<b>C11781KH</b>	Main Component Box, 7"	1	C1178A			4, 6, 8, 9, 23, 32
	Component Box 3500HD, 6-7"	1	C1178BH			
	Raised Torsion Bar Box	1	C1178TR			
	Front & Rear Shock Box	1	C1178N		Incl.	
<b>Chevrolet/GMC 4WD 2500-3500HD</b>						
<b>Options</b>	DEF UREA Skid Plate 2011-16 GM 2500/3500HD	1	DEFG114SP			



Skyjacker® DEF Urea Tank Skid Plate - DEFG114SP







Chevrolet/GMC 2500HD/3500HD 4WD Pickup 2001-2010						
<b>Chevrolet/GMC 4WD/2WD 2500-3500HD - 2001-10 Torsion Bar 2" Leveling</b>						
<b>C103KE</b>	2" KEYS 2500HD/3500HD (Shock Extensions Incl.)	1	C103KE			7, 16, 32
<b>Chevrolet/GMC 4WD 2500-3500HD - 2001-10 - 3" Torsion Bar Suspension Kit with Rear Lift Blocks</b>						
<b>C9381K</b>	Component Box Kit, 3"	1	C9381			
	Rear Block & U-Bolt Kit	1	BUK2082F			
	<b>Select Required Shock Option F&amp;R Shocks (2) each of desired Series</b>					
	<b>Hydro Series Shock with Red Boot, White</b>	2		H7074	H7017	
	<b>Black MAX Performance Shock with Black Boot, Black</b>	2		B8574	B8517	
	<b>M95 Monotube Performance Shock, Silver</b>	2		M9574	M9517	
	<b>Nitro Series Gas Shock with Red Boot, White</b>	2		N8074	N8017	
<b>Chevrolet/GMC 4WD 2500-3500HD - 2001-10 - 6" Torsion Bar Suspension Kit with Rear Lift Blocks</b>						
<b>C9681K-NSP</b>	Main Component Box Kit, 6"	1	C9681A-NSP			9, 18, 23, 32
	Component Box Kit, 6"	1	C9682B			
	<b>Select Required Shock Option F&amp;R Shocks (2) each of desired Series</b>					
	<b>Hydro Series Shock with Red Boot, White</b>	2		H7074	H7036	
	<b>Black MAX Performance Shock with Black Boot, Black</b>	2		B8574	B8536	
	<b>M95 Monotube Performance Shock, Silver</b>	2		M9574	M9536	
	<b>Nitro Series Gas Shock with Red Boot, White</b>	2		N8074	N8036	
<b>Notes</b>	<p>4) OEM 17" &amp; 18" Wheels can be 5) This choice uses a lowering bracket for Torsion bar 6) This choice raises the Torsion bars for additional clearance 7) Shock extensions Incl. in this kit 8) In event of rear driveline vibration install Carrier Bearing kit part# CBL2500 9) OEM Wheels can be used, see Tire/Wheel fitment guide rear of catalog 16) Works with OE color codes Orange, Green, White, Brown 17) Works with OE color codes Purple, Blue, Yellow 18) 3500 Models will require U-bolts and Modification to knuckle 23) Rear Replacement Leaf options available, see GM Master Pages 76-101 32) See Wheel &amp; Tire fitment requirements page 244-245 33) Does not fit models with magnetic ride control.</p>					
NOTE: Many additional applications and Steering Stabilizers available. See GM Chevrolet Master Pages 76-101						



C9681K-NSP



C11350PM



6" C11680K



7" C11781K

# RAM



# 1500

Dodge may have redesigned the 09 and newer 1500 Ram, but Skyjacker® has released two new suspension lift kits that redefine this all new setup. The 4 & 6" kits include CNC Machined Steering knuckles, front & rear crossmembers, 1-piece differential skid plate, 4-link relocation brackets and replacement variable rate Softride® rear coil springs.



## Dodge Ram 1500 Pickup 2012-2018

Kit Ref #	Description	Qty	Part #	Front Shock	Rear Shock	Note
<b>Dodge Ram 4WD 1500 - 2006-18 - 2" Strut Top Mount Spacer Leveling Kit</b>						
<b>R620MS</b>	2006-18 2" Strut Spacer Leveling Kit	1	R620MS			33
<b>Dodge Ram 4WD 1500 - 2006-17 - 1.5 - 2.5" Adjustable Strut Leveling Kit</b>						
<b>D6912ST</b>	2006-18 1.5 - 2" Adjustable Strut Leveling Kit	1	D6912ST			33
<b>Dodge Ram 4WD 1500 &amp; Eco Diesel - 2012-18 - 4" Front Strut Spacer Lift with Replacement Rear Coil Springs</b>						
<b>D1440SSK</b>	Component Box A, 4"	1	D1440A			32
	Component Box B, 4"	1	D1440B			
	Component Box C, 4"	1	D1440C			
	<b>Select Required Shock Option (2) each of desired Series</b>					
	<b>Hydro Series Shock with Red Boot, White</b>	2			H7017	
	<b>Nitro Series Gas Shock with Red Boot, White</b>	2			N8017	
	<b>Black MAX Performance Shock with Black Boot, Black</b>	2			B8517	
<b>M95 Monotube Performance Shock, Silver</b>	2			M9517		
<b>Dodge Ram 4WD 1500 &amp; Eco Diesel 1500 - 2012-18 - 6" Front Strut Spacer Lift with Replacement Rear Coil Springs</b>						
<b>D1460SSK</b>	Component Box A, 6"	1	D1460A			10, 32
	Component Box B, 6"	1	D1460B			
	Component Box C, 6"	1	D1460C			
	<b>Select Required Shock Option (2) each of desired Series</b>					
	<b>Hydro Series Shock with Red Boot, White</b>	2			H7070	
	<b>Nitro Series Gas Shock with Red Boot, White</b>	2			N8070	
	<b>Black MAX Performance Shock with Black Boot, Black</b>	2			B8570	
<b>M95 Monotube Performance Shock, Silver</b>	2			M9570		
<b>Notes</b>	<b>10) TRX Models Require Part # D960TRX4 32) See Wheel &amp; Tire fitment requirements page 244-245 33) Will NOT fit TRX Models or Air Ride</b>					
<b>NOTE: Many additional model applications and steering stabilizers available. See Dodge &amp; Ram Master Pages 102-119.</b>						



Dodge Ram 1500 Pickup 2006-2018							
Kit Ref #	Description	Qty	Part #	Front Shock	Rear Shock	Note	
<b>Dodge Ram 4WD 1500 - 2006-18 - 2" Strut Top Mount Spacer Leveling Kit</b>							
D620MS	2" Top Mount Strut Spacer Leveling Kit	1	D620MS			33	
<b>Dodge Ram 4WD 1500 - 2006-18 - 1.5 - 2.5" Adjustable Replacement Strut Leveling Kit</b>							
D6912ST	1.5 - 2" Adjustable Strut Leveling Kit	1	D6912ST			33	
<b>Dodge Ram 4WD 1500 - 2009-11 - 4" Front Strut Spacer Lift with Replacement Rear Coil Springs</b>							
D940SSK	Component Box 4"	1	D1440A			32	
	Component Box 4"	1	D946B				
	Component Box 4"	1	D1440C				
	<b>Select Required Shock Option (2) each of desired Series</b>						
		<b>Hydro Series Shock with Red Boot, White</b>	2			H7017	
		<b>Nitro Series Gas Shock with Red Boot, White</b>	2			N8017	
		<b>Black MAX Performance Shock with Black Boot, Black</b>	2			B8517	
	<b>M95 Monotube Performance Shock, Silver</b>	2			M9517		
<b>Dodge Ram 1500 - 2009-11 - 6" Front Strut Spacer Lift with Replacement Rear Coil Springs</b>							
D960SSK	Component Box 6"	1	D1460A			32	
	Component Box 6"	1	D946B				
	Component Box 6"	1	D1460C				
	<b>Select Required Shock Option (2) each of desired Series</b>						
		<b>Hydro Series Shock with Red Boot, White</b>	2			H7070	
		<b>Nitro Series Gas Shock with Red Boot, White</b>	2			N8070	
		<b>Black MAX Performance Shock with Black Boot, Black</b>	2			B8570	
	<b>M95 Monotube Performance Shock, Silver</b>	2			M9570		
<b>Dodge Ram 4WD 1500 - 2006-08 - 4" Front Strut Spacer Lift with Rear Lift Blocks</b>							
D640SSK	Component Box 4"	1	D646A			32	
	Component Box 4"	1	D646B				
	Component Box 4"	1	D640C				
	<b>Select Required Shock Option (2) each of desired Series</b>						
		<b>Hydro Series Shock with Red Boot, White</b>	2			H7070	
		<b>Nitro Series Gas Shock with Red Boot, White</b>	2			N8070	
		<b>Black MAX Performance Shock with Black Boot, Black</b>	2			B8570	
	<b>M95 Monotube Performance Shock, Silver</b>	2			M9570		
<b>Dodge Ram 4WD 1500 - 2006-08 - 6" Front Strut Spacer Lift with Rear Lift Blocks</b>							
D660SSK	Component Box 6"	1	D646A			32	
	Component Box 6"	1	D646B				
	Component Box 6"	1	D660C				
	<b>Select Required Shock Option (2) each of desired Series</b>						
		<b>Hydro Series Shock with Red Boot, White</b>	2			H7070	
		<b>Nitro Series Gas Shock with Red Boot, White</b>	2			N8070	
		<b>Black MAX Performance Shock with Black Boot, Black</b>	2			B8570	
	<b>M95 Monotube Performance Shock, Silver</b>	2			M9570		
<b>Notes</b>	<b>32)</b> See Wheel & Tire fitment requirements page 244-245 <b>33)</b> Will not fit TRX Models or Air Ride						

NOTE: Many additional applications and steering stabilizers available. See Dodge & Ram Master Pages 102-119.

# RAM



# 2500

**Skyjacker® is leading the trail** in the RAM Market with the 5" suspension lift for the "big and bold" '10-12 RAM 2500 and 3500 4WD includes replacement full-height Softride® front coil springs, greaseable upper and lower control arms, relocation brackets for the upper arms, pitman arm, bump stops and all necessary hardware.

**Skyjacker® Lives Up To Its Reputation** in the Dodge Market The 5" suspension lift for the "big and bold" '03-'09 Dodge 2500 and 3500 4WD includes replacement full-height Softride® front coil springs, greaseable upper and lower control arms, relocation brackets for the upper arms, pitman arm, bump stops and all necessary hardware.



## Ram 2500 4WD Pickup 2014-2020

Kit Ref #	Description	Qty	Part #	Front Shock	Rear Shock	Note
<b>Ram Gas &amp; Diesel 2500 - 3500 4WD - 2014-2020 - 2" Leveling with Shock Extensions Incl.</b>						
<b>R1325MSB</b>	2" Metal Spacer Leveling Kit w/ Shock Extension Brackets	1	R1325MSB			32
<b>Ram Gas &amp; Diesel 2500 -3500 4WD - 2014-2020 - 2" Leveling with "No" Shock Extensions Incl. (requires front shock choice)</b>						
<b>R1325MS</b>	2" Metal Spacer Leveling Kit (No Shock Ext)	1	R1325MS			32
<b>Ram Diesel 2500 -3500 4WD - 2014-2020 - 2.5" Leveling Front Coil Springs</b>						
<b>R25</b>	2.5" Front Coil Springs	1	R25			32
	<b>Select Required Front Shock option, Rear Shocks Optional (2) each of desired Series</b>					
	<b>Hydro</b> Series Shock with Red Boot, <b>White</b>	2		H7091	H7092	
	<b>Nitro</b> Series Gas Shock with Red Boot, <b>White</b>	2		N8091	N8092	
	<b>Black MAX</b> Performance Shock with Black Boot, <b>Black</b>	2		B8591	B8592	
<b>M95</b> Monotube Performance Shock, <b>Silver</b>	2		M9591	M9592		
<b>Ram Diesel 2500 4WD - 2014-2020 - 4" Lift with Front and Rear Coil Springs (equipped with OE Rear Coils Only)</b>						
<b>R14451K</b>	Ram Front Coil Springs / Pair 4"	1	R45			32
	Component Box 4-6"	1	R461			
	Component Box Ram 4" w/Rear Coil Springs	1	R144C			
	<b>Select Required Shock Option F&amp;R Shocks (2) each of desired Series</b>					
	<b>Hydro</b> Series Shock with Red Boot, <b>White</b>	2		H7092	H7093	
	<b>Nitro</b> Series Gas Shock with Red Boot, <b>White</b>	2		N8092	N8093	
	<b>Black MAX</b> Performance Shock with Black Boot, <b>Black</b>	2		B8592	B8593	
	<b>M95</b> Monotube Performance Shock, <b>Silver</b>	2		M9592	M95932	
<b>Ram Diesel 2500 4WD - 2014-2020 - 6" Lift with Replacement Front and Rear Coil Springs (equipped with OE Rear Coils Only)</b>						
<b>R14651K</b>	Ram Front Coil Springs/pair 6"	1	R65			32
	Component Box 4-6"	1	R461			
	Component Box Ram 6" w/Rear Coil Springs	1	R146C			
	<b>Select Required Shock Option F&amp;R Shocks (2) each of desired Series</b>					
	<b>Hydro</b> Series Shock with Red Boot, <b>White</b>	2		H7093	H7094	
	<b>Nitro</b> Series Gas Shock with Red Boot, <b>White</b>	2		N8093	N8094	
	<b>Black MAX</b> Performance Shock with Black Boot, <b>Black</b>	2		B8593	B8594	
	<b>M95</b> Monotube Performance Shock, <b>Silver</b>	2		M9593	M95942	
<b>Ram 2500 4WD - 2014-2020</b>						
<b>Options</b>	HD OEM Steering Stabilizer <b>White</b> w/Red Boot	1	7014			
	HD OEM Steering Stabilizer <b>Black MAX</b> w/Black Boot	1	8014			
	HD OEM Steering Stabilizer <b>Silver</b> w/Black Boot	1	9014			
	DUAL Steering Stabilizer <b>White</b> w/Black Boot	1	7214			
	DUAL Steering Stabilizer <b>Black MAX</b> w/Black Boot	1	8214			
	DUAL Steering Stabilizer <b>Silver</b> w/Black Boot	1	9214			
<b>Notes</b>	<b>32) See Wheel &amp; Tire fitment requirements page 244-245</b>					
<b>NOTE: Many additional applications and steering stabilizers available. See Dodge &amp; Ram Master Pages 102-119.</b>						



**R1325MSB**



**R14451k**

# F-150



*New Bolt in Skyjacker® Coil-Overs are tuned and tested with application specific valving for maximum performance on and off-road. Purchase as kit or Coil-Over box upgrade for your current Skyjacker® Suspension.*



F1562LSKM



Ford F150 4WD Pickup 2009-2018						
Kit Ref #	Description	Qty	Part #	Front Shock	Rear Shock	Note
<b>Ford F150 4WD 2009-18 - 2" Leveling Kit</b>						
F920MS	2" Leveling Kit	1	F920MS			32
Options	2" Rear Block and U-Bolt kit	1	BUK2074DF			
	<b>Optional Rear Shocks (2) each of desired Series, See master catalog page 207</b>					
<b>Ford F150 4WD 2015-18 - 4.5" Lift Front Strut Spacer Lift with Rear Lift Blocks with Hydro Shocks</b>						
F1545BKH	Main Box 4.5"-6"	1	F15461A			32
	Component Box 4.5" w/Hydro Shocks	1	F1545BH*		Incl.	
Shock Options	<b>*Additional Shock Options Available by replacing above Component Shock Box (1) of desired Series</b>					
	Component Box 4.5" w/Nitro Shocks	1	F1545BN		Incl.	32
	Component Box 4.5" w/Black MAX Shocks	1	F1545BB		Incl.	32
	Component Box 4.5" w/M95 Monotube Shocks	1	F1545BM		Incl.	32
<b>Ford F150 4WD 2015-18 - 6" Lift Front Strut Spacer Lift with Rear Lift Blocks with Hydro Shocks</b>						
F1560BKH	Main Box 4.5"-6"	1	F15461A			32
	Component Box 6" w/Hydro Shocks	1	F1560BH*			32
Shock Options	<b>*Additional Shock Options Available by replacing above Component Shock Box (1) of desired Series</b>					
	Component Box 6" w/Nitro Shocks	1	F1560BN		Incl.	32
	Component Box 6" w/Black MAX Shocks	1	F1560BB		Incl.	32
	Component Box 6" w/M95 Monotube Shocks	1	F1560BM		Incl.	32
<b>Ford F150 4WD 2009-14 - 4.5" Lift with Rear Lift Blocks with Hydro Shocks</b>						
F945BKH	Main Box 4.5"-6"	1	F9461A			32
	Component Box 4.5" w/Hydro Shock	1	F945BH		Incl.	
<b>Ford F150 4WD 2009-14 - 6" Lift with Rear Lift Blocks with Hydro Shocks</b>						
F960BKH	Main Box 4.5"-6"	1	F9461A			32
	Component Box 6" w/Hydro Shock	1	F960BH		Incl.	
<b>Ford F150 4WD 2009-13 - 6" Fox Coil-Over Front Lift with Rear Lift Blocks and M95 Series Performance Monotube Rear Shock</b>						
F962LSKM New	6" Coil-Over	1	F962LS			32
	Main Box 4.5"-6"	1	F9461A			
	Component Box 6" w/M95 Monotube Shocks	1	F962BM		Incl.	
Notes	32) See Wheel & Tire fitment requirements page 244-245					
NOTE: Many additional applications and steering stabilizers available. See Ford Master Pages 120-159.						



F920MS



F1560BKH



# F-150

**3" Kit with Rear Blocks & Ubolts** This 3" suspension kit replaces the factory struts with a performance strut & retains the factory coil springs. You keep the same quiet comfortable ride, but gain the extra clearance needed for a more aggressive tire.



**66-79 F150 Various Kits & Systems Ranging in Heights From 2" - 9" of Lift** Skyjacker® offers a full line of straight axle Ford Kits and Systems that can take your classic Ford to new heights. A wide range of lifts from 2" - 9" gives you the choice of lift desired.



**80-96 F150/Bronco Class I System** The Class I System features replacement cast steel radius arm brackets which are exclusive to Skyjacker®. This System also features Race Style heavy-duty replacement center hinge brackets. The coil springs in these Systems are preset and formed from 5160H chromium alloy to ensure a higher tensile strength and longer life along with the added benefit of full-height rear springs.



Ford F150 Pickup 2004-2008						
Kit Ref #	Description	Qty	Part #	Front Shock	Rear Shock	Note
<b>Ford F150 2004-08 - 2.5" Metal Leveling Kit</b>						
FF25MS	2.5" Leveling Kit	1	FF25MS			32
<b>Shock Options</b>	<b>Optional Rear Shocks select (2) each of desired Series, See master catalog page 207</b>					
<b>4WD Only - Ford F150 - 2004-08 - 3" Lift Performance Front Struts with Rear Blocks &amp; Ubolts - Shocks Incl.</b>						
F430STBH	3" Kit, 4WD w/Hydro Shocks	1	F430STBH		Incl.	32
F430STBN	3" Kit, 4WD w/Nitro Shocks	1	F430STBN		Incl.	32
F430STBB	3" Kit, 4WD w/Black MAX Shocks	1	F430STBB		Incl.	32
F430STBM	3" Kit, 4WD w/M95 Monotube Shocks	1	F430STBM		Incl.	32
<b>4WD Only - Ford F150 2004-08 - 6" Lift with Front Strut Spacers with Rear Blocks &amp; Ubolts - Shocks Incl.</b>						
F460BKH	Main Box 6"	1	F4461A			32
	Component Box 6" w/Hydro Shocks	1	F460BH		Incl.	
F460BKN	Main Box 6"	1	F4461A			32
	Component Box 6" w/Nitro Shocks	1	F460BN		Incl.	
F460BKB	Main Box 6"	1	F4461A			32
	Component Box 6" w/Black MAX Shocks	1	F460BB		Incl.	
F460BKM	Main Box 6"	1	F4461A			32
	Component Box 6" w/M95 Monotube Shocks	1	F460BM		Incl.	
<b>4WD Only - Ford F150 2004-08 - 6" Lift with Performance Front Struts</b>						
F4601K-NSP	Main Box 6"	1	F4601A-NSP			32
	Component Box 6" with Performance Front Struts	1	F4602BST			
	<b>Select Required Shock Option F&amp;R Shocks (2) each of desired Series</b>					
	<b>Hydro Series Shock with Red Boot, White</b>	2			H7060	
	<b>Nitro Series Gas Shock with Red Boot, White</b>	2			N8060	
	<b>Black MAX Performance Shock with Black Boot, Black</b>	2			B8560	
	<b>M95 Monotube Performance Shock, Silver</b>	2			M9560	
<b>2WD Only - Ford F150 - 2004-08 - 3" Lift Performance Front Struts with Rear Blocks &amp; Ubolts - Shocks Incl.</b>						
F432STBH	3" Kit, 2WD w/Hydro Shocks	1	F432STBH		Incl.	32
F432STBN	3" Kit, 2WD w/Nitro Shocks	1	F432STBN		Incl.	32
F432STBB	3" Kit, 2WD w/Black MAX Shocks	1	F432STBB		Incl.	32
F432STBM	3" Kit, 2WD w/M95 Monotube Shocks	1	F432STBM		Incl.	32
<b>Ford F150 Pickup 1997-2003</b>						
<b>4WD Only - Ford F150 1997-03 - 2" Torsion Bar Kit</b>						
F301KE	2" Torsion Key Leveling Kit	1	F301KE			
<b>4WD Only - Ford F150 1997-03 - 6" Lift with Rear Blocks &amp; UBolts</b>						
F9701K-NSP	Main Box 6"	1	F9701A-NSP			23,26,32
	Component Box 6"	1	F9701B			
	<b>Select Required Shock Option F&amp;R Shocks (2) each of desired Series</b>					
	<b>Hydro Series Shock with Red Boot, White</b>	2		H7097	H7061	
	<b>Nitro Series Gas Shock with Red Boot, White</b>	2		N8097	N8061	
	<b>Black MAX Performance Shock with Black Boot, Black</b>	2		B8597	B8561	
	<b>M95 Monotube Performance Shock, Silver</b>	2		M9597	M9561	
<b>Notes</b>	<b>23)</b> Rear Replacement Leaf options available, see Ford Master Pages 120-159 <b>26)</b> Regular Cab & Short Bed models are equipped with factory tapered blocks. To correct driveline angle Part # RBF20 is required <b>32)</b> See Wheel & Tire fitment requirements page 244-245.					



F460BKH



F430STBH / F432STBH



FF25MS

# F250/350 SUPER DUTY

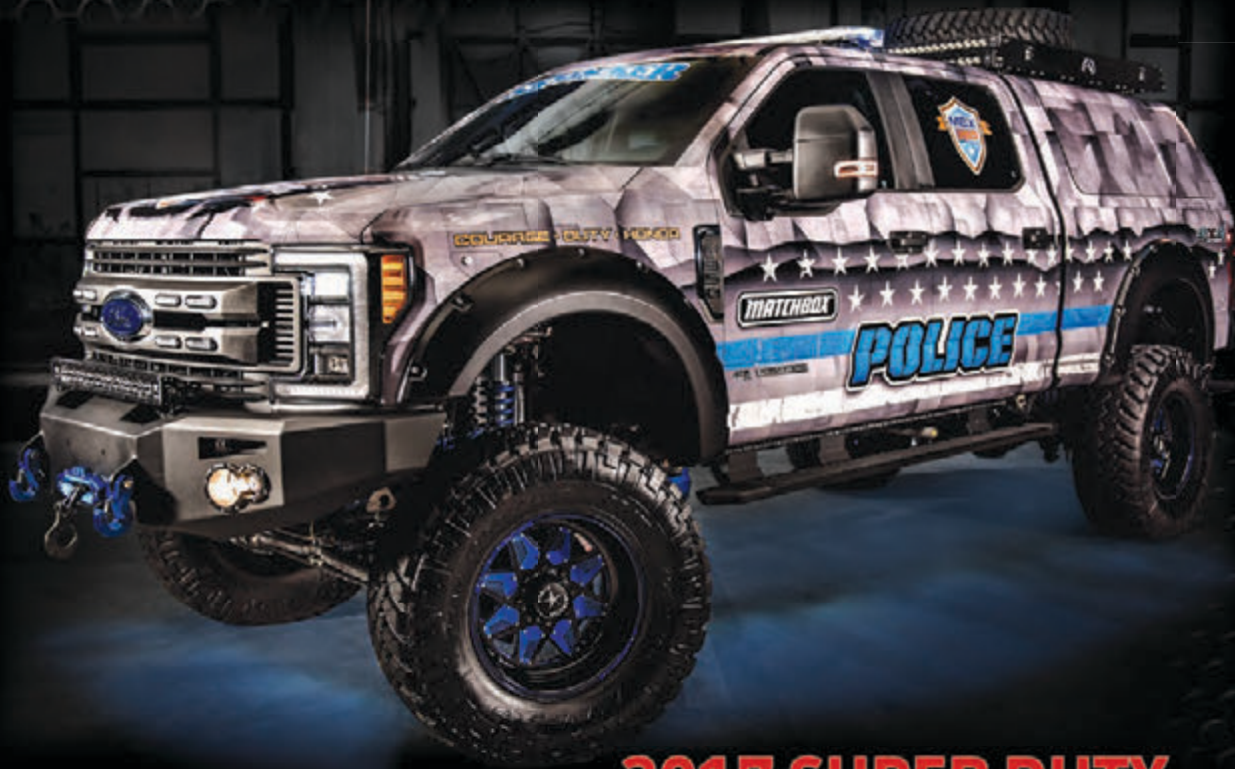

## 2017 SUPER DUTY

- New Variable Rate Coils for Improved Ride Quality
  - Radius Arm Brackets to Correct Geometry
    - Drop Pitman Arm Included ( 6"-8.5" )
    - HD Track Bar Relocation Bracket
  - Available with Fully Adjustable 4-Links
  - 3", 5" & 7" Rear Leaf Springs Available





### Ford F250/350 Super Duty Pickup 2017-19

Kit Ref #	Description	Qty	Part #	Front Shock	Rear Shock	Note
<b>Ford Gas &amp; Diesel F250/350 - 2.5" Metal Spacer Kit with Front Track Bar Bracket</b>						
<b>F528MSP</b>	2.5" Metal Spacer Leveling Kit w/ Front Track Bar Bracket	1	F528MSP			22
<b>Ford Gas &amp; Diesel F250/350 - 1" Metal Spacer Front Kit</b>						
<b>F51MS</b>	1" Metal Spacer Front Lift	1	F51MS			22
<b>Ford Gas &amp; Diesel F250/350 - 2.5" Metal Spacer Front Leveling Kit</b>						
<b>F52MS</b>	2.5" Metal Spacer Front Leveling Kit	1	F52MS			22, 24
	<b>Select Required Shock Option F&amp;R Shocks (2) each of desired Series</b>					
	<b>Hydro Series Shock with Red Boot, White</b>	2		H7091	H7038	
	<b>Nitro Series Gas Shock with Red Boot, White</b>	2		N8091	N8038	
	<b>Black MAX Performance Shock with Black Boot, Black</b>	2		B8591	B8538	
<b>M95 Monotube Performance Shock, Silver</b>	2		M9591	M9538		
<b>Ford Diesel F250/350 - 2 - 2.5" Front Coil Springs / Variable Rate</b>						
<b>F525V</b>	2" - 2.5" Front Coils / Variable Rate	1	F525V			22, 24
	<b>Select Required Shock Option F&amp;R Shocks (2) each of desired Series</b>					
	<b>Hydro Series Shock with Red Boot, White</b>	2		H7091	H7038	
	<b>Nitro Series Gas Shock with Red Boot, White</b>	2		N8091	N8038	
	<b>Black MAX Performance Shock with Black Boot, Black</b>	2		B8591	B8538	
<b>M95 Monotube Performance Shock, Silver</b>	2		M9591	M9538		
<b>Ford Gas &amp; Diesel F250/350 - 4" Metal Spacer Kit with Black MAX shocks</b>						
<b>F1740SPB</b>	4" Complete Front & Rear Kit with Front & Rear <b>Black MAX</b> shocks	1		Incl.	Incl.	21



## 2017-18 Ford F250 Super Duty Pickup

Kit Ref #	Description	Qty	Part #	Front Shock	Rear Shock	Note	
<b>Ford Diesel F250 - 2017-19 - 4" Lift Coil Springs / Variable Rate</b>							
<b>F17451K</b>	4" Front Coils / Variable Rate	1	F545V				
	Component Box F250 4"	1	F17451			21	
<b>F17451KS</b>	4" Front Coils / Variable Rate	1	F545V				
	System Box F250 4"	1	F17451S			21	
	Rear Leaf Springs, 3"	2	FR173S			<b>NEW!</b>	
	Select Required Shock Option F&R Shocks (2) each of desired Series						
	<b>Hydro</b> Series Shock with Red Boot, <b>White</b>	2		H7092	H7068		
	<b>Nitro</b> Series Gas Shock with Red Boot, <b>White</b>	2		N8092	N8068		
	<b>Black MAX</b> Performance Shock with Black Boot, <b>Black</b>	2		B8592	B8568		
	<b>M95</b> Monotube Performance Shock, <b>Silver</b>	2		M9592	M9568		
<b>Ford Diesel F250 - 2017-19 - 6" Lift Coil Springs / Variable Rate</b>							
<b>F17651K</b>	6" Front Coils / Variable Rate	1	F565V				
	Component Box F250 6" w/Pitman Arm Included	1	F17651			21	
<b>F17651KS</b>	6" Front Coils / Variable Rate	1	F565V				
	System Box F250 6" w/Pitman Arm Included	1	F17651S			21	
	Rear Leaf Springs, 5"	2	FR175S			<b>NEW!</b>	
	Select Required Shock Option F&R Shocks (2) each of desired Series						
	<b>Hydro</b> Series Shock with Red Boot, <b>White</b>	2		H7093	H7068	21	
	<b>Nitro</b> Series Gas Shock with Red Boot, <b>White</b>	2		N8093	N8068		
	<b>Black MAX</b> Performance Shock with Black Boot, <b>Black</b>	2		B8593	B8568		
	<b>M95</b> Monotube Performance Shock, <b>Silver</b>	2		M9593	M9568		
<b>Ford Diesel F250 - 2017-19 - 8.5" Lift Coil Springs / Variable Rate</b>							
<b>F17852K</b>	8.5" Front Coils / Variable Rate	1	F585V				
	Component Box 8.5" w/Pitman Arm Included	1	F17852				
	Rear Add-A-Leafs	1	R3815				
	Front 4 Link conversion All Super Duty 4"-8.5"	1	F58484LU				
<b>F17852KS</b>	8.5" Front Coils / Variable Rate	1	F585V				
	System Box 8.5" w/Pitman Arm Included	1	F17852S				
	Front 4 Link conversion All Super Duty 4"-8.5"	1	F58484LU				
	Rear Leaf Springs, 7"	2	FR177S			<b>NEW!</b>	
Select Required Shock Option F&R Shocks (2) each of desired Series							
	<b>Hydro</b> Series Shock with Red Boot, <b>White</b>	2		H7094	H7089		
	<b>Nitro</b> Series Gas Shock with Red Boot, <b>White</b>	2		N8094	N8089		
	<b>Black MAX</b> Performance Shock with Black Boot, <b>Black</b>	2		B8594	B8589		
	<b>M95</b> Monotube Performance Shock, <b>Silver</b>	2		M9594	M9589		



## 2017-19 Ford F350 Super Duty Pickup

Kit Ref #	Description	Qty	Part #	Front Shock	Rear Shock	Note	
<b>Ford Diesel or Gas F350 - 2017-19 - 4" Metal Spacer Kit with Black MAX shocks</b>							
<b>F1740SPB3</b>	4" Complete Front & Rear Kit with Front & Rear <b>Black MAX</b> shocks	1	F1740SPB3	Incl.	Incl.		
<b>Ford Diesel F350 - 2019 - 4" Lift Coil Springs / Variable Rate</b>							
<b>F17451K3</b>	4" Front Coils / Variable Rate	1	F545V				
	Component Box F350 4"	1	F174513			21	
<b>F17451KS</b>	4" Front Coils / Variable Rate	1	F545V				
	System Box F350 4"	1	F17451S			21	
	Rear Leaf Springs, 3"	2	FR173S			<b>NEW!</b>	
	<b>Select Required Shock Option F&amp;R Shocks (2) each of desired Series</b>						
	<b>Hydro</b> Series Shock with Red Boot, <b>White</b>	2			H7092	H7068	
	<b>Nitro</b> Series Gas Shock with Red Boot, <b>White</b>	2			N8092	N8068	
	<b>Black MAX</b> Performance Shock with Black Boot, <b>Black</b>	2			B8592	B8568	
	<b>M95</b> Monotube Performance Shock, <b>Silver</b>	2			M9592	M9568	
<b>Ford Diesel F350 - 2017-19 - 6" Lift Coil Springs / Variable Rate</b>							
<b>F17651K3</b>	6" Front Coils / Variable Rate	1	F565V				
	Component Box F350 6" w/Pitman Arm Included	1	F176513			21	
<b>F17651KS</b>	6" Front Coils / Variable Rate	1	F565V				
	System Box F350 6" w/Pitman Arm Included	1	F17651S			21	
	Rear Leaf Springs, 5"	2	FR175S			<b>NEW!</b>	
	<b>Select Required Shock Option F&amp;R Shocks (2) each of desired Series</b>						
	<b>Hydro</b> Series Shock with Red Boot, <b>White</b>	2			H7093	H7068	
	<b>Nitro</b> Series Gas Shock with Red Boot, <b>White</b>	2			N8093	N8068	
	<b>Black MAX</b> Performance Shock with Black Boot, <b>Black</b>	2			B8593	B8568	
	<b>M95</b> Monotube Performance Shock, <b>Silver</b>	2			M9593	M9568	
<b>Ford Diesel F350 - 2017-19 - 8.5" Lift Coil Springs / Variable Rate</b>							
<b>F17852K</b>	8.5" Front Coils / Variable Rate	1	F585V				
	Component Box 8.5" w/Pitman Arm Included	1	F17852				
	Rear Add-A-Leafs	1	R3815				
	Front 4 Link conversion All Super Duty 4"-8.5"	1	F58484LU				
<b>F17852KS</b>	8.5" Front Coils / Variable Rate	1	F585V				
	System Box 8.5" w/Pitman Arm Included	1	F17852S				
	Front 4 Link conversion All Super Duty 4"-8.5"	1	F58484LU				
	Rear Leaf Springs, 7"	2	FR177S			<b>NEW!</b>	
<b>Select Required Shock Option F&amp;R Shocks (2) each of desired Series</b>							
<b>Hydro</b> Series Shock with Red Boot, <b>White</b>	2			H7094	H7089		
<b>Nitro</b> Series Gas Shock with Red Boot, <b>White</b>	2			N8094	N8089		
<b>Black MAX</b> Performance Shock with Black Boot, <b>Black</b>	2			B8594	B8589		
<b>M95</b> Monotube Performance Shock, <b>Silver</b>	2			M9594	M9589		
<b>Ford Diesel F250/350 - 2017-19</b>							
<b>Options</b>	Front Dual CV Driveshaft	1	F17685DS			23	
	Dual Steering Stabilizer <b>White</b> w/Red Boot	1	7254				
	Dual Steering Stabilizer <b>Black Max</b> w/Black Boot	1	8254				
	Dual Steering Stabilizer <b>Silver</b> w/Black Boot	1	9254				
	Front 4 Link conversion All Super Duty 4"-8"	1	F58484LU				
<b>Notes</b>	<b>21)</b> Optional Radius Arm to 4 Link Conversion available Part # F58484LU <b>22)</b> See Wheel & Tire fitment requirements page 244-245 <b>23)</b> Recommended w/6" Lift - Required w/8.5" Lift <b>24)</b> Front Track Bar Bracket Required - Part# TB1120						
NOTE: Many additional applications and steering stabilizers available. See Ford Master Pages 120-159							

# F250/350 COIL-OVER SERIES

## 2017-19 Ford F250 Super Duty Pickup

Kit Ref #	Description	Qty	Part #	Rear Shock	Note
<b>Ford Diesel/Gas F250 - 2017-19 - 6-8.5" Coil-Overs</b>					
<b>F1761LSK</b>	6" & 8.5" Front Coil-Overs	1	F768FLS		
	6" Front Coil-Over Bracket Box	1	F76FLSB		
	Component Box F250 6" w/Pitman Arm Included	1	F17651		
<b>F1761LSKS</b>	6" & 8.5" Front Coil-Overs	1	F768FLS		
	6" Front Coil-Over Bracket Box	1	F76FLSB		
	System Box F250 6" w/Pitman Arm Included	1	F17651S		
	Rear Leaf Springs, 5"	2	FR175S		<b>NEW!</b>
<b>F17624LSK</b>	6" & 8.5" Front Coil-Overs	1	F768FLS		
	6" Front Coil-Over Bracket Box	1	F76FLSB		
	Component Box F250 6" w/Pitman Arm Included	1	F17651		
	Front 4 Link conversion All Super Duty 4"-8.5"	1	F58484LU		
<b>F17624LSKS</b>	6" & 8.5" Front Coil-Overs	1	F768FLS		
	6" Front Coil-Over Bracket Box	1	F76FLSB		
	System Box F250 6" w/Pitman Arm Included	1	F17651S		
	Front 4 Link conversion All Super Duty 4"-8.5"	1	F58484LU		
	Rear Leaf Springs, 5"	2	FR175S		<b>NEW!</b>
<b>Select Required Shock Option F&amp;R Shocks (2) each of desired Series</b>					
	<b>Hydro Series Shock with Red Boot, White</b>	2		H7068	
	<b>Nitro Series Gas Shock with Red Boot, White</b>	2		N8068	
	<b>Black MAX Performance Shock with Black Boot, Black</b>	2		B8568	
	<b>M95 Monotube Performance Shock, Silver</b>	2		M9568	
<b>F1782LSK</b>	6" & 8.5" Front Coil-Overs	1	F768FLS		
	8.5" Front Coil-Over Bracket Box	1	F78FLSB		
	Component Box 8.5" w/Pitman Arm Included	1	F17852		
	Front 4 Link conversion All Super Duty 4"-8.5"	1	F58484LU		
	Rear Add-A-Leafs	1	R3815		
<b>F1782LSKS</b>	6" & 8.5" Front Coil-Overs	1	F768FLS		
	8.5" Front Coil-Over Bracket Box	1	F78FLSB		
	System Box 8.5" w/Pitman Arm Included	1	F17852S		
	Front 4 Link conversion All Super Duty 4"-8.5"	1	F58484LU		
	Rear Leaf Springs, 7"	2	FR177S		<b>NEW!</b>
<b>Select Required Shock Option F&amp;R Shocks (2) each of desired Series</b>					
	<b>Hydro Series Shock with Red Boot, White</b>	2		H7089	
	<b>Nitro Series Gas Shock with Red Boot, White</b>	2		N8089	
	<b>Black MAX Performance Shock with Black Boot, Black</b>	2		B8589	
	<b>M95 Monotube Performance Shock, Silver</b>	2		M9589	

## 2017-19 Ford F350 Super Duty Pickup

Kit Ref #	Description	Qty	Part #	Rear Shock	Note
<b>Ford Diesel/Gas F350 - 2017-19 - 6-8.5" Coil-Overs</b>					
<b>F1761LSK3</b>	6" & 8.5" Front Coil-Overs	1	F768FLS		
	6" Front Coil-Over Bracket Box	1	F76FLSB		
	Component Box F350 6" w/Pitman Arm Included	1	F176513		
<b>F17624LSK3</b>	6" & 8.5" Front Coil-Overs	1	F768FLS		
	6" Front Coil-Over Bracket Box	1	F76FLSB		
	Component Box F3250 6" w/Pitman Arm Included	1	F176513		
	Front 4 Link conversion All Super Duty 4"-8.5"	1	F58484LU		
<b>F1782LSK</b>	6" & 8.5" Front Coil-Overs	1	F768FLS		
	8.5" Front Coil-Over Bracket Box	1	F78FLSB		
	Component Box 8.5" w/Pitman Arm Included	1	F17852		
	Front 4 Link conversion All Super Duty 4"-8.5"	1	F58484LU		
	Rear Add-A-Leafs	1	R3815		
<b>F1782LSKS</b>	6" & 8.5" Front Coil-Overs	1	F768FLS		
	8.5" Front Coil-Over Bracket Box	1	F78FLSB		
	System Box 8.5" w/Pitman Arm Included	1	F17852S		
	Front 4 Link conversion All Super Duty 4"-8.5"	1	F58484LU		
	Rear Leaf Springs, 7"	2	FR177S		<b>NEW!</b>
<b>Ford Diesel F250/350 - 2017-19</b>					
<b>Options</b>	Front Dual CV Driveshaft	1	F17685DS		23
	Dual Steering Stabilizer <b>White</b> w/Red Boot	1	7254		
	Dual Steering Stabilizer <b>Black MAX</b> w/Black Boot	1	8254		
	Dual Steering Stabilizer <b>Silver</b> w/Black Boot	1	9254		
<b>Notes</b>	<b>22)</b> See Wheel & Tire fitment requirements page 244-245 <b>23)</b> Recommended w/6" Lift - Required w/8.5" Lift				
NOTE: Many additional applications and steering stabilizers available. See Ford Master Pages 120-159.					



• Use in Conjunction with Existing 6" or 8.5" Suspension Lift

- **8.5" Shock with Massive 2 3/16" O.D. Reservoir**
  - Custom Tuned Front Coil-Over Springs
  - Upper & Lower Coil-Over Shock Brackets
  - Mounting Brackets & Grade 8 Hardware



# TOYOTA



# Tundra



*New Bolt in Skyjacker® Coil-Overs are tuned and tested with application specific valving for maximum performance on and off-road. Purchase as kit or Coil-Over box upgrade for your current Skyjacker® Suspension.*



TU762LSKM



## Toyota Tundra Pickup 2007-2019

Kit Ref #	Description	Qty	Part #	Front Shock	Rear Shock	Note
<b>Toyota Tundra 4WD/2WD - 2007-18 - 2" Leveling Kit</b>						
TU720MS	2" Top Mount Leveling Spacer Kit	1	TU720MS			32
Options	<b>Optional Rear Shocks select (2) each desired Series</b>					
	Hydro Series Shock with Red Boot, <b>White</b>	2			H7062	
	Nitro Series Gas Shock with Red Boot, <b>White</b>	2			N8062	
	Black MAX Performance Shock, <b>Black</b>	2			B8562	
	M95 Monotube Performance Shock, <b>Silver</b>	2			M9562	
	1 1/4" Rear Lift Block & U-bolt Kit	1	TU710R			
<b>Toyota Tundra 4WD/2WD - 2007-19- 3" Performance Strut Kit with Rear Hydro Shocks</b>						
TU730STBH	3" Performance Struts, Rear Blocks & U-Bolts w/ 2 Rear Hydro Shocks	1	TU730STBH			32
<b>Toyota Tundra 4WD/2WD - 2007-19 - 3" Coil-Over Kit with 2 Rear Monotube Shocks</b>						
TU730BM	3" Coil-Overs, Rear Blocks & U-Bolts w/ 2 Rear Monotube Shocks	1	TU730BM			32
<b>Toyota Tundra 4WD/2WD - 2007-19 - 3" Performance Strut Lift with Rear Block &amp; U-bolt Kit</b>						
TU730STK	Component Box 3" Performance Struts	1	TU730ST			32
	1 1/4" Rear Lift Block & U-bolt Kit	1	TU710R			
	<b>Select Required Shock Option (2) each of desired Series</b>					
	Hydro Series Shock with Red Boot, <b>White</b>	2			H7062	
	Nitro Series Gas Shock with Red Boot, <b>White</b>	2			N8062	
	Black MAX Performance Shock with Black Boot, <b>Black</b>	2			B8562	
	M95 Monotube Performance Shock, <b>Silver</b>	2			M9562	
<b>Toyota Tundra 4WD/2WD - 2007-19 - 3" FOX Coil-Over Lift with Rear Block &amp; U-bolt Kit</b>						
TU730K	3" Series FOX Coil-Overs w/Mounting Brackets	1	TU730			32
	1 1/4" Rear Lift Block & U-bolt Kit	1	TU710R			
	<b>Select Required Shock Option (2) each of desired Series</b>					
	Hydro Series Shock with Red Boot, <b>White</b>	2			H7062	
	Nitro Series Gas Shock with Red Boot, <b>White</b>	2			N8062	
	Black MAX Performance Shock with Black Boot, <b>Black</b>	2			B8562	
	M95 Monotube Performance Shock, <b>Silver</b>	2			M9562	
<b>Toyota Tundra 4WD/2WD - 2007-19 - 4.5" Lift with Rear Block &amp; U-bolt Kit - Black MAX Shocks Incl.</b>						
TU745BKB	Component Box 4.5 - 6"	1	TU746A			32
	Component Box 4.5" w/ Black MAX Shocks	1	TU745BB		Incl.	
<b>Toyota Tundra 4WD/2WD - 2007-19 - 4"-4.5" Lift with Rear Lift Blocks - M95 Monotube Shocks Incl.</b>						
TU745BKM	Component Box 4.5 - 6"	1	TU746A			32
	Component Box 4.5" w/ M95 Monotube Shocks	1	TU745BM		Incl.	
<b>Toyota Tundra 4WD/2WD - 2007-19 - 6" Strut Spacer Lift with Rear Lift Blocks - Black MAX Shocks Incl.</b>						
TU760BKB	Component Box 4.5 - 6"	1	TU746A			32
	Component Box 6" w/ Black MAX Shocks	1	TU760BB		Incl.	

NOTE: Many additional applications and Steering Stabilizers available. See Toyota Master Pages 180-193



TU720MS



TU730K



TU760BKB



TU730STK



# Tacoma



## Tacoma 3" Performance Series Adjustable Strut kit Features

- 1-3" Adjustable Front Struts • Larger 20mm chromed piston rod
- Gas Charged Design • Bonded Iron Piston • Self-Lubricating spherical bearing for longer life
- Rear Blocks & U-Bolts • 2 Rear Shocks Included
- All necessary mounting hardware

**'05-'16 Tacoma 4WD and 2WD Pre-Runner Skyjacker®** has developed a high performance 2.5"-3" suspension lift for the '05-'16 Tacoma 4WD and 2WD Pre-Runner. The lift features Platinum Series front coil-overs with 2" outside diameter shocks and 15" Softride® coil springs, along with all the necessary mounting hardware. The rear lift is achieved using Skyjacker® rear Leaf Springs or Add-A-Leafs.

## 2.5"-3" Platinum Series Tacoma

**System** This 2.5"-3" Coil-Over Lift fits 1995.5 to '04 Toyota Tacoma models for both 4WD & 2WD 'Pre-Runner' models. The System includes full-height replacement Softride® springs for the rear or choose the Kit with Add-a-Leafs. With either, you have the choice of Hydro or Nitro Series Gas shocks for the rear.



## Toyota Tacoma 4WD/2WD 2005-2018

Kit Ref #	Description	Qty	Part #	Rear Shock	Note
<b>Toyota Tacoma 4WD/2WD - 2005-19 - 2" Leveling Kit</b>					
<b>TT20MS</b>	2005-16 Toyota Tacoma 2" Aluminum Leveling	1	TT20MS		32
<b>Toyota Tacoma 6-Lug 4WD / 2WD PreRunner- 2016-19 Only 3" Performance Front Strut Kit w/ Rear Block &amp; U-Bolt Kit</b>					
<b>TC536STBH</b>	3" Performance Strut Kit - Includes Performance Front Struts, 2" Block & U-Bolts, Rear E-brake Brackets, Differential Drop Kit, & 2 Rear <b>Hydro</b> Shocks	1	TC536STBH	Incl.	32
<b>TC536STBN</b>	3" Performance Strut Kit - Includes Performance Front Struts, 2" Block & U-Bolts, Rear E-brake Brackets, Differential Drop Kit, & 2 Rear <b>Nitro</b> Shockss	1	TC536STBN	Incl.	
<b>TC536STBB</b>	3" Performance Strut Kit - Includes Performance Front Struts, 2" Block & U-Bolts, Rear E-brake Brackets, Differential Drop Kit, & 2 Rear <b>Black MAX</b> Shocks	1	TC536STBB	Incl.	
<b>TC536STBM</b>	3" Performance Strut Kit - Includes Performance Front Struts, 2" Block & U-Bolts, Rear E-brake Brackets, Differential Drop Kit, & 2 Rear <b>Monotube</b> Shocks	1	TC536STBM	Incl.	
<b>Toyota Tacoma 6-Lug 4WD / 2WD PreRunner- 2016-19 Only 3" Coil-Over Kit w/ Rear Block &amp; U-Bolt Kit</b>					
<b>TC536BM</b>	3" Coil-Over Kit - Includes Platinum Coil-Over, 2" Block & U-Bolts, Rear E-brake Brackets, Differential Drop Kit, & 2 Rear <b>Monotube</b> Shocks		TC536BM	Incl.	
<b>Toyota Tacoma 6-Lug 4WD / 2WD PreRunner- 2005-15 Only 3" Performance Front Strut Kit w/ Rear Block &amp; U-Bolt Kit</b>					
<b>TC530STBH</b>	3" Performance Strut Kit - Includes Performance Front Struts, 1.25" Block & U-Bolts, Differential Drop Kit, & 2 Rear <b>Hydro</b> Shocks	1	TC530STBH	Incl.	32
<b>TC530STBN</b>	3" Performance Strut Kit - Includes Performance Front Struts, 1.25" Block & U-Bolts, Differential Drop Kit, & 2 Rear <b>Nitro</b> Shockss	1	TC530STBN	Incl.	
<b>TC530STBB</b>	3" Performance Strut Kit - Includes Performance Front Struts, 1.25" Block & U-Bolts, Differential Drop Kit, & 2 Rear <b>Black MAX</b> Shocks	1	TC530STBB	Incl.	
<b>TC530STBM</b>	3" Performance Strut Kit - Includes Performance Front Struts, 1.25" Block & U-Bolts, Differential Drop Kit, & 2 Rear <b>Monotube</b> Shocks	1	TC530STBM	Incl.	
<b>Toyota Tacoma 6-Lug 4WD / 2WD PreRunner- 2005-15 Only 3" Coil-Over Kit w/ Rear Block &amp; U-Bolt Kit</b>					
<b>TC530BM</b>	3" Coil-Over Kit - Includes Series Coil-Over, 1.25" Block & U-Bolts, Differential Drop Kit, & 2 Rear <b>Monotube</b> Shocks		TC530BM	Incl.	
<b>Toyota Tacoma 4WD/2WD - 2005-15 - 3" Performance Sturt Lift with Rear Add-A-Leaf</b>					
<b>TC530STK</b>	3" Performance Strut w/Rear Add-a-Leaf	1	TC530ST		32
	Rear Add-A-Leaf	1	RTC515		
	Select Required Shock Option (2) each of desired Series				
	<b>Hydro</b> Series Shock with Red Boot, <b>White</b>	2			H7045
	<b>Nitro</b> Series Gas Shock with Red Boot, <b>White</b>	2			N8045
	<b>Black MAX</b> Performance Shock with Black Boot, <b>Black</b>	2			B8545
<b>M95</b> Monotube Performance Shock, <b>Silver</b>	2			M9545	
<b>Toyota Tacoma 4WD/2WD 2005-15 - 3" LeDeuc Series Fox Coil-Over Lift with Rear Add-a-Leaf</b>					
<b>TC530K</b>	3" Fox Coilover w/Rear Add-a-Leaf	1	TC530		32
	Rear Add-A-Leaf	1	RTC515		
	Select Shock Option F&R Shocks (2) each of desired Series				
	<b>Hydro</b> Series Shock with Red Boot, <b>White</b>	2			H7045
	<b>Nitro</b> Series Gas Shock with Red Boot, <b>White</b>	2			N8045
	<b>Black MAX</b> Performance Shock with Black Boot, <b>Black</b>	2			B8545
<b>M95</b> Monotube Performance Shock, <b>Silver</b>	2			M9545	
<b>Notes</b>	32) See Wheel & Tire fitment requirements page 244-245				
NOTE: Many additional applications and Steering Stabilizers available. See Toyota Master Pages 180-193					



TTU20MS

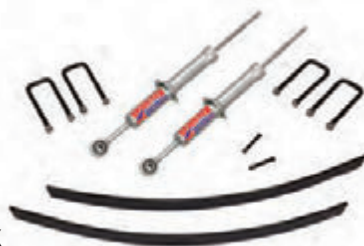

TC530STK



TC530KS



### Toyota Tacoma Pickup 1995.5-04

Kit Ref #	Description	Qty	Part #	Front Shock	Rear Shock	Note
<b>Toyota Tacoma 4WD and 2WD Pre-Runner - 1995.5-04 - 2" Leveling Kit</b>						
<b>TTC20MS</b>	2" Aluminum Leveling Kit		TTC20MS			32
<b>Options</b>	<b>Optional Shocks select (2) each of desired Series</b>					
	<b>Hydro Series Shock with Red Boot, White</b>	2			H7027	
	<b>Nitro Series Gas Shock with Red Boot, White</b>	2			N8027	
	<b>Black MAX Performance Shock with Black Boot, Black</b>	2			B8527	
	<b>M95 Monotube Performance Shock, Silver</b>	2			M9527	
<b>Toyota Tacoma 4WD and 2WD Pre-Runner - 1995.5-04 - 3" Performance Strut Lift with Rear Add-a-Leaf</b>						
<b>TTC30STK</b>	3" Performance Struts with Rear U-Bolts	1	TT430ST			32
	Rear Add-a-Leaf, Pair	1	RTC20			
	<b>Select Required Shock Option (2) each of desired Series</b>					
	<b>Hydro Series Shock with Red Boot, White</b>	2			H7027	
	<b>Nitro Series Gas Shock with Red Boot, White</b>	2			N8027	
	<b>Black MAX Performance Shock with Black Boot, Black</b>	2			B8527	
	<b>M95 Monotube Performance Shock, Silver</b>	2			M9527	
<b>Toyota Tacoma 4WD and 2WD Pre-Runner - 1995.5-04 - 3" Performance Strut Lift with Rear Leaf Springs</b>						
<b>TTC30STKS</b>	3" Performance Struts with Rear U-Bolts	1	TT430ST			32
	Rear Leaf Springs, Each	2	TCR25S			
	<b>Select Required Shock Option (2) each of desired Series</b>					
	<b>Hydro Series Shock with Red Boot, White</b>	2			H7027	
	<b>Nitro Series Gas Shock with Red Boot, White</b>	2			N8027	
	<b>Black MAX Performance Shock with Black Boot, Black</b>	2			B8527	
	<b>M95 Monotube Performance Shock, Silver</b>	2			M9527	
<b>Toyota Tacoma 4WD and 2WD Pre-Runner - 1995.5-04 - 3" Performance Fox Coilover Lift with Rear Add-a-Leaf</b>						
<b>SKTOY30K</b>	3" Performance Coils & Coil-Over Shocks	1	SKTOY30			32
	Rear Add-a-Leaf, Pair	1	RTC20			
	<b>Select Required Shock Option (2) each of desired Series</b>					
	<b>Hydro Series Shock with Red Boot, White</b>	2			H7027	
	<b>Nitro Series Gas Shock with Red Boot, White</b>	2			N8027	
	<b>Black MAX Performance Shock with Black Boot, Black</b>	2			B8527	
	<b>M95 Monotube Performance Shock, Silver</b>	2			M9527	
<b>Toyota Tacoma 4WD and 2WD Pre-Runner - 1995.5-04 - 3" Performance Fox Coilover Lift with Rear Leaf Springs</b>						
<b>SKTOY30KS</b>	3" Performance Coils & Coil-Over Shocks	1	SKTOY30			32
	Rear Leaf Springs, Each	2	TCR25S			
	Rear Component Box	1	UTWR			
	<b>Select Required Shock Option (2) each of desired Series</b>					
	<b>Hydro Series Shock with Red Boot, White</b>	2			H7027	
	<b>Nitro Series Gas Shock with Red Boot, White</b>	2			N8027	
	<b>Black MAX Performance Shock with Black Boot, Black</b>	2			B8527	
	<b>M95 Monotube Performance Shock, Silver</b>	2			M9527	
<b>Notes</b>	32) See Wheel & Tire fitment requirements page 244-245					

NOTE: Many additional applications and Steering Stabilizers available. See Toyota Master Pages 180-193.

# 4Runner



T4330STBB



03-19 Toyota  
4Runner 4WD / 2WD

## Features

- 1-3" Adjustable Front Struts • Larger 20mm chromed piston rod • Gas Charged Design • Bonded Iron Piston
- Self-Lubricating spherical bearing for longer life • Softride Coil Springs
- 2 Rear Shocks Included • All necessary mounting hardware

### Toyota 4Runner 4WD / 2WD - 2003 - 19

Kit Ref #	Description	Qty	Part #	Rear Shock	Note
<b>Toyota 4Runner 4WD / 2WD - 2003 - 19 2" Front Metal Spacer</b>					
TT20MS	2" Front Metal Spacer		TT20MS		
<b>Toyota 4Runner 4WD / 2WD - 2003 - 19 2" Front / 1.5" Rear Kit</b>					
T420MS	2" Front Metal Spacer, 1.5" Rear Polyurethane Kit		T420MS		
<b>Toyota 4Runner 4WD / 2WD - 2003 - 19 3" Performance Front Strut Kit w/ Rear Coil Springs</b>					
T4330STBH	3" Performance Strut Kit - Includes Performance Front Struts, Rear Coil Springs, Rear Sway Bar End Links, Differential Drop Kit, & 2 Rear <b>Hydro</b> Shocks		T4330STBH	Incl.	
T4330STBN	3" Performance Strut Kit - Includes Performance Front Struts, Rear Coil Springs, Rear Sway Bar End Links, Differential Drop Kit, & 2 Rear <b>Nitro</b> Shocks		T4330STBN	Incl.	
T4330STBB	3" Performance Strut Kit - Includes Performance Front Struts, Rear Coil Springs, Rear Sway Bar End Links, Differential Drop Kit, & 2 Rear <b>Black MAX</b> Shocks		T4330STBB	Incl.	
T4330STBM	3" Performance Strut Kit - Includes Performance Front Struts, Rear Coil Springs, Rear Sway Bar End Links, Differential Drop Kit, & 2 Rear <b>Monotube</b> Shocks		T4330STBM	Incl.	
<b>Toyota 4Runner 4WD / 2WD - 2003 - 19 3" Front Coil-Over Kit w/ Rear Coil Springs</b>					
T4330BM	3" Platinum Coil-Over Kit - Includes Platinum Coil-Overs, Rear Coil Springs, Rear Sway Bar End Links, Differential Drop Kit, & 2 Rear <b>Monotube</b> Shocks		T4330BM	Incl.	

TTC20MS



TTC30STK



T4330BM

# FJ Cruiser



Skyjacker® has developed a new 3" Suspension lifts for the '07-'14 FJ Cruiser. The 3" Performance Strut lift features new performance series struts and the factory coil is maintained. The rear lift on both kits is achieved using Skyjacker® rear Softride® coil springs. These are high performance Skyjacker® Suspensions complete with all the options and the ease of a simple bolt-on installation.

## Toyota FJ Cruiser 2007-2014

Kit Ref #	Description	Qty	Part #	Front Shock	Rear Shock	Note
<b>Toyota FJ Cruiser - 2007-14 - 2" Leveling Kit</b>						
TT20MS	2" Aluminum Leveling Kit		TT20MS			32
Options	<b>Optional - Select Shock (2) each of desired Series</b>					
	<b>Hydro Series Shock with Red Boot, White</b>	2			H7098	
	<b>Nitro Series Gas Shock with Red Boot, White</b>	2			N8098	
<b>Toyota FJ Cruiser - 2007-14 - 2" Metal Spacer Front with 1.5" Poly Spacer Rear Lift</b>						
FJ20MS	2" Metal Front, 1.5" Poly Rear Lift	1	FJ20MS			32
	<b>Select Required Shock Option (2) each of desired Series</b>					
	<b>Hydro Series Shock with Red Boot, White</b>	2			H7098	
	<b>Nitro Series Gas Shock with Red Boot, White</b>	2			N8098	
	<b>Black Max Performance Shock, Black</b>	2			B8598	
	<b>M95 Monotube Performance Shock, Silver</b>				M9598	
FJ730STBH	3" Performance Strut Kit 1 box includes: Adj Front Struts, 2.5" rear coils, sway bar end links and 2 rear <b>Hydro shocks</b>		FJ730STBH		Incl.	
FJ730STBN	3" Performance Strut Kit 1 box includes: Adj Front Struts, 2.5" rear coils, sway bar end links and 2 rear <b>Nitro shocks</b>		FJ730STBN		Incl.	
<b>Toyota FJ Cruiser - 2007-14 - 3" Performance Front Strut with Rear Coil Springs</b>						
FJ730STK	3" Performance Struts, with Coil Springs Rear Lift	1	FJ730ST			
	<b>Select Required Shock Option (2) each of desired Series</b>					
	<b>Hydro Series Shock with Red Boot, White</b>	2			H7098	
	<b>Nitro Series Gas Shock with Red Boot, White</b>	2			N8098	
	<b>Black Max Performance Shock, Black</b>	2			B8598	
	<b>M95 Monotube Performance Shock, Silver</b>	2			M9598	
<b>Toyota FJ Cruiser - 2007-14 - 3" FOX Coil-Over Series</b>						
FJ730K	3" FOX Coil-Over kit with Softride® rear coil springs	1	FJ730			
	<b>Select Required Shock Option (2) each of desired Series</b>					
	<b>Hydro Series Shock with Red Boot, White</b>	2			H7098	
	<b>Nitro Series Gas Shock with Red Boot, White</b>	2			N8098	
	<b>Black Max Performance Shock, Black</b>	2			B8598	
	<b>M95 Monotube Performance Shock, Silver</b>	2			M9598	
Notes	30) Shackle reversal Options available See Toyota Master Pages 180-193 31) 3" Fox Coilover Option available, See Toyota Master Pages 180-193 32) See Wheel & Tire fitment requirements page 244-245					

# FJ40 Landcruiser



**2.5" and 4" Lifts For '64-'80 Toyota LandCruisers**  
 Skyjacker® offers Softride® 2.5" and 4" Systems for Toyota's stout short wheel based vehicles. Skyjacker® also offers a System for Cruisers with an installed front shackle correction kit which raises the front 1.5". This System includes 2.5" front and 4" rear Softride® springs to level the vehicle

Toyota FJ40 Landcruiser 1964-1980							
Kit Ref #	Description	Qty	Part #	Front Shock	Rear Shock	Note	
<b>Toyota FJ40 Land Cruiser - 1964-80 - 2.5" Lift Front &amp; Rear Leaf Springs &amp; U-Bolts</b>							
L20KS	2.5" Front Leaf Spring each	2	L20FS			30, 32	
	2.5" Rear Leaf Spring each	2	L20RS				
	2.5"-4" Component Box with Front & Rear U-Bolts	1	L24S				
	<b>Select Required Shock Option F&amp;R Shocks (2) each of desired Series</b>						
	<b>Hydro Series Shock with Red Boot, White</b>	2		H7012	H7023		
	<b>Nitro Series Gas Shock with Red Boot, White</b>	2		N8012	N8023		
	<b>Black MAX Performance Shock with Black Boot, Black</b>	2		B8512	B8523		
<b>M95 Monotube Performance Shock, Silver</b>	2		M9512	M9523			
<b>Toyota FJ40 Land Cruiser - 1964-80 - 4" Lift Front &amp; Rear Leaf Springs &amp; U-Bolts</b>							
L40KS	4" Front Leaf Spring each	2	L40FS			30, 32	
	4" Rear Leaf Spring each	2	L40RS				
	2.5"-4" Component Box with Front & Rear U-Bolts	1	L24S				
	<b>Select Required Shock Option (2) each of desired Series</b>						
	<b>Hydro Series Shock with Red Boot, White</b>	2		H7023	H7041		
	<b>Nitro Series Gas Shock with Red Boot, White</b>	2		N8023	N8041		
	<b>Black MAX Performance Shock with Black Boot, Black</b>	2		B8523	B8541		
<b>M95 Monotube Performance Shock, Silver</b>	2		M9523	M9541			
<b>Notes</b>	<b>30)</b> Shackle reversal Options available See Toyota Master Pages 180-193 <b>32)</b> See Wheel & Tire fitment requirements page 244-245						
<b>NOTE: Many additional applications and Steering Stabilizers available. See Toyota Master Pages 180-193</b>							



FJ20MS



L40KS



FJ730STK

# NISSAN Titan



Skyjacker's new Nissan Titan & Titan XD 2" Aluminum Leveling Spacer is easy to install and combines great looks with strength while providing 2" of lift. This new spacer features aircraft quality, 6061-T6511 Aluminum offering enhanced durability. This simple design is easy to install with a 100% bolt-on installation process. This simple kit takes out the factory rake and levels the front of your truck with the rear, giving your vehicle an overall more aggressive appearance and room for up to 33" tires.

04-19 Nissan Titan							
Kit Ref #	Description	Qty	Part #	Front Shock	Rear Shock	Note	
<b>Nissan Titan / Titan XD 2" Leveling Kit</b>							
<b>NT20MS</b>	2" Leveling Kit	1	NT20MS				
<b>NT26MSP</b>	2" Leveling Kit with Rear Blocks & U-Bolts	1	NT26MSP				



**NT20MS**  
2" 04-19 Nissan Titan  
2WD/4WD & XD



**NT26MSP**  
2" 16-19 Nissan Titan XD  
(Includes Rear Blocks/U-Bolts)



## APPLICATION GUIDE

Chevrolet / GM / GMC	76
Dodge / RAM	102
Ford (4WD & 2WD)	120
Honda (4WD)	160
International	160
Isuzu	160
Jeep (4WD & 2WD)	162
Mazda (4WD & 2WD)	186
Nissan	186
Toyota (4WD & 2WD)	186
Polaris / UTV	200
Shock Application Guide	201
Front Leveling Struts	211
Multiple Shock Kits	212
Shock Specifications Guide	214
Steering Stabilizers	217
Chevrolet / GM Accessories	221
Dodge Accessories	222
Ford Accessories	222
Honda Accessories	225
International Accessories	225
Jeep Accessories	225
Mazda Accessories	225
Toyota Accessories	228
Universal Accessories	228
Polyurethane Clearance Kits / Body Lifts	230
Add-A-Leafs, Softride®	231
Brake Lines, Stainless Steel Braided	234
Coil Springs, Softride®	236
Front Leaf Springs, Softride®	237
Rear Leaf Springs, Softride®	240
Steering Components	244
Rear Lift Blocks & U-Bolt Kits	247
U-Bolts	249
Tire & Wheel Chart	250

**Skyjacker is your most current avenue for information about Skyjacker® Suspensions & our products. It also features all kinds of cool things you'll want to check out.**

- **Product Search** - Find exactly what you need for your customer's vehicle... quickly & accurately.
- **Skygear** - Select from 'official' merchandise... banners, pennants, decals, shirts, caps, & jackets.
- **Dealer Search** - Become a Skyjacker® Authorized Dealer & we'll steer customers to your door.
- **Real Rides** - Expand your 'showroom' to the world. Post your Skyjacker® equipped vehicles on this high traffic area to show-off your expertise & drive new customers into your area.
- **News** - Review Skyjacker's coverage in the media.
- **Project Vehicles** - Vehicles your customer's want to duplicate.
- **Events** - See where the action is & join the fun.
- **New Products** - Find out 'What's New' as we release it.

# CHEVROLET / GMC

LIFT	Quick Kit	KIT NOTES	Component Box	Front Springs		Rear Springs		Add-A-Leafs	Steering Correction
	Reference		(Requires 1 of Each)	Qty	Part #	Qty	Part #		(Order 1 Each)
<b>07-13 AVALANCHE 1500 4WD / 2WD (STRUT FRONT END)</b>									
<b>07-13 Avalanche 1500 4WD / 2WD Kit</b>			<b>Lower Metal Spacers (Front Leveling Kit)</b>						
2"	C1420LMSA	K36	C1420LMSA						
KIT NOTES: Installs Below Strut Assembly. K36. Does NOT Fit Magnaride.									
<b>07-13 Avalanche 1500 4WD / 2WD Kit</b>			<b>Upper Metal Spacers (Front Leveling Kit)</b>						
2"	C720MS	K36	C720MS						
KIT NOTES: Installs Below Strut Assembly. K36. Does NOT Fit Magnaride.									
<b>07-13 Avalanche 1500 4WD Kit</b>			<b>Front Strut Spacers &amp; Replacement Rear Coils (Non-Autoride)</b>						
4"	C7360SK	K23	C7361A+C7360SP+C7361SR						
6"	C7660SK	K23	C7661A+C7660SP+C7661SR						
KIT NOTES: K23. OEM Tires & Wheels can be Used.									
<b>07-13 Avalanche 1500 4WD Kit</b>			<b>Performance Struts with Replacement Rear Coils (Non-Autoride)</b>						
3.5-4"	C7361SK	K23	C7361A+C7361ST+C7361SR						
6"	C7661SK	K23	C7661A+C7661ST+C7661SR						
KIT NOTES: K23. OEM Tires & Wheels can be Used.									
<b>07-13 Avalanche 1500 4WD Kit</b>			<b>Upper Control Arm Kit With Rear Shock Brackets</b>						
3.5-4"	C7350V	K25, K35	C7350V						
KIT NOTES: K25. Does NOT fit Auto Leveling or Auto Ride models. Models with Mass Damper must remove mass damper. K35. Does NOT fit All Wheel Drive models.									
<b>07-13 Avalanche 1500 4WD Kit</b>			<b>6-Lug with Replacement Rear Coils (Autoride)</b>						
3.5"	C7361ARK	K23	C7361A+C7361AR+C7361SR						
KIT NOTES: K23. OEM Tires & Wheels can be Used.									
<b>02-06 1500 AVALANCHE</b>									
<b>02-06 Avalanche 1500 (Torsion Bar Front End)</b>			<b>Torsion Keys (Front Leveling Kit)</b>						
2"	C101KE		C101KE						
<b>02-06 Avalanche 1500 4WD System</b>			<b>6-Lug with Replacement Rear Coils</b>						
3"	C9331K	K16, K23	C9341+C933R						
KIT NOTES: Does Not Require Removal of the Front Upper Differential Housing Mount. K16. Autoride Models Order Part# C93AR. Factory Shocks will be Retained. K23. OEM Tires & Wheels can be Used.									
<b>02-06 Avalanche 1500 4WD System</b>			<b>6-Lug with Replacement Rear Coils (Non Autoride)</b>						
6"	C9631K	K27	C9631A+C9631B			1	C50R		
KIT NOTES: K27. Not Designed for Autoride Models.									
<b>07-14 CADILLAC ESCALADE ESV, EXT 4WD / 2WD (STRUT FRONT END)</b>									
<b>07-14 Cadillac Escalade ESV, EXT 4WD / 2WD</b>			<b>Lower Metal Spacers (Front Leveling Kit)</b>						
2"	C1420LMSA	K31, K35, K36	C1420LMSA						
KIT NOTES: Installs Below Strut Assembly. K31. Part # C12CS Lifts Rear 1.25" if Needed. K35. Does NOT Fit All Wheel Drive. K36. Does NOT Fit Magnaride.									
<b>07-14 Cadillac Escalade ESV, EXT 4WD / 2WD</b>			<b>Upper Metal Spacers (Front Leveling Kit)</b>						
2"	C720MS	K31, K35, K36	C720MS						
KIT NOTES: Installs Above Strut Assembly. K31. Part # C12CS Lifts Rear 1.25" if Needed. K35. Does NOT Fit All Wheel Drive. K36. Does NOT Fit Magnaride.									
<b>07-14 Cadillac Escalade ESV, EXT 4WD System</b>			<b>6-Lug with Replacement Rear Coils (Autoride)</b>						
3.5"	C7361ARK	K17, K23	C7361A+C7361AR+C7361SR						
KIT NOTES: K23. OEM Tires & Wheels can be Used. K17. Autoride Shock Relocation Brackets Included.									
<b>02-06 CADILLAC ESCALADE (TORSION BAR FRONT END)</b>									
<b>02-06 Cadillac Escalade ESV, EXT 4WD / 2WD</b>			<b>Torsion Keys (Front Leveling Kit)</b>						
2"	C101KE		C101KE						
<b>02-06 CADILLAC ESCALADE ESV, EXT 4WD</b>			<b>6-Lug with Replacement Rear Coils (Autoride)</b>						
3"	C933PAK	K17, K23	C933PA+C933PAR						
KIT NOTES: Does Not Require Removal of the Front Upper Differential Housing Mount. K17. Autoride Shock Relocation Brackets Included. K23. OEM Tires & Wheels can be Used.									

# CHEVROLET / GMC

CHEVROLET / GMC

	Steering Stabilizers									HYDRO Shocks		NITRO Shocks		BLACK MAX		M95 Shocks		Labor
	White			Black			Silver			White		White		Black		Silver		Hours
	OEM	Single	Dual	OEM	Single	Dual	OEM	Single	Dual	Front	Rear	Front	Rear	Front	Rear	Front	Rear	

**NOTE: ALL SHOCKS MUST BE ORDERED SEPARATELY**

																			2
--	--	--	--	--	--	--	--	--	--	--	--	--	--	--	--	--	--	--	---

																			2
--	--	--	--	--	--	--	--	--	--	--	--	--	--	--	--	--	--	--	---

																			8
																			8

																			8
																			8

																			5
--	--	--	--	--	--	--	--	--	--	--	--	--	--	--	--	--	--	--	---

																			8
--	--	--	--	--	--	--	--	--	--	--	--	--	--	--	--	--	--	--	---

**NOTE: ALL SHOCKS MUST BE ORDERED SEPARATELY**

																			2
--	--	--	--	--	--	--	--	--	--	--	--	--	--	--	--	--	--	--	---

																			8
--	--	--	--	--	--	--	--	--	--	--	--	--	--	--	--	--	--	--	---

																			10
--	--	--	--	--	--	--	--	--	--	--	--	--	--	--	--	--	--	--	----

**NOTE: ALL SHOCKS MUST BE ORDERED SEPARATELY**

																			2
--	--	--	--	--	--	--	--	--	--	--	--	--	--	--	--	--	--	--	---

																			2
--	--	--	--	--	--	--	--	--	--	--	--	--	--	--	--	--	--	--	---

																			8
--	--	--	--	--	--	--	--	--	--	--	--	--	--	--	--	--	--	--	---

**NOTE: ALL SHOCKS MUST BE ORDERED SEPARATELY**

																			2
--	--	--	--	--	--	--	--	--	--	--	--	--	--	--	--	--	--	--	---

**NOTE: ALL SHOCKS MUST BE ORDERED SEPARATELY**

																			8
--	--	--	--	--	--	--	--	--	--	--	--	--	--	--	--	--	--	--	---

# CHEVROLET / GMC

LIFT	Quick Kit	KIT NOTES	Component Box	Front Springs		Rear Springs		Add-A-Leafs	Steering Correction
	Reference		(Requires 1 of Each)	Qty	Part #	Qty	Part #		(Order 1 Each)
<b>15-20 COLORADO / CANYON 4WD / 2WD</b>									
<b>15-20 COLORADO / CANYON 4WD / 2WD</b>			<b>1" or 2" Adjustable (Front Leveling Kit)</b>						
1"-2"	CC12MS	K20	CC12MS						
KIT NOTES: K20. Does Not Fit ZR2 Model.									
<b>04-12 COLORADO / CANYON 4WD (TORSION BAR FRONT END)</b>									
<b>04-12 Colorado / Canyon 4WD</b>			<b>Torsion Keys (Front Leveling Kit)</b>						
2"	C104KE		C104KE						
<b>04-12 COLORADO / CANYON 4WD (TORSION BAR FRONT END)</b>									
<b>04-12 Colorado / Canyon 4WD Kit</b>			<b>Kit with Rear Add-A-Leafs</b>						
4"	CC409K	K2, K24	CC409					RCC25	
KIT NOTES: K2. Includes Brake Line Brackets. K24. Can NOT Re-Use OEM Wheels. REQUIRES 4.75" Back Spacing on Wheels.									
<b>04-12 Colorado / Canyon 4WD System</b>			<b>System with Rear Springs</b>						
4"	CC409KS	K2, K24	CC409			2	CCR25S		
KIT NOTES: K2. Includes Brake Line Brackets. K24. Can NOT Re-Use OEM Wheels. REQUIRES 4.75" Back Spacing on Wheels.									
<b>04-12 COLORADO / CANYON 2WD (TORSION BAR FRONT END)</b>									
<b>04-12 Colorado / Canyon 2WD</b>			<b>Torsion Keys (Front Leveling Kit)</b>						
2"	C104KE		C104KE						
<b>04-12 COLORADO / CANYON 2WD (TORSION BAR FRONT END)</b>									
<b>04-12 Colorado / Canyon 2WD Kit</b>			<b>Kit with Rear Add-A-Leafs</b>						
4"	CC429K	K2, K24, K25	CC429					RCC25	
KIT NOTES: K2. Includes Brake Line Brackets. K24. Can NOT Re-Use OEM Wheels. REQUIRES 4.75" Back Spacing on Wheels. K25. Kit Designed for 2WD Models.									
<b>04-12 Colorado / Canyon 2WD System</b>			<b>System with Rear Springs</b>						
4"	CC429KS	K2, K24, K25	CC429			2	CCR25S		
KIT NOTES: K2. Includes Brake Line Brackets. K24. Can NOT Re-Use OEM Wheels. REQUIRES 4.75" Back Spacing on Wheels. K25. Kit Designed for 2WD Models.									
<b>07-20 DENALI, DENALI XL, YUKON XL, SUBURBAN 4WD / 2WD (STRUT FRONT END)</b>									
<b>07-20 DENALI, DENALI XL, YUKON XL, SUBURBAN 4WD / 2WD</b>			<b>Lower Metal Spacers (Front Leveling Kit)</b>						
2"	C1420LMSA	K31, K36	C1420LMSA						
KIT NOTES: Installs Below Strut Assembly. K31. Part # C12CS Lifts Rear 1.25" if Needed. K36. Does NOT Fit Magnaride.									
<b>07-20 DENALI, DENALI XL, YUKON XL, SUBURBAN 4WD / 2WD</b>			<b>Metal Spacers (Front Leveling Kit)</b>						
2"	C720MS	K31, K36	C720MS						
KIT NOTES: Installs Above Strut Assembly. K31. Part # C12CS Lifts Rear 1.25" if Needed. K36. Does NOT Fit Magnaride.									
<b>07-20 DENALI, DENALI XL, YUKON XL, SUBURBAN 4WD / 2WD</b>			<b>Upper Control Arm Kit With Rear Shock Brackets</b>						
3.5-4"	C7350V	K24, K25, K35, K36	C7350V						
KIT NOTES: K24. Does NOT fit All Wheel Drive models. K25. Does NOT fit Auto Leveling or Auto Ride models. Models with Mass Damper will need to remove mass damper. K35. Does NOT Fit All Wheel Drive. K36. Does NOT Fit Magnaride.									
<b>07-15 DENALI, DENALI XL, YUKON XL, SUBURBAN 4WD</b>			<b>6-Lug with Replacement Rear Coils (Autoride)</b>						
3.5"	C7361ARK	K23	C7361A+C7361AR+C7361SR						
KIT NOTES: K23. OEM Tires & Wheels can be Used.									
<b>02-06 DENALI, DENALI XL, YUKON XL, SUBURBAN 4WD / 2WD</b>									
<b>02-06 DENALI, DENALI XL, YUKON XL, SUBURBAN 4WD / 2WD</b>			<b>Torsion Keys (Front Leveling Kit)</b>						
2"	C101KE		C101KE						
<b>02-06 DENALI, DENALI XL, YUKON XL, SUBURBAN 4WD</b>			<b>6-Lug with Replacement Rear Coils (Autoride)</b>						
3"	C933PAK	K17, K23	C933PA+C933PAR						
KIT NOTES: Does NOT Require Removal of the Front Upper Differential Housing Mount. K17. Autoride Shock Relocation Brackets Included. K23. OEM Tires & Wheels can be Used.									

# CHEVROLET / GMC

CHEVROLET / GMC

	Steering Stabilizers									HYDRO Shocks		NITRO Shocks		BLACK MAX		M95 Shocks		Labor				
	White			Black			Silver			White		White		Black		Silver		Hours				
	OEM	Single	Dual	OEM	Single	Dual	OEM	Single	Dual	Front	Rear	Front	Rear	Front	Rear	Front	Rear					
<b>NOTE: ALL SHOCKS MUST BE ORDERED SEPARATELY</b>																						
										----	----	H7047	----	----	N8047	----	----	B8547	----	----	M9547	2
<b>NOTE: ALL SHOCKS MUST BE ORDERED SEPARATELY</b>																						
										----	----		----	----		----	----		----	----		2
<b>NOTE: ALL SHOCKS MUST BE ORDERED SEPARATELY</b>																						
										H7040	H7084	N8040	N8084	B8540	B8584	----	----	M9584	8			
										H7040	H7084	N8040	N8084	B8540	B8584	----	----	M9584	8			
<b>NOTE: ALL SHOCKS MUST BE ORDERED SEPARATELY</b>																						
										----	----		----	----		----	----		----	----		2
<b>NOTE: ALL SHOCKS MUST BE ORDERED SEPARATELY</b>																						
										H7040	H7084	N8040	N8084	B8540	B8584	----	----	M9584	8			
										H7040	H7084	N8040	N8084	B8540	B8584	----	----	M9584	8			
<b>NOTE: ALL SHOCKS MUST BE ORDERED SEPARATELY</b>																						
										----	----		----	----		----	----		----	----		2
										----	----		----	----		----	----		----	----		2
										----	----		----	----		----	----		----	----		5
										----	----		----	----		----	----		----	----		8
<b>NOTE: ALL SHOCKS MUST BE ORDERED SEPARATELY</b>																						
										----	----		----	----		----	----		----	----		2
										7196 <sup>(K)</sup>	7296 <sup>(K)</sup>	8196 <sup>(K)</sup>	8296 <sup>(K)</sup>	9196 <sup>(K)</sup>	9296 <sup>(K)</sup>							8
<small>(K) 'Single' or 'Dual' Steering Stabilizers can ONLY be Used with Skyjacker Suspension Lift.</small>																						

# CHEVROLET / GMC

LIFT	Quick Kit	KIT NOTES	Component Box	Front Springs		Rear Springs		Add-A-Leafs	Steering Correction
	Reference		(Requires 1 of Each)	Qty	Part #	Qty	Part #		(Order 1 Each)
<b>06-10 HUMMER H3 / H3T 4WD (TORSION BAR FRONT END)</b>									
<b>06-10 Hummer H3 / H3T 4WD</b>			<b>Torsion Keys (Front Leveling Kit)</b>						
2"	C104KE		C104KE						
<b>03-09 HUMMER H2 4WD</b>									
<b>03-09 Hummer H2 8-Lug (Torsion Bar Front End)</b>			<b>Torsion Keys (Front Leveling Kit)</b>						
2"	C103KE		C103KE						
KIT NOTES: Includes Front Shock Extension Brackets.									
<b>14-20 1500 PICKUP 4WD / 2WD (STRUT FRONT END)</b>									
<b>14-20 1500 Pickup 4WD / 2WD Kit</b>			<b>Lower Cast Steel Spacers (Front Leveling Kit)</b>						
2"	C1420LMSA	K36, K39	C1420LMSA						
KIT NOTES: Installs Below Strut Assembly. K36. Does NOT Fit Magnaride. K39. Does NOT Fit Chevy TrailBoss or GMC AT4.									
<b>14-20 1500 Pickup 4WD / 2WD Kit</b>			<b>Metal Spacers (Front Leveling Kit)</b>						
2"	C720MS	K36, K39	C720MS						
KIT NOTES: Installs Above Strut Assembly. K36. Does NOT Fit Magnaride. K39. Does NOT Fit Chevy TrailBoss or GMC AT4.									
<b>17-18 1500 SIERRA/SILVERADO CONTROL ARM KITS</b>									
<b>17-18 1500 SIERRA/SILVERADO</b>			<b>Upper Control Arm Kit With Rear Shocks</b>						
3.5-4"	C17350PAH	K35, K36	C17350PAH						
3.5-4"	C17350PAN	K35, K36	C17350PAN						
3.5-4"	C17350PAB	K35, K36	C17350PAB						
3.5-4"	C17350PAM	K35, K36	C17350PAM						
KIT NOTES: Installs Above Strut Assembly. K35. Does NOT Fit All Wheel Drive. K36. Does NOT Fit Magnaride.									
<b>14-18 GM 1500 PICKUP 4WD / 2WD SYSTEM WITH COIL-OVERS</b>									
<b>Models Built May 2016-2018 (Equipped with STAMPED STEEL A-ARMS only)</b>									
<b>Models Built 2014-April 2016 (Equipped with OE ALUMINUM Knuckles only)</b>									
<b>14-18 GM 1500 Pick Up 4WD / 2WD Kit (Aluminum Suspension)</b>			<b>Coil-Over System</b>						
6-7"	C14662ALS KM	K33, K34	C7146LS+C14661AAL+ C14661PRM						
<b>Fits Models Equipped with OE CAST STEEL Knuckles only</b>									
<b>2014 - April 2016 GM 1500 Pick Up 4WD / 2WD Kit (Steel Suspension)</b>			<b>Coil-Over System</b>						
6-7"	C14662LS KM	K33, K34	C7146LS+C14661A+ C14661PRM						
KIT NOTES: K33. OEM Wheels can be Used, Except OEM 18" Wheels will Require Optional Wheel Spacer Kit (Part # WSP655). K34. If Driveline vibration occurs, order front driveshaft part # GM10146DS. Will not fit AutoTrac or 6.2L engines.									
<b>14-18 1500 PICKUP 4WD / 2WD (STRUT FRONT END)</b>									
<b>Models Built May 2016-2017 (Equipped with STAMPED STEEL A-ARMS only)</b>									
<b>Models Built 2014-April 2016 (Equipped with OE ALUMINUM Knuckles only)</b>									
<b>14-18 1500 Pickup 4WD / 2WD Kit</b>			<b>Front Strut Spacers with Blocks &amp; U-Bolts</b>						
4"	C14460APK	K23	C14461AAL+C14460SP+ C7361PR						
6-7"	C14660APK	K33, K34	C14661AAL+C14660SP+ C14661PR						
<b>14-17 1500 Pickup 4WD / 2WD Kit</b>			<b>Front Strut Spacers with Rear Springs</b>						
6-7"	C14660APKS	K33, K34	C14661AAL+C14660SP+ C7661PRS			2	CR55S		

# CHEVROLET / GMC

CHEVROLET / GMC

	Steering Stabilizers									HYDRO Shocks		NITRO Shocks		BLACK MAX		M95 Shocks		Labor	
	White			Black			Silver			White		White		Black		Silver			
	OEM	Single	Dual	OEM	Single	Dual	OEM	Single	Dual	Front	Rear	Front	Rear	Front	Rear	Front	Rear	Front	Rear
<b>NOTE: ALL SHOCKS MUST BE ORDERED SEPARATELY</b>																			
										H7003	H7029	N8003	N8029	B8503	B8529	M9503	M9529		2
<b>NOTE: ALL SHOCKS MUST BE ORDERED SEPARATELY</b>																			
										N8017		N8017		B8517		M9517			2
<b>NOTE: ALL SHOCKS MUST BE ORDERED SEPARATELY</b>																			
										----	H7027	----	N8027	----	B8527	----	M9527		2
										----	H7027	----	N8027	----	B8527	----	M9527		2
<b>NOTE: ALL SHOCKS MUST BE ORDERED SEPARATELY</b>																			
										----	Included	----		----		----			5
										----		----	Included	----		----			5
										----		----		----	Included	----			5
										----		----		----		----	Included		5
<b>NOTE: ALL SHOCKS MUST BE ORDERED SEPARATELY</b>																			
										----		----		----		----	Included		8
										----		----		----		----	Included		8
<b>NOTE: ALL SHOCKS MUST BE ORDERED SEPARATELY</b>																			
										----	H7017	----	N8017	----	B8517	----	M9517		8
										----	H7036	----	N8036	----	B8536	----	M9536		8
										----	H7036	----	N8036	----	B8536	----	M9536		8

# CHEVROLET / GMC

LIFT	Quick Kit	KIT NOTES	Component Box (Requires 1 of Each)	Front Springs		Rear Springs		Add-A-Leafs	Steering Correction (Order 1 Each)
	Reference			Qty	Part #	Qty	Part #		
<b>14-16 1500 SIERRA/SILVERADO UPPER CONTROL ARM KITS</b>									
<b>Models Built 2014-April 2016 (Equipped with OE CAST STEEL Knuckles only)</b>									
<b>14-16 1500 SIERRA/SILVERADO</b>			<b>Upper Control Arm Kit With Cast Steel Control Arms &amp; Shocks</b>						
3.5-4"	C14350PH	K35, K36	C14350PH						
3.5-4"	C14350PN	K35, K36	C14350PN						
3.5-4"	C14350PB	K35, K36	C14350PB						
3.5-4"	C14350PM	K35, K36	C14350PM						
KIT NOTES: K35. Does NOT Fit All Wheel Drive. K36. Does NOT Fit Magnaride.									
<b>14-16 1500 SIERRA/SILVERADO</b>			<b>Upper Control Arm Kit With Aluminum Or Stamped Steel Control Arms</b>						
3.5-4"	C14350PAH	K35, K36	C14350PAH						
3.5-4"	C14350PAN	K35, K36	C14350PAN						
3.5-4"	C14350PAB	K35, K36	C14350PAB						
3.5-4"	C14350PAM	K35, K36	C14350PAM						
KIT NOTES: K35. Does NOT fit All Wheel Drive. K36. Does NOT fit MagnaRide.									
<b>Models Built 2014-April 2016 (Equipped with OE CAST STEEL Knuckles only)</b>									
<b>14-16 1500 Pickup 4WD / 2WD Kit</b>			<b>Front Strut Spacers with Blocks &amp; U-Bolts</b>						
4"	C14460PK	K23	C14461A+C14460SP+ C7361PR						
6-7"	C14660PK	K33, K34	C14661A+C14660SP+ C14661PR						
<b>14-16 1500 Pickup 4WD / 2WD Kit</b>			<b>Front Strut Spacers with Replacement Rear Springs</b>						
6-7"	C14660PKS	K33, K34	C14661A+C14660SP+ C7661PRS			2	CR55S		
KIT NOTES: K23. OEM Tires & Wheels can be Used. K33. OEM Wheels can be Used, Except OEM 18" Wheels will Require Optional Wheel Spacer Kit (Part # WSP655). K34. If Driveline vibration occurs, order front driveshaft part # GM10146DS. Will not fit Autorac or 6.2L engines.									
<b>07-13 1500 PICKUP 4WD / 2WD (STRUT FRONT END)</b>									
<b>07-13 1500 Pickup 4WD / 2WD Kit</b>			<b>Lower Metal Spacers (Front Leveling Kit)</b>						
2"	C1420LMSA	K36	C1420LMSA						
KIT NOTES: Installs Below Strut Assembly. K36. Does NOT Fit Magnaride.									
<b>07-13 1500 Pickup 4WD / 2WD Kit</b>			<b>Metal Spacers (Front Leveling Kit)</b>						
2"	C720MS	K36	C720MS						
KIT NOTES: Installs Above Strut Assembly. K36. Does NOT Fit Magnaride.									
<b>07-13 1500 SIERRA/SILVERADO CONTROL ARM KITS 4WD</b>									
<b>07-13 1500 SIERRA/SILVERADO</b>			<b>Upper Control Arm Lift Kit With Rear Shocks</b>						
3.5-4"	C7350PH	K35, K37, K38	C7350PH						
3.5-4"	C7350PN	K35, K37, K38	C7350PN						
3.5-4"	C7350PB	K35, K37, K38	C7350PB						
3.5-4"	C7350PM	K35, K37, K38	C7350PM						
KIT NOTES: K35. Does NOT fit All Wheel Drive. K37. Does NOT fit Auto Leveling or Auto Ride. K38. Models with Mass Damper will need to remove mass damper.									
<b>07-13 1500 Pickup 4WD / 2WD Kit</b>			<b>Front Strut Spacers with Blocks &amp; U-Bolts</b>						
4"	C7360PK	K23, K37	C7361A+C7360SP+C7361PR						
6"	C7660PK	K23, K34, K37	C7661A+C7660SP+C7661PR						
<b>07-13 1500 Pickup 4WD / 2WD System</b>			<b>Front Strut Spacers with Replacement Rear Springs</b>						
6"	C7660PKS	K23, K34, K37	C7661A+C7660SP+C7661PRS			2	CR55S		
<b>07-13 1500 Pickup 4WD / 2WD Kit</b>			<b>Performance Struts with Blocks &amp; U-Bolts</b>						
4"	C7361PK	K23, K37	C7361A+C7361ST+C7361PR						
6"	C7661PK	K23, K34, K37	C7661A+C7661ST+C7661PR						
<b>07-13 1500 Pickup 4WD / 2WD System</b>			<b>Performance Struts with Replacement Rear Springs</b>						
6"	C7661PKS	K23, K34, K37	C7661A+C7661ST+C7661PRS			2	CR55S		
KIT NOTES: K23. OEM Tires & Wheels can be Used. K34. 10-13 Frt DShaft GM10146DS. Will not fit AutoTrac or 6.2L engines. K37. Does NOT fit Auto Leveling or Auto Ride.									



# CHEVROLET / GMC

CHEVROLET / GMC

	Steering Stabilizers									HYDRO Shocks		NITRO Shocks		BLACK MAX		M95 Shocks		Labor
	White			Black			Silver			White		Black		Silver				
	OEM	Single	Dual	OEM	Single	Dual	OEM	Single	Dual	Front	Rear	Front	Rear	Front	Rear	Front	Rear	Hours

**NOTE: ALL SHOCKS MUST BE ORDERED SEPARATELY**

										-----	Included	-----	-----	-----	-----	-----	-----	5
												-----	Included	-----	-----	-----	-----	5
														-----	Included	-----	-----	5
																-----	Included	5

											-----	Included	-----	-----	-----	-----	-----	5
													-----	Included	-----	-----	-----	5
														-----	Included	-----	-----	5
																-----	Included	5

											-----	H7017	-----	N8017	-----	B8517	-----	M9517	8	
												-----	H7036	-----	N8036	-----	B8536	-----	M9536	8

												-----	H7036	-----	N8036	-----	B8536	-----	M9536	8
--	--	--	--	--	--	--	--	--	--	--	--	-------	-------	-------	-------	-------	-------	-------	-------	---

**NOTE: ALL SHOCKS MUST BE ORDERED SEPARATELY**

												-----	H7027	-----	N8027	-----	B8527	-----	M9527	2
--	--	--	--	--	--	--	--	--	--	--	--	-------	-------	-------	-------	-------	-------	-------	-------	---

												-----	H7027	-----	N8027	-----	B8527	-----	M9527	2
--	--	--	--	--	--	--	--	--	--	--	--	-------	-------	-------	-------	-------	-------	-------	-------	---

**NOTE: ALL SHOCKS MUST BE ORDERED SEPARATELY**

												-----	Included	-----	-----	-----	-----	-----	5
														-----	Included	-----	-----	-----	5
																-----	Included	-----	5
																	-----	Included	5

												-----	H7017	-----	N8017	-----	B8517	-----	M9517	8	
													-----	H7036	-----	N8036	-----	B8536	-----	M9536	8

													-----	H7036	-----	N8036	-----	B8536	-----	M9536	8
--	--	--	--	--	--	--	--	--	--	--	--	--	-------	-------	-------	-------	-------	-------	-------	-------	---

													-----	H7017	-----	N8017	-----	B8517	-----	M9517	8	
														-----	H7036	-----	N8036	-----	B8536	-----	M9536	8

														-----	H7036	-----	N8036	-----	B8536	-----	M9536	8
--	--	--	--	--	--	--	--	--	--	--	--	--	--	-------	-------	-------	-------	-------	-------	-------	-------	---

# CHEVROLET / GMC

LIFT	Quick Kit	KIT NOTES	Component Box <i>(Requires 1 of Each)</i>	Front Springs		Rear Springs		Add-A-Leafs	Steering Correction <i>(Order 1 Each)</i>
	Reference			Qty	Part #	Qty	Part #		
<b>COIL-OVER KIT</b>									
<b>07-13 1500 Pickup 4WD / 2WD System</b>			<b>Coil-Over Kit with Rear Blocks &amp; U-Bolts</b>						
6"	C7662LSKM	K34	C7146LS + C7661A + C7661PRM						
Kit includes: Fox 2.5" remote reservoir coilover shocks w/ coil springs, front steering knuckles, front & rear cross members, front differential skid plate, front differential relocation brackets, front CV-axle spacers, front sway bar end links & relocation brackets, front brake lines, rear brake line relocation bracket, rear emergency cable relocation bracket, rear blocks, U-bolts, & rear M95 monotube shocks. No tie rod modification required. K34. 10-13 Frt DShaft GM10146DS. Will not fit AutoTrac or 6.2L engines.									
<b>99-06 1500 PICKUP 4WD / 2WD 6-LUG</b>									
<b>99-06 1500 4WD</b>			<b>Torsion Keys (Front Leveling Kit)</b>						
2"	C101KE		C101KE						
<b>99-06 1500 2WD</b>			<b>Poly Spacers (Front Leveling Kit)</b>						
2"	C209P		C209P						
<b>99-06 &amp; 07 CLASSIC K1500 PICKUP 4WD 6-LUG (TORSION BAR FRONT END)</b>									
<b>99-06 1500 Pickup 4WD Kit</b>			<b>6-Lug with Blocks &amp; U-Bolts</b>						
3"	C9461K	K19, K23, K27, K30	C9331+BUK2063						
KIT NOTES: Will also Fit 2007 Classic K1500 Model. Does NOT Require Removal of the Front Upper Differential Housing Mount. K19. If Rear Add-A-Leafs are Preferred for Rear Lift, Order Part # R1115 Instead of BUK2063. K23. OEM Tires & Wheels can be Used. K27. Not Designed for Autoride Models. K30. Not Designed for 99 Models with "Classic" Body Style.									
<b>99-06 1500 Pickup 4WD Kit</b>			<b>6-Lug with Blocks &amp; U-Bolts &amp; Add-A-Leafs (Without Skid Plate)</b>						
6"	C9661K-NSP	K27, K30	C9661A-NSP+C9662B					Included	
KIT NOTES: Will also Fit 2007 Classic K1500 Model. K27. Not Designed for Autoride Models. K30. Not Designed for 99 Models with "Classic" Body Style.									
<b>99-06 1500 Pickup 4WD System</b>			<b>6-Lug with Replacement Rear Springs (Without Skid Plate)</b>						
6"	C9661KS-NSP	K27, K30	C9661A-NSP+C9662BS			2	CR55S		
KIT NOTES: Will also Fit 2007 Classic K1500 Model. K27. Not Designed for Autoride Models. K30. Not Designed for 99 Models with "Classic" Body Style.									
<b>01-08 1500HD 4WD / 2WD</b>									
<b>01-08 1500HD 4WD / 2WD</b>			<b>Torsion Keys (Front Leveling Kit)</b>						
2"	C102KE		C102KE						
KIT NOTES: C102KE Fits Factory Color Codes: Purple, Blue, Yellow. Includes Front Shock Extension Brackets.									
<b>01-08 1500HD 4WD / 2WD</b>			<b>Torsion Keys (Front Leveling Kit)</b>						
2"	C103KE		C103KE						
KIT NOTES: C103KE Fits Factory Color Codes: Orange, Green, White, Brown. Includes Front Shock Extension Brackets.									
<b>01-08 1500HD, 2500 PICKUP 4WD 8-LUG</b>									
<b>01-08 1500HD, 2500 4WD Kit</b>			<b>8-Lug with Blocks &amp; U-Bolts</b>						
6"	C9651HK	K18, K28	C9651HA+C9682B						
KIT NOTES: K18. CANNOT Re-Use OEM Wheels. REQUIRES 4" Back Spacing on Wheels. K28. Minor Modifications Required on all Duramax Diesel Models.									
<b>01-08 1500HD, 2500 4WD System</b>			<b>8-Lug with Replacement Rear Springs</b>						
6"	C9651HKS	K18, K28	C9651HA+C9682BS			2	CR75S		
KIT NOTES: K18. CANNOT Re-Use OEM Wheels. REQUIRES 4" Back Spacing on Wheels. K28. Minor Modifications Required on all Duramax Diesel Models.									
<b>88-98 1500 PICKUP 4WD 6-LUG</b>									
<b>88-98 1500 4WD</b>			<b>Torsion Keys (Front Leveling Kit)</b>						
2"	C101KE		C101KE						
<b>97-98 K1500 Pickup 4WD Kit</b>			<b>6-Lug with Add-A-Leafs</b>						
2-2.5"	C2567K	K1, K2	C2567					R1120	
KIT NOTES: K1. Includes # FBL97 Front Brake Lines. K2. Includes Brake Line Brackets.									
<b>93-98 K1500 Pickup 4WD Kit</b>			<b>6-Lug with Blocks &amp; U-Bolts</b>						
4.5-6"	C4636K	K2, K3, K26	C46+C466+C4636						
KIT NOTES: K2. Includes Brake Line Brackets. K3. Driveline / Exhaust Modifications may be Necessary. K26. On Canadian Made Vehicle & 98-99 Models Steering Modification will be Necessary.									
<b>93-98 K1500 Pickup 4WD System</b>			<b>6-Lug with Replacement Rear Springs</b>						
4.5-6"	C4636KS	K2, K3, K26	C46+C466+C4636S			2	CR35S		
KIT NOTES: K2. Includes Brake Line Brackets. K3. Driveline / Exhaust Modifications may be Necessary. K26. On Canadian / Made Vehicle & 98-99 Models Steering Modification will be Necessary.									

# CHEVROLET / GMC

CHEVROLET / GMC

	Steering Stabilizers									HYDRO Shocks		NITRO Shocks		BLACK MAX		M95 Shocks		Labor Hours						
	White			Black			Silver			White		White		Black		Silver								
	OEM	Single	Dual	OEM	Single	Dual	OEM	Single	Dual	Front	Rear	Front	Rear	Front	Rear	Front	Rear							
										-----	-----	-----	-----	-----	-----	-----	Included	8						
<b>NOTE: ALL SHOCKS MUST BE ORDERED SEPARATELY</b>																								
										H7003	H7017	N8003	N8017	B8503	B8517	M9503	M9517	2						
										H7006	H7017	-----	-----	N8017	B8506	B8517	M9506	M9517	2					
<b>NOTE: ALL SHOCKS MUST BE ORDERED SEPARATELY</b>																								
										7196 <sup>(K)</sup>	7296 <sup>(K)</sup>	8196 <sup>(K)</sup>	8296 <sup>(K)</sup>	9196 <sup>(K)</sup>	9296 <sup>(K)</sup>	H7003	H7017	N8003	N8017	B8503	B8517	M9503	M9517	8
										7196 <sup>(K)</sup>	7296 <sup>(K)</sup>	8196 <sup>(K)</sup>	8296 <sup>(K)</sup>	9196 <sup>(K)</sup>	9296 <sup>(K)</sup>	H7096	H7036	N8096	N8036	B8596	B8536	M9596	M9536	9
<small>(K) 'Single' or 'Dual' Steering Stabilizers can ONLY be Used with Skyjacker Suspension Lift.</small>																								
										7196 <sup>(K)</sup>	7296 <sup>(K)</sup>	8196 <sup>(K)</sup>	8296 <sup>(K)</sup>	9196 <sup>(K)</sup>	9296 <sup>(K)</sup>	H7096	H7036	N8096	N8036	B8596	B8536	M9596	M9536	9
<small>(K) 'Single' or 'Dual' Steering Stabilizers can ONLY be Used with Skyjacker Suspension Lift.</small>																								
<b>NOTE: ALL SHOCKS MUST BE ORDERED SEPARATELY</b>																								
										H7019	H7017	N8019	N8017	B8519	B8517	M9519	M9517	2						
										H7019	H7017	N8019	N8017	B8519	B8517	M9519	M9517	2						
<b>NOTE: ALL SHOCKS MUST BE ORDERED SEPARATELY</b>																								
										7098	7298 <sup>(K)</sup>	8098	8298 <sup>(K)</sup>	9098	9298 <sup>(K)</sup>	H7074	H7036	N8074	N8036	B8574	B8536	M9574	M9536	10
<small>(K) 'Single' or 'Dual' Steering Stabilizers can ONLY be Used with Skyjacker Suspension Lift.</small>																								
										7098	7298 <sup>(K)</sup>	8098	8298 <sup>(K)</sup>	9098	9298 <sup>(K)</sup>	H7074	H7036	N8074	N8036	B8574	B8536	M9574	M9536	10
<small>(K) 'Single' or 'Dual' Steering Stabilizers can ONLY be Used with Skyjacker Suspension Lift.</small>																								
<b>NOTE: ALL SHOCKS MUST BE ORDERED SEPARATELY</b>																								
										H7081	H7083	N8081	N8083	B8581	B8583	M9581	M9583	2						
										7122		8122		9122		H7081	H7083	N8081	N8083	B8581	B8583	M9581	M9583	8
										H7085	H7086	N8085	N8086	B8585	B8586	M9585	M9586	12						
										H7085	H7086	N8085	N8086	B8585	B8586	M9585	M9586	12						

# CHEVROLET / GMC

LIFT	Quick Kit	KIT NOTES	Component Box	Front Springs		Rear Springs		Add-A-Leafs	Steering Correction
	Reference		(Requires 1 of Each)	Qty	Part #	Qty	Part #		(Order 1 Each)
<b>88-96 K1500 Pickup 4WD Kit</b>									
2-2.5"	C256K		6-Lug with Rear Add-A-Leafs					R1120	
<b>88-92 K1500 Pickup 4WD Kit</b>									
4.5-6"	C4626K	K2, K3, K26	6-Lug with Blocks & U-Bolts	C46+C466+C4626					
KIT NOTES: K2. Includes Brake Line Brackets. K3. Driveline / Exhaust Modifications may be Necessary. K26. On Canadian Made Vehicle & 98-99 Models Steering Modification will be Necessary.									
<b>88-92 K1500 Pickup 4WD System</b>									
4.5-6"	C4626KS	K2, K3, K26	6-Lug with Replacement Rear Springs	C46+C466+C4626S		2	CR35S		
KIT NOTES: K2. Includes Brake Line Brackets. K3. Driveline / Exhaust Modifications may be Necessary. K26. On Canadian Made Vehicle & 98-99 Models Steering Modification will be Necessary.									
<b>11-19 2500HD 4WD 8-LUG (TORSION BAR FRONT END)</b>									
<b>11-19 2500HD 4WD</b>									
2"	C115KE	K36	Torsion Keys (Front Leveling Kit)	C115KE					
KIT NOTES: Includes Front Shock Extension Spacers. K36. Does NOT Fit Magnaride.									
<b>11-19 2500HD 4WD / 2WD</b>									
<b>11-19 2500HD 4WD / 2WD</b>									
3-3.5"	C11350PH	K36, K39	Control Arm Kit w/Front Shock Extensions & Rear Shocks	C11350PH					
3-3.5"	C11350PN	K36, K39		C11350PN					
3-3.5"	C11350PB	K36, K39		C11350PB					
3-3.5"	C11350PM	K36, K39		C11350PM					
KIT NOTES: K36. Does NOT Fit Magnaride. K39. Dually Models Order (1) UDB6R U-Bolt Kit.									
<b>11-19 2500HD Pickup 4WD / 2WD Kit</b>									
6"	C11680K		K2500HD 8-Lug with Blocks & U-Bolts	C1168A+C1178B+C1178N					
7"	C11781K			C1178A+C1178B+C1178N+C1178TR					
KIT NOTES: OEM 17"-18" Wheels can be Used. DEF / Urea Tank Skid Plate Available. Part # DEFG114SP. In the Event of Rear Driveline Vibration Use Carrier Bearing Lowering Kit # CBL2500. K25.									
<b>11-19 3500HD 4WD 8-LUG (TORSION BAR FRONT END)</b>									
<b>11-19 3500HD 4WD</b>									
2"	C115KE		Torsion Keys (Front Leveling Kit)	C115KE					
KIT NOTES: Includes Front Shock Extension Spacers.									
<b>11-19 3500HD 4WD / 2WD</b>									
<b>11-19 3500HD 4WD / 2WD</b>									
3-3.5"	C11350PH	K36, K39	Upper Control Arm Kit w/Front Shock Extensions & Rear Shocks	C11350PH					
3-3.5"	C11350PN	K36, K39		C11350PN					
3-3.5"	C11350PB	K36, K39		C11350PB					
3-3.5"	C11350PM	K36, K39		C11350PM					
KIT NOTES: K36. Does NOT Fit Magnaride. K39. Dually Models Order (1) UDB6R U-Bolt Kit.									
<b>11-19 3500HD Pickup 4WD / 2WD Kit</b>									
6"	C11680KH		K3500HD 8-Lug with Blocks & U-Bolts	C1168A+C1178BH+C1178N					
7"	C11781KH			C1178A+C1178BH+C1178N+C1178TR					
KIT NOTES: OEM 17"-18" Wheels can be Used. DEF / Urea Tank Skid Plate Available. Part # DEFG114SP. In the Event of Rear Driveline Vibration Use Carrier Bearing Lowering Kit # CBL2500.									

# CHEVROLET / GMC

CHEVROLET / GMC

	Steering Stabilizers									HYDRO Shocks		NITRO Shocks		BLACK MAX		M95 Shocks		Labor	
	White			Black			Silver			White		White		Black		Silver			
	OEM	Single	Dual	OEM	Single	Dual	OEM	Single	Dual	Front	Rear	Front	Rear	Front	Rear	Front	Rear	Front	Rear
		7122			8122			9122			H7081	H7083	N8081	N8083	B8581	B8583	M9581	M9583	8
											H7085	H7086	N8085	N8086	B8585	B8586	M9585	M9586	12
											H7085	H7086	N8085	N8086	B8585	B8586	M9585	M9586	12
<b>NOTE: ALL SHOCKS MUST BE ORDERED SEPARATELY</b>																			
	7011		-- --	8011		-- --	9011		-- --		H7027		N8027		B8527		M9527		2
<b>NOTE: ALL SHOCKS MUST BE ORDERED SEPARATELY</b>																			
	7011		-- --	8011		-- --	9011		-- --		Included								5
	7011		-- --	8011		-- --	9011		-- --				Included						5
	7011		-- --	8011		-- --	9011		-- --					Included					5
	7011		-- --	8011		-- --	9011		-- --								Included		5
	7011		7211	8011		8211	9011		9211						Included	Included			9
	7011		7211	8011		8211	9011		9211						Included	Included			9
<b>NOTE: ALL SHOCKS MUST BE ORDERED SEPARATELY</b>																			
	7011		-- --	8011		-- --	9011		-- --		H7027		N8027		B8527		M9527		2
<b>NOTE: ALL SHOCKS MUST BE ORDERED SEPARATELY</b>																			
	7011		-- --	8011		-- --	9011		-- --		Included								5
	7011		-- --	8011		-- --	9011		-- --				Included						5
	7011		-- --	8011		-- --	9011		-- --					Included					5
	7011		-- --	8011		-- --	9011		-- --								Included		5
	7011		7211	8011		8211	9011		9211						Included	Included			9
	7011		7211	8011		8211	9011		9211						Included	Included			9

# CHEVROLET / GMC

LIFT	Quick Kit	KIT NOTES	Component Box	Front Springs		Rear Springs		Add-A-Leafs	Steering Correction
	Reference		(Requires 1 of Each)	Qty	Part #	Qty	Part #		(Order 1 Each)
<b>01-10 2500HD / 3500HD 4WD / 2WD 8-LUG (TORSION BAR FRONT END)</b>									
<b>01-10 2500HD / 3500HD 4WD / 2WD</b>			<b>Torsion Keys (Front Leveling Kit)</b>						
2"	C102KE		C102KE						
KIT NOTES: C102KE Fits Factory Color Codes: Purple, Blue, Yellow. Includes Front Shock Extension Brackets.									
<b>01-10 2500HD / 3500HD 4WD / 2WD</b>			<b>Torsion Keys (Front Leveling Kit)</b>						
2"	C103KE		C103KE						
KIT NOTES: C103KE Fits Factory Color Codes: Orange, Green, White, Brown. Includes Front Shock Extension Brackets.									
<b>01-10 2500HD / 3500HD PICKUP 4WD 8-LUG (TORSION BAR FRONT END)</b>									
<b>01-10 2500HD / 3500HD Pickup 4WD Kit</b>			<b>With Blocks &amp; U-Bolts</b>						
3"	C9381K	K21	C9381+BUK2082F						
KIT NOTES: Can Re-Use OEM Wheels by Re-Routing Brake & ABS Line. (3" Lift Only). K21. 3500 Models will Require Custom Rear U-Bolts & Modification to Knuckles.									
<b>01-10 2500HD / 3500HD Pickup 4WD Kit</b>			<b>With Blocks &amp; U-Bolts</b>						
6"	C9681K-NSP	K18, K21, K28	C9681A-NSP+C9682B						
KIT NOTES: K18. CANNOT Re-Use OEM Wheels. REQUIRES 4" Back Spacing on Wheels. K21. 3500 Models will Require Custom Rear U-Bolts & Modification to Knuckles. K28. Minor Modifications Required on all Duramax Diesel Models.									
<b>01-10 2500HD Pickup 4WD System</b>			<b>With Replacement Rear Springs</b>						
6"	C9681KS-NSP	K15, K18, K28	C9681A-NSP+C9682BS		2	CR75S			
KIT NOTES: K15. Minor Modifications may be Required on Duramax Models. K18. CANNOT Re-Use OEM Wheels. REQUIRES 4" Back Spacing on Wheels. K28. Minor Modifications Required on all Duramax Diesel Models.									
<b>73-87 CHEVY / GMC PICKUP 4WD</b>									
<b>73-87 Chevy / GMC K10 Pickup 4WD Kit</b>			<b>With Blocks &amp; U-Bolts &amp;/or Add-A-Leafs</b>						
2.5"	C125AK	K10	C125A	2	C125S				CA50
4"	C140AK	K6, K7, K10	C140A	2	C140S				CA100
6"	C160AK	K3, K4, K6, K7, K22	C168A	2	C160S				CA100
8"	C180AK	K3, K4, K6, K7, K22	C168A	2	C180S			R1120	CA50+CA100
KIT NOTES: K3. Driveline / Exhaust Modifications may be Necessary. K4. Transfer Case Lowering Kit # TCL15 may be Needed. K6. Optional 4" Offset Drag Link Available - # GMDL4. K7. See Brake Lines Section. K10. Fitted Leafs are Available for Additional Weight Capacity (Heavy Winch Bumper, Big Block or Diesel Engine, Etc.). See Leaf Springs Section. K22. If Vehicle is Equipped with a Front Sway Bar, Lowering Brackets must be Ordered. See Chevrolet / GM Accessories.									
<b>73-87 Chevy / GMC K10 Pickup 4WD System</b>			<b>With Replacement Rear Springs</b>						
2.5"	C125AKS	K10	C124AS	2	C125S	2	CR12S		CA50
4"	C140AKS	K6, K7, K10	C124AS	2	C140S	2	CR14S		CA100
6"	C160AKS	K3, K4, K6, K7, K10, K22	C168AS	2	C160S	2	CR16S		CA100
8"	C180AKS	K3, K4, K6, K7, K10, K22	C168AS	2	C180S	2	CR18S		CA50+CA100
KIT NOTES: K3. Driveline / Exhaust Modifications may be Necessary. K4. Transfer Case Lowering Kit # TCL15 may be Needed. K6. Optional 4" Offset Drag Link Available - # GMDL4. K7. See Brake Lines Section. K10. Fitted Leafs are Available for Additional Weight Capacity (Heavy Winch Bumper, Big Block or Diesel Engine, Etc.). See Leaf Springs Section. K22. If Vehicle is Equipped with a Front Sway Bar, Lowering Brackets must be Ordered. See Chevrolet / GM Accessories.									
<b>73-87 Chevy / GMC K20 Pickup 4WD Kit</b>			<b>With Blocks &amp; U-Bolts &amp;/or Add-A-Leafs</b>						
2.5"	C125BK	K10	C125B	2	C125S				CA50
4"	C140BK	K6, K7, K10	C140B	2	C140S				CA100
6"	C160BK	K3, K4, K6, K7, K10, K22	C168B	2	C160S				CA100
8"	C180BK	K3, K4, K6, K7, K10, K22	C168B	2	C180S			R1120	CA50+CA100
KIT NOTES: K3. Driveline / Exhaust Modifications may be Necessary. K4. Transfer Case Lowering Kit # TCL15 may be Needed. K6. Optional 4" Offset Drag Link Available - # GMDL4. K7. See Brake Lines Section. K10. Fitted Leafs are Available for Additional Weight Capacity (Heavy Winch Bumper, Big Block or Diesel Engine, Etc.). See Leaf Springs Section. K22. If Vehicle is Equipped with a Front Sway Bar, Lowering Brackets must be Ordered.									
<b>73-87 CHEVY / GMC PICKUP 4WD</b>									
<b>73-87 Chevy / GMC K20 Pickup 4WD System</b>			<b>With 52" Replacement Rear Springs</b>						
2.5"	C125BKS	K10	C124BS	2	C125S	2	CR12S		CA50
4"	C140BKS	K5, K6, K7, K10	C124BS	2	C140S	2	CR14S		CA100
6"	C160BKS	K3, K4, K5, K6, K7, K10, K22	C168BS	2	C160S	2	CR16S		CA100
8"	C180BKS	K3, K4, K5, K6, K7, K10, K22	C168BS	2	C180S	2	CR18S		CA50+CA100
KIT NOTES: K3. Driveline / Exhaust Modifications may be Necessary. K4. Transfer Case Lowering Kit # TCL15 may be Needed. K5. Must have 3-Bolt Steering Knuckle. (If Your Vehicle has a 4 Bolt Closed Knuckle use GMDL4 Not CA100). K6. Optional 4" Offset Drag Link Available - # GMDL4. K7. See Brake Lines Section. K10. Fitted Leafs are Available for Additional Weight Capacity (Heavy Winch Bumper, Big Block or Diesel Engine, Etc.). See Leaf Springs Section. K22. If Vehicle is Equipped with a Front Sway Bar, Lowering Brackets must be Ordered. See Chevrolet / GM Accessories.									

# CHEVROLET / GMC

CHEVROLET / GMC

	Steering Stabilizers									HYDRO Shocks		NITRO Shocks		BLACK MAX		M95 Shocks		Labor Hours
	White			Black			Silver			White		White		Black		Silver		
	OEM	Single	Dual	OEM	Single	Dual	OEM	Single	Dual	Front	Rear	Front	Rear	Front	Rear	Front	Rear	

**NOTE: ALL SHOCKS MUST BE ORDERED SEPARATELY**

7098				8098					9098			H7019	H7017	N8019	N8017	B8519	B8517	M9519	M9517	2
------	--	--	--	------	--	--	--	--	------	--	--	-------	-------	-------	-------	-------	-------	-------	-------	---

												H7019	H7017	N8019	N8017	B8519	B8517	M9519	M9517	2
--	--	--	--	--	--	--	--	--	--	--	--	-------	-------	-------	-------	-------	-------	-------	-------	---

**NOTE: ALL SHOCKS MUST BE ORDERED SEPARATELY**

7098		7298 <sup>(K)</sup>		8098		8298 <sup>(K)</sup>		9098		9298 <sup>(K)</sup>		H7074	H7017	N8074	N8017	B8574	B8517	M9574	M9517	8
------	--	---------------------	--	------	--	---------------------	--	------	--	---------------------	--	-------	-------	-------	-------	-------	-------	-------	-------	---

<sup>(K)</sup> 'Single' or 'Dual' Steering Stabilizers can ONLY be Used with Skyjacker Suspension Lift.

7098		7298 <sup>(K)</sup>		8098		8298 <sup>(K)</sup>		9098		9298 <sup>(K)</sup>		H7074	H7036	N8074	N8036	B8574	B8536	M9574	M9536	9
------	--	---------------------	--	------	--	---------------------	--	------	--	---------------------	--	-------	-------	-------	-------	-------	-------	-------	-------	---

<sup>(K)</sup> 'Single' or 'Dual' Steering Stabilizers can ONLY be Used with Skyjacker Suspension Lift.

7098		7298 <sup>(K)</sup>		8098		8298 <sup>(K)</sup>		9098		9298 <sup>(K)</sup>		H7074	H7036	N8074	N8036	B8574	B8536	M9574	M9536	10
------	--	---------------------	--	------	--	---------------------	--	------	--	---------------------	--	-------	-------	-------	-------	-------	-------	-------	-------	----

<sup>(K)</sup> 'Single' or 'Dual' Steering Stabilizers can ONLY be Used with Skyjacker Suspension Lift.

**NOTE: ALL SHOCKS MUST BE ORDERED SEPARATELY**

7055		7220	8055		8220	9055		9220	H7051	H7053	N8051	N8053	B8551	B8553	M9551	M9553	4
7055		7220	8055		8220	9055		9220	H7051	H7053	N8051	N8053	B8551	B8553	M9551	M9553	4
7055		7220	8055		8220	9055		9220	H7071	H7073	N8071	N8073	B8571	B8573	M9571	M9573	6
7055		7220	8055		8220	9055		9220	H7071	H7073	N8071	N8073	B8571	B8573	M9571	M9573	7

7055		7220	8055		8220	9055		9220	H7051	H7053	N8051	N8053	B8551	B8553	M9551	M9553	6
7055		7220	8055		8220	9055		9220	H7051	H7053	N8051	N8053	B8551	B8553	M9551	M9553	6
7055		7220	8055		8220	9055		9220	H7071	H7073	N8071	N8073	B8571	B8573	M9571	M9573	7
7055		7220	8055		8220	9055		9220	H7071	H7073	N8071	N8073	B8571	B8573	M9571	M9573	7

7055		7220	8055		8220	9055		9220	H7051	H7053	N8051	N8053	B8551	B8553	M9551	M9553	4
7055		7220	8055		8220	9055		9220	H7051	H7053	N8051	N8053	B8551	B8553	M9551	M9553	4
7055		7220	8055		8220	9055		9220	H7071	H7073	N8071	N8073	B8571	B8573	M9571	M9573	6
7055		7220	8055		8220	9055		9220	H7071	H7073	N8071	N8073	B8571	B8573	M9571	M9573	7

**NOTE: ALL SHOCKS MUST BE ORDERED SEPARATELY**

7055		7220	8055		8220	9055		9220	H7051	H7053	N8051	N8053	B8551	B8553	M9551	M9553	6
7055		7220	8055		8220	9055		9220	H7051	H7053	N8051	N8053	B8551	B8553	M9551	M9553	6
7055		7220	8055		8220	9055		9220	H7071	H7073	N8071	N8073	B8571	B8573	M9571	M9573	7
7055		7220	8055		8220	9055		9220	H7071	H7073	N8071	N8073	B8571	B8573	M9571	M9573	7

## CHEVROLET / GMC

LIFT	Quick Kit	KIT NOTES	Component Box (Requires 1 of Each)	Front Springs		Rear Springs		Add-A-Leafs	Steering Correction
	Reference			Qty	Part #	Qty	Part #		(Order 1 Each)
<b>73-87 Chevy / GMC K20 Pickup 4WD System With 56" Replacement Rear Springs</b>									
4"	C140BKSD	K5, K6, K7, K10	C124BS	2	C140S	2	CR24S		CA100
6"	C160BKSD	K3, K4, K5, K6, K7, K10, K22	C168BS	2	C160S	2	CR26S		CA100
8"	C180BKSD	K5, K7, K9	C180BSD	2	C180S	2	CR26S		CA50+CA100
KIT NOTES: K3. Driveline / Exhaust Modifications may be Necessary. K4. Transfer Case Lowering Kit # TCL15 may be Needed. K5. Must have 3-Bolt Steering Knuckle. (If Your Vehicle has a 4 Bolt Closed Knuckle Use GMDL4 Not CA100). K6. Optional 4" Offset Drag Link Available - # GMDL4. K7. See Brake Lines Section. K9. This Lift also Includes 2" Blocks. K10. Fitted Leafs are Available for Additional Weight Capacity (Heavy Winch Bumper, Big Block or Diesel Engine, Etc.). See Leaf Springs Section. K22. If Vehicle is Equipped with a Front Sway Bar, Lowering Brackets must be Ordered. See Chevrolet / GM Accessories.									
<b>77-87 Chevy / GMC K30 Pickup 4WD Kit With Blocks &amp; U-Bolts &amp;/or Add-A-Leafs</b>									
2.5"	C125CK	K10	C125C	2	C125S				CA50
4"	C140CK	K6, K7, K10	C140C	2	C140S				CA50
6"	C160CK	K3, K4, K6, K7, K10, K22	C168C	2	C160S				CA50+SB60
8"	C180CK	K3, K4, K6, K7, K10, K22	C168C	2	C180S			R1120	CA50+SB60
KIT NOTES: K3. Driveline / Exhaust Modifications may be Necessary. K4. Transfer Case Lowering Kit # TCL15 may be Needed. K6. Optional 4" Offset Drag Link Available - # GMDL4. K7. See Brake Lines Section. K10. Fitted Leafs are Available for Additional Weight Capacity (Heavy Winch Bumper, Big Block or Diesel Engine, Etc.). See Leaf Springs Section. K22. If Vehicle is Equipped with a Front Sway Bar, Lowering Brackets must be Ordered. See Chevrolet / GM Accessories.									
<b>77-87 Chevy / GMC K30 Pickup 4WD System With Replacement Rear Springs</b>									
4"	C140CKS	K6, K7, K10	C124CS	2	C140S	2	CR24S		CA50
6"	C160CKS	K3, K4, K6, K7, K10, K22	C160CS	2	C160S	2	CR26S		CA50+SB60
8"	C180CKS	K7, K9	C180CS	2	C180S	2	CR26S		CA50+SB60
KIT NOTES: K3. Driveline / Exhaust Modifications may be Necessary. K4. Transfer Case Lowering Kit # TCL15 may be Needed. K6. Optional 4" Offset Drag Link Available - # GMDL4. K7. See Brake Lines Section. K9. This Lift also Includes 2" Blocks. K10. Fitted Leafs are Available for Additional Weight Capacity (Heavy Winch Bumper, Big Block or Diesel Engine, Etc.). See Leaf Springs Section. K22. If Vehicle is Equipped with a Front Sway Bar, Lowering Brackets must be Ordered. See Chevrolet / GM Accessories.									
<b>67-72 CHEVY / GMC PICKUP 4WD</b>									
<b>67-72 Chevy / GMC K10, K20 Pickup 4WD Kit With Blocks &amp; U-Bolts &amp;/or Add-A-Leafs</b>									
2.5"	C225AK		C225A	2	C225S				CA50
4"	C240AK	K5, K6	C240A	2	C240S				CA100
6"	C260AK	K2, K5, K6, K22	C268A	2	C260S				CA100
8"	C280AK	K2, K3, K5, K6, K22	C268A	2	C280S			R1120	CA50+CA100
KIT NOTES: K2. Includes Brake Line Brackets. K3. Driveline / Exhaust Modifications may be Necessary. K5. Must have 3-Bolt Steering Knuckle. (If your Vehicle has a 4 Bolt Closed Knuckle Use GMDL4 Not CA100). K6. Optional 4" Offset Drag Link Available - # GMDL4. K22. Front Sway Bar, Lowering Brackets must be Ordered.									
<b>69-72 Chevy / GMC K10 Pickup 4WD System With 52" Replacement Rear Springs</b>									
2.5"	C225AKS		C224AS	2	C225S	2	CR12S		CA50
4"	C240AKS	K5, K6, K7	C224AS	2	C240S	2	CR14S		CA100
6"	C260AKS	K2, K5, K6, K7, K22	C268AS	2	C260S	2	CR16S		CA100
8"	C280AKS	K2, K3, K5, K6, K7, K22	C268AS	2	C280S	2	CR18S		CA50+CA100
KIT NOTES: K2. Includes Brake Line Brackets. K3. Driveline / Exhaust Modifications may be Necessary. K5. Must have 3-Bolt Steering Knuckle. K6. Optional 4" Offset Drag Link Available - # GMDL4. K7. See Brake Lines Section. K22. If Vehicle is Equipped with a Front Sway Bar, Lowering Brackets must be Ordered.									
<b>69-72 CHEVY / GMC PICKUP 4WD</b>									
<b>69-72 Chevy / GMC K10 Pickup 4WD System With 56" Replacement Rear Springs</b>									
4"	C240AKSD	K5, K6, K7	C224AS	2	C240S	2	CR24S		CA100
6"	C260AKSD	K2, K5, K6, K7, K22	C268AS	2	C260S	2	CR26S		CA100
8"	C280AKSD	K2, K3, K5, K6, K7, K9, K22	C280ASD	2	C280S	2	CR26S		CA50+CA100
KIT NOTES: K2. Includes Brake Line Brackets. K3. Driveline / Exhaust Modifications may be Necessary. K5. Must have 3-Bolt Steering Knuckle. K6. Optional 4" Offset Drag Link Available - # GMDL4. K7. See Brake Lines Section. K9. This Lift also Includes 2" Blocks. K22. If Vehicle is Equipped with a Front Sway Bar, Lowering Brackets must be Ordered. See Accessories Section of catalog.									



# CHEVROLET / GMC

CHEVROLET / GMC

	Steering Stabilizers									HYDRO Shocks		NITRO Shocks		BLACK MAX		M95 Shocks		Labor
	White			Black			Silver			White		White		Black		Silver		Hours
	OEM	Single	Dual	OEM	Single	Dual	OEM	Single	Dual	Front	Rear	Front	Rear	Front	Rear	Front	Rear	
	7055		7220	8055		8220	9055		9220	H7051	H7053	N8051	N8053	B8551	B8553	M9551	M9553	6
	7055		7220	8055		8220	9055		9220	H7071	H7073	N8071	N8073	B8571	B8573	M9571	M9573	7
	7055		7220	8055		8220	9055		9220	H7071	H7073	N8071	N8073	B8571	B8573	M9571	M9573	7

	7055		7255	8055		8255	9055		9255	H7051	H7073	N8051	N8073	B8551	B8573	M9551	M9573	5
	7055		7255	8055		8255	9055		9255	H7051	H7073	N8051	N8073	B8551	B8573	M9551	M9573	5
	7055		7255	8055		8255	9055		9255	H7071	H7078	N8071	N8078	B8571	B8578	M9571	M9578	6
	7055		7255	8055		8255	9055		9255	H7071	H7078	N8071	N8078	B8571	B8578	M9571	M9578	7

	7055		7255	8055		8255	9055		9255	H7051	H7073	N8051	N8073	B8551	B8573	M9551	M9573	6
	7055		7255	8055		8255	9055		9255	H7071	H7078	N8071	N8078	B8571	B8578	M9571	M9578	7
	7055		7255	8055		8255	9055		9255	H7071	H7078	N8071	N8078	B8571	B8578	M9571	M9578	7

**NOTE: ALL SHOCKS MUST BE ORDERED SEPARATELY**

	7055		7220	8055		8220	9055		9220	H7051	H7041	N8051	N8041	B8551	B8541	M9551	M9541	4
	7055		7220	8055		8220	9055		9220	H7051	H7041	N8051	N8041	B8551	B8541	M9551	M9541	4
	7055		7220	8055		8220	9055		9220	H7071	H7060	N8071	N8060	B8571	B8560	M9571	M9560	6
	7055		7220	8055		8220	9055		9220	H7071	H7060	N8071	N8060	B8571	B8560	M9571	M9560	7

	7055		7220	8055		8220	9055		9220	H7051	H7041	N8051	N8041	B8551	B8541	M9551	M9541	6
	7055		7220	8055		8220	9055		9220	H7051	H7041	N8051	N8041	B8551	B8541	M9551	M9541	6
	7055		7220	8055		8220	9055		9220	H7071	H7060	N8071	N8060	B8571	B8560	M9571	M9560	7
	7055		7220	8055		8220	9055		9220	H7071	H7060	N8071	N8060	B8571	B8560	M9571	M9560	7

**NOTE: ALL SHOCKS MUST BE ORDERED SEPARATELY**

	7055		7220	8055		8220	9055		9220	H7051	H7041	N8051	N8041	B8551	B8541	M9551	M9541	6
	7055		7220	8055		8220	9055		9220	H7071	H7060	N8071	N8060	B8571	B8560	M9571	M9560	7
	7055		7220	8055		8220	9055		9220	H7071	H7060	N8071	N8060	B8571	B8560	M9571	M9560	7

# CHEVROLET / GMC

LIFT	Quick Kit	KIT NOTES	Component Box	Front Springs		Rear Springs		Add-A-Leafs	Steering Correction
	Reference		(Requires 1 of Each)	Qty	Part #	Qty	Part #		(Order 1 Each)
<b>15-16 TAHOE / YUKON 1500 4WD</b>									
<b>15-16 Tahoe / Yukon 1500 4WD / 2WD Kit</b>			<b>Upper Control Arm Kit w/ Shock Extensions &amp; Cast Steel Control Arms</b>						
3.5-4"	C15350V	K35, K36	C15350V						
KIT NOTES: K35. Does NOT fit All Wheel Drive models. K36. Does NOT fit Auto Leveling or Auto Ride models. Models with Mass Damper will need to remove mass damper.									
<b>15-16 Tahoe / Yukon 1500 4WD / 2WD Kit</b>			<b>UCA Kit w/ Shock Extensions w/ Aluminum Or Stamped Steel Control Arms</b>						
3.5-4"	C15350VA	K35, K36	C15350VA						
KIT NOTES: K35. Does NOT fit All Wheel Drive models. K36. Does NOT fit Auto Leveling or Auto Ride models. Models with Mass Damper will need to remove mass damper.									
<b>07-20 TAHOE / YUKON 4WD (STRUT FRONT END)</b>									
<b>07-20 Tahoe / Yukon 1500 4WD / 2WD Kit</b>			<b>Lower Cast Steel Spacers (Front Leveling Kit)</b>						
2"	C1420LMSA	K31, K36	C1420LMSA						
KIT NOTES: Installs Below Strut Assembly. K31. Part # C12CS Lifts Rear 1.25" if Needed. K36. Does NOT Fit Magnaride.									
<b>07-20 Tahoe / Yukon 1500 4WD / 2WD KIT</b>			<b>Metal Spacers (Front Leveling Kit)</b>						
2"	C720MS	K31, K36	C720MS						
KIT NOTES: Installs Below Strut Assembly. K31. Part # C12CS Lifts Rear 1.25" if Needed. K36. Does NOT Fit Magnaride.									
<b>07-13 Tahoe / Yukon 1500 4WD KIT</b>			<b>With Rear Shock Brackets</b>						
3.5-4"	C7350V	K25, K35	C7350V						
KIT NOTES: K25. Does NOT fit Auto Leveling or Auto Ride models. Models with Mass Damper must remove mass damper. K35. Does NOT fit All Wheel Drive models.									
<b>07-13 Tahoe / Yukon 1500 4WD KIT</b>			<b>Front Struts 6-Lug with Replacement Rear Coils</b>						
3.5-4"	C7361SK	K23	C7361A+C7361ST+C7361SR						
KIT NOTES: K23. OEM Tires & Wheels can be Used.									
<b>07-13 Tahoe / Yukon 1500 4WD KIT</b>			<b>Front Strut Spacers 6-Lug with Replacement Rear Coils (Autoride)</b>						
3.5"	C7361ARK	K23	C7361A+C7361AR+C7361SR						
KIT NOTES: K23. OEM Tires & Wheels can be Used.									
<b>07-13 Tahoe / Yukon 1500 4WD KIT</b>			<b>Front Struts 6-Lug with Replacement Rear Coils</b>						
6"	C7661SK	K23	C7661A+C7661ST+C7661SR						
KIT NOTES: K23. OEM Tires & Wheels can be Used.									
<b>00-06 TAHOE / YUKON 1500 4WD</b>									
<b>00-06 Tahoe / Yukon 4WD (Torsion Bar Front End)</b>			<b>Torsion Keys (Front Leveling Kit)</b>						
2"	C101KE		C101KE						
<b>00-06 Tahoe / Yukon 1500 4WD System</b>			<b>6-Lug with Replacement Rear Coils</b>						
3"	C9331K	K16, K23	C9341+C933R						
KIT NOTES: Does NOT Require Removal of the Front Upper Differential Housing Mount. K16. Autoride Models Order Part# C93AR. Factory Shocks will be Retained. K23. OEM Tires & Wheels can be Used.									
<b>00-06 Tahoe / Yukon 1500 4WD System</b>			<b>NOT Designed for Autoride Models</b>						
6"	C9631K	K27	C9631A+C9631B			1	C50R		
KIT NOTES: K27. Not Designed for Autoride Models.									
<b>00-06 Tahoe / Yukon 2500 4WD KIT</b>			<b>NOT Designed for Autoride Models</b>						
6"	C9671K	K12	C9671A+C9671B						
KIT NOTES: K12. CANNOT Re-Use OEM Wheels. REQUIRES 4.5" Back Spacing on Wheels.									
<b>92-98 TAHOE / YUKON FULL-SIZE 4WD</b>									
<b>97-98 Tahoe / Yukon Full-Size 4WD Kit</b>			<b>With Rear Add-A-Leafs</b>						
2-2.5"	C2567K	K1, K7	C2567					R1120	
KIT NOTES: K1. Includes # FBL97 Front Brake Lines. K7. See Brake Lines Section.									
<b>92-96 Tahoe / Yukon Full-Size 4WD Kit</b>			<b>With Rear Add-A-Leafs</b>						
2-2.5"	C256K		C256					R1120	
<b>93-98 Tahoe / Yukon Full-Size 4WD Kit (2 Door Only)</b>			<b>With Blocks &amp; U-Bolts</b>						
4.5-6"	C4636K	K2, K3, K11, K26	C46+C466+C4636						
KIT NOTES: K2. Includes Brake Line Brackets. K3. Driveline / Exhaust Modifications may be Necessary. K11. 98-99 4-Door Yukon & Tahoe Extends Strut Arms 2" (4.5-6" Kit - The Strut Arms MUST be Lengthened 2"). K26. On Canadian Made Vehicle & 98-99 Models Steering Modification will be Necessary.									

# CHEVROLET / GMC

CHEVROLET / GMC

	Steering Stabilizers									HYDRO Shocks		NITRO Shocks		BLACK MAX		M95 Shocks		Labor Hours
	White			Black			Silver			White		White		Black		Silver		
	OEM	Single	Dual	OEM	Single	Dual	OEM	Single	Dual	Front	Rear	Front	Rear	Front	Rear	Front	Rear	
<b>NOTE: ALL SHOCKS MUST BE ORDERED SEPARATELY</b>																		
																		5
<b>NOTE: ALL SHOCKS MUST BE ORDERED SEPARATELY</b>																		
																		5
<b>NOTE: ALL SHOCKS MUST BE ORDERED SEPARATELY</b>																		
																		2
																		2
																		5
																		8
																		8
																		8
<b>NOTE: ALL SHOCKS MUST BE ORDERED SEPARATELY</b>																		
																		2
																		8
<i>(K)</i> 'Single' or 'Dual' Steering Stabilizers can ONLY be Used with Skyjacker Suspension Lift.																		
																		10
<i>(K)</i> 'Single' or 'Dual' Steering Stabilizers can ONLY be Used with Skyjacker Suspension Lift.																		
																		8
<i>(K)</i> 'Single' or 'Dual' Steering Stabilizers can ONLY be Used with Skyjacker Suspension Lift.																		
<b>NOTE: ALL SHOCKS MUST BE ORDERED SEPARATELY</b>																		
																		8
																		8
																		12

# CHEVROLET / GMC

LIFT	Quick Kit	KIT NOTES	Component Box	Front Springs		Rear Springs		Add-A-Leafs	Steering Correction
	Reference		(Requires 1 of Each)	Qty	Part #	Qty	Part #		(Order 1 Each)
<b>92-98 Blazer (Torsion Bar Front End)</b>									
2"	C101KE		Torsion Keys (Front Leveling Kit)						
			C101KE						
<b>93-98 Tahoe / Yukon Full-Size 4WD System (2 Door Only)</b>									
4.5-6"	C4636KST	K2, K3, K11, K26	C46+C466+C4636S			2	CR16S		
KIT NOTES: K2. Includes Brake Line Brackets. K3. Driveline / Exhaust Modifications may be Necessary. K11. 98-99 4-Door Yukon & Tahoe Extends Strut Arms 2" (4.5-6" Kit - The Strut Arms MUST be Lengthened 2"). K26. On Canadian Made Vehicle & 98-99 Models Steering Modification will be Necessary.									
<b>92 Blazer / Yukon Full-Size 4WD Kit</b>									
4.5-6"	C4626K	K2, K3, K26	C46+C466+C4626						
KIT NOTES: K2. Includes Brake Line Brackets. K3. Driveline / Exhaust Mods may be Necessary. K26. On Canadian Made Vehicle & 98-99 Models Steering Modification will be Necessary.									
<b>92 Blazer / Yukon Full-Size 4WD System</b>									
4.5-6"	C4626KST	K2, K3, K26	C46+C466+C4626S			2	CR16S		
KIT NOTES: K2. Includes Brake Line Brackets. K3. Driveline / Exhaust Mods may be Necessary. K26. On Canadian Made Vehicle & 98-99 Models Steering Modification will be Necessary.									
<b>67-91 BLAZER / JIMMY FULL-SIZE 4WD</b>									
<b>88-91 Blazer / Jimmy Full-Size 4WD Kit</b>									
<b>With Blocks &amp; U-Bolts &amp;/or Add-A-Leafs</b>									
2.5"	C125AK8	K10	C125A8	2	C125S				CA50
4"	C140AK8	K4, K6, K7, K10	C140A8	2	C140S				CA100
6"	C160AK8	K3, K4, K6, K7, K10, K22	C168A8	2	C160S				CA100
8"	C180AK8	K3, K4, K6, K7, K10, K22	C168A8	2	C180S			R1120	CA50+CA100
KIT NOTES: K3. Driveline / Exhaust Modifications may be Necessary. K4. Transfer Case Lowering Kit # TCL15 may be Needed. K6. Optional 4" Offset Drag Link Available - # GMDL4. K7. See Brake Lines Section. K10. Fitted Leafs are Available for Additional Weight Capacity (Heavy Winch Bumper, Big Block or Diesel Engine, Etc.). See Leaf Springs Section. K22. If Vehicle is Equipped with a Front Sway Bar, Lowering Brackets must be Ordered. See Chevrolet / GM Accessories.									
<b>88-91 Blazer / Jimmy Full-Size 4WD System</b>									
<b>With Replacement Rear Springs</b>									
2.5"	C125AKS8	K10	C124AS8	2	C125S	2	CR12S		CA50
4"	C140AKS8	K4, K6, K7, K10	C124AS8	2	C140S	2	CR14S		CA100
6"	C160AKS8	K3, K4, K6, K7, K10, K22	C168AS8	2	C160S	2	CR16S		CA100
8"	C180AKS8	K3, K4, K6, K7, K10, K22	C168AS8	2	C180S	2	CR18S		CA50+CA100
KIT NOTES: K3. Driveline / Exhaust Modifications may be Necessary. K4. Transfer Case Lowering Kit # TCL15 may be Needed. K6. Optional 4" Offset Drag Link Available - # GMDL4. K7. See Brake Lines Section. K10. Fitted Leafs are Available for Additional Weight Capacity (Heavy Winch Bumper, Big Block or Diesel Engine, Etc.). See Leaf Springs Section. K22. If Vehicle is Equipped with a Front Sway Bar, Lowering Brackets must be Ordered. See Chevrolet / GM Accessories.									
<b>73-87 Blazer / Jimmy Full-Size 4WD Kit</b>									
<b>With Blocks &amp; U-Bolts &amp;/or Add-A-Leafs</b>									
2.5"	C125AK	K10	C125A	2	C125S				CA50
4"	C140AK	K4, K6, K7, K10	C140A	2	C140S				CA100
6"	C160AK	K3, K4, K6, K7, K10, K22	C168A	2	C160S				CA100
8"	C180AK	K3, K4, K6, K7, K10, K22	C168A	2	C180S			R1120	CA50+CA100
KIT NOTES: K3. Driveline / Exhaust Modifications may be Necessary. K4. Transfer Case Lowering Kit # TCL15 may be Needed. K6. Optional 4" Offset Drag Link Available - # GMDL4. K7. See Brake Lines Section. K10. Fitted Leafs are Available for Additional Weight Capacity (Heavy Winch Bumper, Big Block or Diesel Engine, Etc.). See Leaf Springs Section. K22. If Vehicle is Equipped with a Front Sway Bar, Lowering Brackets must be Ordered. See Chevrolet / GM Accessories.									
<b>73-87 Blazer / Jimmy Full-Size 4WD System</b>									
<b>With Replacement Rear Springs</b>									
2.5"	C125AKS	K10	C124AS	2	C125S	2	CR12S		CA50
4"	C140AKS	K4, K6, K7, K10	C124AS	2	C140S	2	CR14S		CA100
6"	C160AKS	K3, K4, K6, K7, K10, K22	C168AS	2	C160S	2	CR16S		CA100
8"	C180AKS	K3, K4, K6, K7, K10, K22	C168AS	2	C180S	2	CR18S		CA50+CA100
KIT NOTES: K3. Driveline / Exhaust Modifications may be Necessary. K4. Transfer Case Lowering Kit # TCL15 may be Needed. K6. Optional 4" Offset Drag Link Available - # GMDL4. K7. See Brake Lines Section. K10. Fitted Leafs are Available for Additional Weight Capacity (Heavy Winch Bumper, Big Block or Diesel Engine, Etc.). See Leaf Springs Section. K22. If Vehicle is Equipped with a Front Sway Bar, Lowering Brackets must be Ordered. See Chevrolet / GM Accessories.									
<b>69-72 Blazer / Jimmy Full-Size 4WD Kit</b>									
<b>With Blocks &amp; U-Bolts &amp;/or Add-A-Leafs</b>									
2.5"	C225AK	K10	C225A	2	C225S				CA50
4"	C240AK	K3, K5, K6, K7, K10	C240A	2	C240S				CA100
6"	C260AK	K3, K5, K6, K7, K10, K22	C268A	2	C260S				CA100
8"	C280AK	K3, K5, K6, K7, K10, K22	C268A	2	C280S			R1120	CA50+CA100
KIT NOTES: K3. Driveline / Exhaust Modifications may be Necessary. K5. Must have 3-Bolt Steering Knuckle. (If Your Vehicle has a 4 Bolt Closed Knuckle, Use GMDL4, Not CA100). K6. Optional 4" Offset Drag Link Available - # GMDL4. K7. See Brake Lines Section. K10. Fitted Leafs are Available for Additional Weight Capacity (Heavy Winch Bumper, Big Block or Diesel Engine, Etc.). See Leaf Springs Section. K22. If Vehicle is Equipped with a Front Sway Bar, Lowering Brackets must be Ordered.									

# CHEVROLET / GMC

CHEVROLET / GMC

	Steering Stabilizers									HYDRO Shocks		NITRO Shocks		BLACK MAX		M95 Shocks		Labor
	White			Black			Silver			White		White		Black		Silver		
	OEM	Single	Dual	OEM	Single	Dual	OEM	Single	Dual	Front	Rear	Front	Rear	Front	Rear	Front	Rear	Hours
										H7081	H8084	N8081	N8084	B8581	B8584	M9581	M9584	2
										H7085	H7086	N8085	N8086	B8585	B8586	M9585	M9586	12
										H7085	H7086	N8085	N8086	B8585	B8586	M9585	M9586	12
										H7085	H7086	N8085	N8086	B8585	B8586	M9585	M9586	12

**NOTE: ALL SHOCKS MUST BE ORDERED SEPARATELY**

	7055		7220	8055		8220	9055		9220	H7051	H7053	N8051	N8053	B8551	B8553	M9551	M9553	4
	7055		7220	8055		8220	9055		9220	H7051	H7053	N8051	N8053	B8551	B8553	M9551	M9553	4
	7055		7220	8055		8220	9055		9220	H7071	H7073	N8071	N8073	B8571	B8573	M9571	M9573	6
	7055		7220	8055		8220	9055		9220	H7071	H7073	N8071	N8073	B8571	B8573	M9571	M9573	7

	7055		7220	8055		8220	9055		9220	H7051	H7053	N8051	N8053	B8551	B8553	M9551	M9553	5
	7055		7220	8055		8220	9055		9220	H7051	H7053	N8051	N8053	B8551	B8553	M9551	M9553	5
	7055		7220	8055		8220	9055		9220	H7071	H7073	N8071	N8073	B8571	B8573	M9571	M9573	6
	7055		7220	8055		8220	9055		9220	H7071	H7073	N8071	N8073	B8571	B8573	M9571	M9573	7

	7055		7220	8055		8220	9055		9220	H7051	H7053	N8051	N8053	B8551	B8553	M9551	M9553	4
	7055		7220	8055		8220	9055		9220	H7051	H7053	N8051	N8053	B8551	B8553	M9551	M9553	4
	7055		7220	8055		8220	9055		9220	H7071	H7073	N8071	N8073	B8571	B8573	M9571	M9573	6
	7055		7220	8055		8220	9055		9220	H7071	H7073	N8071	N8073	B8571	B8573	M9571	M9573	7

	7055		7220	8055		8220	9055		9220	H7051	H7053	N8051	N8053	B8551	B8553	M9551	M9553	5
	7055		7220	8055		8220	9055		9220	H7051	H7053	N8051	N8053	B8551	B8553	M9551	M9553	5
	7055		7220	8055		8220	9055		9220	H7071	H7073	N8071	N8073	B8571	B8573	M9571	M9573	6
	7055		7220	8055		8220	9055		9220	H7071	H7073	N8071	N8073	B8571	B8573	M9571	M9573	7

	7055		7220	8055		8220	9055		9220	H7051	H7041	N8051	N8041	B8551	B8541	M9551	M9541	4
	7055		7220	8055		8220	9055		9220	H7051	H7041	N8051	N8041	B8551	B8541	M9551	M9541	4
	7055		7220	8055		8220	9055		9220	H7071	H7060	N8071	N8060	B8571	B8560	M9571	M9560	6
	7055		7220	8055		8220	9055		9220	H7071	H7060	N8071	N8060	B8571	B8560	M9571	M9560	7

# CHEVROLET / GMC

LIFT	Quick Kit	KIT NOTES	Component Box	Front Springs		Rear Springs		Add-A-Leafs	Steering Correction
	Reference		(Requires 1 of Each)	Qty	Part #	Qty	Part #		(Order 1 Each)
<b>69-72 Blazer / Jimmy Full-Size 4WD System</b>									
			<b>With Replacement Rear Springs</b>						
2.5"	C225AJKS	K10	C224AS	2	C225S	2	CR14S		CA50
4"	C240AJKS	K3, K5, K6, K7, K10, K22	C224AS	2	C240S	2	CR16S		CA100
6"	C260AJKS	K3, K5, K6, K7, K10, K22	C268AS	2	C260S	2	CR18S		CA100
8"	C280AJKS	K3, K5, K6, K7, K9, K10, K22	C280ASD	2	C280S	2	CR18S		CA50+CA100
KIT NOTES: K3. Driveline / Exhaust Modifications may be Necessary. K5. Must have 3-Bolt Steering Knuckle. (If Your Vehicle has a 4 Bolt Closed Knuckle, Use GMDL4, Not CA100). K6. Optional 4" Offset Drag Link Available - # GMDL4. K7. See Brake Lines Section. K9. This Lift also Includes 2" Blocks. K10. Fitted Leafs are Available for Additional Weight Capacity (Heavy Winch Bumper, Big Block or Diesel Engine, Etc.). See Leaf Springs Section. K22. If Vehicle is Equipped with a Front Sway Bar. Lowering Brackets must be Ordered. See Chevrolet / GM Accessories.									
<b>07-20 SUBURBAN / YUKON XL 4WD (STRUT FRONT END)</b>									
<b>07-20 Suburban Yukon XL 1500 4WD Kit</b>			<b>Lower Cast Steel Spacers (Front Leveling Kit)</b>						
2"	C1420LMSA	K31, K36	C1420LMSA						
KIT NOTES: Installs Below Strut Assembly. K31. Part # C12CS Lifts Rear 1.25" if Needed. K36. Does Not Fit Magnaride.									
<b>07-20 Suburban Yukon XL 1500 4WD Kit</b>			<b>Metal Spacers (Front Leveling Kit)</b>						
2"	C720MS	K31, K36	C720MS						
KIT NOTES: Installs Above Strut Assembly. K31. Part # C12CS Lifts Rear 1.25" if Needed. K36. Does Not Fit Magnaride.									
<b>15-16 SUBURBAN / YUKON XL 1500</b>									
<b>15-16 Suburban / Yukon XL 1500 4WD / 2WD</b>			<b>Upper Control Arm Kit w/ Shock Extensions &amp; Cast Steel Control Arms</b>						
3.5-4"	C15350V	K35, K36	C15350V						
KIT NOTES: K35. Does NOT fit All Wheel Drive models. K36. Does NOT fit Auto Leveling or Auto Ride models. Models with Mass Damper will need to remove mass damper.									
<b>15-16 Suburban / Yukon XL 1500 4WD / 2WD</b>			<b>UCA Kit w/ Shock Extensions w/ Aluminum Or Stamped Steel Control Arms</b>						
3.5-4"	C15350VA	K35, K36	C15350VA						
KIT NOTES: K35. Does NOT fit All Wheel Drive models. K36. Does NOT fit Auto Leveling or Auto Ride models. Models with Mass Damper will need to remove mass damper.									
<b>07-13 SUBURBAN / YUKON XL 1500 4WD KIT</b>									
<b>07-13 Suburban / Yukon XL 1500 4WD KIT</b>			<b>With Rear Shock Brackets</b>						
3.5-4"	C7350V	K24, K25	C7350V						
KIT NOTES: K24. Does NOT fit All Wheel Drive models. K25. Does NOT fit Auto Leveling or Auto Ride models. Models with Mass Damper will need to remove mass damper.									
<b>07-13 Suburban Yukon XL 1500 4WD Kit</b>			<b>6-Lug with Replacement Rear Coils</b>						
3.5-4"	C7361SK	K23	C7361A+C7361ST+C7361SR						
KIT NOTES: K23. OEM Tires & Wheels can be Used.									
<b>07-13 Suburban Yukon XL 1500 4WD Kit</b>			<b>6-Lug with Replacement Rear Coils (Autoride)</b>						
3.5"	C7361ARK	K23	C7361A+C7361AR+C7361SR						
KIT NOTES: K23. OEM Tires & Wheels can be Used.									
<b>07-13 Suburban Yukon XL 1500 4WD Kit</b>			<b>6-Lug with Replacement Rear Coils (Not Designed for Autoride)</b>						
6"	C7661SK	K23	C7661A+C7661ST+C7661SR						
KIT NOTES: K23. OEM Tires & Wheels can be Used.									
<b>00-06 SUBURBAN / YUKON XL 4WD</b>									
<b>00-06 Suburban / Yukon XL (Torsion Bar Front End)</b>			<b>Torsion Keys (Front Leveling Kit)</b>						
2"	C101KE		C101KE						
<b>00-06 Suburban Yukon XL 1500 4WD System</b>			<b>6-Lug with Replacement Rear Coils</b>						
3"	C9331K	K16, K23	C9341+C933R						
KIT NOTES: Does NOT Require Removal of the Front Upper Differential Housing Mount. K16. Autoride Models Order Part # C93AR. Factory Shocks will be Retained. K23. OEM Tires & Wheels can be Used.									
<b>00-06 Suburban Yukon XL 1500 4WD System</b>			<b>Not Designed for Autoride Models</b>						
6"	C9631K	K27	C9631A+C9631B			1	C50R		
KIT NOTES: Does NOT Require Removal of the Front Upper Differential Housing Mount. K27. Not Designed for Autoride Models.									
<b>00-06 Suburban Yukon XL 2500 4WD KIT</b>			<b>Not Designed for Autoride Models</b>						
6"	C9671K	K12	C9671A+C9671B						
KIT NOTES: K12. CAN NOT Re-Use OEM Wheels. REQUIRES 4.5" Back Spacing on Wheels.									

# CHEVROLET / GMC

CHEVROLET / GMC

	Steering Stabilizers									HYDRO Shocks		NITRO Shocks		BLACK MAX		M95 Shocks		Labor Hours
	White			Black			Silver			White		White		Black		Silver		
	OEM	Single	Dual	OEM	Single	Dual	OEM	Single	Dual	Front	Rear	Front	Rear	Front	Rear	Front	Rear	Front
	7055		7220	8055		8220	9055		9220	H7051	H7041	N8051	N8041	B8551	B8541	M9551	M9541	5
	7055		7220	8055		8220	9055		9220	H7051	H7041	N8051	N8041	B8551	B8541	M9551	M9541	5
	7055		7220	8055		8220	9055		9220	H7071	H7060	N8071	N8060	B8571	B8560	M9571	M9560	6
	7055		7220	8055		8220	9055		9220	H7071	H7060	N8071	N8060	B8571	B8560	M9571	M9560	7

**NOTE: ALL SHOCKS MUST BE ORDERED SEPARATELY**

										-----	H7027	-----	N8027	-----	B8527	-----	M9527	2
--	--	--	--	--	--	--	--	--	--	-------	-------	-------	-------	-------	-------	-------	-------	---

										-----	H7027	-----	N8027	-----	B8527	-----	M9527	2
--	--	--	--	--	--	--	--	--	--	-------	-------	-------	-------	-------	-------	-------	-------	---

**NOTE: ALL SHOCKS MUST BE ORDERED SEPARATELY**

										-----		-----		-----		-----		5
--	--	--	--	--	--	--	--	--	--	-------	--	-------	--	-------	--	-------	--	---

										-----		-----		-----		-----		5
--	--	--	--	--	--	--	--	--	--	-------	--	-------	--	-------	--	-------	--	---

**NOTE: ALL SHOCKS MUST BE ORDERED SEPARATELY**

										-----		-----		-----		-----		5
--	--	--	--	--	--	--	--	--	--	-------	--	-------	--	-------	--	-------	--	---

										-----	H7030	-----	N8030	-----	B8530	-----	M9530	8
--	--	--	--	--	--	--	--	--	--	-------	-------	-------	-------	-------	-------	-------	-------	---

										-----		-----		-----		-----		8
--	--	--	--	--	--	--	--	--	--	-------	--	-------	--	-------	--	-------	--	---

										-----	H7070	-----	N8070	-----	B8570	-----	M9570	8
--	--	--	--	--	--	--	--	--	--	-------	-------	-------	-------	-------	-------	-------	-------	---

**NOTE: ALL SHOCKS MUST BE ORDERED SEPARATELY**

										-----		-----		-----		-----		2
--	--	--	--	--	--	--	--	--	--	-------	--	-------	--	-------	--	-------	--	---

		7196 <sup>(K)</sup>	7296 <sup>(K)</sup>		8196 <sup>(K)</sup>	8296 <sup>(K)</sup>		9196 <sup>(K)</sup>	9296 <sup>(K)</sup>	H7003	H7017	N8003	N8017	B8503	B8517	M9503	M9517	8
--	--	---------------------	---------------------	--	---------------------	---------------------	--	---------------------	---------------------	-------	-------	-------	-------	-------	-------	-------	-------	---

(K) 'Single' or 'Dual' Steering Stabilizers can ONLY be Used with Skyjacker Suspension Lift.

		7196 <sup>(K)</sup>	7296 <sup>(K)</sup>		8196 <sup>(K)</sup>	8296 <sup>(K)</sup>		9196 <sup>(K)</sup>	9296 <sup>(K)</sup>	H7096	H7036	N8096	N8036	B8596	B8536	M9596	M9536	10
--	--	---------------------	---------------------	--	---------------------	---------------------	--	---------------------	---------------------	-------	-------	-------	-------	-------	-------	-------	-------	----

	7098		7298 <sup>(K)</sup>	8098		8298 <sup>(K)</sup>	9098		9298 <sup>(K)</sup>	H7074	H7036	N8074	N8036	B8574	B8536	M9574	M9536	8
--	------	--	---------------------	------	--	---------------------	------	--	---------------------	-------	-------	-------	-------	-------	-------	-------	-------	---

(K) 'Single' or 'Dual' Steering Stabilizers can ONLY be Used with Skyjacker Suspension Lift.

# CHEVROLET / GMC

LIFT	Quick Kit	KIT NOTES	Component Box	Front Springs		Rear Springs		Add-A-Leafs	Steering Correction
	Reference		(Requires 1 of Each)	Qty	Part #	Qty	Part #		(Order 1 Each)
<b>92-99 SUBURBAN 4WD</b>									
<b>92-99 Suburban (Torsion Bar Front End)</b>			<b>Torsion Keys (Front Leveling Kit)</b>						
2"	C101KE		C101KE						
<b>97-99 Suburban 4WD Kit</b>			<b>6-Lug with Rear Add-A-Leafs</b>						
2-2.5"	C2567K	K1, K2	C2567					R1120	
KIT NOTES: K1. Includes # FBL97 Front Brake Lines. K2. Includes Brake Line Brackets.									
<b>92-96 Suburban 4WD Kit</b>			<b>6-Lug with Rear Add-A-Leafs</b>						
2-2.5"	C256K		C256					R1120	
<b>93-99 Suburban 4WD Kit</b>			<b>6-Lug with Blocks &amp; U-Bolts</b>						
4.5-6"	C4636K	K2, K3, K26	C46+C466+C4636						
KIT NOTES: K2. Includes Brake Line Brackets. K3. Driveline / Exhaust Modifications may be Necessary. K26. On Canadian Made Vehicle & 98-99 Models Steering Mods will be Necessary.									
<b>88-91 SUBURBAN 4WD 6-LUG</b>									
<b>88-91 Suburban 4WD Kit</b>			<b>6-Lug with Blocks &amp; U-Bolts &amp;/or Add-A-Leafs</b>						
2.5"	C125AK8	K10	C125A8	2	C125S				CA50
4"	C140AK8	K7, K10, K22	C140A8	2	C140S				CA50
6"	C160AK8	K3, K6, K7, K10, K22	C168A8	2	C160S				CA100
8"	C180AK8	K3, K4, K6, K7, K10, K22	C168A8	2	C180S			R225	CA50+CA100
KIT NOTES: K3. Driveline / Exhaust Modifications may be Necessary. K4. Transfer Case Lowering Kit # TCL15 may be Needed. K6. Optional 4" Offset Drag Link Available - # GMDL4. K7. See Brake Lines Section. K10. Fitted Leafs are Available for Additional Weight Capacity (Heavy Winch Bumper, Big Block or Diesel Engine, Etc.). See Leaf Springs Section. K22. If Vehicle is Equipped with a Front Sway Bar, Lowering Brackets must be Ordered. See Chevrolet / GM Accessories.									
<b>88-91 Suburban 4WD System</b>			<b>6-Lug with 52" Replacement Rear Springs</b>						
2.5"	C125AKSS8	K10	C124AS8	2	C125S	2	CR14S		CA50
4"	C140AKSS8	K7, K10, K22	C124AS8	2	C140S	2	CR16S		CA50
6"	C160AKSS8	K3, K6, K7, K10, K22	C168AS8	2	C160S	2	CR18S		CA100
8"	C180AKSS8	K3, K4, K6, K7, K9, K10, K22	C180ASD8	2	C180S	2	CR18S		CA50+CA100
KIT NOTES: K3. Driveline / Exhaust Modifications may be Necessary. K4. Transfer Case Lowering Kit # TCL15 may be Needed. K6. Optional 4" Offset Drag Link Available - # GMDL4. K7. See Brake Lines Section. K9. This Lift also Includes 2" Blocks. K10. Fitted Leafs are Available for Additional Weight Capacity (Heavy Winch Bumper, Big Block or Diesel Engine, Etc.). See Leaf Springs Section. K22. If Vehicle is Equipped with a Front Sway Bar, Lowering Brackets must be Ordered.									
<b>88-91 SUBURBAN 4WD</b>									
<b>88-91 Suburban 4WD System</b>			<b>6-Lug with 56" Replacement Rear Springs</b>						
4"	C140AKSD8	K7, K10, K22	C124AS8	2	C140S	2	CR24S		CA50
6"	C160AKSD8	K3, K6, K7, K10, K22	C168AS8	2	C160S	2	CR26S		CA100
8"	C180AKSD8	K3, K4, K6, K7, K9, K10, K22	C180ASD8	2	C180S	2	CR26S		CA50+CA100
KIT NOTES: K3. Driveline / Exhaust Modifications may be Necessary. K4. Transfer Case Lowering Kit # TCL15 may be Needed. K6. Optional 4" Offset Drag Link Available - # GMDL4. K7. See Brake Lines Section. K9. This Lift also Includes 2" Blocks. K10. Fitted Leafs are Available for Additional Weight Capacity (Heavy Winch Bumper, Big Block or Diesel Engine, Etc.). See Leaf Springs Section. K22. If Vehicle is Equipped with a front Sway Bar, Lowering Brackets must be Ordered.									
<b>88-91 Suburban 4WD Kit</b>			<b>8-Lug with Blocks &amp; U-Bolts &amp;/or Add-A-Leafs</b>						
2.5"	C125BK8	K10	C125B8	2	C125S				CA50
4"	C140BK8	K7, K10, K22	C140B8	2	C140S				CA50
6"	C160BK8	K3, K6, K7, K10, K22	C168B8	2	C160S				CA100
8"	C180BK8	K3, K4, K6, K7, K10, K22	C168B8	2	C180S			R225	CA50+CA100
KIT NOTES: K3. Driveline / Exhaust Modifications may be Necessary. K4. Transfer Case Lowering Kit # TCL15 may be Needed. K5. Must have 3-Bolt Steering Knuckle. (If Your Vehicle has a 4 Bolt Closed Knuckle, Use GMDL4, Not CA100) K6. Optional 4" Offset Drag Link Available - # GMDL4. K7. See Brake Lines Section. K10. Fitted Leafs are Available for Additional Weight Capacity (Heavy Winch Bumper, Big Block or Diesel Engine, Etc.). See Leaf Springs Section. K22. If Vehicle is Equipped with a Front Sway Bar, Lowering Brackets must be Ordered. See Chevrolet / GM Accessories.									
<b>88-91 Suburban 4WD System</b>			<b>8-Lug with 56-Inch Replacement Rear Springs</b>						
4"	C140BKSD8	K7, K10, K22	C124BS8	2	C140S	2	CR24S		CA50
6"	C160BKSD8	K3, K6, K7, K10, K22	C168BS8	2	C160S	2	CR26S		CA100
8"	C180BKSD8	K3, K4, K5, K6, K7, K9, K10, K22	C180BSD8	2	C180S	2	CR26S		CA50+CA100
KIT NOTES: K3. Driveline / Exhaust Modifications may be Necessary. K4. Transfer Case Lowering Kit # TCL15 may be Needed. K5. Must have 3-Bolt Steering Knuckle. (If Your Vehicle has a 4 Bolt Closed Knuckle, Use GMDL4, Not CA100) K6. Optional 4" Offset Drag Link Available - # GMDL4. K7. See Brake Lines Section. K9. This Lift also Includes 2" Blocks. K10. Fitted Leafs are Available for Additional Weight Capacity (Heavy Winch Bumper, Big Block or Diesel Engine, Etc.). See Leaf Springs Section. K22. If Vehicle is Equipped with a Front Sway Bar, Lowering Brackets must be Ordered. See Chevrolet / GM Accessories.									



# CHEVROLET / GMC

CHEVROLET / GMC

	Steering Stabilizers									HYDRO Shocks		NITRO Shocks		BLACK MAX		M95 Shocks		Labor Hours
	White			Black			Silver			White		White		Black		Silver		
	OEM	Single	Dual	OEM	Single	Dual	OEM	Single	Dual	Front	Rear	Front	Rear	Front	Rear	Front	Rear	

**NOTE: ALL SHOCKS MUST BE ORDERED SEPARATELY**

										H7081	H7084	N8081	N8084	B8581	B8584	M9581	M9584	2
--	--	--	--	--	--	--	--	--	--	-------	-------	-------	-------	-------	-------	-------	-------	---

		7122			8122			9122		H7081	H7084	N8081	N8084	B8581	B8584	M9581	M9584	8
--	--	------	--	--	------	--	--	------	--	-------	-------	-------	-------	-------	-------	-------	-------	---

		7122			8122			9122		H7081	H7084	N8081	N8084	B8581	B8584	M9581	M9584	8
--	--	------	--	--	------	--	--	------	--	-------	-------	-------	-------	-------	-------	-------	-------	---

										H7085	H7086	N8085	N8086	B8585	B8586	M9585	M9586	12
--	--	--	--	--	--	--	--	--	--	-------	-------	-------	-------	-------	-------	-------	-------	----

**NOTE: ALL SHOCKS MUST BE ORDERED SEPARATELY**

	7055		7220	8055		8220	9055		9220	H7051	H7053	N8051	N8053	B8551	B8553	M9551	M9553	4
--	------	--	------	------	--	------	------	--	------	-------	-------	-------	-------	-------	-------	-------	-------	---

	7055		7220	8055		8220	9055		9220	H7051	H7053	N8051	N8053	B8551	B8553	M9551	M9553	4
--	------	--	------	------	--	------	------	--	------	-------	-------	-------	-------	-------	-------	-------	-------	---

	7055		7220	8055		8220	9055		9220	H7071	H7073	N8071	N8073	B8571	B8573	M9571	M9573	6
--	------	--	------	------	--	------	------	--	------	-------	-------	-------	-------	-------	-------	-------	-------	---

	7055		7220	8055		8220	9055		9220	H7071	H7073	N8071	N8073	B8571	B8573	M9571	M9573	7
--	------	--	------	------	--	------	------	--	------	-------	-------	-------	-------	-------	-------	-------	-------	---

	7055		7220	8055		8220	9055		9220	H7051	H7053	N8051	N8053	B8551	B8553	M9551	M9553	5
--	------	--	------	------	--	------	------	--	------	-------	-------	-------	-------	-------	-------	-------	-------	---

	7055		7220	8055		8220	9055		9220	H7051	H7053	N8051	N8053	B8551	B8553	M9551	M9553	5
--	------	--	------	------	--	------	------	--	------	-------	-------	-------	-------	-------	-------	-------	-------	---

	7055		7220	8055		8220	9055		9220	H7071	H7073	N8071	N8073	B8571	B8573	M9571	M9573	6
--	------	--	------	------	--	------	------	--	------	-------	-------	-------	-------	-------	-------	-------	-------	---

	7055		7220	8055		8220	9055		9220	H7071	H7073	N8071	N8073	B8571	B8573	M9571	M9573	7
--	------	--	------	------	--	------	------	--	------	-------	-------	-------	-------	-------	-------	-------	-------	---

**NOTE: ALL SHOCKS MUST BE ORDERED SEPARATELY**

	7055		7220	8055		8220	9055		9220	H7051	H7053	N8051	N8053	B8551	B8553	M9551	M9553	5
--	------	--	------	------	--	------	------	--	------	-------	-------	-------	-------	-------	-------	-------	-------	---

	7055		7220	8055		8220	9055		9220	H7071	H7073	N8071	N8073	B8571	B8573	M9571	M9573	6
--	------	--	------	------	--	------	------	--	------	-------	-------	-------	-------	-------	-------	-------	-------	---

	7055		7220	8055		8220	9055		9220	H7071	H7073	N8071	N8073	B8571	B8573	M9571	M9573	7
--	------	--	------	------	--	------	------	--	------	-------	-------	-------	-------	-------	-------	-------	-------	---

	7055		7220	8055		8220	9055		9220	H7051	H7053	N8051	N8053	B8551	B8553	M9551	M9553	4
--	------	--	------	------	--	------	------	--	------	-------	-------	-------	-------	-------	-------	-------	-------	---

	7055		7220	8055		8220	9055		9220	H7051	H7053	N8051	N8053	B8551	B8553	M9551	M9553	4
--	------	--	------	------	--	------	------	--	------	-------	-------	-------	-------	-------	-------	-------	-------	---

	7055		7220	8055		8220	9055		9220	H7071	H7073	N8071	N8073	B8571	B8573	M9571	M9573	6
--	------	--	------	------	--	------	------	--	------	-------	-------	-------	-------	-------	-------	-------	-------	---

	7055		7220	8055		8220	9055		9220	H7071	H7073	N8071	N8073	B8571	B8573	M9571	M9573	7
--	------	--	------	------	--	------	------	--	------	-------	-------	-------	-------	-------	-------	-------	-------	---

	7055		7220	8055		8022	9055		9022	H7071	H7073	N8071	N8073	B8571	B8573	M9571	M9573	5
--	------	--	------	------	--	------	------	--	------	-------	-------	-------	-------	-------	-------	-------	-------	---

	7055		7220	8055		8022	9055		9022	H7071	H7073	N8071	N8073	B8571	B8573	M9571	M9573	6
--	------	--	------	------	--	------	------	--	------	-------	-------	-------	-------	-------	-------	-------	-------	---

	7055		7220	8055		8220	9055		9220	H7071	H7073	N8071	N8073	B8571	B8573	M9571	M9573	7
--	------	--	------	------	--	------	------	--	------	-------	-------	-------	-------	-------	-------	-------	-------	---

# CHEVROLET / GMC

LIFT	Quick Kit	KIT NOTES	Component Box	Front Springs		Rear Springs		Add-A-Leafs	Steering Correction
	Reference		(Requires 1 of Each)	Qty	Part #	Qty	Part #		(Order 1 Each)
<b>73-87 SUBURBAN 4WD 6-LUG</b>									
<b>73-87 Suburban 4WD Kit</b>			<b>6-Lug with Blocks &amp; U-Bolts &amp;/or Add-A-Leafs</b>						
2.5"	C125AK	K10	C125A	2	C125S				CA50
4"	C140AK	K7, K10	C140A	2	C140S				CA50
6"	C160AK	K3, K6, K7, K10, K22	C168A	2	C160S				CA100
8"	C180AK	K3, K4, K6, K7, K10, K22	C168A	2	C180S			R225	CA50+CA100
KIT NOTES: K3. Driveline / Exhaust Modifications may be Necessary. K4. Transfer Case Lowering Kit # TCL15 may be Needed. K6. Optional 4" Offset Drag Link Available - # GMDL4. K7. See Brake Lines Section. K10. Fitted Leafs are Available for Additional Weight Capacity (Heavy Winch Bumper, Big Block or Diesel Engine, Etc.). See Leaf Springs Section. K22. If Vehicle is Equipped with a Front Sway Bar, Lowering Brackets must be Ordered. See Chevrolet / GM Accessories.									
<b>73-87 Suburban 4WD System</b>			<b>6-Lug with 52" Replacement Rear Springs</b>						
2.5"	C125AKSS	K10	C124AS	2	C125S	2	CR14S		CA50
4"	C140AKSS	K7, K10	C124AS	2	C140S	2	CR16S		CA50
6"	C160AKSS	K3, K6, K7, K10, K22	C168AS	2	C160S	2	CR18S		CA100
KIT NOTES: K3. Driveline / Exhaust Modifications may be Necessary. K6. Optional 4" Offset Drag Link Available - # GMDL4. K7. See Brake Lines Section. K10. Fitted Leafs are Available for Additional Weight Capacity (Heavy Winch Bumper, Big Block or Diesel Engine, Etc.). See Leaf Springs Section. K22. If Vehicle is Equipped with a Front Sway Bar, Lowering Brackets must be Ordered. See Chevrolet / GM Accessories.									
<b>73-87 Suburban 4WD System</b>			<b>6-Lug with 56" Replacement Rear Springs</b>						
4"	C140AKSD	K10	C124AS	2	C140S	2	CR24S		CA50
6"	C160AKSD	K3, K6, K7, K10, K22	C168AS	2	C160S	2	CR26S		CA100
8"	C180AKSD	K3, K4, K6, K7, K9, K10, K22	C180ASD	2	C180S	2	CR26S		CA50+CA100
KIT NOTES: K3. Driveline / Exhaust Modifications may be Necessary. K4. Transfer Case Lowering Kit # TCL15 may be Needed. K6. Optional 4" Offset Drag Link Available - # GMDL4. K9. This Lift also Includes 2" Blocks. K7. See Brake Lines Section. K10. Fitted Leafs are Available for Additional Weight Capacity (Heavy Winch Bumper, Big Block or Diesel Engine, Etc.). See Leaf Springs Section. K22. If Vehicle is Equipped with a Front Sway Bar, Lowering Brackets must be Ordered. See Chevrolet / GM Accessories.									
<b>73-87 SUBURBAN 4WD</b>									
<b>73-87 Suburban 4WD Kit</b>			<b>8-Lug with Blocks &amp; U-Bolts &amp;/or Add-A-Leafs</b>						
2.5"	C125BK	K10	C125B	2	C125S				CA50
4"	C140BK	K7, K10	C140B	2	C140S				CA50
6"	C160BK	K3, K6, K7, K10, K22	C168B	2	C160S				CA100
8"	C180BK	K3, K4, K6, K7, K10, K22	C168B	2	C180S			R225	CA50+CA100
KIT NOTES: K3. Driveline / Exhaust Modifications may be Necessary. K4. Transfer Case Lowering Kit # TCL15 may be Needed. K5. Must have 3-Bolt Steering Knuckle. (If Your Vehicle has a 4 Bolt Closed Knuckle, Use GMDL4, Not CA100) K6. Optional 4" Offset Drag Link Available - # GMDL4. K7. See Brake Lines Section. K10. Fitted Leafs are Available for Additional Weight Capacity (Heavy Winch Bumper, Big Block or Diesel Engine, Etc.). See Leaf Springs Section. K22. If Vehicle is Equipped with a Front Sway Bar, Lowering Brackets must be Ordered. See Chevrolet / GM Accessories.									
<b>73-87 Suburban 4WD System</b>			<b>8-Lug with 56" Replacement Rear Springs</b>						
4"	C140BKSD	K7, K10	C124BS	2	C140S	2	CR24S		CA50
6"	C160BKSD	K3, K6, K7, K10, K22	C168BS	2	C160S	2	CR26S		CA100
8"	C180BKSD	K3, K4, K6, K7, K9, K10, K22	C180BSD	2	C180S	2	CR26S		CA50+CA100
KIT NOTES: K3. Driveline / Exhaust Modifications may be Necessary. K4. Transfer Case Lowering Kit # TCL15 may be Needed. K5. Must have 3-Bolt Steering Knuckle. (If Your Vehicle has a 4 Bolt Closed Knuckle, Use GMDL4, Not CA100) K6. Optional 4" Offset Drag Link Available - # GMDL4. K7. See Brake Lines Section. K9. This Lift also Includes 2" Blocks. K10. Fitted Leafs are Available for Additional Weight Capacity (Heavy Winch Bumper, Big Block or Diesel Engine, Etc.). See Leaf Springs Section. K22. If Vehicle is Equipped with a Front Sway Bar, Lowering Brackets must be Ordered. See Chevrolet / GM Accessories.									
<b>67-72 SUBURBAN 4WD</b>									
<b>67-72 Suburban 4WD Kit</b>			<b>With Blocks &amp; U-Bolts &amp;/or Add-A-Leafs</b>						
2.5"	C225AK	K10	C225A	2	C225S				CA50
4"	C240AK	K7, K10	C240A	2	C240S				CA50
6"	C260AK	K5, K6, K7, K22	C268A	2	C260S				CA100
8"	C280AK	K3, K5, K6, K7, K22	C268A	2	C280S			R225	CA50+CA100
KIT NOTES: K3. Driveline / Exhaust Modifications may be Necessary. K5. Must have 3-Bolt Steering Knuckle. (If Your Vehicle has a 4 Bolt Closed Knuckle, Use GMDL4, Not CA100) K6. Optional 4" Offset Drag Link Available - # GMDL4. K7. See Brake Lines Section. K22. If Vehicle is Equipped with a Front Sway Bar, Lowering Brackets must be Ordered. See Chevrolet / GM Accessories.									
<b>69-72 Suburban 4WD System</b>			<b>With 52" Replacement Rear Springs</b>						
2.5"	C225AKSS	K10	C224AS	2	C225S	2	CR14S		CA50
4"	C240AKSS	K7, K10	C224AS	2	C240S	2	CR16S		CA50
6"	C260AKSS	K5, K6, K7, K10, K22	C268AS	2	C260S	2	CR18S		CA100
8"	C280AKSS	K3, K5, K6, K7, K9, K10, K22	C280ASD	2	C280S	2	CR18S		CA50+CA100
KIT NOTES: K3. Driveline / Exhaust Modifications may be Necessary. K5. Must have 3-Bolt Steering Knuckle. K6. Optional 4" Offset Drag Link Available - # GMDL4. K7. See Brake Lines Section. K9. This Lift also Includes 2" Blocks. K10. Fitted Leafs are Available for Additional Weight Capacity (Heavy Winch Bumper, Big Block or Diesel Engine, Etc.). See Leaf Springs Section. K22. If Vehicle is Equipped with a Front Sway Bar, Lowering Brackets must be Ordered. See Chevrolet / GM Accessories.									

# CHEVROLET / GMC

CHEVROLET / GMC

	Steering Stabilizers									HYDRO Shocks		NITRO Shocks		BLACK MAX		M95 Shocks		Labor
	White			Black			Silver			White		White		Black		Silver		
	OEM	Single	Dual	OEM	Single	Dual	OEM	Single	Dual	Front	Rear	Front	Rear	Front	Rear	Front	Rear	Hours

**NOTE: ALL SHOCKS MUST BE ORDERED SEPARATELY**

	7055		7220	8055		8220	9055		9220	H7051	H7053	N8051	N8053	B8551	B8553	M9551	M9553	4
	7055		7220	8055		8220	9055		9220	H7051	H7053	N8051	N8053	B8551	B8553	M9551	M9553	4
	7055		7220	8055		8220	9055		9220	H7071	H7073	N8071	N8073	B8571	B8573	M9571	M9573	6
	7055		7220	8055		8220	9055		9220	H7071	H7073	N8071	N8073	B8571	B8573	M9571	M9573	7

	7055		7220	8055		8220	9055		9220	H7051	H7053	N8051	N8053	B8551	B8553	M9551	M9553	6
	7055		7220	8055		8220	9055		9220	H7051	H7053	N8051	N8053	B8551	B8553	M9551	M9553	6
	7055		7220	8055		8220	9055		9220	H7071	H7073	N8071	N8073	B8571	B8573	M9571	M9573	7

	7055		7220	8055		8220	9055		9220	H7051	H7053	N8051	N8053	B8551	B8553	M9551	M9553	6
	7055		7220	8055		8220	9055		9220	H7071	H7073	N8071	N8073	B8571	B8573	M9571	M9573	7
	7055		7220	8055		8220	9055		9220	H7071	H7073	N8071	N8073	B8571	B8573	M9571	M9573	7

**NOTE: ALL SHOCKS MUST BE ORDERED SEPARATELY**

	7055		7220	8055		8220	9055		9220	H7051	H7053	N8051	N8053	B8551	B8553	M9551	M9553	4
	7055		7220	8055		8220	9055		9220	H7051	H7053	N8051	N8053	B8551	B8553	M9551	M9553	4
	7055		7220	8055		8220	9055		9220	H7071	H7073	N8071	N8073	B8571	B8573	M9571	M9573	6
	7055		7220	8055		8220	9055		9220	H7071	H7073	N8071	N8073	B8571	B8573	M9571	M9573	7

	7055		7220	8055		8220	9055		9220	H7051	H7053	N8051	N8053	B8551	B8553	M9551	M9553	6
	7055		7220	8055		8220	9055		9220	H7071	H7073	N8071	N8073	B8571	B8573	M9571	M9573	7
	7055		7220	8055		8220	9055		9220	H7071	H7073	N8071	N8073	B8571	B8573	M9571	M9573	7

**NOTE: ALL SHOCKS MUST BE ORDERED SEPARATELY**

	7055		7220	8055		8220	9055		9220	H7051	H7041	N8051	N8041	B8551	B8541	M9551	M9541	4
	7055		7220	8055		8220	9055		9220	H7051	H7041	N8051	N8041	B8551	B8541	M9551	M9541	4
	7055		7220	8055		8220	9055		9220	H7071	H7060	N8071	N8060	B8571	B8560	M9571	M9560	6
	7055		7220	8055		8220	9055		9220	H7071	H7060	N8071	N8060	B8571	B8560	M9571	M9560	7

	7055		7220	8055		8220	9055		9220	H7051	H7041	N8051	N8041	B8551	B8541	M9551	M9541	6
	7055		7220	8055		8220	9055		9220	H7051	H7041	N8051	N8041	B8551	B8541	M9551	M9541	6
	7055		7220	8055		8220	9055		9220	H7071	H7060	N8071	N8060	B8571	B8560	M9571	M9560	7
	7055		7220	8055		8220	9055		9220	H7071	H7060	N8071	N8060	B8571	B8560	M9571	M9560	7

# DODGE / RAM

LIFT	Quick Kit	KIT NOTES	Component Box	Front Springs		Rear Springs		Add-A-Leafs	Steering Correction
	Reference		(Requires 1 of Each)	Qty	Part #	Qty	Part #		
<b>07-12 DODGE NITRO 2 &amp; 4WD</b>									
<b>07-12 Dodge Nitro</b>									
			<b>Poly Spacers</b>						
2"	KKN25		KKN25						
<b>06-18 1500 RAM, 2019 1500 CLASSIC RAM 4WD</b>									
<b>06-18 1500 RAM 4WD</b>									
			<b>Leveling Spacer Kit</b>						
2"	R620MS	W1	R620MS						
KIT NOTES: W1. Will NOT fit TRX or Factory Air Ride Suspension.									
<b>06-18 1500 RAM &amp; ECODIESEL 4WD</b>									
<b>06-18 1500 RAM 4WD</b>									
			<b>Front Leveling Struts</b>						
1.5-2.5"	D6912ST	W1	D6912ST						
KIT NOTES: W1. Will NOT fit TRX or Factory Air Ride Suspension.									
<b>94-18 DODGE RAM 1500 2WD</b>									
<b>94-18 Dodge RAM 1500 2WD</b>									
			<b>Leveling Spacer Kit</b>						
2"	D220P	W2	D220P						
KIT NOTES: W2. Will NOT fit Air Ride.									
<b>12-18 1500 RAM, 2019 1500 CLASSIC RAM 4WD</b>									
<b>12-18 1500 / 19 1500 Classic RAM 4WD</b>									
			<b>Upper Control Arm Kit with Shocks</b>						
3"	R1230PH	W1	R1230PH						
3"	R1230PN	W1	R1230PN						
3"	R1230PB	W1	R1230PB						
3"	R1230PM	W1	R1230PM						
KIT NOTES: W1. Will NOT fit TRX or Factory Air Ride Suspension.									
<b>12-18 1500 RAM, 2019 1500 CLASSIC RAM &amp; ECODIESEL 4WD</b>									
<b>12-18 1500 / 19 1500 Classic RAM 4WD</b>									
			<b>Strut Spacer Kit with Rear Coils</b>						
4"	D1440SSK		D1440A + D1440B + D1440C						
6"	D1460SSK		D1460A + D1460B + D1460C						
<b>09-11 1500 RAM 4WD</b>									
<b>09-11 1500 RAM 4WD</b>									
			<b>Strut Spacer Kit with Rear Coils</b>						
4"	D940SSK		D1440A + D946B + D1440C						
<b>09-11 1500 RAM 4WD</b>									
<b>09-11 1500 RAM 4WD</b>									
			<b>Strut Spacer Kit with Rear Coils</b>						
6"	D960SSK		D1460A + D946B + D1460C						
KIT NOTES: TRX4 06-11 Models Order Part # D960TRX4.									
<b>06-08 DODGE 1500 4WD</b>									
<b>06-08 Dodge 1500 4WD</b>									
			<b>Strut Spacer Kit with Rear Blocks &amp; U-Bolts</b>						
4"	D640SSK		D646A + D646B + D640C						
6"	D660SSK		D646A + D646B + D660C						
<b>06-08 Dodge 1500 4WD</b>									
<b>06-08 Dodge 1500 4WD</b>									
			<b>Strut Spacer System with Rear Springs</b>						
6"	D660SSKS		D646A + D646B + D660CS			2	DR250S		
<b>05-07 1500 MEGA CAB 4WD</b>									
<b>STANDARD SERIES</b>									
<b>05-07 1500 Mega Cab 4WD Kit</b>									
			<b>Class I with Add-A-Leafs</b>						
3.5"	D301MK		D2513	1	D25			Included	
5.5"	D501MK		D45523 + D4513M	1	D45			Included	Included
<b>02-05 1500 RAM 4WD IFS</b>									
<b>02-05 1500 Ram 4WD (Torsion Bar Front End)</b>									
			<b>Torsion Keys (Front Leveling Kit)</b>						
2"	D201KE		D201KE						
<b>02-05 1500 Ram Pickup 4WD IFS Kit</b>									
			<b>With Blocks &amp; U-Bolts (Without Skid Plate)</b>						
<b>00-01 1500 &amp; 2500 RAM 4WD EQUIPPED WITH V8 ENGINE &amp; 2.5" WIDE REAR SPRINGS</b>									
<b>VALUE KITS</b>									
<b>00-01 1500 Ram Pickup 4WD Kit</b>									
			<b>Metal Spacers with Rear Add-A-Leafs</b>						
2.5"	D20MK		D25MS					R222	

DODGE / RAM

# DODGE / RAM

			Steering Stabilizers						HYDRO Shocks		NITRO Shocks		BLACK MAX		M95 Shocks		Labor				
			White		Black		Silver		White		White		Black		Silver		Hours				
OEM	Single	Dual	OEM	Single	Dual	OEM	Single	Dual	Front	Rear	Front	Rear	Front	Rear	Front	Rear					
NOTE: ALL SHOCKS MUST BE ORDERED SEPARATELY																					
									---	---	H7088	---	---	N8088	---	---	B8588	---	---	M9558	6
									---	---	H7030	---	---	N8030	---	---	B8530	---	---	M9530	3
									---	---	H7030	---	---	N8030	---	---	B8530	---	---	M9530	3
									---	---		---	---		---	---		---	---		2
									---	---	Included	---	---		---	---		---	---		5
									---	---		---	---	Included	---	---		---	---		5
									---	---		---	---		---	---	Included	---	---		5
									---	---		---	---		---	---		---	---	Included	5
									---	---	H7017	---	---	N8017	---	---	B8517	---	---	M9517	8
									---	---	H7070	---	---	N8070	---	---	B8570	---	---	M9570	8
									---	---	H7017	---	---	N8017	---	---	B8517	---	---	M9517	8
									---	---	H7070	---	---	N8070	---	---	B8570	---	---	M9570	8
									---	---	H7070	---	---	N8070	---	---	B8570	---	---	M9570	8
									---	---	H7036	---	---	N8036	---	---	B8536	---	---	M9536	8
									---	---	H7036	---	---	N8036	---	---	B8536	---	---	M9536	8
NOTE: ALL SHOCKS MUST BE ORDERED SEPARATELY																					
	7013			8013			9013				H7092	H7036	N8092	N8036	B8592	B8536	M9592	M9536		6	
	Included		7213			8213			9213		H7094	H7036	N8094	N8036	B8592	B8536	M9594	M9536		9	
NOTE: ALL SHOCKS MUST BE ORDERED SEPARATELY																					
											H7004	H7017	N8004	N8017	B8504	B8517	M9504	M9517		2	
NOTE: ALL SHOCKS MUST BE ORDERED SEPARATELY																					
	7007			8007			9007				H7092	H7017	N8092	N8017	B8592	B8517	M9592	M9517		4	

DODGE / RAM

# DODGE / RAM

LIFT	Quick Kit	KIT NOTES	Component Box	Front Springs		Rear Springs		Add-A-Leafs	Steering Correction
	Reference		(Requires 1 of Each)	Qty	Part #	Qty	Part #		
<b>00-01 1500 Ram Pickup 4WD Kit</b>									
2"	D20PK		Polyurethane Spacers with Rear Add-A-Leafs					R222	
<b>94-18 DODGE RAM 1500 2WD</b>									
<b>94-18 Dodge Ram 1500 2WD</b>									
2"	D220P	W2	Leveling Spacer Kit						
KIT NOTES: W2. Will NOT fit Air Ride.									
<b>STANDARD SERIES</b>									
<b>00-01 1500 Ram Pickup 4WD Kit</b>									
<b>Class I with Add-A-Leafs</b>									
2"	D201K			1	D20			R222	
3"	D3012K	W8	D3012	1	D30			Included	
5"	D5012K	W8, W19	D4552 + D501	1	D50			Included	Included
KIT NOTES: W8. 00-01 Models Equipped with Factory 'OFF-ROAD Package' will Receive 1" Less Lift. W19. All Wheel Drive Models may Experience a Front Driveline Vibration. If so, Order Index Ring Part # IXR20, Seal Adapter Part # DTSA10 & Seal Part # TCS2675.									
<b>00-01 1500 Ram Pickup 4WD System</b>									
<b>Class I with Replacement Rear Springs</b>									
5"	D5012KS	W8, W19, W30	D4552 + D501S	1	D50	2	DR54S		Included
KIT NOTES: W8. 00-01 Models Equipped with Factory 'OFF-ROAD Package' will Receive 1" Less Lift. W19. All Wheel Drive Models may Experience a Front Driveline Vibration. If so, Order Index Ring Part # IXR20, Seal Adapter Part # DTSA10 & Seal Part # TCS2675. W30. Brake Line Brackets Included.									
<b>00-01 1500 Ram Pickup 4WD Kit</b>									
<b>Class II with Add-A-Leafs</b>									
5"	D5022K	W6, W8, W19, W30	D4552 + D502	1	D50			Included	Included
KIT NOTES: W6. Class II Includes Front Dual Shock Brackets, Upper Links & Lower Link Skid Plates. W8. 00-01 Models Equipped with Factory 'OFF-ROAD Package' will Receive 1" Less Lift. W19. All Wheel Drive Models may Experience a Front Driveline Vibration. If so, Order Index Ring Part # IXR20, Seal Adapter Part # DTSA10 & Seal Part # TCS2675. W30. Brake Line Brackets Included.									
<b>00-01 1500 Ram Pickup 4WD System</b>									
<b>Class II with Replacement Rear Springs</b>									
5"	D5022KS	W6 W8, W19, W30	D4552 + D502S	1	D50	2	DR54S		Included
KIT NOTES: W6. Class II Includes Front Dual Shock Brackets, Upper Links & Lower Link Skid Plates. W8. 00-01 Models Equipped with Factory 'OFF-ROAD Package' will Receive 1" Less Lift. W19. All Wheel Drive Models may Experience a Front Driveline Vibration. If so, Order Index Ring Part # IXR20, Seal Adapter Part # DTSA10, & Seal Part # TCS2675. W30. Brake Line Brackets Included.									
<b>00-01 1500 RAM 4WD EQUIPPED WITH V8 ENGINE &amp; 2.5" WIDE REAR SPRINGS</b>									
<b>LONG ARM SERIES</b>									
<b>00-01 1500 Ram Pickup 4WD Kit</b>									
<b>With Blocks &amp; U-Bolts &amp; Add-A-Leafs</b>									
7"	D702K-DX	W6, W25, W26	D7075-DX + D702	1	D70			Included	DA602
KIT NOTES: W6. Class II Includes Front Dual Shock Brackets, Upper Links & Lower Link Skid Plates. W25. Seal Adapter Part # DTSA10 & Seal Part # TCS2675 are Included. W26. 6 Speed Models will Require Modifications to Transmission Bracket.									
<b>00-01 1500 Ram Pickup 4WD System</b>									
<b>With Replacement Rear Springs</b>									
7"	D702KS-DX	W6, W25, W26	D7075-DX + D702S	1	D70	2	DR56S		DA602
KIT NOTES: W6. Class II Includes Front Dual Shock Brackets, Upper Links & Lower Link Skid Plates. W25. Seal Adapter Part # DTSA10 & Seal Part # TCS2675 are Included. W26. 6 Speed Models will Require Modifications to Transmission Bracket.									
<b>94-99 1500 RAM 4WD EQUIPPED WITH V8 ENGINE AND 2.5" WIDE REAR SPRINGS</b>									
<b>VALUE KITS</b>									
<b>94-99 1500 Ram Pickup 4WD Kit</b>									
<b>Metal Spacers with Rear Add-A-Leafs</b>									
2.5"	D20MK		D25MS					R222	
<b>94-99 1500 Ram Pickup 4WD Kit</b>									
<b>Polyurethane Spacers with Rear Add-A-Leafs</b>									
2"	D20PK		D20P					R222	
<b>94-18 DODGE RAM 1500 2WD</b>									
<b>94-18 Dodge Ram 1500 2WD</b>									
2"	D220P	W2	Leveling Spacer Kit						
KIT NOTES: W2. Will NOT fit Air Ride.									
<b>STANDARD SERIES</b>									
<b>94-99 1500 Ram Pickup 4WD Kit</b>									
<b>Class I with Add-A-Leafs</b>									
2"	D201K			1	D20			R222	
3"	D301K		D301	1	D30			Included	
5"	D501K	W1, W30	D4550 + D501	1	D50			Included	Included
KIT NOTES: W11. 5 & 7" Lift Kits are Designed to Only Fit Models Manufactured ON or AFTER February 9, 1994 Due to Size of Track Bar Stud. W30. Brake Line Brackets Included.									

DODGE / RAM

# DODGE / RAM

DODGE / RAM

	Steering Stabilizers									HYDRO Shocks		NITRO Shocks		BLACK MAX		M95 Shocks		Labor Hours
	White			Black			Silver			White		White		Black		Silver		
	OEM	Single	Dual	OEM	Single	Dual	OEM	Single	Dual	Front	Rear	Front	Rear	Front	Rear	Front	Rear	
	7007			8007			9007			H7092	H7017	N8092	N8017	B8592	B8517	M9592	M9517	4
										----	----	----	----	----	----	----	----	2
	7007		7218	8007		8218	9007		9218	H7092	H7017	N8092	N8017	B8592	B8517	M9592	M9517	4
	7007		7218	8007		8218	9007		9218	H7092	H7017	N8092	N8017	B8592	B8517	M9592	M9517	6
	Included		7218	8007		8218	9007		9218	H7093	H7017	N8093	N8017	B8593	B8517	M9593	M9517	9
	Included		7218	8007		8218	9007		9218	H7093	H7017	N8093	N8017	B8593	B8517	M9593	M9517	9
	Included		7218	8007		8218	9007		9218	H7093	H7017	N8093	N8017	B8593	B8517	M9593	M9517	10
										H7058		N8058		B8558		M9558		
Must Order 2 of each Front Shock and 2 Rear Shocks.																		
	Included		7218	8007		8218	9007		9218	H7093	H7017	N8093	N8017	B8593	B8517	M9593	M9517	10
										H7058		N8058		B8558		M9558		
Must Order 2 of each Front Shock and 2 Rear Shocks.																		
<b>NOTE: ALL SHOCKS MUST BE ORDERED SEPARATELY</b>																		
	Included		7218	8007		8218	9007		9218	H7038	H7078	N8038	N8078	B8538	B8578	M9538	M9578	12
										H7060		N8060		B8560		M9560		
Must Order 2 of each Front Shock and 2 Rear Shocks.																		
	Included		7218	8007		8218	9007		9218	H7038	H7078	N8038	N8078	B8538	B8578	M9538	M9578	12
										H7060		N8060		B8560		M9560		
Must Order 2 of each Front Shock and 2 Rear Shocks.																		
<b>NOTE: ALL SHOCKS MUST BE ORDERED SEPARATELY</b>																		
	7007			8007			9007			H7092	H7017	N8092	N8017	B8592	B8517	M9592	M9517	4
	7007			8007			9007			H7092	H7017	N8092	N8017	B8592	B8517	M9592	M9517	4
										----	----	----	----	----	----	----	----	2
	7007		(W13)	8007		(W17)	9007		(W29)	H7092	H7017	N8092	N8017	B8592	B8517	M9592	M9517	4
	7007		(W13)	8007		(W17)	9007		(W29)	H7092	H7017	N8092	N8017	B8592	B8517	M9592	M9517	6
	Included		(W13)	8007		(W17)	9007		(W29)	H7093	H7017	N8093	N8017	B8593	B8517	M9593	M9517	9
W13. On 94-97 Models Use # 7217 Steering Stabilizer. On 98-99 Models with 3" Axle Tube Use # 7218. On 98-99 Models with 3.75" Axle Tube Use # 7270. W17. On 94-97 Models Use # 8217 Steering Stabilizer. On 98-99 Models with 3" Axle Tube Use # 8218. On 98-99 Models with 3.75" Axle Tube Use # 8270. W29. On 94-97 Models Use # 9217 Steering Stabilizer. On 98-99 Models with 3" Axle Tube Use # 9218. On 98-99 Models with 3.75" Axle Tube Use # 9270.																		

# DODGE / RAM

LIFT	Quick Kit	KIT NOTES	Component Box	Front Springs		Rear Springs		Add-A-Leafs	Steering Correction
	Reference		(Requires 1 of Each)	Qty	Part #	Qty	Part #		(Order 1 Each)
<b>94-99 1500 Ram Pickup 4WD System</b>									
<b>Class I with Replacement Rear Springs</b>									
3"	D301KS	W10	D301S	1	D30	2	DR56S		
5"	D501KS	W11, W30	D4550 + D501S	1	D50	2	DR54S		Included

KIT NOTES: W10. The Factory Block is Removed. W11. 5 & 7" Lift Kits are Designed to Only Fit Models Manufactured ON or AFTER February 9, 1994 Due to Size of Track Bar Stud. W30. Brake Line Brackets Included.

<b>94-99 1500 Ram Pickup 4WD Kit</b>									
<b>Class II with Add-A-Leafs</b>									
5"	D502K	W6, W11, W30	D4550 + D502	1	D50			Included	Included

KIT NOTES: W6. Class II Includes Front Dual Shock Brackets, Upper Links & Lower Link Skid Plates. W11. 5 & 7" Lift Kits are Designed to Only Fit Models Manufactured ON or AFTER February 9, 1994 Due to Size of Track Bar Stud. W30. Brake Line Brackets Included.

<b>94-99 1500 Ram Pickup 4WD System</b>									
<b>Class II with Replacement Rear Springs</b>									
3"	D302KS	W6, W10	D302S	1	D30	2	DR56S		
5"	D502KS	W6, W11, W30	D4550 + D502S	1	D50	2	DR54S		Included

KIT NOTES: W6. Class II Includes Front Dual Shock Brackets, Upper Links & Lower Link Skid Plates. W10. The Factory Block is Removed. W11. 5 & 7" Lift Kits are Designed to Only Fit Models Manufactured ON or AFTER February 9, 1994 Due to Size of Track Bar Stud. W30. Brake Line Brackets Included.

## 94-99 1500 RAM 4WD EQUIPPED WITH V8 ENGINE & 2.5" WIDE REAR SPRINGS LONG ARM SERIES

<b>94-99 1500 Ram Pickup 4WD Kit</b>									
<b>With Blocks &amp; U-Bolts &amp; Add-A-Leafs</b>									
7"	D702K-DX	W6, W11, W25, W26	D7075-DX+D702	1	D70			Included	DA600

KIT NOTES: W6. Class II Includes Front Dual Shock Brackets, Upper Links & Lower Link Skid Plates. W11. 5 & 7" Lift Kits are Designed to Only Fit Models Manufactured ON or AFTER February 9, 1994 Due to Size of Track Bar Stud. W25. Seal Adapter Part # DTSA10 & Seal Part # TCS2675 are Included. W26. 6 Speed Models will Require Modifications to Transmission Bracket.

<b>94-99 1500 Ram Pickup 4WD System</b>									
<b>With Replacement Rear Springs</b>									
7"	D702KS-DX	W6, W11, W25, W26	D7075-DX+D702S	1	D70	2	DR56S		DA600

KIT NOTES: W6. Class II Includes Front Dual Shock Brackets, Upper Links & Lower Link Skid Plates. W11. 5 & 7" Lift Kits are Designed to Only Fit Models Manufactured ON or AFTER February 9, 1994 Due to Size of Track Bar Stud. W25. Seal Adapter Part # DTSA10 & Seal Part # TCS2675 are Included. W26. 6 Speed Models will Require Modifications to Transmission Bracket.

## 74.5-93 W150 & W250 4WD FULL-SIZE WITH GAS ENGINES

<b>74.5-93 W150 &amp; W250 Pickup 4WD Full-Size Kit</b>									
<b>With Blocks &amp; U-Bolts &amp; or Add-A-Leafs</b>									
2-2.5"	D200BK	W14, W30	D240B	2	D200S				DA20
4"	D400BK	W14, W15, W16	D240B	2	D400S				DA40
6"	D600BK	W14, W15, W16	D680B	2	D600S				DA60
8"	D800BK	W2, W5, W15, W16	D680B	2	D800S			R1120	DA40 + DA60

KIT NOTES: W2. Pitman Arm Fits 78-93 Models Only (74.5-77 Models Use Part # DA60 on 4" Lifts). Steering Correction (See Steering Components Section). W5. 74.5-77 Models MUST Use # DA65 & # DL10 for Steering Correction. W14. Adjustable Drag Link # DL10 Recommended to Replace Factory Non-Adjustable Link on 72-93 Models. W15. If Vehicle is Equipped with a Front Sway Bar. Lowering Brackets must be Ordered. See Dodge Accessories Section. W16. See Brake Lines Section.

<b>74.5-93 W150 &amp; W250 Pickup 4WD Full-Size Kit</b>									
<b>With Add-A-Leafs</b>									
2.5"	D200BAK	W2, W14, W16	D240BA	2	D200S			R1120	DA20
4"	D400BAK	W1, W2, W14, W15, W16	D240BA	2	D400S			R225	DA40

KIT NOTES: W1. This Kit Uses Add-A-Leafs Instead of Block & U-Bolt Kit for the Rear. W2. Pitman Arm Fits 78-93 Models Only (74.5-77 Models Use DA60 on 4" Lifts). W14. Adjustable Drag Link # DL10 Recommended to Replace Factory Non-Adjustable Link on 72-93 Models. W15. If Vehicle is Equipped with a Front Sway Bar. Lowering Brackets must be Ordered. See Dodge Accessories Section. W16. See Brake Lines Section.

<b>74.5-93 W150 &amp; W250 Pickup 4WD Full-Size System</b>									
<b>With Replacement Rear Springs</b>									
2.5"	D200BKS	W2, W10, W14, W16	D240BS	2	D200S	2	DR40S		DA20
4"	D400BKS	W2, W10, W14, W15, W16	D240BS	2	D400S	2	DR60S		DA40
6"	D600BKS	W14, W15, W16	D680BS	2	D600S	2	DR40S		DA60
8"	D800BKS	W2, W5, W15, W16	D680BS	2	D800S	2	DR60S		DA40 + DA60

KIT NOTES: W2. Pitman Arm Fits 78-93 Models Only (74.5-77 Models Use Part # DA60 on 4" Lifts). Steering Correction (See Steering Components Section). W5. 74.5-77 Models MUST Use # DA65 & # DL10 for Steering Correction. W10. The Factory Block is Removed. W14. Adjustable Drag Link # DL10 Recommended to Replace Factory Non-Adjustable Link on 72-93 Models. W15. If Vehicle is Equipped with a Front Sway Bar. Lowering Brackets must be Ordered. See Dodge Accessories Section. W16. See Brake Lines Section.

DODGE / RAM



# DODGE / RAM

	Steering Stabilizers									HYDRO Shocks		NITRO Shocks		BLACK MAX		M95 Shocks		Labor Hours
	White			Black			Silver			White		White		Black		Silver		
	OEM	Single	Dual	OEM	Single	Dual	OEM	Single	Dual	Front	Rear	Front	Rear	Front	Rear	Front	Rear	
	7007		(W13)	8007		(W17)	9007		(W29)	H7092	H7017	N8092	N8017	B8592	B8517	M9592	M9517	6
	Included		(W13)	8007		(W17)	9007		(W29)	H7093	H7017	N8093	N8017	B8593	B8517	M9593	M9517	9
W13. On 94-97 Models Use # 7217 Steering Stabilizer. On 98-99 Models with 3" Axle Tube Use # 7218. For 98-99 Models with 3.75" Axle Tube Use # 7270. W17. On 94-97 Models Use # 8217 Steering Stabilizer. On 98-99 Models with 3" Axle Tube Use # 8218. For 98-99 Models with 3.75" Axle Tube Use # 8270. W29. On 94-97 Models Use # 9217 Steering Stabilizer. On 98-99 Models with 3" Axle Tube Use # 9218. For 98-99 Models with 3.75" Axle Tube Use # 9270.																		
	Included		(W13)	8007		(W13)	9007		(W13)	H7093	H7017	N8093	N8017	B8593	B8517	M9593	M9517	10
	W13. See Steering Stabilizer Section for Year, Make, Model Fitment.									Must Order 2 of each Front Shock and 2 Rear Shocks.								
	7007		(W13)	8007		(W13)	9007		(W13)	H7092	H7017	N8092	N8017	B8592	B8517	M9592	M9517	8
	Included		(W13)	8007		(W13)	9007		(W13)	H7093	H7017	N8093	N8017	B8593	B8517	M9593	M9517	10
	W13. See Steering Stabilizer Section for Year, Make, Model Fitment.									Must Order 2 of each Front Shock and 2 Rear Shocks.								
<b>NOTE: ALL SHOCKS MUST BE ORDERED SEPARATELY</b>																		
	Included		(W13)	8007		(W13)	9007		(W13)	H7038	H7078	N8038	N8078	B8538	B8578	M9538	M9578	12
	W13. See Steering Stabilizer Section for Year, Make, Model Fitment.									Must Order 2 of each Front Shock and 2 Rear Shocks.								
	Included		(W13)	8007		(W13)	9007		(W13)	H7038	H7078	N8038	N8078	B8538	B8578	M9538	M9578	12
	W13. See Steering Stabilizer Section for Year, Make, Model Fitment.									Must Order 2 of each Front Shock and 2 Rear Shocks.								
<b>NOTE: ALL SHOCKS MUST BE ORDERED SEPARATELY</b>																		
		7110	7220		8110	8220		9110	9220	H7027	H7038	N8027	N8038	B8527	B8538	M9527	M9538	5
		7110	7220		8110	8220		9110	9220	H7017	H7038	N8017	N8038	B8517	B8538	M9517	M9538	5
		7110	7220		8110	8220		9110	9220	H7017	H7068	N8017	N8068	B8517	B8568	M9517	M9568	6
		7110	7220		8110	8220		9110	9220	H7036	H7068	N8036	N8068	B8536	B8568	M9536	M9568	8
		7110	7220		8110	8220		9110	9220	H7027	H7038	N8027	N8038	B8527	B8538	M9527	M9538	5
		7110	7220		8110	8220		9110	9220	H7017	H7038	N8017	N8038	B8517	B8538	M9517	M9538	5
		7110	7220		8110	8220		9110	9220	H7017	H7068	N8017	N8068	B8517	B8568	M9517	M9568	6
		7110	7220		8110	8220		9110	9220	H7036	H7068	N8036	N8068	B8536	B8568	M9536	M9568	8

DODGE / RAM

# DODGE / RAM

LIFT	Quick Kit	KIT NOTES	Component Box	Front Springs		Rear Springs		Add-A-Leafs	Steering Correction
	Reference		(Requires 1 of Each)	Qty	Part #	Qty	Part #		(Order 1 Each)
<b>74.5-93 W350 PICKUP 4WD FULL-SIZE WITH GAS ENGINES</b>									
<b>74.5-93 W350 Pickup 4WD Full-Size Kit With Blocks &amp; U-Bolts</b>									
2.5"	D200CK	W2, W14, W16	D240CD	2	D200S				DA20
3-4"	D400CK	W2, W14, W15, W16	D240CD	2	D400S				DA40
5-6"	D600CK	W2, W14, W15, W16	D600CD	2	D600S				DA40 + SB60
KIT NOTES: W2. Pitman Arm Fits 78-93 Models Only (74.5-77 Models Use Part # DA60 on 4" Lifts). W14. Adjustable Drag Link # DL10 Recommended to Replace Factory Non-Adjustable Link on 72-93 Models. W15. If Vehicle is Equipped with a Front Sway Bar. Lowering Brackets must be Ordered. See Dodge Accessories Section. W16. See Brake Lines Section.									
<b>74.5-93 W350 Pickup 4WD Full-Size Kit With Blocks &amp; U-Bolts &amp;/or Add-A-Leafs</b>									
1.5-2"	D200CAK	W1, W2, W14, W16	D240CDA	2	D200S			R1120	DA20
3-4"	D400CAK	W1, W2, W14, W15, W16	D240CDA	2	D400S			R225	DA40
7-8"	D800CK	W2, W15, W16	D600CD	2	D800S			R225	DA40 + SB60
KIT NOTES: W1. This Kit Uses Add-A-Leafs Instead of Block & U-Bolt Kit for the Rear. W2. Pitman Arm Fits 78-93 Models Only (74.5-77 Models Use Part # DA60 on 4" Lifts). W14. Adjustable Drag Link # DL10 Recommended to Replace Factory Non-Adjustable Link on 72-93 Models. W15. If Vehicle is Equipped with a Front Sway Bar. Lowering Brackets must be Ordered. See Dodge Accessories Section. W16. See Brake Lines Section.									
<b>74.5-93 W350 Pickup 4WD Full-Size System With Replacement Rear Springs</b>									
3-4"	D400CKS	W2, W10, W14, W15, W16	D240CS	2	D400S	2	DR60S		DA40
5-6"	D600CKS	W2, W14, W15, W16	D600CDS	2	D600S	2	DR40S		DA40 + SB60
7-8"	D800CKS	W2, W15, W16	D600CDS	2	D800S	2	DR60S		DA40 + SB60
KIT NOTES: W2. Pitman Arm Fits 78-93 Models Only (74.5-77 Models Use Part # DA60 on 4" Lifts). W10. The Factory Block is Removed. W14. Adjustable Drag Link # DL10 Recommended to Replace Factory Non-Adjustable Link on 72-93 Models. W15. If Vehicle is Equipped with a Front Sway Bar. Lowering Brackets must be Ordered. See Dodge Accessories Section. W16. See Brake Lines Section.									
<b>61-74 W150 &amp; W250 4WD FULL-SIZE WITH GAS ENGINES</b>									
<b>61-74 W150 &amp; W250 Pickup 4WD Full-Size Kit With Blocks &amp; U-Bolts</b>									
2.5"	D200AK		D240A	2	D200S				
4"	D400AK	W7, W14, W15, W16	D240A	2	D400S				DA60
6"	D600AK	W7, W14, W15, W16	D680A	2	D600S				DA60
KIT NOTES: W7. Must have 3-Bolt Steering Knuckle. W14. Adjustable Drag Link # DL10 Recommended to Replace Factory Non-Adjustable Link on 72-93 Models. W15. If Vehicle is Equipped with a Front Sway Bar. Lowering Brackets must be Ordered. See Dodge Accessories Section. W16. See Brake Lines Section.									
<b>72-74 W150 &amp; W250 Pickup 4WD Full-Size System With 52" Replacement Rear Springs</b>									
4"	D400AKS	W7, W10, W14, W15, W16	D240AS	2	D400S	2	DR60S		DA60
6"	D600AKS	W7, W14, W15, W16	D680AS	2	D600S	2	DR40S		DA60
8"	D800AKS	W7, W15, W16	D680AS	2	D800S	2	DR60S		DA65 + DL10
KIT NOTES: W1. This Kit Uses Add-A-Leafs Instead of Block & U-Bolt Kit for the Rear. W7. Must have 3-Bolt Steering Knuckle. W10. The Factory Block is Removed. W14. Adjustable Drag Link # DL10 Recommended to Replace Factory Non-Adjustable Link on 72-93 Models. W15. If Vehicle is Equipped with a Front Sway Bar. Lowering Brackets must be Ordered. See Dodge Accessories Section. W16. See Brake Lines Section.									
<b>14-20 2500 &amp; 3500 RAM 4WD ALL ENGINES</b>									
<b>14-20 2500 Ram Pickup 4WD (All Engines) Metal Spacers (Front Leveling Kit)</b>									
2"	R1325MS		R1325MS						
2"	R1325MSB	W31	R1325MSB						
KIT NOTES: W31. Front Shock Extension Brackets Included.									
<b>94-18 DODGE RAM 2500 &amp; 3500 2WD</b>									
<b>94-18 Dodge Ram 2500 &amp; 3500 2WD Leveling Spacer Kit</b>									
2"	D220P	W2	D220P						
KIT NOTES: W2. Will NOT fit Air Ride.									
<b>13-20 3500 Ram Pickup 4WD (All Engines) Metal Spacers (Front Leveling Kit)</b>									
2"	R1325MS		R1325MS						
2"	R1325MSB	W31	R1325MSB						
KIT NOTES: W31. Front Shock Extension Brackets Included.									
<b>14-20 2500 Ram Pickup 4WD (Diesel Engine Only) Coil Springs (Front Leveling Kit)</b>									
2-2.5"	R25			1	R25				
<b>13-20 3500 Ram Pickup 4WD (Diesel Engine Only) Coil Springs (Front Leveling Kit)</b>									
2-2.5"	R25			1	R25				

DODGE / RAM

# DODGE / RAM

	Steering Stabilizers									HYDRO Shocks		NITRO Shocks		BLACK MAX		M95 Shocks		Labor Hours
	White			Black			Silver			White		White		Black		Silver		
	OEM	Single	Dual	OEM	Single	Dual	OEM	Single	Dual	Front	Rear	Front	Rear	Front	Rear	Front	Rear	
<b>NOTE: ALL SHOCKS MUST BE ORDERED SEPARATELY</b>																		
	7110	7220		8110	8220		9110	9220		H7027	H7038	N8027	N8038	B8527	B8538	M9527	M9538	5
	7110	7220		8110	8220		9110	9220		H7017	H7038	N8017	N8038	B8517	B8538	M9517	M9538	5
	7110	7220		8110	8220		9110	9220		H7017	H7068	N8017	N8068	B8517	B8568	M9517	M9568	6
<b>NOTE: ALL SHOCKS MUST BE ORDERED SEPARATELY</b>																		
	7110	7220		8110	8220		9110	9220		H7027	H7038	N8027	N8038	B8527	B8538	M9527	M9538	6
	7110	7220		8110	8220		9110	9220		H7017	H7038	N8017	N8038	B8517	B8538	M9517	M9538	6
	7110	7220		8110	8220		9110	9220		H7036	H7068	N8036	N8068	B8536	B8568	M9536	M9568	8
<b>NOTE: ALL SHOCKS MUST BE ORDERED SEPARATELY</b>																		
	7110	7220		8110	8220		9110	9220		H7017	H7038	N8017	N8038	B8517	B8538	M9517	M9538	5
	7110	7220		8110	8220		9110	9220		H7017	H7068	N8017	N8068	B8517	B8568	M9517	M9568	6
	7110	7220		8110	8220		9110	9220		H7036	H7068	N8036	N8068	B8536	B8568	M9536	M9568	8
<b>NOTE: ALL SHOCKS MUST BE ORDERED SEPARATELY</b>																		
	7110	7220		8110	8220		9110	9220		H7017	H7038	N8017	N8038	B8517	B8538	M9517	M9538	4
	7110	7220		8110	8220		9110	9220		H7017	H7068	N8017	N8068	B8517	B8568	M9517	M9568	6
	7110	7220		8110	8220		9110	9220		H7036	H7068	N8036	N8068	B8536	B8568	M9536	M9568	8
<b>NOTE: ALL SHOCKS MUST BE ORDERED SEPARATELY</b>																		
	7014			8014			9014			H7091	H7092	N8091	N8092	B8591	B8592	M9591	M9592	2
	7014			8014			9014				H7092		N8092		B8592		M9592	2
										H7020	---	---	---	B8520	---	M9520	---	2
	7014			8014			9014			H7091	H7070	N8091	N8070	B8591	B8570	M9591	M9570	2
	7014			8014			9014				H7070		N8070		B8570		M9570	2
	7014			8014			9014			H7091	H7092	N8091	N8092	B8591	B8592	M9591	M9592	1.5
	7014			8014			9014			H7091	H7070	N8091	N8070	B8591	B8570	M9591	M9570	1.5

DODGE / RAM

# DODGE / RAM

LIFT	Quick Kit	KIT NOTES	Component Box	Front Springs		Rear Springs		Add-A-Leafs	Steering Correction
	Reference		(Requires 1 of Each)	Qty	Part #	Qty	Part #		(Order 1 Each)
<b>14-18 2500 RAM 4WD WITH DIESEL ENGINES</b>									
<b>14-18 2500 Ram Pickup 4WD Kit</b>			<b>Kit with Front &amp; Rear Coil Springs</b>						
4"	R14451K	Does Not Fit Airbag Models	R461 + R144C	1	R45				
<b>14-18 2500 Ram Pickup 4WD Kit</b>			<b>Kit with Front &amp; Rear Coil Springs</b>						
6"	R14651K	Does Not Fit Airbag Models	R461 + R146C	1	R65				
<b>13-18 3500 RAM 4WD WITH DIESEL ENGINES</b>									
<b>13-18 3500 Ram Pickup 4WD Kit</b>			<b>Front Coil Springs &amp; Rear Blocks &amp; U-Bolts</b>						
3.5-4"	R13451K		R461 + R134	1	R45				
<b>13-18 3500 Ram Pickup 4WD Kit</b>			<b>Front Coil Springs &amp; Rear Blocks &amp; U-Bolts</b>						
5.5-6"	R13651K		R461 + R136	1	R65				
<b>10-13 2500 &amp; 10-12 3500 RAM 4WD WITH DIESEL ENGINES</b>									
<b>VALUE KITS</b>									
<b>10-13 2500 &amp; 10-12 3500 Ram Pickup 4WD Kit</b>			<b>Metal Spacers with Rear Add-A-Leafs</b>						
2.5"	D27MK		D25MS					R332	
<b>10-13 2500 &amp; 10-12 3500 Ram Pickup 4WD &amp; Mega Cab Kit</b>			<b>Polyurethane Spacers with Rear Add-A-Leafs</b>						
2"	D27PK		D20P					R332	
<b>94-18 DODGE RAM 2500 &amp; 3500 2WD</b>									
<b>94-18 Dodge Ram 2500 &amp; 3500 2WD</b>			<b>Leveling Spacer Kit</b>						
2"	D220P	W2	D220P						
KIT NOTES: W2. Will NOT fit Air Ride.									
<b>STANDARD SERIES</b>									
<b>10-13 2500 &amp; 10-12 3500 Ram Pickup 4WD &amp; Mega Cab Kit</b>			<b>Class I with Add-A-Leafs</b>						
3.5-4"	D2513K	W28	D2513	1	D25			Included	
<b>10-13 2500 &amp; 10-13 3500 Ram Pickup 4WD Kit</b>			<b>Class I with Add-A-Leafs</b>						
6"	D4510K	W22, W23, W24	D45510 + D4513	1	D45			Included	Included
KIT NOTES: W22. Some Models may Require Indexing Ring Part # IXR20K if a Front Driveline Vibration Develops. W23. If Vehicle is Equipped with a Sterling Rear Axle, Rear U-Bolt Kit Part # U9B12R must be Ordered Separately. W24. On Models with a Rear Carrier Bearing, if a Rear Driveline Vibration Occurs Carrier Bearing Drop Brackets are Available. 1" Drop Part # CBL3401, 2 1/4" Drop Part # CBL214. W28. V8 Gas Engines, Order Part # D30 Coils.									
<b>10-13 2500 &amp; 10-12 3500 Ram Pickup 4WD System</b>			<b>Class I with Rear Springs</b>						
6"	D4510KS	W22, W23, W24	D45510 + D4513S	1	D45	2	DR174S	Included	Included
KIT NOTES: W22. Some Models may Require Indexing Ring Part # IXR20K if a Front Driveline Vibration Develops. W23. If Vehicle is Equipped with a Sterling Rear Axle, Rear U-Bolt Kit Part # U9B12R must be Ordered Separately. W24. On Models with a Rear Carrier Bearing, if a Rear Driveline Vibration Occurs Carrier Bearing Drop Brackets are Available. 1" Drop Part # CBL3401, 2 1/4" Drop Part # CBL214.									
<b>2009 2500 &amp; 3500 RAM 4WD &amp; MEGA CAB WITH DIESEL ENGINES</b>									
<b>VALUE KITS</b>									
<b>2009 2500 &amp; 3500 Ram Pickup 4WD Kit</b>			<b>Metal Spacers with Rear Add-A-Leafs</b>						
2.5"	D27MK		D25MS					R332	
<b>2009 2500 &amp; 3500 Ram Pickup 4WD &amp; Mega Cab Kit</b>			<b>Polyurethane Spacers with Rear Add-A-Leafs</b>						
2"	D27PK		D20P					R332	
<b>94-18 DODGE RAM 2500 &amp; 3500 2WD</b>									
<b>94-18 Dodge Ram 2500 &amp; 3500 2WD</b>			<b>Leveling Spacer Kit</b>						
2"	D220MS	W2	D220MS						
KIT NOTES: W2. Will NOT fit Air Ride.									
<b>STANDARD SERIES</b>									
<b>2009 2500 &amp; 3500 Ram Pickup 4WD &amp; Mega Cab Kit</b>			<b>Class I with Add-A-Leafs</b>						
3.5-4"	D2513K	W28	D2513	1	D25			Included	
<b>2009 2500 &amp; 3500 Ram Pickup 4WD &amp; Mega Cab Kit</b>			<b>Class I with Add-A-Leafs</b>						
6"	D4519K	W22, W23, W24	D45529 + D4513	1	D45			Included	Included
KIT NOTES: W22. Some Models may Require Indexing Ring Part # IXR20K if a Front Driveline Vibration Develops. W23. If Vehicle is Equipped with a Sterling Rear Axle, Rear U-Bolt Kit Part # U9B12R must be Ordered Separately. W24. On Models with a Rear Carrier Bearing, if a Rear Driveline Vibration Occurs Carrier Bearing Drop Brackets are Available. 1" Drop Part # CBL3401, 2 1/4" Drop Part # CBL214.									
<b>2009 2500 &amp; 1 Ram Pickup 4WD &amp; Mega Cab System</b>			<b>Class I with Rear Springs</b>						
6"	D4519KS	W22, W23, W24	D45529 + D4513S	1	D45	2	DR374S	Included	Included
KIT NOTES: W22. Some Models may Require Indexing Ring Part # IXR20K if a Front Driveline Vibration Develops. W23. If Vehicle is Equipped with a Sterling Rear Axle, Rear U-Bolt Kit Part # U9B12R must be Ordered Separately. W24. On Models with a Rear Carrier Bearing, if a Rear Driveline Vibration Occurs Carrier Bearing Drop Brackets are Available. 1" Drop Part # CBL3401, 2 1/4" Drop Part # CBL214.									

DODGE / RAM

# DODGE / RAM

	Steering Stabilizers									HYDRO Shocks		NITRO Shocks		BLACK MAX		M95 Shocks		Labor Hours
	White			Black			Silver			White		White		Black		Silver		
	OEM	Single	Dual	OEM	Single	Dual	OEM	Single	Dual	Front	Rear	Front	Rear	Front	Rear	Front	Rear	
<b>NOTE: ALL SHOCKS MUST BE ORDERED SEPARATELY</b>																		
	7014		7214	8014		8214	9014		9214	H7092	H7093	N8092	N8093	B8592	B8593	M9592	M95932	8
	7014		7214	8014		8214	9014		9214	H7093	H7094	N8093	N8094	B8593	B8594	M9593	M95942	8
<b>NOTE: ALL SHOCKS MUST BE ORDERED SEPARATELY</b>																		
	7014		7214	8014		8214	9014		9214	H7092	H7090	N8092	N8090	B8592	B8590	M9592	M9590	6
	7014		7214	8014		8214	9014		9214	H7093	H7090	N8093	N8090	B8593	B8590	M9593	M9590	6
<b>NOTE: ALL SHOCKS MUST BE ORDERED SEPARATELY</b>																		
	7013			8013			9013			H7092	H7036	N8092	N8036	B8592	B8536	M9592	M9536	4
	7013			8013			9013			H7092	H7036	N8092	N8036	B8592	B8536	M9592	M9536	4
<b>NOTE: ALL SHOCKS MUST BE ORDERED SEPARATELY</b>																		
										----	----	----	----	----	----	----	----	2
	7013		7239	8013		8239	9013		9239	H7092	H7036	N8092	N8036	B8592	B8536	M9592	M9536	6
	Included		7239	8013		8239	9013		9239	H7094	H7036	N8094	N8036	B8594	B8536	M9594	M9536	9
<b>NOTE: ALL SHOCKS MUST BE ORDERED SEPARATELY</b>																		
	Included		7239	8013		8239	9013		9239	H7094	H7036	N8094	N8036	B8594	B8536	M9594	M9536	9
<b>NOTE: ALL SHOCKS MUST BE ORDERED SEPARATELY</b>																		
	7013			8013			9013			H7092	H7036	N8092	N8036	B8592	B8536	M9592	M9536	4
	7013			8013			9013			H7092	H7036	N8092	N8036	B8592	B8536	M9592	M9536	4
<b>NOTE: ALL SHOCKS MUST BE ORDERED SEPARATELY</b>																		
										----	----	----	----	----	----	----	----	2
	7013		7239	8013		8239	9013		9239	H7092	H7036	N8092	N8036	B8592	B8536	M9592	M9536	6
			7239			8239			9239	H7094	H7036	N8094	N8036	B8594	B8536	M9594	M9536	9
<b>NOTE: ALL SHOCKS MUST BE ORDERED SEPARATELY</b>																		
	Included		7239	8013		8239	9013		9239	H7094	H7036	N8094	N8036	B8594	B8536	M9594	M9536	9

DODGE / RAM

# DODGE / RAM

LIFT	Quick Kit	KIT NOTES	Component Box	Front Springs		Rear Springs		Add-A-Leafs	Steering Correction
	Reference		(Requires 1 of Each)	Qty	Part #	Qty	Part #		(Order 1 Each)
<b>2009 2500 &amp; 3500 Ram Pickup 4WD &amp; Mega Cab Kit</b>									
<b>Class II with Add-A-Leafs</b>									
6"	D4529K	W22, W23, W24	D45529 + D4523	1	D45			Included	Included
KIT NOTES: W22. Some Models may Require Indexing Ring Part # IXR20K if a Front Driveline Vibration Develops. W23. If Vehicle is Equipped with a Sterling Rear Axle, Rear U-Bolt Kit Part # U9B12R must be Ordered Separately. W24. On Models with a Rear Carrier Bearing, if a Rear Driveline Vibration Occurs Carrier Bearing Drop Brackets are Available. 1" Drop Part # CBL3401, 2 1/4" Drop Part # CBL214.									
<b>2009 2500 &amp; 3500 Ram Pickup 4WD &amp; Mega Cab Kit</b>									
<b>Class II with Rear Springs</b>									
6"	D4529KS	W22, W23, W24	D45529 + D4523S	1	D45	2	DR374S	Included	Included
KIT NOTES: W22. Some Models may Require Indexing Ring Part # IXR20K if a Front Driveline Vibration Develops. W23. If Vehicle is Equipped with a Sterling Rear Axle, Rear U-Bolt Kit Part # U9B12R must be Ordered Separately. W24. On Models with a Rear Carrier Bearing, if a Rear Driveline Vibration Occurs Carrier Bearing Drop Brackets are Available. 1" Drop Part # CBL3401, 2 1/4" Drop Part # CBL214.									
<b>03-08 2500 &amp; 3500 RAM 4WD &amp; MEGA CAB WITH DIESEL ENGINES</b>									
<b>VALUE KITS</b>									
<b>03-08 2500 &amp; 3500 Ram Pickup 4WD &amp; Mega Cab Kit</b>									
<b>Metal Spacers with Rear Add-A-Leafs</b>									
2.5"	D27MK		D25MS					R332	
<b>03-08 2500 &amp; 3500 Ram Pickup 4WD &amp; Mega Cab Kit</b>									
<b>Polyurethane Spacers with Rear Add-A-Leafs</b>									
2"	D27PK		D20P					R332	
<b>94-18 DODGE RAM 2500 &amp; 3500 2WD</b>									
<b>94-18 Dodge Ram 2500 &amp; 3500 2WD</b>									
<b>Leveling Spacer Kit</b>									
2"	D220P	W2	D220P						
KIT NOTES: W2. Will NOT fit Air Ride.									
<b>STANDARD SERIES</b>									
<b>03-08 2500 &amp; 3500 Ram Pickup 4WD &amp; Mega Cab Kit</b>									
<b>Class I with Add-A-Leafs</b>									
3.5-4"	D2513K		D2513	1	D25			Included	
<b>03-08 2500 &amp; 3500 RAM 4WD &amp; MEGA CAB WITH DIESEL ENGINES</b>									
<b>03-08 2500 &amp; 3500 Ram Pickup 4WD &amp; Mega Cab Kit</b>									
<b>Class I with Add-A-Leafs</b>									
6"	D4513K	W22, W23, W24	D45523 + D4513	1	D45			Included	Included
KIT NOTES: W22. Some Models may Require Indexing Ring Part # IXR20K if a Front Driveline Vibration Develops. W23. If Vehicle is Equipped with a Sterling Rear Axle, Rear U-Bolt Kit Part # U9B12R must be Ordered Separately. W24. On Models with a Rear Carrier Bearing, if a Rear Driveline Vibration Occurs Carrier Bearing Drop Brackets are Available. 1" Drop Part # CBL3401, 2 1/4" Drop Part # CBL214.									
<b>03-08 2500 &amp; 3500 Ram Pickup 4WD &amp; Mega Cab Kit</b>									
<b>Class I with Rear Springs</b>									
6"	D4513KS	W22, W23, W24	D45523 + D4513S	1	D45	2	DR374S	Included	Included
KIT NOTES: W22. Some Models may Require Indexing Ring Part # IXR20K if a Front Driveline Vibration Develops. W23. If Vehicle is Equipped with a Sterling Rear Axle, Rear U-Bolt Kit Part # U9B12R must be Ordered Separately. W24. On Models with a Rear Carrier Bearing, if a Rear Driveline Vibration Occurs Carrier Bearing Drop Brackets are Available. 1" Drop Part # CBL3401, 2 1/4" Drop Part # CBL214.									
<b>03-08 2500 &amp; 3500 Ram Pickup 4WD &amp; Mega Cab Kit</b>									
<b>Class II with Add-A-Leafs</b>									
6"	D4523K	W22, W23, W24	D45523 + D4523	1	D45			Included	Included
KIT NOTES: W22. Some Models may Require Indexing Ring Part # IXR20K if a Front Driveline Vibration Develops. W23. If Vehicle is Equipped with a Sterling Rear Axle, Rear U-Bolt Kit Part # U9B12R must be Ordered Separately. W24. On Models with a Rear Carrier Bearing, if a Rear Driveline Vibration Occurs Carrier Bearing Drop Brackets are Available. 1" Drop Part # CBL3401, 2 1/4" Drop Part # CBL214.									
<b>03-08 2500 &amp; 3500 Ram Pickup 4WD &amp; Mega Cab Kit</b>									
<b>Class II with Rear Springs</b>									
6"	D4523KS	W22, W23, W24	D45523 + D4523S	1	D45	2	DR374S	Included	Included
KIT NOTES: W22. Some Models may Require Indexing Ring Part # IXR20K if a Front Driveline Vibration Develops. W23. If Vehicle is Equipped with a Sterling Rear Axle, Rear U-Bolt Kit Part # U9B12R must be Ordered Separately. W24. On Models with a Rear Carrier Bearing, if a Rear Driveline Vibration Occurs Carrier Bearing Drop Brackets are Available. 1" Drop Part # CBL3401, 2 1/4" Drop Part # CBL214.									
<b>00-02 2500 &amp; 3500 RAM 4WD FOR MODELS WITH V10 / CUMMINS ENGINE EQUIPPED WITH 3" WIDE REAR SPRINGS</b>									
<b>VALUE KITS</b>									
<b>00-02 2500 &amp; 3500 Ram Pickup 4WD Kit</b>									
<b>Metal Spacers with Rear Add-A-Leafs</b>									
2.5"	D25MK		D25MS					R372	
<b>00-02 2500 &amp; 3500 Ram Pickup 4WD Kit</b>									
<b>Polyurethane Spacers with Rear Add-A-Leafs</b>									
2"	D25PK		D20P					R372	
<b>94-18 DODGE RAM 2500 &amp; 3500 2WD</b>									
<b>94-18 Dodge Ram 2500 &amp; 3500 2WD</b>									
<b>Leveling Spacer Kit</b>									
2"	D220P	W2	D220P						
KIT NOTES: W2. Will NOT fit Air Ride.									

DODGE / RAM

# DODGE / RAM

	Steering Stabilizers									HYDRO Shocks		NITRO Shocks		BLACK MAX		M95 Shocks		Labor Hours
	White			Black			Silver			White		White		Black		Silver		
	OEM	Single	Dual	OEM	Single	Dual	OEM	Single	Dual	Front	Rear	Front	Rear	Front	Rear	Front	Rear	
Included		7239	8013		8239	9013		9239	H7094 H7041	H7036	N8094 N8041	N8036	B8594 B8541	B8536	M9594 M9541	M9536		10
									Must Order 2 of each Front Shock and 2 Rear Shocks.									
Included		7239	8013		8239	9013		9239	H7094 H7041	H7036	N8094 N8041	N8036	B8594 B8541	B8536	M9594 M9541	M9536		10
									Must Order 2 of each Front Shock and 2 Rear Shocks.									
<b>NOTE: ALL SHOCKS MUST BE ORDERED SEPARATELY</b>																		
	7013		7213	8013		8213	9013		H7092	H7036	N8092	N8036	B8592	B8536	M9592	M9536		4
	7013		7213	8013		8213	9013		H7092	H7036	N8092	N8036	B8592	B8536	M9592	M9536		4
									----	----	----	----	----	----	----	----		2
	7013		7213	8013		8213	9013		9213	H7092	H7036	N8092	N8036	B8592	B8536	M9592	M9536	6
<b>NOTE: ALL SHOCKS MUST BE ORDERED SEPARATELY</b>																		
Included		7213	8007		8213	9007		9213	H7094	H7036	N8094	N8036	B8594	B8536	M9594	M9536		9
Included		7213	8007		8213	9007		9213	H7094	H7036	N8094	N8036	B8594	B8536	M9594	M9536		9
Included		7213	8007		8213	9007		9213	H7094 H7041	H7036	N8094 N8041	N8036	B8594 B8541	B8536	M9594 M9541	M9536		10
									Must Order 2 of each Front Shock and 2 Rear Shocks.									
Included		7213	8007		8213	9007		9213	H7094 H7041	H7036	N8094 N8041	N8036	B8594 B8541	B8536	M9594 M9541	M9536		10
									Must Order 2 of each Front Shock and 2 Rear Shocks.									
<b>NOTE: ALL SHOCKS MUST BE ORDERED SEPARATELY</b>																		
	7007		7218	8007		8218	9007		9218	H7092	H7036	N8092	N8036	B8592	B8536	M9592	M9536	4
	7007		7218	8007		8218	9007		9218	H7092	H7036	N8092	N8036	B8592	B8536	M9592	M9536	4
									----	----	----	----	----	----	----	----		2

DODGE / RAM

# DODGE / RAM

LIFT	Quick Kit	KIT NOTES	Component Box	Front Springs		Rear Springs		Add-A-Leafs	Steering Correction
	Reference		(Requires 1 of Each)	Qty	Part #	Qty	Part #		(Order 1 Each)
<b>STANDARD SERIES</b>									
<b>00-02 2500 &amp; 3500 Ram Pickup 4WD Kit</b>			<b>Class I with Add-A-Leafs</b>						
3"	D2512K		D2512	1	D25			Included	
5"	D4512K	W9, W22, W24	D4552 + D451	1	D45			Included	Included
KIT NOTES: W9. Models Equipped with a 'Towing Package' REQUIRE Longer U-Bolts. If so Equipped, Order # D451H Instead of # D451. W22. Some Models may Require Indexing Ring Part # IXR20K if a Front Driveline Vibration Develops. W24. On Models with a Rear Carrier Bearing, if a Rear Driveline Vibration Occurs Carrier Bearing Drop Brackets are Available. 1" Drop Part # CBL3401, 2 1/4" Drop Part # CBL214. (Gas Engines will Receive More Lift than Diesel).									
<b>00-02 2500 &amp; 3500 Ram Pickup 4WD System</b>			<b>Class I with Replacement Rear Springs</b>						
5"	D4512KS	W22, W24	D4552 + D451S	1	D45	2	DR74S		Included
KIT NOTES: W22. Some Models may Require Indexing Ring Part # IXR20K if a Front Driveline Vibration Develops. W24. On Models with a Rear Carrier Bearing, if a Rear Driveline Vibration Occurs Carrier Bearing Drop Brackets are Available. 1" Drop Part # CBL3401, 2 1/4" Drop Part # CBL214. (Gas Engines will Receive More Lift than Diesel).									
<b>00-02 2500 &amp; 3500 Ram Pickup 4WD Kit</b>			<b>Class II with Add-A-Leafs</b>						
5"	D4522K	W6, W12, W22, W24	D4552 + D452	1	D45			Included	Included
KIT NOTES: W6. Class II Includes Front Dual Shock Brackets, Upper Links & Lower Link Skid Plates. W12. Models Equipped with a 'Towing Package' REQUIRED Longer U-Bolts. If so Equipped, Order # D452H Instead of # D452. W22. Some Models may Require Indexing Ring Part # IXR20K if a Front Driveline Vibration Develops. W24. On Models with a Rear Carrier Bearing, if a Rear Driveline Vibration Occurs Carrier Bearing Drop Brackets are Available. 1" Drop Part # CBL3401, 2 1/4" Drop Part # CBL214. (Gas Engines will Receive More Lift than Diesel).									
<b>00-02 2500 &amp; 3500 Ram Pickup 4WD System</b>			<b>Class II with Replacement Rear Springs</b>						
5"	D4522KS	W6, W22, W24	D4552 + D452S	1	D45	2	DR74S		Included
KIT NOTES: W6. Class II Includes Front Dual Shock Brackets, Upper Links & Lower Link Skid Plates. W22. Some Models may Require Indexing Ring Part # IXR20K if a Front Driveline Vibration Develops. W24. On Models with a Rear Carrier Bearing, if a Rear Driveline Vibration Occurs Carrier Bearing Drop Brackets are Available. 1" Drop Part # CBL3401, 2 1/4" Drop Part # CBL214. (Gas Engines will Receive More Lift than Diesel).									
<b>00-02 2500 &amp; 3500 RAM 4WD FOR MODELS WITH V10 / CUMMINS ENGINE EQUIPPED WITH 3" WIDE REAR SPRINGS</b>									
<b>LONG ARM SERIES</b>									
<b>00-02 2500 &amp; 3500 Ram Pickup 4WD Kit</b>			<b>With Blocks &amp; U-Bolts &amp; Add-A-Leafs</b>						
7"	D752K-DX	W6, W25, W26, W27, W30	D7075-DX+D752	1	D75			Included	DA602
KIT NOTES: W6. Class II Includes Front Dual Shock Brackets, Upper Links & Lower Link Skid Plates. W25. Seal Adapter Part # DTSA10 & Seal Part # TCS2675 are Included. W26. 6 Speed Models will Require Modifications to Transmission Bracket. W27. 2500 & 3500 Models with a 360 Engine will Sit Slightly Higher in the Front. W30. Brake Line Brackets Included. (Gas Engines will Receive More Lift than Diesel).									
<b>00-02 2500 &amp; 3500 Ram Pickup 4WD System</b>			<b>With Replacement Rear Springs</b>						
7"	D752KS-DX	W6, W25, W26, W27, W30	D7075-DX+D752S	1	D75	2	DR76S		DA602
KIT NOTES: W6. Class II Includes Front Dual Shock Brackets, Upper Links & Lower Link Skid Plates. W25. Seal Adapter Part # DTSA10 & Seal Part # TCS2675 are Included. W26. 6 Speed Models will Require Modifications to Transmission Bracket. W27. 2500 & 3500 Models with a 360 Engine will Sit Slightly Higher in the Front. W30. Brake Line Brackets Included. (Gas Engines will Receive More Lift than Diesel).									
<b>94-99 2500 &amp; 3500 RAM 4WD FOR MODELS WITH V10 / CUMMINS ENGINE EQUIPPED WITH 3" WIDE REAR SPRINGS</b>									
<b>VALUE KITS</b>									
<b>94-99 2500 &amp; 3500 Ram Pickup 4WD Kit</b>			<b>Metal Spacers with Rear Add-A-Leafs</b>						
2.5"	D25MK		D25MS					R372	
<b>94-99 2500 &amp; 3500 Ram Pickup 4WD Kit</b>			<b>Polyurethane Spacers with Rear Add-A-Leafs</b>						
2"	D25PK		D20P					R372	
<b>94-18 DODGE RAM 2500 &amp; 3500 2WD</b>									
<b>94-18 Dodge Ram 2500 &amp; 3500 2WD</b>			<b>Leveling Spacer Kit</b>						
2"	D220MS	W2	D220MS						
KIT NOTES: W2. Will NOT fit Air Ride.									
<b>STANDARD SERIES</b>									
<b>94-99 2500 &amp; 3500 Ram Pickup 4WD Kit</b>			<b>Class I with Add-A-Leafs</b>						
2-2.5"	D251K		D251	1	D25			Included	
4-4.5"	D451K	W9, W22, W24	D4550 + D451	1	D45			Included	Included
KIT NOTES: W9. Models Equipped with a 'Towing Package' REQUIRE Longer U-Bolts. If so Equipped, Order # D451H Instead of # D451. W22. Some Models may Require Indexing Ring Part # IXR20K if a Front Driveline Vibration Develops. W24. On Models with a Rear Carrier Bearing, if a Rear Driveline Vibration Occurs Carrier Bearing Drop Brackets are Available. 1" Drop Part # CBL3401, 2 1/4" Drop Part # CBL214. (Gas Engines will Receive More Lift than Diesel).									

DODGE / RAM



# DODGE / RAM

DODGE / RAM

	Steering Stabilizers									HYDRO Shocks		NITRO Shocks		BLACK MAX		M95 Shocks		Labor Hours
	White			Black			Silver			White		White		Black		Silver		
	OEM	Single	Dual	OEM	Single	Dual	OEM	Single	Dual	Front	Rear	Front	Rear	Front	Rear	Front	Rear	
	7007		7218	8007		8218	9007		9218	H7092	H7036	N8092	N8036	B8592	B8536	M9592	M9536	6
	Included		7218	8007		8218	9007		9218	H7094	H7036	N8094	N8036	B8594	B8536	M9594	M9536	9
DUAL STABILIZER NOTE: For 00-02 with 3.75" Axle Tube Use Part # 7270. For 00-02 Models with 3" Axle Tube Use Part # 7218.																		
	Included		7218	8007		8218	9007		9218	H7094	H7036	N8094	N8036	B8594	B8536	M9594	M9536	9
DUAL STABILIZER NOTE: For 00-02 with 3.75" Axle Tube Use Part # 7270. For 00-02 Models with 3" Axle Tube Use Part # 7218.																		
	Included		7218	8007		8218	9007		9218	H7094	H7036	N8094	N8036	B8594	B8536	M9594	M9536	10
										H7041		N8041		B8541		M9541		
DUAL STABILIZER NOTE: For 00-02 with 3.75" Axle Tube Use Part # 7270. For 00-02 Models with 3" Axle Tube Use Part # 7218. Must Order 2 of each Front Shock and 2 Rear Shocks.																		
	Included		7218	8007		8218	9007		9218	H7094	H7036	N8094	N8036	B8594	B8536	M9594	M9536	10
										H7041		N8041		B8541		M9541		
DUAL STABILIZER NOTE: For 00-02 with 3.75" Axle Tube Use Part # 7270. For 00-02 Models with 3" Axle Tube Use Part # 7218. Must Order 2 of each Front Shock and 2 Rear Shocks.																		
<b>NOTE: ALL SHOCKS MUST BE ORDERED SEPARATELY</b>																		
	Included		(W13)			(W13)			(W13)	H7038	H7078	N8038	N8078	B8538	B8578	M9538	M9578	12
										H7060		N8060		B8560		M9560		
W13. See Steering Stabilizer Section for Year, Make, Model Fitment. Must Order 2 of each Front Shock and 2 Rear Shocks.																		
	Included		(W13)			(W13)			(W13)	H7038	H7078	N8038	N8078	B8538	B8578	M9538	M9578	12
										H7060		N8060		B8560		M9560		
W13. See Steering Stabilizer Section for Year, Make, Model Fitment. Must Order 2 of each Front Shock and 2 Rear Shocks.																		
<b>NOTE: ALL SHOCKS MUST BE ORDERED SEPARATELY</b>																		
	7007			8007			9007			H7092	H7036	N8092	N8036	B8592	B8536	M9592	M9536	4
	7007			8007			9007			H7092	H7036	N8092	N8036	B8592	B8536	M9592	M9536	4
										----	----	----	----	----	----	----	----	2
	7007		(W13)	8007		(W17)	9007		(W29)	H7092	H7036	N8092	N8036	B8592	B8536	M9592	M9536	6
	Included		(W13)			(W17)			(W29)	H7094	H7036	N8094	N8036	B8594	B8536	M9594	M9536	9
W13. On 94-97 Models Use # 7217 Steering Stabilizer. On 98-99 Models with 3" Axle Tube Use # 7218. On 98-99 Models with 3.75" Axle Tube Use # 7270. W17. On 94-97 Models Use # 8217 Steering Stabilizer. On 98-99 Models with 3" Axle Tube Use # 8218. On 98-99 Models with 3.75" Axle Tube Use # 8270. W29. On 94-97 Models Use # 9217 Steering Stabilizer. On 98-99 Models with 3" Axle Tube Use # 9218. On 98-99 Models with 3.75" Axle Tube Use # 9270.																		

# DODGE / RAM

LIFT	Quick Kit	KIT NOTES	Component Box	Front Springs		Rear Springs		Add-A-Leafs	Steering Correction
	Reference		(Requires 1 of Each)	Qty	Part #	Qty	Part #		(Order 1 Each)
<b>94-99 2500 &amp; 3500 Ram Pickup 4WD System Class I with Replacement Rear Springs</b>									
4-4.5"	D451KS	W22, W24	D4550 + D451S	1	D45	2	DR74S		Included
KIT NOTES: W10. The Factory Block is Removed. W22. Some Models may Require Indexing Ring Part # IXR20K if a Front Driveline Vibration Develops. W24. On Models with a Rear Carrier Bearing, if a Rear Driveline Vibration Occurs Carrier Bearing Drop Brackets are Available. 1" Drop Part # CBL3401, 2 1/4" Drop Part # CBL214. (Gas Engines will Receive More Lift than Diesel).									
<b>94-99 2500 &amp; 3500 RAM 4WD FOR MODELS WITH V10 / CUMMINS ENGINE EQUIPPED WITH 3" WIDE REAR SPRINGS</b>									
<b>94-99 2500 &amp; 3500 Ram Pickup 4WD Kit Class II with Add-A-Leafs</b>									
4-4.5"	D452K	W6, W12, W22, W24	D4550 + D452	1	D45			Included	Included
KIT NOTES: W6. Class II Includes Front Dual Shock Brackets, Upper Links & Lower Link Skid Plates. W12. Models Equipped with a 'Towing Package' REQUIRED Longer U-Bolts. If so Equipped, Order # D452H Instead of # D452. W22. Some Models may Require Indexing Ring Part # IXR20K if a Front Driveline Vibration Develops. W24. On Models with a Rear Carrier Bearing, if a Rear Driveline Vibration Occurs Carrier Bearing Drop Brackets are Available. 1" Drop Part # CBL3401, 2 1/4" Drop Part # CBL214. (Gas Engines will Receive More Lift than Diesel).									
<b>94-99 2500 &amp; 3500 Ram Pickup 4WD System Class II with Replacement Rear Springs</b>									
4-4.5"	D452KS	W6, W22, W24	D4550 + D452S	1	D45	2	DR74S		Included
KIT NOTES: W6. Class II Includes Front Dual Shock Brackets, Upper Links & Lower Link Skid Plates. W22. Some Models may Require Indexing Ring Part # IXR20K if a Front Driveline Vibration Develops. W24. On Models with a Rear Carrier Bearing, if a Rear Driveline Vibration Occurs Carrier Bearing Drop Brackets are Available. 1" Drop Part # CBL3401, 2 1/4" Drop Part # CBL214. (Gas Engines will Receive More Lift than Diesel).									
<b>94-99 2500 &amp; 3500 RAM 4WD FOR MODELS WITH V10 / CUMMINS ENGINE EQUIPPED WITH 3" WIDE REAR SPRINGS LONG ARM SERIES</b>									
<b>94-99 2500 &amp; 3500 Ram Pickup 4WD Kit With Blocks &amp; U-Bolts &amp; Add-A-Leafs</b>									
7"	D752K-DX	W6, W25, W26, W27,W30	D7075-DX+D752	1	D75			Included	DA600
KIT NOTES: W6. Class II Includes Front Dual Shock Brackets, Upper Links & Lower Link Skid Plates. Must Order 2 QUAD Shocks Separately. W25. Seal Adapter Part # DTSA10 & Seal Part # TCS2675 are Included. W26. 6 Speed Models will Require Modifications to Transmission Bracket. W27. 2500 & 3500 Models with a 360 Engine will Sit Slightly Higher in the Front. W30. Brake Line Brackets Included. (Gas Engines will Receive More Lift than Diesel).									
<b>94-99 2500 &amp; 3500 Ram Pickup 4WD System With Replacement Rear Springs</b>									
7"	D752KS-DX	W6, W25, W26, W27,W30	D7075-DX+D752S	1	D75	2	DR76S		DA600
KIT NOTES: W6. Class II Includes Front Dual Shock Brackets, Upper Links & Lower Link Skid Plates. Must Order 2 QUAD Shocks Separately. W25. Seal Adapter Part # DTSA10 & Seal Part # TCS2675 are Included. W26. 6 Speed Models will Require Modifications to Transmission Bracket. W27. 2500 & 3500 Models with a 360 Engine will Sit Slightly Higher in the Front. W30. Brake Line Brackets Included. (Gas Engines will Receive More Lift than Diesel).									
<b>92-93 W250 &amp; W350 4WD FULL-SIZE WITH CUMMINS DIESEL ENGINES</b>									
<b>92-93 W250 &amp; W350 Pickup 4WD Full-Size Kit With Blocks &amp; U-Bolts &amp;/or Add-A-Leafs</b>									
1"	D100CDK	W1, W14	D240CDA	2	D100CS			R1120	
2.5"	D200CDAK	W1, W14	D240CDA	2	D200CS			R225	
4"	D400CDAK	W1, W14, W15	D240CDA	2	D400CS			R225	DA20
6"	D692CDK	W15, W16	D692CD	2	D600CS			R225	DA45
KIT NOTES: W1. This Kit Uses Add-A-Leafs Instead of Block & U-Bolt Kit for the Rear. W14. Adjustable Drag Link # DL10 Recommended to Replace Factory Non-Adjustable Link on 72-93 Models. W15. If Vehicle is Equipped with a Front Sway Bar. Lowering Brackets must be Ordered. See Dodge Accessories Section. W16. See Brake Lines Section.									
<b>92-93 W250 &amp; W3500 Pickup 4WD Full-Size System With Replacement Rear Springs</b>									
1"	D192CDKS	W10, W14, W17	D240CDS	2	D100CS	2	DR60S		
2.5"	D292CDKS	W10, W14, W17	D240CDS	2	D200CS	2	DR60S		
4"	D492CDKS	W3, W14, W15, W17	D492CDS	2	D400CS	2	DR60S		DA20
6"	D692CDKS	W4, W14, W15, W16, W17	D692CDS	2	D600CS	2	DR60S		DA45
KIT NOTES: W3. The 6" Factory Blocks are Replaced with 2" Blocks. W4. The 6" Factory Blocks are Replaced with 4.5" Blocks. W10. The Factory Block is Removed. W14. Adjustable Drag Link # DL10 Recommended to Replace Factory Non-Adjustable Link on 72-93 Models. W15. If Vehicle is Equipped with a Front Sway Bar. Lowering Brackets must be Ordered. See Dodge Accessories Section. W16. See Brake Lines Section. W17- Requires SE17D for DR60S									
<b>87-91 W250 &amp; W350 4WD FULL-SIZE LEAF SPRING FRONT WITH CUMMINS DIESEL ENGINES</b>									
<b>87-91 W250 &amp; W350 Pickup 4WD Full-Size Kit With Blocks &amp; U-Bolts</b>									
2.5"	D200CDK	W14, W16	D240CD	2	D200CS				
4"	D400CDK	W14, W15, W16	D240CD	2	D400CS				DA20
6"	D600CDK	W14, W15, W16	D600CD	2	D600CS				DA45
KIT NOTES: W14. Adjustable Drag Link # DL10 Recommended to Replace Factory Non-Adjustable Link on 72-93 Models. W15. If Vehicle is Equipped with a Front Sway Bar. Lowering Brackets must be Ordered. See Dodge Accessories Section. W16. See Brake Lines Section.									

DODGE / RAM

# DODGE / RAM

	Steering Stabilizers						HYDRO Shocks		NITRO Shocks		BLACK MAX		M95 Shocks		Labor Hours
	White		Black		Silver		White		White		Black		Silver		
	OEM	Single Dual	OEM	Single Dual	OEM	Single Dual	Front	Rear	Front	Rear	Front	Rear	Front	Rear	

Included	(W13)	(W17)	(W29)	H7094	H7036	N8094	N8036	B8594	B8536	M9594	M9536	9
<p>W13. On 94-97 Models Use # 7217 Steering Stabilizer. On 98-99 Models with 3" Axle Tube Use # 7218. On 98-99 Models with 3.75" Axle Tube Use # 7270.  W17. On 94-97 Models Use # 8217 Steering Stabilizer. On 98-99 Models with 3" Axle Tube Use # 8218. On 98-99 Models with 3.75" Axle Tube Use # 8270.  W29. On 94-97 Models Use # 9217 Steering Stabilizer. On 98-99 Models with 3" Axle Tube Use # 9218. On 98-99 Models with 3.75" Axle Tube Use # 9270.</p>												

**NOTE: ALL SHOCKS MUST BE ORDERED SEPARATELY**

Included	(W13)	(W13)	(W13)	H7094	H7036	N8094	N8036	B8594	B8536	M9594	M9536	10
				H7041		N8041		B8541		M9541		
<p>Must Order 2 of each Front Shock and 2 Rear Shocks.</p> <p>W13. See Steering Stabilizer Section for Year, Make, Model Fitment.</p>												

Included	(W13)	(W17)	(W29)	H7094	H7036	N8094	N8036	B8594	B8536	M9594	M9536	10
				H7041		N8041		B8541		M9541		
<p>Must Order 2 of each Front Shock and 2 Rear Shocks.</p> <p>W13. See Steering Stabilizer Section for Year, Make, Model Fitment.</p>												

**NOTE: ALL SHOCKS MUST BE ORDERED SEPARATELY**

Included	7217	8217	9217	H7038	H7078	N8038	N8078	B8538	B8578	M9538	M9578	12
				H7060		N8060		B8560		M9560		
<p>Must Order 2 of each Front Shock and 2 Rear Shocks.</p> <p>DUAL STABILIZER NOTE: For 98-99 with 3.75" Axle Tube Use Part # 7270 / 8270 / 9270. For 98-99 Models with 3" Axle Tube Use Part # 7218 / 8218 / 9218.</p>												

Included	7217	8217	9217	H7038	H7078	N8038	N8078	B8538	B8578	M9538	M9578	12
				H7060		N8060		B8560		M9560		
<p>Must Order 2 of each Front Shock and 2 Rear Shocks.</p> <p>DUAL STABILIZER NOTE: For 98-99 with 3.75" Axle Tube Use Part # 7270 / 8270 / 9270. For 98-99 Models with 3" Axle Tube Use Part # 7218 / 8218 / 9218.</p>												

**NOTE: ALL SHOCKS MUST BE ORDERED SEPARATELY**

7110	7220	8110	8220	9110	9220	H7047	H7038	N8047	N8038	B8547	B8538	M9547	M9538	4
7110	7220	8110	8220	9110	9220	H7027	H7038	N8027	N8038	B8527	B8538	M9527	M9538	4
7110	7220	8110	8220	9110	9220	H7017	H7038	N8017	N8038	B8517	B8538	M9517	M9538	4
7110	7220	8110	8220	9110	9220	H7017	H7068	N8017	N8068	B8517	B8568	M9517	M9568	6

7110	7220	8110	8220	9110	9220	H7047	H7038	N8047	N8038	B8547	B8538	M9547	M9538	4
7110	7220	8110	8220	9110	9220	H7027	H7038	N8027	N8038	B8527	B8538	M9527	M9538	4
7110	7220	8110	8220	9110	9220	H7017	H7038	N8017	N8038	B8517	B8538	M9517	M9538	4
7110	7220	8110	8220	9110	9220	H7017	H7068	N8017	N8068	B8517	B8568	M9517	M9568	6

**NOTE: ALL SHOCKS MUST BE ORDERED SEPARATELY**

7110	7220	8110	8220	9110	9220	H7027	H7038	N8027	N8038	B8527	B8538	M9527	M9538	4
7110	7220	8110	8220	9110	9220	H7017	H7038	N8017	N8038	B8517	B8538	M9517	M9538	4
7110	7220	8110	8220	9110	9220	H7017	H7068	N8017	N8068	B8517	B8568	M9517	M9568	6

DODGE / RAM

# DODGE / RAM

LIFT	Quick Kit	KIT NOTES	Component Box	Front Springs		Rear Springs		Add-A-Leafs	Steering Correction
	Reference		(Requires 1 of Each)	Qty	Part #	Qty	Part #		(Order 1 Each)
<b>87-91 W250 &amp; W350 Pickup 4WD Full-Size Kit With Add-A-Leafs</b>									
1"	D100CDK	W1, W14, W16	D240CDA	2	D100CS			R1120	
2.5"	D200CDAK	W1, W14, W16	D240CDA	2	D200CS			R225	
4"	D400CDAK	W1, W14, W15, W16	D240CDA	2	D400CS			R225	DA20
KIT NOTES: W1. This Kit Uses Add-A-Leafs Instead of Block & U-Bolt Kit for the Rear. W14. Adjustable Drag Link # DL10 Recommended to Replace Factory Non-Adjustable Link on 72-93 Models. W15. If Vehicle is Equipped with a Front Sway Bar. Lowering Brackets must be Ordered. See Dodge Accessories Section. W16. See Brake Lines Section.									
<b>87-91 W250 &amp; W350 Pickup 4WD Full-Size System With Replacement Rear Springs</b>									
1"	D100CDKS	W10, W14, W16	D240CDS	2	D100CS	2	DR40S		
2.5"	D200CDKS	W10, W14, W16	D240CDS	2	D200CS	2	DR40S		
6"	D600CDKS	W15, W16	D600CDS	2	D600CS	2	DR40S		DA45
KIT NOTES: W10. The Factory Block is Removed. W14. Adjustable Drag Link # DL10 Recommended to Replace Factory Non-Adjustable Link on 72-93 Models. W15. If Vehicle is Equipped with a Front Sway Bar. Lowering Brackets must be Ordered. See Dodge Accessories Section. W16. See Brake Lines Section.									
<b>87-91 W250 &amp; W350 Pickup 4WD Full-Size System With FULL-Height Replacement Rear Springs</b>									
2.5"	D292CDKS	W10, W14, W16	D240CDS	2	D200CS	2	DR60S		
4"	D400CDKS4	W14, W15, W16	D600CDS	2	D400CS	2	DR40S		DA20
6"	D600CDKS6	W14, W15, W16	D600CDS	2	D600CS	2	DR60S		DA45
KIT NOTES: W10. The Factory Block is Removed. W14. Adjustable Drag Link # DL10 Recommended to Replace Factory Non-Adjustable Link on 72-93 Models. W15. If Vehicle is Equipped with a Front Sway Bar. Lowering Brackets must be Ordered. See Dodge Accessories Section. W16. See Brake Lines Section.									
<b>74.5-93 RAMCHARGER, TRAILDUSTER 4WD</b>									
<b>74.5-93 Ramcharger, Trailduster 4WD Kit With Blocks &amp; U-Bolts &amp;/or Add-A-Leafs</b>									
2.5"	D200BK	W2, W14, W16	D240B	2	D200S				DA20
4"	D400BRK	W2, W14, W15, W16	D400BR	2	D400S				DA40
6"	D600BRK	W14, W15, W16	D680BR	2	D600S				DA60
8"	D800BRK	W2, W5, W15, W16	D680BR	2	D800S			R1120	DA40 + DA60
KIT NOTES: W2. Pitman Arm Fits 78-93 Models Only (74.5-77 Models Use Part # DA60 on 4" Lifts). Steering Correction (See Steering Components Section). W5. 74.5-77 Models MUST Use # DA65 & # DL10. W14. Adjustable Drag Link # DL10 Recommended to Replace Factory Non-Adjustable Link on 72-93 Models. W15. If Vehicle is Equipped with a Front Sway Bar. Lowering Brackets must be Ordered. See Dodge Accessories Section. W16. See Brake Lines Section.									
<b>74.5-93 Ramcharger, Trailduster 4WD Kit With Add-A-Leafs</b>									
2.5"	D200BAK	W1, W2, W14, W16	D240BA	2	D200S			R1120	DA20
KIT NOTES: W1. This Kit Uses Add-A-Leafs Instead of Block & U-Bolt Kit for the Rear. W2. Pitman Arm Fits 78-93 Models Only (74.5-77 Models Use Part # DA60 on 4" Lifts). W14. Adjustable Drag Link # DL10 Recommended to Replace Factory Non-Adjustable Link on 72-93 Models. W16. See Brake Lines Section.									
<b>74.5-93 Ramcharger, Trailduster 4WD System With Replacement Rear Springs</b>									
2.5"	D200BKS	W2, W10, W14, W16	D240BS	2	D200S	2	DR40S		DA20
4"	D400BKS	W2, W10, W14, W15, W16	D240BS	2	D400S	2	DR60S		DA40
6"	D600BKS	W14, W15	D680BS	2	D600S	2	DR40S		DA60
8"	D800BKS	W2, W5, W15, W16	D680BS	2	D800S	2	DR60S		DA40 + DA60
KIT NOTES: W2. Pitman Arm Fits 78-93 Models Only (74.5-77 Models Use Part # DA60 on 4" Lifts) for Steering Correction (See Steering Components Section). W5. 74.5-77 Models MUST Use # DA65 & # DL10. W10. Factory Block is Removed. W14. Adjustable Drag Link # DL10 Recommended to Replace Factory Non-Adjustable Link on 72-93 Models. W15. If Vehicle is Equipped with Front Sway Bar Lowering Brackets must be Ordered. See Dodge Accessories Section.									
<b>61-74 RAMCHARGER, TRAILDUSTER 4WD</b>									
<b>61-74 Ramcharger, Trailduster 4WD Kit With Blocks &amp; U-Bolts &amp;/or Add-A-Leafs</b>									
2.5"	D200AK		D240A	2	D200S				
4"	D400AK	W7, W14, W15	D400BR	2	D400S				
6"	D600AK	W7, W14, W15	D680A	2	D600S				DA60
<b>72-74 Ramcharger, Trailduster 4WD Kit With Blocks &amp; U-Bolts &amp;/or Add-A-Leafs</b>									
8"	D800ARK	W7, W14, W15, W16	D680AR	2	D800S			R1120	DA65 + DL10
KIT NOTES: W7. Must have 3-Bolt Steering Knuckle. W14. Adjustable Drag Link # DL10 Recommended to Replace Factory Non-Adjustable Link on 72-93 Models. W15. If Vehicle is Equipped with a Front Sway Bar. Lowering Brackets must be Ordered. See Dodge Accessories Section. W16. See Brake Lines Section.									
<b>61-74 Ramcharger, Trailduster 4WD Kit With Add-A-Leafs</b>									
2.5"	D200AAK	W1, W14, W16	D240AA	2	D200S			R1120	
KIT NOTES: W1. This Kit Uses Add-A-Leafs Instead of Block & U-Bolt Kit for the Rear. W14. Adjustable Drag Link # DL10 Recommended to Replace Factory Non-Adjustable Link on 72-93 Models. W16. See Brake Lines Section.									
<b>72-74 Ramcharger, Trailduster 4WD System</b>									
2.5"	D200AKS	W14, W16	D240AS	2	D200S	2	DR40S		
4"	D400AKS	W7, W14, W15, W16	D240AS	2	D400S	2	DR60S		DA60
6"	D600AKS	W7, W14, W15, W16	D680AS	2	D600S	2	DR40S		DA60
8"	D800AKS	W7, W15, W16	D680AS	2	D800S	2	DR60S		DA65 + DL10
KIT NOTES: W7. Must have 3-Bolt Steering Knuckle. W14. Adjustable Drag Link # DL10 Recommended to Replace Factory Non-Adjustable Link on 72-93 Models. W15. If Vehicle is Equipped with a Front Sway Bar. Lowering Brackets must be Ordered. See Dodge Accessories Section. W16. See Brake Lines Section.									

DODGE / RAM

# DODGE / RAM

	Steering Stabilizers									HYDRO Shocks		NITRO Shocks		BLACK MAX		M95 Shocks		Labor Hours
	White			Black			Silver			White		White		Black		Silver		
	OEM	Single	Dual	OEM	Single	Dual	OEM	Single	Dual	Front	Rear	Front	Rear	Front	Rear	Front	Rear	
	7110	7220		8110	8220		9110	9220		H7047	H7038	N8027	N8038	B8527	B8538	M9547	M9538	4
	7110	7220		8110	8220		9110	9220		H7027	H7038	N8017	N8038	B8517	B8538	M9527	M9538	4
	7110	7220		8110	8220		9110	9220		H7017	H7038	N8017	N8068	B8517	B8568	M9517	M9538	4
	7110	7220		8110	8220		9110	9220		H7047	H7038	N8047	N8038	B8547	B8538	M9547	M9538	4
	7110	7220		8110	8220		9110	9220		H7027	H7038	N8027	N8038	B8527	B8538	M9527	M9538	4
	7110	7220		8110	8220		9110	9220		H7017	H7068	N8017	N8068	B8517	B8568	M9517	M9568	6
	7110	7220		8110	8220		9110	9220		H7027	H7038	N8027	N8038	B8527	B8538	M9527	M9538	4
	7110	7220		8110	8220		9110	9220		H7017	H7068	N8017	N8068	B8517	B8568	M9517	M9568	4
	7110	7220		8110	8220		9110	9220		H7017	H7068	N8017	N8068	B8517	B8568	M9517	M9568	6
<b>NOTE: ALL SHOCKS MUST BE ORDERED SEPARATELY</b>																		
	7110	7220		8110	8220		9110	9220		H7027	H7038	N8027	N8038	B8527	B8538	M9527	M9538	4
	7110	7220		8110	8220		9110	9220		H7017	H7038	N8017	N8038	B8517	B8538	M9517	M9538	4
	7110	7220		8110	8220		9110	9220		H7017	H7068	N8017	N8068	B8517	B8568	M9517	M9568	6
	7110	7220		8110	8220		9110	9220		H7036	H7068	N8036	N8068	B8536	B8568	M9536	M9568	8
	7110	7220		8110	8220		9110	9220		H7027	H7038	N8027	N8038	B8527	B8538	M9527	M9538	4
	7110	7220		8110	8220		9110	9220		H7027	H7038	N8027	N8038	B8527	B8538	M9527	M9538	4
	7110	7220		8110	8220		9110	9220		H7017	H7068	N8017	N8068	B8517	B8568	M9517	M9568	4
	7110	7220		8110	8220		9110	9220		H7017	H7068	N8017	N8068	B8517	B8568	M9517	M9568	6
	7110	7220		8110	8220		9110	9220		H7036	H7068	N8036	N8068	B8536	B8568	M9536	M9568	8
	7110	7220		8110	8220		9110	9220		H7027	H7038	N8027	N8038	B8527	B8538	M9527	M9538	4
	7110	7220		8110	8220		9110	9220		H7027	H7038	N8027	N8038	B8527	B8538	M9527	M9538	4
	7110	7220		8110	8220		9110	9220		H7017	H7038	N8017	N8038	B8517	B8538	M9517	M9538	4
	7110	7220		8110	8220		9110	9220		H7017	H7068	N8017	N8068	B8517	B8568	M9517	M9568	6
	7110	7220		8110	8220		9110	9220		H7036	H7068	N8036	N8068	B8536	B8568	M9536	M9568	8

DODGE / RAM

# FORD

LIFT	Quick Kit	KIT NOTES	Component Box	Front Springs		Rear Springs		Add-A-Leafs	Steering Correction
	Reference		(Requires 1 Of Each)	Qty	Part #	Qty	Part #		
<b>15-20 F150 PICKUP 4WD</b>									
<b>15-20 F150 Pickup 2WD / 4WD</b>			<b>Upper Metal Spacers (Front Leveling Kit)</b>						
2"	F920MS		F920MS						
<b>STRUT SPACER KITS</b>									
<b>15-20 F150 Pickup 4WD Kit</b>			<b>Front Strut Spacer Kit</b>						
4.5"	F1545BKH	G24	F15461A+F1545BH						
4.5"	F1545BKN	G24	F15461A+F1545BN						
4.5"	F1545BKB	G24	F15461A+F1545BB						
4.5"	F1545BKM	G24	F15461A+F1545BM						
KIT NOTES: 20 Inch Diameter or Larger Wheel must be Used. G24. Does not Fit Single Cab Models									
<b>15-20 F150 Pickup 4WD Kit</b>			<b>Front Strut Spacer Kit</b>						
6"	F1560BKH	G24	F15461A+F1560BH						
6"	F1560BKN	G24	F15461A+F1560BN						
6"	F1560BKB	G24	F15461A+F1560BB						
6"	F1560BKM	G24	F15461A+F1560BM						
KIT NOTES: 20 Inch Diameter or Larger Wheel must be Used. G24. Does not Fit Single Cab Models.									
<b>09-14 F150 PICKUP 2WD / 4WD</b>									
<b>VALUE KITS</b>									
<b>09-14 F150 Pickup 2WD / 4WD</b>			<b>Upper Metal Spacers (Front Leveling Kit)</b>						
2"	F920MS		F920MS						
<b>PERFORMANCE STRUT SERIES</b>									
<b>09-13 F150 Pickup 2WD / 4WD</b>			<b>Front Leveling Struts</b>						
1-2.5"	F9125ST		F9125ST						
<b>09-14 F150 Pickup 4WD Kit</b>			<b>Front Strut Spacer Kit</b>						
4.5"	F945BKH		F9461A+F945BH						
4.5"	F945BKN		F9461A+F945BN						
4.5"	F945BKB		F9461A+F945BB						
4.5"	F945BKM		F9461A+F945BM						
KIT NOTES: 20 Inch Diameter or Larger Wheel must be Used.									
<b>09-14 F150 Pickup 4WD Kit</b>			<b>Front Strut Spacer Kit</b>						
6"	F960BKH		F9461A+F960BH						
6"	F960BKN		F9461A+F960BN						
6"	F960BKB		F9461A+F960BB						
6"	F960BKM		F9461A+F960BM						
KIT NOTES: 20 Inch Diameter or Larger Wheel must be Used.									
<b>09-13 F150 Pickup 4WD Kit</b>			<b>Adjustable Front Strut Kit</b>						
4-6"	F9461K		F9461A+F9461B						
KIT NOTES: 20 Inch Diameter or Larger Wheel must be Used.									
<b>09-13 F150 Pickup 4WD System</b>			<b>Adjustable Front Strut System</b>						
4-6"	F9461KS		F9461A+F9461BS			2	FR904S		
KIT NOTES: 20 Inch Diameter or Larger Wheel must be Used.									
<b>COIL-OVER KIT</b>									
<b>09-13 F150 Pickup 4WD Kit</b>			<b>Coil-Over Kit</b>						
6"	F962LSKM		F962LS+F9461A+F962BM						
KIT NOTES: 20 Inch Diameter or Larger Wheel must be Used. Kit includes front 2.5" remote reservoir coilover shocks w/ coil springs, front steering knuckles, front & rear cross members, front differential skid plate, front differential relocation brackets, front driveshaft spacer, front sway bar lowering brackets, carrier bearing lowering bracket, front & rear brake line relocation brackets, rear blocks, rear U-bolts, & rear M95 monotube shocks.									

FORD

	Steering Stabilizers									HYDRO Shocks		NITRO Shocks		BLACK MAX		M95 Shocks		Labor
	White			Black			Silver			White		White		Black		Silver		Hours
	OEM	Single	Dual	OEM	Single	Dual	OEM	Single	Dual	Front	Rear	Front	Rear	Front	Rear	Front	Rear	

**NOTE: ALL SHOCKS MUST BE ORDERED SEPARATELY.**

										---	---	H7041	---	---	N8041	---	---	B8541	---	---	M9541	4
--	--	--	--	--	--	--	--	--	--	-----	-----	-------	-----	-----	-------	-----	-----	-------	-----	-----	-------	---

										---	---	Included	---	---	---	---	---	---	---	---	---	8
										---	---	---	---	---	Included	---	---	---	---	---	---	8
										---	---	---	---	---	---	---	---	Included	---	---	---	8
										---	---	---	---	---	---	---	---	---	---	Included	---	8

										---	---	Included	---	---	---	---	---	---	---	---	---	8
										---	---	---	---	---	Included	---	---	---	---	---	---	8
										---	---	---	---	---	---	---	---	Included	---	---	---	8
										---	---	---	---	---	---	---	---	---	---	Included	---	8

**NOTE: ALL SHOCKS MUST BE ORDERED SEPARATELY.**

										---	---	H7041	---	---	N8041	---	---	B8541	---	---	M9541	4
--	--	--	--	--	--	--	--	--	--	-----	-----	-------	-----	-----	-------	-----	-----	-------	-----	-----	-------	---

										---	---	H7041	---	---	N8041	---	---	B8541	---	---	M9541	4
--	--	--	--	--	--	--	--	--	--	-----	-----	-------	-----	-----	-------	-----	-----	-------	-----	-----	-------	---

										---	---	Included	---	---	---	---	---	---	---	---	---	8
										---	---	---	---	---	Included	---	---	---	---	---	---	8
										---	---	---	---	---	---	---	---	Included	---	---	---	8
										---	---	---	---	---	---	---	---	---	---	Included	---	8

										---	---	Included	---	---	---	---	---	---	---	---	---	8
										---	---	---	---	---	Included	---	---	---	---	---	---	8
										---	---	---	---	---	---	---	---	Included	---	---	---	8
										---	---	---	---	---	---	---	---	---	---	Included	---	8

										---	---	H7060	---	---	N8060	---	---	B8560	---	---	M9560	8
--	--	--	--	--	--	--	--	--	--	-----	-----	-------	-----	-----	-------	-----	-----	-------	-----	-----	-------	---

										---	---	H7060	---	---	N8060	---	---	B8560	---	---	M9560	8
--	--	--	--	--	--	--	--	--	--	-----	-----	-------	-----	-----	-------	-----	-----	-------	-----	-----	-------	---

										---	---	---	---	---	---	---	---	---	---	---	Included	9
--	--	--	--	--	--	--	--	--	--	-----	-----	-----	-----	-----	-----	-----	-----	-----	-----	-----	----------	---



# FORD

LIFT	Quick Kit		KIT NOTES	Component Box		Front Springs		Rear Springs		Add-A-Leafs	Steering Correction
	Reference			(Requires 1 Of Each)		Qty	Part #	Qty	Part #		
<b>04-08 F150 PICKUP 2WD / 4WD</b>											
<b>VALUE KITS</b>											
<b>04-08 F150 Pickup 2WD / 4WD Kit</b>			<b>Metal Spacers (Front Leveling Kit)</b>								
2.5"	FF25MS		FF25MS								
KIT NOTES: Installed Above Strut Assembly.											
<b>04-08 F150 PICKUP 4WD</b>											
<b>PERFORMANCE STRUT SERIES</b>											
<b>04-08 F150 Pickup 4WD</b>			<b>3" Performance Front Struts</b>								
3"	F423ST		F423ST								
<b>04-08 F150 Pickup 4WD Kit</b>			<b>3" Performance Front Struts With 2" Blocks, U-Bolts &amp; Shocks</b>								
3"	F430STBH	G34	F430STBH								
3"	F430STBN	G34	F430STBN								
3"	F430STBB	G34	F430STBB								
3"	F430STBM	G34	F430STBM								
KIT NOTES: G34. Can Use OEM Wheels. Kit Includes Rear Blocks, U-Bolts.											
<b>04-08 F150 Pickup 4WD Kit</b>			<b>Front Strut Spacer With Rear Blocks &amp; U-Bolts</b>								
6"	F460BKH		F4461A + F460BH								
6"	F460BKB		F4461A + F460BB								
6"	F460BKM		F4461A + F460BM								
<b>04-08 F150 Pickup 4WD Kit</b>			<b>Performance Struts with Rear Add-A-Leafs</b>								
6"	F4601K-NSP		F4601A-NSP+F4602BST								
<b>04-08 F150 Pickup 4WD System</b>			<b>Performance Struts With Replacement Rear Springs</b>								
6"	F4601KS-NSP		F4601A-NSP+F4602BSST			2	FR44S				
<b>04-08 F150 PICKUP 2WD</b>											
<b>04-08 F150 Pickup 2WD</b>			<b>3" Performance Front Struts</b>								
3"	F223ST		F223ST								
<b>04-08 F150 Pickup 2WD Kit</b>			<b>3" Performance Front Struts With 2" Blocks, U-Bolts &amp; Shocks</b>								
3"	F432STBH	G34	F432STBH								
3"	F432STBN	G34	F432STBN								
3"	F432STBB	G34	F432STBB								
3"	F432STBM	G34	F432STBM								
KIT NOTES: G34. Can Use OEM Wheels. Kit Includes Rear Blocks, U-Bolts, & Hydro Shocks. For Nitro Shocks Change 'H' to 'N' & for Monotube Shocks Change 'H' to 'M'.											
<b>97-03 F150 PICKUP 4WD</b>											
<b>97-03 F150 4WD (Torsion Bar Front End)</b>			<b>Torsion Keys (Front Leveling Kit)</b>								
2"	F301KE		F301KE								
<b>97-03 F150 Pickup 4WD Kit</b>			<b>Class I with Blocks &amp; U-Bolts (Without Skid Plate)</b>								
6"	F9701K-NSP	G29	F9701A-NSP+F9701B								
KIT NOTES: (No Skid Plate). G29. Regular Cab, Short Bed Models, are Equipped with a Factory Tapered 2" Block. For Correct Driveline Angle, a Flat 2" Block will be Needed. Part # <b>RBF220</b> .											
<b>97-03 F150 Pickup 4WD System</b>			<b>Class I with Replacement Rear Springs (Without Skid Plate)</b>								
6"	F9701KS-NSP	G29	F9701A-NSP+F9701BS			2	FR15S				
KIT NOTES: (No Skid Plate). G29. Regular Cab, Short Bed Models, are Equipped with a Factory Tapered 2" Block. For Correct Driveline Angle, a Flat 2" Block will be Needed. Part # <b>RBF220</b> .											
<b>80-96 F150 PICKUP 4WD</b>											
<b>80-96 F150 Pickup 4WD Kit</b>			<b>Standard Brackets with Blocks &amp; U-Bolts &amp;/or Add-A-Leafs</b>								
1.5-2"	182K	G1, G18		1	182			R3120			
4"	184PK	G8, G18, G28	184P	1	184				FA400		
6"	186PK	G8, G18, G28	186P	1	186				FA400		
8"	188PK-A	G8, G18, G28	188C+188P	1	188			Included	Included		
KIT NOTES: G1. Oversized Camber / Caster Shims are Required (See Ford Accessories Section). G8. Power Steering Models Only. G18. See Brake Lines Section. G28. If Vehicle is Equipped with a Front Sway Bar. Lowering Brackets must be Ordered. See Ford Accessories Section.											
<b>80-96 F150 Pickup 4WD System</b>			<b>Standard Brackets with Replacement Rear Springs</b>								
4"	184PKS	G8, G10, G18, G28	184PS	1	184	2	FR54S		FA400		
6"	186PKS	G8, G18, G28	186PS	1	186	2	FR54S		FA400		
8"	188PKS-A	G8, G18, G28	188C+188PS	1	188	2	FR56S		Included		
KIT NOTES: G8. Power Steering Models Only. G10. The Factory Block is Removed. G18. See Brake Lines Section. G28. If Vehicle is Equipped with a Front Sway Bar. Lowering Brackets must be Ordered. See Ford Accessories Section.											

FORD



	Steering Stabilizers									HYDRO Shocks		NITRO Shocks		BLACK MAX		M95 Shocks		Labor Hours
	White			Black			Silver			White		White		Black		Silver		
	OEM	Single	Dual	OEM	Single	Dual	OEM	Single	Dual	Front	Rear	Front	Rear	Front	Rear	Front	Rear	

**NOTE: ALL SHOCKS MUST BE ORDERED SEPARATELY.**

											---	---	H7041	---	---	N8041	---	---	B8541	---	---	M9541	2
--	--	--	--	--	--	--	--	--	--	--	-----	-----	-------	-----	-----	-------	-----	-----	-------	-----	-----	-------	---

**NOTE: ALL SHOCKS MUST BE ORDERED SEPARATELY.**

														---	---	H7041	---	---	N8041	---	---	B8541	---	---	M9541	3
--	--	--	--	--	--	--	--	--	--	--	--	--	--	-----	-----	-------	-----	-----	-------	-----	-----	-------	-----	-----	-------	---

														---	---	Included	---	---	---	---	---	---	---	---	6	
														---	---	---	---	---	Included	---	---	---	---	---	6	
														---	---	---	---	---	---	---	---	Included	---	---	6	
														---	---	---	---	---	---	---	---	---	Included	---	---	6

														---	---	Included	---	---	---	---	---	---	---	---	8	
														---	---	---	---	---	---	---	---	Included	---	---	8	
														---	---	---	---	---	---	---	---	---	Included	---	---	8

														---	---	H7060	---	---	N8060	---	---	B8560	---	---	M9560	8
--	--	--	--	--	--	--	--	--	--	--	--	--	--	-----	-----	-------	-----	-----	-------	-----	-----	-------	-----	-----	-------	---

														---	---	H7060	---	---	N8060	---	---	B8560	---	---	M9560	10
--	--	--	--	--	--	--	--	--	--	--	--	--	--	-----	-----	-------	-----	-----	-------	-----	-----	-------	-----	-----	-------	----

**NOTE: ALL SHOCKS MUST BE ORDERED SEPARATELY.**

														---	---	H7041	---	---	N8041	---	---	B8541	---	---	M9541	3
--	--	--	--	--	--	--	--	--	--	--	--	--	--	-----	-----	-------	-----	-----	-------	-----	-----	-------	-----	-----	-------	---

														---	---	Included	---	---	---	---	---	---	---	---	6	
														---	---	---	---	---	Included	---	---	---	---	---	6	
														---	---	---	---	---	---	---	---	Included	---	---	6	
														---	---	---	---	---	---	---	---	---	Included	---	---	6

**NOTE: ALL SHOCKS MUST BE ORDERED SEPARATELY.**

														-----	-----	H7059	-----	-----	N8059	---	---	B8559	-----	-----	M9559	2
--	--	--	--	--	--	--	--	--	--	--	--	--	--	-------	-------	-------	-------	-------	-------	-----	-----	-------	-------	-------	-------	---

																7297 <sup>(G)</sup>			8297 <sup>(G)</sup>			9297 <sup>(G)</sup>	H7097	H7061	N8097	N8061	B8597	B8561	M9597	M9561	8
--	--	--	--	--	--	--	--	--	--	--	--	--	--	--	--	---------------------	--	--	---------------------	--	--	---------------------	-------	-------	-------	-------	-------	-------	-------	-------	---

G. Dual Steering Stabilizer can Only be Used with Skyjacker® 6" Lift.

																7297 <sup>(G)</sup>			8297 <sup>(G)</sup>			9297 <sup>(G)</sup>	H7097	H7061	N8097	N8061	B8597	B8561	M9597	M9561	10
--	--	--	--	--	--	--	--	--	--	--	--	--	--	--	--	---------------------	--	--	---------------------	--	--	---------------------	-------	-------	-------	-------	-------	-------	-------	-------	----

G. Dual Steering Stabilizer can Only be Used with Skyjacker® 6" Lift.

**NOTE: ALL SHOCKS MUST BE ORDERED SEPARATELY.**

																7140	7240		8140	8240		9140	9240	H7052	H7060	N8052	N8060	B8552	B8560	M9552	M9560	4
																7140	7240		8140	8240		9140	9240	H7054	H7060	N8054	N8060	B8554	B8560	M9554	M9560	6
																7140	7240		8140	8240		9140	9240	H7055	H7060	N8055	N8060	B8555	B8560	M9555	M9560	6
																7140	7240		8140	8240		9140	9240	H7055	H7079	N8055	N8079	B8555	B8579	M9555	M9579	7

																7140	7240		8140	8240		9140	9240	H7054	H7060	N8054	N8060	B8554	B8560	M9554	M9560	6
																7140	7240		8140	8240		9140	9240	H7055	H7060	N8055	N8060	B8555	B8560	M9555	M9560	6
																7140	7240		8140	8240		9140	9240	H7055	H7079	N8055	N8079	B8555	B8579	M9555	M9579	7



# FORD

LIFT	Quick Kit	KIT NOTES	Component Box	Front Springs		Rear Springs		Add-A-Leafs	Steering Correction
	Reference		(Requires 1 Of Each)	Qty	Part #	Qty	Part #		(Order 1 Each)

<b>80-96 F150 Pickup 4WD Kit</b>			<b>Class II Brackets &amp; Radius Arms with Blocks &amp; U-Bolts</b>						
6"	286PK-A	G8, G18, G28	286P+RA150	1	186				Included

KIT NOTES: G8. Power Steering Models Only. G18. See Brake Lines Section. G28. If Vehicle is Equipped with a Front Sway Bar. Lowering Brackets must be Ordered. See Ford Accessories Section.

<b>80-96 F150 Pickup 4WD System</b>			<b>Class II Brackets &amp; Radius Arms with Replacement Rear Springs</b>						
4"	284PKS-A	G8, G10, G18, G28	284PS+RA150	1	184	2	FR54S		Included
6"	286PKS-A	G8, G18, G28	286PS+RA150	1	186	2	FR54S		Included

KIT NOTES: G8. Power Steering Models Only. G10. The Factory Block is Removed. G18. See Brake Lines Section. G28. If Vehicle is Equipped with a Front Sway Bar. Lowering Brackets must be Ordered. See Ford Accessories Section.

## 80-96 F150 PICKUP 2WD

<b>80-96 F150 Pickup 2WD Kit</b>			<b>Standard Brackets with Blocks &amp; U-Bolts &amp;/or Add-A-Leafs</b>						
1.5-2"	182P2K	G1, G18		1	182			R225	
8"	188P2K-A	G8, G18, G28	188C+188P2	1	188			Included	Included

KIT NOTES: G1. Oversized Camber / Caster Shims are Required (See Ford Accessories Section). G8. Power Steering Models Only. G18. See Brake Lines Section. G28. If Vehicle is Equipped with a Front Sway Bar. Lowering Brackets must be Ordered. See Ford Accessories Section.

## 66-79 F150 PICKUP 4WD

<b>77-79 F150 Pickup 4WD Kit</b>			<b>With Blocks &amp; U-Bolts &amp;/or Add-A-Leafs</b>						
1.5-2"	172PK	G11, G18		1	172			R3120	
4"	174PK	G4, G13, G18		1	174			R3120	FA300
6"	176PK	G4, G15, G18, G20	176P	1	176				FA300
9"	179PK	G4, G17, G18, G20	179P	1	179			R3120	FA500

KIT NOTES: G4. Pitman Arm Only Fits 76-79 Models with Power Steering. 76-77 Models must Change Drag Link & Tie Rod Assembly to "T" Style. Order # FDL70 & # TRA70. G11. Caster Correction Required; Use # CB400 (# CB477 on 77 Models). G13. Caster Correction Required; Use # RAB27 or # CB700 (# CB777 on 77 Models). For Best Correction, Use RAB27 & CB200 (CB277 on 77 Models). G15. Caster Correction Required; Use # RAB47 or # CB700 (# CB777 on 77 Models). For Best Correction, Use RAB47 & CB200 (# CB277 for 77 Models). G17. Caster Correction Required; Use Both # RAB47 & # CB400 (# CB477 for 77 Models). G18. See Brake Lines Section. G20. Requires Brake Lines # FBL78 + # RBL76.

<b>77-79 F150 Pickup 4WD System</b>			<b>With Replacement Rear Springs</b>						
4"	174PKS	G4, G13, G18	174PS	1	174	2	FR52S		FA300
6"	176PKS	G4, G15, G18, G20	176PS	1	176	2	FR54S		FA300
9"	179PKS	G4, G9, G17, G18, G20	179PS	1	179	2	FR56S		FA500

KIT NOTES: G4. Pitman Arm Only Fits 76-79 Models with Power Steering. 76-77 Models must Change Drag Link & Tie Rod Assembly to "T" Style. Order # FDL70 & on 77 Models). For Best Correction, Use RAB27 & CB200 (CB277 on 77 Models). G9. This Lift also Includes 2" Blocks. G13. Caster Correction Required; Use # RAB27 or # CB700 (# CB777 on 77 Models). For Best Correction, Use RAB27 & CB200 (CB277 on 77 Models). G15. Caster Correction Required; Use # RAB47 or # CB700 (# CB777 for 77 Models). For Best Correction, Use RAB47 & CB200 (# CB277 for 77 Models). G17. Caster Correction Required; Use Both # RAB47 & # CB400 (# CB477 for 77 Models). G18. See Brake Lines Section. G20. Requires Brake Lines # FBL78 + # RBL76.

<b>73-76 F150 Pickup 4WD Kit</b>			<b>With Blocks &amp; U-Bolts &amp;/or Add-A-Leafs</b>						
1.5-2"	172PK	G11, G18		1	172			R3120	
4"	174PK	G4, G18, G21		1	174			R3120	FA300
6"	176PK	G4, G15, G18,	176P	1	176				FA300
9"	179PK	G4, G17, G18	179P	1	179			R3120	FA500

KIT NOTES: G4. Pitman Arm Only Fits 76-79 Models with Power Steering. 76-77 Models must Change Drag Link & Tie Rod Assembly to "T" Style. Order # FDL70 & # TRA70. G11. Caster Correction Required; Use # CB400. G15. Caster Correction Required; Use # RAB47 or # CB700 (For Best Correction, Use RAB47 & CB200). G17. Caster Correction Required; Use Both # RAB47 & # CB400. G18. See Brake Lines Section. G21. Caster Correction Required; Use # RAB27 or # CB700. (For Best Correction, Use RAB47 & CB2000).

<b>73-76 F150 Pickup 4WD System</b>			<b>With Replacement Rear Springs</b>						
1.5-2"	172PKS	G11, G18	U5WWR	1	172	2	FR54S		
4"	174PKS	G4, G18, G21	174PS	1	174	2	FR52S		FA300
6"	176PKS	G4, G15, G18	176PS	1	176	2	FR54S		FA300
9"	179PKS	G4, G9, G17, G18	179PS	1	179	2	FR56S		FA500

KIT NOTES: G4. Pitman Arm Only Fits 76-79 Models with Power Steering. 76-77 Models must Change Drag Link & Tie Rod Assembly to "T" Style. Order # FDL70 & # TRA70. G9. This Lift also Includes 2" Blocks. G10. The Factory Block is Removed. G11. Caster Correction Required; Use # CB400. G15. Caster Correction Required; Use # RAB47 or # CB700 (For Best Correction, Use RAB47 & CB200.) G17. Caster Correction Required; Use Both # RAB47 & # CB400. G18. See Brake Lines Section. G21. Caster Correction Required; Use # RAB27 or # CB700. (For Best Correction, Use RAB27 & CB200).

<b>70-72 F100 Pickup 4WD Kit</b>			<b>With Blocks &amp; U-Bolts &amp;/or Add-A-Leafs</b>						
2"	172EPK	G11, G18		1	172	1		R225	
4"	174EPK	G18, G21		1	174	1		R225	
6"	176PK	G15, G18	176P	1	176				
9"	179PK	G17, G18	179P	1	179	1		R225	

KIT NOTES: G11. Caster Correction Required; Use # CB400. G15. Caster Correction Required; Use # RAB47 or # CB700 (For Best Correction, Use RAB47 & CB200). G17. Caster Correction Required; Use Both # RAB47 & # CB400. G18. See Brake Lines Section. G21. Caster Correction Required; Use # RAB27 or # CB700. (For Best Correction, Use RAB27 & CB200).

FORD

	Steering Stabilizers									HYDRO Shocks		NITRO Shocks		BLACK MAX		M95 Shocks		Labor
	White			Black			Silver			White		White		Black		Silver		Hours
	OEM	Single	Dual	OEM	Single	Dual	OEM	Single	Dual	Front	Rear	Front	Rear	Front	Rear	Front	Rear	Hours

		7140	7240		8140	8240		9140	9240	H7055	H7060	N8055	N8060	B8555	B8560	M9555	M9560	8
--	--	------	------	--	------	------	--	------	------	-------	-------	-------	-------	-------	-------	-------	-------	---

		7140	7240		8140	8240		9140	9240	H7054	H7060	N8054	N8060	B8554	B8560	M9554	M9560	8
		7140	7240		8140	8240		9140	9240	H7055	H7060	N8055	N8060	B8555	B8560	M9555	M9560	8

**NOTE: ALL SHOCKS MUST BE ORDERED SEPARATELY.**

		7140	7240		8140	8240		9140	9240	H7052	H7058	N8052	N8058	B8552	B8558	M9552	M9558	4
		7140	7240		8140	8240		9140	9240	H7055	H7060	N8055	N8060	B8555	B8560	M9555	M9560	7

**NOTE: ALL SHOCKS MUST BE ORDERED SEPARATELY.**

	7030		7210	8030		8210	8030		9210	H7054	H7055	N8054	N8055	B8554	B8555	M9554	M9555	4
	7030		7210	8030		8210	8030		9210	H7055	H7056	N8055	N8056	B8555	B8556	M9555	M9556	6
	7030		7210	8030		8210	8030		9210	H7056	H7059	N8056	N8059	B8556	B8559	M9556	M9559	6
	7030		7210	8030		8210	8030		9210	H7059	H7061	N8059	N8061	B8559	B8561	M9559	M9561	8

	7030		7210	8030		8210	9030		9210	H7055	H7056	N8055	N8056	B8555	B8556	M9555	M9556	6
	7030		7210	8030		8210	9030		9210	H7056	H7059	N8056	N8059	B8556	B8559	M9556	M9559	6
	7030		7210	8030		8210	9030		9210	H7059	H7061	N8059	N8061	B8559	B8561	M9559	M9561	8

	7030	7110	7240	8030	8110	8240	9030	9110	9240	H7023	H7056	N8023	N8056	B8523	B8556	M9523	M9556	4
	7030	7110	7240	8030	8110	8240	9030	9110	9240	H7023	H7056	N8023	N8056	B8523	B8556	M9523	M9556	6
	7030	7110	7240	8030	8110	8240	9030	9110	9240	H7058	H7059	N8058	N8059	B8558	B8559	M9558	M9559	6
	7030	7110	7240	8030	8110	8240	9030	9110	9240	H7060	H7061	N8060	N8061	B8560	B8561	M9560	M9561	8

	7030	7110	7240	8030	8110	8240	9030	9110	9240	H7023	H7056	N8023	N8056	B8523	B8556	M9523	M9556	4
	7030	7110	7240	8030	8110	8240	9030	9110	9240	H7023	H7056	N8023	N8056	B8523	B8556	M9523	M9556	6
	7030	7110	7240	8030	8110	8240	9030	9110	9240	H7058	H7059	N8058	N8059	B8558	B8559	M9558	M9559	6
	7030	7110	7240	8030	8110	8240	9030	9110	9240	H7060	H7061	N8060	N8061	B8560	B8561	M9560	M9561	8

	7030	7110	7210	8030	8110	8210	9030	9110	9210	H7023	H7056	N8023	N8056	B8523	B8556	M9523	M9556	4
	7030	7110	7210	8030	8110	8210	9030	9110	9210	H7023	H7056	N8023	N8056	B8523	B8556	M9523	M9556	6
	7030	7110	7210	8030	8110	8210	9030	9110	9210	H7058	H7059	N8058	N8059	B8558	B8559	M9558	M9559	6
	7030	7110	7210	8030	8110	8210	9030	9110	9210	H7060	H7061	N8060	N8061	B8560	B8561	M9560	M9561	8



# FORD

LIFT	Quick Kit	KIT NOTES	Component Box	Front Springs		Rear Springs		Add-A-Leafs	Steering Correction
	Reference		(Requires 1 Of Each)	Qty	Part #	Qty	Part #		(Order 1 Each)
<b>66-69 F100 Pickup 4WD Kit</b>			<b>With Blocks &amp; U-Bolts &amp;/or Add-A-Leafs</b>						
1.5"-2"	172EPK	G11, G18		1	172			R225	
4"	174EPK	G18, G21		1	174			R225	
6"	176PK	G15, G18	176P	1	176				
9"	179PK	G17, G18	179P	1	179			R225	

KIT NOTES: G11. Caster Correction Required; Use # CB400. G15. Caster Correction Required; Use # RAB47 or # CB700 (For Best Correction, Use RAB47 & CB200). G17. Caster Correction Required; Use Both # RAB47 & # CB400. G18. See Brake Lines Section. G21. Caster Correction Required; Use # RAB27 or # CB700. (For Best Correction, Use RAB27 & CB200).

## 80-96 BRONCO 4WD

<b>80-96 Bronco 4WD Kit</b>			<b>With Blocks &amp; U-Bolts &amp;/or Add-A-Leafs</b>						
1.5-2"	182K	G1, G18		1	182			R3120	
4"	184BK	G8, G18, G28	184B	1	184				FA400
6"	186BK	G8, G18, G28	186B	1	186				FA400
8"	188BK-A	G8, G18	188C+188B	1	188				Included

KIT NOTES: G1. Oversized Camber / Caster Shims are Required (See Ford Accessories Section). G8. Power Steering Models Only. G18. See Brake Lines Section. G28. If Vehicle is Equipped with a Front Sway Bar. Lowering Brackets must be Ordered. See Ford Accessories Section.

## 80-96 Bronco 4WD System

<b>80-96 Bronco 4WD System</b>			<b>With Replacement Rear Springs</b>						
1.5-2"	182BKS	G1, G18	182BS	1	182	2	FR51S		
4"	184BKS	G8, G18, G28	184BS	1	184	2	FR52S		FA400
6"	186BKS	G8, G18, G28	186BS	1	186	2	FR54S		FA400
8"	188BKS-A	G8, G18	188C+188BS	1	188	2	FR56S		Included

KIT NOTES: G1. Oversized Camber / Caster Shims are Required (See Ford Accessories Section). G8. Power Steering Models Only. G18. See Brake Lines Section. G28. If Vehicle is Equipped with a Front Sway Bar. Lowering Brackets must be Ordered. See Ford Accessories Section.

## 80-96 Bronco 4WD Kit

<b>80-96 Bronco 4WD Kit</b>			<b>Class II Brackets &amp; Radius Arms with Blocks &amp; U-Bolts</b>						
6"	286BK-A	G8, G18, G28	286B+RA150	1	186				Included

KIT NOTES: G8. Power Steering Models Only. G18. See Brake Lines Section. G28. If Vehicle is Equipped with a Front Sway Bar. Lowering Brackets must be Ordered. See Ford Accessories Section.

## 80-96 Bronco 4WD System

<b>80-96 Bronco 4WD System</b>			<b>Class II Brackets &amp; Radius Arms with Replacement Rear Springs</b>						
4"	284BKS-A	G8, G18, G28	284BS+RA150	1	184	2	FR52S		Included
6"	286BKS-A	G8, G18, G28	286BS+RA150	1	186	2	FR54S		Included

KIT NOTES: G8. Power Steering Models Only. G18. See Brake Lines Section. G28. If Vehicle is Equipped with a Front Sway Bar. Lowering Brackets must be Ordered. See Ford Accessories Section.

## 67-79 BRONCO 4WD

<b>78-79 Bronco 4WD Kit</b>			<b>With Blocks &amp; U-Bolts &amp;/or Add-A-Leafs</b>						
1.5-2"	172BK	G11, G18		1	172			R3120	
4"	174BK	G8, G18, G21		1	174			R300	FA300
6"	176BK	G8, G15, G18, G20	176B	1	176				FA300
9"	179BK	G8, G17, G18, G20	179B	1	179			R300	FA500

KIT NOTES: G8. Power Steering Models Only. G11. Caster Correction Required; Use # CB400. G15. Caster Correction Required; Use # RAB47 or # CB700 (For Best Correction, Use RAB47 & CB200). G17. Caster Correction Required; Use Both # RAB47 & # CB400. G18. See Brake Lines Section. G20. Requires Brake Lines # FBL78 + # RBL76. G21. Caster Correction Required; Use # RAB27 or #CB700. (For Best Correction, Use RAB27 & CB200).

## 78-79 Bronco 4WD System

<b>78-79 Bronco 4WD System</b>			<b>With Replacement Rear Springs</b>						
4"	174BKS	G8, G18, G21	174BS	1	174	2	FR52S		FA300
6"	176BKS	G8, G15, G18, G20	176BS	1	176	2	FR54S		FA300
9"	179BKS	G8, G17, G18, G20	179BS	1	179	2	FR56S		FA500

KIT NOTES: G8. Power Steering Models Only. G15. Caster Correction Required; Use # RAB47 or # CB700 (For Best Correction, Use RAB47 & CB200). G17. Caster Correction Required; Use Both # RAB47 & # CB400. G18. See Brake Lines Section. G20. Requires Brake Lines # FBL78 # RBL76. G21. Caster Correction Required; Use # RAB27 or # CB700. (For Best Correction, Use RAB27 & CB200).

## 67-77 Bronco 4WD Kit

<b>67-77 Bronco 4WD Kit</b>			<b>With Blocks &amp; U-Bolts &amp;/or Add-A-Leafs</b>						
3"	172EBK	G12, G18		1	172			R225	
5"	174EBK	G5, G14, G18	174EB	1	174V				FA307

KIT NOTES: G5. Pitman Arm Fits Manual & Power Steering. 76-77 Models Must Change Drag Link & Tie Rod Assembly to "T" Style. Order # FDL67 & # TRA60. G12. Caster Correction Required; Use # CB400 (# CB477 on 76-77 Models). G14. Caster Correction Required; Use # RAB40 or # CB700 (# CB777 on 76-77 Models). G18. See Brake Lines Section.

FORD

	Steering Stabilizers									HYDRO Shocks		NITRO Shocks		BLACK MAX		M95 Shocks		Labor Hours
	White			Black			Silver			White		Black		Silver				
	OEM	Single	Dual	OEM	Single	Dual	OEM	Single	Dual	Front	Rear	Front	Rear	Front	Rear	Front	Rear	
	7030	7110	7210	8030	8110	8210	9030	9110	9210	H7023	H7058	N8023	N8058	B8523	B8558	M9523	M9558	4
	7030	7110	7210	8030	8110	8210	9030	9110	9210	H7023	H7058	N8023	N8058	B8523	B8558	M9523	M9558	6
	7030	7110	7210	8030	8110	8210	9030	9110	9210	H7058	H7041	N8058	N8041	B8558	B8541	M9558	M9541	6
	7030	7110	7210	8030	8110	8210	9030	9110	9210	H7060	H7060	N8060	N8060	B8560	B8560	M9560	M9560	8

**NOTE: ALL SHOCKS MUST BE ORDERED SEPARATELY.**

		7140	7240		8140	8240		9140	9240	H7052	H7058	N8052	N8058	B8552	B8558	M9552	M9558	4
		7140	7240		8140	8240		9140	9240	H7054	H7058	N8054	N8058	B8554	B8558	M9554	M9558	6
		7140	7240		8140	8240		9140	9240	H7055	H7060	N8055	N8060	B8555	B8060	M9555	M9560	6
		7140	7240		8140	8240		9140	9240	H7055	H7060	N8055	N8060	B8555	B8560	M9555	M9560	7

		7140	7240		8140	8240		9140	9240	H7052	H7058	N8052	N8058	B8552	B8558	M9552	M9558	4
		7140	7240		8140	8240		9140	9240	H7054	H7058	N8054	N8058	B8554	B8558	M9554	M9558	6
		7140	7240		8140	8240		9140	9240	H7055	H7060	N8055	N8060	B8555	B8560	M9555	M9560	6
		7140	7240		8140	8240		9140	9240	H7055	H7060	N8055	N8060	B8555	B8560	M9555	M9560	7

		7140	7240		8140	8240		9140	9240	H7055	H7060	N8055	N8060	B8555	B8560	M9555	M9560	8
--	--	------	------	--	------	------	--	------	------	-------	-------	-------	-------	-------	-------	-------	-------	---

		7140	7240		8140	8240		9140	9240	H7054	H7058	N8054	N8058	B8554	B8558	M9554	M9558	8
		7140	7240		8140	8240		9140	9240	H7055	H7060	N8055	N8060	B8555	B8560	M9555	M9560	8

**NOTE: ALL SHOCKS MUST BE ORDERED SEPARATELY.**

	7030		7210	8030		8210	9030		9210	H7055 <sup>(A)</sup>	H7023	N8055 <sup>(A)</sup>	N8023	B8555 <sup>(A)</sup>	B8523	M9555 <sup>(A)</sup>	M9523	4
										H7054 <sup>(B)</sup>		N8054 <sup>(B)</sup>		B8554 <sup>(B)</sup>		M9554 <sup>(B)</sup>		
	7030		7210	8030		8210	9030		9210	H7056 <sup>(A)</sup>	H7058	N8056 <sup>(A)</sup>	N8058	B8556 <sup>(A)</sup>	B8558	M9556 <sup>(A)</sup>	M9558	6
										H7055 <sup>(B)</sup>		N8055 <sup>(B)</sup>		B8555 <sup>(B)</sup>		M9555 <sup>(B)</sup>		
	7030		7210	8030		8210	9030		9210	H7059 <sup>(A)</sup>	H7058	N8059 <sup>(A)</sup>	N8058	B8559 <sup>(A)</sup>	B8558	M9559 <sup>(A)</sup>	M9558	6
										H7056 <sup>(B)</sup>		N8056 <sup>(B)</sup>		B8556 <sup>(B)</sup>		M9556 <sup>(B)</sup>		
	7030		7210	8030		8210	9030		9210	H7061 <sup>(A)</sup>	H7060	N8061 <sup>(A)</sup>	N8060	B8561 <sup>(A)</sup>	B8560	M9561 <sup>(A)</sup>	M9560	8
										H7059 <sup>(B)</sup>		N8059 <sup>(B)</sup>		B8559 <sup>(B)</sup>		M9559 <sup>(B)</sup>		

(A). Ahead Of Axle. (B). Behind Axle.

	7030		7210	8030		8210	9030		9210	H7056 <sup>(A)</sup>	H7058	N8056 <sup>(A)</sup>	N8058	B8556 <sup>(A)</sup>	B8558	M9556 <sup>(A)</sup>	M9558	6
										H7055 <sup>(B)</sup>		N8055 <sup>(B)</sup>		B8555 <sup>(B)</sup>		M9555 <sup>(B)</sup>		
	7030		7210	8030		8210	9030		9210	H7059 <sup>(A)</sup>	H7058	N8059 <sup>(A)</sup>	N8058	B8559 <sup>(A)</sup>	B8558	M9559 <sup>(A)</sup>	M9558	6
										H7056 <sup>(B)</sup>		N8056 <sup>(B)</sup>		B8556 <sup>(B)</sup>		M9556 <sup>(B)</sup>		
	7030		7210	8030		8210	9030		9210	H7061 <sup>(A)</sup>	H7060	N8061 <sup>(A)</sup>	N8060	B8561 <sup>(A)</sup>	B8560	M9561 <sup>(A)</sup>	M9560	8
										H7059 <sup>(B)</sup>		N8059 <sup>(B)</sup>		B8559 <sup>(B)</sup>		M9559 <sup>(B)</sup>		

(A). Ahead Of Axle. (B). Behind Axle.

	7030			8030			9030			H7055	H7023	N8055	N8023	B8555	B8523	M9555	M9523	4
	7030			8030			9030			H7055	H7058	N8055	N8058	B8555	B8558	M9555	M9558	6

# FORD

LIFT	Quick Kit	KIT NOTES	Component Box	Front Springs		Rear Springs		Add-A-Leafs	Steering Correction
	Reference		(Requires 1 Of Each)	Qty	Part #	Qty	Part #		(Order 1 Each)
<b>67-77 Bronco 4WD System</b>			<b>With Replacement Rear Springs</b>						
5"	174EBKS	G5, G14, G18	174EBS	1	174V	2	FR64S		FA307
7"	176EBKS	G5, G9, G16, G18	176EBS	1	176	2	FR64S		FA500
KIT NOTES: G5. Pitman Arm Fits Manual & Power Steering. 76-77 Models Must Change Drag Link & Tie Rod Assembly to "T" Style. Order # FDL67 & # TRA60. G9. This Lift also Includes 2" Blocks. G14. Caster Correction Required; Use # RAB40 or # CB700 (# CB777 on 76-77 Models). G16. Caster Correction Required; Use Both # RAB40 & # CB400 (# RAB40 & # CB477 on 76-77 Models). G18. See Brake Lines Section.									
<b>97-08 EXPEDITION 2WD &amp; 4WD</b>									
<b>POLYURETHANE VALUE KIT</b>									
<b>03-08 Expedition 2WD &amp; 4WD Kit</b>			<b>Polyurethane Spacers</b>						
2"	EX20		EX20						
<b>97-02 Expedition 4WD (Torsion Bar Front End)</b>			<b>Torsion Keys (Front Leveling Kit)</b>						
2"	F301KE		F301KE						
<b>00-05 EXCURSION 4WD (FRONT LEAF SPRING)</b>									
<b>00-05 Excursion 4WD Kit</b>			<b>Gas V8 or V10 Engine with Blocks &amp; U-Bolts</b>						
4"	FE40MK	G8	F9402M	2	F920S				FA499
6"	FE60MK	G8, G25	F9602M	2	F940S				FA499
KIT NOTES: G8. Power Steering Models Only. G25. # SBE405 may be Required on Models Equipped with Factory Rear Sway Bar.									
<b>00-05 Excursion 4WD System</b>			<b>Gas V8 or V10 Engine with Replacement Rear Springs</b>						
4"	FE40MKS	G8	F9402MS	2	F920S	2	FR94S		FA499
6"	FE60MKS	G8, G25	F9602MS	2	F940S	2	FR96S		FA499
8"	FE80MKS-A	G8	F9802MS	2	F960S	2	FR98S		Included
KIT NOTES: G8. Power Steering Models Only. G25. # SBE405 may be Required on Models Equipped with Factory Rear Sway Bar.									
<b>00-05 Excursion 4WD Kit</b>			<b>Diesel Engine with Blocks &amp; U-Bolts</b>						
6"	FE65MK	G8, G25	F9602M	2	F945S				FA499
KIT NOTES: G8. Power Steering Models Only. G25. # SBE405 may be Required on Models Equipped with Factory Rear Sway Bar.									
<b>00-05 Excursion 4WD System</b>			<b>Diesel Engine with Replacement Rear Springs</b>						
6"	FE65MKS	G8, G25	F9602MS	2	F945S	2	FR96S		FA499
8"	FE85MKS-A	G8	F9802MS	2	F965S	2	FR98S		Included
KIT NOTES: G8. Power Steering Models Only. G25. # SBE405 may be Required on Models Equipped with Factory Rear Sway Bar.									
<b>17-20 F-250 SUPER DUTY 4WD</b>									
<b>17-20 F-250 Super Duty 4WD Kit</b>			<b>Front Metal Spacers</b>						
1"	F51MS		F51MS						
<b>17-20 F-250 Super Duty 4WD Kit</b>			<b>Front Metal Spacers with Front Track Bar Bracket</b>						
2.5"	F528MSP		F528MSP						
<b>17-20 F-250 Super Duty 4WD Kit</b>			<b>Front Metal Spacers with Shock Extension Brackets</b>						
2.5"	F1752MSB	G40	F1752MSB						
<b>17-20 F-250 Super Duty 4WD Kit (Diesel Engine)</b>			<b>Variable Rate Front Coil Springs</b>						
2.5"	F525V	G40	F525V		Included				
<b>17-20 F-250 Super Duty 4WD Kit (Gas Engine)</b>			<b>Softride® Front Coil Springs</b>						
2"	F520	G40	F520		Included				
KIT NOTES: G40. Front Track Bar Relocation Bracket <b>Required</b> - Part # TB1120									
<b>17-19 F-250 Super Duty 4WD Kit (Diesel or Gas)</b>			<b>Metal Spacer Kit with Blocks &amp; U-Bolts and Black MAX Shocks</b>						
4"	F1740SPB	G42	F1740SPB						
Kit includes front coil spring spacers, front & rear Black MAX shocks, track bar relocation bracket, radius arm relocation brackets, steering stabilizer bracket, front sway bar lowering brackets, front bump stop spacers, front brake line extension brackets, rear lift blocks, & rear u-bolts.									
<b>17-19 F-250 Super Duty 4WD Kit (Diesel Engine)</b>			<b>Variable Rate Front Coil Springs with Rear Blocks &amp; U-Bolts</b>						
4"	F17451K	G42	F17451	1	F545V				
6"	F17651K	G43	F17651	1	F565V				Included
<b>17-19 F-250 Super Duty 4WD System (Diesel Engine)</b>			<b>Variable Rate Front Coil Springs with Rear Leaf Springs</b>						
4"	F17451KS	G42	F17451S	1	F545V	2	FR173S		
6"	F17651KS	G43	F17651S	1	F565V	2	FR175S		Included
<b>17-19 F-250 Super Duty 4WD Kit (Gas Engine)</b>			<b>Softride® Front Coil Springs with Rear Blocks &amp; U-Bolts</b>						
4"	F17401K	G42	F17451	1	F540				
6"	F17601K	G43	F17651	1	F560				Included
<b>17-19 F-250 Super Duty 4WD System (Gas Engine)</b>			<b>Softride® Front Coil Springs with Rear Leaf Springs</b>						
4"	F17401KS	G42	F17451S	1	F540	2	FR173S		
6"	F17601KS	G43	F17651S	1	F560	2	FR175S		Included

FORD

	Steering Stabilizers									HYDRO Shocks		NITRO Shocks		BLACK MAX		M95 Shocks		Labor
	White			Black			Silver			White		White		Black		Silver		Hours
	OEM	Single	Dual	OEM	Single	Dual	OEM	Single	Dual	Front	Rear	Front	Rear	Front	Rear	Front	Rear	
	7030			8030			9030			H7055	H7058	N8055	N8058	B8555	B8558	M9555	M9558	6
	7030			8030			9030			H7056	H7060	N8056	N8060	B8556	B8560	M9556	M9560	6

**NOTE: ALL SHOCKS MUST BE ORDERED SEPARATELY.**

																		6				
										---	---	H7023	---	---	N8023	---	---	B8523	---	---	M9523	2

**NOTE: ALL SHOCKS MUST BE ORDERED SEPARATELY.**

	7099	7199	7299	8099	8199	8299	9099	9199	9299	H7058	H7034	N8058	N8034	B8558	B8534	M9558	M9534	8
	7099	7199	7299	8099	8199	8299	9099	9199	9299	H7041	H7077	N8041	N8077	B8541	B8577	M9541	M9577	8
	7099	7199	7299	8099	8199	8299	9099	9199	9299	H7058	H7034	N8058	N8034	B8558	B8534	M9558	M9534	8
	7099	7199	7299	8099	8199	8299	9099	9199	9299	H7041	H7077	N8041	N8077	B8541	B8577	M9541	M9577	8
	7099	7199	7299	8099	8199	8299	9099	9199	9299	H7060	H7077	N8060	N8077	B8560	B8577	M9560	M9577	8

	7099	7199	7299	8099	8199	8299	9099	9199	9299	H7041	H7077	N8041	N8077	B8541	B8577	M9541	M9577	8
--	------	------	------	------	------	------	------	------	------	-------	-------	-------	-------	-------	-------	-------	-------	---

	7099	7199	7299	8099	8199	8299	9099	9199	9299	H7041	H7077	N8041	N8077	B8541	B8577	M9541	M9577	8
	7099	7199	7299	8099	8199	8299	9099	9199	9299	H7060	H7077	N8060	N8077	B8560	B8577	M9560	M9577	8

**NOTE: ALL SHOCKS MUST BE ORDERED SEPARATELY.**

	7057						9057			H7091	H7038	N8091	N8038	B8591	B8538	M9591	M9538	2				
	7057						9057			H7091	H7038	N8091	N8038	B8591	B8538	M9591	M9538	3				
	7057						9057			---	---	H7038	---	---	N8038	---	---	B8538	---	---	M9538	4
	7057						9057			H7091	H7038	N8091	N8038	B8591	B8538	M9591	M9538	2				
	7057						9057			H7091	H7038	N8091	N8038	B8591	B8538	M9591	M9538	2				
	7057		7254			8254	9057		9254	---	---	---	---	---	---	Included	Included	---	---	---	---	6

	7057		7254			8254	9057		9254	H7092	H7068	N8092	N8068	B8592	B8568	M9592	M9568	6
	7057		7254			8254	9057		9254	H7093	H7068	N8093	N8068	B8593	B8568	M9593	M9568	6

	7057		7254			8254	9057		9254	H7092	H7068	N8092	N8068	B8592	B8568	M9592	M9568	6
	7057		7254			8254	9057		9254	H7093	H7068	N8093	N8068	B8593	B8568	M9593	M9568	6

	7057		7254			8254	9057		9254	H7092	H7068	N8092	N8068	B8592	B8568	M9592	M9568	6
	7057		7254			8254	9057		9254	H7093	H7068	N8093	N8068	B8593	B8568	M9593	M9568	6

	7057		7254			8254	9057		9254	H7092	H7068	N8092	N8068	B8592	B8568	M9592	M9568	6
	7057		7254			8254	9057		9254	H7093	H7068	N8093	N8068	B8593	B8568	M9593	M9568	6



# FORD

LIFT	Quick Kit	KIT NOTES	Component Box	Front Springs		Rear Springs		Add-A-Leafs	Steering Correction
	Reference		(Requires 1 Of Each)	Qty	Part #	Qty	Part #		(Order 1 Each)
<b>CLASS II - ADJUSTABLE 4-LINKS</b>									
<b>17-19 F-250 Super Duty 4WD Class II Kit (Diesel Engine)</b>			<b>Variable Rate Front Coil Springs with Rear Blocks &amp; U-Bolts</b>						
4"	F174524K	G42	F17451 + F58484LU	1	F545V				
6"	F176524K	G43	F17651 + F58484LU	1	F565V				Included
8.5"	F17852K	G43	F17852 + F58484LU	1	F585V			R3815	Included
<b>17-19 F-250 Super Duty 4WD Class II System (Diesel Engine)</b>			<b>Variable Rate Front Coil Springs with Rear Leaf Springs</b>						
4"	F174524KS	G42	F17451S + F58484LU	1	F545V	2	FR173S		
6"	F176524KS	G43	F17651S + F58484LU	1	F565V	2	FR175S		Included
8.5"	F17852KS	G43	F17852S + F58484LU	1	F585V	2	FR177S		Included
<b>17-19 F-250 Super Duty 4WD Class II Kit (Gas Engine)</b>			<b>Softride® Front Coil Springs with Rear Blocks &amp; U-Bolts</b>						
4"	F174024K	G42	F17451 + F58484LU	1	F540				
6"	F176024K	G43	F17651 + F58484LU	1	F560				Included
8.5"	F17802K	G43	F17852 + F58484LU	1	F565V			R3815	Included
<b>17-19 F-250 Super Duty 4WD Class II System (Gas Engine)</b>			<b>Softride® Front Coil Springs with Rear Leaf Springs</b>						
4"	F174024KS	G42	F17451S + F58484LU	1	F540	2	FR173S		
6"	F176024KS	G43	F17651S + F58484LU	1	F560	2	FR175S		Included
8.5"	F17802KS	G43	F17852S + F58484LU	1	F565V	2	FR177S		Included
<b>LEDUC SERIES COIL-OVER KITS</b>									
<b>17-19 F-250 Super Duty 4WD Coil-Over Kit (Diesel or Gas)</b>			<b>Front LeDuc Series Coil-Overs with Rear Blocks &amp; U-Bolts</b>						
6"	F1761LSK	G43	F76FLSB + F17651	1	F768FLS				Included
<b>17-19 F-250 Super Duty 4WD Coil-Over System (Diesel or Gas)</b>			<b>Front LeDuc Series Coil-Overs with Rear Leaf Springs</b>						
6"	F1761LSKS	G43	F76FLSB + F17651S	1	F768FLS	2	FR175S		Included
<b>CLASS II - LEDUC SERIES COIL-OVER KITS WITH ADJUSTABLE 4-LINKS</b>									
<b>17-19 F-250 Super Duty 4WD Class II Kit (Diesel or Gas)</b>			<b>Front LeDuc Series Coil-Overs with Rear Blocks &amp; U-Bolts</b>						
6"	F17624LSK	G43	F76FLSB + F17651 + F58484LU	1	F768FLS				Included
8.5"	F1782LSK	G43	F78FLSB + F17852 + F58484LU	1	F768FLS			R3815	Included
<b>17-19 F-250 Super Duty 4WD Class II System (Diesel or Gas)</b>			<b>Front LeDuc Series Coil-Overs with Rear Leaf Springs</b>						
6"	F17624LSKS	G43	F76FLSB + F17651S + F58484LU	1	F768FLS	2	FR175S		Included
8.5"	F1782LSKS	G43	F78FLSB + F17852S + F58484LU	1	F768FLS	2	FR177S		Included
KIT NOTES: G42. Lift is specifically designed to not require a drop pitman arm. G43. If front drive shaft vibration occurs, front drive shaft modification is required or order a new front drive shaft Part # F17685DS.									
<b>11-16 F-250 SUPER DUTY 4WD DIESEL ENGINE</b>									
<b>11-16 F-250 Super Duty 4WD Kit</b>			<b>Front Metal Spacers</b>						
1"	F51MS		F51MS						
<b>11-16 F-250 Super Duty 4WD Kit</b>			<b>Front Metal Spacers with Front Track Bar Bracket</b>						
2.5"	F528MSP		F528MSP						
<b>11-16 F-250 Super Duty 4WD Kit</b>			<b>Front Metal Spacers with Rear Add-A-Leafs</b>						
2.5"	F82MK	G33	F52MS					R3815	
KIT NOTES: G33. Optional Track Bar Relocation Bracket may be Required. Part # TB1120.									
<b>11-16 F-250 Super Duty (Diesel Engine) 4WD Kit</b>			<b>Diesel Engines with Add-A-Leafs</b>						
2"	F825K	G33		1	F525V			R3815	
KIT NOTES: G33. Optional Track Bar Relocation Bracket may be Required. Part # TB1120.									
<b>11-16 F-250 Super Duty (Diesel Engine) 4WD Kit</b>			<b>Diesel Engines with Blocks &amp; U-Bolts</b>						
4"	F11451K	G31, G32, G36	F11451	1	F545V				FA450
6"	F11651K	G31, G32, G36	F11651	1	F565V				FA450
<b>11-16 F-250 Super Duty (Diesel Engine) 4WD System</b>			<b>Diesel Engines with Rear Springs</b>						
4"	F11451KS	G31, G32, G36	F11451S	1	F545V	2	FR84S		FA450
6"	F11651KS	G31, G32, G36	F11651S	1	F565V	2	FR86S		FA450
KIT NOTES: Upgrade Available for 4 & 6" Kit. Part # F58484LU. Radius Arm Conversion to Upper & Lower Control Arms. G31. Lift is Designed to Level Models with Factory 1 7/8" Rear Blocks. Models with Otional Factory 3 7/8" Rear Blocks will have a Higher Rake Angle in the Rear. G32. Lift Heights will Vary Depending on Factory Pckage Options. G36. Model with Rear Sway Bar must Order Extended Rear Sway Bar End Liks. 4" Lifts Order Part # SBE404, 6" Lifts Order Part # SBE405, 8.5" Lifts Order Part # SBE406.									

FORD



	Steering Stabilizers									HYDRO Shocks		NITRO Shocks		BLACK MAX		M95 Shocks		Labor	
	White			Black			Silver			White		White		Black		Silver		Hours	
	OEM	Single	Dual	OEM	Single	Dual	OEM	Single	Dual	Front	Rear	Front	Rear	Front	Rear	Front	Rear		
7057		7254			8254	9057		9254	H7092	H7068	N8092	N8068	B8592	B8568	M9592	M9568	8		
7057		7254			8254	9057		9254	H7093	H7068	N8093	N8068	B8593	B8568	M9593	M9568	8		
7057		7254			8254	9057		9254	H7094	H7089	N8094	N8089	B8594	B8589	M9594	M9589	8		
7057		7254			8254	9057		9254	H7092	H7068	N8092	N8068	B8592	B8568	M9592	M9568	8		
7057		7254			8254	9057		9254	H7093	H7068	N8093	N8068	B8593	B8568	M9593	M9568	8		
7057		7254			8254	9057		9254	H7094	H7089	N8094	N8089	B8594	B8589	M9594	M9589	8		
7057		7254			8254	9057		9254	H7092	H7068	N8092	N8068	B8592	B8568	M9592	M9568	8		
7057		7254			8254	9057		9254	H7093	H7068	N8093	N8068	B8593	B8568	M9593	M9568	8		
7057		7254			8254	9057		9254	H7094	H7089	N8094	N8089	B8594	B8589	M9594	M9589	10		
7057		7254			8254	9057		9254	H7092	H7068	N8092	N8068	B8592	B8568	M9592	M9568	8		
7057		7254			8254	9057		9254	H7093	H7068	N8093	N8068	B8593	B8568	M9593	M9568	8		
7057		7254			8254	9057		9254	H7094	H7089	N8094	N8089	B8594	B8589	M9594	M9589	10		
7057		7254			8254	9057		9254		H7068		N8068		B8568		M9568	6		
7057		7254			8254	9057		9254		H7068		N8068		B8568		M9568	6		
7057		7254			8254	9057		9254		H7068		N8068		B8568		M9568	9		
7057		7254			8254	9057		9254		H7089		N8089		B8589		M9589	10		
7057		7254			8254	9057		9254		H7068		N8068		B8568		M9568	9		
7057		7254			8254	9057		9254		H7089		N8089		B8589		M9589	10		
<b>NOTE: ALL SHOCKS MUST BE ORDERED SEPARATELY.</b>																			
7054				8054				9054		H7091	H7060	N8091	N8060	B8591	B8560	M9591	M9560	2	
7054				8054				9054		H7091	H7060	N8091	N8060	B8591	B8560	M9591	M9560	3	
7054				8054				9054		H7091	H7060	N8091	N8060	B8591	B8560	M9591	M9560	4	
7054				8054				9054		H7091	H7060	N8091	N8060	B8591	B8560	M9591	M9560	4	
7054	Bkt. Incl.	7254		8054	Bkt. Incl.	8254		9054	Bkt. Incl.	9254	H7092	H7060	N8092	N8060	B8592	B8560	M9592	M9560	6
7054	Bkt. Incl.	7254		8054	Bkt. Incl.	8254		9054	Bkt. Incl.	9254	H7093	H7079	N8093	N8079	B8593	B8579	M9593	M9579	6
7054	Bkt. Incl.	7254		8054	Bkt. Incl.	8254		9054	Bkt. Incl.	9254	H7092	H7060	N8092	N8060	B8592	B8560	M9592	M9560	6
7054	Bkt. Incl.	7254		8054	Bkt. Incl.	8254		9054	Bkt. Incl.	9254	H7093	H7079	N8093	N8079	B8593	B8579	M9593	M9579	6



# FORD

LIFT	Quick Kit	KIT NOTES	Component Box	Front Springs		Rear Springs		Add-A-Leafs	Steering Correction
	Reference		(Requires 1 Of Each)	Qty	Part #	Qty	Part #		(Order 1 Each)
<b>CLASS II - ADJUSTABLE 4-LINKS</b>									
<b>11-16 F-250 Super Duty (Diesel Engine) 4WD Class II Kit</b>			<b>Diesel Engines with Blocks &amp; U-Bolts</b>						
4"	F114524K	G31, G32, G36	F11451 + F58484LU	1	F545V				FA450
6"	F116524K	G31, G32, G36	F11651 + F58484LU	1	F565V				FA450
<b>11-16 F-250 Super Duty (Diesel Engine) 4WD Class II System</b>			<b>Diesel Engines with Rear Springs</b>						
4"	F114524KS	G31, G32, G36	F11451S + F58484LU	1	F545V	2	FR84S		FA450
6"	F116524KS	G31, G32, G36	F11651S + F58484LU	1	F565V	2	FR86S		FA450
<b>11-16 F-250 Super Duty (Diesel Engine) 4WD Class II Kit</b>			<b>Diesel Engines with Blocks &amp; U-Bolts</b>						
8.5"	F11852K	G31, G32, G36	F11852 + F58484LU	1	F585V			R3815	FA450
<b>11-16 F-250 Super Duty (Diesel Engine) 4WD Class II System</b>			<b>Diesel Engines with Rear Springs</b>						
8.5"	F11852KS	G31, G32, G36	F11852S + F58484LU	1	F585V	2	FR88S		FA450
KIT NOTES: 8.5" Lifts - Front & Rear Driveline Modifications Necessary. Call for Details. * Recommend CV Joint at Transfer Case for some Models. G31. Lift is Designed to Level Models with Factory 1 7/8" Rear Blocks. Models with Optional Factory 3 7/8" Rear Blocks will have a Higher Rake Angle in the Rear. G32. Lift Heights will Vary Depending on Factory Package Options. G36. Model with Rear Sway Bar must Order Extended Rear Sway Bar End Links. 4" Lifts Order Part # SBE404, 6" Lifts Order Part # SBE405, 8.5" Lifts Order Part # SBE406.									
<b>11-16 F-250 SUPER DUTY 4WD GAS ENGINE</b>									
<b>11-16 F-250 Super Duty 4WD Kit</b>			<b>Front Metal Spacers</b>						
1"	F51MS		F51MS						
<b>11-16 F-250 Super Duty 4WD Kit</b>			<b>Front Metal Spacers With Rear Add-A-Leafs</b>						
2.5"	F82MK	G33	F52MS					R3815	
<b>11-16 F-250 Super Duty (Gas Engine) 4WD Kit</b>			<b>Gas Engines with Add-A-Leafs</b>						
2"	F820K	G33		1	F520			R3815	
KIT NOTES: G33. Optional Track Bar Relocation Bracket may be Required. Part # TB1120.									
<b>11-16 F-250 Super Duty (Gas Engine) 4WD Kit</b>			<b>Gas Engines with Blocks &amp; U-Bolts</b>						
4"	F11401K	G31, G32, G36	F11451	1	F540				FA450
6"	F11601K	G31, G32, G36	F11651	1	F560				FA450
<b>11-16 F-250 Super Duty (Gas Engine) 4WD System</b>			<b>Gas Engines with Rear Springs</b>						
4"	F11401KS	G31, G32, G36	F11451S	1	F540	2	FR84S		FA450
6"	F11601KS	G31, G32, G36	F11651S	1	F560	2	FR86S		FA450
KIT NOTES: Upgrade Available for 4 & 6" Kit. Part # F58484LU. Radius Arm Conversion to Upper & Lower Control Arms. G31. Lift is Designed to Level Models with Factory 1 7/8" Rear Blocks. Models with Optional Factory 3 7/8" Rear Blocks will have a Higher Rake Angle in the Rear. G32. Lift Heights will Vary Depending on Factory Package Options. G36. Model with Rear Sway Bar must Order Extended Rear Sway Bar End Links. 4" Lifts Order Part # SBE404, 6" Lifts Order Part # SBE405, 8.5" Lifts Order Part # SBE406.									
<b>CLASS II - ADJUSTABLE 4-LINKS</b>									
<b>11-16 F-250 Super Duty (Gas Engine) 4WD Class II Kit</b>			<b>Class II Gas Engines with Blocks &amp; U-Bolts</b>						
4"	F114024K	G31, G32, G36	F11451 + F58484LU	1	F540				FA450
6"	F116024K	G31, G32, G36	F11651 + F58484LU	1	F560				FA450
<b>11-16 F-250 Super Duty (Gas Engine) 4WD System</b>			<b>Class II Gas Engines with Rear Springs</b>						
4"	F114024KS	G31, G32, G36	F11451S + F58484LU	1	F540	2	FR84S		FA450
6"	F116024KS	G31, G32, G36	F11651S + F58484LU	1	F560	2	FR86S		FA450
<b>11-16 F-250 Super Duty (Gas Engine) 4WD Class II Kit</b>			<b>Class II Gas Engines with Blocks &amp; U-Bolts</b>						
8.5"	F11802K	G31, G32, G36	F11852 + F58484LU	1	F565V			R3815	FA450
<b>11-16 F-250 Super Duty (Gas Engine) 4WD System</b>			<b>Class II Gas Engines with Rear Springs</b>						
8.5"	F11802KS	G31, G32, G36	F11852S + F58484LU	1	F565V	2	FR88S		FA450
KIT NOTES: 8.5" Lifts - Front & Rear Driveline Modifications Necessary. Call for Details. * Recommend CV Joint at Transfer Case for some Models. G31. Lift is Designed to Level Models with Factory 1 7/8" Rear Blocks. Models with Optional Factory 3 7/8" Rear Blocks will have a Higher Rake Angle in the Rear. G32. Lift Heights will Vary Depending on Factory Package Options. G36. Model with Rear Sway Bar must Order Extended Rear Sway Bar End Links. 4" Lifts Order Part # SBE404, 6" Lifts Order Part # SBE405, 8.5" Lifts Order Part # SBE406.									
<b>08-10 F-250 SUPER DUTY 4WD DIESEL ENGINE</b>									
<b>08-10 F-250 Super Duty 4WD Kit</b>			<b>Front Metal Spacers</b>						
1"	F51MS		F51MS						
<b>08-10 F-250 Super Duty 4WD Kit</b>			<b>Front Metal Spacers with Front Track Bar Bracket</b>						
2.5"	F528MSP		F528MSP						
<b>08-10 F-250 Super Duty 4WD Kit</b>			<b>Front Metal Spacers With Rear Add-A-Leafs</b>						
2.5"	F82MK	G33	F52MS					R3815	
KIT NOTES: G33. Optional Track Bar Relocation Bracket may be Required. Part # TB1120.									
<b>08-10 F-250 Super Duty (Diesel Engine) 4WD Kit</b>			<b>Diesel Engines with Add-A-Leafs</b>						
2"	F825K	G33		1	F525V			R3815	
KIT NOTES: G33. Optional Track Bar Relocation Bracket may be Required. Part # TB1120.									

FORD

	Steering Stabilizers									HYDRO Shocks		NITRO Shocks		BLACK MAX		M95 Shocks		Labor
	White			Black			Silver			White		White		Black		Silver		Hours
	OEM	Single	Dual	OEM	Single	Dual	OEM	Single	Dual	Front	Rear	Front	Rear	Front	Rear	Front	Rear	

	7054	Bkt. Incl.	7254	8054	Bkt. Incl.	8254	9054	Bkt. Incl.	9254	H7092	H7060	N8092	N8060	B8592	B8560	M9592	M9560	6
	7054	Bkt. Incl.	7254	8054	Bkt. Incl.	8254	9054	Bkt. Incl.	9254	H7093	H7079	N8093	N8079	B8593	B8579	M9593	M9579	6

	7054	Bkt. Incl.	7254	8054	Bkt. Incl.	8254	9054	Bkt. Incl.	9254	H7092	H7060	N8092	N8060	B8592	B8560	M9592	M9560	6
	7054	Bkt. Incl.	7254	8054	Bkt. Incl.	8254	9054	Bkt. Incl.	9254	H7093	H7079	N8093	N8079	B8593	B8579	M9593	M9579	6

	7054	Bkt. Incl.	7254	8054	Bkt. Incl.	8254	9054	Bkt. Incl.	9254	H7094	H7099	N8094	N8099	B8594	B8599	M9594	M9599	12
--	------	------------	------	------	------------	------	------	------------	------	-------	-------	-------	-------	-------	-------	-------	-------	----

	7054	Bkt. Incl.	7254	8054	Bkt. Incl.	8254	9054	Bkt. Incl.	9254	H7094	H7099	N8094	N8099	B8594	B8599	M9594	M9599	12
--	------	------------	------	------	------------	------	------	------------	------	-------	-------	-------	-------	-------	-------	-------	-------	----

**NOTE: ALL SHOCKS MUST BE ORDERED SEPARATELY.**

	7054			8054			9054			H7091	H7060	N8091	N8060	B8591	B8560	M9591	M9560	2
--	------	--	--	------	--	--	------	--	--	-------	-------	-------	-------	-------	-------	-------	-------	---

	7054			8054			9054			H7091	H7060	N8091	N8060	B8591	B8560	M9591	M9560	4
--	------	--	--	------	--	--	------	--	--	-------	-------	-------	-------	-------	-------	-------	-------	---

	7054			8054			9054			H7091	H7060	N8091	N8060	B8591	B8560	M9591	M9560	4
--	------	--	--	------	--	--	------	--	--	-------	-------	-------	-------	-------	-------	-------	-------	---

	7054	Bkt. Incl.	7254	8054	Bkt. Incl.	8254	9054	Bkt. Incl.	9254	H7092	H7060	N8092	N8060	B8592	B8560	M9592	M9560	6
	7054	Bkt. Incl.	7254	8054	Bkt. Incl.	8254	9054	Bkt. Incl.	9254	H7093	H7079	N8093	N8079	B8593	B8579	M9593	M9579	6

	7054	Bkt. Incl.	7254	8054	Bkt. Incl.	8254	9054	Bkt. Incl.	9254	H7092	H7060	N8092	N8060	B8592	B8560	M9592	M9560	6
	7054	Bkt. Incl.	7254	8054	Bkt. Incl.	8254	9054	Bkt. Incl.	9254	H7093	H7079	N8093	N8079	B8593	B8579	M9593	M9579	6

	7054	Bkt. Incl.	7254	8054	Bkt. Incl.	8254	9054	Bkt. Incl.	9254	H7092	H7060	N8092	N8060	B8592	B8560	M9592	M9560	6
	7054	Bkt. Incl.	7254	8054	Bkt. Incl.	8254	9054	Bkt. Incl.	9254	H7093	H7079	N8093	N8079	B8593	B8579	M9593	M9579	6

	7054	Bkt. Incl.	7254	8054	Bkt. Incl.	8254	9054	Bkt. Incl.	9254	H7092	H7060	N8092	N8060	B8592	B8560	M9592	M9560	6
	7054	Bkt. Incl.	7254	8054	Bkt. Incl.	8254	9054	Bkt. Incl.	9254	H7093	H7079	N8093	N8079	B8593	B8579	M9593	M9579	6

	7054	Bkt. Incl.	7254	8054	Bkt. Incl.	8254	9054	Bkt. Incl.	9254	H7094	H7099	N8094	N8099	B8594	B8599	M9594	M9599	12
--	------	------------	------	------	------------	------	------	------------	------	-------	-------	-------	-------	-------	-------	-------	-------	----

	7054	Bkt. Incl.	7254	8054	Bkt. Incl.	8254	9054	Bkt. Incl.	9254	H7094	H7099	N8094	N8099	B8594	B8599	M9594	M9599	12
--	------	------------	------	------	------------	------	------	------------	------	-------	-------	-------	-------	-------	-------	-------	-------	----

**NOTE: ALL SHOCKS MUST BE ORDERED SEPARATELY.**

	7054			8054			9054			H7091	H7060	N8091	N8060	B8591	B8560	M9591	M9560	2
--	------	--	--	------	--	--	------	--	--	-------	-------	-------	-------	-------	-------	-------	-------	---

	7054			8054			9054			H7091	H7060	N8091	N8060	B8591	B8560	M9591	M9560	3
--	------	--	--	------	--	--	------	--	--	-------	-------	-------	-------	-------	-------	-------	-------	---

	7054			8054			9054			H7091	H7060	N8091	N8060	B8591	B8560	M9591	M9560	4
--	------	--	--	------	--	--	------	--	--	-------	-------	-------	-------	-------	-------	-------	-------	---

	7054			8054			9054			H7091	H7060	N8091	N8060	B8591	B8560	M9591	M9560	4
--	------	--	--	------	--	--	------	--	--	-------	-------	-------	-------	-------	-------	-------	-------	---



# FORD

LIFT	Quick Kit	KIT NOTES	Component Box	Front Springs		Rear Springs		Add-A-Leafs	Steering Correction
	Reference		(Requires 1 Of Each)	Qty	Part #	Qty	Part #		(Order 1 Each)
<b>08-10 F-250 Super Duty (Diesel Engine) 4WD Kit Diesel Engines with Blocks &amp; U-Bolts</b>									
4"	F8451K	G31, G32, G36, G37	F8451	1	F545V				Fa450
6"	F8651K	G31, G32, G36, G37	F8651	1	F565V				Fa450
<b>08-10 F-250 Super Duty (Diesel Engine) 4WD System Diesel Engines with Rear Springs</b>									
4"	F8451KS	G31, G32, G36, G37	F8451S	1	F545V	2	FR84S		FA450
6"	F8651KS	G31, G32, G36, G37	F8651S	1	F565V	2	FR86S		FA450
KIT NOTES: Upgrade Available for 4 & 6" Kit. Part # F58484LU. Radius Arm Conversion to Upper & Lower Control Arms. G31. Lift is Designed to Level Models with Factory 1 7/8" Rear Blocks. Models with Optional Factory 3 7/8" Rear Blocks will have a Higher Rake Angle in the Rear. G32. Lift Heights will Vary Depending on Factory Package Options. G36. Model with Rear Sway Bar must Order Extended Rear Sway Bar End Links. 4" Lifts Order Part # SBE404, 6" Lifts Order Part # SBE405. G37. Models Equipped with a Sterling Rear Axle will Need Wider Rear U-Bolts. 4" Kits Order Part # U9B16R, 4" Systems Order Part # U9B12R, 6" Kits Order Part # U9B18R, 6" Systems Order Part # U9B12R.									
<b>CLASS II - ADJUSTABLE 4-LINKS</b>									
<b>08-10 F-250 Super Duty (Diesel Engine) 4WD Class II Kit Diesel Engines with Blocks &amp; U-Bolts</b>									
4"	F84524K	G31, G32, G36, G37	F8451 + F58484LU	1	F545V				FA450
6"	F86524K	G31, G32, G36, G37	F8651 + F58484LU	1	F565V				FA450
<b>08-10 F-250 Super Duty (Diesel Engine) 4WD Class II System Diesel Engines with Rear Springs</b>									
4"	F84524KS	G31, G32, G36, G37	F8451S + F58484LU	1	F545V	2	FR84S		FA450
6"	F86524KS	G31, G32, G36, G37	F8651S + F58484LU	1	F565V	2	FR86S		FA450
<b>08-10 F-250 Super Duty (Diesel Engine) 4WD Class II Kit Diesel Engines with Blocks &amp; U-Bolts</b>									
8.5"	F8852K	G31, G32, G36, G38	F8852 + F58484LU	1	F585V			R3815	FA450
<b>08-10 F-250 Super Duty (Diesel Engine) 4WD Class II System Diesel Engines with Rear Springs</b>									
8.5"	F8852KS	G31, G32, G36	F8852S + F58484LU	1	F585V	2	FR88S		FA450
KIT NOTES: 8.5" Lifts - Front & Rear Driveline Modifications Necessary. Call for Details. * Recommend CV Joint at Transfer Case for some Models. G31. Lift is Designed to Level Models with Factory 1 7/8" Rear Blocks. Models with Optional Factory 3 7/8" Rear Blocks will have a Higher Rake Angle in the Rear. G32. Lift Heights will Vary Depending on Factory Package Options. G36. Model with Rear Sway Bar must Order Extended Rear Sway Bar End Links. 4" Lifts Order Part # SBE404, 6" Lifts Order Part # SBE405. G37. Models Equipped with a Sterling Rear Axle will Need Wider Rear U-Bolts. 4" Kits Order Part # U9B16R, 4" Systems Order Part # U9B12R, 6" Kits Order Part # U9B18R, 6" Systems Order Part # U9B12R. G38. Model with Rear Sway Bar must Order Extended Rear Sway Bar End Links. 8.5" Lifts Order Part # SBE406.									
<b>08-10 F-250 SUPER DUTY 4WD GAS ENGINE</b>									
<b>08-10 F-250 Super Duty 4WD Kit Front Metal Spacers</b>									
1"	F51MS		F51MS						
<b>08-10 F-250 Super Duty 4WD Kit Front Metal Spacers with Front Track Bar Bracket</b>									
2.5"	F528MSP		F528MSP						
<b>08-10 F-250 Super Duty 4WD Kit Front Metal Spacers with Rear Add-A-Leafs</b>									
2.5"	F82MK	G33	F52MS					R3815	
KIT NOTES: G33. Optional Track Bar Relocation Bracket may be Required. Part # TB1120.									
<b>08-10 F-250 Super Duty (Gas Engine) 4WD Kit Gas Engines with Add-A-Leafs</b>									
2"	F820K	G33		1	F520			R3815	
KIT NOTES: G33. Optional Track Bar Relocation Bracket may be Required. Part # TB1120.									
<b>08-10 F-250 Super Duty (Gas Engine) 4WD Kit Gas Engines with Blocks &amp; U-Bolts</b>									
4"	F8401K	G31, G32, G36, G37, G41	F8451	1	F540				FA450
6"	F8601K	G31, G32, G36, G37, G41	F8651	1	F560				FA450
KIT NOTES: Upgrade Available for 4 & 6" Kit. Part # F58484LU. Radius Arm Conversion to Uper & Lower Control Arms. G31. Lift is Designed to Level Models with Factory 1 7/8" Rear Blocks. Models with Optional Factory 3 7/8" Rear Blocks will have a Higher Rake Angle in the Rear. G32. Lift Heights will Vary Depending on Factory Package Options. G36. Model with Rear Sway Bar must Oder Extended Rear Sway Bar End Links. 4" Lifts Order Part # SBE404, 6" Lifts Order Part # SBE405. G37. Models Equipped with a Sterling Rear Axle will Need Wider Rear U-Bolts. 4" Kits Order Part # U9B16R, 4" Systems Order Part # U9B12R, 6" Kits Order Part # U9B18R, 6" Systems Order Part # U9B12R. G41. 4, 6, & 8.5" Lifts Require Minor Exhaust Modifications.									
<b>08-10 F-250 Super Duty (Gas Engine) 4WD System Gas Engines with Rear Springs</b>									
4"	F8401KS	G31, G32, G36, G37, G41	F8451S	1	F540	2	FR84S		FA450
6"	F8601KS	G31, G32, G36, G37, G41	F8651S	1	F560	2	FR86S		FA450
KIT NOTES: Upgrade Available for 4 & 6" Kit. Part # F58484LU. Radius Arm Conversion to Uper & Lower Control Arms. G31. Lift is Designed to Level Models with Factory 1 7/8" Rear Blocks. Models with Optional Factory 3 7/8" Rear Blocks will have a Higher Rake Angle in the Rear. G32. Lift Heights will Vary Depending on Factory Package Options. G36. Model with Rear Sway Bar must Oder Extended Rear Sway Bar End Links. 4" Lifts Order Part # SBE404, 6" Lifts Order Part # SBE405. G37. Models Equipped with a Sterling Rear Axle will Need Wider Rear U-Bolts. 4" Kits Order Part # U9B16R, 4" Systems Order Part # U9B12R, 6" Kits Order Part # U9B18R, 6" Systems Order Part # U9B12R. G41. 4, 6, & 8.5" Lifts Require Minor Exhaust Modifications.									
<b>CLASS II - ADJUSTABLE 4-LINKS</b>									
<b>08-10 F-250 Super Duty (Gas Engine) 4WD Class II Kit Class II Gas Engines with Blocks &amp; U-Bolts</b>									
4"	F84024K	G31, G32, G36, G37, G41	F8451 + F58484LU	1	F540				FA450
6"	F86024K	G31, G32, G36, G37, G41	F8651 + F58484LU	1	F560				FA450
<b>08-10 F-250 Super Duty (Gas Engine) 4WD System Class II Gas Engines with Rear Springs</b>									
4"	F84024KS	G31, G32, G36, G37, G41	F8451S + F58484LU	1	F540	2	FR84S		FA450
6"	F86024KS	G31, G32, G36, G37, G41	F8651S + F58484LU	1	F560	2	FR86S		FA450

FORD

	Steering Stabilizers									HYDRO Shocks		NITRO Shocks		BLACK MAX		M95 Shocks		Labor
	White			Black			Silver			White		White		Black		Silver		Hours
	OEM	Single	Dual	OEM	Single	Dual	OEM	Single	Dual	Front	Rear	Front	Rear	Front	Rear	Front	Rear	
	7054	Included	7254	8054		8254	9054		9254	H7092	H7060	N8092	N8060	B8592	B8560	M9592	M9560	6
	7054	Included	7254	8054		8254	9054		9254	H7093	H7079	N8093	N8079	B8593	B8579	M9593	M9579	6
	7054	Included	7254	8054		8254	9054		9254	H7092	H7060	N8092	N8060	B8592	B8560	M9592	M9560	6
	7054	Included	7254	8054		8254	9054		9254	H7093	H7079	N8093	N8079	B8593	B8579	M9593	M9579	6
	7054	Included	7254	8054		8254	9054		9254	H7092	H7060	N8092	N8060	B8592	B8560	M9592	M9560	6
	7054	Included	7254	8054		8254	9054		9254	H7093	H7079	N8093	N8079	B8593	B8579	M9593	M9579	6
	7054	Included	7254	8054		8254	9054		9254	H7092	H7060	N8092	N8060	B8592	B8560	M9592	M9560	6
	7054	Included	7254	8054		8254	9054		9254	H7093	H7079	N8093	N8079	B8593	B8579	M9593	M9579	6
	7054	Included	7254	8054		8254	9054		9254	H7094	H7099	N8094	N8099	B8594	B8599	M9594	M9599	12
	7054	Included	7254	8054		8254	9054		9254	H7094	H7099	N8094	N8099	B8594	B8599	M9594	M9599	12
<b>NOTE: ALL SHOCKS MUST BE ORDERED SEPARATELY.</b>																		
	7054			8054			9054			H7091	H7060	N8091	N8060	B8591	B8560	M9591	M9560	2
										H7091	H7060	N8091	N8060	B8591	B8560	M9591	M9560	3
	7054			8054			9054			H7091	H7060	N8091	N8060	B8591	B8560	M9591	M9560	4
	7054			8054			9054			H7091	H7060	N8091	N8060	B8591	B8560	M9591	M9560	4
	7054	Included	7254	8054		8254	9054		9254	H7092	H7060	N8092	N8060	B8592	B8560	M9592	M9560	6
	7054	Included	7254	8054		8254	9054		9254	H7093	H7079	N8093	N8079	B8593	B8579	M9593	M9579	6
	7054	Included	7254	8054		8254	9054		9254	H7092	H7060	N8092	N8060	B8592	B8560	M9592	M9560	6
	7054	Included	7254	8054		8254	9054		9254	H7093	H7079	N8093	N8079	B8593	B8579	M9593	M9579	6
	7054	Included	7254	8054		8254	9054		9254	H7092	H7060	N8092	N8060	B8592	B8560	M9592	M9560	6
	7054	Included	7254	8054		8254	9054		9254	H7093	H7079	N8093	N8079	B8593	B8579	M9593	M9579	6
	7054	Included	7254	8054		8254	9054		9254	H7092	H7060	N8092	N8060	B8592	B8560	M9592	M9560	6
	7054	Included	7254	8054		8254	9054		9254	H7093	H7079	N8093	N8079	B8593	B8579	M9593	M9579	6



# FORD

LIFT	Quick Kit	KIT NOTES	Component Box	Front Springs		Rear Springs		Add-A-Leafs	Steering Correction
	Reference		(Requires 1 Of Each)	Qty	Part #	Qty	Part #		(Order 1 Each)
<b>08-10 F-250 Super Duty (Gas Engine) 4WD Class II Kit</b>									
<b>Class II Gas Engines with Blocks &amp; U-Bolts</b>									
8.5"	F8802K	G31, G32, G36, G37, G41	F8852 + F58484LU	1	F565V			R3815	FA450
<b>08-10 F-250 Super Duty (Gas Engine) 4WD System</b>									
<b>Class II Gas Engines with Rear Springs</b>									
8.5"	F8802KS	G31, G32, G36, G37, G41	F8852S + F58484LU	1	F565V	2	FR88S		FA450
KIT NOTES: 8.5" Lifts - Front & Rear Driveline Modifications Necessary. Call for Details. * Recommend CV Joint at Transfer Case for some Models. G31. Lift is Designed to Level Models with Factory 1 7/8" Rear Blocks. Models with Optional Factory 3 7/8" Rear Blocks will have a Higher Rake Angle in the Rear. G32. Lift Heights will Vary Depending on Factory Package Options. G36. Model with Rear Sway Bar must Order Extended Rear Sway Bar End Links. 4" Lifts Order Part # SBE404, 6" Lifts Order Part # SBE405, 8.5" Lifts Order Part # SBE406. G37. Models Equipped with a Sterling Rear Axle will Need Wider Rear U-Bolts. 4" Lifts Order Part # U9B16R, 4" Systems Order Part # U9B12R, 6" Kits Order Part # U9B18R, 6" Systems Order Part # U9B12R. G41. 4, 6, & 8.5" Lifts Require Minor Exhaust Modifications.									
<b>05-07 F-250 SUPER DUTY 4WD DIESEL ENGINE</b>									
<b>05-07 F-250 Super Duty 4WD Kit</b>									
<b>Front Metal Spacers</b>									
1"	F51MS		F51MS						
<b>05-07 F-250 Super Duty 4WD Kit</b>									
<b>Front Metal Spacers with Rear Add-A-Leafs</b>									
2.5"	F52MK	G33	F52MS					R3510	
KIT NOTES: G33. Optional Track Bar Relocation Bracket may be Required. Part # TB520.									
<b>05-07 F-250 Super Duty (Diesel Engine) 4WD Kit</b>									
<b>Diesel Engines with Blocks &amp; U-Bolts</b>									
2-2.5"	F525K	G31, G32		1	F525V			R3510	
4"	F5451K	G31, G32, G36, G37	F5451	1	F545V				FA450
6"	F5651K	G31, G32, G36, G37	F5651	1	F565V				FA450
KIT NOTES: Upgrade Available for 4 & 6" Kit. Part # F58484LU. Radius Arm Conversion to Upper & Lower Control Arms. G31. Lift is Designed to Level Models with Factory 1 7/8" Rear Blocks. Models with Optional Factory 3 7/8" Rear Blocks will have a Higher Rake Angle in the Rear. G32. Lift Heights will Vary Depending on Factory Package Options. G36. Model with Rear Sway Bar must Order Extended Rear Sway Bar End Links. 4" Lifts Order Part # SBE404, 6" Lifts Order Part # SBE405. G37. Models Equipped with a Sterling Rear Axle will Need Wider Rear U-Bolts. 4" Lifts Order Part # U9B16R, 4" Systems Order Part # U9B12R, 6" Kits Order Part # U9B18R, 6" Systems Order Part # U9B12R.									
<b>05-07 F-250 Super Duty (Diesel Engine) 4WD System</b>									
<b>Diesel Engines with Rear Springs</b>									
4"	F5451KS	G31, G32, G36, G37	F5451S	1	F545V	2	FR94S		FA450
6"	F5651KS	G31, G32, G36, G37	F5651S	1	F565V	2	FR96S		FA450
KIT NOTES: Upgrade Available for 4 & 6" Kit. Part # F58484LU. Radius Arm Conversion to Upper & Lower Control Arms. G31. Lift is Designed to Level Models with Factory 1 7/8" Rear Blocks. Models with Optional Factory 3 7/8" Rear Blocks will have a Higher Rake Angle in the Rear. G32. Lift Heights will Vary Depending on Factory Package Options. G36. Model with Rear Sway Bar must Order Extended Rear Sway Bar End Links. 4" Lifts Order Part # SBE404, 6" Lifts Order Part # SBE405. G37. Models Equipped with a Sterling Rear Axle will Need Wider Rear U-Bolts. 4" Lifts Order Part # U9B16R, 4" Systems Order Part # U9B12R, 6" Kits Order Part # U9B18R, 6" Systems Order Part # U9B12R.									
<b>CLASS II - ADJUSTABLE 4-LINKS</b>									
<b>05-07 F-250 Super Duty (Diesel Engine) 4WD Class II Kit</b>									
<b>Diesel Engines with Blocks &amp; U-Bolts</b>									
4"	F54524K	G31, G32, G36, G37	F5451 + F58484LU	1	F545V				FA450
6"	F56524K	G31, G32, G36, G37	F5651 + F58484LU	1	F565V				FA450
<b>05-07 F-250 Super Duty (Diesel Engine) 4WD Class II System</b>									
<b>Diesel Engines with Rear Springs</b>									
4"	F54524KS	G31, G32, G36, G37	F5451S + F58484LU	1	F545V	2	FR94S		FA450
6"	F56524KS	G31, G32, G36, G37	F5651S + F58484LU	1	F565V	2	FR96S		FA450
<b>05-07 F-250 Super Duty (Diesel Engine) 4WD Class II Kit</b>									
<b>Diesel Engines with Blocks &amp; U-Bolts</b>									
8.5"	F5852K	G31, G32, G38	F5852A + F58484LU	1	F585V			R300	FA450
<b>05-07 F-250 Super Duty (Diesel Engine) 4WD Class II System</b>									
<b>Diesel Engines with Rear Springs</b>									
8.5"	F5852KS	G31, G32, G38	F5852AS + F58484LU	1	F585V	2	FR98S		FA450
KIT NOTES: G31. Lift is Designed to Level Models with Factory 1 7/8" Rear Blocks. Models with Optional Factory 3 7/8" Rear Blocks will have a Higher Rake Angle in the Rear. G32. Lift Heights will Vary Depending on Factory Package Options. G36. Model with Rear Sway Bar must Order Extended Rear Sway Bar End Links. 4" Lifts Order Part # SBE404, 6" Lifts Order Part # SBE405. G37. Models Equipped with a Sterling Rear Axle will Need Wider Rear U-Bolts. 4" Lifts Order Part # U9B16R, 4" Systems Order Part # U9B12R, 6" Kits Order Part # U9B18R, 6" Systems Order Part # U9B12R. G38. Model with Rear Sway Bar Must Order Extended Rear Sway Bar End Links. 8.5" Lifts Order Part # SBE406.									
<b>05-07 F-250 SUPER DUTY 4WD GAS ENGINE</b>									
<b>05-07 F-250 Super Duty 4WD Kit</b>									
<b>Front Metal Spacers</b>									
1"	F51MS		F51MS						
<b>05-07 F-250 Super Duty 4WD Kit</b>									
<b>Front Metal Spacers with Rear Add-A-Leafs</b>									
2.5"	F52MK	G33	F52MS					R3510	
KIT NOTES: G33. Optional Track Bar Relocation Bracket may be Required. Part # TB520.									

FORD

	Steering Stabilizers									HYDRO Shocks		NITRO Shocks		BLACK MAX		M95 Shocks		Labor
	White			Black			Silver			White		White		Black		Silver		Hours
	OEM	Single	Dual	OEM	Single	Dual	OEM	Single	Dual	Front	Rear	Front	Rear	Front	Rear	Front	Rear	

	7054	Included	7254	8054		8254	9054		9254	H7094	H7099	N8094	N8099	B8594	B8599	M9594	M9599	12
--	------	----------	------	------	--	------	------	--	------	-------	-------	-------	-------	-------	-------	-------	-------	----

	7054	Included	7254	8054		8254	9054		9254	H7094	H7099	N8094	N8099	B8594	B8599	M9594	M9599	12
--	------	----------	------	------	--	------	------	--	------	-------	-------	-------	-------	-------	-------	-------	-------	----

**NOTE: ALL SHOCKS MUST BE ORDERED SEPARATELY.**

										H7091	H7060	N8091	N8060	B8591	B8560	M9591	M9560	2
--	--	--	--	--	--	--	--	--	--	-------	-------	-------	-------	-------	-------	-------	-------	---

										H7091	H7060	N8091	N8060	B8591	B8560	M9591	M9560	4
--	--	--	--	--	--	--	--	--	--	-------	-------	-------	-------	-------	-------	-------	-------	---

										H7091	H7060	N8091	N8060	B8591	B8560	M9591	M9560	4
		Included	7254			8254			9254	H7092	H7060	N8092	N8060	B8592	B8560	M9592	M9560	8
		Included	7254			8254			9254	H7093	H7079	N8093	N8079	B8593	B8579	M9593	M9579	8

		Included	7254			8254			9254	H7092	H7060	N8092	N8060	B8592	B8560	M9592	M9560	8
		Included	7254			8254			9254	H7093	H7079	N8093	N8079	B8593	B8579	M9593	M9579	8

		Included	7254			8254			9254	H7092	H7060	N8092	N8060	B8592	B8560	M9592	M9560	8
		Included	7254			8254			9254	H7093	H7079	N8093	N8079	B8593	B8579	M9593	M9579	8

		Included	7254			8254			9254	H7092	H7060	N8092	N8060	B8592	B8560	M9592	M9560	8
		Included	7254			8254			9254	H7093	H7079	N8093	N8079	B8593	B8579	M9593	M9579	8

		Included	7254			8254			9254	H7094	H7099	N8094	N8099	B8594	B8599	M9594	M9599	12
--	--	----------	------	--	--	------	--	--	------	-------	-------	-------	-------	-------	-------	-------	-------	----

		Included	7254			8254			9254	H7094	H7099	N8094	N8099	B8594	B8599	M9594	M9599	12
--	--	----------	------	--	--	------	--	--	------	-------	-------	-------	-------	-------	-------	-------	-------	----

**NOTE: ALL SHOCKS MUST BE ORDERED SEPARATELY.**

										H7091	H7060	N8091	N8060	B8591	B8560	M9591	M9560	2
--	--	--	--	--	--	--	--	--	--	-------	-------	-------	-------	-------	-------	-------	-------	---

										H7091	H7060	N8091	N8060	B8591	B8560	M9591	M9560	4
--	--	--	--	--	--	--	--	--	--	-------	-------	-------	-------	-------	-------	-------	-------	---



# FORD

LIFT	Quick Kit	KIT NOTES	Component Box	Front Springs		Rear Springs		Add-A-Leafs	Steering Correction
	Reference		(Requires 1 Of Each)	Qty	Part #	Qty	Part #		(Order 1 Each)
<b>05-07 F-250 Super Duty (Gas Engine) 4WD Kit Gas Engines with Blocks &amp; U-Bolts</b>									
2-2.5"	F520K			1	F520			R3510	
4"	F5401K	G31, G32, G36, G37	F5451	1	F540				FA450
6"	F5601K	G31, G32, G36, G37	F5651	1	F560				FA450

KIT NOTES: Upgrade Available for 4 & 6 " Kit. Part # F58484LU. Radius Arm Conversion to Upper & Lower Control Arms.  
 G31. Lift is Designed to Level Models with Factory 1 7/8" Rear Blocks. Models with Optional Factory 3 7/8" Rear Blocks will have a Higher Rake Angle in the Rear.  
 G32. Lift Heights will Vary Depending on Factory Package Options. G36. Model with Rear Sway Bar must Order Extended Rear Sway Bar End Links. 4" Lifts Order Part # SBE404, 6" Lifts Order Part # SBE405. G37. Models Equipped with a Sterling Rear Axle will Need Wider Rear U-Bolts. 4" Lifts Order Part # U9B16R, 4" Systems Order Part # U9B12R, 6" Kits Order Part # U9B18R, 6" Systems Order Part # U9B12R.

<b>05-07 F-250 Super Duty (Gas Engine) 4WD System Gas Engines with Rear Springs</b>									
4"	F5401KS	G31, G32, G36, G37	F5451S	1	F540	2	FR94S		FA450
6"	F5601KS	G31, G32, G36, G37	F5651S	1	F560	2	FR96S		FA450

KIT NOTES: Upgrade Available for 4 & 6 " System. Part # F58484LU. Radius Arm Conversion to Upper & Lower Control Arms.  
 G31. Lift is Designed to Level Models with Factory 1 7/8" Rear Blocks. Models with Optional Factory 3 7/8" Rear Blocks will have a Higher Rake Angle in the Rear.  
 G32. Lift Heights will Vary Depending on Factory Package Options. G36. Model with Rear Sway Bar must Order Extended Rear Sway Bar End Links. 4" Lifts Order Part # SBE404, 6" Lifts Order Part # SBE405. G37. Models Equipped with a Sterling Rear Axle will Need Wider Rear U-Bolts. 4" Lifts Order Part # U9B16R, 4" Systems Order Part # U9B12R, 6" Kits Order Part # U9B18R, 6" Systems Order Part # U9B12R.

## CLASS II - ADJUSTABLE 4-LINKS

<b>05-07 F-250 Super Duty (Gas Engine) 4WD Class II Kit Gas Engines with Blocks &amp; Add-A-Leafs</b>									
4"	F54024K	G31, G32, G36, G37	F5451 + F58484LU	1	F540				FA450
6"	F56024K	G31, G32	F5651 + F58484LU	1	F560				FA450
<b>05-07 F-250 Super Duty (Gas Engine) 4WD Class II System Gas Engines with Rear Springs</b>									
4"	F54024KS	G31, G32, G36, G37	F5451S + F58484LU	1	F540	2	FR94S		FA450
6"	F56024KS	G31, G32, G36, G37	F5651S + F58484LU	1	F560	2	FR96S		FA450

<b>05-07 F-250 Super Duty (Gas Engine) 4WD Class II Kit Gas Engines with Blocks &amp; Add-A-Leafs</b>									
8.5"	F5802K	G31, G32, G38	F5852A + F58484LU	1	F565V			R300	FA450

<b>05-07 F-250 Super Duty (Gas Engine) 4WD Class II System Gas Engines with Rear Springs</b>									
8.5"	F5802KS	G31, G32, G38	F5852AS + F58484LU	1	F565V	2	FR98S		FA450

KIT NOTES: G31. Lift is Designed to Level Models with Factory 1 7/8" Rear Blocks. Models with Optional Factory 3 7/8" Rear Blocks will have a Higher Rake Angle in the Rear.  
 G32. Lift Heights will Vary Depending on Factory Package Options. G36. Model with Rear Sway Bar must Order Extended Rear Sway Bar End Links. 4" Lifts Order Part # SBE404, 6" Lifts Order Part # SBE405. G37. Models Equipped with a Sterling Rear Axle will Need Wider Rear U-Bolts. 4" Lifts Order Part # U9B16R, 4" Systems Order Part # U9B12R, 6" Kits Order Part # U9B18R, 6" Systems Order Part # U9B12R. G38. Model with Rear Sway Bar must Order Extended Rear Sway Bar End Links. 8.5" Lifts Order Part # SBE406.

## 00-04 F-250 SUPER DUTY 4WD

### SOFTRIDE® LIFT SYSTEMS

<b>00-04 F-250 Super Duty 4WD Kit All Engines with Front Add-A-Leafs Kit</b>									
2-2.5"	F93203K		TB9203					F9320	

<b>00-04 F-250 Super Duty 4WD Kit All Engines with Replacement Front Springs</b>									
1.5-2"	F9202K		F9202M	2	F920S				

<b>00-04 F-250 Super Duty 4WD Kit Gas V8 or V10 Engine with Blocks &amp; U-Bolts</b>									
4"	F9402MK	G7, G8	F9402M	2	F940S				FA499
6"	F9602MK	G7, G8, G25	F9602M	2	F960S				FA499

KIT NOTES: G7. 3/99-03 Ford Super Duty - if Equipped with a Factory 1.875" Rear Block, the Vehicle will Sit Level. G8. Power Steering Models Only. G25. # SBE405 may be Required on Models Equipped with Factory Rear Sway Bar.

<b>00-04 F-250 Super Duty 4WD System Gas V8 or V10 Engine with Replacement Rear Springs</b>									
4"	F9402MKS	G7, G8	F9402MS	2	F940S	2	FR94S		FA499
6"	F9602MKS	G7, G8, G25	F9602MS	2	F960S	2	FR96S		FA499
8"	F9802MKS-A	G7, G8	F9802MS	2	F965S	2	FR98S		Included

KIT NOTES: G7. 3/99-03 Ford Super Duty - if Equipped with a Factory 1.875" Rear Block, the Vehicle will Sit Level. G8. Power Steering Models Only. G25. # SBE405 may be Required on Models Equipped with Factory Rear Sway Bar.

<b>00-04 F-250 Super Duty 4WD Kit Diesel Engine with Blocks &amp; U-Bolts</b>									
4"	F9452MK	G7, G8	F9402M	2	F945S				FA499
6"	F9652MK	G7, G8, G25	F9602M	2	F965S				FA499

KIT NOTES: G7. 3/99-03 Ford Super Duty - if Equipped with a Factory 1.875" Rear Block, the Vehicle will Sit Level. G8. Power Steering Models Only. G25. # SBE405 may be Required on Models Equipped with Factory Rear Sway Bar.

<b>00-04 F-250 Super Duty 4WD System Diesel Engine with Replacement Rear Springs</b>									
4"	F9452MKS	G7, G8	F9402MS	2	F945S	2	FR94S		FA499
6"	F9652MKS	G7, G8, G25	F9602MS	2	F965S	2	FR96S		FA499
8"	F9852MKS-A	G7, G8	F9802MS	2	F985S	2	FR98S		Included

KIT NOTES: G7. 3/99-03 Ford Super Duty - if Equipped with a Factory 1.875" Rear Block, the Vehicle will Sit Level. G8. Power Steering Models Only. G25. # SBE405 may be Required on Models Equipped with Factory Rear Sway Bar.

FORD



	Steering Stabilizers									HYDRO Shocks		NITRO Shocks		BLACK MAX		M95 Shocks		Labor
	White			Black			Silver			White		White		Black		Silver		Hours
	OEM	Single	Dual	OEM	Single	Dual	OEM	Single	Dual	Front	Rear	Front	Rear	Front	Rear	Front	Rear	

										H7091	H7060	N8091	N8060	B8591	B8560	M9591	M9560	4
	Included	7254			8254			9254		H7092	H7060	N8092	N8060	B8592	B8560	M9592	M9560	8
	Included	7254			8254			9254		H7093	H7079	N8093	N8079	B8593	B8579	M9593	M9579	8

	Included	7254			8254			9254		H7092	H7060	N8092	N8060	B8592	B8560	M9592	M9560	8
	Included	7254			8254			9254		H7093	H7079	N8093	N8079	B8593	B8579	M9593	M9579	8

	Included	7254			8254			9254		H7092	H7060	N8092	N8060	B8592	B8560	M9592	M9560	8
	Included	7254			8254			9254		H7093	H7079	N8093	N8079	B8593	B8579	M9593	M9579	8

	Included	7254			8254			9254		H7092	H7060	N8092	N8060	B8592	B8560	M9592	M9560	8
	Included	7254			8254			9254		H7093	H7079	N8093	N8079	B8593	B8579	M9593	M9579	8

	Included	7254			8254			9254		H7094	H7099	N8094	N8099	B8594	B8599	M9594	M9599	12
--	----------	------	--	--	------	--	--	------	--	-------	-------	-------	-------	-------	-------	-------	-------	----

	Included	7254			8254			9254		H7094	H7099	N8094	N8099	B8594	B8599	M9594	M9599	12
--	----------	------	--	--	------	--	--	------	--	-------	-------	-------	-------	-------	-------	-------	-------	----

**NOTE: ALL SHOCKS MUST BE ORDERED SEPARATELY.**

	7099	7199	7299	8099	8199	8299	9099	9199	9299	H7023	H7060	N8023	N8060	B8523	B8560	M9523	M9560	4
--	------	------	------	------	------	------	------	------	------	-------	-------	-------	-------	-------	-------	-------	-------	---

	7099	7199	7299	8099	8199	8299	9099	9199	9299	H7023	H7060	N8023	N8060	B8523	B8560	M9523	M9560	4
--	------	------	------	------	------	------	------	------	------	-------	-------	-------	-------	-------	-------	-------	-------	---

	7099	7199	7299	8099	8199	8299	9099	9199	9299	H7041	H7079	N8041	N8079	B8541	B8579	M9541	M9579	8
	7099	7199	7299	8099	8199	8299	9099	9199	9299	H7060	H7099	N8060	N8099	B8560	B8599	M9560	M9599	8

	7099	7199	7299	8099	8199	8299	9099	9199	9299	H7041	H7079	N8041	N8079	B8541	B8579	M9541	M9579	8
	7099	7199	7299	8099	8199	8299	9099	9199	9299	H7060	H7099	N8060	N8099	B8560	B8599	M9560	M9599	8
	7099	7199	7299	8099	8199	8299	9099	9199	9299	H7060	H7099	N8060	N8099	B8560	B8599	M9560	M9599	8

	7099	7199	7299	8099	8199	8299	9099	9199	9299	H7041	H7079	N8041	N8079	B8541	B8579	M9541	M9579	8
	7099	7199	7299	8099	8199	8299	9099	9199	9299	H7060	H7099	N8060	N8099	B8560	B8599	M9560	M9599	8

	7099	7199	7299	8099	8199	8299	9099	9199	9299	H7041	H7079	N8041	N8079	B8541	B8579	N8041	N8079	8
	7099	7199	7299	8099	8199	8299	9099	9199	9299	H7060	H7099	N8060	N8099	B8560	B8599	N8060	N8099	8
	7099	7199	7299	8099	8199	8299	9099	9199	9299	H7060	H7099	N8060	N8099	B8560	B8599	N8060	N8099	8



# FORD

LIFT	Quick Kit	KIT NOTES	Component Box	Front Springs		Rear Springs		Add-A-Leafs	Steering Correction
	Reference		(Requires 1 Of Each)	Qty	Part #	Qty	Part #		
<b>03/99-99 F-250 SUPER DUTY 4WD (BUILT AFTER MARCH '99 - WITH SQUARE FRONT U-BOLTS)</b>									
<b>SOFTTRIDE® LIFT SYSTEMS</b>									
<b>03/99-99 F-250 Super Duty 4WD Kit</b>			<b>All Engines with Front Add-A-Leafs</b>						
2-2.5"	F93203K		TB9203					F9320	
<b>03/99-99 F-250 Super Duty 4WD Kit</b>			<b>All Engines with Replacement Front Springs</b>						
1.5-2"	F9203K		F9203M	2	F920S				
<b>03/99-99 F-250 Super Duty 4WD Kit</b>			<b>Gas V8 or V10 Engine with Blocks &amp; U-Bolts</b>						
4"	F9403MK	G7, G8	F9403M	2	F940S				FA499
6"	F9603MK	G7, G8, G25	F9603M	2	F960S				FA499
KIT NOTES: G7. 3/99-03 Ford Super Duty - if Equipped with a Factory 1.875" Rear Block, the Vehicle will Sit Level. G8. Power Steering Models Only. G25. # SBE405 may be Required on Models Equipped with Factory Rear Sway Bar.									
<b>03/99-99 F-250 Super Duty 4WD System</b>			<b>Gas V8 or V10 Engine with Replacement Rear Springs</b>						
4"	F9403MKS	G7, G8	F9403MS	2	F940S	2	FR94S		FA499
6"	F9603MKS	G7, G8, G25	F9603MS	2	F960S	2	FR96S		FA499
8"	F9803MKS-A	G7, G8	F9803MS	2	F965S	2	FR98S		Included
KIT NOTES: G7. 3/99-03 Ford Super Duty - if Equipped with a Factory 1.875" Rear Block, the Vehicle will Sit Level. G8. Power Steering Models Only. G25. # SBE405 may be Required on Models Equipped with Factory Rear Sway Bar.									
<b>03/99-99 F-250 Super Duty 4WD Kit</b>			<b>Diesel Engine with Blocks &amp; U-Bolts</b>						
4"	F9453MK	G7, G8	F9403M	2	F945S				FA499
6"	F9653MK	G7, G8, G25	F9603M	2	F965S				FA499
KIT NOTES: G7. 3/99-03 Ford Super Duty - if Equipped with a Factory 1.875" Rear Block, the Vehicle will Sit Level. G8. Power Steering Models Only. G25. # SBE405 may be Required on Models Equipped with Factory Rear Sway Bar.									
<b>03/99-99 F-250 Super Duty 4WD System</b>			<b>Diesel Engine with Replacement Rear Springs</b>						
4"	F9453MKS	G7, G8	F9403MS	2	F945S	2	FR94S		FA499
6"	F9653MKS	G7, G8, G25	F9603MS	2	F965S	2	FR96S		FA499
8"	F9853MKS-A	G7, G8	F9803MS	2	F985S	2	FR98S		Included
KIT NOTES: G7. 3/99-03 Ford Super Duty - if Equipped with a Factory 1.875" Rear Block, the Vehicle will Sit Level. G8. Power Steering Models Only. G25. # SBE405 may be Required on Models Equipped with Factory Rear Sway Bar.									
<b>99-02/99 F-250 SUPER DUTY 4WD (BUILT BEFORE MARCH '99)</b>									
<b>99-02/99 F-250 Super Duty 4WD Kit</b>			<b>All Engines with Front Add-A-Leafs</b>						
2-2.5"	F9320K		TB920	1	F9320				
<b>99-02/99 F-250 Super Duty 4WD Kit</b>			<b>Gas V8 or V10 Engine with Blocks &amp; U-Bolts</b>						
4"	F940MK	G8	F940M	2	F940S				FA400
6"	F960MK	G8, G25	F960M	2	F960S				FA400
KIT NOTES: G8. Power Steering Models Only. G25. # SBE405 may be Required on Models Equipped with Factory Rear Sway Bar.									
<b>99-02/99 F-250 Super Duty 4WD System</b>			<b>Gas V8 or V10 Engine with Replacement Rear Springs</b>						
4"	F940MKS	G8, G10	F940MS	2	F940S	2	FR96S		FA400
6"	F960MKS	G8, G25	F960MS	2	F960S	2	FR94S		FA400
8"	F980MKS-A	G8	F980MS	2	F965S	2	FR96S		Included
KIT NOTES: G8. Power Steering Models Only. G10. The Factory Block is Removed. G25. # SBE405 may be Required on Models Equipped with Factory Rear Sway Bar.									
<b>99-02/99 F-250 Super Duty 4WD Kit</b>			<b>Diesel Engine with Blocks &amp; U-Bolts</b>						
4"	F945MK	G8	F940M	2	F945S				FA400
6"	F965MK	G8, G25	F960M	2	F965S				FA400
KIT NOTES: G8. Power Steering Models Only. G25. # SBE405 may be Required on Models Equipped with Factory Rear Sway Bar.									
<b>99-02/99 F-250 Super Duty 4WD System</b>			<b>Diesel Engine with Replacement Rear Springs</b>						
4"	F945MKS	G8, G10	F940MS	2	F945S	2	FR96S		FA400
6"	F965MKS	G8, G25	F960MS	2	F965S	2	FR94S		FA400
8"	F985MKS-A	G8	F980MS	2	F985S	2	FR96S		Included
KIT NOTES: G8. Power Steering Models Only. G10. The Factory Block is Removed. G25. # SBE405 may be Required on Models Equipped with Factory Rear Sway Bar.									
<b>97-00 F-250 LIGHT DUTY ONLY - 7 LUG (TORSION BAR FRONT END)</b>									
<b>97-00 F250, Light Duty Only 7 Lug</b>			<b>Torsion Keys (Front Leveling Kit)</b>						
2.5"	F301KE		F301KE						
<b>87-98 F-250 INDEPENDENT FRONT SUSPENSION 4WD (IFS)</b>									
<b>87-98 F-250 (IFS) 4WD Kit</b>			<b>302 or 351 Engine with Front Add-A-Leafs</b>						
1.5-2"	F35G	G1, G18						F35G	
KIT NOTES: G1. Oversized Camber / Caster Shims are Required (See Ford Accessories Section). G18. See Brake Lines Section.									

FORD

	Steering Stabilizers									HYDRO Shocks		NITRO Shocks		BLACK MAX		M95 Shocks		Labor
	White			Black			Silver			White		White		Black		Silver		Hours
	OEM	Single	Dual	OEM	Single	Dual	OEM	Single	Dual	Front	Rear	Front	Rear	Front	Rear	Front	Rear	

**NOTE: ALL SHOCKS MUST BE ORDERED SEPARATELY.**

	7099	7199	7299	8099	8199	8299	9099	9199	9299	H7023	H7060	N8023	N8060	B8523	B8560	M9523	M9560	4
--	------	------	------	------	------	------	------	------	------	-------	-------	-------	-------	-------	-------	-------	-------	---

	7099	7199	7299	8099	8199	8299	9099	9199	9299	H7023	H7060	N8023	N8060	B8523	B8560	M9523	M9560	4
--	------	------	------	------	------	------	------	------	------	-------	-------	-------	-------	-------	-------	-------	-------	---

	7099	7199	7299	8099	8199	8299	9099	9199	9299	H7041	H7079	N8041	N8079	B8541	B8579	M9541	M9579	8
--	------	------	------	------	------	------	------	------	------	-------	-------	-------	-------	-------	-------	-------	-------	---

	7099	7199	7299	8099	8199	8299	9099	9199	9299	H7060	H7079	N8060	N8079	B8560	B8579	M9560	M9579	8
--	------	------	------	------	------	------	------	------	------	-------	-------	-------	-------	-------	-------	-------	-------	---

	7099	7199	7299	8099	8199	8299	9099	9199	9299	H7041	H7079	N8041	N8079	B8541	B8579	M9541	M9579	8
--	------	------	------	------	------	------	------	------	------	-------	-------	-------	-------	-------	-------	-------	-------	---

	7099	7199	7299	8099	8199	8299	9099	9199	9299	H7060	H7079	N8060	N8079	B8560	B8579	M9560	M9579	8
--	------	------	------	------	------	------	------	------	------	-------	-------	-------	-------	-------	-------	-------	-------	---

	7099	7199	7299	8099	8199	8299	9099	9199	9299	H7060	H7099	N8060	N8099	B8560	B8599	M9560	M9599	8
--	------	------	------	------	------	------	------	------	------	-------	-------	-------	-------	-------	-------	-------	-------	---

	7099	7199	7299	8099	8199	8299	9099	9199	9299	H7041	H7079	N8041	N8079	B8541	B8579	M9541	M9579	8
--	------	------	------	------	------	------	------	------	------	-------	-------	-------	-------	-------	-------	-------	-------	---

	7099	7199	7299	8099	8199	8299	9099	9199	9299	H7060	H7079	N8060	N8079	B8560	B8579	M9560	M9579	8
--	------	------	------	------	------	------	------	------	------	-------	-------	-------	-------	-------	-------	-------	-------	---

	7099	7199	7299	8099	8199	8299	9099	9199	9299	H7041	H7079	N8041	N8079	B8541	B8579	M9541	M9579	8
--	------	------	------	------	------	------	------	------	------	-------	-------	-------	-------	-------	-------	-------	-------	---

	7099	7199	7299	8099	8199	8299	9099	9199	9299	H7060	H7079	N8060	N8079	B8560	B8579	M9560	M9579	8
--	------	------	------	------	------	------	------	------	------	-------	-------	-------	-------	-------	-------	-------	-------	---

	7099	7199	7299	8099	8199	8299	9099	9199	9299	H7060	H7099	N8060	N8099	B8560	B8599	M9560	M9599	8
--	------	------	------	------	------	------	------	------	------	-------	-------	-------	-------	-------	-------	-------	-------	---

**NOTE: ALL SHOCKS MUST BE ORDERED SEPARATELY.**

	7099	7199	7299	8099	8199	8299	9099	9199	9299	H7023	H7060	N8023	N8060	B8523	B8560	M9523	M9560	4
--	------	------	------	------	------	------	------	------	------	-------	-------	-------	-------	-------	-------	-------	-------	---

	7099	7199	7299	8099	8199	8299	9099	9199	9299	H7041	H7079	N8041	N8079	B8541	B8579	M9541	M9579	8
--	------	------	------	------	------	------	------	------	------	-------	-------	-------	-------	-------	-------	-------	-------	---

	7099	7199	7299	8099	8199	8299	9099	9199	9299	H7060	H7079	N8060	N8079	B8560	B8579	M9560	M9579	8
--	------	------	------	------	------	------	------	------	------	-------	-------	-------	-------	-------	-------	-------	-------	---

	7099	7199	7299	8099	8199	8299	9099	9199	9299	H7041	H7079	N8041	N8079	B8541	B8579	M9541	M9579	8
--	------	------	------	------	------	------	------	------	------	-------	-------	-------	-------	-------	-------	-------	-------	---

	7099	7199	7299	8099	8199	8299	9099	9199	9299	H7060	H7079	N8060	N8079	B8560	B8579	M9560	M9579	8
--	------	------	------	------	------	------	------	------	------	-------	-------	-------	-------	-------	-------	-------	-------	---

	7099	7199	7299	8099	8199	8299	9099	9199	9299	H7060	H7099	N8060	N8099	B8560	B8599	M9560	M9599	8
--	------	------	------	------	------	------	------	------	------	-------	-------	-------	-------	-------	-------	-------	-------	---

	7099	7199	7299	8099	8199	8299	9099	9199	9299	H7041	H7079	N8041	N8079	B8541	B8579	M9541	M9579	8
--	------	------	------	------	------	------	------	------	------	-------	-------	-------	-------	-------	-------	-------	-------	---

	7099	7199	7299	8099	8199	8299	9099	9199	9299	H7060	H7079	N8060	N8079	B8560	B8579	M9560	M9579	8
--	------	------	------	------	------	------	------	------	------	-------	-------	-------	-------	-------	-------	-------	-------	---

	7099	7199	7299	8099	8199	8299	9099	9199	9299	H7041	H7079	N8041	N8079	B8541	B8579	M9541	M9579	8
--	------	------	------	------	------	------	------	------	------	-------	-------	-------	-------	-------	-------	-------	-------	---

	7099	7199	7299	8099	8199	8299	9099	9199	9299	H7060	H7079	N8060	N8079	B8560	B8579	M9560	M9579	8
--	------	------	------	------	------	------	------	------	------	-------	-------	-------	-------	-------	-------	-------	-------	---

	7099	7199	7299	8099	8199	8299	9099	9199	9299	H7060	H7099	N8060	N8099	B8560	B8599	M9560	M9599	8
--	------	------	------	------	------	------	------	------	------	-------	-------	-------	-------	-------	-------	-------	-------	---

**NOTE: ALL SHOCKS MUST BE ORDERED SEPARATELY.**

										H7052	H7056	N8052	N8056	B8552	B8556	M9552	M9556	2
--	--	--	--	--	--	--	--	--	--	-------	-------	-------	-------	-------	-------	-------	-------	---

**NOTE: ALL SHOCKS MUST BE ORDERED SEPARATELY.**

	7140	7240		8140	8240		9140	9240		H7023	H7058	N8023	N8058	B8523	B8558	M9523	M9558	4
--	------	------	--	------	------	--	------	------	--	-------	-------	-------	-------	-------	-------	-------	-------	---



# FORD

LIFT	Quick Kit	KIT NOTES	Component Box	Front Springs		Rear Springs		Add-A-Leafs	Steering Correction
	Reference		(Requires 1 Of Each)	Qty	Part #	Qty	Part #		(Order 1 Each)
<b>87-98 F-250 (IFS) 4WD Kit</b>									
<b>460 or Diesel Engine with Front Add-A-Leafs</b>									
1.5-2"	F46D	G1						F46D	
KIT NOTES: G1. Oversized Camber / Caster Shims are Required (See Ford Accessories Section).									
<b>87-98 F-250 (IFS) 4WD Kit</b>									
<b>With Rear Blocks &amp; U-Bolts</b>									
4"	F840TK	G8, G18, G22, G23	F840T	2	F840S				FA400
6"	F860TK	G8, G18, G22, G23	F860T	2	F860S				FA400
KIT NOTES: G8. Power Steering Models Only. G18. See Brake Lines Section. G22. May Require End Links on Models Equipped with Factory Sway Bars. See Ford Accessories. G23. Vehicles with Diesel Engine will Require Front Fitted Leafs. Vehicles with Extra Weight may Require Fitted Leafs. See Leaf Springs Section.									
<b>87-98 F-250 (IFS) 4WD Kit</b>									
<b>For Rear Towing Package with Blocks &amp; U-Bolts</b>									
4"	F840TK3	G8, G18, G22, G23	F840TH	2	F840S				FA400
6"	F860TK3	G8, G18, G22, G23	F860TH	2	F860S				FA400
KIT NOTES: G8. Power Steering Models Only. G18. See Brake Lines Section. G22. May Require End Links on Models Equipped with Factory Sway Bars. See Ford Accessories. G23. Vehicles with Diesel Engine will Require Front Fitted Leafs. Vehicles with Extra Weight may Require Fitted Leafs. See Leaf Springs Section.									
<b>87-98 F-250 (IFS) 4WD System</b>									
<b>With Replacement Rear Springs</b>									
4"	F840TKS	G8, G18, G22, G23	F840TS	2	F840S	2	FR54S		FA400
6"	F860TKS	G8, G18, G22, G23	F860TS	2	F860S	2	FR56S		FA400
KIT NOTES: G8. Power Steering Models Only. G18. See Brake Lines Section. G22. May Require End Links on Models Equipped with Factory Sway Bars. See Ford Accessories. G23. Vehicles with Diesel Engine will Require Front Fitted Leafs. Vehicles with Extra Weight may Require Fitted Leafs. See Leaf Springs Section.									
<b>80-86 F-250 INDEPENDENT FRONT SUSPENSION 4WD (IFS)</b>									
<b>80-86 F-250 (IFS) 4WD Kit</b>									
<b>302 or 351 Engine with Front Add-A-Leafs</b>									
1.5-2"	F35G	G1						F35G	
KIT NOTES: G1. Oversized Camber / Caster Shims are Required (See Ford Accessories Section).									
<b>80-86 F-250 (IFS) 4WD Kit</b>									
<b>460 or Diesel Engine with Front Add-A-Leafs</b>									
1.5-2"	F46D	G1						F46D	
KIT NOTES: G1. Oversized Camber / Caster Shims are Required (See Ford Accessories Section).									
<b>80-86 F-250 (IFS) 4WD Kit</b>									
<b>With Rear Blocks &amp; U-Bolts</b>									
4"	F840TK	G8, G18, G22, G23	F840T	2	F840S				FA400
6"	F860TK	G8, G18, G22, G23	F860T	2	F860S				FA400
KIT NOTES: G8. Power Steering Models Only. G18. See Brake Lines Section. G22. May Require End Links on Models Equipped with Factory Sway Bars. See Ford Accessories. G23. Vehicles with Diesel Engine will Require Front Fitted Leafs. Vehicles with Extra Weight may Require Fitted Leafs. See Leaf Springs Section.									
<b>80-86 F-250 (IFS) 4WD System</b>									
<b>With Replacement Rear Springs</b>									
4"	F840TKS	G8, G18, G22, G23	F840TS	2	F840S	2	FR54S		FA400
6"	F860TKS	G8, G18, G22, G23	F860TS	2	F860S	2	FR56S		FA400
KIT NOTES: G8. Power Steering Models Only. G18. See Brake Lines Section. G22. May Require End Links on Models Equipped with Factory Sway Bars. See Ford Accessories. G23. Vehicles with Diesel Engine will Require Front Fitted Leafs. Vehicles with Extra Weight may Require Fitted Leafs. See Leaf Springs Section.									
<b>80-97 F-250 2WD WITH DIESEL OR 460 ENGINES</b>									
<b>80-97 F-250 2WD Kit</b>									
<b>With Blocks &amp; U-Bolts</b>									
3"	184F2K	G8, G18	184F2	1	184				FA400
5"	186F2K	G8, G18	186F2	1	186				FA400
3"	184F2KS	G8, G18	184F2S	1	184	2	FR54S		FA400
5"	186F2KS	G8, G18	186F2S	1	186	2	FR56S		FA400
KIT NOTES: G8. Power Steering Models Only. G18. See Brake Lines Section.									
<b>77.5-79 F-250 LOW BOY &amp; 79 F150 SUPERCAB 4WD WITH 3" WIDE REAR SPRINGS</b>									
<b>77.5-79 F-250 Low Boy 4WD Kit</b>									
<b>With Front Add-A-Leafs</b>									
1.5-2"	F46D							F46D	
KIT NOTES:									
<b>77.5-79 F-250 Low Boy 4WD Kit</b>									
<b>With Blocks &amp; U-Bolts</b>									
4"	F749K	G18	F749	2	F724S				SDL250
6"	F760K	G18	F760	2	F746S				SDL250 + FA325
KIT NOTES: G18. See Brake Lines Section.									
<b>77.5-79 F-250 Low Boy 4WD System</b>									
<b>With Replacement Rear Springs</b>									
4"	F749KS	G18	F749S	2	F724S	2	FR54S		SDL250
6"	F760KS	G18	F760S	2	F746S	2	FR56S		SDL250 + FA325
KIT NOTES: G18. See Brake Lines Section.									

FORD

	Steering Stabilizers									HYDRO Shocks		NITRO Shocks		BLACK MAX		M95 Shocks		Labor				
	White			Black			Silver			White		White		Black		Silver		Hours				
	OEM	Single	Dual	OEM	Single	Dual	OEM	Single	Dual	Front	Rear	Front	Rear	Front	Rear	Front	Rear					
	7140	7240		8140	8240		9140	9240		H7023	H7058	N8023	N8058	B8523	B8558	M9523	M9558	4				
	7140	7240		8140	8240		9140	9240		H7041	H7060	N8041	N8060	B8541	B8560	M9541	M9560	6				
	7140	7240		8140	8240		9140	9240		H7041	H7060	N8041	N8060	B8541	B8560	M9541	M9560	8				
	7140	7240		8140	8240		9140	9240		H7041	H7060	N8041	N8060	B8541	B8560	M9541	M9560	6				
	7140	7240		8140	8240		9140	9240		H7041	H7060	N8041	N8060	B8541	B8560	M9541	M9560	8				
	7140	7240		8140	8240		9140	9240		H7041	H7060	N8041	N8060	B8541	B8560	M9541	M9560	6				
	7140	7240		8140	8240		9140	9240		H7041	H7060	N8041	N8060	B8541	B8560	M9541	M9560	8				
<b>NOTE: ALL SHOCKS MUST BE ORDERED SEPARATELY.</b>																						
	7140	7240		8140	8240		9140	9240		H7054	H7058	N8054	N8058	B8554	B8558	M9554	M9558	4				
	7140	7240		8140	8240		9140	9240		H7054	H7058	N8054	N8058	B8554	B8558	M9554	M9558	4				
	7140	7240		8140	8240		9140	9240		H7055	H7060	N8055	N8060	B8555	B8560	M9555	M9560	6				
	7140	7240		8140	8240		9140	9240		H7056	H7060	N8056	N8060	B8555	B8560	M9556	M9560	8				
	7140	7240		8140	8240		9140	9240		H7055	H7060	N8055	N8060	B8555	B8560	M9555	M9560	6				
	7140	7240		8140	8240		9140	9240		H7056	H7060	N8056	N8060	B8555	B8560	M9556	M9560	8				
<b>NOTE: ALL SHOCKS MUST BE ORDERED SEPARATELY.</b>																						
	7140	7240		8140	8240		9140	9240		H7054	H7058	N8054	N8058	B8554	B8558	M9554	M9558	6				
	7140	7240		8140	8240		9140	9240		H7055	H7041	N8055	N8041	B8555	B8541	M9555	M9541	6				
	7140	7240		8140	8240		9140	9240		H7054	H7058	N8054	N8058	B8554	B8558	M9554	M9558	6				
	7140	7240		8140	8240		9140	9240		H7055	H7041	N8055	N8041	B8555	B8541	M9555	M9541	6				
<b>NOTE: ALL SHOCKS MUST BE ORDERED SEPARATELY.</b>																						
	7110	7220		8110	8220		9110	9220		---	---	H7055	---	---	N8055	---	---	B8555	---	---	M9555	4
	7110	7220		8110	8220		9110	9220		---	---	H7056	N8014	N8056	B8514	B8556	M9514	M9556	4			
	7110	7220		8110	8220		9110	9220		---	---	H7059	N8014	N8059	B8514	B8559	M9514	M9559	6			
	7110	7220		8110	8220		9110	9220		---	---	H7056	N8014	N8056	B8514	B8556	M9514	M9556	4			
	7110	7220		8110	8220		9110	9220		---	---	H7059	N8014	N8059	B8514	B8559	M9514	M9559	6			

# FORD

LIFT	Quick Kit	KIT NOTES	Component Box	Front Springs		Rear Springs		Add-A-Leafs	Steering Correction
	Reference		(Requires 1 Of Each)	Qty	Part #	Qty	Part #		(Order 1 Each)
<b>67-77 F-250 HIGH BOY 4WD WITH 2 1/4" WIDE REAR SPRINGS</b>									
<b>67-77 F-250 High Boy 4WD Kit With Blocks &amp; U-Bolts</b>									
2"	F720K		F7240	2	F724S			R5005	
4"	F740K	G18	F7240	2	F746S			R225	
KIT NOTES: G18. See Brake Lines Section.									
<b>67-77 F-250 High Boy 4WD System With Replacement Rear Springs</b>									
2"	F720KS	G6, G10	F720S	2	F724S	2	FR74S		
4"	F740KS	G18	F740S	2	F746S	2	FR74S		
KIT NOTES: G6. The Factory Blocks are Replaced with Included 2" Blocks. G10. The Factory Block is Removed. G18. See Brake Lines Section.									
<b>17-20 F-350 SUPER DUTY 4WD</b>									
<b>17-20 F-350 Super Duty 4WD Kit Front Metal Spacers</b>									
1"	F51MS		F51MS						
<b>17-20 F-350 Super Duty 4WD Kit Front Metal Spacers with Front Track Bar Bracket</b>									
2.5"	F528MSP		F528MSP						
<b>17-20 F-350 Super Duty 4WD Kit Front Metal Spacers with Shock Extension Brackets</b>									
2.5"	F1752MSB	G40	F1752MSB						
<b>17-20 F-350 Super Duty 4WD Kit (Diesel Engine) Variable Rate Front Coil Springs</b>									
2.5"	F525V	G40	F525V		Included				
<b>17-20 F-350 Super Duty 4WD Kit (Gas Engine) Softride® Front Coil Springs</b>									
2"	F520	G40	F520		Included				
KIT NOTES: G40. Front Track Bar Relocation Bracket <b>Required</b> - Part # TB1120									
<b>17-19 F-350 Super Duty 4WD Kit (Diesel or Gas) Metal Spacer Kit with Blocks &amp; U-Bolts and Black MAX Shocks</b>									
4"	F1740SPB3	G42	F1740SPB3						
Kit includes front coil spring spacers, front & rear Black MAX shocks, track bar relocation bracket, radius arm relocation brackets, steering stabilizer bracket, front sway bar lowering brackets, front bump stop spacers, front brake line extension brackets, rear lift blocks, & rear u-bolts.									
<b>17-19 F-350 Super Duty 4WD Kit (Diesel Engine) Variable Rate Front Coil Springs with Rear Blocks &amp; U-Bolts</b>									
4"	F17451K3	G42	F174513	1	F545V				
6"	F17651K3	G43	F176513	1	F565V				Included
<b>17-19 F-350 Super Duty 4WD System (Diesel Engine) Variable Rate Front Coil Springs with Rear Leaf Springs</b>									
4"	F17451KS	G42	F17451S	1	F545V	2	FR173S		
6"	F17651KS	G43	F17651S	1	F565V	2	FR175S		Included
<b>17-19 F-350 Super Duty 4WD Kit (Gas Engine) Softride® Front Coil Springs with Rear Blocks &amp; U-Bolts</b>									
4"	F17401K3	G42	F174513	1	F540				
6"	F17601K3	G43	F176513	1	F560				Included
<b>17-19 F-350 Super Duty 4WD System (Gas Engine) Softride® Front Coil Springs with Rear Leaf Springs</b>									
4"	F17401KS	G42	F17451S	1	F540	2	FR173S		
6"	F17601KS	G43	F17651S	1	F560	2	FR175S		Included
KIT NOTES: G42. Lift is specifically designed to not require a drop pitman arm. G43. If front drive shaft vibration occurs, front drive shaft modification is required or order a new front drive shaft Part # F17685DS.									
<b>CLASS II - ADJUSTABLE 4-LINKS</b>									
<b>17-19 F-350 Super Duty 4WD Class II Kit (Diesel Engine) Variable Rate Front Coil Springs with Rear Blocks &amp; U-Bolts</b>									
4"	F174524K3	G42	F174513 + F58484LU	1	F545V				
6"	F176524K3	G43	F176513 + F58484LU	1	F565V				Included
8.5"	F17852K	G43	F17852 + F58484LU	1	F585V			R3815	Included
<b>17-19 F-350 Super Duty 4WD Class II System (Diesel Engine) Variable Rate Front Coil Springs with Rear Leaf Springs</b>									
4"	F174524KS	G42	F17451S + F58484LU	1	F545V	2	FR173S		
6"	F176524KS	G43	F17651S + F58484LU	1	F565V	2	FR175S		Included
8.5"	F17852KS	G43	F17852S + F58484LU	1	F585V	2	FR177S		Included
<b>17-19 F-350 Super Duty 4WD Class II Kit (Gas Engine) Softride® Front Coil Springs with Rear Blocks &amp; U-Bolts</b>									
4"	F174024K3	G42	F174513 + F58484LU	1	F540				
6"	F176024K3	G43	F176513 + F58484LU	1	F560				Included
8.5"	F17802K	G43	F17852 + F58484LU	1	F565V			R3815	Included
<b>17-19 F-350 Super Duty 4WD Class II System (Gas Engine) Softride® Front Coil Springs with Rear Leaf Springs</b>									
4"	F174024KS	G42	F17451S + F58484LU	1	F540	2	FR173S		
6"	F176024KS	G43	F17651S + F58484LU	1	F560	2	FR175S		Included
8.5"	F17802KS	G43	F17852S + F58484LU	1	F565V	2	FR177S		Included

FORD

	Steering Stabilizers									HYDRO Shocks		NITRO Shocks		BLACK MAX		M95 Shocks		Labor	
	White			Black			Silver			White		White		Black		Silver			
	OEM	Single	Dual	OEM	Single	Dual	OEM	Single	Dual	Front	Rear	Front	Rear	Front	Rear	Front	Rear	Front	Rear

**NOTE: ALL SHOCKS MUST BE ORDERED SEPARATELY.**

		7110	7220		8110	8220		9110	9220	---	---	H7058	N8014	N8058	B8514	B8558	M9514	M9558	4
		7110	7220		8110	8220		9110	9220	---	---	H7058	N8014	N8058	B8514	B8558	M9514	M9558	4

		7110	7220		8110	8220		9110	9220	---	---	H7058	N8014	N8058	B8514	B8558	M9514	M9558	4
		7110	7220		8110	8220		9110	9220	---	---	H7058	N8014	N8058	B8514	B8558	M9514	M9558	4

**NOTE: ALL SHOCKS MUST BE ORDERED SEPARATELY.**

	7057			8054			9057			H7091	H7038	N8091	N8038	B8591	B8538	M9591	M9538	2
--	------	--	--	------	--	--	------	--	--	-------	-------	-------	-------	-------	-------	-------	-------	---

	7057			8054			9057			H7091	H7038	N8091	N8038	B8591	B8538	M9591	M9538	3
--	------	--	--	------	--	--	------	--	--	-------	-------	-------	-------	-------	-------	-------	-------	---

	7057			8054			9057			---	---	H7038	---	---	N8038	---	---	B8538	---	---	M9538	4
--	------	--	--	------	--	--	------	--	--	-----	-----	-------	-----	-----	-------	-----	-----	-------	-----	-----	-------	---

	7057			8054			9057			H7091	H7038	N8091	N8038	B8591	B8538	M9591	M9538	2
--	------	--	--	------	--	--	------	--	--	-------	-------	-------	-------	-------	-------	-------	-------	---

	7057			8054			9057			H7091	H7038	N8091	N8038	B8591	B8538	M9591	M9538	2
--	------	--	--	------	--	--	------	--	--	-------	-------	-------	-------	-------	-------	-------	-------	---

	7057		7254		8254	9057	9254	---	---	---	---	---	---	---	---	Included	Included	---	---	---	---	6
--	------	--	------	--	------	------	------	-----	-----	-----	-----	-----	-----	-----	-----	----------	----------	-----	-----	-----	-----	---

	7057		7254		8254	9057	9254	H7092	H7068	N8092	N8068	B8592	B8568	M9592	M9568	6
--	------	--	------	--	------	------	------	-------	-------	-------	-------	-------	-------	-------	-------	---

	7057		7254		8254	9057	9254	H7093	H7068	N8093	N8068	B8593	B8568	M9593	M9568	6
--	------	--	------	--	------	------	------	-------	-------	-------	-------	-------	-------	-------	-------	---

	7057		7254		8254	9057	9254	H7092	H7068	N8092	N8068	B8592	B8568	M9592	M9568	6
--	------	--	------	--	------	------	------	-------	-------	-------	-------	-------	-------	-------	-------	---

	7057		7254		8254	9057	9254	H7093	H7068	N8093	N8068	B8593	B8568	M9593	M9568	6
--	------	--	------	--	------	------	------	-------	-------	-------	-------	-------	-------	-------	-------	---

	7057		7254		8254	9057	9254	H7092	H7068	N8092	N8068	B8592	B8568	M9592	M9568	6
--	------	--	------	--	------	------	------	-------	-------	-------	-------	-------	-------	-------	-------	---

	7057		7254		8254	9057	9254	H7093	H7068	N8093	N8068	B8593	B8568	M9593	M9568	6
--	------	--	------	--	------	------	------	-------	-------	-------	-------	-------	-------	-------	-------	---

	7057		7254		8254	9057	9254	H7092	H7068	N8092	N8068	B8592	B8568	M9592	M9568	6
--	------	--	------	--	------	------	------	-------	-------	-------	-------	-------	-------	-------	-------	---

	7057		7254		8254	9057	9254	H7093	H7068	N8093	N8068	B8593	B8568	M9593	M9568	6
--	------	--	------	--	------	------	------	-------	-------	-------	-------	-------	-------	-------	-------	---

	7057		7254		8254	9057	9254	H7092	H7068	N8092	N8068	B8592	B8568	M9592	M9568	8
--	------	--	------	--	------	------	------	-------	-------	-------	-------	-------	-------	-------	-------	---

	7057		7254		8254	9057	9254	H7093	H7068	N8093	N8068	B8593	B8568	M9593	M9568	8
--	------	--	------	--	------	------	------	-------	-------	-------	-------	-------	-------	-------	-------	---

	7057		7254		8254	9057	9254	H7094	H7089	N8094	N8089	B8594	B8589	M9594	M9589	10
--	------	--	------	--	------	------	------	-------	-------	-------	-------	-------	-------	-------	-------	----

	7057		7254		8254	9057	9254	H7092	H7068	N8092	N8068	B8592	B8568	M9592	M9568	8
--	------	--	------	--	------	------	------	-------	-------	-------	-------	-------	-------	-------	-------	---

	7057		7254		8254	9057	9254	H7093	H7068	N8093	N8068	B8593	B8568	M9593	M9568	8
--	------	--	------	--	------	------	------	-------	-------	-------	-------	-------	-------	-------	-------	---

	7057		7254		8254	9057	9254	H7094	H7089	N8094	N8089	B8594	B8589	M9594	M9589	10
--	------	--	------	--	------	------	------	-------	-------	-------	-------	-------	-------	-------	-------	----

	7057		7254		8254	9057	9254	H7092	H7068	N8092	N8068	B8592	B8568	M9592	M9568	8
--	------	--	------	--	------	------	------	-------	-------	-------	-------	-------	-------	-------	-------	---

	7057		7254		8254	9057	9254	H7093	H7068	N8093	N8068	B8593	B8568	M9593	M9568	8
--	------	--	------	--	------	------	------	-------	-------	-------	-------	-------	-------	-------	-------	---

	7057		7254		8254	9057	9254	H7094	H7089	N8094	N8089	B8594	B8589	M9594	M9589	10
--	------	--	------	--	------	------	------	-------	-------	-------	-------	-------	-------	-------	-------	----

	7057		7254		8254	9057	9254	H7092	H7068	N8092	N8068	B8592	B8568	M9592	M9568	8
--	------	--	------	--	------	------	------	-------	-------	-------	-------	-------	-------	-------	-------	---

	7057		7254		8254	9057	9254	H7093	H7068	N8093	N8068	B8593	B8568	M9593	M9568	8
--	------	--	------	--	------	------	------	-------	-------	-------	-------	-------	-------	-------	-------	---

	7057		7254		8254	9057	9254	H7094	H7089	N8094	N8089	B8594	B8589	M9594	M9589	10
--	------	--	------	--	------	------	------	-------	-------	-------	-------	-------	-------	-------	-------	----



# FORD

LIFT	Quick Kit	KIT NOTES	Component Box	Front Springs		Rear Springs		Add-A-Leafs	Steering Correction
	Reference		(Requires 1 Of Each)	Qty	Part #	Qty	Part #		(Order 1 Each)

## COIL-OVER SYSTEMS

### 17-19 F-350 Super Duty 4WD Coil-Over Kit (Diesel or Gas) Front Coil-Overs with Rear Blocks & U-Bolts

6"	F1761LSK3	G43	F76FLSB + F176513	1	F768FLS				Included
----	-----------	-----	-------------------	---	---------	--	--	--	----------

### 17-19 F-350 Super Duty 4WD Coil-Over System (Diesel or Gas) Front Coil-Overs with Rear Leaf Springs

6"	F1761LSKS	G43	F76FLSB + F17651S	1	F768FLS	2	FR175S		Included
----	-----------	-----	-------------------	---	---------	---	--------	--	----------

## CLASS II - COIL-OVER SYSTEMS WITH ADJUSTABLE 4-LINKS

### 17-19 F-350 Super Duty 4WD Class II Kit (Diesel or Gas) Front Coil-Overs with Rear Blocks & U-Bolts

6"	F17624LSK3	G43	F76FLSB + F176513 + F58484LU	1	F768FLS				Included
8.5"	F1782LSK	G43	F78FLSB + F17852 + F58484LU	1	F768FLS		R3815		Included

### 17-18 F-350 Super Duty 4WD Class II System (Diesel or Gas) Front Coil-Overs with Rear Leaf Springs

6"	F17624LSKS	G43	F76FLSB + F17651S + F58484LU	1	F768FLS	2	FR175S		Included
8.5"	F1782LSKS	G43	F78FLSB + F17852S + F58484LU	1	F768FLS	2	FR177S		Included

KIT NOTES: G42. Lift is specifically designed to not require a drop pitman arm. G43. If front drive shaft vibration occurs, front drive shaft modification is required or order a new front drive shaft Part # F17685DS.

## 11-16 F-350 SUPER DUTY 4WD DIESEL ENGINE

### 11-16 F-350 Super Duty 4WD Kit Front Metal Spacers

1"	F51MS		F51MS						
----	-------	--	-------	--	--	--	--	--	--

### 11-16 F-350 Super Duty 4WD Kit Front Metal Spacers with Front Track Bar Bracket

2.5"	F528MSP		F528MSP						
------	---------	--	---------	--	--	--	--	--	--

### 11-16 F-350 Super Duty 4WD Kit Front Metal Spacers with Rear Add-A-Leafs

2.5"	F82MK	G33	F52MS				R3815		
------	-------	-----	-------	--	--	--	-------	--	--

KIT NOTES: G33. Optional Track Bar Relocation Bracket may be Required. Part # TB1120.

### 11-16 F-350 Super Duty (Diesel Engine) 4WD Kit Diesel Engines with Add-A-Leafs

2"	F825K	G33	F525V	1	F525V		R3815		
----	-------	-----	-------	---	-------	--	-------	--	--

KIT NOTES: G33. Optional Track Bar Relocation Bracket may be Required. Part # TB1120.

### 11-16 F-350 Super Duty (Diesel Engine) 4WD Kit Diesel Engines with Blocks & U-Bolts

4"	F11451K3	G32, G36	F11451 + F114H	1	F545V				FA450
6"	F11651K3	G32, G36	F11651 + F1168H	1	F565V				FA450

## CLASS II - ADJUSTABLE 4-LINKS

### 11-16 F-350 Super Duty (Diesel Engine) 4WD Class II Kit Diesel Engines with Blocks & U-Bolts

4"	F114524K3	G32, G36	F11451 + F114H + F58484LU	1	F545V				FA450
6"	F116524K3	G32, G36	F11651 + F1168H + F58484LU	1	F565V				FA450

### 11-16 F-350 Super Duty (Diesel Engine) 4WD Class II Kit Diesel Engines with Blocks & U-Bolts

8.5"	F11852K3	G32, G36	F11852 + F1168H + F58484LU	1	F585V		R3815		FA450
------	----------	----------	----------------------------	---	-------	--	-------	--	-------

KIT NOTES: Upgrade Available for 4 & 6" Kit. Part # F58484LU. Radius Arm Conversion to Upper & Lower Control Arms. G32. Lift Heights will Vary Depending on Factory Package Options. G36. Model with Rear Sway Bar must Order Extended Rear Sway Bar End Links. 4" Lifts Order Part # SBE404, 6" Lifts Order Part # SBE405, 8.5" Lifts Order Part # SBE406.

## 08-10 F-350 SUPER DUTY 4WD DIESEL ENGINE

### 08-10 F-350 Super Duty 4WD Kit Front Metal Spacers

1"	F51MS		F51MS						
----	-------	--	-------	--	--	--	--	--	--

### 08-10 F-350 Super Duty 4WD Kit Front Metal Spacers with Front Track Bar Bracket

2.5"	F528MSP		F528MSP						
------	---------	--	---------	--	--	--	--	--	--

### 08-10 F-350 Super Duty (Diesel Engine) 4WD Kit Diesel Engines with Add-A-Leafs

2.5"	F825K	G33	F525V	1	F525V		R3815		
------	-------	-----	-------	---	-------	--	-------	--	--

### 08-10 F-350 Super Duty (Diesel Engine) 4WD Kit Diesel Engines with Blocks & U-Bolts

4"	F8451K3	G31, G32, G36	F8451H	1	F545V				FA450
6"	F8651K3	G31, G32, G36	F8651H	1	F565V				FA450

KIT NOTES: Upgrade Available for 4 & 6" Kit. Part # F58484LU. Radius Arm Conversion to Upper & Lower Control Arms. G31. Lift is Designed to Level Models with Factory 1 7/8" Rear Blocks. Models with Optional Factory 3 7/8" Rear Blocks will have a Higher Rake Angle in the Rear. G32. Lift Heights will Vary Depending on Factory Package Options. G33. Optional Track Bar Relocation Bracket may be Required. Part # TB1120. G36. Model with Rear Sway Bar must Order Extended Rear Sway Bar End Links. 4" Lifts Order Part # SBE404, 6" Lifts Order Part # SBE405.

FORD



	Steering Stabilizers									HYDRO Shocks		NITRO Shocks		BLACK MAX		M95 Shocks		Labor
	White			Black			Silver			White		White		Black		Silver		Hours
	OEM	Single	Dual	OEM	Single	Dual	OEM	Single	Dual	Front	Rear	Front	Rear	Front	Rear	Front	Rear	
	7057		7254			8254	9057		9254		H7068		N8068		B8568		M9568	6
	7057		7254			8254	9057		9254		H7068		N8068		B8568		M9568	6
	7057		7254			8254	9057		9254		H7068		N8068		B8568		M9568	9
	7057		7254			8254	9057		9254		H7089		N8089		B8589		M9589	10
	7057		7254			8254	9057		9254		H7068		N8068		B8568		M9568	9
	7057		7254			8254	9057		9254		H7089		N8089		B8589		M9589	10

**NOTE: ALL SHOCKS MUST BE ORDERED SEPARATELY.**

	7054			8054			9054			H7091	H7060	N8091	N8060	B8591	B8560	M9591	M9560	2
	7054			8054			9054			H7091	H7060	N8091	N8060	B8591	B8560	M9591	M9560	3
	7054			8054			9054			H7091	H7060	N8091	N8060	B8591	B8560	M9591	M9560	4
	7054			8054			9054			H7091	H7060	N8091	N8060	B8591	B8560	M9591	M9560	4
	7054	Bkt. Incl.	7254	8054	Bkt. Incl.	8254	9054	Bkt. Incl.	9254	H7092	H7079	N8092	N8079	B8592	B8579	M9592	M9579	6
	7054	Bkt. Incl.	7254	8054	Bkt. Incl.	8254	9054	Bkt. Incl.	9254	H7093	H7079	N8093	N8079	B8593	B8579	M9593	M9579	6
	7054	Bkt. Incl.	7254	8054	Bkt. Incl.	8254	9054	Bkt. Incl.	9254	H7092	H7079	N8092	N8079	B8592	B8579	M9592	M9579	6
	7054	Bkt. Incl.	7254	8054	Bkt. Incl.	8254	9054	Bkt. Incl.	9254	H7093	H7079	N8093	N8079	B8593	B8579	M9593	M9579	6
	7054		7254	8054		8254	9054		9254	H7094	H7099	N8094	N8099	B8594	B8599	M9594	M9599	12

**NOTE: ALL SHOCKS MUST BE ORDERED SEPARATELY.**

	7054			8054			9054			H7091	H7060	N8091	N8060	B8591	B8560	M9591	M9560	2
	7054			8054			9054			H7091	H7060	N8091	N8060	B8591	B8560	M9591	M9560	3
	7054			8054			9054			H7091	H7060	N8091	N8060	B8591	B8560	M9591	M9560	4
	7054	Included	7254	8054		8254	9054		9254	H7092	H7079	N8092	N8079	B8592	B8579	M9592	M9579	6
	7054	Included	7254	8054		8254	9054		9254	H7093	H7079	N8093	N8079	B8593	B8579	M9593	M9579	6



# FORD

LIFT	Quick Kit	KIT NOTES	Component Box	Front Springs		Rear Springs		Add-A-Leafs	Steering Correction
	Reference		(Requires 1 Of Each)	Qty	Part #	Qty	Part #		(Order 1 Each)
<b>08-10 F-350 Super Duty (Diesel Engine) 4WD System Diesel Engines with Rear Springs</b>									
4"	F8451KS3	G31, G32, G36	F8451SH	1	F545V	2	FR84S		FA450
6"	F8651KS3	G31, G32, G36	F8651SH	1	F565V	2	FR86S		FA450

KIT NOTES: Upgrade Available for 4 & 6 " Kit. Part # F58484LU. Radius Arm Conversion to Upper & Lower Control Arms. G31. Lift is Designed to Level Models with Factory 1 7/8" Rear Blocks. Models with Optional Factory 3 7/8" Rear Blocks will have a Higher Rake Angle in the Rear. G32. Lift Heights will Vary Depending on Factory Package Options. G36. Model with Rear Sway Bar must Order Extended Rear Sway Bar End Links. 4" Lifts Order Part # SBE404, 6" Lifts Order Part # SBE405.

## CLASS II - ADJUSTABLE 4-LINKS

<b>08-10 F-350 Super Duty (Diesel Engine) 4WD Class II Kit Diesel Engines with Blocks &amp; U-Bolts</b>									
4"	F84524K3	G31, G32, G36, G37	F8451H + F58484LU	1	F545V				FA450
6"	F86524K3	G31, G32, G36, G37	F8651H + F58484LU	1	F565V				FA450

<b>08-10 F-350 Super Duty (Diesel Engine) 4WD Class II System Diesel Engines with Rear Springs</b>									
4"	F84524KS3	G31, G32, G36, G37	F8451SH + F58484LU	1	F545V	2	FR84S		FA450
6"	F86524KS3	G31, G32, G36, G37	F8651SH + F58484LU	1	F565V	2	FR86S		FA450

<b>08-10 F-350 Super Duty (Diesel Engine) 4WD Class II Kit Diesel Engines with Blocks &amp; U-Bolts</b>									
8.5"	F8852K3	G31, G32, G38, G39	F8852H + F58484LU	1	F585V			R300	FA450

<b>08-10 F-350 Super Duty (Diesel Engine) 4WD Class II System Diesel Engines with Rear Springs</b>									
8.5"	F8852KS3	G31, G32, G38	F8852SH + F58484LU	1	F585V	2	FR88S		FA450

KIT NOTES: 8.5" Lifts - Front & Rear Driveline Modifications Necessary. Call for Details. \* Recommend CV Joint at Transfer Case for some Models. G31. Lift is Designed to Level Models with Factory 1 7/8" Rear Blocks. Models with Optional Factory 3 7/8" Rear Blocks will have a Higher Rake Angle in the Rear. G32. Lift Heights will Vary Depending on Factory Package Options. G36. Model with Rear Sway Bar must Order Extended Rear Sway Bar End Links. 4" Lifts Order Part # SBE404, 6" Lifts Order Part # SBE405. G37. Models Equipped with a Sterling Rear Axle will Need Wider Rear U-Bolts. 4" Lifts Order Part # U9B16R, 4" Systems Order Part # U9B12R, 6" Kits Order Part # U9B18R, 6" Systems Order Part # U9B12R. G38. Model with Rear Sway Bar must Order Extended Rear Sway Bar End Links. 8.5" Lifts Order Part # SBE406. G39. Models Equipped with a Sterling Rear Axle will Need Wider Rear U-Bolts. 8.5" Kits Order Part # U9B18R, 8.5" Systems Order Part # U9B12R.

## 08-10 F-350 SUPER DUTY 4WD GAS ENGINE

<b>08-10 F-350 Super Duty 4WD Kit Front Metal Spacers</b>									
1"	F51MS		F51MS						

<b>08-10 F-350 Super Duty 4WD Kit Front Metal Spacers with Front Track Bar Bracket</b>									
2.5"	F528MSP		F528MSP						

<b>08-10 F-350 Super Duty 4WD Value Kit Front Metal Spacers with Rear Add-A-Leafs</b>									
2.5"	F82MK	G33	F52MS					R3815	

KIT NOTES: G33. Optional Track Bar Relocation Bracket may be Required. Part # TB1120.

<b>08-10 F-350 Super Duty (Gas Engine) 4WD Kit Gas Engines with Add-A-Leafs</b>									
2"	F820K	G33		1	F520			R3815	

KIT NOTES: G33. Optional Track Bar Relocation Bracket may be Required. Part # TB1120.

<b>08-10 F-350 Super Duty (Gas Engine) 4WD Kit Gas Engines with Blocks &amp; U-Bolts</b>									
4"	F8401K3	G31, G32, G36, G41	F8451H	1	F540				FA450
6"	F8601K3	G31, G32, G36, G41	F8651H	1	F560				FA450

KIT NOTES: Upgrade Available for 4 & 6 " Kit. Part # F58484LU. Radius Arm Conversion to Upper & Lower Control Arms. G31. Lift is Designed to Level Models with Factory 1 7/8" Rear Blocks. Models with Optional Factory 3 7/8" Rear Blocks will have a Higher Rake Angle in the Rear. G32. Lift Heights will Vary Depending on Factory Package Options. G36. Model with Rear Sway Bar must Order Extended Rear Sway Bar End Links. 4" Lifts Order Part # SBE404, 6" Lifts Order Part # SBE405. G41. 4, 6, & 8.5" Lifts Require Minor Exhaust Modifications.

<b>08-10 F-350 Super Duty (Gas Engine) 4WD System Gas Engines with Rear Springs</b>									
4"	F8401KS3	G31, G32, G36, G41	F8451SH	1	F540	2	FR84S		FA450
6"	F8601KS3	G31, G32, G36, G41	F8651SH	1	F560	2	FR86S		FA450

KIT NOTES: Upgrade Available for 4 & 6 " System. Part # F58484LU. Radius Arm Conversion to Upper & Lower Control Arms. G31. Lift is Designed to Level Models with Factory 1 7/8" Rear Blocks. Models with Optional Factory 3 7/8" Rear Blocks will have a Higher Rake Angle in the Rear. G32. Lift Heights will Vary Depending on Factory Package Options. G36. Model with Rear Sway Bar must Order Extended Rear Sway Bar End Links. 4" Lifts Order Part # SBE404, 6" Lifts Order Part # SBE405. G41. 4, 6, & 8.5" Lifts Require Minor Exhaust Modifications.

## CLASS II - ADJUSTABLE 4-LINKS

<b>08-10 F-350 Super Duty (Gas Engine) 4WD Kit Gas Engines with Blocks &amp; U-Bolts</b>									
4"	F84024K3	G31, G32, G36, G37, G41	F8451H + F58484LU	1	F540				FA450
6"	F86024K3	G31, G32, G41	F8651H + F58484LU	1	F560				FA450

<b>08-10 F-350 Super Duty (Gas Engine) 4WD System Class II Gas Engines with Rear Springs</b>									
4"	F84024KS3	G31, G32, G36, G37, G41	F8451SH + F58484LU	1	F540	2	FR84S		FA450
6"	F86024KS3	G31, G32, G36, G37, G41	F8651SH + F58484LU	1	F560	2	FR86S		FA450

FORD

	Steering Stabilizers									HYDRO Shocks		NITRO Shocks		BLACK MAX		M95 Shocks		Labor
	White			Black			Silver			White		White		Black		Silver		Hours
	OEM	Single	Dual	OEM	Single	Dual	OEM	Single	Dual	Front	Rear	Front	Rear	Front	Rear	Front	Rear	
	7054	Included	7254	8054		8254	9054		9254	H7092	H7079	N8092	N8079	B8592	B8579	M9592	M9579	6
	7054	Included	7254	8054		8254	9054		9254	H7093	H7079	N8093	N8079	B8593	B8579	M9593	M9579	6
	7054	Included	7254	8054		8254	9054		9254	H7092	H7079	N8092	N8079	B8592	B8579	M9592	M9579	6
	7054	Included	7254	8054		8254	9054		9254	H7093	H7079	N8093	N8079	B8593	B8579	M9593	M9579	6
	7054		7254	8054		8254	9054		9254	H7094	H7099	N8094	N8099	B8594	B8599	M9594	M9599	12
	7054		7254	8054		8254	9054		9254	H7094	H7099	N8094	N8099	B8594	B8599	M9594	M9599	12
<b>NOTE: ALL SHOCKS MUST BE ORDERED SEPARATELY.</b>																		
	7054			8054			9054			H7091	H7060	N8091	N8060	B8591	B8560	M9591	M9560	2
	7054			8054			9054			H7091	H7060	N8091	N8060	B8591	B8560	M9591	M9560	3
	7054			8054			9054			H7091	H7060	N8091	N8060	B8591	B8560	M9591	M9560	4
	7054			8054			9054			H7091	H7060	N8091	N8060	B8591	B8560	M9591	M9560	4
	7054	Included	7254	8054		8254	9054		9254	H7092	H7079	N8092	N8079	B8592	B8579	M9592	M9579	6
	7054	Included	7254	8054		8254	9054		9254	H7093	H7079	N8093	N8079	B8593	B8579	M9593	M9579	6
	7054	Included	7254	8054		8254	9054		9254	H7092	H7079	N8092	N8079	B8592	B8579	M9592	M9579	6
	7054	Included	7254	8054		8254	9054		9254	H7093	H7079	N8093	N8079	B8593	B8579	M9593	M9579	6
	7054	Included	7254	8054		8254	9054		9254	H7092	H7079	N8092	N8079	B8592	B8579	M9592	M9579	6
	7054	Included	7254	8054		8254	9054		9254	H7093	H7079	N8093	N8079	B8593	B8579	M9593	M9579	6



# FORD

LIFT	Quick Kit	KIT NOTES	Component Box	Front Springs		Rear Springs		Add-A-Leafs	Steering Correction
	Reference		(Requires 1 Of Each)	Qty	Part #	Qty	Part #		(Order 1 Each)
<b>08-10 F-350 Super Duty (Gas Engine) 4WD Kit</b>									
<b>Gas Engines with Blocks &amp; U-Bolts</b>									
8.5"	F8802K3	G31, G32, G38, G39, G41	F8852H + F58484LU	1	F565V			R300	FA450
<b>08-10 F-350 Super Duty (Gas Engine) 4WD System</b>									
<b>Class II Gas Engines with Rear Springs</b>									
8.5"	F8802KS3	G31, G32, G38, G41	F8852SH + F58484LU	1	F565V	2	FR88S		FA450
KIT NOTES: 8.5" Lifts - Front & Rear Driveline Modifications Necessary. Call for Details. * Recommend CV Joint at Transfer Case for some Models. G31. Lift is Designed to Level Models with Factory 1 7/8" Rear Blocks. Models with Optional Factory 3 7/8" Rear Blocks will have a Higher Rake Angle in the Rear. G32. Lift Heights will Vary Depending on Factory Package Options. G36. Model with Rear Sway Bar must Order Extended Rear Sway Bar End Links. 4" Lifts Order Part # SBE404, 6" Lifts Order Part # SBE405. G37. Models Equipped with a Sterling Rear Axle will Need Wider Rear U-Bolts. 4" Lifts Order Part # U9B16R, 4" Systems Order Part # U9B12R, 6" Kits Order Part # U9B18R, 6" Systems Order Part # U9B12R. G38. Model with Rear Sway Bar must Order Extended Rear Sway Bar End Links. 8.5" Lifts Order Part # SBE406. G39. Models Equipped with a Sterling Rear Axle will Need Wider Rear U-Bolts. 8.5" Kits Order Part # U9B18R, 8.5" Systems Order Part # U9B12R. G41. 4, 6, & 8.5" Lifts Require Minor Exhaust Modifications.									
<b>05-07 F-350 SUPER DUTY 4WD DIESEL ENGINE</b>									
<b>05-07 F-350 Super Duty 4WD Kit</b>									
<b>Front Metal Spacers</b>									
1"	F51MS		F51MS						
<b>05-07 F-350 Super Duty 4WD Kit</b>									
<b>Front Metal Spacers with Rear Add-A-Leafs</b>									
2.5"	F52MK	G33	F52MS					R3510	
KIT NOTES: G33. Optional Track Bar Relocation Bracket may be Required. Part # TB520.									
<b>05-07 F-350 Super Duty (Diesel Engine) 4WD Kit</b>									
<b>Diesel Engines with Blocks &amp; U-Bolts</b>									
2-2.5"	F525K	G33		1	F525V			R3510	
4"	F5451K3	G31, G32, G36	F5451H	1	F545V				FA450
6"	F5651K3	G31, G32, G36	F5651H	1	F565V				FA450
KIT NOTES: Upgrade Available for 4 & 6" Kit. Part # F58484LU. Radius Arm Conversion to Upper & Lower Control Arms. G31. Lift is Designed to Level Models with Factory 1 7/8" Rear Blocks. Models with Optional Factory 3 7/8" Rear Blocks will have a Higher Rake Angle in the Rear. G32. Lift Heights will Vary Depending on Factory Package Options. G33. Optional Track Bar Relocation Bracket may be Required. Part # TB520. G36. Model with Rear Sway Bar must Order Extended Rear Sway Bar End Links. 4" Lifts Order Part # SBE404, 6" Lifts Order Part # SBE405.									
<b>05-07 F-350 Super Duty (Diesel Engine) 4WD System</b>									
<b>Diesel Engines with Rear Springs</b>									
4"	F5451KS3	G31, G32, G36	F5451SH	1	F545V	2	FR94S		FA450
6"	F5651KS3	G31, G32, G36	F5651SH	1	F565V	2	FR96S		FA450
KIT NOTES: Upgrade Available for 4 & 6" Kit. Part # F58484LU. Radius Arm Conversion to Upper & Lower Control Arms. G31. Lift is Designed to Level Models with Factory 1 7/8" Rear Blocks. Models with Optional Factory 3 7/8" Rear Blocks will have a Higher Rake Angle in the Rear. G32. Lift Heights will Vary Depending on Factory Package Options. G36. Model with Rear Sway Bar must Order Extended Rear Sway Bar End Links. 4" Lifts Order Part # SBE404, 6" Lifts Order Part # SBE405.									
<b>CLASS II - ADJUSTABLE 4-LINKS</b>									
<b>05-07 F-350 Super Duty (Diesel Engine) 4WD Kit</b>									
<b>Class II Diesel Engines with Blocks &amp; Add-A-Leafs</b>									
8.5"	F5852K3	G31, G32, G38	F5852AH + F58484LU	1	F585V			R300	FA450
<b>05-07 F-350 Super Duty (Diesel Engine) 4WD System</b>									
<b>Class II Diesel Engines with Rear Springs</b>									
8.5"	F5852KS3	G31, G32, G38	F5852ASH + F58484LU	1	F585V	2	FR98S		FA450
KIT NOTES: G31. Lift is Designed to Level Models with Factory 1 7/8" Rear Blocks. Models with Optional Factory 3 7/8" Rear Blocks will have a Higher Rake Angle in the Rear. G32. Lift Heights will Vary Depending on Factory Package Options. G38. Model with Rear Sway Bar must Order Extended Rear Sway Bar End Links. 8.5" Lifts Order Part # SBE406.									
<b>05-07 F-350 SUPER DUTY 4WD GAS ENGINE</b>									
<b>05-07 F-350 Super Duty 4WD Kit</b>									
<b>Front Metal Spacers</b>									
1"	F51MS		F51MS						
<b>05-07 F-350 Super Duty 4WD Kit</b>									
<b>Front Metal Spacers with Rear Add-A-Leafs</b>									
2.5"	F52MK	G33	F52MS					R3510	
KIT NOTES: G33. Optional Track Bar Relocation Bracket may be Required. Part # TB520.									
<b>05-07 F-350 Super Duty (Gas Engine) 4WD Kit</b>									
<b>Gas Engines with Blocks &amp; U-Bolts</b>									
2-2.5"	F520K	G33		1	F520			R3510	
KIT NOTES: G33. Optional Track Bar Relocation Bracket may be Required. Part # TB520.									
<b>05-07 F-350 Super Duty (Gas Engine) 4WD Kit</b>									
<b>Gas Engines with Blocks &amp; U-Bolts</b>									
4"	F5401K3	G31, G32, G36	F5451H	1	F540				FA450
6"	F5601K3	G31, G32, G36	F5651H	1	F560				FA450
KIT NOTES: Upgrade Available for 4 & 6" Kit. Part # F58484LU. Radius Arm Conversion to Upper & Lower Control Arms. G31. Lift is Designed to Level Models with Factory 1 7/8" Rear Blocks. Models with Optional Factory 3 7/8" Rear Blocks will have a Higher Rake Angle in the Rear. G32. Lift Heights will Vary Depending on Factory Package Options. G36. Model with Rear Sway Bar must Order Extended Rear Sway Bar End Links. 4" Lifts Order Part # SBE404, 6" Lifts Order Part # SBE405.									
<b>05-07 F-350 Super Duty (Gas Engine) 4WD System</b>									
<b>Gas Engines with Rear Springs</b>									
4"	F5401KS3	G31, G32, G36	F5451SH	1	F540	2	FR94S		FA450
6"	F5601KS3	G31, G32, G36	F5651SH	1	F560	2	FR96S		FA450
KIT NOTES: Upgrade Available for 4 & 6" Kit. Part # F58484LU. Radius Arm Conversion to Upper & Lower Control Arms. G31. Lift is Designed to Level Models with Factory 1 7/8" Rear Blocks. Models with Optional Factory 3 7/8" Rear Blocks will have a Higher Rake Angle in the Rear. G32. Lift Heights will Vary Depending on Factory Package Options. G36. Model with Rear Sway Bar must Order Extended Rear Sway Bar End Links. 4" Lifts Order Part # SBE404, 6" Lifts Order Part # SBE405.									

FORD

	Steering Stabilizers									HYDRO Shocks		NITRO Shocks		BLACK MAX		M95 Shocks		Labor
	White			Black			Silver			White		White		Black		Silver		Hours
	OEM	Single	Dual	OEM	Single	Dual	OEM	Single	Dual	Front	Rear	Front	Rear	Front	Rear	Front	Rear	Hours

	7054		7254	8054		8254	9054		9254	H7094	H7099	N8094	N8099	B8594	B8599	M9594	M9599	12
--	------	--	------	------	--	------	------	--	------	-------	-------	-------	-------	-------	-------	-------	-------	----

	7054		7254	8054		8254	9054		9254	H7094	H7099	N8094	N8099	B8594	B8599	M9594	M9599	12
--	------	--	------	------	--	------	------	--	------	-------	-------	-------	-------	-------	-------	-------	-------	----

**NOTE: ALL SHOCKS MUST BE ORDERED SEPARATELY.**

										H7091	H7060	N8091	N8060	B8591	B8560	M9591	M9560	2
--	--	--	--	--	--	--	--	--	--	-------	-------	-------	-------	-------	-------	-------	-------	---

										H7091	H7060	N8091	N8060	B8591	B8560	M9591	M9560	4
--	--	--	--	--	--	--	--	--	--	-------	-------	-------	-------	-------	-------	-------	-------	---

										H7091	H7060	N8091	N8060	B8591	B8560	M9591	M9560	4
		Included	7254			8254			9254	H7092	H7079	N8092	N8079	B8592	B8579	M9592	M9579	8
		Included	7254			8254			9254	H7093	H7079	N8093	N8079	B8593	B8579	M9593	M9579	8

		Included	7254			8254			9254	H7092	H7079	N8092	N8079	B8592	B8579	M9592	M9579	8
		Included	7254			8254			9254	H7093	H7079	N8093	N8079	B8593	B8579	M9593	M9579	8

			7254			8254			9254	H7094	H7099	N8094	N8099	B8594	B8599	M9594	M9599	12
--	--	--	------	--	--	------	--	--	------	-------	-------	-------	-------	-------	-------	-------	-------	----

			7254			8254			9254	H7094	H7099	N8094	N8099	B8594	B8599	M9594	M9599	12
--	--	--	------	--	--	------	--	--	------	-------	-------	-------	-------	-------	-------	-------	-------	----

**NOTE: ALL SHOCKS MUST BE ORDERED SEPARATELY.**

										H7091	H7060	N8091	N8060	B8591	B8560	M9591	M9560	2
--	--	--	--	--	--	--	--	--	--	-------	-------	-------	-------	-------	-------	-------	-------	---

										H7091	H7060	N8091	N8060	B8591	B8560	M9591	M9560	4
--	--	--	--	--	--	--	--	--	--	-------	-------	-------	-------	-------	-------	-------	-------	---

										H7091	H7060	N8091	N8060	B8591	B8560	M9591	M9560	4
--	--	--	--	--	--	--	--	--	--	-------	-------	-------	-------	-------	-------	-------	-------	---

		Included	7254			8254			9254	H7092	H7079	N8092	N8079	B8592	B8579	M9592	M9579	8
		Included	7254			8254			9254	H7093	H7079	N8093	N8079	B8593	B8579	M9593	M9579	8

		Included	7254			8254			9254	H7092	H7079	N8092	N8079	B8592	B8579	M9592	M9579	8
		Included	7254			8254			9254	H7093	H7079	N8093	N8079	B8593	B8579	M9593	M9579	8



# FORD

LIFT	Quick Kit	KIT NOTES	Component Box	Front Springs		Rear Springs		Add-A-Leafs	Steering Correction
	Reference		(Requires 1 Of Each)	Qty	Part #	Qty	Part #		(Order 1 Each)
<b>CLASS II - ADJUSTABLE 4-LINKS</b>									
<b>05-07 F-350 Super Duty (Gas Engine) 4WD Kit Class II Gas Engines with Blocks &amp; Add-A-Leafs</b>									
8.5"	F5802K3	G31, G32, G38	F5852AH + F58484LU	1	F565V			R300	FA450
KIT NOTES: G31. Lift is Designed to Level Models with Factory 1 7/8" Rear Blocks. Models with Optional Factory 3 7/8" Rear Blocks will have a Higher Rake Angle in the Rear. G32. Lift Heights will Vary Depending on Factory Package Options. G38. Model with Rear Sway Bar must Order Extended Rear Sway Bar End Links. 8.5" Lifts Order Part # SBE406.									
<b>05-07 F-350 Super Duty (Gas Engine) 4WD System Class II Gas Engines with Rear Springs</b>									
8.5"	F5802KS3	G31, G32, G38	F5852ASH + F58484LU	1	F565V	2	FR98S		FA450
KIT NOTES: G31. Lift is Designed to Level Models with Factory 1 7/8" Rear Blocks. Models with Optional Factory 3 7/8" Rear Blocks will have a Higher Rake Angle in the Rear. G32. Lift Heights will Vary Depending on Factory Package Options. G38. Model with Rear Sway Bar must Order Extended Rear Sway Bar End Links. 8.5" Lifts Order Part # SBE406.									
<b>00-04 F-350 SUPER DUTY 4WD</b>									
<b>SOFTRIDE® LIFT SYSTEMS</b>									
<b>00-04 F-350 Super Duty 4WD Kit All Engines with Front Add-A-Leafs</b>									
2-2.5"	F93203K		TB9203					F9320	
<b>00-04 F-350 Super Duty 4WD Kit All Engines with Replacement Front Springs</b>									
1.5-2"	F9202K		F9202M	2	F920S				
<b>00-04 F-350 Super Duty 4WD Kit Gas V8 or V10 Engine with Blocks &amp; U-Bolts</b>									
4"	F9402MK	G8	F9402M	2	F940S				FA499
6"	F9602MK	G8, G25	F9602M	2	F960S				FA499
KIT NOTES: G8. Power Steering Models Only. G25. # SBE405 may be Required on Models Equipped with Factory Rear Sway Bar.									
<b>00-04 F-350 Super Duty 4WD System Gas V8 or V10 Engine with Replacement Rear Springs</b>									
4"	F9402MKS	G8	F9402MS	2	F940S	2	FR94S		FA499
6"	F9602MKS	G8, G25	F9602MS	2	F960S	2	FR96S		FA499
8"	F9802MKS-A	G8	F9802MS	2	F965S	2	FR98S		Included
KIT NOTES: G8. Power Steering Models Only. G25. # SBE405 may be Required on Models Equipped with Factory Rear Sway Bar.									
<b>00-04 F-350 Super Duty 4WD Kit Diesel Engine with Blocks &amp; U-Bolts</b>									
4"	F9452MK	G8	F9402M	2	F945S				FA499
6"	F9652MK	G8, G25	F9602M	2	F965S				FA499
KIT NOTES: G8. Power Steering Models Only. G25. # SBE405 may be Required on Models Equipped with Factory Rear Sway Bar.									
<b>00-04 F-350 Super Duty 4WD System Diesel Engine with Replacement Rear Springs</b>									
4"	F9452MKS	G8	F9402MS	2	F945S	2	FR94S		FA499
6"	F9652MKS	G8, G25	F9602MS	2	F965S	2	FR96S		FA499
8"	F9852MKS-A	G8	F9802MS	2	F985S	2	FR98S		Included
KIT NOTES: G8. Power Steering Models Only. G25. # SBE405 may be Required on Models Equipped with Factory Rear Sway Bar.									
<b>03/99-99 F-350 SUPER DUTY 4WD (BUILT AFTER MARCH '99 - WITH SQUARE FRONT U-BOLTS)</b>									
<b>SOFTRIDE® LIFT SYSTEMS</b>									
<b>03/99-99 F-350 Super Duty 4WD Kit All Engines with Front Add-A-Leafs</b>									
2-2.5"	F93203K		TB9203					F9320	
<b>03/99-99 F-350 Super Duty 4WD Kit All Engines with Replacement Front Springs</b>									
1.5-2"	F9203K		F9203M	2	F920S				
<b>03/99-99 F-350 Super Duty 4WD Kit Gas V8 or V10 Engine with Blocks &amp; U-Bolts</b>									
4"	F9403MK	G8	F9403M	2	F940S				FA499
6"	F9603MK	G8, G25	F9603M	2	F960S				FA499
KIT NOTES: G8. Power Steering Models Only. G25. # SBE405 may be Required on Models Equipped with Factory Rear Sway Bar.									
<b>03/99-99 F-350 Super Duty 4WD System Gas V8 or V10 Engine with Replacement Rear Springs</b>									
4"	F9403MKS	G8	F9403MS	2	F940S	2	FR94S		FA499
6"	F9603MKS	G8, G25	F9603MS	2	F960S	2	FR96S		FA499
8"	F9803MKS-A	G8	F9803MS	2	F965S	2	FR98S		Included
KIT NOTES: G8. Power Steering Models Only. G25. # SBE405 may be Required on Models Equipped with Factory Rear Sway Bar.									
<b>03/99-99 F-350 Super Duty 4WD Kit Diesel Engine with Blocks &amp; U-Bolts</b>									
4"	F9453MK	G8	F9403M	2	F945S				FA499
6"	F9653MK	G8, G25	F9603M	2	F965S				FA499
KIT NOTES: G8. Power Steering Models Only. G25. # SBE405 may be Required on Models Equipped with Factory Rear Sway Bar.									
<b>3/99-99 F-350 Super Duty 4WD System Diesel Engine with Replacement Rear Springs</b>									
4"	F9453MKS	G8	F9403MS	2	F945S	2	FR94S		FA499
6"	F9653MKS	G8, G25	F9603MS	2	F965S	2	FR96S		FA499
8"	F9853MKS-A	G8	F9803MS	2	F985S	2	FR98S		Included
KIT NOTES: G8. Power Steering Models Only. G25. # SBE405 may be Required on Models Equipped with Factory Rear Sway Bar.									

FORD

	Steering Stabilizers									HYDRO Shocks		NITRO Shocks		BLACK MAX		M95 Shocks		Labor
	White			Black			Silver			White		White		Black		Silver		Hours
	OEM	Single	Dual	OEM	Single	Dual	OEM	Single	Dual	Front	Rear	Front	Rear	Front	Rear	Front	Rear	

			7254			8254			9254	H7094	H7099	N8094	N8099	B8594	B8599	M9594	M9599	12
--	--	--	------	--	--	------	--	--	------	-------	-------	-------	-------	-------	-------	-------	-------	----

			7254			8254			9254	H7094	H7099	N8094	N8099	B8594	B8599	M9594	M9599	12
--	--	--	------	--	--	------	--	--	------	-------	-------	-------	-------	-------	-------	-------	-------	----

**NOTE: ALL SHOCKS MUST BE ORDERED SEPARATELY.**

	7099	7199	7299	8099	8199	8299	9099	9199	9299	H7023	H7060	N8023	N8060	B8523	B8560	M9523	M9560	4
--	------	------	------	------	------	------	------	------	------	-------	-------	-------	-------	-------	-------	-------	-------	---

	7099	7199	7299	8099	8199	8299	9099	9199	9299	H7023	H7060	N8023	N8060	B8523	B8560	M9523	M9560	4
--	------	------	------	------	------	------	------	------	------	-------	-------	-------	-------	-------	-------	-------	-------	---

	7099	7199	7299	8099	8199	8299	9099	9199	9299	H7041	H7079	N8041	N8079	B8541	B8579	M9541	M9579	8
	7099	7199	7299	8099	8199	8299	9099	9199	9299	H7060	H7099	N8060	N8099	B8560	B8599	M9560	M9599	8

	7099	7199	7299	8099	8199	8299	9099	9199	9299	H7041	H7079	N8041	N8079	B8541	B8579	M9541	M9579	8
	7099	7199	7299	8099	8199	8299	9099	9199	9299	H7060	H7099	N8060	N8099	B8560	B8599	M9560	M9599	8
	7099	7199	7299	8099	8199	8299	9099	9199	9299	H7060	H7099	N8060	N8099	B8560	B8599	M9560	M9599	8

	7099	7199	7299	8099	8199	8299	9099	9199	9299	H7041	H7079	N8041	N8079	B8541	B8579	M9541	M9579	8
	7099	7199	7299	8099	8199	8299	9099	9199	9299	H7060	H7099	N8060	N8099	B8560	B8599	M9560	M9599	8

	7099	7199	7299	8099	8199	8299	9099	9199	9299	H7041	H7079	N8041	N8079	B8541	B8579	M9541	M9579	8
	7099	7199	7299	8099	8199	8299	9099	9199	9299	H7060	H7099	N8060	N8099	B8560	B8599	M9560	M9599	8
	7099	7199	7299	8099	8199	8299	9099	9199	9299	H7060	H7099	N8060	N8099	B8560	B8599	M9560	M9599	8

**NOTE: ALL SHOCKS MUST BE ORDERED SEPARATELY.**

	7099	7199	7299	8099	8199	8299	9099	9199	9299	H7023	H7060	N8023	N8060	B8523	B8560	M9523	M9560	4
--	------	------	------	------	------	------	------	------	------	-------	-------	-------	-------	-------	-------	-------	-------	---

	7099	7199	7299	8099	8199	8299	9099	9199	9299	H7023	H7060	N8023	N8060	B8523	B8560	M9523	M9560	4
--	------	------	------	------	------	------	------	------	------	-------	-------	-------	-------	-------	-------	-------	-------	---

	7099	7199	7299	8099	8199	8299	9099	9199	9299	H7041	H7079	N8041	N8079	B8541	B8579	M9541	M9579	8
	7099	7199	7299	8099	8199	8299	9099	9199	9299	H7060	H7099	N8060	N8099	B8560	B8599	M9560	M9599	8

	7099	7199	7299	8099	8199	8299	9099	9199	9299	H7041	H7079	N8041	N8079	B8541	B8579	M9541	M9579	8
	7099	7199	7299	8099	8199	8299	9099	9199	9299	H7060	H7099	N8060	N8099	B8560	B8599	M9560	M9599	8
	7099	7199	7299	8099	8199	8299	9099	9199	9299	H7060	H7099	N8060	N8099	B8560	B8599	M9560	M9599	8

	7099	7199	7299	8099	8199	8299	9099	9199	9299	H7041	H7079	N8041	N8079	B8541	B8579	M9541	M9579	8
	7099	7199	7299	8099	8199	8299	9099	9199	9299	H7060	H7099	N8060	N8099	B8560	B8599	M9560	M9599	8

	7099	7199	7299	8099	8199	8299	9099	9199	9299	H7041	H7079	N8041	N8079	B8541	B8579	M9541	M9579	8
	7099	7199	7299	8099	8199	8299	9099	9199	9299	H7060	H7099	N8060	N8099	B8560	B8599	M9560	M9599	8
	7099	7199	7299	8099	8199	8299	9099	9199	9299	H7060	H7099	N8060	N8099	B8560	B8599	M9560	M9599	8



# FORD

LIFT	Quick Kit		KIT NOTES	Component Box		Front Springs		Rear Springs		Add-A-Leafs	Steering Correction (Order 1 Each)
	Reference			(Requires 1 Of Each)		Qty	Part #	Qty	Part #		
<b>99-2/99 F-350 SUPER DUTY 4WD (BUILT BEFORE MARCH '99)</b>											
<b>99-2/99 F-350 Super Duty 4WD Kit</b>			<b>All Engines with Front Add-A-Leafs</b>								
2-2.5"	F9320K			TB920						F9320	
<b>99-2/99 F-350 Super Duty 4WD Kit</b>			<b>Gas V8 or V10 Engine with Blocks &amp; U-Bolts</b>								
4"	F940MK	G8		F940M	2	F940S					FA400
6"	F960MK	G8, G25		F960M	2	F960S					FA400
KIT NOTES: G8. Power Steering Models Only. G25. # SBE405 may be Required on Models Equipped with Factory Rear Sway Bar.											
<b>99-2/99 F-350 Super Duty 4WD System</b>			<b>Gas V8 or V10 Engine with Replacement Rear Springs</b>								
4"	F940MKS	G8, G10		F940MS	2	F940S	2	FR96S			FA400
6"	F960MKS	G8, G25		F960MS	2	F960S	2	FR94S			FA400
8"	F980MKS-A	G8		F980MS	2	F965S	2	FR96S			Included
KIT NOTES: G8. Power Steering Models Only. G25. # SBE405 may be Required on Models Equipped with Factory Rear Sway Bar. G10. The Factory Block is Removed.											
<b>99-2/99 F-350 Super Duty 4WD Kit</b>			<b>Diesel Engine with Blocks &amp; U-Bolts</b>								
4"	F945MK	G8		F940M	2	F945S					FA400
6"	F965MK	G8, G25		F960M	2	F965S					FA400
KIT NOTES: G8. Power Steering Models Only. G25. # SBE405 may be Required on Models Equipped with Factory Rear Sway Bar.											
<b>99-2/99 F-350 Super Duty 4WD System</b>			<b>Diesel Engine with Replacement Rear Springs</b>								
4"	F945MKS	G8, G10		F940MS	2	F945S	2	FR96S			FA400
6"	F965MKS	G8, G25		F960MS	2	F965S	2	FR94S			FA400
8"	F985MKS-A	G8		F980MS	2	F985S	2	FR96S			Included
KIT NOTES: G8. Power Steering Models Only. G25. # SBE405 may be Required on Models Equipped with Factory Rear Sway Bar. G10. The Factory Block is Removed.											
<b>86-98 F-350 STRAIGHT AXLE / MONO-BEAM 4WD</b>											
<b>86-98 F-350 4WD (Mono-Beam) Kit</b>			<b>All Except Crew Cabs with Front Add-A-Leafs</b>								
1.5-2"	F35G									F35G	
<b>86-98 F-350 4WD (Mono-Beam) Kit</b>			<b>Crew Cabs with Front Add-A-Leafs</b>								
2-2.5"	F3546K			UFF						F35G +F46D	
<b>86-98 F-350 4WD (Mono-Beam) Kit</b>			<b>With Blocks &amp; U-Bolts</b>								
3-4"	F840MK	G8, G18, G22, G23		F840M	2	F840S					FA400
5-6"	F860MK	G8, G18, G22, G23		F860M	2	F860S					FA400
KIT NOTES: G8. Power Steering Models Only. G18. See Brake Lines Section. G22. May Require End Links on Models Equipped with Factory Sway Bars. See Ford Accessories. G23. Vehicles with Diesel Engine will Require Front Fitted Leaf. Vehicles with Extra Weight may Require Fitted Leaf. See Leaf Springs Section.											
<b>86-98 F-350 4WD (Mono-Beam) Kit</b>			<b>For Rear Towing Package with Blocks &amp; U-Bolts</b>								
3-4"	F840MK3	G8, G18, G22, G23		F840MH	2	F840S					FA400
5-6"	F860MK3	G8, G18, G22, G23		F860MH	2	F860S					FA400
KIT NOTES: G8. Power Steering Models Only. G18. See Brake Lines Section. G22. May Require End Links on Models Equipped with Factory Sway Bars. See Ford Accessories. G23. Vehicles with Diesel Engine will Require Front Fitted Leaf. Vehicles with Extra Weight may Require Fitted Leaf. See Leaf Springs Section.											
<b>86-98 F-350 4WD (Mono-Beam) System</b>			<b>With Replacement Rear Springs</b>								
3-4"	F840MKS	G8, G18, G22, G23		F840MS	2	F840S	2	FR54S			FA400
5-6"	F860MKS	G8, G18, G22, G23		F860MS	2	F860S	2	FR56S			FA400
KIT NOTES: G8. Power Steering Models Only. G18. See Brake Lines Section. G22. May Require End Links on Models Equipped with Factory Sway Bars. See Ford Accessories. G23. Vehicles with Diesel Engine will Require Front Fitted Leaf. Vehicles with Extra Weight may Require Fitted Leaf. See Leaf Springs Section.											
<b>80-85 F-350 INDEPENDENT FRONT SUSPENSION 4WD (IFS)</b>											
<b>80-85 F-350 (IFS) 4WD Kit</b>			<b>302 or 351 Engine with Front Add-A-Leafs</b>								
1.5-2"	F35G	G1								F35G	
KIT NOTES: G1. Oversized Camber / Caster Shims are Required (See Ford Accessories Section).											
<b>80-85 F-350 (IFS) 4WD Kit</b>			<b>460 or Diesel Engine with Front Add-A-Leafs</b>								
1.5-2"	F46D	G1								F46D	
KIT NOTES: G1. Oversized Camber / Caster Shims are Required (See Ford Accessories Section).											
<b>80-85 F-350 (IFS) 4WD Kit</b>			<b>Standard Brackets with Blocks &amp; U-Bolts</b>								
4"	F840TK	G8, G18, G22, G23		F840T	2	F840S					FA400
6"	F860TK	G8, G18, G22, G23		F860T	2	F860S					FA400
KIT NOTES: G8. Power Steering Models Only. G18. See Brake Lines Section. G22. May Require End Links on Models Equipped with Factory Sway Bars. See Ford Accessories. G23. Vehicles with Diesel Engine will Require Front Fitted Leaf. Vehicles with Extra Weight may Require Fitted Leaf. See Leaf Springs Section.											
<b>80-85 F-350 (IFS) 4WD Kit</b>			<b>For Rear Towing Package with Blocks &amp; U-Bolts</b>								
4"	F840TK3	G8, G18, G22, G23		F840TH	2	F840S					FA400
6"	F860TK3	G8, G18, G22, G23		F860TH	2	F860S					FA400
KIT NOTES: G8. Power Steering Models Only. G18. See Brake Lines Section. G22. May Require End Links on Models Equipped with Factory Sway Bars. See Ford Accessories. G23. Vehicles with Diesel Engine will Require Front Fitted Leaf. Vehicles with Extra Weight may Require Fitted Leaf. See Leaf Springs Section.											

FORD



	Steering Stabilizers									HYDRO Shocks		NITRO Shocks		BLACK MAX		M95 Shocks		Labor
	White			Black			Silver			White		White		Black		Silver		Hours
	OEM	Single	Dual	OEM	Single	Dual	OEM	Single	Dual	Front	Rear	Front	Rear	Front	Rear	Front	Rear	

**NOTE: ALL SHOCKS MUST BE ORDERED SEPARATELY.**

	7099	7199	7299	8099	8199	8299	9099	9199	9299	H7023	H7060	N8023	N8060	B8523	B8560	M9523	M9560	4
--	------	------	------	------	------	------	------	------	------	-------	-------	-------	-------	-------	-------	-------	-------	---

	7099	7199	7299	8099	8199	8299	9099	9199	9299	H7041	H7079	N8041	N8079	B8541	B8579	M9541	M9579	8
	7099	7199	7299	8099	8199	8299	9099	9199	9299	H7060	H7099	N8060	N8099	B8560	B8599	M9560	M9599	8

	7099	7199	7299	8099	8199	8299	9099	9199	9299	H7041	H7079	N8041	N8079	B8541	B8579	M9541	M9579	8
	7099	7199	7299	8099	8199	8299	9099	9199	9299	H7060	H7099	N8060	N8099	B8560	B8599	M9560	M9599	8
	7099	7199	7299	8099	8199	8299	9099	9199	9299	H7060	H7099	N8060	N8099	B8560	B8599	M9560	M9599	8

	7099	7199	7299	8099	8199	8299	9099	9199	9299	H7041	H7079	N8041	N8079	B8541	B8579	M9541	M9579	8
	7099	7199	7299	8099	8199	8299	9099	9199	9299	H7060	H7099	N8060	N8099	B8560	B8599	M9560	M9599	8

	7099	7199	7299	8099	8199	8299	9099	9199	9299	H7041	H7079	N8041	N8079	B8541	B8579	M9541	M9579	8
	7099	7199	7299	8099	8199	8299	9099	9199	9299	H7060	H7099	N8060	N8099	B8560	B8599	M9560	M9599	8
	7099	7199	7299	8099	8199	8299	9099	9199	9299	H7060	H7099	N8060	N8099	B8560	B8599	M9560	M9599	8

**NOTE: ALL SHOCKS MUST BE ORDERED SEPARATELY.**

		7110	7240		8110	8240		9110	9240	H7023	H7060	N8023	N8060	B8523	B8560	M9523	M9560	4
--	--	------	------	--	------	------	--	------	------	-------	-------	-------	-------	-------	-------	-------	-------	---

		7110	7240		8110	8240		9110	9240	H7023	H7060	N8023	N8060	B8523	B8560	M9523	M9560	4
--	--	------	------	--	------	------	--	------	------	-------	-------	-------	-------	-------	-------	-------	-------	---

		7110	7240		8110	8240		9110	9240	H7041	H7079	N8041	N8079	B8541	B8579	M9541	M9579	6
		7110	7240		8110	8240		9110	9240	H7060	H7079	N8060	N8079	B8560	B8579	M9560	M9579	8

		7110	7240		8110	8240		9110	9240	H7041	H7079	N8041	N8079	B8541	B8579	M9541	M9579	6
		7110	7240		8110	8240		9110	9240	H7060	H7079	N8060	N8079	B8560	B8579	M9560	M9579	8

		7110	7240		8110	8240		9110	9240	H7041	H7079	N8041	N8079	B8541	B8579	M9541	M9579	6
		7110	7240		8110	8240		9110	9240	H7060	H7079	N8060	N8079	B8560	B8579	M9560	M9579	8

**NOTE: ALL SHOCKS MUST BE ORDERED SEPARATELY.**

		7140	7240		8110	8240		9110	9240	H7054	H7058	N8054	N8058	B8554	B8558	M9554	M9558	4
--	--	------	------	--	------	------	--	------	------	-------	-------	-------	-------	-------	-------	-------	-------	---

		7140	7240		8140	8240		9140	9240	H7054	H7058	N8054	N8058	B8554	B8558	M9554	M9558	4
--	--	------	------	--	------	------	--	------	------	-------	-------	-------	-------	-------	-------	-------	-------	---

		7140	7240		8140	8240		9140	9240	H7055	H7060	N8055	N8060	B8555	B8560	M9555	M9560	6
		7140	7240		8140	8240		9140	9240	H7056	H7060	N8056	N8060	B8556	B8560	M9556	M9560	8

		7140	7240		8140	8240		9140	9240	H7055	H7060	N8055	N8060	B8555	B8560	M9555	M9560	6
		7140	7240		8140	8240		9140	9240	H7056	H7060	N8056	N8060	B8556	B8560	M9556	M9560	8



# FORD

LIFT	Quick Kit	KIT NOTES	Component Box	Front Springs		Rear Springs		Add-A-Leafs	Steering Correction
	Reference		(Requires 1 Of Each)	Qty	Part #	Qty	Part #		(Order 1 Each)
<b>80-85 F-350 (IFS) 4WD System</b>			<b>Standard Brackets with Replacement Rear Springs</b>						
4"	F840TKS	G8, G18, G22, G23	F840TS	2	F840S	2	FR54S		FA400
6"	F860TKS	G8, G18, G22, G23	F860TS	2	F860S	2	FR56S		FA400
KIT NOTES: G8. Power Steering Models Only. G18. See Brake Lines Section. G22. May Require End Links on Models Equipped with Factory Sway Bars. See Ford Accessories. G23. Vehicles with Diesel Engine will Require Front Fitted Leaf. Vehicles with Extra Weight may Require Fitted Leaf. See Leaf Springs Section.									
<b>80-97 F-350 2WD WITH DIESEL OR 460 ENGINES</b>			<b>With Blocks &amp; U-Bolts &amp;/or Add-A-Leafs</b>						
<b>80-97 F-350 2WD Kit</b>			<b>With Blocks &amp; U-Bolts &amp;/or Add-A-Leafs</b>						
3"	184F2K	G8, G18	184F2	1	184				FA400
5"	186F2K	G8, G18	186F2	1	186				FA400
3"	184F2KS	G8, G18	184F2S	1	184	2	FR54S		FA400
5"	186F2KS	G8, G18	186F2S	1	186	2	FR56S		FA400
KIT NOTES: G8. Power Steering Models Only. G18. See Brake Lines Section.									
<b>79 F-350 LOW BOY 4WD</b>			<b>Front Add-A-Leafs</b>						
1.5-2"	F46D							F46D	--- ---
<b>83-97 RANGER 4WD</b>			<b>6-Cylinder Engine with Add-A-Leafs</b>						
<b>90-97 Ranger XLT 4WD Kit</b>			<b>6-Cylinder Engine with Add-A-Leafs</b>						
1.5-2"	132XK	G1		1	132X			R3135	
KIT NOTES: G1. Oversized Camber / Caster Shims are Required (See Ford Accessories Section).									
<b>90-97 Ranger XLT 4WD System</b>			<b>6-Cylinder Engine with Replacement Rear Springs</b>						
1.5-2"	132XKS	G1, G10, G27	132XRS	1	132X	2	FR34S		
KIT NOTES: G1. Oversized Camber / Caster Shims are Required (See Ford Accessories Section). G10. The Factory Block is Removed. G27. May Require (2) # HS25 for Alignment & Leveling Aid with 4.0 Liter Engine. May Require End Links.									
<b>90-97 Ranger 4WD Kit</b>			<b>4-Cylinder Engine with Add-A-Leafs</b>						
1.5-2"	132K	G1		1	132			R3135	
KIT NOTES: G1. Oversized Camber / Caster Shims are Required (See Ford Accessories Section).									
<b>87-89 Ranger STX 4WD Kit</b>			<b>With Add-A-Leafs</b>						
1.5-2"	132XK	G1		1	132X			R3135	
KIT NOTES: G1. Oversized Camber / Caster Shims are Required (See Ford Accessories Section).									
<b>87-89 Ranger STX 4WD System</b>			<b>With Replacement Rear Springs</b>						
1.5-2"	132XKS	G1, G10	132XRS	1	132X	2	FR34S		
KIT NOTES: G1. Oversized Camber / Caster Shims are Required (See Ford Accessories Section). G10. The Factory Block is Removed.									
<b>83-89 Ranger 4WD Kit</b>			<b>All (Except Supercab with 2.9 Liter) with Add-A-Leafs</b>						
1.5-2"	132K	G1		1	132			R3135	
KIT NOTES: G1. Oversized Camber / Caster Shims are Required (See Ford Accessories Section).									
<b>83-89 Ranger 4WD System</b>			<b>All (Except Supercab with 2.9 Liter) with Replacement Rear Springs</b>						
1.5-2"	132KS	G1, G10	132RS	1	132	2	FR34S		
KIT NOTES: G1. Oversized Camber / Caster Shims are Required (See Ford Accessories Section). G10. The Factory Block is Removed.									
<b>83-89 Ranger Supercab 4WD Kit</b>			<b>2.9L with Add-A-Leafs</b>						
1.5-2"	132XK	G1		1	132X			R3135	
KIT NOTES: G1. Oversized Camber / Caster Shims are Required (See Ford Accessories Section).									
<b>83-89 Ranger Supercab 4WD System</b>			<b>2.9 Liter with Replacement Rear Springs</b>						
1.5-2"	132XKS	G1, G10	132XRS	1	132X	2	FR34S		
KIT NOTES: G1. Oversized Camber / Caster Shims are Required (See Ford Accessories Section). G10. The Factory Block is Removed.									
<b>83-97 Ranger 4WD Kit</b>			<b>Heavy-Duty Brackets with Blocks &amp; U-Bolts &amp;/or Add-A-Leafs</b>						
4"	134RHK	G8, G18, G27	134RH	1	134				FA400
6"	136RHK	G8, G18, G27	136RH	1	136				FA400
KIT NOTES: G8. Power Steering Models Only. G18. See Brake Lines Section. G27. May Require (2) # HS25 for Alignment & Leveling Aid. May Require End Links.									
<b>83-97 Ranger 4WD System</b>			<b>Heavy-Duty Brackets with Replacement Rear Springs</b>						
4"	134RHKS	G8, G10, G18, G27	134RHS	1	134	2	FR34S		FA400
6"	136RHKS	G8, G18, G27	136RHS	1	136	2	FR34S		FA400
KIT NOTES: G8. Power Steering Models Only. G10. The Factory Block is Removed. G18. See Brake Lines Section. G27. May Require (2) # HS25 for Alignment & Leveling Aid with 4.0 Liter Engine. May Require End Links.									
<b>83-97 Ranger 4WD Kit</b>			<b>Class II Brackets &amp; Radius Arms with Blocks &amp; U-Bolts</b>						
4"	234RHK-A	G8, G18, G27	234RH+RA135	1	134				Included
6"	236RHK-A	G8, G18, G27	236RH+RA135	1	136				Included
KIT NOTES: G8. Power Steering Models Only. G18. See Brake Lines Section. G27. May Require (2) # HS25 for Alignment & Leveling Aid with 4.0 Liter Engine.									

FORD

	Steering Stabilizers									HYDRO Shocks		NITRO Shocks		BLACK MAX		M95 Shocks		Labor
	White			Black			Silver			White		White		Black		Silver		Hours
	OEM	Single	Dual	OEM	Single	Dual	OEM	Single	Dual	Front	Rear	Front	Rear	Front	Rear	Front	Rear	

		7140	7240		8140	8240		9140	9240	H7055	H7060	N8055	N8060	B8555	B8560	M9555	M9560	6
		7140	7240		8140	8240		9140	9240	H7056	H7060	N8056	N8060	B8556	B8560	M9556	M9560	8

**NOTE: ALL SHOCKS MUST BE ORDERED SEPARATELY.**

		7140	7240		8140	8240		9140	9240	H7054	H7058	N8054	N8058	B8554	B8558	M9554	M9558	6
		7140	7240		8140	8240		9140	9240	H7055	H7041	N8055	N8041	B8555	B8541	M9555	M9541	6
		7140	7240		8140	8240		9140	9240	H7054	H7058	N8054	N8058	B8554	B8558	M9554	M9558	6
		7140	7240		8140	8240		9140	9240	H7055	H7041	N8055	N8041	B8555	B8541	M9555	M9541	6

**NOTE: ALL SHOCKS MUST BE ORDERED SEPARATELY.**

		7110	7220		8110	8220		9110	9220	---	---	H7056	---	---	N8056	---	---	B8556	---	---	M9556	3
--	--	------	------	--	------	------	--	------	------	-----	-----	-------	-----	-----	-------	-----	-----	-------	-----	-----	-------	---

**NOTE: ALL SHOCKS MUST BE ORDERED SEPARATELY.**

		7150	7250		8150	8250		9150	9250	H7052	H7060	N8052	N8060	B8552	B8560	M9552	M9560	4
--	--	------	------	--	------	------	--	------	------	-------	-------	-------	-------	-------	-------	-------	-------	---

		7150	7250		8150	8250		9150	9250	H7052	H7060	N8052	N8060	B8552	B8560	M9552	M9560	4
--	--	------	------	--	------	------	--	------	------	-------	-------	-------	-------	-------	-------	-------	-------	---

		7150	7250		8150	8250		9150	9250	H7052	H7060	N8052	N8060	B8552	B8560	M9552	M9560	4
--	--	------	------	--	------	------	--	------	------	-------	-------	-------	-------	-------	-------	-------	-------	---

		7150	7250		8150	8250		9150	9250	H7052	H7060	N8052	N8060	B8552	B8560	M9552	M9560	4
--	--	------	------	--	------	------	--	------	------	-------	-------	-------	-------	-------	-------	-------	-------	---

		7150	7250		8150	8250		9150	9250	H7052	H7060	N8052	N8060	B8552	B8560	M9552	M9560	4
--	--	------	------	--	------	------	--	------	------	-------	-------	-------	-------	-------	-------	-------	-------	---

		7150	7250		8150	8250		9150	9250	H7052	H7060	N8052	N8060	B8552	B8560	M9552	M9560	4
--	--	------	------	--	------	------	--	------	------	-------	-------	-------	-------	-------	-------	-------	-------	---

		7150	7250		8150	8250		9150	9250	H7052	H7060	N8052	N8060	B8552	B8560	M9552	M9560	4
--	--	------	------	--	------	------	--	------	------	-------	-------	-------	-------	-------	-------	-------	-------	---

		7150	7250		8150	8250		9150	9250	H7052	H7060	N8052	N8060	B8552	B8560	M9552	M9560	4
--	--	------	------	--	------	------	--	------	------	-------	-------	-------	-------	-------	-------	-------	-------	---

		7150	7250		8150	8250		9150	9250	H7052	H7060	N8052	N8060	B8552	B8560	M9552	M9560	4
--	--	------	------	--	------	------	--	------	------	-------	-------	-------	-------	-------	-------	-------	-------	---

		7150	7250		8150	8250		9150	9250	H7054	H7060	N8054	N8060	B8554	B8560	M9554	M9560	6
--	--	------	------	--	------	------	--	------	------	-------	-------	-------	-------	-------	-------	-------	-------	---

		7150	7250		8150	8250		9150	9250	H7055	H7060	N8055	N8060	B8555	B8560	M9555	M9560	6
--	--	------	------	--	------	------	--	------	------	-------	-------	-------	-------	-------	-------	-------	-------	---

		7150	7250		8150	8250		9150	9250	H7054	H7060	N8054	N8060	B8554	B8560	M9554	M9560	6
--	--	------	------	--	------	------	--	------	------	-------	-------	-------	-------	-------	-------	-------	-------	---

		7150	7250		8150	8250		9150	9250	H7055	H7060	N8055	N8060	B8555	B8560	M9555	M9560	6
--	--	------	------	--	------	------	--	------	------	-------	-------	-------	-------	-------	-------	-------	-------	---

		7150	7250		8150	8250		9150	9250	H7054	H7060	N8054	N8060	B8554	B8560	M9554	M9560	7
--	--	------	------	--	------	------	--	------	------	-------	-------	-------	-------	-------	-------	-------	-------	---

		7150	7250		8150	8250		9150	9250	H7055	H7060	N8055	N8060	B8555	B8560	M9555	M9560	7
--	--	------	------	--	------	------	--	------	------	-------	-------	-------	-------	-------	-------	-------	-------	---



# FORD

LIFT	Quick Kit	KIT NOTES	Component Box	Front Springs		Rear Springs		Add-A-Leafs	Steering Correction
	Reference		(Requires 1 Of Each)	Qty	Part #	Qty	Part #		(Order 1 Each)
<b>83-97 Ranger 4WD System</b>			<b>Class II Brackets &amp; Radius Arms with Replacement Rear Springs</b>						
4"	234RHKS-A	G8, G10, G18, G27	234RHS+RA135	1	134	2	FR34S		Included
6"	236RHKS-A	G8, G18, G27	236RHS+RA135	1	136	2	FR34S		Included
KIT NOTES: G8. Power Steering Models Only. G10. The Factory Block is Removed. G18. See Brake Lines Section. G27. May Require (2) # HS25 for Alignment & Leveling Aid with 4.0 Liter Engine.									
<b>83-97 RANGER 2WD</b>			<b>2.3, 2.9 &amp; 3.0 Liter Engines with Add-A-Leafs</b>						
1.5-2"	132K	G1		1	132			R3135	
KIT NOTES: G1. Oversized Camber / Caster Shims are Required (See Ford Accessories Section).									
<b>90-97 Ranger 2WD Kit</b>			<b>4.0 Liter Engines with Add-A-Leafs</b>						
1.5-2"	132XK	G1		1	132X			R3135	
KIT NOTES: G1. Oversized Camber / Caster Shims are Required (See Ford Accessories Section).									
<b>83-89 Ranger 2WD Kit</b>			<b>All (Except Supercab with 2.9 Liter) with Add-A-Leafs</b>						
1.5-2"	132K	G1		1	132			R3135	
KIT NOTES: G1. Oversized Camber / Caster Shims are Required (See Ford Accessories Section).									
<b>83-89 Ranger Supercab 2WD Kit</b>			<b>2.9 Liter with Add-A-Leafs</b>						
1.5-2"	132XK	G1		1	132X			R3135	
KIT NOTES: G1. Oversized Camber / Caster Shims are Required (See Ford Accessories Section).									
<b>83-97 Ranger 2WD Kit</b>			<b>With Blocks &amp; U-Bolts</b>						
6"	136R2K	G8, G18, G27	136R2	1	136				FA400
KIT NOTES: G8. Power Steering Models Only. G18. See Brake Lines Section. G27. May Require (2) # HS25 for Alignment & Leveling Aid with 4.0 Liter Engine. May Require End Links.									
<b>83-97 Ranger 2WD Kit</b>			<b>Class II Brackets &amp; Radius Arms with Blocks &amp; U-Bolts</b>						
6"	236R2K-A	G8, G18, G27	236R2+RA235	1	136				Included
KIT NOTES: G8. Power Steering Models Only. G18. See Brake Lines Section. G27. May Require (2) # HS25 for Alignment & Leveling Aid with 4.0 Liter Engine.									
<b>83-97 Ranger 2WD System</b>			<b>Class II Brackets &amp; Radius Arms with Replacement Rear Springs</b>						
6"	236R2KS-A	G8, G18, G27	236R2S+RA235	1	136	2	FR34S		Included
KIT NOTES: G8. Power Steering Models Only. G18. See Brake Lines Section. G27. May Require (2) # HS25 for Alignment & Leveling Aid with 4.0 Liter Engine.									
<b>84-90 BRONCO II 4WD</b>			<b>Heavy-Duty Brackets Blocks &amp; U-Bolts &amp;/or Add-A-Leafs</b>						
1.5-2"	132K	G1, G2		1	132			R3135	
4"	134BHK	G2, G8, G18, G27	134BH	1	134				FA400
6"	136BHK	G2, G8, G18, G27	136BH	1	136				FA400
KIT NOTES: G1. Oversized Camber / Caster Shims are Required (See Ford Accessories Section). G2. On 85-90 Bronco II's Equipped with a 'Tulip-Type' Rear Drive Shaft, the Drive Shaft must be Changed when Lifted 2" or More. G8. Power Steering Models Only. G18. See Brake Lines Section. G27. May Require (2) # HS25 for Alignment & Leveling Aid with 4.0 Liter Engine. May Require End Links.									
<b>84-90 Bronco II 4WD System</b>			<b>Heavy-Duty Brackets with Replacement Rear Springs</b>						
6"	136BHKS	G2, G8, G18, G27	136BHS	1	136	2	FR36S		FA400
KIT NOTES: G2. On 85-90 Bronco II's Equipped with a 'Tulip-Type' Rear Drive Shaft, the Drive Shaft must be Changed when Lifted 2" or More. G8. Power Steering Models Only. G9. This Lift also Includes 2" Blocks. G18. See Brake Lines Section. G27. May Require (2) # HS25 for Alignment & Leveling Aid with 4.0 Liter Engine. May Require End Links.									
<b>84-90 Bronco II 4WD Kit</b>			<b>Class II Brackets &amp; Radius Arms with Blocks &amp; U-Bolts</b>						
6"	236BHK-A	G2, G8, G18, G27	236BH+RA135	1	136				Included
KIT NOTES: G2. On 85-90 Bronco II's Equipped with a 'Tulip-Type' Rear Drive Shaft, the Drive Shaft must be Changed when Lifted 2" or More. G8. Power Steering Models Only. G18. See Brake Lines Section. G27. May Require (2) # HS25 for Alignment & Leveling Aid with 4.0 Liter Engine.									
<b>84-90 Bronco II 4WD System</b>			<b>Class II Brackets &amp; Radius Arms with Replacement Rear Springs</b>						
4"	234BHKS-A	G2, G8, G18, G27	234BHS+RA135	1	134	2	FR34S		Included
6"	236BHKS-A	G2, G8, G18, G27	236BHS+RA135	1	136	2	FR36S		Included
KIT NOTES: G2. On 85-90 Bronco II's Equipped with a 'Tulip-Type' Rear Drive Shaft, the Drive Shaft must be Changed when Lifted 2" or More. G8. Power Steering Models Only. G18. See Brake Lines Section. G27. May Require (2) # HS25 for Alignment & Leveling Aid with 4.0 Liter Engine.									
<b>90-94 EXPLORER 4WD (2 DOOR &amp; 4 DOOR)</b>			<b>With Add-A-Leafs</b>						
1.5-2"	132EXK	G1		1	132X			R225	
KIT NOTES: G1. Oversized Camber / Caster Shims are Required (See Ford Accessories Section).									

FORD

	Steering Stabilizers									HYDRO Shocks		NITRO Shocks		BLACK MAX		M95 Shocks		Labor	
	White			Black			Silver			White		White		Black		Silver			
	OEM	Single	Dual	OEM	Single	Dual	OEM	Single	Dual	Front	Rear	Front	Rear	Front	Rear	Front	Rear	Front	Rear
	7150	7250		8150	8250		9150	9250		H7054	H7060	N8054	N8060	B8554	B8560	M9554	M9560		7
	7150	7250		8150	8250		9150	9250		H7055	H7060	N8055	N8060	B8555	B8560	M9555	M9560		7

**NOTE: ALL SHOCKS MUST BE ORDERED SEPARATELY.**

	7150	7250		8150	8250		9150	9250		H7052	H7058	N8052	N8058	B8552	B8558	M9552	M9558		4
--	------	------	--	------	------	--	------	------	--	-------	-------	-------	-------	-------	-------	-------	-------	--	---

	7150	7250		8150	8250		9150	9250		H7052	H7058	N8052	N8058	B8552	B8558	M9552	M9558		4
--	------	------	--	------	------	--	------	------	--	-------	-------	-------	-------	-------	-------	-------	-------	--	---

	7150	7250		8150	8250		9150	9250		H7052	H7058	N8052	N8058	B8552	B8558	M9552	M9558		4
--	------	------	--	------	------	--	------	------	--	-------	-------	-------	-------	-------	-------	-------	-------	--	---

	7150	7250		8150	8250		9150	9250		H7052	H7058	N8052	N8058	B8552	B8558	M9552	M9558		4
--	------	------	--	------	------	--	------	------	--	-------	-------	-------	-------	-------	-------	-------	-------	--	---

	7150	7250		8150	8250		9150	9250		H7055	H7060	N8055	N8060	B8555	B8560	M9555	M9560		6
--	------	------	--	------	------	--	------	------	--	-------	-------	-------	-------	-------	-------	-------	-------	--	---

	7150	7250		8150	8250		9150	9250		H7055	H7060	N8055	N8060	B8555	B8560	M9555	M9560		7
--	------	------	--	------	------	--	------	------	--	-------	-------	-------	-------	-------	-------	-------	-------	--	---

	7150	7250		8150	8250		9150	9250		H7055	H7060	N8055	N8060	B8555	B8560	M9555	M9560		7
--	------	------	--	------	------	--	------	------	--	-------	-------	-------	-------	-------	-------	-------	-------	--	---

**NOTE: ALL SHOCKS MUST BE ORDERED SEPARATELY.**

	7150	7250		8150	8250		9150	9250		H7052	H7058	N8052	N8058	B8552	B8558	M9552	M9558		4
--	------	------	--	------	------	--	------	------	--	-------	-------	-------	-------	-------	-------	-------	-------	--	---

	7150	7250		8150	8250		9150	9250		H7054	H7058	N8054	N8058	B8554	B8558	M9554	M9558		6
--	------	------	--	------	------	--	------	------	--	-------	-------	-------	-------	-------	-------	-------	-------	--	---

	7150	7250		8150	8250		9150	9250		H7055	H7060	N8055	N8060	B8555	B8560	M9555	M9560		6
--	------	------	--	------	------	--	------	------	--	-------	-------	-------	-------	-------	-------	-------	-------	--	---

	7150	7250		8150	8250		9150	9250		H7055	H7060	N8055	N8060	B8555	B8560	M9555	M9560		6
--	------	------	--	------	------	--	------	------	--	-------	-------	-------	-------	-------	-------	-------	-------	--	---

	7150	7250		8150	8250		9150	9250		H7055	H7060	N8055	N8060	B8555	B8560	M9555	M9560		7
--	------	------	--	------	------	--	------	------	--	-------	-------	-------	-------	-------	-------	-------	-------	--	---

	7150	7250		8150	8250		9150	9250		H7054	H7058	N8054	N8058	B8554	B8558	M9554	M9558		7
--	------	------	--	------	------	--	------	------	--	-------	-------	-------	-------	-------	-------	-------	-------	--	---

	7150	7250		8150	8250		9150	9250		H7055	H7060	N8055	N8060	B8555	B8560	M9555	M9560		7
--	------	------	--	------	------	--	------	------	--	-------	-------	-------	-------	-------	-------	-------	-------	--	---

**NOTE: ALL SHOCKS MUST BE ORDERED SEPARATELY.**

	7150	7250		8150	8250		9150	9250		H7052	H7034	N8052	N8034	B8552	B8534	M9552	M9534		4
--	------	------	--	------	------	--	------	------	--	-------	-------	-------	-------	-------	-------	-------	-------	--	---



# HONDA

LIFT	Quick Kit	KIT NOTES	Component Box	Front Springs		Rear Springs		Add-A-Leafs	Steering Correction
	Reference		(Requires 1 of Each)	Qty	Part #	Qty	Part #		(Order 1 Each)
<b>06-10 HONDA RIDGELINE 4WD</b>									
<b>06-10 Honda Ridgeline 4WD Kit</b>			<b>Front &amp; Rear Metal Strut Spacers (Includes Front Swar Bar End Links)</b>						
2"	HR20MS		HR20MS						
KIT NOTES: Installs Above Strut Assembly. HR20MS Includes Sway Bar End Links.									

# INTERNATIONAL

LIFT	Quick Kit	KIT NOTES	Component Box	Front Springs		Rear Springs		Add-A-Leafs	Steering Correction
	Reference		(Requires 1 of Each)	Qty	Part #	Qty	Part #		(Order 1 Each)
<b>72-82 SCOUT 4WD</b>									
<b>72-82 Scout II, Terra, Traveler 4WD System</b>			<b>With FULL-Height Replacement Springs</b>						
2"	S20K	I3	S24	2	S20FS	2	S20RS		SA40
4"	S40K	I3	S24	2	S40FS	2	S40RS		SA40
KIT NOTES: I3. Power Steering Models Only.									

# ISUZU

LIFT	Quick Kit	KIT NOTES	Component Box	Front Springs		Rear Springs		Add-A-Leafs	Steering Correction
	Reference		(Requires 1 of Each)	Qty	Part #	Qty	Part #		(Order 1 Each)
<b>05-08 ISUZU I-SERIES 4WD (TORSION BAR)</b>									
<b>05-08 Isuzu i-Series 4WD Kit</b>			<b>Kit with Rear Add-A-Leafs</b>						
4"	CC409K	K24	CC409					RCC25	
KIT NOTES: K24. Can NOT Re-Use OEM Wheels. REQUIRES 4.75" Back Spacing on Wheels.									
<b>05-08 Isuzu i-Series 4WD System</b>			<b>Kit with Rear Springs</b>						
4"	CC409KS	K24	CC409			2	CCR25S		
KIT NOTES: K24. Can NOT Re-Use OEM Wheels. REQUIRES 4.75" Back Spacing on Wheels.									

HONDA, INTL., ISUZU

# HONDA

	Steering Stabilizers									HYDRO Shocks		NITRO Shocks		BLACK MAX		M95 Shocks		Labor
	White			Black			Silver			White		White		Black		Silver		Hours
	OEM	Single	Dual	OEM	Single	Dual	OEM	Single	Dual	Front	Rear	Front	Rear	Front	Rear	Front	Rear	
<b>NOTE: ALL SHOCKS MUST BE ORDERED SEPARATELY</b>																		
																		4

# INTERNATIONAL

	Steering Stabilizers									HYDRO Shocks		NITRO Shocks		BLACK MAX		M95 Shocks		Labor
	White			Black			Silver			White		White		Black		Silver		Hours
	OEM	Single	Dual	OEM	Single	Dual	OEM	Single	Dual	Front	Rear	Front	Rear	Front	Rear	Front	Rear	
<b>NOTE: ALL SHOCKS MUST BE ORDERED SEPARATELY</b>																		
		7110			8110			9110		H7055	H7058	N8055	N8058	B8555	B8558	M9555	M9558	6
		7110			8110			9110		H7055	H7058	N8055	N8058	B8555	B8558	M9555	M9558	6

# ISUZU

	Steering Stabilizers									HYDRO Shocks		NITRO Shocks		BLACK MAX		M95 Shocks		Labor	
	White			Black			Silver			White		White		Black		Silver		Hours	
	OEM	Single	Dual	OEM	Single	Dual	OEM	Single	Dual	Front	Rear	Front	Rear	Front	Rear	Front	Rear		
<b>NOTE: ALL SHOCKS MUST BE ORDERED SEPARATELY</b>																			
										H7040	H7084	N8040	N8084	B8540	B8584	—	—	M9584	8
										H7040	H7084	N8040	N8084	B8540	B8584	—	—	M9584	8

HONDA, INTL., ISUZU

LIFT	Quick Kit	KIT NOTES	Component Box	Front Springs		Rear Springs		Steering Correction
	Reference		(Requires 1 of Each)	Qty	Part #	Qty	Part #	

## 2020 JEEP GLADIATOR JT 4 DOOR 4X4 (NON-RUBICON)

### FRONT POLYURETHANE SPACERS

2020 Jeep Gladiator JT 4 Door 4x4		Front 3/4" Poly Spacers, Pair						
3/4"	JTFPS75	E34	JTFPS75					

### METAL SPACER KITS

2020 Jeep Gladiator JT 4 Door 4x4		Includes 2.5" Front Metal Coil Spacers						
2.5"	G25MSFB	E33, E34	G25MSFB					

2020 Jeep Gladiator JT 4 Door 4x4		Includes 2.5" Front Metal Coil Spacers & 1" Rear Coil Spacers						
2.5"	G250MSB	E33, E34	G250MSB					

KIT NOTES: E33 Includes Front Metal Coil Spacer, Front Shock Extensions, Sway Bar End Links, & Front Bump Stop Spacers. E34 Fits All Models.

### FRONT DUAL RATE-LONG TRAVEL COIL & REAR COIL SPACER KIT

2020 Jeep Gladiator JT 4 Door 4x4 (NON-RUBICON)		Includes 2.5" Front Coil Springs, 1" Rear Metal Coil Spacers & Shocks						
2.5"	G250PBLT	E35	G250PBLT	1	Included	1	---	---
2.5"	G250PMLT	E35	G250PMLT	1	Included	1	---	---

### FRONT DUAL RATE-LONG TRAVEL COIL & REAR 2 STAGE VARIABLE COIL SPRING SYSTEM

2020 Jeep Gladiator JT 4 Door 4x4 (NON-RUBICON)		Includes 2.5" Front & 1" Rear Coil Springs & Shocks						
2.5"	G251PBLT	E39	G251PBLT	1	Included	1	Included	
2.5"	G251PMLT	E39	G251PMLT	1	Included	1	Included	

KIT NOTES: E35. Includes Front Only DUAL RATE-LONG TRAVEL Coil Springs, Rear Metal Coil Spacers, Sway bar links, Bump stops & Shocks. E39. Includes Front & Rear DUAL RATE-LONG TRAVEL Coil Springs, Sway bar links, Bump stops & Shocks.

### FRONT DUAL RATE-LONG TRAVEL COIL & REAR COIL SPACER KIT

2020 Jeep Gladiator JT 4 Door 4x4 (NON-RUBICON)		Includes 3.5" Front Coil Springs, 2" Rear Metal Coil Spacers & Shocks						
3.5"	G350PBLT	E37	G350PBLT	1	Included	1	---	---
3.5"	G350PMLT	E37	G350PMLT	1	Included	1	---	---

### FRONT DUAL RATE-LONG TRAVEL COIL & REAR 2 STAGE VARIABLE COIL SPRING SYSTEM

2020 Jeep Gladiator JT 4 Door 4x4 (NON-RUBICON)		Includes 3.5" Front & 2" Rear Coil Springs & Shocks						
3.5"	G351KBLT	E38	G351LT + G35B	1	Included	1	Included	
3.5"	G351KMLT	E38	G351LT + G35M	1	Included	1	Included	

KIT NOTES: E37. Includes Front DUAL RATE-LONG TRAVEL Coil Springs, 2" Rear Metal Coil Spacers, Front Lower Links, Front Adjustable Track Bar, Front & Rear Sway bar links, Front & Rear Bump stops & Shocks

E38. Includes Front DUAL RATE-LONG TRAVEL Coil Springs, Rear 2 Stage Variable Rate coils, Front Lower Links, Front Adjustable Track Bar, Front & Rear Sway bar links, Front & Rear Bump stops & Shocks

### FRONT DUAL RATE-LONG TRAVEL COIL & REAR 2 STAGE VARIABLE COIL SPRING SYSTEM

2020 Jeep Gladiator JT 4 Door 4x4 (NON-RUBICON)		Includes 4.5" Front & 3" Rear Coil Springs & Shocks						
4.5"	G452KBLT	E40	G452LT + G45B	1	Included	1	Included	
4.5"	G452KMLT	E40	G452LT + G45M	1	Included	1	Included	

E40. Includes Front DUAL RATE-LONG TRAVEL Coil Springs, Rear 2 Stage Variable Rate coils, Front Lower Links, Rear Upper Links, Front Adjustable Track Bar, Front & Rear Sway bar links, Front & Rear Bump stops, Rear Track Bar Bracket, Longer Rear Brake Lines & Shocks

## 2020 JEEP GLADIATOR JT 4 DOOR 4X4

Part #	Description	Lift
JTFPS75	3/4" Front Poly Spacers, pair	3/4"
G10MSR	1" Rear Upper Metal Coil Spring Spacers, pair	1"
G20MSR	2" Rear Upper Metal Coil Spring Spacers, pair	2"
JLFTBA18	Adjustable Front Track Bar JL/JT	1-5"
JTGRTBA20	Adjustable Rear Track Bar JT	1-4"
JLL24F-SX	Front Lower Adjustable Control Arms JL/JT, pair	2-5"
JLULF26-SX	Front Upper Adjustable Control Arms JL/JT, pair	2-6"
GLL24R-SX	Rear Lower Adjustable Control Arms JT, pair	2-4"
GULR24-SX	Rear Upper Adjustable Control Arms JT, pair	2-4"



	Steering Stabilizers						HYDRO Shocks		NITRO Shocks		BLACK MAX		M95 Shocks		Labor
	White		Black		Silver		White		White		Black		Silver		Hours
	OEM	Dual	OEM	Dual	OEM	Dual	Front	Rear	Front	Rear	Front	Rear	Front	Rear	

**NOTE: Unless Noted "Included" Under Shock Series SHOCKS & STABILIZERS ORDERED SEPARATELY**

7008	7208 <sup>(B)</sup>	8008	8208 <sup>(B)</sup>	9008	9208 <sup>(B)</sup>	H7384	H7395	N8384	N8395	B8384	B8395	M9384	M9395	1
------	---------------------	------	---------------------	------	---------------------	-------	-------	-------	-------	-------	-------	-------	-------	---

7008	7208 <sup>(B)</sup>	8008	8208 <sup>(B)</sup>	9008	9208 <sup>(B)</sup>	H7386	H7395	N8386	N8395	B8386	B8395	M9386	M9395	2
------	---------------------	------	---------------------	------	---------------------	-------	-------	-------	-------	-------	-------	-------	-------	---

7008	7208 <sup>(B)</sup>	8008	8208 <sup>(B)</sup>	9008	9208 <sup>(B)</sup>	H7386	H7396	N8386	N8396	B8386	B8396	M9386	M9396	3
------	---------------------	------	---------------------	------	---------------------	-------	-------	-------	-------	-------	-------	-------	-------	---

(B). BOOT NOT INCLUDED DUE TO CLEARANCE ISSUES.

7008	7208 <sup>(B)</sup>	8008	8208 <sup>(B)</sup>	9008	9208 <sup>(B)</sup>	---	---	---	---	Included	Included	---	---	4
------	---------------------	------	---------------------	------	---------------------	-----	-----	-----	-----	----------	----------	-----	-----	---

7008	7208 <sup>(B)</sup>	8008	8208 <sup>(B)</sup>	9008	9208 <sup>(B)</sup>	---	---	---	---	---	---	Included	Included	4
------	---------------------	------	---------------------	------	---------------------	-----	-----	-----	-----	-----	-----	----------	----------	---

7008	7208 <sup>(B)</sup>	8008	8208 <sup>(B)</sup>	9008	9208 <sup>(B)</sup>	---	---	---	---	Included	Included	---	---	4
------	---------------------	------	---------------------	------	---------------------	-----	-----	-----	-----	----------	----------	-----	-----	---

7008	7208 <sup>(B)</sup>	8008	8208 <sup>(B)</sup>	9008	9208 <sup>(B)</sup>	---	---	---	---	---	---	Included	Included	4
------	---------------------	------	---------------------	------	---------------------	-----	-----	-----	-----	-----	-----	----------	----------	---

(B). BOOT NOT INCLUDED DUE TO CLEARANCE ISSUES.

7008	7208 <sup>(B)</sup>	8008	8208 <sup>(B)</sup>	9008	9208 <sup>(B)</sup>	---	---	---	---	Included	Included	---	---	5
------	---------------------	------	---------------------	------	---------------------	-----	-----	-----	-----	----------	----------	-----	-----	---

7008	7208 <sup>(B)</sup>	8008	8208 <sup>(B)</sup>	9008	9208 <sup>(B)</sup>	---	---	---	---	---	---	Included	Included	5
------	---------------------	------	---------------------	------	---------------------	-----	-----	-----	-----	-----	-----	----------	----------	---

7008	7208 <sup>(B)</sup>	8008	8208 <sup>(B)</sup>	9008	9208 <sup>(B)</sup>	---	---	---	---	Included	Included	---	---	5
------	---------------------	------	---------------------	------	---------------------	-----	-----	-----	-----	----------	----------	-----	-----	---

7008	7208 <sup>(B)</sup>	8008	8208 <sup>(B)</sup>	9008	9208 <sup>(B)</sup>	---	---	---	---	---	---	Included	Included	5
------	---------------------	------	---------------------	------	---------------------	-----	-----	-----	-----	-----	-----	----------	----------	---

(B). BOOT NOT INCLUDED DUE TO CLEARANCE ISSUES.

7008	7208 <sup>(B)</sup>	8008	8208 <sup>(B)</sup>	9008	9208 <sup>(B)</sup>	---	---	---	---	Included	Included	---	---	7
------	---------------------	------	---------------------	------	---------------------	-----	-----	-----	-----	----------	----------	-----	-----	---

7008	7208 <sup>(B)</sup>	8008	8208 <sup>(B)</sup>	9008	9208 <sup>(B)</sup>	---	---	---	---	---	---	Included	Included	7
------	---------------------	------	---------------------	------	---------------------	-----	-----	-----	-----	-----	-----	----------	----------	---

(B). BOOT NOT INCLUDED DUE TO CLEARANCE ISSUES.

**2020 JEEP GLADIATOR JT 4 DOOR 4X4**

Part #	Description	Lift
JLOSM	Front Outboard Shock Mounting Brackets JL/JT	---
SBE4238	Front Double Disconnect Sway Bar End Links JL/JT	2-3"
SBE4258	Front Double Disconnect Sway Bar End Links JL/JT	3.5-6"
7008	HD OEM Replacement Steering Damper, White	---
8008	HD OEM Replacement Steering Damper, Black	---
9008	HD OEM Replacement Steering Damper, Silver	---
7208	Dual Steering Damper Kit, White	---
8208	Dual Steering Damper Kit, Black	---
9208	Dual Steering Damper Kit, Silver	---



# JEEP

LIFT	Quick Kit	KIT NOTES	Component Box (Requires 1 of Each)	Front Springs		Rear Springs		Steering Correction (Order 1 Each)
	Reference			Qty	Part #	Qty	Part #	

## 2020 JEEP GLADIATOR JT 4 DOOR 4X4 (RUBICON)

### FRONT POLYURETHANE SPACERS

2020 Jeep Gladiator JT 4 Door 4x4		Front 3/4" Poly Spacers, Pair	
3/4"	JTFPS75	E34	JTFPS75

### METAL SPACER KITS

2020 Jeep Gladiator JT 4 Door 4x4		Includes 2.5" Front Metal Coil Spacers	
2.5"	G25MSFB	E33, E34	G25MSFB
2020 Jeep Gladiator JT 4 Door 4x4		Includes 2.5" Front Metal Coil Spacers & 1" Rear Coil Spacers	
2.5"	G250MSB	E33, E34	G250MSB

KIT NOTES: E33 Includes Front Metal Coil Spacer, Front Shock Extensions, Sway Bar End Links, & Front Bump Stop Spacers.  
E34 Fits All Models.

### FRONT DUAL RATE-LONG TRAVEL & REAR COIL SPACER KIT

2020 Jeep Gladiator JT 4 Door 4x4 (RUBICON)		Includes 2.5" Front Coil Springs, 1" Rear Metal Coil Spacers & Shocks	
2.5"	G250RPBLT	E35	G250RPBLT 1 Included 1 --- ---
2.5"	G250RPMLT	E35	G250RPMLT 1 Included 1 --- ---

### FRONT DUAL RATE-LONG TRAVEL COIL & REAR 2 STAGE VARIABLE COIL SPRING SYSTEM

2020 Jeep Gladiator JT 4 Door 4x4 (RUBICON)		Includes 2.5" Front & 1" Rear Coil Springs & Shocks	
2.5"	G251RPBLT	E39	G251RPBLT 1 Included 1 Included
2.5"	G251RPMLT	E39	G251RPMLT 1 Included 1 Included

KIT NOTES: E35. Includes Front Only DUAL RATE-LONG TRAVEL Coil Springs, Rear Metal Coil Spacers, Sway bar links, Bump stops & Shocks. E39. Includes Front & Rear DUAL RATE-LONG TRAVEL Coil Springs, Sway bar links, Bump stops & Shocks.

### FRONT DUAL RATE-LONG TRAVEL COIL & REAR COIL SPACER KIT

2020 Jeep Gladiator JT 4 Door 4x4 (RUBICON)		Includes 3.5" Front Coil Springs, 2" Rear Metal Coil Spacers & Shocks	
3.5"	G350RPBLT	E37	G350RPBLT 1 Included 1 --- ---
3.5"	G350RPMLT	E37	G350RPMLT 1 Included 1 --- ---

### FRONT DUAL RATE-LONG TRAVEL COIL & REAR 2 STAGE VARIABLE COIL SPRING SYSTEM

2020 Jeep Gladiator JT 4 Door 4x4 (RUBICON)		Includes 3.5" Front & 2" Rear Coil Springs & Shocks	
3.5"	G351RKBLT	E38	G351RBLT + G35B 1 Included 1 Included
3.5"	G351RKMLT	E38	G351RMLT + G35M 1 Included 1 Included

KIT NOTES: E37. Includes Front DUAL RATE-LONG TRAVEL Coil Springs, 2" Rear Metal Coil Spacers, Front Lower Links, Front Adjustable Track Bar, Front & Rear Sway bar links, Front & Rear Bump stops & Shocks

E38. Includes Front DUAL RATE-LONG TRAVEL Coil Springs, Rear 2 Stage Variable Rate coils, Front Lower Links, Front Adjustable Track Bar, Front & Rear Sway bar links, Front & Rear Bump stops & Shocks

### FRONT DUAL RATE-LONG TRAVEL COIL & REAR 2 STAGE VARIABLE COIL SPRING SYSTEM

2020 Jeep Gladiator JT 4 Door 4x4 (RUBICON)		Includes 4.5" Front & 3" Rear Coil Springs & Shocks	
4.5"	G452RKBLT	E40	G452RBLT + G45B 1 Included 1 Included
4.5"	G452RKMLT	E40	G452RMLT + G45M 1 Included 1 Included

E40. Includes Front DUAL RATE-LONG TRAVEL Coil Springs, Rear 2 Stage Variable Rate coils, Front Lower Links, Rear Upper Links, Front Adjustable Track Bar, Front & Rear Sway bar links, Front & Rear Bump stops, Rear Track Bar Bracket, Longer Rear Brake Lines & Shocks

## 2020 JEEP GLADIATOR JT 4 DOOR 4X4

Part #	Description	Lift
JTFPS75	3/4" Front Poly Spacers, pair	3/4"
G10MSR	1" Rear Upper Metal Coil Spring Spacers, pair	1"
G20MSR	2" Rear Upper Metal Coil Spring Spacers, pair	2"
JLFTBA18	Adjustable Front Track Bar JL/JT	1-5"
JTGRTBA20	Adjustable Rear Track Bar JT	1-4"
JLL24F-SX	Front Lower Adjustable Control Arms JL/JT, pair	2-5"
JLULF26-SX	Front Upper Adjustable Control Arms JL/JT, pair	2-6"
GLL24R-SX	Rear Lower Adjustable Control Arms JT, pair	2-4"
GULR24-SX	Rear Upper Adjustable Control Arms JT, pair	2-4"

JEEP

	Steering Stabilizers						HYDRO Shocks		NITRO Shocks		BLACK MAX		M95 Shocks		Labor
	White		Black		Silver		White		White		Black		Silver		Hours
	OEM	Dual	OEM	Dual	OEM	Dual	Front	Rear	Front	Rear	Front	Rear	Front	Rear	

	7008	7208 <sup>(B)</sup>	8008	8208 <sup>(B)</sup>	9008	9208 <sup>(B)</sup>	H7384	H7395	N8384	N8395	B8384	B8395	M9384	M9395	1
--	------	---------------------	------	---------------------	------	---------------------	-------	-------	-------	-------	-------	-------	-------	-------	---

	7008	7208 <sup>(B)</sup>	8008	8208 <sup>(B)</sup>	9008	9208 <sup>(B)</sup>	H7386	H7395	N8386	N8395	B8386	B8395	M9386	M9395	2
--	------	---------------------	------	---------------------	------	---------------------	-------	-------	-------	-------	-------	-------	-------	-------	---

	7008	7208 <sup>(B)</sup>	8008	8208 <sup>(B)</sup>	9008	9208 <sup>(B)</sup>	H7386	H7396	N8386	N8396	B8386	B8396	M9386	M9396	3
--	------	---------------------	------	---------------------	------	---------------------	-------	-------	-------	-------	-------	-------	-------	-------	---

(B). BOOT NOT INCLUDED DUE TO CLEARANCE ISSUES.

	7008	7208 <sup>(B)</sup>	8008	8208 <sup>(B)</sup>	9008	9208 <sup>(B)</sup>	---	---	---	---	Included	Included	---	---	4
--	------	---------------------	------	---------------------	------	---------------------	-----	-----	-----	-----	----------	----------	-----	-----	---

	7008	7208 <sup>(B)</sup>	8008	8208 <sup>(B)</sup>	9008	9208 <sup>(B)</sup>	---	---	---	---	---	---	Included	Included	4
--	------	---------------------	------	---------------------	------	---------------------	-----	-----	-----	-----	-----	-----	----------	----------	---

	7008	7208 <sup>(B)</sup>	8008	8208 <sup>(B)</sup>	9008	9208 <sup>(B)</sup>	---	---	---	---	Included	Included	---	---	4
--	------	---------------------	------	---------------------	------	---------------------	-----	-----	-----	-----	----------	----------	-----	-----	---

	7008	7208 <sup>(B)</sup>	8008	8208 <sup>(B)</sup>	9008	9208 <sup>(B)</sup>	---	---	---	---	---	---	Included	Included	4
--	------	---------------------	------	---------------------	------	---------------------	-----	-----	-----	-----	-----	-----	----------	----------	---

(B). BOOT NOT INCLUDED DUE TO CLEARANCE ISSUES.

	7008	7208 <sup>(B)</sup>	8008	8208 <sup>(B)</sup>	9008	9208 <sup>(B)</sup>	---	---	---	---	Included	Included	---	---	5
--	------	---------------------	------	---------------------	------	---------------------	-----	-----	-----	-----	----------	----------	-----	-----	---

	7008	7208 <sup>(B)</sup>	8008	8208 <sup>(B)</sup>	9008	9208 <sup>(B)</sup>	---	---	---	---	---	---	Included	Included	5
--	------	---------------------	------	---------------------	------	---------------------	-----	-----	-----	-----	-----	-----	----------	----------	---

	7008	7208 <sup>(B)</sup>	8008	8208 <sup>(B)</sup>	9008	9208 <sup>(B)</sup>	---	---	---	---	Included	Included	---	---	5
--	------	---------------------	------	---------------------	------	---------------------	-----	-----	-----	-----	----------	----------	-----	-----	---

	7008	7208 <sup>(B)</sup>	8008	8208 <sup>(B)</sup>	9008	9208 <sup>(B)</sup>	---	---	---	---	---	---	Included	Included	5
--	------	---------------------	------	---------------------	------	---------------------	-----	-----	-----	-----	-----	-----	----------	----------	---

(B). BOOT NOT INCLUDED DUE TO CLEARANCE ISSUES.

(B). BOOT NOT INCLUDED DUE TO CLEARANCE ISSUES.

	7008	7208 <sup>(B)</sup>	8008	8208 <sup>(B)</sup>	9008	9208 <sup>(B)</sup>	---	---	---	---	Included	Included	---	---	7
--	------	---------------------	------	---------------------	------	---------------------	-----	-----	-----	-----	----------	----------	-----	-----	---

	7008	7208 <sup>(B)</sup>	8008	8208 <sup>(B)</sup>	9008	9208 <sup>(B)</sup>	---	---	---	---	---	---	Included	Included	7
--	------	---------------------	------	---------------------	------	---------------------	-----	-----	-----	-----	-----	-----	----------	----------	---

(B). BOOT NOT INCLUDED DUE TO CLEARANCE ISSUES.

**2020 JEEP GLADIATOR JT 4 DOOR 4X4**

Part #	Description	Lift
JLOSM	Front Outboard Shock Mounting Brackets JL/JT	---
SBE4238	Front Double Disconnect Sway Bar End Links JL/JT	2-3"
SBE4258	Front Double Disconnect Sway Bar End Links JL/JT	3.5-6"
7008	HD OEM Replacement Steering Damper, White	---
8008	HD OEM Replacement Steering Damper, Black	---
9008	HD OEM Replacement Steering Damper, Silver	---
7208	Dual Steering Damper Kit, White	---
8208	Dual Steering Damper Kit, Black	---
9208	Dual Steering Damper Kit, Silver	---



# JEEP

LIFT	Quick Kit	KIT NOTES	Component Box	Front Springs		Rear Springs		Steering Correction
	Reference		(Requires 1 of Each)	Qty	Part #	Qty	Part #	
<b>2018-20 WRANGLER JL 4WD</b>								
<b>FRONT &amp; REAR POLYURETHANE SPACERS</b>								
<b>2018-20 Wrangler JL 4WD</b>			<b>3/4" Polyurethane Front Spacers</b>					
3/4"	JLFPS75	E34	JLFPS75					
<b>2018-20 Wrangler JL 4WD</b>			<b>3/4" Polyurethane Rear Spacers</b>					
3/4"	JLRPS75	E34	JLRPS75					
<b>METAL SPACER KIT</b>								
<b>2018-20 Wrangler JL 4WD</b>			<b>2.5" Front &amp; 2" Rear - Metal Coil Spacers &amp; Shock Extensions Front/Rear</b>					
2.5/2"	JL25MSB	E34	JL25MSB					
<b>2018-20 Wrangler JL 4WD</b>			<b>(-2-2.5") 4 Coil Drop System (Sport/Sahara Only) w/4 Black MAX Shocks</b>					
(-2-2.5")	LOWJL025PB	E37	LOWJL025PB					
E34: Fits All Models. E37: Fits Sport/Sahara Models ONLY								
<b>2018-20 WRANGLER JL 4WD 4 DOOR (NON-RUBICON)</b>								
<b>FRONT &amp; REAR DUAL RATE-LONG TRAVEL COIL SERIES (FVMS 126 SAFETY COMPLIANT SEE PAGE 3 FOR DETAILS)</b>								
<b>2018-20 Wrangler JL 4WD (NON-RUBICON)</b>			<b>Includes Front &amp; Rear Coil Springs &amp; Shocks</b>					
1-1.5"	JL15BPBLT	E46	JL15BPBLT	1	Included	1	Included	
1-1.5"	JL15BPMLT	E46	JL15BPMLT	1	Included	1	Included	
			<b>Includes Front &amp; Rear Coil Springs &amp; Shocks</b>					
2-2.5"	JL25BPBLT	E31, E46	JL25BPBLT	1	Included	1	Included	
2-2.5"	JL25BPMLT	E31, E46	JL25BPMLT	1	Included	1	Included	
			<b>Includes Front &amp; Rear Coil Springs &amp; Shocks</b>					
3.5-4"	JL40BPBLT	E31, E47	JL40BPBLT	1	Included	1	Included	
3.5-4"	JL40BPMLT	E31, E47	JL40BPMLT	1	Included	1	Included	
<b>2018-20 WRANGLER JL 4WD 2 DOOR (NON-RUBICON)</b>								
			<b>Includes Front &amp; Rear Coil Springs &amp; Shocks</b>					
2-2.5"	JL20BPBLT	E31, E46	JL20BPBLT	1	Included	1	Included	
2-2.5"	JL20BPMLT	E31, E46	JL20BPMLT	1	Included	1	Included	
<b>2018-19 Wrangler JL 4WD (NON-RUBICON)</b>			<b>Includes Front &amp; Rear Coil Springs &amp; Shocks</b>					
3.5-4"	JL35BPBLT	E31, E47	JL35BPBLT	1	Included	1	Included	
3.5-4"	JL35BPMLT	E31, E47	JL35BPMLT	1	Included	1	Included	
E31: Optional HD Lower Links Part# JL24LL or Single Flex Bent Links Part# JL24LLX Upgrade Available, Lower Adjustable Links with Currie Johnny Joints. E46. Includes Front & Rear DUAL RATE-LONG TRAVEL Coil Springs, Bump Stops, Sway Bar Links & Shocks. E47. Includes DUAL RATE-LONG TRAVEL Coil Springs, Adjustable Front Track Bar, Rear Track Bar Bracket, Sway Bar Links, Alignment Cam Bolts, Bump Stops & Shocks.								
<b>2018-20 WRANGLER JL 4WD 4 DOOR (RUBICON)</b>								
<b>FRONT &amp; REAR DUAL RATE-LONG TRAVEL COIL SERIES (FVMS 126 SAFETY COMPLIANT SEE PAGE 3 FOR DETAILS)</b>								
<b>2018-20 Wrangler JL 4WD (RUBICON)</b>			<b>Includes Front &amp; Rear Coil Springs &amp; Shocks</b>					
1-1.5"	JL15RBPBLT	E46	JL15RBPBLT	1	Included	1	Included	
1-1.5"	JL15RBPMLT	E46	JL15RBPMLT	1	Included	1	Included	
<b>2018-20 Wrangler JL 4WD (RUBICON)</b>			<b>Includes Front &amp; Rear Coil Springs &amp; Shocks</b>					
2-2.5"	JL25RBPBLT	E31, E46	JL25RBPBLT	1	Included	1	Included	
2-2.5"	JL25RBPMLT	E31, E46	JL25RBPMLT	1	Included	1	Included	
<b>2018-20 Wrangler JL 4WD (RUBICON)</b>			<b>Includes Front &amp; Rear Coil Springs &amp; Shocks</b>					
3.5-4"	JL40RBPBLT	E31, E47	JL40RBPBLT	1	Included	1	Included	
3.5-4"	JL40RBPMLT	E31, E47	JL40RBPMLT	1	Included	1	Included	
<b>2018-20 WRANGLER JL 4WD 2 DOOR (NON-RUBICON)</b>								
<b>2018-19 Wrangler JL 4WD (RUBICON)</b>			<b>Includes Front &amp; Rear Coil Springs &amp; Shocks</b>					
2-2.5"	JL20RBPBLT	E31, E46	JL20RBPBLT	1	Included	1	Included	
2-2.5"	JL20RBPMLT	E31, E46	JL20RBPMLT	1	Included	1	Included	
<b>2018-19 Wrangler JL 4WD (RUBICON)</b>			<b>Includes Front &amp; Rear Coil Springs &amp; Shocks</b>					
3.5-4"	JL35RBPBLT	E31, E47	JL35RBPBLT	1	Included	1	Included	
3.5-4"	JL35RBPMLT	E31, E47	JL35RBPMLT	1	Included	1	Included	
E31: Optional HD Lower Links Part# JL24LL or Single Flex Bent Links Part# JL24LLX Upgrade Available, Lower Adjustable Links with Currie Johnny Joints. E46. Includes Front & Rear DUAL RATE-LONG TRAVEL Coil Springs, Bump Stops, Sway Bar Links & Shocks. E47. Includes DUAL RATE-LONG TRAVEL Coil Springs, Adjustable Front Track Bar, Rear Track Bar Bracket, Sway Bar Links, Alignment Cam Bolts, Bump Stops & Shocks.								

	Steering Stabilizers						HYDRO Shocks		NITRO Shocks		BLACK MAX		M95 Shocks		Labor
	White		Black		Silver		White		White		Black		Silver		Hours
	OEM	Dual	OEM	Dual	OEM	Dual	Front	Rear	Front	Rear	Front	Rear	Front	Rear	

**NOTE: Unless Noted "Included" Under Shock Series SHOCKS & STABILIZERS ORDERED SEPARATELY**

	7008	7208 <sup>(B)</sup>	8008	8208 <sup>(B)</sup>	9008	9208 <sup>(B)</sup>	H7384	H7386	N8384	N8386	B8384	B8386	M9384	M9386	1
--	------	---------------------	------	---------------------	------	---------------------	-------	-------	-------	-------	-------	-------	-------	-------	---

	7008	7208 <sup>(B)</sup>	8008	8208 <sup>(B)</sup>	9008	9208 <sup>(B)</sup>	H7384	H7386	N8384	N8386	B8384	B8386	M9384	M9386	1
--	------	---------------------	------	---------------------	------	---------------------	-------	-------	-------	-------	-------	-------	-------	-------	---

	7008	7208 <sup>(B)</sup>	8008	8208 <sup>(B)</sup>	9008	9208 <sup>(B)</sup>	---	---	---	---	---	---	---	---	3
--	------	---------------------	------	---------------------	------	---------------------	-----	-----	-----	-----	-----	-----	-----	-----	---

	7008		8008		9008		---	---	---	---	Included	Included	---	---	3
--	------	--	------	--	------	--	-----	-----	-----	-----	----------	----------	-----	-----	---

(B). BOOT NOT INCLUDED DUE TO CLEARANCE ISSUES.

	7008	7208 <sup>(B)</sup>	8008	8208 <sup>(B)</sup>	9008	9208 <sup>(B)</sup>	---	---	---	---	Included	Included	---	---	4
--	------	---------------------	------	---------------------	------	---------------------	-----	-----	-----	-----	----------	----------	-----	-----	---

	7008	7208 <sup>(B)</sup>	8008	8208 <sup>(B)</sup>	9008	9208 <sup>(B)</sup>	---	---	---	---	---	---	Included	Included	4
--	------	---------------------	------	---------------------	------	---------------------	-----	-----	-----	-----	-----	-----	----------	----------	---

	7008	7208 <sup>(B)</sup>	8008	8208 <sup>(B)</sup>	9008	9208 <sup>(B)</sup>	---	---	---	---	Included	Included	---	---	4
--	------	---------------------	------	---------------------	------	---------------------	-----	-----	-----	-----	----------	----------	-----	-----	---

	7008	7208 <sup>(B)</sup>	8008	8208 <sup>(B)</sup>	9008	9208 <sup>(B)</sup>	---	---	---	---	---	---	Included	Included	4
--	------	---------------------	------	---------------------	------	---------------------	-----	-----	-----	-----	-----	-----	----------	----------	---

	7008	7208 <sup>(B)</sup>	8008	8208 <sup>(B)</sup>	9008	9208 <sup>(B)</sup>	---	---	---	---	Included	Included	---	---	6
--	------	---------------------	------	---------------------	------	---------------------	-----	-----	-----	-----	----------	----------	-----	-----	---

	7008	7208 <sup>(B)</sup>	8008	8208 <sup>(B)</sup>	9008	9208 <sup>(B)</sup>	---	---	---	---	---	---	Included	Included	6
--	------	---------------------	------	---------------------	------	---------------------	-----	-----	-----	-----	-----	-----	----------	----------	---

(B). BOOT NOT INCLUDED DUE TO CLEARANCE ISSUES.

	7008	7208 <sup>(B)</sup>	8008	8208 <sup>(B)</sup>	9008	9208 <sup>(B)</sup>	---	---	---	---	Included	Included	---	---	4
--	------	---------------------	------	---------------------	------	---------------------	-----	-----	-----	-----	----------	----------	-----	-----	---

	7008	7208 <sup>(B)</sup>	8008	8208 <sup>(B)</sup>	9008	9208 <sup>(B)</sup>	---	---	---	---	---	---	Included	Included	4
--	------	---------------------	------	---------------------	------	---------------------	-----	-----	-----	-----	-----	-----	----------	----------	---

	7008	7208 <sup>(B)</sup>	8008	8208 <sup>(B)</sup>	9008	9208 <sup>(B)</sup>	---	---	---	---	Included	Included	---	---	4
--	------	---------------------	------	---------------------	------	---------------------	-----	-----	-----	-----	----------	----------	-----	-----	---

	7008	7208 <sup>(B)</sup>	8008	8208 <sup>(B)</sup>	9008	9208 <sup>(B)</sup>	---	---	---	---	---	---	Included	Included	4
--	------	---------------------	------	---------------------	------	---------------------	-----	-----	-----	-----	-----	-----	----------	----------	---

	7008	7208 <sup>(B)</sup>	8008	8208 <sup>(B)</sup>	9008	9208 <sup>(B)</sup>	---	---	---	---	Included	Included	---	---	6
--	------	---------------------	------	---------------------	------	---------------------	-----	-----	-----	-----	----------	----------	-----	-----	---

	7008	7208 <sup>(B)</sup>	8008	8208 <sup>(B)</sup>	9008	9208 <sup>(B)</sup>	---	---	---	---	---	---	Included	Included	6
--	------	---------------------	------	---------------------	------	---------------------	-----	-----	-----	-----	-----	-----	----------	----------	---

	7008	7208 <sup>(B)</sup>	8008	8208 <sup>(B)</sup>	9008	9208 <sup>(B)</sup>	---	---	---	---	Included	Included	---	---	4
--	------	---------------------	------	---------------------	------	---------------------	-----	-----	-----	-----	----------	----------	-----	-----	---

	7008	7208 <sup>(B)</sup>	8008	8208 <sup>(B)</sup>	9008	9208 <sup>(B)</sup>	---	---	---	---	---	---	Included	Included	4
--	------	---------------------	------	---------------------	------	---------------------	-----	-----	-----	-----	-----	-----	----------	----------	---

	7008	7208 <sup>(B)</sup>	8008	8208 <sup>(B)</sup>	9008	9208 <sup>(B)</sup>	---	---	---	---	Included	Included	---	---	6
--	------	---------------------	------	---------------------	------	---------------------	-----	-----	-----	-----	----------	----------	-----	-----	---

	7008	7208 <sup>(B)</sup>	8008	8208 <sup>(B)</sup>	9008	9208 <sup>(B)</sup>	---	---	---	---	---	---	Included	Included	6
--	------	---------------------	------	---------------------	------	---------------------	-----	-----	-----	-----	-----	-----	----------	----------	---

(B). BOOT NOT INCLUDED DUE TO CLEARANCE ISSUES.



# JEEP

LIFT	Quick Kit	KIT NOTES	Component Box	Front Springs		Rear Springs		Steering Correction
	Reference		(Requires 1 of Each)	Qty	Part #	Qty	Part #	

**2018-20 WRANGLER JL 4WD, 4 DOOR / 2 DOOR (SPORT, SAHARA & RUBICON)**

**Coil-Over Extreme Travel Systems**

**2018-20 Wrangler JL 4WD**

**Short Arm Coil-Over Extreme Travel Systems**

				Front Coil-Overs		Rear Coil-Overs			
3.5-6"	JL36SLSK-SX	E49, E50, E51, E52	JL36FLSB + JL36RLSB + JL24LLX + JL36CB	1	JL36FLS	1	JL36RLS		

KIT NOTES: E49 Optional front air bump stop kit Part# JLLSAB. E50. 2 Door models: Require rear aftermarket driveshaft. E51. 4 Door models: Rear driveshaft is recommended. E52. Aftermarket wheels require 4.5" of back spacing.

**2018-19 WRANGLER JL ACCESSORIES**

Part #	Description	Lift
JL24LL	Front & Rear Lower Standard Heavy Duty Links Lift	1-4"
JL24LLX	Front & Rear Lower Adjustable Flex Links	1-6"
JLL24F-SX	Front Lower Adjustable Flex Links	1-6"
JLL24R-SX	Rear Lower Adjustable Flex Links	1-6"
JLULF26-SX	Front Upper Adjustable Flex Links	1-6"
JLULR26-SX	Rear Upper Adjustable Flex Links	1-6"
JLFTBA18	Front Adjustable Track Bar Lift	0-6"
JLRTBA18	Rear Adjustable Track Bar Lift	2-6"
JLFBRC18	Front Track Bar Brace	All

JEEP



	Steering Stabilizers						HYDRO Shocks		NITRO Shocks		BLACK MAX		M95 Shocks		Labor
	White		Black		Silver		White		White		Black		Silver		Hours
	OEM	Dual	OEM	Dual	OEM	Dual	Front	Rear	Front	Rear	Front	Rear	Front	Rear	
	7008	7208 <sup>(B)</sup>	8008	8208 <sup>(B)</sup>	9008	9208 <sup>(B)</sup>	----	----	----	----	----	----	----	----	12

(B). BOOT NOT INCLUDED DUE TO CLEARANCE ISSUES.

**2018-19 WRANGLER JL ACCESSORIES**

Part #	Description	Lift
JLOSM	JL Front Outboard Shock Mounting Brackets	-----
SBE4238	Front Sway Bar Double Disconnect Extended End Links Lift	2-3"
SBE4258	Front Sway Bar Double Disconnect Extended End Links Lift	3.5-6"
TGSSTR2	Tailgate Saver Support System & Spare Tire Relocation Kit	-----
JLFPS75	.75" Front Coil Spring Isolator Pads - Pair	3/4"
JLRPS75	.75" Rear Coil Spring Isolator Pads - Pair	3/4"
JL20PSF	2" Front Coil Spring Isolator Pads - Pair	2"
JL20PSR	2" Rear Coil Spring Isolator Pads - Pair	2"



# JEEP

LIFT	Quick Kit	KIT NOTES	Component Box	Front Springs		Rear Springs		Steering Correction
	Reference		(Requires 1 of Each)	Qty	Part #	Qty	Part #	

## 07-18 WRANGLER JK & RUBICON 2 & 4 DOOR 2WD / 4WD

### LOWERING KIT

**07-18 Wrangler JK & Rubicon 2 & 4 Door 4WD** Includes Front & Rear Lowering Coil Springs

(2)-(2.5")	LOWJK024		LOWJK024	1	Included	1	Included		
------------	----------	--	----------	---	----------	---	----------	--	--

KIT NOTES: These Coil Springs will Lower the Vehicle's Center of Gravity 2-2.5".

### POLYURETHANE SPACERS & VALUE KITS

**07-18 Wrangler JK & Rubicon 2 & 4 Door 2WD / 4WD** Polyurethane Front Spacers

3/4"	JKFPS75		JKFPS75						
------	---------	--	---------	--	--	--	--	--	--

**07-18 Wrangler JK & Rubicon 2 & 4 Door 2WD / 4WD** Polyurethane Rear Spacers

3/4"	JKRPS75		JKRPS75						
------	---------	--	---------	--	--	--	--	--	--

**07-18 Wrangler JK & Rubicon 2 & 4 Door 2WD / 4WD** 2" Front & 2" Rear Kit - Polyurethane Spacers

2"	JK20		JK20						
----	------	--	------	--	--	--	--	--	--

**07-18 Wrangler JK & Rubicon 2 & 4 Door 2WD / 4WD** 2" Front & 3/4" Rear Leveling Kit - Polyurethane Spacers

2"	JK23		JK23						
----	------	--	------	--	--	--	--	--	--

## 07-18 WRANGLER JK & RUBICON (4 DOOR) 2WD / 4WD

### FRONT & REAR DUAL RATE-LONG TRAVEL COIL SERIES (FVMS 126 SAFETY COMPLIANT SEE PAGE 3 FOR DETAILS)

**07-18 Wrangler JK & Rubicon 2 & 4 Door 2WD / 4WD** Includes Front & Rear Dual Rate-Long Travel Coil Springs & Shocks

2-2.5"	JK25BPHLT	E31, E42, E43	JK25BPHLT	1	Included	1	Included		
2-2.5"	JK25BPNTL	E31, E42, E43	JK25BPNTL	1	Included	1	Included		
2-2.5"	JK25BPBLT	E31, E42, E43	JK25BPBLT	1	Included	1	Included		
2-2.5"	JK25BPMLT	E31, E42, E43	JK25BPMLT	1	Included	1	Included		

KIT NOTES: E31. Adjustable Front & Rear Flex Lower Links Upgrade with Currie Johnny Joint Available JK24LLX, E42. Brake Line Upgrades are Available. E43. Includes Front & Rear Dual Rate-Long Travel Coil Springs, Rear Track Bar Bracket, Bump Stops, Sway bar Links & Shocks.

### FRONT & REAR DUAL RATE-LONG TRAVEL COIL SERIES (FVMS 126 SAFETY COMPLIANT SEE PAGE 3 FOR DETAILS)

**07-18 Wrangler JK & Rubicon 4 Door Only 2WD / 4WD** Includes Front & Rear Dual Rate-Long Travel Coil Springs & Shocks

3.5-4"	JK40BPHLT	E27, E31, E32, E42, E44	JK40BPHLT	1	Included	1	Included		
3.5-4"	JK40BPNTL	E27, E31, E32, E42, E44	JK40BPNTL	1	Included	1	Included		
3.5-4"	JK40BPBLT	E27, E31, E32, E42, E44	JK40BPBLT	1	Included	1	Included		
3.5-4"	JK40BPMLT	E27, E31, E32, E42, E44	JK40BPMLT	1	Included	1	Included		

KIT NOTES: E27. 2012-18 Models with 3.5" Lifts & Up will Require Exhaust Spacers Part # JK36ESK E31. Adjustable Front & Rear Flex Lower Links Upgrade with Currie Johnny Joint Available JK24LLX, E32. Long Arm Upgrade Available Order Part# JK46LA-SX E42. Brake Line Upgrades are Available. E44. Includes Front & Rear Dual Rate-Long Travel Coil Springs, Front Adjustable Track Bar, Front Alignment Cam Bolts, Rear Track Bar Bracket, Bump Stops, Sway bar Links & Shocks.

E31. Single Flex Bent Links Upgrade Available for Standard Series Lifts.  
Front and Rear **FLEX** Links with Currie Johnny Joints. (See below)  
E32. Long Arm Upgrade Available. Order Part# **JK46LA-SX**.



## 07-18 WRANGLER JK & RUBICON (2 DOOR) 2WD / 4WD

### FRONT & REAR DUAL RATE-LONG TRAVEL COIL SERIES (FVMS 126 SAFETY COMPLIANT SEE PAGE 3 FOR DETAILS)

**07-18 Wrangler JK & Rubicon 2 Door Only 2WD / 4WD** Includes Front & Rear Dual Rate-Long Travel Coil Springs & Shocks

2-2.5"	JK20BPHLT	E31, E42, E43	JK20BPHLT	1	Included	1	Included		
2-2.5"	JK20BPNTL	E31, E42, E43	JK20BPNTL	1	Included	1	Included		
2-2.5"	JK20BPBLT	E31, E42, E43	JK20BPBLT	1	Included	1	Included		
2-2.5"	JK20BPMLT	E31, E42, E43	JK20BPMLT	1	Included	1	Included		

KIT NOTES: E31. Adjustable Front & Rear Flex Lower Links Upgrade with Currie Johnny Joint Available JK24LLX, E42. Brake Line Upgrades are Available. E43. Includes Front & Rear Dual Rate-Long Travel Coil Springs, Rear Track Bar Bracket, Bump Stops, Sway bar Links & Shocks.

### DUAL RATE-LONG TRAVEL SERIES (FVMS 126 SAFETY COMPLIANT)

**07-18 Wrangler JK & Rubicon 2 Door Only 2WD / 4WD** Includes Front & Rear Dual Rate-Long Travel Coil Springs & Shocks

3.5-4"	JK35BPHLT	E27, E31, E32, E42, E44	JK35BPHLT	1	Included	1	Included		
3.5-4"	JK35BPNTL	E27, E31, E32, E42, E44	JK35BPNTL	1	Included	1	Included		
3.5-4"	JK35BPBLT	E27, E31, E32, E42, E44	JK35BPBLT	1	Included	1	Included		
3.5-4"	JK35BPMLT	E27, E31, E32, E42, E44	JK35BPMLT	1	Included	1	Included		

KIT NOTES: E27. 2012-18 Models with 3.5" Lifts & Up will Require Exhaust Spacers Part # JK36ESK E31. Adjustable Front & Rear Flex Lower Links Upgrade with Currie Johnny Joint Available JK24LLX, E32. Long Arm Upgrade Available Order Part# JK46LA-SX E42. Brake Line Upgrades are Available. E44. Includes Front & Rear Dual Rate-Long Travel Coil Springs, Front Adjustable Track Bar, Front Alignment Cam Bolts, Rear Track Bar Bracket, Bump Stops, Sway bar Links & Shocks.

JEEP



	Steering Stabilizers						HYDRO Shocks		NITRO Shocks		BLACK MAX		M95 Shocks		Labor
	White		Black		Silver		White		White		Black		Silver		Hours
	OEM	Dual	OEM	Dual	OEM	Dual	Front	Rear	Front	Rear	Front	Rear	Front	Rear	

	7003	7203 <sup>(B)</sup>	8003	8203 <sup>(B)</sup>	9003	9203 <sup>(B)</sup>	---	---	N8005	N8007	---	---	---	---	4
(B). BOOT NOT INCLUDED DUE TO CLEARANCE ISSUES.															

	7003	7203 <sup>(B)</sup>	8003	8203 <sup>(B)</sup>	9003	9203 <sup>(B)</sup>	H7001	---	N8001	---	B8501	---	M9501	---	1
--	------	---------------------	------	---------------------	------	---------------------	-------	-----	-------	-----	-------	-----	-------	-----	---

	7003	7203 <sup>(B)</sup>	8003	8203 <sup>(B)</sup>	9003	9203 <sup>(B)</sup>	---	H7007	---	N8007	---	B8507	---	M9507	1
--	------	---------------------	------	---------------------	------	---------------------	-----	-------	-----	-------	-----	-------	-----	-------	---

	7003	7203 <sup>(B)</sup>	8003	8203 <sup>(B)</sup>	9003	9203 <sup>(B)</sup>	H7035	H7037	N8035	N8037	B8535	B8537	M9535	M9537	3
--	------	---------------------	------	---------------------	------	---------------------	-------	-------	-------	-------	-------	-------	-------	-------	---

	7003	7203 <sup>(B)</sup>	8003	8203 <sup>(B)</sup>	9003	9203 <sup>(B)</sup>	H7035	H7007	N8035	N8007	B8535	B8507	M9535	M9507	3
(B). BOOT NOT INCLUDED DUE TO CLEARANCE ISSUES.															

**NOTE: Unless Noted "Included" Under Shock Series SHOCKS & STABILIZERS ORDERED SEPARATELY**

	7003	7203 <sup>(B)</sup>	8003	8203 <sup>(B)</sup>	9003	9203 <sup>(B)</sup>	Included	Included	---	---	---	---	---	---	5
	7003	7203 <sup>(B)</sup>	8003	8203 <sup>(B)</sup>	9003	9203 <sup>(B)</sup>	---	---	Included	Included	---	---	---	---	5
	7003	7203 <sup>(B)</sup>	8003	8203 <sup>(B)</sup>	9003	9203 <sup>(B)</sup>	---	---	---	---	Included	Included	---	---	5
	7003	7203 <sup>(B)</sup>	8003	8203 <sup>(B)</sup>	9003	9203 <sup>(B)</sup>	---	---	---	---	---	---	Included	Included	5

(B). BOOT NOT INCLUDED DUE TO CLEARANCE ISSUES.

	7003	7203 <sup>(B)</sup>	8003	8203 <sup>(B)</sup>	9003	9203 <sup>(B)</sup>	Included	Included	---	---	---	---	---	---	6
	7003	7203 <sup>(B)</sup>	8003	8203 <sup>(B)</sup>	9003	9203 <sup>(B)</sup>	---	---	Included	Included	---	---	---	---	6
	7003	7203 <sup>(B)</sup>	8003	8203 <sup>(B)</sup>	9003	9203 <sup>(B)</sup>	---	---	---	---	Included	Included	---	---	6
	7003	7203 <sup>(B)</sup>	8003	8203 <sup>(B)</sup>	9003	9203 <sup>(B)</sup>	---	---	---	---	---	---	Included	Included	6

(B). BOOT NOT INCLUDED DUE TO CLEARANCE ISSUES.

**NOTE: Unless Noted "Included" Under Shock Series SHOCKS & STABILIZERS ORDERED SEPARATELY**

	7003	7203 <sup>(B)</sup>	8003	8203 <sup>(B)</sup>	9003	9203 <sup>(B)</sup>	Included	Included	---	---	---	---	---	---	5
	7003	7203 <sup>(B)</sup>	8003	8203 <sup>(B)</sup>	9003	9203 <sup>(B)</sup>	---	---	Included	Included	---	---	---	---	5
	7003	7203 <sup>(B)</sup>	8003	8203 <sup>(B)</sup>	9003	9203 <sup>(B)</sup>	---	---	---	---	Included	Included	---	---	5
	7003	7203 <sup>(B)</sup>	8003	8203 <sup>(B)</sup>	9003	9203 <sup>(B)</sup>	---	---	---	---	---	---	Included	Included	5

(B). BOOT NOT INCLUDED DUE TO CLEARANCE ISSUES.

	7003	7203 <sup>(B)</sup>	8003	8203 <sup>(B)</sup>	9003	9203 <sup>(B)</sup>	Included	Included	---	---	---	---	---	---	6
	7003	7203 <sup>(B)</sup>	8003	8203 <sup>(B)</sup>	9003	9203 <sup>(B)</sup>	---	---	Included	Included	---	---	---	---	6
	7003	7203 <sup>(B)</sup>	8003	8203 <sup>(B)</sup>	9003	9203 <sup>(B)</sup>	---	---	---	---	Included	Included	---	---	6
	7003	7203 <sup>(B)</sup>	8003	8203 <sup>(B)</sup>	9003	9203 <sup>(B)</sup>	---	---	---	---	---	---	Included	Included	6

(B). BOOT NOT INCLUDED DUE TO CLEARANCE ISSUES.



# JEEP

LIFT	Quick Kit	KIT NOTES	Component Box	Front Springs		Rear Springs		Steering Correction
	Reference		(Requires 1 of Each)	Qty	Part #	Qty	Part #	

## 07-18 WRANGLER JK & RUBICON 2 & 4 DOOR 2WD / 4WD

### LONG ARM SERIES, FRONT & REAR DUAL RATE-LONG TRAVEL COIL SPRINGS

#### 07-18 Wrangler JK & Rubicon 2 & 4 Door 2WD / 4WD Includes Long Arm Upper & Lower Links, Front & Rear Coil Springs

Lift	Quick Kit Reference	KIT NOTES	Component Box	Qty	Part #	Qty	Part #	Steering Correction
4-5"	JK40LAK-SX	E24, E26, E27, E41	JK46LA-SX + JK45LA + JKFTBA717	1	JKU40FDR	1	JKU40RDR	
6-7"	JK60LAK-SX	E24, E26, E27	JK46LA-SX + JK67LA + JKFTBA717	1	JK60FDR	1	JK60RDR	

KIT NOTES: E24. 2 Door Models receive an Additional 1" of Lift Over 4 Door Models. 6-7" Kit - New Front & Rear Drive Shaft is Required. OEM Wheel can be Used. E26. 2 Door Models will Require Rear CV Driveshaft. Part # CAM700 Required for 2 Door Models for Optimum Pinion Adjustment. E27. For 12-18 Models - 3.5" Lifts & Up will Require Exhaust Spacers Part # JK36ESK. E41. Optional 4" Long Travel Dual Rate Coils available at additional cost, replace Front Springs w/JKU40FDR & Rear Coil Springs w/JKU40RDR. Factory Skid Plates Can Not be Re-Used with Long Arm Series.

## 07-18 WRANGLER JK & RUBICON 2 & 4 DOOR 2WD / 4WD

### Coil-Over Systems

#### 07-18 Wrangler JK & Rubicon 2 & 4 Door 4WD Short Arm Coil-Over Systems

Lift	Quick Kit Reference	KIT NOTES	Component Box	Front Coil-Overs		Rear Coil-Overs		Steering Correction
				Qty	Part #	Qty	Part #	
3.5-4.5"	JK40SLSK-SX	E26, E29	JK62FLSB + JK42RLSB + JK24LLX + JKFTBA717	1	JK62FLS	1	JK62RLS	
5-6"	JK60SLSK-SX	E26, E29, E30	JK62FLSB + JK62RLSB + JK24LLX + JKFTBA717	1	JK62FLS	1	JK62RLS	

KIT NOTES: E26. 2 Door Models will Require Rear CV Driveshaft. Part # CAM700 Required for 2 Door Models for Optimum Pinion Adjustment. E29. Optional air bump stop kit available. Part# JKLSAB (Front), Part# JKLSABR (Rear). E30. 2 Door Models require upper rear adjustable arms. Part# JKULR26-SX.

### Coil-Over Extreme Travel Systems

#### 07-18 Wrangler JK & Rubicon 2 & 4 Door 4WD Long Arm Coil-Over Extreme Travel Systems

Lift	Quick Kit Reference	KIT NOTES	Component Box	Front Coil-Overs		Rear Coil-Overs		Steering Correction
				Qty	Part #	Qty	Part #	
3.5-4.5"	JK44LLSK-SX	E26, E28, E29	JK62FLSB + JK42RLSB + JK46LA-SX + JKFTBA717	1	JK62FLS	1	JK62RLS	
5-6"	JK64LLSK-SX	E26, E28, E29	JK62FLSB + JK62RLSB + JK46LA-SX + JKFTBA717	1	JK62FLS	1	JK62RLS	

KIT NOTES: Factory Skid Plates Can Not be Re-Used with Long Arm Series. E26. 2 Door Models will Require Rear CV Driveshaft. Part # CAM700 Required for 2 Door Models for Optimum Pinion Adjustment. E28. Driveshaft Modifications required. Maximum 4.5" backspacing is required. E29. Optional air bump stop kit available. Part# JKLSAB (Front), Part# JKLSABR (Rear).

## 07-18 WRANGLER JK & RUBICON 2 & 4 DOOR 2WD / 4WD

### WRANGLER JK OPTIONS

Part #	Description	Lift
JKLL24F	Standard Front Lower Links - Pair	2-4"
JKLL24R	Standard Rear Lower Links - Pair	2-4"
JK24LLX	Single Flex Front and Rear Lower Links with Currie Johnny Joints - Set	2-5"
JKLL24F-SX	Single Flex Front Lower Links with Currie Johnny Joints - Pair	2-5"
JKLL24R-SX	Single Flex Rear Lower Links with Currie Johnny Joints - Pair	2-5"
JKULF26-SX	Single Flex Front Upper Links - Pair	2-7"
JKULR26-SX	Single Flex Rear Upper Links - Pair	2-7"

**E31.** Heavy Duty Lower Links & Single Flex Bent Links Upgrade Available. Front & Rear Lower **FLEX** Links with Currie Johnny Joints. Order Part# **JL24LLX**. Front & Rear Heavy Duty Lower Links. Order Part# **JL24LL**.



	Steering Stabilizers						HYDRO Shocks		NITRO Shocks		BLACK MAX		M95 Shocks		Labor
	White		Black		Silver		White		White		Black		Silver		Hours
	OEM	Dual	OEM	Dual	OEM	Dual	Front	Rear	Front	Rear	Front	Rear	Front	Rear	

**NOTE: Unless Noted "Included" Under Shock Series SHOCKS & STABILIZERS ORDERED SEPARATELY**

	7003	7203 <sup>(B)</sup>	8003	8203 <sup>(B)</sup>	9003	9203 <sup>(B)</sup>	H7065	H7067	N8065	N8067	B8565	B8567	M9565	M9567	10
	7003	7203 <sup>(B)</sup>	8003	8203 <sup>(B)</sup>	9003	9203 <sup>(B)</sup>	H7075	H7087	N8075	N8087	B8575	B8587	M9575	M9587	10

(B). BOOT NOT INCLUDED DUE TO CLEARANCE ISSUES.

**NOTE: Unless Noted "Included" Under Shock Series SHOCKS & STABILIZERS ORDERED SEPARATELY**

	7003	7203 <sup>(B)</sup>	8003	8203 <sup>(B)</sup>	9003	9203 <sup>(B)</sup>	----	----	----	----	----	----	----	----	12
	7003	7203 <sup>(B)</sup>	8003	8203 <sup>(B)</sup>	9003	9203 <sup>(B)</sup>	----	----	----	----	----	----	----	----	12

(B). BOOT NOT INCLUDED DUE TO CLEARANCE ISSUES.

	7003	7203 <sup>(B)</sup>	8003	8203 <sup>(B)</sup>	9003	9203 <sup>(B)</sup>	----	----	----	----	----	----	----	----	12
	7003	7203 <sup>(B)</sup>	8003	8203 <sup>(B)</sup>	9003	9203 <sup>(B)</sup>	----	----	----	----	----	----	----	----	12

(B). BOOT NOT INCLUDED DUE TO CLEARANCE ISSUES.

**WRANGLER JK OPTIONS**

Part #	Description	Lift
JKFTBA717	Front Adjustable Track Bar	1-4"
JKRTBA717	Rear Adjustable Track Bar	1-4"
TGSJK1	Tailgate Saver - Spare Tire Support Kit	----
STRJK212	Spare Tire Relocation Kit	----
TGSSTR1	Tailgate Saver - Spare Tire Support & Spare Tire Relocation Combo Kit	----
JKLSAB	Air Bump Stop Kit (FRONT)	----
JK36ESK	Exhaust Spacer (Will not fit JK and JKU models with 3.6L Engine)	4-6"



# JEEP

LIFT	Quick Kit	KIT NOTES	Component Box	Front Springs		Rear Springs		Add-A-Leafs	Steering Correction
	Reference		(Requires 1 of Each)	Qty	Part #	Qty	Part #		(Order 1 Each)
<b>04-06 WRANGLER TJ UNLIMITED LJ / RUBICON UNLIMITED 4WD</b>									
<b>POLYURETHANE VALUE KIT</b>									
<b>04-06 Wrangler TJ Unl. LJ / Rubicon Unl. 4WD</b>			<b>3/4" Front or Rear Polyurethane Spacers</b>						
3/4"	SIP275		SIP275						
			<b>2" Front &amp; Rear Polyurethane Spacers</b>						
2"	TJ20		TJ20						
<b>STANDARD SERIES - SHORT ARM LOWER LINKS ONLY</b>									
<b>04-06 Wrangler TJ Unl. LJ / Rubicon Unl. 4WD</b>			<b>Includes Front &amp; Rear Coil Springs</b>						
2.5"	TJ253KU	E8, E12	TJ253	1	TJ25F	1	TJ25R*		
3"	TJ30BPH	E8, E12	TJ30BPH		Included		Included		
4"	TJ403KU	E8, E12, E27	TJ403	1	TJ40F	1	TJ40R*		
4"	TJ403BPH	E8, E12, E27	TJ403BPH*		Included		Included		
KIT NOTES: * E8. Vehicles with 4 Cyl Engines &/or Soft Tops will Sit a Little Higher Due to the Weight Difference. E12. Optional Stainless Steel Extended Brake Lines Available. E27. Incl Front & Rear Coils, Front & Rear Lower Links, Transfer Case Lowering Kit, Rear Track Bar Bracket, Bumpstop Extensions, F&R Extended End Links & Shocks.									
<b>VALUE FLEX SERIES - SHORT ARMS WITH LOWER LINKS ONLY</b>									
<b>04-06 Wrangler TJ Unl. LJ / Rubicon Unl. 4WD</b>			<b>Includes Front &amp; Rear Coil Springs (Includes NG Rebuildable Rod Ends)</b>						
2.5"	TJ253KU-SVX	E8, E12, E22	TJ253-SVX	1	TJ25F	1	TJ25R*		
4"	TJ403KU-SVX	E8, E12, E22	TJ403-SVX	1	TJ40F	1	TJ40R*		
KIT NOTES: * E8. Vehicles with 4 Cyl Engines &/or Soft Tops will Sit a Little Higher Due to the Weight Difference. E31. Option 4" Long Travel Dual-Rate Coils available at additional cost, replace front springs w/TJ40FDR & rear coil springs w/TJ40RDR E12. See Brake Lines Section. E22. 6 Speed Models May Require Additional Modification. Contact Skyjacker® for more Information. * Part # SIP275 May be Required on Hard Top Models to Level the Rear.									
<b>03-06 WRANGLER TJ &amp; RUBICON 4WD</b>									
<b>POLYURETHANE VALUE KIT</b>									
<b>03-06 Wrangler TJ / Rubicon 4WD System</b>			<b>3/4" Front or Rear Polyurethane Spacers</b>						
3/4"	SIP275		SIP275						
			<b>Polyurethane Spacers</b>						
2"	TJ20		TJ20						
<b>FRONT &amp; REAR DUAL RATE-LONG TRAVEL SYSTEMS</b>									
<b>97-06 Wrangler TJ / Rubicon 4WD System</b>			<b>Includes Front &amp; Rear Dual Rate-Long Travel Coil Springs &amp; Shocks</b>						
2.5"	TJ25BPHLT	E24	TJ25BPHLT		Included		Included		
2.5"	TJ25BPNLT	E24	TJ25BPNLT		Included		Included		
2.5"	TJ25BPBLT	E24	TJ25BPBLT		Included		Included		
2.5"	TJ25BPMLT	E24	TJ25BPMLT		Included		Included		
4"	TJ403BPHLT	E25	TJ403BPHLT		Included		Included		
4"	TJ403BPNLT	E25	TJ403BPNLT		Included		Included		
4"	TJ403BPBLT	E25	TJ403BPBLT		Included		Included		
4"	TJ403BPMLT	E25	TJ403BPMLT		Included		Included		
KIT NOTES: E24. Includes Dual Rate Long Travel F&R Coils, Rear Track Bar Bracket, F&R Bumpstop Extensions, Rear Upper Cam Bolts & Shocks. E25. Incl Dual Rate Long Travel F&R Coils, Front & Rear Lower Links, Transfer Case Lowering Kit, Rear Track Bar Bracket, Bumpstop Extensions, F&R Extended End Links & Shocks.									
<b>STANDARD KITS</b>									
<b>03-06 Wrangler TJ / Rubicon 4WD System</b>			<b>Includes Front &amp; Rear Coil Springs &amp; Shocks</b>						
3"	TJ30BPH	E26	Included		Included		Included		
KIT NOTES: E26. Includes F&R Coil Springs, Rear Track Bar Bracket, Upper Rear Cam Bolts, F&R Bump Stops. Optional Lower Control Arms Part # TJLL24. Optional Transfer Case Lowering Kit Part # TCL103.									
<b>ROCK READY® 1 SERIES - DUAL RATE-LONG TRAVEL LONG ARMS WITH LOWER ROCK READY® LINKS</b>									
<b>03-06 Wrangler TJ / Rubicon 4WD System</b>			<b>Rock Ready® Kit (Includes NG Rebuildable Rod Ends)</b>						
4"	TJ40RR1LTK	E8, E10, E22	TJ40RRX+TJ40XRR1	1	TJ40FDR	1	TJ40RDR		Included (E10)
6"	TJ60RR1LTK	E5, E8, E10, E16, E22	TJ68RRX+TJ60RR1	1	TJ60FDR	1	TJ60RDR		Included (E10)
<b>ROCK READY® 2 SERIES - LONG ARMS WITH UPPER &amp; LOWER ROCK READY® LINKS</b>									
<b>03-06 Wrangler TJ / Rubicon 4WD System</b>			<b>Rock Ready® Kit (Includes NG Rebuildable Rod Ends)</b>						
6"	TJ60RR2LTK	E5, E8, E10, E16, E22	TJ68RRX+TJ60X2	1	TJ60FDR	1	TJ60RDR		Included (E10)
KIT NOTES: E5. Slip Yoke Eliminator Kit # RR231 & Replacement CV Driveshaft is REQUIRED. Available Direct from Skyjacker®. E8. Vehicles with 4 Cylinder Engines &/or Soft Tops will Sit a Little Higher Due to the Weight Difference. E10. # JA750 Included for Power Steering - Order # JA850 for Manual Steering. E16. Modifications to the Factory Exhaust Cross-Over Pipe will be Necessary. E22. 6 Speed Models May Require Additional Modification. Contact Skyjacker® for more Information.									

	Steering Stabilizers									HYDRO Shocks		NITRO Shocks		BLACK MAX		M95 Shocks		Labor Hours
	White			Black			Silver			White		White		Black		Silver		
	OEM	Single	Dual	OEM	Single	Dual	OEM	Single	Dual	Front	Rear	Front	Rear	Front	Rear	Front	Rear	

**NOTE: UNLESS NOTE "INCLUDED" UNDER SHOCK SERIES, ALL SHOCKS MUST BE ORDERED SEPARATELY**

	7009		7219	8009		8219	9009		9219	H7016	H7008	N8016	N8008	B8516	B8508	M9516	M9508	2
	7009		7219	8009		8219	9009		9219	H7016	H7018	N8016	N8018	B8516	B8518	M9516	M9518	3
	7009		7219	8009		8219	9009		9219	H7016	H7018	N8016	N8018	B8516	B8518	M9516	M9518	4
	7009		7219	8009		8219	9009		9219	Included	Included							4
	7009		7219	8009		8219	9009		9219	H7025	H7028	N8025	N8028	B8525	B8528	M9525	M9528	6
	7009		7219	8009		8219	9009		9219	Included	Included							6

**NOTE: UNLESS NOTE "INCLUDED" UNDER SHOCK SERIES, ALL SHOCKS MUST BE ORDERED SEPARATELY**

	7009		7219	8009		8219	9009		9219	H7016	H7018	N8016	N8018	B8516	B8518	M9516	M9518	6
	7009		7219	8009		8219	9009		9219	H7025	H7028	N8025	N8028	B8525	B8528	M9525	M9528	7
	7009		7219	8009		8219	9009		9219	Included	Included							4
	7009		7219	8009		8219	9009		9219			Included	Included					4
	7009		7219	8009		8219	9009		9219					Included	Included			4
	7009		7219	8009		8219	9009		9219	Included	Included					Included	Included	4
	7009		7219	8009		8219	9009		9219			Included	Included					6
	7009		7219	8009		8219	9009		9219			Included	Included					6
	7009		7219	8009		8219	9009		9219					Included	Included			6
	7009		7219	8009		8219	9009		9219							Included	Included	6

	7009		7219	8009		8219	9009		9219	Included	Included							4
--	------	--	------	------	--	------	------	--	------	----------	----------	--	--	--	--	--	--	---

	Included	7112				8112			9112	H7025	H7028	N8025	N8028	B8525	B8528	M9525	M9528	10
	Included	7112				8112			9112	H7049	H7063	N8049	N8063	B8549	B8563	M9549	M9563	12

	Included	7112				8112			9112	H7049	H7063	N8049	N8063	B8549	B8563	M9549	M9563	12
--	----------	------	--	--	--	------	--	--	------	-------	-------	-------	-------	-------	-------	-------	-------	----



# JEEP

LIFT	Quick Kit	KIT NOTES	Component Box	Front Springs		Rear Springs		Add-A-Leafs	Steering Correction
	Reference		(Requires 1 of Each)	Qty	Part #	Qty	Part #		(Order 1 Each)

## 97-02 WRANGLER TJ 4WD

### POLYURETHANE VALUE KIT

<b>97-02 Wrangler TJ 4WD Kit</b>		<b>3/4" Front or Rear Polyurethane Spacers</b>							
3/4"	SIP275		SIP275						
<b>2" Front &amp; Rear Polyurethane Spacers</b>									
2"	TJ20		TJ20						

### FRONT & REAR DUAL RATE-LONG TRAVEL SYSTEMS

<b>97-02 Wrangler TJ/Rubicon 4WD System</b>		<b>Includes Dual Rate-Long Travel Front &amp; Rear Coil Springs &amp; Shocks</b>							
2.5"	TJ25BPHLT	E24	TJ25BPHLT		Included		Included		
2.5"	TJ25BPNTL	E24	TJ25BPNTL		Included		Included		
2.5"	TJ25BPBLT	E24	TJ25BPBLT		Included		Included		
2.5"	TJ25BPMLT	E24	TJ25BPMLT		Included		Included		
4"	TJ401BPHLT	E25	TJ401BPHLT		Included		Included		
4"	TJ401BPNTL	E25	TJ401BPNTL		Included		Included		
4"	TJ401BPBLT	E25	TJ401BPBLT		Included		Included		
4"	TJ401BPBMT	E25	TJ401BPMLT		Included		Included		

KIT NOTES: E24. Includes Dual Rate Long Travel F&R Coils, Rear Track Bar Bracket, F&R Bumpstop Extensions, Rear Upper Cam Bolts & Shocks. E25. Incl Dual Rate Long Travel F&R Coils, Front & Rear Lower Links, Transfer Case Lowering Kit, Rear Track Bar Bracket, Bumpstop Extensions, F&R Extended End Links & Shocks.

### STANDARD SERIES - SHORT ARM LOWER LINKS ONLY

<b>97-02 Wrangler TJ 4WD System</b>		<b>Includes SOFTRIDE® Front &amp; Rear Springs &amp; Shocks</b>							
3"	TJ30BPH	E15	TJ30BPH		Included		Included		

KIT NOTES: E15. Includes F&R Coil Springs, F&R Bump Stops, Rear Track Bar Bracket & Upper Rear Cam Bolts. Optional Lower Control Arms Part # TJLL24. Optional Transfer Case Lowering Kit Part # TCL101.

### VALUE FLEX SERIES - FLEX ARMS WITH LOWER LINKS, DUAL RATE-LONG TRAVEL FRONT & REAR COIL SPRINGS

<b>97-02 Wrangler TJ 4WD System</b>		<b>Incl Dual Rate-Long Travel Front &amp; Rear Coil Springs (NG Rebuildable Rod Ends)</b>							
2.5"	TJ251K-SVX	E8, E12	TJ251-SVX	1	TJ25FDR	1	TJ25RDR		
4"	TJ401K-SVX	E8, E12	TJ401-SVX	1	TJ40FDR	1	TJ40RDR		

KIT NOTES: E8. Vehicles with 4 Cylinder Engines &/or Soft Tops will Sit a Little Higher Due to the Weight Difference. E12. See Brake Lines Section.

### ROCK READY® 1 SERIES - LONG ARMS W/DUAL RATE-LONG TRAVEL FRONT & REAR COIL SPRINGS

<b>97-02 Wrangler TJ / Rubicon 4WD System</b>		<b>Rock Ready® Kit (Includes NG Rebuildable Rod Ends)</b>							
4"	TJ40RR1LTK	E8, E10, E23	TJ40RRX+TJ40XRR1	1	TJ40FDR	1	TJ40RDR		Included (E10)
6"	TJ60RR1LTK	E5, E8, E10, E16, E23	TJ68RRX+TJ60RR1	1	TJ60FDR	1	TJ60RDR		Included (E10)

### ROCK READY® 2 SERIES - LONG ARMS W/DUAL RATE-LONG TRAVEL FRONT & REAR COIL SPRINGS

<b>97-02 Wrangler TJ / Rubicon 4WD System</b>		<b>Rock Ready® Kit (Includes NG Rebuildable Rod Ends)</b>							
6"	TJ60RR2LTK	E5, E8, E10, E16	TJ68RRX+TJ60X2	1	TJ60FDR	1	TJ60RDR		Included (E10)

KIT NOTES: E5. Slip Yoke Eliminator Kit # RR231 & Replacement CV Driveshaft is REQUIRED. Available Direct from Skyjacker®. E8. Vehicles with 4 Cylinder Engines &/or Soft Tops will Sit a Little Higher Due to the Weight Difference. E10. # JA750 Included for Power Steering - Order # JA850 for Manual Steering. E16. Modifications to Factory Exhaust Cross-Over Pipe will be Necessary. E23. Order Part # JUL48SFX to make Rock Ready 2, which Includes Upper Front & Rear Links.

### DUAL RATE-LONG TRAVEL COIL SPRINGS

Part#	Description	Lift	Year
TJ25FDR	Front Dual Rate-Long Travel Coils, Pr	2.5"	1997-06
TJ40FDR	Front Dual Rate-Long Travel Coils, Pr	4"	1997-06
TJ60FDR	Front Dual Rate-Long Travel Coils, Pr	6"	1997-06
TJ80FDR	Front Dual Rate-Long Travel Coils, Pr	8"	1997-06

### SPORT SERIES SYSTEMS

#### 87-96 WRANGLER YJ 4WD

<b>87-96 Wrangler YJ 4WD System</b>		<b>*With Power Steering</b>							
2.5"	YJ21BKH		YJ21BH	2	YJ20FSB	2	YJ20RSB		
4"	YJ41BKH	E12, E19, E20	YJ41BH	2	YJ40FSB	2	YJ40RSB		JA750*

KIT NOTES: E12. See Brake Lines Section. E19. Front Sway Bar Links Included. E20. Transfer Case Lowering Kit Included.

\*For Manual Steering  
Order JA850

### SOFTRIDE® LEAF SPRING SYSTEMS

<b>87-96 Wrangler YJ 4WD System</b>		<b>*With Power Steering</b>							
2-2.5"	YJ20K		YJ20	2	YJ20FS	2	YJ20RS		
3.5-4"	YJ40K	E12, E17, E18	YJ40	2	YJ40FS	2	YJ40RS		JA750*

KIT NOTES: E12. See Brake Lines Section. E17. Optional Front Sway Bar End Links Available - Part# SBE425 (Double Disconnects) or Part# SBE607 (Fixed). Standard E18. Transfer Case Lowering Kit Required. Part # TCL25.

\*For Manual Steering  
Order JA850

	Steering Stabilizers									HYDRO Shocks		NITRO Shocks		BLACK MAX		M95 Shocks		Labor Hours
	White			Black			Silver			White		White		Black		Silver		
	OEM	Single	Dual	OEM	Single	Dual	OEM	Single	Dual	Front	Rear	Front	Rear	Front	Rear	Front	Rear	

**NOTE: UNLESS NOTE "INCLUDED" UNDER SHOCK SERIES, ALL SHOCKS MUST BE ORDERED SEPARATELY**

	7009		7219	8009		8219	9009		9219	H7016	H7008	N8016	N8008	B8516	B8508	M9516	M9508	2
	7009	7119	7219	8009	8119	8219	9009	9119	9219	H7016	H7018	N8016	N8018	B8516	B8518	M9516	M9518	3
	7009		7219	8009		8219	9009		9219	Included	Included							4
	7009		7219	8009		8219	9009		9219			Included	Included					4
	7009		7219	8009		8219	9009		9219					Included	Included			4
	7009		7219	8009		8219	9009		9219							Included	Included	4
	7009		7219	8009		8219	9009		9219	Included	Included							6
	7009		7219	8009		8219	9009		9219			Included	Included					6
	7009		7219	8009		8219	9009		9219					Included	Included			6
	7009		7219	8009		8219	9009		9219							Included	Included	6

	7009	7119	7219	8009	8119	8219	9009	9119	9219	Included	Included							4
--	------	------	------	------	------	------	------	------	------	----------	----------	--	--	--	--	--	--	---

	7009	7119	7219	8009	8119	8219	9009	9119	9219	H7016	H7018	N8016	N8018	B8516	B8518	M9516	M9518	6
	7009	7119	7219	8009	8119	8219	9009	9119	9219	H7025	H7028	N8025	N8028	B8525	B8528	M9525	M9528	7

	Included	7112			8112			9112		H7025	H7028	N8025	N8028	B8525	B8528	M9525	M9528	10
	Included	7112			8112			9112		H7049	H7063	N8049	N8063	B8549	B8563	M9549	M9563	12

	Included	7112			8112			9112		H7049	H7063	N8049	N8063	B8549	B8563	M9549	M9563	12
--	----------	------	--	--	------	--	--	------	--	-------	-------	-------	-------	-------	-------	-------	-------	----

**DUAL RATE-LONG TRAVEL COIL SPRINGS**

Part#	Description	Lift	Year
TJ25RDR	Rear Dual Rate-Long Travel Coils, Pr	2.5"	1997-06
TJ40RDR	Rear Dual Rate-Long Travel Coils, Pr	4"	1997-06
TJ60RDR	Rear Dual Rate-Long Travel Coils, Pr	6"	1997-06

**NOTE: UNLESS NOTE "INCLUDED" UNDER SHOCK SERIES, ALL SHOCKS MUST BE ORDERED SEPARATELY**

	7009	7109	7200	8009	8109	8200	9009	9109	9200	Included	Included							4
	7009	7109	7200	8009	8109	8200	9009	9109	9200	Included	Included							6

	7009	7109	7200	8009	8109	8200	9009	9109	9200	H7056	H7023	N8056	N8023	B8556	B8523	M9556	M9523	4
	7009	7109	7200	8009	8109	8200	9009	9109	9200	H7059	H7088	N8059	N8088	B8559	B8588	M9559	M9558	6



# JEEP

LIFT	Quick Kit	KIT NOTES	Component Box	Front Springs		Rear Springs		Add-A-Leafs	Steering Correction
	Reference		(Requires 1 of Each)	Qty	Part #	Qty	Part #		(Order 1 Each)

## ROCK READY® DOUBLE MILITARY WRAP

87-96 Wrangler YJ 4WD System			*With Power Steering						
2.5"	YJ25K	E6, E7, E12	YJ25	2	YJ25FS	2	YJ25RS		
4"	YJ45K	E6, E12, E17, E18	YJ45	2	YJ45FS	2	YJ45RS		JA750*

KIT NOTES: E6. # YJ5LK - 5th Link Traction Bar is Highly Recommended - See Jeep Accessories. E7. Can be Used as Spring - Over Axle Application. E12. See Brake Lines Section. E17. Optional Front Sway Bar End Links Available - Part# SBE425 (Double Disconnects) or Part# SBE607 (Fixed). E18. Transfer Case Lowering Kit Required. Part # TCL25. \*For Manual Steering Order JA850

## ROCK READY® MONOLINEAR (SINGLE LEAF SPRING)

87-96 Wrangler YJ 4WD System			*With Power Steering						
6"	YJ60MK	E4, E5, E6	YJ60M	2	Included	2	Included		JA750*

KIT NOTES: E4. This Component Box Includes the 4 Monolinear Leaves. E5. Slip Yoke Eliminator Kit # RR231 & Replacement CV Driveshaft is REQUIRED. Available Direct from Skyjacker®. E6. # YJ5LK - 5th Link Traction Bar is Highly Recommended - See Jeep Accessories. \*For Manual Steering Order JA850

## 76-86 CJ5, CJ7, CJ8 4WD

### SPORT SERIES SYSTEMS

76-86 CJ5, CJ7, CJ8 WD System			With Power Steering						
2.5"	J21BKH	E2, E12	J21BH	2	J20FSB	2	J20RSB		
4"	J41BKH	E2, E12	J41BH	2	J40FSB	2	J40RSB		JA250

KIT NOTES: E2. Scrambler Models May Require an Additional Rear "Fitted" Leaf (Ordered Separately - See Leaf Springs Section). E12. See Brake Lines Section.

76-86 CJ5, CJ7, CJ8 WD System			With Manual Steering						
2.5"	J21BKH	E2, E12	J21BH	2	J20FSB	2	J20RSB		
4"	J41BKH	E2, E12	J41BH	2	J40FSB	2	J40RSB		JA150

KIT NOTES: E2. Scrambler Models May Require an Additional Rear "Fitted" Leaf (Ordered Separately - See Leaf Springs Section). E12. See Brake Lines Section.

### SOFTRIDE® LEAF SPRING SYSTEMS

76-86 CJ5, CJ7, CJ8 4WD System			With Power Steering						
2-2.5"	J20K	E2, E12	J24	2	J20FS	2	J20RS		
3.5-4"	J40K	E2, E12	J24	2	J40FS	2	J40RS		JA250

KIT NOTES: E2. Scrambler Models May Require an Additional Rear "Fitted" Leaf (Ordered Separately - See Leaf Springs Section). E12. See Brake Lines Section.

76-86 CJ5, CJ7, CJ8 4WD System			With Manual Steering						
2-2.5"	J20K	E2, E12	J24	2	J20FS	2	J20RS		
3.5-4"	J40K	E2, E12	J24	2	J40FS	2	J40RS		JA150

KIT NOTES: E2. Scrambler Models May Require an Additional Rear "Fitted" Leaf (Ordered Separately - See Leaf Springs Section). E12. See Brake Lines Section.

## 72-75 CJ5, CJ7 4WD

72-75 CJ5, CJ6 4WD System			With Power Steering						
2-2.5"	J32K	E12	J34	2	J32FS	2	J32RS		JA552
3.5-4"	J34K	E12	J34	2	J34FS	2	J34RS		JA550

KIT NOTES: E12. See Brake Lines Section.

72-75 CJ5, CJ6 4WD System			With Manual Steering						
2-2.5"	J32K	E12	J34	2	J32FS	2	J32RS		JA652
3.5-4"	J34K	E12	J34	2	J34FS	2	J34RS		JA650

KIT NOTES: E12. See Brake Lines Section.

## 55-71 CJ5, CJ6 4WD

55-71 CJ5, CJ6 4WD System			Includes Front & Rear Springs						
2-2.5"	J32K	E12	J34	2	J32FS	2	J32RS		
3.5-4"	J34K	E12	J34	2	J34FS	2	J34RS		

KIT NOTES: E12. See Brake Lines Section.



	Steering Stabilizers									HYDRO Shocks		NITRO Shocks		BLACK MAX		M95 Shocks		Labor	
	White			Black			Silver			White		White		Black		Silver			
	OEM	Single	Dual	OEM	Single	Dual	OEM	Single	Dual	Front	Rear	Front	Rear	Front	Rear	Front	Rear	Front	Rear

	7009	7109	7200	8009	8109	8200	9009	9109	9200	H7056	H7023	N8056	N8023	B8556	B8523	M9556	M9523	4
	7009	7109	7200	8009	8109	8200	9009	9109	9200	H7059	H7088	N8059	N8088	B8559	B8588	M9559	M9558	6

	7009	7109	7200	8009	8109	8200	9009	9109	9200	H7061	H7088	N8061	N8088	B8561	B8588	M9561	M9558	10
--	------	------	------	------	------	------	------	------	------	-------	-------	-------	-------	-------	-------	-------	-------	----

**NOTE: UNLESS NOTE "INCLUDED" UNDER SHOCK SERIES, ALL SHOCKS MUST BE ORDERED SEPARATELY**

	7001	7100	7200	8009	8100	8200	9009	9100	9200	Included	Included	----	----	----	----	----	----	4
	7001	7100	7200	8009	8100	8200	9009	9100	9200	Included	Included	----	----	----	----	----	----	5

	7001	7100	7200	8009	8100	8200	9009	9100	9200	Included	Included	----	----	----	----	----	----	4
	7001	7100	7200	8009	8100	8200	9009	9100	9200	Included	Included	----	----	----	----	----	----	5

	7001	7100	7200	8009	8100	8200	9009	9100	9200	H7012	H7023	N8012	N8023	B8512	B8523	M9512	M9523	4
	7001	7100	7200	8009	8100	8200	9009	9100	9200	H7023	H7058	N8023	N8058	B8523	B8558	M9523	M9558	5

	7001	7100	7200	8009	8100	8200	9009	9100	9200	H7012	H7023	N8012	N8023	B8512	B8523	M9512	M9523	4
	7001	7100	7200	8009	8100	8200	9009	9100	9200	H7023	H7058	N8023	N8058	B8523	B8558	M9523	M9558	5

**NOTE: UNLESS NOTE "INCLUDED" UNDER SHOCK SERIES, ALL SHOCKS MUST BE ORDERED SEPARATELY**

		7100	7200		8100	8200		9100	9200	H7023	H7023	N8023	N8023	B8523	B8523	M9523	M9523	4
		7100	7200		8100	8200		9100	9200	H7058	H7058	N8058	N8058	B8558	B8558	M9558	M9558	5

		7100	7200		8100	8200		9100	9200	H7023	H7023	N8023	N8023	B8523	B8523	M9523	M9523	4
		7100	7200		8100	8200		9100	9200	H7058	H7058	N8058	N8058	B8558	B8558	M9558	M9558	5

**NOTE: UNLESS NOTE "INCLUDED" UNDER SHOCK SERIES, ALL SHOCKS MUST BE ORDERED SEPARATELY**

		7100	7200		8100	8200		9100	9200	H7023	H7023	N8023	N8023	B8523	B8523	M9523	M9523	4
		7100	7200		8100	8200		9100	9200	H7058	H7058	N8058	N8058	B8558	B8558	M9558	M9558	5



# JEEP

LIFT	Quick Kit	KIT NOTES	Component Box	Front Springs		Rear Springs		Add-A-Leafs	Steering Correction
	Reference		(Requires 1 of Each)	Qty	Part #	Qty	Part #		(Order 1 Each)

## 84-01 CHEROKEE XJ 4WD, 2WD

### POLYURETHANE VALUE KIT

#### 84-01 Cherokee XJ 4WD, 2WD Kit **2" Polyurethane Spacers, 1" Lift Rear Shackles**

2"	XJ20		XJ20						
----	------	--	------	--	--	--	--	--	--

KIT NOTES: Includes Rear Lift Shackles.

### SPORT SERIES

#### 84-01 Cherokee XJ 4WD, 2WD Kit **With Rear Add-A-Leafs**

3"	JC301BH	E12	JC301BH		Included			Included	
----	---------	-----	---------	--	----------	--	--	----------	--

KIT NOTES: E12. See Brake Lines Section.

### DUAL RATE-LONG TRAVEL KITS

#### 84-01 Cherokee XJ 4WD, 2WD Kit **With Dual Rate Long Travel Front Coils & Rear Add-A-Leafs**

3"	JC301BPHLT	E26	JC301BPHLT		Included			Included	
3"	JC301BPNTL	E26	JC301BPNTL		Included			Included	
3"	JC301BPBLT	E26	JC301BPBLT		Included			Included	
3"	JC301BPMLT	E26	JC301BPMLT		Included			Included	
4.5"	JC451KHLT	E26	JC45H	1	JC45FDR			R3136	
4.5"	JC451KNLT	E26	JC45N	1	JC45FDR			R3136	
4.5"	JC451KBLT	E26	JC45B	1	JC45FDR			R3136	
4.5"	JC451KMLT	E26	JC45M	1	JC45FDR			R3136	

KIT NOTES: E26. Kit includes Front & Rear Dual Rate Long Travel Coils, Rear Add-A-Leaf, U-Bolts and Shocks.

### DUAL RATE-LONG TRAVEL SYSTEMS

#### 84-01 Cherokee XJ 4WD, 2WD Kit **With Dual Rate Long Travel Front Coils & Replacement Rear Spings**

3"	JC3158KSBLT	E27, E30	JC3158SBLT		Included	2	JC25RSB		
3"	JC3158KSMLT	E27, E30	JC3158SMLT		Included	2	JC25RSB		
4.5"	JC4558KSBLT	E27, E30	JC4558SB	1	JC45FDR	2	JC25RSB		
4.5"	JC4558KSMLT	E27, E30	JC4558SM	1	JC45FDR	2	JC25RSB		
6"	JC6058KSBLT	E27, E30	JC48RRX + JC6058SB	1	JC60FDR	2	JC55RSB		
6"	JC6058KSMLT	E27, E30	JC48RRX + JC6058SM	1	JC60FDR	2	JC55RSB		

KIT NOTES: E27. Kit includes Front & Rear Dual Rate Long Travel Coils, Rear Replacement Leaf Springs, U-Bolts and Shocks.

E30 Fits both Dana 35 and Chrysler 8.25" Rear Axles

### STANDARD SERIES - INCLUDES HEAVY DUTY CONTROL ARMS

#### 84-01 Cherokee XJ 4WD, 2WD Kit **With Rear Add-A-Leafs**

3"	JC301K	E12	JC30	1	JC30F			R3136	
4.5"	JC451K	E12, E14	JC45	1	JC45F			R3136	Included

KIT NOTES: E12. See Brake Lines Section. E14. Includes Bent Lower Control Arms, Upper Control Arms, Adj. Front Track Bar, Longer Rear Spring Shackles

### ROCK READY® 2 SERIES

#### 84-01 Cherokee XJ 4WD, 2WD System **With Replacement Rear Springs (Dana 35 Rear Axle)**

4.5"	JC4552LTKS		JC48RRX+JC405XS2	1	JC45FDR	2	JC25RS		Included
6"	JC6052LTKS	E5, E11	JC48RRX+JC605XS2	1	JC60FDR	2	JC55RS		Included
8"	JC8052LTKS	E5, E11	JC48RRX+JC805XS2	1	JC80FDR	2	JC75RS		Included

#### 84-01 Cherokee XJ 4WD, 2WD System **With Replacement Rear Springs (Chrysler 8.25" Rear Axle)**

4.5"	JC4582LTKS		JC48RRX+JC408XS2	1	JC45FDR	2	JC25RS		Included
6"	JC6082LTKS	E5, E11	JC48RRX+JC608XS2	1	JC60FDR	2	JC55RS		Included
8"	JC8082LTKS	E5, E11	JC48RRX+JC808XS2	1	JC80FDR	2	JC75RS		Included

KIT NOTES: E5. Slip Yoke Eliminator Kit # RR231 (See Jeep Accessories) & Replacement CV Driveshaft is REQUIRED.

E11. Transfer Case Lowering Kit Required - Part # TCL32.

### DUAL RATE-LONG TRAVEL COIL SPRINGS

Part#	Description	Lift	Year
JC30FDR	Front Dual Rate-Long Travel Coils, Pr	3"	1984-01
JC45FDR	Front Dual Rate-Long Travel Coils, Pr	4.5"	1984-01

	Steering Stabilizers									HYDRO Shocks		NITRO Shocks		BLACK MAX		M95 Shocks		Labor Hours
	White			Black			Silver			White		White		Black		Silver		
	OEM	Single	Dual	OEM	Single	Dual	OEM	Single	Dual	Front	Rear	Front	Rear	Front	Rear	Front	Rear	

**NOTE: UNLESS NOTE "INCLUDED" UNDER SHOCK SERIES, ALL SHOCKS MUST BE ORDERED SEPARATELY**

7009				8009					9009			H7016	H7018	N8016	N8018	B8516	B8518	M9516	M9518	3
------	--	--	--	------	--	--	--	--	------	--	--	-------	-------	-------	-------	-------	-------	-------	-------	---

7009				8009					9009			Included	Included	----	----	----	----	----	----	4
------	--	--	--	------	--	--	--	--	------	--	--	----------	----------	------	------	------	------	------	------	---

7009				8009					9009			Included	Included	----	----	----	----	----	----	4
7009				8009					9009			----	----	Included	Included	----	----	----	----	4
7009				8009					9009			----	----	----	----	Included	Included	----	----	4
7009				8009					9009			----	----	----	----	----	----	Included	Included	4
7009				8009					9009			Included	Included	----	----	----	----	----	----	6
7009				8009					9009			----	----	Included	Included	----	----	----	----	6
7009				8009					9009			----	----	----	----	Included	Included	----	----	6
7009				8009					9009			----	----	----	----	----	----	Included	Included	6

7009				8009					9009			----	----	----	----	Included	Included	----	----	6
7009				8009					9009			----	----	----	----	----	----	Included	Included	6
7009				8009					9009			----	----	----	----	Included	Included	----	----	6
7009				8009					9009			----	----	----	----	----	----	Included	Included	6
7009				8009					9009			----	----	----	----	Included	Included	----	----	8
7009				8009					9009			----	----	----	----	----	----	Included	Included	8

7009				8009					9009			H7016	H7018	N8016	N8018	B8516	B8518	M9516	M9518	4
7009				8009					9009			H7025	H7028	N8025	N8028	B8525	B8528	M9525	M9528	6

Included												H7025	H7028	N8025	N8028	B8525	B8528	M9525	M9528	9
Included												H7049	H7063	N8049	N8063	B8549	B8563	M9549	M9563	10
Included												H7049	H7063	N8049	N8063	B8549	B8563	M9549	M9563	12

Included												H7025	H7028	N8025	N8028	B8525	B8528	M9525	M9528	9
Included												H7049	H7063	N8049	N8063	B8549	B8563	M9549	M9563	10
Included												H7049	H7063	N8049	N8063	B8549	B8563	M9549	M9563	12

**DUAL RATE-LONG TRAVEL COIL SPRINGS**

Part#	Description	Lift	Year
JC60FDR	Front Dual Rate-Long Travel Coils, Pr	6"	1984-01
JC80FDR	Front Dual Rate-Long Travel Coils, Pr	8"	1984-01



# JEEP

LIFT	Quick Kit	KIT NOTES	Component Box	Front Springs		Rear Springs		Add-A-Leafs	Steering Correction
	Reference		(Requires 1 of Each)	Qty	Part #	Qty	Part #		(Order 1 Each)
<b>74-91 CHEROKEE / WAGONEER / GRAND WAGONEER 4WD - FULL-SIZE</b>									
<b>84-91 Grand Wagoneer 4WD Kit</b>			<b>With Rear Blocks</b>						
3.5-4"	JP45K	E9, E12	JP45	2	JP40FS				JA350
KIT NOTES: E9. Power Steering Models Only. E12. See Brake Lines Section.									
<b>84-91 Grand Wagoneer 4WD Kit</b>			<b>Includes Front &amp; Rear Full Height Replacement Springs</b>						
3.5-4"	JP45KS	E9, E12	JP45S	2	JP40FS	2	JP40RS		JA350
KIT NOTES: E9. Power Steering Models Only. E12. See Brake Lines Section.									
<b>74-83 Cherokee / Wagoneer 4WD Kit</b>			<b>With Rear Blocks</b>						
3.5-4"	JP40K	E9, E12	JP40	2	JP40FS				JA350
KIT NOTES: E9. Power Steering Models Only. E12. See Brake Lines Section.									
<b>76-83 Cherokee / Wagoneer 4WD System</b>			<b>Includes Front &amp; Rear Full Height Replacement Springs</b>						
3.5-4"	JP40KS	E9, E12	JP40S	2	JP40FS	2	JP40RS		JA350
KIT NOTES: E9. Power Steering Models Only. E12. See Brake Lines Section.									
<b>74-88 J10, J20 PICKUP 4WD - FULL-SIZE</b>									
<b>74-88 J10, J20 Pickup 4WD Kit</b>			<b>With Rear Blocks</b>						
3.5-4"	JP40K	E9, E12	JP40	2	JP40FS				JA350
KIT NOTES: E9. Power Steering Models Only. E12. See Brake Lines Section.									
<b>74-88 J10, J20 Pickup 4WD System</b>			<b>Includes Front &amp; Rear Full Height Replacement Springs</b>						
3.5-4"	JP40KS	E1, E9, E12	JP40S	2	JP40FS	2	JP40RS		JA350
KIT NOTES: E1. 74-75 Models MUST have 131" Wheel Base & 7,200 lb. GVWR or More for Rear Springs to Fit. E9. Power Steering Models Only. E12. See Brake Lines Section.									
<b>86-92 COMANCHE PICKUP MJ 4WD, 2WD</b>									
<b>POLYURETHANE VALUE KIT</b>									
<b>86-92 Comanche Pickup MJ 4WD, 2WD Kit</b>			<b>2" Polyurethane Spacers, 1" Lift Rear Shackles</b>						
2"	XJ20		XJ20						
KIT NOTES: Includes Rear Lift Shackles.									
<b>STANDARD SERIES - SHORT ARM LOWER LINKS ONLY</b>									
<b>86-92 Comanche Pickup MJ 4WD, 2WD Kit</b>			<b>With Rear Add-A-Leafs</b>						
3"	JC351K	E12	JC30	1	JC30F			R3136	
KIT NOTES: E12. See Brake Lines Section.									
<b>VALUE FLEX SERIES - SHORT ARMS WITH LOWER LINKS ONLY</b>									
<b>86-92 Comanche Pickup MJ 4WD, 2WD Kit</b>			<b>With Rear Add-A-Leafs (Includes NG Rebuildable Rod Ends)</b>						
3"	JC351K-SVX	E12	JC30-SVX	1	JC30F			R3136	
KIT NOTES: E12. See Brake Lines Section.									
<b>06-10 COMMANDER XK 4WD, 2WD</b>									
<b>POLYURETHANE VALUE KITS</b>									
<b>06-10 Commander XK 4WD, 2WD Kit</b>			<b>Polyurethane Spacers</b>						
2"	XK20		XK20						
<b>08-12 LIBERTY KK 4WD, 2WD</b>									
<b>08-12 Liberty KK 4WD, 2WD Kit</b>			<b>Polyurethane Spacers</b>						
2.5"	KKN25		KKN25						
<b>08-12 Liberty KK 4WD, 2WD Kit</b>			<b>With Rear Coil Springs</b>						
2.5-3"	LIB258K		LIB250			1	LIB208R		
<b>02-07 LIBERTY KJ 4WD, 2WD</b>									
<b>VALUE KITS</b>									
<b>02-07 Liberty KJ 4WD, 2WD Kit</b>			<b>Polyurethane Spacers</b>						
2.5"	KJ25		KJ25						
KIT NOTES: Installs Inside Strut Assembly.									
<b>PERFORMANCE COIL-OVER® SERIES</b>									
<b>02-07 Liberty KJ 4WD, 2WD System</b>			<b>With Rear Coil Springs</b>						
2.5"	LIB250K	E21	LIB250			1	LIB25R		
KIT NOTES: E21. Skyjacker® Limiting Straps Recommended. Diesel Engines will Sit Lower in Front.									

JEEP

	Steering Stabilizers									HYDRO Shocks		NITRO Shocks		BLACK MAX		M95 Shocks		Labor Hours				
	White			Black			Silver			White		White		Black		Silver						
	OEM	Single	Dual	OEM	Single	Dual	OEM	Single	Dual	Front	Rear	Front	Rear	Front	Rear	Front	Rear					
<b>NOTE: UNLESS NOTE "INCLUDED" UNDER SHOCK SERIES, ALL SHOCKS MUST BE ORDERED SEPARATELY</b>																						
	7009			8009			9009			H7088	H7088	N8088	N8088	B8588	B8588	M9558	M9558	4				
	7009			8009			9009			H7088	H7088	N8088	N8088	B8588	B8588	M9558	M9558	6				
	7005			8005			9005			H7088	H7088	N8088	N8088	B8588	B8588	M9558	M9558	4				
	7005			8005			9005			H7088	H7088	N8088	N8088	B8588	B8588	M9558	M9558	6				
<b>NOTE: UNLESS NOTE "INCLUDED" UNDER SHOCK SERIES, ALL SHOCKS MUST BE ORDERED SEPARATELY</b>																						
	7005			8005			9005			H7088	H7088	N8088	N8088	B8588	B8588	M9558	M9558	4				
	7005			8005			9005			H7088	H7088	N8088	N8088	B8588	B8588	M9558	M9558	6				
<b>NOTE: UNLESS NOTE "INCLUDED" UNDER SHOCK SERIES, ALL SHOCKS MUST BE ORDERED SEPARATELY</b>																						
	7009			8009			9009			H7016	H7023	N8016	N8023	B8516	B8523	M9516	M9523	3				
	7009			8009			9009			H7016	H7023	N8016	N8023	B8516	B8523	M9516	M9523	6				
	7009			8009			9009			H7016	H7023	N8016	N8023	B8516	B8523	M9516	M9523	7				
<b>NOTE: UNLESS NOTE "INCLUDED" UNDER SHOCK SERIES, ALL SHOCKS MUST BE ORDERED SEPARATELY</b>																						
										---	---	H7088	---	---	N8088	---	---	B8588	---	---	M9558	5
<b>NOTE: UNLESS NOTE "INCLUDED" UNDER SHOCK SERIES, ALL SHOCKS MUST BE ORDERED SEPARATELY</b>																						
										---	---	H7088	---	---	N8088	---	---	B8588	---	---	M9558	5
										---	---	H7088	---	---	N8088	---	---	B8588	---	---	M9558	6
<b>NOTE: UNLESS NOTE "INCLUDED" UNDER SHOCK SERIES, ALL SHOCKS MUST BE ORDERED SEPARATELY</b>																						
										---	---	H7088	---	---	N8088	---	---	B8588	---	---	M9558	6
										---	---	H7088	---	---	N8088	---	---	B8588	---	---	M9558	8



# JEEP

LIFT	Quick Kit	KIT NOTES	Component Box	Front Springs		Rear Springs		Add-A-Leafs	Steering Correction
	Reference		(Requires 1 of Each)	Qty	Part #	Qty	Part #		(Order 1 Each)
<b>05-10 GRAND CHEROKEE WK 4WD, 2WD</b>									
<b>POLYURETHANE VALUE KIT</b>									
<b>05-10 Grand Cherokee WK 4WD, 2WD Kit</b> Polyurethane Spacers									
2"	WK20		WK20						
<b>99-04 GRAND CHEROKEE WJ 4WD, 2WD</b>									
<b>POLYURETHANE VALUE KIT</b>									
<b>99-04 Grand Cherokee WJ 4WD, 2WD Kit</b> Polyurethane Spacers									
2"	WJ20		WJ20						
<b>93-98 GRAND CHEROKEE ZJ 4WD, 2WD</b>									
<b>POLYURETHANE VALUE KIT</b>									
<b>93-98 Grand Cherokee ZJ 4WD, 2WD Kit</b> Polyurethane Spacers									
2"	ZJ20		ZJ20						
<b>STANDARD SERIES - SHORT ARM LOWER LINKS ONLY</b>									
<b>93-98 Grand Cherokee ZJ 4WD, 2WD System</b> With Rear Coil Springs									
3"	GC301K		GC30	1	JC30F	1	GC20R		

	Steering Stabilizers									HYDRO Shocks		NITRO Shocks		BLACK MAX		M95 Shocks		Labor													
	White			Black			Silver			White		White		Black		Silver		Hours													
	OEM	Single	Dual	OEM	Single	Dual	OEM	Single	Dual	Front	Rear	Front	Rear	Front	Rear	Front	Rear														
<b>NOTE: UNLESS NOTE "INCLUDED" UNDER SHOCK SERIES, ALL SHOCKS MUST BE ORDERED SEPARATELY</b>																															
												---	---	H7088	---	---	N8088	---	---	B8588	----	----	M9558	4							
<b>NOTE: UNLESS NOTE "INCLUDED" UNDER SHOCK SERIES, ALL SHOCKS MUST BE ORDERED SEPARATELY</b>																															
														H7016	H7044	N8016	N8044	B8516	B8544	M9516	M9544	4									
<b>NOTE: UNLESS NOTE "INCLUDED" UNDER SHOCK SERIES, ALL SHOCKS MUST BE ORDERED SEPARATELY</b>																															
														7009			8009			9009			H7016	H7023	N8016	N8023	B8516	B8523	M9516	M9523	4
														7009			8009			9009			H7016	H7023	N8016	N8023	B8516	B8523	M9516	M9523	5



# MAZDA

LIFT	Quick Kit	KIT NOTES	Component Box	Front Springs		Rear Springs		Add-A-Leafs	Steering Correction
	Reference		(Requires 1 of Each)	Qty	Part #	Qty	Part #		(Order 1 Each)
<b>94-97 MAZDA B3000,B4000 4WD</b>									
<b>94-97 Mazda B3000,B4000 4WD Kit</b>			<b>6-Cylinder Engine with Add-A-Leafs</b>						
1.5-2"	132XK	G1, G27		1	132X			R3135	
KIT NOTES: G1. Oversized Camber / Caster Shims are REQUIRED (See Mazda Accessories). G27. May Require # HS25 for Alignment & Leveling Aid.									
<b>94-97 Mazda B3000,B4000 4WD Kit</b>			<b>4-Cylinder Engine with Add-A-Leafs</b>						
1.5-2"	132K	G1, G27		1	132			R3135	
KIT NOTES: G1. Oversized Camber / Caster Shims are REQUIRED (See Mazda Accessories). G27. May Require # HS25 for Alignment & Leveling Aid.									
<b>94-97 Mazda B3000,B4000 4WD System</b>			<b>6-Cylinder Engine with Replacement Rear Springs</b>						
1.5-2"	132XKS	G1, G10	132XRS	1	132X	2	FR34S		
KIT NOTES: G1. Oversized Camber / Caster Shims are REQUIRED (See Mazda Accessories). G10. The Factory Block is Removed.									
<b>94-97 Mazda B3000,B4000 4WD System</b>			<b>4-Cylinder Engine with Replacement Rear Springs</b>						
1.5-2"	132KS	G1, G10	132RS	1	132	2	FR34S		
KIT NOTES: G1. Oversized Camber / Caster Shims are REQUIRED (See Mazda Accessories). G10. The Factory Block is Removed.									
<b>94-97 Mazda B3000,B4000 4WD Kit</b>			<b>Heavy-Duty Brackets with Blocks &amp; U-Bolts &amp;/or Add-A-Leafs</b>						
4"	134RHK	G8, G18, G27	134RH	1	134				FA400
6"	136RHK	G8, G18, G27	136RH	1	136				FA400
8"	138RHK-A	G8, G18, G27	138C+138RH	1	138			R3135	Included
KIT NOTES: G8. Power Steering Models Only. G27. May Require # HS25 for Alignment & Leveling Aid. May Require End Links. G18. See Brake Lines Section.									
<b>94-97 Mazda B3000,B4000 4WD System</b>			<b>Heavy-Duty Brackets with Replacement Rear Springs</b>						
4"	134RHKS	G8, G10, G18, G27	134RHS	1	134	2	FR34S		FA400
6"	136RHKS	G8, G18, G27	136RHS	1	136	2	FR34S		FA400
8"	138RHKS-A	G8, G18, G27	138C+138RHS	1	138	2	FR36S		Included
KIT NOTES: G8. Power Steering Models Only. G10. The Factory Block is Removed. G27. May Require # HS25 for Alignment & Leveling Aid. May Require End Links. G18. See Brake Lines Section.									
<b>94-97 Mazda B3000,B4000 4WD Kit</b>			<b>Class II Brackets &amp; Radius Arms with Blocks &amp; U-Bolts</b>						
4"	234RHK-A	G8, G18, G27	234RH+RA135	1	134				Included
6"	236RHK-A	G8, G18, G27	236RH+RA135	1	136				Included
KIT NOTES: G8. Power Steering Models Only. G27. May Require # HS25 for Alignment & Leveling Aid. G18. See Brake Lines Section.									
<b>94-97 Mazda B3000,B4000 4WD System</b>			<b>Class II Brackets &amp; Radius Arms with Replacement Rear Springs</b>						
4"	234RHKS-A	G8, G10, G18, G27	234RHS+RA135	1	134	2	FR34S		Included
6"	236RHKS-A	G8, G18, G27	236RHS+RA135	1	136	2	FR34S		Included
KIT NOTES: G8. Power Steering Models Only. G10. The Factory Block is Removed. G27. May Require # HS25 for Alignment & Leveling Aid. G18. See Brake Lines Section.									
<b>94-97 MAZDA B SERIES B2300</b>									
<b>94-97 Mazda B2300 2WD Kit</b>			<b>2.3, 2.9 &amp; 3.0 Liter Engines with Add-A-Leafs</b>						
1.5-2"	132K	G1		1	132			R3135	
KIT NOTES: G1. Oversized Camber / Caster Shims are REQUIRED (See Mazda Accessories).									
<b>94-97 Mazda B2300 2WD Kit</b>			<b>4.0 Liter Engines with Add-A-Leafs</b>						
1.5-2"	132XK	G1, G27		1	132X			R3135	
KIT NOTES: G1. Oversized Camber / Caster Shims are REQUIRED (See Mazda Accessories). G27. May Require # HS25 for Alignment & Leveling Aid. 4.0 Model May Sit Lower in Front.									
<b>94-97 Mazda B2300 2WD Kit</b>			<b>2.3 Liter Engine SuperCab with Add-A-Leafs</b>						
1.5-2"	132K	G1		1	132			R3135	
KIT NOTES: G1. Oversized Camber / Caster Shims are REQUIRED (See Mazda Accessories).									
<b>94-97 Mazda B2300 2WD Kit</b>			<b>2.9 Liter Engine SuperCab with Add-A-Leafs</b>						
1.5-2"	132XK	G1		1	132X			R3135	
KIT NOTES: G1. Oversized Camber / Caster Shims are REQUIRED (See Mazda Accessories).									
<b>94-97 Mazda B2300 2WD Kit</b>			<b>Standard Brackets with Blocks &amp; U-Bolts</b>						
4"	134R2K	G8, G18, G27	134R2	1	134				FA400
6"	136R2K	G8, G18, G27	136R2	1	136				FA400
KIT NOTES: G8. Power Steering Models Only. G18. See Brake Lines Section. G27. May Require # HS25 for Alignment & Leveling Aid. May Require End Links.									
<b>94-97 Mazda B2300 2WD System</b>			<b>Standard Brackets with Replacement Rear Springs</b>						
4"	134R2KS	G8, G18, G27	134R2S	1	134	2	FR34S		FA400
6"	136R2KS	G8, G18, G27	136R2S	1	136	2	FR34S		FA400
KIT NOTES: G8. Power Steering Models Only. G18. See Brake Lines Section. G27. May Require # HS25 for Alignment & Leveling Aid. May Require End Links.									



# MAZDA

	Steering Stabilizers									HYDRO Shocks		NITRO Shocks		BLACK MAX		M95 Shocks		Labor Hours
	White			Black			Silver			White		Black		Silver				
	OEM	Single	Dual	OEM	Single	Dual	OEM	Single	Dual	Front	Rear	Front	Rear	Front	Rear	Front	Rear	
<b>NOTE: ALL SHOCKS MUST BE ORDERED SEPARATELY</b>																		
										H7052	H7060	N8052	N8060	B8552	B8560	M9552	M9560	4
										H7052	H7060	N8052	N8060	B8552	B8560	M9552	M9560	4
										H7052	H7060	N8052	N8060	B8552	B8560	M9552	M9560	4
										H7052	H7060	N8052	N8060	B8552	B8560	M9552	M9560	4
										H7054	H7060	N8054	N8060	B8554	B8560	M9554	M9560	6
										H7055	H7060	N8055	N8060	B8555	B8560	M9555	M9560	6
										H7055	H7079	N8055	N8079	B8555	B8579	M9555	M9579	7
										H7054	H7060	N8054	N8060	B8554	B8560	M9554	M9560	6
										H7055	H7060	N8055	N8060	B8555	B8560	M9555	M9560	6
										H7055	H7079	N8055	N8079	B8555	B8579	M9555	M9579	7
										H7054	H7060	N8054	N8060	B8554	B8560	M9554	M9560	7
										H7055	H7060	N8055	N8060	B8555	B8560	M9555	M9560	7
<b>NOTE: ALL SHOCKS MUST BE ORDERED SEPARATELY</b>																		
		7150	7250		8150	8250		9150	9250	H7052	H7058	N8052	N8058	B8552	B8558	M9552	M9558	4
		7150	7250		8150	8250		9150	9250	H7052	H7058	N8052	N8058	B8552	B8558	M9552	M9558	4
		7150	7250		8150	8250		9150	9250	H7052	H7058	N8052	N8058	B8552	B8558	M9552	M9558	4
		7150	7250		8150	8250		9150	9250	H7052	H7058	N8052	N8058	B8552	B8558	M9552	M9558	4
		7150	7250		8150	8250		9150	9250	H7054	H7060	N8054	N8060	B8554	B8560	M9554	M9560	6
		7150	7250		8150	8250		9150	9250	H7055	H7060	N8055	N8060	B8555	B8560	M9555	M9560	6
		7150	7250		8150	8250		9150	9250	H7054	H7060	N8054	N8060	B8554	B8560	M9554	M9560	6
		7150	7250		8150	8250		9150	9250	H7055	H7060	N8055	N8060	B8555	B8560	M9555	M9560	6

# MAZDA

LIFT	Quick Kit	KIT NOTES	Component Box	Front Springs		Rear Springs		Add-A-Leafs	Steering Correction
	Reference		(Requires 1 of Each)	Qty	Part #	Qty	Part #		(Order 1 Each)
<b>94-97 Mazda B2300 2WD Kit</b>									
<b>Class II Brackets &amp; Radius Arms with Blocks &amp; U-Bolts</b>									
4"	234R2K-A	G8, G18, G27	234R2+RA235	1	134				Included
6"	236R2K-A	G8, G18, G27	236R2+RA235	1	136				Included
KIT NOTES: G8. Power Steering Models Only. G18. See Brake Lines Section. G27. May Require # HS25 for Alignment & Leveling Aid. May Require End Links.									
<b>94-97 Mazda B2300 2WD System</b>									
<b>Class II Brackets &amp; Radius Arms with Replacement Rear Springs</b>									
4"	234R2KS-A	G8, G18, G27	234R2S+RA235	1	134	2	FR34S		Included
6"	236R2KS-A	G8, G18, G27	236R2S+RA235	1	136	2	FR34S		Included
KIT NOTES: G8. Power Steering Models Only. G18. See Brake Lines Section. G27. May Require # HS25 for Alignment & Leveling Aid. May Require End Links.									
<b>90-94 NAVAJO 4WD 2 &amp; 4 DOOR</b>									
<b>90-94 Navajo 4WD 2 &amp; 4 Door Kit</b>									
<b>With Add-A-Leafs</b>									
1.5-2"	132EXK	G1		1	132X			R225	
KIT NOTES: G1. Oversized Camber / Caster Shims are REQUIRED (See Mazda Accessories).									
<b>90-94 NAVAJO 2WD 2 &amp; 4 DOOR</b>									
<b>90-94 Navajo 2WD 2 &amp; 4 Door Kit</b>									
<b>With Add-A-Leafs</b>									
1.5-2"	132EXK	G1		1	132X			R225	
KIT NOTES: G1. Oversized Camber / Caster Shims are REQUIRED (See Mazda Accessories).									

# NISSAN

LIFT	Quick Kit	KIT NOTES	Component Box	Front Springs		Rear Springs		Add-A-Leafs	Steering Correction
	Reference		(Requires 1 of Each)	Qty	Part #	Qty	Part #		(Order 1 Each)
<b>2016 - 2017 NISSAN TITAN XD 4WD / 2WD</b>									
<b>SPACER VALUE KIT</b>									
<b>2016 - 2017 Nissan Titan XD 4WD / 2WD</b>									
<b>Spacer Value Kit (2" Metal Front &amp; 1.25" Rear Block/U Bolt Kit)</b>									
2"	NT26MSP		NT26MSP						
KIT NOTES: Will Not Work on Pro-4X Models.									
<b>2004 - 2017 NISSAN TITAN 4WD / 2WD / XD</b>									
<b>SPACER KIT</b>									
<b>2004 - 2017 Nissan Titan 4WD, 2WD, &amp; XD</b>									
<b>Spacer Kit (2" Metal Front Kit)</b>									
2"	NT20MS		NT20MS						
KIT NOTES: Will Not Work on Pro-4X Models									
<b>04-15 NISSAN TITAN 4WD / 2WD</b>									
<b>POLYURETHANE VALUE KIT</b>									
<b>04-15 Nissan Titan 4WD / 2WD</b>									
<b>Front Leveling Kit - Polyurethane Spacers</b>									
2.5"	NT25	N2	NT25						
KIT NOTES: N2. Optional 1.25" Block Ubolt Kit # TU710R Available.									

# TOYOTA

LIFT	Quick Kit	KIT NOTES	Component Box	Front Springs		Rear Springs		Add-A-Leafs	Steering Correction
	Reference		(Requires 1 of Each)	Qty	Part #	Qty	Part #		(Order 1 Each)
<b>05-14 HILUX / TIGER / VIGO 4WD</b>									
<b>05-14 HiLux / Tiger / Vigo 4WD</b>									
<b>Adjustable Front Struts</b>									
1-3"	HL13ST		HL13ST						
<b>05-14 HiLux / Tiger / Vigo 4WD Kit</b>									
<b>Adjustable Front Struts with Rear Blocks &amp; U-Bolts</b>									
2-3"	HL30STK		HL30STK						

# MAZDA

	Steering Stabilizers									HYDRO Shocks		NITRO Shocks		BLACK MAX		M95 Shocks		Labor Hours
	White			Black			Silver			White		White		Black		Silver		
	OEM	Single	Dual	OEM	Single	Dual	OEM	Single	Dual	Front	Rear	Front	Rear	Front	Rear	Front	Rear	
	7150	7250		8150	8250		9150	9250		H7054	H7060	N8054	N8060	B8554	B8560	M9554	M9560	7
	7150	7250		8150	8250		9150	9250		H7055	H7060	N8055	N8060	B8555	B8560	M9555	M9560	7
	7150	7250		8150	8250		9150	9250		H7054	H7060	N8054	N8060	B8554	B8560	M9554	M9560	7
	7150	7250		8150	8250		9150	9250		H7055	H7060	N8055	N8060	B8555	B8560	M9555	M9560	7

**NOTE: ALL SHOCKS MUST BE ORDERED SEPARATELY**

	7150	7250		8150	8250		9150	9250		H7052	H7039	N8052	N8039	B8552	B8539	M9552	M9539	4
--	------	------	--	------	------	--	------	------	--	-------	-------	-------	-------	-------	-------	-------	-------	---

**NOTE: ALL SHOCKS MUST BE ORDERED SEPARATELY**

	7140	7240		8150	8250		9150	9250		H7052	H7029	N8052	N8029	B8552	B8529	M9552	M9529	4
--	------	------	--	------	------	--	------	------	--	-------	-------	-------	-------	-------	-------	-------	-------	---

# NISSAN

	Steering Stabilizers									HYDRO Shocks		NITRO Shocks		BLACK MAX		M95 Shocks		Labor Hours
	White			Black			Silver			White		White		Black		Silver		
	OEM	Single	Dual	OEM	Single	Dual	OEM	Single	Dual	Front	Rear	Front	Rear	Front	Rear	Front	Rear	

**NOTE: ALL SHOCKS MUST BE ORDERED SEPARATELY**

										---	---	---	---	---	---	---	---	2
--	--	--	--	--	--	--	--	--	--	-----	-----	-----	-----	-----	-----	-----	-----	---

**NOTE: ALL SHOCKS MUST BE ORDERED SEPARATELY**

										---	---	---	---	---	---	---	---	2
--	--	--	--	--	--	--	--	--	--	-----	-----	-----	-----	-----	-----	-----	-----	---

**NOTE: ALL SHOCKS MUST BE ORDERED SEPARATELY**

										---	---	---	---	---	---	---	---	2
--	--	--	--	--	--	--	--	--	--	-----	-----	-----	-----	-----	-----	-----	-----	---

# TOYOTA

	Steering Stabilizers									HYDRO Shocks		NITRO Shocks		BLACK MAX		M95 Shocks		Labor Hours
	White			Black			Silver			White		White		Black		Silver		
	OEM	Single	Dual	OEM	Single	Dual	OEM	Single	Dual	Front	Rear	Front	Rear	Front	Rear	Front	Rear	

**NOTE: ALL SHOCKS MUST BE ORDERED SEPARATELY**

										---	H7047	---	N8047	---	B8547	---	M9547	2
--	--	--	--	--	--	--	--	--	--	-----	-------	-----	-------	-----	-------	-----	-------	---

										---	H7027	---	N8027	---	B8527	---	M9527	3
--	--	--	--	--	--	--	--	--	--	-----	-------	-----	-------	-----	-------	-----	-------	---

# TOYOTA

LIFT	Quick Kit	KIT NOTES	Component Box	Front Springs		Rear Springs		Add-A-Leafs	Steering Correction
	Reference		(Requires 1 of Each)	Qty	Part #	Qty	Part #		
<b>05-20 TACOMA 4WD &amp; PRE-RUNNER 2WD</b>									
<b>PERFORMANCE STRUT SERIES</b>									
<b>16-20 Tacoma 4WD &amp; Pre-Runner 2WD System</b>			<b>Performance Strut Kit with Rear Blocks &amp; U-Bolts</b>						
3"	TC536STBH	G19, G21	Included						
Kit includes front struts, front differential drop kit, rear lift blocks, rear u-bolts, & rear Hydro 7000 shocks (2).									
3"	TC536STBN	G19, G21	Included						
Kit includes front struts, front differential drop kit, rear lift blocks, rear u-bolts, & rear Nitro 8000 shocks (2).									
3"	TC536STBB	G19, G21	Included						
Kit includes front struts, front differential drop kit, rear lift blocks, rear u-bolts, & rear Black MAX shocks (2).									
3"	TC536STBM	G19, G21	Included						
Kit includes front struts, front differential drop kit, rear lift blocks, rear u-bolts, & rear Black MAX shocks (2).									
KIT NOTES: G19. Will NOT Fit TRD PRO Models. G21. Will also NOT Fit Models Equipped with: XSP-X or models with 5 lug wheels									
<b>COIL-OVER KITS</b>									
<b>16-20 Tacoma 4WD &amp; Pre-Runner 2WD System</b>			<b>Coil-Over Kit with Rear Block &amp; U-Bolts</b>						
3"	TC536BM		Included	Included					
Kit includes front coil-over shocks, front coil springs, upper coil-over shock brackets, front differential drop kit, front sway bar relocation brackets, rear lift blocks, rear u-bolts, & rear M95 Monotube shocks.									
<b>VALUE KIT</b>									
<b>05-20 Tacoma 4WD &amp; Pre-Runner 2WD System</b>			<b>Front Metal Strut Spacers (Leveling Kit)</b>						
2"	TT20MS	G19, G21	TT20MS						
KIT NOTES: Installs Above Strut Assembly. G19. Will NOT Fit TRD Models. G21. Will also NOT Fit Models Equipped with: XSP-X or models with 5 lug wheels									
<b>05-20 Tacoma 4WD &amp; Pre-Runner 2WD System</b>			<b>Front Strut Spacers with 1.25" Rear Block &amp; U-Bolts</b>						
2"	TT20MSP	G19, G21	TT20MSP						
KIT NOTES: G19. Will NOT Fit TRD PRO Models. G21. Will also NOT Fit Models Equipped with: XSP-X or models with 5 lug wheels									
<b>PERFORMANCE STRUT SERIES</b>									
<b>05-20 Tacoma 4WD &amp; Pre-Runner 2WD Kit</b>			<b>Adjustable Front Struts</b>						
1-3"	TC513ST	G19, G21	TC513ST						
KIT NOTES: G19. Will NOT Fit TRD Models.									
<b>05-15 Tacoma 4WD &amp; Pre-Runner 2WD Kit</b>			<b>With Blocks &amp; U-Bolts</b>						
3"	TC530STBH	G19, G21	Included						
Kit includes front struts, front differential drop kit, rear lift blocks, rear u-bolts, & rear Hydro 7000 shocks (2).									
3"	TC530STBN	G19, G21	Included						
Kit includes front struts, front differential drop kit, rear lift blocks, rear u-bolts, & rear Nitro 8000 shocks (2).									
3"	TC530STBB	G19, G21	Included						
Kit includes front struts, front differential drop kit, rear lift blocks, rear u-bolts, & rear Nitro 8000 shocks (2).									
3"	TC530STBM	G19, G21	Included						
Kit includes front struts, front differential drop kit, rear lift blocks, rear u-bolts, & rear M95 Monotube shocks (2).									
KIT NOTES: G19. Will NOT Fit TRD PRO Models. G21. Will also NOT Fit Models Equipped with: XSP-X or models with 5 lug wheels									
<b>05-15 Tacoma 4WD &amp; Pre-Runner 2WD Kit</b>			<b>With Add-A-Leafs</b>						
2.5-3"	TC530STK	G19, G21	TC530ST					RTC515	
2.5-3"	TC530STBH	G19, G21	Struts, Blocks & U-Bolts, Rear Hydros						
KIT NOTES: G19. Will NOT Fit TRD PRO Models.									
<b>05-15 Tacoma 4WD &amp; Pre-Runner 2WD System</b>			<b>With Replacement Rear Springs</b>						
2.5-3"	TC530STKS	G19, G21	TC530ST			2	TCR515S		
KIT NOTES: G19. Will NOT Fit TRD PRO Models. G21. Will also NOT Fit Models Equipped with: XSP-X or models with 5 lug wheels									
<b>COIL-OVER KITS</b>									
<b>05-15 Tacoma 4WD &amp; Pre-Runner 2WD Kit</b>			<b>With Blocks &amp; U-Bolts</b>						
3"	TC530BM		Included						
Kit includes front coil-over shocks, front coil springs, upper coil-over shock brackets, front differential drop kit, front sway bar relocation brackets, rear lift blocks, rear u-bolts, & rear M95 Monotube shocks (2).									
<b>05-15 Tacoma 4WD &amp; Pre-Runner 2WD Kit</b>			<b>With Add-A-Leafs</b>						
2.5-3"	TC530K		TC530					RTC515	
<b>05-15 Tacoma 4WD &amp; Pre-Runner 2WD System</b>			<b>With Replacement Rear Springs</b>						
2.5-3"	TC530KS		TC530			2	TCR515S		
<b>98-04 TACOMA 4WD &amp; PRE-RUNNER 2WD</b>									
<b>95.5-04 Tacoma 4WD &amp; Pre-Runner 2WD Value Kit</b>			<b>Metal Spacers (Leveling Kit)</b>						
2"	TTC20MS		TTC20MS						
KIT NOTES: Installs Above Strut Assembly.									

	Steering Stabilizers									HYDRO Shocks		NITRO Shocks		BLACK MAX		M95 Shocks		Labor Hours
	White			Black			Silver			White		White		Black		Silver		
	OEM	Single	Dual	OEM	Single	Dual	OEM	Single	Dual	Front	Rear	Front	Rear	Front	Rear	Front	Rear	Hours

NOTE: ALL SHOCKS MUST BE ORDERED SEPARATELY

												---		Included	---		---		---				6
												---		---		---				---			6
												---		---		---				---			6
												---		---						---			6

												---		---						---			7
--	--	--	--	--	--	--	--	--	--	--	--	-----	--	-----	--	--	--	--	--	-----	--	--	---

												---		H7048	---		N8048	---		B8548	---		M9548	2
--	--	--	--	--	--	--	--	--	--	--	--	-----	--	-------	-----	--	-------	-----	--	-------	-----	--	-------	---

												---		H7045	---		N8045	---		B8545	---		M9545	2
--	--	--	--	--	--	--	--	--	--	--	--	-----	--	-------	-----	--	-------	-----	--	-------	-----	--	-------	---

												---		H7048	---		N8048	---		B8548	---		M9548	2
--	--	--	--	--	--	--	--	--	--	--	--	-----	--	-------	-----	--	-------	-----	--	-------	-----	--	-------	---

												---		Included	---		---			---			6
--	--	--	--	--	--	--	--	--	--	--	--	-----	--	----------	-----	--	-----	--	--	-----	--	--	---

												---		---						---			6
--	--	--	--	--	--	--	--	--	--	--	--	-----	--	-----	--	--	--	--	--	-----	--	--	---

												---		---						---			6
--	--	--	--	--	--	--	--	--	--	--	--	-----	--	-----	--	--	--	--	--	-----	--	--	---

												---		---						---			6
--	--	--	--	--	--	--	--	--	--	--	--	-----	--	-----	--	--	--	--	--	-----	--	--	---

												---		H7045	---		N8045	---		B8545	---		M9545	6
--	--	--	--	--	--	--	--	--	--	--	--	-----	--	-------	-----	--	-------	-----	--	-------	-----	--	-------	---

												---		Included	---		---			---			6
--	--	--	--	--	--	--	--	--	--	--	--	-----	--	----------	-----	--	-----	--	--	-----	--	--	---

												---		H7045	---		N8045	---		B8545	---		M9545	4
--	--	--	--	--	--	--	--	--	--	--	--	-----	--	-------	-----	--	-------	-----	--	-------	-----	--	-------	---

												---		---						---			Included	6
--	--	--	--	--	--	--	--	--	--	--	--	-----	--	-----	--	--	--	--	--	-----	--	--	----------	---

												---		H7045	---		N8045	---		B8545	---		M9545	4
--	--	--	--	--	--	--	--	--	--	--	--	-----	--	-------	-----	--	-------	-----	--	-------	-----	--	-------	---

												---		H7045	---		N8045	---		B8545	---		M9545	4
--	--	--	--	--	--	--	--	--	--	--	--	-----	--	-------	-----	--	-------	-----	--	-------	-----	--	-------	---

NOTE: ALL SHOCKS MUST BE ORDERED SEPARATELY

												---		H7047	---		N8047	---		B8547	---		M9547	2
--	--	--	--	--	--	--	--	--	--	--	--	-----	--	-------	-----	--	-------	-----	--	-------	-----	--	-------	---

MAZDA / NISSAN / TOYOTA

# TOYOTA

LIFT	Quick Kit	KIT NOTES	Component Box	Front Springs		Rear Springs		Add-A-Leafs	Steering Correction (Order 1 Each)
	Reference		(Requires 1 of Each)	Qty	Part #	Qty	Part #		
<b>95.5-04 Tacoma 4WD &amp; Pre-Runner 2WD Value Kit</b> Polyurethane Value Kit									
2.5"	TTC25		TTC25						
KIT NOTES: Installs Above Strut Assembly.									
<b>PERFORMANCE STRUT SERIES</b>									
<b>95.5-04 Tacoma 4WD &amp; Pre-Runner 2WD Kit</b> Adjustable Front Struts									
1-3"	TT413ST		TT413ST						
<b>95.5-04 Tacoma 4WD &amp; Pre-Runner 2WD Kit</b> With Add-A-Leafs									
3"	TTC30STK		TT430ST				RTC20		
KIT NOTES: Recommend Use with Manual Hub Models. Do NOT Lift Auto Locking Hub Models More than 2".									
<b>98-04 Tacoma 4WD &amp; Pre-Runner 2WD System</b> With Replacement Rear Springs									
3"	TTC30STKS		TT430ST			2	TCR25S		
KIT NOTES: Recommend Use with Manual Hub Models. Do NOT Lift Auto Locking Hub Models More than 2".									
<b>COIL-OVER KITS</b>									
<b>95.5-04 Tacoma 4WD &amp; Pre-Runner 2WD Kit</b> With Blocks & U-Bolts &/or Add-A-Leafs									
2.5-3"	SKTOY30K		SKTOY30				RTC20		
KIT NOTES: Recommend Use with Manual Hub Models. Do NOT Lift Auto Locking Hub Models More than 2".									
<b>98-04 Tacoma 4WD &amp; Pre-Runner 2WD System</b> With Replacement Rear Springs									
2.5-3"	SKTOY30KS		SKTOY30+UTWR			2	TCR25S		
KIT NOTES: Recommend Use with Manual Hub Models. Do NOT Lift Auto Locking Hub Models More than 2".									
<b>07-20 TUNDRA PICKUP</b>									
<b>07-20 Tundra Pickup 2WD / 4WD Value Kit</b> Front Leveling Spacers									
2"	TU720MS	G19	TU720MS						
KIT NOTES: Installs Above Strut Assembly. OEM Wheels & Tires can be Used. G19. Will NOT Fit TRD Pro or Air Ride, Rock Warrior, XSP-X Models.									
<b>07-20 Tundra Pickup 2WD / 4WD Value Kit</b> Strut Spacers with 1.25" Rear Blocks & U-Bolts									
2"	TU720MSP	G19	TU720MSP						
KIT NOTES: G19. Will NOT Fit TRD Pro or Air Ride Models. Rock Warrior, XSP-X									
<b>PERFORMANCE STRUT SERIES</b>									
<b>07-20 Tundra Pickup 2WD / 4WD</b> Adjustable Front Struts									
1-3"	TU713ST	G19	TU713ST						
KIT NOTES: G19. Will NOT Fit TRD Pro or Air Ride Models.									
<b>07-20 Tundra Pickup 2WD / 4WD Kit</b> Performance Strut Lift with Rear Blocks & U-Bolts									
3"	TU730STBH	G19	Included						
Kit includes front struts, rear lift blocks, rear u-bolts, & rear Hydro 7000 shocks (2). G19 Will not fit Pro, Rock Warrior, XSP-X, or Air Ride									
3"	TU730STBN	G19	Included						
Kit includes front struts, rear lift blocks, rear u-bolts, & rear Nitro 8000 shocks (2). G19 Will not fit Pro, Rock Warrior, XSP-X, or Air Ride									
3"	TU730STBB	G19	Included						
Kit includes front struts, rear lift blocks, rear u-bolts, & rear Black MAX shocks (2). G19 Will not fit Pro, Rock Warrior, XSP-X, or Air Ride									
3"	TU730STBM	G19	Included						
Kit includes front struts, rear lift blocks, rear u-bolts, & rear M95 Monotube shocks (2). G19 Will not fit Pro, Rock Warrior, XSP-X, or Air Ride									
<b>07-20 Tundra Pickup 2WD / 4WD Kit</b> Performance Strut Lift									
3"	TU730STK	G19	TU730ST+TU710R						
KIT NOTES: OEM Wheels & Tires can be Used. G19. Will NOT Fit TRD Pro or Air Ride, Rock Warrior, or XSP-X Models.									
<b>07-20 Tundra Pickup 4WD Value Kit</b> Adjustable Coil-Over Lift Kit									
2-3"	TU730K	G19	TU730+TU710R						
KIT NOTES: OEM Wheels & Tires can be Used. G19 Will not fit Rock Warrior or XSP-X									
<b>07-20 Tundra Pickup 2WD / 4WD Kit</b> Front Strut Spacer Kit with Rear Blocks & U-Bolts									
4.5"	TU745BKH	G19	TU746A+TU745BH						
KIT NOTES: 17" or Larger Wheels Must be Used for 4.5" Lifts. G19. Will NOT Fit TRD Pro or Air Ride Models, Rock Warrior or XSP-X.									
<b>07-20 Tundra Pickup 2WD / 4WD Kit</b> Front Strut Spacer Kit with Rear Blocks & U-Bolts									
6"	TU760BKH	G19	TU746A+TU760BH						
KIT NOTES: G19. Will NOT Fit TRD Pro or Air Ride, Rock Warrior, or XSP-X Models.									
<b>07-20 Tundra Pickup 2WD / 4WD Kit</b> Performance Strut Lift with Rear Blocks & U-Bolts									
6"	TU761PK	G19	TU761A+TU761PR						
KIT NOTES: G19. Will NOT Fit TRD Pro or Air Ride, Rock Warrior, or XSP-X Models.									
<b>07-20 Tundra Pickup 4WD Kit</b> Performance Strut Lift with Replacement Rear Springs									
6"	TU761PKS	G19	TU761A+TU761PRS			2	TUR47S		
KIT NOTES: 17" or Larger Wheels Must be Used for 6" Lifts. G19. Will NOT Fit TRD Pro or Air Ride, Rock Warrior, or XSP-X Models.									

# TOYOTA

	Steering Stabilizers									HYDRO Shocks		NITRO Shocks		BLACK MAX		M95 Shocks		Labor Hours				
	White			Black			Silver			White		Black		Silver								
	OEM	Single	Dual	OEM	Single	Dual	OEM	Single	Dual	Front	Rear	Front	Rear	Front	Rear	Front	Rear					
										---	---	H7027	---	---	N8027	---	---	B8527	---	---	M9527	4
										---	---	H7047	---	---	N8047	---	---	B8547	---	---	M9547	4
										---	---	H7027	---	---	N8027	---	---	B8527	---	---	M9527	8
										---	---	H7027	---	---	N8027	---	---	B8527	---	---	M9527	10
										---	---	H7027	---	---	N8027	---	---	B8527	---	---	M9527	4
										---	---	H7027	---	---	N8027	---	---	B8527	---	---	M9527	4
<b>NOTE: ALL SHOCKS MUST BE ORDERED SEPARATELY</b>																						
										---	---	H7062	---	---	N8062	---	---	B8562	---	---	M9562	2
										---	---	H7062	---	---	N8062	---	---	B8562	---	---	M9562	2
										---	---	H7062	---	---	N8062	---	---	B8562	---	---	M9562	4
										---	---	Included	---	---	---	---	---	---	---	---	---	4
										---	---	---	---	Included	---	---	---	---	---	---	---	4
										---	---	---	---	---	Included	---	---	---	---	---	---	4
										---	---	---	---	---	---	Included	---	---	---	---	---	4
										---	---	H7062	---	---	N8062	---	---	B8562	---	---	M9562	4
										---	---	H7062	---	---	N8062	---	---	B8562	---	---	---	4
										---	---	Included	---	---	---	---	---	---	---	---	---	10
										---	---	Included	---	---	---	---	---	---	---	---	---	10
										---	---	H7066	---	---	N8066	---	---	B8566	---	---	M9566	10
										---	---	H7066	---	---	N8066	---	---	B8566	---	---	M9566	10

# TOYOTA

LIFT	Quick Kit	KIT NOTES	Component Box	Front Springs		Rear Springs		Add-A-Leafs	Steering Correction
	Reference		(Requires 1 of Each)	Qty	Part #	Qty	Part #		(Order 1 Each)
<b>COIL-OVER KITS</b>									
<b>07-20 Tundra Pickup 4WD Value Kit</b>			<b>Coil-Over Lift Kit with Blocks &amp; U-Bolts</b>						
3"	TU730BM	G19	Included	Included					
Kit includes front coil-over shocks, front coil springs, upper coil-over shock brackets, front sway bar relocation brackets, rear lift blocks, rear u-bolts, & rear M95 Monotube shocks (2). G19 Will not fit Pro, Air Ride, Rock Warrior, or XSP-X Models.									
<b>07-20 Tundra Pickup 4WD Value Kit</b>			<b>Adjustable Coil-Over Lift Kit</b>						
2-3"	TU730K	G19	TU730+TU710R						
KIT NOTES: OEM Wheels & Tires can be Used. G19 Will not fit Pro, Air Ride, Rock Warrior, or XSP-X Models.									
<b>00-06 TUNDRA PICKUP 4WD</b>									
<b>00-06 Tundra Pickup 4WD Value Kit</b>			<b>Metal Spacers (Front Leveling Kit)</b>						
2"	TTU20MS		TTU20MS						
KIT NOTES: Installs Above Strut Assembly.									
<b>POLY VALUE KITS</b>									
<b>00-06 Tundra Pickup 4WD Value Kit</b>			<b>Polyurethane Value Kit with Rear Add-A-Leafs</b>						
2.5"	TTU25		TTU25					RTU20	
KIT NOTES: Installs Above Strut Assembly.									
<b>PERFORMANCE STRUT SERIES</b>									
<b>00-06 Tundra Pickup 4WD Kit</b>			<b>Adjustable Front Struts</b>						
1-3"	TT413ST		TT413ST						
<b>00-06 Tundra Pickup 4WD Kit</b>			<b>With Add-A-Leafs</b>						
2.5-3"	TTU30STK		TT430ST					RTU20	
<b>COIL-OVER KITS</b>									
<b>00-06 Tundra Pickup 4WD Kit</b>			<b>With Add-A-Leafs</b>						
2.5-3"	SKTUN30K		SKTUN30					RTU20	
<b>86-95 PICKUP STANDARD &amp; EXTENDED CAB 4WD</b>									
<b>89-95 Pickup Standard Cab 4WD Kit</b>			<b>Class II with Blocks &amp; U-Bolts</b>						
4"	T432K		T422 & T431R						
<b>89-95 Pickup Extended Cab 4WD Kit</b>			<b>Class II with Blocks &amp; U-Bolts</b>						
4"	T422K		T422 & T421R						
<b>86-88 Pickup Standard &amp; Extended Cab 4WD Kit</b>			<b>Class II with Blocks &amp; U-Bolts</b>						
4"	T422K		T422 & T421R						
<b>89-95 Pickup Standard Cab 4WD System</b>			<b>Class II with Replacement Rear Springs</b>						
4"	T432KS		T422 & T431RS			2	TR49S		
<b>89-95 Pickup Extended Cab 4WD System</b>			<b>Class II with Replacement Rear Springs</b>						
4"	T422KS		T422 & T421RS			2	TR49S		
<b>86-88 Pickup Standard &amp; Extended Cab 4WD System</b>			<b>Class II with Replacement Rear Springs</b>						
4"	T442KS		T422 & T421RS			2	TR40S		
<b>84-85 PICKUP 4WD</b>									
<b>84-85 Pickup 4WD Kit</b>			<b>Front Leafs with Blocks &amp; U-Bolts &amp;/or Add-A-Leafs</b>						
3"	T303PK		T303P	2	T303S			R5005	
5"	T305PK		T305P	2	T305S				TDL5
7"	T307PK	I1	T307P	2	T307S			R5005	TDL5
NOTES: I1. 7" Lifts REQUIRE the Following: # TDL5 Adjustable Drag Link, # FBL30 & # RBL30 Longer Stainless Steel Brake Lines, Lengthening of Front Driveshaft & Modifying Factory Steering Arm so that Ball is Pointing Out the Top of Arm (Rather than Pointing Down).									
<b>84-85 Pickup 4WD System</b>			<b>Front Leafs with Replacement Rear Springs</b>						
3"	T303PKS		T303PS	2	T303S	2	TR20S		
5"	T305PKS		T305PS	2	T305S	2	TR40S		TDL5
7"	T307PKS	I1	T307PS	2	T307S	2	TR60S		TDL5
NOTES: I1. 7" Lifts REQUIRE the Following: # TDL5 Adjustable Drag Link, # FBL30 & # RBL30 Longer Stainless Steel Brake Lines, Lengthening of Front Driveshaft & Modifying Factory Steering Arm so that Ball is Pointing Out the Top of Arm (Rather than Pointing Down).									
<b>79-83 PICKUP 4WD</b>									
<b>79-83 Pickup 4WD Kit</b>			<b>Front Leafs with Blocks &amp; U-Bolts &amp;/or Add-A-Leafs</b>						
3"	T303PK		T303P	2	T303S			R5005	
5"	T305PK		T305P	2	T305S				TDL5
7"	T307PK	I1	T307P	2	T307S			R5005	TDL5
KIT NOTES: I1. 7" Lifts REQUIRE the Following: # TDL5 Adjustable Drag Link, # FBL30 & # RBL30 Longer Stainless Steel Brake Lines, Lengthening of Front Driveshaft & Modifying Factory Steering Arm so that Ball is Pointing Out the Top of Arm (Rather than Pointing Down).									



# TOYOTA

	Steering Stabilizers									HYDRO Shocks		NITRO Shocks		BLACK MAX		M95 Shocks		Labor Hours
	White			Black			Silver			White		White		Black		Silver		
	OEM	Single	Dual	OEM	Single	Dual	OEM	Single	Dual	Front	Rear	Front	Rear	Front	Rear	Front	Rear	
										---	---	---	---	---	---	---	Included	4
										---	H7062	---	N8062	---	B8562	---	---	4
<b>NOTE: ALL SHOCKS MUST BE ORDERED SEPARATELY</b>																		
										---	---	---	---	---	---	---	---	2
										---	H7048	---	N8048	---	B8548	---	M9548	4
										---	H7048	---	N8048	---	B8548	---	M9548	4
										---	H7048	---	N8048	---	B8548	---	M9548	8
										---	H7048	---	N8048	---	B8548	---	M9548	4
<b>NOTE: ALL SHOCKS MUST BE ORDERED SEPARATELY</b>																		
		7186			8186			9186		H7004	H7027	N8004	N8027	B8504	B8527	M9504	M9527	8
		7186			8186			9186		H7004	H7027	N8004	N8027	B8504	B8527	M9504	M9527	8
		7186			8186			9186		H7004	H7027	N8004	N8027	B8504	B8527	M9504	M9527	8
		7186			8186			9186		H7004	H7027	N8004	N8027	B8504	B8527	M9504	M9527	8
		7186			8186			9186		H7004	H7027	N8004	N8027	B8504	B8527	M9504	M9527	8
		7186			8186			9186		H7004	H7027	N8004	N8027	B8504	B8527	M9504	M9527	8
<b>NOTE: ALL SHOCKS MUST BE ORDERED SEPARATELY</b>																		
		7175	7276 <sup>(P)</sup>		8175	8276 <sup>(P)</sup>		9175	9276 <sup>(P)</sup>	H7055	H7027	N8055	N8027	B8555	B8527	M9555	M9527	4
		7175	7276 <sup>(P)</sup>		8175	8276 <sup>(P)</sup>		9175	9276 <sup>(P)</sup>	H7055	H7036	N8055	N8036	B8555	B8536	M9555	M9536	6
		7175	7276 <sup>(P)</sup>		8175	8276 <sup>(P)</sup>		9175	9276 <sup>(P)</sup>	H7056	H7036	N8056	N8036	B8556	B8536	M9556	M9536	7
<b>(P) Parallel Mount.</b>																		
		7175	7276 <sup>(P)</sup>		8175	8276 <sup>(P)</sup>		9175	9276 <sup>(P)</sup>	H7055	H7027	N8055	N8027	B8555	B8527	M9555	M9527	4
		7175	7276 <sup>(P)</sup>		8175	8276 <sup>(P)</sup>		9175	9276 <sup>(P)</sup>	H7055	H7036	N8055	N8036	B8555	B8536	M9555	M9536	6
		7175	7276 <sup>(P)</sup>		8175	8276 <sup>(P)</sup>		9175	9276 <sup>(P)</sup>	H7056	H7036	N8056	N8036	B8556	B8536	M9556	M9536	7
<b>(P) Parallel Mount.</b>																		
<b>NOTE: ALL SHOCKS MUST BE ORDERED SEPARATELY</b>																		
		7175	7275 <sup>(P)</sup>		8175	8275 <sup>(P)</sup>		9175	9275 <sup>(P)</sup>	H7055	H7058	N8055	N8058	B8555	B8527	M9555	M9558	4
		7175	7275 <sup>(P)</sup>		8175	8275 <sup>(P)</sup>		9175	9275 <sup>(P)</sup>	H7055	H7060	N8055	N8060	B8555	B8560	M9555	M9560	6
		7175	7275 <sup>(P)</sup>		8175	8275 <sup>(P)</sup>		9175	9275 <sup>(P)</sup>	H7056	H7060	N8056	N8060	B8556	B8560	M9556	M9560	7
<b>(P) Parallel Mount</b>																		

# TOYOTA

LIFT	Quick Kit	KIT NOTES	Component Box	Front Springs		Rear Springs		Add-A-Leafs	Steering Correction
	Reference		(Requires 1 of Each)	Qty	Part #	Qty	Part #		(Order 1 Each)
<b>79-83 Pickup 4WD System</b>			<b>Front Leafs with Replacement Rear Springs</b>						
3"	T303PKS		T303PS	2	T303S	2	TR20S		
5"	T305PKS		T305PS	2	T305S	2	TR40S		TDL5
7"	T307PKS	I1	T307PS	2	T307S	2	TR60S		TDL5
KIT NOTES: I1. 7" Lifts REQUIRE the Following: # TDL5 Adjustable Drag Link, # FBL30 & # RBL30 Longer Stainless Steel Brake Lines, Lengthening of Front Driveshaft & Modifying Factory Steering Arm so that Ball is Pointing Out the Top of Arm (Rather than Pointing Down).									
<b>06-20 4RUNNER 4WD / 2WD</b>									
<b>06-20 4Runner 4WD / 2WD</b>			<b>Spacer Kit (2" Metal Front &amp; 1.5" Polyurethane Rear)</b>						
2"	T420MS	G20	T420MS						
<b>03-20 4Runner 4WD / 2WD</b>			<b>Spacer Kit (2" Metal Front Only)</b>						
2"	TT20MS	G20	TT20MS						
KIT NOTES: G20. Does NOT fit models equipped with X-REAS, KDSS, Trail Edition or TRD Pro Packages.									
<b>PERFORMANCE STRUT SERIES</b>									
<b>03-20 4Runner 2WD / 4WD</b>			<b>Performance Strut Kit with Rear Coil Springs</b>						
3"	T4330STBH	G20	T4330STBH				Included		
Kit includes front struts, front differential drop kit, rear coil springs, rear sway bar end links, & rear Hydro 7000 shocks (2).									
3"	T4330STBN	G20	T4330STBN				Included		
Kit includes front struts, front differential drop kit, rear coil springs, rear sway bar end links, & rear Nitro 8000 shocks (2).									
3"	T4330STBB	G20	T4330STBB				Included		
Kit includes front struts, front differential drop kit, rear coil springs, rear sway bar end links, & rear Black Max shocks (2).									
3"	T4330STBM	G20	T4330STBM				Included		
Kit includes front struts, front differential drop kit, rear coil springs, rear sway bar end links, & rear M95 Monotube shocks (2).									
KIT NOTES: G20. Does NOT fit models equipped with X-REAS or KDSS Packages.									
<b>COIL-OVER KITS</b>									
<b>03-20 4Runner 2WD / 4WD</b>			<b>Coil-Over Kit with Rear Coil Springs</b>						
3"	T4330BM	G20	T4330BM		Included		Included		
Kit includes front coil-over shocks, front coil springs, upper coil-over shock brackets, front differential drop kit, front sway bar relocation brackets, rear coil springs, rear sway bar end links, & rear M95 Monotube shocks (2).									
KIT NOTES: G20. Does NOT fit models equipped with X-REAS or KDSS Packages.									
<b>86-02 4RUNNER 4WD</b>									
<b>SPACER VALUE KIT</b>									
<b>96-02 4Runner 4WD (Old Body Style)</b>			<b>Spacer Value Kit (2" Metal Front &amp; 1.5" Polyurethane Rear)</b>						
2"	TRU20		TRU20						
<b>86-89 4Runner 4WD Kit</b>			<b>Class II with 3.25" Wide Rear U-Bolts &amp; Blocks &amp; U-Bolts</b>						
4"	T432K		T422 & T431R						
<b>86-89 4Runner 4WD System</b>			<b>Class II with 3.25" Wide Rear U-Bolts &amp; Replacement Rear Springs</b>						
4"	T432RKS		T422 & T431RS			2	TR60S		
<b>86-89 4Runner 4WD Kit</b>			<b>Class II with 2.5" Wide Rear U-Bolts &amp; Blocks &amp; U-Bolts</b>						
4"	T422K		T422 & T421R						
<b>86-89 4Runner 4WD System</b>			<b>Class II with 2.5" Wide Rear U-Bolts &amp; Replacement Rear Springs</b>						
4"	T422RKS		T422 & T421RS			2	TR60S		
<b>84-85 4RUNNER 4WD</b>									
<b>84-85 4Runner 4WD Kit</b>			<b>Front Leafs with Blocks &amp; U-Bolts &amp;/or Add-A-Leafs</b>						
3"	T303PK		T303P	2	T303S			R5005	
5"	T305PK		T305P	2	T305S				TDL5
7"	T307PK	I1	T307P	2	T307S			R5005	TDL5
KIT NOTES: I1. 7" Lifts REQUIRE the Following: # TDL5 Adjustable Drag Link, # FBL30 & # RBL30 Longer Stainless Steel Brake Lines, Lengthening of Front Driveshaft & Modifying Factory Steering Arm so that Ball is Pointing Out the Top of Arm (Rather than Pointing Down).									
<b>84-85 4Runner 4WD System</b>			<b>Front Leafs with Replacement Rear Springs</b>						
3"	T303RKS		T303PS	2	T303S	2	TR40S		
5"	T305RKS		T305PS	2	T305S	2	TR60S		TDL5
7"	T307RKS	I1, I4	T307RS	2	T307S	2	TR60S		TDL5
KIT NOTES: I1. 7" Lifts REQUIRE the Following: # TDL5 Adjustable Drag Link, # FBL30 & # RBL30 Longer Stainless Steel Brake Lines, Lengthening of Front Driveshaft & Modifying Factory Steering Arm so that Ball is Pointing Out the Top of Arm (Rather than Pointing Down). I4. This Lift also Includes 2" Blocks.									

	Steering Stabilizers									HYDRO Shocks		NITRO Shocks		BLACK MAX		M95 Shocks		Labor Hours
	White			Black			Silver			White		White		Black		Silver		
	OEM	Single	Dual	OEM	Single	Dual	OEM	Single	Dual	Front	Rear	Front	Rear	Front	Rear	Front	Rear	
	7175	7275 <sup>(P)</sup>		8175	8275 <sup>(P)</sup>		9175	9275 <sup>(P)</sup>		H7055	H7058	N8055	N8058	B8555	B8527	M9555	M9558	4
	7175	7275 <sup>(P)</sup>		8175	8275 <sup>(P)</sup>		9175	9275 <sup>(P)</sup>		H7055	H7060	N8055	N8060	B8555	B8560	M9555	M9560	6
	7175	7275 <sup>(P)</sup>		8175	8275 <sup>(P)</sup>		9175	9275 <sup>(P)</sup>		H7056	H7060	N8056	N8060	B8556	B8560	M9556	M9560	7

(P) Parallel Mount

**NOTE: ALL SHOCKS MUST BE ORDERED SEPARATELY**

										---	---	H7098	---	---	N8098	---	---	B8598	---	---	M9598	8
										---	---	H7098	---	---	N8098	---	---	B8598	---	---	M9598	8

										---	---	Included	---	---	---	---	---	---	---	---	---	5
										---	---	---	---	---	Included	---	---	---	---	---	---	5
										---	---	---	---	---	---	Included	---	---	---	---	---	5
										---	---	---	---	---	---	---	Included	---	---	---	---	5

										---	---	---	---	---	---	---	---	---	---	---	Included	6
--	--	--	--	--	--	--	--	--	--	-----	-----	-----	-----	-----	-----	-----	-----	-----	-----	-----	----------	---

**NOTE: ALL SHOCKS MUST BE ORDERED SEPARATELY**

										---	---	H7022	---	---	N8022	---	---	B8522	---	---	M9522	8
	7186			8186			9186			H7004	H7027	N8004	N8027	B8504	B8527	M9504	M9527	8				
	7186			8186			9186			H7004	H7027	N8004	N8027	B8504	B8527	M9504	M9527	8				
	7186			8186			9186			H7004	H7027	N8004	N8027	B8504	B8527	M9504	M9527	8				
	7186			8186			9186			H7004	H7027	N8004	N8027	B8504	B8527	M9504	M9527	8				

**NOTE: ALL SHOCKS MUST BE ORDERED SEPARATELY**

	7175	7276 <sup>(P)</sup>		8175	8276 <sup>(P)</sup>		9175	9276 <sup>(P)</sup>		H7055	H7027	N8055	N8027	B8555	B8527	M9555	M9527	4
	7175	7276 <sup>(P)</sup>		8175	8276 <sup>(P)</sup>		9175	9276 <sup>(P)</sup>		H7055	H7036	N8055	N8036	B8555	B8536	M9555	M9536	6
	7175	7276 <sup>(P)</sup>		8175	8276 <sup>(P)</sup>		9175	9276 <sup>(P)</sup>		H7056	H7036	N8056	N8036	B8556	B8536	M9556	M9536	7

(P) Parallel Mount

	7175	7276 <sup>(P)</sup>		8175	8276 <sup>(P)</sup>		9175	9276 <sup>(P)</sup>		H7055	H7027	N8055	N8027	B8555	B8527	M9555	M9527	6
	7175	7276 <sup>(P)</sup>		8175	8276 <sup>(P)</sup>		9175	9276 <sup>(P)</sup>		H7055	H7036	N8055	N8036	B8555	B8536	M9555	M9536	6
	7175	7276 <sup>(P)</sup>		8175	8276 <sup>(P)</sup>		9175	9276 <sup>(P)</sup>		H7056	H7036	N8056	N8036	B8556	B8536	M9556	M9536	8

(P) Parallel Mount

# TOYOTA

LIFT	Quick Kit		KIT NOTES	Component Box		Front Springs		Rear Springs		Add-A-Leafs	Steering Correction
	Reference			(Requires 1 of Each)		Qty	Part #	Qty	Part #		
<b>01-07 SEQUOIA 4WD / 2WD</b>											
<b>01-07 Sequoia 2WD / 4WD Value Kit</b>			<b>Metal Spacers (Front Leveling Kit)</b>								
2"	TU20MS		TU20MS								
<b>01-07 SEQUOIA 2WD / 4WD</b>											
<b>01-07 Sequoia 2WD / 4WD Value Kit</b>			<b>Polyurethane Spacer Leveling Kit</b>								
2.5"	TSQ25		TSQ25								
<b>07-14 FJ CRUISER 4WD</b>											
<b>VALUE KIT</b>											
<b>07-14 FJ Cruiser 4WD KIT</b>			<b>Metal Spacers (Front Leveling Kit)</b>								
2"	TT20MS		TT20MS								
KIT NOTES: Installs above Strut assembly.											
<b>07-14 FJ Cruiser 4WD KIT</b>			<b>Spacer Kit (2" Metal Front &amp; 1.5" Polyurethane Rear)</b>								
2"	FJ20MS		FJ20MS								
<b>PERFORMANCE STRUT SERIES</b>											
<b>07-14 FJ Cruiser 4WD KIT</b>			<b>Adjustable Front Struts</b>								
1-3"	FJ713ST		Included								
<b>07-14 FJ Cruiser 4WD KIT</b>			<b>Front Struts with Rear Coil Springs and Shocks</b>								
3"	FJ730STBH		Included								
Kit includes front struts, rear coil springs, rear sway bar end links, & rear Hydro 7000 shocks (2).											
3"	FJ730STBN		Included								
Kit includes front struts, rear coil springs, rear sway bar end links, & rear Nitro 8000 shocks (2).											
3"	FJ730STBB		Included								
Kit includes front struts, rear coil springs, rear sway bar end links, & rear Black MAX shocks (2).											
3"	FJ730STBM		Included								
Kit includes front struts, rear coil springs, rear sway bar end links, & rear M95 Monotube shocks (2).											
<b>07-14 FJ Cruiser 4WD KIT</b>			<b>With Rear Coil Springs</b>								
3"	FJ730STK		FJ730ST					Included			
KIT NOTES: FJ730STK Includes Rear Coil Springs & Sway Bar End Links.											
<b>COIL-OVER KITS</b>											
<b>07-14 FJ Cruiser 4WD KIT</b>			<b>With Front &amp; Rear Coil Springs</b>								
3"	FJ730BM		Included			Included		Included			
Kit includes front coil-over shocks, front coil springs, upper coil-over shock brackets, front sway bar relocation brackets, rear coil springs, rear sway bar end links, & rear M95 Monotube shocks (2).											
<b>07-14 FJ Cruiser 4WD KIT</b>			<b>With Rear Coil Springs</b>								
3"	FJ730K		FJ730			Included		Included			
KIT NOTES: FJ730K Includes Rear Coil Springs & Sway Bar End Links.											
<b>64-80 FJ40 LANDCRUISER 4WD</b>											
<b>64-80 FJ40 LandCruiser 4WD System</b>			<b>Front Leafs with Replacement Springs</b>								
2.5"	L20KS		L24S		2	L20FS	2	L20RS			
4"	L40KS		L24S		2	L40FS	2	L40RS			
<b>64-80 FJ40 LandCruiser 4WD System</b>			<b>Shackle Reversal Front Leafs with Replacement Springs</b>								
2.5"-4"	L24KS	I2	L24S		2	L20FS	2	L40RS			
NOTES: I2. This System is for Applications that HAVE Installed a Front Shackle Correction Kit which has Increased the Front 1.5". This System Adds 2.5" Front & 4" Rear to be Level.											

	Steering Stabilizers									HYDRO Shocks		NITRO Shocks		BLACK MAX		M95 Shocks		Labor Hours				
	White			Black			Silver			White		White		Black		Silver						
	OEM	Single	Dual	OEM	Single	Dual	OEM	Single	Dual	Front	Rear	Front	Rear	Front	Rear	Front	Rear					
<b>NOTE: ALL SHOCKS MUST BE ORDERED SEPARATELY</b>																						
										---	---	H7098	---	---	N8098	---	---	B8598	---	---	M9598	4
<b>NOTE: ALL SHOCKS MUST BE ORDERED SEPARATELY</b>																						
										---	---	H7098	---	---	N8098	---	---	B8598	---	---	M9598	4
<b>NOTE: ALL SHOCKS MUST BE ORDERED SEPARATELY</b>																						
										---	---		---	---		---	---		---	---		2
										---	---	H7098	---	---	N8098	---	---	B8598	---	---	M9598	4
										---	---		---	---		---	---		---	---		6
										---	---	Included	---	---		---	---		---	---		6
										---	---		---	---	Included	---	---		---	---		6
										---	---		---	---		---	---	Included	---	---		6
										---	---		---	---		---	---		---	---	Included	6
										---	---	H7098	---	---	N8098	---	---	B8598	---	---	M9598	6
										---	---		---	---		---	---		---	---	Included	6
										---	---	H7098	---	---	N8098	---	---	B8598	---	---	M9598	6
<b>NOTE: ALL SHOCKS MUST BE ORDERED SEPARATELY</b>																						
		7160			8160			9160		H7012	H7023	N8012	N8023	B8512	B8523	M9512	M9523					4
		7160			8160			9160		H7023	H7041	N8023	N8041	B8523	B8541	M9523	M9541					6
		7160			8160			9160		H7023	H7041	N8023	N8041	B8523	B8541	M9523	M9541					4

# POLARIS / UTV

LIFT	Quick Kit Reference	KIT NOTES	Component Box (Requires 1 of Each)
<b>13-19 POLARIS RANGER 900 XP / CREW 4WD</b>			
<b>13-19 Polaris Ranger 900 XP / Crew 4WD</b>			<b>Forward A-Arm Kit</b>
2"	FAA303		FAA303
<b>13 Polaris Ranger 900 XP / Crew 4WD</b>			<b>Nerf Bars</b>
	NBP103		NBP103
<b>05-12 POLARIS RANGER XP / CREW 4WD</b>			
<b>05-12 Polaris Ranger XP / Crew 4WD</b>			<b>Forward A-Arm Kit</b>
1"	FAA281		FAA281
KIT NOTES: This Lift is Designed to Fit Midsize Polaris Ranger Applications Equipped with McPerson Struts Thru 2012. See Listed Applications Here: 05-08 Polaris Ranger 500 XP, 06-09 Polaris Ranger 700 XP / Crew & 10-12 Polaris Ranger EV, 400, 500 XP / Crew.			
<b>10-12 POLARIS RANGER CREW 4WD</b>			
<b>10-12 Polaris Ranger Crew 4WD</b>			<b>Forward A-Arm Kit</b>
2"	FAA301		FAA301
KIT NOTES: Easy Bolt on Installation. Includes Upper & Lower A-Arms, Bushings, Front Bumper Relocation Brackets, & Upper Shock Relocation Brackets. Moves Tire Forward to Clear 30" Tires & Retains OEM Ride. Maintains OEM Suspension Travel, Ball Joints, & Suspension Geometry.			
<b>10-12 Polaris Ranger Crew 4WD</b>			<b>Rear Winch Mount</b>
	RWM101		RWM101
KIT NOTES: Kit Mounts to Rear Frame & Retains Use of Receiver Hitch. 3/16" P&O Steel with Grade 8 Mounting Hardware. Install Up to 4,000 lb. Rear Winch.			
<b>10-12 Polaris Ranger Crew 4WD</b>			<b>Nerf Bars</b>
	NBPC101		NBPC101
<b>10-12 Polaris Ranger XP 4WD</b>			<b>Nerf Bars</b>
	NBP100		NBP100
<b>10-15 POLARIS RANGER CREW 4WD</b>			
<b>10-15 Polaris 800,900, &amp; 1000</b>			<b>Coil Springs</b>
1-2"	P8912	P8912FR Pair	P8912
KIT NOTES: Will Not Fit Midsize Models with Single Struts.			



FAA303



P8912



FAA281



RWM101

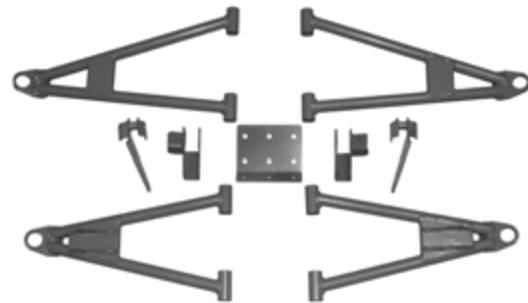

FAA301

# SHOCK APPLICATION GUIDE

Lift Height		HYDRO		Fact. Front	NITRO		Fact. Front	BLACK MAX		Fact. Front	MONOTUBE	
Front	Rear	Front	Rear	Dual	Front	Rear	Dual	Front	Rear	Dual	Front	Rear
<b>CADILLAC</b>												
<b>02-06 Escalade, ESV, EXT 4WD / 2WD</b>												
0"	0-2"	H7009	H7027	----	N8009	N8027	----	B8509	B8527	----	M9509	M9527
2-3"	3-4"	H7003	H7017	----	N8003	N8017	----	B8503	B8517	----	M9503	M9517
5-6"	5-6"	H7096	H7070	----	N8096	N8070	----	B8596	B8570	----	M9596	M9570
<b>99-01 Escalade 4WD</b>												
0"	0"	H7081 <sup>(A10)</sup>	H7084 <sup>(A10)</sup>	----	N8081 <sup>(A10)</sup>	N8084 <sup>(A10)</sup>	----	B8581 <sup>(A10)</sup>	B8584 <sup>(A10)</sup>	----	M9581 <sup>(A10)</sup>	M9584 <sup>(A10)</sup>
A10. Shocks Not Intended for Auto Ride Models.												
<b>CHEVROLET / GMC</b>												
<b>07-13 Avalanche 1500 4WD / 2WD (Strut Front End)</b>												
----	0-1"	----	H7047	----	----	N8047	----	----	B8547	----	----	M9547
----	2-4"	----	H7030	----	----	N8030	----	----	B8530	----	----	M9530
----	5-6"	----	H7070	----	----	N8070	----	----	B8570	----	----	M9570
<b>02-06 Avalanche 1500 4WD / 2WD</b>												
0-1"	0-1"	H7009 <sup>(A10)</sup>	H7047 <sup>(A10)</sup>	----	N8009 <sup>(A10)</sup>	N8047 <sup>(A10)</sup>	----	B8509 <sup>(A10)</sup>	B8547 <sup>(A10)</sup>	----	M9509 <sup>(A10)</sup>	M9547 <sup>(A10)</sup>
3-4"	2-4"	H7003 <sup>(A10)</sup>	H7030 <sup>(A10)</sup>	----	N8003 <sup>(A10)</sup>	N8030 <sup>(A10)</sup>	----	B8503 <sup>(A10)</sup>	B8530 <sup>(A10)</sup>	----	M9503 <sup>(A10)</sup>	M9530 <sup>(A10)</sup>
5-6"	5-6"	H7096 <sup>(A10)</sup>	H7070 <sup>(A10)</sup>	----	N8096 <sup>(A10)</sup>	N8070 <sup>(A10)</sup>	----	B8596 <sup>(A10)</sup>	B8570 <sup>(A10)</sup>	----	M9596 <sup>(A10)</sup>	M9570 <sup>(A10)</sup>
A10. Shocks Not Intended for Auto Ride Models.												
<b>02-06 Avalanche 2500 4WD / 2WD</b>												
0-1"	0-2"	H7019 <sup>(A10)</sup>	H7027 <sup>(A10)</sup>	----	N8019 <sup>(A10)</sup>	N8027 <sup>(A10)</sup>	----	B8519 <sup>(A10)</sup>	B8527 <sup>(A10)</sup>	----	M9519 <sup>(A10)</sup>	M9527 <sup>(A10)</sup>
2-3"	3-4"	H7004 <sup>(A10)</sup>	H7017 <sup>(A10)</sup>	----	N8004 <sup>(A10)</sup>	N8017 <sup>(A10)</sup>	----	B8504 <sup>(A10)</sup>	B8517 <sup>(A10)</sup>	----	M9504 <sup>(A10)</sup>	M9517 <sup>(A10)</sup>
4-6"	4.5-6"	H7074 <sup>(A10)</sup>	H7036 <sup>(A10)</sup>	----	N8074 <sup>(A10)</sup>	N8036 <sup>(A10)</sup>	----	B8574 <sup>(A10)</sup>	B8536 <sup>(A10)</sup>	----	M9574 <sup>(A10)</sup>	M9536 <sup>(A10)</sup>
A10. Shocks Not Intended for Auto Ride Models.												
<b>04-12 Colorado, Canyon 4WD / 2WD</b>												
3-5"	3-4"	H7040 <sup>(A10)</sup>	H7084 <sup>(A10)</sup>	----	N8040 <sup>(A10)</sup>	N8084 <sup>(A10)</sup>	----	B8540 <sup>(A10)</sup>	B8584 <sup>(A10)</sup>	----	----	M9584 <sup>(A10)</sup>
<b>07-20 1500 Pickup 4WD / 2WD (Strut Front End)</b>												
----	0"	----	H7027	----	----	N8027	----	----	B8527	----	----	M9527
----	1.5-3"	----	H7017	----	----	N8017	----	----	B8517	----	----	M9517
----	4-6"	----	H7036	----	----	N8036	----	----	B8536	----	----	M9536
<b>99-06 1500 Pickup 4WD</b>												
0-1"	0-2"	H7009 <sup>(A10)</sup>	H7017 <sup>(A10)</sup>	----	N8009 <sup>(A10)</sup>	N8017 <sup>(A10)</sup>	----	B8509 <sup>(A10)</sup>	B8517 <sup>(A10)</sup>	----	M9509 <sup>(A10)</sup>	M9517 <sup>(A10)</sup>
2-3"	0-2"	H7003 <sup>(A10)</sup>	H7017 <sup>(A10)</sup>	----	N8003 <sup>(A10)</sup>	N8017 <sup>(A10)</sup>	----	B8503 <sup>(A10)</sup>	B8517 <sup>(A10)</sup>	----	M9503 <sup>(A10)</sup>	M9517 <sup>(A10)</sup>
5-6"	3-6"	H7096 <sup>(A10)</sup>	H7036 <sup>(A10)</sup>	----	N8096 <sup>(A10)</sup>	N8036 <sup>(A10)</sup>	----	B8596 <sup>(A10)</sup>	B8536 <sup>(A10)</sup>	----	M9596 <sup>(A10)</sup>	M9536 <sup>(A10)</sup>
A10. Shocks Not Intended for Auto Ride Models.												
<b>99-06 1500 Pickup 2WD</b>												
0-2"	0-2"	H7006	H7030	----	----	N8030	----	B8506	B8530	----	M9506	M9530
<b>88-98 1500, 2500, 3500 Pickup 4WD with IFS</b>												
0-3"	0-2"	H7081	H7083	----	N8081	N8083	----	B8581	B8583	----	M9581	M9583
4-6"	3-5.5"	H7085	H7086	----	N8085	N8086	----	B8585	B8586	----	M9585	M9586
<b>88-98 1500 Pickup 2WD</b>												
1-2.5"	0-2"	H7006	H7072	----	----	N8072	----	B8506	B8572	----	M9506	M9572
<b>01-08 1500HD Pickup 4WD</b>												
0"	0-3"	H7019 <sup>(A10)</sup>	H7017 <sup>(A10)</sup>	----	N8019 <sup>(A10)</sup>	N8017 <sup>(A10)</sup>	----	B8519 <sup>(A10)</sup>	B8517 <sup>(A10)</sup>	----	M9519 <sup>(A10)</sup>	M9517 <sup>(A10)</sup>
2-3"	2"	H7004 <sup>(A10)</sup>	H7017 <sup>(A10)</sup>	----	N8004 <sup>(A10)</sup>	N8017 <sup>(A10)</sup>	----	B8504 <sup>(A10)</sup>	B8517 <sup>(A10)</sup>	----	M9504 <sup>(A10)</sup>	M9517 <sup>(A10)</sup>
5-6"	4-6"	H7074 <sup>(A10)</sup>	H7036 <sup>(A10)</sup>	----	N8074 <sup>(A10)</sup>	N8036 <sup>(A10)</sup>	----	B8574 <sup>(A10)</sup>	B8536 <sup>(A10)</sup>	----	M9574 <sup>(A10)</sup>	M9536 <sup>(A10)</sup>
A10. Shocks Not Intended for Auto Ride Models.												
<b>11-19 2500HD, 3500HD Pickup 4WD / 2WD</b>												
2"	0-2.5"	----	H7027	----	----	N8027	----	----	B8527	----	----	M9527
<b>01-10 2500HD, 3500HD Pickup 4WD / 2WD</b>												
0"	0-2"	H7019 <sup>(A10)</sup>	H7017 <sup>(A10)</sup>	----	N8019 <sup>(A10)</sup>	N8017 <sup>(A10)</sup>	----	B8519 <sup>(A10)</sup>	B8517 <sup>(A10)</sup>	----	M9519 <sup>(A10)</sup>	M9517 <sup>(A10)</sup>
2-3"	2"	H7004 <sup>(A10)</sup>	H7017 <sup>(A10)</sup>	----	N8004 <sup>(A10)</sup>	N8017 <sup>(A10)</sup>	----	B8504 <sup>(A10)</sup>	B8517 <sup>(A10)</sup>	----	M9504 <sup>(A10)</sup>	M9517 <sup>(A10)</sup>
3-6"	3-6"	H7074 <sup>(A10)</sup>	H7036 <sup>(A10)</sup>	----	N8074 <sup>(A10)</sup>	N8036 <sup>(A10)</sup>	----	B8574 <sup>(A10)</sup>	B8536 <sup>(A10)</sup>	----	M9574 <sup>(A10)</sup>	M9536 <sup>(A10)</sup>
A10. Shocks Not Intended for Auto Ride Models.												
<b>02-10 Hummer H2 4WD</b>												
0"	0-2"	H7019	H7017	----	N8019	N8017	----	B8519	B8517	----	M9519	M9517
2-3"	0-2"	H7004	H7017	----	N8004	N8017	----	B8504	B8517	----	M9504	M9517
5-6"	3-6"	H7074	H7036	----	N8074	N8036	----	B8574	B8536	----	M9574	M9536
<b>06-10 Hummer H3, H3T 4WD</b>												
0"	0-1.5"	H7009	H7084	----	N8009	N8084	----	B8509	B8584	----	M9509	M9584
2-3"	0-1.5"	H7003	H7084	----	N8003	N8084	----	B8503	B8584	----	M9503	M9584
<b>07-18 Suburban, Yukon XL 1500 4WD / 2WD (Strut Front End)</b>												
----	0-1"	----	H7027	----	----	N8027	----	----	B8527	----	----	M9527
----	2-3"	----	H7030	----	----	N8030	----	----	B8530	----	----	M9530
----	4-6"	----	H7070	----	----	N8070	----	----	B8570	----	----	M9570
<b>00-06 Suburban 1500 4WD / 2WD</b>												
0-1"	0-2"	H7009 <sup>(A10)</sup>	H7027 <sup>(A10)</sup>	----	N8009 <sup>(A10)</sup>	N8027 <sup>(A10)</sup>	----	B8509 <sup>(A10)</sup>	B8527 <sup>(A10)</sup>	----	M9509 <sup>(A10)</sup>	M9527 <sup>(A10)</sup>
3-4"	3-4"	H7003 <sup>(A10)</sup>	H7017 <sup>(A10)</sup>	----	N8003 <sup>(A10)</sup>	N8017 <sup>(A10)</sup>	----	B8503 <sup>(A10)</sup>	B8517 <sup>(A10)</sup>	----	M9503 <sup>(A10)</sup>	M9517 <sup>(A10)</sup>
5-6"	5-6"	H7096 <sup>(A10)</sup>	H7036 <sup>(A10)</sup>	----	N8096 <sup>(A10)</sup>	N8036 <sup>(A10)</sup>	----	B8596 <sup>(A10)</sup>	B8536 <sup>(A10)</sup>	----	M9596 <sup>(A10)</sup>	M9536 <sup>(A10)</sup>
A10. Shocks Not Intended for Auto Ride Models.												

# SHOCK APPLICATION GUIDE

Lift Height		HYDRO		Fact. Front	NITRO		Fact. Front	BLACK MAX		Fact. Front	MONOTUBE	
Front	Rear	Front	Rear	Dual	Front	Rear	Dual	Front	Rear	Dual	Front	Rear
<b>00-06 Suburban 2500 4WD / 2WD</b>												
0"	0-2"	H7019	H7027	----	N8019 <sup>(A10)</sup>	N8027 <sup>(A10)</sup>	----	B8519 <sup>(A10)</sup>	B8527 <sup>(A10)</sup>	----	M9519 <sup>(A10)</sup>	M9527 <sup>(A10)</sup>
5-6"	3-6"	H7074	H7017	----	N8074 <sup>(A10)</sup>	N8017 <sup>(A10)</sup>	----	B8574 <sup>(A10)</sup>	B8517 <sup>(A10)</sup>	----	M9574 <sup>(A10)</sup>	M9517 <sup>(A10)</sup>
<b>00-06 Tahoe, Yukon 1500 4WD / 2WD</b>												
0-1"	0-1"	H7009	H7027	----	N8009	N8027	----	B8509	B8527	----	M9509	M9527
2-4"	2-3"	H7003	H7030	----	N8003	N8030	----	B8503	B8530	----	M9503	M9530
5-6"	4-6"	H7096	H7070	----	N8096	N8070	----	B8596	B8570	----	M9596	M9570
A10. Shocks Not Intended for Auto Ride Models.												
<b>00-06 Tahoe, Yukon 2500 4WD</b>												
0"	0-2"	H7019 <sup>(A10)</sup>	H7027 <sup>(A10)</sup>	----	N8019 <sup>(A10)</sup>	N8027 <sup>(A10)</sup>	----	B8519 <sup>(A10)</sup>	B8527 <sup>(A10)</sup>	----	M9519 <sup>(A10)</sup>	M9527 <sup>(A10)</sup>
5-6"	3-6"	H7074 <sup>(A10)</sup>	H7036 <sup>(A10)</sup>	----	N8074 <sup>(A10)</sup>	N8036 <sup>(A10)</sup>	----	B8574 <sup>(A10)</sup>	B8536 <sup>(A10)</sup>	----	M9574 <sup>(A10)</sup>	M9536 <sup>(A10)</sup>
<b>07-20 Yukon XL 1500 4WD / 2WD</b>												
----	0-1"	----	H7027	----	----	N8027	----	----	B8527	----	----	M9527
----	2-3"	----	H7030	----	----	N8030	----	----	B8530	----	----	M9530
----	4-6"	----	H7070	----	----	N8070	----	----	B8570	----	----	M9570
A10. Shocks Not Intended for Auto Ride Models.												
<b>00-06 Yukon XL 1500 4WD / 2WD</b>												
0-1"	0-2"	H7009 <sup>(A10)</sup>	H7027 <sup>(A10)</sup>	----	N8009 <sup>(A10)</sup>	N8027 <sup>(A10)</sup>	----	B8509 <sup>(A10)</sup>	B8527 <sup>(A10)</sup>	----	M9509 <sup>(A10)</sup>	M9527 <sup>(A10)</sup>
3-4"	3-4"	H7003 <sup>(A10)</sup>	H7030 <sup>(A10)</sup>	----	N8003 <sup>(A10)</sup>	N8030 <sup>(A10)</sup>	----	B8503 <sup>(A10)</sup>	B8530 <sup>(A10)</sup>	----	M9503 <sup>(A10)</sup>	M9530 <sup>(A10)</sup>
5-6"	5-6"	H7096 <sup>(A10)</sup>	H7070 <sup>(A10)</sup>	----	N8096 <sup>(A10)</sup>	N8070 <sup>(A10)</sup>	----	B8596 <sup>(A10)</sup>	B8570 <sup>(A10)</sup>	----	M9596 <sup>(A10)</sup>	M9570 <sup>(A10)</sup>
A10. Shocks Not Intended for Auto Ride Models.												
<b>73-87 K10, K15, K25 Pickup 4WD</b>												
0-1.5"	0-1.5"	H7021	H7043	H7023	N8021	N8043	N8023	B8521	B8543	B8523	M9521	M9543
2-5"	2-4"	H7051	H7053	H7058	N8051	N8053	N8058	B8551	B8553	B8558	M9551	M9553
6-8"	4.5-8"	H7071	H7073	H7060	N8071	N8073	N8060	B8571	B8573	B8560	M9571	M9573
9-12"	9-12"	H7032	H7078	H7079	N8032	N8078	N8079	B8532	B8578	B8579	M9532	M9578
<b>67-72 K10, K15, K25 Pickup 4WD, K5 Blazer, Jimmy 4WD</b>												
0-1.5"	0-1.5"	H7021	H7023	----	N8021	N8023	----	B8521	B8523	----	M9521	M9523
2-5"	2-4"	H7051	H7041	----	N8051	N8041	----	B8551	B8541	----	M9551	M9541
6-8"	4.5-8"	H7071	H7060	----	N8071	N8060	----	B8571	B8560	----	M9571	M9560
<b>77-87 K30 Pickup 4WD</b>												
0-1.5"	0-1.5"	H7021	H7053	H7023	N8021	N8053	N8023	B8521	B8553	B8523	M9521	M9553
2-5"	2-4"	H7051	H7073	H7058	N8051	N8073	N8058	B8551	B8573	B8558	M9551	M9573
6-8"	4.5-10"	H7071	H7078	H7060	N8071	N8078	N8060	B8571	B8578	B8560	M9571	M9578
9-12"	4.5-10"	H7032	H7078	H7079	N8032	N8078	N8079	B8532	B8578	B8579	M9532	M9578
<b>73-91 K5 Blazer, Jimmy, Suburban 4WD</b>												
0-1.5"	0-1.5"	H7021	H7043	----	N8021	N8043	----	B8521	B8543	----	M9521	M9543
2-5"	2-4"	H7051	H7053	----	N8051	N8053	----	B8551	B8553	----	M9551	M9553
6-8"	4.5-8"	H7071	H7073	----	N8071	N8073	----	B8571	B8573	----	M9571	M9573
9-12"	9-12"	H7032	H7078	----	N8032	N8078	----	B8532	B8578	----	M9532	M9578
<b>73-87 1500, 2500, 3500 C10, C20, C30 Pickup 2WD</b>												
0-1"	0-2"	H7080	H7043	----	----	N8043	----	----	B8543	----	----	M9543
1.5-3"	3-4"	H7011	H7083	----	N8011	N8083	----	B8511	B8583	----	M9511	M9583
<b>63-72 1500, 2500, 3500 C10, C20 &amp; C30 Pickup 2WD</b>												
0-1"	0"	H7080	H7012	----	----	N8012	----	----	B8512	----	----	M9512
1.5-3"	1-3"	H7011	H7023	----	N8011	N8023	----	B8511	B8523	----	M9511	M9523
<b>95-00 Tahoe, Yukon 4WD / 2WD</b>												
0-3"	0-2"	H7081	H7084	----	N8081	N8084	----	B8581	B8584	----	M9581	M9584
4-6"	3-5.5"	H7085	H7083	----	N8085	N8083	----	B8585	B8583	----	M9585	M9583
<b>92-99 Suburban 4WD / 2WD</b>												
0-3"	0-2.5"	H7081	H7084	----	N8081	N8084	----	B8581	B8584	----	M9581	M9584
4-6"	3-5.5"	H7085	H7083	----	N8085	N8083	----	B8585	B8583	----	M9585	M9583
<b>73-84 Blazer, Jimmy 2WD - Full-Size</b>												
0-1"	0-2"	H7080	H7043	----	----	N8043	----	----	B8543	----	----	M9543
1.5-3"	3-4"	H7011	H7083	----	N8011	N8083	----	B8511	B8583	----	M9511	M9583
<b>67-72 Blazer, Jimmy 2WD</b>												
0-1"	0"	H7080	H7012	----	----	N8012	----	----	B8512	----	----	M9512
1.5-3"	1-3"	H7011	H7023	----	N8011	N8023	----	B8511	B8523	----	M9511	M9523
<b>69-91 Suburban 2WD</b>												
0-1"	0-2"	H7080	H7043	----	----	N8043	----	----	B8543	----	----	M9543
1.5-3"	3-4"	H7011	H7083	----	N8011	N8083	----	B8511	B8583	----	M9511	M9583
<b>94-98 S10, S15 Series Pickup 4WD with ZR2 Package</b>												
0-2"	0-2"	H7082	H7072	----	N8082	N8072	----	B8582	B8572	----	M9582	M9572
0-3"	0-3"	H7082	H7083	----	N8082	N8083	----	B8582	B8583	----	M9582	M9583
<b>DODGE</b>												
<b>09-18 Ram 1500 Pickup 4WD</b>												
----	0-2"	----	H7030	----	----	N8030	----	----	B8530	----	----	M9530
----	3-4"	----	H7017	----	----	N8017	----	----	B8517	----	----	M9517



# SHOCK APPLICATION GUIDE

Lift Height		HYDRO		Fact. Front	NITRO		Fact. Front	BLACK MAX		Fact. Front	MONOTUBE	
Front	Rear	Front	Rear	Dual	Front	Rear	Dual	Front	Rear	Dual	Front	Rear
---	---	---	---	---	---	---	---	---	---	---	---	---
---	5-6"	---	H7070	---	---	N8070	---	---	B8570	---	---	M9570
<b>09-18 Ram 1500 Pickup 2WD</b>												
1-2.5"	0-2"	H7020	H7030	---	---	N8030	---	B8520	B8530	---	M9520	M9530
---	3-4"	---	H7017	---	---	N8017	---	---	B8517	---	---	M9517
---	5-6"	---	H7070	---	---	N8070	---	---	B8570	---	---	M9570
<b>06-08 Ram 1500 Pickup 4WD</b>												
---	0"	---	H7017	---	---	N8017	---	---	B8517	---	---	M9517
---	2-3"	---	H7070	---	---	N8070	---	---	B8570	---	---	M9570
---	4-5.5"	---	H7036	---	---	N8036	---	---	B8536	---	---	M9536
<b>02-08 Ram 1500 Pickup 2WD</b>												
1-2.5"	0-1"	H7020	H7017	---	---	N8017	---	B8520	B8517	---	M9520	M9517
<b>02-05 Ram 1500 Pickup 4WD</b>												
0"	0"	H7019	H7017	---	N8019	N8017	---	B8519	B8517	---	M9519	M9517
2"	2-3"	H7004	H7070	---	N8004	N8070	---	B8504	B8570	---	M9504	M9570
5-6"	4-5.5"	H7091	H7036	---	N8091	N8036	---	B8591	B8536	---	M9591	M9536
<b>94-01 Ram 1500 Pickup 2WD</b>												
1-2.5"	0-1"	H7010	H7027	---	---	N8027	---	B8510	B8527	---	M9510	M9527
<b>94-01 Ram 1500 Pickup 4WD</b>												
0-1"	0"	H7091	H7027	---	N8091	N8027	---	B8591	B8527	---	M9591	M9527
2-3"	1-5"	H7092	H7017	---	N8092	N8017	---	B8592	B8517	---	M9592	M9517
4-5"	1-5"	H7093	H7017	---	N8093	N8017	---	B8593	B8517	---	M9593	M9517
<b>14-20 Ram 2500 4WD</b>												
0-1"	0-1"	---	H7091	---	---	N8091	---	---	B8591	---	---	M9591
2"	2"	H7091	H7092	---	N8091	N8092	---	B8591	B8592	---	M9591	M9592
4"	4"	H7092	H7093	---	N8092	N8093	---	B8592	B8593	---	M9592	M9593
6"	6"	H7093	H7094	---	N8093	N8094	---	B8593	B8594	---	M9593	M9594
<b>13-20 Ram 3500 4WD</b>												
0-1"	0-1"	H7091	H7070	---	---	N8070	---	---	B8570	---	---	M9570
2"	2-3"	H7091	H7036	---	N8091	N8036	---	B8591	B8536	---	M9591	M9536
4"	4"	H7092	H7090	---	N8092	N8090	---	B8592	B8590	---	M9592	M9590
6"	6"	H7093	H7090	---	N8093	N8090	---	B8593	B8590	---	M9593	M9590
<b>03-13 Ram 2500 Pickup 4WD</b>												
0"	0"	H7091	H7017	---	N8091	N8017	---	B8591	B8517	---	M9591	M9517
1-2.5"	1-4.5"	H7092	H7036	---	N8092	N8036	---	B8592	B8536	---	M9592	M9536
4-6"	1-4.5"	H7094	H7036	---	N8094	N8036	---	B8594	B8536	---	M9594	M9536
<b>03-12 Ram 3500 Pickup 4WD</b>												
0"	0"	H7091	H7017	---	N8091	N8017	---	B8591	B8517	---	M9591	M9517
1-2.5"	1-4.5"	H7092	H7036	---	N8092	N8036	---	B8592	B8536	---	M9592	M9536
4-6"	1-4.5"	H7094	H7036	---	N8094	N8036	---	B8594	B8536	---	M9594	M9536
<b>03-11 Ram 2500, 3500 / Mega Cab 2WD</b>												
1-2.5"	0-1"	H7026	H7017	---	N8026	N8017	---	B8526	B8517	---	M9526	M9517
<b>94-02 Ram 2500, 3500 Pickup 4WD with V10 / Cummins Engine</b>												
0-1"	0-1"	H7091	H7017	---	N8091	N8017	---	B8591	B8517	---	M9591	M9517
1.5-3"	1.5-4.5"	H7092	H7036	---	N8092	N8036	---	B8592	B8536	---	M9592	M9536
4-5"	1.5-4.5"	H7094	H7036	---	N8094	N8036	---	B8594	B8536	---	M9594	M9536
<b>94-02 Ram 2500, 3500 / Mega Cab 2WD</b>												
1-2.5"	0-1"	H7010	H7027	---	---	N8027	---	B8510	B8527	---	---	M9527
<b>61-93 Ram 1500, 2500, 3500 Pickup 4WD</b>												
0-1"	0-3.5"	H7047	H7038	---	N8047	N8038	---	B8547	B8538	---	M9547	M9538
1.5-3"	0-3.5"	H7027	H7038	---	N8027	N8038	---	B8527	B8538	---	M9527	M9538
4"	0-3.5"	H7017	H7038	---	N8017	N8038	---	B8517	B8538	---	M9517	M9538
5-6"	4-7"	H7017	H7068	---	N8017	N8068	---	B8517	B8568	---	M9517	M9568
7-8"	4-7"	H7036	H7068	---	N8036	N8068	---	B8536	B8568	---	M9536	M9568
<b>61-93 Ramcharger, Trailduster 4WD</b>												
0-1"	0-3.5"	H7047	H7038	---	N8047	N8038	---	B8547	B8538	---	M9547	M9538
1.5-3"	0-3.5"	H7027	H7038	---	N8027	N8038	---	B8527	B8538	---	M9527	M9538
4"	0-3.5"	H7017	H7038	---	N8017	N8038	---	B8517	B8538	---	M9517	M9538
5-6"	4-7"	H7017	H7068	---	N8017	N8068	---	B8517	B8568	---	M9517	M9568
7-8"	4-7"	H7036	H7068	---	N8036	N8068	---	B8536	B8568	---	M9536	M9568
<b>61-71 D200 3/4 Ton Pickup 2WD</b>												
0-2"	0-2"	H7017	H7058	---	N8017	N8058	---	B8517	B8558	---	M9517	M9558
<b>61-71 D300 1 Ton Pickup 2WD</b>												
0"	0"	H7017	H7012	---	N8017	N8012	---	B8517	B8512	---	M9517	M9512

# SHOCK APPLICATION GUIDE

Lift Height		HYDRO		Fact. Front	NITRO		Fact. Front	BLACK MAX		Fact. Front	MONOTUBE	
Front	Rear	Front	Rear	Dual	Front	Rear	Dual	Front	Rear	Dual	Front	Rear
<b>97-99 Dakota 4WD</b>												
0"	0"	H7052	H7058	----	N8052	N8058	----	B8552	B8558	----	M9552	M9558
3-4"	3-4"	H7054	H7017	----	N8054	N8017	----	B8554	B8517	----	M9554	M9517
<b>86-96 Dakota 4WD</b>												
0-1.5"	0"	H7052	H7029	----	N8052	N8029	----	B8552	B8529	----	M9552	M9529
2-4"	1-2"	H7054	H7029	----	N8054	N8029	----	B8554	B8529	----	M9554	M9529
<b>82-91 Ram D50 Mini 4WD</b>												
1-2"	0-2"	H7013	H7058	----	N8013	N8058	----	B8513	B8558	----	M9513	M9558
<b>79-92 Ram D50 Mini 2WD</b>												
1-2"	0-2"	H7013	H7012	----	N8013	N8012	----	B8513	B8512	----	M9513	M9512
<b>89-91 Raider 4WD with V6 Engine</b>												
1-2"	0-2"	H7013	H7012	----	N8013	N8012	----	B8513	B8512	----	M9513	M9512
<b>87-89 Raider 4WD with 4 Cylinder Engine</b>												
1-2"	0-2"	H7013	H7023	----	N8013	N8023	----	B8513	B8523	----	M9513	M9523
<b>79-82 Plymouth Arrow 4WD</b>												
1-2"	0-2"	H7013	H7023	----	N8013	N8023	----	B8513	B8523	----	M9513	M9523
<b>FORD</b>												
<b>04-20 F-150 4WD / 2WD</b>												
----	0"	----	H7041	----	----	N8041	----	----	B8541	----	----	M9541
----	1-4.5"	----	H7060	----	----	N8060	----	----	B8560	----	----	M9560
<b>97-03 F-150 &amp; SuperCrew 4WD</b>												
0-1"	0-2"	H7052	H7059	----	N8052	N8059	----	B8552	B8559	----	M9552	M9559
5-6"	3-5"	H7097	H7061	----	N8097	N8061	----	B8597	B8561	----	M9597	M9561
<b>80-96 F-150 4WD</b>												
0-2"	0-1"	H7052 <sup>(B)</sup>	H7058	H7055 <sup>(A)</sup>	N8052 <sup>(B)</sup>	N8058	N8055 <sup>(A)</sup>	B8552 <sup>(B)</sup>	B8558	B8555 <sup>(A)</sup>	M9552	M9558
3"	1.5-5"	H7054 <sup>(B)</sup>	H7060	H7055 <sup>(A)</sup>	N8054 <sup>(B)</sup>	N8060	N8055 <sup>(A)</sup>	B8554 <sup>(B)</sup>	B8560	B8555 <sup>(A)</sup>	M9554	M9560
4"	1.5-5"	H7054 <sup>(B)</sup>	H7060	H7057 <sup>(A)</sup>	N8054 <sup>(B)</sup>	N8060	N8057 <sup>(A)</sup>	B8554 <sup>(B)</sup>	B8560	B8557 <sup>(A)</sup>	M9554	M9560
5-6"	1.5-5"	H7055 <sup>(B)</sup>	H7060	H7057 <sup>(A)</sup>	N8055 <sup>(B)</sup>	N8060	N8057 <sup>(A)</sup>	B8555 <sup>(B)</sup>	B8560	B8557 <sup>(A)</sup>	M9555	M9560
7-8"	6-9"	H7055 <sup>(B)</sup>	H7079	H7057 <sup>(A)</sup>	N8055 <sup>(B)</sup>	N8079	N8057 <sup>(A)</sup>	B8555 <sup>(B)</sup>	B8579	B8557 <sup>(A)</sup>	M9555	M9579
<b>77-79 F-100, F-150 4WD</b>												
0-2"	0-1"	H7054	H7055	H705	N8054	N8055	N8055	B8554	B8555	B8555	M9554	M9555
3-4"	1.5-2"	H7055	H7056	H7056	N8055	N8056	N8056	B8555	B8556	B8556	M9555	M9556
5-6"	3.5-4"	H7056	H7059	H7059	N8056	N8059	N8059	B8556	B8559	B8559	M9556	M9559
7-9"	5-8"	H7059	H7061	H7061	N8059	N8061	N8061	B8559	B8561	B8561	M9559	M9561
<b>70-76 F-100, F-150 4WD</b>												
0-1"	0-1"	H7012	H7055	H7055	N8012	N8055	N8055	B8512	B8555	B8555	M9512	M9555
1.5-4"	1.5-2"	H7023	H7056	H7056	N8023	N8056	N8056	B8523	B8556	B8556	M9523	M9556
5-6"	3.5-4"	H7058	H7059	H7059	N8058	N8059	N8059	B8558	B8559	B8559	M9558	M9559
7-9"	5-8"	H7060	H7061	H7061	N8060	N8061	N8061	B8560	B8561	B8561	M9560	M9561
<b>66-69 F-100, F-150 4WD</b>												
0-1"	0"	H7012	H7023	----	N8012	N8023	----	B8512	B8523	----	M9512	M9523
1.5-4"	1-3"	H7023	H7058	----	N8023	N8058	----	B8523	B8558	----	M9523	M9558
5-6"	3.5-4.5"	H7058	H7041	----	N8058	N8041	----	B8558	B8541	----	M9558	M9541
7-9"	5-8"	H7060	H7060	----	N8060	N8060	----	B8560	B8560	----	M9560	M9560
<b>97-03 F-150 2WD</b>												
0-1"	0"	H7013	H7056		N8013	N8056		B8513	B8556		M9513	M9556
<b>80-96 F-150 2WD</b>												
0-2"	0-3.5"	H7052 <sup>(B)</sup>	H7058	H7055 <sup>(A)</sup>	N8052 <sup>(B)</sup>	N8058	N8055 <sup>(A)</sup>	B8552 <sup>(B)</sup>	B8558	B8555 <sup>(A)</sup>	M9552	M9558
3"	0-3.5"	H7054 <sup>(B)</sup>	H7058	H7055 <sup>(A)</sup>	N8054 <sup>(B)</sup>	N8058	N8055 <sup>(A)</sup>	B8554 <sup>(B)</sup>	B8558	B8555 <sup>(A)</sup>	M9554	M9558
4"	0-3.5"	H7054 <sup>(B)</sup>	H7058	H7057 <sup>(A)</sup>	N8054 <sup>(B)</sup>	N8058	N8057 <sup>(A)</sup>	B8554 <sup>(B)</sup>	B8558	B8557 <sup>(A)</sup>	M9554	M9558
5-8"	4-8"	H7055 <sup>(B)</sup>	H7060	H7057 <sup>(A)</sup>	N8055 <sup>(B)</sup>	N8060	N8057 <sup>(A)</sup>	B8555 <sup>(B)</sup>	B8560	B8557 <sup>(A)</sup>	M9555	M9560
<b>70-79 F-100, F-150 2WD Except Crew Cab</b>												
0-1"	0-1"	H7052	H7054	----	N8052	N8054	----	B8552	B8554	----	M9552	M9554
2-3"	2-3"	H7054	H7055	----	N8054	N8055	----	B8554	B8555	----	M9554	M9555
<b>80-96 Bronco 4WD / 2WD</b>												
0-2"	0-3.5"	H7052 <sup>(B)</sup>	H7058	H7055 <sup>(A)</sup>	N8052 <sup>(B)</sup>	N8058	N8055 <sup>(A)</sup>	B8552 <sup>(B)</sup>	B8558	B8555 <sup>(A)</sup>	M9552	M9558
3"	0-3.5"	H7054 <sup>(B)</sup>	H7058	H7055 <sup>(A)</sup>	N8054 <sup>(B)</sup>	N8058	N8055 <sup>(A)</sup>	B8554 <sup>(B)</sup>	B8558	B8555 <sup>(A)</sup>	M9554	M9558
4"	0-3.5"	H7054 <sup>(B)</sup>	H7058	H7057 <sup>(A)</sup>	N8054 <sup>(B)</sup>	N8058	N8057 <sup>(A)</sup>	B8554 <sup>(B)</sup>	B8558	B8557 <sup>(A)</sup>	M9554	M9558
5-8"	4-8"	H7055 <sup>(B)</sup>	H7060	H7057 <sup>(A)</sup>	N8055 <sup>(B)</sup>	N8060	N8057 <sup>(A)</sup>	B8555 <sup>(B)</sup>	B8560	B8557 <sup>(A)</sup>	M9555	M9560

KIT NOTES: (A) Ahead of Axle (B) Behind Axle.

# SHOCK APPLICATION GUIDE

Lift Height		HYDRO		Fact. Front	NITRO		Fact. Front	BLACK MAX		Fact. Front	MONOTUBE	
Front	Rear	Front	Rear	Dual	Front	Rear	Dual	Front	Rear	Dual	Front	Rear
<b>78-79 Bronco 4WD</b>												
0-2"	0-2"	H7055 <sup>(A)</sup>	H7023	H7055 <sup>(A)</sup>	N8055 <sup>(A)</sup>	N8023	N8055 <sup>(A)</sup>	B8555 <sup>(A)</sup>	B8523	B8555 <sup>(A)</sup>	M9555 <sup>(A)</sup>	M9523
		H7054 <sup>(B)</sup>		H7054 <sup>(B)</sup>	N8054 <sup>(B)</sup>		N8054 <sup>(B)</sup>	B8554 <sup>(B)</sup>		B8554 <sup>(B)</sup>	M9554 <sup>(B)</sup>	
3-5"	3.5-4.5"	H7056 <sup>(A)</sup>	H7058	H7056 <sup>(A)</sup>	N8056 <sup>(A)</sup>	N8058	N8056 <sup>(A)</sup>	B8556 <sup>(A)</sup>	B8558	B8556 <sup>(A)</sup>	M9556 <sup>(A)</sup>	M9558
		H7055 <sup>(B)</sup>		H7055 <sup>(B)</sup>	N8055 <sup>(B)</sup>		N8055 <sup>(B)</sup>	B8555 <sup>(B)</sup>		B8555 <sup>(B)</sup>	M9555 <sup>(B)</sup>	
6"	5-7"	H7059 <sup>(A)</sup>	H7058	H7059 <sup>(A)</sup>	N8059 <sup>(A)</sup>	N8058	N8059 <sup>(A)</sup>	B8559 <sup>(A)</sup>	B8558	B8559 <sup>(A)</sup>	M9559 <sup>(A)</sup>	M9558
		H7056 <sup>(B)</sup>		H7056 <sup>(B)</sup>	N8056 <sup>(B)</sup>		N8056 <sup>(B)</sup>	B8556 <sup>(B)</sup>		B8556 <sup>(B)</sup>	M9556 <sup>(B)</sup>	
7-9"	8-10"	H7061 <sup>(A)</sup>	H7060	H7061 <sup>(A)</sup>	N8061 <sup>(A)</sup>	N8060	N8061 <sup>(A)</sup>	B8561 <sup>(A)</sup>	B8560	B8561 <sup>(A)</sup>	M9561 <sup>(A)</sup>	M9560
		H7059 <sup>(B)</sup>		H7059 <sup>(B)</sup>	N8059 <sup>(B)</sup>		N8059 <sup>(B)</sup>	B8559 <sup>(B)</sup>		B8559 <sup>(B)</sup>	M9559 <sup>(B)</sup>	
<b>67-77 Bronco 4WD</b>												
0-1"	0"	H7054	H7012	----	N8054	N8012	----	B8554	B8512	----	M9554	M9512
2-3"	1-2.5"	H7055	H7023	----	N8055	N8023	----	B8555	B8523	----	M9555	M9523
4-6"	3.5-5"	H7055	H7058	----	N8055	N8058	----	B8555	B8558	----	M9555	M9558
6.5-8"	5.5-10"	H7056	H7060	----	N8056	N8060	----	B8556	B8560	----	M9556	M9560
<b>00-05 Excursion 4WD (Leaf Spring Front End)</b>												
0-3"	0"	H7023	H7034	----	N8023	N8034	----	B8523	B8534	----	M9523	M9534
4-6"	1-4.5"	H7041	H7034	----	N8041	N8034	----	B8541	B8534	----	M9541	M9534
7-8"	5.5-8"	H7060	H7077	----	N8060	N8077	----	B8560	B8577	----	M9560	M9577
<b>2017-20 F-250, F-350 Super Duty 4WD</b>												
0-3"	0"	H7091	H7038	----	N8091	N8038	----	B8591	B8538	----	M9591	M9538
4"	2-4.5"	H7092	H7068	----	N8092	N8068	----	B8592	B8568	----	M9592	M9560
6"	2-4.5"	H7093	H7068	----	N8093	N8068	----	B8593	B8568	----	M9593	M9568
8.5"	5.5-7.5"	H7094	H7089	----	N8094	N8089	----	B8594	B8589	----	M9594	M9589
<b>05-16 F-250 Super Duty 4WD</b>												
0-3"	0-3"	H7091	H7060	----	N8091	N8060	----	B8591	B8560	----	M9591	M9560
3.5-5"	3.5-5"	H7092	H7060	----	N8092	N8060	----	B8592	B8560	----	M9592	M9560
6-7"	6-7"	H7093	H7079	----	N8093	N8079	----	B8593	B8579	----	M9593	M9579
8.5"	8.5"	H7094	H7099	----	N8094	N8099	----	B8594	B8599	----	M9594	M9599
<b>05-16 F-350 Super Duty 4WD</b>												
0-3"	0-3"	H7091	H7060	----	N8091	N8060	----	B8591	B8560	----	M9591	M9560
3.5-5"	3.5-5"	H7092	H7079	----	N8092	N8060	----	B8592	B8560	----	M9592	M9560
6-7"	6-7"	H7093	H7079	----	N8093	N8079	----	B8593	B8579	----	M9593	M9579
8.5"	8.5"	H7094	H7099	----	N8094	N8099	----	B8594	B8599	----	M9594	M9599
<b>05-16 F-250, F-350 Super Duty 2WD</b>												
0-1"	0"	H7052	H7041	----	N8052	N8041	----	B8552	B8541	----	M9552	M9541
2-4"	1-4"	H7054	H7060	----	N8054	N8060	----	B8554	B8560	----	M9554	M9560
6-8"	6-8"	H7055	H7079	----	N8055	N8079	----	B8555	B8579	----	M9555	M9579
<b>99-04 F-250, F-350 Super Duty 4WD</b>												
0-3"	0-1"	H7023	H7060	----	N8023	N8060	----	B8523	B8560	----	M9523	M9560
4-5"	2-7"	H7041	H7079	----	N8041	N8079	----	B8541	B8579	----	M9541	M9579
6-8"	2-7"	H7060	H7079	----	N8060	N8079	----	B8560	B8579	----	M9560	M9579
<b>99-04 F-250, F-350 Super Duty 2WD</b>												
0-1"	0-3"	H7052	H7060	----	N8052	N8060	----	B8552	B8560	----	M9552	M9560
2-4"	4-6"	H7054	H7079	----	N8054	N8079	----	B8554	B8579	----	M9554	M9579
6-8"	7-8"	H7055	H7099	----	N8055	N8099	----	B8555	B8599	----	M9555	M9599
KIT NOTES: (A) Ahead of Axle (B) Behind Axle.												
<b>97-98 F-250 HD 4WD with IFS Leaf Spring Front</b>												
0-2"	0-1"	H7023	H7058	----	N8023	N8058	----	B8523	B8558	----	M9523	M9558
<b>87-97 F-250 4WD with IFS</b>												
0-2"	0-1"	H7023	H7058	----	N8023	N8058	----	B8523	B8558	----	M9523	M9558
3-6"	1.5-5"	H7041	H7060	----	N8041	N8060	----	B8541	B8560	----	M9541	M9560
<b>80-86 F-250 4WD with IFS</b>												
0-2"	0-1"	H7054	H7058	----	N8054	N8058	----	B8554	B8558	----	M9554	M9558
3-4"	1.5-5"	H7055	H7060	----	N8055	N8060	----	B8555	B8560	----	M9555	M9560
5-6"	1.5-5"	H7056	H7060	----	N8056	N8060	----	B8556	B8560	----	M9556	M9560
5-8"	6-8"	H7056	H7079	----	N8056	N8079	----	B8556	B8579	----	M9556	M9579
<b>77.5-79 F-250 4WD Low Boy</b>												
0"	0"	----	H7055	----	----	N8055	----	----	B8555	----	----	M9555
1-3"	1-3"	----	H7056	----	----	N8056	----	----	B8556	----	----	M9556
3.5-4"	1-3"	----	H7056	----	N8014	N8056	----	B8514	B8556	----	M9514	M9556
5-7"	3.5-6"	----	H7059	----	N8014	N8059	----	B8514	B8559	----	M9514	M9559
<b>66-77 F-250 4WD High Boy</b>												
----	0-4"	----	H7058	----	----	N8058	----	----	B8558	----	----	M9558
2-4"	0-4"	----	H7058	----	N8014	N8058	----	B8514	B8558	----	M9514	M9558
<b>97-98 F-250 Light Duty 2WD</b>												
3-6"	1.5-5"	H7041	H7060	----	N8041	N8060	----	B8541	B8560	----	M9541	M9560

# SHOCK APPLICATION GUIDE

Lift Height		HYDRO		Fact. Front	NITRO		Fact. Front	BLACK MAX		Fact. Front	MONOTUBE	
Front	Rear	Front	Rear	Dual	Front	Rear	Dual	Front	Rear	Dual	Front	Rear
<b>80-96 F-250 2WD</b>												
0-2"	0-2"	H7052	H7058	----	N8052	N8058	----	B8552	B8558	----	M9552	M9558
3-4"	0-2"	H7054	H7058	----	N8054	N8058	----	B8554	B8558	----	M9554	M9558
5-8"	3-4.5"	H7055	H7041	----	N8055	N8041	----	B8555	B8541	----	M9555	M9541
<b>86-98 F-350 4WD with Straight Axle</b>												
0-2"	0-2"	H7023	H7060	----	N8023	N8060	----	B8523	B8560	----	M9523	M9560
3-4"	3-6"	H7041	H7079	----	N8041	N8079	----	B8541	B8579	----	M9541	M9579
5-6"		H7060	H7079	----	N8060	N8079	----	B8560	B8579	----	M9560	M9579
<b>80-85 F-350 4WD with IFS</b>												
0-2"	0-1"	H7054	H7058	----	N8054	N8058	----	B8554	B8558	----	M9554	M9558
3-6"	1.5-5"	H7055	H7060	----	N8055	N8060	----	B8555	B8560	----	M9555	M9560
<b>79 F-350 4WD</b>												
1-2"	1-3"	----	H7056	----	----	N8056	----	----	B8556	----	----	M9556
3-4"	1-3"	----	H7056	----	N8014	N8056	----	B8514	B8556	----	M9514	M9556
5-7"	4-6"	----	H7059	----	N8014	N8059	----	B8514	B8559	----	M9514	M9559
<b>80-96 F-250, F-350 2WD</b>												
0-2"	0-2"	H7052	H7058	----	N8052	N8058	----	B8552	B8558	----	M9552	M9558
3-4"	0-2"	H7054	H7058	----	N8054	N8058	----	B8554	B8558	----	M9554	M9558
5-8"	3-4.5"	H7055	H7041	----	N8055	N8041	----	B8555	B8541	----	M9555	M9541
<b>83-97 Ranger Splash 4WD</b>												
0-2"	0-1"	H7052	H7058	----	N8052	N8058	----	B8552	B8558	----	M9552	M9558
3"	0-1"	H7054	H7058	----	N8054	N8058	----	B8554	B8558	----	M9554	M9558
4"	1.5-4.5"	H7054	H7060	----	N8054	N8060	----	B8554	B8560	----	M9554	M9560
5-6"	1.5-4.5"	H7055	H7060	----	N8055	N8060	----	B8555	B8560	----	M9555	M9560
7-8"	5-6"	H7055	H7079	----	N8055	N8079	----	B8555	B8579	----	M9555	M9579
<b>83-97 Ranger 2WD, Bronco II 4WD / 2WD</b>												
0-2"	0-3.5"	H7052	H7058	----	N8052	N8058	----	B8552	B8558	----	M9552	M9558
3-4"	0-3.5"	H7054	H7058	----	N8054	N8058	----	B8554	B8558	----	M9554	M9558
5-8"	4-8"	H7055	H7060	----	N8055	N8060	----	B8555	B8560	----	M9555	M9560
<b>90-94 Explorer 4WD / 2WD</b>												
0-2"	0-2"	H7052	H7029	----	N8052	N8029	----	B8552	B8529	----	M9552	M9529
3-4"	3-6"	H7054	H7034	----	N8054	N8034	----	B8554	B8534	----	M9554	M9534
5-6"	3-6"	H7055	H7034	----	N8055	N8034	----	B8555	B8534	----	M9555	M9534
<b>HONDA</b>												
<b>94-95 Passport 4WD</b>												
0"	0"	H7052	H7055	----	N8052	N8055	----	B8552	B8555	----	M9552	M9555
<b>ISUZU</b>												
<b>05-08 Isuzu i-Sries 4WD</b>												
3-5"	3-4"	H7040	H7084	----	N8040	N8074	----	B8540	B8574	----	M9540	M9574
<b>89-95 Amigo 4WD / 2WD</b>												
0-1"	0"	H7052	H7023	----	N8052	N8023	----	B8552	B8523	----	M9552	M9523
<b>87-91 Trooper II 4WD</b>												
0-1"	0"	H7052	H7055	----	N8052	N8055	----	B8552	B8555	----	M9552	M9555
<b>84-86 Trooper II 4WD</b>												
0-1"	0"	H7052	H7023	----	N8052	N8023	----	B8552	B8523	----	M9552	M9523
<b>81-92 Pickup 4WD</b>												
1-2"	0-1"	H7052	H7012	----	N8052	N8012	----	B8552	B8512	----	M9552	M9512
<b>91-95 Pickup 2WD</b>												
0"	0"	H7052	H7023	----	N8052	N8023	----	B8552	B8523	----	M9552	M9523
<b>JEEP</b>												
<b>20 Gladiator JT Pickup</b>												
0"	0"	H7384	H7395	----	N8384	N8395	----	B8384	B8395	----	M9384	M9395
1-2"	1-2"	H7385	H7396	----	N8385	N8396	----	B8385	B8396	----	M9385	M9396
2.5-3"	1-2"	H7386	H7396	----	N8386	N8396	----	B8386	B8396	----	M9386	M9396
3.5-4"	3-3.5"	H7387	H7397	----	N8387	N8397	----	B8387	B8397	----	M9387	M9397
4.5-5"	3-3.5"	H7388	H7397	----	N8388	N8397	----	B8388	B8397	----	M9388	M9397
4.5-5"	4-4.5"	H7388	H7398	----	N8388	N8398	----	B8388	B8398	----	M9388	M9398
<b>18-20 Wrangler JL Standard Linear Coil or Spacer Lift</b>												
0-1.5"	0-1.5"	H7384	H7386	----	N8384	N8386	----	B8384	B8386	----	M9384	M9386
2-2.5"	2-3"	H7385	H7387	----	N8385	N8387	----	B8385	B8387	----	M9385	M9387
3-4"	3.5-4"	H7386	H7388	----	N8386	N8388	----	B8386	B8388	----	M9386	M9388
<b>18-20 Wrangler JL Dual Rate-Long Travel</b>												
1-1.5"	1-1.5"	H7385	H7387	----	N8385	N8387	----	B8385	B8387	----	M9385	M9387
2-2.5"	2-3"	H7386	H7388	----	N8386	N8388	----	B8386	B8388	----	M9386	M9388
3-4"	3.5-4"	H7387	H7389	----	N8387	N8389	----	B8387	B8389	----	M9387	M9389
3-4"	3.5-4"	H7388 (4)	H7389	----	N8388 (4)	N8389	----	B8388 (4)	B8389	----	M9388 (4)	M9389

KIT NOTES: (4) 4 Door Only

# SHOCK APPLICATION GUIDE

Lift Height		HYDRO		Fact. Front	NITRO		Fact. Front	BLACK MAX		Fact. Front	MONOTUBE	
Front	Rear	Front	Rear	Dual	Front	Rear	Dual	Front	Rear	Dual	Front	Rear
<b>07-18 Wrangler JK 2 / 4 Door 4WD / 2WD</b>												
(-2)-(-2.5)"	(-2)-(-2.5)"	----	----	----	N8005	N8007	----	----	B8507	----	----	----
0-1"	0-1"	H7001	H7007	----	N8001	N8007	----	----	B8501	B8507	----	M9501
1-2.5"	2-3.5"	H7035	H7037	----	N8035	N8037	----	----	B8535	B8537	----	M9535
3-5"	4-5"	H7065	H7067	----	N8065	N8067	----	----	B8565	B8567	----	M9565
6-7"	6-7"	H7075	H7087	----	N8075	N8087	----	----	B8575	B8587	----	M9575
<b>97-06 Wrangler TJ Unlimited Rubicon 4WD (TJ Rear Shock Relocation Brackets Available, Part # TJRSB10)</b>												
0-3"	0"	H7016	H7008	----	N8016	N8008	----	----	B8516	B8508	----	M9516
0-3"	1-3"	H7016	H7018	----	N8016	N8018	----	----	B8516	B8518	----	M9516
3.5-4"	3.5-4"	H7025	H7028	----	N8025	N8028	----	----	B8525	B8528	----	M9525
6-9"	6-8"	H7049	H7063	----	N8049	N8063	----	----	B8549	B8563	----	M9549
<b>87-96 Wrangler YJ 4WD</b>												
0-1"	0"	H7055	H7012	----	N8055	N8012	----	----	B8555	B8512	----	M9555
2-2.5"	1-2.5"	H7056	H7023	----	N8056	N8023	----	----	B8556	B8523	----	M9556
3.5-4"	3-6"	H7059	H7088	----	N8059	N8088	----	----	B8559	B8588	----	M9559
5-6"	3-6"	H7061	H7088	----	N8061	N8088	----	----	B8561	B8588	----	M9561
<b>82-86 CJ5, CJ7, Scrambler 4WD</b>												
0-2.5"	0-2.5"	H7012	H7023	----	N8012	N8023	----	----	B8512	B8523	----	M9512
3-5"	3-5"	H7023	H7058	----	N8023	N8058	----	----	B8523	B8558	----	M9523
<b>76-81 CJ5, CJ7, Scrambler 4WD</b>												
0-2.5"	0"	H7012	H7012	----	N8012	N8012	----	----	B8512	B8512	----	M9512
0-2.5"	1-3"	H7012	H7023	----	N8012	N8023	----	----	B8512	B8523	----	M9512
3-5"	1-3"	H7023	H7023	----	N8023	N8023	----	----	B8523	B8523	----	M9523
3-5"	3.5-5.5"	H7023	H7058	----	N8023	N8058	----	----	B8523	B8558	----	M9523
<b>55-75 CJ5, CJ6, 3B, M38A1 4WD</b>												
0-1"	0"	H7012	H7012	----	N8012	N8012	----	----	B8512	B8512	----	M9512
1.5-2.5"	1-3"	H7023	H7023	----	N8023	N8023	----	----	B8523	B8523	----	M9523
3-5"	3.5-5.5"	H7058	H7058	----	N8058	N8058	----	----	B8558	B8558	----	M9558
<b>41-63 MB, M38, CJ2A, CJ3A, CJ3B 4WD</b>												
0-1"	0-1"	H7012	H7012	----	N8012	N8012	----	----	B8512	B8512	----	M9512
<b>All U.S. Post Office Jeep FJ8A, FJ9 2WD</b>												
0"	0"	H7012	H7012	----	N8012	N8012	----	----	B8512	B8512	----	M9512
<b>02-12 Liberty KJ 4WD / 2WD</b>												
----	2.5"	----	H7088	----	----	N8088	----	----	----	B8588	----	M9558
<b>84-01 Cherokee XJ 4WD / 2WD</b>												
0-3"	0"	H7016	H7008	----	N8016	N8008	----	----	B8516	B8508	----	M9516
0-3"	1-3"	H7016	H7018	----	N8016	N8018	----	----	B8516	B8518	----	M9516
4-5"	4-5"	H7025	H7028	----	N8025	N8028	----	----	B8525	B8528	----	M9525
6-8"	5-8"	H7049	H7063	----	N8049	N8063	----	----	B8549	B8563	----	M9549
<b>06-10 Commander XK 4WD / 2WD</b>												
----	0-2"	----	H7088	----	----	N8088	----	----	----	B8588	----	M9558
<b>06-10 Grand Cherokee WK 4WD / 2WD</b>												
----	0-2"	----	H7088	----	----	N8088	----	----	----	B8588	----	M9558
<b>99-04 Grand Cherokee WJ 4WD / 2WD</b>												
0"	0"	H7015	H7042	----	N8015	N8042	----	----	B8515	B8542	----	M9515
2-3"	2-3"	H7016	H7044	----	N8016	N8044	----	----	B8516	B8544	----	M9516
<b>93-98 Grand Cherokee ZJ 4WD / 2WD</b>												
0-3"	0-3"	H7016	H7023	----	N8016	N8023	----	----	B8516	B8523	----	M9516
4-5"	4-5"	H7025	H7058	----	N8025	N8058	----	----	B8525	B8558	----	M9525
<b>84-91 Grand Wagoneer 4WD - Full-Size</b>												
0-1"	0-1"	H7012	H7012	----	N8012	N8012	----	----	B8512	B8512	----	M9512
2-3"	2-3"	H7023	H7023	----	N8023	N8023	----	----	B8523	B8523	----	M9523
4-5"	4-5"	H7088	H7088	----	N8088	N8088	----	----	B8588	B8588	----	M9558
<b>74-83 Cherokee, Wagoneer 4WD - Full-Size</b>												
0-1"	0-1"	H7012	H7012	----	N8012	N8012	----	----	B8512	B8512	----	M9512
2-3"	2-3"	H7023	H7023	----	N8023	N8023	----	----	B8523	B8523	----	M9523
4-5"	4-5"	H7088	H7088	----	N8088	N8088	----	----	B8588	B8588	----	M9558
<b>86-92 Comanche MJ 4WD / 2WD</b>												
0-3"	0-3"	H7016	H7023	----	N8016	N8023	----	----	B8516	B8523	----	M9516
4-5"	4-5"	H7025	H7058	----	N8025	N8058	----	----	B8525	B8558	----	M9525
<b>74-88 J10, J20 Pickup 4WD</b>												
0-1"	0-1"	H7012	H7012	----	N8012	N8012	----	----	B8512	B8512	----	M9512
2-3"	2-3"	H7023	H7023	----	N8023	N8023	----	----	B8523	B8523	----	M9523
4-5"	4-5"	H7088	H7088	----	N8088	N8088	----	----	B8588	B8588	----	M9558

# SHOCK APPLICATION GUIDE

Lift Height		HYDRO		Fact. Front	NITRO		Fact. Front	BLACK MAX		Fact. Front	MONOTUBE	
Front	Rear	Front	Rear	Dual	Front	Rear	Dual	Front	Rear	Dual	Front	Rear
<b>63-73 Wagoneer 4WD</b>												
2-3"	2-4"	H7058	H7023	----	N8058	N8023	----	B8558	B8523	----	M9558	M9523
<b>69-73 Jeepster, C101, Commando 4WD</b>												
0-2"	0-2"	H7012	H7023	----	N8012	N8023	----	B8512	B8523	----	M9512	M9523
3-4"	3-4"	H7023	H7058	----	N8023	N8058	----	B8523	B8558	----	M9523	M9558
<b>47-62 Utility Wagon 4WD</b>												
2-4"	2-4"	H7012	H7023	----	N8012	N8023	----	B8512	B8523	----	M9512	M9523
<b>63-73 Gladiator 4WD</b>												
0-1"	0-1"	H7012	H7012	----	N8012	N8012	----	B8512	B8512	----	M9512	M9512
2-3"	2-3"	H7058	H7023	----	N8058	N8023	----	B8558	B8523	----	M9558	M9523
<b>47-62 Utility Truck 4WD</b>												
1.5-2"	1.5-2"	H7012	H7012	----	N8012	N8012	----	B8512	B8512	----	M9512	M9512
<b>LINCOLN</b>												
<b>06-08 Mark LT 4WD</b>												
----	0-2.5"	----	H7041	----	----	N8041	----	----	B8541	----	----	M9541
<b>MAZDA</b>												
<b>94-97 B4000 4WD</b>												
0-2"	0-4"	H7052	H7060	----	N8052	N8060	----	B8552	B8560	----	M9552	M9560
3-4"	0-4"	H7054	H7060	----	N8054	N8060	----	B8554	B8560	----	M9554	M9560
5-6"	0-4"	H7055	H7060	----	N8055	N8060	----	B8555	B8560	----	M9555	M9560
<b>87-93 B2600 4WD</b>												
0-2"	0-1"	H7052	H7027	----	N8052	N8027	----	B8552	B8527	----	M9552	M9527
<b>90-94 Navajo 4WD</b>												
0-2"	0-2"	H7052	H7029	----	N8052	N8029	----	B8552	B8529	----	M9552	M9529
2-4"	3-8"	H7054	H7039	----	N8054	N8039	----	B8554	B8539	----	M9554	M9539
5-8"	3-8"	H7055	H7039	----	N8055	N8039	----	B8555	B8539	----	M9555	M9539
<b>94-97 B Series 2WD</b>												
0-1"	0-3.5"	H7052	H7058	----	N8052	N8058	----	B8552	B8558	----	M9552	M9558
2-4"	0-3.5"	H7054	H7058	----	N8054	N8058	----	B8554	B8558	----	M9554	M9558
5-8"	4-6"	H7055	H7041	----	N8055	N8041	----	B8555	B8541	----	M9555	M9541
<b>86-93 B-2000 &amp; B-2200 2WD</b>												
0-2"	0"	H7052	H7012	----	N8052	N8012	----	B8552	B8512	----	M9552	M9512
<b>MITSUBISHI</b>												
<b>85-89 Montero 4WD with 4 Cylinder Engine</b>												
1-2"	1-2"	H7013	H7023	----	N8013	N8023	----	B8513	B8523	----	M9513	M9523
<b>83-84 Montero 4WD</b>												
1-2"	1-2"	H7013	H7023	----	N8013	N8023	----	B8513	B8523	----	M9513	M9523
<b>83-91 Pickup 4WD</b>												
1-2"	1-2"	H7013	H7058	----	N8013	N8058	----	B8513	B8558	----	M9513	M9558
<b>NISSAN</b>												
<b>86.5-93 Pathfinder and Terrano 4WD / 2WD</b>												
0-1"	0-1"	H7052	H7023	----	N8052	N8023	----	B8552	B8523	----	M9552	M9523
2-4"	2-4"	H7054	H7041	----	N8054	N8041	----	B8554	B8541	----	M9554	M9541
<b>86.5-92 Hardbody 4WD</b>												
2-3"	1-2"	H7052	H7023	----	N8052	N8023	----	B8552	B8523	----	M9552	M9523
4-5"	3-4"	H7054	H7058	----	N8054	N8058	----	B8554	B8558	----	M9554	M9558
<b>83.5-86 Pickup 4WD</b>												
1-2"	0-1"	H7052	H7023	----	N8052	N8023	----	B8552	B8523	----	M9552	M9523
<b>87-93 Pickup 2WD</b>												
1-2"	0-1"	H7052	H7023	----	N8052	N8023	----	B8552	B8523	----	M9552	M9523
<b>SCOUT</b>												
<b>72-82 Scout II, Terra / Traveler 4WD</b>												
0-1"	0-1"	H7054	H7012	----	N8054	N8012	----	B8554	B8512	----	M9554	M9512
2-4"	2-4"	H7055	H7058	----	N8055	N8058	----	B8555	B8558	----	M9555	M9558
<b>61-71 Scout 80 / 800 4WD</b>												
0-1"	0-1"	H7012	H7054	----	N8012	N8054	----	B8512	B8554	----	M9512	M9554
<b>SUZUKI</b>												
<b>85-92 Samurai / Santana 4WD</b>												
0-2"	0-2"	H7052	H7012	----	N8052	N8012	----	B8552	B8512	----	M9552	M9512
3-4"	3-4"	H7054	H7023	----	N8054	N8023	----	B8554	B8523	----	M9554	M9523
<b>85-88 LJ10 / SJ10 / LJ413 4WD</b>												
0-1"	0-1"	H7054	H7012	----	N8054	N8012	----	B8554	B8512	----	M9554	M9512
<b>82-85 LJ413 4WD</b>												
0-1"	0-1"	H7052	H7012	----	N8052	N8012	----	B8552	B8512	----	M9552	M9512

# SHOCK APPLICATION GUIDE

Lift Height		HYDRO		Fact. Front	NITRO		Fact. Front	BLACK MAX		Fact. Front	MONOTUBE	
Front	Rear	Front	Rear	Dual	Front	Rear	Dual	Front	Rear	Dual	Front	Rear
<b>TOYOTA</b>												
<b>05-14 HiLux, Tiger, Vigo 4WD</b>												
----	0-1.5"	----	H7027	----	----	N8027	----	----	B8527	----	----	M9527
<b>05-20 Tacoma 4WD, Pre-Runner 2WD</b>												
----	0-1"	----	H7048	----	----	N8048	----	----	B8548	----	----	M9548
----	1.5-3"	----	H7045	----	----	N8045	----	----	B8545	----	----	M9545
<b>95.5-04 Tacoma 4WD, Pre-Runner 2WD</b>												
----	0-1"	----	H7047	----	----	N8047	----	----	B8547	----	----	M9547
----	2-4"	----	H7027	----	----	N8027	----	----	B8527	----	----	M9527
<b>07-20 Tundra 4WD / 2WD</b>												
----	0-2"	----	H7062	----	----	N8062	----	----	B8562	----	----	M9562
----	4-5"	----	H7066	----	----	N8066	----	----	B8566	----	----	M9566
<b>00-06 Tundra 4WD</b>												
----	1-2.5"	----	H7048	----	----	N8048	----	----	B8548	----	----	M9548
<b>93-98 T100 4WD</b>												
0-2"	0-1"	H7002	H7058	----	N8002	N8058	----	B8502	B8558	----	M9502	M9558
3-4"	2-4"	H7004	H7060	----	N8004	N8060	----	B8504	B8560	----	M9504	M9560
<b>86-95 Pickup 4WD</b>												
0-2"	0-2"	H7002	H7047	----	N8002	N8047	----	B8502	B8547	----	M9502	M9547
3-4"	3-4"	H7004	H7027	----	N8004	N8027	----	B8504	B8527	----	M9504	M9527
<b>84-85 Pickup 4WD</b>												
0-1"	0-1"	H7052	H7047	----	N8052	N8047	----	B8552	B8547	----	M9552	M9547
1.5-2.5"	0-1"	H7054	H7047	----	N8054	N8047	----	B8554	B8547	----	M9554	M9547
3-4"	1.5-3.5"	H7055	H7027	----	N8055	N8027	----	B8555	B8527	----	M9555	M9527
5-6"	4-8.5"	H7055	H7036	----	N8055	N8036	----	B8555	B8536	----	M9555	M9536
7-8"	4-8.5"	H7056	H7036	----	N8056	N8036	----	B8556	B8536	----	M9556	M9536
<b>79-83 Pickup 4WD</b>												
0-1"	0-2"	H7052	H7058	----	N8052	N8058	----	B8552	B8558	----	M9552	M9558
1.5-2.5"	0-2"	H7054	H7058	----	N8054	N8058	----	B8554	B8558	----	M9554	M9558
3-4"	0-2"	H7055	H7058	----	N8055	N8058	----	B8555	B8558	----	M9555	M9558
5-6"	3-7"	H7055	H7060	----	N8055	N8060	----	B8555	B8560	----	M9555	M9560
7-8"	3-7"	H7056	H7060	----	N8056	N8060	----	B8556	B8560	----	M9556	M9560
<b>03-20 4Runner 4WD / 2WD</b>												
----	2-3"	----	H7098	----	----	N8098	----	----	B8598	----	----	M9598
<b>96-01 4Runner 4WD</b>												
----	0-2.5"	----	H7022	----	----	N8022	----	----	B8522	----	----	M9522
<b>90-95 4Runner 4WD / 2WD</b>												
0-2"	0-2"	H7002	H7022	----	N8002	N8022	----	B8502	B8522	----	M9502	M9522
3-4"	3-4"	H7004	H7024	----	N8004	N8024	----	B8504	B8524	----	M9504	M9524
<b>86-89 4Runner 4WD</b>												
0-2"	0-2"	H7002	H7047	----	N8002	N8047	----	B8502	B8547	----	M9502	M9547
3-4"	3-4"	H7004	H7027	----	N8004	N8027	----	B8504	B8527	----	M9504	M9527
<b>84-85 4Runner 4WD</b>												
0-1"	0-1"	H7052	H7047	----	N8052	N8047	----	B8552	B8547	----	M9552	M9547
1.5-2.5"	0-1"	H7054	H7047	----	N8054	N8047	----	B8554	B8547	----	M9554	M9547
3-4"	1.5-3.5"	H7055	H7027	----	N8055	N8027	----	B8555	B8527	----	M9555	M9527
5-6"	4-8.5"	H7055	H7036	----	N8055	N8036	----	B8555	B8536	----	M9555	M9536
7-8"	4-8.5"	H7056	H7036	----	N8056	N8036	----	B8556	B8536	----	M9556	M9536
<b>07-14 FJ Cruiser 4WD</b>												
----	1.5"-2.5"	----	H7098	----	----	N8098	----	----	B8598	----	----	M9598
<b>84-87 LandCruiser 60 Series 4WD (Model FJ60)</b>												
0"	0"	H7091	H7047	----	N8091	N8047	----	B8591	B8547	----	M9591	M9547
<b>81-83 LandCruiser 60 Series 4WD (Model FJ60)</b>												
0"	0"	H7091	H7023	----	N8091	N8023	----	B8591	B8523	----	M9591	M9523
<b>84-89 LandCruiser BJ70, BJ71, BJ73, BJ75 4WD</b>												
0-1"	0-1"	H7091	H7047	----	N8091	N8047	----	B8591	B8547	----	M9591	M9547
<b>91-97 LandCruiser FJ80 4WD</b>												
----	0-2"	----	H7024	----	----	N8024	----	----	B8524	----	----	M9524
<b>86-89 LandCruiser FJ60 4WD</b>												
0-2"	0-2"	H7022	H7047	----	N8022	N8047	----	B8522	B8547	----	M9522	M9547
<b>88-89 LandCruiser HJ40 4WD</b>												
0"	0"	H7091	H7047	----	N8091	N8047	----	B8591	B8547	----	M9591	M9547

# SHOCK APPLICATION GUIDE

Lift Height		HYDRO		Fact. Front	NITRO		Fact. Front	BLACK MAX		Fact. Front	MONOTUBE	
Front	Rear	Front	Rear	Dual	Front	Rear	Dual	Front	Rear	Dual	Front	Rear
<b>64-84 LandCruiser FJ40, BJ40, BJ42 4WD</b>												
0-2"	0-2"	H7012	H7023	----	N8012	N8023	----	B8512	B8523	----	M9512	M9523
3-4"	3-4"	H7023	H7041	----	N8023	N8041	----	B8523	B8541	----	M9523	M9541
5-6"	5-6"	H7023	H7060	----	N8023	N8060	----	B8523	B8560	----	M9523	M9560
<b>94-95 LandCruiser KZJ70, KZJ73 4WD</b>												
0"	0"	H7091	H7047	----	N8091	N8047	----	B8591	B8547	----	M9591	M9547
<b>90-93 LandCruiser LJ70, LJ73 4WD</b>												
0"	0"	H7091	H7047	----	N8091	N8047	----	B8591	B8547	----	M9591	M9547
<b>64-81 Wagon FJ43, FJ45 4WD</b>												
0-1.5"	0-1.5"	H7012	H7023	----	N8012	N8023	----	B8512	B8523	----	M9512	M9523
<b>88-89 LandCruiser HJ40 4WD</b>												
0"	0"	H7091	H7047	----	N8091	N8047	----	B8591	B8547	----	M9591	M9547
<b>64-84 LandCruiser FJ40, BJ40, BJ42 4WD</b>												
0-2"	0-2"	H7012	H7023	----	N8012	N8023	----	B8512	B8523	----	M9512	M9523
3-4"	3-4"	H7023	H7041	----	N8023	N8041	----	B8523	B8541	----	M9523	M9541
5-6"	5-6"	H7023	H7060	----	N8023	N8060	----	B8523	B8560	----	M9523	M9560
<b>94-95 LandCruiser KZJ70 / KZJ73 4WD</b>												
0"	0"	H7091	H7047	----	N8091	N8047	----	B8591	B8547	----	M9591	M9547
<b>90-93 LandCruiser LJ70 / LJ73 4WD</b>												
0"	0"	H7091	H7047	----	N8091	N8047	----	B8591	B8547	----	M9591	M9547
<b>64-81 Wagon FJ43 / FJ45 4WD</b>												
0-1.5"	0-1.5"	H7012	H7023	----	N8012	N8023	----	B8512	B8523	----	M9512	M9523



# FRONT PERFORMANCE ADJUSTABLE LEVELING STRUTS

Year	Make / Model	Height (in.)		Front Strut (Single)	Rear Lift	Rear Shocks			
		Front	Rear			Hydro	Nitro	Black MAX	M95
NOTES: Struts Sold Individually. Order (2) for Pair. Shocks Sold Individually. Order (2) for Pair.									
<b>DODGE</b>									
06-18	Dodge Ram 1500 4WD	1.5-2.5"	-----	D6912STS	-----	H7030	N8030	B8530	M9530
NOTES: Will NOT Fit TRX or Air Ride.									
<b>FORD</b>									
09-13	F-150 Pickup 4WD	1-2.5"	-----	F9125STS	-----	H7041	N8041	B8541	M9541
09-13	F-150 Pickup 2WD	2-2.5"	-----	F9125STS	-----	H7041	N8041	B8541	M9541
04-08	F-150 Pickup 4WD	3"	-----	F223STS	-----	H7041	N8041	B8541	M9541
04-08	F-150 Pickup 2WD	3"	-----	F423STS	-----	H7041	N8041	B8541	M9541
<b>LINCOLN</b>									
06-08	Mark LT 4WD	2-2.5"	-----	F9125STS	-----	H7041	N8041	B8541	M9541
<b>TOYOTA</b>									
07-14	FJ Cruiser 4WD	1-3"	-----	FJ713STS	-----	-----	-----	-----	-----
07-20	Tundra Pickup 2WD / 4WD	1-3"	-----	TU713STS	-----	H7062	N8062	B8562	M9562
00-06	Tundra Pickup 4WD	1-3"	-----	TT413STS	-----	-----	-----	-----	-----
05-20	Tacoma 4WD / Pre-Runner 2WD	1-3"	-----	TC513STS	-----	H7048	N8048	B8548	M9548
95.5-04	Tacoma 4WD / Pre-Runner 2WD	1-3"	-----	TT413STS	-----	H7047	N8047	B8547	M9547
03-20	4Runner 2WD / 4WD	1-3"	-----	TC513STS	-----	-----	-----	-----	-----
05-16	HiLux / Tiger / Vigo 4WD	1-3"	-----	HL13STS	-----	H7047	N8048	B8547	M9547

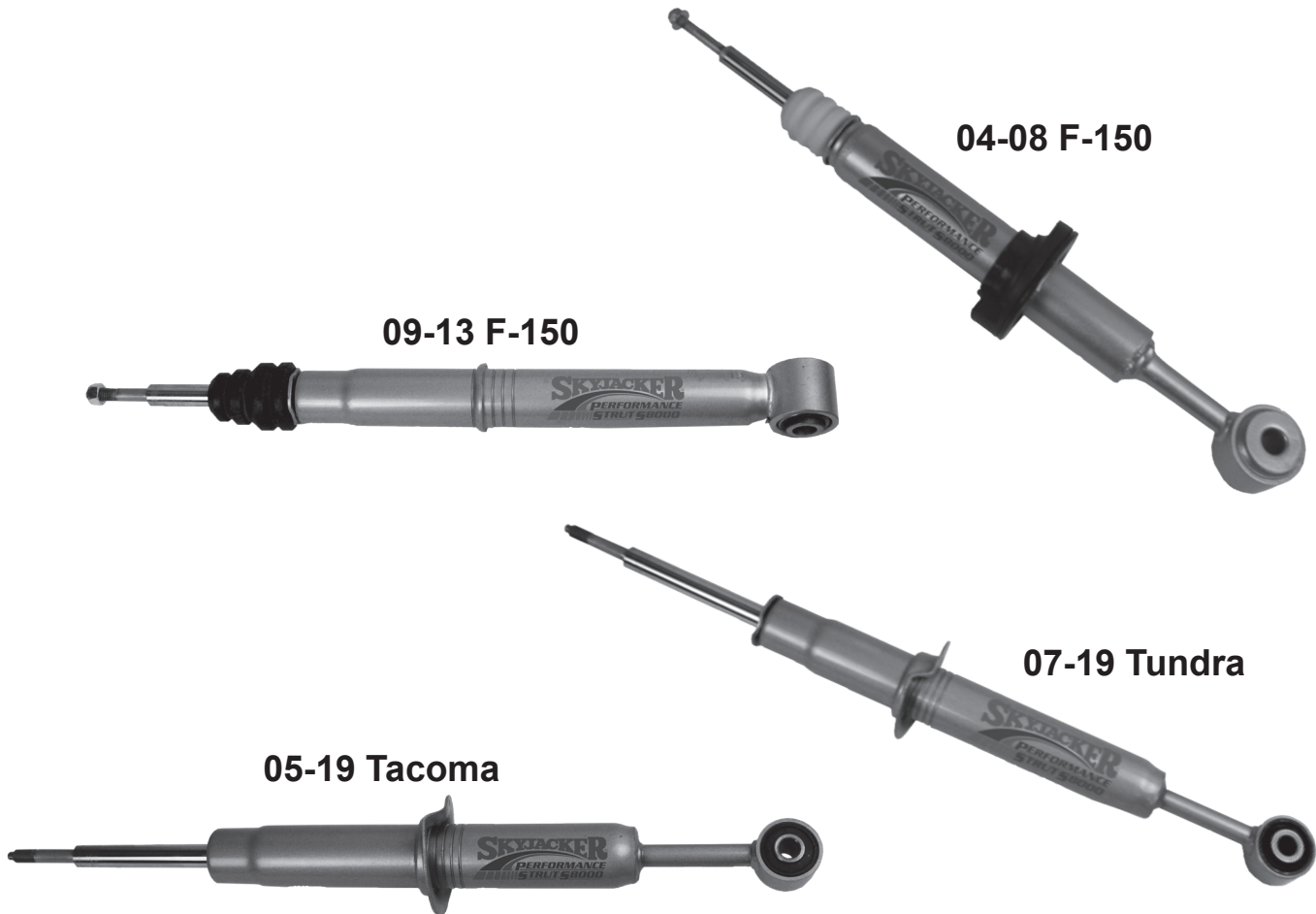

# FRONT MULTIPLE SHOCK APPLICATION GUIDE

LIFT	TYPE	PART #	QTY.	HYDRO	BLACK MAX	NOTES
NOTES: ALL SHOCKS MUST BE ORDERED SEPARATELY.						
<b>CHEVROLET / GMC</b>						
<b>67-91 K10, K20, &amp; K30</b>						
<b>Pickup, K5 Blazer, Jimmy &amp; Suburban 4WD</b>						
0-1.5"	Dual Front	DS250	2	H7021	B8521	
2-5"	Dual Front	DS250	2	H7051	B8551	
6-8"	Dual Front	DS250	2	H7071	B8571	
9-12"	Dual Front	DS250	2	H7032	B8532	
<b>DODGE</b>						
<b>03-13 2500 / 03-12 3500 Ram Pickup 4WD</b>						
0"	Dual Front	DS393	2	H7023	B8523	
2.5"	Dual Front	DS393	2	H7058	B8558	
4.5-5"	Dual Front	DS393	2	H7041	B8541	
<b>94-01 1500, 2500 Ram Pickup 4WD</b>						
0-1"	Dual Front	DS390	2	H7023	B8523	
2-3"	Dual Front	DS390	2	H7023	B8523	
4-6"	Dual Front	DS390	2	H7058	B8558	
7"	Dual Front	DS390	2	H7041	B8541	
<b>94-01 2500 HD, 3500 Ram Pickup 4WD</b>						
0-1"	Dual Front	DS390	2	H7023	B8523	
1.5-3"	Dual Front	DS390	2	H7058	B8558	
4-5"	Dual Front	DS390	2	H7041	B8541	
7"	Dual Front	DS390	2	H7060	B8560	
<b>74.5-93 W100, W150, W250, W350 Pickup, 74.5-93 Ramcharger / Trailduster 4WD</b>						
0-1"	Dual Front	DS350	2	H7023	B8523	
1.5-3"	Dual Front	DS350	2	H7058	B8558	
4-6"	Dual Front	DS350	2	H7041	B8541	
7-8"	Dual Front	DS350	2	H7060	B8560	
<b>FORD</b>						
<b>80-96 F-100, F-150 &amp; Bronco 4WD</b>						
0-2"	Dual Front	DS280	2	H7052	B8552	
3-4"	Dual Front	DS280	2	H7054	B8554	
5-8"	Dual Front	DS280	2	H7055	B8555	
<b>77-79 F-100, F-150 4WD</b>						
0-2"	Dual Front	DS260	2	H7054	B8554	
3-4"	Dual Front	DS260	2	H7055	B8555	
5-6"	Dual Front	DS260	2	H7056	B8556	
7-9"	Dual Front	DS260	2	H7059	B8559	
<b>70-76 F-100, F-150 4WD</b>						
0-1"	Dual Front	DS260	2	H7052	B8552	
1.5-2"	Dual Front	DS260	2	H7054	B8554	
2.5-4"	Dual Front	DS260	2	H7055	B8555	
5-6"	Dual Front	DS260	2	H7055	B8555	
7-9"	Dual Front	DS260	2	H7061	B8561	
<b>00-05 Excursion 4WD &amp; 99-04 F-250 &amp; F-350 Super Duty 4WD</b>						
0-3"	Triple Front	TS950	4	H7012	B8512	A9
4-5"	Triple Front	TS950	4	H7058	B8558	A9
6-8"	Triple Front	TS950	4	H7041	B8541	A9
KIT NOTES: A9. This Kit Adds 2 Shocks Per Side & Requires the Use of OEM Position Front Shock.						

LIFT	TYPE	PART #	QTY.	HYDRO	BLACK MAX	NOTES
<b>87-98 F-250 4WD - IFS</b>						
0-2"	Triple Front	TS450	4	H7012	B8512	
3-6"	Triple Front	TS450	4	H7058	B8558	
<b>80-86 F-250 4WD - IFS</b>						
0-2"	Triple Front	TS450	4	H7012	B8512	
3-6"	Triple Front	TS450	4	H7023	B8523	
<b>77.5-79 F-250 4WD</b>						
4-7"	Dual Front	DS300	2	N8014	B8514	
<b>66-77 F-250 High Boy 4WD</b>						
2-4"	Dual Front	DS310	2	N8014	B8514	
<b>80-96 F-250 &amp; F-350 2WD</b>						
0-2"	Dual Front	DS280	2	H7052	B8552	
3-4"	Dual Front	DS280	2	H7054	B8554	
5-8"	Dual Front	DS280	2	H7055	B8555	
<b>86-98 F-350 4WD with Straight Axle</b>						
0-2"	Triple Front	TS450	4	H7012	B8512	
3-4"	Triple Front	TS450	4	H7058	B8558	
5-6"	Triple Front	TS450	4	H7041	B8541	
<b>80-85 F-350 4WD - IFS</b>						
0-2"	Triple Front	TS450	4	H7012	B8512	
3-6"	Triple Front	TS450	4	H7023	B8523	
<b>83-97 Ranger &amp; Bronco II 4WD, 2WD, 94-97 Mazda B4000 4WD, 2WD</b>						
0-2"	Dual Front	DS220	2	H7052	B8552	
3-4"	Dual Front	DS220	2	H7054	B8554	
5-8"	Dual Front	DS220	2	H7055	B8555	
<b>90-94 Explorer 4WD, 2WD, 90-94 Mazda Navajo 4WD, 2WD</b>						
0-2"	Dual Front	DS220	2	H7052	B8552	
3-4"	Dual Front	DS220	2	H7054	B8554	
5-8"	Dual Front	DS220	2	H7055	B8555	

# REAR MULTIPLE SHOCK APPLICATION GUIDE

LIFT	TYPE	PART #	QTY.	HYDRO	BLACK MAX	NOTES
NOTES: ALL SHOCKS MUST BE ORDERED SEPARATELY.						
<b>CHEVROLET / GMC</b>						
<b>73-87 K10, K15 Pickup 4WD</b>						
0-1.5"	Dual Rear	DS440	2	H7043	B8543	
2-4"	Dual Rear	DS440	2	H7053	B8553	
4.5-8"	Dual Rear	DS440	2	H7073	B8573	
<b>73-87 K20, K25 Pickup 4WD</b>						
0-1.5"	Dual Rear	DS445	2	H7043	B8543	
2-4"	Dual Rear	DS445	2	H7053	B8553	
4.5-8"	Dual Rear	DS445	2	H7073	B8573	
<b>77-87 K30 Pickup 4WD</b>						
0-.5"	Dual Rear	DS445	2	H7053	B8553	
2-4"	Dual Rear	DS445	2	H7073	B8573	
4.5-10"	Dual Rear	DS445	2	H7078	B8578	
<b>67-72 K10, K15, K20, K25 Pickup 4WD</b>						
0-1.5"	Dual Rear	DS442	2	H7043	B8543	
2-4"	Dual Rear	DS442	2	H7053	B8553	
4.5-8"	Dual Rear	DS442	2	H7073	B8573	
<b>73-87 K5 Blazer, Jimmy Full-Size 4WD</b>						
0-1.5"	Dual Rear	DS440	2	H7043	B8543	
2-4"	Dual Rear	DS440	2	H7053	B8553	
4.5-8"	Dual Rear	DS440	2	H7073	B8573	
<b>69-72 K5 Blazer, Jimmy Full-Size 4WD</b>						
0-1.5"	Dual Rear	DS442	2	H7043	B8543	
2-4"	Dual Rear	DS442	2	H7053	B8553	
4.5-8"	Dual Rear	DS442	2	H7073	B8573	
<b>73-91 K10, K15 Suburban 4WD</b>						
0-1.5"	Dual Rear	DS440	2	H7043	B8543	
2-4"	Dual Rear	DS440	2	H7053	B8553	
4.5-8"	Dual Rear	DS440	2	H7073	B8573	
<b>73-91 K20, K25 Suburban 4WD</b>						
0-1.5"	Dual Rear	DS445	2	H7043	B8543	
2-4"	Dual Rear	DS445	2	H7053	B8553	
4.5-8"	Dual Rear	DS445	2	H7073	B8573	
<b>67-72 K10, K15 Suburban 4WD</b>						
0-1.5"	Dual Rear	DS442	2	H7043	B8543	
2-4"	Dual Rear	DS442	2	H7053	B8553	
4.5-8"	Dual Rear	DS442	2	H7073	B8573	
<b>DODGE</b>						
<b>69-93 W100, W150, W250 &amp; W350 Pickup, 69-93 Ramcharger / Trailduster 4WD</b>						
0-3.5"	Dual Rear	DS360	2	H7060	B8560	
4-8"	Dual Rear	DS360	2	H7079	B8579	
<b>FORD</b>						
<b>80-96 F-100, F-150 4WD - Except with Dual Gas Tanks</b>						
0-1"	Dual Rear	DS360	2	H7058	B8558	
1.5-5"	Dual Rear	DS360	2	H7060	B8560	
6-9"	Dual Rear	DS360	2	H7079	B8579	
<b>70-79 F-100, F-150 4WD</b>						
0-1"	Dual Rear	DS360	2	H7023	B8523	
1.5-2"	Dual Rear	DS360	2	H7041	B8541	
3.5-4"	Dual Rear	DS360	2	H7041	B8541	
5-8"	Dual Rear	DS360	2	H7060	B8560	
<b>80-96 F-150 2WD</b>						
0-3.5"	Dual Rear	DS360	2	H7058	B8558	
4-8"	Dual Rear	DS360	2	H7060	B8560	

LIFT	TYPE	PART #	QTY.	HYDRO	BLACK MAX	NOTES
<b>80-96 Bronco 4WD, 2WD</b>						
0-3.5"	Dual Rear	DS360	2	H7058	B8558	
4-8"	Dual Rear	DS360	2	H7060	B8560	
<b>78-79 Bronco 4WD</b>						
0"	Dual Rear	DS360	2	H7012	B8512	
1-2"	Dual Rear	DS360	2	H7023	B8523	
3-5"	Dual Rear	DS360	2	H7058	B8558	
6-10"	Dual Rear	DS360	2	H7060	B8560	
<b>67-77 Bronco 4WD</b>						
0"	Dual Rear	-----	2	H7012	B8512	
1-2.5"	Dual Rear	-----	2	H7023	B8523	
3.5-5"	Dual Rear	-----	2	H7058	B8558	
5.5-10"	Dual Rear	-----	2	H7060	B8560	
<b>80-96 F-250 4WD - Except with Dual Gas Tanks</b>						
0-1"	Dual Rear	DS360	2	H7058	B8558	
1.5-5"	Dual Rear	DS360	2	H7060	B8560	
5.5-8"	Dual Rear	DS360	2	H7079	B8579	
<b>77.5-79 F-250 4WD - Except with Dual Gas Tanks</b>						
0"	Dual Rear	DS360	2	H7058	B8558	
1-3"	Dual Rear	DS360	2	H7041	B8541	
3.5-6"	Dual Rear	DS360	2	H7060	B8560	
<b>66-77 F-250 High Boy 4WD - Except with Dual Gas Tanks</b>						
0-4"	Dual Rear	DS360	2	H7041	B8541	
<b>80-96 F-250 &amp; F-350 2WD</b>						
0-3.5"	Dual Rear	DS360	2	H7058	H7058	
4-8"	Dual Rear	DS360	2	H7060	H7060	
<b>80-98 F-350 High Boy 4WD - Except with Dual Gas Tanks</b>						
0-4"	Dual Rear	DS360	2	H7060	B8560	
4.5-8"	Dual Rear	DS360	2	H7079	B8579	
<b>83-97 Ranger 4WD</b>						
0-1"	Dual Rear	DS320	2	H7058	B8558	
1.5-4"	Dual Rear	DS320	2	H7060	B8560	
4.5-8"	Dual Rear	DS320	2	H7079	B8579	
<b>83-97 Ranger 2WD</b>						
0-3.5"	Dual Rear	DS320	2	H7058	B8558	
4-8"	Dual Rear	DS320	2	H7060	B8560	
<b>83-90 Bronco II 4WD, 2WD</b>						
0-3.5"	Dual Rear	DS320	2	H7058	B8558	
4-8"	Dual Rear	DS320	2	H7060	B8560	

# SHOCK SPECIFICATIONS GUIDE

SHOCKS SERIES				LENGTHS		MOUNTING CODES		OPTION	NOTES
HYDRO	NITRO	Black MAX	M95	EXTENDED	COLLAPSED	UPPER	LOWER		
H7001	N8001	B8501	M9501	22.30	13.52	S1	ES25	EB1	
H7002	N8002	B8502	M9502	15.30	10.02	S1	ES113	EB4	
H7003	N8003	B8503	M9503	18.52	12.24	S1	Clevis	-----	
H7004	N8004	B8504	M9504	18.30	11.52	S1	ES60, ES113	EB4	
-----	N8005	-----	-----	21.25	13.05	S1	ES25	EB1	
H7006	-----	B8506	M9506	16.18	10.25	S1	BP4	EB1	A2
A2. Slim Body - 2" OD Body									
H7007	N8007	B8507	M9507	22.71	13.93	BP12	ES25	EB1, EB1	
H7008	N8008	B8508	M9508	19.32	12.01	BP18	ES24	EB1, EB1	A2
H7009	N8009	B8509	M9509	15.21	10.55	S1	Clevis	-----	
H7010	-----	B8510	M9510	16.14	10.15	S1	ES34	EB4	A2
A2. Slim Body - 2" OD Body									
H7011	N8011	B8511	M9511	19.32	12.01	EB7	ES24	EB1, EB1	A2
H7012	N8012	B8512	M9512	19.32	12.01	ES25	ES25	EB1, EB1	A2
H7013	N8013	B8513	M9513	15.30	10.02	S1	BP4	EB1	
-----	N8014	B8514	M9514	26.52	15.74	S1	S1	-----	
H7015	N8015	B8515	M9515	18.30	11.52	S1	BP4	EB1	
H7016	N8016	B8516	M9516	22.30	13.52	S1	BP4	EB1	
H7017	N8017	B8517	M9517	27.19	16.16	ES34	ES34	EB4, EB4	
H7018	N8018	B8518	M9518	22.71	13.93	BP18	ES24	EB1, EB1	
H7019	N8019	B8519	M9519	15.30	10.02	S1	ES34, ES60	EB4	
H7020	-----	B8520	M9520	16.14	10.15	S1	BP13	EB1	A2
A2. Slim Body - 2" OD Body									
H7021	N8021	B8521	M9521	19.32	12.01	ES31	ES24	EB1	A2
H7022	N8022	B8522	M9522	22.30	13.52	S1	EB4	-----	
H7023	N8023	B8523	M9523	22.71	13.93	ES25	ES25	EB1, EB1	
H7024	N8024	B8524	M9524	24.30	14.52	S1	EB4	-----	
H7025	N8025	B8525	M9525	24.30	14.52	S1	BP4	EB1	
H7026	N8026	B8526	M9526	18.30	11.52	S1	BP13	EB1	
H7027	N8027	B8527	M9527	24.94	14.91	ES34	ES34	EB4, EB4	
H7028	N8028	B8528	M9528	24.94	14.91	BP18	ES24	EB1, EB1	A2
A2. Slim Body - 2" OD Body									
H7029	N8029	B8529	M9529	24.94	14.91	BP8	ES25	EB1, EB1	
H7030	N8030	B8530	M9530	26.83	15.91	ES34	ES34	EB4, EB4	A2
A2. Slim Body - 2" OD Body									
H7032	N8032	B8532	M9532	29.83	17.30	ES31	ES24	EB1	
H7034	N8034	B8534	M9534	29.83	17.30	BP8	ES25	EB1, EB1	
H7035	N8035	B8535	M9535	23.32	14.04	S1	ES25	EB1	
H7036	N8036	B8536	M9536	29.83	17.36	ES34	ES34	EB4, EB4	
H7037	N8037	B8537	M9537	25.44	15.06	BP12	ES25	EB1, EB1	A2
A2. Slim Body - 2" OD Body									
H7038	N8038	B8538	M9538	29.83	17.30	ES27	ES34	EB1, EB4	
H7040	N8040	B8540	-----	18.18	11.26	S1	ES37	-----	A1
A1. Slim Body - 1.86" OD Body									
H7041	N8041	B8541	M9541	26.33	15.55	ES25	ES25	EB1, EB1	
H7042	N8042	B8542	M9542	22.71	13.93	ES82	ES24	EB1, EB1	
H7043	N8043	B8543	M9543	24.94	14.91	EB7	ES34	EB1, EB4	
H7044	N8044	B8544	M9544	24.94	14.91	ES82	ES24	EB1, EB1	
H7045	N8045	B8545	M9545	24.30	14.52	S1	ES22	-----	
H7047	N8047	B8547	M9547	22.71	13.93	ES34	ES34	EB4, EB4	
H7048	N8048	B8548	M9548	22.30	13.52	S1	ES22	-----	
H7049	N8049	B8549	M9549	28.80	16.27	S1	BP4	EB1	
H7051	N8051	B8551	M9551	22.70	13.93	ES31	ES24	EB1	
H7052	N8052	B8552	M9552	15.30	10.02	S1	ES25	EB1	
H7053	N8053	B8553	M9553	27.19	16.16	EB7	ES34	EB1, EB4	
H7054	N8054	B8554	M9554	18.30	11.52	S1	ES25	EB1	
H7055	N8055	B8555	M9555	22.30	13.52	S1	ES25	EB1	
H7056	N8056	B8556	M9556	24.30	14.52	S1	ES25	EB1	
H7057	N8057	B8557	M9557	26.30	15.52	S1	ES25	EB1	A2
A2. Slim Body - 2" OD Body									
H7058	N8058	B8558	M9558	24.94	14.91	ES25	ES25	EB1, EB1	
H7059	N8059	B8559	M9559	27.80	16.62	S1	ES25	EB1	
H7060	N8060	B8560	M9560	29.83	17.30	ES25	ES25	EB1, EB1	

# SHOCK SPECIFICATIONS GUIDE

SHOCKS SERIES				LENGTHS		MOUNTING CODES		OPTION	NOTES
HYDRO	NITRO	Black MAX	M95	EXTENDED	COLLAPSED	UPPER	LOWER		
H7061	N8061	B8561	M9561	29.80	17.27	S1	ES25	EB1	
H7062	N8062	B8562	M9562	25.75	15.44	S38	ES25	EB1	
H7063	N8063	B8563	M9563	27.33	16.05	BP18	ES24	EB1, EB1	A2
A2. Slim Body - 2" OD Body									
----	N8064	----	----	31.5	18.25	ES34	ES34	EB4, EB4	
H7065	N8065	B8565	M9565	24.30	14.52	S1	ES25	EB1	
H7066	N8066	B8566	M9566	27.00	16.50	S38	ES25	EB1	
H7067	N8067	B8567	M9567	26.83	15.91	BP12	ES25	EB1, EB1	A2
A2. Slim Body - 2" OD Body									
H7068	N8068	B8568	M9568	34.22	20.19	ES27	ES34	EB4	
H7070	N8070	B8570	M9570	28.79	16.70	ES34	ES34	EB4, EB4	A2
A2. Slim Body - 2" OD Body									
H7071	N8071	B8571	M9571	26.33	15.55	ES31	ES24	EB1	
H7072	N8072	B8572	M9572	26.33	15.55	BP8	ES34	EB1, EB1	
H7073	N8073	B8573	M9573	29.83	17.30	EB7	ES34	EB1, EB4	
H7074	N8074	B8574	M9574	22.30	13.52	S38	ES60	EB4	A2
A2. Slim Body - 2" OD Body									
H7075	N8075	B8575	M9575	26.31	15.39	S1	ES25	EB1	
H7077	N8077	B8577	M9577	34.22	20.19	BP8	ES25	EB1, EB1	
H7078	N8078	B8578	M9578	34.22	20.19	EB7	ES34	EB1, EB4	
H7079	N8079	B8579	M9579	34.22	20.19	ES25	ES25	EB1, EB1	
H7080	----	----	----	13.95	9.68	EB7	ES24	EB1, EB1	
H7081	N8081	B8581	M9581	19.32	12.01	ES33	ES82	EB1	A2
H7082	N8082	B8582	M9582	19.32	12.01	ES82	ES82	EB1, EB1	A2
H7083	N8083	B8583	M9583	27.33	16.05	BP8	ES34	EB1, EB4	A2
A2. Slim Body - 2" OD Body									
H7084	N8084	B8584	M9584	24.94	14.91	BP8	ES34	EB1, EB4	
H7085	N8085	B8585	M9585	22.71	13.93	ES33	ES82	EB1	
H7086	N8086	B8586	M9586	29.83	17.30	BP8	ES34	EB1, EB4	
H7087	N8087	B8587	M9587	28.71	16.79	BP12	ES25	EB1, EB1	A2
A2. Slim Body - 2" OD Body									
H7088	N8088	B8588	M9588	24.94	14.91	ES25	ES25	EB1, EB1	A2
A2. Slim Body - 2" OD Body									
H7090	N8090	B8590	M9590	34.22	20.19	ES34	ES34	EB4, EB4	
H7091	N8091	B8591	M9591	22.65	13.87	S38	ES34	EB4	
H7092	N8092	B8592	M9592	24.65	14.87	S38	ES34	EB4	
H7093	N8093	B8593	M9593	26.65	15.87	S38	ES34	EB4	
H7094	N8094	B8594	M9594	28.76	16.98	S38	ES34	EB4	
----	----	----	B8595	24.18	15.45	----		----	
H7096	N8096	B8596	M9596	21.50	13.68	S1	Clevis	----	
H7097	N8097	B8597	M9597	23.32	13.92	S1	ES25	EB1	A2
A2. Slim Body - 2" OD Body									
H7098	N8098	B8598	M9598	24.75	15.84	S59	ES36	----	
H7099	N8099	B8599	M9599	35.375	21.625	ES25	ES25	EB1, EB1	

STEERING STABILIZER SERIES			LENGTHS		MOUNTING CODES		OPTION	NOTES
WHITE	BLACK	SILVER	EXTENDED	COLLAPSED	UPPER	LOWER		
7000	8000	9000	24.21	14.68	EB1	EB1	----	
7202	8202	9202	20.67	12.54	EB1	EB1	----	A1
7263	----	9263	27.63	16.27	EB22	EB22	----	A1
7400	8400	9400	19.33	12.05	EB1	EB1	----	
7500	8500	9500	17.00	10.64	S1	EB1	----	A1
7800	8800	9800	21.88	12.85	S1	S1	----	
7900	8900	9900	20.27	12.00	S1	S1	----	
A1. Slim Body - 1.86" OD Body								

SHOCK & STABILIZER BOOTS							
Color	EACH		Color	EACH		Color	EACH
Blue	B10B		Hot Green	B10FG		Orange	B10OG
Black	B10K		Hot Pink	B10FP		Purple	B10PR
Red	B10R		Gray	B10GY		Teal	B10TL
Yellow	B10Y		Hunter Green	B10HG		White	B10WH
Clear	B10CL		Light Blue	B10LB			

# SHOCK SPECIFICATIONS GUIDE

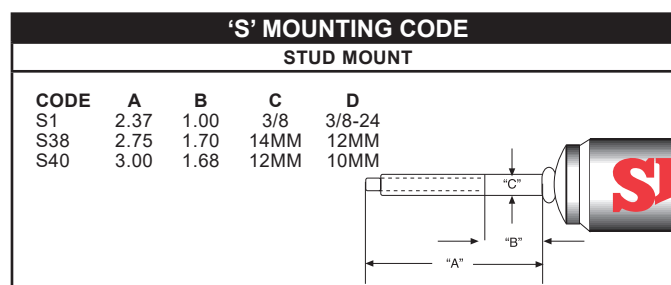
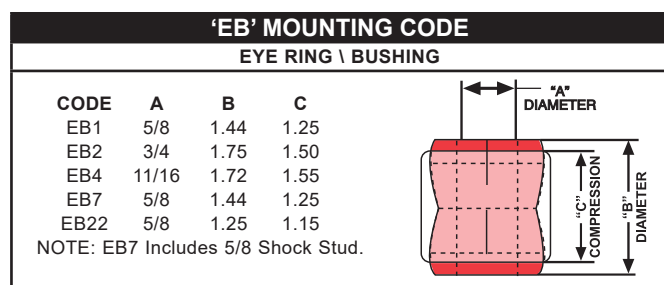
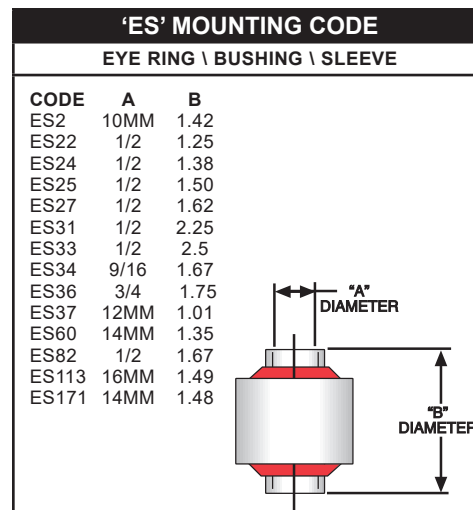
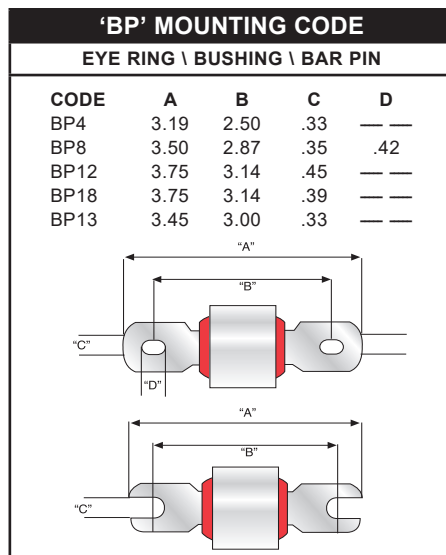
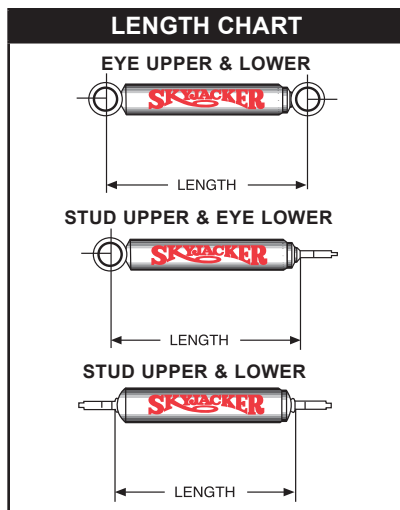

To order replacement hardware, please use mounting code part numbers listed under appropriate shock in Shock Specifications Guide.

For example:

ES25 = (1) Hourglass 5/8" Bushing + (1) Sleeve for (1) Shock End

BP4 = (1) Hourglass 5/8" Bushing + (1) Bar Pin for (1) Shock End

Note: All mounting code hardware contains (1) bushing.

SHOCK & STABILIZER BOOTS							
Color	EACH		Color	EACH		Color	EACH
Blue	B10B		Hot Green	B10FG		Orange	B10OG
Black	B10K		Hot Pink	B10FP		Purple	B10PR
Red	B10R		Gray	B10GY		Teal	B10TL
Yellow	B10Y		Hunter Green	B10HG		White	B10WH
Clear	B10CL		Light Blue	B10LB			

# STEERING STABILIZERS

OEM REPLACEMENT, SINGLE & DUAL KITS												
	HEAVY DUTY OEM			SINGLE STABILIZER			DUAL STABILIZER			Single Cylinder used in kit without hardware		
	White	Black	Silver	White	Black	Silver	White	Black	Silver	White	Black	Silver
KIT NOTES: (I). In-Line Mounting. (P). Parallel Mounting.												
<b>CADILLAC</b>												
<b>00-06 1500 Cadillac Escalade, EXT, ESV 4WD</b>												
00-06 1500 Cadillac Escalade, EXT, ESV 4WD with Skyjacker® 3" Lift				7196	8196	9196	7296	8296	9296	7500	8500	9500
<b>CHEVROLET / GMC</b>												
<b>02-06 1500 Avalanche 4WD</b>												
02-06 Avalanche 1500 4WD				7196	8196	9196				7500	8500	9500
02-06 Avalanche 1500 4WD with Skyjacker® 3" or 6" Lift							7296	8296	9296	7500	8500	9500
<b>00-06 1500 Tahoe / Yukon 4WD</b>												
00-06 1500 Tahoe / Yukon 4WD with Skyjacker® 3" or 6" Lift				7196	8196	9196	7296	8296	9296	7500	8500	9500
<b>02-06 1500 Denali, Denali XL 4WD</b>												
02-06 1500 Denali, Denali XL 4WD				7196	8196	9196				7500	8500	9500
02-06 1500 Denali, Denali XL 4WD with Skyjacker® 3" Lift							7296	8296	9296	7500	8500	9500
<b>02-06 2500 Avalanche 4WD</b>												
02-06 Avalanche 2500 4WD	7098	8098	9098							7202	8202	9202
02-06 Avalanche 2500 4WD with Skyjacker® 6" Lift							7298	8298	9298	7500	8500	9500
<b>00-06 2500 Tahoe / Yukon 4WD</b>												
00-06 2500 Tahoe / Yukon 4WD	7098	8098	9098							7202	8202	9202
00-06 2500 Tahoe / Yukon 4WD with Skyjacker® 6" Lift							7298	8298	9298	7500	8500	9500
<b>11-19 2500HD / 3500HD Pickup 4WD</b>												
11-19 2500HD / 3500HD Pickup 4WD	7011 (B)	8011 (B)	9011 (B)							7000	8000	9000
11-19 2500HD / 3500HD Pickup 4WD with 4" or More Lift							7211 (B)(I)	8211 (B)(I)	9211 (B)(I)	7202	8202	9202
<b>01-10 2500HD / 3500HD Pickup 4WD</b>												
01-10 2500HD / 3500HD Pickup 4WD	7098	8098	9098							7202	8202	9202
01-10 2500HD / 3500HD Pickup 4WD with Skyjacker® 6" Lift							7298	8298	9298	7500	8500	9500
<b>02-10 Hummer H2 4WD</b>												
02-10 Hummer H2 4WD	7098	8098	9098							7202	8202	9202
02-10 Hummer H2 4WD with Skyjacker® 6" Lift							7298	8298	9298	7500	8500	9500
<b>99-06 K1500 6-Lug Pickup 4WD</b>												
99-06 K1500 6-Lug Pickup 4WD with Skyjacker® 3" or 6" Lift				7196	8196	9196	7296	8296	9296	7500	8500	9500
<b>88-98 1500 &amp; 2500 6-Lug Pickup 4WD</b>												
88-98 1500 & 2500 6-Lug Pickup 4WD with 0-2.5" Lift				7122	8122	9122				7800	8800	9800
<b>67-87 K10, K15, K20, K25, K30 Pickup 4WD</b>												
67-87 K10, K15, K20, K25 Pickup 4WD	7055	8055	9055				7220 (I)	8220 (I)	9220 (I)	7000	8000	9000
77-87 K30 Pickup 4WD	7055	8055	9055				7255 (P)	8255 (P)	9255 (P)	7000	8000	9000
77-87 K30 Pickup 4WD*	7055	8055	9055				7255 (P)	8255 (P)	9255 (P)	7000 7800	8000 8800	9000 9800
*Check Stabilizer Body to Confirm Replacement Cylinder 4-Digit Number.												
<b>92-98 Blazer / Tahoe, Jimmy / Yukon 4WD</b>												
92-98 Blazer / Tahoe, Jimmy / Yukon 4WD with 0-2.5" Lift				7122	8122	9122				7800	8800	9800
<b>69-91 Blazer, Jimmy 4WD, 2WD</b>												
69-91 Blazer, Jimmy 4WD	7055	8055	9055				7220 (I)	8220 (I)	9220 (I)	7000	8000	9000

# STEERING STABILIZERS

OEM REPLACEMENT, SINGLE & DUAL KITS												
	HEAVY DUTY OEM			SINGLE STABILIZER			DUAL STABILIZER			Single Cylinder used in kit without hardware		
	White	Black	Silver	White	Black	Silver	White	Black	Silver	White	Black	Silver
<b>00-06 2500 Suburban 4WD</b>												
00-06 2500 Tahoe / Yukon 4WD	7098	8098	9098							7202	8202	9202
00-06 2500 Tahoe / Yukon 4WD with Skyjacker® 3" or 6" Lift							7298	8298	9298	7500	8500	9500
<b>00-06 1500 Suburban 4WD</b>												
00-06 Suburban 1500 4WD				7196	8196	9196				7500	8500	9500
00-06 Suburban 1500 4WD with Skyjacker® 3" or 6" Lift							7296	8296	9296	7500	8500	9500
<b>92-98 Suburban 4WD, 6-Lug</b>												
92-98 Suburban 4WD, 6-Lug with 0-2.5" Lift				7122	8122	9122				7800	8800	9800
<b>67-91 Suburban 4WD</b>												
67-91 Suburban 1500 & 2500 4WD	7055	8055	9055				7220 (I)	8220 (I)	9220 (I)	7000	8000	9000
<b>57-73 1500, 2500 &amp; 3500 Pickup 4WD</b>												
58-72 1500, 2500 & 3500 Pickup 4WD - Up to 3" Diameter Axle				7110	8110	9110				7800	8800	9800
57-73 Dana 60 Axles 4WD -Up to 3" O.D.				7110	8110	9110				7800	8800	9800
<b>DANA AXLES</b>												
<b>All Dana Axles 2.75-3.5" Axle Tubes</b>												
All Dana 30 Axles - Up to 2.75" Axle Tube				7100	8100	9100				7900	8900	9900
All Dana 44 Axles - Up to 3" Axle Tube				7110	8110	9110				7800	8800	9800
All Dana 60 Axles - Up to 3" Diameter				7110	8110	9110				7800	8800	9800
<b>DODGE</b>												
<b>03-20 2500 &amp; 3500 Ram 4WD</b>												
14-20 2500 Ram 4WD - Must have at least 4" lift for Dual Stabilizers	7014	8014	9014				7214	8214	9214	7000	8000	9000
13-20 3500 Ram 4WD - Must have at least 4" lift for Dual Stabilizers	7014	8014	9014				7214	8214	9214	7000	8000	9000
09-13 2500 & 09-12 3500 Ram 4WD							7239	8239	9239	7000	8000	9000
03-08 2500 & 3500 Ram 4WD	7013	8013	9013				7213 (I)	8213 (I)	9213 (I)	7000	8000	9000
03-08 2500 & 3500 Ram 4WD (Update Kit)							7213UP	7213UP	7213UP			
NOTES: Part # 7213UP is to be Used when Customer has Replaced their 03-08 Dodge OEM Drag Link with the New OEM Heavy Duty Dodge Drag Link.												
<b>98-02 1/2, 3/4 &amp; 1 Ton Ram 4WD</b>												
98-01 1/2, 98-02 3/4 & 1 Ton Ram 4WD	7007	8007	9007				7218 (I)	8218 (I)	9218 (I)	7000	8000	9000
98-01 1/2, 98-02 3/4 & 1 Ton Ram 4WD with Drop Pitman Arm	7017	8017	9017				7218 (I)	8218 (I)	9218 (I)	7000	8000	9000
98-02 3/4 & 1 Ton Ram 4wd with 3 3/4 Axle Tube							7270	8270	9270	7000	8000	9000
<b>94-97 1/2, 3/4 &amp; 1 Ton Ram 4WD</b>												
94-97 1/2, 3/4 & 1 Ton Ram 4WD	7007	8007	9007				7217 (P)	8217 (P)	9217 (P)	7000	8000	9000
94-97 1/2, 3/4 & 1 Ton Ram 4WD with Drop Pitman Arm	7017	8017	9017				7217 (P)	8217 (P)	9217 (P)	7000	8000	9000
<b>60-93 1/2, 3/4 &amp; 1 Ton Pickup &amp; Ramcharger 4WD</b>												
60-93 1/2, 3/4 & 1 Ton Pickup & Ramcharger 4WD				7110	8110	9110	7220 (I)	8220 (I)	9220 (I)	7000	8000	9000
<b>45-93 Power Wagon 4WD</b>												
45-93 Power Wagon 4WD with Larger than 3" Front Axle				7110	8110	9110				7800	8800	9800
<b>86-89 Raider 4WD</b>												
86-89 Raider 4WD				7100	8100	9100				7900	8900	9900
<b>54-71 1/2, 3/4 &amp; 1 Ton Pickup 2WD</b>												
54-71 1/2, 3/4 & 1 Ton Pickup 2WD with Straight Front Axle				7100	8100	9100				7900	8900	9900
KIT NOTES: (I). In-Line Mounting. (P). Parallel Mounting. (B). Boot Not Included Due to Clearance Issues.												



# STEERING STABILIZERS

OEM REPLACEMENT, SINGLE & DUAL KITS												
	HEAVY DUTY OEM			SINGLE STABILIZER			DUAL STABILIZER			Single Cylinder used in kit without hardware		
	White	Black	Silver	White	Black	Silver	White	Black	Silver	White	Black	Silver
<b>FORD</b>												
<b>70-03 F-100, F-150 Pickup 4WD</b>												
97-03 F-150 Pickup 4WD with Skyjacker® 6" Lift							7297	8297	9297	7500	8500	9500
80-96 F-150 Pickup 4WD				7140	8140	9140	7240 (P)	8240 (P)	9240 (P)	7800	8800	9800
70-79 F-100, F-150 Pickup 4WD	7030	8030	9030							7800	8800	9800
71-76 F-150 Pickup 4WD with No OEM Location				7110	8110	9110	7240 (P)	8240 (P)	9240 (P)	7800	8800	9800
70-77 F-150 Pickup 4WD with OEM Location							7210	8210	9210	7800	8800	9800
77-79 F-100, F-150 Pickup 4WD							7210 (P)	8210 (P)	9210 (P)	7800	8800	9800
<b>50-96 F-100, F-150 Pickup 2WD</b>												
80-96 F-100, F-150 Pickup 2WD				7140	8140	9140	7240 (P)	8240 (P)	9240 (P)	7800	8800	9800
50-64 1/2 Ton Pickup 2WD with Straight Axle				7100	8100	9100				7900	8900	9900
<b>59-20 F-250 &amp; F-350 Pickup 4WD</b>												
11-20 F-250 & F-350 Super Duty 4WD							7254 (I) A4	8254 (I) A4	9254 (I) A4	7000	8000	9000
08-16 Ford Super Duty 4WD F250, F350, F450, F550	7054	8054	9054									
05-10 F-250 & F-350 Super Duty 4WD with 4" Lift				7154	8154	9154	7254 (I)	8254 (I)	9254 (I)	7000	8000	9000
05-10 F-250 & F-350 Super Duty 4WD with 6" Lift				7156	8156	9156	7254 (I)	8254 (I)	9254 (I)	7000	8000	9000
99-04 F-250 & F-350 Super Duty 4WD	7099	8099	9099	7199	8199	9199	7299 (I)	8299 (I)	9299 (I)	7000	8000	9000
80-98 F-250 & F-350 IFS Pickup 4WD				7140 A3	8140 A3	9140 A3	7240 (P) A3	8240 (P) A3	9240 (P) A3	7800	8800	9800
80-85 F-350 IFS Pickup 4WD				7140 A3	8140 A3	9140 A3	7240 (P) A3	8240 (P) A3	9240 (P) A3	7800	8800	9800
86-98 F-350 Straight Axle Pickup 4WD				7110	8110	9110	7240 (P) A3	8240 (P) A3	9240 (P) A3	7800	8800	9800
59-79 F-250 & F-350 Pickup 4WD (Except with Slave Cylinder PS)				7110	8110	9110	7220 (I) A3	8220 (I) A3	9220 (I) A3	7000	8000	9000
KIT NOTE: A3. (I). In-Line Mounting. (P). Parallel Mounting. (B). Must have a Minimum of 3" Lift. A4 4" Lift.												
<b>00-05 Excursion 4WD</b>												
00-05 Excursion 4WD	7099	8099	9099	7199	8199	9199	7299 (I)	8299 (I)	9299 (I)	7000	8000	9000
<b>83-97 Ranger 4WD, 2WD</b>												
83-97 Ranger 4WD, 2WD				7150	8150	9150	7250 (P)	8250 (P)	9250 (P)	7900	8900	9900
<b>83-90 Bronco II 4WD</b>												
83-90 Bronco II 4WD				7150	8150	9150	7250 (P)	8250 (P)	9250 (P)	7900	8900	9900
<b>83-90 Bronco II 2WD</b>												
83-90 Bronco II 2WD				7140	8140	9140	7240 (P)	8240 (P)	9240 (P)	7800	8800	9800
<b>90-94 Explorer 4WD</b>												
90-94 Explorer 4WD				7150	8150	9150	7250 (P)	8250 (P)	9250 (P)	7900	8900	9900
<b>90-94 Explorer 2WD</b>												
90-94 Explorer 2WD				7140	8140	9140	7240 (P)	8240 (P)	9240 (P)	7800	8800	9800
<b>66-96 Bronco 4WD</b>												
80-96 Bronco 4WD				7140	8140	9140	7240 (P)	8240 (P)	9240 (P)	7800	8800	9800
78-79 Bronco 4WD	7030	8030	9030				7210	8210	9210	7800	8800	9800
70-77 Bronco 4WD	7030	8030	9030							7800	8800	9800
66-75 Bronco 4WD				7110	8110	9110				7800	8800	9800
<b>INTERNATIONAL</b>												
<b>61-82 Scout 4WD, 2WD</b>												
69-82 Scout II, Terra & Traveler 4WD, 2WD				7110	8110	9110				7800	8800	9800
67-75 Scout 4, 6 & 8 Cylinder, 4WD, 2WD Includes Scout II				7110	8110	9110				7800	8800	9800
61-68 Scout 80 & 800 Series 4WD, 2WD (Except V8)				7100	8100	9100				7900	8900	9900

# STEERING STABILIZERS

OEM REPLACEMENT, SINGLE & DUAL KITS												
	HEAVY DUTY OEM			SINGLE STABILIZER			DUAL STABILIZER			Single Cylinder used in kit without hardware		
	White	Black	Silver	White	Black	Silver	White	Black	Silver	White	Black	Silver
<b>60-75 Pickup, Travelall &amp; Metros 4WD, 2WD</b>												
60-75 1/2 & 3/4 Ton Pickup & Travelall 4WD, 2WD with Straight Axle				7110	8110	9110				7800	8800	9800
60-75 1/2 & 3/4 Ton Metros 4WD with Straight Axle				7110	8110	9110				7800	8800	9800
60-74 1/2 & 3/4 Ton Metros 2WD with Straight Axle				7100	8100	9100				7900	8900	9900
<b>MITSUBISHI</b>												
<b>86-90 Montero 4WD</b>												
86-88 Montero Raider 4WD				7100	8100	9100				7900	8900	9900
<b>JEEP</b>												
<b>41-20 JT, JL, JK, TJ, YJ, CJ 4WD</b>												
'20 Gladiator JT Pickup 4WD	7008	8008	9008				7208 (B)	8208 (B)	9208 (B)	7500	8500	9500
2018-20 Wrangler JL 4WD	7008	8008	9008				7208 (B)	8208 (B)	9208 (B)	7500	8500	9500
07-18 Wrangler JK, Rubicon 4WD	7003	8003	9003				7203 (B)	8203 (B)	9203 (B)	7500	8500	9500
07-18 Wrangler JK Rubicon 4WD with Heavy Duty Tire Rod							7206	8206	9206			
97-06 Wrangler TJ, Rubicon, Unlimited, Unlimited Rubicon 4WD	7009	8009	9009	7119	8119	9119	7219	8219	9219	7400	8400	9400
with Skyjacker Adjustable Track Bar & Stabilizer Assembly				7112	8112	9112				7400	8400	9400
*Check Stabilizer Body to Confirm Replacement Cylinder 4-Digit Number.												
87-96 Wrangler YJ 4WD*	7009	8009	9009	7109	8109	9109	7200 (P)	8200 (P)	9200 (P)	7400	8400	9400
										7900	8900	9900
*Check Stabilizer Body to Confirm Replacement Cylinder 4-Digit Number.												
76-86 CJ's 4WD*	7001	8001	9001	7100	8100	9100	7200 (P)	8200 (P)	9200 (P)	7500	8500	9500
										7900	8900	9900
*Check Stabilizer Body to Confirm Replacement Cylinder 4-Digit Number.												
41-86 All CJ's (Except CJ's with Slave Cylinder Power Steering)				7100	8100	9100				7900	8900	9900
<b>47-01 Jeep SUVs 4WD, 2WD</b>												
84-01 Cherokee XJ Midsize 4WD, 2WD	7009	8009	9009							7400	8400	9400
74-83 Cherokee Full-Size 4WD	7005	8005	9005							7000	8000	9000
93-98 Grand Cherokee ZJ 4WD, 2WD	7009	8009	9009							7400	8400	9400
84-91 Grand Wagoneer Full-Size 4WD	7005	8005	9005							7000	8000	9000
84-90 Wagoneer XJ 4WD, 2WD	7009	8009	9009							7400	8400	9400
74-83 Wagoneer Full-Size 4WD	7005	8005	9005							7000	8000	9000
66-73 Jeepster / Commando 4WD				7100	8100	9100				7900	8900	9900
86-92 Comanche Pickup 4WD, 2WD	7009	8009	9009							7400	8400	9400
74-88 J10, J20 Pickup 4WD	7005	8005	9005							7000	8000	9000
63-73 Gladiator Series				7110	8110	9110				7800	8800	9800
47-63 Utility Series & Wagons				7110	8110	9110				7800	8800	9800
<b>PLYMOUTH</b>												
<b>54-93 B100, B200, B300, Trailduster 4WD</b>												
74-93 Trailduster 4WD				7110	8110	9110	7220 (I)	8220 (I)	9220 (I)	7000	8000	9000
54-71 B100, B200, B300 4WD with Straight I-Beam Axle				7100	8100	9100				7900	8900	9900
<b>TOYOTA</b>												
<b>61-95 Pickup &amp; SUVs 4WD</b>												
86-95 Pickup & 4Runner 4WD				7186	8186	9186				7900	8900	9900
79-85 Pickup & 4Runner 4WD	7070	8070	9070							7900	8900	9900
84-85 Pickup & 4Runner 4WD				7175	8175	9175	7276 (P)	8276 (P)	9276 (P)	7900	8900	9900
79-83 Pickup 4WD				7175	8175	9175	7275 (P)	8275 (P)	9275 (P)	7900	8900	9900
61-82 LandCruiser 4WD				7160	8160	9160				7900	8900	9900
<b>SUZUKI</b>												
<b>79-91 Samurai, Santana, LJ10, SJ10, LJ413 4WD</b>												
79-91 Samurai, Santana, LJ10, SJ10, LJ413 4WD				7100	8100	9100				7900	8900	9900
KIT NOTES: (S1). Slim Body - 1.86" (I). In-Line Mounting. (P). Parallel Mounting. (B). Boot Not Included Due to Clearance Issues.												

## CHEVROLET / GMC - ACCESSORIES

### ALIGNMENT SHIMS

Description	DEGREE	Part #
<b>88-98 1500, 2500 Pickups 4WD</b>		
Eccentric Cam Bolt Kit	0-2	1088H
<b>92-98 K5 Blazer, Tahoe, Jimmy, Yukon, Suburban 4WD</b>		
Eccentric Cam Bolt Kit	0-2	1088H

### DRAG LINK & TIE ROD ASSEMBLIES

Description	LIFT	Part #	NOTES
<b>67-87 K10, K15, K20, K25 Pickup 4WD (4" Offset)</b>			
Offset & Adjustable Drag Link			
	4-6"	GMDL4	
<b>77-87 K15, K25, K30 Pickup 4WD</b>			
Offset & Adjustable Drag Link			
	4-6"	GMDL4	
<b>67-91 K5 Blazer, Jimmy, Suburban 4WD</b>			
Offset & Adjustable Drag Link			
	4-6"	GMDL4	
Replacement End for GMDL4			
		GMDL4-1	

### DRIVE TRAIN

Description	LIFT	Part #	NOTES
<b>10-18 Chevrolet / GMC 1500 4WD</b>			
Front Drive Shaft - 6" Lift			
		GM10146DS	GS

KIT NOTES: G5 Will NOT Fit Autotrac or 6.2 Liter Engine.



### 11-19 Chevrolet / GMC 2500HD / 3500HD

Carrier Bearing Lowering Kit - 2" Drop			
		CBL2500	

### FRAME SHACKLE BUSHING KITS

Description	FRONT	REAR	NOTES
<b>Original Equipment</b>			
<b>69-87 K10 &amp; K20 Pickups 4WD with 52" Rear Springs</b>		SE13C	
<b>71-87 K10, K20 &amp; K30 Pickups 4WD</b>	SE12C		
<b>67-87 K5 Blazer, Jimmy, Suburban 4WD</b>	SE12C	SE13C	Z1
<b>69-91 K5 Blazer, Jimmy, Suburban 4WD with 52" Rear Springs</b>	SE12C	SE13C	Z1

KIT NOTES: Z1. Front Upper Shackle Mounts will NOT Fit 67-70 Models.

### POLY BUMP STOPS - PAIR

LIFT	FRONT	REAR	NOTES
<b>67-87 K10, K15, K20, K25, K30 Pickups 4WD</b>			
4.5"	BP45	BP45	

### SKID PLATES, OIL PANS & SHIFTER BRACKET

Description	LIFT	Part #	NOTES
<b>11-19 GM 2500HD / 3500HD 4WD DEF / Urea Tank Skid Plate</b>			
DEF / Urea Tank Skid Plate		DEFG114SP	

### SPRING EYE BUSHING KITS

Description	FRONT	REAR	NOTES
<b>Original Equipment</b>			
<b>69-87 K10, K15, K20, K25 Pickups 4WD with 52" Rear Springs</b>		SE15C	
<b>88-91 K5 Blazer, Jimmy, Suburban 4WD</b>	SE18C		
<b>69-91 K5 Blazer, Jimmy, Suburban 4WD with 52" Rear Springs</b>		SE15C	
<b>Skyjacker® Softride®</b>			
<b>67-87 K10, K15, K20, K25 Pickups 4WD</b>	SE11C		
<b>69-87 K10, K15, K20, K25 Pickups 4WD with 52" Rear Springs</b>		SE15C	
<b>88-91 K5 Blazer, Jimmy, Suburban 4WD</b>	SE17C		
<b>67-87 K5 Blazer, Jimmy, Suburban 4WD</b>	SE11C		
<b>69-91 K5 Blazer, Jimmy, Suburban 4WD with 52" Rear Springs</b>		SE15C	

### SWAY BAR BUSHING KITS

Description	FRONT	REAR
<b>80-87 K10, K15, K20, K25, K30 Pickup 4WD</b>	CSB148	
<b>88-91 K5 Blazer, Jimmy, Suburban 4WD</b>	CSB148	
<b>73-79 K10, K15, K20, K25, K30 Pickup 4WD K5 Blazer, Jimmy, Suburban 4WD</b>	CSB149	

### SWAY BAR EXTENDED END LINKS

End Links Include Bushings			
		LOCATION	
Description	LIFT	FRONT	REAR
<b>07-18 GM 1500 4WD</b>			
	4"	C766SBL	
	6"	C966SBL	
<b>01-10 GM 2500HD / 3500HD 4WD</b>			
	3"	C766SBL	
	6"	C966SBL	
<b>99-06 &amp; 07 Classic GM 1500 4WD</b>			
	3-4"	C766SBL	
	6"	C966SBL	
<b>00-06 Avalanche / Tahoe GM 1500 4WD</b>			
	3"	C766SBL	
	6"	C966SBL	
<b>02-10 Hummer H2 4WD</b>			
	6"	C966SBL	

### SWAY BAR LOWERING KITS

<b>ALL K10, K15, K20, K25, K30 Pickup, K5 Blazer, Jimmy, Suburban 4WD with Front Leaf Springs</b>			
		4"	SBL20
		6-8"	SBL40

### TRANSFER CASE LOWERING KITS

Description	LIFT	Part #
<b>73-87 Pickup. 73-91 K5 Blazer, Jimmy, Yukon, Tahoe &amp; Suburban 4WD - Full-Size with Leaf Spring Front</b>		
	4-8"	TCL15

### WHEEL SPACERS

<b>14-18 GM 1500 4WD</b>	
<b>WHEEL SPACERS, 6X5.5, 18" OEM WHEEL</b>	
	WSP655

# ACCESSORIES

## DODGE - Accessories

### DRAG LINK & TIE ROD ASSEMBLIES

Description	LIFT	Part #	NOTES
-------------	------	--------	-------

**72-93 W100, W150, W250, W350 Pickup, Ramcharger, Trailduster 4WD - Full-Size**

Adjustable Drag Link	2-8"	DL10	
----------------------	------	------	--

### FRAME SHACKLE BUSHING KITS

Description	FRONT	REAR	NOTES
-------------	-------	------	-------

#### Original Equipment

<b>61-93 W100, W150, W250, W350 Pickup, Ramcharger, Trailduster 4WD</b>	SE14D		
---	-------	--	--

### POLY BUMP STOPS - PAIR

LIFT	FRONT	REAR	NOTES
------	-------	------	-------

**94-01 1500, 2500, 3500 Ram Pickup 4WD**

6"	BP60		
----	------	--	--

### ROD ENDS

#### Heavy-Duty Kevlar® / Teflon® Lined Self-Lubricating Rod Ends

Description	Part #
-------------	--------

Heavy-Duty - Non Teflon Lined (Right Hand Thread)

Used on 94-01 Dodge Adjustable Track Bar	HD34X34DTB
--	------------

### SPRING EYE BUSHING KITS

Description	FRONT	REAR	NOTES
-------------	-------	------	-------

#### Original Equipment

<b>61-93 W100, W150, W250, W350 Pickup, Ramcharger, Trailduster 4WD</b>	SE12D		
---	-------	--	--

#### Skyjacker® Softride®

<b>61-93 W100, W150, W250, W350 Pickup, Ramcharger, Trailduster 4WD</b>	SE12D		
---	-------	--	--

<b>92-93 W250, W350 with 3/4" Main Eye Bolt</b>		SE17D	
---	--	-------	--

### SWAY BAR BUSHING KITS

Description	FRONT	REAR
-------------	-------	------

**94-01 W100, W150, W250, W350 Pickup 4WD**

	DSB94	
--	-------	--

### SWAY BAR EXTENDED END LINKS

End Links Include Bushings

Description	LIFT	LOCATION	
		FRONT	REAR

**02-05 Dodge Ram 1500 4WD**

	5-6"	SBE5069	
--	------	---------	--

**06-18 Dodge Ram 1500 4WD**

	4-6"	C966SBL	
--	------	---------	--

### SWAY BAR LOWERING KITS

Description	Lift	Part #
-------------	------	--------

**94-01 1500 Pickup 4WD**

	4-5"	SBL20
--	------	-------

**94-12 2500, 3500 4WD**

	4-5"	SBL20
--	------	-------

**61-93 1500, 2500, 3500 Pickup, Ramcharger, Trailduster 4WD with Front Leaf Springs**

	4"	SBL20
--	----	-------

	6-8"	SBL40
--	------	-------

### TRACK BAR COMPONENTS

Description	LIFT	Part #	NOTES
-------------	------	--------	-------

**94-01 Dodge 1500, 2500, 3500 4WD**

Adjustable Replacement Front Track Bar Kit			
--	--	--	--

	4-7"	DTBA27	
--	------	--------	--

### TRANSFER CASE RE-INDEXING RING & SEAL ADAPTER (6 BOLT TRANSFER CASE ONLY)

Description	LIFT	Part #	NOTES
-------------	------	--------	-------

**94-01 Ram 1500, 2500, 3500 4WD** 7" & Above IXR10 K19

**94-01 Ram 1500, 2500, 3500 4WD** IXR20 K19

**KIT NOTES:** K19. Seal Part # TCS2675 & Seal Adapter Required, Part # DTSA10 (2.57") or DTSA269 (2.69") Seal Adapter which will Only Work on Models with 6 Bolts Attaching Transmission to Transfer Case.

### Transfer Case Re-Indexing Ring & Seal Adapter (6 Bolt Transfer Case Only)



**02-05 Ram 1500 4WD** IXR20K K20, K21

**03-13 Ram 2500, 03-12 3500 4WD** IXR20K K20, K21

**KIT NOTES:** K20. Designed for Custom Applications Only - Includes 2.69" Seal. K21. Seal Adapter DTSA10 may be Required on Some Models.

## FORD - Accessories

### ALIGNMENT SHIMS

**KIT NOTES:** Shims Sold as Single. Order 1 Per Side.

Description	DEGREE	Part #
-------------	--------	--------

**09-14 F-150 4WD**

Caster / Camber Alignment Shim		F900CAK
--------------------------------	--	---------

**04-08 F-150 4WD**

Caster / Camber Alignment Shim		F462-AK
--------------------------------	--	---------

**80-96 F-150, Bronco, F-250 4WD**

Caster / Camber Shim	0-2.75	1032H
----------------------	--------	-------

**87-96 F-150, Bronco, F-250 2WD**

Caster / Camber Shim	0-2	1029H
----------------------	-----	-------

**82-86 F-100, F-150, Bronco, F-250 2WD**

Caster / Camber Shim	0-2	1043H
----------------------	-----	-------

**80-85 F-350 4WD**

Caster / Camber Shim	0-2.75	1032H
----------------------	--------	-------

**90-97 Ranger 4WD**

Caster / Camber Shim	0-2	1039H
----------------------	-----	-------

**89-97 Ranger, Bronco II 2WD**

Caster / Camber Shim	0-2	1029H
----------------------	-----	-------

**83-88 Ranger, Bronco II 2WD**

Caster / Camber Shim	0-2	1043H
----------------------	-----	-------

**90-94 Explorer 4WD**

Caster / Camber Shim	0-2	1039H
----------------------	-----	-------

**90-94 Explorer 2WD**

Caster / Camber Shim	0-2	1029H
----------------------	-----	-------

### C' BUSHING KITS - 4 PIECE ONLY

Description	LIFT	DEGREE	Part #
-------------	------	--------	--------

**66-79 F-100, F-150 4WD**

	4-5	7	CB70
--	-----	---	------

**78-79 Bronco 4WD**

	0-1	2	CB20
--	-----	---	------

	2-3	4	CB40
--	-----	---	------

	4-5	7	CB70
--	-----	---	------

**66-77 Bronco 4WD**

	0-1	2	CB20
--	-----	---	------

	2-3	4	CB40
--	-----	---	------

	4-5	7	CB70
--	-----	---	------

# ACCESSORIES

<b>C' BUSHING KITS (COMPLETE) - 14 PIECE</b>			
C' Bushings, Radius Arm & Track Bar Bushings			
66-76 F100, F150 4WD & 78-79 F100, F150 4WD	0-1"	2	CB200
	2-3"	4	CB400
	4-5"	7	CB700
77 F-100, F-150 4WD	0-1"	2	CB277
	2-3"	4	CB477
	4-5"	7	CB777
78-79 Bronco 4WD	0-1"	2	CB200
	2-3"	4	CB400
	4-5"	7	CB700
76-77 Bronco 4WD	2-3"	4	CB477
	4-5"	7	CB777
	0-1"	2	CB200
66-75 Bronco 4WD	2-3"	4	CB400
	4-5"	7	CB700
	<b>TRACK ARM BUSHING KIT</b>		
66-76 F100, F150 4WD			TAB75
78-79 F100, F150 4WD			TAB75
77 F100, F150 4WD			TAB77
66-75 Bronco 4WD			TAB75
78-79 Bronco 4WD			TAB75
76-77 Bronco 4WD			TAB77
<b>RADIUS ARM BUSHING KIT</b>			
66-79 F100, F150 4WD			SAB75
66-77 Bronco 4WD			SAB75
78-79 Bronco 4WD			SAB75
<b>CENTER HINGE DROP BRACKETS - PAIR</b>			
Description		LIFT	Part #
<b>80-96 F-150, Bronco 4WD, 2WD</b>			
		4-6"	CHB54
		8"	CHB58
<b>80-98 F-250 IFS 4WD</b>			
		4-6"	CHB75
<b>80-85 F-350 IFS</b>			
		4-6"	CHB75
<b>83-97 Ranger, Bronco II 4WD</b>			
		4-6"	CHB352
<b>83-97 Ranger, Bronco II 2WD</b>			
		4-6"	CHB324
		4-6"	CHB326
<b>90-94 Explorer 4WD</b>			
		4-6"	CHB352
<b>CENTER HINGE PIVOT BUSHINGS</b>			
Re-Uses Existing OEM Metal Outer Shells			Part #
80-96 F-150, Bronco 4WD, 2WD			CHB80
80-85 F-350 IFS 4WD			CHB80
80-98 F-250 IFS 4WD			CHB80
83-97 Ranger 4WD			CHB80
83-90 Bronco II 4WD			CHB80
90-94 Explorer 4WD			CHB80
<b>COIL SPRING Spacers</b>			
Description		LIFT	Part #
<b>05-20 Ford F-250, F-350 4x4</b>			
Coil Spring Spacers - Pair		1"	F51MS
Coil Spring Spacers - Pair		2.5"	F52MS
<b>DRAG LINK &amp; TIE ROD ASSEMBLIES</b>			
Description	LIFT	Part #	NOTES
<b>76-79 F-100, F-150 4WD</b>			
Adjustable Drag Link	0-9"	FDL70	V1
Adjustable Tie Rod	0-9"	TRA70	
KIT NOTES: V1. On 76-77 Models, Must be Used with a Pitman Arm for 78-79 Ford Power Steering Boxes (Skyjacker® Drop Pitman Arm # FA300 or FA600).			

<b>78-79 Bronco 4WD</b>			
Adjustable Drag Link	0-9"	FDL70	
Adjustable Tie Rod	0-9"	TRA70	
<b>77.5-79 F-250, F-350 4WD</b>			
Offset Adjustable Drag Link			
	3-4"	SDL250	
Offset Adjustable Drag Link + FA325 Drop Pitman Arm			
	5-6"	SDL250 + FA325	
Replacement End for SDL250			
		TRE250	
<b>DRIVE TRAIN</b>			
Description	LIFT	Part #	NOTES
<b>17-20 F-250, F-350, Super Duty</b>			
Front Drive Shaft - 6-8.5" Lift			
		F17685DS	
			
<b>05-16 F-250, F-350, Super Duty</b>			
Carrier Bearing Lowering Kit			
	2" Drop	CBL206	
<b>80-04 F-250, F-350, Super Duty</b>			
Carrier Bearing Lowering Kit			
	1" Drop	CBL3401	
Carrier Bearing Lowering Kit			
	2-2.25" Drop	CBL214	
<b>FRAME SHACKLE BUSHING KITS</b>			
Description	FRONT	REAR	NOTES
<b>ORIGINAL EQUIPMENT</b>			
80-98 F-250, F-350 4WD	SE85F		
<b>RADIUS ARM DROP BRACKETS</b>			
Description	LIFT	Part #	
<b>REPLACEMENT DROP BRACKETS</b>			
80-96 F-150 4WD, 2WD	4-6"	RAB54	
80-96 F-150 4WD, 2WD	8"	RAB58	
80-96 Bronco 4WD, 2WD	4-6"	RAB54	
80-96 Bronco 4WD, 2WD	8"	RAB58	
83-97 Ranger 4WD, 2WD	4-6"	RABE30	
83-97 Ranger 4WD	8"	RAB38	
83-90 Bronco II 4WD, 2WD	4-6"	RABE30	
91-94 Explorer 4WD, 2WD	4-6"	RABE30	
<b>RELOCATING DROP BRACKETS</b>			
66-79 F-150 4WD	2.75" Drop	3.5-4"	RAB27
	4.75" Drop	5-6"	RAB47
78-79 Bronco 4WD	2.75" Drop	3.5-4"	RAB27
	4.75" Drop	5-6"	RAB47
66-77 Bronco 4WD	4" Drop	5"	RAB40
<b>FRAME SUPPORT BAR</b>			
80-96 F-150, Bronco 4WD		4-8"	FSB80
<b>RADIUS / STRUT ARM BUSHINGS</b>			
Description			Part #
<b>2 DEGREE ADJUSTABLE CASTER</b>			
80-83 F-150 2WD			SAB20
80-96 Bronco 4WD			SAB20
87-02 F-250, F-350 2WD			SAB20
83-88 Ranger 2WD			SAB20
86-88 Bronco II 2WD			SAB20

# ACCESSORIES

OEM REPLACEMENT			
80-96 F-150 4WD, 2WD			SAB85
66-79 F-100, F-150 4WD, 2WD			SAB75
80-96 Bronco 4WD			SAB85
66-79 Bronco 4WD			SAB75
80-96 F-250 2WD			SAB85
83-97 Ranger 4WD, 2WD			SAB83
83-90 Bronco II 4WD, 2WD			SAB83
90-94 Explorer 4WD, 2WD			SAB83
REPLACEMENT TUBULAR RADIUS ARMS - CLASS II			
Description	LIFT	Part #	
80-96 F-150, Bronco 4WD, 2WD - 15" Longer than Stock (Includes Poly Bushings)			
	4-6"	RA150	
83-97 Ranger, Bronco II, Explorer 4WD - 15" Longer than Stock Includes Mounting Brackets & Bushings			
	4-6"	RA135	
83-97 Ranger, Bronco II 2WD - 15" Longer than Stock Mounting Brackets & Bushings			
	4-6"	RA235	
ROD ENDS			
Heavy-Duty Kevlar®/ Teflon® Lined Self-Lubricating Rod Ends			
Description			Part #
Heavy-Duty - Non Teflon Lined (Right Hand Thread) Used on 05-08 F-250 / 350 Adjustable 4-Link (F58484LU)			HDRB114X1R
SPRING EYE BUSHING KITS			
Description	FRONT	REAR	NOTES
<b>Softride® - For Skyjacker® Leaf Springs Only</b>			
99-04 F-250, F-350 4WD	SE90F		
80-98 F-250, F-350 4WD	SE80F	SE84R	
67-79 F-250, F-350 4WD	SE70F		
SPRING SPACER PLATES			
Description	LIFT	Part #	
80-96 F-150, Bronco 4WD, 2WD - No More than 2 Per Coil Spring can be Used			
Coil Spring Spacer Plates - Each	3/8"	HS25	
83-97 Ranger 4WD, 2WD - No More than 2 Per Coil Spring can be Used			
Coil Spring Spacer Plates - Each	3/8"	HS25	
83-90 Bronco II 4WD - No More than 2 Per Coil Spring can be Used			
Coil Spring Spacer Plates - Each	3/8"	HS25	
90-94 Explorer, Mazda Navajo 4WD, 2WD - No More than 2 Per Coil Spring can be Used			
Coil Spring Spacer Plates - Each	3/8"	HS25	
SWAY BAR EXTENDED END LINKS			
End Links Include Polyurethane Bushings			
		LOCATION	
Description	LIFT	FRONT	REAR
97-03 F-150 4WD			
	6"	C966SBL	
77-79 F-150 4WD			
	3-4"	SBE204	
	6-9"	SBE205	
78-79 Bronco 4WD			
	3-4"	SBE204	
	6-9"	SBE205	
00-05 Excursion 4WD			
	3-4"	SBE407	
	5-8"	SBE408	
08-16 F-250, F-350 Super Duty 4WD			
	4"		SBE404
	6"		SBE405
	8.5"		SBE406

<b>08-10 F-250, F-350 Super Duty 4WD</b>			
	4"	SBE5084	
	6-8"	SBE5086	
<b>05-07 F-250, F-350 Super Duty 4WD</b>			
	3-4"	SBE5954	SBE404
	5-8"	SBE5956	SBE405
	7-8"		SBE406
<b>00-04 F-250, F-350 Super Duty 4WD</b>			
	3-4"	SBE407	SBE404
	5-8"	SBE408	SBE405
	7-8"	SBE408	SBE406
<b>03/99-99 F-250, F-350 Super Duty 4WD - Built After March '99</b>			
	3-4"	SBE402	SBE404
	5-6"	SBE403	SBE405
	7-8"	SBE403	SBE406
<b>99 F-250 Super Duty 4WD - Built Before March '99</b>			
	3-4"	SBE402	
	5-6"	SBE403	
	7-8"	SBE403	
<b>80-98 F-250 IFS 4WD</b>			
	3-4"	SBE302	
	5-6"	SBE303	
	2-3"		SBE304
	3.5-5"		SBE305
<b>86-98 F-350 4WD</b>			
	3-4"	SBE304	
	5-6"	SBE305	
<b>80-85 F-350 IFS 4WD</b>			
	3-4"	SBE302	
	5-6"	SBE303	
<b>80-97 F-350 4WD</b>			
	2-3"		SBE304
	3.5-5"		SBE305
<b>87-97 Ranger, Bronco II 4WD</b>			
	3-4"	SBE638	
	5-6"	SBE734	
<b>87-97 Ranger 2WD</b>			
	4-6"	SBE638	
<b>90-94 Explorer 4WD, 2WD</b>			
	3-4"	SBE734	
SWAY BAR LOWERING KITS			
Description	Lift	Part #	
80-96 F-100, F-150 4WD, 2WD	4-6"	SBL20	
80-96 Bronco 4WD, 2WD	4-6"	SBL20	
83-97 Ranger 4WD, 2WD	4-6"	SBL20	
83-90 Bronco II 4WD, 2WD	4-6"	SBL20	
90-94 Explorer 4WD, 2WD	4-6"	SBL20	
SWAY BAR BUSHING KITS			
Description			Part #
66-79 F-100, F-150 4WD			TAB75
66-75 Bronco 4WD			TAB75
78-79 Bronco 4WD			TAB75
76-77 Bronco 4WD			TAB77
TRACK BAR COMPONENTS			
Description	LIFT	Part #	NOTES
<b>08-20 F-250, F-350, Super Duty 4WD</b>			
Front Track Bar Bracket			
	2-2.5"	TB1120	
<b>05-07 F-250, F-350, Super Duty 4WD</b>			
Front Track Bar Bracket			
	2"	TB520	
<b>03/99-04 Excursion, F-250, F-350, Super Duty 4WD</b>			
Adjustable Replacement Front Track Bar			
	2-8"	FTBA99	V9
KIT NOTES: V9. Requires Use of Aftermarket Differential Track Bar Bracket.			

# ACCESSORIES

03/99-04 Excursion, F-250, F-350, Super Duty 4WD - Built After March '99			
Front Track Bar Bracket - Lower (at Differential)			
	2"	TB9203	
Front Track Bar Bracket - Upper (at Frame)			
	4-6"	TB9483	
	8"	TB9483	TB9203
99 F-250, F-350, Super Duty 4WD - Built Before March '99			
Front Track Bar Bracket - Lower (at Differential)			
	2"	TB920	
Front Track Bar Bracket - Upper (at Frame)			
	4-8"	TB948	
	8"	TB948	TB920
86-97 F-350 4WD			
Front OEM Track Bar Drop Bracket			
	4-6"	TB35	
HONDA - ACCESSORIES			
SWAY BAR EXTENDED END LINKS			
End Links Include Polyurethane Bushings			
		LOCATION	
Description	LIFT	FRONT	REAR
06-12 Honda Ridgeline 4WD			
	2"	HR20SBL	
INTERNATIONAL - ACCESSORIES			
FRAME SHACKLE BUSHING KITS			
72-82 SCOUT II, Terra, Traveler 4WD	SE40S		Z2
KIT NOTES: Z2. Shackle Kit Includes Bushings for BOTH Front & Rear.			
SPRING EYE BUSHING KITS			
Description	FRONT	REAR	NOTES
<b>Skyjacker® Softride®</b>			
72-82 SCOUT II, Terra, Traveler 4WD	SE40S	SE40S	
JEEP - ACCESSORIES			
UNIVERSAL BODY LIFT BLOCKS			
Description		SIZE	
2" Universal Body Lift Block		2"	BPS227B
3" Universal Body Lift Block		3"	BPS237B
COIL SPRING ISOLATORS			
Description		SIZE	
2018-20 Wrangler JL 4WD			
Front Coil Spring Isolator Pads - Pair		3/4"	JLFPS75
Rear Coil Spring Isolator Pads - Pair		3/4"	JLRPS75
07-18 Wrangler JK 2 & 4 Door 2WD / 4WD			
Front Coil Spring Isolator Pads - Pair		3/4"	JKFPS75
Rear Coil Spring Isolator Pads - Pair		3/4"	JKRPS75
Front Coil Spring Isolator Pads - Pair		2"	JK20PSF
Rear Coil Spring Isolator Pads - Pair		2"	JK20PSR
97-06 Wrangler TJ 4WD - Front or Rear			
Coil Spring Isolator Pads - Pair		3/4"	SIP275
Coil Spring Poly Spacer - Pair		2"	JPS20
All Years Cherokee XJ, Grand Cherokee ZJ & Comanche MJ 4WD - Front Only			
Coil Spring Isolator Pads - Pair		3/4"	SIP275
Coil Spring Poly Spacer - Pair		2"	JPS20

CAM BOLT KITS			
Description		SIZE	
<b>PAIR (ORDER 1 PER VEHICLE)</b>			
2018-20 Wrangler JL 4WD			
Front Cam Bolt Kit		1-4"	CAM800
Rear Cam Bolt Kit		1-4"	CAM700
07-18 Wrangler JK 2 & 4 Door			
Front & Rear Upper Cam Bolt Kit		1-4"	CAM700
97-06 Wrangler TJ			
Rear Pinion Cam Bolt Kit		1-4"	CAM500
93-98 Grand Cherokee ZJ 4WD, 2WD			
Rear Pinion Cam Bolt Kit		1-4"	CAM500
DRAG LINK & TIE ROD ASSEMBLIES			
Description	LIFT	Part #	NOTES
07-18 Wrangler JK / Rubicon 2 & 4 Door 4WD			
Rock Ready Heavy Duty Drag Link			
	ALL	JK717DL	
Rock Ready Heavy Duty Tie Rod			
	ALL	JK717TR	
Replacement Cartridge for Tie Rod JK717TR / Drag Link JK717DL			
	ALL	JK717RC	
97-06 Wrangler TJ 4WD			
Replacement Heavy-Duty Tie Rod 1.250" HD DOM Swedged Tubular			
	ALL	TR300	
91-01 Cherokee XJ 4WD, 2WD			
Replacement Heavy-Duty Tie Rod 1.250" HD DOM Swedged Tubular			
	ALL	TR300	
93-98 Grand Cherokee ZJ 4WD / 2WD			
Replacement Heavy-Duty Tie Rod 1.250" HD DOM Swedged Tubular			
	ALL	TR300	
91-92 Comanche MJ 4WD / 2WD			
Replacement Heavy-Duty Tie Rod 1.250" HD DOM Swedged Tubular			
	ALL	TR300	
BALL JOINTS			
Description	LIFT	Part #	NOTES
07-18 Wrangler JK / Rubicon 2 & 4 Door 4WD			
Rock Ready Dual Load Ball Joint Kit			
	ALL	JK2717B	
2004-2006 Jeep Wrangler Unlimited LJ			
1997-2006 Jeep Wrangler TJ			
1993-1998 Jeep Grand Cherokee ZJ			
1987-1995 Jeep Wrangler YJ			
1984-2001 Jeep Cherokee XJ			
Rock Ready Dual Load Ball Joint Kit			
	ALL	JD302B	
DRIVE TRAIN			
Description	LIFT	Part #	NOTES
03-06 Wrangler TJ 4WD - Automatic & 6 Cylinder Engine with Dana 35 Rear Differential & OEM Skid Plate			
Rear Drive Shaft			
	6-8"	TJRS	E6
97-03 Wrangler TJ 4WD - 5 Speed & 6 Cylinder Engine with Dana 35 Rear Differential & OEM Skid Plate			
Rear Drive Shaft			
	6-8"	TJRS	E6
03-06 Wrangler TJ Rubicon 4WD			
Rear C.V. Yoke			
	6-10"	CVR680	



# ACCESSORIES

<b>94-96 YJ 4WD with 1330 Series 5-Speed Manual Transmission &amp; 6 Cylinder Engine Only</b>			
Rear Drive Shaft			
	6"	YJRSL	E6
<b>87-93 YJ 4WD - 1310 Series 5-Speed Manual Transmission &amp; 6 Cylinder Engine Only</b>			
Rear Drive Shaft			
	6"	YJRSE	E6
<b>97-06 Wrangler / Unlimited</b>			
Rock Ready Slip Yoke Eliminator Kit			
	ALL	RR231	E13
KIT NOTES: E6. Slip Yoke Eliminator Kit is Required. Use Part # RR231 Available Direct from Skyjacker®. E13. Replacement C.V. Driveshaft is REQUIRED. Available Direct from Skyjacker®.			
<b>EXHAUST SPACER KIT</b>			
Description	Part #		
<b>12-18 JK 2 &amp; 4 Door 4WD</b>	JK36ESK		
<b>FRAME SHACKLE BUSHING KITS</b>			
Description	FRONT	REAR	NOTES
<b>ORIGINAL EQUIPMENT</b>			
<b>87-96 Wrangler YJ 4WD</b>	SE3YJ		Z2
<b>76-86 CJ5, CJ7 &amp; Scrambler 4WD</b>	SE4CJ		Z2
<b>55-75 CJ5, CJ6 4WD</b>	SE3CJ		Z2
KIT NOTES: Z2. Shackle Kit Includes Enough Bushings for BOTH Front & Rear.			
<b>LINKS / CONTROL ARMS</b>			
Description	LIFT	Part #	
<b>18-20 JL 2 &amp; 4 Door 4WD</b> (Front Standard Lower Links)	1-4"	JL24LL	
<b>18-20 JL 2 &amp; 4 Door 4WD</b> (Front & Rear Lower Adjustable Flex Links)	1-6"	JL24LLX	
<b>18-20 JL 2 &amp; 4 Door 4WD</b> (Front Lower Adjustable Flex Links)	1-6"	JLL24F-SX	
<b>18-20 JL 2 &amp; 4 Door 4WD</b> (Rear Lower Adjustable Flex Links)	1-6"	JLL24R-SX	
<b>18-20 JL 2 &amp; 4 Door 4WD</b> (Front Upper Adjustable Flex Links)	1-6"	JLULF26-SX	
<b>18-20 JL 2 &amp; 4 Door 4WD</b> (Rear Upper Adjustable Flex Links)	1-6"	JLULR26-SX	
<b>07-18 JK 2 &amp; 4 Door 4WD</b> (Front Standard Lower Links)	2-5"	JKLL24F	
<b>07-18 JK 2 &amp; 4 Door 4WD</b> (Front Single Flex Lower Links)	2-5"	JKLL24F-SX	
<b>07-18 JK 2 &amp; 4 Door 4WD</b> (Front Single Flex Upper Links)	2-7"	JKULF26-SX	
<b>07-18 JK 2 &amp; 4 Door 4WD</b> (Rear Standard Lower Links)	2-5"	JKLL24R	
<b>07-18 JK 2 &amp; 4 Door 4WD</b> (Rear Single Flex Lower Links)	2-5"	JKLL24R-SX	
<b>07-18 JK 2 &amp; 4 Door 4WD</b> (Rear Single Flex Upper Links)	2-7"	JKULR26-SX	
<b>97-06 Jeep TJ</b> (Standard Links)	0"	JLL01	
<b>97-06 Jeep TJ</b> (Standard Links)	2-4"	TJLL24	
<b>97-06 Jeep TJ</b> (Single & Value Flex Links)	0-4"	JLL24-SX	
<b>97-06 Jeep TJ</b> (Front & Rear Upper Flex Links)	2-6"	JUL48SFX	
<b>97-06 Jeep TJ</b> (Front Upper Flex Links)	2-6"	JULF24-FX	
<b>97-06 Jeep TJ</b> (Rear Upper Flex Links)	2-6"	JULR24-SX	
<b>POLY BUMP STOPS - PAIR</b>			
LIFT	FRONT	REAR	NOTES
<b>97-06 Wrangler TJ</b>			
2.5"	BP50	BP50	
2"	BPS20	BPS20	Z4
3"	BPS30	BPS30	Z4
KIT NOTES: Z4. Not a Poly Bump Stop. They are Bump Stop SPACERS.			

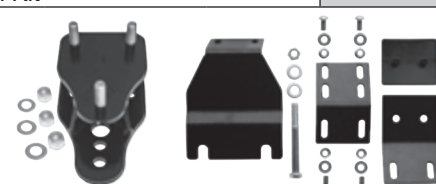
<b>76-86 CJ &amp; Scrambler 4WD</b>			
3"	BP30	BP30	Z3
KIT NOTES: Z3. # BP30 is Not a Polyurethane Bump Stop. They are Bump Stop BRACKETS that Mount on the Axle.			
<b>REPLACEMENT CARTRIDGE</b>			
Description	Part #		
<b>07-18 JK 2 &amp; 4 Door 4WD</b>	JK717RC		
<b>SHACKLES - GREASEABLE</b>			
Description	LIFT	Part #	
<b>84-01 Jeep Cherokee XJ</b>			
Rear Shackles, Pair	1"	SH130	
<b>87-95 Jeep YJ</b>			
Front Shackles, Pair	1"	SH2545F	
<b>87-95 Jeep YJ</b>			
Rear Shackles, Pair	1"	SH2545R	
<b>SHOCK RELOCATION BRACKETS</b>			
Description	LIFT	Part #	
<b>18 Jeep JL Models</b>			
Front Outboard Shock Mounting Brackets		JLOSM	
<b>97-06 Jeep TJ Models</b>			
Rear Brackets	ALL	TJR5B10	
<b>SKID PLATES, OIL PANS &amp; SHIFTER BRACKET</b>			
Description	LIFT	Part #	NOTES
<b>97-06 Wrangler TJ, Including Rubicon Package 4WD</b>			
Skid Plate	ALL	SP176	E12, E20
KIT NOTES: Will Not Work with Manual Transmission on '03-'06 TJ, LJ. E12. Manual Trans REQUIRES # SPS28M Transmission Mount. E20. Must have at least 1" Body Lift.			
<b>97-06 Wrangler TJ 4WD</b>			
Steering Box Skid Plate	ALL	RRSP20	
<b>High Clearance Transfer Case Skid Plate - Auto &amp; Manual Transmission</b>			
<b>High Capacity Transmission Oil Pan - Auto Only</b> (Holds 2 Extra Quarts)			
	87-02	OPA999	
KIT NOTES: YJ Models Must Modify Factory Skid Plate to Allow for Installation.			
<b>Jeep Wrangler TJ Shifter Relocation Bracket 97-06 Models</b>			
	ALL	JSRB231A	E11
KIT NOTES: E11. Manual AX15 Transmission REQUIRES Modification to Bracket & Stock Linkage.			
<b>SPARE TIRE SUPPORT / RELOCATION</b>			
18-20 Jeep JL / Tailgate Saver & Spare Tire Relocation Kit	TGSSTR2		
18-20 Jeep JL / Spare Tire Relocation	STRJL18		
18-20 Jeep JL / Tailgate Saver Kit	TGSJL1		
07-18 Jeep JK / Tailgate Saver & Spare Tire Relocation Kit	TGSSTR1		
07-18 Jeep JK / Tailgate Saver Kit	TGSJK1		
07-18 Jeep JK / Spare Tire Relocation Kit	STRJK212		
			



SPRING EYE BUSHING KITS			
Description	FRONT	REAR	NOTES
<b>ORIGINAL EQUIPMENT</b>			
76-86 CJ5, CJ7 & Scrambler 4WD	SE40J	SE45J	
55-75 CJ5, CJ6 4WD	SE34J	SE34J	
<b>Skyjacker® Softride®</b>			
87-96 Wrangler YJ 4WD	SE4YJ	SE4YJ	
76-86 CJ5, CJ7 & Scrambler 4WD	SE40J	SE45J	
55-75 CJ5, CJ6 4WD	SE34J	SE34J	
SWAY BAR BUSHING KITS			
Description	FRONT	REAR	
76-86 CJs & Scrambler	JSB15		
SWAY BAR EXTENDED END LINKS			
Extended Sway Bar End Links Include Bushings			
Description	LIFT	LOCATION	
		FRONT	REAR
<b>18 JL 2 &amp; 4 Door 4WD</b>			
Double Disconnect	2-3"	SBE4238	
Double Disconnect	3.5-6"	SBE4258	
<b>07-18 JK 2 &amp; 4 Door 4WD</b>			
Double Disconnect	2.5-5"	SBE126	
	2-3.5"		SBE502
	4-5"		SBE504
<b>97-06 Wrangler TJ 4WD</b>			
Double Disconnect	2.5-4"	SBE120	
Double Disconnect	8-9"	SBE228	
Double Disconnect	6"	SBE226	
Fixed	2-4"	SBE401	SBE500
	6-9"		SBE606
<b>87-96 Wrangler YJ 4WD</b>			
Double Disconnect	2-2.5"	SBE424	
Double Disconnect	3.5-6"	SBE425	
<b>76-86 CJs</b>			
Double Disconnect	2-2.5"	SBE524	
Double Disconnect	3.5-4"	SBE525	
<b>93-98 Grand Cherokee ZJ 4WD, 2WD</b>			
Double Disconnect	3-4"	SBE124	
<b>84-01 Cherokee XJ 4WD, 2WD</b>			
Double Disconnect	3-4"	SBE320	
Double Disconnect	6"	SBE326	
Double Disconnect	8"	SBE328	
SWAY BARS - HEAVY-DUTY REPLACEMENT			
Description	Location	Part #	
97-06 (Adjustable)	Rear	RSBA410	
97-06 (Adjustable)	Front	JFSBA10	
SWAY BAR LOWERING KITS			
Description	Lift	Part #	
76-86 CJs & Scrambler 4WD	3-4"	SBL20	
TAILGATE SAVER (TIRE SUPPORT) NEW!			
Description	Part #		
18-20 JL 2 & 4 Door 4WD	TGSJL1		
07-18 JK 2 & 4 Door 4WD	TGSJK1		
TIE ROD			
Description	Part #		
07-18 JK 2 & 4 Door 4WD	JK717TR		

TRACK BAR COMPONENTS			
Description	LIFT	Part #	NOTES
<b>18-20 JL 2 &amp; 4 Door 4WD</b>			
Adjustable Front Track Bar Assembly	0-6"	JLFTBA18	
Adjustable Rear Track Bar Assembly	2-6"	JLRTBA18	
<b>07-18 JK 2 &amp; 4 Door 4WD</b>			
Adjustable Front Track Bar Assembly	0-6"	JKFTBA717	
Adjustable Rear Track Bar Assembly	0-6"	JKRTBA717	
Adjustable Front Track Bar Assembly	4-6"	FTBA45	
Adjustable Rear Track Bar Assembly	4-6"	RTBA45	
Front Track Bar Bracket	2.5-5"	JKFTB	
Front Track Bar Brace (Dana 30 & 44 Front Axle)	2.5-6"	JKBRC34	
Rear Track Bar Bracket	3.5-5"	JK24RTB	
KIT NOTES: Must have Skyjacker® Relocation Bracket.			
Rear Track Bar Brace (Dana 44 Rear Axle)	2.5-6"	JKBRC15	
KIT NOTES: Must have Skyjacker® Relocation Bracket.			
<b>97-06 Wrangler TJ FRONT</b>			
Adjustable Front Track Bar Assembly	4"	TBA10	
	6"	TBA60	
	8-9"	TBA80	
<b>97-06 Wrangler TJ REAR</b>			
Rear Track Bar Relocation Bracket	2-4"	TJRTB	
Option for the Skyjacker® Kit			
For Use on Vehicles Equipped with Skyjacker® Kit			
	6-9"	RTBA168	
<b>87-96 Wrangler YJ</b>			
Front OEM Track Bar Relocation Bracket	2-5"	JB40F	
Rear OEM Track Bar Relocation Bracket	2-5"	JB40	
Front Extended Track Bar	6"	TBA70	
<b>84-01 Cherokee XJ 4WD, 2WD</b>			
Adjustable Front Track Bar Assembly	2-5"	TBA10	
	6"	TBA60	
	8"	TBA80	
Front OEM Track Bar Relocation Bracket	2-4"	JTBF	
<b>93-98 Grand Cherokee ZJ 4WD, 2WD</b>			
Adjustable Front Track Bar Assembly	3-4"	TBA10	
Front OEM Track Bar Relocation Bracket	3-4"	JTBF	

# ACCESSORIES

## 5TH LINK TRACTION BAR

Part #	NOTES
--------	-------

### 87-96 Wrangler YJ 4WD

#### 5th Link Traction Bar Assembly

YJ5LK	E6	Fits Stock or Lifted YJ
-------	----	-------------------------

KIT NOTES: E6. # YJ5LK - 5th Link Traction Bar is Highly Recommended for Skyjacker®'s 6" YJ Monolinear Kit & for Any Spring Over Applications.



### 5th Link Traction Bar Only - Universal

TB500K
--------

## TRANSFER CASE LOWERING KITS

Description	LIFT	Part #
03-06 Wrangler TJ + Rubicon 4WD	2-2.5"	TCL103
03-06 Wrangler TJ + Rubicon 4WD	3.5-4"	TCL153
97-02 Wrangler TJ 4WD	2-2.5"	TCL101
97-02 Wrangler TJ 4WD	3.5-4"	TCL151
87-96 Wrangler YJ 4WD	2-4"	TCL25
76-86 CJ5, CJ7 & CJ8 4WD	2-4"	TCL35
55-75 CJ5, CJ6 4WD	2-4"	TCL45
94-01 Cherokee XJ 4WD, 2WD	3"	TCL31
84-93 Cherokee XJ 4WD, 2WD	3"	TCL30

## MAZDA - ACCESSORIES

### ALIGNMENT SHIMS

Description	DEGREE	Part #
90-94 Mazda Navajo & 94-97 BSeries 4WD		
Caster / Camber Shims	0-2	1039H
90-94 Mazda Navajo & 94-97 BSeries 2WD		
Caster / Camber Shims	0-2	1029H

### CENTER HINGE DROP BRACKETS - PAIR

Description	LIFT	Part #
90-94 Mazda Navajo & 94-97 BSeries 4WD		
Heavy-Duty - Class I	4-6"	CHB35
Heavy-Duty - Class II	4-6"	CHB352

### CENTER HINGE PIVOT BUSHINGS

Re-Uses Existing OEM Metal Outer Shells	Part #
94-96 B Series Pickup 4WD	CHB80
90-94 Mazda Navajo 4WD	CHB80

### RADIUS / STRUT ARM BUSHINGS

Description	Part #
-------------	--------

### OEM REPLACEMENT

94-97 B Series Pickup 4WD, 2WD	SAB83
91-94 Navajo 4WD, 2WD	SAB83

### SWAY BAR EXTENDED END LINKS

End Links Include Polyurethane Bushings

Description	LIFT	LOCATION	
		FRONT	REAR
90-94 Mazda Navajo 4WD, 2WD	3-4"	SBE734	

### SWAY BAR LOWERING KITS

Description	LIFT	Part #
94-97 B Series Pickup 4WD	4-6"	SBL20
91-94 Navajo 4WD, 2WD	4-6"	SBL20

## TOYOTA - ACCESSORIES

### DRAG LINK & TIE ROD ASSEMBLIES

Description	LIFT	Part #	NOTES
79-85 Pickup, 4Runner 4WD			
Offset Adjustable Drag Link	5-7"	TDL5	V8

KIT NOTES: V8. 7" Lifts REQUIRE the Following: Modifying Factory Steering Arm so that Ball is Pointing Out the Top of Arm (Rather than Pointing Down).

## FRAME SHACKLE BUSHING KITS

Description	FRONT	REAR	NOTES
-------------	-------	------	-------

### ORIGINAL EQUIPMENT

79-85 Pickup, 4Runner 4WD	SE31T		
---------------------------	-------	--	--

### SPRING EYE BUSHING KITS

Description	FRONT	REAR	NOTES
-------------	-------	------	-------

#### Skyjacker® Softride®

79-85 Pickup, 4Runner 4WD	SE30T		
79-88 Pickup, 4Runner 4WD		SE35T	
89-95 Pickup, 4Runner 4WD		SE39T	
64-80 LandCruiser FJ40 4WD	SE40L	SE40L	

### SWAY BAR EXTENDED END LINKS

End Links Include Polyurethane Bushings

Description	LIFT	LOCATION	
		FRONT	REAR

### 07-19 Tundra 4WD

	6"	TU76SBL	
--	----	---------	--

### 79-85 Pickup, 4Runner 4WD

	3-5"	SBE30	
--	------	-------	--

### TRACK BAR COMPONENTS

Description	LIFT	Part #	NOTES
-------------	------	--------	-------

### 79-85 Pickup, 4Runner 4WD

Front OEM Torque Bar Relocation Bracket	3-7"	TB30	
---	------	------	--

## UNIVERSAL APPLICATIONS - ACCESSORIES

### UNIVERSAL BODY LIFT BLOCKS

Description	SIZE	Part #
2" Universal Body Lift Block	2"	BPS227B
3" Universal Body Lift Block	3"	BPS237B

### DEGREE SHIMS

Description	SIZE
-------------	------

### FLAT - PAIR SHIMS FOR SPRINGS ON TOP OF AXLE

(Tie Bolts Ordered Separately)

Description	DEGREE	Part #
2-2.25" Wide Leaf Springs	4	WS30
2.5" Wide Leaf Springs	4	WS325
3" Wide Leaf Springs	4	WS430

### CONTOURED - PAIR SHIMS FOR SPRINGS BELOW AXLE

(Tie Bolts Ordered Separately)

Description	DEGREE	Part #
1.75" Wide Leaf Springs	6	WSC61
2.5" Wide Leaf Springs	6	WSC60
2.5" Wide Leaf Springs	8	WSC80

### TIE BOLTS - PAIR

Description	SIZE	Part #
3/8 x 3" Tie Bolts with Nuts	3/8" X 3"	3803
3/8 x 6" Tie Bolts with Nuts	3/8" X 6"	3806
3/8 x 10" Tie Bolts with Nuts	3/8" X 10"	3810
5/16 x 3" Tie Bolts with Nuts	5/16" X 3"	5163
7/16 x 4" Tie Bolts with Nuts	7/16" X 4"	7164
7/16 x 6" Tie Bolts with Nuts	7/16" X 6"	7166
1/2 x 4" Tie Bolts with Nuts	1/2" X 4"	1204
1/2 x 6" Tie Bolts with Nuts	1/2" X 6"	1206

### HI-LIFT JACK

Polyurethane Isolator	HLI100
-----------------------	--------

### LIMITING STRAPS

All Applications		
16" Limiting Straps - BLACK	Pair	LS16K
20" Limiting Straps - BLACK	Pair	LS20K
24" Limiting Straps - BLACK	Pair	LS24K
28" Limiting Straps - BLACK	Pair	LS28K
32" Limiting Straps - BLACK	Pair	LS32K

# ACCESSORIES

POLY BUMP STOPS - PAIR			
	FRONT	REAR	NOTES
<b>Bump Stop with Single Stud Mount (Universal)</b>			
4.5" Tall	BP45	BP45	

ROCK READY GRAB HANDLES	
DESCRIPTION	Part #
2" RR Grab Handles Pair-Red	RRGH20-R
3" RR Grab Handles Pair-Red	RRGH30-R
2" RR Grab Handles Pair-Black	RRGH20-K
3" RR Grab Handles Pair-Black	RRGH30-K

ROCK READY GRAB HANDLES - RETAIL PACKAGING	
2" RR Grab Handles Pair-Red	RRGH20RP-R
3" RR Grab Handles Pair-Red	RRGH30RP-R
2" RR Grab Handles Pair-Black	RRGH20RP-K
3" RR Grab Handles Pair-Black	RRGH30RP-K

## ROD ENDS & JAM NUTS

### NG Rebuildable Rod Ends



Description	SIZE	Part #
1.25" Rod Ends with .75" Bolt Hole		
- LEFT Hand Threads	1.25" X .75"	RR114X1L
1.25" Rod Ends with .75" Bolt Hole		
- RIGHT Hand Threads	1.25" X .75"	RR114X1R
.75" Rod Ends with .625" Bolt Hole		
- LEFT Hand Threads	.75" X .625"	RR34X58L
.75" Rod Ends with .625" Bolt Hole		
- RIGHT Hand Threads	.75" X .625"	RR34X58R

Rebuild Kits for NG Rebuildable Rod Ends		
1.25" Rod Ends with .75" Bolt Hole	1.25" X .75"	RBK114
.75" Rod Ends with .625" Bolt Hole	.75" X .625"	RBK34

Heavy-Duty Kevlar® / Teflon® Lined Self-Lubricating Rod Ends		
Description	SIZE	Part #
1.25" Rod Ends with 1" Bolt Hole		
- LEFT Hand Threads	1.25" X 1"	RE114X1L
1.25" Rod Ends with 1" Bolt Hole		
- RIGHT Hand Threads	1.25" X 1"	RE114X1R
.75" Rod Ends with .75" Bolt Hole		
- LEFT Hand Threads	.75" X .75"	RE34X34L
.75" Rod Ends with .75" Bolt Hole		
- RIGHT Hand Threads	.75" X .75"	RE34X34R

Jam Nuts		
NOTES: The Following Jam Nuts can be Used for both Rebuildable & Self-Lubricating Rod Ends		
1.25" Jam Nut with Fine Threads		
- LEFT Hand Threads	1.25"	114LFTJN
1.25" Jam Nut with Fine Threads		
- RIGHT Hand Threads	1.25"	114RFTJN
.75" Jam Nut with Fine Threads		
- LEFT Hand Threads	.75"	34LFTJN
.75" Jam Nut with Fine Threads		
- RIGHT Hand Threads	.75"	34RFTJN

SPRING SPACER PLATES		
Description	SIZE	Part #
<b>ANY &amp; ALL - LEAF SPRING MODELS WITH 2.5-3" WIDE LEAF SPRINGS ON TOP OF REAR AXLE</b>		
2.5" Wide Leaf Spring Spacer Plates	1/2"	SP1225
3" Wide Leaf Spring Spacer Plates	1/2"	SP1230

TIE BOLTS - PAIR		
Description	SIZE	Part #
3/8 x 3" Tie Bolts with Nuts	3/8" X 3"	3803
3/8 x 6" Tie Bolts with Nuts	3/8" X 6"	3806
3/8 x 10" Tie Bolts with Nuts	3/8" X 10"	3810
5/16 x 3" Tie Bolts with Nuts	5/16" X 3"	5163
7/16 x 4" Tie Bolts with Nuts	7/16" X 4"	7164
7/16 x 6" Tie Bolts with Nuts	7/16" X 6"	7166
1/2 x 4" Tie Bolts with Nuts	1/2" X 4"	1204
1/2 x 6" Tie Bolts with Nuts	1/2" X 6"	1206

# POLYURETHANE CLEARANCE KITS / BODY LIFTS

Skyjacker® has 2" & 3" Body Lifts available for the following Jeep Applications.

We also a 1" Clearance Kit available. This Kit Completely Replaces the factory rubber body mounts with a more durable, long-lasting Polyurethane material. 1" of Clearance Lift is attained by using 1" Taller Mounts.

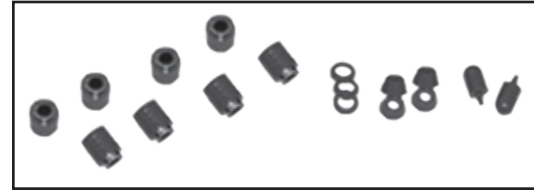

Replacement Shocks are also recommended, but not required. (See Shock Application Guide - Page 188).

1" Lift Part #	2" Lift Part #	3" Lift Part #	Includes Bumper Brackets	Automatic or Manual Transmission	KIT NOTES
<b>JEEP</b>					
<b>97-06 Wrangler TJ + Rubicon - Clearance Kit</b>					
SS941P			(Clearance Kit)	Both	Ø21
KIT NOTES: Ø21. Completely Replaces Factory Body Mounts. 1" of Clearance Lift Attained by Using 1" Taller Polyurethane Mounts.					
<b>97-06 Wrangler TJ + Rubicon</b>					
SS951	SS952			Both	
<b>87-96 Wrangler YJ with Manual Transmission Only</b>					
SS931	SS932	SS933		Manual Only	
<b>87-96 Wrangler YJ with Automatic Transmission Only</b>					
SS931	SS932A	SS933A		Auto Only	
<b>UNIVERSAL</b>					
<b>Universal Body Lift Blocks - Single</b>					
	BPS227B			Both	
	BPS237B			Both	

**WARNING.** . . Skyjacker® Suspensions Does NOT Recommend the Combined Use of Body Lifts & Suspension Lifts or Other Lifting Devices.

# ADD-A-LEAFS

Softride® is the best way of describing the ride quality of our Long Add-A-Leafs. The Softride® Long Add-A-Leafs will bring new life & lift to your fatigued stock springs & you can rest easy knowing that the Skyjacker® Softride® Technology is at work in each pair.

Also available are the Heavy-Duty Add-A-Leafs. These units are shorter & are designed for extra payload capacity.

Tie Bolts are included in each Pair of Skyjacker® Add-A-Leafs.

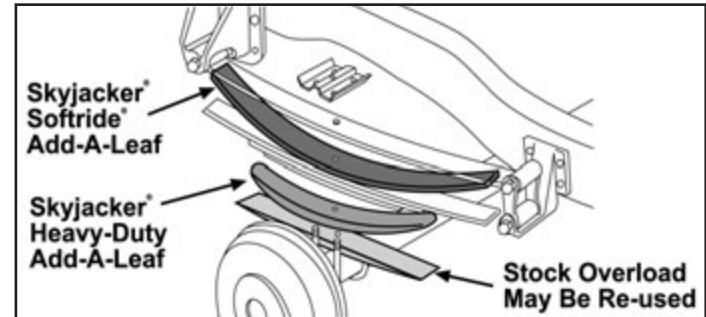

Also available are 'Fitted Leafs'. Fitted Leafs are designed as an option Exclusively for Skyjacker® Softride® Lifted Leaf Springs. These are used when the additional weight of aftermarket accessories are installed such as a heavy winch bumper, an engine conversion, a swing-away tire carrier, all your extra gear, etc.). The Fitted Leafs Application are listed in the Leaf Spring Charts. Start at Page 222 for Front & Page 225 for Rear Applications.

ADD-A-LEAFS - PAIR WITH TIE BOLTS															
FRONT	FRONT	FRONT	REAR	REAR	REAR	Front Shocks				Rear Shocks				KIT	
LIFT	SOFRIDE®	HEAVY-DUTY	LIFT	SOFRIDE®	HEAVY-DUTY	HYDRO	NITRO	Black MAX	M95	HYDRO	NITRO	Black MAX	M95	NOTES	
<b>CHEVROLET / GMC</b>															
<b>04-12 Colorado / Canyon 4WD / 2WD</b>															
			2.5"	RCC25						H7084	N8084	B8584	M9584		
<b>99-20 1500 &amp; 2500 Pickup 4WD - IFS</b>															
			1.5"	R1115						H7017	N8017	B8517	M9517		
<b>88-98 1500, 2500 Pickup 4WD - IFS</b>															
			2"	R1120	R225					H7083	N8083	B8583	M9583		
<b>67-87 1500, 2500 &amp; 3500 Pickup 4WD</b>															
<b>73-87 1500 &amp; 2500 Pickup 4WD</b>															
2"	F1100		2"	R1120	R225	H7051	N8051	B8551	M9551	H7053	N8053	B8553	M9553		
<b>67-72 1500 &amp; 2500 Pickup 4WD</b>															
2"	F1100		2"	R1120	R225	H7051	N8051	B8551	M9551	H7041	N8041	B8541	M9541		
<b>73-87 1 Ton Pickup 4WD</b>															
1.5-2"	F1100		1.5-2"	R1120	R225	H7051	N8051	B8551	M9551	H7053	N8053	B8553	M9553		
<b>69-91 Blazer / Jimmy 4WD</b>															
<b>73-91 Blazer / Jimmy 4WD</b>															
2"	F1100		2"	R1120	R225	H7051	N8051	B8551	M9551	H7053	N8053	B8553	M9553		
<b>69-72 Blazer / Jimmy 4WD</b>															
2"	F1100		2"	R1120	R225	H7051	N8051	B8551	M9551	H7041	N8041	B8541	M9541		
<b>67-91 Suburban 4WD</b>															
<b>73-91 Suburban 4WD</b>															
2"	F1100		1.5-2"	R1120	R225	H7051	N8051	B8551	M9551	H7053	N8053	B8553	M9553		
<b>67-72 Suburban 4WD</b>															
2"	F1100				R225	H7051	N8051	B8551	M9551	H7041	N8041	B8541	M9541		
<b>83-97 S10 / S15 Models 4WD - Except ZR2</b>															
			2"		R225					H7083	N8083	B8583	M9583		
<b>DODGE</b>															
<b>61-13 1/2, 3/4 &amp; 1 Ton Ram Pickup 4WD</b>															
<b>03-13 2500 / 03-12 3500 Ram Pickup 4WD</b>															
			2"		R332					H7017	N8017	B8517	M9517		
			4"		R334					H7017	N8017	B8517	M9517		
<b>94-01 1500 Ram Pickup 4WD &amp; 2500 Ram Pickup 4WD with 2.5" Wide Rear Springs</b>															
			2"		R222					H7017	N8017	B8517	M9517		
			4"		R224					H7017	N8017	B8517	M9517		
<b>94-02 2500 Ram Pickup 4WD with 3" Wide Rear Springs &amp; 3500</b>															
			1-1.5"		R372					H7036	N8036	B8536	M9536		
			3"		R370					H7036	N8036	B8536	M9536		
<b>61-93 W100, W150, W250, W350 Pickup 4WD Full-Size</b>															
2"	F1100		2"	R1120	R225	H7027	N8027	B8527	M9527	H7038	N8038	B8538	M9538		

# ADD-A-LEAFS

ADD-A-LEAFS - PAIR WITH TIE BOLTS														
FRONT	FRONT	FRONT	REAR	REAR	REAR	Front Shocks				Rear Shocks				KIT
LIFT	SOFTTRIDE®	HEAVY-DUTY	LIFT	SOFTTRIDE®	HEAVY-DUTY	HYDRO	NITRO	Black MAX	M95	HYDRO	NITRO	Black MAX	M95	NOTES
<b>FORD</b>														
<b>66-20 F-100, F-150 Pickup 4WD, 2WD</b>														
<b>09-20 F-150 Pickup 4WD</b>														
			4"	R3940						H7060	N8060	B8560	M9560	
<b>04-08 F-150 Pickup 4WD</b>														
			4"	R3440						H7060	N8060	B8560	M9560	
<b>97-03 F-150 Pickup 4WD</b>														
			2"	R2520						H7061	N8061	B8561	M9561	
<b>80-96 F-100, F-150 Pickup 4WD</b>														
			2"	R3120	R300					H7060	N8060	B8560	M9560	
<b>80-96 F-100, F-150 Pickup 2WD</b>														
			2"		R225					H7058	N8058	B8558	M9558	
<b>73-79 F-100, F-150 Pickup 4WD</b>														
			2"	R3120	R300					H7057	N8057	B8557	M9557	
<b>70-72 F-100, F-150 Pickup 4WD</b>														
			2"		R225					H7057	N8057	B8557	M9557	
<b>66-69 F-100, F-150 Pickup 4WD</b>														
			2"		R225					H7041	N8041	B8541	M9541	
<b>00-05 Excursion 4WD</b>														
2.5 -3"	F9320		2.5"	R300		H7023	N8023	B8523	M9523	H7034	N8034	B8534	M9534	Q9
KIT NOTES: Q9. Front Add-A-Leafs REQUIRE # TB9203 Track Bar Bracket.														
<b>08-20 F-250 Super Duty 4WD</b>														
			1.5"	R3815						H7060	N8060	B8560	M9560	
<b>05-07 F-250 Super Duty 4WD</b>														
			1"	R3510						H7060	N8060	B8560	M9560	
			2.5"	R300						H7060	N8060	B8560	M9560	
<b>99-04 F-250 Super Duty 4WD</b>														
<b>99-04 F-250 Super Duty 4WD - Built AFTER March '99</b>														
2-2.5"	F9320		2.5"	R300		H7023				H7079	N8079	B8579	M9579	Q9
KIT NOTES: Q9. Front Add-A-Leafs REQUIRE # TB9203 Track Bar Bracket.														
<b>99-04 F-250 Super Duty 4WD - Built BEFORE March '99</b>														
2-2.5"	F9320		2.5"	R300		H7023				H7079	N8079	B8579	M9579	Q10
KIT NOTES: Q10. Front Add-A-Leafs REQUIRE # TB920 Track Bar Bracket.														
<b>80-98 F-250 4WD, 2WD</b>														
<b>87-98 F-250 4WD IFS with 460 &amp; Diesel Engine</b>														
2"	F46D		1.5-2"	R3120	R300	H7023				H7060	N8060	B8560	M9560	
<b>87-98 F-250 4WD IFS with 302 &amp; 351 Gas Engine</b>														
2"	F35G		1.5-2"	R3120	R300	H7023				H7060	N8060	B8560	M9560	
<b>80-86 F-250 4WD IFS with 460 &amp; Diesel Engine</b>														
2"	F46D		1.5-2"	R3120	R300	H7054				H7060	N8060	B8560	M9560	
<b>80-86 F-250 4WD IFS with 302 &amp; 351 Gas Engine</b>														
2"	F35G		1.5-2"	R3120	R300	H7054				H7060	N8060	B8560	M9560	
<b>80-98 F-250 2WD</b>														
			2"		R225					H7058	N8058	B8558	M9558	
<b>66-79 F-250 4WD</b>														
<b>77.5-79 F-250 4WD</b>														
2"	F46D		1.5-2"	R3120	R300					H7057	N8057	B8557	M9557	
<b>66-77 F-250 4WD</b>														
			1.5-2"		R225					H7058	N8058	B8558	M9558	
<b>08-20 F-350 Super Duty 4WD</b>														
			1.5"	R3815						H7060	M9560	B8560	M9560	
<b>05-07 F-350 Super Duty 4WD</b>														
			1"	R3510						H7060	M9560	B8560	M9560	
			2.5"	R300										
<b>99-04 F-350 Super Duty 4WD</b>														
2-2.5"	F9320		2.5"	R300		H7023	N8023	B8523	M9523	H7079	N8079	B8579	M9579	

## ADD-A-LEAFS - PAIR WITH TIE BOLTS

FRONT	FRONT	FRONT	REAR	REAR	REAR	Front Shocks				Rear Shocks				KIT
LIFT	SOFTTRIDE®	HEAVY-DUTY	LIFT	SOFTTRIDE®	HEAVY-DUTY	HYDRO	NITRO	Black MAX	M95	HYDRO	NITRO	Black MAX	M95	NOTES
<b>86-98 F-350 &amp; Super Duty 4WD</b>														
<b>86-98 F-350 4WD - Except Crew Cabs</b>														
1.5"	F35G	-----	1.5-2"	R3120	R300	H7023	N8023	B8523	M9523	H7060	N8060	B8560	M9560	
<b>86-98 F-350 &amp; Super Duty 4WD</b>														
<b>86-98 F-350 Crew Cab 4WD</b>														
2-2.5"	F35G+F46D	-----	1.5-2"	R3120	R300	H7023	N8023	B8523	M9523	H7060	N8060	B8560	M9560	Q11
KIT NOTES: Q11. Front Add-A-Leafs REQUIRE # UFF Front U-Bolt Kit.														
<b>80-85 F-350 &amp; Super Duty 4WD</b>														
<b>80-85 F-350 4WD IFS with 460 &amp; Diesel Engine</b>														
2"	F46D	-----	1.5-2"	R3120	R300	H7054	N8054	B8554	M9554	H7060	N8060	B8560	M9560	
<b>80-85 F-350 4WD IFS with 302 &amp; 351 Gas Engine</b>														
2"	F35G	-----	1.5-2"	R3120	R300	H7054	N8054	B8554	M9554	H7060	N8060	B8560	M9560	
<b>66-96 Bronco</b>														
<b>80-96 Bronco 4WD</b>														
	-----	-----	2"	R3120	R300					H7058	N8058	B8558	M9558	
<b>78-79 Bronco 4WD</b>														
	-----	-----	2"	R3120	R300					H7026	N8026	B8526	M9526	
<b>67-77 Bronco 4WD</b>														
	-----	-----	2"	-----	R225					H7058	N8058	B8558	M9558	
<b>66 Bronco 4WD</b>														
	-----	-----	2"	-----	R225					H7055	N8055	B8555	M9555	
<b>83-97 Ranger, Bronco II, Explorer 4WD, 2WD</b>														
<b>83-97 Ranger 4WD</b>														
	-----	-----	2"	R3135	-----					H7060	N8060	B8560	M9560	
<b>83-97 Ranger 2WD</b>														
	-----	-----	2"	R3135	-----					H7058	N8058	B8558	M9558	
<b>83-90 Bronco II 4WD</b>														
	-----	-----	2"	R3135	-----					H7058	N8058	B8558	M9558	
<b>90-94 Explorer 4WD, 2WD</b>														
	-----	-----	2"	-----	R225					H7029	N8029	B8529	M9529	
<b>JEEP</b>														
<b>84-01 Cherokee XJ 4WD, Comanche Pickup</b>														
<b>84-01 Cherokee XJ 4WD</b>														
	-----	-----	2"	R3136	-----					H7018	N8018	B8518	M9518	
<b>86-92 Comanche Pickup</b>														
	-----	-----	2"	R3136	-----					H7023	N8023	B8523	M9523	
<b>TOYOTA</b>														
<b>95.5-20 Tundra 4WD, Tacoma 4WD, 2WD</b>														
<b>00-06 Tundra 4WD</b>														
	-----	-----	2"	RTU20	-----					H7048	N8048	B8548	M9548	
<b>05-20 Tacoma 4WD, 2WD</b>														
	-----	-----	2"	RTC515	-----					H7056	N8056	B8556	M9556	
<b>95.5-04 Tacoma 4WD, 2WD</b>														
	-----	-----	2"	RTC20	-----					H7027	N8027	B8527	M9527	
<b>79-95 Pickup 4WD</b>														
<b>89-95 Pickup 4WD</b>														
	-----	-----	2"	-----	R225					H7047	N8047	B8547	M9547	
<b>84-88 Pickup 4WD</b>														
	-----	-----	2"	R5005	-----					H7027	N8027	B8527	M9527	
<b>79-83 Pickup 4WD</b>														
	-----	-----	2"	R5005	-----					H7058	N8058	B8558	M9558	
<b>85-89 4Runner 4WD</b>														
	-----	-----	2"	-----	R225					H7047	N8047	B8547	M9547	

# BRAKE LINES

STAINLESS STEEL BRAIDED BRAKE LINES					
	LIFT	FRONT	UNIT	REAR	UNIT
<b>CHEVROLET / GMC</b>					
<b>07-16 Chevy / GMC 1500 4WD</b>					
	6"	FBL83	Pair	-----	-----
<b>04-12 Colorado / Canyon 4WD</b>					
	3-4"	FBL48	Pair		
<b>88-98 1500, 2500 Pickup 4WD</b>					
	0-3"	FBL97	Pair	RBL88	Single
	4-6"	FBL88	Pair	RBL88	Single
<b>68-87 K10, K15, K20, K25 Pickup 4WD (3/4 Tons 7200 GVWR or Less)</b>					
<b>79-87 K10, K15, K20, K25 Pickup 4WD (3/4 Tons 7200 GVWR or Less)</b>					
	3-4"	FBL17	Pair	RBL21	Single
	6-8"	FBL19	Pair	RBL20	Single
<b>73-78 K10, K15, K20, K25 Pickup 4WD (3/4 Tons 7200 GVWR or Less)</b>					
	3-4"	FBL16	Pair	RBL21	Single
	6-8"	FBL18	Pair	RBL20	Single
<b>70-72 K10, K15, K20, K25 Pickup 4WD with Disc Brakes (3/4 Tons 7200 GVWR or Less)</b>					
	3-4"	FBL16	Pair	RBL12	Single
	6-8"	FBL18	Pair	RBL13	Single
<b>68-69 K10, K15, K20, K25 Pickup Ton 4WD With Drum Brakes ONLY - Will NOT Fit Suburbans</b>					
	3-4"	FBL12	Pair	RBL12	Single
	6-8"	FBL13	Pair	RBL13	Single
<b>68-87 K20, K25, K30 Pickup 4WD (3/4 Tons 8600 GVWR or Greater)</b>					
<b>79-87 K20, K25, K30 Pickup 4WD (3/4 Tons 8600 GVWR or Greater)</b>					
	3-4"	FBL27	Pair	RBL21	Single
	6-8"	FBL29	Pair	RBL20	Single
<b>73-78 K20, K25, K30 Pickup 4WD (3/4 Tons 8600 GVWR or Greater)</b>					
	3-4"	FBL26	Pair	RBL21	Single
	6-8"	FBL28	Pair	RBL20	Single
<b>70-72 K20, K25, K30 Ton Pickup 4WD (3/4 Tons 8600 GVWR or Greater)</b>					
	3-4"	FBL26	Pair	RBL12	Single
	6-8"	FBL28	Pair	RBL13	Single
<b>68-69 K10, K15, K20, K25 Pickup 4WD with Drum Brakes ONLY - Will NOT Fit Suburbans</b>					
	3-4"	FBL12	Pair	RBL12	Single
	6-8"	FBL13	Pair	RBL13	Single
<b>68-98 Blazer / Jimmy, Tahoe / Yukon 4WD - Full-Size</b>					
<b>92-98 K5 Blazer / Jimmy, Tahoe / Yukon 4WD - Full-Size</b>					
	0-3"	FBL97	Pair	RBL88	Single
	4-6"	FBL88	Pair	RBL88	Single
<b>79-91 K5 Blazer / Jimmy 4WD - Fullsize</b>					
	3-4"	FBL17	Pair	RBL21	Single
	6-8"	FBL19	Pair	RBL20	Single
<b>73-78 K5 Blazer / Jimmy 4WD - Full-Size</b>					
	3-4"	FBL16	Pair	RBL21	Single
	6-8"	FBL18	Pair	RBL20	Single

STAINLESS STEEL BRAIDED BRAKE LINES					
	LIFT	FRONT	UNIT	REAR	UNIT
<b>70-72 K5 Blazer / Jimmy 4WD - Full-Size - with Disc Brakes</b>					
	3-4"	FBL16	Pair	RBL12	Single
	6-8"	FBL18	Pair	RBL13	Single
<b>69 Blazer 4WD with Drum Brakes ONLY - Will NOT Fit Suburbans</b>					
	3-4"	FBL12	Pair	RBL12	Single
	6-8"	FBL13	Pair	RBL13	Single
<b>70-98 Suburban 4WD</b>					
<b>92-98 Suburban 4WD</b>					
	0-3"	FBL97	Pair	RBL88	Single
	4-6"	FBL88	Pair	RBL88	Single
<b>79-91 Suburban 4WD</b>					
	3-4"	FBL27	Pair	RBL21	Single
	6-8"	FBL29	Pair	RBL20	Single
<b>73-78 Suburban 4WD</b>					
	3-4"	FBL26	Pair	RBL21	Single
	6-8"	FBL28	Pair	RBL20	Single
<b>70-72 Suburban 4WD</b>					
	3-4"	FBL26	Pair	-----	-----
	6-8"	FBL28	Pair	-----	-----
<b>DODGE</b>					
<b>94-02 W100, W150, W250, W350 Ram Pickup 4WD</b>					
<b>94-01 W100, W150, W250, W350 Ram Pickup 4WD</b>					
	1-4"	-----	-----	RBL60	Single
<b>61-93 W100, W150, W250, W350 Pickup, Ramcharger, Trailduster 4WD</b>					
<b>82-93 Models W100, W150, W250, W350</b>					
	4-8"	FBL60	Single	RBL60	Single
<b>76-81 Models W100, W150, W250, W350</b>					
	4-8"	FBL60	Single	RBL61	Single
<b>72-75 Models W100, W150, W250, W350</b>					
	4-8"	FBL65	Single	RBL65	Single
<b>69-71 Models W100, W150, W250, W350</b>					
	4-8"	FBL61	Single	-----	Single
<b>61-68 Models W100, W150, W250, W350</b>					
	4-8"	FBL61	Single	-----	-----
	LIFT	FRONT	UNIT	REAR	UNIT
<b>FORD</b>					
<b>66-96 F-100, F-150 4WD, 2WD</b>					
<b>90-96 F-150 4WD, 2WD</b>					
	4-8"	FBL81	Pair	RBL80	Single
<b>80-89 F-150 4WD, 2WD</b>					
	4-8"	FBL80	Pair	RBL80	Single
<b>76-79 F-100, F-150 4WD</b>					
	3-9"	FBL78	Single	RBL76	Single
<b>66-75 F-100, F-150 4WD</b>					
	3-9"	-----	-----	RBL76	Single
<b>73-10 F-250, F-350, Super Duty / Excursion 4WD, 2WD</b>					
<b>08-10 F-250 / F-350 Super Duty 4WD</b>					
	4"	FBL84	Pair		
	6-8"	FBL86	Pair		
<b>05-07 F-250 / F-350 Super Duty 4WD</b>					
	4"	FBL54	Pair		
	6-8"	FBL56	Pair		



# BRAKE LINES

STAINLESS STEEL BRAIDED BRAKE LINES					
	LIFT	FRONT	UNIT	REAR	UNIT
<b>2004 F-250 / F-350 Super Duty / Excursion 4WD</b>					
	4-6"	FBL92	Pair	RBL99	
<b>00-03 F-250 / F-350 Super Duty / Excursion 4WD</b>					
	4-8"	FBL92	Pair	RBL99	Single
<b>99 F-250 / F-350 Super Duty / Excursion 4WD</b>					
	4-8"	FBL99	Pair	RBL99	Single
<b>90-98 F-250, F-350 4WD, 2WD</b>					
	4-6"	FBL91	Pair	RBL90	Single
<b>80-89 F-250, F-350 4WD, 2WD - ONLY Fits Vehicles with a 7/16" Banjo Bolt</b>					
	4-6"	FBL90	Pair	RBL90	Single
<b>76-79 F-250, F-350 4WD</b>					
	4-6"	FBL93	Pair	RBL93	Single
<b>73-75 F-250, F-350 4WD</b>					
	4-6"	FBL95	Pair	RBL95	Single
<b>66-96 Bronco 4WD</b>					
<b>90-96 Bronco 4WD</b>					
	4-8"	FBL81	Pair	RBL80	Single
<b>80-89 Bronco 4WD</b>					
	4-8"	FBL80	Pair	RBL80	Single
<b>78-79 Bronco 4WD</b>					
	3-9"	FBL78	Single	RBL76	Single
<b>66-77 Bronco 4WD</b>					
	3-7"	FBL77	Single	RBL77	Single
<b>83-97 Ranger, Bronco II, Explorer 4WD, 2WD</b>					
<b>89-97 Ranger, Bronco II - Will NOT Fit with ABS</b>					
	4-6"	FBL36	Pair	RBL35	Single
<b>83-88 Ranger, Bronco II 4WD, 2WD</b>					
	4-6"	FBL35	Pair	RBL35	Single
<b>83-97 Ranger, Bronco II 4WD, 2WD with 8" Lift - Will NOT Fit with ABS</b>					
	8"	FBL38	Pair	RBL35	Single
<b>90-94 Explorer 4WD, 2WD - Will NOT Fit with ABS</b>					
	4-6"	FBL36	Pair	RBL35	Single
<b>MAZDA</b>					
<b>94-97 Mazda B4000 4WD, 2WD - Will NOT Fit with ABS</b>					
	4-6"	FBL36	Pair	RBL35	Single
<b>91-94 Navajo 4WD - Will NOT Fit with ABS</b>					
	4-6"	FBL36	Pair	RBL35	Single
<b>JEEP</b>					
<b>87-18 Wrangler 4WD</b>					
<b>07-18 Wrangler JK 4WD</b>					
	4-7"	JKFBL60	Pair	JKRBL60	Pair
<b>97-06 Wrangler TJ 4WD</b>					
	4-8"	FBL44	Pair	RBL98	Single
<b>87-96 Wrangler YJ 4WD</b>					
	3.5-6"	FBL47	Pair	RBL47	Single

STAINLESS STEEL BRAIDED BRAKE LINES					
	LIFT	FRONT	UNIT	REAR	UNIT
<b>55-86 CJs &amp; Scrambler 4WD</b>					
<b>82-86 CJs &amp; Scrambler 4WD</b>					
	0-2.5"	FBL402	Pair	RBL402	Single
	3-5"	FBL40	Pair	RBL40	Single
<b>76-81 CJs &amp; Scrambler 4WD with Disc Brakes</b>					
	0-2.5"	FBL412	Pair	RBL402	Single
	3-5"	FBL41	Pair	RBL40	Single
<b>76-81 CJs &amp; Scrambler 4WD with Drum Brakes</b>					
	0-2.5"	-----	Pair	RBL402	Single
	3-5"	FBL46	Pair	RBL40	Single
<b>74-75 CJs 4WD</b>					
	2.5-4"	FBL42	Pair	RBL42	Single
<b>67-73 CJs 4WD</b>					
	2.5-4"	FBL43	Pair	RBL43	Single
<b>55-66 CJs 4WD</b>					
	2.5-4"	FBL45	Pair	RBL45	Single
<b>84-01 Cherokee XJ 4WD</b>					
<b>84-01 Cherokee XJ 4WD</b>					
	3-8"	FBL44	Pair	RBL44	Single
<b>74-83 Cherokee, Wagoneer 4WD Full-Size</b>					
<b>79-83 Cherokee, Wagoneer 4WD - Full-Size</b>					
	2.5-4"	FBL40	Pair	RBL41	Single
<b>74-78 Cherokee, Wagoneer 4WD - Full-Size - with Disc Brakes</b>					
	2.5-4"	FBL41	Pair	RBL41	Single
<b>84-91 Grand Wagoneer 4WD - Full-Size</b>					
	2.5-4"	FBL40	Pair	RBL41	Single
<b>74-88 J10, J20 Pickup 4WD Full Size</b>					
<b>79-88 J10, J20 Pickup 4WD Full-Size - with Disc Brake Only</b>					
	2.5-4"	FBL40	Pair	RBL41	Single
<b>74-78 J10, J20 Pickup 4WD Full-Size - with Disc Brake Only</b>					
	2.5-4"	FBL41	Pair	RBL41	Single
<b>TOYOTA</b>					
<b>79-95 Pickup &amp; 4Runner 4WD</b>					
	3-7"	FBL30	Pair	RBL30	Single
<b>64-82 LandCruiser FJ40 4WD - Will NOT Fit 64-74 LandCruiser with Front 2-Line Wheel Cylinder</b>					
	2-4"	FBL31	Single	RBL30	Single
<b>INTERNATIONAL</b>					
<b>74-80 Scout II 4WD</b>					
	2-4"	FBL50	Pair	RBL50	Single

# SOFTTRIDE® COIL SPRINGS

	LIFT	COILS - PAIR		KIT
	Height	Front	Rear	NOTES
<b>CHEVROLET / GMC</b>				
<b>00-06 GM Avalanche, Tahoe, Suburban, Yukon 4WD</b>				
	4.5"		C50R	
<b>DODGE</b>				
<b>14-20 2500 Ram Pickup 4WD - Diesel Engines</b>				
<b>13-20 3500 Ram Pickup 4WD - Diesel Engines</b>				
	2-2.5"	R25		
	4"	R45		
	6"	R65		
<b>03-13 2500 / 03-12 3500 Ram Pickup 4WD V10 / Diesel Engines</b>				
	3-4"	D25		
	5-6"	D45		
<b>94-01 1500 Ram Pickup 4WD</b>				
<b>94-01 1500 Ram Pickup 4WD V-8 Engines</b>				
	2"	D20		Q14
	3"	D30		Q14
	5"	D50		Q14
	7"	D70		Q14
KIT NOTES: Q14. 00-01 Models Equipped with Factory 'OFF-ROAD Package' will Receive 1" Less Lift.				
<b>94-02 2500 with 3" Wide Rear Springs &amp; 3500 Ram Pickup 4WD - V10 / Diesel Engines</b>				
	2-2.5"	D25		
	4-4.5"	D45		
	7"	D75		
<b>FORD</b>				
<b>83-97 Ranger 4WD, 2WD Leveling Kits</b>				
<b>90-97 Ranger 4WD with 4 Cylinder Engine</b>				
	1.5-2"	132		
<b>90-97 Ranger XLT 4WD with 6 Cylinder Engine</b>				
	1.5-2"	132X		
<b>90-97 Ranger 2WD with 2.3, 2.9 &amp; 3.0 Liter Engine</b>				
	1.5-2"	132		
<b>90-97 Ranger 2WD with 4.0 Liter Engine</b>				
	1.5-2"	132X		
<b>87-89 Ranger STX 4WD</b>				
	1.5-2"	132X		
<b>83-89 Ranger 4WD, 2WD - Except Super Cab with 2.9 Liter Engine</b>				
	1.5-2"	132		
<b>83-89 Ranger Super Cab 4WD, 2WD with 2.9 Liter Engine</b>				
	1.5-2"	132X		
<b>83-97 Ranger 4WD, 2WD - 4", 6" &amp; 8" Lifts</b>				
<b>83-97 Ranger 4WD, 2WD</b>				
	4"	134		
	6"	136		
	8"	138		
<b>83-90 Bronco II 4WD, 2WD</b>				
<b>83-90 Bronco II 4WD, 2WD</b>				
	1.5-2"	132		
	4"	134		
	6"	136		
	8"	138		
<b>66-96 F-100, F-150 4WD, 2WD</b>				
<b>80-96 F-100, F-150 4WD, 2WD &amp; 80-96 Bronco 4WD</b>				
	2"	182		
	4"	184		
	6"	186		
	8"	188		

	LIFT	COILS - PAIR		KIT
	Height	Front	Rear	NOTES
<b>66-79 F-100, F-150 4WD &amp; 78-79 Bronco 4WD</b>				
	2"	172		
	4"	174		
	6"	176		
	9"	179		
<b>66-77 Bronco 4WD</b>				
	3"	172		
	5"	174V		VR
	7"	176		
<b>05-20 F-250, F-350 4WD, Diesel</b>				
<b>05-20 F-250, F-350 4WD, Diesel</b>				
	2"	F525V		VR
	4"	F545V		VR
	6"	F565V		VR
	8.5"	F585V		VR
<b>05-20 F-250, F-350 4WD, GAS</b>				
	2"	F520		
	4"	F540		
	6"	F560		
	8.5"	F565V		VR
VR = Variable Rate Coil Springs Provide A Lower Spring Rate Under Unloaded Conditions For A Smoother Ride, Higher Spring Rate Under Loaded Conditions Resulting In More Support & Control.				
<b>02-10 Hummer H2</b>				
	5.5"		H250R	
<b>JEEP</b>				
<b>07-18 Jeep Wrangler JK 2WD / 4WD 4 Door</b>				
	2.5"	JKU25FDR	JKU25RDR	DRLT Coils
	4"	JKU40FDR	JKU40RDR	DRLT Coils
	6"	JK60FDR	JK60RDR	DRLT Coils
<b>07-18 Jeep Wrangler JK 2WD / 4WD 2 Door</b>				
	2"	JK20FDR	JK20RDR	DRLT Coils
	3.5"	JK35FDR	JK35RDR	DRLT Coils
	7"	JK60FDR	JK60RDR	DRLT Coils
<b>97-06 Wrangler TJ / Rubicon 2WD / 4WD</b>				
	2.5"	TJ25FDR	TJ25RDR	DRLT Coils
	4"	TJ40FDR	TJ40RDR	DRLT Coils
	6"	TJ60FDR	TJ60RDR	DRLT Coils
	8"	TJ80FDR	TJ80RDR	DRLT Coils
<b>04-06 Wrangler Unlimited LJ 2WD / 4WD</b>				
	2.5"	TJ25FDR	TJ25RDR*	DRLT Coils
	4"	TJ40FDR	TJ40RDR*	DRLT Coils
	6"	TJ60FDR	TJ60RDR*	DRLT Coils
	8"	TJ80FDR	TJ80RDR	DRLT Coils
NOTES: * Part # SIP275 May be Required on Hard Top Models to Level the Rear.				
<b>08-12 Liberty KJ 2WD / 4WD</b>				
	2"		LIB208R	
<b>02-07 Liberty KJ 2WD / 4WD</b>				
	2.5"		LIB25R	
<b>84-01 Cherokee XJ 2WD / 4WD</b>				
	3"	JC30FDR		DRLT Coils
	4.5"	JC45FDR		DRLT Coils
	6"	JC60FDR		DRLT Coils
	8"	JC80FDR		DRLT Coils
<b>93-98 Grand Cherokee ZJ 2WD / 4WD</b>				
	2"		GC20R	
	3"	JC30FDR		DRLT Coils
<b>86-92 Comanche MJ 2WD / 4WD</b>				
	3"	JC30FDR		DRLT Coils

# FRONT SOFTRIDE® LEAF SPRINGS

**Softride® Technology** gives you all the vigorous off-road handling needed while providing the smooth street riding characteristics that you demand. Skyjacker's advanced method of shotpeening, tapered, leaves, Teflon® wear pads & 'presetting' process achieves articulation at its best...without sacrificing the life of the spring.

From this chart, you can find a 'Pair of Springs with Bushings' or 'Single Springs' & the 'Bushings Sets' needed for the Single unit (Ordered Separately). Also available are '**Fitted Leafs**'. Fitted Leafs are designed as an option Exclusively for Skyjacker® Softride® Lifted Leaf Springs. These are used when the additional weight of aftermarket accessories are installed such as a heavy winch bumper, an engine conversion, a swing-away tire carrier, all your extra gear, etc.

FRONT LIFT	NOTES	SINGLE SPRING	QTY.	BUSHING SETS TO FIT 2 SINGLE SPRINGS	QTY.	FITTED LEAFS FOR PAIR	U-BOLT KIT
<b>CHEVROLET / GMC</b>							
<b>73-87 K10, K15, K20, K25 Pickup 4WD</b>							
2.5"		C125S	2	SE11C	1	FLC125	UCABF
4"		C140S	2	SE11C	1	FLC140	UCABF
6"		C160S	2	SE11C	1	FLC160	UCABF
8"		C180S	2	SE11C	1	FLC180	UCABF
<b>67-72 K10, K15, K20, K25 Pickup 4WD</b>							
2.5"		C225S	2	SE11C	1	FLC225	UC2F
4"		C240S	2	SE11C	1	FLC240	UC2F
6"		C260S	2	SE11C	1	FLC260	UC2F
8"		C280S	2	SE11C	1	FLC280	UC2F
<b>77-87 K30 Pickup 4WD</b>							
2.5"		C125S	2	SE11C	1	FLC125	UCCF
4"		C140S	2	SE11C	1	FLC140	UCCF
6"		C160S	2	SE11C	1	FLC160	UCCF
8"		C180S	2	SE11C	1	FLC180	UCCF
<b>88-91 K5 Blazer, Jimmy Full-Size</b>							
2.5"		C125S	2	SE17C	1	FLC125	UCABF
4"		C140S	2	SE17C	1	FLC140	UCABF
6"		C160S	2	SE17C	1	FLC160	UCABF
8"		C180S	2	SE17C	1	FLC180	UCABF
<b>73-87 K5 Blazer, Jimmy Full-Size</b>							
2.5"		C125S	2	SE11C	1	FLC125	UCABF
4"		C140S	2	SE11C	1	FLC140	UCABF
6"		C160S	2	SE11C	1	FLC160	UCABF
8"		C180S	2	SE11C	1	FLC180	UCABF
<b>69-72 K5 Blazer, Jimmy Full-Size</b>							
2.5"		C225S	2	SE11C	1	FLC225	UC2F
4"		C240S	2	SE11C	1	FLC240	UC2F
6"		C260S	2	SE11C	1	FLC260	UC2F
8"		C280S	2	SE11C	1	FLC280	UC2F
<b>88-91 Suburban K15 &amp; K25 4WD</b>							
2.5"		C125S	2	SE17C	1	FLC125	UCABF
4"		C140S	2	SE17C	1	FLC140	UCABF
6"		C160S	2	SE17C	1	FLC160	UCABF
8"		C180S	2	SE17C	1	FLC180	UCABF
<b>73-87 Suburban K15 &amp; K25 4WD</b>							
2.5"		C125S	2	SE11C	1	FLC125	UCABF
4"		C140S	2	SE11C	1	FLC140	UCABF
6"		C160S	2	SE11C	1	FLC160	UCABF
8"		C180S	2	SE11C	1	FLC180	UCABF
<b>67-72 Suburban K15 &amp; K25 4WD</b>							
2.5"		C225S	2	SE11C	1	FLC225	UC2F
4"		C240S	2	SE11C	1	FLC240	UC2F
6"		C260S	2	SE11C	1	FLC260	UC2F
8"		C280S	2	SE11C	1	FLC280	UC2F
<b>DODGE</b>							
<b>61-93 W150 &amp; W250 Pickup 4WD (GAS Engines)</b>							
2.5"		D200S	2	SE12D	1	FLD200	UDWR
4"		D400S	2	SE12D	1	FLD400	UDWR

# FRONT SOFTRIDE® LEAF SPRINGS

FRONT LIFT	NOTES	SINGLE SPRING	QTY.	BUSHING SETS TO FIT 2 SINGLE SPRINGS	QTY.	FITTED LEAFS FOR PAIR	U-BOLT KIT
<b>DODGE - CONTINUED</b>							
<b>61-93 W150 &amp; W250 Pickup 4WD (GAS Engines)</b>							
6"		D600S	2	SE12D	1	FLD600	UDWR
8"		D800S	2	SE12D	1	FLD800	UDWR
<b>87-93 W250 &amp; W350 Pickup 4WD (DIESEL Engines)</b>							
1"		D100CS	2	SE12D	1	FLD200	UDCF
2"		D200CS	2	SE12D	1	FLD400	UDCF
4"		D400CS	2	SE12D	1	FLD600	UDCF
6"		D600CS	2	SE12D	1	FLD800	UDCF
<b>74.5-93 W350 Pickup 4WD (GAS Engines)</b>							
1.5-2"		D200S	2	SE12D	1	FLD200	UDCF
3-4"		D400S	2	SE12D	1	FLD400	UDCF
5-6"		D600S	2	SE12D	1	FLD600	UDCF
7-8"		D800S	2	SE12D	1	FLD800	UDCF
<b>72-93 Ramcharger, Trailduster 4WD</b>							
2.5"		D200S	2	SE12D	1	FLD200	UDBF
4"		D400S	2	SE12D	1	FLD400	UDBF
6"		D600S	2	SE12D	1	FLD600	UDBF
8"		D800S	2	SE12D	1	FLD800	UDBF
<b>FORD</b>							
<b>00-05 Excursion 4WD (GAS Engines)</b>							
4"		F920S	2	SE90F	1		U9FF
6"		F940S	2	SE90F	1		U9FF
8"		F960S	2	SE90F	1		U10FF
<b>00-05 Excursion 4WD (DIESEL Engines)</b>							
6"		F945S	2	SE90F	1		U9FF
8"		F965S	2	SE90F	1		U10FF
<b>99-04 F-250, F-350 Super Duty 4WD (GAS Engines)</b>							
2"		F920S	2	SE90F	1		U9FF
4"		F940S	2	SE90F	1		U9FF
6"		F960S	2	SE90F	1		U9FF
8"		F965S	2	SE90F	1		U10FF
<b>99-04 F-250, F-350 Super Duty 4WD (DIESEL Engines)</b>							
1.5"		F920S	2	SE90F	1		U9FF
4"		F945S	2	SE90F	1		U9FF
6"		F965S	2	SE90F	1		U9FF
8"		F985S	2	SE90F	1		U10FF
<b>80-98 F-250 4WD</b>							
4"		F840S	2	SE80F	1	FLF840	UFF
6"		F860S	2	SE80F	1	FLF860	UFF
<b>77.5-79 F-250 4WD</b>							
4"		F724S	2	SE70F	1	FLF724	UFF
6"		F746S	2	SE70F	1	FLF746	UFF
<b>67-77 F-250 Highboy</b>							
2"		F724S	2	SE70F	1	FLF724	UFF
4"		F746S	2	SE70F	1	FLF746	UFF
<b>86-98 F-350 Monobeam Straight Axle 4WD</b>							
3-4"		F840S	2	SE80F	1	FLF840	UFF
5-6"		F860S	2	SE80F	1	FLF860	UFF
<b>80-85 F-350 IFS 4WD</b>							
4"		F840S	2	SE80F	1	FLF840	UFF
6"		F860S	2	SE80F	1	FLF860	UFF
<b>79 F-350 Low Boy</b>							
3-4"		F724S	2	SE70F	1	FLF724	UFF
5-6"		F746S	2	SE70F	1	FLF746	UFF

# FRONT SOFTRIDE® LEAF SPRINGS

FRONT LIFT	NOTES	SINGLE SPRING	QTY.	BUSHING SETS TO FIT 2 SINGLE SPRINGS	QTY.	FITTED LEAFS FOR PAIR	U-BOLT KIT
<b>JEEP</b>							
<b>87-96 Wrangler YJ</b>							
2-2.5"		YJ20FS	2	SE4YJ	1	FLYJ20F	UYJF
3.5"-4"		YJ40FS	2	SE4YJ	1	FLYJ40F	UYJF
<b>87-96 Wrangler YJ Rock Ready® Double Military Wrap</b>							
2.5"		YJ25FS	2	SE45YJ			UYJF
4"		YJ45FS	2	SE45YJ			UYJF
<b>76-86 CJ &amp; Scrambler</b>							
2-2.5"		J20FS	2	SE40J	1	FLJ20F	UCJF
3.5"-4"		J40FS	2	SE40J	1	FLJ40F	UCJF
<b>55-75 CJ</b>							
2-2.5"		J32FS	2	SE34J	1	FLJ32F	UCJF
3.5"-4"		J34FS	2	SE34J	1	FLJ34F	UCJF
<b>84-91 Grand Wagoneer 4WD Full-Size</b>							
3.5-4"		JP40FS	2	SE4JP	1	FLJP40F	UJPF
<b>74-83 Cherokee, Wagoneer 4WD Full-Size</b>							
3.5-4"		JP40FS	2	SE4JP	1	FLJP40F	UJPF
<b>74-88 J10, J20 Pickup 4WD Full-Size</b>							
3.5-4"		JP40FS	2	SE4JP	1	FLJP40F	UJPF
<b>TOYOTA</b>							
<b>79-85 Pickup &amp; 4Runner 4WD</b>							
3"		T303S	2	SE30T	1	FLT303	UTF
5"		T305S	2	SE30T	1	FLT305	UTF
7"		T307S	2	SE30T	1	FLT307	UTF
<b>64-80 FJ40 LandCruiser 4WD</b>							
2.5"		L20FS	2	SE40L	1	FLL20F	ULF
4"		L40FS	2	SE40L	1	FLL40F	ULF
<b>INTERNATIONAL</b>							
<b>72-82 Scout II, Terra, Traveler 4WD</b>							
2"		S20FS	2	SE40S	1	FLS20F	USF
4"		S40FS	2	SE40S	1	FLS40F	USF
<b>JEEP SPORTS SERIES</b>							
<b>87-96 Wrangler YJ</b>							
2-2.5"		YJ20FSB	2	SE4YJ	1	FLYJ20F	UYJF
3.5"-4"		YJ40FSB	2	SE4YJ	1	FLYJ40F	UYJF
<b>76-86 CJ &amp; Scrambler</b>							
2-2.5"		J20FSB	2	SE40J	1	FLJ20F	UCJF
3.5"-4"		J40FSB	2	SE40J	1	FLJ40F	UCJF

# REAR SOFTRIDE® LEAF SPRINGS

**Softride® Technology** enhances every steely aspect of leaf spring performance, giving you all the vigorous off-road handling needed while providing the smooth street riding characteristics that you demand. Skyjacker's advanced method of shotpeening, tapered leaves, Teflon® wear pads & 'presetting' process achieves articulation at its best... without sacrificing the life of the spring. From this chart, you can find a 'Pair of Springs with Bushings' or 'Single Springs' & the 'Bushing Sets' needed for the Single unit (Ordered Separately). Also available are 'Fitted Leafs'. Fitted Leafs are designed as an option Exclusively for Skyjacker® Softride® Lifted Leaf Springs. These are used when the additional weight of aftermarket accessories are installed such as a heavy winch bumper, an engine conversion, a swing-away tire carrier, all you extra gear, etc.

FRONT LIFT	NOTES	SINGLE SPRING	QTY.	BUSHING SETS TO FIT 2 SINGLE SPRINGS	QTY.	FITTED LEAFS FOR PAIR	U-BOLTS 1/2 TON, 1500	U-BOLTS 3/4 TON, 2500	U-BOLTS 1 TON, 3500
<b>CHEVROLET / GMC</b>									
<b>99-18 1500 Ton Pickup 4WD</b>									
5"		CR55S	2	Pre-Installed Rubber			UDBR		
<b>01-08 1500HD / 2500 Pickup 4WD</b>									
5"		CR75S	2	Pre-Installed Rubber			UC2ASR		
<b>01-10 2500HD / 3500HD 2500 &amp; 3500 Pickup 4WD</b>									
5"		CR75S	2	Pre-Installed Rubber			UC2ASR	UC2ASR	
<b>92-98 Blazer, Yukon, Tahoe 4WD</b>									
2"		CR12S	2	Pre-Installed Rubber		FLCR12	UDBR		
4"		CR14S	2	Pre-Installed Rubber		FLCR14	UDBR		
6"		CR16S	2	Pre-Installed Rubber		FLCR16	UDBR		
<b>88-98 1500, 2500 6 Lug Pickup 4WD</b>									
5-5.5"		CR35S	2	Pre-Installed Rubber		FLCR35	UDBR		
<b>69-87 K10, K15, K25 Pickup 4WD with 52" Rear Springs</b>									
2"		CR12S	2	Pre-Installed Rubber		FLCR12	UC1ASR	UC1BSR	
4"		CR14S	2	Pre-Installed Rubber		FLCR14	UC1ASR	UC1BSR	
6"		CR16S	2	Pre-Installed Rubber		FLCR16	UC1ASR	UC1BSR	
8"		CR18S	2	Pre-Installed Rubber		FLCR18	UC1ASR	UC1BSR	
<b>69-87 K25 &amp; K30 Pickup 4WD with 56" Rear Springs</b>									
4"		CR24S	2	Pre-Installed Rubber		FLCR24		UC1BSR	UC1CSR
6"		CR26S	2	Pre-Installed Rubber		FLCR26		UC1BSR	
<b>73-91 K5 Blazer, Jimmy 4WD</b>									
2"		CR12S	2	Pre-Installed Rubber		FLCR12	UC1ASR		
4"		CR14S	2	Pre-Installed Rubber		FLCR14	UC1ASR		
6"		CR16S	2	Pre-Installed Rubber		FLCR16	UC1ASR		
8"		CR18S	2	Pre-Installed Rubber		FLCR18	UC1ASR		
<b>69-72 K5 Blazer, Jimmy 4WD</b>									
2"		CR14S	2	Pre-Installed Rubber		FLCR14	UC2ASR		
4"		CR16S	2	Pre-Installed Rubber		FLCR16	UC2ASR		
6"		CR18S	2	Pre-Installed Rubber		FLCR18	UC2ASR		
<b>69-91 Suburban 4WD with 52" Rear Springs</b>									
2"		CR14S	2	Pre-Installed Rubber		FLCR14	UC1ASR		
4"		CR16S	2	Pre-Installed Rubber		FLCR16	UC1ASR		
6"		CR18S	2	Pre-Installed Rubber		FLCR18	UC1ASR		
<b>69-91 Suburban 4WD with 56" Rear Springs</b>									
4"		CR24S	2	Pre-Installed Rubber		FLCR24		UC1BSR	
6"		CR26S	2	Pre-Installed Rubber		FLCR26		UC1BSR	
<b>DODGE</b>									
<b>02-08 1500 Ram Pickup 4WD</b>									
5"		DR250S	2	Pre-Installed Rubber			UDB8R		
<b>94-01 1500 &amp; 2500 Ram Pickup 4WD with 2.5" Wide Rear Springs</b>									
4"		DR54S	2	Pre-Installed Rubber		FLDR54	UD57R		
6"		DR56S	2	Pre-Installed Rubber			UD57R		
<b>10-12 2500 &amp; 3500 Ram Pickup 4WD</b>									
4"		DR174S	2	Pre-Installed Rubber			USB1R		

## REAR SOFTRIDE® LEAF SPRINGS

FRONT LIFT	NOTES	SINGLE SPRING	QTY.	BUSHING SETS TO FIT 2 SINGLE SPRINGS	QTY.	FITTED LEAFS FOR PAIR	U-BOLTS 1/2 TON, 1500	U-BOLTS 3/4 TON, 2500	U-BOLTS 1 TON, 3500
<b>03-09 2500 &amp; 3500 Ram Pickup 4WD</b>									
4"		DR374S	2	Pre-Installed Rubber				U5B1R	U5B1R
<b>94-01 2500 Heavy Duty &amp; 3500 Ram Pickup 4WD with 3" Wide Rear Springs</b>									
4"		DR74S	2	Pre-Installed Rubber		FLDR74		U5B7R	U5B7R
6"		DR76S	2	Pre-Installed Rubber		FLDR76		U5B7R	U5B7R
<b>72-93 W100, W150, W250 Pickup 4WD</b>									
4"	Q6	DR40S	2	Pre-Installed Rubber		FLDR40	UTBR	UTBR	
6"	Q6	DR60S	2	Pre-Installed Rubber		FLDR60	UTBR	UTBR	
KIT NOTES: Q6. Factory Block can be Removed to Reduce Lift 3.5" (Cummins Models will be 4-6" Less Lift). Some 2500 & 3500 Models have 2500" Spring Eye Bolts & REQUIRE Bushing Kit # SE17D.									
<b>72-93 Ramcharger, Trailduster 4WD</b>									
6"	Q6	DR40S	2	Pre-Installed Rubber		FLDR40	UTBR		
8"	Q6	DR60S	2	Pre-Installed Rubber		FLDR60	UTBR		
KIT NOTES: Q6. Factory Block can be Removed to Reduce Lift 3.5" (Cummins Models will be 4-6" Less Lift). Some 2500 & 3500 Models have 2500" Spring Eye Bolts & REQUIRE Bushing Kit # SE17D.									
<b>FORD</b>									
<b>09-14 F-150 4WD</b>									
4"		FR904S	2	Pre-Installed Rubber			UFF		
<b>04-08 F-150 4WD</b>									
4.5"		FR44S	2	Pre-Installed Rubber		FLFR44	U544R		
<b>97-03 F-150 4WD Includes SuperCrew</b>									
5"		FR15S	2	Pre-Installed Rubber			U5WR		
<b>73-96 F-100, F-150 4WD</b>									
2"	Q6, Q7	FR52S	2	Pre-Installed Rubber		FLFR52	U5WWR <sup>(Q6)</sup>	U5B2R <sup>(Q7)</sup>	
4"	Q6, Q7	FR54S	2	Pre-Installed Rubber		FLFR54	U5WWR <sup>(Q6)</sup>	U5B2R <sup>(Q7)</sup>	
6"	Q6, Q7	FR56S	2	Pre-Installed Rubber		FLFR56	U5WWR <sup>(Q6)</sup>	U5B2R <sup>(Q7)</sup>	
KIT NOTES: Q6. Only fits 80-96 Models. Q7. Only fits 73-79 Models.									
<b>80-96 F-100, F-150 2WD</b>									
2"		FR34S	2	Pre-Installed Rubber			U5WWR		
4"		FR36S	2	Pre-Installed Rubber			U5WR		
<b>78-96 Bronco 4WD</b>									
2"		FR51S	2	Pre-Installed Rubber		FLFR51	U5WWR		
4"		FR52S	2	Pre-Installed Rubber		FLFR52	U5WR		
6"		FR54S	2	Pre-Installed Rubber		FLFR54	U5WR		
8"		FR56S	2	Pre-Installed Rubber		FLFR56	U5WR		
<b>66-77 Bronco 4WD</b>									
4.5"		FR64S	2	Pre-Installed Rubber		FLFR64	U5WWR		
<b>00-04 Excursion 4WD</b>									
4"		FR94S	2	Pre-Installed Rubber			U7B10R		
6"		FR96S	2	Pre-Installed Rubber			U7B10R		
8"		FR98S	2	Pre-Installed Rubber			U7B10R		
<b>80-98 F-250 4WD, 2WD</b>									
1-2"	Q4, Q5	FR52S	2	Pre-Installed Rubber		FLFR52		U7B1R <sup>(Q4)</sup>	UC1BSR <sup>(Q5)</sup>
3-4"	Q4, Q5	FR54S	2	Pre-Installed Rubber		FLFR54		U7B1R <sup>(Q4)</sup>	UC1BSR <sup>(Q5)</sup>
5-6"	Q4, Q5	FR56S	2	Pre-Installed Rubber		FLFR56		U7B1R <sup>(Q4)</sup>	UC1BSR <sup>(Q5)</sup>
KIT NOTES: Q4. Fits 4WD only. Q5. Fits 2WD only.									
<b>77.5-79 F-250 Lowboy 4WD</b>									
1-2"		FR52S	2	Pre-Installed Rubber		FLFR52		U5B2R	
3-4"		FR54S	2	Pre-Installed Rubber		FLFR54		U5B2R	
5-6"		FR56S	2	Pre-Installed Rubber		FLFR56		U5B2R	

# REAR SOFTRIDE® LEAF SPRINGS

FRONT LIFT	NOTES	SINGLE SPRING	QTY.	BUSHING SETS TO FIT 2 SINGLE SPRINGS	QTY.	FITTED LEAFS FOR PAIR	U-BOLTS 1/2 TON, 1500	U-BOLTS 3/4 TON, 2500	U-BOLTS 1 TON, 3500
<b>FORD - CONTINUED</b>									
<b>17-20 F-250 / F-350 Super Duty 4WD</b>									
3"		FR173S	2	Pre-Installed Rubber				U9B10R	U9B10R
5"		FR175S	2	Pre-Installed Rubber				U9B10R	U9B10R
7"		FR177S	2	Pre-Installed Rubber				U9B10R	U9B10R
<b>08-16 F-250 Super Duty 4WD</b>									
4"		FR84S	2	Pre-Installed Rubber				U9B6R	
6"		FR86S	2	Pre-Installed Rubber				U9B6R	
8"		FR88S	2	Pre-Installed Rubber				U9B6R	
<b>99-07 F-250 / F-350 Super Duty 4WD</b>									
4"		FR94S	2	Pre-Installed Rubber				U9B6R	U9B6R
6"		FR96S	2	Pre-Installed Rubber				U9B6R	U9B6R
8"		FR98S	2	Pre-Installed Rubber				U9B6R	U9B6R
<b>66-77 F-250 Highboy 4WD</b>									
4"		FR74S	2	Pre-Installed Rubber		FLFR74		UC168AR	
<b>80-98 F-350 4WD</b>									
1"		FR52S	2	Pre-Installed Rubber		FLFR52		U7B1R <sup>(Q8)</sup>	U7B2R <sup>(Q9)</sup>
3"		FR54S	2	Pre-Installed Rubber		FLFR54		U7B1R <sup>(Q8)</sup>	U7B2R <sup>(Q9)</sup>
5"		FR56S	2	Pre-Installed Rubber		FLFR56		U7B1R <sup>(Q8)</sup>	U7B2R <sup>(Q9)</sup>
KIT NOTES: Q8. Only fits 80-85 Models. Q9. Only fits 86-98 Models.									
<b>83-97 Ranger 4WD, 2WD</b>									
4"		FR34S	2	Pre-Installed Rubber		FLFR34	U3WR		
6"		FR36S	2	Pre-Installed Rubber		FLFR36	U3BR		
KIT NOTES: Q3. Factory Block can be Removed to Reduce Lift 2-3" Depending on Factory Block Size.									
<b>83-90 Bronco II 4WD, 2WD</b>									
4"		FR34S	2	Pre-Installed Rubber		FLFR34	U3WR		
6"		FR36S	2	Pre-Installed Rubber		FLFR36	U3WR		
<b>JEEP</b>									
<b>87-96 Wrangler YJ</b>									
2-2.5"		YJ20RS	2	SE4YJ	1	FLYJ20R	UJ4R		
3.5"-4"		YJ40RS	2	SE4YJ	1	FLYJ40R	UJ4R		
<b>87-96 Wrangler YJ Rock Ready® Double Military Wrap</b>									
2.5"		YJ25RS	2	SE45YJ	1		UJ4R		
4"		YJ45RS	2	SE45YJ	1		UJ4R		
<b>76-86 CJ &amp; Scrambler</b>									
2-2.5"		J20RS	2	SE45J	1	FLJ20R	UJ4R		
3.5"-4"		J40RS	2	SE45J	1	FLJ40R	UJ4R		
<b>55-75 CJ</b>									
2-2.5"		J32RS	2	SE34J	1	FLJ32R	UJ3R		
3.5"-4"		J34RS	2	SE34J	1	FLJ34R	UJ3R		
<b>84-01 Cherokee XJ 4WD, 2WD</b>									
2.5"		JC25RS	2	Pre-Installed Rubber		FLJC25R	UJ3R		
5.5"	Q5	JC55RS	2	Pre-Installed Rubber			UJ3R		
7.5"	Q5	JC75RS	2	Pre-Installed Rubber			UJ3R		
KIT NOTES: Q5. Skyjacker® Shackles # SH130 are REQUIRED.									
<b>84-91 Grand Wagoneer 4WD Full-Size</b>									
3-4"		JP40RS	2	Pre-Installed Rubber		FLJP40R	U5B2R		
<b>76-83 Cherokee, Wagoneer 4WD Full-Size</b>									
4"		JP40RS	2	Pre-Installed Rubber		FLJP40R	U5B2R		
<b>74-88 J10, J20 Pickup 4WD Full-Size</b>									
4"	Q8	JP40RS	2	Pre-Installed Rubber		FLJP40R	U5B2R		
KIT NOTES: Q8. 74-75 Models MUST have 131" Wheel Base & 7,200 lb. GVWR or More for Rear Springs to Fit.									



## REAR SOFTRIDE® LEAF SPRINGS

FRONT LIFT	NOTES	SINGLE SPRING	QTY.	BUSHING SETS TO FIT 2 SINGLE SPRINGS	QTY.	FITTED LEAFS FOR PAIR	U-BOLTS 1/2 TON, 1500
<b>TOYOTA</b>							
<b>07-20 Tundra 4WD</b>							
4-4.5"		TUR47S	2	Pre-Installed Rubber			TU761PRS
<b>05-20 Tacoma 4WD</b>							
1.5"-2"		TCR515S	2	Pre-Installed Rubber			UTWR
<b>98-04 Tacoma 4WD, 2WD</b>							
2.5"		TCR25S	2	Pre-Installed Rubber			UTWR
<b>95-97 Tacoma 4WD, 2WD</b>							
3.5"		TR39S	2	SE39T	1	FLTR49	T431RS
<b>89-95 Pickup 4WD</b>							
4"		TR49S	2	SE39T	1	FLTR49	T431RS
<b>79-88 Pickup 4WD</b>							
2"		TR20S	2	SE35T	1	FLTR20	UDWR
4"		TR40S	2	SE35T	1	FLTR40	UDWR
6"		TR60S	2	SE35T	1	FLTR60	UDWR
<b>85-89 4Runner 4WD</b>							
0-1"		TR20S	2	SE35T	1	FLTR20	UTF
<b>85-89 4Runner 4WD</b>							
2-3"		TR40S	2	SE35T	1	FLTR40	UTF
4-5"		TR60S	2	SE35T	1	FLTR60	UTF
<b>64-80 FJ40 LandCruiser 4WD</b>							
2.5"		L20RS	2	SE40L	1	FLL20R	U5WWR
3.5"		L40RS	2	SE40L	1	FLL40R	U5WWR
<b>INTERNATIONAL</b>							
<b>72-82 Scout II, Terra, Traveler 4WD</b>							
2"		S20RS	2	SE40S	1	FLS20R	UJ3R
4"		S40RS	2	SE40S	1	FLS40R	UJ3R
<b>JEEP SOFTRIDE® SERIES</b>							
<b>87-96 Wrangler YJ</b>							
2-2.5"		YJ20RSB	2	SE4YJ	1	FLYJ20R	UJ4R
3.5"-4"		YJ40RSB	2	SE4YJ	1	FLYJ40R	UJ4R
<b>76-86 CJ &amp; Scrambler</b>							
2-2.5"		J20RSB	2	SE45J	1	FLJ20R	UJ4R
3.5"-4"		J40RSB	2	SE45J	1	FLJ40R	UJ4R
<b>84-01 Cherokee XJ 4WD, 2WD</b>							
2.5"		JC25RSB	2	Pre-Installed Rubber		FLJC25R	UJ3R
5.5"	Q5	JC55RSB	2	Pre-Installed Rubber			UJ3R

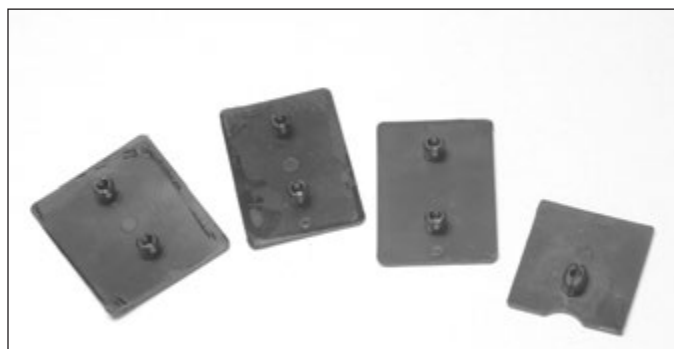

LEAF SPRING ACCESSORIES		
REPLACEMENT TEFLON® WEAR PADS - EACH		
Fits LEAF SPRING MODELS with 2", 2.5 or 3" Wide Leaf Springs.		
Spring Width	Button Style	Part #
2"	Single	IN200C
2.5"	Single	IN212C
2.5"	Double	IN212D
2.5"	Off-Center	IN212
3"	Double	IN300D

# STEERING COMPONENTS

PITMAN ARMS, STEERING ARMS & DRAG LINKS						
LIFT HEIGHT	NOTES	PITMAN ARM		STEERING		OFFSET & ADJUSTABLE DRAGLINK
		DROP	EXTREME DROP	ARM	BLOCK	
<b>CHEVROLET / GMC</b>						
<b>77-91 K10, K20 &amp; K30 Pickup 4WD</b>						
<b>67-91 K30 Pickup 4WD - For Open Knuckles Only</b>						
2.5-4"		CA50			SB60	
6"						GMDL4
<b>67-87 K10, K20 Pickup 4WD - Must Have 3-Bolt Steering Knuckle</b>						
2.5"		CA50				
4-6"				CA100		GMDL4
8"				CA150		
<b>67-91 K5 Blazer, Jimmy, K10, K20 Pickup &amp; Suburban - Must Have 3-Bolt Steering Knuckle</b>						
2.5"		CA50				
4-6"				CA100		GMDL4
8"				CA150		
<b>DODGE</b>						
<b>61-20 1500, 2500 &amp; 3500 Ram Pickup 4WD</b>						
<b>14-20 2500 / 13-20 3500 Ram Pickup 4WD</b>						
4-6"		RA100				
<b>09-12 2500 / 3500 Ram Pickup 4WD</b>						
4-5"		DA309				
<b>03-08 2500 / 3500 Ram Pickup 4WD</b>						
4-5"		DA303				
<b>00-02 2500 &amp; 3500 Ram Pickup 4WD</b>						
3-5"		DA302				
5-8"			DA602			
<b>00-01 1500 Ton Ram Pickup 4WD</b>						
3-5"		DA302				
5-8"			DA602			
<b>94-99 1500, 2500 &amp; 3500 Ram Pickup 4WD</b>						
3-6"		DA300				
6-8"			DA600			
<b>87-93 W250, W350 Pickup 4WD with Cummins Diesel &amp; Power Steering</b>						
4"		DA20			SB60	DL10
6"		DA45			SB60	DL10
<b>78-93 W100, W150 Pickup 4WD Except Cummins Diesel &amp; Power Steering Models</b>						
2"	V10	DA20			SB60	DL10
4"	V10	DA40			SB60	DL10
KIT NOTES: V10. Steering Block for 3500 4x4 Dana 60 Applications Only.						
<b>78-93 W100, W150 Pickup 4WD Must have 3-Bolt Steering Knuckle</b>						
6"	25			DA60	SB60	DL10
KIT NOTES: V10. Steering Block for 3500 4x4 Dana 60 Applications Only.						
<b>72-93 Full Size 4WD To Replace Factory Non-Adjustable Drag Link</b>						
ALL						DL10
<b>72-77 Full Size 4WD Must have 3-Bolt Steering Knuckle &amp; Must Use Adjustable Drag Link # DL10</b>						
8"				DA65		DL10
<b>61-77 Full Size 4WD Must have 3-Bolt Steering Knuckle</b>						
4-6"				DA60		DL10
<b>61-93 Full Size 4WD Dana 60 Axles Open Knuckles Only</b>						
2.5"					SB60	DL10

# STEERING COMPONENTS

PITMAN ARMS, STEERING ARMS & DRAG LINKS						
LIFT HEIGHT	NOTES	PITMAN ARM		STEERING		OFFSET & ADJUSTABLE DRAGLINK
		DROP	EXTREME DROP	ARM	BLOCK	
<b>FORD</b>						
<b>66-20 ALL FORD MODELS</b>						
<b>17-20 F-250, F-350 Super-Duty 4WD</b>						
6-8.5"	V11	FA450				
KIT NOTES: V11. FA450 Pitman arm not to be used on less than 6" of lift for 17-18 Models.						
<b>05-16 F-250, F-350 Super-Duty 4WD</b>						
4-8.5"		FA450				
<b>99-04 F-250, F-350 Super-Duty, 00-05 Excursion 4WD (After March '99)</b>						
4-6"		FA499				
8"			FA699			
<b>99 F-250, F-350 Super-Duty 4WD (Before March '99)</b>						
4-6"		FA400				
8"			FA600			
<b>83-97 Ranger, Bronco II &amp; Explorer 4WD, 2WD with Power Steering</b>						
4-6"		FA400				
6-8"			FA600			
<b>80-96 F-150 &amp; Bronco, 80-98 F-250, F-350 4WD, 2WD with Power Steering</b>						
4-6"		FA400				
6-8"			FA600			
<b>78-79 Bronco 4WD with Power Steering</b>						
4-6"		FA300				
6-9"			FA500			
<b>77.5-79 F-250 4WD with Power Steering (For 5-6" Lifts Combine with # SDL250 Drag Link)</b>						
2-3"		FA325				
<b>77.5-79 F-250, F-350 4WD (For 5-6" Lifts Combine with # FA325 Pitman Arm)</b>						
3-4"						SDL250
<b>76-79 F-100, F-150 4WD with Power Steering</b>						
4-6"	V6	FA300				
6-9"	V6		FA500			
KIT NOTES: V6. Pitman Arm ONLY Fits 76-79 Models with Power Steering. 76-77 Models MUST Change Drag Link & Tie Rod Assembly to "T" Style. Order # FDL70 & # TRA70.						
<b>66-77 Bronco 4WD with Power or Manual Steering</b>						
4-5"	V7	FA307				
KIT NOTES: V7. Pitman Arm Fits Manual & Power Steering. 76-77 Models MUST Change Drag Link & Tie Rod Assembly to "T" Style. Order # FDL67 & # TRA60.						
<b>JEEP</b>						
<b>07-18 Jeep JK 2 &amp; 4 Door 4WD</b>						
<b>07-18 Jeep JK 2 &amp; 4 Door with Power Steering</b>						
4-7"		JA770				
<b>Heavy Duty 1 3/4" O. D. Drag Link</b>						
ALL		JK717DL				
<b>Heavy Duty 1 3/4" O. D. Tie Rod</b>						
ALL		JK717TR				
<b>72-06 JEEP TJ, YJ, CJ</b>						
<b>97-06 Wrangler TJ with Power Steering</b>						
4-6"	V10	JA750				
8-10"	V10	JA500				
KIT NOTES: V10. Designed for Skyjacker Lifts Only.						
<b>97-06 Wrangler TJ Right Hand Steer with Power Steering</b>						
4-6"		JA250				
<b>97-06 Wrangler TJ with Manual Steering</b>						
4-6"		JA850				

# STEERING COMPONENTS

PITMAN ARMS, STEERING ARMS & DRAG LINKS						
LIFT HEIGHT	NOTES	PITMAN ARM		STEERING		OFFSET & ADJUSTABLE DRAGLINK
		DROP	EXTREME DROP	ARM	BLOCK	
<b>87-96 Wrangler YJ with Power Steering</b>						
3.5-4"		JA750				
<b>87-96 Wrangler YJ with Manual Steering</b>						
3.5-4"		JA850				
<b>76-86 CJ &amp; Scrambler with Power Steering</b>						
3.5-4"		JA250				
<b>76-86 CJ &amp; Scrambler with Manual Steering</b>						
3.5-4"		JA150				
<b>72-75 CJ &amp; Scrambler with Power Steering</b>						
2"		JA552				
<b>72-75 JEEP CJ</b>						
<b>72-75 CJ with Manual Steering</b>						
2"		JA652				
<b>72-75 CJ with Manual Steering</b>						
3-4"		JA650				
<b>74-01 JEEP SUV</b>						
<b>84-01 Cherokee XJ, 4WD, 2WD 5.25" Drop Below Factory Arm</b>						
4-8"			JA500			
<b>93-98 Grand Cherokee ZJ, 4WD, 2WD 5.25" Drop Below Factory Arm</b>						
4-8"			JA500			
<b>84-91 Grand Wagoneer Full-Size 4WD with Power Steering</b>						
3.5-4"		JA350				
<b>74-83 Cherokee, Wagoneer Full-Size 4WD with Power Steering</b>						
3.5-4"		JA350				
<b>74-88 J10, J20 Pickup 4WD with Power Steering</b>						
3.5-4"		JA350				
<b>TOYOTA</b>						
<b>79-85 Pickup, 4Runner 4WD</b>						
<b>79-85 Pickup, 4Runner 4WD</b>						
4-7"	V8					TDL5
KIT NOTE: V8. 7" Lifts REQUIRE the Following: # TDL5 Adjustable Drag Link, # FBL30 & # RBL30 Longer Stainless Steel Brake Lines, Lengthening of Front Driveshaft & Modifying Factory Steering Arm so that Ball is Pointing Out the Top of Arm (Rather than Pointing Down).						
<b>INTERNATIONAL</b>						
<b>72-81 Scout II 4WD</b>						
<b>72-81 Scout II 4WD with Power Steering</b>						
2-4"	SA40					

## 07-18 Jeep JK

### JK717DL

Heavy Duty 1 3/4" O. D. Drag Link

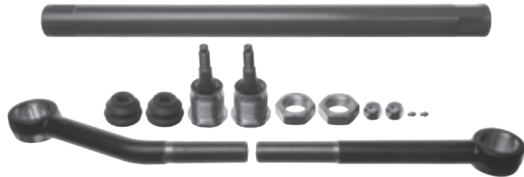

### JK717TR

Heavy Duty 1 3/4" O. D. Tie Rod

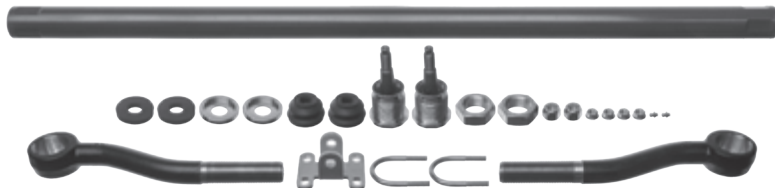

# REAR BLOCKS & U-BOLT KITS

REAR BLOCKS & U-BOLT KITS					
Make/ Model	REAR LIFT HEIGHT				
	1 1/4"	2"	3.5"	4.5"	5.5"
<b>CHEVROLET / GMC</b>					
<b>1500 &amp; 2500 6 Lug Pickup 2WD</b>					
99-06	BUK12562	-----	-----	-----	-----
<b>1500 &amp; 2500 6 Lug Pickup 4WD</b>					
07-20	BUK12563	BUK2063	-----	-----	BUK5795
99-06	BUK12563	BUK2063	BUK3564	BUK4565	-----
88-98	BUK12563	BUK2061	BUK3564	BUK4564	BUK5565
69-72	-----	BUK2081	BUK3581	BUK4582	BUK5584
73-87	-----	BUK2087	BUK3588	BUK4589	BUK5589
<b>2500 8 Lug Pickup 4WD - 00-04 Fits 2500HD</b>					
11-20	-----	BUK2789	-----	-----	-----
00-10	BUK12581	BUK2082	BUK3584	BUK4584	-----
88-98	-----	BUK2061	-----	BUK4564	-----
73-87	-----	-----	-----	-----	BUK5592
<b>3500 Pickup 4WD Except Crew Cab &amp; Dually</b>					
88-98	-----	BUK2082	BUK3584	BUK4584	-----
73-87	-----	BUK2082	BUK3584	BUK4584	-----
<b>3500 Crew Cab Pickup 4WD - Except Dually</b>					
92-98	-----	BUK2082	BUK3584	-----	-----
73-91	-----	BUK2082	BUK3584	-----	-----
<b>Blazer, Jimmy, Tahoe, Yukon 4WD</b>					
92-99	BUK12563	BUK2061	-----	BUK4564	-----
73-91	-----	-----	BUK3588	BUK4589	BUK5589
69-72	-----	BUK2080	-----	-----	-----
<b>Suburban 1500 &amp; 2500 6 Lug 4WD</b>					
92-99	BUK12563	BUK2061	-----	BUK4564	-----
73-91	-----	-----	BUK3588	BUK4589	BUK5589
<b>Suburban 2500 8 Lug 4WD</b>					
92-99	BUK12563	BUK2063	-----	BUK4564	-----
73-87	-----	BUK2091	BUK3592	BUK4592	BUK5592
<b>DODGE</b>					
<b>2500 Pickup</b>					
94-02	-----	BUK2713	-----	-----	-----
<b>1500 Pickup, Ramcharger / Trailduster</b>					
69-01	-----	BUK2064	BUK3565	BUK4564	-----
<b>2500 Pickup 4WD</b>					
69-93	-----	BUK2064	BUK3565	BUK4564	-----



<b>FORD</b>					
<b>F-100, F-150 2WD / 4WD</b>					
04-20	-----	BUK2074DF	-----	-----	-----
<b>F-100, F-150 4WD</b>					
97-03	-----	BUK2072	BUK3573	BUK4573	BUK5574
80-96	-----	BUK2072	BUK3572	BUK4573	BUK5574
66-79	-----	-----	BUK3572	BUK4574	BUK5574
<b>F-100, F-150 2WD</b>					
80-96	-----	BUK2071	BUK3572	BUK4573	BUK5573
<b>Bronco</b>					
80-96	-----	BUK2071	BUK3572	BUK4573	BUK5573
78-79	-----	BUK2071	BUK3572	BUK4573	BUK5573
66-77	-----	BUK2071	BUK3572	BUK4573	BUK5573
<b>F-250 4WD / F350</b>					
11-20	-----	BUK2055	BUK3559	BUK4559	BUK5559
<b>F-250 4WD with Factory 2" Block / 00-05 Excursion</b>					
99-10	-----	BUK2095	BUK3596	BUK4597	BUK5598
00-05	-----	BUK2095	BUK3596	BUK4597	BUK5598
<b>F-250 4WD</b>					
80-98	-----	BUK2091	BUK3592	BUK4593	BUK5593
<b>F-250 2WD</b>					
80-98	-----	BUK2090	BUK3591	BUK4592	BUK5593
<b>F-350 4WD with Factory 2" Block (No Overload)</b>					
99-10	-----	BUK2095	BUK3596	BUK4597	BUK5598
<b>F-350 4WD Except Dually</b>					
83-97	-----	BUK2091	BUK3592	BUK4593	BUK5593
<b>Ranger 4WD</b>					
83-97	-----	BUK2024	BUK3526	BUK4526	BUK5526
<b>Ranger 2WD</b>					
83-97	-----	BUK2033	BUK3524	BUK4526	BUK5526
<b>Bronco II</b>					
84-90	-----	BUK2023	BUK3524	BUK4526	BUK5526
<b>JEEP</b>					
<b>J-10, J20 Pickup, Cherokee / Wagoneer Full-Size 4WD</b>					
74-90	-----	BUK2071	BUK3572	BUK4573	BUK5573
<b>TOYOTA</b>					
<b>Tundra 2WD / 4WD</b>					
07-20	BUK12592	-----	-----	-----	-----
<b>Pickup 4WD with 2.5" Wide U-Bolt - Except 89-96 Short Bed Standard Cab</b>					
79-96	-----	BUK2068	BUK3563	-----	-----
<b>Short Bed Standard Cab Pickup 4WD with 3.25" Wide U-Bolt</b>					
89-96	-----	-----	-----	-----	-----
<b>4Runner 4WD</b>					
79-86	-----	BUK2068	BUK3563	-----	-----
<b>LIFT BLOCKS, REAR - PAIR</b>					
Blocks are High Quality Ductile Iron (NOT Gray Iron), Tapered & are 1-Piece Construction with Axle Pins Built-In.					
NOTE: Blocks are Designed for Rear Springs on Top of Rear Axle Applications ONLY.					
Description	LIFT	Part #			
Center Pinned, Flat Block	1.25"	RBF2125			
Center Pinned, 3 Degree	2"	RB220			
Center Pinned, Flat Block	2"	RBF220			
Off-Center Pinned, 5 Degree	3.5"	RB235			
Off-Center Pinned, Flat Block	4.25"	RBF2425			
Off-Center Pinned, 5 Degree	4.5"	RB245			
Center Pinned, Flat Block	5"	RBF250			
Off-Center Pinned, 5 Degree	5.5"	RB255			

# U-BOLTS - SINGLE

U-BOLTS EACH Includes Nylon Insert Lock Nuts				
NUT SIZE	I.D. WIDTH	I.D. LENGTH	U-BOLT SHAPE	PART NUMBER
<b>5/16 THREAD SIZE</b>				
5/16	1	1-3/4	ROUND	516X1X134
5/16	1-1/4	1-3/4	ROUND	516X114X134
5/16	1-1/2	2	ROUND	516X112X2
5/16	1-1/2	2-1/4	ROUND	516X112X214
5/16	1-3/4	2-5/8	ROUND	516X134X258
<b>3/8 THREAD SIZE</b>				
3/8	1-7/16	2-3/4	ROUND	38X1716X234
3/8	2-3/4	3	ROUND	38X234X3
3/8	2-3/4	3-1/2	ROUND	38X234X312
3/8	3-1/8	3-1/2	ROUND	38X318X312
3/8	3-3/4	4-1/2	ROUND	38X334X412
<b>1/2 THREAD SIZE</b>				
1/2	2-1/2	4-1/4	ROUND	12X212X414
1/2	2-1/2	5-1/4	ROUND	12X212X514
1/2	2-1/2	6-1/4	ROUND	12X212X614
1/2	2-3/4	6	ROUND	12X234X6
1/2	2-3/4	8-1/2	ROUND	12X234X812
1/2	2-3/4	9-1/2	ROUND	12X234X912
1/2	2-3/4	10-1/2	ROUND	12X234X1012
1/2	3	10-1/2	ROUND	12X3X1012
1/2	3-1/8	6-1/2	ROUND	12X318X612
1/2	3-1/8	8-1/2	ROUND	12X318X812
1/2	3-3/4	9-1/2	ROUND	12X334X912
<b>9/16 THREAD SIZE</b>				
9/16	2-1/4	8-1/2	SQUARE	916X214X812
9/16	2-1/2	7	SQUARE	916X212X7
9/16	2-1/2	8-3/4	SQUARE	916X212X834
9/16	2-1/2	10-1/2	SQUARE	916X212X1012
9/16	2-1/2	12	SQUARE	916X212X12
9/16	2-1/2	13-1/2	SQUARE	916X212X1312
9/16	2-1/2	15-1/2	SQUARE	916X212X1512
9/16	2-1/2	17	SQUARE	916X212X17
9/16	3	7-1/2	ROUND	916X3X712
9/16	3-1/8	8-1/2	SQUARE	916X318X812
9/16	3-1/8	9-1/2	SQUARE	916X318X912
9/16	3-1/8	9-1/2	SEMI-Round	916X318X912FS
9/16	3-1/8	10-1/2	SEMI-Round	916X318X1012FS
9/16	3-1/8	13-1/2	SQUARE	916X318X1312
9/16	3-1/4	7-1/2	ROUND	916X314X712
9/16	3-1/4	9-1/2	ROUND	916X314X912
9/16	3-1/4	11-1/2	ROUND	916X314X1112
9/16	3-1/4	13-1/2	ROUND	916X314X1312
9/16	3-1/4	15-1/2	ROUND	916X314X1512
9/16	3-3/4	8-1/4	ROUND	916X334X814
9/16	4	9-1/2	ROUND	916X4X912
9/16	3-5/8	8	ROUND	916X358X8
9/16	3-5/8	12-1/2	ROUND	916X358X1212
9/16	4	13	ROUND	9/16X4X13
9/16	4	15	ROUND	9/16X4X15
<b>5/8 THREAD SIZE</b>				
5/8	2-3/4	9	SQUARE	58X234X9
5/8	2-3/4	10-1/2	SQUARE	58X234X1012
5/8	2-3/4	12-1/2	SQUARE	58X234X1212
5/8	2-5/8	14-1/2	SQUARE	58X258X1412
5/8	3	17-1/2	SQUARE	58X3X1712
5/8	3-1/8	7-1/2	ROUND	58X318X712
5/8	3-1/8	9-1/2	ROUND	58X318X912
5/8	3-1/8	11	ROUND	58X318X11
5/8	3-1/8	12-1/2	ROUND	58X318X1212
5/8	3-1/8	13-1/2	SQUARE	58X318X1312

5/8	3-1/8	16-1/2	SQUARE	58X318X1612
5/8	3-1/4	16	SEMI-Round	58X325X16SP
5/8	3-1/4	18	SEMI-Round	58X325X18SP
5/8	3-1/4	20	SEMI-Round	58X325X20SP
5/8	3-3/8	9-1/2	ROUND	58X338X912
5/8	3-3/8	13	ROUND	58X338X13
5/8	3-3/8	14-1/2	ROUND	58X338X1412
5/8	3-3/8	16-1/2	ROUND	58X338X1612
5/8	3-3/8	19	ROUND	58X338X19
5/8	3-1/2	12	ROUND	58x312x12
5/8	3-1/2	14	ROUND	58x312x14
5/8	3-1/2	16	ROUND	58x312x16
5/8	3-1/2	18	ROUND	58x312x18
5/8	3-5/8	9-1/4	ROUND	58X358X914
5/8	4	10	ROUND	58X4X10
5/8	4	12	ROUND	58X4X12
5/8	4	16	ROUND	58X4X16
5/8	4	18	ROUND	58X4X18

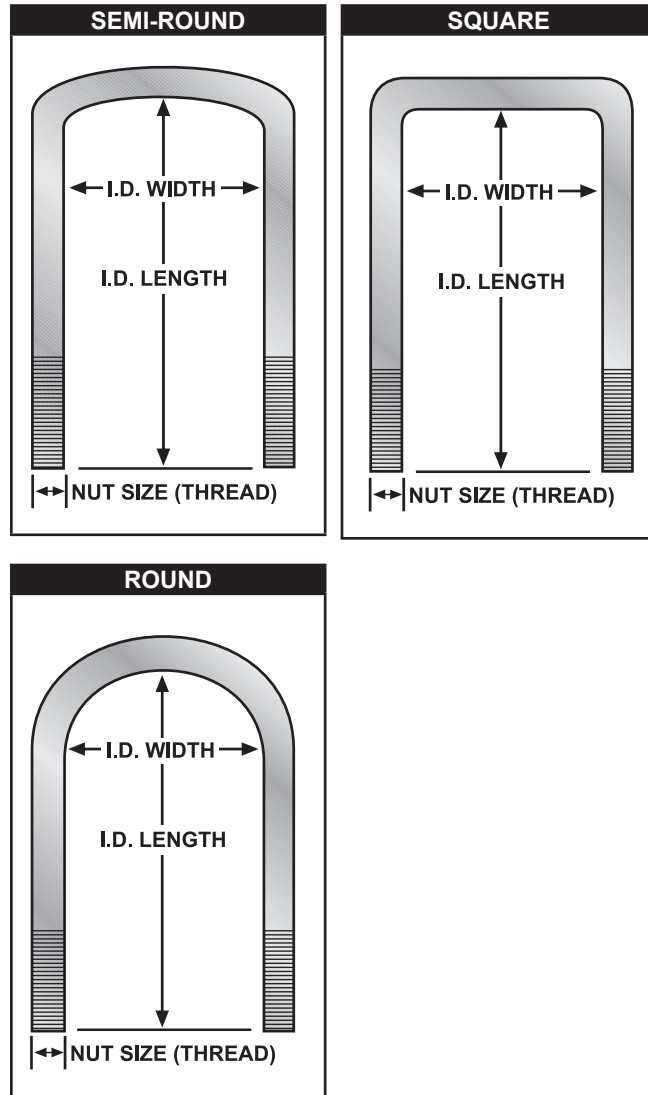

**Part # Consists of:**  
**1 U-Bolt AND**  
**2 Nylon Insert Lock Nuts**

# NOTES

U-BOLT KIT BREAKDOWN ALL U-BOLT KITS INCLUDE NUTS						
KIT		SINGLE	NUT	I.D.	I.D.	U-BOLT
Part #	QTY.	U-BOLT #	SIZE	WIDTH	LENGTH	SHAPE
UCABF	3	58X318X712	5/8	3-1/8	7-1/2	Round
	1	58X358X914	5/8	3-5/8	9-1/4	Round
UCCF	2	58X318X912	5/8	3-1/8	9-1/2	Round
	1	58X4X10	5/8	4	10	Round
	2	58X314CTB	5/8	Stud	3-1/4	Bolt
UC1ASR	4	58X318X912	5/8	3-1/8	9-1/2	Round
UC1BSR	4	58X338X912	5/8	3-3/8	9-1/2	Round
UC1CSR	4	58X234X1012	5/8	2-3/4	10-1/2	Square
UC125BR	4	58X338X11	5/8	3-3/8	11	Round
UC140AR	4	58X318X11	5/8	3-1/8	11	Round
UC140BR	4	58X338X13	5/8	3-3/8	13	Round
UC140CR	4	58X234X1212	5/8	2-3/4	12-1/2	Square
UC168AR	4	58X318X1212	5/8	3-1/8	12-1/2	Round
UC168BR	4	58X338X1412	5/8	3-3/8	14-1/2	Round
UC168CR	4	58X258X1412	5/8	2-5/8	14-1/2	Square
UDBF	2	916X3X712	9/16	3	7-1/2	Round
	1	916X334X814	9/16	3-3/4	8-1/4	Round
	2	916X3CTB	9/16	Stud	3	Bolt
UDCF	2	916X314X712	9/16	3-1/4	7-1/2	Round
	1	916X4X912	9/16	4	9-1/2	Round
	2	916X3CTB	9/16	Stud	3	Bolt
UDWR	4	916X212X7	9/16	2-1/2	7	Square
UDBR	4	916X212X1012	9/16	2-1/2	10-1/2	Square
UDB2R	4	916X212X1312	9/16	2-1/2	13-1/2	Square
UDBBR	4	916X212X1512	9/16	2-1/2	15-1/2	Square
UDB3R	4	916X212X17	9/16	2-1/2	17	Square
UDB6R	4	58X318X1612	5/8	3-1/8	16-1/2	Square
U3WR	4	12X234X812	1/2	2-3/4	8-1/2	Round
U3B2R	4	12X234X1012	1/2	2-3/4	10-1/2	Round
U3B4R	4	12X338X712	1/2	3-3/8	7-1/2	Round
U4WR	4	12X3X1012	1/2	3	10-1/2	Round
U5WWR	4	916X314X712	9/16	3-1/4	7-1/2	Round
U5WR	4	916X314X912	9/16	3-1/4	9-1/2	Round
U5B2R	4	916X314X1112	9/16	3-1/4	11-1/2	Round
U5B3R	4	916X314X1312	9/16	3-1/4	13-1/2	Round
U5B5R	4	916X314X1512	9/16	3-1/4	15-1/2	Round
U5B7R	4	916X318X1312	9/16	3-1/4	13-1/2	Square
U5B8R	4	916X4X15	9/16	4	15	Round
UFF	4	916X318X912	9/16	3-1/8	9-1/2	Square
U9FF	4	916X318X912	9/16	3-1/8	9-1/2	Semi-Round
U7B1R	4	58X338X11	5/8	3-3/8	11	Round
U7B2R	4	58X338X13	5/8	3-3/8	13	Round
U7B3R	4	58X338X1412	5/8	3-3/8	14-1/2	Round
U7B4R	4	58X338X1612	5/8	3-3/8	16-1/2	Round
U9B5R	4	58X3X1712	5/8	3	17-1/2	Square
U9B6R	4	58X312X12	5/8	3-1/2	12	Round

U9B7R	4	58X312X14	5/8	3-1/2	14	Round
U9B8R	4	58X312X16	5/8	3-1/2	16	Round
U9B9R	4	58X312X18	5/8	3-1/2	18	Round
U16FUR	4	58X325X16	5/8	3-1/4	16	Semi-Round
U18FUR	4	58X325X18	5/8	3-1/4	18	Semi-Round
U20FUR	4	58X325X20	5/8	3-1/4	20	Semi-Round
UJPF	2	916X3X712	9/16	3	7-1/2	Round
	2	916X334X814	9/16	3-3/4	8-1/4	Round
UJ3R	4	12X234X6	1/2	2-3/4	6	Round
UJ4R	4	12X212X614	1/2	2-1/2	6-1/4	Round
UTF	4	916X214X812	9/16	2-1/4	8-1/2	Square
UTWR	4	916X212X7	9/16	2-1/2	7	Square
UTBR	4	916X212X1012	9/16	2-1/2	10-1/2	Square

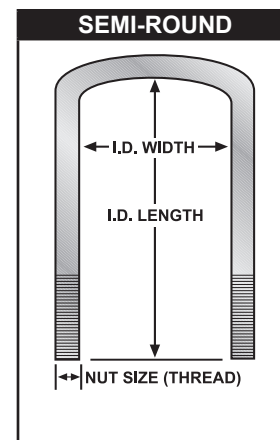
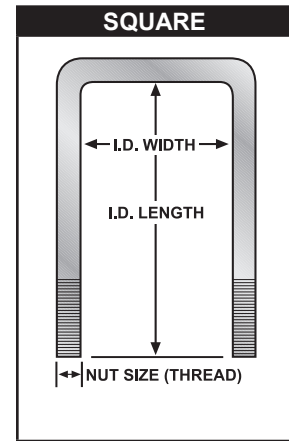
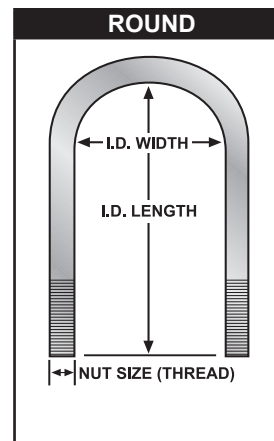





# SKYJACKER® WHEEL & TIRE SPECIFICATIONS

Vehicle		Lift	Maximum Tire			Wheel	
Year	Model		Height	Width	Diameter	Width	Back Space
86-91	F-350 4WD Mono Beam	2"	36"	12.5"	16.5-20"	9.75"	4.625"
		4"	38"	12.5"	16.5-20"	9.75"	4.625"
		6"	40"	12.5"	16.5-20"	9.75"	4.625"
92-98	F-250 4WD Twin I Beam	2"	33"	12.5"	16.5-20"	9.75"	4.625"
		4"	35"	12.5"	16.5-20"	9.75"	4.625"
		6"	37"	12.5"	16.5-20"	9.75"	4.625"
80-91	F-250, F-350 4WD Twin I Beam	2"	33"	12.5"	16.5-20"	9.75"	4.625"
		4"	35"	12.5"	16.5-20"	9.75"	4.625"
		6"	37"	12.5"	16.5-20"	9.75"	4.625"
92-96	F-250, F-350 2WD	2"	32"	12.5"	16-20"	8"	3.75"
		4"	34"	12.5"	16-20"	8"	3.75"
		6"	36"	12.5"	16-20"	8"	3.75"
78-79	F-250 Low Boy 4WD	2"	35"	12.5"	16.5-20"	9.75"	3.75"
		4"	37"	12.5"	16.5-20"	9.75"	3.75"
		6"	40"	12.5"	16.5-20"	9.75"	3.75"
66-77	F-250 High Boy 4WD	2"	38"	12.5"	16.5-20"	9.75"	3.75"
		4"	40"	12.5"	16.5-20"	9.75"	3.75"
<b>FORD Ranger, Bronco II, Explorer, Navajo</b>							
93-97	Ranger 4WD	2"	32"	12.5"	15-20"	8"	4"
		4"	33"	12.5"	15-20"	8"	4"
		6"	34"	12.5"	15-20"	8"	4"
		8"	36"	12.5"	15-20"	8"	4"
90-94	Explorer, Navajo 4WD	2"	31"	12.5"	15-20"	8"	4"
83-92	Ranger, Bronco II 4WD	2"	28"	12.5"	15-20"	8"	4"
		4"	30"	12.5"	15-20"	8"	4"
		6"	32"	12.5"	15-20"	8"	4"
<b>HONDA</b>							
06-12	Ridgeline 4WD <sup>2</sup>	2"	30"	10.5"	17-20"	8"	5"
<b>INTERNATIONAL</b>							
72-82	Scout II 4WD	2"	31"	12.5"	15-20"	8"	3.75"
72-82	Scout II 4WD	4"	33"	12.5"	15-20"	8"	3.75"
<b>ISUZU</b>							
05-08	Isuzu i-Series	4"	33"	11.5"	17-20"	8"	4.75"
<b>JEEP</b>							
2020	Gladiator JT Pickup						
S.A.(1)	NON-Rubicon	2.5"	35"	12.5"	17-20"	9"	4.5"
S.A.(1)	NON-Rubicon	3.5"	37"	12.5"	17-20"	9"	4.5"
S.A.(1)	NON-Rubicon	4.5"	38"	13.5"	17-20"	9"	4.5"
OFA(2)	NON-Rubicon	2.5"	33"	12.5"	17-20"	9"	4.5"
OFA(2)	NON-Rubicon	3.5"	35"	12.5"	17-20"	9"	4.5"
OFA(2)	NON-Rubicon	4.5"	37"	12.5"	17-20"	9"	4.5"
S.A.(1)	Rubicon	2.5"	37"	12.5"	17-20"	9"	4.5"
S.A.(1)	Rubicon	3.5"	38"	13.5"	17-20"	9"	4.5"
S.A.(1)	Rubicon	4.5"	38-40"	12.5"	17-20"	9"	4.5"
OFA(2)	Rubicon	2.5"	35"	12.5"	17-20"	9"	4.5"
OFA(2)	Rubicon	3.5"	37"	12.5"	17-20"	9"	4.5"
OFA(2)	Rubicon	4.5"	38"	13.5"	17-20"	9"	4.5"
S.A.(1)	Street Articulation & Light Off-Road Use.	OFA(2)	<b>Off-Road Full Articulation.</b>				

Vehicle		Lift	Maximum Tire			Wheel	
Year	Model		Height	Width	Diameter	Width	Back Space
18-20	JL 2 Door / 4 Door						
S.A.(1)	NON-Rubicon	1-1.5"	35"	12.5"	17-20"	9"	5"
S.A.(1)	NON-Rubicon	2-2.5"	37"	12.5"	17-20"	9"	5"
S.A.(1)	NON-Rubicon	3.5-4"	38"	13.5"	17-20"	9"	5"
OFA(2)	NON-Rubicon	1-1.5"	33"	12.5"	17-20"	9"	5"
OFA(2)	NON-Rubicon	2-2.5"	35"	12.5"	17-20"	9"	5"
OFA(2)	NON-Rubicon	3.5-4"	37"	12.5"	17-20"	9"	5"
S.A.(1)	Rubicon	1-1.5"	37"	12.5"	17-20"	9"	5"
S.A.(1)	Rubicon	2-2.5"	38"	13.5"	17-20"	9"	5"
S.A.(1)	Rubicon	3.5-4"	38-40"	12.5"	17-20"	9"	5"
OFA(2)	Rubicon	1-1.5"	35"	12.5"	17-20"	9"	5"
OFA(2)	Rubicon	2-2.5"	37"	12.5"	17-20"	9"	5"
OFA(2)	Rubicon	3.5-4"	38"	13.5"	17-20"	9"	5"
S.A.(1)	Street Articulation & Light Off-Road Use.	OFA(2)	<b>Off-Road Full Articulation.</b>				
07-18	Wrangler JK 2 Door & 4 Door <sup>1,2</sup>	2"	33"	12.5"	16-20"	8"	4.5"
		2.5-3.5"	34"	12.5"	16-20"	8"	4.5"
		4-5"	35"	12.5"	16-20"	8"	4.5"
		6-7"	37"	12.5"	16-20"	8"	4.5"
04-06	Wrangler Unlimited, Rubicon	2"	32"	11.5"	15-20"	8"	3.75"
		4"	34"	12.5"	15-20"	8"	3.75"
		6"	35"	12.5"	15-20"	10"	3.75"
		8"	37"	12.5"	15-20"	10"	3.75"
97-03	Wrangler TJ	2"	32"	11.5"	15-20"	8"	3.75"
		4"	34"	12.5"	15-20"	8"	3.75"
		6"	35"	12.5"	15-20"	10"	3.75"
		8"	37"	12.5"	15-20"	10"	3.75"
		10"	38"	12.5"	15-20"	10"	3.75"
87-96	Wrangler YJ	2"	31"	10.5"	15-20"	8"	3.75"
		4"	33"	12.5"	15-20"	8"	3.75"
		6"	35"	12.5"	15-20"	8"	3.75"
55-86	CJ & Scrambler	2"	31"	12.5"	15-20"	8"	3.75"
		4"	33"	12.5"	15-20"	10"	3.75"
05-12	Grand Cherokee WK 4WD, 2WD <sup>2</sup>	2"	30.5"	9.5"	17-20"	8"	OEM
99-04	Grand Cherokee WJ 4WD	2"	31"	10.5"	16-20"	8"	3.75-4.5"
93-98	Grand Cherokee ZJ 4WD, 2WD	3"	31"	10.5"	15-20"	8"	3.75-4.5"
08-12	Liberty 4WD, 2WD	2.5"	30.5"	10"	16-20"	8-9"	OEM
02-07	Liberty 4WD, 2WD <sup>1</sup>	2.5"	30.5"	10"	16-20"	8-9"	OEM
84-01	Cherokee XJ 4WD, 2WD	2"	30"	9.5"	15-20"	7-8"	3.75"
		3"	31"	10.5"	15-20"	8"	3.75"
		6"	33"	12.5"	15-20"	8"	3.75"
		8"	35"	12.5"	15-20"	8"	3.75"
06-10	Jeep Commander XK <sup>2</sup>	2"	30.5"	9.5"	17-20"	8"	OEM
86-92	Comanche 4WD, 2WD	3"	31"	10.5"	15-20"	8"	3.75"
74-91	J10, J20, Cherokee, Wagoneer	4"	35"	12.5"	15-20"	10"	3.75"

# SKYJACKER® WHEEL & TIRE SPECIFICATIONS

Vehicle		Lift	Maximum Tire			Wheel	
Year	Model		Height	Width	Diameter	Width	Back Space
<b>NISSAN</b>							
04-20	Titan 4WD <sup>2</sup>	2.5"	33"	12.5"	17-20"	7"	OEM
04-11	Armada 4WD <sup>2</sup>	2.5"	33"	11.5"	18-20"	7"	5
<b>TOYOTA</b>							
07-14	FJ Cruiser <sup>2</sup>	2"	32"	10.5"	17-20"	8"	OEM
		3"	33"	11.5"	17-20"	8"	4.5
01-03	Sequoia 4WD	2.5"	32"	11.5"	16-20"	8"	3.5"
00-06	Tundra 4WD	2"	32"	11.5"	16-20"	8"	3.5"
		3"	32"	11.5"	16-20"	8"	3.5"
07-20	Tundra 2WD,4WD	2"	32"	11.5"	17-20"	9"	6"
		3"	32"	11.5"	17-20"	9"	6"
		6"	35"	12.5"	17-20"	8"	4.5"
05-20	Tacoma 4WD, Pre-Runner 2WD <sup>1,2</sup>	2"	31"	11.5"	16-20"	8"	4.5"
		2.5"-3"	33"	11.5"	16-20"	8"	5"
96-04	Tacoma 4WD, Pre-Runner 2WD <sup>1</sup>	2.5"-3"	32"	10.5"	15-20"	8"	4.5"
86-95	IFS Pickup 4WD	4"	33"	12.5"	15-20"	8"	3.75"
03-20	4Runner 2WD / 4WD <sup>1,2</sup>	2"	31"	11.5"	17-20"	8"	4.5"
		3"	33"	11.5"	17-20"	8"	4.5"
96-01	4Runner 4WD	2.5"	31"	11.5"	15-20"	8"	3.5"
84-85	Pickup, 4Runner 4WD	3"	33"	12.5"	15-20"	8"	3.75"
		5"	35"	12.5"	15-20"	8"	3.75"
		7"	37"	12.5"	15-20"	8"	3.75"
79-83	Pickup, 4Runner 4WD	3"	35"	12.5"	15-20"	8"	3.75"
		5"	37"	12.5"	15-20"	8"	3.75"
		7"	39"	12.5"	15-20"	8"	3.75"
91-97	FJ80 LandCruiser 4WD	2.5"	33"	12.5"	15-20"	8"	3.75"
64-80	LandCruiser 4WD	2"	32"	12.5"	15-20"	8"	3.75"
		4"	35"	12.5"	15-20"	8"	3.75"

<sup>1</sup> Footnote: Requires minor trimming.

<sup>2</sup> Footnote: If you change the Tire Diameter / Wheel Size on this application, you must still maintain the equivalent 'Section Width' & 'Overall Diameter' to the 'Height' & 'Width' dimensions listed in the chart. If 20" Diameter or larger wheels, OE back spacing may be used.

<sup>3</sup> Footnote: Can use OEM Wheel

<sup>4</sup> Footnote: If equipped with Factory 17" wheels, then must stay with 17" wheels or larger. Do Not downsize from OEM wheel size.

**NOTE:** This Chart is to be Used Strictly as a REFERENCE Due to Actual Lift Heights & Variances in Tire Sizes from Various Manufacturers.