

RHINO-RACK

CATALOG

February 2017



RHINO-RACK HAS BEEN CREATING WORLD-CLASS ROOF RACKS SINCE 1992.

Today we're the proud owner of the world's most diverse and innovative range of roof rack products, supplying high quality gear to all industry segments.

We're there for the contractors.

When you need reliable gear that works as hard as you do, look no further than our massive range of Heavy Duty roof racks, ladder racks, trays, conduits and more.

We're there for the sportsmen.

Loading your bikes, kayaks, canoes, skis and snowboards has never been easier - meaning we help you get out on the trail, water or slopes quicker than ever before.

We're there for the sun-seekers and nature lovers.

Indulge your taste for adventure with a Rhino-Rack Foxwing Awning, boat loader, luggage basket or fishing-rod holders. Everything the camper needs for the ultimate getaway.

We're there for the environment.

We think nature is pretty awesome. And if we don't take care of it, our kids and grandkids might not be able to do all the camping, biking, skiing and surfing that we do. So we're committed to minimizing our environmental impact across every aspect of the Rhino-Rack business.

Most of all, we're there for the customer.

We're there to offer expert advice, help you choose the perfect roof rack product, and guide you on the best way to fit it to your vehicle.



**THE MIDDLE OF NOWHERE IS
NOT AS FAR AS YOU THINK.**



ROOF RACK SYSTEMS

- 06 Rail Mount
- 07 2500 Removable
- 08 Gutter Mount
- 09 Fix Point Mount
- 10 Track Mount
- 11 Tracks
- 12 Ditch Bracket
- 14 Rhino-Rack Backbone Jeep
- 15 Rhino-Rack Backbone FJ Cruiser
- 16 Rhino-Rack Backbone Land Cruiser
- 17 Rhino-Rack Backbone Prado 150
- 18 Rhino-Rack Backbone 4 Runner
- 18 Rhino-Rack Backbone Tacoma
- 19 Rhino-Rack Backbone Discovery 4
- 20 Cap/Toppers
- 23 Spacers
- 25 Masterkey

ACCESSORIES

- 28 Pioneer Tray
- 29 Pioneer Elevation
- 30 Pioneer Platform

- 31 Pioneer Platform Rails
- 31 Pioneer Accessory Bars
- 32 Universal Pioneer Platform
- 34 Pioneer Accessories
- 38 Alloy Trays
- 39 Alloy Tray Accessories
- 40 Xtray
- 40 Luggage Bags
- 41 Steel Mesh Platform
- 41 Steel Mesh Baskets
- 42 Locking Tie Down Straps
- 43 Tie Down Straps
- 44 Rooftop Boxes
- 48 Foxwing Awning
- 48 Foxwing Eco Awning
- 49 Sunseeker Awning
- 50 Dome Awning
- 51 Base Tent
- 54 Awning Accessories
- 56 Camping Chair and Stretcher
- 57 Led Lighting
- 59 Kayak Carriers
- 61 SUP & Kayak Accessories
- 62 Kayak Loaders

- 65 Boat Loaders
- 66 Fishing Rod Carriers
- 67 Snowboard & Ski Carriers
- 68 Roof Mounted Bike Carriers
- 70 Rear Mounted Bike Carriers
- 71 Bike Carrier Accessories

TRADESMEN/CONTRACTOR

- 72 Ladder Racks
- 74 Securing
- 75 Conduits
- 76 Brackets



CROSS BAR OPTIONS

HOW MUCH CAN THEY CARRY?

This varies considerably from vehicle to vehicle, so **always check website** for your specific vehicle model, or speak to your local expert dealer. As an example, our Trackmount systems are rated from 220lbs for a two crossbar system to 330lbs for our 3 bar system. **Always remember that our engineers design all our roof rack systems according to the available capacity of the vehicles roof as specified by the vehicle manufacturer.**

VORTEX [VA]

COLOR



PERFECT FOR:

Recreational and commercial use. This is the most versatile crossbar on the market

- SECURECORE™ locking endcaps included.
- Masterkey™ compatible
- Strong and durable for offroad and commercial use
- Suits most load carrying accessories on the market
- Vortex Generating Strip (VGS) is included
- Extruded structural aluminum curved to suit the contour of your roof



MASTERKEY COMPATIBLE

BAR LENGTHS AVAILABLE:

419.3", 464.6", 496.1", 541.3", 590.6", 649.6", 708.7", 787.4"

HEAVY DUTY [HD]

COLOR



PERFECT FOR:

Commercial accessories e.g. ladder racks

- Designed for heavy duty use
- Extruded structural aluminium
- Strong and durable for offroad and commercial use
- Large range of commercial carrying solutions available
- Rubber strips included



BAR LENGTHS AVAILABLE:

440.9", 492.1", 541.3", 590.6", 649.6", 708.7", 787.4", 944.9"

EURO

COLOR



PERFECT FOR:

Light duty load carrying

- Fits 2500 leg system
- Light-weight quality materials
- Accessories available
- Not suitable for offroad or heavy duty commercial use
- Available in black



STEALTHBAR™



The Rhino-Rack Vortex StealthBar™ is a low profile roof rack system for use with factory raised rails. It features adjustable legs, co-molded stainless steel / rubber locking straps to suit all size rails and comes preassembled for easy installation.

FEATURES:

- Maximum load capacity is 176lbs*
- Low profile, sits 1.4" above rails
- Steel locks included
- Compatible with all Vortex bar accessories
- 3.9" of adjustability
- **VGS™** rubber for low noise
- Locking straps available to suit rails of all sizes
- Contoured to follow your vehicle's roof
- Simple DIY installation



3.9" of adjustability



Compatible with Vortex accessories



Contoured Vortex bar



VGS™ rubber for low wind noise



Available in black and silver bars



* Refer to the vehicle manufacturers manual



STEALTHBAR

- Black and silver colour options
- It sits 1.4" above factory rails making it one of the lowest roof rack system on the market
- Features a slight curve in the bar that compliments your vehicle's roofline

SUITS

 MASTERKEY COMPATIBLE



VORTEX SX

- Suitable for raised factory rails
- Quick installation
- Engineered fit
- Security fasteners
- Minimal wind noise

SUITS



VORTEX SX

- Suitable for solid factory rails
- Durable and sleek design
- Quick installation
- Unique internal pad design to suit vehicle specific rails
- Secure Core key locking
- Minimal wind noise

SUITS

 MASTERKEY COMPATIBLE



CXB

- Factory Rails
- Quick installation
- Security fasteners

SUITS





EURO 2500

 MASTERKEY COMPATIBLE

- Quick to install
- Perfect DIY Kit
- Key locks included
- Engineered fit
- Vehicle specific pad and clamp design
- Gutterless mounting
- Installation tools included
- Economical
- Load rating 132lbs [^]



VA 2500

 MASTERKEY COMPATIBLE

- Quick to install
- Perfect DIY Kit
- Engineered fit
- Key locks included
- Vehicle specific pad and clamp design
- Gutterless mounting
- Installation tools included
- 50% reduced load capacity for Offroad
- Overhang for maximum load area
- Large range of accessories
- Load rating 165lbs [^]



HD 2500

 MASTERKEY COMPATIBLE

- Quick to install
- Perfect DIY Kit
- Key locks included
- Engineered fit
- Vehicle specific pad and clamp design
- Gutterless mounting
- Installation tools includes
- 50% reduced load capacity for Offroad
- Ideal for ladder loaders
- Overhang for maximum load area
- Load rating 165lbs [^]



2500 RS

 MASTERKEY COMPATIBLE

- Quick to install
- Perfect DIY Kit
- Engineered fit
- Key locks included
- Vehicle specific pad and clamp design
- Gutterless mounting
- Installation tools included
- Slick design with no overhang
- Load rating 165lbs [^]

[^] 50% reduced load capacity for Offroad



SG GUTTERMOUNT LEG

- Easy to install / remove
- Suitable for light off-road use
- Compatible with a wide range of accessories



RL GUTTERMOUNT LEG

- Heavy duty legs to fit to gutter mounts
- Heights available 4.3", 5.9", 8.3", 11"



HIGH ROOF GUTTERMOUNT

- Removable
- Easy to install / remove
- Suitable for light off-road use
- Compatible with a wide range of accessories





RLTF

- Sleek in design
- Strong and durable
- Compatible with a wide range of accessories
- Precision fitment parts for your vehicle
- Offers level bars across your vehicle's roof



RLCP

- Fits factory mounting points - vehicle specific
- Molded, contoured base



2500 FMP

- Specifically molded to fit the contours of your vehicle's roof
- Also available with bar overhang
- Lockable legs for added security
- Glass Reinforced Nylon legs
- Suitable for light off-road use



RSP

- Specifically molded to fit the contours of your vehicle's roof
- Available in two different heights
- Lockable legs for added security
- Compatible with a range of accessories
- Suitable for heavy off-road use
- Vehicle specific fitments only





RLT600

- Simple, secure, removable
- Single person operation
- Ideal for low clearance
- Simple trigger locking system for quick attachment
- Lockable cover plate with Masterkey™ compatibility
- Maximum load capacity across 2 bars is 220lbs (always refer to the vehicle manual)
- Lifetime Warranty



RLT500

- Compatible with the RTC and RTS tracks.
- Position your roof rack system along the track
- The legs are sold as a pair.



RLTF/RLTP

- Low profile
- Solid 2 bolt design
- Proven over 20 years
- Available in 31.5" or 19.7" heights
- For Rhino-Rack tracks only
- High strength/heavy offroad use



RSPT

- Flush bars with no overhang
- Stylish design
- Strong and built to last
- Suitable for heavy off-road use
- Compatible with a wide range of accessories
- Lifetime Warranty



OFFROAD
PROVEN PRODUCT



Image shows RTS Track



RTV TRACK

- Flat bottomed track designed to sit on the roof of a vehicle
- The most versatile track option
- Sold as a pair.
- Rivets and end caps included
- Suits RLTP/F, RLT600, RLT500 legs



RTC TRACK

- Made for Canopies
- Sold as a pair.
- T-bolts and end caps included
- Suits RLTP/F, RLT600, RLT500 legs



RTS TRACK

- Unique track made for specific vehicles
- Sold as a pair.
- Rivets and end caps included
- Suits RLTP/F, RLT600, RLT500 legs



RT TRACK

- Flat bottomed track designed to sit on the roof of a vehicle
- The most versatile track option
- Sold as a pair.
- Rivets and end caps included
- Suits RLTP/F, RLT600, RLT500 legs

MAXIMUM ON/OFF ROAD CARRYING CAPACITY

Tracks are our specialty. We have a range of tracks so please contact your Rhino-Rack dealer.

Just some of the vehicles we have tracks for:

Canopy / Hard Tonneau Track Mount
Ford Ranger PX
Holden Colorado
Hyundai iLoad
Isuzu D-MAX
Isuzu MU-X
Jeep Wrangler
Mazda BT50
Mercedes Sprinter
Mitsubishi Challenger

Mitsubishi Triton
Mitsubishi Pajero
Nissan Navara
Nissan Pathfinder
Range Rover
Toyota Hilux
Toyota Landcruiser
Toyota Prado
Toyota Rav 4
Toyota 4 Runner
Toyota Tacoma
VW Transporter



We now have a specialized option for those hard to fit vehicles.

Ditch Brackets provide fixed mounting points to attach roof racks with the highest load capacity for a vehicle*. It is a sleek, clean fit that can be used in conjunction with a range of roof racks.

Ditch Brackets require a specialized fit. Please contact your local Rhino-Rack dealer for more information or to organize a fitment.

*Please refer to the vehicle manufacturer's handbook for specific vehicle load ratings.



RHINO-RACK BACKBONE



**INCREASE YOUR
JEEP'S LOAD RATING
UP TO 800LBS
WITH THE RHINO-RACK
BACKBONE SYSTEM**

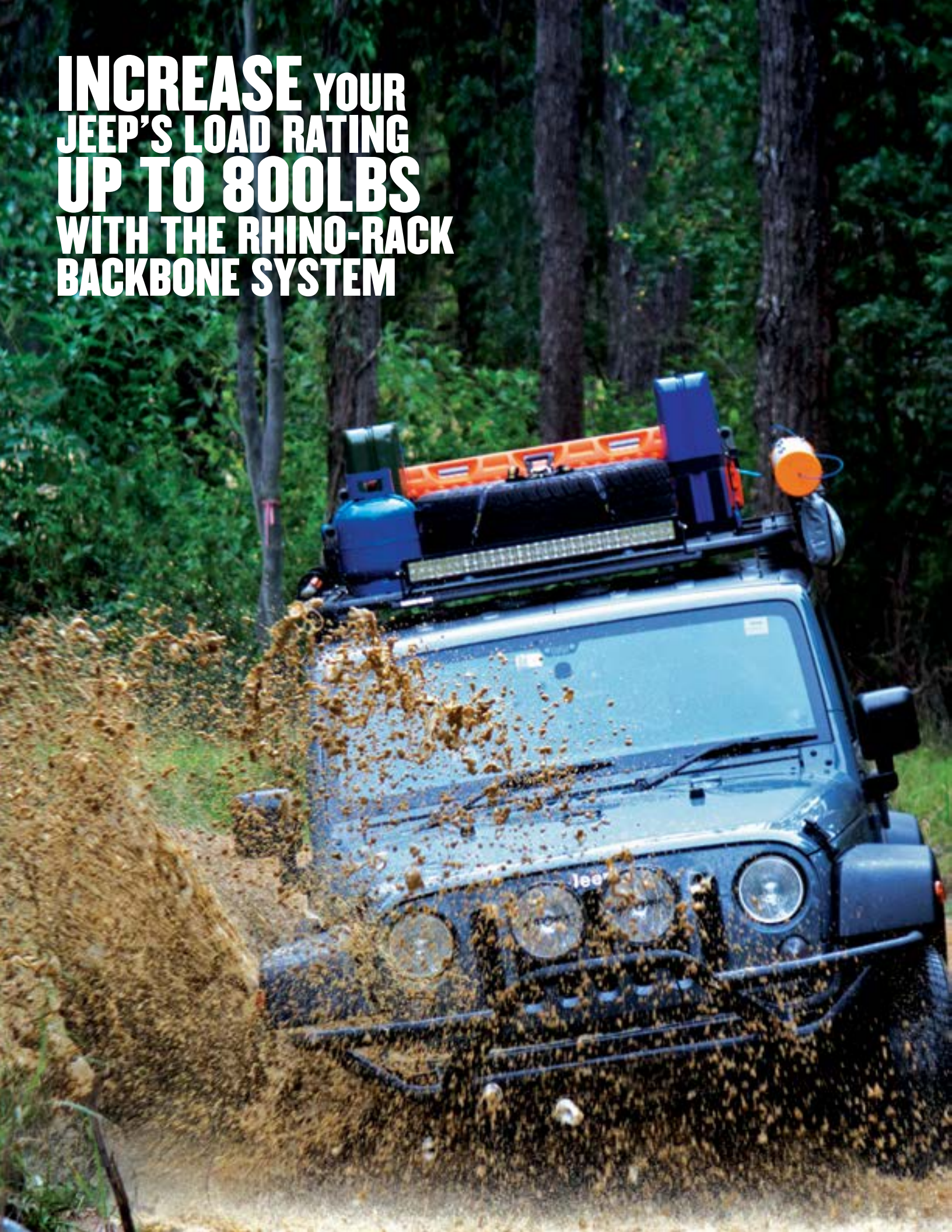



JEEP JK/JKU

**RHINO-RACK
BACKBONE**



SYSTEM INCLUDES: Pioneer Platform, Rhino-Rack BACKBONE, RLT600 Leg Set, Leg Height Spacers

SYSTEM INCLUDES: Pioneer Tradie, Rhino-Rack BACKBONE, RLCP38 Leg Set, Leg Height Spacers

Pioneer System	Pioneer Platform	Pioneer Elevation
Product Image		
Features	Low Profile	Fixed Side Rails
Mount Type	RLT600 or RLCP38/RLCP39	RLT600 or RLCP38/RLCP39
JEEP Wrangler JK 4dr 4WD Hard Top 07/ On		
Sizes	1828x1426mm / 72x56"	1828x1426mm / 72x56"
RLT600 Load Rating	Static 360kgs / 800lbs Onroad 120kgs / 264lbs Offroad 80kgs / 175lbs	Static 360kgs / 800lbs Onroad 120kgs / 264lbs Offroad 80kgs / 175lbs
JEEP Wrangler JK 2dr 4WD Hard Top 07/ On		
Sizes	1328x1426mm / 52x56"	1328x1426mm / 52x56"
RLT600 Load Rating	Static 240kgs / 530lbs Onroad 100kgs / 220lbs Offroad 67kgs / 148lbs	Static 240kgs / 530lbs Onroad 100kgs / 220lbs Offroad 67kgs / 148lbs

NB: The height difference between the RLT600 Leg and the RLCP38/39 is 40mm

**THE RHINO-RACK
BACKBONE IS THE
NEXT LEVEL OF
STYLE AND STRENGTH**



TOYOTA TACOMA



Pioneer System	Pioneer Platform	Pioneer Trays	Pioneer Elevation
Product Image			
Features	Low Profile	Fixed Rails	Fixed Side Rails
Mount Type	Rhino-Rack Backbone / RLT600	Rhino-Rack Backbone / RLT600	Rhino-Rack Backbone / RLT600
Sizes Available	2128x1426mm / 84"x56" 2128x1236mm / 84"x49"	2000x1330mm / 79"x52" 2000x1140mm / 79"x44"	2128x1426mm / 84"x56" 2128x1236mm / 84"x48"
Tacoma			
Rhino-Rack Backbone Load Rating	Static: 320kg / 705lb Onroad: 100kg / 220lb Offroad: 66kg / 145lb	Static: 320kg / 705lb Onroad: 100kg / 220lb Offroad: 66kg / 145lb	Static: 320kg / 705lb Onroad: 100kg / 220lb Offroad: 66kg / 145lb
RLT600 Load Rating	Static: 320kg / 705lb Onroad: 100kg / 220lb Offroad: 66kg / 145lb	Static: 320kg / 705lb Onroad: 100kg / 220lb Offroad: 66kg / 145lb	Static: 320kg / 705lb Onroad: 100kg / 220lb Offroad: 66kg / 145lb

TOYOTA 4 RUNNER



Pioneer System	Pioneer Platform	Pioneer Trays	Pioneer Elevation
Product Image			
Features	Low Profile	Fixed Rails	Fixed Side Rails
Mount Type	Rhino-Rack Backbone / RLT600	Rhino-Rack Backbone / RLT600	Rhino-Rack Backbone / RLT600
Sizes Available	2128x1426mm / 84"x56" 2128x1236mm / 84"x49"	2000x1330mm / 79"x52" 2000x1140mm / 79"x44"	2128x1426mm / 84"x56" 2128x1236mm / 84"x48"
4 RUNNER			
Rhino-Rack Backbone Load Rating	Static: 320kg / 705lb Onroad: 100kg / 220lb Offroad: 66kg / 145lb	Static: 320kg / 705lb Onroad: 100kg / 220lb Offroad: 66kg / 145lb	Static: 320kg / 705lb Onroad: 100kg / 220lb Offroad: 66kg / 145lb
RLT600 Load Rating	Static: 320kg / 705lb Onroad: 100kg / 220lb Offroad: 66kg / 145lb	Static: 320kg / 705lb Onroad: 100kg / 220lb Offroad: 66kg / 145lb	Static: 320kg / 705lb Onroad: 100kg / 220lb Offroad: 66kg / 145lb



SKID-PLATE

TRD PRO



Pioneer System	Pioneer Platform	Pioneer Trays	Pioneer Elevation
Product Image			
Features	Low Profile	Fixed Rails	Fixed Side Rails
Mount Type	Rhino-Rack Backbone / RLT600 / RLCP	Rhino-Rack Backbone / RLT600 / RLCP	Rhino-Rack Backbone / RLT600 / RLCP
Sizes Available	2128x1236mm / 84"x49" 2128x1426mm / 84"x56"	2000x1140mm / 79"x45" 2000x1330mm / 79"x52"	2128x1236mm / 84"x49" 2128x1426mm / 84"x56"
TOYOTA Land Cruiser 4dr 4WD 200 Series 11/07 On			
Rhino-Rack Backbone Load Rating	Static 360kgs / 800lbs Onroad 120kgs / 265lbs Offroad 80kgs / 175lbs	Static 360kgs / 800lbs Onroad 120kgs / 265lbs Offroad 80kgs / 175lbs	Static 360kgs / 800lbs Onroad 120kgs / 265lbs Offroad 80kgs / 175lbs
RLT600 Load Rating	Onroad: 150kg / 330lb Offroad: 100kg / 220lb	Onroad: 150kg / 330lb Offroad: 100kg / 220lb	Onroad: 150kg / 330lb Offroad: 100kg / 220lb
RLCP17 Load Rating	Onroad: 150kg / 330lb Offroad: 100kg / 220lb	Onroad: 150kg / 330lb Offroad: 100kg / 220lb	Onroad: 150kg / 330lb Offroad: 100kg / 220lb
TOYOTA Land Cruiser 4dr 4WD 100 Series 03/98 to 10/07			
RLCP02 Load Rating	Onroad: 120kg / 265lb Offroad: 80kg / 176lb	Onroad: 120kg / 265lb Offroad: 80kg / 176lb	Onroad: 120kg / 265lb Offroad: 80kg / 176lb

TOYOTA PRADO



Pioneer System	Pioneer Platform	Pioneer Trays	Pioneer Elevation
Product Image			
Features	Low Profile	Fixed Rails	Fixed Side Rails
Mount Type	Rhino-Rack Backbone / RLT600 / RLCP	Rhino-Rack Backbone / RLT600 / RLCP	Rhino-Rack Backbone / RLT600 / RLCP
Sizes Available	2128x1236mm / 84"x49"	2000x1140mm / 79"x45"	2128x1236mm / 84"x49"
TOYOTA Prado 150 Series 5dr 4WD 11/09 On			
Rhino-Rack Backbone Load Rating	Static 360kgs / 800lbs Onroad 120kgs / 265lbs Offroad 80kgs / 175lbs	Static 360kgs / 800lbs Onroad 120kgs / 265lbs Offroad 80kgs / 175lbs	Static 360kgs / 800lbs Onroad 120kgs / 265lbs Offroad 80kgs / 175lbs
RLT600 Load Rating	Onroad: 100kg / 220lb Offroad: 67kg / 148lb	Onroad: 100kg / 220lb Offroad: 67kg / 148lb	Onroad: 100kg / 220lb Offroad: 67kg / 148lb
RLCP23 Load Rating	Onroad: 100kg / 220lb Offroad: 67kg / 148lb	Onroad: 100kg / 220lb Offroad: 67kg / 148lb	Onroad: 100kg / 220lb Offroad: 67kg / 148lb
TOYOTA Prado 120 Series 5dr 4WD 03/03 to 11/09			
RLCP03 Load Rating	Onroad: 100kg / 220lb Offroad: 67kg / 148lb	Onroad: 100kg / 220lb Offroad: 67kg / 148lb	Onroad: 100kg / 220lb Offroad: 67kg / 148lb

**FEATURING A
LOW PROFILE
DESIGN,
THE RHINO-RACK
BACKBONE INCREASES
THE LOAD RATING OF
YOUR VEHICLES ROOF**

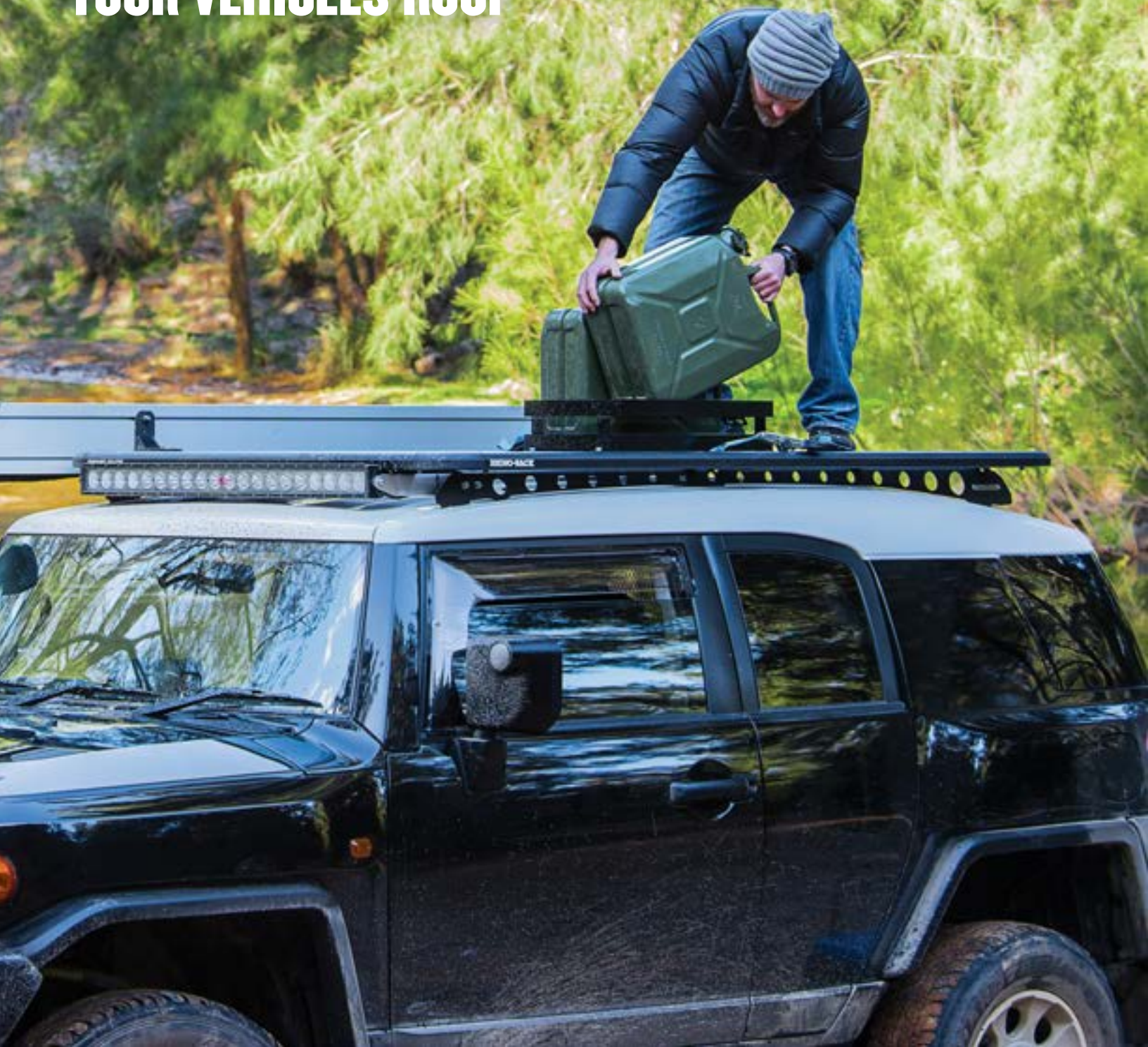

TOYOTA FJ CRUISER



Pioneer System	Pioneer Platform	Pioneer Trays	Pioneer Elevation
Product Image			
Features	Low Profile	Fixed Rails	Fixed Side Rails
Mount Type	Rhino-Rack Backbone or RLCP	Rhino-Rack Backbone or RLCP	Rhino-Rack Backbone or RLCP
Sizes Available	2128x1236mm / 83"x48" 2128x1426mm / 83"x56"	2000x1330mm / 79"x52" 2000x1140mm / 79"x45"	2128x1236mm / 83"x48" 2128x1426mm / 83"x56"
TOYOTA FJ Cruiser 2dr 4WD 06/On			
Rhino-Rack Backbone Load Rating	Static 360kgs / 800lbs Onroad 120kgs / 265lbs Offroad 80kgs / 175lbs	Static 360kgs / 800lbs Onroad 120kgs / 265lbs Offroad 80kgs / 175lbs	Static 360kgs / 800lbs Onroad 120kgs / 265lbs Offroad 80kgs / 175lbs
RLCP25 Load Rating	Onroad: 70kg / 154lb Offroad: 47kg / 103lb	Onroad: 70kg / 154lb Offroad: 47kg / 103lb	Onroad: 70kg / 154lb Offroad: 47kg / 103lb



Pioneer System	Pioneer Platform	Pioneer Trays	Pioneer Elevation
Product Image			
Features	Low Profile	Fixed Rails	Fixed Side Rails
Mount Type	Rhino-Rack Backbone / RLT	Rhino-Rack Backbone / RLT	Rhino-Rack Backbone / RLT
Sizes Available	2128x1426mm / 84"x56" 2128x1236mm / 84"x49"	2000x1330mm / 79"x52" 2000x1140mm / 79"x44"	2128x1426mm / 84"x56" 2128x1236mm / 84"x48"
LAND ROVER Discovery 3 / 4 4dr 4WD 04/05 On			
Rhino-Rack Backbone Load Rating	Static 360kgs / 800lbs Onroad 100kgs / 220lbs Offroad 66kgs / 145lbs	Static 360kgs / 800lbs Onroad 100kgs / 220lbs Offroad 66kgs / 145lbs	Static 360kgs / 800lbs Onroad 100kgs / 220lbs Offroad 66kgs / 145lbs
RLT Load Rating	zlbs Offroad 66kgs / 145lbs	Static 360kgs / 800lbs Onroad 100kgs / 220lbs Offroad 66kgs / 145lbs	Static 360kgs / 800lbs Onroad 100kgs / 220lbs Offroad 66kgs / 145lbs

CAP/TOPPERS

CAP/TOPPER

WE SPECIALIZE IN ROOF RACKS TO SUIT THE MOST POPULAR CAP/TOPPERS ON THE MARKET.

Our Engineering team tests each canopy to ensure they are fitted with the strongest, most suitable option.



COMPLETE KITS



PART NO: YO1-470/B: 50"/1270mm bar
YO1-480/B: 54"/1370mm bar
YO1-490/B: 59"/1500mm bar

- HD Bar
- Available in silver or black



PART NO: YO2-110/B: 50"/1270mm bar
YO2-120/B: 54"/1370mm bar
YO2-130/B: 59"/1500mm bar

- VA Bar
- Available in silver or black



PART NO: YO3-310/B: 50"/1270mm bar
YO3-320/B: 54"/1370mm bar
YO3-330/B: 59"/1500mm bar

- VA Bar
- Available in silver or black



PART NO: YO4-240/B: 50"/1270mm bar
YO4-250/B: 54"/1370mm bar
YO4-260/B: 59"/1500mm bar

- HD Bar
- Available in silver or black



PART NO: YO1-120NT: 54"/1370mm bar
YO1-130NT: 59"/1500mm bar

- HD Bar
- No Track for fit to competitive track



PART NO: YO2-480NT: 54"/1370mm bar
YO2-490NT: 59"/1500mm bar

- VA Bar
- No Track for fit to competitive track



PART NO: YO5-450: 37"/940mm bar
YO5-450: 44"/1120mm bar

- Sportz Bar
- No overhang



PART NO: YO6-550: 37"/940mm bar
YO6-560: 44"/1120mm bar

- Sportz Bar
- No overhang
- Trackmount



FIXED MOUNT
PART NO: RFMPS

Our Fixed Mount is secured on the canopy roof with the GE backing plate (included). Only suitable for lighter loads. Legs are available in 1.9" and 3.1" height.



CABIN MOUNT
Image showing PART NO: RFMRL

The Cabin Mount is fixed to the roof providing the platform for any height Rhino-Rack Heavy Duty Gutter Mount leg. This is the ideal solution for cabin bars that need to match high roof canopies.



FIXED MOUNT
Image showing PART NO: RFMC2

Swivel base allows fitting with a wider variety of roof shapes including flat, angled and curved. High profile design, ideal for highly curved roofs or levelling bars. Suitable for heavy off-road use.



TRACK MOUNT
Tracks are mounted to the canopy, hard top tonneau and hard top resin roofs. Crossbars can be adjusted along the tracks to accommodate your various loads.



FIXED MOUNT
Image showing PART NO: RFMPS2

Low profile design makes for a great look on your roof. Strong and built to last. Compatible with a wide range of accessories.



QM MOUNT
Image showing PART NO: QMCM01

The internal backing mounts used to fit a Quick Mount RLT600 leg to a canopy. Suitable for 2 bars, 4 mounts included. For fibreglass canopies.



ARTIFICIAL GUTTER
Image showing PART NO: 739A, 739AHALF

Artificial Gutters will allow the use of traditional roof rack crossbars on fibre glass or metal canopies. Only suitable for lighter loads.



TJM TRACK LEG
Fits directly to the factory fitted track supplied with early model TJM Canopies. PART NO: RLT504



NEED TO LEVEL THINGS OUT? THE BENEFIT OF LEG HEIGHT SPACERS

Perfect for creating more height or for leveling your roof rack crossbars



Rhino-Rack offers a wide variety of leveling spacers that simply connect onto the leg. The spacers can range from 0.2-1.2" in height and fit to a wide variety of our leg types. They also fit neatly in one another to provide a seamless finish and style to the vehicle.

The roof of a vehicle as in most cases has a subtle or dramatic curve from front to rear. When fitting three or more crossbars to a vehicle there is the challenge of maintaining a level working surface. Crossbars that are not level cause serious problems when loading and unloading not to mention they do not distribute the weight evenly onto the roof of the vehicle. This can become a safety concern.



Image shows a 2500 fitment

Available for VA and HD bars

**ROOF RACKS THAT
ARE NOT LEVEL CAN
RESULT IN SERIOUS
SAFETY ISSUES**

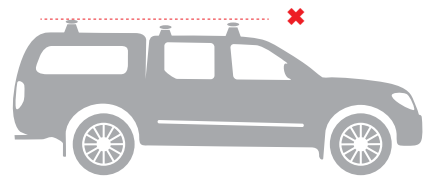
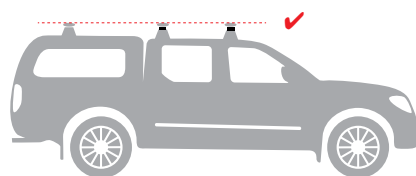

SPACER COMPATIBILITY CHART

PART#	DESCRIPTION	BAR TYPE	LEG TYPE
LHS-A1PAIR LHS-A2PAIR	2 x 0.4" Leg Height Spacers Incl: 2 x M6 x 1.8" Bolts 4 x 0.4" Leg Height Spacers Incl: 2 x M6 x 2.2" Bolts	VA VA	RL, RLCP, RLTP, RLTF
LHSPAIR LHS2PAIR	2 x 0.4" Leg Height Spacers Incl: 2 x M10 x 1.4" Bolts 4 x 0.4" Leg Height Spacers Incl: 2 x M10 x 1.8" Bolts	HD	RL, RLCP, RLTP, RLTF
LHS-10 Pack	10 x 0.4" Leg Height Spacers Incl: 10 x M10 x 1.4" Bolts	HD	RL, RLCP, RLTP, RLTF
LHSPIV	Pivoting Leg Height Spacer Incl: 4 Adapters in Kit	HD	RL, RLCP, RLTP, RLTF
CXBS1 CXBS2 CXBS3 CXBS4	0.2" CXB Spacer Set 0.5" CXB Spacer Set 0.7" CXB Spacer Set 0.9" CXB Spacer Set	HD	CXB
RLKS1 RLKS2 RLKS3 RLKS4 RLKS5	2 x 0.4" Spacer Blocks 4 x Spacer Blocks max height 0.7" 6 x Spacer Blocks max height 1" 8 x Spacer Blocks max height 1.3" 10 x Spacer Blocks max height 1.7"	VA	RLK 2500
QMHD05 QMVA05 QMW05	4 x Spacer Blocks max height 0.2" 0.2" Quick Mount Base Wedge	HD VA	RLT600
QMHD10 QMVA10 QMW10	4 x Spacer Blocks max height 0.4" 0.4" Quick Mount Base Wedge	HD VA	RLT600
QMHD15 QMVA15	4 x Spacer Blocks max height 0.6"	HD VA	RLT600
QMHD20 QMVA20	4 x Spacer Blocks max height 0.8"	HD VA	RLT600
QMHD25 QMVA25	4 x Spacer Blocks max height 1"	HD VA	RLT600
QMHD30	4 x Spacer Blocks max height 1.2"	HD	RLT600



- PART NO:** PLHS1
- PART NO:** PLHS2
- PART NO:** PLHSPAIR
- PART NO:** PLHS3
- PART NO:** QMPLHS01

NB: each kit includes 8 spacers to add an extra 0.8"

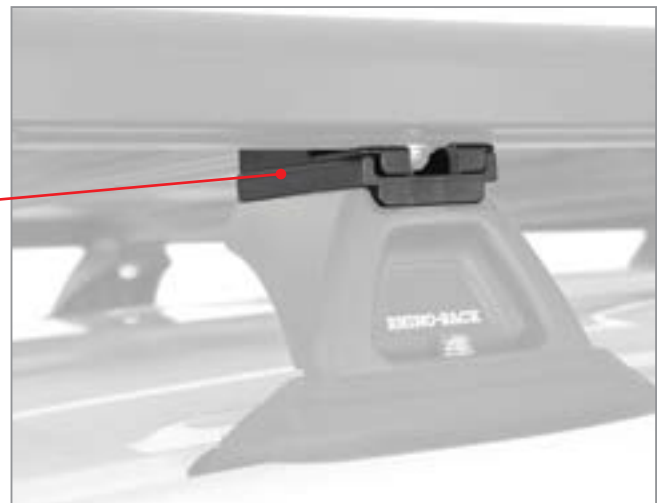
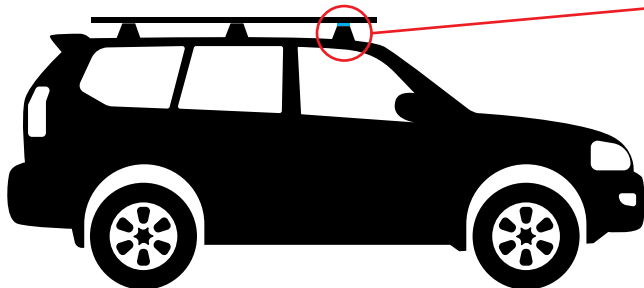

The Pioneer Leg Height Spacers are used to level a Pioneer system on a vehicle. These spacers can raise the height of the Pioneer by 2.9" overall. This allows each of the Pioneers to fit a wider range of vehicles, with the option of choosing a narrower or wider tray/platform. It also enables you to level the crossbars across your vehicle.



The Rhino-Rack Masterkey system allows you to upgrade the locks in your Rhino-Rack roof racks & accessories to eliminate carrying multiple keys. Available in 2, 4 & 8 barrel packs. Each pack contains 2 moulded Masterkeys in blue for easy identification.

KEY FEATURES

The Rhino-Rack Master Key is a one key system that fits most Rhino-Rack products.

Features:

- 1 One key for all your Rhino-Rack products
- 2 Simply replace the lock barrels in all your Rhino-Rack products
- 3 Eliminate the hassle of carrying multiple keys
- 4 Barrel sets available in 2, 4 & 8 packs



COMPATIBLE PRODUCTS:

Roof Rack	2500 System, RLT600, SRB Leg, VA-SEC2/4
Watersport	580, 581
Ski Carrier	572U, 574U, 576U
Bike Carrier	RBC035, RBC036, RBC050
Securing	RTD35L, RTD45L, RTD55L, 43205, 43206, 43207, 43208, 43209, 43210
Other	Conduit Locking End Cap

ACCESS ALL AREAS WITH OUR

COMPLETE RANGE OF ACCESSORIES





ROOF TRAYS



PIONEER TRAY

OFFROAD
PROVEN PRODUCT



- Structural grade aluminum
- Welded rails
- Alloy front wind fairing
- Tried and proven flexible glass re-enforced nylon components
- 5 year warranty
- Black powder coated finish for improved appearance and corrosion resistance
- Full range of accessories available

PART NO.	SIZE (EXTERNAL)	SIZE (INTERNAL)	WEIGHT
41100	1520 x 1260mm/59" x 49"	1400 x 1140mm/55" x 45"	25kg/55lb
41101	1520 x 1400mm/59" x 55"	1400 x 1280mm/55" x 50"	29kg/64lb
41102	1920 x 1260mm/75" x 49"	1800 x 1140mm/71" x 45"	32kg/70lb
41103	1920 x 1400mm/75" x 55"	1800 x 1280mm/71" x 50"	37kg/81lb
41104	2120 x 1450mm/83" x 57"	2000 x 1330mm/79" x 52"	39kg/86lb
41107	2120 x 1260mm/83" x 49"	2000 x 1140mm/ 79" x 45"	33kg/72lb

NB: Rhino-Rack leg kits to suit specific vehicles are sold separately.

FOR A FULL RANGE OF ACCESORIES GO TO PAGE 34



PIONEER ELEVATION

OFFROAD
PROVEN PRODUCT



The Pioneer Elevation is the ideal solution for those who need to carry a wide variety of gear on their roof. With its open front and rear you can easily load ladders, pipes or long objects and support against sides.

- Open front and rear
- Structural grade aluminum
- Welded rails
- Designed to minimize wind and noise on the road
- Non corrosive so it won't rust or fade
- Made from strong and durable materials
- Full range of Rhino-Rack accessories

NB: Rhino-Rack leg kits to suit specific vehicles are sold separately.

[FOR A FULL RANGE OF ACCESORIES GO TO PAGE 34](#)

PART NO.	SIZE (EXTERNAL)	WEIGHT
45100B	1528 X 1236mm/61" x 48"	21.5kg/47lb
45101B	1528 X 1376mm/61" x 54"	24.5kg/54lb
45102B	1928 X 1236mm/76" x 48"	27.5kg/60lb
45103B	1928 X 1376mm/76" x 54"	32kg/70lb
45104B	2128 X 1426mm /84" x 56"	35kg/77lb
45107B	2128 X 1236mm/84" x 48"	30.5kg/67lb
45108B	1426 X 1828mm/72" x 56"	31kg/68lb
45109B	1236 X 1328mm/52" x 48"	24kg/53lb
45110B	1376 X 1328mm/52" x 54"	27kg/59lb
45111B	1426 X 1328mm/52" x 56"	27kg/59lb

ROLLERS



PART NO.	LENGTH
43129	42.1"
43130	47.6"
43131	49.6"
43176	51.1"

PIONEER PLATFORM



- Low Clearance
- Easy assembly
- Structural grade aluminum
- Black powder coated finish and corrosion resistant
- Most versatile platform on the market
- Cross bars built in
- Optional rail systems available
- Largest range of accessories to suit

FACTORY RAIL FIT AVAILABLE



NB: Rhino-Rack leg kits and SX leg kits suit specific vehicles & are sold separately. Contact your local dealer for model listings.

PART NO.	SIZE (EXTERNAL)	WEIGHT
42100B	1528 x 1236mm/61" x 48"	20kg/44lb
44100B		
42101B	1528 x 1376mm/61" x 54"	23kg/51lb
44101B		
42108B	1828 x 1426mm/72" x 56"	25.5kg/56lb
42102B	1928 x 1236mm/76" x 48"	26.5kg/58lb
44102B		
42103B	1928 x 1376mm/76" x 54"	31kg/68lb
44103B		
42104B	2128 x 1426mm/84" x 56"	34kg/75lb
42105B	2728 x 1465mm/107" x 58"	38kg/83lb
42107B	2128 x 1236mm/84" x 48"	27.5kg/60lb
42108B	1828 x 1426mm/72" x 56"	25.5kg/56lb
42109B	1328 x 1236mm/52" x 48"	22kg/48lb
42110B	1328 x 1376mm/52" x 54"	24kg/53lb
42111B	1328 x 1426mm/52" x 56"	24kg/53lb
42112B	928 x 1426mm/36" x 56"	18kg/40lb

FOR A FULL RANGE OF ACCESSORIES GO TO PAGE 34

PIONEER RAILS

(SOLD SEPARATELY)

OPTIONAL SIDE RAILS ALLOWS YOU TO CONFIGURE YOUR PLATFORM IN THE BEST WAY TO SUIT YOUR LOAD







Rails can be mounted to all planks in any location with our "C" channel mounting system.

We have rails to suit all sizes of Pioneer Platforms.

PIONEER ACCESSORY BAR



PART NO.	LENGTH	ACCESSORIES TO SUIT
43119B	1220mm/48" Black	HD Channel 
43120B	1360mm/53" Black	HD Channel 
43137B	1220mm/48" Black	VA Channel 
43138B	1360mm/53" Black	VA Channel 

ROOF TRAYS



Accessory C Channels to mount all your favorite Pioneer accessories



Universal clamp mount included



C Channel mount also included



The Pioneer Platform **now fits more vehicles.**

Our universal clamping system means that you can fit Rhino-Racks most popular luggage tray to any roof rack.

- Universal Clamping system to suit the most popular roof racks on the market
- Low Clearance
- Easy assembly
- Structural grade aluminum
- Black powder coated finish and corrosion resistant
- Most versatile platform on the market
- Optional rail systems available
- Largest range of accessories to suit

PART NO.	SIZE (EXTERNAL)	WEIGHT
42115BF	1478 x 1184mm/58" x 46"	14kg/30lb
42114BF	1228 x 952mm/48" x 37"	12kg/26lb



JERRY CAN HOLDERS

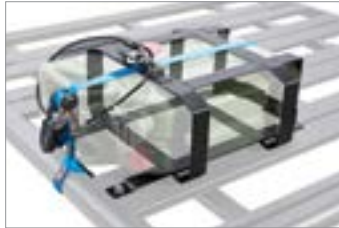

FLAT

PART NO: 43153

- Powder coated steel structure
- Corrosion resistant
- Carries 1 jerry can flat
- Suits the Pioneer Platform, Pioneer Tradie, Pioneer Tray
- Off-road proven
- Locking cables to secure your jerry can
- Suits most 20L metal or plastic jerry cans



DOUBLE JERRY CAN HOLDERS



VERTICAL

PART NO: 43151

- Carries 2 jerry cans vertically
- Suits the Pioneer Platform, Pioneer Tradie, Pioneer Tray
- Off-road proven
- Locking cables to secure your jerry cans
- Suits most 20L and 10L metal or plastic jerry cans



HORIZONTAL

PART NO: 43152

- Carries 2 jerry cans horizontally
- Suits the Pioneer Platform, Pioneer Tradie, Pioneer Tray
- Off-road proven
- Locking cables to secure your jerry cans
- Suits most 20L metal or plastic jerry cans

RECOVERY TRACK BRACKET



SIDE ANGLED

PART NO: 43159

- Mount your Maxtrax to the side of most Rhino-Rack Pioneer range at a 75 degree angle
- Recommended number of Maxtrax fitted is 2



If fitting 3 or 4, the Pioneer Maxtrax Support Bracket Part No: 43197 is required



FLAT

PART NO: 43158

- Mount your Maxtrax on most of the Rhino-Rack Pioneer range
- Made from strong 0.1" stainless steel
- Corrosion resistant with Black Powder Coating
- Recommended number of Maxtrax fitted is 2



Note:

- To mount your **Maxtrax** to this bracket, an additional Maxtrax Mounting Pin Set (MTXMP5) is required
- To mount **other branded** recovery tracks our Recovery Straps (#43199) is required

PART NO: 43199

CABLE CORE LOCKDOWN



VA BAR & PIONEER

PART NO: 43205 - 23.6"

PART NO: 43206 - 47.2"

PART NO: 43207 - 70.9"

- Suits the Pioneer range and Vortex Bars
- 8mm (0.3") PVC coated steel wire with zinc protection provides security for your valuables.
- Available in 3 different lengths



HD BAR

PART NO: 43208 - 23.6"

PART NO: 43209 - 47.2"

PART NO: 43210 - 70.9"

- Suits a Rhino-Rack Heavy Duty crossbars

LED LIGHT BRACKET



PIONEER

PART NO: 43173

- Suits Rhino-Rack Pioneer Platforms and Pioneer Elevation on all sides and the Pioneer Tray on the rear and sides
- Suits most LED Light Bars
- Made from strong, non-corrosive powder coated steel
- Mount your LED light level with the top of the platform for minimal interference with your load

VORTEX/HD BAR

PART NO: 43174

- Supports LED light bars up to 17lbs
- Suits a range of crossbars including Rhino-Rack Vortex and Heavy Duty, as well as Whipbar HD and ROLA HD
- Can be secured to either the top or bottom of the Crossbar

PICK UP KIT



RATCHET

PART NO: 43175

- Suits Pioneer range
- 2 ratchet straps (72.8") included
- 4x moldings (mounting blocks)
- Lashing capacity: 496lbs
- 1 Year Warranty

CAM BUCKLE

PART NO: 43179

- Suits Pioneer range
- Product comes with 2 cam buckle straps
- 4 x moldings (mounting blocks)
- All the required hardware for installation
- 1 Year Warranty

PIONEER ACCESSORIES



Platform Roller
Available in a variety of widths



Ratchet Grab
43139



Rhino Spare Wheel Strap
RSWS
Used with 43117 Eye Bolt Kit (3)



Jerry Can Holders
Available in a variety of sizes



Rhino Gas Bottle Holder
RGBH4



Luggage Bags
Available in a variety of sizes



Wrap Pads
43150



Shovel Holder Bracket
43103



High Lifting Jack Bracket
43101



High Lifting Jack & Shovel Bracket Kit
43157



Eye bolt Kit
43106 2 kit
43178 4 kit



NOTE: The image shown is for presentation purposes only. Please check your vehicles roof and roof rack load rating to determine the weight that you can carry.



Multipurpose
Holder Bracket
31114



Conduit Clamps
BC2



Conduit Locking
End Cap
LSE100H/LSE100



Awning Brackets
43100



Foxwing Awning
31100



Sunseeker 2.5m Awning
32105



Brackets
LED/Spot Light **43156**
LED Light **43173**



Work Light Bracket
SWLB



Rapid Straps
Available in a
variety of sizes



Pickup Kit
Ratchet **43175**
Cam Buckle **43179**



Adjustable Load Holder
RLH2

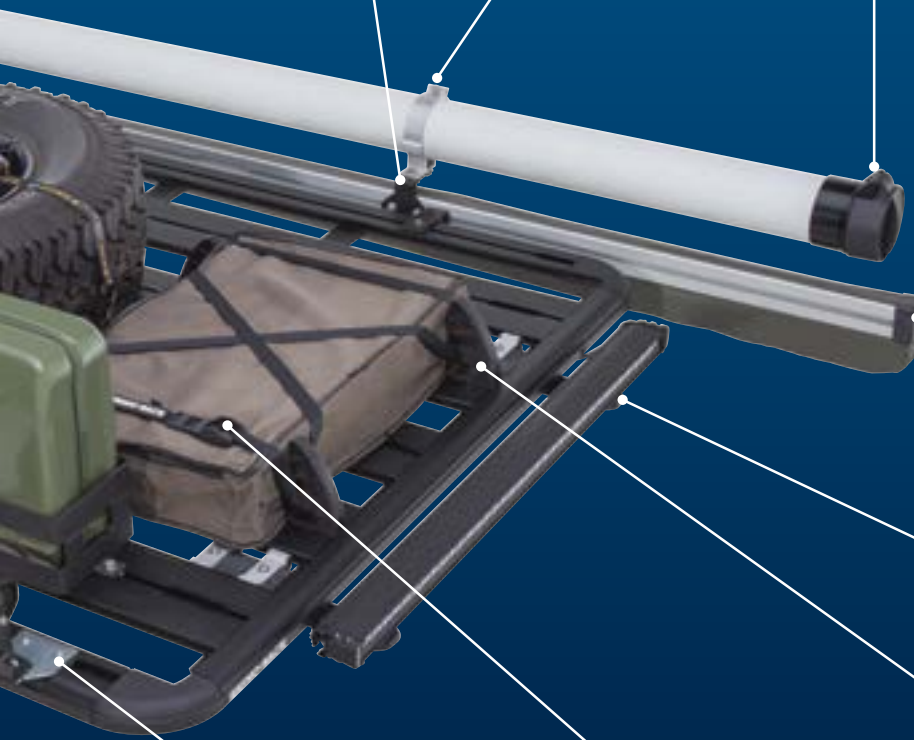

ROOF TRAYS



ALLOY TRAY



- Easy to assemble and install
- Heavy duty, non-corrosive components
- Unique tie-down points
- Aerodynamic shape for less wind resistance
- Available in a range of sizes
- Suitable for Rhino-Rack Heavy Duty & Rhino-Rack Vortex style crossbars
- Available in silver



PART NO.	INTERNAL LENGTH	INTERNAL WIDTH	CROSSBARS REQUIRED	PLANKS	TRAY WEIGHT
AT1210	1200mm/47"	1010mm/40"	2	4	13.5kg/30lb
AT1510	1500mm/59"	1010mm/40"	2	4	14.5kg/32lb
AT1512	1500mm/59"	1240mm/49"	2	5	18.0kg/39lb
AT1810	1800mm/71"	1010mm/40"	3	4	18.0kg/39lb
AT1812	1800mm/71"	1240mm/49"	3	5	20.5kg/45lb
AT2012	2000mm/79"	1240mm/49"	3	5	21.5kg/47lb

NB: Alloy Trays require either a Heavy Duty fitting kit or a Vortex fitting kit (sold separately). Thule fit kits also available.

YOUR FAVORITE ACCESSORIES THAT FIT THE ALLOY TRAY AND CROSS BARS



LOCKABLE SHOVEL HOLDER
PART NO: RSHB-L
SUITS: Alloy Tray



SHOVEL HOLDER
PART NO: RSHB
SUITS: Alloy Tray



LOCK
PART NO: RSHL
SUITS: Shovel Holder



HORIZONTAL JERRY CAN HOLDER
• Cans up to 18.7" high
PART NO: 43108
SUITS: Pioneer Range & Alloy Tray



VERTICAL JERRY CAN HOLDER
PART NO: 43107
SUITS: Pioneer Range & Alloy Tray



HI-LIFTING JACK HOLDER
Mounts directly to Rhino-Rack Heavy Duty crossbar. Suits most hi-lifting jacks. Provision for pad lock. Use in conjunction with the Alloy Tray.
PART NO: RJHB
SUITS: Alloy Tray



VORTEX HIGH LIFTING JACK HOLDER BRACKET
Mounts directly to Rhino-Rack Vortex crossbar. Suits most hi-lifting jacks. Provision for pad lock. Use in conjunction with the Alloy Tray.
PART NO: SJHB
SUITS: VA Bar



RHINO WHEEL STEP
Mounts directly onto your rear wheel to enable you easier rooftop access.
PART NO: RWS
SUITS: All

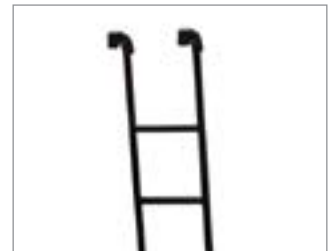

RHINO FOLDING LADDER
The ladder folds down and has its own bag for easy storage and transportation.
PART NO: RFL
SUITS: Pioneer Range & Alloy Tray



RHINO GAS BOTTLE HOLDER
• Suits 4 kg bottle only
PART NO: RGBH4
SUITS: Pioneer Range & Alloy Tray



SPARE WHEEL HOLDER
PART NO: RSWH
SUITS: Pioneer Range & Alloy Tray



STEEL SHOVEL
The Rhino-Rack square mouth shovel is corrosion resistant and powder coated black. The contoured grip is designed to be non slip with superior comfort to provide greater control. Beneath the grip consists of a composite multicore fibreglass (PVC and TPE) handle.
PART NO: 43123



ALLOY TRAY LIGHT BRACKET
Enables you to easily mount your driving lights to the front or rear of your Alloy Tray.
PART NO: ATLB
SUITS: Alloy Tray



XTRAY

PART NO: RMCB01 47.2" x 35.4" x 7.9" (external)
PART NO: RMCB02 58.3" x 42.9" x 5.9" (external)

- Universal clamp fits most crossbar types
- 3 year warranty
- 165lbs load rating
- Engineered 2pc construction
- Corrosion resistant
- Fits roof racks of varying distances.
- Bar spacing: Max = 29.9" Min = 21.1"



75KG LOAD RATING



RUST PROOF

LUGGAGE NETS
PART NO: RLN1 + RLN2

LUGGAGE BAGS

HALF

PART NO: LBH
 55.1" L x 19.7" W x 11.8" H

SMALL

PART NO: LBS
 43.3" L x 31.5" W x 11.8" H

MEDIUM

PART NO: LBM
 47.2" L x 37.8" W x 11.8" H

LARGE

PART NO: LBL
 59.1" L x 43.3" W x 11.8" H

EXTRA LARGE

PART NO: LBXL
 70.9" L x 43.3" W x 11.8" H



ZIPOUT LINING



- Heavy duty carry handle
- 1200 Denier Oxford Material with UPVC Coating
- Securing straps with heavy duty buckle
- YKK heavy duty zipper with dust proof hook and loop fastener flap
- Water resistant
- 1 year warranty

STEEL MESH PLATFORM

- Strong and Durable
- Corrosion Resistant
- Zinc-plated and powder-coated to avoid corrosion and color fading



NB: Fitting Kits sold separately

PART NO.	DESCRIPTION	LENGTH	WIDTH	MESH SIZE	TRAY WEIGHT
RPBH	Half Size	59.1"	25.6"	0.2"	27lbs
RPBS	Small	49"	37"	0.2"	18lbs
RPBM	Medium	52.8"	43.3"	0.2"	40lbs
RPBL	Large	62.6"	47.4"	0.2"	46lbs
RPXL	Extra Large	82.7"	45.9"	0.2"	60lbs

STEEL MESH BASKET

- Strong and Durable
- Corrosion Resistant
- Zinc-plated and powder-coated to avoid corrosion and color fading



NB: Fitting Kits sold separately

PART NO.	DESCRIPTION	INTERNAL LENGTH	INTERNAL WIDTH	INTERNAL DEPTH	MESH SIZE	BASKET WEIGHT
RLBS	Small	46.1"	34.4"	5.1"	0.2"	19lbs
RLBM	Medium	47.6"	38.2"	5.5"	0.2"	30lbs
RLBH	Half	55.5"	22.8"	4.7"	0.2"	22lbs
RLBL	Large	60.6"	45.3"	6.3"	0.2"	41lbs
RLBXL	Extra Large	71.3"	45.7"	5.9"	0.2"	48lbs
RLBXXL	2 Extra Large	82.7"	45.9"	5.9"	0.2"	60lbs
RLBHL	Half Long	82.7"	22.4"	4.7"	0.2"	37lbs
RLBN	Narrow	82.7"	13.8"	4.7"	0.2"	29lbs

FIT KITS



RHINO U-BOLTS
2.9" x 2.6"
PART NO: RUBK
SUITS: Rhino-Rack Heavy Duty Bar



RHINO U-BOLTS
2.5" x 3.9"
PART NO: S280
SUITS: Rhino-Rack Vortex Bar



EUROPEAN U-BOLTS
1.3" x 1.5"
PART NO: MUBK
SUITS: Rhino-Rack Euro Bar



BASKET PLATES
Recommended for RLBL, RLBXL & RPBL baskets. For offroad use.
PART NO: BP4





RAPID LOCKING STRAPS

PART NO: RTD25L
LENGTH: 98.4"

PART NO: RTD35L
LENGTH: 137.8"

PART NO: RTD45L
LENGTH: 177.2"

PART NO: RTD55L
LENGTH: 216.5"

- Straps can be tightened before & after cover is locked
- 0.1" PU coated steel wire encased in the strap to protect against cutting
- Steel wire starts 9.8" from the end, allowing easy feed of strap through the cambuckle and ease in tying off excess strap
- Lower vibration noise caused by wind when compared to regular tie down straps
- Maximum lashing capacity is 496lbs
- Tested to AS4380:2001
- Cambuckle Cover is completely removable to aid in feeding/securing strap
- Security stop inside cover helps prevent theft
- Aluminum cambuckle is corrosion resistant



Lockable cover is completely removable and Masterkey™ compatible



Rubberized cambuckle helps protect your load/vehicle from damage



Cable Core - 0.1" PU coated steel wire encased through length of the strap



Included: 2 x straps, 2 x covers with locks, 2 x keys, 2 x storage hook and loop



LASHING CAPACITY
STANDARDS AS/NZS 4380

RAPID STRAPS

PART NO: RTD35P
COLOUR: BLACK
LENGTH: 137.8"

PART NO: RTD45P
COLOUR: RED
LENGTH: 177.2"

PART NO: RTD55P
COLOUR: BLUE
LENGTH: 216.5"

PART NO: RTD35C, RTD45C
COLOUR: CAMO
LENGTH: 137.8", 177.2"

- Unique design registered Buckle Protector, designed to encase the metal cam buckle
- Buckle Protector is made from TPV rubber and provides maximum protection for your gear or vehicle.
- Sewn in hook and loop fastener "Roll it" Strap to keep the strap neatly stowed and indicate strap length.
- Low vibration noise caused by wind
- Maximum lashing capacity is 496lbs
- Tested to AS4380:2001
- Aluminum cambuckle is corrosion resistant





LUGGAGE BOXES

- Low profile
- Safe and secure fit
- Suitable for crossbars with a max width of 35.4" & max height of 13.8in
- 5 year warranty
- 165lbs load rating



MasterFit Clamp

Quick and easy to use

Comparison Chart	RMFZ66	RMFZ86	RMFB440	RMFB550	RMF440	RMF550
Colour	Brilliant Black	Brilliant Black	Black	Black	Silver	Silver
External Length (mm)	76"	85"	76"	85"	76"	85"
External Width (mm)	32"	35"	32"	36"	32"	36"
External Height (mm)	14"	15"	17"	17"	17"	17"
Capacity (litres)	400L	440L	440L	550L	440L	550L
Box weight	37.5lbs	52lbs	39lbs	45lbs	32lbs	45lbs
Max. allowed weight	165lbs	165lbs	165lbs	165lbs	165lbs	165lbs
Crossbar Spacing	640-815mm	620-930mm	620-930mm	620-930mm	620-930mm	620-930mm
Material	ABS/PMMA***	ABS/PMMA***	ABS/ASA**	ABS/ASA**	ABS/ASA**	ABS/ASA**
Opening	Dual	Dual	Dual	Dual	Dual	Dual
Locking points	3	3	3	3	3	3
Load securing straps included	4	4	4	4	4	4
Manufacturers warranty	5 years	5 years	5 years	5 years	5 years	5 years

ABS/PMMA*** = Acrylonitrile Butadiene Styrene/Para-Methoxymethamphetamine

ABS/ASA** = Acrylonitrile Butadiene Styrene/Arcrylic Styrene Acrylonitrile



Twist dial



Jaws tighten around crossbar



Press button to lock



T-Bolts available for 'C' Channel fitment
PART NO: RMF-23408

NB: To fit on to heavy duty crossbars please use RUBK-MF fitting kit.

“We have used many carriers over the years, but none have compared to the style, ease of use, and durability of Rhino-Rack. Colorado winters are a true test for any roof racking system and as the world’s largest ski specialty brand we need reliable cargo systems for transporting equipment to world cup events, resorts, US Ski Team, and athlete adventures. The Rhino-Rack systems offer flexibility in carriers, style for our Audi fleet, and are durable enough to take on the coldest and harshest conditions. Rhino-Rack delivers everything we need to tackle our year round adventures!”

Brady Collings - VP marketing, SPYDER Active Sports

ZENITH LUGGAGE BOXES

PART NO: RMFZ66 - 400L

PART NO: RMFZ86 - 440L



With it’s modern design the Zenith Masterfit Luggage Box is aerodynamic, reliable and secure.

- Stylish with a modern and elegant design
- The capacity of this luggage box is 440L
- Made from ABS/PMMA with a metallic paint finish
- UV Protected
- Impact Resistant
- Includes 4x premium fit mounts
- The luggage box has dual side opening for convenience
- It has a 3 point central locking system
- A specifically designed rear wind diffuser for aerodynamics
- Includes 3x tie down straps

LUGGAGE BOX WALL HANGER

PART NO: RWHMF

- 3 year warranty
- Powdercoated steel tubes with UV protection rubber padding
- Adjustable arms to allow for various sized boxes



WE'VE GOT YOU COVERED WITH OUR

RANGE OF SHADE ACCESSORIES





SHADE



FOXWING AWNING



- PART NO: 31200** Foxwing 2500 (right hand)
- PART NO: 31100** Foxwing 2500 (left hand)
- PART NO: 31117** Foxwing Eco 2100 (left hand)

- One person operation
- UV Protected
- MouldShield™
- Rip stop heavy duty polycotton canvas
- Telescopic poles, pegs and ropes included
- One piece awning that covers 270 degrees



270 Degrees of SHADE

Dimensions		
Part No	31100, 31200	31117
Size (Closed)	98.4" x 7.1" x 2.4"	78.8" x 7.9" x 3.5"
Height (Open)	86.6"	86.6"
Mount Position	Left, right	Left
Material	Ripstop Polycotton Canvas	Lightweight polyester with polyurethane (PU) coating
Colour	Taupe	Light Grey
Weight	40lbs	33lbs
Warranty	1 year	1 year
Add-On Accessories Refer to pg 54	Awning Extension Part# 31101 Tapered Zip Extension Part# 31112 Mesh Floor Saver Part# 31115 Tagalong Tent Part# RV5T Sand Screws Part# 31113 Sand Bags Part# 31109 Front Edge Zippered Insert Part#31124	Awning Extension Part# 31118 Sand Screws Part# 31113 Sand Bags Part# 31109



UV PROTECTED



WATERPROOF



SUNSEEKER AWNING



PART NO: 32109 Sunseeker 2000
PART NO: 32105 Sunseeker 2500

- High quality rip-stop polycotton canvas
- UV protected & waterproof
- MouldShield™
- Corrosion resistant
- Complete with telescopic poles, guy ropes and pegs

Accessories for both the Foxwing and the Sunseeker are available. For a full list go to page 54.

Dimensions		
Part No	32105	32109
Size (Closed)	98.4" x 70.9" x 2.4"	78.7" x 7.9" x 3.5"
Height (Open)	86.6"	86.6"
Mount Position	Left or Right	Left or Right
Material	Ripstop PolycottonCanvas	Ripstop PolycottonCanvas
Color	Taupe	Taupe
Weight	25lbs	22lbs
Warranty	1 year	1 year
Add-On Accessories Refer to pg 54	Awning Extension Part# 31101 Side Wall Extension Part# 32112 Mesh Room Part# 32108 Tagalong Tent Part# RV5T Sand Screws Part# 31113 Sand Bags Part# 31109 2.5m Fly Extension Part# 32117	Awning Extension Part# 32111 Side Wall Extension Part# 32112 Mesh Room Part# 32118 Tagalong Tent Part# RV5T Sand Screws Part# 31113 Sand Bags Part# 31109



DOME AWNING

The Dome 1300 (51.2") is a compact awning that you can fit to the side or rear of your vehicle providing you with a large area of cover. Perfect for tailgating, camping, picnics, or lazy days at the beach.

PART NO: 32125

Key features include:

- Ripstop polycotton canvas construction
- Provides UV protection (UV50+) and is waterproof (PU59")
- Domed shaped ceiling provides ample headspace & allows boot of vehicle to be opened
- Fold out sides provides extra area of cover
- Can withstand strong weather conditions
- Domed shaped promotes effective water run off during showers/storms
- Can also be fitted to the side of a vehicle
- Quick and easy one person setup
- Comes with mounting hardware, 2 x guy ropes, 2 x vertical poles and 2 x dome support poles



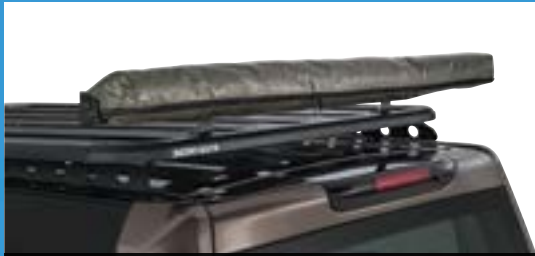

Packed away - nice and compact

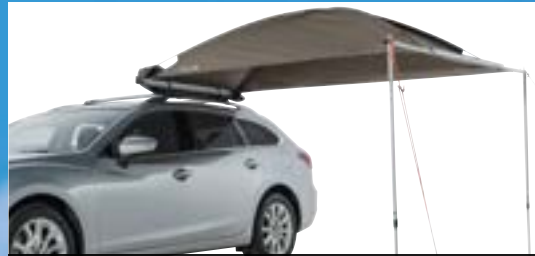

Side mounted



Ripstop polycotton canvas construction



Rear mounted



Fold out sides provides extra coverage



Allows boot to be opened completely



SHADE

The new **Base Tent** (Part# 32119) has been designed to keep you comfortable in any environment. With its tried and tested polycotton construction, large fly screen doors and unique domed roof, the Base Tent is a great place to stay protected from nature's elements and pests during those overnight trips or extended adventures. You can extend the front flap for extra shade throughout the day. Zipper ports for your lighting needs during the evening and a simple setup and pack down into a compact bag, make Base Tent a traveler's best friend.



BASE TENT 2500

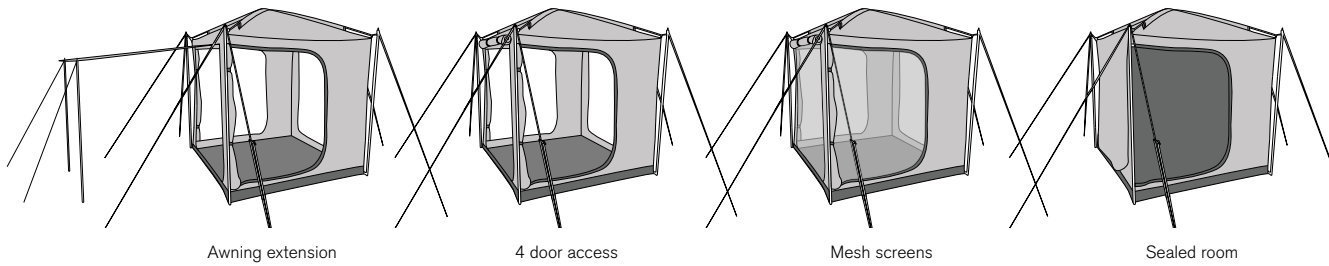

PART NO. 32119

98.4" (l) x 82.7" (w) x 86.6" (h)

Weight: 26lbs

- Packed away size: 35.4" L x 10.6" W x 10.6" H
- Dome roof for extra internal height and effective water run off
- 4 doors for easy access
- Internal roof storage
- Insect proof mesh screens
- Front zippered door can double as a front awning
- Cross flow ventilation pockets for reduced condensation
- Attaches to Sunseeker 2500 or use as a stand alone unit
(Pole Kit sold separately Part# 32124)
- Your Sunseeker acts as a thermal barrier from the sun
- Can be used in conjunction with a Tagalong Tent & Awning Extension
- Two internal zippered power ports and cable routing for LED light cables
- Weatherproof zippers
- UV protected and waterproof ripstop polycotton canvas
- PVC waterproof floor
- Tough carry bag, guy ropes & pegs are included



Cross air flow ventilation



**Insect proof mesh screen
& sealed room for camping**



Cable routing for tidy LED light cables
(lighting sold separately)



Internal roof storage



FOXWING TAPERED ZIP EXTENSION

PART NO: 31112

SUITS

F2100	F2500	S2000	S2500	D1300
x	31112	x	31112	31112

- Zippered sides. Join together to form a full enclosure
- Up to 4 extensions can be used
- Size 90.6" x 102.4" (flared at the bottom to 149.6")
- Telescopic poles, guys ropes and pegs are included
- Storage bag included
- Material: Ripstop Polycotton Canvas
- Water Rating: 4.9'



FOXWING FRONT EDGE ZIPPERED INSERT

PART NO: 31124

SUITS

F2100	F2500	S2000	S2500	D1300
x	31124	x	x	x

- Pole features a with unique twin peg base and hook top pin.
- Easy zipper attachment to your Foxwing Awning
- Compact and simple to carry and store
- Telescopic pole, metal peg, guy rope and bag included



FOXWING ECO EXTENSION

PART NO: 31118

SUITS

F2100	F2500	S2000	S2500	D1300
31118	x	x	x	x

- Zippered sides. Join together to form a full enclosure
- Up to 4 extensions can be used
- Size 79" x 75"
- Telescopic poles, guys ropes and pegs are included
- Storage bag included
- Material: Ripstop Polycotton Canvas
- Water Rating: 4.9'



TAGALONG TENT

PART NO: RV5T

SUITS

F2100	F2500	S2000	S2500	D1300
x	RV5T	x	RV5T	RV5T

- Quick & Easy to store and carry
- UV Protected
- Waterproof (Rating:4.9')
- Mold Resistant
- Rust Proof
- Insect proof mesh screens



SUNSEEKER 2500 FLY EXTENSION

PART NO: 32117

SUITS

F2100	F2500	S2000	S2500	D1300
x	x	x	32117	32117

- Quick & Easy to attach
- Includes 4 walls and ceiling made all from fine midge proof mesh
- Zippers on each side wall to allow easy entry and access to vehicle
- Snap hooks to connect to awning poles
- Suitable with the Sunseeker Awning range



FOXWING MESH FLOOR SAVER

PART NO: 31115

SUITS

F2100	F2500	S2000	S2500	D1300
✘	31115	✘	✘	✘

- Quick & Easy to store and carry
- Made from heavy duty Polyethylene mesh cloth
- Designed to match the shape of the Foxwing Awning
- Light weight (7lbs)
- UV Protected
- Waterproof
- Mold Resistant
- 1 Year Warranty



SUNSEEKER MESH FLOOR SAVER

PART NO: 32128 /32129

SUITS

F2100	F2500	S2000	S2500	D1300
✘	✘	32128	32129	✘

- Quick & Easy to store and carry
- Made from heavy duty Polyethylene
- Abrasion Resistant
- UV Protected
- Mold Resistant
- Designed to match the shape of the Sunseeker 2500 Awning and Mesh Room 2500
- Light weight
- 1 Year Warranty



MESH ROOM

PART NO: 32108 / 32118

SUITS

F2100	F2500	S2000	S2500	D1300
✘	✘	32118	32108	✘

- Quick & Easy to attach
- Includes 4 walls and ceiling made all from fine midge proof mesh
- Zippers on each side wall to allow easy entry and access to vehicle
- Snap hooks to connect to awning poles
- Suitable with the Sunseeker Awning range



SUNSEEKER SIDE WALL

PART NO: 32112

SUITS

F2100	F2500	S2000	S2500	D1300
✘	✘	32112	32112	✘

- Provides an additional 78.7" x 78.7" of additional coverage
- Fits both the Sunseeker and the Sunseeker
- Can be pitched at an angle, straight to the ground
- UV Protected
- Waterproof (rating: 4.9')
- Mould Shield™



SUNSEEKER EXTENSION

PART NO: 31101 / 32111

SUITS

F2100	F2500	S2000	S2500	D1300
✘	31101	32111	31101	✘

- UV Protected
- Waterproof (Rating: 59in)
- Mould Shield™
- Adds another 78.7" in width



CAMPING CHAIR

PART NO: RCC

Features:

- Load Rating: 250lbs/115kg
- Material: 600D PVC Fabric.
- Warranty: 1 year
- Product Measurement (folded):
37.4" (L) x 9.8" (D) x 9.8" (H)
- Quick set up and pack down
- Carry bag included. 300D Polyester with PU coating.
- UV Protected



CAMPING STRETCHER

PART NO: 34004

Features:

- Load Rating: 250lbs/115kg
- Material: 600D PVC Fabric.
- Product Measurement (open):
79.1" (L) x 28.7" (D) x 18.3" (H)
- Warranty: 1 year
- Quick set up and pack down
- Carry bag included. 300D Polyester with PU coating.
- UV Protected





LED LIGHTING KITS



19.7IN BAR LED LIGHT KIT

PART NO: LEDKIT1

Kit contents:

- 4 x 19.7" LED Light Bar
- 4 x Dimmer Switch
- 2 x Three Way Splitter
- 2 x 47.2" Connector Lead
- 2 x 98.4" Connector Lead
- 1 x 393.7" Connector Lead
- 1 x Power Adaptor
- 1 x Alligator Clip
- 1 x Merit / Cigarette Plug
- 2 x hook and loop fastener Strap Set (6pcs)
- 1 x Padded Carry Bag



11.8IN BAR LED LIGHT KIT PART

PART NO: LEDKIT7

Kit contents:

- 3 x 11.8" LED Light Bar
- 1 x Dimmer Switch
- 1 x 47.2" Connector Lead
- 1 x 98.4" Connector Lead
- 1 x Merit / Cigarette Plug
- 1 x hook and loop fastener Strap Set (6pcs)
- 1 x Padded Carry Bag



COMPONENTS SOLD SEPARATELY



Waterproof



Tough Heavy Duty Bar



LED LIGHT BAR

Features:

- Input Voltage: 12V
- Color: Pure White 5500k Kelvin
- Beam Angle: 120 degree
- LED Life: 50,000 Hours
- Ingress Protection Rating: IP68
- Material: Aluminum/PMMA/PC
- Warranty: 5 Years

	PART NO: LED02	PART NO: LED01	PART NO: LED30
Length	11.8"	19.7"	39.4"
Width	0.5"	0.5"	0.5"
Power	3.6W	6W	12W
Current Draw	0.3A	0.5A	1.0A
LED Type	18 Tri-Chip	30 Tri-Chip	60 Tri-Chip
Lumens	432lm	720lm	1440lm



DIMMER SWITCH

PART NO: LED03

Features:

- Voltage: 12v
- Adjustable brightness
- Remote combo on/off dimmer

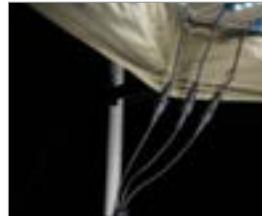

3 WAY SPLITTER

PART NO: LED10

Note: A maximum of 2x 39.4" / 6x 19.7" / 10x 11.8" LED bars can be used off one circuit. Any additional bars may cause overheating and damage to the items/circuits.



RF REMOTE KIT

PART NO: LED04

Features:

- Control up to 98.4' range
- Adjustable brightness
- Remote combo on/off dimmer

This RF Remote Kit is not weather protected and must have adequate protection from moisture and rain.



POWER ADAPTOR

PART NO: LED14

Features:

- Indoor 240V power adaptor
- AC/DC wall mounted



12 VOLT ALLIGATOR CLIP

PART NO: LED05

Features:

- Power your LED lights from a auxiliary battery
- To be used in conjunction with merit / cigarette plug



HOOK AND LOOP FASTENER STRAP SET

hook and loop fastener straps holds items firmly & securely.

PART NO: LED12

Features:

- Length: 7.9"
- 6pcs in pack



12 VOLT MERIT / CIGARETTE PLUG

PART NO: LED11

Features:

- 98.4' quick connect cable with cigarette attachment
- Cigarette lead comes with merit plug 12v input



PADDED CARRY BAG

PART NO: LED16

Features:

- Suitable for storing up to 7 LED Bars
- 4 padded compartments
- Heavy duty rubber handle
- Durable material

CONTENTS ARE NOT INCLUDED.



CONNECTOR LEAD

PART NO: LED06 - 32.8ft

PART NO: LED07 - 8.2ft

PART NO: LED08 - 3.9ft

Features:

- Waterproof / Weather Protected
- 3 different lengths



BATTERY PACK AND CHARGER

LITHIUM-ION 12V 5AH BATTERY

PART NO: LED8

- Lightweight rechargeable battery set
- 19.7" LED Bar - 10 hours run time,
- 11.8" LED Bar - 16 hours run time
- Battery Pack includes cover

LITHIUM-ION 12V CHARGER

PART NO: LED25

OUR CARRIERS ARE NOT ONLY PERFECT FOR YOUR KAYAK OR CANOE BUT ALSO YOUR SUP



LOCKABLE KAYAK CARRIER



PART NO: 580 Side Loading

PART NO: 581 Rear Loading

Features:

- Hidden locks
- Fits a variety of hull shapes
- Marine grade felt lined rear cradles for maximum hull protection
- 0.2" thick TPV (santoprene rubber front pads)
- Pads provide 3" x 7.9" contact surface area
- Perfect hull contact
- Unique 180 degree rotation
- 4 cradles included
- Includes 4 straps (2x 196.9", 2x 137.8") with buckle protector

Fit kit sold separately for heavy duty crossbars



MASTERKEY COMPATIBLE

UNIVERSAL KAYAK CARRIER



PART NO: 570 Side Loading

PART NO: 571 Rear Loading

Features:

- Universal crossbar fit
- Fits a variety of hull shapes
- Perfect hull contact
- Marine grade felt lined rear cradles for maximum hull protection
- 0.2" thick TPV (santoprene rubber front pads)
- Pads provide 3" x 7.9" contact surface area
- Unique 180 degree rotation
- Includes 4 straps (2x 196.9", 2x 137.8") with buckle protector

Fit kit sold separately for heavy duty crossbars



STRAPS INCLUDED

All Nautic Kayak Carriers include 4 straps (2x 196.9", 2x 137.8") featuring our buckle protector

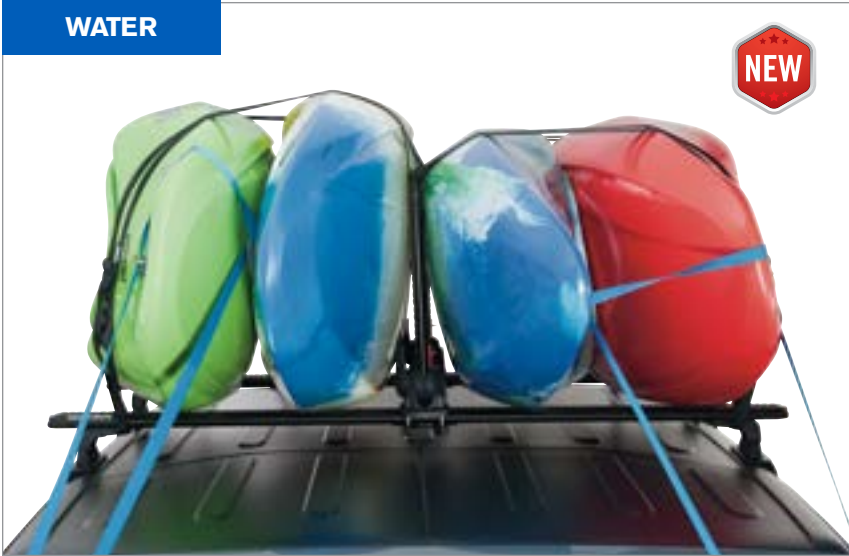

NAUSIC STACK
PART NO: S520

- Perfect for white water or short kayaks
- Holds up to 4 kayaks
- Optional fitting application - clamp or C channel nut and bolt system
- Foldable Stack arm when not in use
- Glass reinforced nylon base adds exceptional strength
- Stack Arm made of high strength anodised alloy



FOLDABLE
PART NO: S512

- Side loading
- Rubber tube padding protection
- Steel tube with state of the art coating protection
- Universal mounting system to suit all cross bar shapes
- Paddle holder attached
- Straps included



KAYAK CARRIER EXTENSION
PART NO: S512X

- Features:
- Enables you to transport 1 extra watercraft at the same time
 - Suitable for the S512
 - Includes straps



FIXED POSITION
PART NO: S510

- Features:
- Side loading
 - Rubber tube padding protection
 - Stainless steel hardware included
 - Steel tube with state of the art coating protection
 - Universal mounting system to suit all crossbar shapes
 - Includes straps



UNIVERSAL WRAP PAD
PART NO: RWP01, RWP02, RWP03, RWP04, RWP05

- Features:
- Protect your roof racks from damage when loading and unloading your surfboard, canoe, kayak, paddleboards, etc with the Rhino-Rack Universal Wrap Pads.
 - Available in 4 different lengths



Image shows RWP03



SUP & KAYAK ACCESSORIES



'C' CHANNEL FIT KIT
PART NO: KC FK8
 Fits S510, S512 Kayak Carrier and S512X Extension Piece into the 'C' Channel. Suitable for Rhino-Rack Heavy Duty, Aero and Thule Aero.



WALL MOUNT
PART NO: RWHL, RWHS
 Perfect for kayaks or luggage boxes



RHINO MULTI PURPOSE HOLDER
PART NO: RMPHU
 • Designed to carry 1-2 paddles
 • Strong UV materials
 • Fits all leading crossbar brands



PADDLE BOARD WALL HANGER
PART NO: RWHPB
 Features:
 • Powder coated
 • UV protected
 • 3 year warranty



KAYAK BOW STRAP
PART NO: RBAS1
PART NO: RBAS2
 (Perfect for SUPs)



BONNET ANCHOR STRAP
PART NO: RBAS
PART NO: RAS

**WE HAVE A NUMBER OF
SOLUTIONS TO HELP YOU
LOAD YOUR KAYAK OR BOAT
WITHOUT THE STRAIN OF
HEAVY LIFTING.**

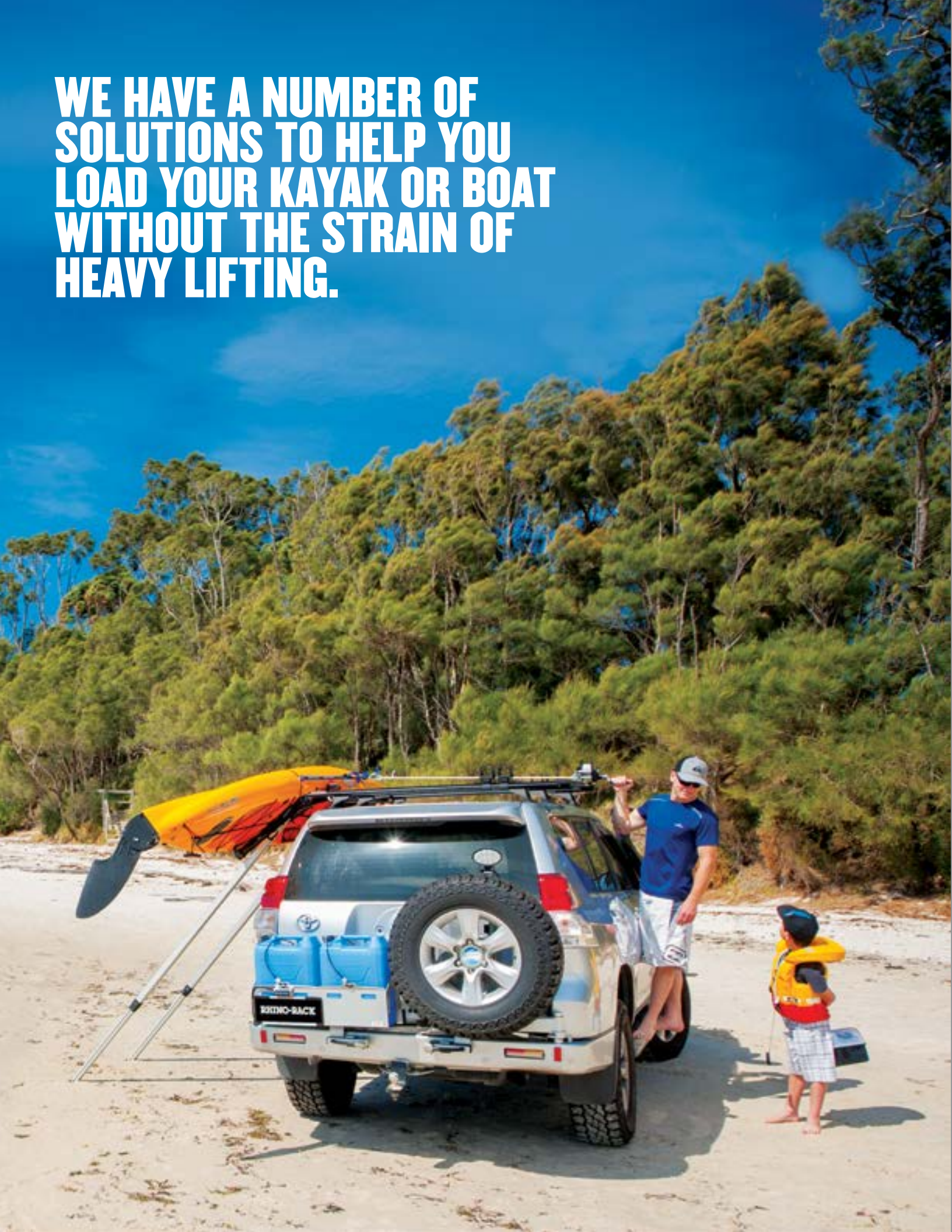

NAUTIC KAYAK LIFTER

Look no further, Rhino-Rack introduces the Nautic Kayak Lifter, the only kayak lifter on the market that has:

1. 176lbs load capacity
2. No heavy lifting
3. Single person operation

- Quick set up
- Fits most popular roof racks
- No drilling required in kayak
- Lifts kayaks up to 176lbs
- Height adjustable to suit various vehicle heights
- Low friction, easy slide ramps
- Rust proof
- UV protection
- 5 year warranty

Kit includes:

- 2x adjustable alloy ramps
- 2x alloy roller support bars
- Manual Winch
- Hardware
- 26.25' non stretch marine rope
- Harness Kit (6 straps included)



Manual Winch included



T-LOAD



DO YOU NEED A CROSSBAR?



TOW BALL MOUNT

PART NO:
RTL001



HITCH MOUNT

PART NO:
RTL002

Included

- 49.2" Aero crossbar
- One Kayak Sling Kit (Part # RTLK)

OR DO YOU ALREADY HAVE A CROSSBAR THAT FITS?



TOW BALL MOUNT

PART NO:
RTL003



HITCH MOUNT

PART NO:
RTL004

Not Included

- 49.2" Aero crossbar
- One Kayak Sling Kit (Part # RTLK)



T-LOAD NUMBER PLATE HOLDER

PART NO: RTLNPH

Our T-Load Number Plate Holder will help you keep your number plate in clear view.



Versatile, multi-purpose

UNIVERSAL SIDE LOADER



Additional clamps to suit a range of crossbars

PART NO: RUSL

Features:

- Push button for quick release and easy storage
- Includes cross bar clamps to suit all popular roof racks
- Includes heavy duty storage bag
- Includes support pole for kayaks greater than 44lbs

- Integrated load stop prevents kayak from sliding off bar
- Foam padding for protection of kayak
- Padding on the underside of clamps to protect vehicle roof
- Clamps to suit Rhino Aero/HD/Euro, Thule, Rola, Prorack*
- * Fit certain bar profiles

SIDE LOADER



PART NO: SLH01

Features:

- A padded hook and loop fastener wrap kit is included to protect the kayak when you load and slide it to the top of your vehicle
- A rubber mat is included to protect your kayak from scraping the floor when loading



SIDE BOAT LOADER



PART NO: RSBL

- Features:
- Single person operation
 - Load and unload your tinnie without unhitching the caravan or trailer
 - Uses a hand drill for effortless loading (18 volt drill recommended)
 - Ideal for boats up to 176lbs in weight*
 - Fits Rhino Heavy Duty and Rhino Aero crossbars 49.2" and up
 - Minimum requirement of only 2 crossbars
 - Fits a range of vehicles including 4WD's, low roof camper vans and station wagons.
 - No need for a boat trailer
 - * Check your manufacturers load rating to determine the maximum carrying capacity of your specific vehicle.



2x adjustable alloy ramps included



Worm drive included



2 ratchet straps included

SNOW



Image shows the 572 Carrier mounted to a Side Angled Recovery Track Bracket (Part No. 43159)

FISHING ROD HOLDER/ SKI & SNOWBOARD HOLDER



572/573 SERIES

PART NO: 572

PART NO: 573

These stylish locking arms provide a simple, effective method of locking down your gear without a fuss. This carrier will fit all leading crossbar brands.

- Internal Measurement = 9.8"
- External Measurement = 15.6"



MASTERKEY COMPATIBLE

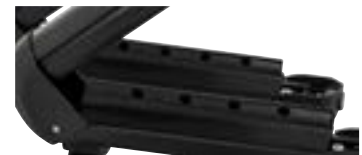

Molded rubber designed to secure rods into position



MULTI-PURPOSE HOLDER

PART NO: RMPHU

The Rhino-Rack Multi Purpose Holder is perfect for carrying fishing rods, ski poles & kayak paddles!

SKI & SNOWBOARD HOLDER

- Fits up to 6 pairs of skis / 4 snowboards
- Sold in a pair
- Key locking for security. Masterkey compatible
- Easy to use locking mechanism
- Rubber grip to position and secure your equipment
- Universal fit to suit the most popular roof racks on the market

PART NO.	INTERNAL DIMENSION	SUITABLE FOR SKI	SUITABLE FOR SNOWBOARDS
572	9.8"	2	-
573	12.8"	3	2
574	19.7"	4	2
576	27.4"	6	4



Rubber Grip Protection



Easy Locking Mechanism



Universal Mounting



C-Channel Mounting



UV PROTECTED



ANODIZED SURFACE



RUST PROOF



MASTERKEY COMPATIBLE



HYBRID

BIKE CARRIER

PART NO: RBC050



Bike Adapter

Fits 20" kids bikes up to 29" mountain bikes.



Fat Bike Adapter

For tires up to 5" wide. Adapter sold separately.

Premium aluminium tray

Triple Security

3 locking points offer more security than the competitors

- ▶ Cover plate
- ▶ Handle
- ▶ Security cable

Masterkey Compatible

All 3 locking points are Masterkey compatible.



Universal Fit

Fits most popular roof racks on the market.



C-Channel Fit

Optional C-Channel fitment. Sold separately.



Lockable Handle

Easily secure the front wheel with no fuss.



Left or Right

Swing arm can be adjusted to driver or passenger side.



Security Cable

Lockable security cable included to secure bike frame to carrier.



Folds completely flat when not in use

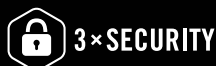
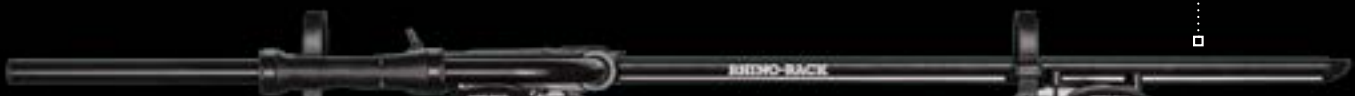



ROOF MOUNTED BIKE CARRIER



MOUNTAINTRAIL PART NO: RBC035

Features:

- Low profile
- Universal crossbar fit
- Fits all wheel dimensions
- Locks included to secure carrier to both the bicycle and crossbars
- Easily adjustable locking skewer
- Fits discs and standard brake systems
- Suitable for bikes up to 33lbs
- Min. cross bar spacing: 21.7", max: 39.8"



MASTERKEY COMPATIBLE



ROAD WARRIOR PART NO: RBC036

Features:

- Low profile
- Suits most "C" Channel crossbar profiles
- Rear wheel strap fits all wheel dimensions
- Lockable
- Suits most types of bikes with either standard or disc brake systems
- Adjustable locking skewer
- Suitable for bikes up to 33lbs
- Min. cross bar spacing: 21.7", max: 39.8"



MASTERKEY COMPATIBLE



DUAL TREKKER

PART NO: RBC048

Features:

- 2 bike platform carrier
- Fits both 2" & 1-1/4" hitch receivers.
- Mounts with a ratcheting arm over the front tyre.
- Rear wheel straps secures the bikes
- Access to the rear of your vehicle is always available, even when bicycles are loaded
- Carrier folds up and against the vehicle when not in use
- 90lbs load rating

 **CARRYING CAPACITY**

 **HITCH MOUNT**

REAR MOUNTED BIKE CARRIER



HITCH MOUNT BIKE CARRIER

PART NO: RBC044

Features:

- Fits up to 4 Bikes
- Hitch Mounted Carrier
- Fits 2 & 1-1/4 Hitch Receivers
- Adjustable Cradles designed to fit a wide range of bike frames
- Foam padding for extra protection



CARRYING CAPACITY



FOLD DOWN SHAFT



HITCH MOUNT



HITCH MOUNT BIKE CARRIER

PART NO: RBC045

Features:

- Fits up to 2 Bikes
- Hitch Mounted Carrier
- Fits 2 & 1-1/4 Hitch Receivers
- Adjustable Cradles designed to fit all types of bike frames
- Folding top arm and pull latch for access to rear life gate on vehicle



CARRYING CAPACITY



FOLD DOWN SHAFT



HITCH MOUNT



SPARE WHEEL BIKE CARRIER

PART NO: RBC025

Features:

- Ultra-light material
- 3 year warranty
- Carrying capacity of two bikes



CARRYING CAPACITY

Note: Not recommended for off road use or rear mounting on caravans

BIKE CARRIER ACCESSORIES



KEY LOCKING SKEWER

PART NO: RBCA022

Option available for quick release bike carriers.



BAR ADAPTOR

PART NO: RBCA021

The Bar Adapter allows for use with oversize bike frames, childrens bikes and most ladies bikes. Capable of handling up to a 2.2" headset and a seat tube diameter of 1.2".



THE CLAW

PART NO: RBCA010

Quick release fork mount bike carrier. Used for utilities, trailers and minivans.



BIKE CARRIER LOCKING CABLE

PART NO: RBCA023

- Lock your bikes to the hitch pin on the Rhino-Rack RBC044 bike carrier.
- 11.4' plastic-sheathed steel intertwined steel cords
- 2 keys included



BIKE CARRIER LOCKING CABLE

PART NO: RBCA024

- Lock your bikes to the hitch pin on the Rhino-Rack RBC008, RBC038 bike carriers.
- 11.4' plastic-sheathed steel intertwined steel cords
- 2 keys included



WE HAVE A LARGE RANGE OF LADDER CARRIERS TO HELP YOU LOAD AND TRANSPORT YOUR LADDERS SAFELY

RHINO ECONOMY LADDER SLIDE KIT



PART NO: REGLK (to suit HD Bars)
PART NO: SEGLK (to suit VA Bars)

- To suit a 3 bar system
- This allows ladders to be carried safely on Rhino Heavy Duty Bars.
- The kit consists of:
 - 1 x RLS5 - Ladder Strap
 - 1 x RUH - Ladder Hoops
 - 3 x REG - Ladder Slides





RHINO-RACK EASY SLIDE



PART NO: RES (1 Pair)

- Used for ladders, timber planks and long items
- Can be used as a roller replacement
- Made from UV stabilised polyethylene

RHINO-RACK LADDER SLIDE



PART NO: REG (1 Pair to suit HD Bars)

PART NO: SEG (1 Pair to suit VA Bars)

Allows smooth and easy ladder loading and solid load holding capabilities all in one compact easy to use item.

RHINO-RACK ROLLERS



TO SUIT HD BAR

PART NO: RR540 (21.3")

PART NO: RR615 (24.2")

PART NO: RR1375 (54.1")

PART NO: RR1500 (59.1")

PART NO: RR1650 (65")

TO SUIT VA BAR

PART NO: SR540 (21.3")

PART NO: SR680 (26.8")

Replacement roller mounting brackets available

SECURING

Securing your load in the right way helps prevent injury and damage.



RHINO LOAD HOLDER

PART NO: RLH1 (Suits Rhino-Rack HD Bars)

PART NO: RLH2 (Suits Rhino-Rack VA Bars & Pioneer range)

- Position your load so it doesn't slide in transit
- Height adjustable to cater for different size loads.
- Quick release for easy adjustment
- Sold in a pair



RATCHET GRAB

PART NO: RRG (to suit HD Bars)

PART NO: SRG (to suit VA Bars)

- Stainless Steel
- 6.5' strap included
- Attaches to the crossbar
- Load Rating: 485lbs



EYEBOLT

PART NO: REB (1pr) to suit HD Bar

PART NO: S604 (1pr) to suit VA Bar

- Ideal for use with all of our Ratchet Grab products.



T-BOLT

PART NO: STB16 (2pr)

PART NO: STB25 (2pr)

- Used for a variety of mounting applications Rhino-Rack Heavy Duty Bar with ease



CABLE LOCK

PART NO: RLLB

- A great easy solution for locking your ladders to your Rhino-Rack Heavy Duty Bars.



LADDER STRAP

PART NO: RLS5 (to suit HD Bar)

PART NO: SLS5 (to suit VA Bar)

PART NO: SLS45 (to suit VA Bar)

PART NO: RLS5-15 (to suit HD Bar)

- Camloc type features "snap on" fastening shackle. Secures your ladder quickly and easily



RHINO J BOLT

PART NO: RJBS (8.1in)

PART NO: RJBL (9.8in)

- Quick and easy accessory that allows you to safely secure a spare wheel to a Rhino-Rack Heavy Duty crossbar
- Hook spacing 1.7"
- Hook thread 4.1"



LADDER PEG

PART NO: RSLP (Small 3" (1pr))

PART NO: RMLP (Medium 5.3"(1pr))

PART NO: RLLP (Large 8.3" (1pr))

- Used for a variety of mounting applications Rhino-Rack Heavy Duty Bar with ease
- Perfect for positioning ladders



RATCHET GRAB

PART NO: RRG Length 78.7"

PART NO: RRG1 Length 118.1"

PART NO: RRG2 Length 177.2"

- Secure your load with confidence
- Strap made from high-grade webbing
- Load rating up to 1499lbs
- High quality, durable stainless steel

CONDUITS



LOCKING END CAP

Black

PART NO: LSE100 (2)

PART NO: LSE100H (1)

Safety Orange

PART NO: LSE101 (2)

PART NO: LSE101H (1)



MASTERKEY COMPATIBLE

- Two conduit locking end caps are included
- Suits 3.9" PVC pipes
- Integrated lock, Masterkey™ compatible
- O-Ring seal reduces dust and water build up inside the conduit pipe
- Locking end cap sits flush with internal conduit pipe so there is no interference with your conduit load
- Lid remains open even when your vehicle is parked on an incline
- Double wall internal pivot plate
- Dynamic testing to AS1235:2000
- Crash tested to ISO11154:2006
- Recommended maximum carrying capacity is 33lbs
- 5 Year Warranty



CONDUIT LOWER SIDE BRACKET

PART NO: BC3-LSB

- Mounts Conduit to the side of your vehicle, reducing overall height
- Clamp secures conduit while still allowing for sliding door clearance
- Stainless steel, nylon moulding
- Suit Rhino-Rack HD Bars
- Adjustable to accommodate most vans and vehicle widths



CONDUIT

PART NO: P30-100

(15'/3.9" diameter)

PART NO: P30-150

(15'/5.9" diameter)

PART NO: P46-100

(15'/3.9" diameter)

PART NO: P46-150

(15'/5.9" diameter)



CONDUIT REINFORCED END CAP

PART NO: BCW-C

(Copper Conduit Endcap)

- Rated to 33lbs



CONDUIT END CAP

PART NO: BCW (1) (3.9" orange)

PART NO: BC150 (1) (3.9" orange)

- Secure wire trace to prevent loss
- Ribbed for extra grip
- Crash tested for proven reliability



CONDUIT END CAP & SLEEVE

PART NO: BEC (3.9")

PART NO: BEC150 (5.9")

- Secure wire trace to prevent loss
- Ribbed for extra grip
- Crash tested for proven reliability



CONDUIT CLAMP

PART NO: RPC4 (2)

(3.9" clamp. To suit HD Bars)

PART NO: RPC6 (2)

(5.9" clamp. To suit HD Bars)

PART NO: SPC4 (2)

(3.9" clamp. To suit VA Bars)

PART NO: SPC6 (2)

(5.9" clamp. To suit VA Bars)



CONDUIT CLAMP

PART NO: BC2 (3.9" clamp. (2))

PART NO: BC3 (3.9" clamp. (3))

PART NO: BC4 (3.9" clamp. (4))

PART NO: BC2-150 (2) (5.9")

PART NO: BC3-150 (2) (5.9")

- Attaches 3.9" conduit to the Rhino Heavy Duty Bar

WE SPECIALISE IN **BRACKETS**

A E R I A L



MULTI-PURPOSE
PART NO: RMPB

BARS	USE
Rhino-Rack Heavy Duty	Aerial Lights



VORTEX AERIAL BRACKET
PART NO: S613

BARS	USE
Rhino-Rack Vortex	Aerial



BEACON MOUNTING PLATE
PART NO: RBP (to suit HD)
PART NO: SBP (to suit VA)

BARS	USE
Rhino-Rack Heavy Duty	Beacon Light



VORTEX WORK LIGHT BRACKET
PART NO: SWLB

BARS	USE
Rhino-Rack Vortex	Beacon Light



HIGH LEVEL TAIL BRACKET
PART NO: RHLL

BARS	USE
Rhino-Rack Vortex	Lights



AERIAL MOUNT KIT
PART NO: RAMK

BARS	USE
Rhino-Rack Heavy Duty	Aerial



AERIAL MOUNT BRACKET KIT
PART NO: RABK

BARS	USE
Rhino-Rack Heavy Duty	Aerial



RHINO BEACON PLATE-CAB BAR MOUNT
PART NO: RBP-CBM

BARS	USE
Rhino-Rack Heavy Duty	Beacon Light

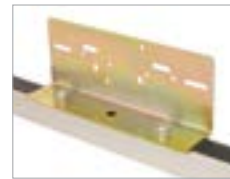

LIGHT ANGLE BRACKET
PART NO: RLAB

BARS	USE
Rhino-Rack Heavy Duty	Lights



LIGHT MOUNT BRACKET
PART NO: RWLB

BARS	USE
Rhino-Rack Heavy Duty	Lights Aerials

L I G H T S

We have a range of **all purpose plates** ideal for various applications such as setting up roof rack bars in custom configurations.

For specialist advice talk to your local Rhino-Rack dealer

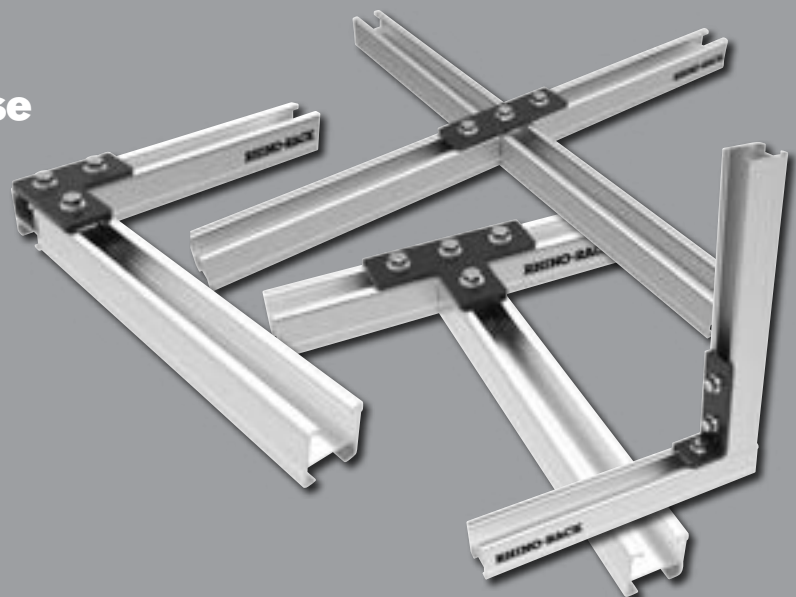



RHINO-RACK UNIVERSAL

PART NO: 31111

BARS	AWNING
Rhino-Rack Vortex Heavy Duty Pioneer range	Most popular



RHINO-RACK VA/HD

PART NO: 31108

BARS	AWNING
Rhino-Rack Vortex Heavy Duty	Foxwing



RHINO-RACK HD

PART NO: 32102

BARS	AWNING
Rhino-Rack Heavy Duty	Sunseeker



RHINO-RACK EURO

PART NO: 31105

BARS	AWNING
Rhino-Rack Euro Prorack P, Carac Thule (Square Bar)	Foxwing



RHINO-RACK HD

PART NO: 31102

BARS	AWNING
Rhino-Rack Heavy Duty	Foxwing



RHINO-RACK PIONEER TRAY

PART NO: 43100

BARS	AWNING
Rhino-Rack Pioneer range	Foxwing + Sunseeker



**SUNSEEKER AWNING
ANGLED DOWN BRACKET**

PART NO: 32127

BARS	AWNING
Rhino-Rack flush bars	Sunseeker



RHINO-RACK VA/HD

PART NO: 32114

BARS	AWNING
Rhino-Rack Vortex Heavy Duty	Sunseeker



TRACKLANDER TRAY

PART NO: 31104

BARS	AWNING
Tracklander	Foxwing



ARB/TJM TRAY

PART NO: 31103

BARS	AWNING
ARB/TJM	Foxwing



**SUNSEEKER AWNING
ANGLED UP BRACKET**

PART NO: 32123

BARS	AWNING
Rhino-Rack flush bars	Sunseeker



THULE ROOF RACKS

PART NO: 31105

BARS	AWNING
Rhino-Rack Pioneer range	Foxwing



FIXING BRACKET

Part# A116B

- Right angle fastening bracket
- Hardware included



T SHAPE FITTING PLATE

Part# C641

- Black powder coated steel
- 0.3" hardware required



L SHAPE FLAT FITTING PLATE

Part# C642

- Black powder coated steel
- 0.3" hardware required



Z SHAPE FITTING PLATE

Part# C637

- Black powder coated steel
- 0.3" hardware required



FLAT FITTING PLATE

Part# C638

- Black powder coated steel
- 0.3" hardware required



L SHAPE UPRIGHT FITTING PLATE

Part# C640

- Black powder coated steel
- 0.3" hardware required

Rhino-Rack

Environmental Policy

Rhino-Rack Australia is committed to the protection of the environment and the reduction of environmental impacts from our operations. This commitment applies across the whole of our business covering the design, manufacture & distribution of motor vehicle roof racks and accessories. As part of this commitment Rhino-Rack Australia Pty Limited will:

- Comply with ISO 14001 the International Standard for Environmental Management Systems and with all applicable legal and regulatory requirements.
- Work to prevent pollution and to achieve continual improvement in environmental performance by having operating procedures necessary to identify, monitor and mitigate the impact of our operations on the environment.
- Establish programmes to achieve agreed environmental targets and objectives.
- Plan for and conduct site operations in a manner that safeguards health and safety whilst minimising environmental impacts.
- Communicate our environmental policy to employees, suppliers, contractors & other interested parties to encourage participation in achieving our environmental objectives.
- Promote this commitment by making this policy available to the public.



