

# RETRAC<sup>®</sup>

## 2020 CATALOG





# ONE-STOP SHOP

## TOWING & TRUCK ACCESSORIES

CURT Group is a leading sales, marketing, engineering and distribution company of towing products and truck accessories for all types of vehicles, from passenger cars to commercial trucks. We stand for EXCELLENCE in our products and our associates. We aspire to be the industry LEADER by recognizing that the customer is KING and our associates are our greatest ASSET.

### OUR FAMILY OF BRANDS



CURT is a supplier of a complete line of towing products and the leading manufacturer of USA-made custom-fit trailer hitches.



LUVERNE is a leading manufacturer of functional aftermarket accessories for pickup trucks, commercial vans and SUVs.



RETRAC is a leading manufacturer of OEM and aftermarket mirrors and front-end protection for heavy-duty and medium-duty trucks. [r](#)



ARIES is a fast-paced marketer and innovator of truck, Jeep, SUV and CUV accessories.



UWS is a leading manufacturer and designer of USA-assembled truck tool boxes.



# RETRAC®

## CUSTOMER-FIRST SERVICE

CURT Group is dedicated to a customer-first mentality. That means approaching each new challenge by thinking from the customer's perspective first.

Our goal is to offer our customers the best service, fastest order-fill, richest marketing resources and highest-quality products. One of our latest enhancements is CURT Group University. This tool is a comprehensive database for marketing literature, training presentations, videos and more.



We are a team of 1,000+ associates dedicated to thinking from the customer back.

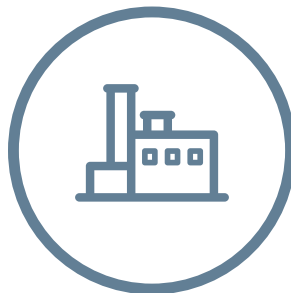

We manufacture products in Wisconsin, South Dakota, Florida and Mexico.



We ship from 12 regional warehouses across the United States and Canada.

**THINKING FROM THE CUSTOMER BACK**



# PRODUCT INDEX

Accessory mounting tabs	26
Adjustable stabilizers and braces	65
Aerodynamic convex mirror heads	46
Aerodynamic west coast mirror heads	30
Aerodynamic west coast replacement glass	32
Angle-back west coast mirror heads	40
Auxiliary mirror mounting brackets	68
Bubble mirror heads	47
Bubble-back west coast mirror heads	37
MileStone™ bumper guards	06
MileStone™ bumper guards, license plate bracket	08
MileStone™ bumper guards, light cage	08
Center-mount convex mirror heads	48
Chevron west coast mirror heads	36
Convex step van mirror heads	63
Custom light-duty west coast mirror assemblies	58
Custom west coast mirror assemblies	42
Economy west coast mirror heads	35
Grab handles	65
Grille guard mounting systems	20
Junior west coast mirror head	58
LED light bars	09
LED work lights	09
License plate bracket, MileStone™ bumper guards	08
License plate bracket, grille guards	21
Light-duty mirror heads	59
Look-down convex mirror assemblies	53
MagLatch™ grille guard mounting systems	20
Mirror clamps	69
Mirror extensions	59

Mirror J-brackets	69
Mirror loops	66
Motorized west coast mirror heads	35
OEM step van mirror assembly sets	62
Off-road west coast mirror heads	33
Offset-mount convex mirror heads	50
Pedestal-mount mirror assemblies	34
ProTec™ grille guards	16
ProTec Edge™ grille guard	18
Pyramid-back west coast mirror heads	38
Rear view mirror	59
Rear-mount safety mirror assemblies	55
Rectangular convex mirror heads	52
Rectangular convex utility mirror assembly	53
Rib-back west coast mirror heads	37
Safety mirror assemblies	54
Standard grille guard mounting systems	20
Stick-on convex mirrors	52
Tuff Guard® grille guards	10
Tuff Guard® van grille guards	26
Tuff Guard® van mounting brackets	27
Tuff Guard XT™ grille guards	12
Tuff Guard II™ grille guards	14
Universal cabover mirror assembly	43
Universal conventional mirror assembly	43
Universal light-duty mirror assemblies	58
Universal light-duty mirror head with gooseneck	59
Universal step van mirror assembly set	62
West coast conversion mounting kit	68
West coast step van mirror heads	63

# TABLE OF CONTENTS

## HEAVY-DUTY GRILLE GUARDS

MileStone™ bumper guards, LED lights, Tuff Guard®, Tuff Guard XT™, Tuff Guard II™, ProTec™, ProTec Edge™, accessories, mounting systems

04 - 27

## HEAVY-DUTY MIRRORS

Aerodynamic, off-road, west coast, custom and universal assemblies

28 - 43

## CONVEX & SAFETY MIRRORS

Aerodynamic, bubble, center and offset-mount, rectangular, stick-on, safety assemblies

44 - 55

## LIGHT-DUTY MIRRORS

Custom and universal assemblies, mirror heads, junior west coast, rear view

56 - 59

## STEP VAN MIRRORS

OEM and universal assembly sets, west coast and convex mirror heads, FedEx and USPS color-matching

60 - 63

## COMPONENT PARTS

Clamps, loops, J-brackets, stabilizers, braces, grab handles

64 - 69

## MARKETING MATERIALS

Literature, catalog, banners, retail signage, display stands

70 - 72



# HEAVY-DUTY GRILLE GUARDS

**DELIVERING. DEPENDABLE. QUALITY.**

Tuff Guard II™ on 2020 Peterbilt 389

## FEATURED PRODUCTS



### ProTec Edge™ grille guard

Now available in polished stainless, this grille guard contours the body lines of modern trucks and offers superior front end protection.



### MileStone™ bumper guard

With a low profile and optional integrated light cage, this new guard offers enhanced road safety without obstructing the fold-down hood.



### MagLatch™ brackets

MagLatch™ brackets feature rare-earth magnets and fold down as needed for convenient hood access. Standard latch also available.

## PRODUCT INDEX



**06**  
MileStone™  
Bumper Guards



**08**  
MileStone™  
Light Cages



**09**  
LED Light Bars  
& Work Lights



**10**  
Tuff Guard®  
Grille Guards



**12**  
Tuff Guard XT™  
Grille Guards



**14**  
Tuff Guard II™  
Grille Guards



**16**  
ProTec™  
Grille Guards



**18**  
ProTec Edge™  
Grille Guards



**20**  
Grille Guard  
Brackets



**21**  
Grille Guard  
Accessories



**26**  
Tuff Guard® Van  
Grille Guards

# 3"

# MILESTONE™ BUMPER GUARDS

## KEY FEATURES

Sleek, subtle design contours to the truck bumper for a streamlined fit

Available with or without patented light cage and 30" LED light bar

## Product Details

- Integrated light bar for enhanced visibility and safety on the road
- Patented light cage keeps the light bar protected from theft and the elements
- Channel mount allows light bar to be adjusted and aligned unlike welded tabs
- Low profile for full under-the-hood access without needing to fold down the guard
- 3" diameter, 14-gauge stainless steel tubing for solid front-end protection
- 6mm upright plates provide enhanced strength and a highly secure mount
- Heavy-duty extruded rubber facings shield uprights against scuffs and scratches
- Easy installation with no drilling or front-end modification required
- Limited lifetime warranty (see last page for details)
- Patent# US9108581B2
- [See adjacent page for application information](#)



207800



208805

## Finishes & Materials



**Finish:**  
Polished  
stainless

**Material:**  
Stainless  
steel

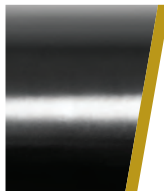

**Finish:**  
Smooth  
black

**Material:**  
Stainless  
steel





2019 Volvo VNL 300



## APPLICATION GUIDE

### MileStone™ Bumper Guards

Make / Model	Years	Kit† (Guard, Brackets, Light Cage and Light Bar)		Guard & Brackets		Light Cage Only†		Light Bar Only*
		Polished#	Black#	Polished#	Black#	Polished#	Black#	Light Bar#
<b>Freightliner</b>								
B2	09 - 20	208775†	208770†	207775	207770	207715†	207710†	391264*
M2 106	09 - 20	208775†	208770†	207775	207770	207715†	207710†	391264*
New Cascadia	18 - 20	208805†	208800†	207805	207800	207715†	207710†	391264*
<b>International</b>								
LT625	17 - 20	208755†	208750†	207755	207750	207715†	207710†	391264*
ProStar	08 - 18	208755†	208750†	207755	207750	207715†	207710†	391264*
<b>Volvo</b>								
VNL	04 - 20	208705†	208700†	207705	207700	207715†	207710†	391264*

\* LED light may require additional wire for proper installation

† Light cage is not compatible with VORAD systems



## MILESTONE™ BUMPER GUARD LIGHT CAGES

- Compatible with all MileStone™ bumper guards
- Channel-style bracket accepts one or multiple light bars up to 30" in total length (see adjacent page for LED lights)
- Helps protect light bar from theft and the elements
- Non-corrosive stainless steel construction in two finish options
- Includes mounting hardware for bolting onto the guard



207715



207710

Part#	Inside Width	Inside Height	Inside Depth	Finish
207715	34-3/8"	4-1/4"	2" (open back)	Polished
207710	34-3/8"	4-1/4"	2" (open back)	Smooth black

## MILESTONE™ BUMPER GUARD LICENSE PLATE BRACKET

- Easily bolts onto the crossbar, using included hardware
- Provides a solid mounting location to keep license plate visible
- Strong steel construction with a durable black powder coat finish
- Includes license plate mounting bolts



207735



Part#	Includes	Finish
207735	Bracket and mounting hardware	Steel with black powder coat

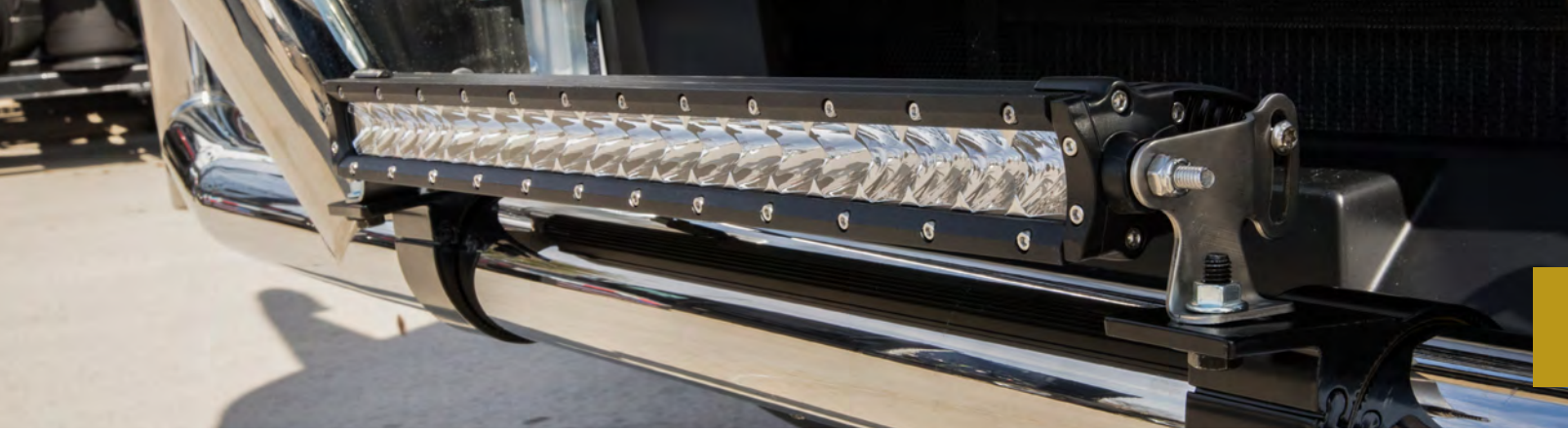

# LED LIGHT BARS & WORK LIGHTS

- Constructed with grade-A, Cree LED chips for superior quality
- IP68 and IP69K waterproof and dustproof ratings to keep water and air from getting trapped inside
- Rust-free aluminum housing with rugged, crack-resistant Lexan lens
- Durable, painted, UV-resistant and mar-resistant finish
- Advanced optics system reduces wasted light for 96% reflector efficiency
- Dual, oversize heat sinks maintain low, efficient running temperatures
- Instant on-off requires no warmup time
- 50,000+ hours average lifespan for five years of continuous use
- Passes CE, RoHS, UV, extreme temperature, vibration, dust and salt testing
- Operates in temperatures from -40°F up to 145°F for extreme conditions
- Fitted with a strong, waterproof wiring harness for a reliable connection
- Includes stainless steel screws and a pivoting bracket for custom angling
- Limited lifetime warranty (see last page for details)



Part#	Light Type	Configuration	Light Size	Beam	Lumens
391252	Work light	Square (set of two)	2"	Spot	2,200
391262	Light bar	Single-row	20"	Combo	9,800
391264	Light bar	Single-row	30"	Combo	14,800

# 3"

# TUFF GUARD® GRILLE GUARDS

## KEY FEATURES

3" diameter, 14-gauge stainless steel tubing for added vehicle protection

Compatible with VORAD systems and fog lights

## Product Details

- Compatible with standard latch or MagLatch™ brackets (both sold separately, see page 20)
- Versatile design fits multiple heavy-duty trucks (brackets vehicle-specific)
- Folds down for convenient access under the hood
- Easy installation with no drilling or front-end modification required
- Limited lifetime warranty (see last page for details)

• See page 22 for application information

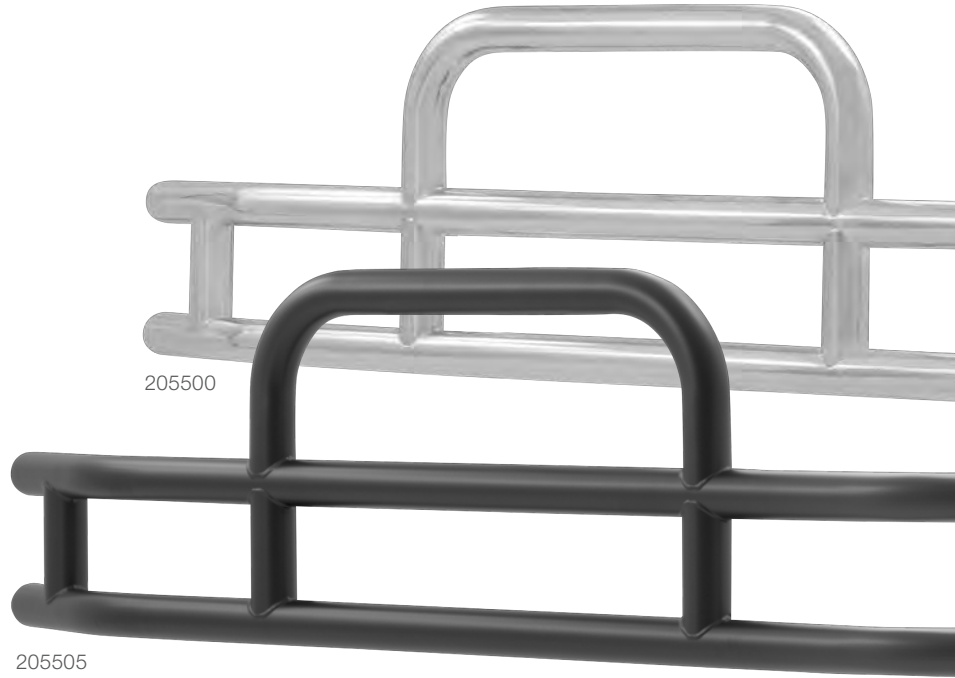

## Finishes & Materials

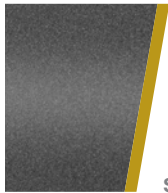

**Finish:**  
Textured  
black

**Material:**  
Stainless  
steel



**Finish:**  
Polished  
stainless

**Material:**  
Stainless  
steel

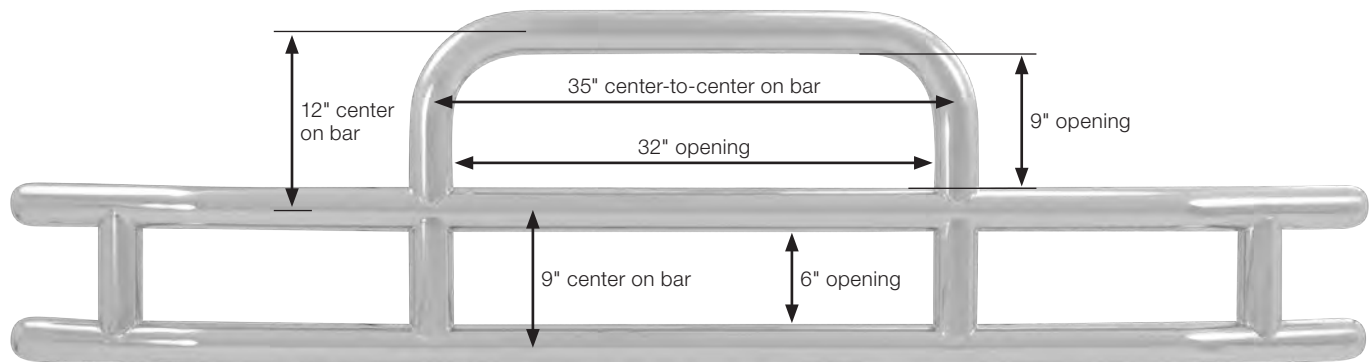



2017 Kenworth T880



2017 Kenworth W900



2019 Volvo VNL 760

# 3"

# TUFF GUARD XT™ GRILLE GUARDS

## KEY FEATURES

3" diameter, 14-gauge stainless steel tubing for added vehicle protection

Taller frame allows compatibility with VORAD systems and fog lights on select applications

## Product Details

- Compatible with standard latch or MagLatch™ brackets (both sold separately, see page 20)
- Versatile design fits multiple heavy-duty trucks (brackets vehicle-specific)
- Folds down for convenient access under the hood
- Easy installation with no drilling or front-end modification required
- Limited lifetime warranty (see last page for details)
- [See page 22 for application information](#)

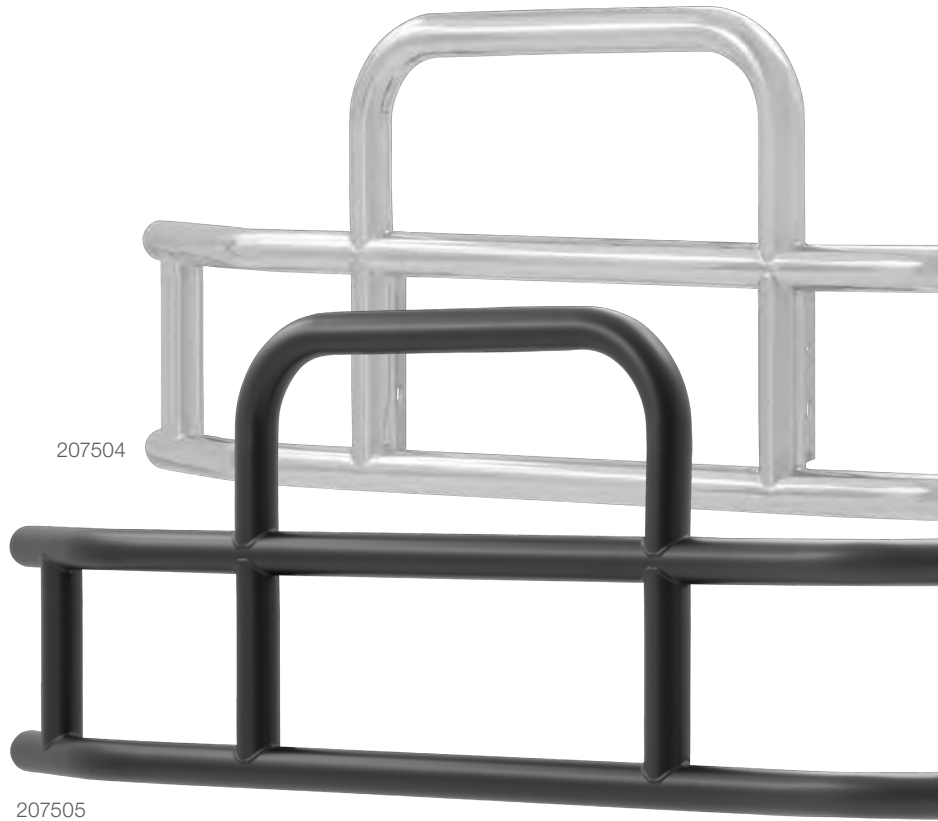

## Finishes & Materials

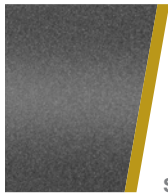

**Finish:**  
Textured  
black

**Material:**  
Stainless  
steel



**Finish:**  
Polished  
stainless

**Material:**  
Stainless  
steel

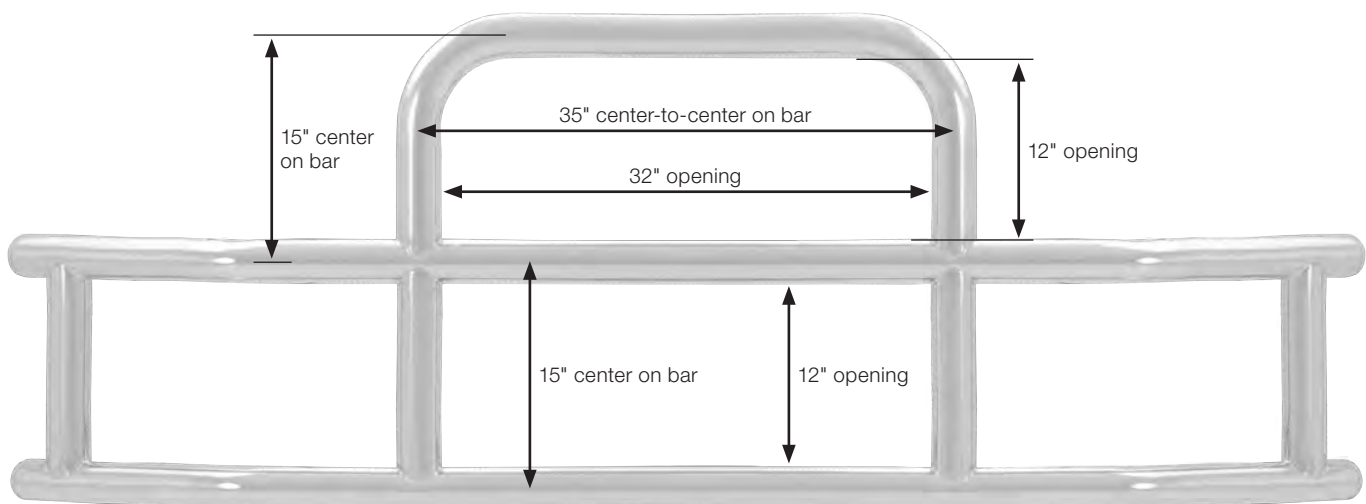



2018 Freightliner Cascadia



2018 Cascadia



2018 Hino 268



2018 Hino 268

# 3"

# TUFF GUARD II™ GRILLE GUARDS

## KEY FEATURES

3" diameter, 14-gauge stainless steel tubing for added vehicle protection

Welded, overlapping tube layout for enhanced strength

## Product Details

- Compatible with VORAD systems and fog lights
- Compatible with standard latch or MagLatch™ brackets (both sold separately, see page 20)
- Versatile design fits multiple heavy-duty trucks (brackets vehicle-specific)
- Folds down for convenient access under the hood
- Easy installation with no drilling or front-end modification required
- Limited lifetime warranty (see last page for details)
- See page 22 for application information

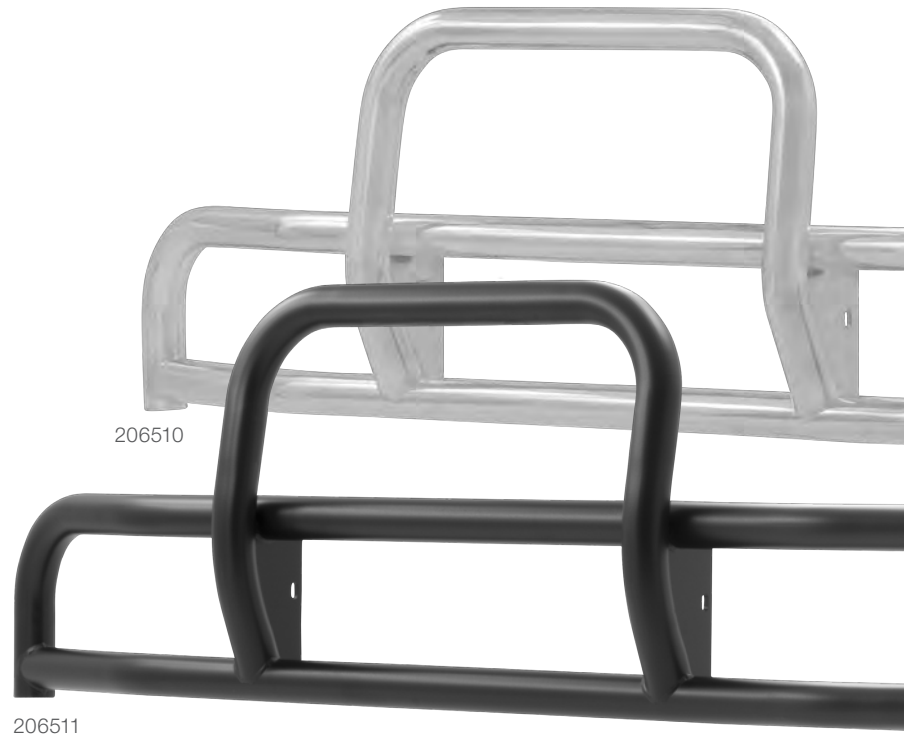

## Finishes & Materials

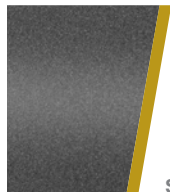

**Finish:**  
Textured black  
**Material:**  
Stainless steel



**Finish:**  
Polished stainless  
**Material:**  
Stainless steel

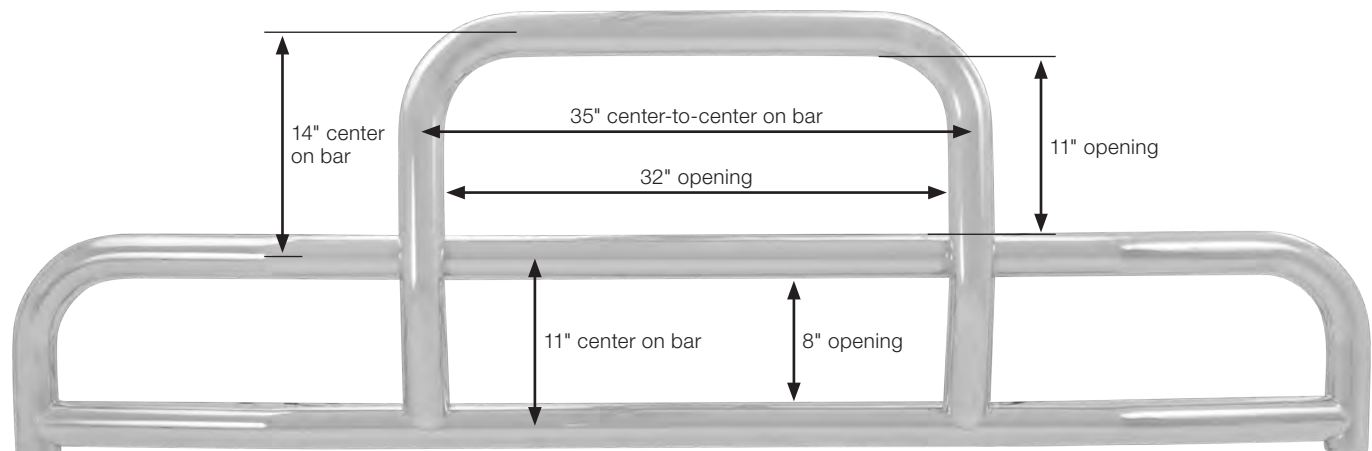





2016 Volvo VNL 860



2019 Mack Anthem



2016 Volvo VNL 4300



2018 Hino 368

# 3"

# PROTEC™ GRILLE GUARDS

## KEY FEATURES

3" diameter, 14-gauge stainless steel tubing for added vehicle protection (11-gauge for carbon steel)

Welded, double-stacked layout protects bumper, grille and lights

## Product Details

- Compatible with VORAD systems and fog lights
- Compatible with standard latch or MagLatch™ brackets (both sold separately, see page 20)
- Versatile design fits multiple heavy-duty trucks (brackets vehicle-specific)
- Folds down for convenient access under the hood
- Easy installation with no drilling or front-end modification required
- Limited lifetime warranty (see last page for details)
- See page 22 for application information



## Finishes & Materials

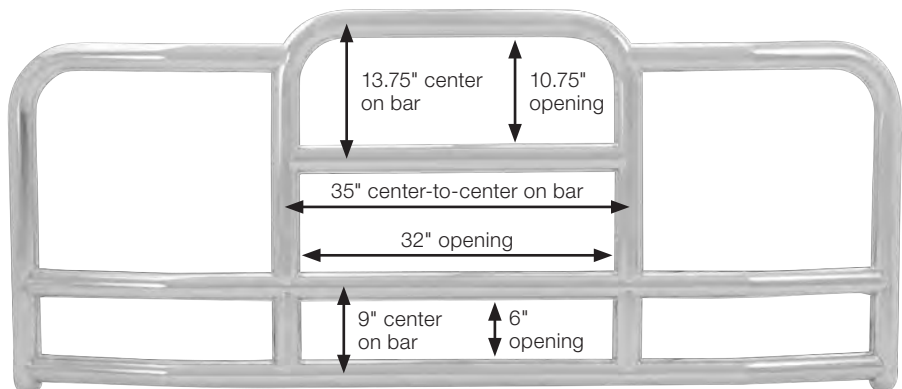
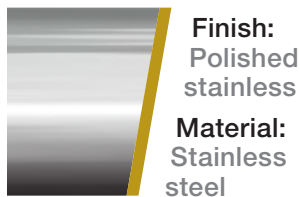
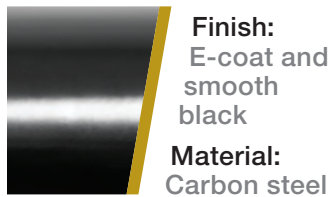



2017 Kenworth W900



2016 Freightliner Cascadia



2018 Volvo VNR 300



2018 Cascadia

# 2 1/2"

# PROTEC EDGE™ GRILLE GUARDS

## KEY FEATURES

2-1/2" diameter, 14-gauge steel tubing for solid front-end strength

Contoured design follows body lines of modern aerodynamic trucks

## Product Details

- Multiple crossbars and curved sides provide superior protection
- Textured, bedliner-type finish with E-coat for exceptional corrosion resistance  
**New polished stainless steel finish option**
- Compatible with standard latch or MagLatch™ brackets (both sold separately, see page 20)
- Versatile design fits multiple heavy-duty trucks (brackets vehicle-specific)
- Compatible with VORAD systems and fog lights (most applications)
- Folds down for convenient access under the hood
- Easy installation with no drilling or front-end modification required
- Limited lifetime warranty (see last page for details)
- **See page 22 for application information**

**NEW**



## Finishes & Materials



**Finish:**  
E-coat and bedliner-type spray

**Material:**  
Carbon steel



**Finish:**  
Polished stainless

**Material:**  
Stainless steel

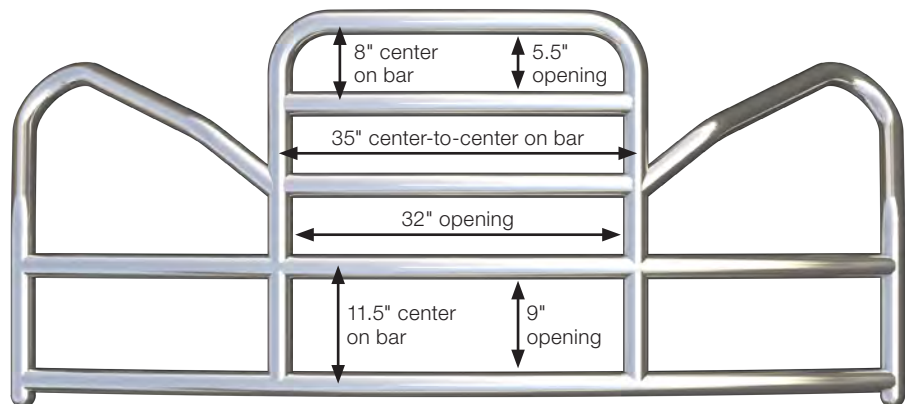



2020 Peterbilt 579



2019 Volvo VNL 300



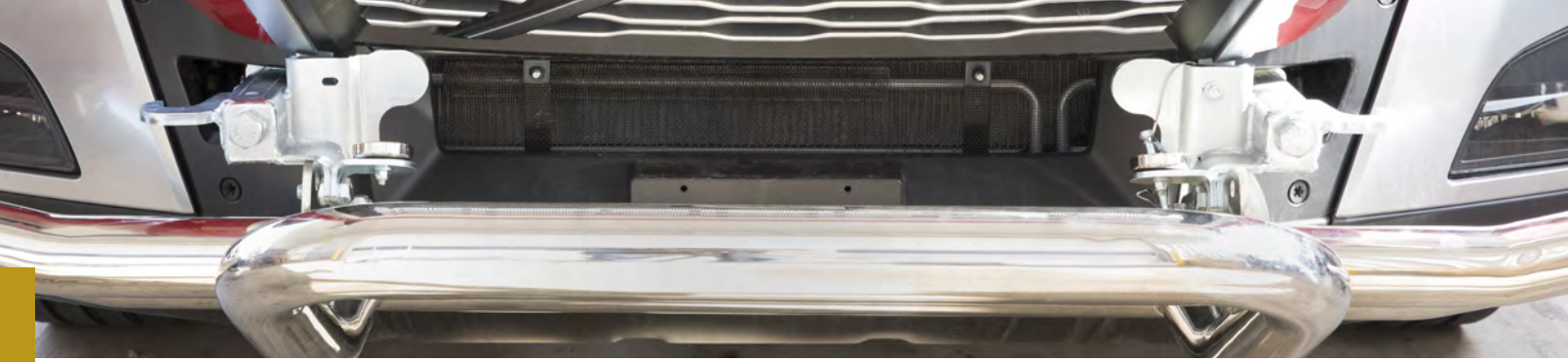

# GRILLE GUARD BRACKETS

See page 22 for application information

## / MagLatch™ Grille Guard Brackets

- Vehicle-specific design with built-in adjustments for an easy, secure, no-drill install
- Fold-down latches use rare-earth magnets to secure grille guard upright
- Included safety pin adds security (see below)
- High-strength steel build with a zinc-plated finish
- Patent# 9,505,364

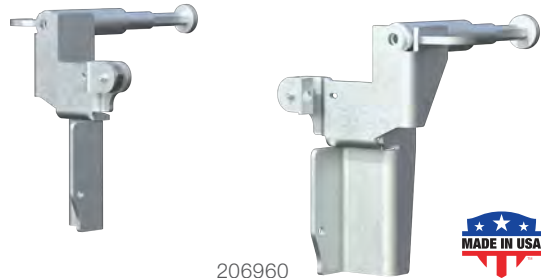

206960



## / MagLatch™ Safety Pins

- Adds security to MagLatch™ bracket magnets while maintaining simple operation
- Zinc-plated finish for lasting rust resistance

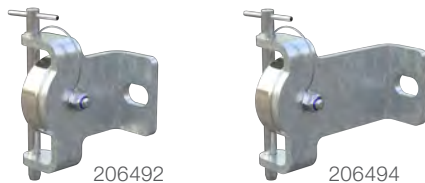

206492

206494



Pin adds security to the magnetic system

Part#	Description
206492	Short latch
206494	Long latch (only fits 206840)

## / Standard Grille Guard Brackets

- Vehicle-specific design for secure, no-drill install
- Fold-down latches use rubber bushings and T-handle locks to secure grille guard upright
- High-strength steel build with a zinc-plated finish



205960



## / Mounting Bracket Spacer Kit

- For select trucks with all-metal bumpers
- Spaces out grille guard mounting brackets for bumper clearance

Part#	Includes	Finish
205696	Four spacers	Zinc-plated steel

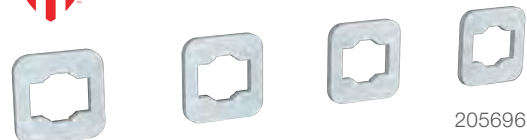

205696



# GRILLE GUARD ACCESSORIES

## / License Plate Bracket

- Universal design fits any RETRAC heavy-duty grille guard
- Provides a solid mounting point to keep license plate visible
- High-strength carbon steel construction with a durable black powder coat finish
- Includes license plate bracket and mounting hardware

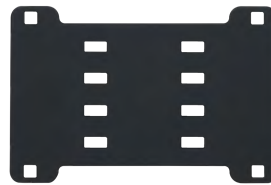

205495



Part#	Finish
205495	Carbon steel with black powder coat

## / 3" Accessory Mounting Tabs

- Fits most RETRAC grille guards or any 3" diameter tube
- 14mm hole for mounting lights, license plate bracket or other accessories
- Rust-free, powder-coated cast aluminum construction
- Includes two tabs and mounting hardware



309102



Part#	Fits	Finish
390102	3" tube diameters	Aluminum with black powder coat

# APPLICATION GUIDE

## Heavy-Duty Grille Guards & Brackets

Make / Model	Style / Notes	Years	Footnotes	Brackets Only	
				MagLatch™#	Standard#
<b>Freightliner</b>					
B2	All	09 - 20	--	206220	--
Business Class M2	All	09 - 12	--	206220	--
Cascadia	Excluding 505 HP or larger	08 - 20	--	206760	205760
Classic	All	01 - 11	--	--	205560
Columbia	Painted 3-piece standard bumper	01 - 20	--	--	205600
Coronado	Glider	01 - 20	--	206120	--
	SD, forward set axle	10 - 20	--	206140	--
	SD, rearward set axle	10 - 20	--	206160	--
M2 106	All	09 - 20	--	206220	--
M2 112	All	09 - 20	--	206220	--
New Cascadia	Excluding fog lights	18 - 20	--	206940	205940
	Excluding radar	18 - 20	--	206960	205960
	With fog lights and radar	18 - 20	--	206960	205960
<b>Hino</b>					
238	All	10 - 14	--	206200	--
258	All	10 - 19	--	206200	--
268	All	10 - 19	--	206200	--
338	All	10 - 20	--	206200	--
<b>International</b>					
4400	All	02 - 19	--	--	205740
8600 TranStar	All	08 - 18	--	--	205740
9200 SBA	All	97 - 00	--	206580	205580*
9200i SBA	All	00 - 11	--	206580	205580*
9400	All	97 - 00	--	206580	205580*
9400i SBA	All	00 - 11	--	206580	205580*
9900	All	99 - 00	--	206100	--
9900i	Excluding fog lights	00 - 18	--	206580	205580*
	With fog lights	00 - 18	--	206100	--
9900i SFA	Excluding fog lights	00 - 03	--	206580	205580*
9900ix	Excluding fog lights	00 - 09	--	206580	205580*
9900ix SFA	Excluding fog lights	01 - 03	--	206580	205580*
Durastar	All	13 - 13	--	--	205740
LT625	All	17 - 20	1	206695	205695
ProStar	All	08 - 18	1	206695	205695
<b>Kenworth</b>					
T600A	All	88 - 07	--	--	205660
T660	All	08 - 18	--	206720	205720
T680	All	13 - 20	--	206840	205840
T700	All	11 - 15	--	206840	205840
T800	All	87 - 20	--	206540	--
T880	All	14 - 20	--	206540	--
W900	Excluding four-bolt bumper	82 - 20	--	206640	--

1. All metal bumpers require kit #205696

\* Continued while supplies last



	Tuff Guard® Guard Only#		Tuff Guard XT™ Guard Only#		Tuff Guard II™ Guard Only#		ProTec™ Guard Only#		ProTec Edge™ Guard Only#	
	Polished#	Black#	Polished#	Black#	Polished#	Black#	Polished#	Black#	Polished#	Black#
										<b>Freightliner</b>
	205504	205505	207504	207505	206510	206511	205517	205518	--	--
	205504	205505	207504	207505	206510	206511	205517	205518	--	--
	205504	205505	--	--	206510	206511	205517	205518	--	--
	205500	205501	--	--	206510	206511	205515	205516	--	--
	205500	205501	--	--	206510	206511	205515	205516	--	--
	205500	205501	--	--	206510	206511	205515	205516	--	--
	205500	205501	--	--	206510	206511	205515	205516	--	--
	205504	205505	207504	207505	206510	206511	205517	205518	--	--
	205504	205505	207504	207505	206510	206511	205517	205518	--	--
	205504	205505	--	--	206510	206511	205517	205518	207525	207520
	--	--	--	--	206510	206511	205517	205518	--	--
	--	--	207504	207505	--	--	--	--	--	--
										<b>Hino</b>
	205504	205505	--	--	206510	206511	205517	205518	--	--
	205504	205505	--	--	206510	206511	205517	205518	--	--
	205504	205505	--	--	206510	206511	205517	205518	--	--
	205504	205505	--	--	206510	206511	205517	205518	--	--
										<b>International</b>
	205504	205505	--	--	206510	206511	205515	205516	--	--
	205504	205505	--	--	206510	206511	205517	205518	--	--
	205500	205501	--	--	206510	206511	205515	205516	--	--
	205500	205501	--	--	206510	206511	205515	205516	--	--
	205500	205501	--	--	206510	206511	205515	205516	--	--
	205500	205501	--	--	206510	206511	205515	205516	--	--
	205500	205501	--	--	206510	206511	205515	205516	--	--
	205500	205501	--	--	206510	206511	205515	205516	--	--
	205500	205501	--	--	206510	206511	205515	205516	--	--
	205500	205501	--	--	206510	206511	205515	205516	--	--
	205504	205505	--	--	206510	206511	205517	205518	--	--
	205504	205505	207504	207505	206510	206511	205517	205518	207525	207520
	205504	205505	207504	207505	206510	206511	205517	205518	207525	207520
										<b>Kenworth</b>
	205504	205505	--	--	206510	206511	205517	205518	--	--
	205504	205505	--	--	206510	206511	205517	205518	--	--
	205504	205505	--	--	206510	206511	205517	205518	207525	207520
	205504	205505	--	--	206510	206511	205517	205518	207525	207520
	205500	205501	207504	207505	206510	206511	205515	205516	207525	207520
	205500	205501	207504	207505	206510	206511	205515	205516	207525	207520
	205500	205501	--	--	206510	206511	205515	205516	--	--

Applications continued on the following page

# APPLICATION GUIDE

## Heavy-Duty Grille Guards & Brackets

Make / Model	Style / Notes	Years	Footnotes	Brackets Only	
				MagLatch™#	Standard#
<b>Mack</b>					
Anthem	All	18 - 20	--	206990	--
CHU	Excluding fog lights	08 - 19	--	206880	205880
	With fog lights	08 - 19	--	206780	205780
CXU	Steel bumper with plastic end caps, excluding fog lights	08 - 19	--	206880	205880
	Steel bumper with plastic end caps, with fog lights	08 - 19	--	206780	205780
<b>Peterbilt</b>					
378	Excluding kick back bumper	88 - 07	--	--	205520
	With kick back bumper	88 - 07	--	--	205520
379	All	87 - 09	--	--	205520
386	All	06 - 16	--	206720	205720
388	Excluding fog lights	08 - 15	--	206820	205820*
389	Excluding fog lights	08 - 20	--	206820	205820*
567		14 - 20	--	206820	205820*
579	All	13 - 20	--	206840	205840
587	All	11 - 18	--	206870	
<b>Volvo</b>					
VNL	Excluding fog lights	18 - 20	--	206180	--
	With fog lights	18 - 20	--	206180	--
	All	04 - 17	--	--	205620
VNM	All	04 - 18	--	--	205620
VNR	Excluding fog lights	18 - 20	--	206180	--
	With fog lights	18 - 20	--	206180	--
VNX	All	15 - 17	--	--	205620
VT	All	06 - 10	--	--	205620
<b>Western Star</b>					
4900SA	Rearward set axle	11 - 18	--	--	205900*
5700XE	Excluding fog lights	16 - 20	--	206940	205940
	With fog lights	16 - 20	--	206940	205940
	Excluding radar	16 - 20	--	206960	205960
	With radar	16 - 20	--	206940	205940
	With fog lights and radar (high mount brackets)	16 - 20	--	206940	205940
	With fog lights and radar (low mount brackets)	16 - 20	--	206960	205960

1. All metal bumpers require kit #205696

\*Continued while supplies last

	Tuff Guard® Guard Only#		Tuff Guard XT™ Guard Only#		Tuff Guard II™ Guard Only#		ProTec™ Guard Only#		ProTec Edge™ Guard Only#	
	Polished#	Black#	Polished#	Black#	Polished#	Black#	Polished#	Black#	Polished#	Black#
<b>Mack</b>										
	205504	205505	--	--	206510	206511	205517	205518	--	--
	205504	205505	--	--	206510	206511	205517	205518	--	--
	205504	205505	--	--	206510	206511	205517	205518	--	--
	205504	205505	--	--	206510	206511	205517	205518	--	--
	205504	205505	--	--	206510	206511	205517	205518	--	--
<b>Peterbilt</b>										
	205500	205501	--	--	206510	206511	205515	205516	--	--
	205504	205505	--	--	206510	206511	205517	205518	--	--
	205500	205501	--	--	206510	206511	205515	205516	--	--
	205504	205505	--	--	206510	206511	205517	205518	--	--
	205500	205501	207504	207505	206510	206511	205515	205516	--	--
	205500	205501	207504	207505	206510	206511	205515	205516	--	--
	205500	205501	--	--	206510	206511	205515	205516	--	--
	205504	205505	--	--	206510	206511	205517	205518	207525	207520
	205504	205505	--	--	206510	206511	205517	205518	--	--
<b>Volvo</b>										
	205504	205505	--	--	206510	206511	205517	205518	207525	207520
	--	--	--	--	206510	206511	205517	205518	207525	207520
	205500	205501	--	--	206510	206511	205515	205516	207525	207520
	205500	205501	--	--	206510	206511	205515	205516	207525	207520
	205504	205505	--	--	206510	206511	205515	205516	--	--
	--	--	--	--	206510	206511	205515	205516	--	--
	--	--	--	--	--	--	--	--	--	--
	205500	205501	--	--	206510	206511	205515	205516	207525	207520
<b>Western Star</b>										
	205504	205505	--	--	206510	206511	205517	205518	--	--
	205504	205505	--	--	206510	206511	205517	205518	207525	207520
	--	--	--	--	--	--	--	--	207525	207520
	--	--	--	--	206510	206511	205517	205518	--	--
	--	--	--	--	--	--	--	--	207525	207520
	--	--	--	--	--	--	--	--	207525	207520
	--	--	207504	207505	--	--	--	--	--	--

# 3"

# TUFF GUARD® VAN GRILLE GUARDS



## KEY FEATURES

Powder-coated stainless steel construction for maximum corrosion resistance

3" diameter, 14-gauge stainless steel tube design for added vehicle protection

## Product Details

- Durable, textured black powder coat for a sleek, professional finish
- Solid, bolt-on installation using pre-existing mounting points (some models may require minor drilling into plastic)
- High-strength steel mounting brackets with a durable black powder coat finish
- Limited lifetime warranty (see last page for details)
- **See adjacent page for application information**



205530

## Finish & Material

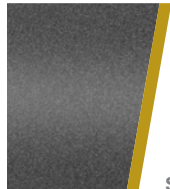

**Finish:**  
Textured black

**Material:**  
Stainless steel

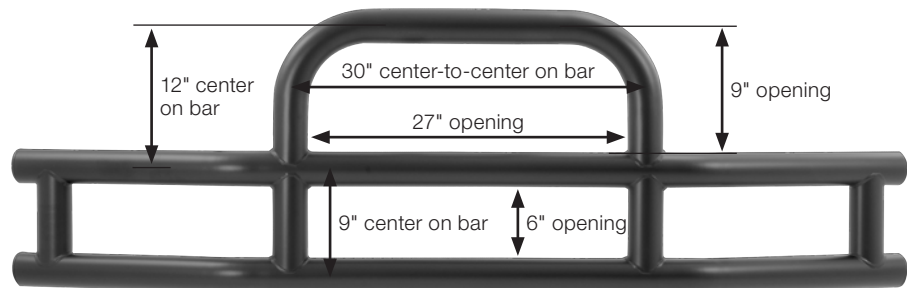

## 3" ACCESSORY MOUNTING TABS

- Fits most RETRAC grille guards or any 3" diameter tube
- 14mm hole for mounting lights, license plate bracket or other accessories
- Rust-free, powder-coated cast aluminum construction
- Includes two tabs and mounting hardware



390102



Part#	Fits	Finish
390102	3" tube diameters	Aluminum with black powder coat



2017 Ford Transit-350HD

# APPLICATION GUIDE

## Tuff Guard® Van Grille Guard and Mounting Brackets

Make / Model	Years	Footnotes	Guard Only	Brackets Only
			Black#	Bracket#
<b>Dodge</b>				
Sprinter 2500	07 - 09	--	205530	205860*
Sprinter 3500	07 - 09	--	205530	205860*
<b>Ford</b>				
Transit-150	15 - 19	--	205530	205920
Transit-250	15 - 19	--	205530	205920
Transit-350	15 - 19	--	205530	205920
<b>Freightliner</b>				
Sprinter 2500	14 - 17	1	205530	205930
	07 - 13	--	205530	205860*
Sprinter 3500	14 - 17	1	205530	205930
	07 - 13	--	205530	205860*
<b>Mercedes-Benz</b>				
Sprinter 2500	14 - 17	1	205530	205930
	10 - 13	--	205530	205860*
Sprinter 3500	14 - 18	1	205530	205930
	10 - 13	--	205530	205860*
<b>Ram</b>				
ProMaster 1500	14 - 20	--	205530	205910
ProMaster 2500	14 - 20	--	205530	205910
ProMaster 3500	14 - 20	--	205530	205910

1. Will interfere with parking sensors

\* Continued while supplies last



# HEAVY-DUTY MIRRORS

**DELIVERING. DEPENDABLE. QUALITY.**

Chevron west coast mirror head

## FEATURED PRODUCTS



### West coast mirror heads

RETRAC offers a wide variety of west coast mirrors to provide the perfect OE replacement for any heavy-duty or medium-duty truck.



### Aerodynamic mirror heads

Engineered to promote maximum efficiency and safety, aerodynamic mirrors feature a sleek design to reduce wind resistance and drag.



### Custom mirror assemblies

These vehicle-specific mirror mounts and heads integrate with the truck design, offering an exact replacement with no drilling required.

## PRODUCT INDEX



**30**

Aerodynamic  
West Coast  
Mirror Heads



**33**

Off-Road  
West Coast  
Mirror Heads



**34**

Pedestal-Mount  
Mirror  
Assemblies



**35**

West Coast  
Mirror Heads



**42**

Custom West  
Coast Mirror  
Assemblies



**43**

Universal  
Mirror  
Assemblies

# AERODYNAMIC WEST COAST MIRROR HEADS

- Aerodynamic head design for reduced drag and wind resistance
- Original equipment, west coast style to provide a perfect OEM replacement
- Universal clamp easily attaches to any 3/4" to 1-1/4" diameter tube
- Flat mirror provides an extra-wide view to minimize blind spots
- First-surface electro-chrome glass eliminates glare for maximum safety
- Motorized glass angles horizontally and vertically with 4-way actuator (select models)
- Automated smart heater evenly defrosts glass to maintain visibility (select models)
- Marker light provides additional safety by signaling other drivers (select models)
- Injection-molded ABS plastic available in bright chrome or **paintable black**



Convex aerodynamic mirrors available, see page 46

Part#	Flat Glass Size (W x H)	Convex Glass Size (W x H)	Finish	Adjustable Glass	Heated	Lighted
<b>Single-Vision</b>						
610872	8" x 17"	--	Black	Not adjustable	No	No
610873	8" x 17"	--	Black	Not adjustable	Yes	No
610878	8" x 17"	--	Chrome	Not adjustable	No	No
610879	8" x 17"	--	Chrome	Not adjustable	Yes	No
613410	8" x 19"	--	Black	Motorized	No	No
613412	8" x 19"	--	Black	Motorized	Yes	No
613414	8" x 19"	--	Black	Motorized	Yes	Yes
613510	8" x 19"	--	Black	Manual	No	No
613512	8" x 19"	--	Black	Manual	Yes	No
613411	8" x 19"	--	Chrome	Motorized	No	No
613413	8" x 19"	--	Chrome	Motorized	Yes	No
613415	8" x 19"	--	Chrome	Motorized	Yes	Yes
613511	8" x 19"	--	Chrome	Manual	No	No
613513	8" x 19"	--	Chrome	Manual	Yes	No
613515	8" x 19"	--	Chrome	Manual	Yes	Yes
<b>Dual-Vision</b>						
613420	7" x 13-1/2"	7" x 4-1/2"	Black	Motorized	No	No
613422	7" x 13-1/2"	7" x 4-1/2"	Black	Motorized	Yes	No
613424	7" x 13-1/2"	7" x 4-1/2"	Black	Motorized	Yes	Yes
613520	7" x 13-1/2"	7" x 4-1/2"	Black	Manual	No	No
613522	7" x 13-1/2"	7" x 4-1/2"	Black	Manual	Yes	No
613524	7" x 13-1/2"	7" x 4-1/2"	Black	Manual	Yes	Yes
613421	7" x 13-1/2"	7" x 4-1/2"	Chrome	Motorized	No	No
613423	7" x 13-1/2"	7" x 4-1/2"	Chrome	Motorized	Yes	No
613425	7" x 13-1/2"	7" x 4-1/2"	Chrome	Motorized	Yes	Yes
613521	7" x 13-1/2"	7" x 4-1/2"	Chrome	Manual	No	No
613523	7" x 13-1/2"	7" x 4-1/2"	Chrome	Manual	Yes	No
613525	7" x 13-1/2"	7" x 4-1/2"	Chrome	Manual	Yes	Yes



# AERODYNAMIC WEST COAST MIRROR HEADS

See page 32 for replacement glass



610873



610879



613410  
613412  
613512  
front



613420  
613422  
613424  
613522  
613524  
front



613410  
613412  
613512  
613420  
613422  
613522  
back



613414  
613514  
613424  
613524  
back



613411  
613413  
613414  
613415  
613513  
613515  
front



613421  
613423  
613425  
613523  
613525  
front



613411  
613413  
613513  
613421  
613423  
613523  
back



613415  
613515  
613425  
613525  
back



613510  
front



613520  
front



613510 and 613520  
back



613511  
front



613521  
front



613511 and 613521  
back



## AERODYNAMIC WEST COAST MIRROR HEAD REPLACEMENT GLASS

- Flat mirror provides an extra-wide view to minimize blind spots
- Convex glass provides a wide view of blind spots
- First-surface electro-chrome glass eliminates glare for maximum safety
- Compatible with heated and non-heated mirrors (unless specified)



613474



613495



613496



613465



610885 (heated)  
610884 (not heated)



613460

Part#	Description	Heated	Flat Glass Size (W x H)	Convex Glass Size (W x H)
<b>Single-Vision</b>				
613465†	Flat glass	Yes	8" x 19"	--
610885	Flat glass	Yes	8" x 17"	--
610884	Flat glass	No	8" x 17"	--
<b>Dual-Vision</b>				
613474†	Flat and convex glass kit	Yes	7" x 13-1/2"	7" x 4-1/2"
613495†	Flat glass	Yes	7" x 13-1/2"	--
613496†	Convex glass	Yes	--	7" x 4-1/2"
<b>Replacement Switch</b>				
613460	4-way actuator switch for single- and dual-vision mirrors			

† Compatible with heated and non-heated mirrors

# OFF-ROAD WEST COAST MIRROR HEADS

- Shatterproof glass ideal for agricultural, mining and military applications
- E-stamped approved and certified
- Universal clamp sizes to easily mount onto an existing loop
- Semi-convex mirror provides an extra-wide view to minimize blind spots
- First-surface electro-chrome glass eliminates glare for maximum safety
- Black injection-molded ABS plastic can be painted to match any vehicle



611770



611773



610295



611774



610290

Part#	Glass Size (W x H)	Finish	Vision Type	Fits Tube
611770	7" x 9"	Black ABS plastic	Single-vision	5/8" to 7/8"
611773	7" x 9"	Black ABS plastic	Single-vision	1" to 1-1/8"
610295	8" x 16"	Black ABS plastic	Single-vision	5/8" to 3/4"
610290	9" x 17"	Black ABS plastic	Single-vision	5/8" to 7/8"
611774	9" x 17"	Black ABS plastic	Single-vision	1" to 1-1/8"

# PEDESTAL-MOUNT MIRROR ASSEMBLIES

- No-drill, vehicle-specific design to perfectly match the factory holes
- Aerodynamic head design for reduced drag and wind resistance
- Motorized glass angles vertically and horizontally with 4-way actuator (switch not included)
- Automated smart heater evenly defrosts glass to maintain visibility
- Computer-printed heating element self-regulates based on ambient temperatures
- Flat mirror provides a wide view to minimize blind spots
- First-surface electro-chrome glass eliminates glare for maximum safety
- Chrome injection-molded ABS plastic construction for a bright, rust-free accent



Convex glass helps eliminate blind spots for safer maneuvering



No-drill, vehicle-specific design to perfectly match the factory holes



612165



612167

## Pedestal-Mount Mirror Assemblies

Make / Model	Style	Years	Flat Glass Size (W x H)	Convex Glass Size (W x H)	Motorized	Heated	Vision Type	Driver / Left Part#	Passenger / Right Part#
<b>Freightliner</b>									
Cascadia	113	09 - 19	7" x 12-1/2"	7" x 5"	Yes	Yes	Dual-vision	612165	612166
			--	8" x 6"	No	No	Single-vision	612167	612168
	125	08 - 19	7" x 12-1/2"	7" x 5"	Yes	Yes	Dual-vision	612165	612166
			--	8" x 6"	No	No	Single-vision	612167	612168

# MOTORIZED WEST COAST MIRROR HEADS

- Motorized glass angles vertically and horizontally with 4-way actuator
- Universal mounts attach to all standard loops
- Fits most class 8 trucks
- Automated smart heater evenly defrosts glass to maintain visibility (select models)
- First-surface electro-chrome glass eliminates glare for maximum safety
- Stamped metal construction with rigid mounts to reduce vibrations
- Includes 14' electrical cord and switch for motorized adjustment



Marker light provides additional safety by signaling other drivers (select models)



Motorized glass angles vertically and horizontally with 4-way actuator



613460



Single vision front



Dual vision front



607002  
607004  
607012  
607014  
back



607008  
607018  
back

Part#	Flat Glass Size (W x H)	Convex Glass Size (W x H)	Finish	Vision Type	Heated	Lighted
<b>Mirror Heads</b>						
607002	7" x 16"	--	Polished stainless	Single-vision	No	No
607004	7" x 16"	--	Polished stainless	Single-vision	Yes	No
607008	7" x 16"	--	Polished stainless	Single-vision	Yes	Yes
607012	7" x 16"	6-1/4" x 4"	Polished stainless	Dual-vision	No	No
607014	6-1/4" x 10-3/4"	6-1/4" x 4"	Polished stainless	Dual-vision	Yes	No
607018	6-1/4" x 10-3/4"	6-1/4" x 4"	Polished stainless	Dual-vision	Yes	Yes
<b>Replacement Switch</b>						
613460	4-way actuator switch for single- and dual-vision mirrors					

# ECONOMY WEST COAST MIRROR HEADS

- Universal mounts easily attach to all standard loops
- Original equipment, west coast style to fit most class 8 trucks
- Flat mirror provides a wide view to help minimize blind spots
- Stamped aluminum construction to be strong, lightweight and rust-free

Part#	Bulk 10-Pack#	Glass Size (W x H)	Finish	Vision Type
610321	--	6" x 16"	Brushed aluminum	Single-vision
--	610278	6" x 16"	Brushed aluminum with black plastic end caps	Single-vision



610321

610278  
back



## CHEVRON WEST COAST MIRROR HEADS

- Bright chevrons add style and visibility to the vehicle
- Universal flange mounts easily attach to all standard loops and swedged loops
- Automated smart heater evenly defrosts glass to maintain visibility (select models)
- Marker light provides additional safety by signaling other drivers (select models)
- Flat mirror provides a wide view to help minimize blind spots
- First-surface electro-chrome glass eliminates glare for maximum safety



Part#	Flat Glass Size (W x H)	Convex Glass Size (W x H)	Finish	Vision Type	Heated	Lighted
<b>Yellow Chevron Style</b>						
600932	6" x 16"	--	Anodized aluminum	Single-vision	No	No
600960	6" x 16"	--	Anodized aluminum	Single-vision	Yes	No
601010*	6" x 16"	--	Anodized aluminum	Single-vision	Yes	Yes
601017	6" x 12"	6" x 4"	Anodized aluminum	Dual-vision	No	No
<b>Embossed Chevron Style</b>						
601142	6" x 16"	--	Anodized aluminum	Single-vision	No	No
601250	6" x 16"	--	Anodized aluminum	Single-vision	Yes	Yes



\* Continued while supplies last



## RIB-BACK & BUBBLE-BACK WEST COAST MIRROR HEADS

- Universal stud mounts easily attach to all standard loops
- Built-in heater evenly defrosts glass to maintain visibility (select models)
- Flat mirror provides a wide view to help minimize blind spots



610226  
rib back



610216  
rib back



610221  
rib back



610236  
rib back



610256  
bubble back



610246  
bubble back



610266  
bubble back

Part#	Glass Size (W x H)	Finish	Vision Type	Heated
<b>Rib-Back Style</b>				
610226	7" x 16"	Polished stainless	Single-vision	No
610231	7" x 16"	Polished stainless	Single-vision	Yes
610216	7" x 16"	Carbon steel with black enamel	Single-vision	No
610221	7" x 16"	Carbon steel with black enamel	Single-vision	Yes
610236	7" x 16"	Carbon steel with white enamel	Single-vision	No
<b>Bubble-Back Style</b>				
610256	7" x 16"	Polished stainless	Single-vision	No
610246	7" x 16"	Carbon steel with black enamel	Single-vision	No
610266	7" x 16"	Carbon steel with white enamel	Single-vision	No
610271*	7" x 16"	Carbon steel with white enamel	Single-vision	Yes



610271  
bubble  
back

\* Continued while supplies last



## PYRAMID-BACK WEST COAST MIRROR HEADS

- Universal stud mounts easily attach to all standard loops
- Automated smart heater evenly defrosts glass to maintain visibility (select models)
- Flat mirror provides a wide view to help minimize blind spots
- First-surface electro-chrome glass eliminates glare for maximum safety



Large corner radius with stud mount



Small corner radius with flange mount

Part#	Glass Size (W x H)	Finish	Vision Type	Heated	Lighted
<b>Rounded Housing (Large Corner Radius)</b>					
605403	7" x 16"	Polished stainless	Single-vision	No	No
610331	7" x 16"	Polished stainless	Single-vision	No	No
610204	7" x 16"	Polished stainless	Single-vision	Yes	No
610336	7" x 16"	Polished stainless	Single-vision	Yes	No
605409†	7" x 16"	Polished stainless	Single-vision	Yes	No
605448‡	7" x 16"	Polished stainless	Single-vision	Yes	No
610351	7" x 16"	Carbon steel with black powder coat	Single-vision	No	No
<b>Straight Housing (Small Corner Radius)</b>					
600807	7" x 16"	Polished stainless	Single-vision	No	No
600835	7" x 16"	Polished stainless	Single-vision	Yes	No
600682	7" x 16"	Carbon steel with white powder coat	Single-vision	No	No
600710*	7" x 16"	Carbon steel with white powder coat	Single-vision	Yes	No
600685	7" x 16"	Carbon steel with black powder coat	Single-vision	No	No

† #605409 includes GM-specific wiring harness (29" wire length)

‡ #605448 includes Isuzu-specific wiring harness (42.37" wire length)

\* Continued while supplies last



# PYRAMID-BACK WEST COAST MIRROR HEADS



605403



610204



GM plug  
(29" wire)

605409



610331



610336



Isuzu plug  
(42.37" wire)

605448



610351



600682



600807



600685



600710



600835



## ANGLE-BACK WEST COAST MIRROR HEADS

- Universal stud mounts easily attach to all standard loops
- Built-in heater evenly defrosts glass to maintain visibility (select models)
- Flush-mount marker light provides additional safety by signaling other drivers (select models)
- Flat mirror provides a wide view to help minimize blind spots
- First-surface electro-chrome glass eliminates glare for maximum safety



Small corner radius with contoured end cap



Square corner with flat end cap

Part#	Flat Glass Size (W x H)	Convex Glass Size (W x H)	Finish	Vision Type	Heated	Lighted
<b>Straight Housing (Small Corner Radius)</b>						
605400	7" x 16"	--	Black ABS plastic	Single-vision	No	No
601272	7" x 16"	--	Polished stainless	Single-vision	No	No
601285	7" x 16"	--	Polished stainless	Single-vision	Yes	No
601288	7" x 16"	--	Polished stainless	Single-vision	Yes	Yes
601268	6" x 10"	6" x 4"	Polished stainless	Dual-vision	No	No
601274	6" x 10"	6" x 4"	Polished stainless	Dual-vision	Yes	No
<b>Square Housing (Square Corner)</b>						
601292	6" x 16"	--	Polished stainless	Single-vision	No	No
610301	7" x 16"	--	Polished stainless	Single-vision	No	No
610311	7" x 16"	--	Polished stainless	Single-vision	No	Yes
601305	6" x 16"	--	Polished stainless	Single-vision	Yes	No
610306	7" x 16"	--	Polished stainless	Single-vision	Yes	No
610316	7" x 16"	--	Polished stainless	Single-vision	Yes	Yes

# ANGLE-BACK WEST COAST MIRROR HEADS





# CUSTOM WEST COAST MIRROR ASSEMBLIES

- Patented retractable assembly for added clearance whenever needed
- Universal 5/16" studs easily attach the mirror head to the loop
- Stainless steel, 7" x 16" flat mirror provides a wide view to help minimize blind spots (excluding #611786, #611788)
- First-surface electro-chrome glass eliminates glare for maximum safety
- Mounting assembly constructed from rust-free, polished stainless steel
- Includes mounting hardware

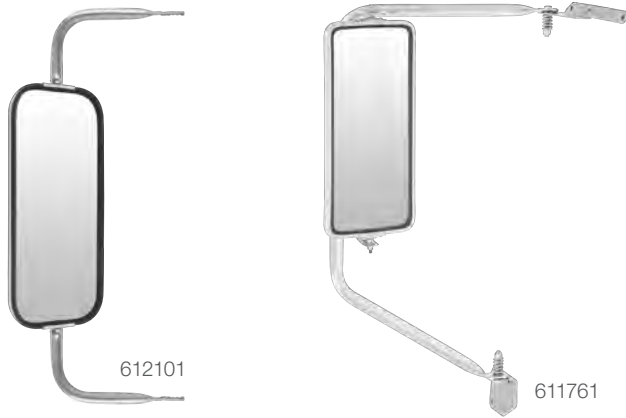

## Custom West Coast Mirror Assemblies

Make / Model	Style	Foot Notes	Years	Driver-Side#	Pass-Side#
<b>Ford</b>					
F600	--	--	70 - 94	605051	605053
F700	--	--	70 - 98	605051	605053
F7000	--	--	70 - 87	605051	605053
L800	--	--	80 - 85	605051	605053
L8000	--	--	81 - 88	605051	605053
L9000	--	--	81 - 97	605051	605053
<b>Freightliner</b>					
FL106	--	--	94 - 03	612116	612118
FL112	Base	--	96 - 03	612116	612118
FL50	--	--	95 - 05	612116	612118
FL60	--	--	92 - 04	612116	612118
FL70	--	--	93 - 05	612116	612118
FL80	--	--	93 - 06	612116	612118
FLD112	--	--	91 - 06	612101	612103
FLD120	--	--	89 - 11	612101	612103
FLD120SD	--	--	03 - 12	612101	612103
FLD132	--	--	01 - 11	612101	612103

1. Mirror head not included

## Custom West Coast Mirror Assemblies

Make / Model	Style	Foot Notes	Years	Driver-Side#	Pass-Side#
<b>International</b>					
4200	--	1	02 - 10	611786	611788
		--	02 - 10	611761	611763
4300 - 4400	--	1	02 - 18	611786	611788
		--	02 - 18	611761	611763
4700	--	1	01 - 08	611786	611788
		--	01 - 08	611761	611763
7300 / 7400 / 7500	--	1	02 - 18	611786	611788
		--	02 - 18	611761	611763
7600	--	1	03 - 17	611786	611788
		--	03 - 17	611761	611763
7700	--	1	05 - 07	611786	611788
		--	05 - 07	611761	611763
8500	--	1	02 - 07	611786	611788
		--	02 - 07	611761	611763
S-Series	--	--	80 - 80	603515	603516
<b>Mack</b>					
CH	--	--	89 - 05	611781	611783
CHN	--	--	06 - 07	611781	611783
CHU	--	--	08 - 18	611781	611783

1. Mirror head not included



## UNIVERSAL CONVENTIONAL MIRROR ASSEMBLY

- Universal design fits a wide variety of heavy-duty applications
- Patented retractable assembly for added clearance whenever needed
- Universal stud mounts easily attach the mirror head to the loop
- 7" x 16" flat mirror provides a wide view to help minimize blind spots
- First-surface electro-chrome glass eliminates glare for maximum safety
- Polished stainless steel construction for a bright, rust-free accent
- Includes mirror head, mounting assembly and hardware
- Fits driver side or passenger side

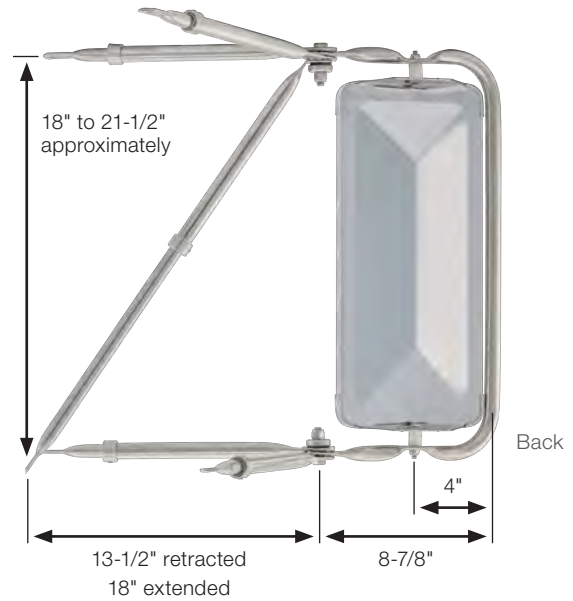

Part#	Glass Size (W x H)	Finish
603862	7" x 16"	Polished stainless



## UNIVERSAL CABOVER MIRROR ASSEMBLY

- Universal design fits a wide variety of heavy-duty applications
- Patented retractable assembly for added clearance whenever needed
- Vertically adjustable to fit 20" to 34" window and door sizes
- Universal clamp mounts easily attach the mirror head to the loop
- 7" x 16" flat mirror provides a wide view to help minimize blind spots
- First-surface electro-chrome glass eliminates glare for maximum safety
- Polished stainless steel construction for a bright, rust-free accent
- Includes mirror head, mounting assembly and hardware
- Fits driver side or passenger side

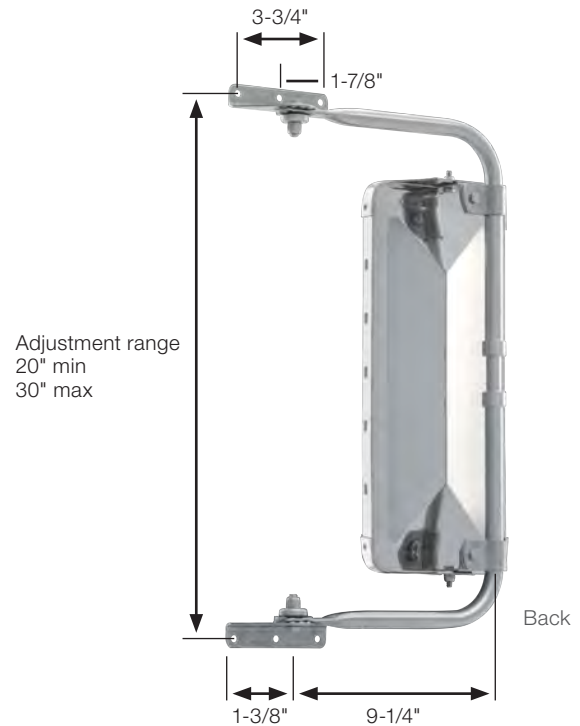

Part#	Glass Size (W x H)	Finish
603890	7" x 16"	Polished stainless



# CONVEX & SAFETY MIRRORS

**DELIVERING. DEPENDABLE. QUALITY.**

Offset-mount convex mirror and safety assembly

## FEATURED PRODUCTS



### | Safety mirror assemblies

With a universal design, these assemblies allow our safety mirrors to be mounted on a variety of trucks, adding visibility on the road.



### | Offset-mount mirror heads

The offset mounting option provides an extended view and wider range of adjustment for maximum visibility of blind spots.



### | Center-mount mirror heads

Center-mount safety mirrors offer enhanced vibration resistance, and most are available with a plastic ball stud for greater weather resistance.

## PRODUCT INDEX



**46**

Aerodynamic  
Mirror Heads



**47**

Bubble  
Mirror Heads



**48**

Center-Mount  
Mirror Heads



**50**

Offset-Mount  
Mirror Heads



**52**

Rectangular  
Mirror Heads



**52**

Stick-On  
Mirrors



**53**

Rectangular  
Utility Mirror  
Assembly



**53**

Look-Down  
Mirror  
Assemblies



**54**

Safety Mirror  
Assemblies



**55**

Rear-Mount  
Safety Mirror  
Assemblies

# AERODYNAMIC CONVEX MIRROR HEADS

- Aerodynamic head design for reduced drag and wind resistance
- Original equipment style to provide a perfect OEM replacement
- Universal clamp easily attaches to any 3/4" to 1-1/4" diameter tube
- Automated smart heater evenly defrosts glass to maintain visibility (select models)
- Convex glass helps eliminate blind spots for safer maneuvering
- First-surface electro-chrome glass eliminates glare for maximum safety
- Injection-molded ABS plastic available in bright chrome or paintable black



Part#	Glass Size (W x H)	Finish	Heated
<b>Mirror Heads</b>			
610875	8" x 8-1/2"	Black	--
610876	8" x 8-1/2"	Black	Yes
610881	8" x 8-1/2"	Chrome	--
610882	8" x 8-1/2"	Chrome	Yes
<b>Replacement Glass</b>			
610886	8" x 8-1/2"	--	--
610887	8" x 8-1/2"	--	Yes







## BUBBLE MIRROR HEADS

- Bubble glass helps eliminate blind spots for safer maneuvering
- Center-mount ball stud for added stability and easy tilt adjustment
- Plastic ball stud will never rust and will not crack the mirror backing (select models)
- Vibration-tested and salt-spray-tested for a minimum of 360 hours to ensure long life



609955  
semi-bubble



610775  
full bubble



604947  
semi-bubble



609955



609965



610775



610750



604945



604946



604953



604954



604947

Part#	Glass Diameter	Finish	Bubble Depth	J-Bracket Included	Ball Stud
609955	8"	Polished stainless	Semi-bubble	--	Metal
609965	8"	Polished stainless	Semi-bubble	--	Plastic
610775	8"	Polished stainless	Full bubble	--	Metal
610750	8"	Carbon steel with black powder coat	Full bubble	--	Metal
604945	10"	Black plastic	Semi-bubble	--	Plastic
604946	10"	White plastic	Semi-bubble	--	Plastic
604953	10"	Polished stainless	Semi-bubble	--	Metal
604954*	10"	Carbon steel with black powder coat	Semi-bubble	--	Metal
604947	12"	Black plastic	Semi-bubble	--	Plastic

\* Continued while supplies last



## CENTER-MOUNT CONVEX MIRROR HEADS

- Center-mount ball stud allows for added stability and easy tilt adjustment
- Convex glass helps eliminate blind spots for safer maneuvering
- Built-in heater evenly defrosts glass to maintain visibility (select models)
- Plastic ball stud will never rust and will not crack the mirror backing (select models)
- Vibration-tested and salt-spray-tested for a minimum of 360 hours to ensure long life

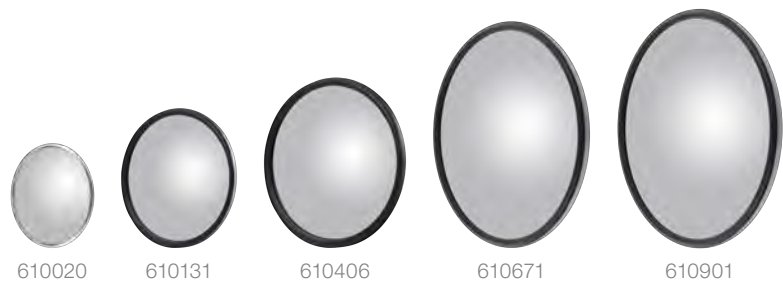

Part#	Glass Diam.	Finish	Heated	Brkt. Incl.	Ball Stud
610020	3-3/4"	Brushed aluminum	--	--	Metal
610146	5"	Polished stainless	--	--	Metal
610148	5"	Polished stainless	--	Yes	Metal
604950	5"	Brushed aluminum	--	--	Metal
610076*	5"	Brushed aluminum	--	--	Metal
610131	5"	Carbon steel with black powder coat	--	--	Metal
610133	5"	Carbon steel with black powder coat	--	Yes	Metal
610401	6"	Polished stainless	--	--	Plastic
610191	6"	Polished stainless	--	--	Metal
610403	6"	Polished stainless	--	Yes	Plastic
610193	6"	Polished stainless	--	Yes	Metal
610176	6"	Anodized aluminum	--	--	Metal
610178	6"	Anodized aluminum	--	Yes	Metal
610161	6"	Aluminum with black powder coat	--	--	Metal
610406	6"	Carbon steel with black powder coat	--	--	Metal
610408	6"	Carbon steel with black powder coat	--	Yes	Metal

\* Continued while supplies last

Part#	Glass Diam.	Finish	Heated	Brkt. Incl.	Ball Stud
604976	7-1/2"	Polished stainless	--	--	Metal
604978	7-1/2"	Polished stainless	--	Yes	Metal
609816	7-1/2"	Polished stainless	--	--	Plastic
609818	7-1/2"	Polished stainless	--	Yes	Plastic
604983	7-1/2"	Carbon steel with black powder coat	--	Yes	Metal
604895	8"	Polished stainless	Yes	--	Plastic
604898	8"	Polished stainless	--	--	Plastic
610671	8"	Polished stainless	--	--	Metal
610673	8"	Polished stainless	--	Yes	Metal
610703	8"	Polished stainless	--	Yes	Plastic
610676	8"	Polished stainless	Yes	--	Metal
610711	8"	Carbon steel with black powder coat	--	--	Metal
604913*	8"	Carbon steel with black powder coat	--	--	Plastic
610713	8"	Carbon steel with black powder coat	--	Yes	Metal
610743	8"	Carbon steel with black powder coat	--	Yes	Plastic
610901	8-1/2"	Polished stainless	--	Yes	Metal

\* Continued while supplies last

# CENTER-MOUNT CONVEX MIRROR HEADS



610020



610146



610148



604950



610076



610131



610133



610401



610191



610403



610193



610176



610178



610161



610406



610408



604976



604978



609816



609818



604983



604895



604898



610671



610673



610703



610676



610711



604913



610713



610743



610901

**NEW**



## OFFSET-MOUNT CONVEX MIRROR HEADS

- Offset ball stud provides a wider view with easy tilt adjustment
- Convex glass helps eliminate blind spots for safer maneuvering
- Built-in heater evenly defrosts glass to maintain visibility (select models)
- Plastic ball stud will never rust and will not crack the mirror backing (select models)
- Vibration-tested and salt-spray-tested for a minimum of 360 hours to ensure long life



609841



610556



609936

Part#	Glass Diameter	Finish	Heated	J-Bracket Included	Ball Stud
609876	7-1/2"	Polished stainless	--	--	Plastic
609836	7-1/2"	Polished stainless	--	--	Metal
609878	7-1/2"	Polished stainless	--	Yes	Plastic
609838	7-1/2"	Polished stainless	--	Yes	Metal
609841*	7-1/2"	Carbon steel with black powder coat	--	--	Metal
609843	7-1/2"	Carbon steel with black powder coat	--	Yes	Metal
604798	8"	Polished stainless	--	--	Plastic
610551	8"	Polished stainless	--	--	Metal
610583	8"	Polished stainless	--	Yes	Plastic
610553	8"	Polished stainless	--	Yes	Metal
604793	8"	Polished stainless	Yes	--	Plastic
610556	8"	Polished stainless	Yes	--	Metal
604827	8"	Carbon steel with black powder coat	--	--	Plastic
610591	8"	Carbon steel with black powder coat	--	--	Metal
610623	8"	Carbon steel with black powder coat	--	Yes	Plastic
610596	8"	Carbon steel with black powder coat	Yes	--	Metal
609936	8-1/2"	Polished stainless	--	--	Plastic
609896	8-1/2"	Polished stainless	--	--	Metal
609938	8-1/2"	Polished stainless	--	Yes	Plastic
609898	8-1/2"	Polished stainless	--	Yes	Metal
609946	8-1/2"	Polished stainless	Yes	--	Plastic
609901*	8-1/2"	Carbon steel with black powder coat	--	--	Metal
609903	8-1/2"	Carbon steel with black powder coat	--	Yes	Metal

\* Continued while supplies last

# OFFSET-MOUNT CONVEX MIRROR HEADS



609876



609836



609878



609838



609841



609843



604798



610551



610583



610553



604793



610556



604827



610591



610623



610596



609936



609896



609938



609898



609946



609901



609903

# RECTANGULAR CONVEX MIRROR HEADS

- Center-mount ball stud for added stability and easy tilt adjustment (select models)
- Convex glass helps eliminate blind spots for safer maneuvering
- Vibration-tested and salt-spray-tested for a minimum of 360 hours to ensure long life



Part#	Glass Diameter (W x H)	Finish	Ball Stud
610450	5-1/2" x 7-1/2"	Stainless steel	Metal
610465	5-1/2" x 7-1/2"	Aluminum with black powder coat	Metal
610456	5-1/2" x 7-1/2"	Anodized aluminum	Metal
604778*	5-1/2" x 7-1/2"	Anodized aluminum	--

\* Continued while supplies last

# STICK-ON CONVEX MIRRORS

- Convex glass helps eliminate blind spots for safer maneuvering
- Tape backing allows for fast, easy installation on existing mirrors
- Double-sided, water-resistant tape to easily outlast the elements



Part#	Glass Size (W x H)	Style	Finish
610851	2" x 1"	Wedge	Black ABS plastic
610854*	3-3/4" x 2-1/2"	Wedge	Black ABS plastic
604770	5-1/4" x 4"	Rectangular	Black ABS plastic
604771	2" diameter	Round	Stamped aluminum
604772	3" diameter	Round	Stamped aluminum
604773	3-3/4" diameter	Round	Stamped aluminum

\* Continued while supplies last



Easily sticks onto a pre-existing mirror for added visibility



## LOOK-DOWN CONVEX MIRROR ASSEMBLIES

- Universal design for over-the-door, peek-a-boo or back window applications
- Adjustable design to find the perfect angle for each application
- Convex mirror provides a wide-angle view wherever needed
- Shatterproof glass ideal for agricultural, mining and military applications (#612785)
- Includes mirror head and mounting bracket



610868



612785

Part#	Glass Size (W x H)	Finish
610868	8" x 4"	Polished stainless
612785	10" x 6"	Black ABS plastic



## RECTANGULAR CONVEX UTILITY MIRROR ASSEMBLY

- Universal I-bracket fits a wide variety of heavy-duty applications
- Adjustable design to find the perfect angle for each application
- Convex mirror provides a wide-angle view wherever needed
- Bright, anodized aluminum construction is lightweight and rust-free
- Includes mirror head and mounting bracket



Front

Back

Part#	Glass Size (W x H)	Finish
604650	7-1/2" x 5-1/2"	Anodized aluminum

# SAFETY MIRROR ASSEMBLIES

- Universal mounts fit a wide variety of heavy-duty applications
- Adjustable design to find the perfect angle for each application
- Convex mirrors help eliminate blind spots for safer maneuvering (select models)
- Compatible with all round and rectangular convex mirrors, starting on page 46
- Most models include mounting assembly only
- Most models made in USA (#604673 and #611922 excluded)



Part#	Adjustment Range	Application Type	Mount Style	Mirror Included	Glass Diameter	Finish
604671	--	Cabover mount	Bolts onto side mirror assembly	--	--	Polished stainless
604674	12" to 19"	Cowl or fender mount	Bell-type mount	--	--	Polished stainless
611651*	12" to 19"	Conventional fender guide mount	L-bracket mount	--	--	Polished stainless
604696	14" to 19"	Hood mount	Four-bolt pod mount	--	--	Polished stainless
604697	18" to 23"	Hood mount	Four-bolt pod mount	--	--	Polished stainless
611922	16" to 23"	Conventional fender mount	Bell-type mount	--	--	Polished stainless
604676	16" to 23"	Conventional fender mount	Bell-type mount	Yes	8"	Polished stainless
604677	22" to 31"	Fender mount	Bell-type mount	--	--	Polished stainless
604673	22" to 31"	Fender mount	Bell-type mount	Yes	8"	Polished stainless

\* Continued while supplies last





## REAR-MOUNT SAFETY MIRROR ASSEMBLIES

- Universal design for rear van, straight truck or look-down applications
- Ideal for adding visibility on delivery and emergency vehicles
- Includes mounting assembly only



608135



608100



608137



608102



604698

Part#	Finish	Mount Style
608135	Polished stainless	Four-bolt vertical bracket mount
608100	Polished stainless	Four-bolt horizontal bracket mount
608102*	Carbon steel with black powder coat	Four-bolt horizontal bracket mount
608137*	Carbon steel with black powder coat	Four-bolt vertical bracket mount
604698*	Polished stainless	--

\* Continued while supplies last



# LIGHT-DUTY MIRRORS

**DELIVERING. DEPENDABLE. QUALITY.**

Universal light-duty mirror assembly

## FEATURED PRODUCTS



### Light-duty mirror heads

For pickups from Chevrolet, Dodge, Ford, GMC, Ram and more, these mirrors offer the look and functionality of original equipment.

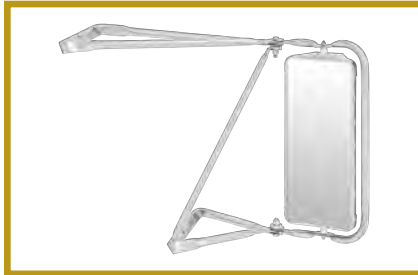

### Custom assemblies

These assemblies are designed to be a perfect, vehicle-specific mirror replacement option for light-duty pickup trucks and SUVs.

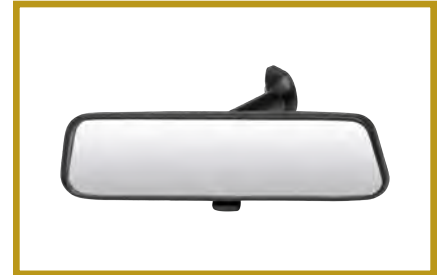

### Universal mirrors

With a universal design, these mirrors fit a wide variety of light-duty pickup trucks. All come with first-surface glass to eliminate glare.

## PRODUCT INDEX



58

Custom  
West Coast  
Assemblies



58

Universal  
Light-Duty  
Assembly



58

Junior  
West Coast  
Mirror Head



59

Light-Duty  
Mirror Heads



59

Universal  
Mirror Head  
with Gooseneck



59

Rear View  
Mirror



## CUSTOM WEST COAST MIRROR ASSEMBLIES

- Original equipment, light-duty style to provide a perfect OEM replacement
- No-drill, vehicle-specific design to perfectly match the factory holes
- Patented retractable assembly for added clearance when needed
- Universal stud mounts easily attach the mirror head to the loop
- 7" x 16" flat mirror provides a wide view to help minimize blind spots
- First-surface electro-chrome glass eliminates glare for maximum safety
- Polished stainless steel construction for a bright, rust-free accent
- Includes mirror head, mounting assembly and hardware



605073  
back

605073  
front

### Custom West Coast Mirror Assemblies

Make / Model	Years	Driver-Side#	Passenger-Side#
<b>Ford</b>			
F-150	80 - 98	605071	605073
F-250	80 - 98	605071	605073
F-350	80 - 97	605071	605073



## UNIVERSAL LIGHT-DUTY MIRROR ASSEMBLY

- Provides a wide view to help minimize blind spots
- First-surface electro-chrome glass eliminates glare for maximum safety
- Bright, anodized aluminum head and stainless steel mounting assembly
- Includes mirror head, mounting assembly and hardware



611500  
back

Part#	Glass Size (W x H)	Mirror Finish	Assembly Finish	Pivot
611500	7-1/2" x 10-1/2"	Anodized aluminum	Polished stainless	12"



## JUNIOR WEST COAST MIRROR HEAD

- Bright, yellow, embossed chevrons add style and visibility to the vehicle
- Universal flange mounts easily attach to all standard loops and swedged loops
- Provides a wide view to help minimize blind spots
- First-surface electro-chrome glass eliminates glare for maximum safety
- Stamped aluminum construction to be strong, lightweight and rust-free
- Includes mirror head only (mounting assembly not included)



Front



Back

Part#	Glass Size (W x H)	Finish
601331	6" x 12"	Anodized aluminum



## LIGHT-DUTY MIRROR HEADS

- Original equipment, light-duty style
- Flat glass provides a clear view
- First-surface electro-chrome glass eliminates glare for maximum safety
- Center-mount ball stud for easy tilt adjustment (#610480, #610485)
- Includes mirror head only (mounting assembly not included)



610480



610485



604768



604769

Part#	Glass Size (W x H)	Finish	Center Ball Stud
604768	9" x 6"	Polished stainless	--
604769	8" x 5"	Polished stainless	--
610480	5-1/2" x 7-1/2"	Stainless steel	Metal
610485	5-1/2" x 7-1/2"	Anodized aluminum	Metal



## UNIVERSAL MIRROR WITH GOOSENECK

- Provides a wide view to help minimize blind spots
- First-surface electro-chrome glass eliminates glare for maximum safety
- Gooseneck positions mirror for an extended view
- Includes mirror head and gooseneck only



Front



Back

Part#	Glass Size (W x H)	Finish
611600	7-1/2" x 10-1/2"	Polished stainless

## GOOSENECK MIRROR EXTENSION

- Positions mirror for an extended view

Part#	Description	Finish
605755	Gooseneck extension	Polished stainless

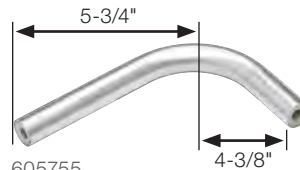

605755  
(10" before being bent)

## REAR VIEW MIRROR

- Day / night prismatic ground glass can be tilted down to dim bright lights
- First-surface electro-chrome glass eliminates glare for maximum safety
- Stick-on adhesive pad allows for quick, easy installation
- Includes mirror head and mounting bracket with double-sided tape



Front



Back

Part#	Glass Size	Finish
102558	10" width	Black vinyl



# STEP VAN MIRRORS

**DELIVERING. DEPENDABLE. QUALITY.**

OEM assembly set on USPS delivery van

## FEATURED PRODUCTS



### West coast mirror heads

These west-coast-style mirrors come ready to mount onto an existing mirror loop on the van, providing a clear view and OE look.



### Convex mirror heads

Our convex mirrors offer a wide-angle view to reduce dangerous blind spots. They are available in multiple finishes.

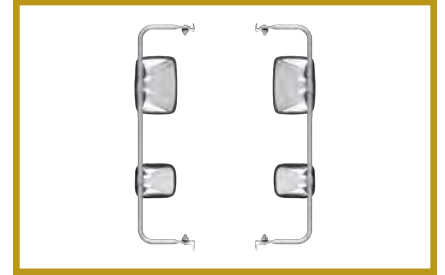

### Custom mirror assemblies

For a complete OE solution, our step van mirrors are available in sets, including the driver and passenger-side mirrors and assemblies.

## PRODUCT INDEX



**62**  
OEM  
Step Van  
Assembly Sets



**62**  
Universal  
Step Van Mirror  
Assembly Set



**63**  
West Coast  
Step Van Mirror  
Heads



**63**  
Convex  
Step Van Mirror  
Heads



## OEM STEP VAN ASSEMBLY SETS

- Original equipment, light-duty style to provide a perfect OEM replacement
- No-drill, vehicle-specific design to perfectly match the factory holes
- Patented retractable assembly for added clearance when needed
- First-surface electro-chrome glass eliminates glare for maximum safety
- Available in multiple finishes to match various step vans
- Includes driver-side and passenger-side mirror heads, assemblies and hardware



Part#	Loop	Flat Glass Size	Convex Glass Size	Finish
609105	Long	15-1/2" x 6-5/8"	N/A	Stainless steel
605680	Short	6-1/4" x 9-3/4"	5-3/4" x 6-1/4"	Stainless steel



## UNIVERSAL STEP VAN MIRROR ASSEMBLY SET

- Universal design to fit all models of step vans
- Bright chevrons add style and visibility to the vehicle
- Patented retractable assembly for added clearance when needed
- Mirror adjusts up or down on the loop to fit various window and door sizes
- First-surface electro-chrome glass eliminates glare for maximum safety
- Includes driver-side and passenger-side mirror heads, assemblies and hardware

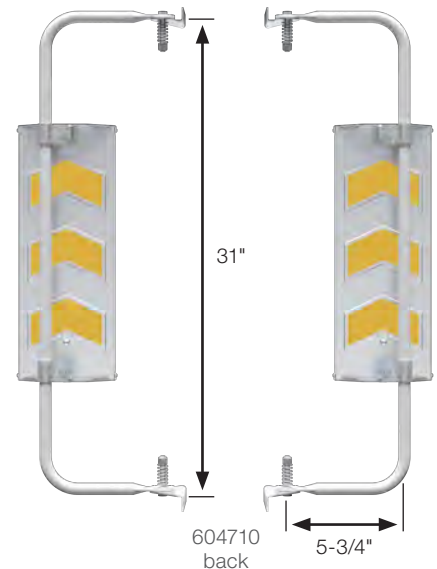

Part#	Mirror Head Finish	Assembly Finish	Flat Glass Size
604710	Polished stainless	Carbon steel with white powder coat	5-5/8" x 16-1/4"





# WEST COAST STEP VAN MIRROR HEADS

- Original equipment, light-duty style to provide a perfect OEM replacement
- Flat mirror provides a wide view to help minimize blind spots
- Clamp mounts securely attach to an existing loop
- First-surface electro-chrome glass eliminates glare for maximum safety
- Available in multiple finishes to match FedEx, USPS and other step vans
- Includes mirror head only (mounting assembly not included)



610827



610829



610840



610848



607972

Part#	Glass Size (W x H)	Finish
<b>Mirror Heads</b>		
610827	6-1/2" x 10"	Carbon steel with white powder coat
610829	6-1/2" x 10"	Polished stainless
610840	6-1/2" x 10"	White ABS plastic
610848	6-1/2" x 10"	Black ABS plastic
610809	7-1/2" x 10-1/2"	Anodized aluminum
<b>Replacement Glass</b>		
607972	6-1/2" x 10"	--



610809



# CONVEX STEP VAN MIRROR HEADS

- Original equipment, light-duty style to provide a perfect OEM replacement
- Convex glass helps eliminate blind spots for safer maneuvering
- First-surface electro-chrome glass eliminates glare for maximum safety
- Available in multiple finishes to match FedEx, USPS and other step vans
- Includes mirror head only (mounting assembly not included)



610815



610819



610836



610844

Part#	Glass Size (W x H)	Finish
<b>Mirror Heads</b>		
610815	6-1/2" x 6"	Polished stainless
610819	6-1/2" x 6"	Carbon steel with white powder coat
610836	6-1/2" x 6"	White ABS plastic
610844	6-1/2" x 6"	Black ABS plastic
610806*	7-1/2" x 10-1/2"	Aluminum with black powder coat

\* Continued while supplies last



610806



# COMPONENT PARTS

**DELIVERING. DEPENDABLE. QUALITY.**

Loop shown with bubble-back west coast mirror



# ADJUSTABLE STABILIZERS AND BRACES

- Helps stabilize mirror head and mounting assembly for reduced vibration
- Adjustable design extends to fit multiple applications
- Polished stainless steel construction for a bright, rust-free accent

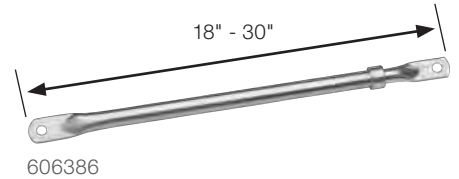
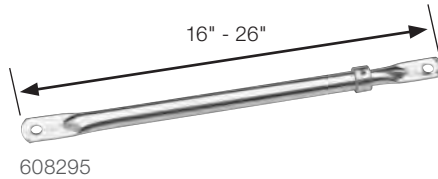
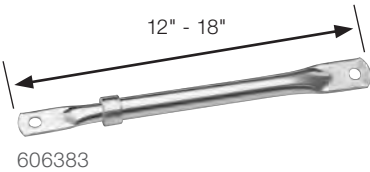
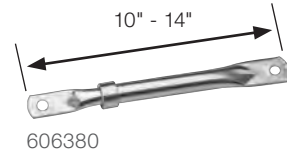
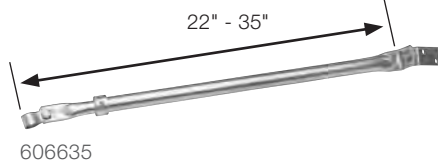
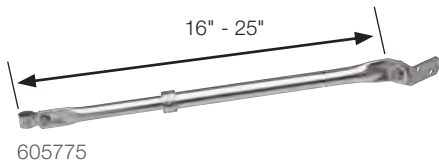

Part#	Mount Style	Retracted Length	Extended Length	Finish
605775	Stabilizer	16"	25"	Polished stainless
606635	Stabilizer	22"	35"	Polished stainless
606380	Brace	10"	14"	Polished stainless
606383	Brace	12"	18"	Polished stainless
608295	Brace	16"	26"	Polished stainless
606386	Brace	18"	30"	Polished stainless



Reduces vibrations and stabilizes assembly



# GRAB HANDLES

- Provides a sturdy, 5/8" diameter handle for easier vehicle entry and exit
- Polished stainless steel construction for a bright, rust-free accent
- Includes one grab handle (mounting hardware not included)

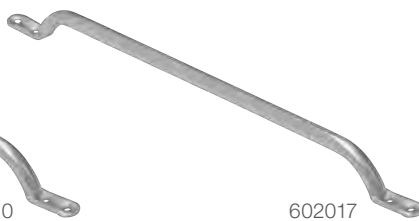

Provides a sturdy anchor for a quick, easy grip

Part#	Handle Dimension (End-to-End)	Mounting Hole Dimensions		Finish
		Inside Hole to Inside Hole	Inside Hole to Outside Hole	
602000	11-9/16"	8-11/16" center-to-center	1" center-to-center	Polished stainless
602010	14"	11-1/8" center-to-center	1" center-to-center	Polished stainless
602017	27-1/2"	24-5/8" center-to-center	1" center-to-center	Polished stainless



# MIRROR LOOPS

- Plain-type design to accept west coast mirror heads with clamp mounts
- Swedge-type design to accept RETRAC west coast mirror heads with stud mounts
- A wide variety of sizes available to fit virtually any heavy-duty mirror and assembly
- Available in polished stainless or powder-coated steel in a variety of colors
- Includes loop only (mirror head and other mounting assembly components not included)

## Measuring a mirror loop

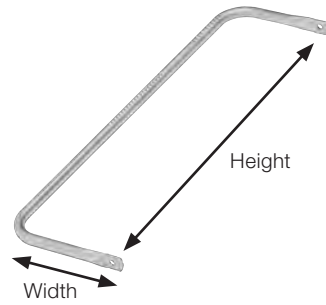

## Finish options



Polished stainless

White powder coat

Black powder coat

Grey powder coat

## Loop type



Swedge-type



Plain-type

## Product photos

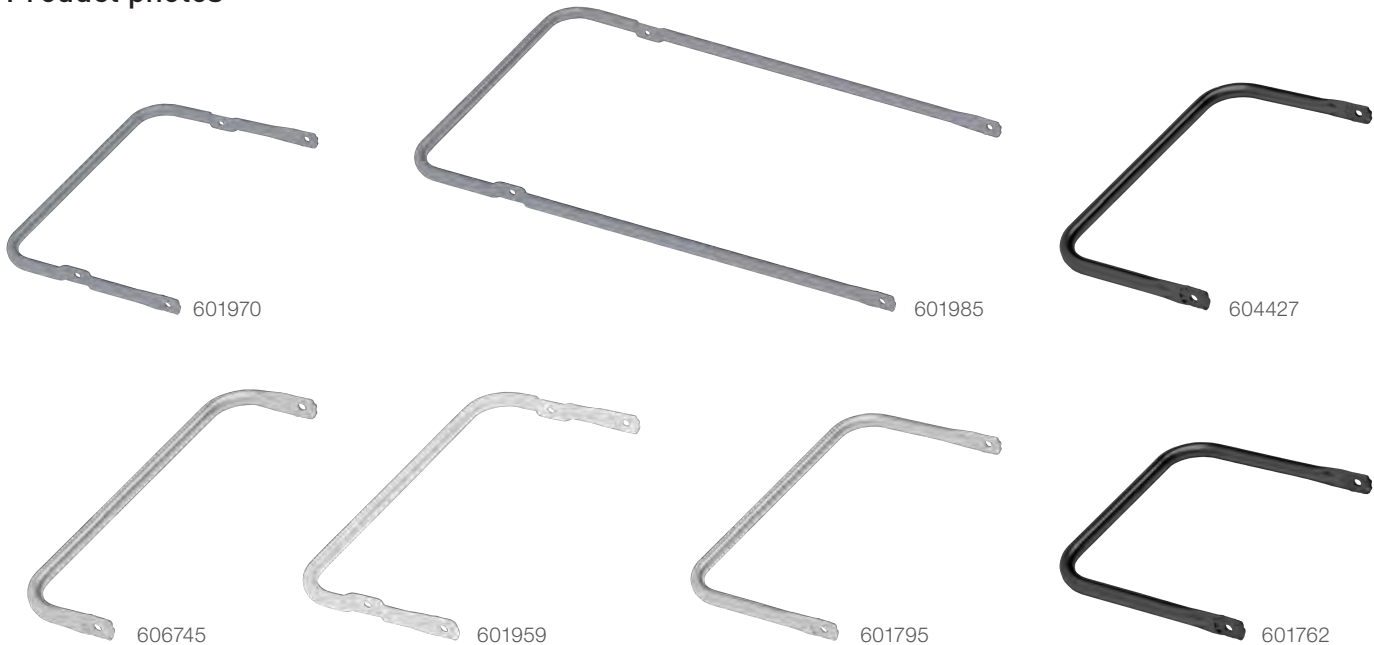

601970

601985

604427

606745

601959

601795

601762



## MIRROR LOOPS

Dimensions		Finishes			
Width	Height	Stainless#	White#	Black#	Grey#
<b>Swedge-Type</b>					
7.25"	18"	--	601959	--	--
8.875"	18"	601870	601873	--	601872
12"	18.50"	601970	--	--	601972
17"	18.50"	608160	--	--	--
30.3125"	18.50"	--	--	--	601985
<b>Plain-Type</b>					
8.78"	17.096"	604425	--	604427	--
11.91"	17.096"	612240	--	--	--
9.25"	18.50"	601795	--	--	--
12"	18.50"	601885	--	--	--
9.25"	18.50" - 30.50"	602105	--	--	--
5.25"	19.675"	606745	--	--	--
15.25"	20.675"	604378	--	--	--
8.50"	20"	612305*	--	--	--
9.25"	20" - 32"	602104	602106	--	--
16.375"	21.192"	608185	--	--	--
7.50"	21.75"	601890	--	--	--
5.50"	22.50"	601900	--	--	--
5.75"	23.25"	601905	--	--	--
10"	23.25"	--	601834	--	--
11.50"	24.50"	601835	601839	--	--
14.50"	24.50"	601960	--	--	--
8.9375"	25.125"	--	--	606742	--
7.25"	26.25"	601925	--	--	--
13.5625"	28.875"	601994	--	--	--
5.75"	29.875"	601920	601924	--	601923
10"	30"	601860	--	601862	--
20.75"	30"	612200	--	--	--
8.81"	30.182"	--	--	--	606789
7.58"	33.24"	--	--	606737	--
7.25"	34.105"	608225	--	608227	--
8.81"	35.125"	--	608183	608182	--
10.125"	35.142"	606720	--	--	--
15.50"	36.50"	601935	--	--	--

\*612305 is used for aerodynamic mirror heads

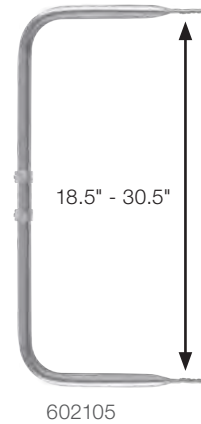
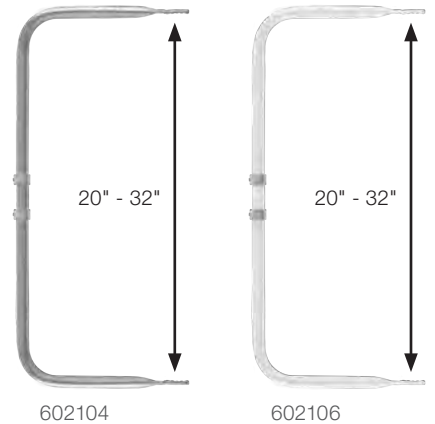



## AUXILIARY MIRROR MOUNTING BRACKETS

- Provides a solid mount for an auxiliary mirror
- Standard J-bracket design fits most RETRAC convex mirrors
- Available in polished stainless or grey powder-coated steel



Part#	Stud Hole	Leg Length	Includes	Finish
608351	--	4"	Brace and tube clamp	Polished stainless
608357	--	4"	Brace and tube clamp	Carbon steel with grey powder coat
608359	--	6"	Brace and tube clamp	Polished stainless
608365	--	6"	Brace and tube clamp	Carbon steel with grey powder coat
608361	3/8"	4"	Brace and tube clamp (608351) with J-bracket (607968)	Polished stainless
608367	3/8"	6"	Brace and tube clamp (608359), with J-bracket (607968)	Polished stainless



## WEST COAST CONVERSION MOUNTING KIT

- Converts a swedge-type loop to a plain-type
- Allows swedged loops to work with a wider variety of west coast mirrors
- Polished stainless steel construction for a bright, rust-free accent



Part#	Finish
604205	Polished stainless



# MIRROR CLAMPS

- Mounts a west coast mirror head or spot mirror to a standard mirror loop



607965



607956 (shown apart)



607961



607962



607958



607959



607956



612994



612995



612996



607952

Part#	Mount Style	Fits	Stub Hole	Finish
607965	OEM	3/4" O.D. tube	5/16"	Carbon steel with plastic coating
607961	Two-piece dovetail	3/4" O.D. tube	3/8"	Polished stainless
607962	Two-piece dovetail	3/4" O.D. tube	3/8"	Carbon steel with zinc plating
607958	Two-piece dovetail	3/4" O.D. tube	1/4"	Polished stainless
607959	Two-piece dovetail	3/4" O.D. tube	1/4"	Carbon steel with zinc plating
607956	Two-piece dovetail	5/8" O.D. tube	3/8"	Carbon steel with zinc plating
612994	Two-piece dovetail	1" O.D. tube	3/8"	Polished stainless
612995	Two-piece dovetail	1-1/8" O.D. tube	3/8"	Polished stainless
612996	Two-piece dovetail	1-1/4" O.D. tube	3/8"	Polished stainless
607952	Twisted	1/4" hole	1/4"	Polished stainless
607964	GM-style	1/4" hole	5/16" slotted	Carbon steel with plastic coating



607964



# MIRROR J-BRACKETS

- Standard J-bracket design fits most RETRAC convex mirrors
- Available in polished stainless or zinc-plated carbon steel



607969



607968



607966



607967

Part#	Stud Hole	Finish
607969	3/8"	Carbon steel with zinc plating
607968	3/8"	Polished stainless
607967	1/4"	Carbon steel with zinc plating
607966	1/4"	Polished stainless
607978	1/4" stud (slot is 5/16" x 1-1/8")	Polished stainless



Allows for attachment of convex mirrors to the mirror assembly



607978



# MARKETING MATERIALS

FULLY SUPPORTING YOUR BUSINESS

Display stands and signage



Contact your sales representative for a complete list of available items and how to qualify.

### Literature & Catalog

- Tri-fold literature (8-1/2" x 3-1/2") focuses on educating the consumer about the advantages of RETRAC HD grille guards
- The catalog provides a complete listing of RETRAC products and vehicle applications (#9930014)
- Clear plastic stands available for displaying literature (#99129)



9930004



9930014

### Banner & Retail Signage

- Attractive signage for use on walls, displays and in-store to help customers identify your RETRAC product offering
- Banner for use in-store and outdoors to help identify and promote your RETRAC offering



9930005 header card



9930001 banner



9930007 counter mat

### Display Stands & Adapters

- Contact your RETRAC sales representative to determine the product lineup best tailored to meet your needs
- Floor stand display (#9930010) can mount the Tuff Guard® with use of the #9930008 adapter
- Floor stand display (#590710) for mounting the Tuff Guard®
- Counter display (#613004) for mounting mirror heads



613004



590710 display stand (guard sold separately)



9930010 display stand with 9930008 adapter (guard sold separately)