



TOYOTA TACOMA GAP GUARDS INSTALLATION INSTRUCTIONS 2005-2015 KIT# PA6337

⚠ WARNING
Before you install this kit, read and understand all instructions, warnings, cautions, and notes in this instruction sheet.

⚠ NOTE
No two vehicles have holes spaced identically. If you are stretching a hole on the gap guard too much, punch another hole with a 1/4" paper punch. Most stock guards mount from the inside, but our gap guards mount from the outside.

Before Starting Installation

⚠ NOTE
Kit parts are prefaced by the word *kit* and appear in **bold** print.

1. Carefully read all warnings and instructions completely before beginning.
2. Verify all parts have been received in this kit by checking the parts list at the end of this document.

⚠ NOTE
If parts are missing from kit, please be prepared to provide the following information:
1. **Name** of purchase location
2. **Bar Code** on side of box
3. **Date** above bar code
4. **Date** inside box cover
5. **Inspector #** from inside box cover

1. **Only install this kit on the vehicle for which it is specified.** If anytime during the installation you encounter something different from what is outlined in the instructions, call technical support.
2. Special tools needed:
 - a. Drill with 7/32" & 1/4" drill bit
3. Park vehicle on a clean, dry, flat, level surface and block tires so vehicle cannot roll in either direction.

Install Kit

1. Front
 - a. Remove screw from wheel well.

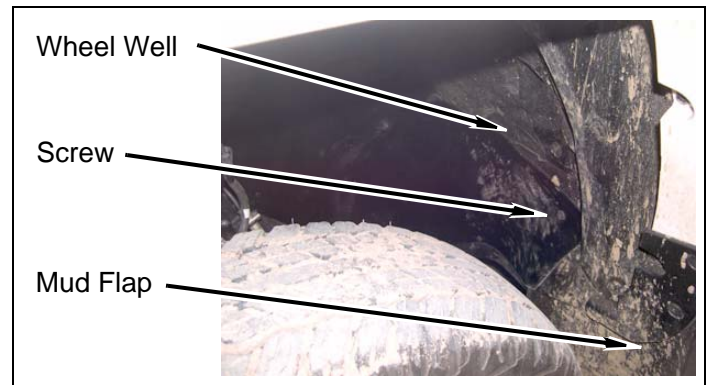

- b. At driver side front wheel well, position **kit gap guard** (PA6337-1), with dull finish facing outward, to cover side of engine compartment.

⚠ CAUTION
Before drilling, check to ensure there are no wire harnesses, fuel lines, brake lines, etc.

- c. Mark top hole and drill if necessary with a 7/32" drill bit.
- d. Install **kit clip** (push) through **kit gap guard** and into the wheel well.
- e. Check alignment and mark next hole while keeping **kit gap guard** snug.
- f. Proceed with three previous steps until **kit gap guard** is installed.

- g. Drill a 7/32" hole through *kit gap guard* and install screw through *kit gap guard*.
- h. Drill a 7/32" hole through *kit gap guard* and frame. Install *kit clip* (push) through *kit gap guard* and frame.

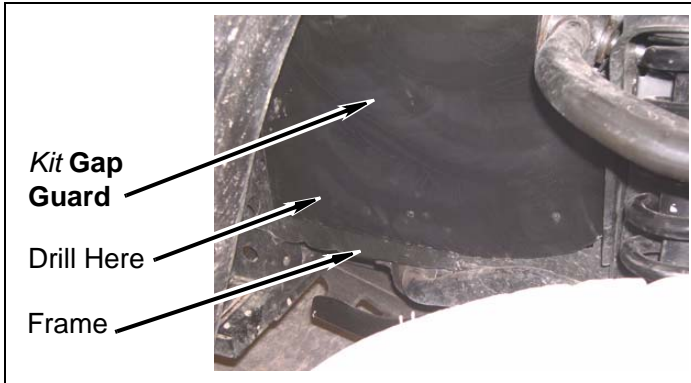

- i. Repeat above steps for front passenger side *kit gap guard* (PA6337-2).

2. Remove one bolt from brace.

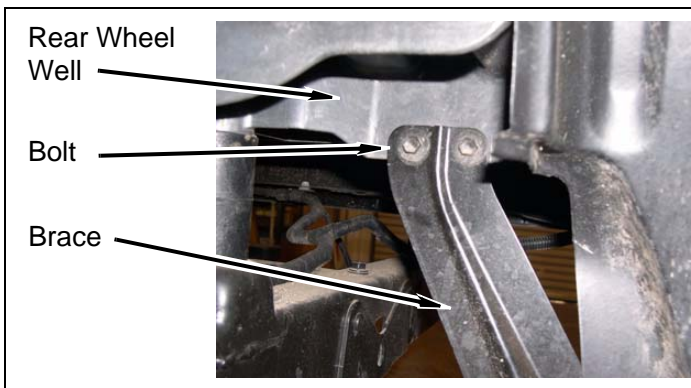

3. Remove screw from lower rear wheel well.

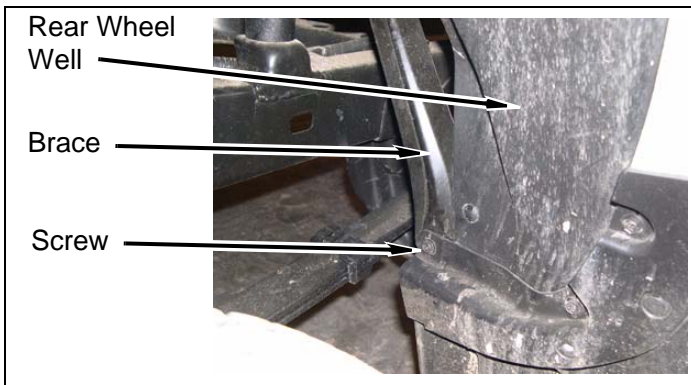

4. Long Bed Models: Subframe assembly

- a. Assemble two *kit brackets* (12" long), *kit bracket* (11" long), *kit bracket* (3" stand off) and *kit bracket* (L-shaped) with three *kit bolts* (1/4" x 1") and three *kit nuts* (1/4" Nylock).

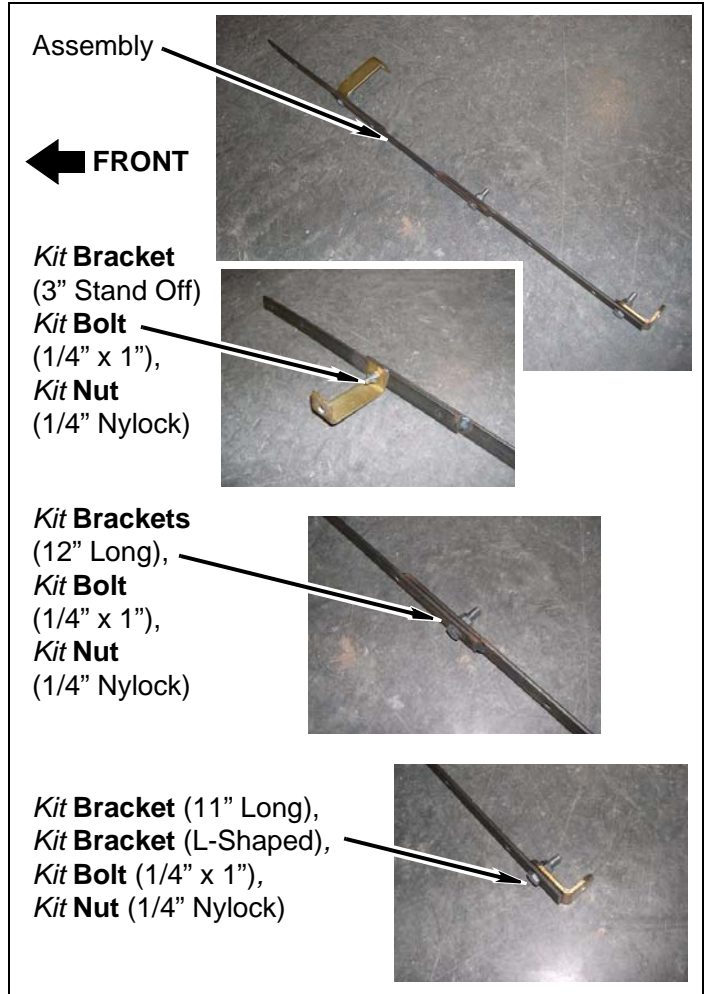

- b. Use assembly as a template and mark driver side bed supports as shown.

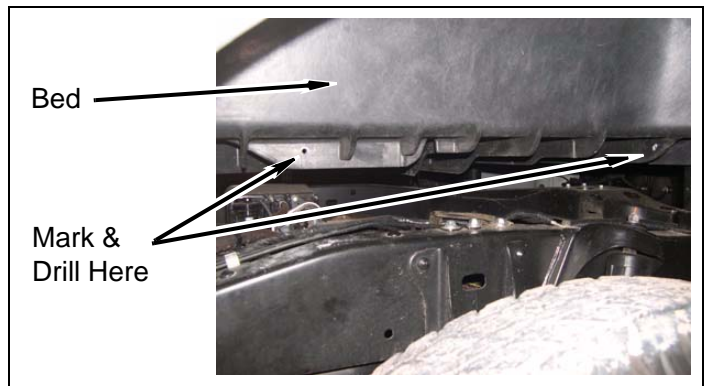

- c. Drill two 1/4" holes at marked locations.

- d. Install assembly with two *kit bolts* (1/4" x 1"), four *kit washers* (1/4" SAE) and two *kit nuts* (1/4" Nylock).

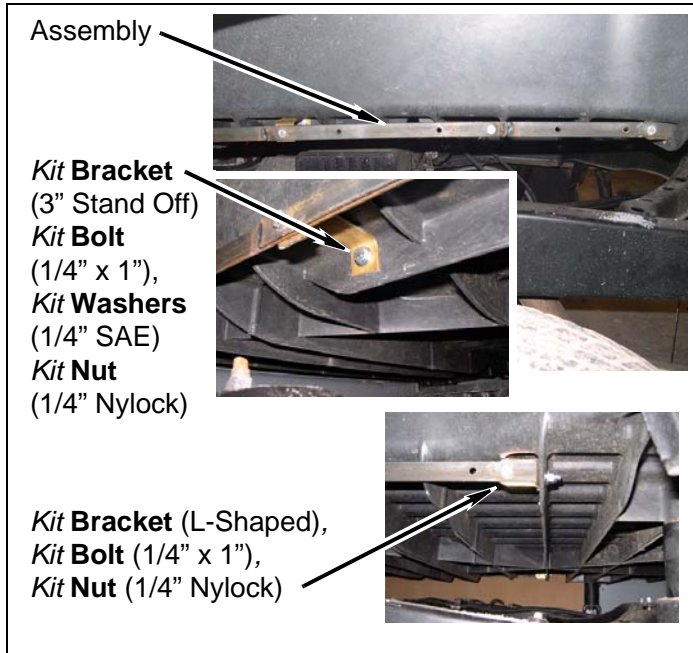

5. **Short Bed Models:** Subframe assembly

- a. Assemble two *kit brackets* (12" long), *kit bracket* (11" long), *kit bracket* (3" stand off), and *kit bracket* (J-shaped) with four *kit bolts* (1/4" x 1") and four *kit nuts* (1/4" Nylock).

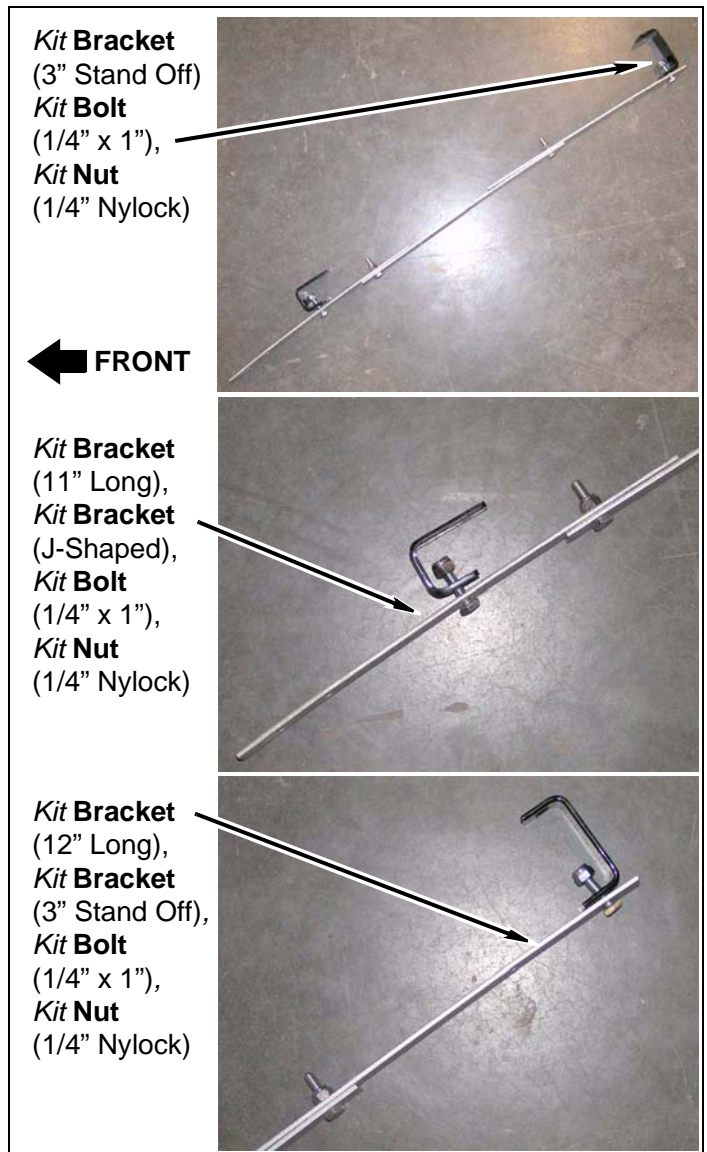

- b. Use assembly as a template and mark driver side bed supports as shown.

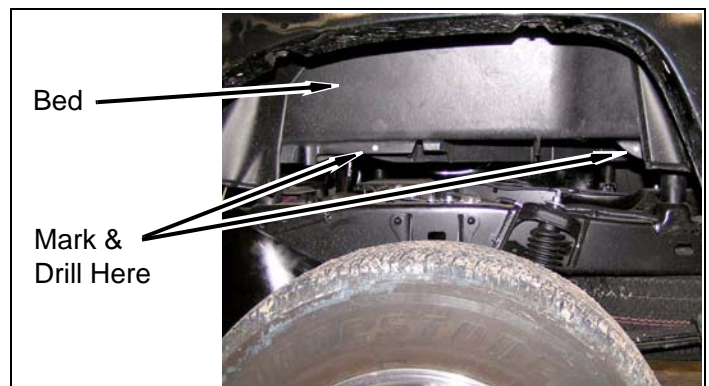

c. Drill two 1/4" holes at marked locations.

d. Install assembly onto bed with two *kit bolts* (1/4" x 1"), four *kit washers* (1/4" SAE), and two *kit nuts* (1/4" Nylock).

e. Drill 7/32" hole in *kit gap guard* and factory wheel well and install *kit clip* (push) and *kit washer* (1/4" SAE).

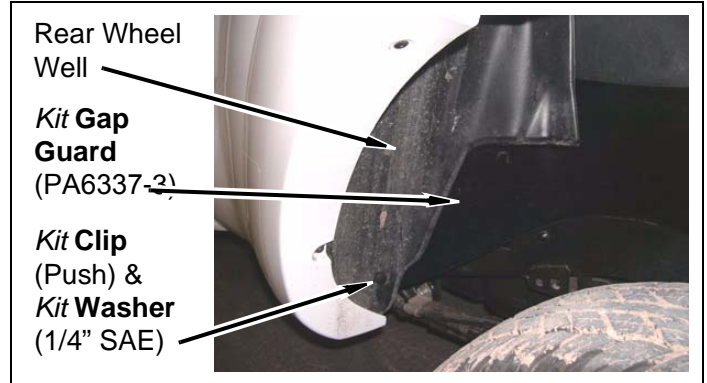
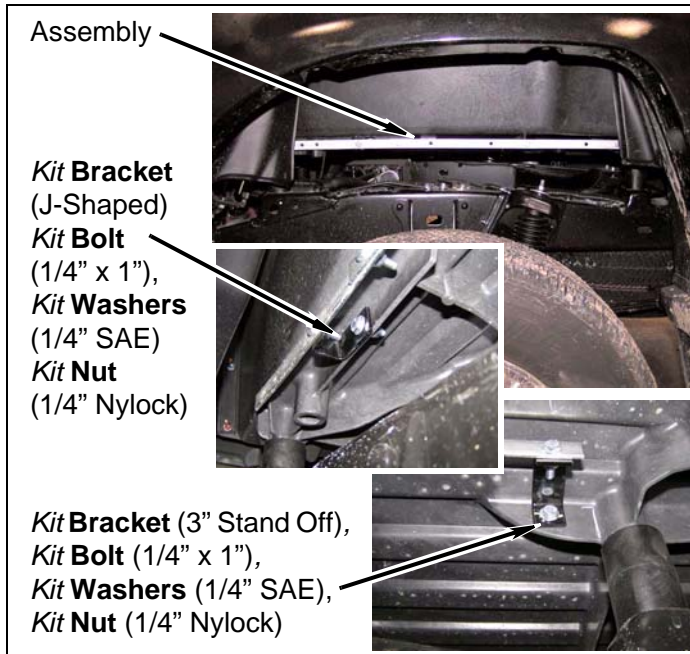

f. Drill 7/32" hole in *kit gap guard* and install bolt through *kit gap guard* into brace.

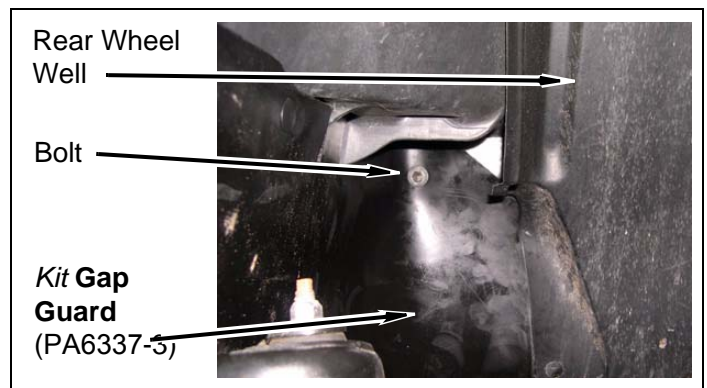

g. Drill 7/32" hole in *kit gap guard* and install screw through *kit gap guard* into wheel well.

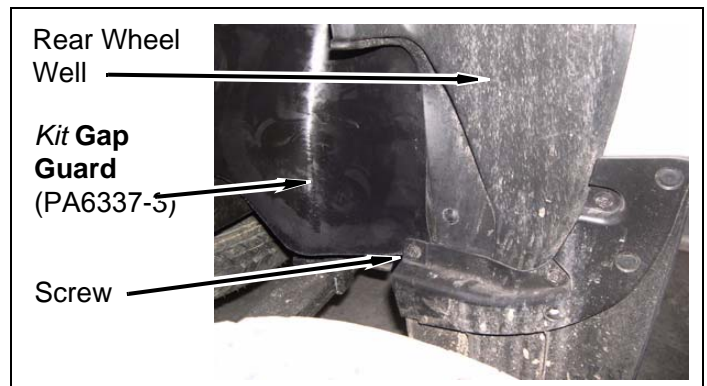

h. Repeat above steps for rear passenger side *kit gap guard* (6337-4).

6. Rear

a. At driver side rear wheel well, position *kit gap guard* (6337-3) in wheel well and mark first hole to be drilled.

b. If necessary, drill hole with 7/32" drill bit, insert *kit clip* (push) through *kit gap guard* and press into hole. Install *kit washer* (1/4" SAE) on back-side of *kit clip* (push).

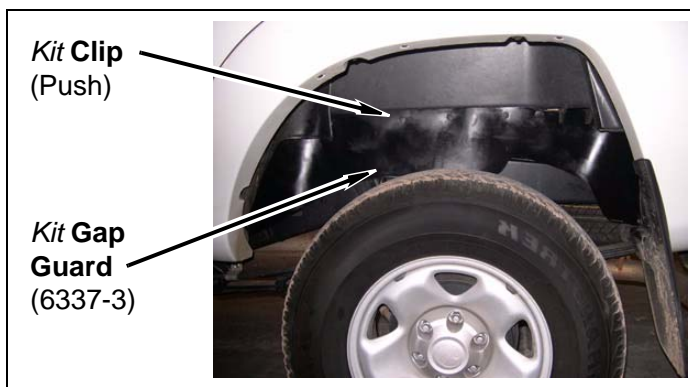

c. Realign *kit gap guard* in wheel well, mark and drill the next hole. Insert *kit clips* (push) and *kit washers* (1/4" SAE).

d. Repeat two previous steps while keeping *kit gap guard* snug.

Kit Parts List

Qty. Description

12	Bolt (1/4" x 1")
4	Bracket (12" long)
2	Bracket (11" long)
2	Bracket (3" stand off)
2	Bracket (J-shaped)
2	Bracket (L-shaped)
34	Clip (push)
1	Gap guard (front driver)
1	Gap guard (front passenger)
1	Gap guard (rear driver)
1	Gap guard (rear passenger)
12	Nut (1/4" Nylock)
24	Washer (1/4" SAE)