

MILE MARKER

2019

PRODUCT CATALOG



WINCHES + RECOVERY GEAR + ACCESSORIES + HUBS

Mile Marker - your home for durable off-roading gear.
We specialize in powerful electric winches, our legendary hydraulic winches, and premium locking hubs.

When you need high quality, well-tested products for your truck, ATV or 4x4, you can count on Mile Marker and our team of professionals to help you out. We are an ISO certified organization and a TACOM approved supplier to the US Military.

Mile Marker Mission:

Mile Marker empowers a winning team that anticipates and fulfills the needs of our Military and Commercial consumers by creating innovative solutions with superior value.

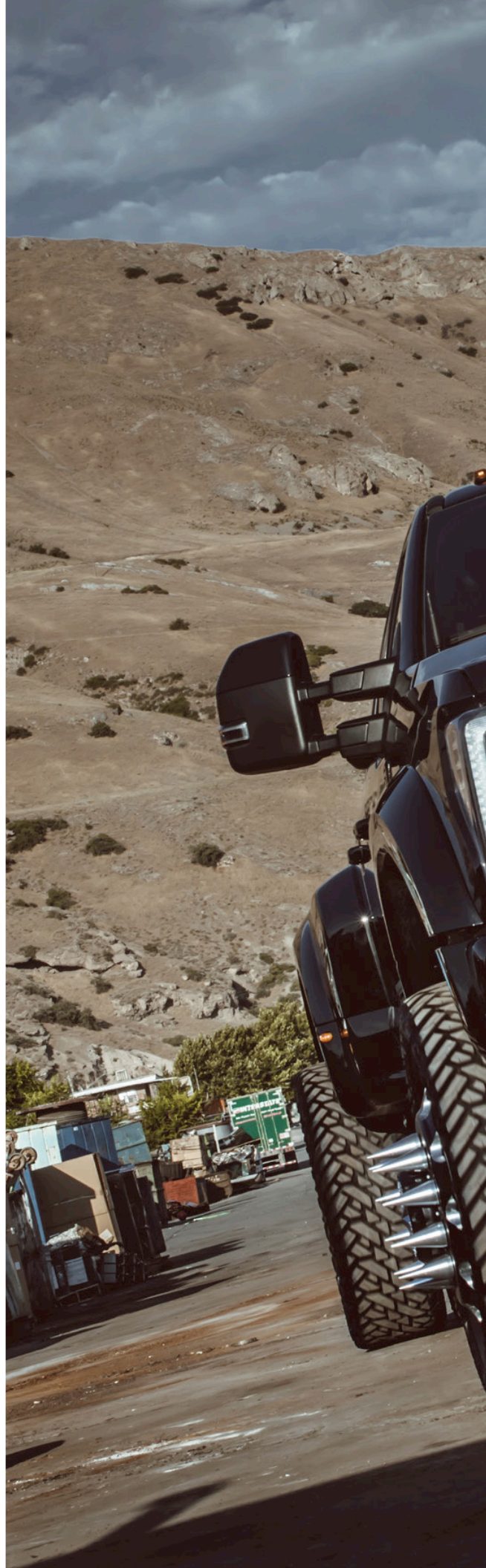



Build by Diesel Brothers



TABLE OF CONTENTS

**4 JEEP/TRUCK/SUV
WINCHES**

**9 TRAILER & UTILITY
WINCH**

**10 POWERSPORTS
WINCHES**

**13 HYDRAULIC
WINCHES**

**23 MOUNTING
SYSTEMS**

**28 JEEP
ACCESSORIES**

**30 TRUCK
ACCESSORIES**

32 RECOVERY GEAR

**35 WINCH
ACCESSORIES**

**38 PREMIUM LOCKING
HUBS**

**40 HUB APPLICATION
GUIDE**

JEEP/TRUCK/SUV WINCHES

SUBMERSIBLE SOLENOID

Marine grade connections at the remote control plug and socket

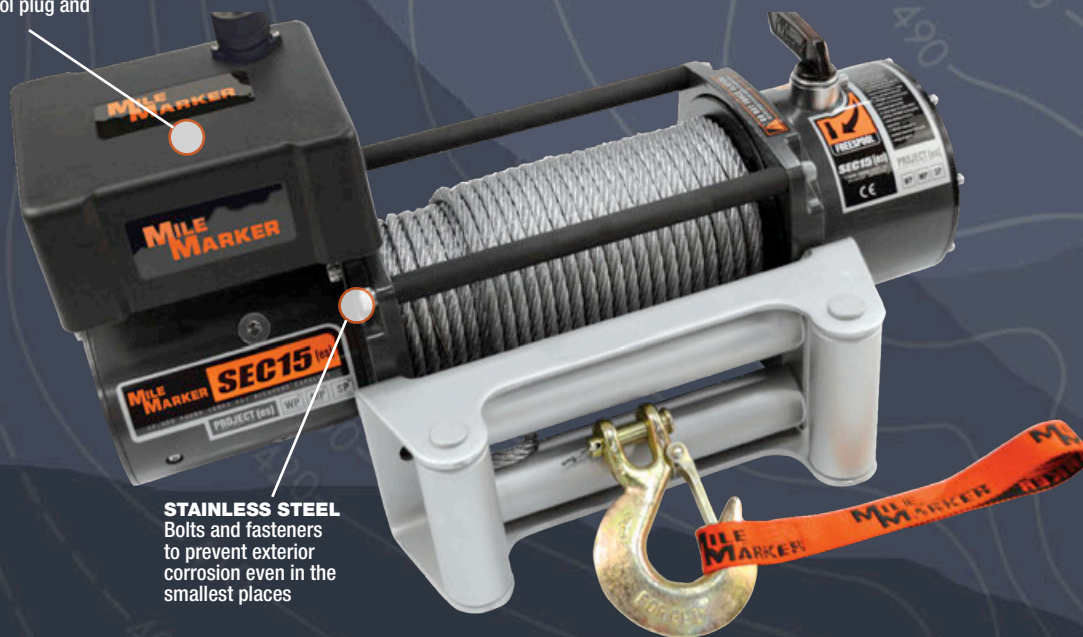

STAINLESS STEEL

Bolts and fasteners to prevent exterior corrosion even in the smallest places

ALL WEATHER WINCHING

Our completely sealed, fully submersible winch is a design that can truly spite the weather. A winch at its core is a tool, waiting for its call to action. Wherever you off-road, our waterproof winches will always be ready to perform. No rusting, no corroding, no pitting.

STRENGTH, PERFORMANCE, VALUE

Mile Marker winches define value – both our working range line speeds and our performance are the best in the class. This comes from years of motor tuning and gear ratio development to ensure high quality performance across the electric winch line.

CHOOSE THE WINCH FOR YOU

We offer 8,000, 9,500, 12,000 and 15,000 pound units for your off-roading truck, Jeep or SUV. Our 18,000 pound winch's innovative design is perfect for your tow truck or industrial DC applications.



WATERPROOF

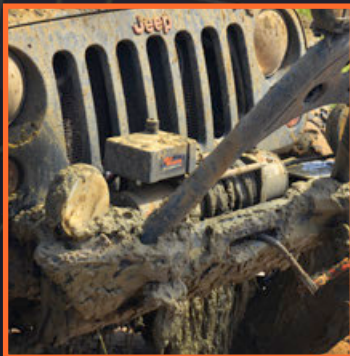

MUD PROOF

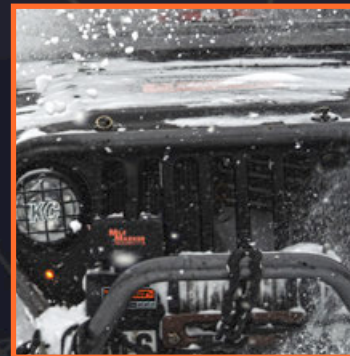

SNOW PROOF

SEC18

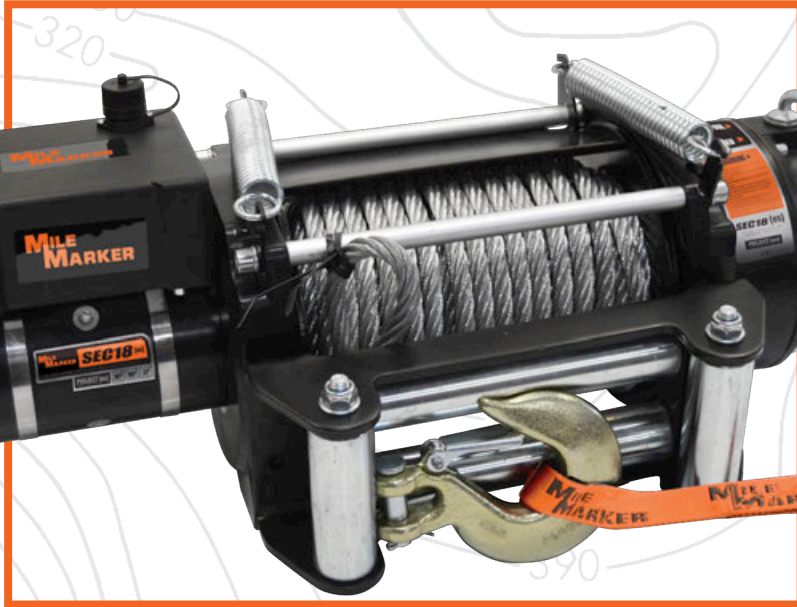

77-50280W

FEATURES:

- 7.7 HP Series Wound Motor
- Rugged Planetary Gear Sets
- Clockable Gear Housing
- Fast Line Speeds
- Submersible, 500 Amp Solenoid
- Automatic Load Holding Brake
- Corrosion Resistant Stainless Steel Fasteners
- 75' Steel Cable
- Roller Fairlead
- Waterproof
- Handheld Remote Control

STRONGEST ELECTRIC WINCH

The SEC18 pulls 18,000 pounds of recovery power. This industrial grade winch is perfect for your tow truck, fire truck, utility vehicle, or industrial DC. Our SEC18 is lightweight for its strength and features fast line speeds.

SPECIFICATIONS (18K):

Rated Line Pull	18000 lbs. (8164 kg)
Gear Train	3 Stage planetary
Gear Ratio	315:1
Motor	12 Volt DC, input power 7.7hp (5.7 kw) 24 volt available
Remote	Power in, Power out w/12' cable (3.7 m)
Dimensions (LxWxH)	26 X 9.5 X 8.5 (661 mm X 241 mm X 216 mm)
Steel Cable	1/2" X 75' (12.7 mm X 22.8 m) (19,505 lb. breaking strength)
Drum Size Diameter x Length	4.0" X 10" (101.6 mm X 254 mm)
Flange Diameter	9" (228.6 mm)
Net Weight	158 lbs (71.7 kg)
Bolt Pattern	11.48" X 8" (291.59 mm X 203.2mm) 8 bolts, 5/8"-11

PERFORMANCE (18K):

Line Pull		Line Speed				Motor Current	
lb	kg	fpm (12V)	mpm (12V)	fpm (24V)	mpm (24V)	amps @ 12 V	amps @ 24 V
0	0	23.6	7.2	27.9	8.5	68	25
6000	2720	10.2	3.1	12.5	3.8	235	150
8000	3630	9.2	2.8	7.5	2.3	282	176
10000	4540	4.9	1.5	6.9	2.1	310	185
12000	5440	3.9	1.2	5.9	1.8	378	198
15000	6800	3.3	1	4.6	1.4	420	213
18000	8170	2.6	0.8	3.6	1.1	469	233

SEC15

BIG WINCH POWER, SMALL WINCH WEIGHT

Our 15,000 pound winch packs heavy duty power. The light, compact design mounts easily to a full size truck or Jeep. Each SEC15 includes a 15' recovery strap for longer pulls.



Steel Cable

76-50260W



Synthetic Rope

76-53260W

FEATURES:

- 6.8 HP Series Wound Motor
- Rugged Planetary Gear Sets
- Clockable Gear Housing
- Fast Line Speeds
- Submersible, 500 Amp Solenoid
- Automatic Load Holding Brake
- Corrosion Resistant Stainless Steel Fasteners
- 78' Synthetic Rope or 79' Steel Cable
- Aluminum Hawse or Roller Fairlead
- Waterproof
- Handheld Remote Control
- Includes 15' Recovery Strap

SPECIFICATIONS (15K):

Rated Line Pull	15000 lbs (6803 kgs)
Gear Train	3 Stage planetary
Gear Ratio	296:1
Motor	Series wound, 6.8 hp (5 kw), 12 Volt 24 volt available
Remote	Power in, Power out w/12' cable (3.7 m)
Dimensions (LxWxH)	22.44" X 6.29" X 11.00" (570 mm X 160 mm X 280 mm)
Steel Cable	3/8" X 79'(9.5 mm X 24 m) (16,409 lb. breaking strength)
Synthetic Rope	3/8" X 78' (9.5 mm X 24 m) (18,078 lb. breaking strength)
Drum Size Diameter x Length	2.9" X 8.9" (75 mm X 226 mm)
Net Weight Synthetic Rope	63 lbs (28.5 kgs)
Net Weight Steel Cable	85 lbs (38.5 kgs)
Bolt Pattern	4 bolt pattern, 4.5" x 10" (114.3 mm X 254 mm)

PERFORMANCE (15K):

Line Pull		Line Speed		Motor Current
lb	kg	fpm	mpm	amps @ 12 V
0	0	15.8	4.8	74
5000	2270	7.6	2.3	202
9000	4086	5.9	1.8	290
12000	5448	4.6	1.4	335
15000	6810	3.3	1	420



LIGHTEST, MOST COMPACT 15K WINCH IN THE INDUSTRY



INCLUDES 15' RECOVERY STRAP

SEC12 & SEC95

PROVEN WINCH DESIGN, UNMATCHED VALUE

Heavy duty series wound motors and rugged planetary gear sets are the backbone of Mile Marker. With robust controls and a fully sealed solenoid and body, the SEC12 and SEC95 are proven winches at an unmatched value.



76-50251BW



76-50246BW

SPECIFICATIONS (12K):

Rated Line Pull	12000 lbs (5443 kg)
Gear Train	3 Stage planetary
Gear Ratio	296:1
Motor	Series wound, 4.8 hp (3.6 kw), 12 Volt, 24 volt available
Remote	Power in, Power out w/12' cable (3.7 m)
Dimensions (LxWxH)	22.25" X 6.25" X 8.00" (565.2 mm X 158.8 mm X 203.2 mm)
Steel Cable	3/8" X 100' (9.53 mm X 30.5 m) (14,400 lb. breaking strength)
Synthetic Rope	3/8" X 100' (9.53 mm X 30.5 m) (18,078 lb. breaking strength)
Drum Size Diameter X Length	2.5" X 9" (63.5 mm X 228.6 mm)
Net Weight Synthetic Rope	67 lbs (30.39 kg)
Net Weight Steel Cable	92 lbs (41.73 kg)
Bolt Pattern	4 Bolt pattern, 4.5" x 10" (114.3 mm X 254 mm)

PERFORMANCE (12K):

Line Pull lb	Line Pull kg	Line Speed fpm	Line Speed mpm	Motor Current amps @ 12 V
0	0	23	7	90
2000	907	12.8	3.9	145
4000	1814	9.7	3.0	185
6000	2722	7.9	2.4	230
8000	3629	7.1	2.2	270
10000	4536	5.1	1.6	315
12000	5443	4.5	1.4	370

SPECIFICATIONS (9.5K):

Rated Line Pull	9500 lbs (4309 kg)
Gear Train	3 Stage planetary
Gear Ratio	210:1
Motor	Series wound, 4.8 hp (3.6 kw), 12 Volt, 24 volt available
Remote	Power in, Power out w/12' cable (3.7 m)
Dimensions (LxWxH)	22.25" X 6.25" X 8.00" (565.2 mm X 158.8 mm X 203.2 mm)
Steel Cable	3/8" X 100' (9.53 mm X 30.5 m) (14,400 lb. breaking strength)
Synthetic Rope	3/8" X 100' (9.53 mm X 30.5 m) (18,078 lb. breaking strength)
Drum Size Diameter X Length	2.5" X 9" (63.5 mm X 228.6 mm)
Net Weight Synthetic Rope	67 lbs (30.39 kg)
Net Weight Steel Cable	92 lbs (41.73 kg)
Bolt Pattern	4 Bolt pattern, 4.5" x 10" (114.3 mm X 254 mm)

PERFORMANCE (9.5K):

Line Pull lb	Line Pull kg	Line Speed fpm	Line Speed mpm	Motor Current amps @ 12 V
0	0	25.7	7.8	85
2000	907	15.1	4.6	150
4000	1814	10.5	3.2	210
6000	2722	7.9	2.4	270
8000	3629	5.9	1.8	320
9500	4309	4.3	1.3	375

FEATURES:

- 4.8 HP Series Wound Motor
- Rugged Planetary Gear Sets
- Clockable Gear Housing
- Fast Line Speeds
- Submersible, 400 Amp Solenoid
- Automatic Load Holding Brake
- Corrosion Resistant Stainless Steel Fasteners
- 100' of Synthetic Rope or Steel Cable
- Aluminum Hawse or Roller Fairlead
- Waterproof
- Handheld Remote Control

SEC8

WORKING RANGE PERFORMANCE

The SEC8 is light and affordable for the standard off road vehicle. With robust controls and a fully sealed solenoid and body, Mile Marker redefines performance in the 8,000 pound winch class.



Steel Cable



Synthetic Rope

SPECIFICATIONS (8K):

Rated Line Pull	8000 lbs (3629 kg)
Gear Train	3 Stage planetary
Gear Ratio	152:1
Motor	Series wound, 4.8 hp (3.6 kw), 12 V 24 volt available
Remote	Power in, Power out w/12' cable (3.7 m)
Dimensions (LxWxH)	21.50" X 6.25" X 8.00" (546.1 mm X 158.8 mm X 203.2 mm)
Steel Cable	5/16" X 100' (7.94 mm X 28.5 m) (9,800 lb. breaking strength)
Synthetic Rope	5/16" X 100' (7.94 mm X 28.5 m) (13,228lb. breaking strength)
Drum Size Diameter X length	2.5" X 9" (63.5 mm X 228.6 mm)
Net Weight Synthetic Rope	57.5 lbs (37 kg)
Net Weight Steel Cable	70 lbs (31.75 kg)
Bolt Pattern	4 bolt pattern, 4.5" x 10" (114.3 mm X 254 mm)

FEATURES:

- 4.8 HP Series Wound Motor
- Rugged Planetary Gear Sets
- Clockable Gear Housing
- Fast Line Speeds
- Submersible, 400 Amp Solenoid
- Automatic Load Holding Brake
- Corrosion Resistant Stainless Steel Fasteners
- 100' of Synthetic Rope or Steel Cable
- Aluminum Hawse or Roller Fairlead
- Waterproof
- Handheld Remote Control

PERFORMANCE: (8K)

Line Pull		Line Speed		Motor Current
lb	kg	fpm	mpm	amps @ 12 V
0	0	26	7.9	95
2000	907	20	6	175
4000	1814	14	4.3	240
6000	2722	12	3.8	295
8000	3629	10.8	3.3	370

TRAILER & UTILITY WINCH

SEC4500



76-50115BW

FEATURES:

- 3.7 HP Series Wound Motor
- Low Amperage Draw
- Rugged Planetary Gear Sets
- Clockable Gear Housing
- Submersible, 250 Amp Solenoid
- Automatic Load Holding Brake
- Corrosion Resistant Stainless Steel Fasteners
- 80' Steel Cable
- Roller Fairlead
- Waterproof
- Handheld Remote Control
- Includes Mounting Plate
- Includes Tow Strap for Car Haulers

SAME SEC DESIGN, LOW AMPERAGE DRAW

The SEC4500 is perfect for your large side by side or UTV. Fast line speeds and low amperage draw define this versatile recovery tool. It's compact in size and powerful in pull.

SPECIFICATIONS (4.5K):

Rated Line Pull	4500 lbs (2041 kg)
Gear Train	3 Stage planetary
Gear Ratio	150:1
Motor	12 V DC, input power 3.7hp (2.7 kw) 24V available
Remote	Power in, Power out w/ 12' cable (3.7 m)
Dimensions (LxWxH)	17.2" X 6.2" X 7.3" (436 mm X 157 mm X 185 mm)
Steel Cable	1/4" X 80' (6.35 mm X 24 m) (7,000 lb. breaking strength)
Drum Size Diameter X Length	2.5" X 5.5" (63 mm X 140 mm)
Net Weight	51 lbs (23 kg) (with mounting plate)
Bolt Pattern	4 Bolt pattern 6.535" X 4.5" (165.9 mm X 114.3 mm)

PERFORMANCE (4.5K):

Line Pull	Line Speed	Motor Current		
lb	kg	fpm	mpm	amps @ 12 V
0	0	14	4.3	35
1500	681	6.6	2	80
3000	1362	4.6	1.4	145
4500	2043	3.3	1	170

Layer	Rated Line Pull		Cable Capacity	
	lb	kg	ft	meters
1	4500	2043	15	4.6
2	4264	1935	31.5	9.6
3	3725	1691	50	15.2
4	3307	1501	70	21.3



MOUNTING PLATE INCLUDED



TOW STRAP INCLUDED

POWERSPORTS WINCHES

WATERPROOF

Marine grade connectors at the control and solenoid



HIGH OUTPUT MOTOR

These winches pack enough punch to take on the most daunting task

COMPACT POWER

The Mile Marker Powersports winch line packs powerful recovery into a rugged, compact size. Your ATV or UTV can always rely on our planetary gear systems and high output motor for your most daunting off road pulls. No weather worries with completely sealed units to the IP68 Standard.

CHOOSE THE WINCH FOR YOU

We offer 5,000, 3,500, 2,500 pound winches to best suit your vehicle. All three are available with 50 feet of either synthetic rope or steel cable.



FASTEST, MOST POWERFUL



RUGGED COMPACT SIZE



COMPLETELY ELEMENT SEALED

PE5000

PACK THE POWER

The PE5000 slams raw power into a lightweight, compact design for your ATV/UTV. Metal planetary gear systems and a fully waterproof solenoid lets you winch wherever you ride.

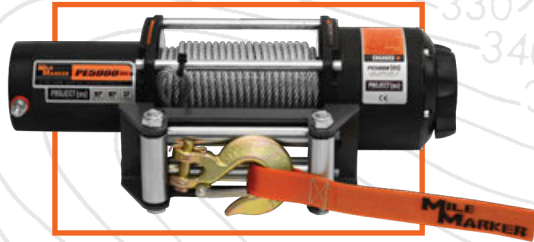

Steel Cable

77-50120W



Synthetic Rope

77-53120W

SPECIFICATIONS (5K):

Rated Line Pull	5000 lbs (2267.9 kg)
Gear Train	3 Stage planetary
Gear Ratio	165:1
Motor	12 V DC, input power 3.8hp 24V available
Remote	Power in, Power out w/12' cable (3.7 m)
Steel Cable	1/4" X 50' (6.35 mm X 30.5 m) (5,600 lb. breaking strength)
Synthetic Rope	1/4" X 50' (6.35 mm X 30.5 m) (5,071 lb. breaking strength)
Drum Size Diameter X Length	2.01" X 5.4" (51 mm X 137.1 mm)
Net Weight Synthetic Rope	19 lbs (8.6 kg)
Net Weight Steel Cable	24 lbs (10.8 kg)
Bolt Pattern	4 Bolt pattern 3" X 6.61" (76.2 mm X 167.9 mm)
Winch Dimensions (LxWxH)	15.62" X 4.61" X 4.72" (396.7 mm X 117 mm X 119.8 mm)

FEATURES:

- 3.8 HP Series Wound Motor
- All Metal Planetary Gearing
- Submersible, 250 Amp Solenoid
- Automatic Load Holding Brake
- Center Focused Drum
- Fast Line Speeds
- 50' of Synthetic Rope or Steel Cable
- Aluminum Hawse or Roller Fairlead
- Waterproof
- Handheld Remote Controls

PERFORMANCE (5K):

Line Pull		Line Speed 12V		Motor Current 12V
lbs	kgs	fpm	mpm	amp
0	0	20.7	6.3	34
2000	908	15.1	4.6	135
3000	1360	11.5	4	155
4000	1810	10.5	3.2	190
5000	2270	9.2	2.8	230



PE3.5 & PE2.5



PE3.5 Steel Cable

77-50112BW



PE3.5 Synthetic Rope

77-53112BW



PE2.5 Steel Cable

77-50105BW



PE2.5 Synthetic Rope

77-53105BW

FEATURES:

- 2 HP Series Wound Motor
- All Metal Planetary Gearing
- Submersible, 250 Amp Solenoid
- Automatic Load Holding Brake
- Center Focused Drum
- Fast Line Speeds
- 50' of Synthetic Rope or Steel Cable
- Aluminum Hawse or Roller Fairlead
- Waterproof
- Handheld and Handlebar Controls

SPECIFICATIONS:

Rated Line Pull	PE3.5	3500 lbs (1587.5 kg)
Rated Line Pull	PE2.5	2500 lbs (1133.9 kg)
Gear Train	All	3 Stage planetary
Gear Ratio	PE3.5	153:1
Gear Ratio	PE2.5	241:1
Motor	All	2 hp (1.5kw), 12 V DC
Remote	All	Power in, Power out w/ 12' cable (3.7 m)
Dimensions (LxWxH)	PE3.5	13.0" X 4.1" X 4.2" (330 mm X 104 mm X 106 mm)
Dimensions (LxWxH)	PE2.5	13.0" X 4.18" X 4.3" (330 mm X 106 mm X 109 mm)
Steel Cable	PE3.5	7/32" X 50' (5.5 mm X 15.2 m) (5,600 lb. breaking strength)
Steel Cable	PE2.5	3/16" X 50' (4.7 mm X 15.2 m) (4,200 lb. breaking strength)
Synthetic Rope	All	3/16" X 50' (4.7 mm X 15.2 m) (5,071 lb. breaking strength)
Drum Size Diameter X Length	PE3.5	1.5" X 3.15" (38 mm X 80 mm)
Drum Size Diameter X Length	PE2.5	2" X 3.15" (50.8 mm X 80 mm)
Net Weight Synthetic rope	PE3.5	15.9 lbs (7.2 kg)
Net Weight Synthetic Rope	PE2.5	14.8 lbs (6.7 kg)
Net Weight Steel Cable	PE3.5	20.7 lbs (9.3 kg)
Net Weight Steel Cable	PE2.5	18.5 lbs (8.3 kg)
Bolt Pattern	All	4 Bolt pattern, 4.88" X 3" (123.9 mm X 76.2 mm)

PERFORMANCE: PE3.5

Line Pull	Line Speed	Motor Current		
lb	kg	fpm	mpm	amps @ 12 V
0	0	19	5.8	43
500	227	16.2	4.9	62
1000	454	14.4	4.4	95
1500	680	13	3.9	110
2000	907	11.7	3.6	130
2500	1134	10.8	3.3	140
3000	1360	10.2	3.1	152
3500	1588	9.8	2.9	160

PERFORMANCE: PE2.5

Line Pull	Line Speed	Motor Current		
lb	kg	fpm	mpm	amps @ 12 V
0	0	24	7.3	41
500	227	21.8	6.64	70
1000	454	17.1	5.2	100
2000	907	10.9	3.32	175
2500	1134	7.5	2.28	212

HYDRAULIC WINCHES



LEGENDARY POWER

The serious off-roaders dream winch, Mile Marker hydraulics utilize the power steering pump as the power source instead of a battery. The result? Continuous winching. Quality winching. Uninterrupted winching. Legendary power.

CHOOSE THE WINCH FOR YOU

We offer the H series and HI series winches for standard vehicles in 9,000, 10,500 and 12,000 pound capacity. We also offer 18K hydraulic winches for heavy duty applications, a low pressure option for lower PSI vehicles, and a hydraulic winch just for tow trucks.

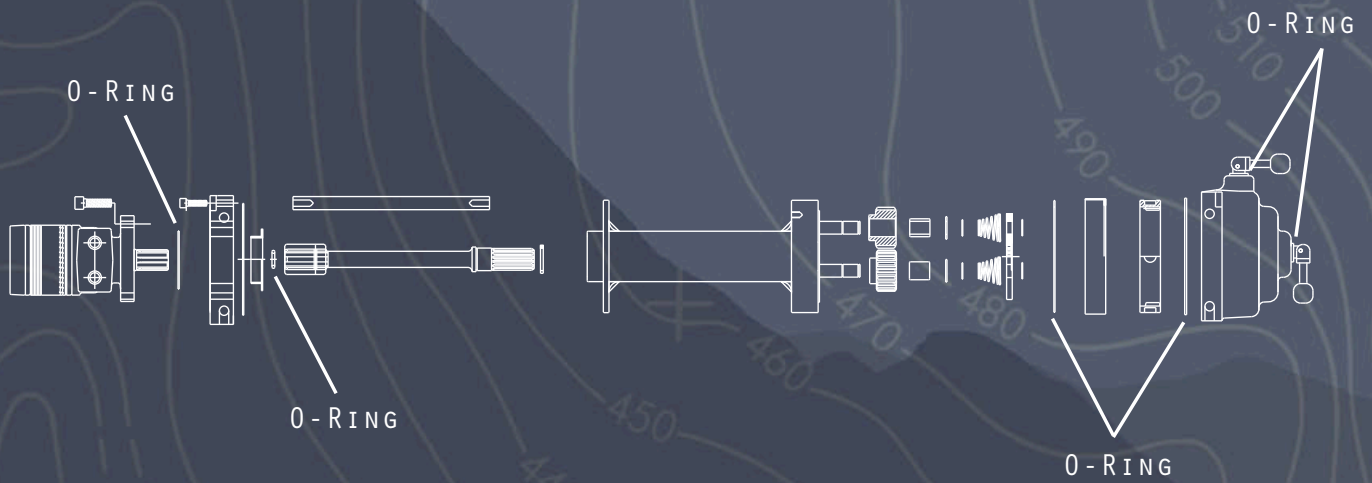

CONSTRUCTION

Internally sealed winches with O-rings in every critical spot make all our hydraulics completely element proof. Six seals keep any contaminants outside. Using the relief valve as a built in governor, it is impossible to overload or overwork the pump of your vehicle's power steering, the source of the winch's legendary power.

INSTALLATION

Vehicle specific adapter kits are required for most applications to connect the winch to the pump (see page 20).



34 SERIES



35 SERIES



BUILT TO LAST



CONTINUOUS USE



ELEMENT PROOF

H SERIES

Mile Marker's H Series hydraulics mount to either the front or the rear of the vehicle as a permanent or detachable winch. The system is independent from its solenoid control valve to allow for these mounting options. Most applications require a 34 series kit to fit the winch to your vehicle. The kit includes important components for installation.

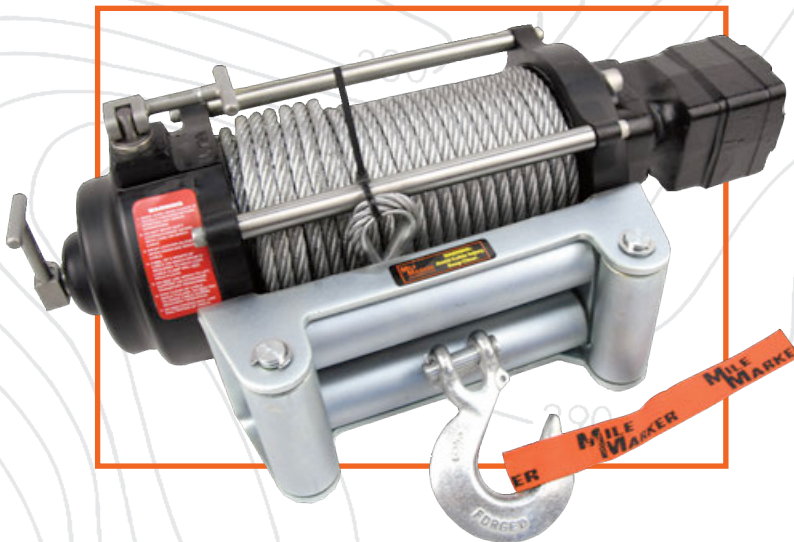

H9000

9,000 LB (4082 kg)
70-50080C

H10500

10,500 LB (4763 kg)
70-50050C

H12000

12,000 LB (5443 kg)
70-52000C

FEATURES:

- 100% Duty Cycle
- 2 Speed
- Power Steering Pump Powered
- Submersible
- Stainless Steel Tie Bars and Fasteners
- Ductile Iron Body (H12000 Only)
- Reversible Mounting (H9000 & H10500 Only)
- 3 Mounting Positions (H12000 Only)
- Mechanical Lock
- Corrosion Resistant
- 100' Steel Cable
- Roller Fairlead
- Free Spooling

SPECIFICATIONS:

Gear Train	Planetary
Gear Ratio	6:1
Motor	9k: 14 cubic inch; 10.5k: 17.9 cubic inch; 12k: 19.5 cubic inch 24V available
Remote	Not included
Steel Cable	3/8" X 100' (9.53 mm X 30.5 m)
Dimensions (LxWxH)	22.5" X 6.5" X 7.8" (571.5mm X 165.1mm X 198.1mm)
Drum Size Diameter X Length	2.5" X 9" (63.5 mm X 228.6 mm)
Net Weight	H9000/H10500: 93 lbs (42.2 kgs) H12000: 101 lbs (45.8 kgs)
Bolt Pattern	4 Bolt pattern, 4.5" X 10" (114.3 mm X 254 mm)
Power Steering Min. Requirements	3.5 GPM @ 1500 psi (13.25 l/min @ 103.4 bars)

PERFORMANCE:

9000

3.5 GPM @ 1500 PSI (13.25 L/m @ 103.4 bars)

Layer of Cable	1	2	3	4
Line speed - low gear (FPM)	6.16	7.48	8.8	10.5
Rated pull (lbs.)	9,000	7,300	6,200	5,400
Line speed - high gear (FPM)	33.6	38.4	48	57
Rated pull (lbs.)	1,500	1,200	1,000	900

10500

3.5 GPM @ 1500 PSI (13.25 L/m @ 103.4 bars)

Layer of Cable	1	2	3	4
Line speed - low gear (FPM)	5.65	6.43	7.41	8.58
Rated pull (lbs.)	10,500	8,500	7,400	6,400
Line speed - high gear (FPM)	31	36	42	48
Rated pull (lbs.)	1,600	1,300	1,200	1,000

12000

3.5 GPM @ 1500 PSI (13.25 L/m @ 103.4 bars)

Layer of Cable	1	2	3	4
Line speed - low gear (FPM)	5.65	6.43	7.41	8.58
Rated pull (lbs.)	12,000	9,400	8,200	7,000
Line speed - high gear (FPM)	31	36	42	48
Rated pull (lbs.)	2,000	1,550	1,350	1,150



34 SERIES ADAPTER KIT MAY BE REQUIRED
SEE APPLICATION CHART ON PAGE 20

HI SERIES

The Mile Marker HI Series hydraulic winch is designed for permanent mounting on the front of your vehicle. The solenoid control valve is integrated into the winch. A 35 Series adapter kit is needed to adapt to your power steering pump.



HI9000

9,000 LB (4082 kg)
75-50085C

HI10500

10,500 LB (4763 kg)
75-50050C

HI12000

12,000 LB (5443 kg)
75-52000C

FEATURES:

- 100% Duty Cycle
- 2 Speed
- Power Steering Pump Powered
- Submersible
- Stainless Steel Tie Bars and Fasteners
- Ductile Iron Body (HI12000 Only)
- Reversible Mounting (HI9000 & HI10500 Only)
- 3 Mounting Positions (HI12000 Only)
- Mechanical Lock
- Corrosion Resistant
- 100' Steel Cable
- Roller Fairlead
- Free Spooling
- Handheld Remote Control

SPECIFICATIONS:

Gear Train:	Planetary
Gear Ratio	6:1
Motor	9k: 14 cubic inch; 10.5k: 17.9 cubic inch; 12k: 19.5 cubic inch 24V available
Remote	Not included
Steel Cable	3/8" X 100' (9.53 mm X 30.5 m)
Dimensions	21.9" X 7.8" HI9000 22.1" X 7.8" HI10500 22.5" X 7.8" HI12000
Drum Size Diameter X Length	2.5" X 9" (63.5 mm X 228.6 mm)
Net weight	HI9000/HI10500: 103 lbs (47 kgs) HI12000: 110 lbs (50 kgs)
Bolt Pattern	4 Bolt pattern, 4.5" X 10" (114.3 mm X 254 mm)
Power Steering Min. Requirements	3.5 GPM @ 1500 psi (13.25 l/min @ 103.4 bars)

PERFORMANCE:

9000

3.5 GPM @ 1500 PSI (13.25 L/m @ 103.4)				
Layer of Cable	1	2	3	4
Line speed - low gear (FPM)	6.16	7.48	8.8	10.5
Rated pull (lbs.)	9,000	7,300	6,200	5,400
Line speed - high gear (FPM)	33.6	38.4	48	57
Rated pull (lbs.)	1,500	1,200	1,000	900

10500

3.5 GPM @ 1500 PSI (13.25 L/m @ 103.4)				
Layer of Cable	1	2	3	4
Line speed - low gear (FPM)	5.65	6.43	7.41	8.58
Rated pull (lbs.)	10,500	8,500	7,400	6,400
Line speed - high gear (FPM)	31	36	42	48
Rated pull (lbs.)	1,600	1,300	1,200	1,000

12000

3.5 GPM @ 1500 PSI (13.25 L/m @ 103.4)				
Layer of Cable	1	2	3	4
Line speed - low gear (FPM)	5.65	6.43	7.41	8.58
Rated pull (lbs.)	12,000	9,400	8,200	7,000
Line speed - high gear (FPM)	31	36	42	48
Rated pull (lbs.)	2,000	1,550	1,350	1,150

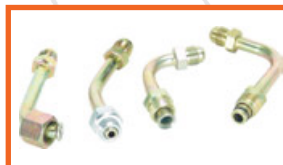

35 SERIES ADAPTER KIT MAY BE REQUIRED
SEE APPLICATION CHART ON PAGE 20

18K ONE SPEED HYDRAULIC WINCH

Our most powerful hydraulic winch, the 18K winch is designed for heavy duty, commercial, utility and wrecker applications.

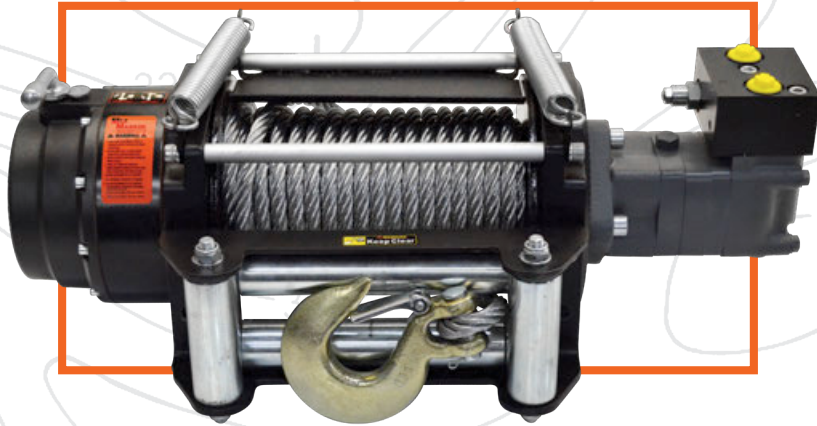

70-58010C

SPECIFICATIONS:

Gear Train	Planetary, hardened steel gear
Gear Ratio	36:01
Motor	7.6 C.I. (124.5 CC)
Remote	Not included
Dimensions (LxWxH)	25.8" X 8.4" X 9.6" (656 mm X 214 mm X 245 mm)
Cable Size	75' X 1/2" (22 m X 12.7 mm) Nominal breaking strength = 26,600 lbs
Drum Size Diameter X Length	4" X 9.95" (102 mm x 253 mm)
Net Weight	158.7 lbs (72 kgs)
Bolt Pattern	8 bolt pattern 6.5" X 12" (165 mm X 304.8 mm) Outer 4.5" X 12" (114.3 mm X 304.8 mm) Inner

FEATURES:

- Heavy Duty Disc Brake
- Heavy Duty Engagement Clutch
- Submersible
- Stainless Steel Tie Bars and Fasteners
- Mechanical Lock
- Corrosion Resistant
- 75' of 1/2" Steel Cable
- Roller Fairlead
- Free Spooling

PERFORMANCE:

High Speed Performance Specification (max 2030 PSI or 140BAR) (max 103.4 bars)

LAYER	Rated Line Pull		Line Speed				Cable Capacity	
			At 15 GPM (56.8.1 L/m)		At 20 GPM (75.71 L/m)			
	lbs	kgs	fpm	mpm	fpm	mpm	ft	m
1	18000	8165	14.9	4.5	17.4	5.3	21	6.4
2	14727	6680	18.2	5.5	21.3	6.5	46	14
3	12461	5652	21.5	6.6	25.6	7.8	75	22.9

First Layer Performance

Line Load	Pressure drop at 15 GPM (56.8.1 L/m)		Pressure drop at 20 GPM (75.71 L/m)	
	lbs	kgs	psi	bar
0	0	113	7.8	592
3000	1361	345	23.8	763
6000	2722	599	41.3	940
9000	4082	867	59.8	1123
12000	5443	1137	78.4	1311
15000	6804	1446	99.7	1506
18000	8165	1617	11.5	1706



Build by MOD Mafia

LOW PRESSURE WINCH

Jeeps, mid sized trucks and sport utility vehicles – we designed a winch for you. If your vehicle produces less than 1500 PSI, you can still harness the legendary power of the Mile Marker hydraulic winch without upgrading the power steering equipment. The low pressure winch will pull 9,100 pounds at 1100 PSI.

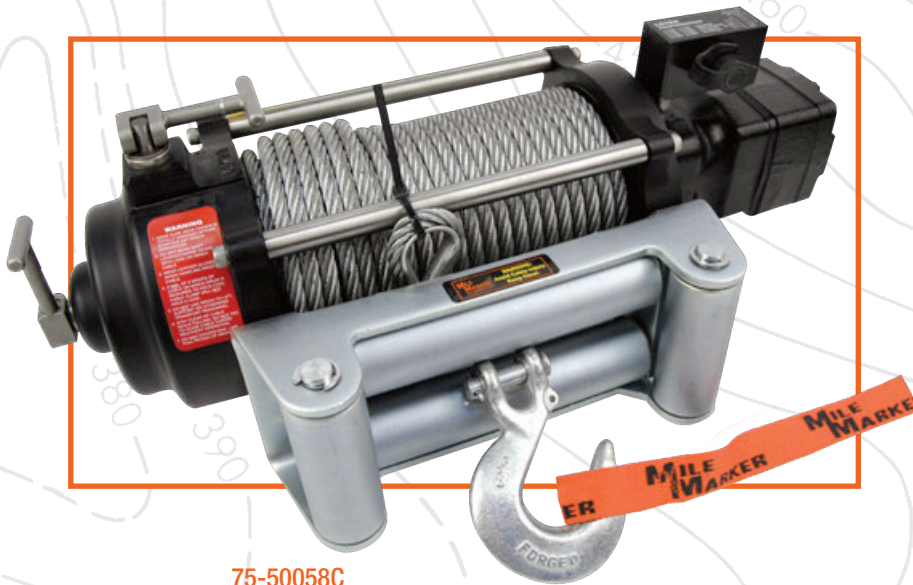

75-50058C

FEATURES:

- 2 Speed
- Integrated Solenoid Valve
- Submersible
- Stainless Steel Tie Bars and Fasteners
- Mechanical Lock
- Corrosion Resistant
- 100' Steel Cable
- Roller Fairlead
- Freespooling
- Handheld Remote Control

SPECIFICATIONS:

Gear Train	Planetary
Gear Ratio	6:1
Motor	19.5 cubic inch
Remote	Illuminated joystick remote, 12'
Steel Cable	3/8" X 100' (nominal 14,400 lbs) (9.53 mm X 30.5 m)
Drum Size: Diameter X Length	2.5" X 9" (63.5 mm X 228.6 mm)
Net Weight	103 lbs (47 kgs)
Bolt Pattern	4 Bolt pattern, 4.5" X 10" (114.3 mm X 254 mm)

PERFORMANCE:

LAYER	LOAD	PSI	GPM
1	6700	900	3
1	7800	1000	3
1	9100	1100	3
1	10100	1200	3
1	11000	1300	3
1	12000	1400	3



35 SERIES ADAPTER KIT MAY BE REQUIRED
SEE APPLICATION CHART ON PAGE 20

VEHICLE ADAPTER & VALVE KITS APPLICATION CHART

34 KIT FOR H SERIES WINCHES

REMOTE SOLENOID VALVE

Includes: Remote control with 12' lead, all hoses and fittings, remote solenoid activated control valve, adapter kit for power steering pump (vehicle specific). Rated 7 gpm.

PART NUMBER:	APPLICATION:
AM GENERAL	
34-5010-17	Valve Kit - H1 (civilian)
CHEVY/GMC/H2	
34-5020-14	Valve Kit - '72-'87 GM C/K, '88-'91 RV Series
34-5010-15	Valve Kit - '88-'98 GM C/K, '99 Tahoe/Suburban Silverado
34-5020-16	Valve Kit - '12-'16 GM 2500 & 3500 HD
34-5010-13	Valve Kit - GM S Series with 4.3L Vortec
34-5010-15	Valve Kit - H2
DODGE	
34-5020-22	Valve Kit - Dodge Dakota 6 & 8 cylinder
34-5010-20	Valve Kit - Dodge Dakota 4 cylinder
34-5020-23	Valve Kit - '72-'93 Dodge Full Size
34-5020-24	Valve Kit - '94 Dodge Full Size
FORD	
34-5010-09	Valve Kit - '97 Ford F-150 Expedition
34-5020-35	Valve Kit - '05 Ford F-250/F-350/F-450/F-550 Excursion
34-5020-37	Valve Kit - '11 Ford F-250/F-350/F-450/F-550 Excursion
34-5010-34	Valve Kit - '99-'04 Ford F-250/F-350/F-450/F-550 Excursion
34-5020-06	Valve Kit - '72-'77 Ford Full Size
34-5020-07	Valve Kit - '78-'96 Ford Full Size, '97-'98 F-250 & F-350
34-5010-07H	Valve Kit - '78-'98 Ford Full Size (with hydro boost)
34-5020-04	Valve Kit - '83-'92 Ford Ranger, '90-'94 Explorer
34-5020-05	Valve Kit - '93-'96 Ford Ranger, '95-'96 Explorer
34-5020-10	Valve Kit - '02 Ford Ranger/Sport Trac
34-5020-38	Valve Kit - Ford '12 Super Duty
34-5020-38H	Valve Kit - Ford '12 Super Duty with hydro boost
INTERNATIONAL	
34-5010-18	Valve Kit - International Truck & Scout
JEEP	
34-5010-50	Valve Kit - Jeep Cherokee
34-5020-51	Valve Kit - Jeep CJ Scrambler
34-5020-55	Valve Kit - Jeep YJ, TJ, JK & Rubicon
LAND ROVER	
34-5010-45	Valve Kit - Land Rover Discovery
NISSAN	
34-5010-30	Valve Kit - '86-'93 Nissan (except Pathfinder)
34-5010-31	Valve Kit - '91-'95 Nissan Pathfinder, '94-'96 Truck
TOYOTA	
34-5020-41	Valve Kit - '79-'02 Toyota
MEDIUM DUTY TRUCKS	
34-5010-80	Valve Kit - (Comes with size 8 hose, pressure relief)

35 KIT FOR HI SERIES WINCHES

INTEGRATED SOLENOID VALVE

Adapts power steering pump to HI Series winches. Includes vehicle specific power steering pump fittings and adapters.

PART NUMBER:	APPLICATION:
35-5020-17	Adapter Kit - AM General Hummer H1
35-5020-81	Adapter Kit - Chevy 5500
35-5020-16	Adapter Kit - '12 GM 2500 & 3500 HD
35-5020-15	Adapter Kit - GM Dodge International Chevrolet H2
35-5020-22	Adapter Kit - '03 & up Durango
35-5020-07	Adapter Kit - Ford up to '98
35-5020-34	Adapter Kit - '97-'04 Ford F-150, '99-'04 Ford
35-5020-10	Adapter Kit - Ford Sport Track Ford Ranger
35-5020-51	Adapter Kit - Jeep
35-5020-45	Adapter Kit - Land Rover
35-5020-31	Adapter Kit - Nissan
35-5020-41	Adapter Kit - Toyota
35-5020-38H	Adapter Kit - '12 Ford Super Duty with hydro boost
35-5020-38	Adapter Kit - '12 Ford Super Duty
35-5020-37	Adapter Kit - '11 Ford Super Duty
35-5020-35	Adapter Kit - '05-'10 Ford Super Duty
35-5020-36	Adapter Kit - '07 Ford F-550 only



34 KIT

VEHICLE SPECIFIC APPLICATIONS

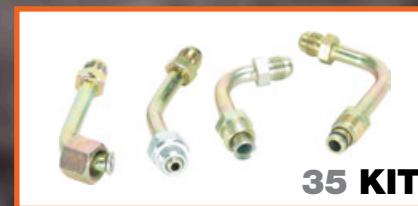

35 KIT

VEHICLE SPECIFIC APPLICATIONS

TOW WINCH

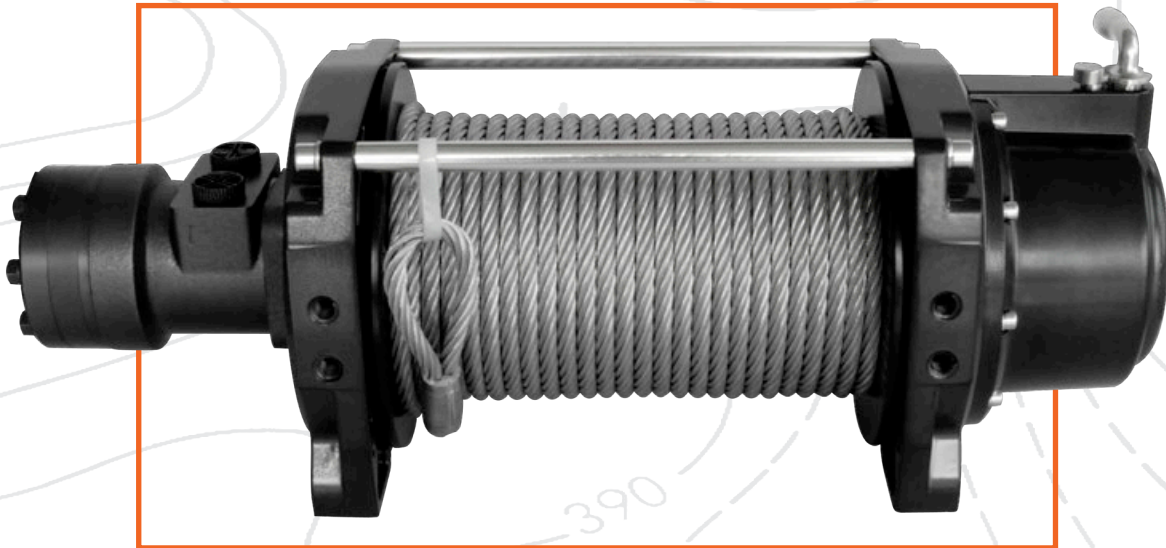

HS9000

70-59000C

SPECIFICATIONS:

Gear Train	Planetary, hardened steel gear
Gear Ratio	27:1
Motor	4.91 C.I (80.6 CC)
Dimensions (LxWxH)	23.6" X 8.43" X 9.25" (600 mm X 214 mm X 235 mm)
Steel Cable	3/8" X 100' (9.5 mm X 30.5 m) (14,400 breaking strength)
Drum Size Diameter/Length	4" X 9.96" (102 mm X 253 mm)
Net Weight	78 lbs
Bolt Pattern	Bottom: 4.5" X 6.4" X 12" (114.3 mm X 165 mm X 304.8 mm) Side: 1.25" X 12" (31.8 mm X 304.8 mm)
Duty Cycle	Intermittent per SAE J706 section 6.2 565' (172 m)

FEATURES:

- Automatic Load Holding Brake
- Heavy Duty Engagement Clutch
- Submersible
- Mechanical Lock
- Corrosion Resistant
- Clockwise & Counter Clockwise Rotation
- Cable Tension Plate Sold Separately
- Clutch Kits Sold Separately
- Free Spooling

PERFORMANCE:

Line Pull		Line Speed		
lb	kg	fpm	mpm	flow L/m
0	0	27.3	8.3	59
4000	2270	25.5	7.8	56.3
8000	4086	26.2	8	56.2
9000	5448	26.2	8	55.6

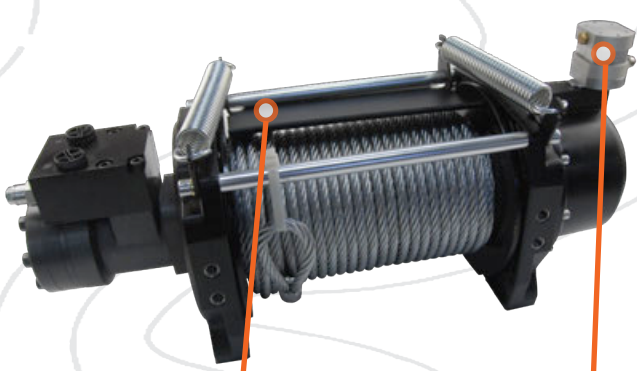

Winch Cable Tension Plate

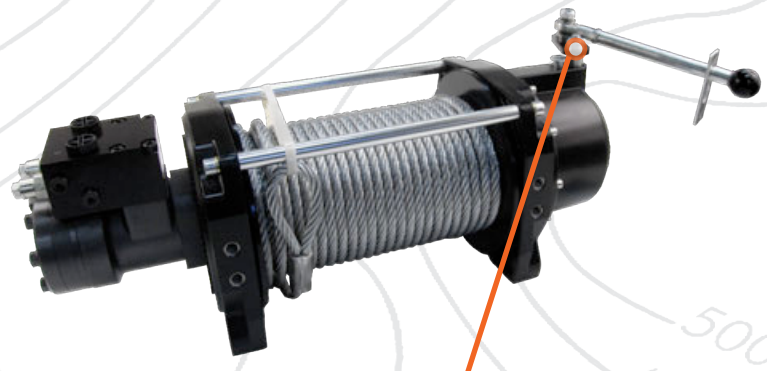

Remote Manual Clutch Kit



Remote Pneumatic Clutch Kit

Winch Cable Tension Plate: 70591
Remote Pneumatic Clutch Kit: 70593
Remote Manual Clutch Kit: 70592

MOUNTING SYSTEMS

ATV/UTV MOUNTS

The high quality choice for ATV and UTV winch mounts. Heavy duty steel construction and powder coating finishes enhance durability for these made to order custom mounts.

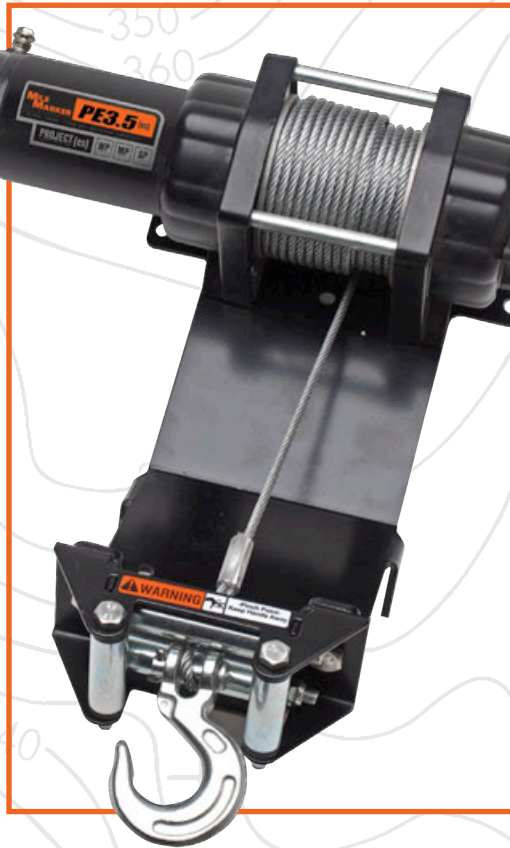

TRUCK & SUV MOUNTS

Protect your vehicle and your winch with our custom built Xtreme II grille guards. All incorporate a 1/4 inch thick mounting steel plate and can accommodate up to a 15,000 pound Mile Marker winch. Optional "wraparound" brush guards can be added to finish out the protection. See chart on the next page for vehicle specific application guide.

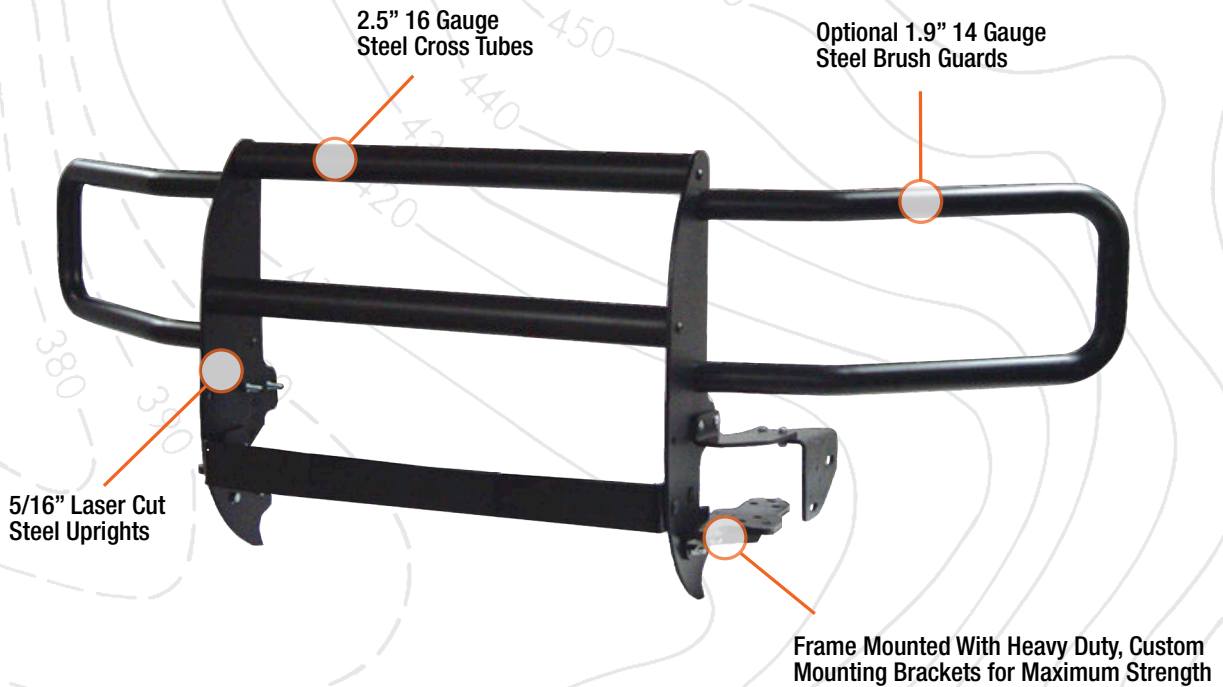

Mount (With Brush Guard)



Mount (No Brush Guard)

TRUCK & SUV

MOUNT APPLICATION GUIDE

Year	Make & Model (Check Product Guide Below)	Part Number & Mount Model			
		Grille Guard (up to 15,000 Lb winches) CHROME	Grille Guard (up to 15,000 Lb winches) BLACK	Brush Guard CHROME	Brush Guard BLACK
CHEVROLET					
'15-'19	Silverado 2500HD/3500 (7)	50-34752C	50-34752	50-26736C	50-26736
'11-'14	Silverado 2500HD/3500 (7)	50-34751C	50-34751	50-26751C	50-26751
'16-'18	Silverado 1500 (4) (7)	50-34746C	50-34746	50-26736C	50-26736
'14-'15	Silverado 1500 (4) (7)	50-34736C	50-34736	50-26736C	50-26736
'07-'13	Silverado 1500 (4) (7)	50-34735C	50-34735	50-26735C	50-26735
'07-'10	Silverado/Classic 2500HD/3500 Classic (1)	50-34738C	50-34738	50-26738C	50-26738
DODGE					
'10-'19	Ram 2500/3500 (3) (7) (10)	50-34669C	50-34669	50-26669C	50-26669
'07-'19	Ram 3500-5500 Chassis Cab (7)	50-34665C	50-34665	50-26663C	50-26663
'09-'18	Ram 1500 (3) (7) (10)	50-34671C	50-34671	50-26669C	50-26669
FORD					
'10-'13	Expedition (4) (6) (7)		50-34619		
'17-'19	Super Duty F250-550 (7) (8) (10)	50-34647C	50-34647	50-26647C	50-26647
'11-'16	Super Duty F250-550 (7) (10)	50-34644C	50-34644	50-26644C	50-26644
'08-'10	Super Duty F250-F550 (2) (7)	50-34642C	50-34642	50-26642C	50-26642
'09-'13	F150 (2) (4) (5) (6) (7)	50-34639C	50-34639	50-26639C	50-26639
'15-'17	F150 (7) (8) (9) (10)	50-34650C	50-34650	50-26650C	50-26650
'06-'08	F150 (1)	50-34637C	50-34637	50-26637C	50-26637
GMC					
'15-'19	Sierra 2500HD/3500 (1) (7)	50-34754C	50-34754		
'11-'14	Sierra 2500HD/3500 (1) (7)	50-34751C	50-34751	50-26751C	50-26751
'14-'18	Sierra 1500 (1) (4) (7)	50-34749C	50-34749		
'07-'13	Sierra 1500 (1) (4) (7)	50-34745C	50-34745		
NISSAN					
'05-'12	Pathfinder		50-34160		

Product Guide

1. Will not fit Denali Models or Denali Style Grilles
2. Will not fit Harley Davidson Models
3. Will not fit Ram Sport or Plastic Bum Bumpers
4. Trimming may be required
5. Will not fit Lariat Limited
6. Will fit F-150 EcoBoost
7. Interferes with front bumper sensors
8. May interfere with adaptive power steering
9. Will not work with 5.0 V8 Engines
10. Will interfere with OEM front facing cameras

CHANNEL MOUNTS

TRUCK/SUV MOUNTING SYSTEMS

The simple mounting solution for your vehicle, these mounts can be welded or bolted to adapt to almost any application. All are made from 1/4" high quality steel and finished with a black powder coat.

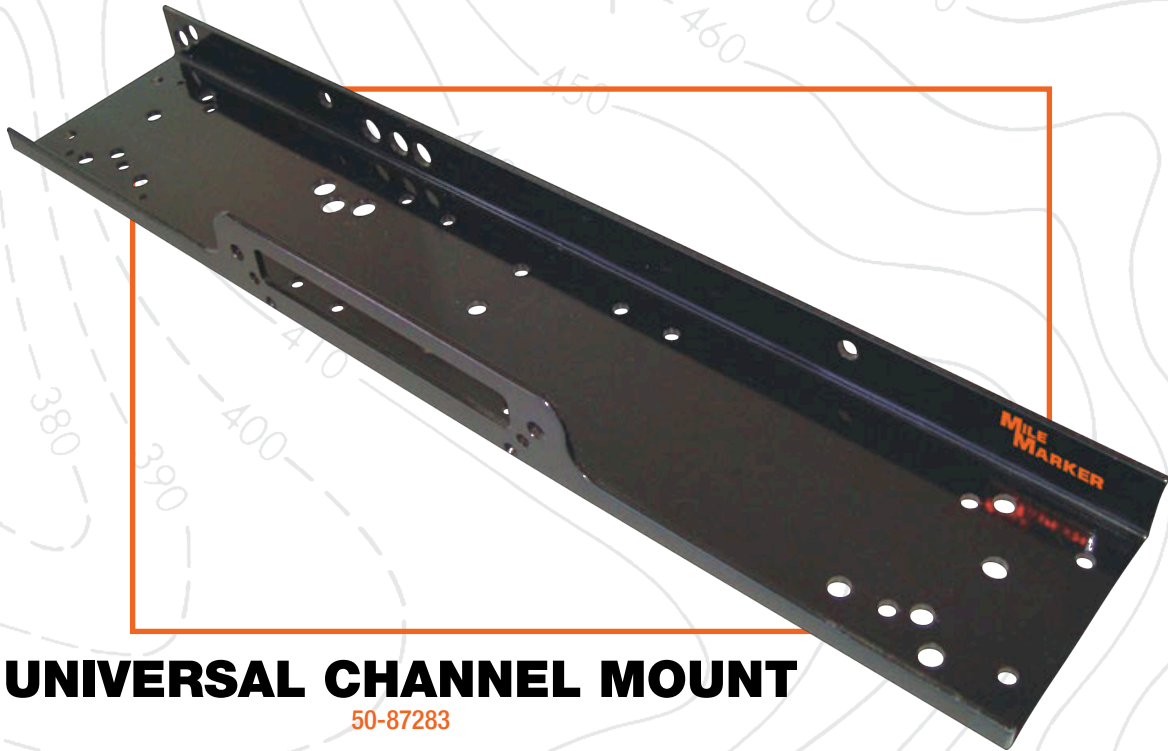

UNIVERSAL CHANNEL MOUNT

50-87283



TRAILER MOUNT

60-50015



JEEP WRANGLER (TJ/YJ)

60-50059

RECEIVER MOUNTS



DETACHABLE MOUNTING SYSTEMS

Mile Marker's receiver mounts are detachable, providing versatility needed to move winches from back to front or from vehicle to vehicle. Simply add quick disconnect wiring and you're ready to go (See page 36 for quick disconnect kits).



FULL SIZE CRADLE MOUNT

60-06495



RECEIVER MOUNT DESIGNED
TO WORK WITH ATV/UTV WINCHES

51-06496



ATV/UTV RECEIVER MOUNT

51-4677

JEEP ACCESSORIES



JEEP FRONT BUMPER 52098

- Easy to install, no brackets needed
- Laser cut 3/16" steel plate material
- Black wrinkle finish
- 3 year warranty on workmanship and materials; 1 year warranty on finish
- Lights not included

BULL BAR 52298

- 1.9" Diameter tubing
- Mounts to existing holes in the bumper
- Holds up to two 6" lights
- Black wrinkle finish
- 3 year warranty on workmanship and materials; 1 year warranty on finish
- Lights not included

Windshield Light Bracket



Cube Light
Bracket Combo



JEEP STEPS 52398

- 1.9" Tubing with diamond plated steps
- Black wrinkle powder coat finish
- 3 year warranty on workmanship and materials; 1 year warranty on finish

LIGHT BRACKETS

52598 (Windshield Light Bracket)
52599 (Cube Light Bracket Combo, as shown in picture)

- Easy to install
- 4.27Lbs
- Black wrinkle powder coat finish
- 3 year warranty on workmanship and materials; 1 year warranty on finish
- Lights not included

JEEP REAR BUMPER

52001

- Bolt-on replacement
- Laser cut 3/16" steel plate material
- Brake light relocater included
- Black wrinkle powder coat finish
- Features two Heim joints
- Comes with swing arm and straight tire carrier
- 3 year warranty on workmanship and materials; 1 year warranty on finish
- Optional slant tire carrier (94202)
- Lights not included



APPLICATION GUIDE

Year	Description	Part Number
'07-'19	JK Front Bumper - Winch Style	52098
'07-'19	JK Rear Bumper (with Straight Tire Attachment)	52001
'07-'19	JK Optional Slant Tire Mount	52200
'07-'19	JK Bull Bar	52298
'07-'19	JK Tubular Steps (4 Door Models Only)	52398
'07-'19	JK Rear Bumper (No Tire Attachment)	52498
'07-'19	JK Light Bracket/Windshield Light Bracket	52598
'07-'19	JK Cube Light Bracket Combo	52599
'07-'19	JK Stage II Front Bumper	52100

TRUCK ACCESSORIES



BAJA RAKS

- Universal top mounting plate that will hold light bars up to 50"
- Dual tubular frame for maximum strength
- 16 gauge removable side plates with stainless steel button head bolts
- Constructed out of 1.9" 14 gauge tubing
- Gives a wide off-road appearance from the side viewing angle
- Mounting foot has a built in tie down for securing items in bed
- 3 year warranty on workmanship, materials and finish (excludes fading)

APPLICATION GUIDE

Year	Make & Model	Part Number
	CHEVROLET/GMC	
'07-'14	Silverado/Sierra 2500HD/3500	51735
'07-'13	Silverado/Sierra 1500	51735
	TOYOTA	
'07-'19	Tundra	51708



BAJA BUMPER REPLACEMENTS

- 3/4" D rings
- Works with existing skid plate
- Winch controls accessible through the front entry points
- 7 gauge plated bumper that is laser cut, formed and welded together as one piece
- Offers maximum clearance
- Optional Bull Bar mounting surface of 18" for light bar
- 3 year warranty on workmanship, materials and finish (excludes fading)
- Lights not included

APPLICATION GUIDE

Year	Make & Model	Part Number
FORD		
'17-'19	F-450 & F-550 Super Duty *	58147
'11-'16	F-250 & F-550 Super Duty *	58145
'10-'14	F-150 (Non-ECO boost)	58139
'10-'15	F-150 Raptor SVT	58139RAP
'10-'15	Optional Bull Bar for 8139RAP only	58100
TOYOTA		
'14-'17	Tundra*	58106

* Will not work with OEM front facing cameras.

RECOVERY GEAR



Off-Road Recovery Kit
19-00100

Everything you need to get out of a pinch. In the event of a snap, our winch dampener directs the cable to the ground and keeps you safe. Doubling as the bag, it houses a 15' recovery strap, gloves, 20K snatch block with grease fitting, and two powder coated shackles.



Choose the right kit for you.
You can count on Mile Marker recovery gear to overcome the elements.



Heavy Duty Recovery Kit: 19-00150

Designed for the heaviest of tasks in recovery. Includes: 10 ft. tow chain, leather gloves, 30K industrial snatch block, two 3/4 in. alloy shackles, and a 30 ft. recovery strap. Housed in a weather proof bag with removable work tray.



ATV/UTV Recovery Kit: 19-00105

Push your ATV or UTV to the limits. Includes: two powder coated shackles, gloves, 8K snatch block, and two 8 ft. recovery straps. Housed in a durable carrying case with strap.





Orange Powder Coated Shackles

3/4" Shackle **60-50134**

5/8" Shackle **60-50158**

Orange powder coated shackles. Working load limit of 4.75 tons for the 3/4" shackles and 3.25 tons for the 5/8" shackles.



Steel Hitch Receiver With D-Ring

60-65000C

Zinc coated, forged cast, solid steel hitch receiver fits standard Class III hitches with 2" receivers. Includes a 4-way hole system and a 3/4" orange shackle to meet any mounting needs.



Recovery Gloves

(L) **30-19-G4**

(XL) **30-19-G2**

Gloves feature cowhide palms with SBR padding to protect your hands from cable burns and rope burns, while a combination of synthetic leather and neoprene lines allow excellent breath ability and functional dexterity.



Recovery Strap 15' & 30'

3" X 15' **19315**

3" X 30' **19330**

These straps have built in blue lines that appear over time indicating that the strap is no longer safe to use & needs to be replaced. 30,000 pound capacity.



ATV Recovery Strap 8'

1" X 8' **19108**

8 foot Recovery strap rated to 7,200 pounds, with reinforced eyelet on each end.



Tree Saver Strap 6'

4" X 6' **19406**

Be conscious of your environment with this 6' Tree Saver strap. This Tree Saver Strap is rated to 50,000 pounds.



Industrial Snatch Block 30K

60-50185

Enables you to retrieve loads that are double a winch's capacity by reducing the load on the winch by half. It also facilitates winching from various angles when straight ahead isn't the best option. This snatch block is a serviceable assembly featuring a grease fitting and brass bushing for years of trouble free duty.



Heavy Duty Snatch Block 20K

60-50083

Enables you to retrieve loads that are double a winch's capacity by reducing the load on the winch by half. It also facilitates winching from various angles when straight ahead isn't the best option. This snatch block is a serviceable assembly featuring a grease fitting and bronze bushing for years of trouble free duty.



ATV/UTV Snatch Block 8K

60-50105

Enables you to retrieve loads that are double a winch's capacity by reducing the load on the winch by half. It also facilitates winching from various angles when straight ahead isn't the best option.

ACCESSORIES



Wireless Remote
7076

WINCH WITHOUT WIRES

The plug & play wireless remote operates your winch from anywhere up to 50 feet away! Simply plug a receiver into your control box and you're ready to winch. Can adapt to most electric and hydraulic winches.

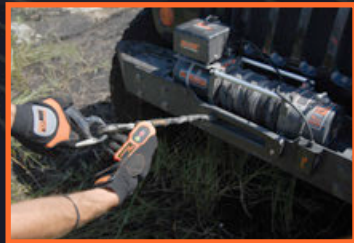

WIRELESS OPERATION UP TO 50 FT AWAY



ADAPTS TO MOST ELECTRIC WINCHES

QUICK DISCONNECT KITS

Adding a quick disconnect kit allows for easy winch removal. Move your winch from the front to the back of your vehicle, or switch vehicles, whenever you need. Best used in conjunction with a receiver style mount.

JEEP/TRUCK/SUV



Electric Front Quick Disconnect Kit
76-93-54000



Electric Rear Quick Disconnect Kit
76-93-53000

POWERSPORTS



ATV/UTV Front Quick Disconnects
93-53106

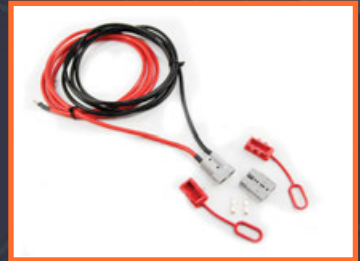

ATV/UTV Rear Quick Disconnects
10' 93-53105 / 12' 93-53108

HYDRAULIC



Hydraulic Front Quick Disconnect Kit
70-54000



Hydraulic Rear Quick Disconnect Kit
70-53000



Replacement Solenoid
(Full size winches)

For permanent magnet motors **76-50140-06**
For series wound motors **77-50141W-31**



Roller Fairlead Cover 8402

This impact resistant cover protects your Mile Marker WH-10 roller fairlead from weather and debris while adding a finished look to the front of your vehicle.



Neoprene Winch Covers
Wraps snugly around your winch for all weather protection

Fits hydraulic winches **8503**
Fits ATV winches **8505**
Fits full size winches **8506**



Roller Fairlead WH-18
Works with 18,000 lb. winches



Roller Fairlead WH-10
Universal roller fairlead works with 8000-15000 pound winches. Also fits winch mount bumpers.



Powersports Winch Rollers
For winches 5000 pounds ONLY **WH-5**
For winches 4500 pounds ONLY **WH-4**
For winches 2000-3500 pounds **WH-2**



Aluminum Hawse Fairlead
For use with synthetic rope
(ATV/UTV) **19-52000**
(PE5000) **19-52005**
(Full Size) **19-52001**



Hydraulic Remote 93-50057
For use with Mile Marker solenoid controlled hydraulic winches with an IP67 connector.



Handlebar Remote 93-50106D
For use with Mile Marker ATV/UTV winches. Adjustable mount provides accessible control to your trail blazing ATV.



Electric Remote 77-50141W-50
For use with Mile Marker electric winches with standard solenoids.



Replacement Cable
5/16" X 100' **19-50010C**
3/8" X 100' **19-50020C**
Steel cable with removable hook.



Synthetic Rope
19-52038-100C *
3/8" X 100' Assembly
(16,200 lbs. Min Break Force)
19-52516-100C *
5/16" X 100' Assembly
(11,700 lbs. Min Break Force)
19-52014-50
1/4" X 50' Assembly
(7,740 lbs. Min Break Force)
19-52316-50
3/16" X 50' Assembly
(5,440 lbs. Min Break Force)

Attached hook included *



Winch Shackle Mount
60-12166

PREMIUM LOCKING HUBS

Mile Marker hubs allow you to manually lock your vehicle into 4 wheel drive and are built to last through all weather and terrain. Use the two guides to choose the right hub for your vehicle and the correct conversion kit if needed (see next page for conversion kits)



104



302



428



449SS

HUB SPECIFICATION GUIDE

All specifications must match exactly for hub to fit.

Part Number	Bolt Circle	# of Bolts	# of Splines	Axle O.D.
104		Internal	19	1.250
302		Internal	19	1.250
423	3.750	6	19	1.250
426	Internal	Internal	27	1.210
427	4.500	5	23	1.016
428	4.500	5	27	1.206
430	3.260	6	27	1.094
435	3.260	6	28	1.143
436	3.543	6	26	1.080
438	90	6	26	104
449SS		Internal	30	1.312
457	3.437	6	27	1.187

Part Number	Bolt Circle	# of Bolts	# of Splines	Axle O.D.
459SS		Internal	35	1.500
460	76	6	26	91
466	3.543	6	30	1.300
470	3.440	5	27	1.187
481	3.437	6	10	1.125
490	3.543	6	26	1.100
11017-01	3.968	8	21	1.375
11022-01	4.000	6	16	1.437
11034-01	3.960	8	30	1.312
11035-01	4.375	6	21	1.375
11165-01	5.563	16	34	1.750
95-37044	4.500	5	19	1.250

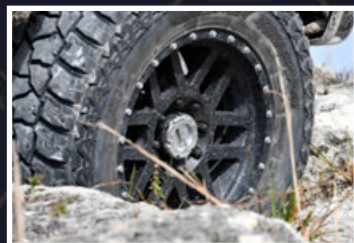

BUILT TO LAST



MADE FOR EXTREME TRACTION

CONVERSION KITS

For owners of full time 4WD vehicles, convert from 4WD to 2WD effortlessly. Conversion kits reduce wear and tear on your drivetrain, saving you money at the gas pump and providing years of trouble free service.

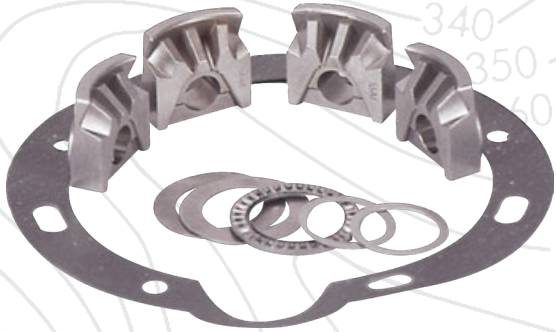

FORD & GM 203 NEW PROCESS

203 Transfer case without hubs **501**

With premium 1/2 Ton hubs **502**
(also fits '78-'79 3/4 Ton)

With premium locking hubs **503**
Fits '73-'77 3/4 Ton

With premium locking hubs **505**
1 Ton GM, Ford

Bearing kit **701**



AMC QUADRA-TRAC

BORG WARNER 1339 TRANSFER CASE FITS '73-'79 VEHICLES ONLY

Part time conversion

No hubs or chain (uses stock chain)

Same as above w/ premium 1/2 Ton hubs

Same as above with CJ hubs

95-91204

95-12204

95-15204



HUB APPLICATION GUIDE

Vehicle Model/Year	Part Number
AMC/JEEP	
Cherokee '74 - '87	104, 302
CJ Universal '42 - '71	481
CJ Universal '72 - '86	457
CJ Universal '80 - '86	470
Gladiator '74 - '87	104, 302
J10 Pickup '74 - '80	104, 302
J20 Pickup '74 - '77	423
J20 Pickup '78 - '90	104, 302
M725, M726, M728, M715 - ALL	11035-01
Military 1 1/4 Ton - ALL	11035-01
Wagoneer '71 - '73	457
Wagoneer '74 - '87	104, 302
CHEVROLET/GMC	
1/2 Ton Pickup (K10) '69 - '87	104, 302
3/4 Ton Pickup '78 - '87	104, 302
Blazer '69 - '91	104, 302
Chevy 3/4 Ton (K-20) Pickup '60 - '77	423
Chevy IT (K-30) Pickup '77 - '87	449SS
Chevy IT Dana 50 & 60 Axle '77 - '87	449SS
Jimmy '69 - '91	104, 302
Suburban '69 - '91	104, 302
CHRYSLER/PLYMOUTH/DODGE	
1/2T W-100 P/U '69 - '93	104, 302
1/2T W-100 P/U '57 - '68	423
3/4 Ton W-200 Pickup except full-time 4WD - ALL	423
1 Ton W-300 Series '58 - '67	11035-01
1 Ton W-300 Series '68 - '75	11017-01
1 Ton W-300 Series '76 - '89	11034-01
1 Ton Dana 50 & 60 Axle '90 - '93	449SS
1 Ton WC-50, WC-60 - ALL	11022-01
1 Ton WM-300 '57 - '75	11022-01
Power Wagon '42 - '56	11022-01
RAM Charger '80 - '93	104, 302
Trail Duster '80 - '93	104, 302
FORD	
3/4 Ton P/U w/Spline wheel hub (A,B) - ALL *	104, 302

Vehicle Model/Year	Part Number
3/4 Ton w/3500 Axle ex. F/T '63 - '77	423
1 Ton Pickup '59 - '96 ***	104, 302
1 Ton Dana 50 & 60 Axle '76 - '04 (A,B) *	449SS
F-150 '59 - '81(A,B) ***	104, 302
F-150 '82 - '96 (A,B) *	104, 302
F-250 '99 - '04	449SS
F-250 ex. F/T '59 - '98 ***	449SS
F-350 '88 - '98 ***	449SS
F-350 '99 - '04	449SS
F-350 Dana 50 & 60 Axle '76 - '04 (A,B) *	449SS
F-450 '88 - '98 ***	449SS
F-450 '99 - '04	449SS
F-450 Dana 50 & 60 Axle '76 - '04 ***	449SS
F-550 '99 - '04	449SS
Bronco '66 - '96 (A, B) *	104, 302
Bronco II '83 - '90 (A) ***	427
Excursion '99 - '04	449SS
Explorer '90 - '94 (A) ***	428
Ranger '83 - '97 (A) ***	428
Ranger '98 - '00 (A) **	426
GEO	
Tracker (all)	436
INTERNATIONAL HARVESTER	
1/2 Ton Pickup '74 - '75	457
1/2 Ton Pickup '64 - '73	104, 302
3/4 Ton Pickup '56 - '75	423
1 Ton HD. 200 with FA-20 Axle - ALL	11034-01
Scout '61 - '71	481
Scout II (ex. F/T) '72 - '80	457
Travel-all 1/2 Ton '64 - '73	104, 302
Travel-all 1/2 Ton '74 - '75	457
Travel-all 3/4 Ton '56 - '75	423
KIA	
Sportage '97 - '02	460
Grand Sportage '97 - '02	460

Vehicle Model/Year	Part Number
MAZDA	
B3000 '01 - '08	426
B4000 '01 - '08	426
Navajo '90 - '94 (A) *	428
Pickup '94 - '97 (A) *	428
NISSAN	
1/2 Ton P/U '85 1/2 - '89	430
Frontier '98 - '04	435
Hardbody '90 - '97	435
Hardbody (6 Bolt 27 Spline) '86 1/2 - '89	430
Pathfinder '90 - '01	435
Pathfinder (6 Bolt 27 Spline) '86 1/2 - '89	430
Xterra '00 - '04	435
All Nissan (6 Bolt 28-Spline) - ALL	435
ROCKWELL	
RDS 90 Axle 16 Hole	11165-01
SUZUKI	
Jimny '98 and earlier	438
Samurai '82 - '98	436
Samurai '99 - '01	438
Sidekick '82 - '98	438
Sierra '82 - '98	436
X-90 '82 - '98	438
TOYOTA	
4 Runner '76 - '98 ***	490
4 Runner 4x4 Pickup '86 - '94	490
Hilux '76 - '98 ***	490
Land Cruiser '63 - '98 ***	490
Land Cruiser '76 - '85	466
Pickup '76 - '85	466
Pickup '76 - '98 ***	490
T-100 '93 - '98	490
HEAVY DUTY	
35 spline Dana 70 hub	459SS

Nut Conversion Kits

104, 302	95-32720
427	95-27988
428	95-27997
449SS	95-32721
490	95-29918

- If OEM automatic hubs, a conversion kit is required to convert to manual hubs
 - '73-'79 vehicles with full-time 4 wheel drive require a transfer case conversion kit
- * Nut Conversion Kit required
 ** Not required on these model years 99-04
 *** Depending on application Nut Conversion Kit may be required

