



# Overland Expedition Equipment

# Roof racks reinvented.

Kargo Master are proud to offer a high quality product at the industries most competitive pricing!



# 02

## About KM Safari

|               |   |
|---------------|---|
| About Us      | 2 |
| Happy Jeepers | 3 |

# 04

## Racks & Cages

|  |    |
|--|----|
| JK Congo Pro Cage                                    | 5  |
| The Congo Pro or LO-PRO Choice                       | 6  |
| Modular Platform System                              | 8  |
| Modular Platform Racks                               | 10 |
| Classic Congo Cages                                  | 13 |
| Basket Racks / Basket Racks & Mount Bracket Packages | 14 |
| Jeep Classic Congo Cage & Basket Rack Packages       | 15 |

# 12

## EZ Access

|                    |    |
|--------------------|----|
| EZ Access Products | 17 |
|--------------------|----|

# 14

## Accessories

|   |    |
|---|----|
| Accessories   | 19 |
| Base Rack Mounts                                    | 20 |
| SUV Rack Mounting Systems / Basket Rack Accessories | 21 |
| MOD-RAK Accessories                                 | 23 |
| Base Rack Accessories                               | 25 |
| Load Bars & Accessories                             | 27 |



Whether you're into off-roading, overlanding, camping, kayaking, skiing, mountain biking or surfing, KM Safari has the perfect jeep or SUV rack to transport all the gear you need for your next big adventure. We manufacture a complete line of Congo Cages and accessories. Known for manufacturing stylish and durable truck and van racks, Kargo Master has put over three decades of experience to work when creating our Congo Cage Jeep Roof Racks, Bushman Basket Racks and related after-market equipment.

KM Safari Jeep and SUV racks are designed for owners who would rather be out on the trails than following complicated instructions. All of our racks are easy to install – no drilling required! Every rack comes standard with a heavy-duty marine-grade powder coat finish designed to resist the elements. And Kargo Master's excellent warranty proves that we stand behind our products 100 percent.

# About KM Safari

For more than 40 years, Kargo Master has been recognized as one of the premier manufacturers of truck racks, van racks and equipment in the country. Founder David Lewis teamed up with fellow outdoorsman Rustin Smith to pursue their mutual passion to produce superior quality after-market products for Jeep enthusiasts. Thus, KM Safari was born.



## Rustin Smith

President

Rustin Smith is President of Kargo Master Safari. He lives on a cattle ranch in eastern Oregon and hates being indoors. He loves anything with wheels and tires, especially the knobby kind. He spends more time than most inside or underneath heavy equipment. His best years were bounced away in a Jeep, as the founder of Rubicon Express he brings a solid off-road background. He has passion for designing and developing new products that create value and utility for your vehicle. As a true enthusiast, he leads the KM Safari team in our quest to reinvent roof racks and produce the best rack system money can buy.



## David Lewis

Founder & Visionary

David Lewis is the founder of Kargo Master and KMS. He lives in the hills of Northern California not far from the factory. They don't make them like David anymore. He is a man of rare qualities and unique talents, short on words, long on deeds. He is an avid horseman, hunter and an accomplished archer. He is a born and bred motorcyclist and can't resist the call of the open road.

David has made everything under the sun at one time or another. His knowledge and expertise in design and fabrication are at the heart of every product we make. His legacy was made the hard way, no shortcuts, just years of blood sweat and tears. Don't look for him in the boardroom ... he's on the shop floor setting up the next job.





About Us



**Take all your gear anywhere.**



# JK Congo Pro Cage

The JK Congo Pro Cage is a heavy-duty 2" tubular exo-skeleton racking system. The modular construction is made for ease of installation and allows for ample unique modifications. Loading strength, rigidity and stability are characteristics of this new generation system. Our complete line up of accessories allows you to customize and change up your Congo Pro for any hauling or outdoor application.

## #55000/#55010

### JK Congo Pro Kits

The JK Congo Pro 4 Door and 2 Door base racks are the foundation for installing any of our basket racks, platform racks, load bar systems and accessories. Works with both soft and hard tops, freedom panels are accessible and hard top can be removed with rack in place. Hinged design allows clearance to operate factory soft top (tools required). Packages include Roof Rails and JK Front and Rear Hoop Kit.



### JK Congo Pro: Parts

| PART#  | DESCRIPTION  | VISUAL |        |                                      |  |
|--------|--|--------|--------|--------------------------------------|--|
| #55000 | JK Congo Pro 4 Door Kit<br>Includes Side Rails (pair), Front Hoop, Rear Hoop & Frame Bracket (55020 + 55027) |        |        |                                      |  |
|        |  | #55020 | #55027 |                                      |  |
| #55010 | JK Congo Pro 2 Door Kit<br>Includes Side Rails (pair), Front Hoop, Rear Hoop & Frame Bracket (55025 + 55027) |        |        |                                      |  |
|        |  | #55025 | #55027 |                                      |  |
| #55015 | JK Congo Pro Front Hoop  |        | #55016 | JK Congo Pro Front Hoop (no handles) |  |
|        |  |        |        |                                      |  |
| #55020 | JK Congo Pro Roof Rails 4 Door   |        |        |                                      |  |
| #55025 | JK Congo Pro Roof Rails 2 Door   |        |        |                                      |  |
| #55026 | JK Congo Pro Rear Hoop   |        |        |                                      |  |
| #55027 | JK Congo Pro Front and Rear Hoop Kit (55015 + 55026 & Frame Bracket)   |        |        |                                      |  |

# Install a platform rack on your Jeep with a Congo Pro base rack or flush mount with the LO-PRO.

## JK Congo Pro

Side rails, hoops, platform & accessories



- Easy no drill installation
- Works with soft top and hard tops.
- Base rack is optimized for roof top tent mounting.
- Allows mounting of baskets, platforms, load bars, lights and accessories
- Full length great for boats and longer loads.
- Easy to remove when not in use.

## JK LO-PRO

Platform, side rails & accessories



- Mounts through hard top to roll cage.
- Low profile platform style rack
- Lightest installed weight.
- Highest load capacity
- Sleek styling and customizable with accessories
- Can be up-fitted with A-frame, kat-walk and spreader bars.





## Jeep JK CONGO PRO KIT Base Package and Options

**#60335** 1-1/8" ALUMINUM LOAD BAR (3 ITEMS)

**#55027** FRONT AND REAR HOOP KIT

**#60325** 2" – 1-1/8" ALUMINUM CROSSOVER CLAMP (PAIR)

**#60245** 2" ALUMINUM GRAB HANDLE KIT  
(ACCESS SYSTEMS OPTION)

**#55020** ROOF RAILS 4 DOOR (PAIR)  
**#55025** ROOF RAILS 2 DOOR (PAIR)

**#60320** 2" – 1-1/8" ALUMINUM STAND-OFF BRACKET

**#55027** FRONT AND REAR HOOP KIT

**#60260** HINGE STEPS (PAIR)  
(ACCESS SYSTEMS OPTION)

**#60255** KAT-WALK  
(ACCESS SYSTEMS OPTION)

**#56000** ROCKER WALK SIDE STEPS 4 DOOR (PAIR)  
**#56010** ROCKER WALK SIDE STEPS 2 DOOR (PAIR)  
(ACCESS SYSTEMS OPTION)

**#55000** 4 Door includes #55020 Roof Rails and #55027 Front and Rear Hoops

**#55010** 2 Door includes #55025 Roof Rails and #55027 Front and Rear Hoops

## Jeep JK CONGO PRO KIT Base Package and Options

**#50231** BUSHMAN STEEL SAFARI BASKET KIT WITH #60310 MOUNTS  
(OPTIONAL)

**#60245** 2" ALUMINUM GRAB HANDLE KIT  
(ACCESS SYSTEMS OPTION)

**#55020** JK CONGO PRO ROOF RAILS 4 DOOR (PAIR)

**#60300** LIGHT BAR MOUNT KIT FOR 2" DIA. TUBE  
(OPTIONAL)

**#55025** JK CONGO PRO ROOF RAILS 2 DOOR (PAIR)

**#55027** FRONT AND REAR HOOP KIT

**#60245** 2" ALUMINUM GRAB HANDLE KIT  
(ACCESS SYSTEMS OPTION)

**#60255** KAT-WALK  
(ACCESS SYSTEMS OPTION)

**#55027** FRONT AND REAR HOOP KIT

**#60260** HINGE STEPS (PAIR)  
(ACCESS SYSTEMS OPTION)

**#56000** ROCKER WALK SIDE STEPS 4 DOOR (PAIR)  
(ACCESS SYSTEMS OPTION)

**#55000** 4 Door includes 55020 Roof Rails and 55027 Front and Rear Hoops

**#55010** 2 Door includes 55025 Roof Rails and 55027 Front and Rear Hoops  
Showing Bushman Steel Safari Basket

# Modular Platform System

There is nothing lower and lighter than our LO-PRO MOD-RAK system. Unique integrated roll-cage mounting provides our highest load rated platform with sleek styling that can be built up or down with optional equipment.

## #55070

### JK MOD-RAK LO-PRO Platform

Modular aluminum direct attachment platform (46"x 52"). Direct attachment to factory roll bar assembly through the hard top. Rear roll bar extension included. Allows user to mount heavy loads using the lowest platform of KM Safari line. Side extrusion allows user to mount K-Rails, Grab-Rails, Load Bars and other accessories for any cargo requirement. In addition, a Fence Kit (#60360) provides complete perimeter enclosure. Front to Back Rails (#55045) and a JK Front Hoop (#55015) can be attached to provide a full roof top load handling system. Will not work with soft top.



At the heart of the LO-PRO Platform is our innovative support system. Featuring an extended rear roll bar hoop. The rack is entirely supported directly to the roll bar for unrivaled load capacity. Drilling of 4 holes through hardtop is required. Rack can be used with or without factory hardtop.



## #55040

### JK LO-PRO Roof Rack System 4 Door

The essentials of the full JK LO-PRO system. Package includes: JK MOD-RAK LO-PRO Kit (#55070), JK Congo Pro Front Hoop (#55015) and JK LO-PRO Front to Back Rails (#55045).#



| PART# | DESCRIPTION  | VISUAL  |  |   |
|-------|--|---|--|---|
| 55040 | JK LO-PRO Roof Rack System<br>4 Door<br>Includes Platform, Front Hoop<br>& Side Rails (pair)<br>(#55070 + #55015 + #55045) |  |  |  |
|       |  | #55070  | #55015   | #55045  |

## #55045

### JK LO-PRO Front to Back Rails

1-5/8" tube Roof Rails, full length roof top rail system. Connects LO-PRO Platform and JK Congo Pro Front Hoop. Load handling and accessories mount along length of rail. Attachment of: Crossover Clamps, Grab Handles, Standoff Brackets and Light Mount Kits. Use with Front Hoop (#55015) and LO-PRO Platform (#55070).



## Jeep JK LO-PRO MOD-RAK System

#55045 JK LO-PRO FRONT TO BACK RAILS (PAIR)

#55070 JK MOD-RAK LO-PRO KIT

#55015 FRONT HOOP  
KIT/LIGHT BAR ONLY

EXTRUSION



#55040 4 Door Only includes #55070 Platform, #55045 Front to Back Rails and #55015 Front Hoop

## Jeep JK LO-PRO MOD-RAK System Package and Options

#55070 JK MOD-RAK LO-PRO KIT

#60360 ALUMINUM FENCE KIT (FRONT & REAR CROSS RAILS)

#60360 ALUMINUM FENCE KIT (FRONT  
& REAR CROSS RAILS)

#60240 GRAB RAIL 1-1/8" DIA. X 24" L (PAIR)  
(ACCESS SYSTEMS OPTION)

#55045 JK LO-PRO FRONT TO BACK RAILS (PAIR)

#60300 ALUMINUM LIGHT BAR MOUNT KIT  
FOR 2" DIA. TUBE (PAIR)  
(OPTIONAL ACCESSORY)

#55015 FRONT HOOP KIT/LIGHT BAR ONLY

#60255 KAT-WALK  
(ACCESS SYSTEMS OPTION)

#56000 ROCKER WALK SIDE STEPS 4 DOOR (PAIR)  
(ACCESS SYSTEMS OPTION)

#60260 HINGE STEPS (PAIR)  
(ACCESS SYSTEMS OPTION)



#55040 4 Door Only includes #55070 Platform, #55045 Front to Back Rails and #55015 Front Hoop

# Modular Platform Racks

Designed for versatility, our MOD-RAK platforms are an all aluminum product with unique construction allowing for a myriad of potential configurations. If you want to stand out in the crowd choose a platform rack and accessorize.

## #55075





### JK MOD-RAK EXP

(Use with 55000 Only)

Extended aluminum platform for high capacity loading and gear (55.5" x 78.5"). Includes brackets for direct mount to the JK Congo Pro. For all other applications must buy mounts. Integrated extrusion allows user to mount K-Rails, Baskets, Grab-Rails, Load Bar Mounts and various accessories for unlimited load handling. With over 30 square feet of deck space the EXP is in a class of it's own. Not compatible with Classic Congo Cage.



Must have or purchase 55000 to install

| PART#  | DESCRIPTION  | VISUAL  |  |  |   |
|--------|--|---|--|--|---|
| #55000 | JK Congo Pro 4 Door Kit<br>Includes Side Rails (pair), Front Hoop, Rear Hoop & Mount Brackets<br>(55020 + 55027) |  |  |  |  |
|        |  | #55020  | #55027   |  |   |

## #55060

### JK MOD-RAK Stealth Kit

(Use with #55000 or #55010)

Aluminum cargo platform (38"x 62") mounted flush between Congo Pro Roof Rails. Includes mounts. Our lowest and lightest rack for the Congo Pro is sleek and stout. Use with the Congo Pro Front Hoop, Roof Rails and Rear Hoop. Integrated aluminum extrusion allows user to mount a variety of K-Rails, Grab-Rails, Load Bars and other accessories for versatile load containment. Not compatible with Classic Congo Cage.



Must have or purchase 55000 or 55010 to install

| PART#  | DESCRIPTION  | VISUAL  |  |   |   |
|--------|--|---|--|---|---|
| #55010 | JK Congo Pro 2 Door Kit<br>Includes Side Rails (pair), Front Hoop, Rear Hoop & Mount Brackets<br>(#55025 + #55027) |  |  |  |  |
|        |  | #55025  | #55027   |   |   |

MOD-RAK Accessories, see page 23

Base Rack Accessories, see page 25

Load Bars & Accessories, see page 27

## Jeep JK MOD-RAK EXP #55075 Platform 4 Door Only

#60210 K-RAILS 1 5/8" DIA. X 48" L (PAIR)

#60200 K-RAILS 1 5/8" DIA. X 54" L (PAIR)

#60240 GRAB RAIL  
1 1/8" DIA. X 24" (PAIR)

#55075 MOD-RAK EXP

#60245 2" ALUMINUM GRAB  
HANDLE KIT

#55020 ROOF RAILS 4 DOOR (PAIR)

#55027 FRONT AND REAR  
HOOP KIT

#55027 FRONT AND REAR  
HOOP KIT

#55015 FRONT HOOP  
KIT/LIGHT BAR ONLY

#60260 HINGE STEPS (PAIR)  
(ACCESS SYSTEMS OPTION)

#60255 KAT-WALK  
(ACCESS SYSTEMS OPTION)

#56000 ROCKER WALK SIDE STEPS 4 DOOR (PAIR)  
(ACCESS SYSTEMS OPTION)



You must purchase #55000 (#55027 Front and Rear Hoop Kit and #55020 Roof Rails)

## Jeep JK MOD-RAK STEALTH #55060 Platform Only

#55060 MOD-RAK STEALTH KIT

#60210 K-RAILS 1 5/8" DIA. X 48" L (PAIR)

#55027 FRONT AND REAR  
HOOP KIT

#55020 JK CONGO PRO ROOF RAILS 4 DOOR (PAIR)

#55025 JK CONGO PRO ROOF RAILS 2 DOOR (PAIR)

#55027 FRONT AND REAR  
HOOP KIT

#55015 FRONT HOOP  
KIT/LIGHT BAR ONLY

#60260 HINGE STEPS (PAIR)  
(ACCESS SYSTEMS OPTION)

#60255 KAT-WALK  
(ACCESS SYSTEMS OPTION)

#56000 ROCKER WALK SIDE STEPS 4 DOOR (PAIR)  
(ACCESS SYSTEMS OPTION)



You must purchase #55000 (#55027 Front and Rear Hoop Kit and #55020 Roof Rails) - 4 Door  
or #55010 (#55027 Front and Rear Hoop Kit and #55025 Roof Rails) - 2 Door

Solid as a rock.



# Classic Congo Cages

Our original line of cages is as popular today, as they were when first introduced to the market several years ago. They are rock solid cages engineered and built to handle tough challenges and last a lifetime. They can be installed on the latest JK's and Jeeps pre-dating 1995.

## #50341/#50351

### Jeep Congo Cage

JK 4 Door & 2 Door, 2007 & Up

The "Classic" Congo Cage provides a rock solid foundation for KMS Racks, Aluminum and Steel Load Bars, and a host of other cargo management devices. It's the perfect Jeep roof rack to carry canoes, kayaks, surfboards, snowboards and other tools of the trade. Our "Classic" Congo Cages for Jeeps are made with 1-5/8" diameter high tensile strength steel tubing and are convertible allowing easy access to the soft top. No-drill installation makes this system perfect for the do-it-yourselfer. Epoxy zinc primer and marine grade black gloss powder coat provide a durable and corrosion-resistant finish.

**50351** 4 Door

**50341** 2 Door



## #50301

### Jeep Congo Cage

CJ7 & YJ Up to 1995



## #50311

### Jeep Congo Cage

TJ 1997 & Up



## #50331

### Jeep Congo Cage

TJ Unlimited 2005 & Up



For Base Rack Accessories for your Congo Cage, see page 21.

For Load Bars & Accessories, see page 23.

# Basket Racks

Our stylish and durable Bushman Steel Basket Racks are the best way to contain and transport the gear you need for big adventures.

The 4" deep basket side rails are highly crafted from 1" round steel tubing with formed "airfoil" cross beams and stainless fasteners. Floor rails are made from lightweight rust proof 1" square aluminum tubing and mounting hardware bolts directly to the factory rails or rain gutters. Accepts Yakima, Thule and most other accessory mounts. Epoxy zinc primer and a marine-grade black gloss powder coat provide a handsome, durable, and rust-resistant finish. These racks are sized to mount perfectly on our Congo Cages and to maximize the above-roof carrying capacity of your Jeep or SUV. We have a full line of accessories to dress out your basket for ultra utility.





For mounts  
see page 21

## #50460/#50470

### Basket Rack & Mount Bracket Packages

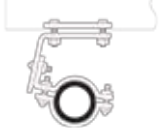
An easy on and off combo for those who like going topless. No base rack needed. Rack mounts with brackets that are specially designed to position the front of the rack just behind the windshield and the rear of the rack just in front of the back seat. The 50470 is just the right size basket for the XJ with mounts and includes a 52" x 60" Bushman basket and rain gutter mounts for a Cherokee XJ.

| PART#  | DESCRIPTION   | VISUAL  |   |
|--------|---|---|---|
| #50460 | 52" x 50"<br>Bushman Basket Mounts to<br>Jeep Roll Bar<br>(#50241 + #50501) |  |  |
|        |   | 50241   | 50501   |
| #50470 | 52" x 60"<br>Bushman Basket Mounts to<br>Cherokee XJ<br>(#50231 + #50621)   |  |  |
|        |   | 50231   | 50621   |
| #50201 | Bushman Steel Rack 42" W x 50" L (Must Buy Mounts)                          |   |   |
| #50231 | Bushman Steel Rack 52" W x 60" L (Must Buy Mounts)                          |   |   |
| #50241 | Bushman Steel Rack 52" W x 50" L (Must Buy Mounts)                          |   |   |
| #50251 | Bushman Steel Rack 52" W x 74" L (Must Buy Mounts)                          |   |   |















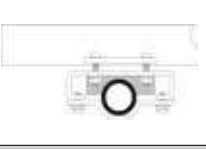

**#50400/#50410/#50420/  
#50430/#50450**

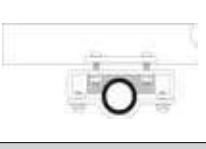
**Jeep Classic Congo Cage &  
Bushman Basket Packages**

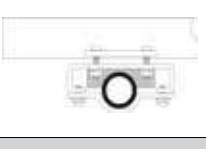
Each package comes complete with a “Classic” Congo Cage for your model Jeep, a Bushman Steel Basket Rack and the mounts required to attach the Basket to the Congo Cage.

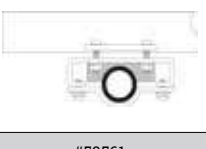

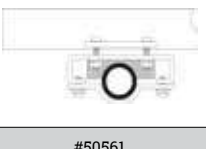
| PART#         | DESCRIPTION  | VISUAL   |   |   |
|---------------|--|--|---|---|
| <b>#50400</b> | CJ/YJ<br>Up to 1995 Package<br>(#50301 + #50561+ #50231)         |    |    |    |
|               |  |  | #50231  | #50561  |
| <b>#50410</b> | TJ 2 Door<br>Up to 2005 Package<br>(#50311 + #50561 + #50231)    |    |    |    |
|               |  |  | #50231  | #50561  |
| <b>#50420</b> | TJ Unlimited<br>Up to 2005 Package<br>(#50331 + #50561 + #50251) |  |  |  |
|               |  |  | #50251  | #50561  |
| <b>#50430</b> | JK 2 Door<br>2007 & Up Package<br>(#50341 + #50561 + #50231)     |  |  |  |
|               |  |  | #50231  | #50561  |
| <b>#50450</b> | JK 4 Door<br>2007 & Up Package<br>(#50351 + #50561 + #50251)     |  |  |  |
|               |  |  | #50251  | #50561  |



Reach the top. Easily.

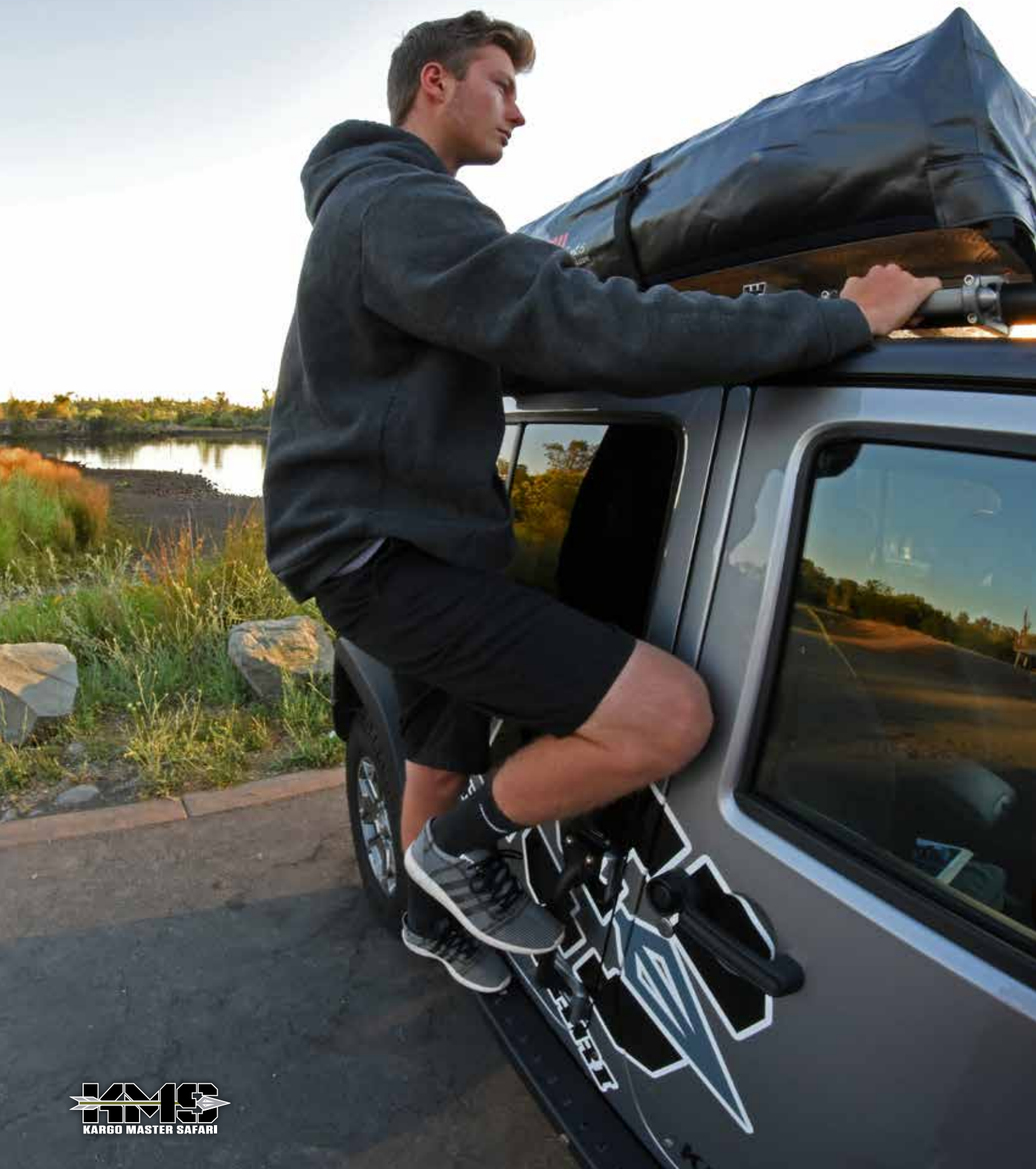

# EZ Access Products

Every serious Jeeper with a rack, platform or basket wants an easy way to access the Jeep roof. KM Safari EZ Access products do just that. Five amazingly unique products help one step up and reach the roof to load, adjust and unload anything and everything you can imagine carrying above you.

## #56000/#56010

### JK Rocker Walk Side Steps



Heavy-duty non-slip, side step for JK 4 Door and 2 Door Jeeps. Easy entry and exit of vehicle. Hard mounts to JK frame and body for a sturdy step and rigid side panel protection.

**#56000** 4 Door

**#56010** 2 Door

## #55015

### JK Congo Pro Front Hoop



The Front Hoop for the JK Congo Pro #55000 & #55010 has a built-in Grab Handle on both sides which aids one in accessing the Jeep roof or optional Kat-Walk. Available without handle #55016.

## #60260

### JK Hinge Steps (Pair)



Foot pegs mount to JK door hinge assembly, front or rear, about 15" above Rocker Walk. Provides a mid-step solution between Rocker Walks, Kat-Walk and JK roof top. Permits easy access to cargo on the roof. Ideal use with: Rocker Walks and Kat-Walk. Sold in pairs.

The Rocker Walk and Hinge Steps can be installed on all JK's.

The Kat-Walk can be installed on any Jeep which has front hoop #55015.

The Grab Handles (#60245 & #60250) can be used on all KM Safari Cages or Rails #60245 for 2" Dia. & #60250 for 1-5/8" Dia. tubes.

## #60255

### JK Kat-Walk (Use with #55015)



Mounts on JK Front Hoop as a non-slip step platform, spans windshield/hood area of JK. Bolt-on use with JK Front Hoop. Made of high grade tubular steel, supports 350 lbs.

## #60245/#60250

### Grab Handle Kit



Grab Handle, hard anodized and machined billet aluminum. Attach to any 2" or 1-5/8" KM Safari product including: JK LO-PRO Front to Back Rails, K-Rails and "Classic" Congo Cage. Allows users a convenient grab hold for climbing up, on or around the Jeep. Sold as one handle.

**#60245** Grab Handle Kit For 2" Dia. Congo Pro Cages

**#60250** Grab Handle Kit For 1-5/8" Dia. Tube

(Use with #503xx Congo Cages or #55045)

**Escape the ordinary by customizing  
your Jeep with KM Safari accessories.**



# Imagine ...

... how you can tailor your jeep to your own personal taste or needs using KM Safari accessories.

With our 100% modular base rack, the configuration of your Jeep is only limited by your imagination. Whether you wish to carry a few small items for a day trip or half your garage for a month on the trails, our low profile MOD-RAK, Classic Congo Cage or the JK Congo Pro lets you secure the load with confidence.

Add our versatile Bushman Basket Rack, K-Rails and Fence Kits to turn your Jeep into a rock solid transport system for a host of recreational products such as bikes, canoes, kayaks and paddle boards.

And to really “top it off”, you could purchase your favorite roof top tent for your jeep and never sleep on the ground again!

Imagine ...



**Practical for work or play.**



# Basket Rack Mounts & Accessories

Get the right mount for your Bushman Basket Rack.  
A mount for every application.

## BASE RACK MOUNTS

#50561/#60310

Bushman Basket Rack

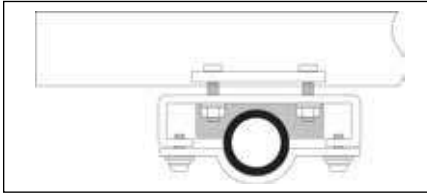

**#50561** Brackets to mount Bushman Basket Rack On "Classic" Congo Cage.



**#60310** Brackets to Mount Bushman Basket Rack on JK Congo Pro. An easy low profile mount for attaching almost any rack to 2" round tubing.  
(Use with #50231 4 Door or #50241 2 Door)

## SUV RACK MOUNTING SYSTEMS

#50541/#50551

Rain Gutter

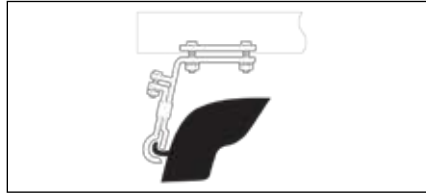

**#50541** Brackets to Mount Bushman Basket Rack Bottom 4" Above Gutter.

**#50551** Extra Wide - Brackets to Mount Bushman Basket Rack Bottom 5" Above Gutter. *Not Shown.*

**#50721**  
Fiberglass Top Mount

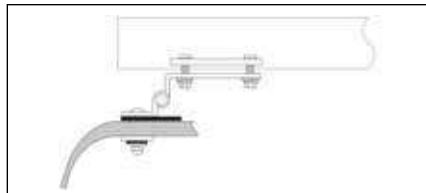

Mounts Bushman Basket to Fiberglass Roof.

(Use with #50201, #50231, #50241, #50251)

#50611/#50621/#50631

Luggage Rack (Set of 4)

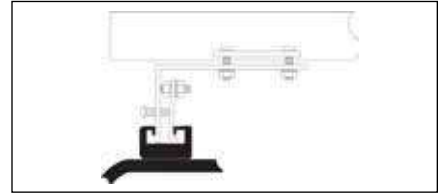

**#50611** Luggage Rack - Rail on Roof - "C" Channel Opens Up.

**#50621** Luggage Rack - Cherokee Type Up to 1998. *Not Shown.*

**#50631** Luggage Rack - Rail Above Roof "C" Channel Opens In. *Not Shown.*  
(Use with 50201, 50231, 50241, 50251)

**#50501**  
Jeep "Roll Bar"



Mounts Bushman Basket to Jeep "Roll Bar." Fits 1987 to 2006 Wrangler, Rubicon and Unlimited Without Top.

(Use with #50201, #50231, #50241, #50251)

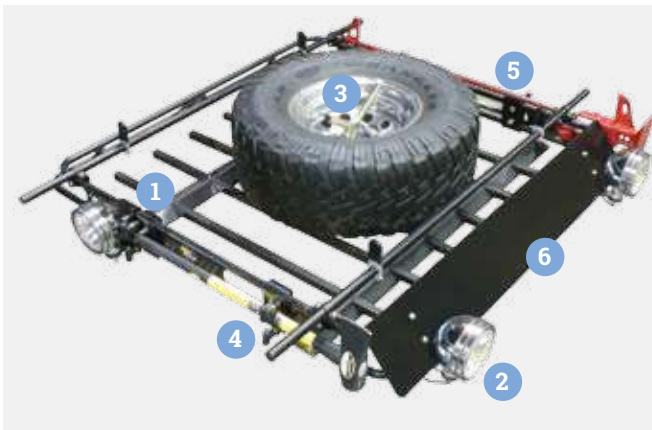

## Bushman Basket Rack Accessories

- 1 60081** Light Brackets for Baskets with Straight Front (Up to 9/2011)
- 2 60181** Light Brackets for Baskets with Angled Front (9/2011 & Up)
- 3 60091** Spare Tire Bracket Kit
- 4 60101** Ax or Shovel Mounting Brackets
- 5 60111** High Lift Jack Mounting Brackets
- 6 60171** Wind Deflector for 52" W Bushman Basket Rack.

Lowest profile rack on the planet.





# MOD-RAK Accessories

Optimize your platform rack for the job at hand. We have a wide range of products designed to help you get the most out of your rack. Get creative and you will probably never see another setup just like yours.

## #60200/#60210/#60220

### K-Rails 1-5/8" Diameter

K-Rails provide style and function to any of our modular racks. Mounts to the aluminum slotted extrusions found on MOD-RAK Stealth, JK LO-PRO or MOD-RAK EXP platforms. Can be used for direct load containment, anchor points for tie downs and grab handles. Cross Over Brackets, Grab Handles, Standoff Brackets and Light Mount Kits are additional accessories that mount to K-Rails. Sold in pairs.

**#60200** K-Rails 1-5/8" Dia. x 54" L (Pair)  
(Use with #55075 or #55060)

**#60210** K-Rails 1-5/8" Dia. x 48" L (Pair)  
(Use with #55070, #55075 or #55060)

**#60220** K-Rails 1-5/8" Dia. x 24" L (Pair)  
(Use with #55075, #55070, or #55060)



## #60230/#60235/#60240

### Grab Rails 1-1/8" Diameter

Mounts to extrusion on MOD-RAK Stealth, JK LO-PRO, or MOD-RAK EXP Platforms. On the MOD-RAK EXP Platform, mount vertically or horizontally. Recommended for use as grab holds, but can be used for lighter direct load containment and anchor points for tie downs. Sold in pairs.

**#60230** Grab Rails 1-1/8" Dia. x 54" L (Pair)  
(Use with #55075 or #55060)

**#60235** Grab Rails 1-1/8" Dia. x 48" L (Pair)  
(Use with #55070, #55075 or #55060)

**#60240** Grab Rails 1-1/8" Dia. x 24" L (Pair)  
(Use with #55075, #55040, #55070 or #55060)



## #60221

### Tie Down Rings - 6x



Eye nuts for anchor points on your modular platform rack. Secure your load with as many as needed. Sold in 6 pack.

## #60225

### Miscellaneous Hardware



A selection of hardware for modular platform racks. A must have for your toolbox. Most everything you would need for just in case ...

**A real warrior ... on or off road.**



# Base Rack Accessories

Load up your Congo Pro or Classic Congo Cage with any of our problem solving products. Your base rack is a great place to mount lights, awnings, tents, jacks, cans, steps and any other gear with simple clamp on mounts.

## #60161

Wind Deflector for "Classic" Congo Cage or Cage/Basket



KM Safari racks are designed to minimize wind noise, but sometimes basket location, cab lights, atmospheric conditions or other accessories can cause noise. This wind deflector bolts to the front cross bar, and can be positioned to optimally deflect wind up over the cab, reducing or eliminating noise.

## #60300

Light Bar Mount Kit (Pair)  
2" Dia. Tube



The trickiest light mounts money can buy. CNC machined and hard anodized billet aluminum clamps. Mount aftermarket light bars to any 2" KM Safari product, including: Front Hoop, Roof Rails and Rear Hoop. Max light bar length 42" on Front Hoop. *Light bar not included.*

## #60305

Light Bar Mount Kit (Pair)  
1-5/8" Dia. Tube



This is the same style mount as the #60300 to the left. Mount aftermarket light bar to 1-5/8" KM Safari product, including: JK LO-PRO Front to Back Rails and K-Rails. Can be used on "Classic" Congo Cage tubing.

## #60320/#60321

Stand-Off Bracket (Pair)  
1-5/8" x 1-1/8" or 2" x 1-1/8"



A great way to attach a load bar to a Congo Cage. Hard anodized and machined billet aluminum brackets. Opposite side of bracket has a 1-1/8" mounting hole for aluminum load bar (#60335) or other aftermarket load bars. Can be used on "Classic" Congo Cage tube diameter. Parallel design with 4" offset, not cross over. Sold in pairs.

**#60320** Stand-Off Bracket 1-5/8" x 1-1/8"

**#60321** Stand-Off Bracket 2" x 1-1/8"

Total versatility for any adventure.



# Load Bars & Accessories

Install Load Bars anywhere and on anything with our large selection of both steel and aluminum parts. 1-1/8" bars accept most all makes of specialty mounts and carriers (bike, boat, ski, box, etc.). Our Fence Kits double as a basket /load bar for maximum adaptability.

## #60360

**Fence Kit** (Front and Rear Cross Rails)

(Use with #55040, #55070 & #55060\*)

Hard anodized aluminum Front and Rear "Fence" kit assembly. Constructed of 1-1/8" dia. aluminum tube. Exclusive bolt-on kit for JK LO-PRO Platform (#55070) and JK LO-PRO Roof Rack System 4 Door (#55040). Mounts to the front and rear panel of platform for load containment. Full perimeter containment basket is created when used with Front to Back Rails.

Includes: platform mounts, four 46-1/2" aluminum load bars and necessary brackets to assemble the fence unit.

\*Special brackets required. Call for details.



## #60325/#60330

**Cross Over Clamp** (Pair)



Multi-purpose mounting solution. Adjustable Hard anodized, machined billet aluminum brackets for intersect or parallel attachment of 1-1/8" dia. Aluminum load bars or other aftermarket load bars to cage rails. Sold in pairs.

#60325 2" – 1-1/8" Cross Over Clamp

#60330 1-5/8" – 1-1/8" Cross Over Clamp

## #60335

**Aluminum Load Bar 1-1/8"**

(Use with 60320/60321/60325/60330)



60" hard anodized aluminum universal load bar, lightweight and strong, 1-1/8" standard diameter. Permits attachment of recreational equipment and cargo carrying products. Use with KM Safari specialty brackets and clamps for greater versatility and load configuration options including Cross Over Clamps or Standoff Brackets. Easily cut to any length.

## #60121

**Load Bars Congo Classic**

Mounts to 1-5/8" Rails



Install a pair of 60" HD Steel Load Bars on the "Classic" Congo Cage for additional support needed to carry canoes, bicycles, kayaks, camping gear, and other adventuring equipment. 1-1/8" diameter bars accept Yakima style accessories. Sold in pairs. Includes brackets.

## #60141

**Load Retainer Brackets** (Set of 4)

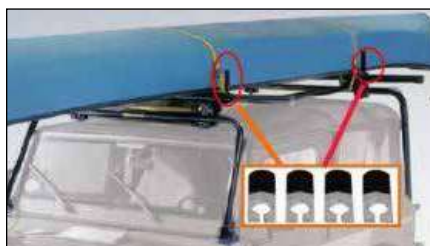

For part #60121. Handy aluminum clamp on retainers help keep loads inline. Use these brackets with any 1-1/8" load bars to control cargo. Package includes 4 uprights.

## #60331

**Load Bars JK Congo Pro** (Pair)



Use these 60" HD Steel Load Bars for maximum load capacity on the JK Congo Pro. Black powder coat steel 1-1/8" dia. bars accept Yakima style accessories. Sold in pairs. Includes brackets.

## #60131

**Brackets for Congo Classic**

Mounts to 1-5/8" Rails



Use these brackets to mount 1" Yakima Crossbars to a "Classic" Congo Cage.

# Index

| PART # | PAGE #   | PART NAME   |
|--------|----------|---|
| #50201 | 14       | Bushman Steel Rack 42" W x 50" L                                    |
| #50231 | 14, 15   | Bushman Steel Rack 52" W x 60" L                                    |
| #50241 | 14       | Bushman Steel Rack 52" W x 50" L                                    |
| #50251 | 14, 15   | Bushman Steel Rack 52" W x 74" L                                    |
| #50301 | 13       | Congo Cage 1-5/8" - CJ7 & YJ Up to 1995                             |
| #50311 | 13       | Congo Cage 1-5/8" - TJ 1997 & Up                                    |
| #50331 | 13       | Congo Cage 1-5/8" - TJ Unlimited 2005 & Up                          |
| #50341 | 13       | Congo Cage 1-5/8" - JK 2 Door 2007 & Up                             |
| #50351 | 13       | Congo Cage 1-5/8" - JK 4 Door 2007 & Up                             |
| #50400 | 15       | CJ/YJ Up to 1995 Package  |
| #50410 | 15       | TJ 2 Door Up to 2005 Package  |
| #50420 | 15       | TJ Unlimited Up to 2005 Package                                     |
| #50430 | 15       | JK 2 Door 2007 & Up Package   |
| #50450 | 15       | JK 4 Door 2007 & Up Package   |
| #50460 | 14       | 52" x 50" Bushman Basket Mounts to Jeep Roll Bar                    |
| #50470 | 14       | 52" x 60" Bushman Basket Mouns to Cherokee XJ                       |
| #50501 | 21       | Brackets To Mount Bushman Basket Rack On Jeep "Roll Bar"            |
| #50541 | 21       | Rain Gutter - Bushman Basket Rack Bottom 4" Above Gutter            |
| #50551 | 21       | Rain Gutter Extra Wide - Bushman Basket Rack Bottom 5" Above Gutter |
| #50561 | 21       | Brackets To Mount Bushman Basket Rack On Congo Cage                 |
| #50611 | 21       | Luggage Rack - Rail On Roof - "C" Channel Opens Up                  |
| #50621 | 21       | Luggage Rack - Cherokee Type - Up To 1998                           |
| #50631 | 21       | Luggage Rack - Rail Above Roof - "C" Channel Opens In               |
| #50721 | 21       | Fiberglass Top Mount  |
| #55000 | 5, 7, 10 | JK Congo Pro 4 Door Kit   |
| #55010 | 5, 7, 10 | JK Congo Pro 2 Door Kit   |
| #55015 | 5, 17    | Congo Pro Front Hoop for All JK                                     |
| #55016 | 5, 17    | Congo Pro Front Hoop for All JK (No Handle)                         |
| #55020 | 5        | JK Congo Pro Roof Rails 4 Door                                      |
| #55025 | 5        | JK Congo Pro Roof Rails 2 Door                                      |
| #55026 | 5        | JK Congo Pro Rear Hoop  |
| #55027 | 5        | JK Congo Pro Front and Rear Hoop Kit Including Frame Bracket        |
| #55040 | 8, 9     | JK LO-PRO Roof Rack System 4 Door                                   |
| #55045 | 8        | JK LO-PRO Front to Back Rails                                       |
| #55060 | 10, 11   | JK MOD-RAK Stealth Kit  |

| PART # | PAGE # | PART NAME  |
|--------|--------|--|
| #55070 | 8      | JK MOD-RAK LO-PRO Platform   |
| #55075 | 10, 11 | JK MOD-RAK EXP   |
| #56000 | 17     | JK Rocker Walk Side Steps 4 Door   |
| #56010 | 17     | JK Rocker Walk Side Steps 2 Door   |
| #60081 | 21     | Light Brackets For Baskets With Straight Front (Up To 9/2011)                  |
| #60091 | 21     | Spare Tire Bracket Kit   |
| #60101 | 21     | Ax or Shovel Mounting Brackets   |
| #60111 | 21     | High Lift Jack Mounting Brackets   |
| #60121 | 27     | Load Bars Congo Classic (Pair) - 1-1/8" Dia. Bars Accept Yakima Accessories    |
| #60131 | 27     | Brackets for Congo Classic - Mount 1" Yakima Crossbars to 1-5/8" Rails         |
| #60141 | 27     | Load Retainer Brackets (Set of 4)  |
| #60161 | 25     | Wind Deflector For Congo Cage Only or Cage+Basket Packages                     |
| #60171 | 21     | Wind Deflector For 52" W Safari Basket   |
| #60181 | 21     | Light Brackets For Baskets With Angled Front (9/2011 & Up)                     |
| #60200 | 23     | K-Rails 1-5/8" Dia. x 54" L (Pair)   |
| #60210 | 23     | K-Rails 1-5/8" Dia. x 48" L (Pair)   |
| #60220 | 23     | K-Rails 1-5/8" Dia. x 24" L (Pair)   |
| #60221 | 23     | Tie Down Rings - 6x  |
| #60225 | 23     | Miscellaneous Hardware   |
| #60230 | 23     | Grab Rails 1-1/8" Dia. x 54" L (Pair)  |
| #60235 | 23     | Grab Rails 1-1/8" Dia. x 48" L (Pair)  |
| #60240 | 23     | Grab Rails 1-1/8" Dia. x 24" L (Pair)  |
| #60245 | 17     | Grab Handle Kit For 2" Dia. Congo Pro Cage                                     |
| #60250 | 17     | Grab Handle Kit For 1-5/8" Dia. Classic Congo Cage                             |
| #60255 | 17     | Kat-Walk   |
| #60260 | 17     | Hinge Steps (Pair) - Foot Pegs Mount To Door Hinge About 15" Above Rocker Walk |
| #60300 | 25     | Light Bar Mount Kit For 2" Dia. Tube   |
| #60305 | 25     | Light Bar Mount Kit For 1-5/8" Dia. Tube                                       |
| #60310 | 21     | Brackets To Mount Safari Rack On Congo Pro                                     |
| #60320 | 25     | Stand-Off Bracket 1-5/8" x 1-1/8" (Pair)                                       |
| #60321 | 25     | Stand-Off Bracket 2" x 1-1/8" (Pair)   |
| #60325 | 27     | 2" - 1-1/8" Cross Over Clamp (Pair)  |
| #60330 | 27     | 1-5/8" - 1-1/8" Cross Over Clamp (Pair)  |
| #60331 | 27     | Load Bars JK Congo Pro (Pair) - 1-1/8" Dia. Bars Accept Yakima Accessories     |
| #60335 | 27     | Aluminum Load Bar 1-1/8"   |
| #60360 | 27     | Fence Kit (Front and Rear Cross Rails)   |



Located near the foothills of the world famous Rubicon Trail, KM Safari designs and develops industry leading high-performance overland expedition equipment. Our driving purpose is to create off-road accessories that give users the confidence to explore the outdoors without hesitation.

Whether you are a weekend warrior or a full time overlander, you will not find a more capable, adaptable or reliable rack system. Being an industry leader takes passion, an understanding of people who love adventure and a commitment to delivering superior products and service.

This is the heart of what we do and the roots of our company ... to create products you trust and are proud to own and use. We pledge to provide the best products money can buy. We guarantee every single product against failure. We diligently control the quality and consistency of every part and support our customers by always going the extra mile.

With KM Safari you can take anything, anywhere, anytime without concern. Simply put, we build the most durable, flexible, highest performing products on the market. When you want the absolute best, KM Safari has no equal.



**When failure is not an option.**

