



One Piece Grille Guard Installation Instructions

Part: # 4059/4061/4068/4069

Chevy Silverado 1500/2500HD/3500HD 2007-2010

Click To Select:

4059

2003 CHEVY SILVERADO 1500 SERIES 2/4 WD

4061

2003 CHEVY SILVERADO 2500 HD/3500 HD 2/4 WD

4068

2007 CHEVY SILVERADO 1500 LD

4069

CHEVY SILVERADO 2500HD/3500HD



GRILLE GUARD

INSTALLATION INSTRUCTIONS
FRONT BAR PART #4059
2003 CHEVY SILVERADO 1500 SERIES 2/4 WD
2003-05 AVALANCHE 1500

PARTS LIST

2- FRAME MOUNTING BRACKETS	2- 3/8 X 1" HEX BOLTS
2- TOP SUPPORT BRACKETS	2- 3/8 HEX NUTS
10- 1/2 X 1 1/4" HEX BOLTS	2- 3/8 FLAT WASHERS
10- 1/2 HEX NUTS	2- M12 X 1.75 X 40mm BOLTS
20- 1/2 FLAT WASHERS	

INSTALLING FRAME BRACKETS

1. Remove factory tow hooks from front section of vehicle (if equipped). NOTE: IF RE-USING TOW HOOK, YOU MUST SWITCH DRIVER FOR PASSENGER VISE-VERSA ,SOME MODELS DO NOT ALIGN COMPLETELY. YOU MUST TRIM OFF SMALL PORTION OFF THE TOW HOOK. Refer to illustration.
2. Attach the frame brackets as shown in illustration, using bolts, supplied in kit. Hand-tighten in case you have to adjust the front bar to align it.

INSTALLING THE FRONT BAR

1. Line up the 3 holes on the lower portion of the bar with the 3 holes in the frame brackets (inner edge). Attach front bar using 1/2 x 1 1/4" hex bolts, nuts, & washers. Hand tighten only.
2. Open hood and remove the rivets securing the top plastic trim panel (temporarily) from the vehicle to access the factory bumper bolts.
3. Proceed to install upper support brackets, remove factory bolts, place driver side bracket into area - re-use factory bolt – using 3/8 x 1 button bolts to go from bracket up-rights plates of grill guard as shown in illustration 3.
4. Align front bar assembly with front of the vehicle and secure all fasteners.
5. Re-attach the plastic trim panel.

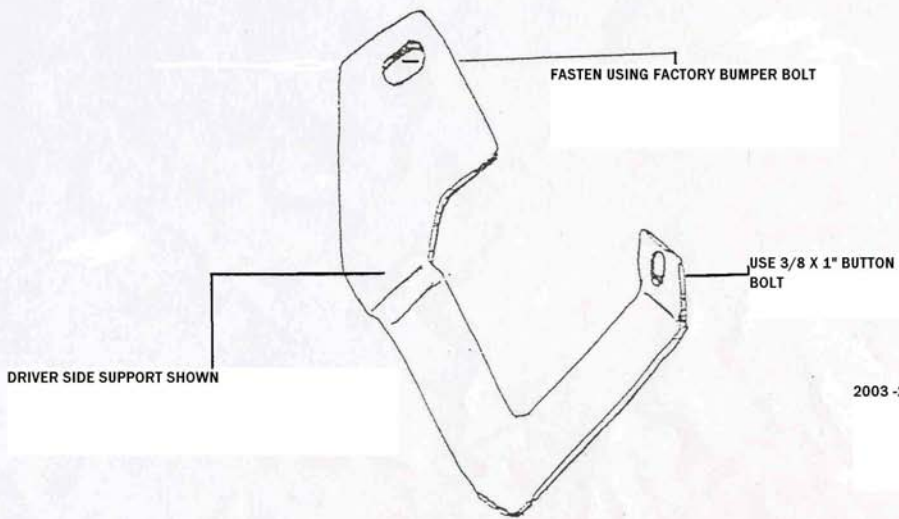
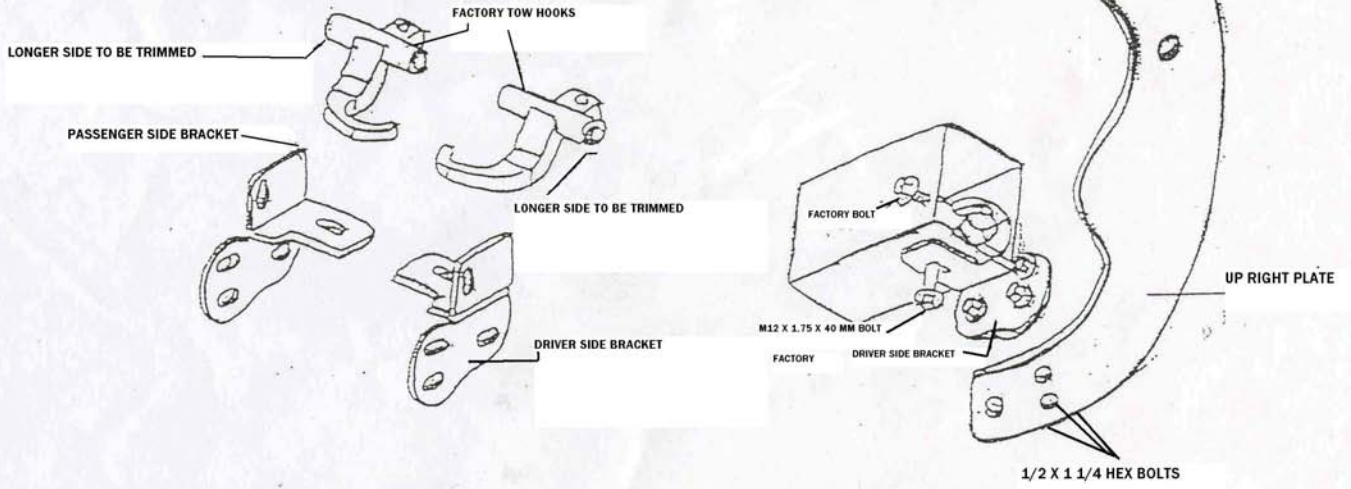

2003 -2005 CHEVROLET SILVERADO 2/4WD 1500



INSTALLATION INSTRUCTIONS

FRONT BAR PART #4061

GRILLE GUARD

2003 CHEVY SILVERADO 2500 HD 2/4 WD

PARTS LIST

2- FRAME MOUNTING BRACKETS

2- 3/8 X 1" HEX BOLTS

2- TOP SUPPORT BRACKETS

2- 3/8 HEX NUTS

6- 7/16 X 1 1/4" HEX BOLTS

2- 3/8 FLAT WASHERS

6- 7/16 HEX NUTS

2-1/2"x1 1/2" HEX BOLTS

12- 7/16 FLAT WASHERS

2-1/2" FLAT WASHERS

INSTALLING FRAME BRACKETS

1. Remove factory tow hooks from front section of vehicle (if equipped). Once the tow hooks are removed, proceed to install the frame brackets. Use illustration "1" to identify the correct bracket for each side. The brackets fit inside of the frame as shown in illustration "2". The holes used to fasten the tow hooks to the frame will be used to fasten the brackets.
2. Insert the brackets inside the frame and align the bracket holes with the frame holes and fasten (tight) using the 7/16 x 1 1/4 hex bolts, hex nuts and washers as shown in illustration 2. USE 1/2 bolts & washers for bottom of mount bracket.

INSTALLING THE FRONT BAR

1. Line up the two back holes on the lower portion of the bar with the two of the holes in the frame brackets (inner edge). Attach front bar using 7/16 x 1 1/4" hex bolts, nuts, washers. Hand-tighten only.
2. Open hood and remove the rivets securing the top plastic trim panel (temporarily) from the vehicle to access the factory bumper bolts.
3. proceed to install upper support brackets, remove factory bolts, place driver side bracket into area, re-use factory bolt-using the 3/8 x 1 button bolts to go from bracket up-rights places of grill guard as shown in illustration "3".
4. Align front bar assembly with front of the vehicle and secure all fasteners.
5. Re-attach the plastic trim panel.

ILLUSTRATION

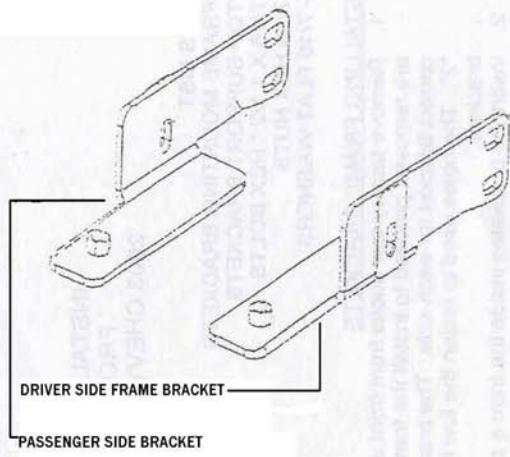

ILLUSTRATION 2

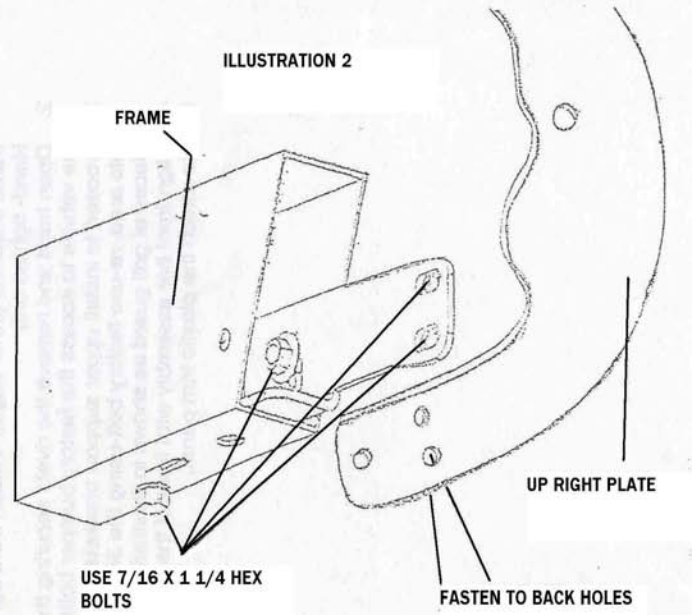
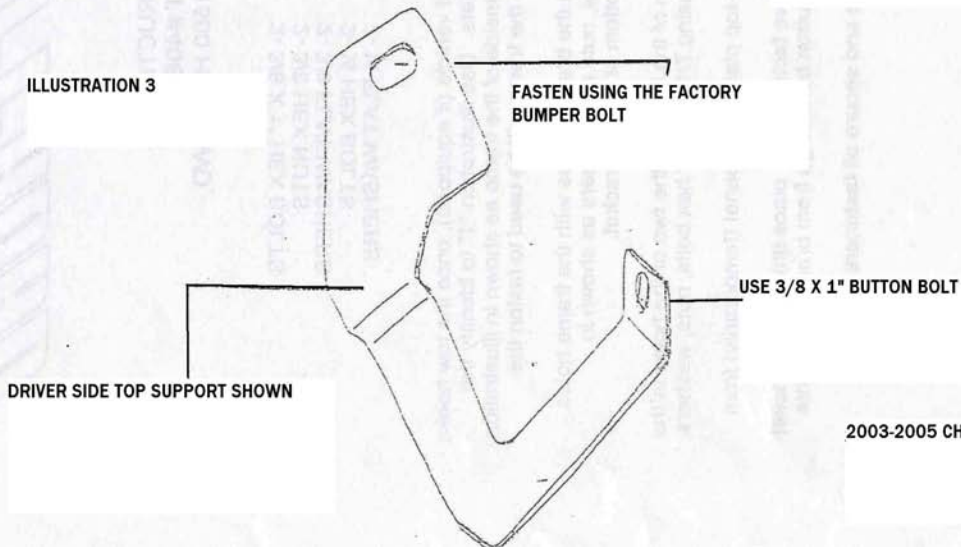

ILLUSTRATION 3



2003-2005 CHEVROLET HD 2500/3500



**INSTALLATION INSTRUCTIONS
GRILL GUARD PART#4068/4068-2
07 CHEVROLET SILVERADO 1500LD**

PARTS LIST:

- | | |
|---------------------------------|-----------------------------------|
| 1 Grill Guard | 2 Upper Support Brackets |
| 2 Frame Mounting Brackets | 2 Lower Frame Support Brackets |
| 8 12-1.75mmX30mm Hex Head Bolts | 8 12mm Nylock Nuts |
| 16 12mm Fender Washers | 2 8-1.25mmX25mm Button Head Bolts |
| 2 8mm Nylock Nuts | 4 8mm Flat Washers |

PROCEDURE:

1. REMOVE CONTENTS FROM BOX AND VERIFY ALL PARTS ARE PRESENT. READ INSTRUCTIONS CAREFULLY. DO NOT ATTEMPT INSTALLATION ALONE; PERSONAL INJURY OR DAMAGE TO THE TRUCK MAY RESULT.
2. Locate, remove and set aside the hardware kit and the brackets. Determine the driver and passenger sides for the brackets.
3. Open the hood and remove the radiator cover to access the small radiator shield (Fig 1)
4. Use a small flat head screw driver to remove the retainer plugs (Fig 2)
5. Use a 10MM socket to remove the small shield between the radiator and the grille.(Fig 3)
6. Using a pair of "needle nose" pliers squeeze the eight grille mounting clips. (Fig 4) Begin from one end of the grille and insert a small screwdriver into the clips to prevent them from popping back into place. Remove the grille by pulling on it gently and evenly forward.
7. Remove the two top existing frame bolts and install them into the upper brackets. Reinstall the bolts but leave them loose temporarily. (Fig 5).
8. Reinstall your grille at this time, line up the clips and gently push it into place. Do not reinstall top covers at this time.
9. Using a sharp utility knife cutout an opening to allow the bumper brackets to pass through (Fig 6)
10. To install the lower two frame mounting bracket and two support brackets, remove the tow hook bolts and use them to install the frame brackets and the support brackets. The tow hooks remain in their stock position in the frame rails (Fig 7).
11. Connect the lower support bracket to the frame mounting bracket using one of the 12mm bolts two washers and Nylock nut supply with your bumper guard (Fig 7).
12. With help position the grille guard and install the six 12MM bolts into the bottom bracket (Fig 8)
13. Install the two 8MM bolts and lock nuts in the top brackets. (Fig 9)
14. Level and adjust the bar and the brackets and tighten all the fasteners. (Fig 10)
15. After you are sure all mounting bolts are tight reinstall the top plastic shields.

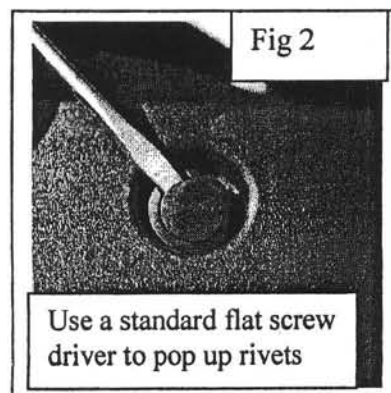
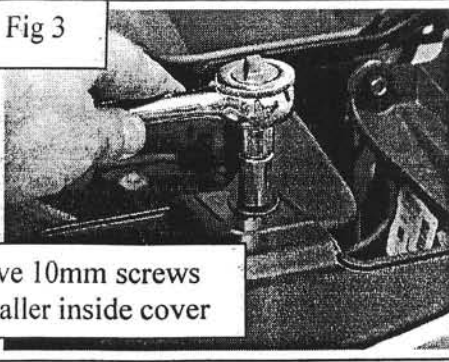

Fig 3



Remove 10mm screws and smaller inside cover

Pinch grille mounting clips and remove grille from truck



Fig 4

Fig 5

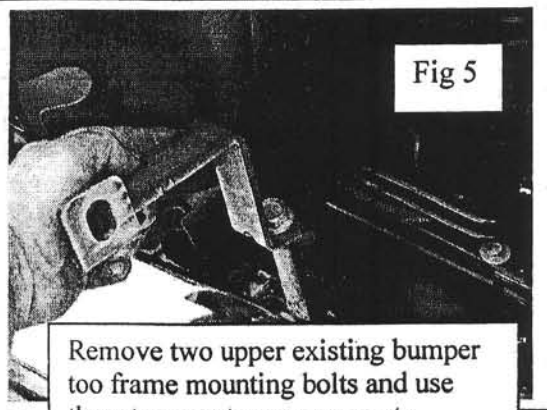

Remove two upper existing bumper too frame mounting bolts and use them to mount upper supports

Fig 6

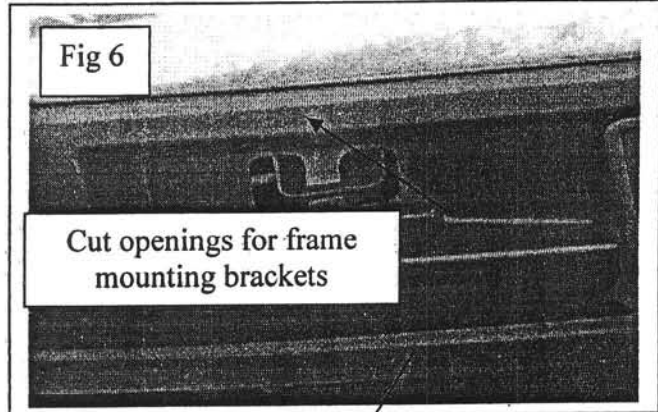

Cut openings for frame mounting brackets

Fig 7

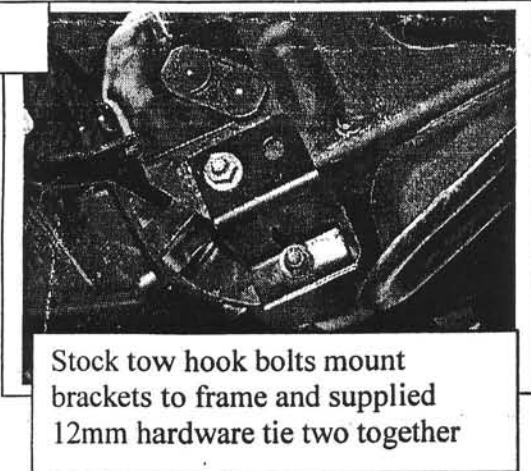

Stock tow hook bolts mount brackets to frame and supplied 12mm hardware tie two together

Fig 8

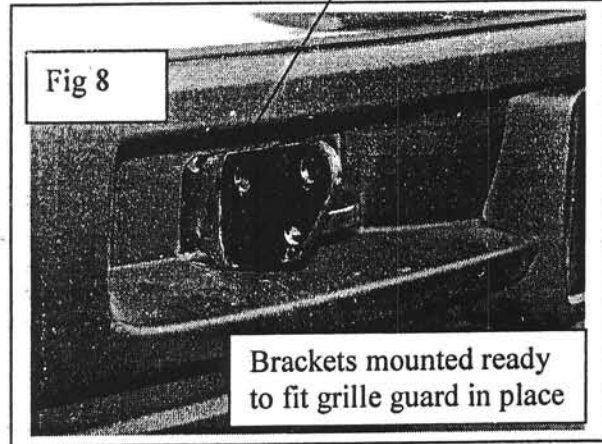

Brackets mounted ready to fit grille guard in place

Fig 9

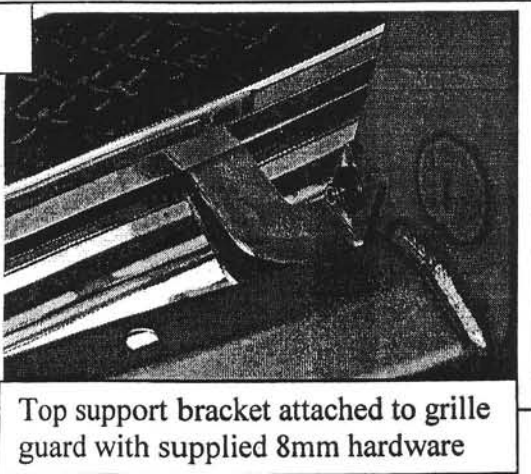

Top support bracket attached to grille guard with supplied 8mm hardware

Fig 10

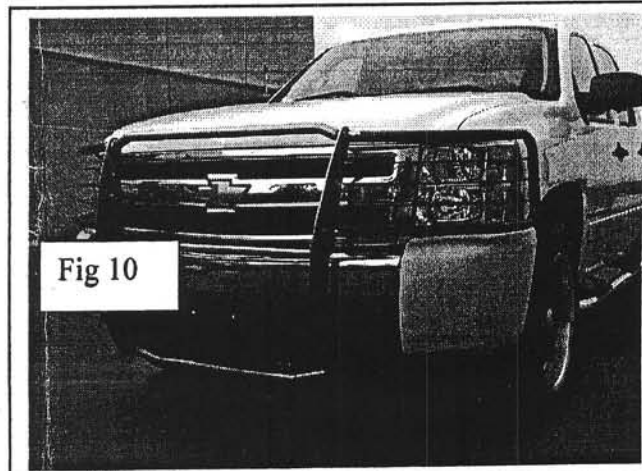

GRILLE GUARD



Chev HD Part#4069/4069-2 Installation Instructions

Parts List

1 – Front bar	2 – Bottom Mount Brackets
2 – Top Support Brackets (2 piece)	2 – ¼ Spacer Plates
2 – ¼ - 2 x 1 ¾ Bolt Plate	

Fasteners

For Bottom Mount Brackets to Frame

6 – ½ x 1 ¼ Hex Bolts	2 – ½ Lock Nuts
8 – ½ USS Flat Washers	

Bottom Brackets to Guard

6 – ½ x 1 ½ Hex Bolts	6 – ½ Lock Nuts
12 – ½ USS Flat Washers	

For Top Support Brackets to Vehicle

2 – ½ x 1 ¼ Hex Bolts	4 – ½ USS Flat Washers
2 – ½ Lock Nuts	

Attaching 2 piece Top Support Bracket together

2 - 3/8 x 1 Hex Bolts	2 – 3/8 Lock Nuts
4 – 3/8 USS Flat Washers	

Top Support Brackets to Guard

2 – 3/8 x 1 Button Bolts	2 – 3/8 Lock Nuts
4 – 3/8 USS Flat Washers	

Installing the Bottom Mount Brackets

1. Remove the factory tow hooks. *The tow hooks cannot be reinstalled with this application.*
2. Start with the passenger side. Insert mount bracket through the opening where the tow hooks were located. Ensure the bracket wall is facing out and is lined up with the hole on the side of the frame. Attach the wall of the bracket to the side of the frame with ½ bolt, ½ washers and ½ lock nut.
3. Attach the bottom of the mount bracket to the bottom of the frame using (2) ½ x 1 ¼ bolts, (2) ½ flat washers and the bolt plate. Use the bolt plate for the larger hole located on the bottom of the frame.
4. Repeat steps 2 & 3 for the driver side.

Installing the Top Support Brackets

1. Start with passenger side. Open hood, locate a small tab with a hole located under the front grill. **See image# 1.** Use a $\frac{1}{2}$ x $1\frac{1}{4}$ bolt, $\frac{1}{2}$ washer and $\frac{1}{2}$ lock nut to attach the bottom of the top bracket to the tab.
2. From underneath the vehicle, locate an existing bolt that attaches to the bumper. **See image# 2.** Remove existing bolt and attach bottom portion of top bracket with the same bolt.

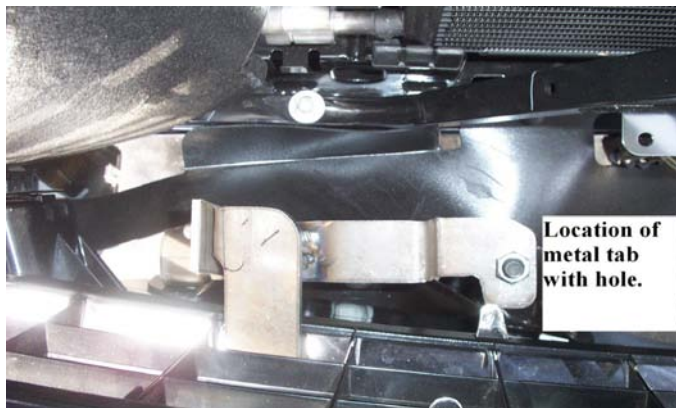

Image 1



Image 2

3. Now slide the upper portion of the top bracket through the grill. Attach the bottom to the upper portion of the top bracket by using the $\frac{3}{8}$ x 1 bolt, $\frac{3}{8}$ washer and $\frac{3}{8}$ lock nut.
4. Repeat steps 1 through 3 for the driver side.

Installing Guard to Brackets

1. Line up the 3 holes on the mount bracket with the lower portion of the guard.
2. Slide the $\frac{1}{4}$ spacer plates between the guard and mount brackets. Now use the $\frac{1}{2}$ x $1\frac{1}{2}$ bolts, $\frac{1}{2}$ washers and $\frac{1}{2}$ lock nuts to attach the mount brackets, spacers and guard together.
3. The top brackets are attached to the hole on the side plate of the guard. Use the $\frac{3}{8}$ button bolts, $\frac{3}{8}$ washers and $\frac{3}{8}$ lock nuts.