



2019 CATALOG



Table of Contents

New Part Numbers / Part Numbers Superseded	2
Application and Numerical Listings	
Specialty Shocks	3
Medium Duty & Heavy Duty Trucks, Trailers & Buses Application Listing	5
Medium Duty & Heavy Duty Trucks, Trailers & Buses Numerical Listing.....	227
Fleetline / GasSLX Interchange	240
Competitive and OEM Interchange	241
How to Determine the Correct Shock for Your Truck.....	291
Specifications by End Moun	300
Specifications by Part Numbe	316
Mounting Accessory Packages and Component Parts	331
Mounting Accessory Packages - Buyer's Guide	338

NEW PART NUMBERS IN THIS CATALOG

83081	83905
83180	83906
83363	85182
83364	85637
83391	85638
83395	85639
83901	89503

PART NUMBERS DROPPED FROM THIS CATALOG

83052	83176	85346	85731	85974	89412
83060	85011	85347	85905	85975	89441
83061	85083	85378	85907	85980	83014
83100	85085	85379	85912	85984	83046
83115	85092	85380	85913	86201	83634
83145	85097	85703	85930	86202	83636
83155	85099	85706	85966	86203	85701
83161	85313	85707	85968	87016	85719
83171	85324	85710	85969	87017	85730
83174	85342	85715	85971	87019	89416

9 YEAR SUPERSEDURE LIST

DELETE	THEN USE
83032	83025HD
83146	83364
83200	89402
83353	85740
83362	83215
83404	83159
85050	83221
85312	85733
85330	85379
85714	85715
85717	85715
85718	85732
89403	89401

APPLICATION GUIDE - SPECIALITY

Year	Model	OEM #	Fleetline #
ADVANCE MIXER			
	Rear Discharge Mixers with Self - Steering Axle Shock	12111 ADV	646155
CHALLENGE			
	Cement Mixer	632147 632155	632147 646177
GRANNING SUSPENSION			
	Model L120 Self Steer Axle	701071-01	646155
HENDRICKSON TRAILER SUSPENSION SYSTEMS			
Auxiliary Liftable Steerable System (HL)			
	HLP Paralift	A-14496	646155
	HLU Paralift Ultra	A-14496	646155
HENDRICKSON TRUCK SUSPENSION SYSTEMS			
Dual Tire Steer Lift Axle			
	Tough Lift LK Series	A-14496	646155
INGERSALL MACHINE			
	700060-0 Axle Assy.	665472	665472
	Models with O.E.M. Number	665904	665472
KIMBLE MIXER CO			
	Rear Discharge Mixers with Self - Steering Axle Shock	OE10455	646155
LINK/HIGH-STEER			
	6000 Steering Stabilizer	632155	646177
	9000 Steering Stabilizer	1210-0007 1210-0009	665937 665937
	Models with O.E.M. Number	1210-0001 1210-0002 1210-0010 1210-0012 646168	646155 632147 646155 646155 646155
LONDON MIXER			
	Rear Discharge Mixers with Self - Steering Axle Shock	MB-37737-30	646155
MC NEILUS TRUCK & MAN.			
	Booster Axles	1170719 600-115994B	632147 632147
	Bridgemaster V models with Self - Steering Axle Shocks	600-188206	646155
	Models with O.E.M. Number	1473224 2034140 MTM 600-11599M	646155 646155 632147
	Pusher Axles	600-115994B	632147
OSHKOSH MOTORS			
	Models with O.E.M. Number	2034140	646177
PIERCE MANUFACTURING INC.			
	Models with O.E.M. Number	2034140	646177
REX MIXER			
	Rear Discharge Mixers with Self - Steering Axle Shock	102-13441-10	646155
REYCO SUSPENSION			
	L132 Steering Stabilizer	701071-01	665937
RIDEWELL CORPORATION			
	RLT-230	1310002	665937
	RSS-232	1317570B001	646155
	RSS-236/R	1310002 1310004	665937 665937

APPLICATION GUIDE - SPECIALITY

Year	Model	OEM #	Fleetline #
------	-------	-------	-------------

SAF HOLLAND

	Self - Steering Axle Shocks	646201 90045331	646177 646155
--	-----------------------------	--------------------	------------------

Neway V-Steer II

	Self - Steering Axle Shocks	632155	646177
--	-----------------------------	--------	--------

SPRING VALLEY

	SS120 Steering Stabilizer	632155	646177
	SS130L Steering Stabilizer	632155	646177

SUSPENSIONS INC.

	LP11 Steerable Lift Axle	200188	646155
--	--------------------------	--------	--------

TEREX CORPORATION

	Rear Discharge Mixers with Self - Steering Axle Shock	12111	646155
--	---	-------	--------

TUTHILL TECHNOLOGIES

	Models with O.E.M. Number	66502	646155
--	---------------------------	-------	--------

VARIOUS

Steering Stabilizer

	Various Class 8 Trucks with Front Axle Rating of 10,000 lb to 20,000 lb	SC-2920	83176
--	---	---------	-------

WATSON & CHALIN MFG. INC.









Self - Steering Axle Suspension Systems

	LW5L-1100 SR	11418	646155
	Models with O.E.M. Number	17069	632147
	SL-2089 Steerable Lift Axle Suspension	11418	646155
	WCAL-1000 SST	11418	646155
	WCAL-1100 LR	11418	646155
	WCAL-1100 SR	11418	646155
	WCAL-1100 SRLP	11418	646155
	WCAL-1100 SSR	11418	646155
	WCHL-1100 FL	11418	646155
	WCHL-1100 HI-LIFT	11418	646155

WESTPORT AXLE CORP

	Self - Steering Axle Shocks	143699-0185 646124	646177 646177
--	-----------------------------	-----------------------	------------------

APPLICATION GUIDE - TRUCKS, TRAILERS, AND BUSES

Year	Model	OEM #	Front		Rear	
						
						
			Fleetline	GasSLX	Fleetline	GasSLX

ABC BUS

	Drive Axle	12J-5-10		01-	85733	...
	T2100 Van Hool Buses with O.E.M. Number (Front & Tag Axle)	10685703	- -	695406
		624314570	- -	695406
		90-2291	- -	695406
	Models with O.E.M. Number	050134513	010	85732
		12L-5-88		01-	85729	...
		6243-13790	- -	85708
		6243-14040	- -	85708
	Additional O.E.M. Interchanges	12B-5-1	010				85735	
		12L-5-114	- -				85727	
		12L-5-72	- -				85709	
		3166657	010				85700	
		680323	010				85700	

ACF BRILL BUS

	37R Models	010	85736
	C-27 and C-31 City Bus	010	85736	...	010	85702	...
	C-36 City Bus Serial #1051 and on	010	85736	...	010	85702	...
	C-37M Models	010	85736	...	010	85702	...
	C-44 City Bus and T-44 Trolley Bus		85308	...	010	85308	89422
	IC-41 Intercity Bus Serial #1088 and on		85308	...	010	85308	89422
	IC-41 Intercity Bus to Serial #1088	010	85736	...	010	85702	...
	Additional O.E.M. Interchanges	610513	010				85307	
		631237	010				85308 or 89422	
		641521	010				85308 or 89422	
		649648	010				85308 or 89422	
		659129	010				85303 or 89422	
		661732	010				83215	
		661733	010				83225	
		995891	010				85307	

ADVANCE MIXER

	Advance Mixer part number	13424 ADV		010	83207	89407
		14626 ADV		010	83209	...
		23458 ADV		01-	83112	...
	Models with 20,000 lb Front Axle	13883	010	85334
		13883 ADV	010	85334
		680087	010	85334

ALLCO TRAILER

	Dump Trailers with Watson & Chalin TA-5000-DB-19 Air Suspension	727602		010	83122	89406
--	---	--------	--	-----	-----	-----	-------	-------





AM GENERAL

	Small Bus	5979484		010	85302	89420
	Additional O.E.M. Interchanges	3166657	010				85700	
		4975501	010				85700	
		5565748	010				85700	
		5957136	010				85700	
		5969438	010				85700	
		5978712	010				85700	
		5979574	010				85700	
		5982537	010				85700	

ARVIN MERITOR

	Blue Bird Motor Home with IFS (37 Foot)	7805-N-1002	010	85329
--	---	-------------	-----	-------	-----	--	-----	-----





APPLICATION GUIDE - TRUCKS, TRAILERS, AND BUSES

Year	Model	OEM #	Front		Rear	
			 Fleetline	 GasSLX	 Fleetline	 GasSLX

ARVIN MERITOR(Cont'd.)

	Blue Bird Motor Home with IFS (37 Foot)	7805-S-1007	010	85329
	Models with Manufacturing Number	085009	-10	85009
		085014		010	85014	...
		085321		010	85321	...
		654907		010	85000	89436
		654958	010	83164
		659016	010	83064				
		659222	010	83171
		665044		010	83209	...
		665724		010	85000	89436
		665746		010	85000	89436
		665760		010	85045	...
		665769		010	85052	...
		665804		010	85939	...
		671091		-1-	85069	89455
		671092	010	85012	89413	
		671507		010	87015	...
		671707		010	85323	89436
		680102	010	85712				
		680322	010	85704				
		680331	010	85702				
		680337	-1-	85708				
		680347	010	85732				
		680464	010	85005				
		680518	010	85700				
		680584		010	85938	...
		680671		-1-	85708	...
		695172	-1-	85707				
		695180	-1-	85705				
		695181	-1-	85707				
		695214	-1-	85722				
		695348	010	87018				
		695406	-1-	695406				
		727600	010	83200				
		727607	010	83207 or 89407				
		727609	010	83209				
		727614	010	83214				
		727615	010	83215				
		727616	010	83216				
		727619	010	83219				
		727625	010	83225				
		727628	-10	83301				
		727630	010	83303				
		727631	010	83304				
		727635	010	83308				
		727636	010	83309 or 89446				
		727639	010	83312 or 89409				
		727641	010	83314				
		727645	-10	83318				
		727671	-1-	83613				
		727672	010	83242				
		728601	010	85001 or 89410				
		728603	010	85003 or 89411				
		728604	010	85300				
		728606	010	85302 or 89420				

APPLICATION GUIDE - TRUCKS, TRAILERS, AND BUSES

Year	Model	OEM #	Front		Rear	
						
			Fleetline	GasSLX	Fleetline	GasSLX

ARVIN MERITOR(Cont'd.)





Models with Manufacturing Number	728608	010	85304			
	728609	010	85305			
	728611	010	85307			
	728612	010	85308 or 89422			
	728614	-1-	85310 or 89423			
	728615	-10	85311 or 89424			
	728616	010	85004			
	728617	010	85005			
	728618	010	85006			
	728619	010	85007 or 89412			
	728621	-10	85009
	728622	010	85010			
	728623	010	85011			
	728624	010	85012 or 89413			
	728625	010	85013 or 89414			
	728626	01-	85733			
	728627	010	85313			
	728628	010	85314 or 89425			
	728631	010	85029			
	728632	010	85030 or 89440			
	728635	-1-	85318			
	728639	01-	85026 or 89417			
	728640	-1-	85027 or 89418			
	728800	-10	85711			
	728806	010	85736			
	728811	-1-	85707			
	728812	-1-	85705			

AUTOCAR

XPEDITOR

08 - 19	4 X 2 Models with Hendrickson Primaax EX 232 Air Suspensions Standard with 8 1/2" to 10" Ride Height	60657-003	010	85072	...
		60657-003L	010	85072	...
08 - 19	6 X 4 Models with Hendrickson HMX 400/460 Haulmax with 16.5" Saddle	60680-004	01-	83143	...
		60680-004L	01-	83143	...
08 - 19	6 X 4 Models with Hendrickson HMX 400/460 Haulmax with 17.5" & 18.5" Saddle	60680-005	01-	83142	...
		60680-005L	01-	83142	...
08 - 19	6 X 4 Models with Hendrickson HN - 522	60680-003	01-	83112	...
		60680-003L	01-	83112	...
08 - 19	6 X 4 Models with Hendrickson Primaax EX 462 Air Suspensions Standard with 12 1/2" - 14 3/8" - 15 1/2" Ride Height Standard with 8 1/2" to 10" Ride Height	60665-011	010	85967	...
		60657-003	010	85072	...
		60657-003L	010	85072	...
08 - 19	8 X 4 Models with Chalmers 800 Series - 46K Tandem Truck Suspensions (HD Shock Kit with High Mounts)	800670	010	85060	...
08 - 19	8 X 4 Models with Chalmers 800 Series - 46K Tandem Truck Suspensions (HD Shock Kit with Low Mounts)	800781	010	85314	89425
08 - 19	8 X 4 Models with Hendrickson Primaax EX 462 Air Suspensions Standard with 12 1/2" - 14 3/8" - 15 1/2" Ride Height Standard with 8 1/2" to 10" Ride Height	60665-011	010	85967	...
		60657-003	010	85072	...
		60657-003L	010	85072	...

APPLICATION GUIDE - TRUCKS, TRAILERS, AND BUSES

Year	Model	OEM #	Front		Rear	
						
			Fleetline	GasSLX	Fleetline	GasSLX

AUTOCAR(Cont'd.)

XPERT(Cont'd.)

	4 X 2 Models (CLASS 7 & 8) with Hendrickson HAS-210 or HAS-230 Air Suspensions With O.E.M. Number	60670-005 60675-003 60675-003L		010	83137	...
08 - 19	4 X 2 Models (CLASS 8) with Hendrickson EX-262 Air Suspensions	60665-013		010	85965	...
08 - 19	6 X 4 Models with Hendrickson HMX 400 Haulmax with 16.5" Saddle	60680-004 60680-004L		01-	83143	...
08 - 19	6 X 4 Models with Hendrickson HMX 400 Haulmax with 17.5" & 18.5" Saddle	60680-005 60680-005L		01-	83142	...
08 - 19	6 X 4 Models with Hendrickson Primaax EX 462 Air Suspensions Standard with 12 1/2" - 14 3/8" - 15 1/2" Ride Height Standard with 8 1/2" to 10" Ride Height	60665-011 60657-003 60657-003L		010	85967	...
				010	85072	...
				010	85072	...

XSPOTTER

08 - 18	6 X 4 Off-Road Terminal Tractors with Hendrickson HN - 462	60680-003 60680-003L		01-	83112	...
				01-	83112	...

Additional Applications

	A42B, A42F, A64B A64F Models From Feb. 1971 Thru Jan. 1971	03-1106460 28R010	010	85005	89430	
	ACM, ACL Models	35901-3201 37301-3201	010	83216
	C65T, C70T, C70TS, C90, C75, C90T, DC74, DC75, DC102, DC104 Models	01-	85027	89418	010	85024	...
	DC87T, DC9364 From Feb. 1971	010	83216
	DC87T, DC9364 From Feb. 1971	010	83122	89406	
	Models with Air Suspension and O.E.M. Number	8026658 8071524		010	85046	89434
	Models with Hendrickson HTS 210, HTS 230 and HTS 260 Suspensions	60665-025 60665-025L		010	85024	...
	Models with Hendrickson HTS 210, HTS 230 and HTS 260 Suspensions	60665-025 60665-025L		010	85036	89405
	Models with O.E.M. Number	1011839 28CFG-910 37301-3202 660186 849246	010	83216
			010	83216
			01-	85026	89417	
			010	83216
			010	83216

BECK BUS

	Deck and 1/2 Bus - Spring Suspension		85307	...	010	85307	...
	Deck and 1/2 Bus - Trailing Wheel	010	85301	...
	Deck and 1/2 Bus with Air Suspension		85304	...	010	85304	...
	Luxury Liner Bus - Spring Suspension		85307	...	010	85307	...
	Mainliner with Air Suspension		85304	...	010	85304	...
	Models with O.E.M. Number	14QK-140 14QK-2102	010	85304
				010	85304	...









BENSON TRUCK BODIES INC.

	Models with Hendrickson Intrax Air Suspension	A-20002		010	85000	89436
	Models with Neway Air Suspension	90044089		010	83124	89407

BERING TRUCK CORP.

	HD80TT Models with Hendrickson HAS-400 Air Suspension	47902-24		010	83137	...
	Models with Hendrickson HAS-230 Air Suspension	47902-24		010	83137	...

APPLICATION GUIDE - TRUCKS, TRAILERS, AND BUSES

Year	Model	OEM #	Front		Rear	
						
						
			Fleetline	GasSLX	Fleetline	GasSLX

BERKSHIRE COACH

- 2019	Ultra 28 Coaches with Ford E450 Chassis	ASH-1136		-10	83178	...
		ASH-1154	-10	83177

BLUEBIRD SCHOOL BUS





All American Series (FE & RE Models)

	Buses with 13,200 lb, 2-Leaf Parabolic Springs	1658525	010	85971
				85058	89431	
	Buses with 19,000 lb - 21,000 lb - 2 Stage Leaf Springs	AMS65110		010	85005	89430
06 - 19	Buses with Comfort Air Suspensions	00085991		010	85006	...
		47170000428		010	85006	...
		60998-001		010	85006	...
		60998-003		010	85006	...
06 - 19	Buses with Hendrickson Airtek Front Air Suspension (10,000 lb Capacity)	58913-009	010	85959
		58913-009L	010	85959
- 2019	Buses with Hendrickson Airtek Front Air Suspension (13, 200 to 14,600 lb Capacity)	58913-011	010	85959
		58913-011L	010	85959
98 - 15	Buses with Hendrickson Parasteer Suspensions	0015222	010	85919
		0040015	010	85919
		481700131438	010	85919
		59483-000	010	85919
		60665-005	010	85919
		60665-005L	010	85919
		60998-002	010	85919
		60998-002L	010	85919
- 2019	Buses with Hendrickson Softek Suspension (13,200 lb - 14,600 lb Capacity)	0106303	010	85106
		471700002919	010	85106
		58913-010	010	85106
		58913-010L	010	85106
06 - 19	Buses with Hendrickson Softek Suspension (8,500 lb - 10,000 lb Capacity)	58913-009	010	85959
		58913-009L	010	85959
05 - 16	Buses with Leaf Spring Rear Suspension	0088035		010	85090	...
		47170000464		010	85090	...
	Buses with O.E.M. Number	0110808	010	83124	89407	
		0823054	010	85304
	FE Models School Bus (Front Engine)	0014605		010	85036	89405
		0014985		010	83137	...
		59057-001		010	83137	...
		59057-002		010	85036	89405
	RE (Rear Engine) Models with Ridewell RAS - 227 Steer Axle Air Suspension	1260008		010	87017	...
		90-2610 SP1		010	87017	...
	RE Models School Bus (Rear Engine) with 1 " Mounting Pins	300-0614966	010	85307
		300-0614974		010	85304	...
		609180		010	85304	...
		614958	010	85307

D3 Series (FE & RE Models)

10 - 13	Buses with Comfort Air Suspensions	00085991		010	85006	...
		47170000428		010	85006	...
		60998-001		010	85006	...
		60998-003		010	85006	...
10 - 13	Buses with Hendrickson Airtek Front Air Suspension	0110808	010	83124	89407	
10 - 13	Buses with Hendrickson Airtek Front Air Suspension (13, 200 to 14,600 lb Capacity)	58913-011	010	85959

APPLICATION GUIDE - TRUCKS, TRAILERS, AND BUSES

Year	Model	OEM #	Front		Rear	
						
			Fleetline	GasSLX	Fleetline	GasSLX

BLUEBIRD SCHOOL BUS(Cont'd.)

D3 Series (FE & RE Models)(Cont'd.)

10 - 13	Buses with Hendrickson Airtek Front Air Suspension (13, 200 to 14,600 lb Capacity)	58913-011L	OIO	85959
10 - 13	Buses with Hendrickson Softek Suspension (13,200 lb - 14,600 lb Capacity)	0106303	OIO	85106
		471700002919	OIO	85106
		58913-010	OIO	85106
		58913-010L	OIO	85106
10 - 13	Buses with Leaf Spring Rear Suspension	0088035		OIO	85090
		471700000464		OIO	85090

TC 2000 Bus, TC/2000 FE Series

	Buses with Neway Rear Air Suspension	90045050		OIO	85914
	Buses with Ridewell Front Suspension Option #4540	1004167	OIO	85712
		1317767	OIO	85029
		1667831	OIO	85029
		300-1317767	OIO	85029
		AMS65119	OIO	85029
	Buses with Ridewell Rear Suspension Option #4540	1316546		OIO	85006
		1658533		OIO	85010
		305-0961284		OIO	85734
	Buses with Standard Flat Leaf Rear Springs	1746163		OIO	85006
	Buses with Standard Parabolic Front Springs	1658525	OIO	85971





Type A School Bus

92 - 19	MicroBird Type A School bus with Ford E350 Chassis	8C24-18045-DA	-IO	83177
		8C2Z-18124-D	-IO	83177
		ASH-1154	-IO	83177
		AT-163G	-IO	83177
		8C24-18080-DB		-IO	83178
		8C2Z-18125-D		-IO	83178
		ASH-1136		-IO	83178
		AT-164G		-IO	83178
00 - 19	MicroBird Type A School bus with Ford E450 Chassis	8C24-18045-DA	-IO	83177
		8C2Z-18124-D	-IO	83177
		ASH-1154	-IO	83177
		AT-163G	-IO	83177
		8C24-18080-DB		-IO	83178
		8C2Z-18125-D		-IO	83178
		ASH-1136		-IO	83178
		AT-164G		-IO	83178

Vision Series

06 - 19	Buses with Comfort Air Suspensions	00085991		OIO	85006
		471700000428		OIO	85006
		471700131545		OIO	85006
		60998-001		OIO	85006
		60998-003		OIO	85006
	Buses with Hendrickson Airtek Front Air Suspension	00119797	OIO	85959
		65992-003	OIO	85959
06 - 19	Buses with Hendrickson Airtek Front Air Suspension (10,000 lb Capacity)	0055017	OIO	85959
		0085990	OIO	85959
		471700000456	OIO	85959
		58913-008	OIO	85959
		58913-008L	OIO	85959
		58913-009	OIO	85959
		58913-009L	OIO	85959
12 - 19	Buses with Hendrickson Airtek Front Air Suspension (13, 200 to 14,600 lb Capacity)	58913-011	OIO	85959

APPLICATION GUIDE - TRUCKS, TRAILERS, AND BUSES

Year	Model	OEM #	Front		Rear	
						
			Fleetline	GasSLX	Fleetline	GasSLX

BLUEBIRD SCHOOL BUS(Cont'd.)

Vision Series(Cont'd.)

12 - 19	Buses with Hendrickson Airtek Front Air Suspension (13, 200 to 14,600 lb Capacity)	58913-011L	○ ○	85959
- 2019	Buses with Hendrickson Softek Suspension (13,200 lb - 14,600 lb Capacity)	0106303	○ ○	85106
		471700002919	○ ○	85106
		58913-010	○ ○	85106
		58913-010L	○ ○	85106
06 - 19	Buses with Hendrickson Softek Suspension (8,500 lb - 10,000 lb Capacity)	0055008	○ ○	85959
		0085990	○ ○	85959
		471700000456	○ ○	85959
		58913-007	○ ○	85959
		58913-007L	○ ○	85959
		58913-009	○ ○	85959
05 - 16	Buses with Leaf Spring Rear Suspension	0088035		○ ○	85090	...
		471700000464		○ ○	85090	...





Additional Applications

	Buses with 3/4" Mounting Pins	2021459		85012	...	○ ○	85012	89413
	Buses with 35" Chassis	303-1350628	○ ○	85712
		90-1968	○ ○	85712
	Buses with Flat Leaf Rear Spring Suspensions (8,200 lb to 10,400 lb)	1707405		○ ○	85005	89430
	Buses with Neway Air Suspensions with O.E.M. Number	1526417		○ ○	85052	...
		90044448		○ ○	85051	...
		90044915		○ ○	83127	...
		90045083		○ ○	85910	...
	Buses with Reyco Air Suspension	1668722	○ ○	85030	89440	
		1668730		○ ○	85013	89414
		1722222		○ ○	85013	89414
	City Bird Buses with 1 " Mounting Pins	300-0614966	○ ○	85307
		300-0614974		○ ○	85304	...
		609180		○ ○	85304	...
		614958	○ ○	85307
	Low Floor Bus Models with O.E.M. Number	0075916	○ ○	85086
		4759272		- -	...	89447
		4760958	○ ○	85086
		680667		- -	...	89447
	Motor Home with IFS (37 Foot)	7805-N-1002	○ ○	85329
		7805-S-1007	○ ○	85329
	WanderLodge Drive Axle Front with Reyco Air Suspension	1750793		○ ○	85712	...
		90-1968-SP1	○ ○	85712
		1722214		○ ○	85030	89440
	WanderLodge LX, LXI - Models Front Rear	90-2497-SP1	
		90-1951-SP1		○ ○	85734	...
	Models with O.E.M. Number	00119798	○ ○	85106
		0020326		○ ○	85976	...
		300-1316546		○ ○	85006	...
		614974	○ ○	85304
		65992-004	○ ○	85106
		680783	○ ○	85304

Additional O.E.M. Interchanges

	Additional O.E.M. Interchanges	0523047	○ ○	85736				
--	--------------------------------	---------	-----	--------------	--	--	--	--

APPLICATION GUIDE - TRUCKS, TRAILERS, AND BUSES

Year	Model	OEM #	Front		Rear	
						

CARPENTER BUS

Models with O.E.M. Number	0272-SS5	OIO	85712
	63-0001		OIO	85713	...

CASCADE TRAILER

Models with Air Suspension	120-1		OIO	83125	...
----------------------------	-------	--	-----	-----	-----	-------	-----

CATERPILLAR

12 - 17	CT660 Models with Hendrickson HMX 460 Haulmax with 16.5" Saddle	60680-004		OIO	83143	...
		60680-004L		OIO	83143	...
12 - 17	CT660 Models with Hendrickson HMX 460 Haulmax with 17.5" & 18.5" Saddle	60680-005		OIO	83142	...
		60680-005L		OIO	83142	...

CHALLENGE COOK

Cement Truck

Cement Trucks with 1/2" Bearing mount	632147	OIO	632147				
Cement Trucks with 3/4" Bushing & Sleeve mount	1540212	OIO	646155				
	1540459	OIO	646155				
	632155	OIO	646177				

CHALMERS SUSPENSION

K800199 Model Shock Kit (Stanard)	K800199		OIO	85060	...
K880233 Model Shock Kit (Standard 50K Suspension)	K880233		OIO	85060	...
K880247 Model Shock Kit	K880247		OIO	85060	...
K880248 Model Shock Kit	K880248		OIO	85314	89425
K880642 Model Shock Kit (Used on Western Star only)	K880642		OIO	85060	...
Single Axle Truck Suspension (1023-23K, 1030 -30K, 1040-40K)	665174		OIO	85060	...
800 Series - 46K Tandem Truck Suspensins (HD Shock Kit with High Mounts)	800670		OIO	85060	...
800 Series - 46K Tandem Truck Suspensins (HD Shock Kit with Low Mounts)	800781		OIO	85314	89425
Models with O.E.M. Number	21335		OIO	G63355	...

CHAMPION BUS INC

- 2019	American Coach Series Shuttle buses with Ford E350 and E450 Chassis	ASH-1136		-IO	83178	...
		ASH-1154	-IO	83177
- 2019	American Crusader Series Shuttle buses with Ford E350 Chassis	ASH-1136		-IO	83178	...
		ASH-1154	-IO	83177
- 2019	Challenger Series Shuttle buses with Ford E350 and E450 Chassis	ASH-1136		-IO	83178	...
		ASH-1154	-IO	83177
- 2019	Crusader Series Shuttle buses with Ford E350 Chassis	ASH-1136		-IO	83178	...
		ASH-1154	-IO	83177
- 2019	FL Transport Series Shuttle buses with Ford E450 Chassis	ASH-1136		-IO	83178	...
		ASH-1154	-IO	83177
	GMC P6000 Chassis	22064230	-I-	83136
		22064231		-I-	85324	...
	Models with Ford F650 and F750 Chassis - See Ford section for proper year and model information				
	Models with Freightliner M2 Chassis - See Freightliner section for proper year and model information				

CHANCE COACH

Buses with 3/4" Mounting Pins	2021459		85012	...	OIO	85012	89413
Models with O.E.M. Number	59039		83207	...	OIO	83207	89407

APPLICATION GUIDE - TRUCKS, TRAILERS, AND BUSES

Year	Model	OEM #	Front			Rear		
			Fleetline	GasSLX		Fleetline	GasSLX	

CHANCE COACH(Cont'd.)

Models with O.E.M. Number	665017	OIO	OIO	85014	...	
	6892		83207	...	OIO	83207	89407	
	6893		83203	89436		
	728600		83203	...	OIO	83203	89436	
	AS789B		85014	...	OIO	85014	...	
Additional O.E.M. Interchanges	270-6708	OIO	85014					

CHEVROLET TRUCK (ALSO SEE GMC TRUCK)

4, 40, 4000 & 4500 Series

69 - 72	All - Exc. Tilt Cab	22012096 3192892		83221	...	OIO	83221	...
				83221	...	OIO	83221	...
60 - 68	C-40 , P-40, SS-40 Models	OIO	85005	89430	
1968	Cowl - Exc. School Bus	22012096	OIO	83221
		3192892	OIO	83221
69 - 70	D-D Forward Control with 9000 & 11000 lb Axles - Exc. Tilt Cab	22012096	OIO	83221
		3192892	OIO	83221
69 - 70	D-D Forward Control with Tilt Cab	22012095	OIO	83126	89430	
		4940606	OIO	83126	89430	
67 - 72	S-40 School Bus	22012096		83221	...	OIO	83221	...
		3192892		83221	...	OIO	83221	...
67 - 68	TDM 4 Cycle Detroit Diesel with Tandem Axle - Exc. Tilt Cab	22012096		OIO	83221	...
		3192892		OIO	83221	...





5, 50, 5000 & 5500 Series

69 - 72	All - Exc. Tilt Cab	22012096 3192892		83221	...	OIO	83221	...
				83221	...	OIO	83221	...
73 - 80	C, M, S Chassis - Conventional Cab	22007750	OIO	83207	89407	
		4975467	OIO	83207	89407	
		4975494	OIO	83207	89407	
75 - 80	C, M, S Chassis - Conventional Cab	4975510	OIO	83221
76 - 89	C, M, S Chassis - Conventional Cab	22002294	OIO	83304
		22007752	OIO	83304
		22012096		OIO	83221	...
		22012169		OIO	83221	...
73 - 80	C, S Chassis - Conventional Cab and School Bus	22012096		OIO	83221	...
		3192892		OIO	83221	...
73 - 89	C, S Chassis - Conventional Cab and School Bus	22012095		OIO	83126	89430
		22012166		OIO	83126	89430
63 - 69	C-50, M-50, S-50, SE-50, T-50 Models	OIO	85005	89430	OIO	83221	...
1968	Cowl - Exc. School Bus	22012096	OIO	83221
		3192892	OIO	83221
69 - 70	D-D Forward Control with 9000 & 11000 lb Axles - Exc. Tilt Cab	22012096	OIO	83221
		3192892	OIO	83221
69 - 70	D-D Forward Control with Tilt Cab	22012095	OIO	83126	89430	
		4940606	OIO	83126	89430	
69 - 72	S-50 School Bus	3192892		83221	...	OIO	83221	...
73 - 78	S-50 School Bus	22012166		OIO	83126	89430
		3192892		OIO	83221	...
67 - 68	TDM 4 Cycle Detroit Diesel with Tandem Axle - Exc. Tilt Cab	22012096		OIO	83221	...
		3192892		OIO	83221	...
71 - 72	TDM 4 Cycle Detroit Diesel with Tandem Axle - Exc. Tilt Cab	22012095		OIO	83126	89430
		4940606		OIO	83126	89430

6, 60, 6000 & 6500 Series

69 - 72	All - Exc. Tilt Cab	22012096 3192892		83221	...	OIO	83221	...
				83221	...	OIO	83221	...
68 - 69	All with 9000 & 11000 lb Axles - Exc. Tilt Cab	22012095	OIO	83126	89430	

APPLICATION GUIDE - TRUCKS, TRAILERS, AND BUSES





Year	Model	OEM #	Front		Rear	
						
			Fleetline	GasSLX	Fleetline	GasSLX

CHEVROLET TRUCK (ALSO SEE GMC TRUCK)(Cont'd.)

6, 60, 6000 & 6500 Series(Cont'd.)

68 - 69	All with 9000 & 11000 lb Axles - Exc. Tilt Cab	4940606	010	83126	89430	
79 - 89	B6P042 School Bus (Axle codes F070, F070D)	22002294	010	83304
		22007752	010	83304
79 - 89	B6P042 School Bus (Axle codes F090, F120D)	22002295	010	83303
		22007753	010	83303
		22017531	010	83303
79 - 89	B6P042 School Bus w/15000 lb or 17000 lb Rear Springs	22012096		010	83221	...
		22012169		010	83221	...
79 - 89	B6P042 School Bus w/18500 or 20800 lb Rear Springs	22012095		010	83126	89430
		22012166		010	83126	89430
76 - 89	C, M Chassis - Conventional Cab	22002294	010	83304
		22007752	010	83304
75 - 80	C, M, S Chassis - Conventional Cab and School Bus	4975510	010	83221
73 - 75	C, M, S Chassis - Conventional Cab and School Bus with 5000 & 7000 lb Axle	22007750	010	83207	89407	
		4975467	010	83207	89407	
		4975494	010	83207	89407	
73 - 89	C, S Chassis - Conventional Cab and School Bus - Exc. with 20800 & 23000 lb Rear Axle	22012096		010	83221	...
		22012169		010	83221	...
		3192892		010	83221	...
73 - 89	C, S Chassis - Conventional Cab and School Bus with 20800 & 23000 lb Rear Axles	22012095		010	83126	89430
		22012166		010	83126	89430
		4940606		010	83126	89430
79 - 89	C, S Chassis - Conventional Cab and School Bus	22002295	010	83303
		22007753	010	83303
		22017530	010	83303
		22017531	010	83303
73 - 80	C, S, T Chassis - Conventional & Tilt Cab and School Bus with 5000 & 7000 lb Axle	22002293	010	83126	89430	
		22007701	010	83126	89430	
		22007751	010	83303
		22012095	010	83126	89430	
		3192890	010	83126	89430	
		4940606	010	83126	89430	
		4940662	010	83126	89430	
4975497	010	83126	89430			
71 - 72	Conventional Cab & Tilt Cab with 9000 & 11000 lb Axles	22012095		010	83126	89430
		4940606		010	83126	89430
1968	Cowl - Exc. School Bus	22012096	010	83221
		3192892	010	83221
69 - 70	D - D Forward Control with 9000 & 11000 lb Axles - Exc. Tilt Cab	22012096	010	83221
		3192892	010	83221
76 - 89	S Chassis - School Bus	22002294	010	83304
		22007702	010	83304
		22007752	010	83304
69 - 78	S-60	3192892		83221	...	010	83221	...
		4975510		83221	...	010	83221	...
73 - 78	S-60 w/Air Brakes	22007701		010	83126	89430
		22007751		010	83303	...
		22012095		010	83126	89430
		22012166		010	83126	89430
		3171069		010	85304	...
4940606		010	83126	89430		

APPLICATION GUIDE - TRUCKS, TRAILERS, AND BUSES

Year	Model	OEM #	Front		Rear	
			 Fleetline	 GasSLX	 Fleetline	 GasSLX

CHEVROLET TRUCK (ALSO SEE GMC TRUCK)(Cont'd.)





6, 60, 6000 & 6500 Series(Cont'd.)

73 - 75	SE, SS-60 thru Serial # 134487 (1975 1st Design)	22007700	010	83207	89407	
		22007750	010	83207	89407	
		4975467	010	83207	89407	
		4975494	010	83207	89407	
76 - 78	SE-60 From Serial # 120000 (1976 2nd Design)	22002294	010	83304
		22007752	010	83304
76 - 78	SE-60 w/Hydraulic Brakes from Serial # 120000 (1975 2nd Design)	22012169		010	83221	...
		3192892		010	83221	...
73 - 74	SG, SM-60	3192890	010	83126	89430	
73 - 74	SG, SM-61	4940606	010	83126	89430	
73 - 74	SG, SM-62	22002293	010	83126	89430	
73 - 74	SG, SM-63	22007701	010	83126	89430	
73 - 74	SG, SM-64	22007751	010	83303
60 - 62	Standard and Heavy Duty Truck and School Bus (2 Ton)	010	83221	...
71 - 72	TDM 4 Cycle Detroit Diesel with Tandem Axle	22012095		010	83126	89430
		4940606		010	83126	89430
67 - 68	TDM 4 Cycle Detroit Diesel with Tandem Axle - Exc. Tilt Cab	22012096		010	83221	...
		3192892		010	83221	...
79 - 80	W Chassis - 72" BBC Steel Tilt Cab	22002293	010	83126	89430	
		22007751	010	83303

7, 70 & 7000 Series

66 - 72	72" BBC Steel Tilt Cab with V-6 2 Cycle Diesel Engine	22012095	010	83126	89430	
		3171462	010	83126	89430	
		3192890	010	83126	89430	
66 - 72	72" BBC Steel Tilt Cab with V-6 2 Cycle Diesel Engine with 17201 and 17221 Axle	22012096		010	83221	...
		3192892		010	83221	...
66 - 72	72" BBC Steel Tilt Cab with V-6 2 Cycle Diesel Engine with 19101 and 19201 Axle	4940600		010	83209	89414
66 - 72	92" BBC Conventional Cab	3192657	010	83216
		4940614	010	83216
		4963854	010	83216
79 - 89	C, M Chassis - 97" BBC Conventional Cab	22002294	010	83304
		22002295	010	83303
		22007752	010	83304
		22007753	010	83303
		22012095		010	83126	89430
		22012166		010	83126	89430
		22017530	010	83303
22017531	010	83303		
66 - 72	Conventional Cab with Tapered 2-Leaf Softride 11000 lb Rating and F120 Axle (12000 lb)	22046483	010	85304
		22052336	010	85304
		3171069	010	85304
66 - 72	Conventional Cab With Tapered 2-Leaf Softride 7000 & 9000 lb Rating and F070, F090, F120 Axle (7000, 9000 & 12000 lb)	3171068	010	83216
		3192657	010	83216
		4940614	010	83216
		4963853	010	83216
		4963854	010	83216
77 - 80	H, J Chassis - 92" BBC Conventional Cab	4963854	010	83216
		4984526	010	83216
73 - 80	H, J Chassis - 92" BBC Conventional Cab with V-6, V8 Diesel Engines	4940614	010	83216
		4963854	010	83216
73 - 80	H, J, M Chassis - 92" & 114" BBC Conventional Cab	2204683	010	85304

APPLICATION GUIDE - TRUCKS, TRAILERS, AND BUSES

Year	Model	OEM #	Front		Rear	
						
			Fleetline	GasSLX	Fleetline	GasSLX

CHEVROLET TRUCK (ALSO SEE GMC TRUCK)(Cont'd.)

7, 70 & 7000 Series(Cont'd.)

73 - 80	H, J, M Chassis - 92" & 114" BBC Conventional Cab	3171069	010	85304
73 - 80	R Chassis - Rear Engine Bus	22012090	010	85308	89422	
		5552451	010	85308	89422	
		5552456		010	85307	...
		5552552		010	85303	89422
83 - 84	S7T042 Forward Control Chassis w/17000, 18500, 21000, 23000 lb Rear Axle	22012095		010	83126	89430
		22012166		010	83126	89430
83 - 84	STT042 Forward Control Chassis	22012065	010	85304
		3171069	010	85304
73 - 80	T, W Chassis - 72" BBC Steel Tilt Cab (4 x 2) with V-6 Diesel Engine	22007751	010	83303
		22012095	010	83126	89430	
		4940606	010	83126	89430	
		4975497	010	83126	89430	
73 - 80	T, W Chassis - 72" BBC Steel Tilt Cab with V-6 Gas Engine	22012091	010	85303	89422	
		5552452	010	85303	89422	





8, 80 & 8000 Series

66 - 69	72" BBC Steel Tilt Cab	5544060	010	85302	89420	
66 - 72	92" BBC Conventional Cab	3171068	010	83216
		3192657	010	83216
		4940614	010	83216
		4963853	010	83216
		4963854	010	83216
66 - 72	92" BBC Conventional Cab with 7000 & 9000 lb Axles - Exc. 2-Leaf Softride	22046483	010	85304
		22052336	010	85304
		3171069	010	85304
79 - 82	H, J Chassis - 92" BBC Conventional Cab 4 x 2 with Air Suspension	22012065		010	85304	...
		22046483		010	85304	...
		22052336		010	85304	...
		3171069		010	85304	...
73 - 81	H, J Chassis - 92" BBC Conventional Cab	4940614	010	83216
		4963854	010	83216
		4984526	010	83216
73 - 86	H, J, M Chassis - 92" & 114" BBC Conventional Cab	22046483	010	85304
		22052336	010	85304
		3171069	010	85304
73 - 80	R Chassis - Rear Engine Bus	22012090	010	85308	89422	
		22012091		010	85303	89422
		5552451	010	85308	89422	
		5552452		010	85303	89422
		5552456		010	85307	...
70 - 80	T, W Chassis - 72" BBC Steel Tilt Cab with V-6 Gas Engine	22012091	010	85303	89422	
		5552452	010	85303	89422	

9000 Series

70 - 72	54" BBC Aluminum Tilt Cab 6 x 4	22046483		85304	...	010	85304	...
		22052336		85304	...	010	85304	...
		3171069		85304	...	010	85304	...
70 - 72	92" & 114" BBC Conventional Cab - Exc. 6 x 4	4940614	010	83216
		4963854	010	83216
70 - 72	92" & 114" BBC Conventional Cab 6 x 4	22046483		85304	...	010	85304	...
		22052336		85304	...	010	85304	...
		3171069		85304	...	010	85304	...

APPLICATION GUIDE - TRUCKS, TRAILERS, AND BUSES

Year	Model	OEM #	Front			Rear		
							Fleetline	GasSLX

CHEVROLET TRUCK (ALSO SEE GMC TRUCK)(Cont'd.)

9000 Series(Cont'd.)

70 - 86	D, F Chassis - 54" BBC Aluminum Tilt Cab with Rear GM Air Ride Suspension (4 Req'd)	22012065		85304	...	010	85304	...
		22046483		85304	...	010	85304	...
		22052336		85304	...	010	85304	...
		3171069		85304	...	010	85304	...
70 - 86	H, J Chassis - 92" BBC Conventional Cab	22046483	010	85304
		22052336	010	85304
		3171069	010	85304
77 - 86	M, N Chassis - 114" BBC Conventional & 108" BBC Aluminum Conventional Cab with Rear GM Air-Ride Suspension (4 Req'd)	22012065		85304	...	010	85304	...
		22046483		85304	...	010	85304	...
		22052336		85304	...	010	85304	...
		3171069		85304	...	010	85304	...
70 - 80	T, W Chassis - 72" BBC Steel Tilt Cab	22012091	010	85303	89422	
		5552452	010	85303	89422	

B - Series - School Bus

90 - 98	B6, B7 Model School Bus Chassis With 11000, 13500, 15000 lb Taperleaf Springs With 15000, 19000, 21000 lb Multileaf Springs	22064231		- -	85324	...
		15174902		- -	85071	...
		22064232		- -	85071	...
	Models with O.E.M. Number	15123676	- -	83136
		15588554	- -	83136
		22064230	- -	83136
		88982682	- -	83136





C - Series (C4500, C5500) Kodiak

90 - 09	C Chassis - Conventional Cab Front Shock with O.E.M. Number With 15000, 19000, 21000 lb Multileaf Springs	15123676	- -	83136
		15588554	- -	83136
		15887728	- -	83136
		19152843	- -	83136
		22064230	- -	83136
		88982682	- -	83136
		15174902		- -	85071	...
		22064232		- -	85071	...
		88982686		- -	85071	...
		04 - 09	C Chassis - Conventional Cab (Non 4x4 Option) with 13,500 Multi-leaf Spring	15185644		010
508-89				010	83155	...
L-12706				010	83155	...
1990 -	C Chassis - Conventional Cab w/11000, 13500, 15000 lb Taperleaf Springs	22064231		- -	85324	...
90 - 06	C Chassis - Conventional Cab w/16900 or 17850 lb Taperleaf Springs	21998392		- -	85336	...
		22064489		- -	85336	...
		88963409		- -	85336	...
1990 -	C Chassis - Conventional Cab w/19000, 21000, 23000 lb Taperleaf Springs (EXC Low Profile Vehicle)	22064233		- -	83136	...
83 - 99	C Chassis - Conventional Cab with 9100 to 17500 lb Rear Axle	22064432		010	85050	...
03 - 09	C Chassis - Conventional Cab with Taperleaf Rear Suspension Models with O.E.M. Number	15185643		010	83153	...
		88982684	- -	83136
		88982688		- -	85336	...

C - Series (C6500, C7500, C8500) Kodiak

04 - 08	Conventional Cab (Low Profile) with 12000, 15000, & 17000 lb Leaf Spring	15174901		- -	85342	...
		507-22		- -	85342	...
		88982685		- -	85342	...
90 - 09	Conventional Cab w/ Front Shock with O.E.M. Number	15123676	- -	83136

APPLICATION GUIDE - TRUCKS, TRAILERS, AND BUSES

Year	Model	OEM #	Front		Rear	
						

CHEVROLET TRUCK (ALSO SEE GMC TRUCK)(Cont'd.)

C - Series (C6500, C7500, C8500) Kodiak(Cont'd.)

90 - 09	Conventional Cab w/ Front Shock with O.E.M. Number	15174898	- -	83136
		15588554	- -	83136
		15887728	- -	83136
		19152843	- -	83136
		22064230	- -	83136
		88982682	- -	83136
1990 -	Conventional Cab w/11000, 13500, 15000 lb Taperleaf Springs	22064231		- -	85324	...
90 - 09	Conventional Cab w/15000, 19000, 21000 lb Multileaf Springs	15174902		- -	85071	...
		22064232		- -	85071	...
		88982686		- -	85071	...
90 - 06	Conventional Cab w/16900 or 17850 lb Taperleaf Springs	21998392		- -	85336	...
		22064489		- -	85336	...
		88963409		- -	85336	...
1990 -	Conventional Cab w/19000, 21000, 23000 lb Taperleaf Springs (EXC Low Profile Vehicle)	22064233		- -	83136	...
04 - 08	Conventional Cab with 19000 lb Leaf Spring	15174903		- -	85342	...
		507-23		- -	85342	...
		88982687		- -	85342	...
83 - 99	Conventional Cab with 9100 to 17500 lb Rear Axle	22064432		0 0	85050	...
95 - 02	Models with Hendrickson Air Suspension (Stamping number 47902-13)	12474915		0 0	83122	89406
		15963161		0 0	83122	89406
96 - 02	Models with Hendrickson Air Suspension (Stamping number 47902-29)	12474917		0 0	83137	...
		15740554		0 0	83137	...
	Models with O.E.M. Number	88982684	- -	83136
		88982688		- -	85336	...

P - Series

92 - 96	Motorhome Chassis	22064231		- -	85324	...
		22064233		- -	83136	...

T - Series (T5500, T6500, T7500, T8500)

1997 -	FL1 Tilt Cab with 8100 lb Axle	22064804	- -	83136
		22064805	- -	83136
		22165187	- -	83136
		22165188	- -	83136
1997 -	FL2 Tilt Cab with 5000 to 11000 lb Axle	22064807	- -	83136
		22166442	- -	83136
1997 -	FL3 Tilt Cab with 14575 lb Axle	22064806	- -	83136
		22165189	- -	83136
1999	Models with Hendrickson Air Suspension (Stamping number 47902-13)	12474915		0 0	83122	89406
		15963161		0 0	83122	89406
90 - 99	Tilt Cab w/11000, 13500, 15000 lb Taperleaf Springs	22064231		- -	85324	...
90 - 06	Tilt Cab w/15000, 19000, 21000 lb Multileaf Springs	15174902		- -	85071	...
		22064232		- -	85071	...
92 - 06	Tilt Cab w/16900 lb Taperleaf Springs	21998392		- -	85336	...
		22064489		- -	85336	...
		88963409		- -	85336	...
92 - 99	Tilt Cab w/19000, 21000, 23000 lb Taperleaf Springs (EXC Low Profile Veh.)	22064233		- -	83136	...
06 - 09	Tilt Cab Models with O.E.M. Number	15174901		- -	85342	...
		15174903		- -	85342	...
		507-22		- -	85342	...
		507-23		- -	85342	...
		88982685		- -	85342	...
		88982687		- -	85342	...

APPLICATION GUIDE - TRUCKS, TRAILERS, AND BUSES

Year	Model	OEM #	Front		Rear	
			 Fleetline	 GasSLX	 Fleetline	 GasSLX

CHEVROLET TRUCK (ALSO SEE GMC TRUCK)(Cont'd.)





W - Series (Isuzu)(Cont'd.)

83 - 95	W4 Models	9-51630-666-0 9-51630-666-2		OIO	85012	89413
				OIO	85012	89413
86 - 90	W4 Models	8-94454-986-0 8-94454-987-0 9-51630-647-1	-IO	83515
				83515
				83515
89 - 90	W4 Models Flatlow	9-51630-647-1	-IO	83515
89 - 92	W4 Models Flatlow	9-51630-666-0 9-51630-666-2		OIO	85012	89413
				OIO	85012	89413
86 - 95	W4 Models with 11000 lb Suspension	97083027	-IO	83515
87 - 95	W4 Models with 13000 lb Suspension	94454987 97083029	-IO	83515
				83515
88 - 97	W5 Models	1-51630-217-0 1-51630-217-1 1-51630-219-1	-IO	83114
				83114
				83114
86 - 91	W6 Models	1-51630-168-1 1-51630-217-0 1-51630-217-1	-IO	83515
				83114
				83114
	Models with O.E.M. Number	8-94057-593-0 8-97201-960-0 94033786 94051090 94057593 97201960	-IO	83114
				83515
				83114
				83114
				83114
				83515

Additional O.E.M. Interchanges

	Models with O.E.M. Number	15642943 22046489 22065218 22065251 22099889 507-24 508-86 508-88	OIO	- -	83136	...
				85303	89422	
				G63347
				85030	89440	
				- -	85336	...
				- -	85336	...
				- -	83136	...
				OIO	83153	...
	Additional O.E.M. Interchanges	22007703 22012067 22012082 22012083 22012114 22012131 22024673 22045526 22046481 22046485 22046499 22052014 22052424 3171696 3172948 3175509 3178157 3178233 3178507 3178995 3188626 3188729	OIO	83303				
			OIO	85700				
			OIO	85702				
			-IO	85711				
			OIO	85700				
			-IO	85711				
			-IO	85710				
			OIO	85702				
			OIO	85702				
			-IO	85710				
			-IO	85710				
			OIO	85702				
			-IO	85710				
			OIO	85307				
			OIO	85303 or 89422				
			OIO	85735				
			OIO	85700				
			OIO	85734				
			OIO	85700				
			OIO	85700				
			OIO	85300 or 89419				
OIO	85303 or 89422							

APPLICATION GUIDE - TRUCKS, TRAILERS, AND BUSES





Year	Model	OEM #	Front		Rear	
						
			Fleetline	GasSLX	Fleetline	GasSLX

CHEVROLET TRUCK (ALSO SEE GMC TRUCK)(Cont'd.)

Additional O.E.M. Interchanges(Cont'd.)

Additional O.E.M. Interchanges	4939852	010	85308 or 89422
	4939967	010	85308 or 89422
	4940601	010	83216
	4940627	010	83203 or 89436
	4940640	010	83216
	4940650	010	83207 or 89407
	4940654	010	83216
	4940660	010	83207 or 89407
	4963844	010	85307
	4964853	010	83217
	4974401	010	85700
	4975429	010	85300 or 89419
	4975479	-1-	83400
	4975480	-1-	83400
	4975516	010	85702
	4975518	010	85704
	4975538	010	85700
	4975549	010	83216
	4975550	010	85702
	507-3	010	85307
	5171068	010	83216
	5316784	010	85700
	5316791	010	83219
	5316792	010	85305
	5316793	010	85305
	5321920	010	85307
	5321929	010	85307
	5348631	010	83203 or 89436
	5352858	010	85305
	5353054	010	85303 or 89422
	5355798	010	85307
	5357955	010	85300 or 89419
	5357956	010	85734
	5357959	010	85300 or 89419
	5361994	010	85734
	5374779	010	85308 or 89422
	5374999	010	85307
	5385939	010	85307
	5392387	010	85303 or 89422
	5394448	010	85305
5394467	010	85305	
5394468	010	85735	
5455798	010	85307	
5513489	010	83216	
5513716	010	85304	
5516459	010	85305	
5522781	010	85735	
5522794	010	85308 or 89422	
5522818	010	85305	
5527001	010	85300 or 89419	
5527271	010	85700	
5527272	010	85700	
5527606	010	85305	
5531027	010	85301	
5531435	010	85307	

APPLICATION GUIDE - TRUCKS, TRAILERS, AND BUSES

Year	Model	OEM #	Front		Rear	
						
			Fleetline	GasSLX	Fleetline	GasSLX

CHEVROLET TRUCK (ALSO SEE GMC TRUCK)(Cont'd.)









Additional O.E.M. Interchanges(Cont'd.)

Additional O.E.M. Interchanges	5531436	010	85307
	5531437	010	85307
	5532026	010	85304
	5532425	010	83207 or 89407
	5532433	010	83207 or 89407
	5532675	010	85307
	5534430	010	85303 or 89422
	5534439	010	85304
	5534447	010	85303 or 89422
	5544112	010	83216
	5544581	010	85302 or 89420
	5544716	010	85304
	5544717	010	85304
	5544812	010	83308
	5544818	010	85735
	5549899	010	83207 or 89407
	5549924	010	85700
	5549925	010	85304
	5552111	010	85304
	5552112	010	85307
	5552114	010	83216
	5552205	010	83217
	5552206	010	83214
	5552207	010	83217
	5552208	010	83217
	5552209	010	83215
	5552210	010	85308 or 89422
	5552244	010	85308 or 89422
	5552285	010	83214
	5552286	010	83217
	5552287	010	83217
	5552288	010	83217
	5552453	010	85301
	5552527	010	85735
	5554184	010	85302 or 89420
	5554589	010	85307
	5554596	010	85303 or 89422
	5554814	010	85302 or 89420
	5554959	010	83401
	5554995	010	85305
5559363	010	83203 or 89436	
5585939	010	85307	
684280	010	83209 or 89414	
97-2210-00164	-1-	85708	
97-2210-00170	01-	85733	

CHEVROLET TRUCK CAB SHOCKS

	Bruin Tractors with J9 Cabs with Link Cabmate Model GMC92J9	1202-0012	010	83023
1990 -	Kodiak Truck Cabs with Link Cabmate Model GMC104TK	1202-0054	010	83021
- 1989	Kodiak Truck Cabs with Link Cabmate Model GMC92TK	1202-0012	010	83023
	Titan Cabover (Sleeper & Non-Sleeper Trucks) with Link Cabmate Model GMC-2P-A	1202-0032	010	83016

APPLICATION GUIDE - TRUCKS, TRAILERS, AND BUSES

Year	Model	OEM #	Front		Rear	
						
						
			Fleetline	GasSLX	Fleetline	GasSLX

CHRYSLER

Motorhome Chassis

73 - 81	M & R-300, 400, 500 Motorhome Chassis	3638112		OIO	G63183	...
63 - 72	M-300, M-375 & R-375 Motorhome Chassis	2961043		OIO	G63183	...
		3633744		OIO	G63183	...

CLARK EQUIPMENT

	Model 130885 (Air Suspension)	5532675		OIO	85307	...
	Ross Carrier	355778		85315	...	OIO	85315	...
		680042		85301	...	OIO	85301	...

CNH GLOBAL N V

	Models with O.E.M. Number	87019546	OIO				83022	
		87268250	OIO				83021	

COACH HOUSE RV

Class C MotorHomes





04 - 19	Platinum Series MotorHomes with Ford E450 Chassis	ASH-1136		-IO	83178	...
		ASH-1154	-IO	83177

COACHMEN RV

Class A MotorHomes

01 - 09	Aurora Series MotorHomes with Ford F53 Chassis with 16,000 lb GVW to 22,000 lb GVW	1C34-18045-AA	OIO	83209	89414	
		1C34-18045-JA	OIO	83209	89414	
		9U94-18045-AA	OIO	83209	89414	
		9U94-18080-AA		OIO	83122	89406
		9U9Z-18124-A	OIO	83209	89414	
		9U9Z-18125-A		OIO	83122	89406
		ASH-1022	OIO	83209	89414	
		ASH-1023		OIO	83122	89406
		ASH-1205	OIO	83209	89414	
		ASH-1206		OIO	83122	89406
		ASH-1228	OIO	83209	89414	
		ASH-1229	OIO	83209	89414	
		ASH-1230		OIO	83122	89406
		ASH-137		OIO	83122	89406
		ASH-25822	OIO	83209	89414	
		ASH-25823	OIO	83209	89414	
ASH-25824		OIO	83122	89406		
ASH-294	OIO	83209	89414			
AT-620	OIO	83209	89414			
AT-621		OIO	83122	89406		
AT-766	OIO	83209	89414			
03 - 05	Cross Country Elite & SE Series MotorHomes with Freightliner XC Chassis ADL200 Suspension w/ 20K Rear AS120 Front Suspension Rear Shock with O.E.M. Number ZF - IFS Front Suspension with 23,000 lb GVW or Greater	16-16873-000		OIO	85029	...
		141700131810	OIO	83160
		16-16737-000	OIO	83160
		16-16874-000	OIO	83160
		141700131809		OIO	85029	...
		16-16736-000		OIO	85029	...
2006	Cross Country Series MotorHomes with Freightliner XC Chassis ADL200 Suspension w/ 20K Rear	16-16873-000		OIO	85029	...
			

APPLICATION GUIDE - TRUCKS, TRAILERS, AND BUSES





Year	Model	OEM #	Front		Rear	
			 Fleetline	 GasSLX	 Fleetline	 GasSLX

COACHMEN RV(Cont'd.)

Class A MotorHomes(Cont'd.)

	AS120 Front Suspension Rear Shock with O.E.M. Number ZF - IFS Front Suspension with 23,000 lb GVW or Greater	141700131810	010	83160
		16-16737-000	010	83160
		16-16874-000	010	83160
		141700131809		010	85029	...
		16-16736-000		010	85029	...
		16-18103-000	-1-	85900
		481700000493	-1-	85900
11 - 15	Encounter Series MotorHomes with Ford F53 Chassis with 16,000 lb GVW to 22,000 lb GVW	ASH-1229	010	83209	89414	
		ASH-25822	010	83209	89414	
		ASH-25823	010	83209	89414	
		ASH-25824		010	83122	89406
99 - 19	Mirada Series MotorHomes with Ford F53 Chassis with 16,000 lb GVW to 22,000 lb GVW	1C34-18045-AA	010	83209	89414	
		1C34-18045-JA	010	83209	89414	
		9U94-18045-AA	010	83209	89414	
		9U94-18080-AA		010	83122	89406
		9U9Z-18124-A	010	83209	89414	
		9U9Z-18125-A		010	83122	89406
		ASH-1022	010	83209	89414	
		ASH-1023		010	83122	89406
		ASH-1205	010	83209	89414	
		ASH-1206		010	83122	89406
		ASH-1228	010	83209	89414	
		ASH-1229	010	83209	89414	
		ASH-1230		010	83122	89406
		ASH-137		010	83122	89406
		ASH-25822	010	83209	89414	
		ASH-25823	010	83209	89414	
		ASH-25824		010	83122	89406
		ASH-294	010	83209	89414	
		AT-620	010	83209	89414	
		AT-621		010	83122	89406
AT-766	010	83209	89414			
	Models with Workhorse UFO Chassis with Hendrickson Softek Front Suspension	66153-002	010	83124	89407	
		F4-BE5-C832-MO	010	83124	89407	
04 - 19	Pursuit Series MotorHomes with Ford F53 Chassis with 16,000 lb GVW to 22,000 lb GVW	1C34-18045-AA	010	83209	89414	
		1C34-18045-JA	010	83209	89414	
		9U94-18045-AA	010	83209	89414	
		9U94-18080-AA		010	83122	89406
		9U9Z-18124-A	010	83209	89414	
		9U9Z-18125-A		010	83122	89406
		ASH-1022	010	83209	89414	
		ASH-1023		010	83122	89406
		ASH-1205	010	83209	89414	
		ASH-1206		010	83122	89406
		ASH-1228	010	83209	89414	
		ASH-1229	010	83209	89414	
		ASH-1230		010	83122	89406
		ASH-137		010	83122	89406
		ASH-25822	010	83209	89414	
		ASH-25823	010	83209	89414	
		ASH-25824		010	83122	89406
ASH-294	010	83209	89414			

APPLICATION GUIDE - TRUCKS, TRAILERS, AND BUSES

Year	Model	OEM #	Front		Rear	
			 Fleetline	 GasSLX	 Fleetline	 GasSLX

COACHMEN RV(Cont'd.)

Class A MotorHomes(Cont'd.)

04 - 19	Pursuit Series MotorHomes with Ford F53 Chassis with 16,000 lb GVW to 22,000 lb GVW	AT-620	OIO	83209	89414	
		AT-621		OIO	83122	89406
		AT-766	OIO	83209	89414	

Class C MotorHomes

	Catalina Series MotorHomes with Ford E350 & E450 Chassis	ASH-1136		-IO	83178	...
		ASH-1154	-IO	83177
04 - 19	Concord Series MotorHomes with Ford E350 & E450 Chassis	ASH-1136		-IO	83178	...
		ASH-1154	-IO	83177
08 - 09	Freedom Express Series MotorHomes with Ford E350 & E450 Chassis	ASH-1136		-IO	83178	...
		ASH-1154	-IO	83177
03 - 19	Freelander Series MotorHomes with Ford E350 & E450 Chassis	ASH-1136		-IO	83178	...
		ASH-1154	-IO	83177
03 - 19	Leprechaun Series MotorHomes with Ford E350 & E450 Chassis	ASH-1136		-IO	83178	...
		ASH-1154	-IO	83177
00 - 03	Pathfinder Sport Series MotorHomes with Ford E350 & E450 Chassis	ASH-1136		-IO	83178	...
		ASH-1154	-IO	83177
99 - 06	Santara Series MotorHomes with Ford E350 & E450 Chassis	ASH-1136		-IO	83178	...
		ASH-1154	-IO	83177

COLLINS BUS CORP

- 2019	Type A School Bus models with Ford E350 & E450 Chassis	ASH-1136		-IO	83178	...
		ASH-1154	-IO	83177

CONTINENTAL TRAILWAYS-EAGLE INT'L

	Buses with O.E.M. Number	01-0100-020		85307	...	OIO	85307	...
		5532026		85304	...	OIO	85304	...
		6-05-5		85307	...	OIO	85307	...
	Silver Eagle	01-0100-905		85303	...	OIO	85303	89422
		5394467		85305	...	OIO	85305	...
		680091		85303	...	OIO	85303	89422
		70039		85303	...	OIO	85303	89422
		70041		85305	...	OIO	85305	...





COUNTRY COACH

	Models with O.E.M. Number	89406	OIO	...	89406	
		89414		OIO	...	89414

CRANE CARRIER

	Models with Hendrickson HMX 400 Haulmax (with 16.5" Saddle)	60680-004		OIO	83143	...
		60680-004L		OIO	83143	...
		64178-001		OIO	83143	...
	Models with Ridewell RDS-209 Tandem Air Drive Suspension	1310002		OIO	665937	...
	Models with Ridewell Truck Air-Ride Suspension with O.E.M. Number	1265157B000		OIO	85712	...
	Models with O.E.M. Number	227A-14	OIO	85716
		277A-1	OIO	85307
		277A-13	OIO	85302	89420	
		277A-14	OIO	85304
		277A-8	OIO	85303	89422	
		277A-9	OIO	85307
		680091	OIO	85303	89422	

APPLICATION GUIDE - TRUCKS, TRAILERS, AND BUSES

Year	Model	OEM #	Front		Rear	
						
			Fleetline	GasSLX	Fleetline	GasSLX

CRANE CARRIER(Cont'd.)

Additional O.E.M. Interchanges	277A-12	OIO	85304
	680088	OIO	85713

CROWN COACH

All with Steel Spring Suspension	3188729	OIO	85303	89422
	5532026		85304	...	OIO	85304
Models with O.E.M. Number	5532036		85734	...	OIO	85734

CUNHA PRODUCTS OHD

Truck Dollies	CP-5222	OIO	85315	...
---------------	---------	-----	-----	-----	-------	-----

CUSH CORPORATION

Models with O.E.M. Number	C0227	OIO	85014	...
	C0228		OIO	85005

Trailer Suspensions - Low Mount

25k UnderMount Econo 6/9	C0078	OIO	85000	89436
CompacTrac 4.5/7 RH	C0078	OIO	85000	89436
CP Competitor Series (U-Bolted) 25K & 3K	C0226	OIO	85064	...
DiscMATE LowMount 25K Disc Brake	C0062-D	OIO	85000	89436
Performance Yoke-8in 25K Undermount	C0062-D	OIO	85000	89436
RideBest 25KHD 6	C0062-D	OIO	85000	89436
RideBest 25KHD 8	C0062-D	OIO	85000	89436
RideBest Yoke 25KHD 9	C0062-D	OIO	85000	89436
RoughNeck Series, Cush Integrated, LowMount 30k	C0226	OIO	85064	...
RoughNeck, Cush Integrated, LowMount 25K	C0062-D	OIO	85000	89436

Trailer Suspensions - Top Mount









CLT-25 CushLITE BigFOOT (245 Style)	C0078	OIO	85000	89436
CLX25-317 CushLITE BigFOOT (317 style)	C0078	OIO	85000	89436
CP Performance Top Mount	C0226	OIO	85064	...
CT250TB Top Mount High Travel (U-Bolted)	C0226	OIO	85064	...
DiscMATE 25K Roughneck Topmount	C0226	OIO	85064	...
RideBest 25K TopMount	C0226	OIO	85064	...
RideBest 25KHD TopMount 14-19	C0226	OIO	85064	...
RoughNeck Series, Cush Integrated, TopMount 25K	C04045	OIO	85045	...
RoughNeck Series, Cush Integrated, TopMount 30K	C0226	OIO	85064	...

DAMON MOTOR COACH

Class A MotorHomes

01 - 15	Challenger Series MotorHomes with Ford F53 Chassis with 16,000 lb GVW to 22,000 lb GVW	ASH-1229	OIO	83209	89414
		ASH-25822	OIO	83209	89414
		ASH-25823	OIO	83209	89414
		ASH-25824		OIO	83122
99 - 13	Daybreak Series MotorHomes with Ford F53 Chassis with 16,000 lb GVW to 22,000 lb GVW	ASH-1229	OIO	83209	89414
		ASH-25822	OIO	83209	89414
		ASH-25823	OIO	83209	89414
		ASH-25824		OIO	83122
99 - 06	Intruder Series MotorHomes with Ford F53 Chassis with 16,000 lb GVW to 22,000 lb GVW	ASH-1229	OIO	83209	89414
		ASH-25822	OIO	83209	89414
		ASH-25823	OIO	83209	89414
		ASH-25824		OIO	83122
05 - 14	Models with Workhorse W20 , W22, & W24 MotorHome Chassis with O.E.M. Number	24-153256		- -	85124
		F4-BE5-F325-HO		- -	85124
		W0005663		- -	85124

APPLICATION GUIDE - TRUCKS, TRAILERS, AND BUSES

Year	Model	OEM #	Front		Rear	
						
						
			Fleetline	GasSLX	Fleetline	GasSLX

DAMON MOTOR COACH(Cont'd.)

Class A MotorHomes(Cont'd.)

98 - 04	Models with Workhorse W20 , W22, & W24 MotorHome Chassis with O.E.M. Number	24-186537		0 -	85126	...
		F4-BE5-A011-HO		0 -	85126	...
98 - 14	Models with Workhorse W20 , W22, & W24 MotorHome Chassis with O.E.M. Number	24-153249	0 0	85125
		24-186629	0 0	85125
		F4-BE5-A832-MO	0 0	85125
		F4-BE5-B492-HO	0 0	85125
		F4-BE5-F324-HO	0 0	85125
		W0005662	0 0	85125
		W0006254	0 0	85125
07 - 14	Outlaw Series MotorHomes with Ford F53 Chassis with 16,000 lb GVW to 22,000 lb GVW	ASH-1229	0 0	83209	89414	
		ASH-25822	0 0	83209	89414	
		ASH-25823	0 0	83209	89414	
		ASH-25824		0 0	83122	89406

DANA

	Dana Smart Ride - RF and RS Models - 20,000 lb and 23,000 lb	SR1VJ100		0 0	85078	...
--	--	----------	--	-----	-----	-----	-------	-----

DEXTER AXLE

Trailer

	86 AR / RS 1015, 1035, 3015, 3035 Slider Air Suspension	18165-01		0 0	85006	...
--	---	----------	--	-----	-----	-----	-------	-----

DIAMOND COACH

- 2019	All Shuttle buses with Ford E350 and E450 Chassis	ASH-1136		- 0	83178	...
		ASH-1154	- 0	83177

DIAMOND T

	Models with O.E.M. Number	5549925	0 0	85304
--	---------------------------	---------	-----	-------	-----	--	-----	-----

DIAMOND-REO

	All w/Velvet Ride Suspension	0 0	85307	...
	C054, C088 w/FH or FL Axle	0 0	85307
	C054, C088, C114, C116 w/FF Axle	220-55-1	0 0	83214
		220-55-6	0 0	83214
	C090, C090D, C101	220-55-2	0 0	85304
		220-55-7	0 0	85304
	C114, C116 w/FH or FL Axle	220-55-2	0 0	85304
		220-55-7	0 0	85304
	CF Models	220-55-8	0 0	83217
	DC101	220-55-2	0 0	85304
		220-55-7	0 0	85304
	Additional O.E.M. Interchanges	220-S5-10		0 0	85712	...

DINA BUS

	F Models Coaches with O.E.M. Number (Drive Axle)	39390339-6		0 0	85307	...
	Marco Polo Viaggio GV 1000 Front Shock Tag Axle	39380353-6	0 0	85716
		39390340-4		0 0	85716	...
11 - 13	Outsider Buses	1520030010		- 0	83317	...
		152E030030	0 0	85014
	P Chassis with O.E.M. Number (Drive Axle)	39390339-6		0 0	85307	...
11 - 13	Picker Buses	1520030010		- 0	83317	...
		152E030030	0 0	85014

APPLICATION GUIDE - TRUCKS, TRAILERS, AND BUSES

Year	Model	OEM #	Front			Rear		
			○ ○	○ ○	- ○	○ ○	○ ○	
			Fleetline	GasSLX		Fleetline	GasSLX	

DINA BUS(Cont'd.)

11 - 13	Runner 10E Buses	1520030010		- ○	83317	...
		152E030030	○ ○	85014
11 - 13	Runner 8, 9 & 10 Buses	1520030010		- ○	83317	...
		152E030030	○ ○	85014

DODGE TRUCK

D Series- Conventional Cab 4 x 2

74 - 78	D-500, D-600, D-700, D-800	3633643		○ ○	G63183	...
1973	D-500, D-600, D-800	2516009		○ ○	G63183	...

LN & LNT - Conventional Cab

64 - 72	LN, LV Models	2516009		○ ○	G63183	...
---------	---------------	---------	--	-----	-----	-----	--------	-----

LNT, LVT, NLT, VLT- Tilt Cab 6 x 4

64 - 73	LNT, LVT Models	2516009		○ ○	G63183	...
---------	-----------------	---------	--	-----	-----	-----	--------	-----

LS & LT-Steel Tilt Cab

73 - 75	LS-1000, LT-1000	2516009		○ ○	G63183	...
---------	------------------	---------	--	-----	-----	-----	--------	-----

Motorhome Chassis

73 - 81	M & R-300, 400, 500 Motorhome Chassis	3638112		○ ○	G63183	...
		3638631	○ ○	G63605
63 - 72	M-300, M-375 & R-375 Motorhome Chassis	2961043		○ ○	G63183	...
		3633744		○ ○	G63183	...
77 - 81	M-6 Motorhome Chassis	3638112		○ ○	G63183	...
		4036892	○ ○	G63605

P Series - Forward Control

72 - 82	P-300	○ ○	G63183	...
63 - 78	P-400	○ ○	G63183	...
63 - 71	PC-500 and PC-600, PD-500 and PD-600	○ ○	G63183	...

School Buses

61 - 71	S-400, S-500, S-600	○ ○	G63183	...
72 - 73	S-500, S-600	2516009		○ ○	G63183	...
74 - 78	S-600, S-700	3633643		○ ○	G63183	...

W-Series And Power Wagons

61 - 72	W-500, WT-500 Models	○ ○	G63183	...
1973	W-600 Models	2516009		○ ○	G63183	...
		2960707	○ ○	G63183
74 - 78	W-600 Models	3633643		○ ○	G63183	...

DUPLEX TRUCK

	Models with O.E.M. Number	59024		83204	...	○ ○	83204	...
		7604-3371		83204	...	○ ○	83204	...

DURA SUSPENSION

	Models with O.E.M. Number	1080099		○ ○	83203	89436
		12866		○ ○	83207	89407
		59024		○ ○	83204	...
		59030		○ ○	83203	89436
		665133		○ ○	83203	89436
		665267		○ ○	85029	...
		7604-3371		○ ○	83204	...
		A-2212		○ ○	85029	...

DUTCHMEN RV

Class C MotorHomes

92 - 09	All Type C Motorhomes with Ford E350 & E450 Chassis	8C24-18045-DA	- ○	83177
		8C2Z-18124-D	- ○	83177
		ASH-1154	- ○	83177

APPLICATION GUIDE - TRUCKS, TRAILERS, AND BUSES

Year	Model	OEM #	Front		Rear	
			Fleetline	GasSLX	Fleetline	GasSLX

Class C MotorHomes(Cont'd.)

92 - 09	All Type C Motorhomes with Ford E350 & E450 Chassis	AT-163G 8C24-18080-DB 8C2Z-18125-D ASH-1136 AT-164G	-IO	83177
			-IO	83178	...	
			-IO	83178	...	
			-IO	83178	...	
			-IO	83178	...	

DYNAMAX CORP (COUNTRY COACH)

Class C MotorHomes

- 2019	All Models with Freightliner FAS II Rear Air Suspension	16-18708-000 471700002809		OIO	85724	89443
			OIO	85724	89443	
14 - 19	DX3 Series Motorhomes with M2-106 Chassis	10-13760-000 471700002991 SDA471700002991	OIO	85959	89503	
			OIO	85959	89503	
			OIO	85959	89503	
06 - 08	Dyna Quest XL Series Motorhomes with M2-112 Chassis	10-13634-000 471700000449	OIO	85918	89449	
			OIO	85918	89449	
09 - 19	Dyna Quest XL Series Motorhomes with M2-112 Chassis	10-13809-000 471700003920	OIO	85958
			OIO	85958
15 - 19	Force Series Motorhomes with M2-106 Chassis	10-13760-000 471700002991 SDA471700002991	OIO	85959	89503	
			OIO	85959	89503	
			OIO	85959	89503	
99 - 19	Isata 4 Series Motorhomes with Ford E350 & E450 Chassis	8C24-18045-DA 8C2Z-18124-D ASH-1154 AT-163G 8C24-18080-DB 8C2Z-18125-D ASH-1136 AT-164G	-IO	83177
			-IO	83177
			-IO	83177
			-IO	83177
			-IO	83178	...	
			-IO	83178	...	
			-IO	83178	...	





EAGLE MOTOR COACH

	Buses with Rubber Torsion Suspension	6-05-5		OIO	85307	...
	Buses with Steel Spring Suspension	5532026		85304	...	OIO	85304	...
	Models with O.E.M. Number	01-0100-020 01-0100-905 014-0100-905 101364 154-0100-514 5394467 680091 70039 70041	OIO	85307	...	OIO	85307	...
			OIO	85308	89422		85303	89422
			OIO	85305	...	OIO	85305	...
			OIO	85314	89425	
			OIO	85305	...	OIO	85305	...
			OIO	85303	...	OIO	85303	89422
			OIO	85303	...	OIO	85303	89422
			OIO	85305	...	OIO	85305	...
			OIO	85305	...	OIO	85305	...
	Additional O.E.M. Interchanges	0140100-905 12B-5-1 12J-5-10 690060	OIO	85308 or 89422				
			OIO	85735				
			OIO	85733				
			OIO	85713				

EAST MANUFACTURING CORP.

Identification of the trailer suspension is necessary to determine what section of the catalog to refer to. Some possible options can be Chalmers, Hendrickson, Neway, Ridewell, Reyco.								
	Shocks with stamping number	A-20002 A-20126	OIO	85000	89436	
			OIO	85323	89436	
	Trailers with East Trailer part number	517-05001-18 517-05001-23 517-05006-20 517-05009-14	OIO	87015	...	
			OIO	85005	89430	
			OIO	85030	89440	
			OIO	83125	...	

APPLICATION GUIDE - TRUCKS, TRAILERS, AND BUSES

Year	Model	OEM #	Front		Rear	
						
			Wrench	Wrench	Wrench	Wrench
			Fleetline	GasSLX	Fleetline	GasSLX

EAST MANUFACTURING CORP.(Cont'd.)

	Trailers with East Trailer part number	517-05010-07		010	83214	...
		517-05022-07		010	83217	...
		517-05110-20		010	85000	89436
		517-05511-14		010	83128	...
		517-05805-20		010	85000	89436
		517-05806-20		010	85029	...
		517-05808-20		010	85738	...
		517-05809-20		010	...	89437
		517-05916-14		010	83124	89407

ELDORADO NATIONAL

02 - 13	40 Foot Low Floor Buses with O.E.M	13208701		-1-	85746	...
		13208801	-1-	85745
- 2019	Advantage Series Shuttle buses with Ford E350 & E450 Chassis	ASH-1136		-10	83178	...
		ASH-1154	-10	83177
- 2019	Aerolite Series Shuttle buses with Ford E350 Chassis	ASH-1136		-10	83178	...
		ASH-1154	-10	83177
- 2019	Aerotech Series Shuttle buses with Ford E350 & E450 Chassis	ASH-1136		-10	83178	...
		ASH-1154	-10	83177

ELKHART COACH

- 2019	Coaches with Ford E350 and E450 Chassis	ASH-1136		-10	83178	...
		ASH-1154	-10	83177

ENTEGRA COACH

Class A MotorHomes

2019	Emblem Series MotorHomes with Ford F53 Chassis with 16,000 lb GVW to 22,000 lb GVW	ASH-1229	010	83209	89414	
		ASH-25822	010	83209	89414	
		ASH-25823	010	83209	89414	
		ASH-25824		010	83122	89406
2019	Vision Series MotorHomes with Ford F53 Chassis with 16,000 lb GVW to 22,000 lb GVW	ASH-1229	010	83209	89414	
		ASH-25822	010	83209	89414	
		ASH-25823	010	83209	89414	
		ASH-25824		010	83122	89406





Class C MotorHomes

17 - 19	Esteem Series MotorHomes with Ford E350 & E450 Chassis	ASH-1136		-10	83178	...
		ASH-1154	-10	83177
17 - 19	Odyssey Series MotorHomes with Ford E350 & E450 Chassis	ASH-1136		-10	83178	...
		ASH-1154	-10	83177

FEDERAL COACH

- 2019	Shuttle buses with Freightliner M2-106 Chassis	16-18708-000		010	85724	89443
		471700002809		010	85724	89443
02 - 08	Shuttle buses with Freightliner M2-106 Chassis	10-12388-000	010	85920	89503	
		10-12390-000	010	85920	89503	
09 - 19	Shuttle buses with Freightliner M2-106 Chassis	10-13760-000	010	85959	89503	
		471700002991	010	85959	89503	
		SDA471700002991	010	85959	89503	
- 2019	Spirit Series Shuttle buses with Ford E450 Chassis	ASH-1136		-10	83178	...
		ASH-1154	-10	83177

APPLICATION GUIDE - TRUCKS, TRAILERS, AND BUSES

Year	Model	OEM #	Front		Rear	
						
			Fleetline	GasSLX	Fleetline	GasSLX

FLEETWOOD RV

Class A MotorHomes

2018	Axon Series MotorHomes with Ford F53 Chassis with 16,000 lb GVW to 22,000 lb GVW	ASH-1229	010	83209	89414			
		ASH-25822	010	83209	89414			
		ASH-25823	010	83209	89414			
		ASH-25824		010	83122	89406		
02 - 06	Boulder / Discovery & Expedition MotorHomes with Freightliner XC Chassis ADL200 Suspension w/ 20K Rear AS120 Front Suspension Rear Shock with O.E.M. Number ZF - IFS Front Suspension with 23,000 lb GVW or Greater	16-16873-000		010	85029	...		
		141700131810	010	83160		
		16-16737-000	010	83160		
		16-16874-000	010	83160		
		141700131809		010	85029	...		
		16-16736-000		010	85029	...		
		16-18103-000	-1-	85900		
		481700000493	-1-	85900		
		01 - 19	Boulder Series MotorHomes with Ford F53 Chassis with 16,000 lb GVW to 22,000 lb GVW	1C34-18045-AA	010	83209	89414	
				1C34-18045-JA	010	83209	89414	
9U94-18045-AA	010			83209	89414			
9U94-18080-AA				010	83122	89406		
9U9Z-18124-A	010			83209	89414			
9U9Z-18125-A				010	83122	89406		
ASH-1022	010			83209	89414			
ASH-1023				010	83122	89406		
ASH-1205	010			83209	89414			
ASH-1206				010	83122	89406		
ASH-1228	010			83209	89414			
ASH-1229	010			83209	89414			
ASH-1230				010	83122	89406		
ASH-137				010	83122	89406		
ASH-25822	010			83209	89414			
ASH-25823	010			83209	89414			
ASH-25824				010	83122	89406		
ASH-294	010			83209	89414			
AT-620	010			83209	89414			
AT-621				010	83122	89406		
AT-766	010	83209	89414					
03 - 06	Excursion & Providence MotorHomes with Freightliner XC Chassis ADL200 Suspension w/ 20K Rear AS120 Front Suspension Rear Shock with O.E.M. Number ZF - IFS Front Suspension with 23,000 lb GVW or Greater	16-16873-000		010	85029	...		
		141700131810	010	83160		
		16-16737-000	010	83160		
		16-16874-000	010	83160		
		141700131809		010	85029	...		
		16-16736-000		010	85029	...		
		16-18103-000	-1-	85900		
		481700000493	-1-	85900		
06 - 19	Flair Series MotorHomes with Ford F53 Chassis with 16,000 lb GVW to 22,000 lb GVW	ASH-1229	010	83209	89414			
		ASH-25822	010	83209	89414			
		ASH-25823	010	83209	89414			
		ASH-25824		010	83122	89406		
05 - 14	Models with Workhorse W20 , W22, & W24 MotorHome Chassis with O.E.M. Number	24-153256		-1-	85124	...		
		F4-BE5-F325-HO		-1-	85124	...		
		W0005663		-1-	85124	...		

APPLICATION GUIDE - TRUCKS, TRAILERS, AND BUSES

Year	Model	OEM #	Front		Rear	
			Fleetline	GasSLX	Fleetline	GasSLX

FLEETWOOD RV(Cont'd.)

Class A MotorHomes(Cont'd.)

98 - 04	Models with Workhorse W20 , W22, & W24 MotorHome Chassis with O.E.M. Number	24-186537		01-	85126	...
		F4-BE5-A011-HO		01-	85126	...
98 - 14	Models with Workhorse W20 , W22, & W24 MotorHome Chassis with O.E.M. Number	24-153249	010	85125
		24-186629	010	85125
		F4-BE5-A832-MO	010	85125
		F4-BE5-B492-HO	010	85125
		F4-BE5-F324-HO	010	85125
		W0005662	010	85125
		W0006254	010	85125
99 - 19	SouthWind Series MotorHomes with Ford F53 Chassis with 16,000 lb GVW to 22,000 lb GVW	1C34-18045-AA	010	83209	89414	
		1C34-18045-JA	010	83209	89414	
		9U94-18045-AA	010	83209	89414	
		9U94-18080-AA		010	83122	89406
		9U9Z-18124-A	010	83209	89414	
		9U9Z-18125-A		010	83122	89406
		ASH-1022	010	83209	89414	
		ASH-1023		010	83122	89406
		ASH-1205	010	83209	89414	
		ASH-1206		010	83122	89406
		ASH-1228	010	83209	89414	
		ASH-1229	010	83209	89414	
		ASH-1230		010	83122	89406
		ASH-137		010	83122	89406
		ASH-25822	010	83209	89414	
		ASH-25823	010	83209	89414	
		ASH-25824		010	83122	89406
		ASH-294	010	83209	89414	
		AT-620	010	83209	89414	
		AT-621		010	83122	89406
AT-766	010	83209	89414			
05 - 18	Storm Series MotorHomes with Ford F53 Chassis with 16,000 lb GVW to 22,000 lb GVW	ASH-1229	010	83209	89414	
		ASH-25822	010	83209	89414	
		ASH-25823	010	83209	89414	
		ASH-25824		010	83122	89406

Class C MotorHomes

99 - 19	Jamboree Series MotorHomes with Ford E350 & E450 Chassis	ASH-1136		-10	83178	...
		ASH-1154	-10	83177
2018	Surge Series MotorHomes with Ford E350 & E450 Chassis	ASH-1136		-10	83178	...
		ASH-1154	-10	83177
99 - 16	Tioga Series MotorHomes with Ford E350 & E450 Chassis	ASH-1136		-10	83178	...
		ASH-1154	-10	83177

FLUIDRIVE

Models T950-1200, -1400, -1700	2697		010	85712	...
--------------------------------	------	--	-----	-----	-----	-------	-----

FLXIBLE BUS

29 Passenger & Vista Coach		83217	...	010	83217	...
2-Level Intercity Bus		85736	...	010	85736	...
City Bus - 51 Passenger	6-05-1	010	85736
	6-05-2	010	85736
	6-05-3	010	85736
	6-05-4	010	85736





APPLICATION GUIDE - TRUCKS, TRAILERS, AND BUSES

Year	Model	OEM #	Front		Rear	
			Fleetline	GasSLX	Fleetline	GasSLX

FLXIBLE BUS(Cont'd.)

	City Bus - 51 Passenger	6-05-5	010	85307
		6-05-6	010	85736
		6-05-7	010	85736
		6-05-8	010	85736
	City Bus - 51 Passenger with Rubber Torsion Suspension	6-05-1		85736	...	010	85736	...
		6-05-2		010	85736	...
		6-05-3		010	85736	...
		6-05-4		010	85736	...
		6-05-5		010	85307	...
		6-05-6		010	85736	...
		6-05-7		010	85736	...
		6-05-8		010	85736	...
	CNG Bus (Natural Gas)	87-2519-00002	-10	85731
		87-2519-00004	-10	85731
		87-2520-00002		010
		87-2520-00004		010
		97-2201-00008	-10	85731
		97-2210-00010		010
	Model 870 Flex Bus, Metro	22024506	-10	85703
		22025066	-10	85703
		4975518		010	85704	...
		680320	-10	85703
		74412		010	85704	...
		87-2519-00001	-10	85703
		87-2519-00003	-10	85703
		87-2520-00001		010	85704	...
		87-2520-00003		010	85704	...
		97-2201-00003	-10	85703
		97-2201-00005	-10	85703
		97-2201-00006	-10	85703
		97-2201-00007	-10	85703
		97-2201-00009	-10	85703
		97-2210-00001		010	85704	...
		97-2210-00002		010	85704	...
		97-2210-00003		010	85704	...
		97-2210-00004		010	85704	...
		97-2210-00005		010	85704	...
		97-2210-00006		010	85704	...
97-2210-00009		010	85704	...		
97-2210-00011		010	85704	...		
	Models with O.E.M. Number	22012067		85700	...	010	85700	...
		22012114		85700	...	010	85700	...
		22024061		010	85704	...
		22025067		010	85704	...
		22025305		010	85704	...
		3166657		85700	...	010	85700	...
		3192333		85700	...	010	85700	...
		6-05-13		010	85304	...
		6-05-9	010	85304
		6-367-12		85700	...	010	85700	...
		6-367-14		85700	...	010	85700	...
		6-367-16		85700	...	010	85700	...
		6-367-8		85700	...	010	85700	...
		695125		010	85704	...
		97-2201-00001	-10	85703

APPLICATION GUIDE - TRUCKS, TRAILERS, AND BUSES

Year	Model	OEM #	Front		Rear	
			 	 		
			Fleetline	GasSLX	Fleetline	GasSLX

FLXIBLE BUS(Cont'd.)

	Models with O.E.M. Number	97-2201-0002	-10	85703
		97-2201-0004	-10	85703
		97-2201-00151		85700	...	010	85700	...
		97-2210-00170		85733	...	01-	85733	...
		97-9999-02592	-10	85710
	Additional O.E.M. Interchanges	015813	-1-				85708	
		06-0367-00151	010				85700	
		06-0367-00156	010				85702	
		48-1-239	010				85736	
		48-1-241	010				85712	
		6-05-10	010				85734	
		6-367-1	-10				85711	
		6-367-11	-10				85711	
		6-367-17	010				85700	
		6-367-2	010				85736	
		6-367-3	010				85304	
		6-367-4	010				83217	
		6-367-6	-10				85711	
		6-367-7	010				85305	
		6-367-9	-10				85711	
		680029	010				85301	
		680155	010				85712	
		97-2210-00156	010				85702	
		97-2210-00157	-1-				85708	
		97-2210-00160	-1-				85705 or 89447	
		97-2210-00164	-1-				85708	
		97-9999-00732	-1-				85707	
		97-9999-00807	010				85307	
		97-9999-02514	010				85700	
		97-9999-02515	010				85702	
		97-9999-02519	-1-				85707	
		97-9999-02595	010				85313	
97-9999-02632	-10				85711			
97-9999-02633	-10				85311 or 89424			
97-9999-02634	01-				85733			
97-9999-02635	010				85732			
97-9999-02636	010				85716			

FLYER INDUSTRIES





	Coaches with Low Floor	15813		-1-	85708	...
1991 -	Coaches with Low Floor	009863	-1-	85722
	Additional O.E.M. Interchanges	015915	-10				85711	
		22012067	010				85700	
		22012114	010				85700	
		3166657	010				85700	
		3192333	010				85700	
		4975501	010				85700	
		4975552	-10				85711	
		592-6568	010				85700	
5979574	010				85700			

FORD

AeroMax (A, AT, AAT, 8500, 9500) Series

1996	8000 Models with 12000 or 13000 lb Axles	F6HT-18045-LA	010	85376
1996	8000 Models with 16000 lb. Multileaf Spring	F6HT-18045-AA	010	85054	89438	

APPLICATION GUIDE - TRUCKS, TRAILERS, AND BUSES

Year	Model	OEM #	Front		Rear	
						
			Fleetline	GasSLX	Fleetline	GasSLX

FORD(Cont'd.)

AeroMax (A, AT, AAT, 8500, 9500) Series(Cont'd.)

96 - 97	9500 (113" & 122" BBC) Models with 10000 lb Axle and 54" Multileaf Spring	F6HT-18045-KA	010	83200	89402	
1996 -	9500 (113" & 122" BBC) Models with 12000 or 13200 lb Axle and 54" Multileaf Spring	F6HT-18045-BC	010	85047	89435	
96 - 97	9500 (113" & 122" BBC) Models with 8500 or 9000 lb Axle and 54" Taperleaf Spring	F6HT-18045-HC	010	85054	89438	
1996 -	All Models with 10000 lb or 12000 lb Axle and 54" Taperleaf Spring	F6HT-18045-AC	010	85054	89438	
		F6HZ-18124-A	010	85054	89438	
		F6HZ-18124-G	010	85054	89438	
1996 -	All with 12000 lb, 13000 lb or 14600 lb Axle and 60" Taperleaf Spring	F6HT-18045-EB	010	85055	89439	
		F6HT-18045-EC	010	85055	89439	
		F6HZ-18124-D	010	85055	89439	
		F6HZ-18124-E	010	85055	89439	
		F6HZ-18124-F	010	85055	89439	
1996 -	All with 13200 lb or 14600 lb Axle and 54" Taperleaf Spring	F6HT-18045-GB	010	85030	89440	
		F6HT-18045-GC	010	85030	89440	
1996 -	All with 21000 lb or 23000 lb Axle and 46" Taperleaf spring	F5HZ-18125-B		010	85001	89410
1996 -	All with 23000 lb Axle and 52" Taperleaf spring	F5HZ-18125-A		010	85314	89425
96 - 97	All with Hendrickson 40LH Model Tandem Axle	57241-2		01-	83109	...
		F6HT-18080-B		01-	83109	...
		F6HT-18080-DA		01-	83109	...
		F6HZ-18125-B		01-	83109	...
		47902-28		010	85013	89414
96 - 97	All with Hendrickson HAS-400, HA-210 or HA-230 Air Suspension	F6HZ-18080-FC		010	85013	89414
		F6HZ-18125-D		010	85013	89414
		90045068		-10	...	89441
96 - 97	All with Neway AD-123 Air Suspension	F6HZ-18125-C		-10	...	89441
		90045099		010	85906	89407
96 - 97	All with Neway AD-246 Air Suspension	90045132		010	85909	...

B - Series - Bus Cowl Chassis

61 - 79	B - 500, B - 600, B - 700, B - 750 Models	D2TF-18080-HA		010	83225	...
		D7HT-18080-BA		010	83225	...
70 - 79	B - 500, B - 600, B - 700, B - 750 Models	D2TF-18045-GA	010	83308
		D7HT-18045-GA	010	83308
61 - 69	B - 500, B - 600, B - 700, B - 750 with 4000, 4700 and 5000 lb Axle	-1-	83400
61 - 69	B - 500, B - 600, B - 700, B - 750 with 6000 & 7000 lb Axle	C2TA-18045-A	010	83216
77 - 96	B - 600, B - 700, B - 750, B - 800, B - 7000 with 18500 lb Axle	ASH-24446		010	83215	...
		AX-310		010	83215	...
		D7HT-18080-AA		010	83215	...
		D7HT-18080-DA		010	83215	...
		D7HT-18080-DA		010	83215	...
		E0HT-18080-AA		010	83215	...
80 - 96	B - 600, B - 700, B - 800, B - 7000 Models	E0HT-18045-AA	010	83309	89446	
		E0HT-18045-AB	010	83309	89446	
		F1HT-18045-AA	010	83309	89446	
94 - 97	B - 700, B - 800 with 14600 lb Multileaf Spring	F4HT-18045-EA	010	83125
94 - 97	B - 700, B - 800 with 15000, 17500, 19000 lb Taperleaf Springs	F4HT-18080-AA		010	85314	89425
		F4HT-18080-AB		010	85314	89425
94 - 97	B - 700, B - 800 with 21000 lb Taperleaf Springs	F4HT-18080-BA		010	85001	89410
94 - 97	B - 700, B - 800 with 52" Multileaf Spring	F4HT-18045-CB	010	83107

C & CT Series - Tilt Cab

71 - 73	C-500, C-550, C-600, C-650, C-700, C-750 with 6000 & 7000 lb Axle	D1TF-18045-LA	010	83312	89409	
---------	---	---------------	-----	-------	-------	--	-----	-----

APPLICATION GUIDE - TRUCKS, TRAILERS, AND BUSES

Year	Model	OEM #	Front		Rear	
			Fleetline	GasSLX	Fleetline	GasSLX

FORD(Cont'd.)

C & CT Series - Tilt Cab(Cont'd.)

64 - 67	C-550, C-600 with 6000 lb Axle - and Power Steering	C2TA-18045-A	010	83216
64 - 67	C-550, C-600 with 6000 lb Axle - Exc. with Power Steering	C6PF-18077-A	010	G63306
64 - 67	C-550, C-600, C-650, C-700, C-750 Models	C6PF-18077-F		010	83225	...
67 - 69	C-600, C-650, C-700, C-750, C-800, C-850, C-1000 with 7000, 9000, 11000, 12000, 15000 lb Axles - Exc. with 175" Wheel Base	D2HF-18045-CA	010	83308
67 - 71	C-600, C-650, C-700, C-750, C-800, C-850, C-1000 with 7000, 9000, 11000, 12000, 15000 lb Axles and 175" Wheel Base	C8HA-18045-A	010	83312	89409	
80 - 90	C-600, C-700, C-7000, C-800, C-8000, CT-800, CT-8000 with 3100 lb Spring and 7000 lb Axle	D7HT-18045-JA	010	83308
76 - 79	C-600, C-700, C-750, C-800, C-900, CT-800, CT-900 Models	D2EF-18045-AA	010	83312	89409	
		D7KF-18045-EA	010	83312	89409	
80 - 90	C-600, C-700, C-800, C-7000, CT-800, CT-8000 with 4040, 5040 lb Springs and 7000, 9000, 12000 lb Axles	D2EF-18045-AA	010	83312	89409	
64 - 66	C700/1100, CT-700/1100 with 7000, 9000, 11000, 15000 lb Axles	D2HF-18045-CA	010	83308
69 - 79	C-750, C-800, C-850, C-900, CT-750, CT-800, CT-850, CT-900, CT-950 with 9000 lb to 15000 lb Axles	C8HA-18045-A	010	83312	89409	
		D1TF-18045-LA	010	83312	89409	
		D2KF-18045-AA	010	83312	89409	

CF Series (Brazilian Built)

86 - 89	CF - 600, CF - 700 Models	E5HT-18045-AA	010	85301
		E5HT-18080-DA		010	85315	...
		E5HT-18080-EA		010	85315	...
96 - 97	CF-7000, CF-8000 or CFT-8000 Models with 16000 lb. Multileaf Spring	F6HT-18045-AA	010	85054	89438	
92 - 97	CF-7000, CF-8000 or CFT-8000 Models with 9000 lb Axle	F2HT-18045-BA	010	85376
		F2HT-18045-CA	010	85376
		F2HZ-18124-A	010	85376
		F6HT-18045-LA	010	85376
86 - 97	CF-7000, CF-8000 with 12000 lb or 13000 lb Axle	010	85302	89420
		87HU-18045-AA	010	85301
		E5HT-18045-AA	010	85301
		E6HZ-18124-A	010	85301
		E7HZ-18124-A	010	85301





CL & CLT Series - Highway Tractor Tilt Cab

78 - 89	CL-9000, CLT-9000 Models	D7HT-18045-NA	010	85301
90 - 91	CL-9000, CLT-9000 with Multileaf Spring	F1HT-18045-NA	010	85040
78 - 89	CL-9000, CLT-9000 with Rear Tandem Axle with Neway Suspension	D7HA-18080-AA		010	83123	89405
78 - 89	CL-9000, CLT-9000 with Single Rear Axle Suspension	D4HA-18080-AA		010	83209	89414
	Models with Hendrickson Rear Air Suspension	47902-13		010	83122	89406

E Series - E350, E450 Models

92 - 19	Type A School bus with Ford E350 & E450 Chassis	8C24-18045-DA	-10	83177
		8C2Z-18124-D	-10	83177
		ASH-1154	-10	83177
		AT-163G	-10	83177
		8C24-18080-DB		-10	83178	...
		8C2Z-18125-D		-10	83178	...
		ASH-1136		-10	83178	...
92 - 19	Type C Motorhomes with Ford E350 & E450 Chassis	8C24-18045-DA	-10	83177
		8C2Z-18124-D	-10	83177
		ASH-1154	-10	83177
		AT-163G	-10	83177
		8C24-18080-DB		-10	83178	...
		8C2Z-18125-D		-10	83178	...
		ASH-1136		-10	83178	...

APPLICATION GUIDE - TRUCKS, TRAILERS, AND BUSES

Year	Model	OEM #	Front		Rear	
						
			Fleetline	GasSLX	Fleetline	GasSLX

FORD(Cont'd.)





E Series - E350, E450 Models(Cont'd.)

92 - 19	Type C Motorhomes with Ford E350 & E450 Chassis	AT-164G		-IO	83178	...
---------	---	---------	--	-----	-----	-----	-------	-----

F Series - Conventional Cab

64 - 66	F-1000 Models with 11000 lb to 15000 lb Axles	C1TT-18045-D	OIO	G63406
64 - 79	F-500, F-600 (2 x 4), F-650, F-700, F-750	C7PF-18077-A		OIO	83225	...
		D2TF-18080-HA		OIO	83225	...
67 - 69	F-500, F-600, F-650, F-700, F-750 with 5500, 6000, 7000 & 9000 lb Axles	C8TA-18045-AA	-IO	G63386
70 - 79	F-500, F-600, F-650, F-700, F-750 with 5500, 6000, 7000 & 9000 lb Axles	D2HT-18045-GA	OIO	83308
70 - 79	F-500, F-600, F-650, F-700, F-750, F-800 with 5500, 6000, 7000 & 9000 lb Axles	D2TF-18045-GA	OIO	83308
64 - 69	F-500, F-600, F-700, F-750 with 6000 & 7000 Axle	C2TA-18045-A	OIO	83216
86 - 90	F-600	E6HT-18080-AA		OIO	83215	...
		E6HZ-18125-D		OIO	83215	...
80 - 94	F-600, F-6000, F-700, F-7000, F-800, F-8000, FT-700, FT-800, FT-8000 - Exc. 9000 lb Axle with H.D. Suspension & 12000 lb Axle	E0HT-18045-AA	OIO	83309	89446	
		E0HT-18045-AB	OIO	83309	89446	
83 - 89	F-600, F-6000, F-700, F-7000, F-800, F-8000, FT-700, FT-800, FT-8000 with 9000 lb Axle with H.D. Suspension & 12000 lb Axle	D2HF-18045-AA	OIO	83314
		D7HT-18045-CA	OIO	83314
64 - 90	F-600, F-650, F-700, F-750, F-800 with 13000 & 15000 lb Rear Axle	D7HT-18080-BA		OIO	83225	...
86 - 90	F-600, F-700, F-800	ASH-24446		OIO	83215	...
		AX-310		OIO	83215	...
80 - 90	F-600, F-700, F-800 with 17000 & 18000 lb Rear Axle	D7HF-18080-AA		OIO	83215	...
		D7HT-18080-DA		OIO	83215	...
1990	F-600, F-700, F-800, FT-800, FT-900, with Multileaf Spring	F1HT-18045-AA	OIO	83309	89446	
89 - 94	F-600, F-700, LPO (Low Profile Vehicle)	E9HS-18045-AA	OIO	83309	89446	
		E9HS-18080-AA		OIO	85716	...
70 - 72	F-700 (Diesel), F-750 with 9000 lb Axle	D2HF-18045-CA	OIO	83308
73 - 79	F-700 (Diesel), F-750, F-800 with 9000 lb Axle	D2EF-18045-AA	OIO	83312	89409	
		D2TF-18045-AA	OIO	83312	89409	
		D7HT-18045-BA	OIO	83312	89409	
86 - 97	F-700, F-800	ASH-24446		OIO	83215	...
		AX-310		OIO	83215	...
		E6HT-18080-AA		OIO	83215	...
		E6HZ-18125-D		OIO	83215	...
94 - 98	F-700, F-800 with 15000, 17500, 19000 lb Taperleaf Springs	F4HT-18080-AA		OIO	85314	89425
		F4HT-18080-AB		OIO	85314	89425
		F5HZ-18125-A		OIO	85314	89425
94 - 97	F-700, F-800 with 21000 lb Taperleaf Springs	F4HT-18080-BA		OIO	85001	89410
94 - 97	F-700, F-800 with 52" or 54" Taperleaf Springs and with 10000 or 12000 lb Axle	F4HT-18045-DA	OIO	85063
		F5HZ-18124-C	OIO	85063
94 - 97	F-700, F-800 with Multileaf Spring and 14600 lb Axle	F4HT-18045-EA	OIO	83125
		F5HZ-18124-D	OIO	83125
94 - 97	F-700, F-800 with Multileaf Spring and with 10000, 12000 or 13200 lb Axle	F4HT-18045-CB	OIO	83107
		F5HZ-18124-B	OIO	83107
94 - 98	F-700, F-800 with Taperleaf Springs and with 6000, 7000, 8500, 9000 lb Axle	F4HT-18045-AB	OIO	83314
		F4HT-18045-AC	OIO	83314
		F5HZ-18124-A	OIO	83314
76 - 79	F-800	D2HT-18080-HA		OIO	83225	...
		D7HT-18045-GA	OIO	83308
64 - 66	F-800, F-850, F-900, F-950, F-1000 - Exc. Diesel with 11000 CP Axle	C1TT-18045-D	OIO	G63406

APPLICATION GUIDE - TRUCKS, TRAILERS, AND BUSES

Year	Model	OEM #	Front		Rear	
						
			Fleetline	GasSLX	Fleetline	GasSLX

FORD(Cont'd.)





F Series - Conventional Cab(Cont'd.)

64 - 69	F-800, F-850-,F-900, F-950, F-1000 with 6000, 7000, 9000, 11000, 12000, 15000, 18000 lb Axles (Exc. Diesel with 6000 and 7000 lb Axles)	C1TT-18045-C	010	83312	89409	
			010	83312	89409	
64 - 69	F-950, F-1000, F-1100 Diesel with 7000 lb Axle	C6PF-18077-DN	010	83314

F Series - F450, F550, F650, F750 Models

99 - 04	F-450 , F-550 Superduty with single or dual rear wheels with 165" or 201" wheel base	ASH-23486 ASH-247 AT-610 AT-611 F81A-18080-DCA F81Z-18125-DC		010	G63461	...
				010	G63461	...
				010	G63461	...
				010	G63461	...
				010	G63461	...
				010	G63461	...
00 - 15	F-650 with 10,000 lb Front Suspension	3584116C1 3584116C2 4C4Z-18124-QA AA-616	010	83175
			010	83175
			010	83175
			010	83175
00 - 15	F-650 with 12,000 & 13,200 lb Front Springs	3584118C2 4C4Z-18124-JB 4C4Z-18124-RA AA-617 AT-812	010	85928
			010	85928
			010	85928
			010	85928
July/2015 - 19	F-650 with 13,500, 15,500 & 19,000 lb Multi-leaf Rear Springs	471700011531 ASH-24660 FC44-18080-AB FC4Z-18125-A		010	85180	...
				010	85180	...
				010	85180	...
				010	85180	...
July/2015 - 19	F-650 with 19.5" or 22.5" Wheels (22,000 lb GVW)	471700011530 ASH-24658 ASH-24659 FC44-18045-BB FC4Z-18124-A FC4Z-18124-B	010	85181
			010	85181
			010	85181
			010	85181
			010	85181
			010	85181
- 2015	F-650 with 21,000 lb Rear Air Suspension	3578858C1 3578858C2 4C4Z-18125-DA		010	85926	...
				010	85926	...
				010	85926	...
04 - 11	F-650 with 22,000 lb Multi-leaf Rear Springs	4C4Z-18125-B 501906C92		-10	83317	...
				-10	83317	...
00 - 03	F-650 with 23,000 lb Multi-leaf Rear Springs	ASH-2447 AT-696 F81A-18080-ZC F81Z-18125-ZA		010	83140	...
				010	83140	...
				010	83140	...
				010	83140	...
00 - 15	F-650 with 8,500 lb Front Suspension	3584117C2 4C4Z-18124-HB 4C4Z-18124-P AA-615 AT-811 FC4Z-18124-HB	010	83135
			010	83135
			010	83135
			010	83135
			010	83135
			010	83135
00 - 01/23/02	F-650 with 8500 or 9000 lb Front Axle	3U2Z-18124-MAA AA-494 ASH-397 XC35-18045-AB XC35-18045-AD XC35-18045-JA XC3Z-18124-JA	010	83131
			010	83131
			010	83131
			010	83131
			010	83131
			010	83131
			010	83131
			010	83131

APPLICATION GUIDE - TRUCKS, TRAILERS, AND BUSES





Year	Model	OEM #	Front		Rear	
						
			Fleetline	GasSLX	Fleetline	GasSLX

FORD(Cont'd.)

F Series - F450, F550, F650, F750 Models(Cont'd.)

00 - 03	F-650 with Hendrickson HAS - 190 Rear Air Suspension	1C44-18080-AA		010	83123	89405
		60670-008		010	83123	89405
		60670-008L		010	83123	89405
04 - 09	F-650 with Hendrickson HAS - 230 Rear Air Suspension	4C4Z-18125-CA		010	85976	...
		60675-003		010	85976	...
		60675-003L		010	85976	...
		ASH-1105		010	85976	...
		ASH-722		010	85976	...
05 - 07	F-650 with O.E.M. Number	3553628C1	010	85927
		3553628C2	010	85927
00 - 15	F-750 with 10,000 lb Front Suspension	3584116C1	010	83175
		3584116C2	010	83175
		4C4Z-18124-QA	010	83175
		AA-616	010	83175
00 - 15	F-750 with 12,000 & 13,200 lb Front Springs	3584118C2	010	85928
		4C4Z-18124-JB	010	85928
		4C4Z-18124-RA	010	85928
		AA-617	010	85928
		AT-812	010	85928
July/2015 - 19	F-750 with 13,500, 15,500 & 19,000 lb Multi-leaf Rear Springs	471700011531		010	85180	...
		ASH-24660		010	85180	...
		FC44-18080-AB		010	85180	...
		FC4Z-18125-A		010	85180	...
July/2015 - 19	F-750 with 19.5" or 22.5" Wheels (22,000 lb GVW)	471700011530	010	85181
		ASH-24658	010	85181
		ASH-24659	010	85181
		FC44-18045-BB	010	85181
		FC4Z-18124-A	010	85181
		FC4Z-18124-B	010	85181
- 2015	F-750 with 21,000 lb Rear Air Suspension	3578858C1		010	85926	...
		3578858C2		010	85926	...
		4C4Z-18125-DA		010	85926	...
04 - 11	F-750 with 22,000 lb Rear Spring Suspension	4C4Z-18125-B		-10	83317	...
		501906C92		-10	83317	...
00 - 03	F-750 with 23000 lb Multi-leaf Rear Springs	ASH-2447		010	83140	...
		AT-696		010	83140	...
		F81A-18080-ZC		010	83140	...
		F81Z-18125-ZA		010	83140	...
00 - 15	F-750 with 8,500 lb Front Suspension	3584117C2	010	83135
		4C4Z-18124-HB	010	83135
		4C4Z-18124-P	010	83135
		AA-615	010	83135
		AT-811	010	83135
		FC4Z-18124-HB	010	83135
00 - 01/23/02	F-750 with 8500 or 9000 lb Front Axle	3U2Z-18124-MAA	010	83131
		AA-494	010	83131
		ASH-397	010	83131
		XC35-18045-AB	010	83131
		XC35-18045-AD	010	83131
		XC35-18045-JA	010	83131
		XC3Z-18124-JA	010	83131
00 - 03	F-750 with Hendrickson HAS - 190 Rear Air Suspension	1C44-18080-AA		010	83123	89405
		60670-008		010	83123	89405

APPLICATION GUIDE - TRUCKS, TRAILERS, AND BUSES

Year	Model	OEM #	Front		Rear	
			 Fleetline	 GasSLX	 Fleetline	 GasSLX

FORD(Cont'd.)

F Series - F450, F550, F650, F750 Models(Cont'd.)

00 - 03	F-750 with Hendrickson HAS - 190 Rear Air Suspension	60670-008L		010	83123	89405
04 - 09	F-750 with Hendrickson HAS - 230 Rear Air Suspension	4C4Z-18125-CA		010	85976	...
		60675-003		010	85976	...
		60675-003L		010	85976	...
		ASH-1105		010	85976	...
		ASH-722		010	85976	...
05 - 07	F-750 with O.E.M. Number	3553628C1	010	85927
		3553628C2	010	85927

FT Series - Conventional Cab

90 - 92	FT-900 (Low Profile Vehicle)	E9HS-18080-AA		010	85716	...
90 - 94	FT-900 (Low Profile Vehicle)	E9HZ-18124-A	010	83309	89446	
94 - 97	FT-900 with 46" Taperleaf Spring and 15000, 17500 or 19000 lb Axle	F4HT-18080-AA		010	85314	89425
		F4HT-18080-AB		010	85314	89425
		F5HZ-18125-DA		010	85314	89425
94 - 97	FT-900 with 46" Taperleaf Springs and 21000 lb Axle	F4HT-18080-BA		010	85001	89410
94 - 97	FT-900 with 52 or 54" Taperleaf Springs and with 10000 or 12000 lb Axle	F4HT-18045-DA	010	85063
		F5HZ-18124-C	010	85063
90 - 94	FT-900 with 9000 lb Axle with H.D. Suspension or 10000, 11000, or 12000 lb Axles	C4HZ-18124-E	010	83309	89446	
		F1HT-18045-AA	010	83309	89446	
		F1HZ-18124-A	010	83309	89446	
94 - 97	FT-900 with Multileaf Spring and 14600 lb Axle	F4HT-18045-EA	010	83125
		F5HZ-18124-D	010	83125
94 - 97	FT-900 with Multileaf Spring and with 10000, 12000 or 13200 lb Axle	F4HT-18045-CB	010	83107
		F5HZ-18124-B	010	83107
90 - 97	FT-900 with shock located forward of rear axle	ASH-24446		010	83215	...
		AX-310		010	83215	...
		E6HT-18080-AA		010	83215	...
		E6HZ-18125-D		010	83215	...
90 - 94	FT-900, FT-900LP with 9000 lb Axle with H.D. Suspension or 10000, 11000, or 12000 lb Axles	E9HS-18045-AA	010	83309	89446	
94 - 97	FT-900, with Taperleaf Springs and with 6000, 7000, 8500 or 9000 lb Axles	F4HT-18045-AB	010	83314
		F5HZ-18124-A	010	83314









H and HT Series - Hi Tilt Cab

61 - 63	HT-950 with 11000 lb Axle	010	83314
61 - 66	HT-950 with 12000 & 15000 lb Axle	010	83314

L, LT & LTS - Conventional Cab

73 - 90	L-800, L8000, L-900, L-9000, LT-800, LT-880, LT8000, LT-900, LT-9000 with 7000, 9000, 12000 lb Axles	D2EF-18045-AA	010	83312	89409	
		D2KF-18045-AA	010	83312	89409	
		D7HF-18045-FA	010	83312	89409	
		D7HT-18045-BA	010	83312	89409	
73 - 85	L-800, L8000, L-900,L-9000, LT-800, LT-880, LT8000, LT-900, LT-9000, LTS-8000, LTS-900, LTS-9000 with 7000, 9000, 12000, 16000 lb Axles	D2HF-18045-AA	010	83314
		D2HT-18045-CA	010	83314
73 - 90	L-800, L850, L-900,L-9000, LT-800, LT-850, LT880, LT-900, LT-9000, LTS-800, LTS-850, LTS-900 with 7000, 9000, 12000, 16000 lb Axles	D2HF-18045-BA	010	83309	89446	
		D7HT-18045-DA	010	83309	89446	
94 - 97	L-8000, L-9000, LT-8000 or LT-9000 Models with 21000 or 23000 lb. with 46" Taperleaf Spring	F4HT-18080-BA		010	85001	89410
90 - 97	L-8000, L-9000, LT-8000, LT-9000 with 52" Taperleaf Spring	F1HT-18045-GA	010	85006	89401	
		F1HT-18045-GB	010	85006	89401	

APPLICATION GUIDE - TRUCKS, TRAILERS, AND BUSES

Year	Model	OEM #	Front		Rear	
						
						
			Fleetline	GasSLX	Fleetline	GasSLX

FORD(Cont'd.)

L, LT & LTS - Conventional Cab(Cont'd.)

90 - 97	L-8000, L-9000, LT-8000, LT-9000 with 58" Parabolic Taperleaf Spring	F1HT-18045-RA	OIO	...	89402	
		F1HT-18045-RB	OIO	...	89402	
	L-8000, L-9000, LT-8000, LT-9000 with Hendrickson Rear Air Suspension	47902-13		OIO	83122	89406
91 - 97	L-8000, L-9000, LT-8000, LT-9000 with Multileaf Spring	F1HT-18045-DA	OIO	83312	89409	
91 - 97	L-8000, L-9000, LT-8000, LT-9000 with 4000, 4500, 5400, 6000, 7200 lb Multileaf Springs and with 9000, 10000, 12000 or 16000 lb Axles	F1HT-18045-CB	OIO	83216
91 - 97	L-8000, L-9000, LT-8000, LT-9000 with 4500, 5400, 6000, 7200, 10000 lb Multileaf Springs and with 10000, 12000, 13200, 16000 lb Axles	F1HT-18045-DB	OIO	83308
73 - 89	LTS-800, LTS-850, LTS-900, LTS-9000 with 16000 lb Axle	D0HA-18045-E	OIO	83312	89409	
		D2HF-18045-DA	OIO	83312	89409	
		D7HT-18045-EA	OIO	83312	89409	

LA, LS & LST - Conventional Cab

1996	LA-8000 Models with 12000 or 13000 lb Axles	F6HT-18045-LA	OIO	85376
1996	LA-8000 Models with 16000 lb. Multileaf Spring	F6HT-18045-AA	OIO	85054	89438	
91 - 96	LA-8000, LA-9000 Models with 4000, 4500, 5400, 6000, or 7200 lb. Multileaf Spring	F1HT-18045-CB	OIO	83216
91 - 96	LA-8000, LA-9000 Models with Hendrickson Rear Air Suspension	47902-28		OIO	85013	89414
90 - 97	LA-8000, LA-9000, LS-8000, LST-8000 with 4500 lb to 10000 lb Multileaf Spring	F1HT-18045-CA	OIO	83308
90 - 97	LA-8000, LS-8000, LST-8000 with 52" Taperleaf Spring	F1HT-18045-EA	OIO	...	89402	
91 - 96	LA-8000, LS-8000, LST-8000 with 58" Taperleaf Spring	F1HT-18045-EB	OIO	...	89402	





LL, LLA, LTA, LTL, LTLA - Conventional Cab

91 - 95	LL-9000 with 4500, 5000, 6000 lb Springs and with 10000, 11000, 12000 lb Axles	F1HT-18045-DB	OIO	83308
91 - 96	LL-9000, LLA-9000, LTA-9000, LTLA-9000, with 4000, 4500, 5400, 6000 or 7200 lb Multileaf Springs and with 9000, 10000, 12000 or 16000 lb Axles	F1HT-18045-CB	OIO	83216
91 - 96	LLA-9000, LTLA-9000 with 4500, 5400, 6500 lb 58" Parabolic Taperleaf Spring	F0HT-18045-CA	OIO	85006	89401	
		F1HT-18045-HB	OIO	85006	89401	
91 - 96	LTA-9000, LLA-9000 or LTLA-9000 Models With 4500, 5400, 6000, 7200 or 10000 lb. Multileaf Spring	F1HT-18045-CA	OIO	83308
	With Hendrickson Rear Air Suspension	47902-28		OIO	85013	89414
80 - 85	LTL-900, LTL-9000 with 7000, 9000, 12000 lb Axle	D2HF-18045-AA	OIO	83314

LN & LNT - Conventional Cab

1972	LN-500, LN-550 with 11000, 13000, 15000, 17000 lb Axles	D2TF-18080-HA		OIO	83225	...
70 - 72	LN-500, LN-550 with 5000, 5500, 6000 & 7000 lb Axles	D2TF-18045-GA	OIO	83308
72 - 79	LN-600, LN-650, LN-700, LN-750 with 11000, 13000, 15000, 17000 lb Axles	D2TF-18080-HA		OIO	83225	...
70 - 89	LN-600, LN-650, LN-700, LN-750, LN-7000, LN-800, LN-8000, LNT-800, LNT-8000 with 3000, 3300 lb Springs and 5000, 5500, 6000, 7000 lb Axles	D7HT-18045-GA	OIO	83308
76 - 79	LN-600, LN-650, LN-700, LN-800	D7HT-18045-BA	OIO	83312	89409	
70 - 89	LN-600, LN-700, LN-7000, LN-800, LN-8000, LNT-800, LNT-8000 with 4400 lb Spring and 7000, 9000 lb Axles	D2EF-18045-AA	OIO	83312	89409	
80 - 89	LN-600, LN-700, LN-750 with 11000, 13000, 15000, 17000 lb Axles	D7HT-18080-BA		OIO	83225	...
70 - 75	LN-700, LN-750 Diesel with 9000 lb Axle	C1TT-18045-C	OIO	83312	89409	
94 - 97	LN-7000, LN-8000, LN-9000, LNT-8000 or LNT-9000 Models with 21000 or 23000 lb. with 46" Taperleaf Spring	F4HT-18080-BA		OIO	85001	89410
91 - 97	LN-7000, LN-8000, LN-9000, LNT-8000 or LNT-9000 Models with 4000, 4500, 5400, 6000 or 7200 lb. Multileaf Springs and with 9000, 10000, 12000 or 16000 lb. Axles	F1HT-18045-CB	OIO	83216
90 - 97	LN-7000, LN-8000, LN-9000, LNT-8000, LNT-9000 with 52" Taperleaf Spring	F1HT-18045-GA	OIO	85006	89401	
		F1HT-18045-GB	OIO	85006	89401	
90 - 97	LN-7000, LN-8000, LN-9000, LNT-8000, LNT-9000 with 58" Parabolic Taperleaf Spring	F1HT-18045-RA	OIO	...	89402	

APPLICATION GUIDE - TRUCKS, TRAILERS, AND BUSES

Year	Model	OEM #	Front		Rear	
			 Fleetline	 GasSLX	 Fleetline	 GasSLX

FORD(Cont'd.)

LN & LNT - Conventional Cab(Cont'd.)

90 - 97	LN-7000, LN-8000, LN-9000, LNT-8000, LNT-9000 with 58" Parabolic Taperleaf Spring	F1HT-18045-RB	010	...	89402	
	LN-7000, LN-8000, LN-9000, LNT-8000, LNT-9000 with Hendrickson Rear Air Suspension	47902-13		010	83122	89406
		F0HT-18080-AA F0HZ-18125-A		010	83122	89406
90 - 97	LN-7000, LN-8000, LN-9000, LNT-8000, LNT-9000 with Multileaf Spring	F1HT-18045-DA	010	83312	89409	
91 - 97	LN-7000, LN-8000, LN-9000, LNT-8000, LNT-9000 with 4500, 5400, 6000, 7200, 10000 lb Springs and with 10000, 12000, 13200, 16000 lb Axles	F1HT-18045-DB	010	83308
76 - 77	LN-800, LN-8000, LN-900, LN-9000, LNT-800, LNT-8000, LNT-900, LNT-9000	D2KF-18045-AA	010	83312	89409	
76 - 81	LN-800, LN-8000, LN-900, LN-9000, LNT-800, LNT-8000, LNT-900, LNT-9000	D2HF-18045-AA	010	83314
		D7HT-18045-CA	010	83314
70 - 71	LN-800, LN-850, LNT-900, with 7000, 9000, 12000 lb Axles	D2TF-18045-GA	010	83308
70 - 89	LN-800, LN-850, LN-8000, LN-900, LN-9000, LNT-800, LNT-850, LNT-880, LNT-8000, LNT-900, LNT-9000 with 6000, 7000, 9000, 12000, 16000 lb Axles	D2HF-18045-BA	010	83309	89446	
		D7HT-18045-DA	010	83309	89446	





Louisville Series - Conventional Cab

96 - 97	All Models with 10000 lb or 12000 lb Axle and 54" Taperleaf Spring	F6HT-18045-AC	010	85054	89438	
		F6HZ-18124-A	010	85054	89438	
		F6HZ-18124-G	010	85054	89438	
96 - 97	All with 12000 lb, 13000 lb or 14600 lb Axle and 60" Taperleaf Spring	F6HT-18045-EB	010	85055	89439	
		F6HT-18045-EC	010	85055	89439	
		F6HZ-18124-D	010	85055	89439	
		F6HZ-18124-E	010	85055	89439	
		F6HZ-18124-F	010	85055	89439	
1996 -	All with 13200 lb or 14600 lb Axle and 54" Taperleaf Spring	F6HT-18045-GB	010	85030	89440	
		F6HT-18045-GC	010	85030	89440	
1996 -	All with 54" Multi-leaf Spring and 14600 or 16000 lb Axle	F6HT-18045-CC	010	85055	89439	
		F6HZ-18124-C	010	85055	89439	
	All with 54" Multileaf Spring and with 12000 or 13200 lb Axle	F6HT-18045-BC	010	85047	89435	
96 - 97	All with 54" Multileaf Spring and with 8500 or 9000 lb Axle	F6HT-18045-JB	010	83200	89402	
		F6HT-18045-JC	010	83200	89402	
		F6HZ-18124-J	010	83200	89402	
96 - 97	All with 8500 lb or 9000 lb Axle with 54" Taperleaf Spring	F6HT-18045-HB	010	85054	89438	
		F6HT-18045-HC	010	85054	89438	
		F6HZ-18124-H	010	85054	89438	
	All with Hendrickson HAS-400 Air Suspension	47902-28		010	85013	89414
		F6HZ-18080-FC		010	85013	89414
		F6HZ-18125-D		010	85013	89414
	All with Neway AD-123 Air Suspension	90045068		-10	...	89441
		F6HZ-18125-C		-10	...	89441
	All with Neway AD-246 Air Suspension	90045099		010	85906	89407
		90045132		010	85909	...

Motorhome Chassis

99 - 19	F53 Motorhome Chassis with 16,000 lb GVW to 22,000 lb GVW	1C34-18045-AA	010	83209	89414	
		1C34-18045-JA	010	83209	89414	
		9U94-18045-AA	010	83209	89414	
		9U9Z-18124-A	010	83209	89414	
		ASH-1022	010	83209	89414	
		ASH-1205	010	83209	89414	
		ASH-1228	010	83209	89414	

APPLICATION GUIDE - TRUCKS, TRAILERS, AND BUSES

Year	Model	OEM #	Front		Rear	
						
			Fleetline	GasSLX	Fleetline	GasSLX

FORD(Cont'd.)

Motorhome Chassis(Cont'd.)

99 - 19	F53 Motorhome Chassis with 16,000 lb GVW to 22,000 lb GVW	ASH-1229	010	83209	89414	
		ASH-25822	010	83209	89414	
		ASH-25823	010	83209	89414	
		ASH-294	010	83209	89414	
		AT-620	010	83209	89414	
		AT-766	010	83209	89414	
99 - 19	F53 Motorhome Chassis with 20,500 lb GVW to 22,000 lb GVW	9U94-18080-AA		010	83122	89406
		9U9Z-18125-A		010	83122	89406
		ASH-1023		010	83122	89406
		ASH-1206		010	83122	89406
		ASH-1230		010	83122	89406
		ASH-137		010	83122	89406
		ASH-25824		010	83122	89406
		AT-621		010	83122	89406
73 - 76	M-400 & M-500 Motorhome Chassis	010	85012	89413	010	83225	...
57 - 76	P-400 & 4000 Motorhome Chassis with H.D. Springs	010	85012	89413	

N and NT 89" BBC Conventional Cab

64 - 69	M-750, N-800, N-850, N-900, N-950 with 6000, 7000, 9000, 11000, 12000 lb Axles	C1TT-18045-C	010	83312	89409	
64 - 69	N-1100 with 11000 thru 15000 lb Axles	C6PF-18077-DN	010	83314
64 - 69	N-500, N-550, N-600, N-650, N-700 with 5000, 6000, 7000 & 9000 lb Axles	D2TF-18045-GA	010	83308
64 - 69	N-500, N-550, N-600, N-650, N-700, N-750	C7PF-18077-A D2TF-18080-HA		010	83225	...
				010	83225	...
64 - 69	N-600, N-650, N-700, N-750, N-800, N-850, N-900, N-950 with 6000, 7000, 9000, 11000, 12000 lb Axles	C6PF-18077-DL	010	83312	89409	
67 - 69	N-850, N-900, N-950, N-1000, NT-850, NT-900, NT-950, NT-1000 with 6000, 7000, 9000, 11000, 12000, 15000, 18000 lb Axles	C1TT-18045-D	010	G63406

P-Series - Parcel Delivery

57 - 76	P-400 & 4000 w/ H. D. Springs	010	85012	89413	
57 - 76	P500, P-5000	010	85012	89413	010	83225	...
78 - 79	P-600	D7HT-18045-HA D7HT-18080-CA	010	85012	89413	
				010	83225	...

T-Series - Conventional Tandem

64 - 69	T-750, T-800, T-850, T-900, T-950 with 6000, 7000, 9000, 11000, 12000, 15000, 18000 lb Axles	C1TT-18045-D	010	G63406
64 - 69	T-750, T-800, T-850, T-900, T-950 with 9000 thru 15000 lb Axles	C1TT-18045-E C6PF-18077-DN	010	83314
			010	83314









W and WT Series - Hi Tilt Cab Highway Tractor

66 - 71	W-900, W-950, W-1000, WT-900, WT-950, WT-1000 with 11000 lb Axle	D2HA-18045-E1A D2HA-18045-E1B D2HA-18045-E2A D2HA-18045-E2B	010	85304
			010	85304
			010	85304
			010	85304
66 - 77	W-900, W-950, W-1000, WT-900, WT-950, WT-1000 with 12000 & 15000 lb Axle	C6TA-18045-Y C6TA-18045-Z	010	85301
			010	85301
73 - 77	W-900, WT-900 with Air Suspension	D2HZ-18080-A D4HA-18080-AA		010	83209	89414
				010	83209	89414

Additional O.E.M. Interchanges

	HN-80 with 21000 lb or 23000 lb Axle & 52" Taper leaf Rear Suspension	F6HT-18080-JA		010	85305	...
	Models with O.E.M. Number	0017LA-18080-G 2C4Z-18124-BA 2C7Z-18125-AA 2C7Z-18125-CA	010	-10	83161	...
83175				
...				...	010	G63837	...	
...				...	010	G63607	...	

APPLICATION GUIDE - TRUCKS, TRAILERS, AND BUSES





Year	Model	OEM #	Front		Rear	
						
						
			Fleetline	GasSLX	Fleetline	GasSLX

FORD(Cont'd.)

Additional O.E.M. Interchanges(Cont'd.)

Year	Model	OEM #	Front	Rear
	Models with O.E.M. Number	3U2Z-18124-BAA	010 G63809
		3U2Z-18124-BV	-10 G63614
		3U2Z-18124-BW	-10 G63614
		3U2Z-18124-EA	-10 G63772
		3U2Z-18124-FA	-10 G63608
		3U2Z-18124-FAA	-10 G63809
		3U2Z-18124-JAA	-10 G63614
		3U2Z-18124-YAA	010 G63809
		3U2Z-18125-AD	-10 69575 ...
		3U2Z-18125-CA	010 G63607 ...
		3U2Z-18125-DA	010 G63525 ...
		3U2Z-18125-EA	010 G63524 ...
		3U2Z-18125-RA	-10 G63623 ...
		47902-8	010 83122 89406
		4U2Z-18V124-AA	-10 G63678
		57365-111	010 85006 89401
		5C3Z-18124-JA	-10 G63969
		5C3Z-18125-CF	010 77969 ...
		5C3Z-18125-DA	010 77968 ...
		5U2Z-18V124-AA	-10 G63714
		5U2Z-18V124-AHA	01- G63622
		5U2Z-18V124-AU	-10 G63772
		5U2Z-18V124-BA	-10 G63716
		5U2Z-18V124-CAA	010 G63809
		5U2Z-18V124-DB	010 G63455
		5U2Z-18V124-GA	-10 G63809
		5U2Z-18V124-LA	-10 G63929
		5U2Z-18V125-AE	010 G63808 ...
		5U2Z-18V125-AF	010 G63810 ...
		5U2Z-18V125-BDA	-10 G63623 ...
		5U2Z-18V125-BGA	-10 G63778 ...
		5U2Z-18V125-BS	010 G63607 ...
		5U2Z-18V125-BT	010 G63525 ...
		5U2Z-18V125-BU	010 G63524 ...
		5U2Z-18V125-F	010 G63676 ...
		5U2Z-18V125-G	010 G63837 ...
		5U2Z-18V125-H	010 G63406 ...
		6C2Z-18124-B	-10 G63929
		6ETZ-18124-AA	010 83145
		6ETZ-18125-A	010 83146 ...
		6U2Z18V125A	010 G63837 ...
		6U2Z-18V125-B	010 G63607 ...
		70127	010 85006 89401
		70128	010 85006 89401
		7C34-18045-HB	-10 G63969
		7C34-18080-DCB	010 77968 ...
		7W7Z-18125-B	-10 69574 ...
		90044769	010 83207 89407
		90044770	010 83207 89407
		AX-267A	010 83309 89446
		B3Q-18124-A	010 83219
		B3Q-18125-A	010 83217 ...
		B3TZ-18125-A	010 83217 ...
		B6TZ-18124-A	010 83219
		B6TZ-18125-B	-10 83161 ...

APPLICATION GUIDE - TRUCKS, TRAILERS, AND BUSES

Year	Model	OEM #	Front		Rear	
						
			Fleetline	GasSLX	Fleetline	GasSLX

FORD(Cont'd.)

Additional O.E.M. Interchanges(Cont'd.)

Year	Model	OEM #	Front Fleetline	Front GasSLX	Front Interchange	Rear Fleetline	Rear GasSLX	Rear Interchange
	Models with O.E.M. Number	B6TZ-18125-C	-IO	83161
		B6TZ-18125-E	-IO	83161
		B7C-18125-A	OIO	83217
		B7T-18124-C	OIO	83225
		B7TZ-18124-B	OIO	83216
		B7TZ-18124-C	OIO	83216
		B7TZ-18124-D	OIO	83219
		B7TZ-18124-E	OIO	83217
		B7TZ-18125-C	OIO	83217
		B8Q-18125-A	OIO	85307
		B8QZ-18124-A	OIO	83312	89409
		B8TZ-18124-A	OIO	83219
		B9TT-18045-C	OIO	83219
		B9TT-18045-D	OIO	83219
		B9TT-18080-B	-IO	83161
		B9TZ-18125-B	-IO	83161
		C0TT-18045-A	OIO	83219
		C0TT-18045-D	OIO	83216
		C0TZ-18124-A	OIO	83216
		C1TT-18045-G	OIO	83216
		C1TT-18080-B	OIO	83217
		C1TZ-18045-C	OIO	83312	89409
		C1TZ-18124-A	OIO	83217
		C1TZ-18124-B	OIO	83216
		C1TZ-18124-C	OIO	83312	89409
		C1TZ-18124-D	OIO	83309	89446
		C1TZ-18124-E	OIO	83312	89409
		C1TZ-18124-F	OIO	83312	89409
		C1TZ-18124-N	OIO	83314
		C1TZ-18124-P	OIO	83312	89409
		C1TZ-18125-B	OIO	83217
		C1VT-18080-B	OIO	83217
		C2TA-18045-B	OIO	83308
		C2TZ-18124-A	OIO	83308
		C3TA-18045-A	OIO	83216
		C3TZ-18124-A	OIO	83308
		C4HZ-18124-A	OIO	83312	89409
		C4HZ-18124-B	OIO	83309	89446
		C4HZ-18124-C	OIO	83314
		C4HZ-18124-D	OIO	83312	89409
		C4HZ-18124-F	OIO	83308
		C4PF-18045-H	OIO	83216
		C4TZ-18124-AA	OIO	83308
		C4TZ-18124-AB	OIO	83308
		C4TZ-18124-B	OIO	83308
		C5TZ-18124-A	OIO	83308
		C6PF-18077-AC	-IO	83161
		C6TA-18045-U	OIO	85301
		C6TA-18045-V	OIO	85301
		C6TS-18080-A	OIO	83217
		C6TZ-18124-D	OIO	85301
		C6TZ-18124-E	OIO	85301
		C6TZ-18124-H	OIO	85301
		C6TZ-18124-J	OIO	85301
		C7HZ-18124-A	OIO	83312	89409

APPLICATION GUIDE - TRUCKS, TRAILERS, AND BUSES





Year	Model	OEM #	Front		Rear	
			Fleetline	GasSLX	Fleetline	GasSLX

FORD(Cont'd.)

Additional O.E.M. Interchanges(Cont'd.)

Year	Model	OEM #	Front	Rear	Front	Rear
	Models with O.E.M. Number	C7TA-18045-R	010	83216
		C7TA-18045-Z	010	85301
		C8PF-18045-CM	010	83216
		C8PF-18045-S	-10	83161
		C8PF-18045-T	-10	83161
		C8TA-18080-Y		...	-10	83161
		C8TA-18080-Z		...	-10	83161
		C8TZ-18125-D		...	-10	83161
		D0HA-18045-D	010	83309	89446	...
		D0HZ-18124-A	010	83309	89446	...
		D0HZ-18124-B	010	83312	89409	...
		D0HZ-18124-C	010	83314
		D1TZ-18124-D	010	83308
		D1TZ-18124-E	010	83216
		D1TZ-18124-F	010	83312	89409	...
		D1TZ-18125-E		...	010	83217
		D2EF-18124-AA	010	83312	89409	...
		D2HA-18045-EB	010	85301
		D2HA-18045-F1A	010	85301
		D2HA-18045-F1B	010	85301
		D2HA-18045-F2A	010	85301
		D2HA-18045-F2B	010	85301
		D2HF-18045-A	010	83314
		D2HF-18124-AA	010	83314
		D2HT-18045-EA	010	83312	89409	...
		D2HZ-18125-A		...	010	83209
		D2HZ-18125-B		...	010	83209
		D2KF-18124-AA	010	83312	89409	...
		D2TA-18045-AAA	010	83219
		D2TA-18045-ZA	010	83219
		D2TF-18045-FA	010	83312	89409	...
		D2TF-18080-NA		...	010	83217
		D2TF-18124-F	010	83309	89446	...
		D2TZ-18124-A	010	83308
		D2TZ-18124-E	010	83312	89409	...
		D2TZ-18124-F	010	83309	89446	...
		D2TZ-18124-G	010	83314
		D2TZ-18124-H	010	83308
		D2TZ-18124-J	010	83312	89409	...
		D3TA-18045-BA	010	83219
		D3TZ-18124-B	010	83219
		D3TZ-18125-C		...	010	83217
		D3TZ-18125-D		...	010	83217
		D4HA-18080-A		...	010	83209
		D4TF-18045-AA	010	83312	89409	...
		D4TZ-18124-J	010	83308
		D5TZ-18124-B	010	83308
		D5TZ-18124-C	010	83312	89409	...
		D7HF-18125-AA		...	010	83215
		D7HT-18124-BA	010	83312	89409	...
		D7HT-18124-CA	010	83314
		D7HT-18124-DA	010	83309	89446	...
		D7HT-18124-EA	010	83312	89409	...
		D7HT-18124-FA	010	83312	89409	...
		D7HT-18124-GA	010	83308

APPLICATION GUIDE - TRUCKS, TRAILERS, AND BUSES

Year	Model	OEM #	Front		Rear	
						
			Fleetline	GasSLX	Fleetline	GasSLX

FORD(Cont'd.)

Additional O.E.M. Interchanges(Cont'd.)

Year	Model	OEM #	Front	Rear
	Models with O.E.M. Number	D7HT-18124-HA	010 83219
		D7HT-18124-JA	010 83308
		D7HT-18124-KA	010 85301
		D7HT-18125-BA	010 83217 ...
		D7HT-18125-CA	010 83217 ...
		D7HT-18125-DA	010 83215 ...
		D7HT-18125-FA	010 83123 89405
		D7HZ-18125-A	010 83215 ...
		D7TA-18124-GA	010 83314
		D7TZ-18125-C	010 83217 ...
		D8HZ-18124-A	010 85301
		D8HZ-18125-A	010 83209 89414
		D8HZ-18125-B	010 83123 89405
		E0HZ-18124-A	010 83309 89446	...
		E1TA-18045-AA	010 83309 89446	...
		E1TD-18045-AA	010 83309 89446	...
		E5HT-18045-DA	010 85301
		E5HT-18045-EA	010 85301
		E6HZ-18124-D	010 85301
		E6HZ-18125-E	010 85315 ...
		E6HZ-18125-F	010 85315 ...
		E7XZ-18124-A	-10 G63386
		E7XZ-18124-B	-10 G63500
		E7XZ-18124-C	-10 G63511
		E7XZ-18124-D	-10 G63396
		E7XZ-18124-F	-10 G63398
		E7XZ-18124-G	-10 G63398
		E7XZ-18125-A	-10 G63350 ...
		E7XZ-18125-B	-10 G63387 ...
		E7XZ-18125-C	010 G63409 ...
		E7XZ-18125-D	010 G63406 ...
		E7XZ-18125-E	010 G63406 ...
		E7XZ-18125-G	010 G63811 ...
		E7XZ-18125-J	010 G63299 ...
		E9HZ-18125-A	010 85716 ...
		E9HZ-18125-AA	010 85716 ...
		F0HS-18045-AA	010 85006 89401	...
		F0HT-18045-AA	010 85006 89401	...
		F0HZ-18124-A	010 85006 89401	...
		F0HZ-18124-B	010 85006
		F1HT-18045-KB	010 85006 89401	...
		F1HT-18045-LB	010 85006 89401	...
		F1HZ-18124-AA	010 83309 89446	...
		F1HZ-18124-B	010 83308
		F1HZ-18124-C	010 ... 89402	...
		F1HZ-18124-D	010 85006 89401	...
		F1HZ-18124-E	010 85006 89401	...
		F1HZ-18124-F	010 85006 89401	...
		F1HZ-18124-G	010 85006 89401	...
		F1HZ-18124-H	010 85040
		F1HZ-18124-J	010 83308
		F1HZ-18124-K	010 ... 89402	...
		F2HT-18045-DA	010 85006 89401	...
		F2HT-18080-DA	010 85712 ...
		F2HZ-18124-B	010 85301

APPLICATION GUIDE - TRUCKS, TRAILERS, AND BUSES









Year	Model	OEM #	Front		Rear	
			Fleetline	GasSLX	Fleetline	GasSLX

FORD(Cont'd.)

Additional O.E.M. Interchanges(Cont'd.)

Year	Model	OEM #	Front	Rear
	Models with O.E.M. Number	F2HZ-18124-C	O10 85006 89401
		F2HZ-18125-A	O10 85712 ...
		F4TA-18045-TA	O10 G63455
		F4TA-18080-PA	O10 G63461 ...
		F4TZ-18124-D	-10 G63414
		F4TZ-18124-K	O10 G63455
		F4TZ-18125-E	O10 G63461 ...
		F4TZ-18125-L	O10 G63406 ...
		F57Z-18125-BB	O10 G63679 ...
		F5HZ-18124-AA	O10 83314
		F5HZ-18124-C	O10 85063
		F5HZ-18124-DA	O10 83125
		F5HZ-18125-A	O10 85314 89425
		F5HZ-18125-AA	O10 85314 89425
		F5HZ-18125-B	O10 85001 89410
		F5HZ-18125-BA	O10 85001 89410
		F5TZ-18124-B	-10 G63608
		F5TZ-18125-BC	O10 G63607 ...
		F5UZ-18124-A	O1- G63622
		F5UZ-18124-B	O1- G63622
		F5UZ-18125-A	-10 G63623 ...
		F5UZ-18125-C	-10 G63624 ...
		F6HT-18045-KA	O10 83200 89402
		F6HT-18045-MA	O10 85006 89401
		F6HT-18080-CA	O10 85314 89425
		F6HT-18080-EA	O10 85906 89407
		F6HT-18080-FC	O10 85013 89414
		F6HZ-18124-B	O10 83308
		F6HZ-18124-KA	O10 83200 89402
		F6HZ-18124-MA	O10 85006 89401
		F6HZ-18125-A	O10 85314 89425
		F6HZ-18125-JA	O10 85305 ...
		F7C2Z-18124-BR	-10 G63929
		F7TA-18045-AA	-10 G63608
		F7TA-18080-BA	O10 G63607 ...
		F81Z-18124-AL	O1- G63622
		F81Z-18124-BK	O10 G63809
		F81Z-18124-PA	O10 85928
		F87Z-18125-CA	O10 G63773 ...
		F87Z-18125-RA	O10 G63775 ...
		LA-18080	-10 83161 ...
		LA-18080-A	-10 83161 ...
		LA-18080-B	-10 83161 ...
		LA-18080-C	-10 83161 ...
		LA-18080-F	-10 83161 ...
		LA-18080-J	-10 83161 ...
		TAAH-18080-A	-10 83161 ...
		TAAH-18080-A2	-10 83161 ...
		TAAH-18080-A3	-10 83161 ...
		TAAK-18080-A	-10 83161 ...
		TAAK-18080-A1	-10 83161 ...
		TAAK-18080-A2	-10 83161 ...
		TACAA-18045-A	O10 83216
		TANNA-18045-A	O10 83312 89409
		TBAK-18080-A	-10 83161 ...

APPLICATION GUIDE - TRUCKS, TRAILERS, AND BUSES

Year	Model	OEM #	Front		Rear	
						
						
			Fleetline	GasSLX	Fleetline	GasSLX

FORD(Cont'd.)

Additional O.E.M. Interchanges(Cont'd.)

Models with O.E.M. Number	TBDA-18080-A	OIO	83217	...
	TBDA-18080-B	OIO	83217	...
	TDAA-18080-A	-IO	83161	...
	TDAA-18080-B	OIO	83217	...
	TDBA-18045-A	OIO	83219
	TDBA-18045-B	OIO	83219
	TDBA-18080-A	OIO	83217	...
	TDBA-18080-B	OIO	83217	...
	TDBA-18080-C	OIO	83217	...
	TDBE-18045-A	OIO	83219
	TFAA-18045-B	OIO	83219
	TFAA-18045-C	OIO	83219
	TFAA-18080-A	OIO	85307	...
	THAB-18045-A	OIO	83219
	THAB-18045-B	OIO	83219
	TQSH-18045-A	OIO	83309	89446		...
	XC45-18045-AA	OIO	83216
	XL2Z-18124-EA	-IO	G63678
	XL2Z-18125-BA	OIO	G63679	...
	XL2Z-18125-CA	OIO	G63679	...
XL2Z-18125-EA	OIO	G63679	...	
YL5Z-18124-AA	-IO	G63772	
Additional O.E.M. Interchanges	680029	OIO			85301	
	C6PF-18077-DD	OIO			83216	
	C6PF-18077-DE	OIO			83219	
	C7PF-18077-Z	OIO			83217	

FORD CAB SHOCKS

8500 Series

Models with 101", 113" & 122" BBC Conventional Tractors with Link Cabmate Models FH101, FH1322 & FH1322-A	1201-1043	OIO	83025
	1202-1043	OIO	83025

9500 Series

Models with 101", 113" & 122" BBC Conventional Tractors with Link Cabmate Models FH101, FH1322 & FH1322-A	1201-1043	OIO	83025
	1202-1043	OIO	83025
Models with O.E.M. Number	F6HZ-5K407-AB	OIO	83034
	F6HZ-5K407-BA	OIO	83033
	F8HT-5K407-AA	OIO	83033

Additional Applications

CL9000 & CLT9000 Cabover Tractors (Sleeper & Non-Sleeper) with Link Cabmate Model FCL110-2P	1202-0032	OIO	83016
Models with Link Cab Suspension	1202-0042	OIO	83025

L-Series Conventional





All with 60" Able Body Sleepers with Link Bunkmate Models FAS60-A & FAS60-AS	1201-1044	OIO	83025
	1202-1044	OIO	83025
L, LT, LN, LNT 800, 8000, 9000 Models, LTS, LS 8000, 9000 Models, & LTL, LL 9000 Models with Link Cabmate Model FN89-A	1201-0012	OIO	83023
	1202-0012	OIO	83023

FOREST RIVER INC

Class A MotorHomes

01 - 19	Georgetown Series MotorHomes with Ford F53 Chassis with 16,000 lb GVW to 22,000 lb GVW	1C34-18045-AA	OIO	83209	89414	
				83209	89414	
		1C34-18045-JA	OIO	83209	89414	

APPLICATION GUIDE - TRUCKS, TRAILERS, AND BUSES

Year	Model	OEM #	Front		Rear	
			 Fleetline	 GasSLX	 Fleetline	 GasSLX

FOREST RIVER INC(Cont'd.)





Class A MotorHomes(Cont'd.)

01 - 19	Georgetown Series MotorHomes with Ford F53 Chassis with 16,000 lb GVW to 22,000 lb GVW	9U94-18045-AA	010	83209	89414	
		9U94-18080-AA		010	83122	89406
		9U9Z-18124-A	010	83209	89414	
		9U9Z-18125-A		010	83122	89406
		ASH-1022	010	83209	89414	
		ASH-1023		010	83122	89406
		ASH-1205	010	83209	89414	
		ASH-1206		010	83122	89406
		ASH-1228	010	83209	89414	
		ASH-1229	010	83209	89414	
		ASH-1230		010	83122	89406
		ASH-137		010	83122	89406
		ASH-25822	010	83209	89414	
		ASH-25823	010	83209	89414	
		ASH-25824		010	83122	89406
		ASH-294	010	83209	89414	
		AT-620	010	83209	89414	
AT-621		010	83122	89406		
AT-766	010	83209	89414			
	Models with Workhorse UFO Chassis with Hendrickson Softek Front Suspension	66153-002	010	83124	89407	
		F4-BE5-C832-MO	010	83124	89407	
02 - 04	Reflection Series MotorHomes with Freightliner XC Chassis ADL200 Suspension w/ 20K Rear AS120 Front Suspension Rear Shock with O.E.M. Number ZF - IFS Front Suspension with 23,000 lb GVW or Greater	16-16873-000		010	85029	...
		141700131810	010	83160
		16-16737-000	010	83160
		16-16874-000	010	83160
		141700131809		010	85029	...
		16-16736-000		010	85029	...
		16-18103-000	-1-	85900
481700000493	-1-	85900		
02 - 06	Tsunami Series MotorHomes with Freightliner XC Chassis ADL200 Suspension w/ 20K Rear AS120 Front Suspension Rear Shock with O.E.M. Number ZF - IFS Front Suspension with 23,000 lb GVW or Greater	16-16873-000		010	85029	...
		141700131810	010	83160
		16-16737-000	010	83160
		16-16874-000	010	83160
		141700131809		010	85029	...
		16-16736-000		010	85029	...
		16-18103-000	-1-	85900
481700000493	-1-	85900		

Class C MotorHomes

2017	All American Series MotorHomes with Ford E350 & E450 Chassis	ASH-1136		-10	83178	...
		ASH-1154	-10	83177
17 - 19	Forester GTS Series MotorHomes with Ford E350 & E450 Chassis	ASH-1136		-10	83178	...
		ASH-1154	-10	83177
04 - 19	Forester Series MotorHomes with Ford E350 & E450 Chassis	ASH-1136		-10	83178	...
		ASH-1154	-10	83177
04 - 15	Lexington Series MotorHomes with Ford E350 & E450 Chassis	ASH-1136		-10	83178	...
		ASH-1154	-10	83177
15 - 19	Sunseeker Grand Touring Series MotorHomes with Ford E350 & E450 Chassis	ASH-1136		-10	83178	...
		ASH-1154	-10	83177
16 - 19	Sunseeker GTS Series MotorHomes with Ford E350 & E450 Chassis	ASH-1136		-10	83178	...

APPLICATION GUIDE - TRUCKS, TRAILERS, AND BUSES

Year	Model	OEM #	Front		Rear	
						
			Fleetline	GasSLX	Fleetline	GasSLX

FOREST RIVER INC(Cont'd.)

Class C MotorHomes(Cont'd.)

16 - 19	Sunseeker GTS Series MotorHomes with Ford E350 & E450 Chassis	ASH-1154	-IO	83177
99 - 19	Sunseeker Series MotorHomes with Ford E350 & E450 Chassis	ASH-1136		-IO	83178	...
		ASH-1154	-IO	83177

FREIGHTLINER

Argosy

99 - 07	Models with 12000 lb Taperleaf Front Suspension	10-12703-000	OIO	85918	89449	
		10-13634-000	OIO	85918	89449	
		471700000449	OIO	85918	89449	
99 - 07	Models with Freightliner FAS II Rear Air Suspension	16-13957-000		OIO	85724	89443
		16-15817-000		OIO	85724	89443
		680339		OIO	85724	89443
		680611		OIO	85724	89443
99 - 07	Models with Freightliner Low Profile Rear Air Suspension (18,000 to 40,000 lb)	16-14259-000		OIO	85331	...
		16-18706-000		OIO	85331	...
		471700002992		OIO	85331	...
		680511		OIO	85331	...
99 - 07	Models with Rear 10000 lb - 15000 lb Low Profile AirLiner	16-16577-000		OIO	85335	...
		16-18711-000		OIO	85335	...
		471700002996		OIO	85335	...

Cargo - FC70 & FC80

99 - 07	FC70 & FC80 Models with 10,000 to 18,000 lb Suspension	10-13759-000	OIO	85006
		471700003009	OIO	85006
		6803230300	OIO	85006
		GBL665538	OIO	85006
99 - 07	FC70 & FC80 Models with 6000 to 9000 lb Front Axle	654654	OIO	85043
		6803230200	OIO	85043
99 - 07	FC70 & FC80 Models with FAS II Rear Air Suspension	16-13957-000		OIO	85724	89443
		16-15817-000		OIO	85724	89443
		680339		OIO	85724	89443
		680611		OIO	85724	89443









Cascadia

09 - 18	Models with 12000 to 13300 lb Taperleaf Front Suspension	10-13809-000	OIO	85958
		SDA471400003920	OIO	85958
2008	Models with 12000 to 13300 lb Taperleaf Front Suspension	10-13211-000	OIO	85918	89449	
		10-13634-000	OIO	85918	89449	
		471700000449	OIO	85918	89449	
		471700131155	OIO	85918	89449	
09 - 19	Models with Hendrickson Front Airtek	471700006269	OIO	85932	89453	
		471700131331	OIO	85932	89453	
		58913-003	OIO	85932	89453	
		58913-003L	OIO	85932	89453	
		58913-012	OIO	85932	89453	
		58913-012L	OIO	85932	89453	
09 - 19	Models with FAS II (40,000 lb) Rear Air Suspension	16-15817-000		OIO	85724	89443
		16-18708-000		OIO	85724	89443
		471700002809		OIO	85724	89443
		481700006848		OIO	85724	89443
		680611		OIO	85724	89443
		SDA471700002809		OIO	85724	89443

Century Class - C112, C120, CST112 & CST120

00 - 11	Models with 12000 lb Taperleaf Front Suspension	10-13021-000	OIO	85918	89449	
---------	---	--------------	-----	-------	-------	--	-----	-----

APPLICATION GUIDE - TRUCKS, TRAILERS, AND BUSES

Year	Model	OEM #	Front		Rear	
						
						
			Fleetline	GasSLX	Fleetline	GasSLX

FREIGHTLINER(Cont'd.)

Century Class - C112, C120, CST112 & CST120(Cont'd.)

00 - 11	Models with 12000 lb Taperleaf Front Suspension	10-13063-000 10-13211-000 10-13634-000 471700000449 471700000449 471700131155	O10	85918	89449	
			O10	85918	89449	
			O10	85918	89449	
			O10	85918	89449	
			O10	85918	89449	
			O10	85918	89449	
97 - 99	Models with 12000 lb Taperleaf Front Suspension	10-12542-000	O10	85901
97 - 11	Models with FAS II Rear Air Suspension	16-13957-000 16-15817-000 16-18708-000 471700002809 481700006848 680339 680611 SDA471700002809		O10	85724	89443
				O10	85724	89443
				O10	85724	89443
				O10	85724	89443
				O10	85724	89443
				O10	85724	89443
				O10	85724	89443
97 - 11	Models with Freightliner Low Profile Rear Air Suspension (18,000 to 40,000 lb)	16-14259-000 16-18706-000 471700002992 680511		O10	85331	...
				O10	85331	...
				O10	85331	...
				O10	85331	...
02 - 11	Models with Hendrickson Front Airtek	471700131331 58913-003 58913-003L	O10	85932	89453	
			O10	85932	89453	
			O10	85932	89453	
	Models with Low Profile Front	10-12703-000	O10	85918	89449	









Classic/ClassicXL

03 - 11	Models with 12000 lb Taperleaf Front Suspension	10-13021-000 10-13063-000 10-13211-000 10-13634-000 471700000449 471700000449 471700131155	O10	85918	89449	
			O10	85918	89449	
			O10	85918	89449	
			O10	85918	89449	
			O10	85918	89449	
			O10	85918	89449	
03 - 11	Models with FAS II Rear Air Suspension	16-15817-000 16-18708-000 471700002809 481700006848 680611 SDA471700002809		O10	85724	89443
				O10	85724	89443
				O10	85724	89443
				O10	85724	89443
				O10	85724	89443
03 - 11	Models with Hendrickson Front Airtek	471700131331 58913-003 58913-003L	O10	85932	89453	
			O10	85932	89453	
			O10	85932	89453	
	Models with O.E.M. Number	10-12032-002 10-12032-004 680009 70029	O10	85320	89429	
			O10	85320	89429	
			O10	85302	89420	
			O10	85308	89422	

Columbia

03 - 08	Models with 12000 lb Taperleaf Front Suspension	10-13021-000 10-13063-000 10-13211-000 10-13634-000 471700000449 471700131155	O10	85918	89449	
			O10	85918	89449	
			O10	85918	89449	
			O10	85918	89449	
			O10	85918	89449	
			O10	85918	89449	
09 - 18	Models with 12000 lb Taperleaf Front Suspension	10-13809-000 SDA471400003920	O10	85958
			O10	85958
03 - 17	Models with Hendrickson Front Airtek	471700006269	O10	85932	89453	

APPLICATION GUIDE - TRUCKS, TRAILERS, AND BUSES

Year	Model	OEM #	Front		Rear	
						
						
			Fleetline	GasSLX	Fleetline	GasSLX

FREIGHTLINER(Cont'd.)

Columbia(Cont'd.)

03 - 17	Models with Hendrickson Front Airtek	471700131331 58913-003 58913-003L 58913-012 58913-012L	OIO	85932	89453	
			OIO	85932	89453	
			OIO	85932	89453	
			OIO	85932	89453	
			OIO	85932	89453	
	Models with O.E.M. Number	10-13684-000 471700000470	OIO	85918	89449	
			OIO	85918	89449	
03 - 18	All Models with Freightliner TufTrac Rear Air Suspension	16-15770-000 481700125969		OIO	85956	...
				OIO	85956	...
03 - 18	Models with FAS II Rear Air Suspension	16-15817-000 16-18708-000 471700002808 471700002809 481700006848 680611 SDA471700002809		OIO	85724	89443
				OIO	85724	89443
				OIO	85724	89443
				OIO	85724	89443
				OIO	85724	89443
				OIO	85724	89443
				OIO	85724	89443

Condor

01 - 07	Models with 14,600 to 20,000 lb Front Suspension	10-13211-000 10-13634-000 471700000449 471700131155	OIO	85918	89449	
			OIO	85918	89449	
			OIO	85918	89449	
			OIO	85918	89449	
01 - 07	Models with Chalmers 46,000 lb Rear Suspension	665174		OIO	85060	...
01 - 07	Models with FAS II Rear Air Suspension	16-13957-000 16-15817-000 16-18708-000 471700002809 481700006848 680339 SDA471700002809		OIO	85724	89443
				OIO	85724	89443
				OIO	85724	89443
				OIO	85724	89443
				OIO	85724	89443
				OIO	85724	89443
01 - 07	Models with Freightliner TufTrac Rear Air Suspension	16-15770-000 481700125969		OIO	85956	...
				OIO	85956	...
02 - 07	Models with Hendrickson HMX 400/460 Haulmax with 16.5" Saddle	60680-004 60680-004L H60680004		OI-	83143	...
				OI-	83143	...
				OI-	83143	...
02 - 07	Models with Hendrickson HMX 400/460 Haulmax with 17.5" or 18.5" Saddle Height	60680-005 60680-005L H60680005		OI-	83142	...
				OI-	83142	...
				OI-	83142	...

Coronado

10 - 19	Models with 12,000 lb to 20,000 Front Axle	10-13809-000 471700003920	OIO	85958	
			OIO	85958	
	Models with 12000 lb Taperleaf Front Suspension	10-13211-000	OIO	85918	89449	
10 - 16	Models with Hendrickson Front Airtek	471700006269 471700131331 58913-003 58913-003L 58913-012 58913-012L	OIO	85932	89453	
			OIO	85932	89453	
			OIO	85932	89453	
			OIO	85932	89453	
			OIO	85932	89453	
			OIO	85932	89453	
10 - 14	Models with Chalmers 46,000 lb Rear Suspension	665174		OIO	85060	...
10 - 19	Models with FAS II (40,000 lb) Rear Air Suspension	16-15817-000 16-18708-000 471700002809 481700006848 680611		OIO	85724	89443
				OIO	85724	89443
				OIO	85724	89443
				OIO	85724	89443
				OIO	85724	89443

APPLICATION GUIDE - TRUCKS, TRAILERS, AND BUSES

Year	Model	OEM #	Front		Rear	
			Fleetline	GasSLX	Fleetline	GasSLX

FREIGHTLINER(Cont'd.)

Coronado(Cont'd.)

10 - 19	Models with FAS II (40,000 lb) Rear Air Suspension	SDA471700002809		OIO	85724	89443
10 - 18	Models with Freightliner TufTrac Rear Air Suspension	16-15770-000		OIO	85956	...
		481700125969		OIO	85956	...

FL50, 60, 70, 80 - Business Class

	FAS Airliner, Single / Tandem Past Production	16-11133-000		OIO	85007	89412
92 - 06	FL Models with 15000 lb Rear Suspension	6803260000		OI-	83120	...
		GBL654725		OI-	83120	...
92 - 06	FL Models with 10,000 to 18,000 lb Suspension	10-13759-000	OIO	85006
		471700003009	OIO	85006
		6803230300	OIO	85006
		GBL665538	OIO	85006
92 - 06	FL Models with 6000 to 9000 lb Front axle	654654	OIO	85043
		6803230200	OIO	85043
92 - 06	FL Models with FAS II Rear Air Suspension	16-13957-000		OIO	85724	89443
		16-15817-000		OIO	85724	89443
		680339		OIO	85724	89443
		680611		OIO	85724	89443





FLA & FLB Series - COE Truck & Tractor

89 - 02	COE Models	10-12030-002	OIO	85320	89429	
		10-12032-000	OIO	85320	89429	
		10-12032-001	OIO	85320	89429	
		10-12032-002	OIO	85320	89429	
		10-12032-003	OIO	85320	89429	
		10-12032-004	OIO	85320	89429	
89 - 02	COE Models with Airliner Rolling Lobe Spring Air Suspension	16-13947-000		-IO	85319	89428
		681-326-0400		-IO	85319	89428
89 - 02	COE Models with Convolute Spring Air Suspension	16-12117-000		OIO	85007	89412
		16-18705-000		OIO	85007	89412
		471700002990		OIO	85007	89412
		665236		OIO	85007	89412
89 - 02	COE Models with FAS II Rear Air Suspension	16-13957-000		OIO	85724	89443
		16-15817-000		OIO	85724	89443
		680339		OIO	85724	89443
		680611		OIO	85724	89443
	COE Models with Neway Tag Axle Air Suspension	90044162		OIO	83128	89436

FLC & FLD Series - 112 & 120 Conventional Truck & Tractor

00 - 11	Conventional Models with 12000 lb Taperleaf Front Suspension	10-13021-000	OIO	85918	89449	
		10-13063-000	OIO	85918	89449	
		10-13211-000	OIO	85918	89449	
		10-13634-000	OIO	85918	89449	
		471700000449	OIO	85918	89449	
		471700000449	OIO	85918	89449	
		471700131155	OIO	85918	89449	
- 1994	Conventional Models with Airliner Rolling Lobe Spring Air Suspension	16-13947-000		-IO	85319	89428
		681-326-0400		-IO	85319	89428
- 2008	Conventional Models with Convolute Spring Air Suspension	16-12117-000		OIO	85007	89412
		16-18705-000		OIO	85007	89412
		471700002990		OIO	85007	89412
		665236		OIO	85007	89412
- 2011	Conventional Models with FAS II Rear Air Suspension	16-13957-000		OIO	85724	89443
		16-15817-000		OIO	85724	89443
		16-18708-000		OIO	85724	89443
		471700002809		OIO	85724	89443
		481700006848		OIO	85724	89443

APPLICATION GUIDE - TRUCKS, TRAILERS, AND BUSES

Year	Model	OEM #	Front		Rear	
						
			Fleetline	GasSLX	Fleetline	GasSLX

FREIGHTLINER(Cont'd.)

FLC & FLD Series - 112 & 120 Conventional Truck & Tractor(Cont'd.)

- 2011	Conventional Models with FAS II Rear Air Suspension	680339		010	85724	89443
		680611		010	85724	89443
		SDA471700002809		010	85724	89443
02 - 11	Conventional Models with Hendrickson Front Airtex	471700131331	010	85932	89453	
		58913-003	010	85932	89453	
		58913-003L	010	85932	89453	
	Conventional Models with Neway Tag Axle Air Suspension	90044162		010	83128	89436
	Conventional Models with O.E.M. Number	10-12030-002	010	85320	89429	
		10-12032-000	010	85320	89429	
		10-12032-001	010	85320	89429	
		10-12032-002	010	85320	89429	
		10-12032-003	010	85320	89429	
		10-12032-004	010	85320	89429	
09 - 11	Models with 12000 lb Taperleaf Front Suspension	10-13809-000	010	85958
		SDA471400003920	010	85958
08 - 11	Models with Freightliner TufTrac Rear Air Suspension	16-15770-000		010	85956	...
		481700125969		010	85956	...
		SDA481700125969		010	85956	...

L - Line 8500 Series - Conventional Cab

	LT 8500 Models with Freightliner TufTrac Rear Air Suspension	16-15770-000		010	85956	...
		481700125969		010	85956	...

L - Line 9500 Series - Conventional Cab

	LT 9500 Models with Freightliner TufTrac Rear Air Suspension	16-15770-000		010	85956	...
		481700125969		010	85956	...

Legacy

- 1998	Models with FAS II Rear Air Suspension	16-13957-000		010	85724	89443
		680339		010	85724	89443
1999 -	Models with FAS II Rear Air Suspension	16-15817-000		010	85724	89443
		680611		010	85724	89443
	Models with O.E.M. Number	681-323-0900	-10	85009

M2 - Business Class

02 - 08	M2-106 Models with 10000 to 12000 lb. Taper-leaf Spring Suspension	10-12390-000	010	85920	89503	
02 - 08	M2-106 Models with 6000 to 9000 lb Front axle	10-12388-000	010	85920	89503	
09 - 19	M2-106 Models with 8000 to 16000 lb Front Axle and Taperleaf Spring	10-13760-000	010	85959	89503	
		471700002991	010	85959	89503	
		SDA471700002991	010	85959	89503	
04 - 08	M2-112 Models with 12000 lb to 20000 Front Axle	10-13211-000	010	85918	89449	
		10-13634-000	010	85918	89449	
		471700000449	010	85918	89449	
		471700131155	010	85918	89449	
09 - 19	M2-112 Models with 12000 lb to 20000 Front Axle	10-13809-000	010	85958
		471700003920	010	85958
	Models O.E.M. Number	10-13592-000	010	85959	89503	
		471700000440	010	85959	89503	
02 - 19	Models with FAS II Rear Air Suspension	16-15817-000		010	85724	89443
		16-18708-000		010	85724	89443
		471700002809		010	85724	89443
		481700006848		010	85724	89443
		680611		010	85724	89443
		SDA471700002809		010	85724	89443
02 - 15	Models with Freightliner Low Profile Rear Air Suspension (18,000 to 40,000 lb)	16-14259-000		010	85331	...
		16-18706-000		010	85331	...

APPLICATION GUIDE - TRUCKS, TRAILERS, AND BUSES

Year	Model	OEM #	Front			Rear		
			Fleetline	GasSLX		Fleetline	GasSLX	

FREIGHTLINER(Cont'd.)

M2 - Business Class(Cont'd.)

02 - 15	Models with Freightliner Low Profile Rear Air Suspension (18,000 to 40,000 lb)	47170002992	010	85331	...
			680511	010	85331
01 - 19	Models with Freightliner TufTrac Rear Air Suspension	16-15770-000	010	85956	...
		481700125969	010	85956	...
	Models with Hendrickson HMX 400/460 Haulmax with 16.5" Saddle	60680-004	01-	83143	...
		60680-004L	01-	83143	...
		H60680004	01-	83143	...
	Models with Hendrickson HMX 400/460 Haulmax with 17.5" or 18.5" Saddle Height	60680-005	01-	83142	...
		60680-005L	01-	83142	...
		H60680005	01-	83142	...
2002 -	Models with Rear 10000 lb - 15000 lb Low Profile AirLiner	16-16577-000	010	85335	...
		16-18711-000	010	85335	...
		47170002996	010	85335	...
02 - 14	Models with Rear 52" Spring ,10000 lb - 15000 lb	16-16486-000	-10	83134	...
		16-18710-000	-10	83134	...
		47170002995	-10	83134	...
02 - 14	Models with Rear 52" Spring ,18000 lb - 23000 lb	16-16442-000	-10	83134	...
		16-18709-000	-10	83134	...
		47170002994	-10	83134	...
2002 -	Models with Rear 60" Spring ,18000 lb - 23000 lb	16-15765-000	-10	85921	...
		16-18707-000	-10	85921	...
		47170002993	-10	85921	...









Severe Duty Series - 108SD, 114SD & 122SD

12 - 19	All Models with 12,000 to 16,000 lb. Front Axle and Taperleaf Spring	10-13760-000	010	85959	89503
		47170002991	010	85959	89503
12 - 17	All Models with 18,000 lb Flat Leaf Spring	10-13684-000	010	85918	89449
		47170000470	010	85918	89449
12 - 19	All Models with 20,000 lb Flat Leaf Spring	10-13809-000	010	85958
		471700003920	010	85958
12 - 14	All Models with O.E.M. Number	10-13934-000	01-	85123
		471700006929	01-	85123
12 - 19	All Models with FAS II (40,000 lb) Rear Air Suspension	16-15817-000	010	85724	89443
		16-18708-000	010	85724	89443
		47170002809	010	85724	89443
		481700006848	010	85724	89443
		680611	010	85724	89443
		SDA471700002809	010	85724	89443
12 - 19	All Models with Freightliner TufTrac Rear Air Suspension	16-15770-000	010	85956	...
		481700125969	010	85956	...
12 - 19	All Models with Hendrickson HMX 400/460 Haulmax - with 16.5" Saddle	60680-004	01-	83143	...
		60680-004L	01-	83143	...
		60680-005	01-	83142	...
		60680-005L	01-	83142	...

Additional O.E.M. Interchanges

	Models with 7000 lb Front Suspension	10-13776-000	010	85005	89430
	Models with Neway Air Suspension with shock stamping	90045083		010	85910
	Models with O.E.M. Number	10-12046-000	010	85320	89429
		10-12396-000	010	85918	89449
		10-12594-000	010	85984
		10-13051-001	010	85005	89430
		10-13859-000	010	85005	89430

APPLICATION GUIDE - TRUCKS, TRAILERS, AND BUSES

Year	Model	OEM #	Front		Rear	
						
						
			Fleetline	GasSLX	Fleetline	GasSLX

FREIGHTLINER(Cont'd.)

Additional O.E.M. Interchanges(Cont'd.)

	Models with O.E.M. Number	16-10688-000		OIO	85042	...
		16-14577-000	OIO	85043
		16-14667-000		OIO	85005	89430
		16-14668-000		OIO	83127	...
		16-14669-000	OIO	G63403
		16-14759-000	OIO	85000	89436			...
		16-15591-000		OIO	85043	...
		16-16765-000		OIO	85006	...
		16-16826-000	OIO	85904
		16-17211-000		OIO	85909	...
		16-17759-000		OIO	85919	...
		16-19138-000	OIO	85058	89431			...
		3638112		OIO	G63183	...
		4036892	OIO	G63605
		47902-13		OIO	83122	89406
		535228	OIO	85302	89420			...
		61300224	OIO	85918	89449			...
		61300240	OIO	85918	89449			...
		650224		OIO	83225	...
		651352		OIO	85042	...
		654875		OIO	83117	...
		654918	OIO	83118
		659060	OIO	85920	89503			...
		659062		-IO	83134	...
		659063		-IO	83134	...
		659300	OIO	85005	89430			...
		660235		OIO	85042	...
		665409	-IO	85009
		671908	OIO	85918	89449			...
		671945	OIO	85920	89503			...
		671946		-IO	85921	...
		680009	OIO	85302	89420			...
		680442		-IO	85319	89428
		680651		OIO	85335	...
680782	OIO	85302	89420			...		
6813230900	-IO	85009		
6813260200		OIO	85011	...		
70042	OIO	85302	89420			...		
SDA471700000440	OIO	85959	89503			...		
	Additional O.E.M. Interchanges	10-13205-000	OIO	85918	89449	
		471700131646	OIO	85918	89449	
		680008	OIO	85300 or 89419				
		680017	OIO	85302 or 89420				
		681-323-1100	OIO	85301				

FREIGHTLINER CAB SHOCKS

Argosy

00 - 06	Models with O.E.M. Number	18-37813-000	OIO	83044
---------	---------------------------	--------------	-----	--------------

Cascadia

17 - 19	Day Cab and Sleeper cabs w/OEM Number and 12 mm Top mounting bolt	18-67845-000	OIO	83906
		18-69674-000	OIO	83906
		814903012666	OIO	83906
		814903015188	OIO	83906
09 - 17	Models with 72" High-Roof Sleeper and 1/2" Top mounting bolt	18-41762-000	OIO	83038

APPLICATION GUIDE - TRUCKS, TRAILERS, AND BUSES

Year	Model	OEM #	Front		Rear	
			Fleetline	GasSLX	Fleetline	GasSLX

FREIGHTLINER CAB SHOCKS(Cont'd.)

Cascadia(Cont'd.)

09 - 17	Models with 72" High-Roof Sleeper and 1/2" Top mounting bolt	18-60764-000	010		83038
		814903003528	010		83038

Century Class

	Day Cab Suspensions with O.E.M. Number	18-32999-001	010		83006
	Models with O.E.M. Number	18-41762-000	010		83038
		18-41762-001	010		83047
		18-41762-002	010		83038
	Sleeper-Cabs with O.E. Number	18-30378-000	010		83001
		18-32999-000	010		83001

Classic

	Models with O.E.M. Number	18-29846-000	010		83009
--	---------------------------	--------------	-----	--	-------

Columbia

	Models with O.E.M. Number	18-29846-000	010		83009
03 - 17	Models with Sleeper Cabs w/O.E.M. Numbers	18-41762-000	010		83038
		18-60764-000	010		83038
		814903003528	010		83038
17 - 18	Models with Sleeper Cabs w/O.E.M. Numbers	18-69674-000	010		83906
		814903015188	010		83906

Coronado

17 - 19	Day Cab and Sleeper Cabs w/O.E.M. Numbers	18-69674-000	010		83906
		814903015188	010		83906
10 - 17	Models with Sleeper Cabs w/O.E.M. Numbers	18-41762-000	010		83038
		18-41762-002	010		83038
		18-60764-000	010		83038
		18-60765-002	010		83038
		814903003528	010		83038

FL 60, 70, 80 & 106 Series - Business Class Conventional

	Models with O.E.M. Number	18-30378	010		83006
1991 -	Trucks with Link Cabmate Models FRT153BC-A , FRT106BC or FRT106HD-A	1201-0054	010		83021
		1202-0054	010		83021

FL112 Conventional

1997 -	FL112 Business Class Day Cab Tractors with Link Cabmate Model FRT112DC	1202-1044	010		83025
--------	--	-----------	-----	--	-------

FLA - COE Truck & Tractors

1989 -	Cabover Tractors with 86", 96" & 104" Cabs with Link Cabmate Model FRT285	1202-0032	010		83016
	Models with O.E.M. Number	681-891-02-05	010		83017

FLB - COE Truck & Tractors

1993 -	90", 100", & 110" Cabs with Link Cabmate Models FRT46-2P-A or FRT46-2P-B	1201-0054	010		83021
1984 -	Cabover Tractors with 86", 96" & 104" Cabs with Link Cabmate Model FRT285	1202-0032	010		83016
		1202-0054	010		83021





FLC - 112 & 120 Conventional Tractors

1989 -	Conventional Tractors with Link Cabmate Model FRTE120-A	1201-1043	010		83025
		1202-1043	010		83025
1997 -	FL112 Models Business Class Day Cab Models with Link Cabmate Model FRT112DC	1201-1044	010		83025
- 03/88	Models with Link Cabmate FRTC120-A or FRTC120-AW Air Suspension	1201-0012	010		83023
		1202-0012	010		83023

FLD 112 & 120 Conventional Truck & Tractor

	FLD Sleeper with Air Suspension	18-29846-000	010		83009
--	---------------------------------	--------------	-----	--	-------

APPLICATION GUIDE - TRUCKS, TRAILERS, AND BUSES

Year	Model	OEM #	Front		Rear	
						
			Fleetline	GasSLX	Fleetline	GasSLX

FREIGHTLINER CAB SHOCKS(Cont'd.)

FLD Series - 112 & 120 Conventional Truck & Tractor(Cont'd.)

09/93 -	64" Able Body Sleepers with Link Bunkmate Models FRTA64 or FRTAS64-A	1202-1044	010	83025
1989 -	Conventional Tractors with Link Cabmate Model FRTE120-A	1202-1043	010	83025
	D2 Cab	18-41762-001	010	83047
		18-60765-001	010	83047
		814903003486	010	83047
01 - 12	FLD Sleeper with Air Suspension	18-29846-001	010	83064
	FLD112 Daycab with Air Suspension	18-31476-000	010	83020

M2 - Business Class

03 - 10	Crew Cab Models with O.E.M. Number	18-43504-000	010	83057
		18-60768-000	010	83057
		814903003484	010	83057
02 - 19	M2-106 Models with Spring Suspension	18-47350-000	010	83040
		18-60766-000	010	83040
		814903003482	010	83040
03 - 16	M2-112 Crew Cab Models with O.E.M. Number	18-41762-000	010	83038
		18-60764-000	010	83038
		814903003528	010	83038
03 - 18	M2-112 Day Cab Models with Leaf Spring Suspensions	18-47349-000	010	83039
		18-60767-000	010	83039
		814903003483	010	83039

Severe Duty Series - 108SD, 114SD & 122SD

12 - 19	108 SD Models with O.E.M. Number	18-60766-000	010	83040
		814903003482	010	83040
12 - 19	114 SD Models with O.E.M. Number	18-60766-000	010	83040
		814903003482	010	83040
12 - 16	122 SD Crew Cab Models with O.E.M. Number	18-60764-000	010	83038
		814903003528	010	83038
17 - 18	Models with O.E.M. Numbers	18-69674-000	010	83906
		814903015188	010	83906

Additional Applications

	Models with 60" Sleeper w/ Link Bunkmate Model FRTS60-A	1202-1043	010	83025
	Models with Link Cab Suspension	1202-0042	010	83025
		1202-0043	010	83032
		1202-0044	010	83025
	Models with O.E.M. Number	18-42613-000	010	83033
		18-44321-000	010	83009
		18-45067-000	010	83034
		18-60295-000	010	83006
		18-60765-000	010	83038
		18-60769-000	010	83009
		18-60772-000	010	83026
		18-60773-000	01-	83027
		654739	010	83009
		654819	010	83001
		654831	010	83006
		654841	010	83020
		654990	010	83038
		659079	010	83040
		659080	010	83039
		659125	010	83047
		659178	010	83038
		659288	010	83006
		814903003496	010	83009
		GBL 650361	010	83017





APPLICATION GUIDE - TRUCKS, TRAILERS, AND BUSES

Year	Model	OEM #	Front		Rear	
			Fleetline	GasSLX	Fleetline	GasSLX

FREIGHTLINER CUSTOM CHASSIS

06 - 18	B2 Bus Chassis	10-13211-000	010	85918	89449	
		10-13634-000	010	85918	89449	
06 - 18	B2 Bus Chassis With FAS II Rear Air Suspension	16-15817-000		010	85724	89443
		16-18708-000		010	85724	89443
	F65 School bus chassis with 10,000 to 18,000 lb Suspension	10-13759-000	010	85006
		47170003009	010	85006
		6803230300	010	85006
		GBL665538	010	85006
	F65 School bus chassis with Taperleaf Spring	6803260000		01-	83120	...
		GBL654725		01-	83120	...
	FB 65 Models with O.E.M. Number	10-13358-000	010	85097
	FB Shuttle bus chassis with O.E.M. Number	16-16765-000	010	85006
		471700131775	010	85006
	FedEx Trucks with O.E.M. Number	MAE16950	010	83118
		P117146	010	83118
	Fleetwood Motor Home with O.E.M. Number	GBL 651375	010	83119
		RW24285	010	83119
06 - 08	Front - Engine Diesel Chassis (FRED Chassis)	16-18095-000		01-	85092	...
		16-18455-000	010	85918	89449	
		471700000467		01-	85092	...
		471700002726	010	85918	89449	
	MB Chassis (VIP bus)	16-16827-000		010	85331	...
		16-17760-000		010	85331	...
		471700131778		010	85331	...
	MB55 & MT55 Models	16-17684-000	010	85058	89431	
	MB55 Chassis	16-17759-000	010	85919
		471700000447	010	85919
	MB55 Shuttle bus w/8000 lb. flat leaf front suspension	16-15676-000	010	85058	89431	
96 - 99	MC Chassis for Class A Motorhomes	654918	010	83118
		P117099		01-	83120	...
		P117146	010	83118
	MC Chassis with Hendrickson Softek Front Suspension	16-18094-000	010	85959
		471700000466	010	85959
	MC Chassis with O.E.M. Number	16-18456-000		010	85959	...
		471700002727		010	85959	...
	MC-L Chassis with 9,000 lb Suspension	16-18455-000	010	85918	89449	
		471700002726	010	85918	89449	
	M-Line Walk in Van with O.E.M. Number	MAE 16949		01-	83120	...
		MAE 16950	010	83118
		P117099		01-	83120	...
		P117146	010	83118
- 2018	Models with B2 Bus Chassis & 15000 lb Rear Suspension	6803260000		01-	83120	...
	Motor Homes with O.E.M. Number	P116168		010	83117	...
	MP 14 and MP 19 Chassis	16-15475-000	010	83164
	MP14 and 19 (UPS)	P117253	010	83116
	MT135	GBL654875		010	83117	...
	MT45 Step Van	16-15064-000		01-	83154	...
	MT45 Step Van - Rear - w/35" Front Spring - w/38" Front Spring	16-15394-000		01-	83120	...
		16-15473-000	010	83157
		16-15474-000	010	83157
		16-15089-000	010	83164
	MT55 Step Van	16-15436-000		01-	83154	...
		16-15705-000		01-	83120	...
		16-15934-000		01-	83120	...







APPLICATION GUIDE - TRUCKS, TRAILERS, AND BUSES

Year	Model	OEM #	Front		Rear	
						
			Fleetline	GasSLX	Fleetline	GasSLX

FREIGHTLINER CUSTOM CHASSIS(Cont'd.)

	MT55 Step Van	16-16262-000 16-16542-000		O -	83120	...
				O -	83154	...
	MT55 Step Van - w/35" Front Spring	16-15473-000 16-15474-000	O O	83157
	- w/38" Front Spring	16-15089-000	O O	83164
	MT55 Utility Van w/8000 lb. flat leaf front suspension	16-15676-000	O O	85058	89431	
	Oshkosh Motor Home with O.E.M. Number	1398980 GBL654875		83127	...	O O	83127	...
				O O	83117	...
	School Bus Chassis with 7,000 lb Suspension	10-13859-000 471700005079	O O	85005	89430	
			O O	85005	89430	
	Shuttle Bus Chassis	16-16082-000	O O	85043
	Step Van and Motorhome chassis with O.E.M. Number	16-15475-000	O O	83164
	Step Van Models with O.E.M. Number	16-19138-000 471700003011	O O	85058	89431	
			O O	85058	89431	
09-12	Type C School bus chassis with O.E.M. Number	16-18713-000 471700003070		O -	85122	...
				O -	85122	...
03 - 07	VC Chassis ADL200 Suspension w/ 20K Rear	16-16873-000 471700131974		O O	85029	...
	Rear Shock with O.E.M. Number	141700131809		O O	85029	...
		16-16736-000		O O	85029	...
	ZF - IFS Front Suspension with 23,000 lb GVW or Greater	16-18103-000 481700000493	- -	85900
			- -	85900
93 - 07	VC Chassis (Up To 22000 lb GVW) AS120 Front Suspension	16-16737-000	O O	83160
	XC & XB MotorHome Chassis with Neway AS-120, 10,500 lb Front Air Suspension	141700000377 16-18075-000	O O	83174
			O O	83174
	XC & XB MotorHome Chassis with Neway AS-120, 12,000 lb Front Air Suspension	141700000378 141700131975 16-16874-000 16-18076-000	O O	83160
			O O	83160
			O O	83160
			O O	83160
03 - 07	XC Chassis ADL200 Suspension w/ 20K Rear AS120 Front Suspension	16-16873-000 141700131810 16-16737-000 16-16874-000	O O	O O	85029	...
			O O	83160
			O O	83160
	Rear Shock with O.E.M. Number	141700131809		O O	85029	...
		16-16736-000		O O	85029	...
	ZF - IFS Front Suspension with 23,000 lb GVW or Greater	16-18103-000 481700000493	- -	85900
			- -	85900
93 - 07	XC Chassis (Up To 22000 lb GVW) AS120 Front Suspension	16-16737-000	O O	83160
	XC MotorHome Chassis with ZF- IFS, 12,000 lb Front Air Suspension	16-17144-000 16-17361-000 481700000477 481700131919	- -	85900
			- -	85900
			- -	85900
			- -	85900
00 - 02	XCS Chassis (22000 lb GVW) w/ O.E.M. Number	16-15592-000 16-15755-000 16-16043-000	O -	83154
			O O	85043
			O O	85043
01 - 02	XCS Chassis with Freightliner Rear Air Suspension	16-16093-000	O O	83160
	Models with O.E.M. Number	16-14794-000 16-16083-000		O -	83154	...
				O O	85331	...

APPLICATION GUIDE - TRUCKS, TRAILERS, AND BUSES

Year	Model	OEM #	Front		Rear	
						
						
			Fleetline	GasSLX	Fleetline	GasSLX

FREIGHTLINER CUSTOM CHASSIS(Cont'd.)

Models with O.E.M. Number	16-16836-000						
	654953	010	85058	89431	01-	83154	...
	659227	010	85058	89431	
	GBL 654870	010	83116
	GBL654918	010	83118
Additional O.E.M. Interchanges	1745500	010	89430				
	659104	010	85097				
	66554540I	010	89430				
Models with O.E.M. Number	16-15805-000		01-	83120	...

FRUEHAUF

"L" Suspensions	UCD-006216-001						
"T" Suspensions	UCE-1295-901		010	83203	89436
"T" Suspensions With Drop Frame (NT Construction)	UCF-8339-001		010	85300	89419
	UCF-8339-002		010	85321	...
All with Air Suspension and O.E.M. Number	UCE-1295-1		010	85321	...
All with Lift Axle	UCE-9399-1		010	85300	89419
Model "T" Low Mount with 48 ft drop-deck trailer	010	83122	89406
Model UCA-5431	5352858		010	85327	...
Model W24T1 Air Ride	UCE-2983-000		010	85305	...
	UCE-2983-001		010	85322	...
Tractor & Trailer Lift Axle with O.E.M. Number	5116-117		010	85322	89406
Models with O.E.M. Number	144-5910		010	83122	89406
	680117		010	85300	89419
	680298		010	85300	89419
	UCA-01113		010	85321	...
	UCA-5431		010	85304	...
	UCD-6216-1		010	85305	...
	UCE-2983-1		010	83203	89436
	UEY 1124-001		010	85322	...
			010	85030	89440

FWD TRUCK

Models with O.E.M. Number	450739						
		010	85302	89420	

GENERAL TRAILER CO

Models with Air Suspension	120-1						
Additional O.E.M. Interchanges	12608	010	83125				









GEORGIE BOY MANUFACTURING

Models with Workhorse UFO Chassis with Hendrickson Softek Front Suspension	66153-002						
	F4-BE5-C832-MO	010	83124	89407	
		010	83124	89407	

Class A MotorHomes

99 - 09	All Series MotorHomes with Ford F53 Chassis with 16,000 lb GVW to 22,000 lb GVW	1C34-18045-AA						
		1C34-18045-JA	010	83209	89414		...	
		9U94-18045-AA	010	83209	89414		...	
		9U94-18080-AA	010	83209	89414		...	
		9U9Z-18124-A	010	010	83122	89406
		9U9Z-18125-A	010	83209	89414		...	
		ASH-1022	010	010	83122	89406
		ASH-1023	010	83209	89414		...	
		ASH-1205	010	010	83122	89406
		ASH-1206	010	83209	89414		...	
		ASH-1228	010	010	83122	89406
		ASH-1229	010	83209	89414		...	

APPLICATION GUIDE - TRUCKS, TRAILERS, AND BUSES

Year	Model	OEM #	Front		Rear	
						
						
			Fleetline	GasSLX	Fleetline	GasSLX

GEORGIE BOY MANUFACTURING(Cont'd.)

Class A MotorHomes(Cont'd.)

99 - 09	All Series MotorHomes with Ford F53 Chassis with 16,000 lb GVW to 22,000 lb GVW	ASH-1230		010	83122	89406
		ASH-137		010	83122	89406
		ASH-25822	010	83209	89414	
		ASH-25823	010	83209	89414	
		ASH-25824		010	83122	89406
		ASH-294	010	83209	89414	
		AT-620	010	83209	89414	
		AT-621		010	83122	89406
		AT-766	010	83209	89414	

Class C MotorHomes

99 - 09	Maverick Series MotorHomes with Ford E450 Chassis	ASH-1136		-10	83178	...
		ASH-1154	-10	83177

GILLIG BROS.





	Models with Neway Air Suspension with shock stamping	90045084		010	85968	...
	Models with Neway ARD-234 Models Truck & Tractor Air Suspension (ARD-234-6)	90044046		010	83123	89405
	Phantom Models (30 Foot) with O.E.M. Number	90-2164 SP1	01-	85723
00 - 11	Phantom Models with O.E.M. Number	90-2627		010	...	89461
	School Bus w/1" Mounting Pins	200-171		85304	...	010	85304	...
		53-176		85304	...	010	85304	...
	School Bus w/3/4" Mounting Pins	57113	010	83219
		57131		010	83216	...
	Transit Bus, Phantom 55, 40, TB40	53-14010		-1-	85318	...
		53-24685	01-	85723
		695110		-1-	85318	...
		90F-1912		-1-	85318	...
	Models with O.E.M. Number	1583470		010	85051	...
		695109	01-	85723
		82-01878		83122	...	010	83122	89406
		90044683		010	83122	89406
		90044769		010	83207	89407
		90044770		010	83207	89407
		90-1951-SP1		010	85734	...
		90-1968	010	85712
		90-2423	01-	85723
		H53-02132-14005	01-	85723
		H53-20415-006		010	85051	...
		MR6394	01-	85723
	Additional O.E.M. Interchanges	53-02132	01-				85723	
		53-02133-000	-1-				85318	
		53-13952-000	-1-				85722	
		53-14005-000	01-				85723	
		665568	010				85051	
		680009	010				85302 or 89420	
		680333	-1-				85708	
		70034	010				85302 or 89420	
		82-21542-000	010				85716	
		82-30159-000	-1-				85708	
		90-1908	01-				85723	

GLAVAL BUS CO.

Concorde II - Series

00 - 15	Models with F-650 chassis with 10,000 lb Front Suspension	3584116C1	010	83175
----------------	---	-----------	-----	-------	-----	-----	-----	-----

APPLICATION GUIDE - TRUCKS, TRAILERS, AND BUSES

Year	Model	OEM #	Front		Rear	
						
			Fleetline	GasSLX	Fleetline	GasSLX

GLAVAL BUS CO.(Cont'd.)

Concorde II - Series(Cont'd.)

00 - 15	Models with F-650 chassis with 10,000 lb Front Suspension	3584116C2 4C4Z-18124-QA AA-616	010	83175
			010	83175
			010	83175
00 - 15	Models with F-650 chassis with 12,000 & 13,200 lb Front Springs	3584118C2 4C4Z-18124-JB 4C4Z-18124-RA AA-617 AT-812	010	85928
			010	85928
			010	85928
			010	85928
			010	85928
July/2015 - 19	Models with F-650 chassis with 13,500, 15,500 & 19,000 lb Multi-leaf Rear Springs	471700011531 ASH-24660 FC44-18080-AB FC4Z-18125-A	010	85180	...
			010	85180	...
			010	85180	...
			010	85180	...
July/2015 - 19	Models with F-650 chassis with 19.5" or 22.5" Wheels (22,000 lb GVW)	471700011530 ASH-24658 ASH-24659 FC44-18045-BB FC4Z-18124-A FC4Z-18124-B	010	85181
			010	85181
			010	85181
			010	85181
			010	85181
			010	85181
- 2015	Models with F-650 chassis with 21,000 lb Rear Air Suspension	3578858C1 3578858C2 4C4Z-18125-DA	010	85926	...
			010	85926	...
			010	85926	...
04 - 11	Models with F-650 chassis with 22,000 lb Multi-leaf Rear Springs	4C4Z-18125-B 501906C92	-10	83317	...
			-10	83317	...

E350 & E450 Ford Chassis Models

- 2019	Primetime Series Shuttle buses with Ford E350 Chassis	ASH-1136 ASH-1154	-10	83178	...
			-10	83177
- 2019	Sport Series Shuttle buses with Ford E350 Chassis	ASH-1136 ASH-1154	-10	83178	...
			-10	83177
- 2019	Universal Series Shuttle buses with Ford E350 & E450 Chassis	ASH-1136 ASH-1154	-10	83178	...
			-10	83177

GMC TRUCK

		1591501	-1-	85722	...
--	--	---------	-----	-----	-----	-------	-----









3500 & 4000 Series

60 - 62	3500, 4000, B-4000, L-4000, S-4000 with H-130, H-150 and 13800 Axles	010	83221	...
63 - 66	Truck and School Bus	010	85005	89430	010	83221

4500 Series

66 - 72	CE-4500, CS-4500 Conventional Cab with V-8 Gas or In-line 6 Gas Engines	22012096 3192892	83221	...	010	83221	...
			83221	...	010	83221	...
66 - 72	EG-4500, EM-4500, ES-4500 Cab/Cowl with V-6 Gas or Diesel or In-line 6 Gas Engines	3171068 3192657 4940614 4963853 4963854 22012095 3171462 3192890	010	83216
			010	83216
			010	83216
			010	83216
			010	83216
			010	83126	89430
			010	83126	89430
72 - 80	PS4620 P, 4650P Step Van (Walk-in) 3/4" Upper bolt	22002293 22007701 22012095	010	83126	89430
			010	83126	89430
			010	83126	89430

APPLICATION GUIDE - TRUCKS, TRAILERS, AND BUSES

Year	Model	OEM #	Front		Rear	
						
						
			Fleetline	GasSLX	Fleetline	GasSLX

GMC TRUCK(Cont'd.)

4500 Series(Cont'd.)

72 - 80	PS4620 P, 4650P Step Van (Walk-in) 3/4" Upper bolt	22012166 3192890 4940606 4975497	O10	83126	89430	
			O10	83126	89430	
			O10	83126	89430	
			O10	83126	89430	
72 - 80	PS4620 P, 4650P Step Van (Walk-in) 5/8" Upper bolt	22007751	O10	83303	
72 - 80	PS4620 P, 4650P Step Van (Walk-in)	22012096 3192892		O10	83221	...
				O10	83221	...

5000 Series

60 - 62	5000, B-5000, L-5000, S-5000 with 1618 or 16802 Axle	O10	83221	...
75 - 80	C Chassis - Conventional Cab	4975510	O10	83221
76 - 89	C Chassis - Conventional Cab	22002294	O10	83304
		22007752	O10	83304
		22007757	O10	83304
		22012096		O10	83221	...
		22012196		O10	83221	...
73 - 80	C, S Chassis - Conventional Cab	22007750	O10	83207	89407	
		4975467	O10	83207	89407	
		4975494	O10	83207	89407	
73 - 80	C,S Chassis - Conventional Cab and School Bus	22012096		O10	83221	...
		3192892		O10	83221	...
73 - 89	C,S Chassis - Conventional Cab and School Bus	22012095 22012166		O10	83126	89430
60 - 68	SP-5000, DSP-5000 School Bus	O10	85302	89420	O10	85307	...
63 - 66	Truck and School Bus	O10	85005	89430	
63 - 68	W-5000, BW-5000, DW-5000	O10	85005	89430	





5500 Series

66 - 72	CE-5500, CS-5500 Conventional Cab with V-8 Gas or In-line 6 Gas Engines	22012096 3192891 3192892		83221	...	O10	83221	...
				83221	...	O10	83221	...
				83221	...	O10	83221	...
66 - 72	CG-5500, CM-5500, T-5500 Conventional & Tilt Cab with V-6 Gas or Diesel Engines	22012095	O10	83126	89430	
		3192890	O10	83126	89430	
		4940606	O10	83126	89430	
66 - 72	EG-5500, EM-5500, ES-5500 Cab/Cowl with 6 Cyl. Engines	3171068	O10	83216
		3192657	O10	83216
		4940614	O10	83216
		4963853	O10	83216
		4963854	O10	83216
		22012095		O10	83126	89430
		3171462		O10	83126	89430
3192890		O10	83126	89430		
60 - 68	LW-5500	O10	85307	
67 - 68	Truck and School Bus	O10	85005	89430	O10	83221	...
63 - 68	W-5500	O10	85005	89430		...	

6000 Series

76 - 89	C Chassis - Conventional Cab	22002294 22007752 22007757	O10	83304
			O10	83304
			O10	83304
75 - 80	C, S Chassis - Conventional Cab and School Bus	4975510	O10	83221	
79 - 89	C, S Chassis - Conventional Cab and School Bus	22002295	O10	83303	
		22007753	O10	83303	
		22017530	O10	83303	
		22017531	O10	83303	

APPLICATION GUIDE - TRUCKS, TRAILERS, AND BUSES

Year	Model	OEM #	Front		Rear	
			 Fleetline	 GasSLX	 Fleetline	 GasSLX

GMC TRUCK(Cont'd.)









6000 Series(Cont'd.)

73 - 75	C, S Chassis - Conventional Cab and School Bus - Exc. with 18500, 20800 & 23000 lb Rear Axle	22007750	010	83207	89407	
		4975467	010	83207	89407	
		4975494	010	83207	89407	
73 - 89	C, S Chassis - Conventional Cab and School Bus - Exc. with 18500, 20800 & 23000 lb Rear Axle	22012096		010	83221	...
		22012169		010	83221	...
		3192892		010	83221	...
73 - 89	C, S Chassis - Conventional Cab and School Bus with 18500, 20800 & 23000 lb Rear Axle	22012095		010	83126	89430
		22012166		010	83126	89430
		4940606		010	83126	89430
73 - 80	C, S, T Chassis - Conventional & Tilt Cab and School Bus with 5000 & 7000 lb Axle	22002293	010	83126	89430	
		22007701	010	83126	89430	
		22007751	010	83303
		22012095	010	83126	89430	
		3192890	010	83126	89430	
		4940606	010	83126	89430	
		4940662	010	83126	89430	
		4975497	010	83126	89430	
63 - 68	DW - 6000	010	85005	89430	
60 - 68	L - 6000	010	85307
79 - 89	S Chassis - School Bus	22002294	010	83304
		22007702	010	83304
		22007752	010	83304
		22007757	010	83304
79 - 80	W Chassis - 72" BBC Steel Tilt Cab	22002293	010	83126	89430	
		22007751	010	83303

6500 Series

75 - 76	C, M Chassis - Conventional Cab	4975510	010	83221
76 - 89	C, M Chassis - Conventional Cab	22002294	010	83304
		22007752	010	83304
		22007757	010	83304
73 - 75	C, M Chassis - Conventional Cab with 9000 & 12000 lb Axle	22012095	010	83126	89430	
		3192890	010	83126	89430	
		4940606	010	83126	89430	
		4940614	010	83216
		4963854	010	83216
		4975497	010	83126	89430	
75 - 89	C, M Chassis - Conventional Cab with 9000 & 12000 lb Axle	22002295	010	83303
		22007751	010	83303
		22017530	010	83303
		22017531	010	83303
		4975511	010	83303
73 - 75	C, M, S Chassis - Conventional Cab and School Bus	22007750	010	83207	89407	
		4975467	010	83207	89407	
		4975494	010	83207	89407	
73 - 80	C, M, S Chassis - Conventional Cab and School Bus - Exc. with 20800 or 23000 lb Rear Axle	22012096		010	83221	...
		22012169		010	83221	...
		3192892		010	83221	...
73 - 80	C, M, S Chassis - Conventional Cab and School Bus with 20800 or 23000 lb Rear Axle	22012095		010	83126	89430
		22012166		010	83126	89430
		4940606		010	83126	89430
73 - 80	C, S, T Chassis - Conventional & Tilt Cab and School Bus	22002293	010	83126	89430	

APPLICATION GUIDE - TRUCKS, TRAILERS, AND BUSES

Year	Model	OEM #	Front		Rear	
						
						
			Fleetline	GasSLX	Fleetline	GasSLX

GMC TRUCK(Cont'd.)

6500 Series(Cont'd.)

73 - 80	C, S, T Chassis - Conventional & Tilt Cab and School Bus	22012095	OIO	83126	89430	
		3192890	OIO	83126	89430	
		4940606	OIO	83126	89430	
		4975497	OIO	83126	89430	
66 - 72	CE-6500, CM-6500 Conventional Cab with V-6 Diesel or V-8 Gas Engine	3192892		OIO	83221	...
66 - 72	CE-6500, ME-6500 Conventional Cab with V-8 Gas Engine - Exc. 11000 lb Axle	22012096	OIO	83221
		3192891	OIO	83221
		3192892	OIO	83221
66 - 72	CE-6500, ME-6500 Conventional Cab with V-8 Gas Engine with 11000 lb Axle	22012095	OIO	83126	89430	
		3192890	OIO	83126	89430	
		4940606	OIO	83126	89430	
66 - 72	CM-6500, TE-6500, TM-6500 Conventional Cab with V-6 Diesel or V-8 Gas Engine	22012095	OIO	83126	89430	
		22012096		OIO	83221	...
		3192890	OIO	83126	89430	
		4940606	OIO	83126	89430	
66 - 72	EG-6500, DM-6500, ES-6500 Cab/Cowl with V-6 Gas or Diesel or In-line 6 Gas Engines	3171068	OIO	83216
		3192657	OIO	83216
		4963853	OIO	83216
		22012095		OIO	83126	89430
		3171462		OIO	83126	89430
		3192890		OIO	83126	89430







7000 Series

79 - 89	C, M Chassis - 97" BBC Conventional Cab	22002294	OIO	83304
		22002295	OIO	83303
		22007752	OIO	83304
		22007753	OIO	83303
		22007757	OIO	83304
		22017530	OIO	83303
		22017531	OIO	83303
79 - 81	C, M Chassis - 97" BBC Conventional Cab - Exc. with 18500, 20800 & 23000 lb Rear Axle	22012096		OIO	83221	...
		2212169		OIO	83221	...
79 - 89	C, M Chassis - 97" BBC Conventional Cab with 18500, 20800 & 23000 lb Rear Axle	22012095		OIO	83126	89430
		22012166		OIO	83126	89430
79 - 80	W Chassis - 72" BBC Steel Tilt Cab	22002293	OIO	83126	89430	
		22007751	OIO	83303

7500 Series

66 - 69	72" BBC Tilt Cab	22012095	OIO	83126	89430	
		3171462	OIO	83126	89430	
		4940606	OIO	83126	89430	
66 - 72	72" BBC Tilt Cab with V-6 2 Cycle Diesel Engine with 17221 Axle	22012096		OIO	83221	...
		3192892		OIO	83221	...
66 - 72	72" BBC Tilt Cab with V-6 2 Cycle Diesel Engine with 19101 and 19201 Axle	4940600		OIO	83209	89414
70 - 72	72" BBC Tilt Cab with Air Brakes - Exc. Gas Engine	22012095	OIO	83126	89430	
		3171462	OIO	83126	89430	
		4940606	OIO	83126	89430	
70 - 72	72" BBC Tilt Cab with Air Brakes & Gas Engine	22012091	OIO	85303	89422	
		5552452	OIO	85303	89422	
66 - 72	92" BBC Conventional Cab with Tapered 2-Leaf Softride 11000 lb Rating and F120 Axle (12000 lb)	22046483	OIO	85304

APPLICATION GUIDE - TRUCKS, TRAILERS, AND BUSES

Year	Model	OEM #	Front		Rear	
						
						
			Fleetline	GasSLX	Fleetline	GasSLX

GMC TRUCK(Cont'd.)





7500 Series(Cont'd.)

66 - 72	92" BBC Conventional Cab with Tapered 2-Leaf Softride 11000 lb Rating and F120 Axle (12000 lb)	22052336	010	85304	
		3171069	010	85304	
66 - 72	92" BBC Conventional Cab with Tapered 2-Leaf Softride 7000 & 9000 lb Rating and F070, F090, F120 Axle (7000, 9000 & 12000 lb)	3171068	010	83216	
		3192657	010	83216	
		4940614	010	83216	
		4963853	010	83216	
		4963854	010	83216	
77 - 80	H, J Chassis - 92" BBC Conventional Cab	4963854	010	83216	
		4984526	010	83216	
73 - 80	H, J, M Chassis - 92" & 114" BBC Conventional Cab	22046483	010	85304	
		22052336	010	85304	
		3171069	010	85304	
73 - 80	H, J, M Chassis - 92" & 114" BBC Conventional Cab with V-6, V-8 Gas or V-6 Diesel Engines	4940614	010	83216	
		4963854	010	83216	
73 - 80	R Chassis - Rear Engine Bus	22012090	010	85308	89422	
		22012091		010	85303	89422
		5552451	010	85308	89422	
		5552452		010	85303	89422
		5552456		010	85307	...
73 - 80	T, W Chassis - 72" BBC Steel Tilt Cab with V-6 Diesel Engine	22007751	010	83303	
		22012095	010	83126	89430	
		4940606	010	83126	89430	
		4975497	010	83126	89430	
73 - 80	T, W Chassis - 72" BBC Steel Tilt Cab with V-6 Gas Engine	22012091	010	85303	89422	
		5552452	010	85303	89422	

8500 Series

66 - 72	72" BBC Tilt Cab	5544060	010	85302	89420	
1967	92" BBC Conventional Cab	3171068	010	83216	
		3192657	010	83216	
		4940614	010	83216	
		4963853	010	83216	
		4963854	010	83216	
66 - 72	92" BBC Conventional Cab with 7000 & 9000 lb Axles	22046483	010	85304	
		22052336	010	85304	
		3171069	010	85304	
79 - 80	D, F Chassis - 54" BBC Aluminum Tilt Cab	22046483	010	85304	
		22052336	010	85304	
		3171069	010	85304	
79 - 82	H, J Chassis - 92" BBC Conventional Cab 4 x 2 with Air Suspension	22012065		010	85304	...
		22046483		010	85304	...
		22052336		010	85304	...
		3171069		010	85304	...
73 - 81	H, J Chassis - 92" BBC Conventional Cab with V-6, V-8 Gas Engine	4940614	010	83216	
		4963854	010	83216	
		4984526	010	83216	
73 - 86	H, J, M Chassis - 92" & 114" BBC Conventional Cab	22046483	010	85304	
		22052336	010	85304	
		3171069	010	85304	
73 - 80	R Chassis - Rear Engine Bus	22012090	010	85308	89422	
		22012091		010	85303	89422
		5552451	010	85308	89422	

APPLICATION GUIDE - TRUCKS, TRAILERS, AND BUSES

Year	Model	OEM #	Front		Rear	
						
			Fleetline	GasSLX	Fleetline	GasSLX

GMC TRUCK(Cont'd.)

8500 Series(Cont'd.)

73 - 80	R Chassis - Rear Engine Bus	5552452		○ ○	85303	89422
		5552456		○ ○	85307	...
73 - 80	T, W Chassis - 72" BBC Steel Tilt Cab with V-6 Gas Engine	22012091	○ ○	85303	89422	
		5552452	○ ○	85303	89422	

9500 Series

66 - 72	48" BBC Aluminum Tilt Cab	5552454	○ ○	85302	89420	
66 - 72	72" BBC Steel Tilt Cab	22012091	○ ○	85303	89422	
		5552452	○ ○	85303	89422	
67 - 72	92" & 114" BBC Conventional Cab	3171068	○ ○	83216
		3192657	○ ○	83216
		4940614	○ ○	83216
		4963853	○ ○	83216
		4963854	○ ○	83216
73 - 89	D, F Chassis - 54" BBC Aluminum Tilt Cab with Rear GM Air Ride Suspension (4 Req'd)	22012065		85304	...	○ ○	85304	...
		22046483		85304	...	○ ○	85304	...
		22052336		85304	...	○ ○	85304	...
		3171069		85304	...	○ ○	85304	...
73 - 89	H, J Chassis - 92" BBC Conventional Cab with Rear GM Air-Ride Suspension (4 req'd)	22012065		85304	...	○ ○	85304	...
		22046483		85304	...	○ ○	85304	...
		22052336		85304	...	○ ○	85304	...
		3171069		85304	...	○ ○	85304	...
77 - 89	M, N Chassis - 114" BBC Conventional & 108" BBC Aluminum Conventional Cab with Rear GM Air-Ride Suspension (4 req'd)	22046483		85304	...	○ ○	85304	...
		22052336		85304	...	○ ○	85304	...
		3171069		85304	...	○ ○	85304	...
73 - 80	T, W Chassis - 72" BBC Steel Tilt Cab	22012091	○ ○	85303	89422	
		5552452	○ ○	85303	89422	

B - Series - School Bus

90 - 98	B7 Model School Bus Chassis w/11000, 13500, 15000 lb Taperleaf Springs	22064231		- -	85324	...
90 - 06	B7 Model School Bus Chassis w/15000, 19000, 21000 lb Multileaf Springs	15174902		- -	85071	...
		22064232		- -	85071	...
- 2009	B6 , B7 Models with O.E.M. Number	15123676	- -	83136
		15588554	- -	83136
		22064230	- -	83136
		88982682	- -	83136

C - Series (C4500, C5500) Topkick

04 - 09	C Chassis - Conventional Cab (Non 4x4 Option) with 13,500 Multi-leaf Spring	15185644		○ ○	83155	...
		508-89		○ ○	83155	...
		L-12706		○ ○	83155	...
1990 -	C Chassis - Conventional Cab with 11000, 13500, 15000 lb Taperleaf Springs	22064231		- -	85324	...
90 - 09	C Chassis - Conventional Cab with 15000, 19000, 21000 lb Multileaf Springs	15174902		- -	85071	...
		22064232		- -	85071	...
		88982686		- -	85071	...
90 - 06	C Chassis - Conventional Cab with 16900 or 17850 lb Taperleaf Springs	21998392		- -	85336	...
		22064489		- -	85336	...
		88963409		- -	85336	...
1990 -	C Chassis - Conventional Cab with 19000, 21000, 23000 lb Taperleaf Springs (EXC Low Profile Vehicle)	22064233		- -	83136	...
83 - 99	C Chassis - Conventional Cab with 9100 to 17500 lb Rear Axle	22064432		○ ○	85050	...

APPLICATION GUIDE - TRUCKS, TRAILERS, AND BUSES

Year	Model	OEM #	Front			Rear		
			Fleetline	GasSLX		Fleetline	GasSLX	

GMC TRUCK(Cont'd.)

C - Series (C4500, C5500) Topkick(Cont'd.)

90 - 09	C Chassis - Conventional Cab with Front Shock with O.E.M. Number	15123676	- -	83136	...	0 0
			- -	83136	...	0 0
			- -	83136	...	0 0
			- -	83136	...	0 0
			- -	83136	...	0 0
			- -	83136	...	0 0
03 - 09	C Chassis - Conventional Cab with Taperleaf Rear Suspension	15185643		0 0	83153	...
	Models with O.E.M. Number	88982684	- -	83136	...	0 0
		88982688		- -	85336	...





C - Series (C6500, C7500, C8500) Topkick

90 - 09	Conventional Cab Front Shock with O.E.M. Number	15123676	- -	83136	...	0 0
			- -	83136	...	0 0
			- -	83136	...	0 0
			- -	83136	...	0 0
			- -	83136	...	0 0
			- -	83136	...	0 0
			- -	83136	...	0 0
			- -	83136	...	0 0
			- -	83136	...	0 0
			- -	83136	...	0 0
04 - 08	Conventional Cab (Low Profile) with 12000, 15000, & 17000 lb Leaf Spring	15174901		- -	85342	...
				507-22	...	- -	85342	...
				88982685	...	- -	85342	...
1990 -	Conventional Cab w/11000, 13500, 15000 lb Taperleaf Springs	22064231		- -	85324	...
90 - 06	Conventional Cab w/16900 or 17850 lb Taperleaf Springs	21998392		- -	85336	...
				22064489	...	- -	85336	...
				88963409	...	- -	85336	...
1990 -	Conventional Cab w/19000, 21000, 23000 lb Taperleaf Springs (EXC Low Profile Vehicle)	22064233		- -	83136	...
04 - 08	Conventional Cab with 19000 lb Leaf Spring	15174903		- -	85342	...
				507-23	...	- -	85342	...
				88982687	...	- -	85342	...
83 - 99	Conventional Cab with 9100 to 17500 lb Rear Axle	22064432		0 0	85050	...
95 - 02	Models with Hendrickson Air Suspension (Stamping number 47902-13)	12474915		0 0	83122	89406
				15963161	...	0 0	83122	89406
96 - 02	Models with Hendrickson Air Suspension (Stamping number 47902-29)	12474917		0 0	83137	...
				15740554	...	0 0	83137	...
	Models with O.E.M. Number	88982684	- -	83136	...	0 0
		88982688		- -	85336	...

Coaches

4100, 4900 Models	3182842	85711	...	- 0	85711	...
		85711	...	- 0	85711	...
		85711	...	- 0	85711	...
		85711	...	- 0	85711	...
4500, 5300 Models	3166657	85700	...	0 0	85700	...
		85700	...	0 0	85700	...
Models with O.E.M. Number	3175509	85735	...	0 0	85735	...
		85700	...	0 0	85700	...
		85700	...	0 0	85700	...
		85700	...	0 0	85700	...
		85700	...	0 0	85700	...

APPLICATION GUIDE - TRUCKS, TRAILERS, AND BUSES

Year	Model	OEM #	Front		Rear	
						
			Fleetline	GasSLX	Fleetline	GasSLX

GMC TRUCK(Cont'd.)

Coaches(Cont'd.)

Year	Model	OEM #	Fleetline	GasSLX	Fleetline	GasSLX	
	Models with O.E.M. Number	5304059	85700	...	010	85700	...
		5316784	85700	...	010	85700	...
		5316794	85700	...	010	85700	...
		5316984	85313	...	010	85313	...
		5352857	85700	...	010	85700	...
		5527271	85700	...	010	85700	...
		5527272	85700	...	010	85700	...
		5549924	85700	...	010	85700	...

P - Series

92 - 96	Motorhome Chassis	22064231	-1-	85324	...
		22064233	-1-	83136	...

T - Series (T5500, T6500, T7500, T8500)

1997 -	FL1 Tilt Cab with 8100 lb Axle	22064804	-1-	83136	
		22064805	-1-	83136	
		22165187	-1-	83136	
		22165188	-1-	83136	
1997 -	FL2 Tilt Cab with 5000 to 11000 lb Axle	22064807	-1-	83136	
		22166442	-1-	83136	
1997 -	FL3 Tilt Cab with 14575 lb Axle	22064806	-1-	83136	
		22165189	-1-	83136	
1999	Models with Hendrickson Air Suspension (Stamping number 47902-13)	12474915		010	83122	89406
		15963161		010	83122	89406
06 - 09	Tilt Cab Models with O.E.M. Number	15174901		-1-	85342	...
		15174903		-1-	85342	...
		507-22		-1-	85342	...
		507-23		-1-	85342	...
		88982685		-1-	85342	...
		88982687		-1-	85342	...
90 - 99	Tilt Cab with 11000, 13500, 15000 lb Taperleaf Springs	22064231		-1-	85324	...
90 - 06	Tilt Cab with 15000, 19000, 21000 lb Multileaf Springs	15174902		-1-	85071	...
		22064232		-1-	85071	...
92 - 06	Tilt Cab with 16900 lb Taperleaf Springs RR SUSP(GZH) Heavy Duty	21998392		-1-	85336	...
		22064489		-1-	85336	...
		88963409		-1-	85336	...
92 - 99	Tilt Cab with 19000, 21000, 23000 lb Taperleaf Springs (EXC Low Profile Veh.)	22064233		-1-	83136	...

W - Series (Isuzu)

	Models with O.E.M. Number	8-97253664-0		010	83159	...
		97253664		010	83159	...
83 - 95	W4 Models	8-51630-666-0		010	85012	89413
		9-51630-666-0		010	85012	89413
89 - 90	W4 Models Flatlow	9-51630-647-1	-10	83515
89 - 92	W4 Models Flatlow	8-51630-666-0		010	85012	89413
86 - 09	W4 Models with 11000 lb & 13000 lb Suspension	8-94454-986-0	-10	83515
		8-94454-987-0	-10	83515
		8-97253-620-0	-10	83515
		94454987	-10	83515
		9-51630-647-1	-10	83515
		97083027	-10	83515
		97083029	-10	83515
		97253620	-10	83515
		98232671	-10	83515
01 - 08	W4 Models with O.E.M. Number	97253651		010	83404	...

APPLICATION GUIDE - TRUCKS, TRAILERS, AND BUSES

Year	Model	OEM #	Front			Rear		
			Fleetline	GasSLX		Fleetline	GasSLX	

GMC TRUCK(Cont'd.)

W - Series (Isuzu)(Cont'd.)

02 - 14	W4 Models with O.E.M. Number	8-97253665-0 898098-0580 898098-0581 898098-0590 97253665 98098058 98098059		OIO	83159	...	
				OIO	83159	...	
				OIO	83159	...	
				OIO	83159	...	
				OIO	83159	...	
				OIO	83159	...	
				OIO	83159	...	
88 - 99	W5 Models	1-51630-217-0 1-51630-217-1 1-51630-219-1	-IO	83114	
			-IO	83114	
			-IO	83114	
03 - 09	W5 Models with 11000 lb & 13000 lb Suspension	97253620	-IO	83515	
03 - 09	W5 Models with O.E.M. Number	97253665		OIO	83159	...	
86 - 91	W6 Models	1-51630-168-1 1-51630-217-1	-IO	83515	
			-IO	83114	
	Models with O.E.M. Number	8-94057-593-0 8-97083-029-0 8-97201-960-0 898098-1250 898098-1270 90044769 90044770 94033786 94051090 94057593 94454987 9-51630-666-2 97201960 97253616 97253621 97253623 98098125 98098127	-IO	83114	
			-IO	83515	
			-IO	83515	
			-IO	83515	
			-IO	83515	
				OIO	83207	89407	
				OIO	83207	89407	
				-IO	83114	...	
			-IO	83114	
			-IO	83114	
			-IO	83515	
				OIO	85012	89413	
			-IO	83515	
			-IO	83515	
			-IO	83515	
			-IO	83515	

WCA & WIA Series

	Models with O.E.M. Number	37301-0016 37301-0021 37301-3202	OIO	85026	89417	
			OIO	85026	89417	
			OIO	85026	89417	

WH Series

	WHS, WHR, WHL or WHE Models with Front Dual Shocks	3082284	-IO	83400
--	--	---------	-----	-------	-----	--	-----	-----





Additional Applications

	1500 Models Models with Rear Suspension	35901-0005		OIO	83219	...
				OIO	83209	89414
	Models with O.E.M. Number	35901-0001		OIO	83209	89414

Additional O.E.M. Interchanges

	Models with O.E.M. Number	15642943 22024061 22025067 22025305 22046489 22065218 22065251 22099889 507-24 508-88 87-2520-00003		-IO	83136	...
				OIO	85704	...
				OIO	85704	...
				OIO	85704	...
			OIO	85303	89422	
			OIO	G63347
			OIO	85030	89440	
				-IO	85336	...
				-IO	85336	...
				OIO	83153	...
				OIO	85704	...

APPLICATION GUIDE - TRUCKS, TRAILERS, AND BUSES





Year	Model	OEM #	Front		Rear	
						
			Fleetline	GasSLX	Fleetline	GasSLX

GMC TRUCK(Cont'd.)

Additional O.E.M. Interchanges(Cont'd.)

Models with O.E.M. Number	U0109-014		- -	83400	...
Additional O.E.M. Interchanges	22007703	010				83303	
	22012067	010				85700	
	22012082	010				85702	
	22012083	-10				85711	
	22012083GS	-10				85711	
	22012114	010				85700	
	22012131	-10				85711	
	22024673	-10				85710	
	22045526	010				85702	
	22046481	010				85702	
	22046485	-10				85710	
	22046499	-10				85710	
	22052014	010				85702	
	22052424	-10				85710	
	3171696	010				85307	
	3172948	010				85303 or 89422	
	3178157	010				85700	
	3178233	010				85734	
	3188626	010				85300 or 89419	
	3188729	010				85303 or 89422	
	35901-0003	010				85301	
	35901-0004	010				83219	
	35901-0017	010				83314	
	4939852	010				85308 or 89422	
	4939967	010				85308 or 89422	
	4940601	010				83216	
	4940627	010				83203 or 89436	
	4940640	010				83216	
	4940650	010				83207 or 89407	
	4940654	010				83216	
	4940660	010				83207 or 89407	
	4963844	010				85307	
	4964853	010				83217	
	4974401	010				85700	
	4975429	010				85300 or 89419	
	4975472	-10				83161	
	4975479	-1-				83400	
	4975480	-1-				83400	
	4975501	010				85700	
	4975516	010				85702	
	4975518	010				85704	
	4975538	010				85700	
	4975549	010				83216	
	4975550	010				85702	
	507-16	010				85700	
	507-19	010				85700	
	5171068	010				83216	
	5316791	010				83219	
	5316792	010				85305	
	5316793	010				85305	
	5321920	010				85307	
	5321929	010				85307	
	5348631	010				83203 or 89436	
	5352858	010				85305	

APPLICATION GUIDE - TRUCKS, TRAILERS, AND BUSES

Year	Model	OEM #	Front		Rear	
						
			Fleetline	GasSLX	Fleetline	GasSLX

GMC TRUCK(Cont'd.)

Additional O.E.M. Interchanges(Cont'd.)

Additional O.E.M. Interchanges	5353054	010	85303 or 89422
	5355798	010	85307
	5357955	010	85300 or 89419
	5357956	010	85734
	5357959	010	85300 or 89419
	5361994	010	85734
	5374779	010	85308 or 89422
	5374999	010	85307
	5385939	010	85307
	5392387	010	85303 or 89422
	5394448	010	85305
	5394467	010	85305
	5394468	010	85735
	5455798	010	85307
	5513489	010	83216
	5513716	010	85304
	5516459	010	85305
	5522781	010	85735
	5522794	010	85308 or 89422
	5522818	010	85305
	5527001	010	85300 or 89419
	5527606	010	85305
	5531027	010	85301
	5531435	010	85307
	5531436	010	85307
	5531437	010	85307
	5532026	010	85304
	5532425	010	83207 or 89407
	5532433	010	83207 or 89407
	5532675	010	85307
	5533699	010	85302 or 89420
	5534430	010	85303 or 89422
	5534439	010	85304
	5534447	010	85303 or 89422
	5544112	010	83216
	5544581	010	85302 or 89420
	5544716	010	85304
	5544717	010	85304
	5544812	010	83308
	5544818	010	85735
5549899	010	83207 or 89407	
5549925	010	85304	
5552111	010	85304	
5552112	010	85307	
5552114	010	83216	
5552205	010	83217	
5552206	010	83214	
5552207	010	83217	
5552208	010	83217	
5552209	010	83215	
5552210	010	85308 or 89422	
5552244	010	85308 or 89422	
5552285	010	83214	
5552286	010	83217	
5552287	010	83217	

APPLICATION GUIDE - TRUCKS, TRAILERS, AND BUSES

Year	Model	OEM #	Front		Rear	
			Fleetline	GasSLX	Fleetline	GasSLX

GMC TRUCK(Cont'd.)

Additional O.E.M. Interchanges(Cont'd.)

	Additional O.E.M. Interchanges	5552288	010		83217
		5552453	010		85301
		5552527	010		85735
		5554184	010		85302 or 89420
		5554589	010		85307
		5554596	010		85303 or 89422
		5554814	010		85302 or 89420
		5554959	010		83401
		5554995	010		85305
		5559363	010		83203 or 89436
		5585939	010		85307
		684280	010		83209 or 89414
		97-2210-00156	010		85702
		97-2210-00164	-1-		85708
		97-2210-00170	01-		85733

GMC TRUCK CAB SHOCKS

	Astro Cabover (Sleeper & Non-Sleeper Trucks) with Link Cabmate Model GMC-2P-A	1202-0032	010		83016
	Brigadier Tractors with J9 Cabs with Link Cabmate Model GMC92J9	1202-0012	010		83023
2003 -	C4500 , C5500 Models Models with Link Cabmate Model GMT560	1201-1043	010		83025
		1202-1043	010		83025
1979 -	Conventional Trucks measuring 108" BBC or 116" BBC with Link Cabmate Model GMC816	1202-0012	010		83023
1990 -	TopKick Truck Cabs with Link Cabmate Model GMC104TK	1202-0054	010		83021
- 1989	TopKick Truck Cabs with Link Cabmate Model GMC92TK	1202-0012	010		83023

GOSHEN COACH

- 2019	Impule Series Shuttle buses with Ford E350 & E450 Chassis	ASH-1136		-10	83178	...
		ASH-1154	-10	83177
- 2019	Pacer II Series Shuttle buses with Ford E350 Chassis	ASH-1136		-10	83178	...
		ASH-1154	-10	83177

GRANNING SUSPENSION

	Models T950-1200, -1400, -1700	2697		010	85712	...
	Models with O.E.M. Number	1085		010	83214	...
		680162		010	85300	89419
		OE12425		010	83214	...

GREAT DANE TRAILER

Identification of the trailer suspension is necessary to determine what section of the catalog to refer to. Some possible options can be Chalmers, Hendrickson, Neway, Ridewell, Reyco.									
	Trailers with Great Dane part number	HENS-20001		010	83128	89436	
		HENS-20002		010	85000	89436	
		HENS-20126		010	85323	89436	
		HENS-21292		010	85052	...	
		HENS-23566		010	85000	89436	
		HENS-23649		010	85064	...	
		MER202447		010	85919	...	
		REY18165-01		010	85006	...	
Trailers with Great Dane part number Heavy Duty Standard	HENS-24088		010	85000	89436		
	HENS-24088		010	83128	89436		
Trailers with Reyco 86 AR / RS 1015, 1035, 3015, 3035 Slider Air Suspension		18165-01		010	85006	...	

APPLICATION GUIDE - TRUCKS, TRAILERS, AND BUSES

Year	Model	OEM #	Front			Rear		
			Fleetline	GasSLX		Fleetline	GasSLX	

GREAT DANE TRAILER(Cont'd.)

	Trailers with Reyco Suspension 87	18163-01		010	83207	89407
	Trailers with Reyco Suspension 88	18164-01		010	83122	89406

GRECH MOTORS

	Models with Freightliner M2 Chassis - See Freightliner section for proper year and model information				
- 2019	Shuttle buses with Ford E450 Chassis	ASH-1136		-10	83178	...
		ASH-1154	-10	83177

GREYHOUND BUS

	City Cruiser	12TA-01-013		85303	...	010	85303	89422
	MC5, MC7, MC8	12B-5-1		85735	...	010	85735	...
		3178157		85700	...	010	85700	...
	Additional O.E.M. Interchanges	3166657	010	85700				
		3178154	010	85735				
		3192333	010	85700				
		690029	010	85700				
		74413	010	85313				

GRUMMAN BUS









	Model 870 Flex Bus	22024506	-10	85703
		22025066	-10	85703
		22025067		010	85704	...
		22025305		010	85704	...
		97-2201-00001	-10	85703
		97-2201-00002	-10	85703
		97-2201-00003	-10	85703
		97-2201-00004	-10	85703
		97-2201-00005	-10	85703
		97-2210-00001		010	85704	...
		97-2210-00002		010	85704	...
		97-2210-00003		010	85704	...
		97-2210-00004		010	85704	...
		97-2210-00005		010	85704	...
			Additional O.E.M. Interchanges	690029	010	85700		

GULF STREAM COACH

Class A MotorHomes

03 - 06	Atrium Series MotorHomes with Freightliner XC Chassis ADL200 Suspension w/ 20K Rear AS120 Front Suspension	16-16873-000		010	85029	...		
		141700131810	010	83160		
		16-16737-000	010	83160		
		16-16874-000	010	83160		
		Rear Shock with O.E.M. Number	141700131809		010	85029	...	
		16-16736-000		010	85029	...		
		ZF - IFS Front Suspension with 23,000 lb GVW or Greater	16-18103-000	-1-	85900	
			481700000493	-1-	85900	
		02 - 06	Friendship & Scenic Cruiser Series MotorHomes with Freightliner XC Chassis ADL200 Suspension w/ 20K Rear AS120 Front Suspension	16-16873-000		010	85029	...
				141700131810	010	83160
16-16737-000	010			83160		
16-16874-000	010			83160		
Rear Shock with O.E.M. Number	141700131809				010	85029	...	
16-16736-000				010	85029	...		
ZF - IFS Front Suspension with 23,000 lb GVW or Greater	16-18103-000			-1-	85900	

APPLICATION GUIDE - TRUCKS, TRAILERS, AND BUSES

Year	Model	OEM #	Front		Rear	
						
						
			Fleetline	GasSLX	Fleetline	GasSLX

GULF STREAM COACH(Cont'd.)

Class A MotorHomes(Cont'd.)

02 - 06	ADL200 Suspension w/ 20K Rear	48170000493	- -	85900
2002	Independence Series MotorHomes with Freightliner XC Chassis							
	ADL200 Suspension w/ 20K Rear	16-16873-000		010	85029	...
	AS120 Front Suspension	141700131810	010	83160
		16-16737-000	010	83160
		16-16874-000	010	83160
	Rear Shock with O.E.M. Number	141700131809		010	85029	...
		16-16736-000		010	85029	...
	ZF - IFS Front Suspension with 23,000 lb GVW or Greater	16-18103-000	- -	85900
	48170000493	- -	85900	
02 - 04	Yellowstone Series MotorHomes with Freightliner XC Chassis							
	ADL200 Suspension w/ 20K Rear	16-16873-000		010	85029	...
	AS120 Front Suspension	141700131810	010	83160
		16-16737-000	010	83160
		16-16874-000	010	83160
	Rear Shock with O.E.M. Number	141700131809		010	85029	...
		16-16736-000		010	85029	...
	ZF - IFS Front Suspension with 23,000 lb GVW or Greater	16-18103-000	- -	85900
	48170000493	- -	85900	

Class C MotorHomes

02 - 19	BT Cruiser Series MotorHomes with Ford E350 & E450 Chassis	ASH-1136		- 0	83178	...
		ASH-1154	- 0	83177
2004	Cavalier Series MotorHomes with Ford E350 & E450 Chassis	ASH-1136		- 0	83178	...
		ASH-1154	- 0	83177
93 - 19	Conquest Series MotorHomes with Ford E350 & E450 Chassis	ASH-1136		- 0	83178	...
		ASH-1154	- 0	83177
04 - 08	Endura Series MotorHomes with Chevy Kodiak Chassis	- -	83136
03 - 08	Independence Series MotorHomes with Ford E350 & E450 Chassis	ASH-1136		- 0	83178	...
		ASH-1154	- 0	83177
00 - 08	Ultra Series MotorHomes with Ford E350 & E450 Chassis	ASH-1136		- 0	83178	...
		ASH-1154	- 0	83177
02 - 09	Yellowstone Series MotorHomes with Ford E350 & E450 Chassis	ASH-1136		- 0	83178	...
		ASH-1154	- 0	83177

HARDEE MFG

	Models with O.E.M. Number	8030223		010	83207	89407
		AS789B		010	85014	...

HAUSMAN





	Models with O.E.M. Number	695110		- -	85318	...
		695119		010	85702	...
		695198		- -	85706	...

HENDRICKSON TRAILER SUSPENSION SYSTEMS

Intraax

	AA230T & AA250T Models with O.E.M. Number	A-20002		010	85000	89436	
		A-20126		010	85323	89436	
		A-20889		010	85323	89436	
		B-22345		010	85911	...	
	AAEDL Models								
		For Models with 12" Ride Height	B-24023		010	85738	...
		For Models with 14" to 19" Ride Height	B-23316		010	85382	...

APPLICATION GUIDE - TRUCKS, TRAILERS, AND BUSES

Year	Model	OEM #	Front		Rear	
			 Fleetline	 GasSLX	 Fleetline	 GasSLX

HENDRICKSON TRAILER SUSPENSION SYSTEMS(Cont'd.)









Intraax(Cont'd.)

	For Models with 9" Ride Height	B-24579	010	85939	...
	AAEDT 30K Models (w/14" and 15" Ride Height- High Damping)	B-25436	010	85916	89430
	(w/14" Ride Height)	B-23361	010	85911	...
	(w/15", 16" & 17" Ride Height)	B-25515	010	85338	...
	AAL 23K, 25K & 30K Models Front shocks with 12" Ride Height	B-23566	010	85000	89436
	Front shocks with 14" to 19" Ride Height	A-2212	010	85029	...
	Front shocks with 6.5" to 9" Ride Height	B-23651	010	85045	...
	Rear shocks with 14" to 17" Ride Height	B-25437	010	85337	...
	Rear shocks with 6.5" to 7.5" Ride Height	B-20345	010	85345	...
	Rear shocks with 9" to 12" Ride Height	B-25436	010	85916	89430
	AANL 23K Models with 12" to 17" Ride Height - High Damping	B-25515	010	85338	...
	with 6.5" to 9" Ride Height - High Damping	B-24579	010	85939	...
	with 6.5" to 9" Ride Height - Standard	B-23651	010	85045	...
	AANLS - 20K with Rear shocks with 9" Ride Height	B-23316	010	85382	...
	AANT 23K Models (High Damping)	B-24023	010	85738	...
	(Hvy Duty)	B-24125	010	85323	89436
	(Limited Rebound)	B-23361	010	85911	...
	(Standard)	B-23566	010	85000	89436
	AAT 23K Models (High Damping)	B-24023	010	85738	...
	(Hvy Duty)	B-24125	010	85323	89436
	(Limited Rebound)	B-23361	010	85911	...
	(Standard)	B-23566	010	85000	89436
	AAT 25K Models (High Damping)	B-24023	010	85738	...
	(Hvy Duty)	B-24125	010	85323	89436
	(Limited Rebound)	B-23361	010	85911	...
	(Standard)	B-23566	010	85000	89436
	AAT 30K Models	B-24023	010	85738	...
	AAZL 23K / 46K Models with 12" Ride Height - High Damping	B-24023	010	85738	...
	with 12" Ride Height - Standard	B-23566	010	85000	89436
	with 6.5" to 9" Ride Height - High Damping	B-24579	010	85939	...
	with 6.5" to 9" Ride Height - Standard	B-23651	010	85045	...
	AAZNT 23K / 46K / 69K Models with 12" to 17" Ride Height - High Damping	B-24023	010	85738	...
	with 12" to 17" Ride Height - Standard	B-23566	010	85000	89436
	Low Ride Height Models with (10.5" to 15" Ride Height)	B-23013	010	85000	89436
	(15.5" to 21" Ride Height - High Damping)	B-23316	010	85382	...
	(15.5" to 21" Ride Height - Std Damping)	B-23315	010	85029	...
	(6.5" to 8" Ride Height - High Damping)	B-22312	010	85939	...
	(6.5" to 8" Ride Height)	B-22311	010	85045	...

Top Mount Style

	HT190T (All Models)	A-20001	010	83128	89436
	HT230T All except Models listed below	A-20002	010	85000	89436
	(TA14-020)	B-22345	010	85911	...
	(TA15-521, TA17-521)	B-21553	010	85738	...
	(TA15-522, TA17-522)	B-21699	010	87018	...

APPLICATION GUIDE - TRUCKS, TRAILERS, AND BUSES

Year	Model	OEM #	Front		Rear	
						
						
			Fleetline	GasSLX	Fleetline	GasSLX

HENDRICKSON TRAILER SUSPENSION SYSTEMS(Cont'd.)





Top Mount Style(Cont'd.)

	(-14-020, -14-021, TA14-021)	A-2212	010	85029	...
	(-14-17, -15-17,-15-517,-17-517,TA15-517,TA15-520,TA17-517)	A-20126	010	85323	89436
	(-14-7,-14-11, -15-7,-15-11,-15-12,-15-28,TA14-7,TA15-7,TA16-7,TA17-7,TB14-33,TB15-28)	A-2160	010	85014	...
	HT250T (All Models)	A-2212	010	85029	...
	HT300T & N-HT300T (All except Models listed below)	A-20126	010	85323	89436
		A-2160	010	85014	...
		B-21553	010	85738	...
		B-24579	010	85939	...
	(-15-007, -15-011, -15-021,-17-007,-17-011, -17-012, TB19-007,TB19-020)	A-2160	010	85014	...
	(-15-017, -15-518, -17-518,-17-520)	B-21553	010	85738	...
	(TB15-027)	B-24579	010	85939	...
	(TB15-518)	B-21699	010	87018	...
	T-15-140, -155, -172, 244, -376	A-2218	010	85030	89440
	T-15-324	A-2160	010	85014	...
	T-17-141, -174, -284	A-2218	010	85030	89440
	TMB-14-120	A-2213	010	85010	...
	TMB-17-135	A-4084	010	85005	89430

UnderSlung Style

	HT190U (-6.75-001 / -6.75-002 / -6.75-003 / -6.75-020) (U-7.5-517) (U-9-022 / UB7-021) (All except Models listed above)	A-2212	010	85029	...
		A-20002	010	85000	89436
		B-23649	010	85064	...
		A-20001	010	83128	89436
	HT250U & N-HT250U (All except Models listed below) (U-6.5-030, U-6.5-031) (U-6.5-27,U-9-27 & -28,U-14-28,UB6.5-522,UB7.5-27 & -522,UB9-522,UB12-27 & -28,UB14-27 & -28) (U-6.5-517, U-7.5-17, U-7.5-517, U-9-517, U-12-517, U-14-514, UB6.5-517, UB7.5-517) (U-7.5-021, U-7.5-022) (U-9-20 & -21 & -23, U-9.5-26, U-15-22, UB9-22, UB15-22)	A-20002	010	85000	89436
		A-2160	010	85014	...
		B-21553	010	85738	...
		A-20126	010	85323	89436
		A-1667	010	85000	89436
		A-2212	010	85029	...
	HT250US - 5.5 to 6.5" Ride Height (High Damping)	B-23744	010	85344	...
		S-23744	010	85344	...
	HT250US (Models with Angled and Frame Clearance Mount) (Standard Travel w/ 6.5", 7.5" & 14" Ride Height -High Damping) (Standard Travel w/ 6.5", 7.5" & 14" Ride Height)	B-24579	010	85939	...
		B-23651	010	85045	...
	HT250US (Models with O.E.M. Number)	B-21936	010	85064	...
		B-21947	010	85052	...
		B-22862	010	85045	...
	HT250US (Models with Remote Shock Mount) (Extended Rebound w/ 6.5" to 9" Ride Height -High Damping) (Extended Rebound w/ 6.5" to 9" Ride Height) (Standard Travel w/ 12" to 14" Ride Height) (Standard Travel w/ 5.5" to 6.5" Ride Height) (Standard Travel w/ 7.5" to 9" Ride Height -High Damping) (Standard Travel w/ 7.5" to 9" Ride Height)	B-23316	010	85382	...
		A-2212	010	85029	...
		A-2212	010	85029	...
		B-23650	010	85052	...
		B-23743	010	85938	...
		B-23649	010	85064	...
	HT250US (Models with Standard Shock Mount) (Extended Rebound w/ 6.5" Ride Height -High Damping) (Extended Rebound w/ 6.5" Ride Height) (Standard Travel w/ 3.5" to 4" Ride Height) (Standard Travel w/ 5.5" to 6.5" Ride Height) (Standard Travel w/ 7.5" to 14" Ride Height -High Damping) (Standard Travel w/ 7.5" to 14" Ride Height)	B-24579	010	85939	...
		B-23651	010	85045	...
		B-23548	010	85079	...
		B-23650	010	85052	...
		B-23743	010	85938	...
		B-23649	010	85064	...

APPLICATION GUIDE - TRUCKS, TRAILERS, AND BUSES

Year	Model	OEM #	Front			Rear		
							Fleetline	GasSLX

HENDRICKSON TRAILER SUSPENSION SYSTEMS(Cont'd.)

UnderSlung Style(Cont'd.)

	HT250U-Y (All Models)	A-20002	010	85000	89436
	HT300U & N-HT300U (All except Models listed below) (U-7.5-519,U-9-011,U-9-519,U-12-011,U-12-015,U-14-011,U-14-015,U-17-011)	A-20126	010	85323	89436
		B-21699	010	87018	...
	T-12-139	A-2213	010	85010	...
	T-23-US-9-011	A-2213	010	85010	...
	T30-US-9, -17	A-10348	010	85043	...
	T-4-392	A-2160	010	85014	...
	T-6-062, -295, -370, -422	A-1667	010	85000	89436
	T-6-071	A-2212	010	85029	...
	T-9-084	A-2240	010	85013	89414
	T-9-106, -278, -313	A-4084	010	85005	89430
	T-9-175	A-2160	010	85014	...
	T-9-325	A-2218	010	85030	89440
	T-9-390	A-2213	010	85010	...





Vantraax

	HKA180 Heavy Duty	B-24088	010	85000	89436
		S-24088	010	85000	89436
	Standard	B-24088	010	83128	89436
		S-24088	010	83128	89436
	HKA200	B-23566	010	85000	89436
		S-23566	010	85000	89436
	HKA250 (Standard)	B-24023	010	85738	...
	HKAL 46K Models	B-23566	010	85000	89436
	HKANT 40K Heavy Duty	B-24088	010	85000	89436
		S-24088	010	85000	89436
	Standard	B-24088	010	83128	89436
		S-24088	010	83128	89436
	HKANT 46K	B-23566	010	85000	89436
		S-23566	010	85000	89436
	HKANT 69K23	S-23566	010	85000	89436
		S-23566	010	85000	89436
	HKARL 46K Disc Brake Applications	B-25436	010	85916	89430
		S-25436	010	85916	89430
	Drum Brake Applications	B-23566	010	85000	89436
		S-23566	010	85000	89436
	HKAT 46K	B-23566	010	85000	89436
		S-23566	010	85000	89436
	HKAT 50K	B-24023	010	85738	...
		S-24023	010	85738	...
	HKAT 69K	B-24023	010	85738	...
		S-24023	010	85738	...

Additional Applications

	AB-32-001 Models	A-1667	010	85000	89436
	HK190T (Slider Air Suspension)	A-21292	010	85052	...
	HK230 (Slider Air Suspension)	A-21292	010	85052	...
	HS190T (Slider Air Suspension)	A-20001	010	83128	89436
	HS230 (Slider Air Suspension)	A-20002	010	85000	89436
	MT-45,MTL45,MTL-50	S-1667	010	85000	89436
	TDC-014	665267	010	85029	...

APPLICATION GUIDE - TRUCKS, TRAILERS, AND BUSES

Year	Model	OEM #	Front		Rear	
			 Fleetline	 GasSLX	 Fleetline	 GasSLX

HENDRICKSON TRAILER SUSPENSION SYSTEMS(Cont'd.)

Additional Applications(Cont'd.)

TDC-014	A-2212	010	85029	...
---------	--------	-----	-----	-----	-------	-----

Additional O.E.M. Interchanges

Models with O.E.M. Number	OEM #	Fleetline	GasSLX	Fleetline	GasSLX
57905-2	010	85006	...
60675-004	010	85006	...
654951	010	85000	89436
659024	010	85052	...
665190	010	85006	...
665246	010	85043	...
665405	010	85030	89440
665406	010	85010	...
665531	010	85000	89436
665532	010	85013	89414
665533	010	85005	89430
665536	010	85000	89436
665693	010	85064	...
665694	010	85052	...
665698	010	85911	...
665733	010	85045	...
665756	010	85000	89436
665758	010	85064	...
665759	010	85052	...
665760	010	85045	...
665761	010	85911	...
665763	010	85079	...
665764	010	85029	...
665765	010	83150	...
665766	010	85000	89436
665767	010	85045	...
671779	010	...	89414
671948	010	85000	89436
680102	010	85712	...
680341	010	85323	89436
680463	010	...	89440
680467	010	85323	89436
680509	010	85738	...
680565	010	85738	...
680566	010	85938	...
680568	010	85323	89436
680570	010	...	89437
680571	010	85738	...
680573	010	85939	...
680579	010	85939	...
680614	010	85338	...
680616	010	...	89430
680617	010	85337	...
680702	010	85323	89436
680756	010	85323	89436
680769	010	85911	...
680776	010	85338	...
98583-019	010	85323	89436
98583-020	010	...	89414
A-10023	010	85000	89436
A-11931	010	85000	89436
A-14583	010	85000	89436

APPLICATION GUIDE - TRUCKS, TRAILERS, AND BUSES









Year	Model	OEM #	Front		Rear	
			Fleetline	GasSLX	Fleetline	GasSLX

HENDRICKSON TRAILER SUSPENSION SYSTEMS(Cont'd.)

Additional O.E.M. Interchanges(Cont'd.)

Models with O.E.M. Number	OEM #	Fleetline	GasSLX	Fleetline	GasSLX
A-1668	85000	89436
A-20345	85345	...
A-20886	85030	89440
A-20887	85005	89430
A-2230	85005	89430
A-2232	85005	89430
A-2240-1	85043	...
A-2471	85006	...
A-4089	83209	89414
A-4890	85712	...
A-6156	85301	...
B-21832	85323	89436
B-21936	85064	...
B-21994	85938	...
B-21995	85344	...
B-22715	85000	89436
B-23014	85738	...
B-23290	83150	...
B-23362	89437
B-25174	85029	...
B-26652	85000	89436
B-27058	83128	89436
B-27747	85911	...
B-29432	85323	89436
B-29678	85911	...
B-29826	85338	...
B-33312	85338	...
B-33313	85338	...
NS500699	85005	89430
S-10348	85043	...
S-14583	85000	89436
S-1668	85000	89436
S-20001	83128	89436
S-20002	85000	89436
S-20126	85323	89436
S-20345	85345	...
S-20886	85030	89440
S-20887	85005	89430
S-20889	85323	89436
S-21292	85052	...
S-21553	85738	...
S-2160	85014	...
S-21699	87018	...
S-21832	85323	89436
S-21936	85064	...
S-21947	85052	...
S-2212	85029	...
S-2213	85010	...
S-2218	85030	89440
S-2230	85005	89430
S-22311	85045	...
S-22312	85939	...
S-2232	85005	89430
S-22345	85911	...
S-2240	85013	89414

APPLICATION GUIDE - TRUCKS, TRAILERS, AND BUSES

Year	Model	OEM #	Front		Rear	
						
						
			Fleetline	GasSLX	Fleetline	GasSLX

HENDRICKSON TRAILER SUSPENSION SYSTEMS(Cont'd.)

Additional O.E.M. Interchanges(Cont'd.)

	Models with O.E.M. Number	S-22715	O10	85000	89436
		S-22862	O10	85045	...
		S-23013	O10	85000	89436
		S-23014	O10	85738	...
		S-23290	O10	83150	...
		S-23315	O10	85029	...
		S-23316	O10	85382	...
		S-23361	O10	85911	...
		S-23362	O10	...	89437
		S-23548	O10	85079	...
		S-23649	O10	85064	...
		S-23650	O10	85052	...
		S-23651	O10	85045	...
		S-23743	O10	85938	...
		S-24023	O10	85738	...
		S-24125	O10	85323	89436
		S-24579	O10	85939	...
		S-2471	O10	85006	...
		S-25437	O10	85337	...
		S-25515	O10	85338	...
		S-26652	O10	85000	89436
		S-29432	O10	85323	89436
		S-29678	O10	85911	...
		S-29826	O10	85338	...
		S-33312	O10	85338	...
		S-33313	O10	85338	...
		S-33313L	O10	85338	...
		S-4084	O10	85005	89430
		S-4089	O10	83209	89414
		S-4890	O10	85712	...
	Models with O.E.M. Number						
	Heavy Duty	S-24088	O10	85000	89436
	Standard	S-24088	O10	83128	89436

HENDRICKSON TRUCK SUSPENSION SYSTEMS

Airtek - Series

	Airtek Front		O10	85959
	Used on BlueBird	47170000456	O10	85959
		58913-007	O10	85959
		58913-007L	O10	85959
		58913-008	O10	85959
		58913-008L	O10	85959
		58913-009	O10	85959
		58913-009L	O10	85959
		65992-003	O10	85959
	Used on Freightliner / Western Star	471700006269	O10	85932	89453
		58913-003	O10	85932	89453
		58913-003L	O10	85932	89453
		58913-012	O10	85932	89453
		58913-012L	O10	85932	89453
	Used on International	65992-001	O10	85955
		65992-002	O10	85955
		65992-002L	O10	85955
		65992-006	O10	85986

APPLICATION GUIDE - TRUCKS, TRAILERS, AND BUSES

Year	Model	OEM #	Front		Rear	
			Fleetline	GasSLX	Fleetline	GasSLX

HENDRICKSON TRUCK SUSPENSION SYSTEMS(Cont'd.)

Airtek - Series(Cont'd.)

Used on Volvo / Mack	64838-001	OIO	85933	89454	
	64838-001L	OIO	85933	89454	
	64838-002	OIO	85933	89454	
	64838-002L	OIO	85933	89454	
	64838-003	OIO	85933	89454	
	64838-003L	OIO	85933	89454	

All American Series (FE & RE Models)

Buses with Hendrickson 14,600 lb Capacity-Left Hand Drive Steertek Axle	58913-011	OIO	85959
	58913-011L	OIO	85959

Comfort Air - Series

Conventional Hino Models with Single Axle Air Suspension	60670-013		OIO	83148	...
	60670-017		OIO	83148	...
Models with O.E.M. Number	471700131545		OIO	85006	...
	60998-001		OIO	85006	...
	60998-003		OIO	85006	...





Firemaax - Series

Firemaax 240 Air Suspensions Disc Brake Applications with 8 1/2" to 10" Ride Height Drum Brake Applications with 8 1/2" to 10" Ride Height	60665-014		OIO	85962	...	
	60665-018		OIO	85961	...	
	60665-018L		OIO	85961	...	
	Standard with 12 1/2" - 14 3/8" - 15 1/2" Ride Height	60665-011		OIO	85967	...
	Standard with 8 1/2" to 10" Ride Height	60657-003		OIO	85072	...
	60657-003L		OIO	85072	...	
Firemaax 270 Air Suspensions Disc Brake Applications with 8 1/2" to 10" Ride Height Drum Brake Applications with 8 1/2" to 10" Ride Height	60665-015		OIO	85966	...	
	60665-013		OIO	85965	...	
Firemaax 480 Air Suspensions Disc Brake Applications with 8 1/2" to 10" Ride Height Drum Brake Applications with 8 1/2" to 10" Ride Height Standard with 12 1/2" - 14 3/8" - 15 1/2" Ride Height Standard with 8 1/2" to 10" Ride Height	60665-014		OIO	85962	...	
	60665-018		OIO	85961	...	
	60665-018L		OIO	85961	...	
	60665-011		OIO	85967	...	
	60657-003		OIO	85072	...	
	60657-003L		OIO	85072	...	
Firemaax 540 Air Suspensions Disc Brake Applications with 8 1/2" to 10" Ride Height Drum Brake Applications with 8 1/2" to 10" Ride Height	60665-015		OIO	85966	...	
	60665-013		OIO	85965	...	
Firemaax EX 242 Air Suspensions Standard with 12 1/2" - 14 3/8" - 15 1/2" Ride Height Standard with 8 1/2" to 10" Ride Height	60665-011		OIO	85967	...	
	60657-003		OIO	85072	...	
	60657-003L		OIO	85072	...	
Firemaax EX 272 Air Suspensions Disc Brake Applications with 8 1/2" to 10" Ride Height Drum Brake Applications with 8 1/2" to 10" Ride Height	60665-015		OIO	85966	...	
	60665-013		OIO	85965	...	
Firemaax EX 482 Air Suspensions Standard with 12 1/2" - 14 3/8" - 15 1/2" Ride Height Standard with 8 1/2" to 10" Ride Height	60665-011		OIO	85967	...	
	60657-003		OIO	85072	...	
	60657-003L		OIO	85072	...	
Firemaax EX 542 Air Suspensions Disc Brake Applications with 8 1/2" to 10" Ride Height Drum Brake Applications with 8 1/2" to 10" Ride Height	60665-015		OIO	85966	...	
	60665-013		OIO	85965	...	

HA - Series

HA - 180 (Used on all except Mack)	47902-13		OIO	83122	89406
	47902-8		OIO	83122	89406
HA - 200 (Used on all except Mack)	47902-13		OIO	83122	89406

APPLICATION GUIDE - TRUCKS, TRAILERS, AND BUSES

Year	Model	OEM #	Front		Rear	
						
			Wrench	Fleetline	GasSLX	Wrench

HENDRICKSON TRUCK SUSPENSION SYSTEMS(Cont'd.)

HA - Series(Cont'd.)

HA - 200 (Used on all except Mack)	47902-8	010	83122	89406
HA - 230 (Used on all except Mack)	47902-13	010	83122	89406
	47902-8	010	83122	89406
HA - 360 (Used on all except Mack)	47902-13	010	83122	89406
	47902-8	010	83122	89406
HA - 400 (Used on all except Mack)	47902-13	010	83122	89406
	47902-8	010	83122	89406
HA - 460 (Used on all except Mack)	47902-13	010	83122	89406
	47902-8	010	83122	89406
HA Series Air Suspension (All Models used on Mack)	47902-19	010	83123	89405
	47902-9	010	83123	89405
HA-360/400/460 Edge System High Torque Rise	60675-003	010	85976	...
	60675-003L	010	85976	...

HAS - Series

HAS - 120L	60670-010	010	83149	...
HAS - 150L	60670-003	010	83149	...
HAS - 190 With O.E.M. Number	60670-005	010	83137	...
	60675-003	010	85976	...
	60675-003L	010	85976	...
HAS - 190L	60670-008	010	83123	89405
	60670-008L	010	83123	89405
HAS - 210 With O.E.M. Number	60670-005	010	83137	...
	60675-003	010	85976	...
	60675-003L	010	85976	...
HAS - 210L	60670-008	010	83123	89405
	60670-008L	010	83123	89405
HAS - 230 With O.E.M. Number	60670-005	010	83137	...
	60675-003	010	85976	...
	60675-003L	010	85976	...
HAS - 230L	60670-008	010	83123	89405
	60670-008L	010	83123	89405
HAS - 360 With O.E.M. Number	60670-005	010	83137	...
	60675-003	010	85976	...
	60675-003L	010	85976	...
HAS - 400 Mack & Kenworth Air Suspensions Standard Inboard Rear With O.E.M. Number	47902-25	010	83125	...
	60670-007	010	83144	...
	60670-007L	010	83144	...
	60670-005	010	83137	...
	60675-003	010	85976	...
	60675-003L	010	85976	...
	60675-006	010	85909	...
60675-006L	010	85909	...	
HAS - 400L	60670-008	010	83123	89405
	60670-008L	010	83123	89405
HAS - 402 Standard Inboard Rear With O.E.M. Number	60670-007	010	83144	...
	60670-007L	010	83144	...
	60670-005	010	83137	...
	60675-003	010	85976	...

APPLICATION GUIDE - TRUCKS, TRAILERS, AND BUSES

Year	Model	OEM #	Front			Rear		
			Fleetline	GasSLX		Fleetline	GasSLX	

HENDRICKSON TRUCK SUSPENSION SYSTEMS(Cont'd.)

HAS - Series(Cont'd.)

	Standard Inboard Rear	60675-003L	010	85976	...
		60675-006	010	85909	...
		60675-006L	010	85909	...
	HAS - 402L	60670-008	010	83123	89405
		60670-008L	010	83123	89405
	HAS - 40LH With O.E.M. Number	60680-001	01-	83111	...
		60680-001L	01-	83111	...
		60685-001	01-	85977	...
	HAS - 460 Standard Inboard Rear With O.E.M. Number	60670-007	010	83144	...
		60670-007L	010	83144	...
		60670-005	010	83137	...
		60675-003	010	85976	...
		60675-003L	010	85976	...
		60675-006	010	85909	...
		60675-006L	010	85909	...
	HAS - 460L	60670-008	010	83123	89405
		60670-008L	010	83123	89405
	Models with O.E.M. Number	60675-014	010	85978	...
		60675-8Q	010	85976	...

HN - Series

	HN - 400 Models built between Mar/96 - Sept/97 Models built between Nov/88 - Feb/96	60680-003	01-	83112	...
		60680-003L	01-	83112	...
		60670-002	010	83207	89407
		60670-002L	010	83207	89407
	HN - 402 Models built between Apr/96 - Dec/04	57241-003	01-	83112	...
		60680-003	01-	83112	...
		60680-003L	01-	83112	...
	HN - 460 Models built between Mar/96 - Sept/97 Models built between Nov/88 - Feb/96	57241-003	01-	83112	...
		60680-003	01-	83112	...
		60680-003L	01-	83112	...
		60670-002	010	83207	89407
		60670-002L	010	83207	89407
	HN - 462 Models built between Apr/96 - 2015	57241-003	01-	83112	...
		60680-003	01-	83112	...
		60680-003L	01-	83112	...
96 - 15	HN - 522	60680-003	01-	83112	...
		60680-003L	01-	83112	...
	HNT - 460	47902-18	010	85030	89440





HTB 400 LT - Series

	HTB 400LT Rear Air Suspensions	60657-006	010	85102	...
		60657-010	010	85102	...
		60657-011	010	85102	...

Primaax - Series

	230 Air Suspensions For International Models with 9" Ride Height Standard with 12 1/2" - 14 3/8" - 15 1/2" Ride Height Standard with 8 1/2" to 10" Ride Height	60657-003	010	85072	...
		60657-003L	010	85072	...
		60665-011	010	85967	...
		60657-003	010	85072	...

APPLICATION GUIDE - TRUCKS, TRAILERS, AND BUSES

Year	Model	OEM #	Front		Rear	
						
			Fleetline	GasSLX	Fleetline	GasSLX

HENDRICKSON TRUCK SUSPENSION SYSTEMS(Cont'd.)

Primaax - Series(Cont'd.)

	For International Models with 9" Ride Height	60657-003L	010	85072	...
	260 Air Suspensions						
	Disc Brake Applications with 8 1/2" to 10" Ride Height	60665-015	010	85966	...
	Drum Brake Applications with 8 1/2" to 10" Ride Height	60665-013	010	85965	...
	460 Air Suspensions						
	For International Models with 9" Ride Height	60657-003	010	85072	...
		60657-003L	010	85072	...
	Standard with 12 1/2" - 14 3/8" - 15 1/2" Ride Height	60665-011	010	85967	...
	Standard with 8 1/2" to 10" Ride Height	60657-003	010	85072	...
		60657-003L	010	85072	...
	520 Air Suspensions						
	Disc Brake Applications with 8 1/2" to 10" Ride Height	60665-015	010	85966	...
	Drum Brake Applications with 8 1/2" to 10" Ride Height	60665-013	010	85965	...
	690 Air Suspensions						
	For International Models with 9" Ride Height	60657-003	010	85072	...
		60657-003L	010	85072	...
	Standard with 12 1/2" - 14 3/8" - 15 1/2" Ride Height	60665-011	010	85967	...
	Standard with 8 1/2" to 10" Ride Height	60657-003	010	85072	...
		60657-003L	010	85072	...
	780 Air Suspensions						
	Disc Brake Applications with 8 1/2" to 10" Ride Height	60665-015	010	85966	...
	Drum Brake Applications with 8 1/2" to 10" Ride Height	60665-013	010	85965	...
	EX 232 Air Suspensions						
	Standard with 12 1/2" - 14 3/8" - 15 1/2" Ride Height	60665-011	010	85967	...
	Standard with 8 1/2" to 10" Ride Height	60657-003	010	85072	...
		60657-003L	010	85072	...
	EX 262 Air Suspensions						
	Disc Brake Applications with 8 1/2" to 10" Ride Height	60665-015	010	85966	...
	Drum Brake Applications with 8 1/2" to 10" Ride Height	60665-013	010	85965	...
	EX 462 Air Suspensions						
	Standard with 12 1/2" - 14 3/8" - 15 1/2" Ride Height	60665-011	010	85967	...
	Standard with 8 1/2" to 10" Ride Height	60657-003	010	85072	...
		60657-003L	010	85072	...
	EX 522 Air Suspensions						
	Disc Brake Applications with 8 1/2" to 10" Ride Height	60665-015	010	85966	...
	Drum Brake Applications with 8 1/2" to 10" Ride Height	60665-013	010	85965	...
	EX 692 Air Suspensions						
	Standard with 12 1/2" - 14 3/8" - 15 1/2" Ride Height	60665-011	010	85967	...
	Standard with 8 1/2" to 10" Ride Height	60657-003	010	85072	...
		60657-003L	010	85072	...
	EX 782 Air Suspensions						
	Disc Brake Applications with 8 1/2" to 10" Ride Height	60665-015	010	85966	...
	Drum Brake Applications with 8 1/2" to 10" Ride Height	60665-013	010	85965	...
	Models with O.E.M. Number	60657-005	010	85087	...
		60657-005L	010	85087	...

Additional Applications

	Conventional Hino Models with Hendrickson Comfort Air Suspension	60670-020	010	83148	...
	HAS 400 / 460 Suspensions with O.E.M. Number	60675-005	010	85980	...
		60675-005L	010	85980	...
	HAS 460 Suspensions with O.E.M. Number	60675-12	010	85638	...
	Hendrickson Rear Air Suspension used on Conventional Hino Models (23,000 lb Capacity)	60670-018	010	83166	...
	HMX 400/460 Haulmax with 16.5" Saddle Height	60680-004	01-	83143	...
		60680-004L	01-	83143	...

APPLICATION GUIDE - TRUCKS, TRAILERS, AND BUSES

Year	Model	OEM #	Front		Rear	
			Fleetline	GasSLX	Fleetline	GasSLX

HENDRICKSON TRUCK SUSPENSION SYSTEMS(Cont'd.)

Additional Applications(Cont'd.)

	HMX 400/460 Haulmax with 17.5" or 18.5" Saddle Height	60680-005 60680-005L		OI-	83142	...
				OI-	83142	...
	HTS 210 For Spartan Chassis (Type C School Bus Applications)	60665-025 60665-025L		OIO	85036	89405
				OIO	85036	89405
	MaxAir / AL-405 Models	57241-006 57241-006L		OI-	83111	...
				OI-	83111	...
	Parasteer Suspensions Models with O.E.M. Number	59483-000 60665-005 60665-005L 60998-002 60998-002L	OIO OIO OIO OIO OIO
				85919
				85919
				85919
				85919
	RT2 & RTE2 (400 / 520) Models Air Suspension (Note: For Ride Height of 10.41" to 12.27" with 52" & 54" Beams and 8.52" to 10.37" with 60" Beams.)	57324-6		OIO	85904	...

Additional O.E.M. Interchanges

	Hendrickson Comfort Air Rear Air Suspension	60670-006 60670-006L		OIO	83147	...
				OIO	83147	...
	Models with O.E.M. Number	12738		OIO	83225	...
		47902-11		OIO	83207	89407
		47902-15		OIO	83137	...
		47902-20		OIO	85036	89405
		47902-21		OIO	85976	...
		47902-22		OIO	85916	89430
		47902-24		OIO	83137	...
		47902-26		OIO	83144	...
		47902-27		OIO	83123	89405
		47902-28		OIO	85013	89414
		47902-29		OIO	83149	...
		47902-3		OIO	85005	89430
		503610C2		OIO	83207	89407
		5554596		OIO	85303	89422
		57241-001		OI-	83111	...
		57241-002		OI-	83109	...
		57241-004		OI-	83110	...
		57324-1		OIO	85036	89405
		57324-11		OIO	85305	...
		57324-2		OIO	85976	...
		57324-3		OIO	85916	89430
		57324-5		OIO	85903	...
		57905-1		OIO	85976	...
		58623-1		OIO	85978	...
		59048-001		OIO	83148	...
		59057-001		OIO	83137	...
		59057-002		OIO	85036	89405
		59305-1		OIO	85979	...
		59851-1		OIO	85976	...
		59852-1		OI-	85977	...
		59852-2		OI-	85977	...
		60657-007		OIO	85072	...
60665-003		OIO	83137	...		
60665-004		OIO	85036	89405		
60665-004L		OIO	85036	89405		
60665-008		OIO	85978	...		
60665-009		OIO	85904	...		

APPLICATION GUIDE - TRUCKS, TRAILERS, AND BUSES





Year	Model	OEM #	Front		Rear	
			Fleetline	GasSLX	Fleetline	GasSLX

HENDRICKSON TRUCK SUSPENSION SYSTEMS(Cont'd.)

Additional O.E.M. Interchanges(Cont'd.)

Year	Model	OEM #	Front	Rear	Front	Rear
	Models with O.E.M. Number	60665-020	OIO	85919
		60665-024	OIO	85903
		60670-001	OIO	83123
		60670-004	OIO	83123
		60670-009	OIO	85013
		60670-011	OIO	83148
		60670-012	OIO	83168
		60670-014	OIO	83166
		60670-019	OIO	83166
		60670-12	OIO	83168
		60675-001	OIO	85978
		60675-001L	OIO	85978
		60675-002	OIO	85979
		60675-002L	OIO	85979
		60680-002	OI-	83109
		60680-009	OI-	85083
		60680-012	OI-	85083
		60680-012L	OI-	85083
		654890	OIO	83207
		654891	OIO	83149
		654894	OIO	83123
		654895	OIO	83137
		654896	OIO	83147
		654897	OIO	83144
		654897	OIO	83144
		654898	OIO	83123
		654899	OIO	85013
		654900	OIO	83149
		654903	OI-	83111
		654904	OI-	83109
		654905	OI-	83112
		659000	OIO	83148
		659004	OIO	83123
		659048	OI-	83143
		659049	OI-	83142
		659155	OIO	83147
		659202	OIO	83148
		659292	OIO	83148
		665816	OIO	85072
		665892	OIO	85072
		671006	OIO	85036
		671007	OIO	83137
		671009	OIO	85919
		671030	OI-	85083
		671063	OI-	85083
		671105	OIO	85072
		671603	OIO	85919
		671606	OIO	85955
		671611	OIO	85955
		671704	OIO	85904
		671764	OIO	85967
		671792	OIO	85965
		671793	OIO	85966
		671798	OIO	85962
		672009	OIO	85903

APPLICATION GUIDE - TRUCKS, TRAILERS, AND BUSES

Year	Model	OEM #	Front		Rear	
						
			Fleetline	GasSLX	Fleetline	GasSLX

HENDRICKSON TRUCK SUSPENSION SYSTEMS(Cont'd.)

Additional O.E.M. Interchanges(Cont'd.)

	Models with O.E.M. Number	680091	OIO	85303	89422
		680600	OIO	85305	...
		70018	OIO	85303	89422
		70021	OIO	85303	89422
		70088	OIO	85307	...
		98583-005	OIO	83168	...
		98583-006	OIO	83148	...
		98583-016	OIO	83147	...
		98583-032	OIO	85072	...
		AE76164-3	OIO	85307	...
		AE76164-4	OIO	83225	...
		BE76164-2	OIO	85303	89422
		BE76164-3	OIO	85307	...
		BE76164-4	OIO	83225	...

HIGHWAY PRODUCT

	Transit Bus with Air Suspension	OIO	83203	89436
	Transit Bus with Leaf Spring Suspension		83203	...	OIO	83203 89436
	A1-6-134			OIO	83207 89407
	A1-6-135		OIO	83203	89436		...

HINO

145 Series

05 - 10	Models with O.E.M. Number	48500-3710	OIO	83126	89430	
		485003710A	OIO	83126	89430	
		S4850-03710	OIO	83126	89430	
		48530-3280		OIO	G63440	...
		S4853-03280		OIO	G63440	...

155 Series

13 - 17	Models with O.E.M. Number	48511-37320	-IO	83518
13 - 18	Models with O.E.M. Number	48511-80162	-IO	83518

165 Series

05 - 10	Models with O.E.M. Number	48500-3710	OIO	83126	89430	
		485003710A	OIO	83126	89430	
		S4850-03710	OIO	83126	89430	
		48530-3280		OIO	G63440	...
		S4853-03280		OIO	G63440	...

185 Series

05 - 10	Models with O.E.M. Number	48500-3710	OIO	83126	89430	
		485003710A	OIO	83126	89430	
		48500-3720	OIO	83140	
		S4850-03710	OIO	83126	89430	
		S4850-03720	OIO	83140	
		48530-3280		OIO	G63440	...
		S4853-03280		OIO	G63440	...

195 Series

12 - 17	Models with Hendrickson Comfort Air Suspension (23,000 lb Capacity)	60670-018		OIO	83166	...
13 - 17	Models with O.E.M. Number	48511-37320	-IO	83518
13 - 18	Models with O.E.M. Number	48511-80162	-IO	83518
		48531-37361		OIO	83519	...
		48531-37362		OIO	83519	...

238 Series

05 - 14	Models with O.E.M. Number	48500-3720	OIO	83140
---------	---------------------------	------------	-----	--------------	-----	-----	-----

APPLICATION GUIDE - TRUCKS, TRAILERS, AND BUSES

Year	Model	OEM #	Front				Rear			
Fleetline		GasSLX		Fleetline		GasSLX				

HINO(Cont'd.)

238 Series(Cont'd.)

05 - 14	Models with O.E.M. Number	S4850-03720	OIO	83140
15 - 16	Models with O.E.M. Number	48500-E0420	OIO	83391

258 Series

08 - 18	258 ALP Models with Hendrickson Rear Air Suspension	60670-014		OIO	83166	...
		60670-019		OIO	83166	...
08 - 18	258 LP Car Carrier Models with Hendrickson Rear Air Suspension	48530E0100		OIO	83166	...
		60670-014		OIO	83166	...
08 - 18	258 Models with Hendrickson Rear Air Suspension	60670-019		OIO	83166	...
		60670-014		OIO	83166	...
05 - 14	Models with O.E.M. Number	48500-3720	OIO	83140
		S4850-03720	OIO	83140
15 - 18	Models with O.E.M. Number	48500-E0420	OIO	83391

268, 268A Series

	Models with Hendrickson Rear Air Suspension (Shock stamping #)	60670-012		OIO	83168	...
05 - 14	Models with O.E.M. Number	48500-3720	OIO	83140
		S4850-03720	OIO	83140
15 - 18	Models with O.E.M. Number	48500-E0420	OIO	83391

308 Series

07 - 10	Models with O.E.M. Number	48500-3720	OIO	83140
		S4850-03720	OIO	83140

338 Series

08 - 17	Models with Hendrickson Rear Air Suspension	48530E0100		OIO	83166	...
		60670-014		OIO	83166	...
05 - 14	Models with O.E.M. Number	48500-3720	OIO	83140
		S4850-03720	OIO	83140
15 - 17	Models with O.E.M. Number	48500-E0420	OIO	83391

358 Series

	Models with Hendrickson Rear Air Suspension	48530E0100		OIO	83166	...
		60670-014		OIO	83166	...
07 - 14	Models with O.E.M. Number	48500-3720	OIO	83140
		S4850-03720	OIO	83140
15 - 17	Models with O.E.M. Number	48500-E0420	OIO	83391

FA, FB Series

89 - 04	FA, FB Models Trucks with: Front Shock with O.E.M. Number	48500-1950	-IO	G63610	
		48500-2750	-IO	G63610	
		66639	-IO	G63610	
		S4850-01950	-IO	G63610	
		S4850-02750	-IO	G63610	
	Rear Shock with O.E.M. Number	34802		OIO	83216	...
		48530-1910		OIO	83216	...
		48530-2510		OIO	83216	...
		S4853-01910		OIO	83216	...
		S4853-02510		OIO	83216	...
89 - 96	FA14, FB14	48500-1950	-IO	G63610	
		48530-1910		OIO	83216	...
93 - 97	FA1415 (FA15), FB1715 (FB15)	48500-1950	-IO	G63610	
		48530-1910		OIO	83216	...
92 - 96	FA15, FB15	48500-1950	-IO	G63610	
		48530-1910		OIO	83216	...
1998	FA1517, FA1817, FB1817	OIO	G63419	...
		48530-2510		OIO	83216	...

APPLICATION GUIDE - TRUCKS, TRAILERS, AND BUSES

Year	Model	OEM #	Front			Rear		
			○ ○	Fleetline	GasSLX	○ ○	Fleetline	GasSLX

HINO(Cont'd.)

FD Series(Cont'd.)

98 - 03	FD Models Trucks with O.E.M. Number	48500-1801	○ ○	83216
		48530-1880		○ ○	83362	...
86 - 87	FD16	48500-1801	○ ○	83216
		48530-1880		○ ○	83362	...
88 - 91	FD17	48500-1801	○ ○	83216
		48530-1880		○ ○	83362	...
1992	FD20	48500-1801	○ ○	83216
93 - 97	FD2218, FD2218LD (FD5H). FE5H, FF5H	48500-1801	○ ○	83216
		48530-1880		○ ○	83362	...
1998	FD2220, FD2220 Lo Pro	48500-1801	○ ○	83216

FE Series

86 - 87	FE16	48500-1801	○ ○	83216
		48530-1890		○ ○	83104	...
84 - 91	FE17, FE19	48530-1900		○ ○	83104	...
1992	FE20	48530-1900		○ ○	83104	...
93 - 97	FE2618 (FE5H)	48530-1900		○ ○	83104	...
1998	FE2620	48530-1880		○ ○	83362	...
98 - 04	FE Models Trucks with: Front Shock with O.E.M. Number Rear Shock with O.E.M. Number	48500-1941	○ ○	83141
		S4850-01941	○ ○	83141
		48530-1900		○ ○	83104	...
		S4853-01900		○ ○	83104	...
		48530-3280		○ ○	G63440	...
		S4853-03280		○ ○	G63440	...

FF Series

98 - 03	FF Models Trucks with O.E.M. Number	48500-1941	○ ○	83141
		48530-1900		○ ○	83104	...
84 - 91	FF17, FF19	48530-1900		○ ○	83104	...
1992	FF20, FF23	48530-1900		○ ○	83104	...
93 - 97	FF3018 (FF5H)	48530-1900		○ ○	83104	...
93 - 97	FF3020 (FF4H)	48530-1900		○ ○	83104	...
1998	FF3320	48530-1880		○ ○	83362	...
87 - 88	FFC1	48530-1900		○ ○	83104	...

FG Series

84 - 85	FG19, FG22	48530-1900		○ ○	83104	...
---------	------------	------------	--	-----	-----	-----	-------	-----





GC Series

90 - 91	GC17	48500-1801	○ ○	83216
		48530-2050		○ ○	83217	...
1992	GC20	48500-1801	○ ○	83216
		48530-2050		○ ○	83217	...

SG Series

98 - 03	SG Models Trucks with O.E.M. Number	48500-1941	○ ○	83141
		S4850-01941	○ ○	83141
86 - 91	SG19	48500-1941	○ ○	83141
1992	SG20	48500-1941	○ ○	83141
1986	SG22 Straight Truck	48500-1941	○ ○	83141
1986	SG221 Tractor	48500-1941	○ ○	83141
87 - 92	SG23 Straight Truck	48500-1941	○ ○	83141
87 - 92	SG231 Tractor	48500-1941	○ ○	83141
93 - 97	SG3320 (SG4H)	48500-1941	○ ○	83141
93 - 97	SG3323 (SG1H) Straight Truck	48500-1941	○ ○	83141
93 - 97	SG5523 (SG1HD) Tractor	48500-1941	○ ○	83141

APPLICATION GUIDE - TRUCKS, TRAILERS, AND BUSES

Year	Model	OEM #	Front		Rear	
						
			Fleetline	GasSLX	Fleetline	GasSLX

HINO(Cont'd.)

Additional Applications(Cont'd.)

	Conventional Hino Models with Hendrickson Comfort Air Suspension	60670-020		010	83148	...
	Conventional Hino Models with Hendrickson Comfort Air Suspension (23,000 lb Capacity)	60670-018		010	83166	...
	Conventional Hino Models with Hendrickson Comfort Air Suspension (19,000 lb & 21,000 lb Capacity)	60670-013		010	83148	...
	Conventional Hino Models with Hendrickson Rear Air Suspension	60670-014		010	83166	...
		60670-019		010	83166	...
	Models with O.E.M. Number	48500-1800	010	83216
		48500-1940	010	83141
		48530-1120		010	83104	...
		48530-1460		010	83215	...
		48530-1620		010	83104	...
		48530-1770		010	83215	...

HOBBS TRAILERS

	Models with O.E.M. Number	680117		010	85300	89419
--	---------------------------	--------	--	-----	-----	-----	-------	-------

HOLIDAY RAMBLER

	Models with Mor-Ryde Suspension	U0109-007		010	G63183	...
	Models with Neway Trailer Air Suspension	90044794		010	83127	...

Class A MotorHomes

90 - 97	Admiral, Endeavor Gas and Vacationer Models with F53 Motorhome Chassis (7.5 L, Gas V8)	010	85097	...
99 - 19	Admiral, Endeavor Gas and Vacationer Models with Ford F53 Motorhome Chassis (16,000 lb to 22,000 lb GVW)	1C34-18045-AA	010	83209	89414	
		1C34-18045-JA	010	83209	89414	
		9U94-18045-AA	010	83209	89414	
		9U94-18080-AA		010	83122	89406
		9U9Z-18124-A	010	83209	89414	
		9U9Z-18125-A		010	83122	89406
		ASH-1022	010	83209	89414	
		ASH-1023		010	83122	89406
		ASH-1205	010	83209	89414	
		ASH-1206		010	83122	89406
		ASH-1228	010	83209	89414	
		ASH-1229	010	83209	89414	
		ASH-1230		010	83122	89406
		ASH-137		010	83122	89406
		ASH-25822	010	83209	89414	
		ASH-25823	010	83209	89414	
		ASH-25824		010	83122	89406
ASH-294	010	83209	89414			
AT-620	010	83209	89414			
AT-621		010	83122	89406		
AT-766	010	83209	89414			
05 - 14	Models with Workhorse W20 , W22, & W24 MotorHome Chassis with O.E.M. Number	24-153256		- -	85124	...
		F4-BE5-F325-HO		- -	85124	...
		W0005663		- -	85124	...
98 - 04	Models with Workhorse W20 , W22, & W24 MotorHome Chassis with O.E.M. Number	24-186537		01-	85126	...
		F4-BE5-A011-HO		01-	85126	...
98 - 14	Models with Workhorse W20 , W22, & W24 MotorHome Chassis with O.E.M. Number	24-153249	010	85125
		24-186629	010	85125
		F4-BE5-A832-MO	010	85125

APPLICATION GUIDE - TRUCKS, TRAILERS, AND BUSES

Year	Model	OEM #	Front			Rear		
			○ ○	Fleetline	GasSLX	○ ○	Fleetline	GasSLX

HOLIDAY RAMBLER(Cont'd.)

Class A MotorHomes(Cont'd.)

98 - 14	Models with Workhorse W20 , W22, & W24 MotorHome Chassis with O.E.M. Number	F4-BE5-B492-HO F4-BE5-F324-HO W0005662 W0006254	○ ○	85125
			○ ○	85125
			○ ○	85125
			○ ○	85125
95 - 99	MotorHomes with Freightliner XC Chassis (22,000 to 26,000 lb GVW)	○ ○	83160	...	○ ○	85029	...

Class C MotorHomes

18 - 19	Altera Series MotorHomes with Ford E450 Chassis	ASH-1136 ASH-1154		- ○	83178	...
			- ○	83177
99 - 06	Atlantis Models with Ford E450 Chassis	ASH-1136 ASH-1154		- ○	83178	...
			- ○	83177
07 - 18	Augusta Series MotorHomes with Ford E450 Chassis	ASH-1136 ASH-1154		- ○	83178	...
			- ○	83177
17 - 19	Vesta Series MotorHomes with Ford E450 Chassis	ASH-1136 ASH-1154		- ○	83178	...
			- ○	83177

HOLLAND - BINKLEY

	Air Plus Integrated Air Susp. with ProPar Parallel Spindle Axles	6898		○ ○	83125	...
	Holland ProPar NT2 Air Suspension	680298		○ ○	85321	...

HOLLAND (SEE NEWAY)

Refer to SAF Holland Section for application information								
--	--	--	--	--	--	--	--	--

HUTCHENS SUSPENSION

	Models with O.E.M. Number	9423-00		○ ○	83203	89436
--	---------------------------	---------	--	-----	-----	-----	-------	-------

HYSTER

	Straddle Carrier	650150 73516		83217	...	○ ○	83217	...
				83217	...	○ ○	83217	...

IC CORPORATION

AE Series School Bus

	AE Model School Buses with O.E.M. Number	3902993C1 3902993C2 3902993C3	○ ○	83135
			○ ○	83135
			○ ○	83135

BE Series School Bus

- 2012	BE200 Model School Buses with 7000 lb Front Axle	3605735C1 3605735C2	○ ○	83156
			○ ○	83156









CE Series School Bus

06 - 18	CE Model School Buses (71 Capacity) with 9,000 to 10,000 lb Front Suspension	3578105C1 3578105C2 6127088C1 OE13402S	○ ○	83163
			○ ○	83163
			○ ○	83163
			○ ○	83163
10 - 15	CE Model School Buses with 20,000 lb International IROS Air Suspension	3578858C2		○ ○	85926	...
16 - 17	CE Model School Buses with 20,000 lb Rear Air Suspension	3601600C3		○ ○	85082	...
05 - 13	CE Model School Buses with 22,000 lb Rear Spring Suspension	501906C91 501906C92 OE13424S		- ○	83317	...
				- ○	83317	...
				- ○	83317	...
13 - 18	CE Model School Buses with 6,000 to 8,000 lb Front Axles	3533356C3	○ ○	83169

RE Series School Bus

	Low-Profile models with O.E.M. Number	1660846C92		○ ○	83101	...
--	---------------------------------------	------------	--	-----	-----	-----	-------	-----

APPLICATION GUIDE - TRUCKS, TRAILERS, AND BUSES

Year	Model	OEM #	Front		Rear	
						
						
			Fleetline	GasSLX	Fleetline	GasSLX

IC CORPORATION(Cont'd.)

RE Series School Bus(Cont'd.)

	RE Model School Buses with 12,000 to 14,000 lb Front Axles	2200327C1	- O	85332
03 - 17	RE Model School Buses with Hendrickson AirTek Front Suspension	65992-006	O O	85986
		H65992-006	O O	85986
	RE Model School Buses with O.E.M. Number	1675455C1		O O	85003	89411
		2018987C1		O O	85003	89411
		3604282C1	- O	85351
		472412C91	- -	83456	89447	
		501553C91		O O	85003	89411
		537524C91		O O	83123	89405

INGERSOLL AXLES

	Ingersoll part number	653511-01		O O	85323	89436
		653511-02		O O	85938	...
		653511-03		O O	85045	...
		653511-04		O O	85052	...

INTERNATIONAL (NAVISTAR)

A, B, AC and BC Conventional

	A-140 (4 x 4) Models	O O	83216	...
	A-160, A-170, A-180, AC-160, AC-170, AC-180, B-160, B-170, B-180, BC-160, BC-170, BC-180 Models	308649C91		O O	83216	...
		308650C91		O O	83216	...
		453567C91		O O	83216	...
	A-170, B-170, AC-170, ACF-170, BC-170, A-180, B-180, AC-180, BC-180, BCF-170 Models	308646C91	O O	85012	89413	
	AB-140 Models		G63306	...	O O	G63306	...
	AC-170 & BC-170 (4 x 4) Models	O O	83216	...
	AC-180 & BC-180 (4 x 4) Models	O O	83216	...
	BCF-195-D Models	O O	83225	...
	C-150 Models	O O	G63306
		308649C91		O O	83216	...
		308668C91		O O	85012	89413
		453556C91		O O	85012	89413
		453567C91		O O	83216	...

BE Series School Bus

- 2012	BE200 Model School Bus Chassis with 7000 lb Front Axle	3605735C1	O O	83156
		3605735C2	O O	83156
	with 9000 lb Rear Suspension	3609400C1		- O	83317	...
		3609400C2		- O	83317	...





Binder

	Binder	453556C91	O O	85012	89413	
		453571C91		O O	83216	...
		467983C91	O O	85012	89413	
		467985C91	O O	85012	89413	
		471201C91	O O	85012	89413	
	S Models Binder	472367C91	- -	83318

Cargostar

	CO-1600, CO-1610A & B, CO-1630A & B, CO-1700, CO-1710A & B, CO-1730A & B, CO-1750, CO-1750A & B, CO-1800, CO-1810A & B, CO-1830A & B, CO-1850, and CO-1850A & B	206620R91		O O	83216	...
		206621R92		O O	83216	...
		294334C91		O O	83216	...
		3085640C92		O O	83216	...
					O O	83216

APPLICATION GUIDE - TRUCKS, TRAILERS, AND BUSES

Year	Model	OEM #	Front			Rear		
							Fleetline	GasSLX

INTERNATIONAL (NAVISTAR)(Cont'd.)









Cargostar(Cont'd.)

	CO-1600, CO-1610A & B, CO-1630A & B, CO-1700, CO-1710A & B, CO-1730A & B, CO-1750, CO-1750A & B, CO-1800, CO-1810A & B, CO-1830A & B, CO-1850, and CO-1850A & B	308646C91		010	85012	89413
		308649C91		010	83216	...
		308650C92		010	83216	...
		360444C91		010	85012	89413
		453564C91		010	85012	89413
		453567C91		010	83216	...
		453570C91		010	83216	...
		467983C91		010	85012	89413
		467984C91		010	83216	...
	CO-1610A & B, CO-1630A & B, CO-1710A & B, CO-1730A & B, CO-1750A & B, CO-1810A & B, CO-1830A & B, COF-1810A & B - Exc. with 9000, 10800, or 12000 lb Front Axle	453572C91	010	83309	89446	
	CO-1610A & B, CO-1630A & B, CO-1710A & B, CO-1730A & B, CO-1750A & B, CO-1810A & B, CO-1830A & B, COF-1810A & B - With 9000, 10800, or 12000 lb Front Axle	873619C92	010	83314
873619C93		010	83314	
	CO-190, VCO-190, CO-200, DCO-200, VCO-200, CO-220, VCO-220 With Air Ride Suspension After Chassis No G-387453	350425C1		010	85300	89419
462557C91			010	85300	89419	
	CO-190, VCO-190, CO-200, DCO-200, VCO-200, CO-220, VCO-220 With Air Ride Suspension before Chassis No G-387453	350426C91		010	85734	...
	CO-190, COF-190, CO-1950, COF-1950 & COT-1950, VCO-190, VCOF-190 & CO-200, DCO-200, VCO-200 & CO-220, VCO-220 & VCO-190 (4 man cab)	204994R91	010	83225
	CO-190, COF-190, VCO-190, VCOF-190 & CO-200, DCO-200, VCO-200 & CO-220, VCO-220 & VCO-190 (4 man cab)	210534R92	010	83225
288920C91		010	83225	
288921R92		010	83225	
308648C91		010	83225	
452566C91		010	83225	
453561C91		010	83225	
453562C91		010	83225	
453565C91		010	83225	
453569C91		010	83225	
467371C91		010	83225	
467372C91	010	83225		
	CO-1910A & B, CO-1950A & B, COF-1910A & B, COF-1950A & B	453572C91	010	83309	89446	
873619C92		010	83314	
	CO-1950, COF-1950 & COT-1950	288920C91	010	83225
288921C91		010	83225	
308648C91		010	83225	
453561C91		010	83225	
453565C91		010	83225	
453566C91		010	83225	
453569C91		010	83225	
467371C91		010	83225	
467372C91		010	83225	
	CO-1950 with Air Ride Suspension After Chassis No. G-387453	350425C1		010	85300	89419
462557C91			010	85300	89419	
	CO-1950 with Air Ride Suspension Before Chassis No. G-387453	350426C1		010	85734	...

CE Series School Bus

06 - 18	CE Model School Buses (71 Capacity) with 9,000 to 10,000 lb Front Suspension	3578105C1	010	83163
		3578105C2	010	83163

APPLICATION GUIDE - TRUCKS, TRAILERS, AND BUSES

Year	Model	OEM #	Front		Rear	
						
						
			Fleetline	GasSLX	Fleetline	GasSLX

INTERNATIONAL (NAVISTAR)(Cont'd.)

CE Series School Bus(Cont'd.)

06 - 18	CE Model School Buses (71 Capacity) with 9,000 to 10,000 lb Front Suspension	6127088C1	010	83163
		OE13402S	010	83163
10 - 18	CE Model School Buses with 20,000 lb International IROS Air Suspension	3578858C2		010	85926	...
		6127713C1		010	85926	...
05 - 13	CE Model School Buses with 22,000 lb Rear Spring Suspension	501906C92		-10	83317	...
		OE13424S		-10	83317	...
13 - 18	CE Model School Buses with 6,000 to 8,000 lb Front Axles	6127688C1	010	83169

Co-Transtar and Transtar II

7070B, F-7070B, CO-7070B & COF-7070B Models	426744R91 426744R92 453576C91 453576C92 477132C1	010	85303	89422	
		010	85303	89422	
		010	85303	89422	
		010	85303	89422	
		010	85303	89422	
CO-4010, COF-4010, COT-4010, COT-4010D, CO-4050, COF-4050, COT-4050, CO-4040A & B, CO-4070D, COF-4070B, COF-4070D, COT-4070D, COF-4077, COF-4077A, COF-4080D, CO-4090A, COF-4090A	426744R91 426744R92 453576C91 453576C92 477132C1	010	85303	89422	
		010	85303	89422	
		010	85303	89422	
		010	85303	89422	
CO-4070A, COF-4070A, COF-4090A with Rear Suspension	462557C91		010	85300	89419

CXT Series

CXT Models with 9,000 to 10,000 lb Front Suspension	3606770C1	010	83163
	3606770C2	010	83163

DuraStar - 1000 Series

1300 Models	56110-T8123	-10	G63432
	56110-T8129	-10	G63432
	66400	-10	G63432

DuraStar - 4300, 4400 Series

2013	Low-Profile models with O.E.M. Number	1660846C92		010	83101	...
2016 -	Models with 10,500 or 13,500 lb Vari-Rate Rear Spring Suspension	6127087C1		010	83364	...
16 - 19	Models with 11,000 lb to 14,000 lb Front axle	6127714C1	010	85928
02 - 15	Models with 12,000 lb Front axle	3533357C1	010	85957
		3533357C2	010	85957
		3533357C3	010	85957
- 2015	Models with 20,000 lb International IROS Air Suspension	3578858C1		010	85926	...
		3578858C2		010	85926	...
16 - 19	Models with 20,000 lb International IROS Air Suspension	6127713C1		010	85926	...
02 - 13	Models with 22,000 lb Rear Spring Suspension	501906C91		-10	83317	...
		501906C92		-10	83317	...
- 2011	Models with 40,000 lb Rear Air Suspension	3549099C2		010	85923	89458
02 - 12	Models with 6,000 to 8,000 lb Front Suspension	3533356C1	010	83135
		3533356C2	010	83135
13 - 18	Models with 6,000 to 8,000 lb Front Suspension	3533356C3	010	83169
		6127688C1	010	83169
- 2015	Models with 9,000 to 10,000 lb Front Suspension	3578105C2	010	83163
16 - 19	Models with 9,000 to 10,000 lb Front Suspension	6127088C1	010	83163
- 2019	Models with Hendrickson HAS - 230 or 460 Rear Air Suspension	3514952C1		010	85976	...
		57905-001		010	85976	...
		60675-003		010	85976	...
		60675-003L		010	85976	...

APPLICATION GUIDE - TRUCKS, TRAILERS, AND BUSES

Year	Model	OEM #	Front			Rear		
			Fleetline	GasSLX				

INTERNATIONAL (NAVISTAR)(Cont'd.)

DuraStar - 4300, 4400 Series(Cont'd.)

- 2019	Models with Hendrickson HAS - 230 or 460 Rear Air Suspension	H60675-003		010	85976	...
	Models with International IROS Air Suspension	3553628C1		010	85927	...
		3553628C2		010	85927	...
		3553628C3		010	85927	...
		3553628C4		010	85927	...
	Models with O.E.M. Number	6127690C1		010	85923	89458
16 - 17	Models with Vari-Rate Rear Spring Suspension	6127700C1		-10	83395	...
02 - 12	School Bus models with 6,000 to 8,000 lb Front Suspension	3533356C1	010	83135
		3533356C2	010	83135









F & S Series

	1600, 1700, 1800, 1900, 2100 Models	3000070C91	-1-	83456	89447	
		453576C92	010	85303	89422	
	1600, 1700, 1800, 1900, 2100 Models with International Air Suspension	1675455C1		010	85003	89411
		1690035C1		010	85003	89411
		2018987C1		010	85003	89411
		2018987C2		010	85003	89411
		501553C91		010	85003	89411
	1600, 1700, 1800, 1900, 2100 Models with Neway ARD-234 Air Suspension	537524C91		010	83123	89405
	1624, 1654, 1724, 1754, 1824, 1854, 1924, F1924, 1925, 1954, F1954, 1955, 2124, 2125, F2125, 2154, 2155 Models Exc. with Rear Axle Codes 14029, 14030, 14187	501905C91		-10	83301	...
		501906C91		-10	83317	...
	1624, 1654, 1724, 1754, 1824, 1854, 1924, F1924, 1925, 1954, F1954, 1955, 2124, 2125, F2125, 2154, 2155 Models with 5000, 6000 or 7500 lb Front Axle	472367C91	-1-	83318
	1624, 1654, 1724, 1754, 1824, 1854, 1924, F1924, 1925, 1954, F1954, 1955, 2124, 2125, F2125, 2154, 2155 Models with Rear Axle Codes 14029, 14030, 14187	501905C91		-10	83301	...
	1624, 1654, 1724, 1754, 1824, 1854, 1924, F1924, 1925, 1954, F1954, 1955, 2124, 2125, F2125, 2154, 2155, 2275, F2275, 2524, F2524, 2554, F2554, 2574, F2574, 2575, F2575, F2624, F2654, F2674 Models with 9000, 10800 or 12000 lb Front Axle	472411C91	-1-	83456	89447	
		472412C91	-1-	83456	89447	
		586724C91	-1-	83456	89447	
	1924, 1954 (6 x 6) Models	472367C91	-1-	83318
		472414C91	-1-	83318
	2275, F2275, 2524, F2524, 2554, F2554, 2574, F2574, 2575, F2575, F2624, F2654, F2674 Models with International Corporate Air Suspension	1675455C1		010	85003	89411
		1690035C1		010	85003	89411
		2018987C1		010	85003	89411
		2018987C2		010	85003	89411
		501553C91		010	85003	89411
	2275, F2275, 2524, F2524, 2554, F2554, 2574, F2574, 2575, F2575, F2624, F2654, F2674 Models with Neway ARD-125/244 Air Suspension	790335C91		010	83209	89414
	2275, F2275, 2524, F2524, 2554, F2554, 2574, F2574, 2575, F2575, F2624, F2654, F2674 Models with Neway ARD-234 Air Suspension	537524C91		010	83123	89405
	2275, F2275, 2524, F2524, 2554, F2554, 2574, F2574, 2575, F2575, F2624, F2654, F2674 Models with Ridwell Rear Suspension	534464C1		010	85734	...

Firetruck

	CO-8190	204994R91	010	83225
		308648C91	010	83225
		453561C91	010	83225
		453565C91	010	83225
		467371C91	010	83225

APPLICATION GUIDE - TRUCKS, TRAILERS, AND BUSES

Year	Model	OEM #	Front		Rear	
						
						
			Fleetline	GasSLX	Fleetline	GasSLX

INTERNATIONAL (NAVISTAR)(Cont'd.)

Firetruck(Cont'd.)

Models with O.E.M. Number	210919R91	OIO	85307	...
---------------------------	-----------	-----	-----	-----	--------------	-----

Fleetstar - Conventional

1900, F-1900, T-1900, 1950, F-1950, T-1950, 2000, 2000D, F-2000D & T-2000D Models	210535R91	OIO	83225
	453568C91	OIO	83225
	467372C91	OIO	83225
1910A, F-1910A, 2010A, F-2010A, 2050A, F-2050A, 2070A, F-2070A, 2110A & 2150A Models	206621R92	OIO	83216
	308650C92	OIO	83216
	453570C91	OIO	83216
2000D, 2010A, 2050A, 2070A, 2110A, 2150A with Air Ride Suspension After Chassis No G-387453	350425C1		OIO	85300	89419
	462557C91		OIO	85300	89419
2000D, 2010A, 2050A, 2070A, 2110A, 2150A with Air Ride Suspension Before Chassis No G-387453	350426C1		OIO	85734	...
			OIO	85300	89419
F-2010A, F-2050A, F-2000D with Air Ride Suspension	350425C1		OIO	85300	89419
	462557C91		OIO	85300	89419
R-185, R-190, RD-190, R-200, RD-200, RF-200, RDF-200, R-220, RD-220, R210 & RF-210	210533R91	OIO	83225
	210534R92	OIO	83225
	210535R91	OIO	83225
	210536R91	OIO	83225
	210537R91	OIO	83225
	210538R91	OIO	83225
	453562C91	OIO	83225
	453568C91	OIO	83225
	467371C91	OIO	83225
467372C91	OIO	83225	





HV - Series

2019	Models with Hendrickson HMX 400/460 Haulmax with 16.5" Saddle	60680-004	OIO	83143	...
		60680-004L	OIO	83143	...
		H60680004	OIO	83143	...
2019	Models with Hendrickson HMX 400/460 Haulmax with 17.5" or 18.5" Saddle Height	60680-005	OIO	83142	...
		60680-005L	OIO	83142	...
		H60680005	OIO	83142	...
2019	Models with Hendrickson Primaax 230/460 Air Suspension with 9" Ride Height	60657-003	OIO	85072	...
		60657-003L	OIO	85072	...
		H60657003	OIO	85072	...

HX - Series

18 - 19	Models with Hendrickson HAS - 230 or 460 Rear Air Suspension	60675-003	OIO	85976	...
		60675-003L	OIO	85976	...
		H60675003	OIO	85976	...
18 - 19	Models with Hendrickson HMX 400/460 Haulmax with 16.5" Saddle	60680-004	OIO	83143	...
		60680-004L	OIO	83143	...
		H60680004	OIO	83143	...
18 - 19	Models with Hendrickson HMX 400/460 Haulmax with 17.5" or 18.5" Saddle Height	60680-005	OIO	83142	...
		60680-005L	OIO	83142	...
		H60680005	OIO	83142	...
18 - 19	Models with Hendrickson Primaax 520 Rear Air Suspension (10" Ride Height-Disc Brakes only)	60665-015	OIO	85966	...
		H60665015	OIO	85966	...

APPLICATION GUIDE - TRUCKS, TRAILERS, AND BUSES

Year	Model	OEM #	Front		Rear	
			 Fleetline	 GasSLX	 Fleetline	 GasSLX

INTERNATIONAL (NAVISTAR)(Cont'd.)

HX - Series(Cont'd.)

18 - 19	Models with Hendrickson Primaax 520 Rear Air Suspension (10" Ride Height-Drum Brakes only)	60665-013	010	85965	...
		H60665013	010	85965	...





Loadstar - Conventional

	1600, 1600 (4x4), 1610, 1610 (4x4), 1610FC, 1700, 1700 (4x4), 1710, 1710 (4x4), F-1700, 1750, 1800, 1810, F-1800, F-1800-D, 1850, F-1850, 1890 & 1890-D with 9000, 10800 or 12000 lb Front Axle	329316C92	010	85012	89413	
		360444C91	010	85012	89413	
		453564C91	010	85012	89413	
		467983C91	010	85012	89413	
		471201C91	010	85012	89413	
	1600, 1600 (4x4), 1610, 1610 (4x4), 1610FC, 1700, 1700 (4x4), 1710, 1710 (4x4), F-1700, 1750, 1800, 1810, F-1800, F-1800-D, 1850, F-1850, 1890 & 1890-D with Axle Codes 02089, 02091	206620R91	010	83216	
		308649C91	010	83216	
		453567C91	010	83216	
	1600, 1600 (4x4), 1610, 1610 (4x4), 1700, 1700 (4x4), 1710, 1710 (4x4), 1750, 1800, 1810, 1850, 1890 & 1890-D Models	206620R91		010	83216	...
		206621R91		010	83216	...
		308649C91		010	83216	...
		308650C92		010	83216	...
		329316C92		010	85012	89413
		360444C91		010	85012	89413
		383379C91		010	83308	...
		453564C91		010	85012	89413
		453567C91		010	83216	...
		453570C91		010	83216	...
		453575C91		010	83308	...
		467983C91		010	85012	89413
		467984C91		010	83216	...
		471203C91		010	83308	...
		474002C91		010	83308	...
873622C91		010	83308	...		
	1600, 1600 (4x4), 1610, 1610 (4x4), 1700, 1700 (4x4), 1710, 1710 (4x4), F-1700, 1750, 1800, 1810, F-1800, F-1800-D, 1850, F-1850, 1890 & 1890-D Exc. Axle Codes 02054, 02057, 02059, 02089, 02091, 02098, 02101, 02109, 02139, 02208, 02218, 02228, 02309, 0232	308668C92	010	85012	89413	
		453556C91	010	85012	89413	
		467985C91	010	85012	89413	
		874695R91	010	85012	89413	
		874695R92	010	85012	89413	
	1600, 1610FC, 1700, 1700 (4x4), 1800, 1890, 1890D Models	384435C91		010	83216	...
		453571C91		010	83216	...
		462753C91		010	83216	...
	1700, 1750, 1800, 1850 Models with Air Ride Suspension	462557C91		010	85300	89419
	M1600, M1700, M1800, M1900, M2100 Models	453576C92	010	85303	89422	

LoneStar - Series

09 - 15	All models with 40,000 lb Rear Air Suspension	3620395C1		010	85931	89458
08 - 10	Models with 12,000 lb Mono-leaf Front Spring	3819277C1	010	85969
		3819279C1	010	85969
09 - 18	Models with 12,350 lb Front Mono Leaf Spring Suspension	3813341C1	010	85963
		3813341C2	010	85963
		3813341C3	010	85963
		3813341C4	010	85963
- 2017	Models with Hendrickson HAS - 230 or 460 Rear Air Suspension	3514952C1		010	85976	...

APPLICATION GUIDE - TRUCKS, TRAILERS, AND BUSES

Year	Model	OEM #	Front		Rear	
						
			Fleetline	GasSLX	Fleetline	GasSLX

INTERNATIONAL (NAVISTAR)(Cont'd.)

LoneStar - Series(Cont'd.)

- 2017	Models with Hendrickson HAS - 230 or 460 Rear Air Suspension	57905-001		010	85976	...
		60675-003		010	85976	...
		60675-003L		010	85976	...
		H60675-003		010	85976	...
12 - 16	Models with International 40,000 lb Rear Air Suspension (52" Spacing- Heavy Duty Rear)	3688614C1		010	85923	89458
		3688616C1		010	85923	89458
2013 -	Models with O.E.M. Number	3810581C3	010	85995
		3810581C4	010	85995
09 - 19	Sleeper Cab models with 14,000 lb Parabolic Taperleaf Front Spring	3813340C1	010	85964
		3813340C2	010	85964
		3813340C3	010	85964
		3813340C4	010	85964





LT - Series

2018 - 19	LT-625 Models with 12,000 - 14,000 lb Taperleaf Spring Suspension	4050444C2	010	85994
2018 - 19	LT-625 Models with 12,000 lb - 13,200 lb Mono-Leaf Spring Suspension	4050443C2	010	85994
2018	Models with Hendrickson HTB 400LT Rear Air Suspension	3684524C1		010	85102	...
		60657-010		010	85102	...
		H60657-010		010	85102	...

Metro & Multi-Shop Series

	AM and AMC-160, AMC-164	308649C91	010	83216
		453567C91	010	83216
	M1600, M1700, M1800, M1900, M2100 Models	453576C92	010	85303	89422	
	M1600, M1700, M1800, M1900, M2100 Models - Exc. with Rear Axle Codes 14029, 14030, 14187	501905C91		-10	83301	...
		501906C91		-10	83317	...
	M1600, M1700, M1800, M1900, M2100 Models with 5000, 6000 or 7500 lb Front Axle	472367C91	-1-	83318
	M1600, M1700, M1800, M1900, M2100 Models with 9000, 10800 or 12000 Front Axle	472411C91	-1-	83456	89447	
	M1600, M1700, M1800, M1900, M2100 Models with Front Axle Codes 02109, 02118, 02309, 02127, 02139, 02329, 02339	472412C91	-1-	83456	89447	
		586724C91	-1-	83456	89447	
	M1600, MC1600, M1700 & MC1700	206620R91		010	83216	...
		308649C91		010	83216	...
		308668C91	010	85012	89413	
		308669C91	010	85012	89413	
		453556C91	010	85012	89413	
		453597C91		010	83216	...
		874695R91	010	85012	89413	
		874696R91	010	85012	89413	
	MA1200, M1400, M1500, MA1500	287318C91		G63306	...	010	G63306	...
		308649C91		010	83216	...
		308669C91		010	85012	89413
		453531C91		010	G63306	...
		453556C91		010	85012	89413
		453557C91		010	G63306	...
		453567C91		010	83216	...
		467980C91		G63306	...	010	G63306	...
66 - 72	Metro Models M1200 - Exc. Frame Code 01000.0962	010	G63299	
66 - 72	Metro Models M1200 with 14016 Reg. Rear Springs & with 14020 Rear Axle Code		G63306	...	010	G63306	
66 - 72	Metro Models M1200 with Axle Code 0208 & Frame Code 01000.0962		G63306	...	010	G63306	

APPLICATION GUIDE - TRUCKS, TRAILERS, AND BUSES

Year	Model	OEM #	Front		Rear	
			 Fleetline	 GasSLX	 Fleetline	 GasSLX

INTERNATIONAL (NAVISTAR)(Cont'd.)

Metro & Multi-Shop Series(Cont'd.)

66 - 72	Metro Models M1200 with Code 03204 Aux. Springs	010	G63299	...
66 - 72	Metro Models M700, 800, 900-U, 1000, 1100,	G63306	...	010	G63306	...
73 - 75	Multi-Stop Models MS-1210 & 1510	010	G63306	...

MV Series

2019	MV 607 Models with 9,000 to 10,000 lb Front Suspension	6127088C1	010	83163
------	--	-----------	-----	-------	-----	-----	-----





Paystar - 5000 Series

	5010, F-5010, F-5050, F-5050SF, 5070, F-5070, F-5070SF Models	426744R91	010	85303	89422
		426744R92	010	85303	89422
		453576C91	010	85303	89422
		453576C92	010	85303	89422
		477132C1	010	85303	89422
- 2012	5600i Models with 16,000 lb Front axle	1667520C1	010	85058	89431
		4070336C1	010	85058	89431
04 - 12	5900 SB Models with 18,000 lb Front axle	1667520C1	010	85058	89431
04 - 15	5900 SB Models with 46,000 lb Hendrickson Rear Air Suspension	3626571C1		010	85072
		H60657-003		010	85072
- 2018	5900 SB Models with Hendrickson Primaax 230, 460 and 690 Air Suspension (8-1/2" to 10" Ride Height)	60657-003		010	85072
		60657-003L		010	85072
- 2018	5900 SB Models with Hendrickson Primaax EX 232, 462 and 692 Air Suspension (8-1/2" to 10" Ride Height)	60657-003		010	85072
		60657-003L		010	85072
09 - 11	5900i Models with 12,000 lb - 14,000 lb Front axle	2015556C1	010	85316	89426
04 - 12	5900i SFA Models with 16,000 lb Front axle	1667520C1	010	85058	89431
04 - 09	5900i SFA Models with 46,000 lb Neway Rear Air Suspension	2029200C91		010	83126 89430
		90044626		010	83126 89430
	Models with 10,000 to 16,000 lb Front Suspension	3576465C2	010	85999
		3816234C1	010	85999
10 - 13	Models with 12,000 to 14,000 lb Front Taperleaf Suspension	3868264C1	010	85998
- 2013	Models with Hendrickson HMX 400/460 Haulmax with 16.5" Saddle	60680-004		01-	83143
		60680-004L		01-	83143
	Models with O.E.M. Number	6127690C1		010	85923 89458

ProStar - Series

09 - 17	All models with 40,000 lb Rear Air Suspension	3620395C1		010	85931 89458
		4050340C1		010	85931 89458
		4050340C2		010	85931 89458
	Day Models with O.E.M. Number	3737576C1		010	85931 89458
2013 -	Models with 113" Sleeper Cab	3806341C3	010	85995
		3806341C4	010	85995
		3810581C3	010	85995
		3810581C3	010	85995
		3810581C4	010	85995
- 2013	Models with 12,350 lb Front Mono Leaf Spring Suspension	3610198C1	010	85963
09 - 18	Models with 12,350 lb Front Mono Leaf Spring Suspension	3813341C3	010	85963
		3813341C4	010	85963
16 - 17	Models with Day Cab and 12,000 - 14,000 lb Taperleaf Front Spring Suspension	4050444C1	010	85994
		4050444C2	010	85994
-2015	Models with Day Cab and 12,000 to 14,000 lb Taperleaf Front Spring Suspension	3606859C1	010	85954
		3606859C2	010	85954
		3606859C3	010	85994
		3737574C1	010	85954
		3812837C1	010	85954

APPLICATION GUIDE - TRUCKS, TRAILERS, AND BUSES

Year	Model	OEM #	Front		Rear	
						
			Fleetline	GasSLX	Fleetline	GasSLX

INTERNATIONAL (NAVISTAR)(Cont'd.)

ProStar - Series(Cont'd.)

	Models with Day Cab and Air Suspension	3610199C1	OIO	85964
- 2017	Models with Hendrickson HAS - 230 or 460 Rear Air Suspension	3514952C1		OIO	85976	...
		57905-001		OIO	85976	...
		60675-003		OIO	85976	...
		60675-003L		OIO	85976	...
		H60675-003		OIO	85976	...
	Models with Hendrickson HTB 400LT Rear Air Suspension	60657-006		OIO	85102	...
		60657-010		OIO	85102	...
		60657-011		OIO	85102	...
		H60657-006		OIO	85102	...
		H60657-010		OIO	85102	...
		H60657-011		OIO	85102	...
	Models with O.E.M. Number	3668566C1	OIO	85954
		3688729C1		OIO	85931	89458
		3688732C1		OIO	85931	89458
		3821760C1		OIO	85931	89458
- 2014	Models with Sleeper Cab and 12,350 lb Leaf Spring Suspension	3606857C1	OIO	85954
		3606857C2	OIO	85954
14 - 15	Models with Sleeper Cab and 12,350 lb Leaf Spring Suspension	3606857C3	OIO	85994
	Models with Sleeper Cab with O.E.M. Number	3737575C1	OIO	85954
2016 -	Sleeper Cabs with 12,000 lb - 13,200 lb Mono-Leaf Spring Suspension	4050443C1	OIO	85994
		4050443C2	OIO	85994





RH - Series

2018 - 19	RH-613 Models with 12,000 lb - 13,200 lb Mono-Leaf Spring Suspension	4050443C2	OIO	85994
-----------	--	-----------	-----	-------	-----	--	-----	-----

S Series School Bus

	1603, 1703, 1803 & 1853	206620R91	OIO	OIO	83216	...
		206621R91		OIO	83216	...
		306444C91		OIO	85012	89413
		308649C91		OIO	83216	...
		308650C92		OIO	83216	...
		329316C92		OIO	85012	89413
		383379C91		OIO	83308	...
		453564C91		OIO	85012	89413
		453567C91		OIO	83216	...
		453570C91		OIO	83216	...
		453575C91		OIO	83308	...
		467983C91		OIO	85012	89413
		471201C91		...	85012	89413
		471203C91		OIO	83308	...
		474002C91		OIO	83308	...
		873622C91		OIO	83308	...
	1603, 1703, 1803 & 1853 - Exc. Axle Codes 02054, 02057, 02059, 02089, 02091, 02098, 02101, 02109, 02139, 02208, 02218, 02228, 02309, 02329, 02339	308668C92	OIO	85012	89413	
		453556C91	OIO	85012	89413	
		467985C91	OIO	85012	89413	
	1603, 1703, 1803 & 1853 with Axle Codes 02089, 02091	874695R91	OIO	85012	89413	
		206620R91	OIO	83216
		308649C91	OIO	83216
		453567C91	OIO	83216
		467984C91	OIO	83216

APPLICATION GUIDE - TRUCKS, TRAILERS, AND BUSES

Year	Model	OEM #	Front		Rear	
			 Fleetline	 GasSLX	 Fleetline	 GasSLX

INTERNATIONAL (NAVISTAR)(Cont'd.)









S Series School Bus(Cont'd.)

	1603, 1703, 1803 & 1853 with 9000, 10800 or 12000 lb Front Axle	320444C91	010	85012	89413	
			010	85012	89413	
			010	85012	89413	
			010	85012	89413	
	1723 S Models with 5000, 6000 or 7500 lb Front Axle	472367C91	-1-	83318
	1723, 1823, 1853 Models with International Air Suspension	1675455C1		010	85003	89411
				010	85003	89411
				010	85003	89411
				010	85003	89411
				010	85003	89411
	1723, 1823, 1853 Models with Neway ARD-234 Air Suspension	537524C91		010	83123	89405
	173 FC & 183 FC - Exc. Axle Codes 14149 & 14189	210918R91		010	83215	...
				010	85307	...
	173 FC & 183 FC with Axle Codes 14149 & 14189	210535R91		010	83225	...
				010	83225	...
				010	83225	...
	173 FC, 183 FC, 183RE, 193 RE, 1853 FC & 1853 DFC	204994R91	010	83225
			010	83225
			010	83225
			010	83225
			010	83225
	1823 S Models - Exc. with Rear Axle Codes 14029,14030, 14187	501906C91		-10	83317	...
	1823, 1853 S Models with 9000, 10800 or 12000 lb Front Axle	472411C91	-1-	83456	89447	
			-1-	83456	89447	
			-1-	83456	89447	
	183 RE Models with Axle Codes 14043, 14147 & 14186	210533R91		010	83225	...
				010	83225	...
				010	83225	...
				010	83225	...
	1853 DFC3	210920R91	010	85308	89422	
			010	85308	89422	
	1853 FC & 1853 DFC with Axle Code 14136	210919R91		010	85307	...
				010	85307	...
				010	85307	...
	1853 FC & 1853 DFC with Axle Code 14149 with FD Serial Numbers	453567C91		010	83216	...
	1853 FC & 1853 DFC with Axle Codes 14039, 14139, 14149 & 14189 - Exc. 14149 with FD Serial Numbers	210533R91		010	83225	...
				010	83225	...
				010	83225	...
				010	83225	...
	1853 FC & 1853 DFC with Axle Codes 14044, 14045, 14060, 14145, 14146, 14150 and 14186	208664C91		010	85307	...
				010	85307	...
				010	85307	...
	193 RE Models	210920R91	010	85308	89422	
			010	85308	89422	
	193 RE Models - Exc. Axle Codes 14039 & 14189	210533R91		010	83225	...
				010	83225	...
				010	83225	...
				010	83225	...
	RE Models	3604282C1	-10	85351

Series 1000 Forward Control Chassis

	1452, 1652 Models	453576C92	010	85303	89422	
--	-------------------	-----------	-----	-------	-------	--	-----	-----

APPLICATION GUIDE - TRUCKS, TRAILERS, AND BUSES

Year	Model	OEM #	Front		Rear	
						
						
			Fleetline	GasSLX	Fleetline	GasSLX

INTERNATIONAL (NAVISTAR)(Cont'd.)

Series 1000 Forward Control Chassis(Cont'd.)

1452, 1652 Models	472412C91	- -	83456	89447	
	586724C91	- -	83456	89447	
1452, 1652 Models with International Air Suspension	1675455C1		0 0	85003	89411
	1690035C1		0 0	85003	89411
	2018987C1		0 0	85003	89411
	2018987C2		0 0	85003	89411
	501553C91		0 0	85003	89411
1452, 1652 Models with MOR-RYDE Rear Suspension	548532C1		- -	83103	...
1654 LP Models (Low Profile Vehicle)	1660846C91		0 0	83101	...
	1660846C92		0 0	83101	...
	1663471C1	- -	83103
	2039565C1		0 0	83100	...
M1400, M1600 Models	472412C91	- -	83456	89447	
	501905C91		- 0	83301	...
	586724C91	- -	83456	89447	

Series 2000 - Conventional Truck (Severe Service)

2554, 2574, 2654, 2674 Models with International Air Suspension	1675455C1		0 0	85003	89411
	1690035C1		0 0	85003	89411
	2018987C1		0 0	85003	89411
	2018987C2		0 0	85003	89411
	501553C91		0 0	85003	89411
2554, 2574, 2654, 2674 Models with International Vari-Rate Rear Suspension	501506C91		- 0	83317	...
All 2000 Models With 12000 lb Front Axle With 16000 or 18000 lb Springs Without 16000 or 18000 lb Springs	472412C91	- -	83456	89447	
	1667520C1	0 0	85058	89431	
	2015556C1	- 0	85316	89426	





Series 3000 - School Bus Chassis

3000, 3400 Models with 10,000 to 14,000 lb Front axle	3533357C1	0 0	85957
	3533357C2	0 0	85957
	3533357C3	0 0	85957
3000, 3400 Models with 6,000 to 8,000 lb Front axle	3533356C1	0 0	83135
	3533356C2	0 0	83135
3700, 3800 Models	472412C91	- -	83456	89447	
	501905C91		- 0	83301	...
	501906C91		- 0	83317	...
	586724C91	- -	83456	89447	
3700, 3800 Models with International Air Suspension	1675455C1		0 0	85003	89411
	1690035C1		0 0	85003	89411
	2018987C1		0 0	85003	89411
	2018987C2		0 0	85003	89411
	501553C91		0 0	85003	89411
3700, 3800 Models with MOR-RYDE Rear Suspension	548532C1		- -	83103	...
3700, 3800 Models with Neway ARD-234 Air Suspension	537524C91		0 0	83123	89405
	537525C91		0 0	83123	89405
3900FC Models	1677707C1	0 0	85030	89440	
	2015557C1	0 0	85030	89440	
	467371C91		83225	...	0 0	83225	...
3900FC Models (Genesis - Front Engine)	2200327C1	- 0	85332
3900FC Models (Genesis - Rear Engine)	2039549C1	- 0	85333

Series 400, 500, 600, 700, & 900 - Medium Cabover Truck & Tractor (Nissan)

400 Models	56101 Z5008	- 0	83114
	56101 Z5011	- 0	G63610
500 Models	56101 Z5011	- 0	G63610

APPLICATION GUIDE - TRUCKS, TRAILERS, AND BUSES

Year	Model	OEM #	Front		Rear	
			 Fleetline	 GasSLX	 Fleetline	 GasSLX

INTERNATIONAL (NAVISTAR)(Cont'd.)

Series 400, 500, 600, 700, & 900 - Medium Cabover Truck & Tractor (Nissan)(Cont'd.)

	600, 700, 900 Models	56101 Z1030	-IO	85311	89424	
		56101 Z2000	-IO	85311	89424	

Series 4000 - Short Conventional Medium Truck & Tractor

	4000 Models with Hendrickson HAS-230 Rear Air Suspension	AMS650420		OIO	85013	89414
	4600, 4700, 4800, 4900 Models	1663606C91	-I-	85027	89418	
		1667520C1	OIO	85058	89431	
		586724C91	-I-	83456	89447	
	4600, 4700, 4800, 4900 Models with 10000 lb Front Axle	472412C91	-I-	83456	89447	
	4600, 4700, 4800, 4900 Models with International Air Suspension (Exc. Low Profile)	1675455C1		OIO	85003	89411
		1690035C1		OIO	85003	89411
		2018987C1		OIO	85003	89411
		2018987C2		OIO	85003	89411
		501553C91		OIO	85003	89411
	4600LP, 4700LP Models (Low Profile Vehicle) U-Haul	540395C91	-I-	83613
		540395C92	-I-	83613
02/95-	4600LP, 4700LP Models (Low Profile Vehicle) U-Haul	2039565C1		OIO	83100	...
	4600LP, 4700LP Models (Low Profile Vehicle) with Air Suspension	1660846C91		OIO	83101	...
		1660846C92		OIO	83101	...
	F-4900 & 4600LP Models (Low Profile Vehicle)	501906C91		-IO	83317	...
		501906C92		-IO	83317	...
90 - 02	F-4900 Models with 10000 lb Front Axle	472412C91	-I-	83456	89447	
90 - 02	F-4900 Models with Dual Doors	2015556C1	-IO	85316	89426	
	F-4900 Models with Hendrickson HN - 400 Models Rear suspension	60680-003		OI-	83112	...
		60680-003L		OI-	83112	...

Series 405

	Models with O.E.M. Number	293009C91	OIO	85308	89422	
		426744R91	OIO	85303	89422	
		453576C91	OIO	85303	89422	
		453577C91	OIO	85308	89422	

Series 417

	DCO-417 & DCOF-417	426744R91	OIO	85303	89422	
		453576C91	OIO	85303	89422	





Series 5000, 5000i - Severe Service Conventional Truck & Tractor

	6 X 4 Models with Neway AD-246-10 Air Suspension and 60" Axle Spacing															
									Heavy Duty	2029200C91		OIO	85030	89440
										AMS 600172		OIO	85030	89440
									Standard	2029200C91		OIO	83126	89430
		AMS 600172		OIO	83126	89430								

Series 7000 - Short Conventional Medium Truck & Tractor

	7000 Models School Bus with O.E.M. Number	3609400C1		-IO	83317	...
		3609400C2		-IO	83317	...
	7100 Models	1663606C91	-I-	85027	89418	
		472412C91	-I-	83456	89447	
		586724C91	-I-	83456	89447	
	7100 Models with International Air Suspension	1675455C1		OIO	85003	89411
		1690035C1		OIO	85003	89411
		2018987C1		OIO	85003	89411
		2018987C2		OIO	85003	89411
		501553C91		OIO	85003	89411
	7300, 7400, 7500, 7600 Models w/ IAS Suspension w/ 5.3" Ride Height	3544766C1		OIO	85930	...

APPLICATION GUIDE - TRUCKS, TRAILERS, AND BUSES

Year	Model	OEM #	Front		Rear	
						
			Fleetline	GasSLX	Fleetline	GasSLX

INTERNATIONAL (NAVISTAR)(Cont'd.)

Series 8000 - Conventional Heavy Duty Tractor(Cont'd.)

	8100 Models Car Hauler	1664524C1 472412C91	- -	- O	85935	...
	8100, 8200, 8300 Models	3000070C91 501906C91	- -	83456	89447	
	8100, 8200, 8300 Models - with Hendrickson HA-460 Air Suspension with 55" & 60" axle spacing and 40000 & 46000 lb capacity	AMS 600102		O O	85005	89430
	8100, 8200, 8300 Models with 12000 - 14000 lb Suspension	1664788C2 2015556C1	- O	85316	89426	
	8100, 8200, 8300 Models with 15000 - 18000 lb Suspension	1667520C1	O O	85058	89431	
	8100, 8200, 8300 Models with Hendrickson HA-230 Rear Air Suspension	AMS 600102		O O	85005	89430
	8100, 8200, 8300 Models with International Air Suspension (Except Lo-Profile and Carhauler)	1675455C1 1690035C1 2018987C1 2018987C2 501553C91		O O	85003	89411
	8100LP, 8200LP & 8300LP Models - 6 X 4 & 4 X 2 Models with International Air Suspension for Lo-Profile and Carhauler	1660846C91 1660846C92		O O	83101	...
07 - 08	8600 Models with Taperleaf Front Spring Suspension	3670156C1	O O	85954
	Models with Neway AD-246-10 Air Suspension and 60" Axle Spacing							
	Heavy Duty	2029200C91 AMS 600172		O O	85030	89440
	Standard	2029200C91 AMS 600172		O O	83126	89430
				O O	83126	89430





Series 9100, 9100i - Tractor & Straight Truck

	6 X 4 Models with International Air Suspension For Lo-Profile	1660846C91 1660846C92		O O	83101	...
	6 X 4 Models with Neway AD-246-10 Air Suspension and 60" Axle Spacing							
	Heavy Duty	2029200C91 AMS 600172		O O	85030	89440
	Standard	2029200C91 AMS 600172		O O	83126	89430
	9100 Models - with Hendrickson HA-460 Models Air Suspension	AMS 600102		O O	85005	89430
	9100 Models with 12000 - 14000 lb Suspension	1664788C2 2015556C1 2032533C1	- O - O - O	85316	89426	
	Models with International Air Suspension (Except Lo-Profile)	2018987C1 2018987C2		O O	85003	89411
				O O	85003	89411

Series 9200, 9200i - Tractor & Straight Truck

	4 X 2 Models with International Air Suspension	2018987C1 2018987C2		O O	85003	89411
	6 X 4 Models with 12,000 to 14,000 lb Front Axles	3581109C3 3581109C4	O O O O	85924	89457	
	6 X 4 Models with International Air Suspension	2018987C1 2018987C2		O O	85003	89411
	6 X 4 Models with International Air Suspension For Lo-Profile	1660846C91 1660846C92		O O	83101	...
	6 X 4 Models with Neway AD-246-10 Air Suspension and 60" Axle Spacing							
	Heavy Duty	2029200C91 AMS 600172		O O	85030	89440
	Standard	2029200C91		O O	83126	89430

APPLICATION GUIDE - TRUCKS, TRAILERS, AND BUSES

Year	Model	OEM #	Front		Rear	
			 Fleetline	 GasSLX	 Fleetline	 GasSLX

INTERNATIONAL (NAVISTAR)(Cont'd.)





Series 9200, 9200i - Tractor & Straight Truck(Cont'd.)

	Heavy Duty	AMS 600172		010	83126	89430
	Models with 12,000 - 18,000 lb Suspension	1664788C2	-10	85316	89426	
		2015556C1	-10	85316	89426	
		2032533C1	-10	85316	89426	
00 - 09	Models with 12,000 lb Front Axle	3581107C1	010	85924	89457	
		3581107C2	010	85924	89457	
		3581107C3	010	85924	89457	
		3584535C3	010	85924	89457	
		6127705C1	010	85924	89457	
04 - 09	Models with 40,000 lb Rear Air Suspension	3586883C1		010	85931	89458
	Models with Day Cab & Hendrickson AirTek Suspension	3613984C1	010	85955
		3660549C1	010	85955
		65992-002	010	85955
		65992-002L	010	85955
	Models with Hendrickson HA-460 Models Air Suspension	AMS 600102		010	85005	89430
	Models with IAS Suspension w/ 9.25" or 9.5" Ride Height	3573265C1		010	85931	89458
	Models with International Air Suspension	1675455C1		010	85003	89411
		1690035C1		010	85003	89411
		501553C91		010	85003	89411
	Models with Sleeper Cab & Hendrickson AirTek Suspension	3609178C1	010	85955
		3660548C1	010	85955
		65992-001	010	85955

Series 9300, 9300i, 9400 & 9400i Long Hood Conventional Truck & Tractor

	6 X 4 Models with International Air Suspension Exc. Lo-Profile	2018987C1		010	85003	89411
		2018987C2		010	85003	89411
	6 X 4 Models with International Air Suspension For Lo-Profile	1660846C91		010	83101	...
		1660846C92		010	83101	...
	6 X 4 Models with Neway AD-246-10 Air Suspension and 60" Axle Spacing							
	Heavy Duty	2029200C91		010	85030	89440
		AMS 600172		010	85030	89440
	Standard	2029200C91		010	83126	89430
		AMS 600172		010	83126	89430
	Models with 10,800 lb Suspension	503610C2	010	83207	89407	
	Models with 12,000 - 14,000 lb Suspension	1664788C2	-10	85316	89426	
		2015556C1	-10	85316	89426	
		2032533C1	-10	85316	89426	
00 - 09	Models with 12,000 lb Front Axle	3581107C1	010	85924	89457	
		3581107C2	010	85924	89457	
		3581107C3	010	85924	89457	
		3584535C3	010	85924	89457	
	Models with 16,000 - 18,000 lb Suspension	1667520C1	010	85058	89431	
04 - 09	Models with 40,000 lb Rear Air Suspension	3586883C1		010	85931	89458
	Models with Day Cab & Hendrickson AirTek Suspension	3613984C1	010	85955
		3660549C1	010	85955
		65992-002	010	85955
		65992-002L	010	85955
	Models with Hendrickson HA-460 Models Air Suspension	AMS 600102		010	85005	89430
	Models with IAS Suspension w/ 9.25" or 9.5" Ride Height	3573265C1		010	85931	89458
	Models with International Air Suspension	1675455C1		010	85003	89411
		1690035C1		010	85003	89411
		501553C91		010	85003	89411
	Models with Neway ARD-125/244 Air Suspension	790335C91		010	83209	89414
	Models with O.E.M Number	3571713C1	-10	85333
	Models with Sleeper Cab & Hendrickson AirTek Suspension	3609178C1	010	85955

APPLICATION GUIDE - TRUCKS, TRAILERS, AND BUSES

Year	Model	OEM #	Front		Rear	
						
				Fleetline	GasSLX	Fleetline

INTERNATIONAL (NAVISTAR)(Cont'd.)

Series 9300, 9300i, 9400 & 9400i Long Hood Conventional Truck & Tractor(Cont'd.)

	Models with Sleeper Cab & Hendrickson AirTek Suspension	3660548C1 65992-001	○IO	85955
			○IO	85955
	Set Back Axle Models with 16,000 lb to 18,000 lb Suspension	1664149C1	○IO	85029
	Set Foreward Axle Models with 16,000 lb to 18,000 lb Suspension	507202C1	○IO	85030	89440	

Series 9600 & 9700 Premium Cabover Tractor

	9600, 9700 Models	507202C1	○IO	85030	89440	
	9600, 9700 Models Except Low Profile	1664788C2	-IO	85316	89426	
		2015556C1	-IO	85316	89426	
	9600, 9700 Models for Low Profile	503610C2	○IO	83207	89407	
	9600, 9700 Models with 16000 - 18000 lb Suspension	1667520C1	○IO	85058	89431	
	9600, 9700 Models with Hendrickson HA-460 Air Suspension with 55" or 60" axle spacing and 40000 or 46000 lb capacity	AMS 600102		○IO	85005	89430
	9600, 9700 Models with International STL Spring Suspension	503550C1		○IO	83207	89407
	9600, 9700 Models with Neway ARD-125/244 Air Suspension	790335C91		○IO	83209	89414
	9600, 9700 Models with Neway ARD-234 Air Suspension	537524C91		○IO	83123	89405
	Models with International Air Suspension	1675455C1		○IO	85003	89411
		1690035C1		○IO	85003	89411
		2018987C1		○IO	85003	89411
		2018987C2		○IO	85003	89411
		501553C91		○IO	85003	89411





Series 9800 - Premium Cabover Tractor

	6 X 4 Models with International Air Suspension	2018987C1		○IO	85003	89411
		2018987C2		○IO	85003	89411
	6 X 4 Models with Neway AD-246-10 Air Suspension and 60" Axle Spacing Heavy Duty	2029200C91		○IO	85030	89440
		AMS 600172		○IO	85030	89440
		2029200C91		○IO	83126	89430
		AMS 600172		○IO	83126	89430
	9800 Models - with Hendrickson HA-460 Air Suspension with 55" & 60" axle spacing and 40000 & 46000 lb capacity	AMS 600102		○IO	85005	89430
	9800 Models - with Hendrickson HAS-402-60 Air Suspension	AMS 650420		○IO	85013	89414
	9800 Models - with Set Back axle	2015556C1	-IO	85316	89426	
	9800 Models - with Set Forward axle	503610C2	○IO	83207	89407	

Series 9900, 9900i, 9900ix Long Hood Conventional Truck

	6 X 4 Models with International Air Suspension Exc. Lo-Profile	2018987C1		○IO	85003	89411
		2018987C2		○IO	85003	89411
	6 X 4 Models with International Air Suspension For Lo-Profile	1660846C91		○IO	83101	...
		1660846C92		○IO	83101	...
	6 X 4 Models with Neway AD-246-10 Air Suspension and 60" Axle Spacing Heavy Duty	2029200C91		○IO	85030	89440
		AMS 600172		○IO	85030	89440
		2029200C91		○IO	83126	89430
		AMS 600172		○IO	83126	89430
- 2011	Day Cab Models with 12,000 lb Front Axles	3581106C1	○IO	85924	89457	
		3581106C2	○IO	85924	89457	
		3581106C3	○IO	85924	89457	
	Models with 10,800 lb - 14,600 lb Suspension	503610C2	○IO	83207	89407	
	Models with 12,000 - 14,000 lb Suspension	1664788C2	-IO	85316	89426	
		2015556C1	-IO	85316	89426	
		2032533C1	-IO	85316	89426	
04 - 09	Models with 12,000 lb Front axle	3584535C3	○IO	85924	89457	
2013 -	Models with 12,000 lb Front axle	3810581C3	○IO	85995
		3810581C4	○IO	85995

APPLICATION GUIDE - TRUCKS, TRAILERS, AND BUSES

Year	Model	OEM #	Front		Rear	
			 Fleetline	 GasSLX	 Fleetline	 GasSLX

INTERNATIONAL (NAVISTAR)(Cont'd.)

Series 9900, 9900i, 9900ix Long Hood Conventional Truck(Cont'd.)

	Models with 16,000 - 18,000 lb Suspension	1667520C1	010	85058	89431	
04 - 11	Models with 40,000 lb Rear Air Suspension	3586883C1		010	85931	89458
02 - 17	Models with Hendrickson HAS - 230 or 460 Rear Air Suspension	3514952C1		010	85976	...
		57905-001		010	85976	...
		60675-003		010	85976	...
		60675-003L		010	85976	...
		H60675-003		010	85976	...
- 2016	Models with International 40,000 lb Rear Air Suspension (52" Spacing- Heavy Duty Rear)	3688616C1		010	85923	89458
	Models with International Air Suspension	1675455C1		010	85003	89411
		1690035C1		010	85003	89411
		501553C91		010	85003	89411
	Models with Neway ARD-125/244 Air Suspension	790335C91		010	83209	89414
	Models with O.E.M Number	3571713C1	-10	85333
14 - 16	Models with Sleeper Cab and 14,000 to 16,000 lb Taperleaf Front Spring Suspension	3977759C2	010	85639
	Set Back Axle Models with 16,000 lb to 18,000 lb Suspension	1664149C1	010	85029
	Set Forward Axle Models with 16,000 lb to 18,000 lb Suspension	507202C1	010	85030	89440	

TerraStar

2014	4 WD Models with Rear Spring Suspension	3945165C1		010	83180	...
		6127096C1		010	83180	...
12 - 15	Models with 10,000 & 13,500 lb Vari-Rate Rear Spring Suspension	3586902C2		010	83146	...
12 - 17	Models with 10,500 or 13,500 lb Vari-Rate Rear Spring Suspension	3586902C3		010	83364	...
		6127087C1		010	83364	...
13 - 14	Models with 6,000 to 7,000 lb Front Axle	3902993C3	010	83135
		3991991C1	010	83135
		OE 18513	010	83135
2012	Models with 6,000 to 7,000 lb Front Axle	3902993C1	010	83167
		OE17103	010	83167
	Models with International IROS Air Suspension	3892445C3		010	85931	89458





TranStar - 8500, 8600 Series

03 - 15	Models with 10,000 to 14,000 lb Front axle	3533357C1	010	85957
		3533357C2	010	85957
		3588209C1	010	85957
		3588209C2	010	85957
03 - 18	Models with 40,000 lb Rear Air Suspension	3549099C1		010	85923	89458
		3549099C2		010	85923	89458
		3549099C3		010	85923	89458
	Models with O.E.M. Number	6127690C1		010	85923	89458
- 2013	Models with O.E.M. Number	3674348C1	010	85954
14 - 17	Models with O.E.M. Number	6127086C1	010	85637

Transtar - Conventional

	4170, F-4170, 4200, F-4200, 4300 & F-4300 Models	426744R91	010	85303	89422	
		426744R92	010	85303	89422	
		453576C91	010	85303	89422	
		453576C92	010	85303	89422	
		477132C1	010	85303	89422	
	4170, F-4170, 4200, F-4200, 4300 & F-4300 with Air Ride Suspension	350425C1		010	85300	89419
		462557C91		010	85300	89419
	D-400, DF-400, DC-400, DCF-400 & DCF-400M - Exc. Axle Code 02136	426744R91	010	85303	89422	
		426744R92	010	85303	89422	

APPLICATION GUIDE - TRUCKS, TRAILERS, AND BUSES

Year	Model	OEM #	Front		Rear	
						
			Fleetline	GasSLX	Fleetline	GasSLX

INTERNATIONAL (NAVISTAR)(Cont'd.)

Transtar - Conventional(Cont'd.)

	D-400, DF-400, DC-400, DCF-400 & DCF-400M - Exc. Axle Code 02136	453576C91	010	85303	89422	
	D-400, DF-400, DC-400, DCF-400 & DCF-400M with Axle Code 02136	293009C91	010	85308	89422	
		453577C91	010	85308	89422	





Unistar

	CO7044A	426744R91		85303	...	010	85303	89422
		426744R92		85303	...	010	85303	89422
		453576C91		85303	...	010	85303	89422
	Additional O.E.M. Interchanges	56101 Z5008	-10	83114				
		596329C1	010	85014				

WorkStar - 7000 Series

	7300, 7400, 7500, 7600 Models with 16,000 lb to 20,000 lb Multi-leaf Spring Severe Duty Standard	3541456C1	010	85929
		3558089C1	010	85925
		3558089C2	010	85925
		3558089C3	010	85925
- 2019	7400 Models with O.E.M. Number	3885832C1	010	83135
		3885832C2	010	83135
04 - 15	7400, 7500, 7600 Models with 12,000 lb Front axle	3533357C1	010	85957
		3533357C2	010	85957
		3533357C3	010	85957
16 - 18	7400, 7500, 7600 Models with 12,000 lb Front axle	6127714C1	010	85928
- 2018	7400, 7500, 7600 Models with 18,000 lb Front Axles	3576464C1	010	85957
		3576464C2	010	85957
	7400, 7500, 7600 Models with Hendrickson HAS - 400 (Standard Inboard Rear)	60670-007		010	83144	...
		60670-007L		010	83144	...
	Models with 10,000 to 16,000 lb Front Suspension	3576465C2	010	85999
		3816234C1	010	85999
10 - 13	Models with 12,000 to 14,000 lb Front Taperleaf Suspension	3868264C1	010	85998
	Models with 18,000 to 20,000 lb Front Axle	3868265C1	010	85998
- 2018	Models with 40,000 lb Rear Air Suspension	3549099C3		010	85923	89458
02 - 17	Models with Hendrickson HAS - 230 or 460 Rear Air Suspension	3514952C1		010	85976	...
		57905-001		010	85976	...
		60675-003		010	85976	...
		60675-003L		010	85976	...
		H60675-003		010	85976	...
- 2014	Models with Hendrickson HMX 400/460 Haulmax with 16.5" Saddle	60680-004		01-	83143	...
		60680-004L		01-	83143	...
- 2018	Models with Hendrickson Primaax 230, 460 and 690 Air Suspension (8-1/2" to 10" Ride Height)	60657-003		010	85072	...
		60657-003L		010	85072	...
- 2018	Models with Hendrickson Primaax EX 232, 462 and 692 Air Suspension (8-1/2" to 10" Ride Height)	60657-003		010	85072	...
		60657-003L		010	85072	...
	Models with O.E.M. Number	4070336C1	010	85058	89431	
		6127690C1		010	85923	89458
	S7700 Models w/ Multistage Front Suspension	3588591C1	010	85953
		3588591C2	010	85953
		3588592C1	010	85953
		3588592C2	010	85953
	Additional O.E.M. Interchanges	453527C91	-10	85311 or 89424				
		453528C91	-10	85311 or 89424				

APPLICATION GUIDE - TRUCKS, TRAILERS, AND BUSES

Year	Model	OEM #	Front		Rear	
			 Fleetline	 GasSLX	 Fleetline	 GasSLX

INTERNATIONAL (NAVISTAR)(Cont'd.)

Additional O.E.M. Interchanges	462603C91	- -	85705 or 89447
	463926C91	- -	85705 or 89447

Additional O.E.M. Interchanges

Models with Chalmers 40,000 lb Rear Suspension	800670		0 0	85060	...
Models with Meritor AirLink Suspension	446-51-211		0 0	85739	...
Models with O.E.M. Number	3000098C1		- 0	83317	...
	3571711C1	- 0	85316	89426	
	3581109C1	0 0	85924	89457	
	3584116C1	0 0	83175
	3584116C2	0 0	83175
	3584117C1	0 0	83135
	3584117C2	0 0	83135
	3584118C1	0 0	85928
	3584118C2	0 0	85928
	3584535C1	0 0	85924	89457	
	3584535C2	0 0	85924	89457	
	3601600C1	0 0	85082				
	3601600C2	0 0	85082				
	3601600C3	0 0	85082				
	47902-24		0 0	83137	...
	4C4Z-18124-N	0 0	85957
	4C4Z-18125-DA		0 0	85926	...
	503610C1		0 0	83207	89407
	6ETZ-18125-A		0 0	83146	...
	90044025		0 0	83209	89414
Additional O.E.M. Interchanges	3541456C1	0 0				85929	
	3544768C1	0 0				85926	
	3549100C1	0 0				85926	
	3558989C1	0 0				85925	
	3558989C2	0 0				85925	
	3596107C1	0 0				85927	
	3596107C2	0 0				85927	
	3596107C3	0 0				85927	
	3596107C4	0 0				85927	
	70334	- 0				85316 or 89426	
	AMS650102	0 0				85001 or 89410	
	AMS650107	- 0				85316 or 89426	
	AMS650400	- 0				85033 or 89427	
	AMS650402	- 0				85311 or 89424	
	AMS650404	- -				85310 or 89423	
	AMS650405	0 0				85023 or 89415	
	AMS650406	0 0				85024	
AMS650408	- 0				85319 or 89428		

INTERNATIONAL (NAVISTAR) CAB SHOCKS

1997 -	Eagle Pro-Sleeper	1202-0054	0 0	83021
09 - 17	LoneStar Models with 72" Hi Roof Sleeper	2595314C1	0 -	83062
		2600491C91	0 -	83062
2018	LT Models With 56" or 72" Hi Roof Sleeper	2595314C1	0 -	83062
	Models with Link Cab Suspension NPS90	1202-0054	0 0	83021
	Models with Link Cabmate Suspensions with O.E.M. Number	1201-9003	0 0	83052
		1201-9007	0 0	83054
		1201-9009	0 0	83054
		1201-9013	0 -	83062
		1201-9014	0 -	83062

APPLICATION GUIDE - TRUCKS, TRAILERS, AND BUSES

Year	Model	OEM #	Front		Rear	
			Fleetline	GasSLX	Fleetline	GasSLX

INTERNATIONAL (NAVISTAR) CAB SHOCKS(Cont'd.)

	Models with Link Cabmate Suspensions with O.E.M. Number	1201-9018	01-	83062
		1201-9021	01-	83062
		1202-0012	010	83023
		1202-0032	010	83016
		1202-0042	010	83025
		1202-0043	010	83032
		1202-0044	010	83025
		1202-0054	010	83021
		1202-1212	010	83013
		1202-1213	01-	83005
	Models with O.E.M. Number	1201-1212	010	83013
		2023685C1	01-	83015
		2500013C1	010	83013
		2507409C1	010	83052
		2507761C1	010	83052
		2507763C1	010	83052
		2507948C1	010	83054
		2508326C1	010	83021
		2508327C1	010	83025
		2590915C1	01-	83062
		2590916C1	01-	83062
		2597458C91	01-	83062
		2601488C91	01-	83062
		2602021C1	01-	83062
		3557165C1	010	83053
		3557166C1	010	83052
		3557167C3	010	83053
		3557169C1	010	83052
		3557169C2	010	83052
		3560649C1	010	83052
		3560649C2	010	83052
		3560705C2	010	83054
		AMS66160	010	83052
AMS66161	010	83053		
OE14771	01-	83062		
- 1991	Navistar 60" Sleepers with Link Cabmate Model IHS60	1202-1043	010	83025
11 - 15	Pro-Star Models With 56" or 72" Hi Roof Sleeper	2593803C91	01-	83062
		2595314C1	01-	83062
2018 - 19	RH Models With 56" or 72" Hi Roof Sleeper	2595314C1	01-	83062
	S2500, S2600, 8100, 8200, & 8300 Models Conventional Tractors with Link Cabmate Model NAV80	1202-1043	010	83025
- 2017	TranStar 8600 Models With O.E.M. Number	2595314C1	01-	83062





4000 Series

	4600, 4700, 4800, 4900 Models with Link Cab Suspension	1201-1044	010	83025
		2012769C2	01-	83005
	Cabover Tractors with 74", 84" or 88" cabs with Link Cabmate Model IHB-2P	1202-0032	010	83016
	Conventional Tractors with Link Cabmate Model IHC43	1201-0012	010	83023
		1202-0012	010	83023
- 2017	DuraStar - 4300, 4400 Models Conventional Tractors with O.E.M. Number	2509221C91	010	83054
	HPV 4000 Models travel crew cabs with ITC 42 Link Cabmate Model	1201-9002	010	83052

4300 , 4400 Series

18 - 19	DuraStar - 4300, 4400 Models Models with O.E.M. Number	2509223C91	010	83054
---------	--	------------	-----	-------

APPLICATION GUIDE - TRUCKS, TRAILERS, AND BUSES

Year	Model	OEM #	Front		Rear	
						
			Fleetline	GasSLX	Fleetline	GasSLX

INTERNATIONAL (NAVISTAR) CAB SHOCKS(Cont'd.)

5000 Series(Cont'd.)

09/94 -	Paystar - SBA Conventionals with Link Cabmate Model NP50 & NP50-A built after August of 1994	1201-1044	010	83025
		1202-1044	010	83025
09/96 -	Paystar - SFA Conventionals with Link Cabmate Model NP50 & NP50-A built after August of 1996	1201-1044	010	83025
		1202-1044	010	83025

7000 Series

	7300, 7400 & 7500 Models trucks with day cab or extended cabs with Link Cabmate Model IDC734	1201-9001	010	83052
	7300, 7400 & 7500 Models trucks with day cab or extended cabs with Link Cabmate Model IDC7345	1201-9008	010	83054
	7300, 7400, 7500 & 7600 Models with Link Cabmate Suspensions with O.E.M. Number	1201-1043	010	83025
		1201-1049	010	83025
	7600 Models trucks with day cab or extended cabs with Link Cabmate Model IDC76	1201-9010	010	83053
- 2015	WorkStar - 7000 Models Models with O.E.M. Number	2509224C91	010	83053
- 2019	WorkStar - 7000 Models Models with O.E.M. Number	2509223C91	010	83054

8000 Series

	8100, 8200, & 8300 Model Trucks with Link Cabmate with O.E.M. Number	1201-1213	01-	83005
	8100, 8200, & 8300 Model Trucks with O.E.M. Number	2012768C1	010	83013
		2012769C1	01-	83005
		2025790C1	010	83013
	8500 Model trucks with day cab or extended cabs with Link Cabmate Model IDC85	1201-9008	010	83054
	8600 Model trucks with day cab or extended cabs with Link Cabmate Model IDC86	1201-9011	010	83053
- 2013	TranStar - 8500, 8600 Models Tractors with O.E.M. Number	2509223C91	010	83054
04 - 09	TranStar - 8500, 8600 Models Tractors with 36" Sleepers	2509222C91	010	83053

9000 Series

01/93-	48" & 60" Bentz Sleepers on 9000 Models Conventional Tractors with Link Cabmate Model IHS4860	1201-1044	010	83025
		1202-1044	010	83025
03/97 -	9100 & 9200 Models Conventionals with Link Cabmate Model ND92-A	1202-1043	010	83025
		2023684C1	01-	83015
	9300 & 9400 Conventional Tractors with Link Cabmate Model IHC93-A	1202-1043	010	83025
		2503529C1	010	83025
1981 -	9670 Cabover Tractors with 89" or 110" cabs with Link Cabmate Models IH967-A or IH97110	1202-0032	010	83016
1982 -	9670, 9700 & 9800 Cabovers with 89" & 110" cabs with Link Cabmate Model NAV9876	1202-0054	010	83021
1989 -	9700 Cabover Tractors with 110" cabs with Link Cabmate Model IH97110	1202-0032	010	83016
1989 -	9700 Cabover Tractors with 89" cabs with Link Cabmate Model IH9789	1202-0032	010	83016
04 - 09	Models With 51" Low-Roof Sleeper	1201-0154	010	83051
		2585145C1	010	83051
04 - 09	Models with 72" High-Roof Sleeper	1201-0254	010	83051
		2589922C1	010	83051

MV Series

2019	MV607 Models with O.E.M. Number	2509223C91	010	83054
------	---------------------------------	------------	-----	-------

ISUZU









EVR Series

87 - 92	EVR Models	1-51630-160-0	-10	83162
---------	------------	---------------	-----	-------	-----	-----	-----

FSR Series

10/89 - 96	FSR Models	1-51630-167-0		-1-	83613	...
------------	------------	---------------	--	-----	-----	-----	-------	-----

APPLICATION GUIDE - TRUCKS, TRAILERS, AND BUSES

Year	Model	OEM #	Front		Rear	
						
						
			Fleetline	GasSLX	Fleetline	GasSLX

ISUZU(Cont'd.)

FSR Series(Cont'd.)

86 - 92	FSR Models	1-51630-160-0	-10	83162
		1-51630-168-1	-10	83515
		51630168	-10	83515
86 - 96	FSR Models	1-51630-217-1	-10	83114
97 - 03	Models with 11000, 13500, 15000 lb Taperleaf Springs	8-22064231-0		-1-	85324	...
97 - 03	Models with 15000, 19000, 21000 lb Multileaf Springs	8-22064232-0		-1-	85071	...
97 - 03	Models with 16900 lb Taperleaf Springs	8-22064489-0		-1-	85336	...
97 - 03	Models with 19000, 21000, 23000 lb Taperleaf Springs (EXC Low Profile Veh.)	8-22064233-0		-1-	83136	...
		8-22064804-0	-1-	83136
		8-22064805-0	-1-	83136

FTR Series

97 - 03	FL2 Tilt Cab with 5000 to 11000 lb Axle	8-22064807-0	-1-	83136
97 - 03	FL3 Tilt Cab with 14575 lb Axle	8-22064806-0	-1-	83136
86 - 96	FTR Models	1-51630-167-0		-1-	83613	...
05 - 09	FTR Models with 15000, 19000, 21000 lb Multileaf Springs	15174902		-1-	85071	...
		88982686		-1-	85071	...
05 - 09	FTR Models with O.E.M. Number	15123676	-1-	83136
		88982682	-1-	83136
		8-98098-059-0		010	83159	...
		8-98098-059-1		010	83159	...
		8-98098-127-0	-10	83515
		8982326720	-10	83515
		8-98316-228-0		010	83159	...
		98098059		010	83159	...
		98098127	-10	83515
97 - 03	Tilt Cab w/11000, 13500, 15000 lb Taperleaf Springs	8-22064231-0		-1-	85324	...
97 - 03	Tilt Cab w/15000, 19000, 21000 lb Multileaf Springs	8-22064232-0		-1-	85071	...
97 - 03	Tilt Cab w/16900 lb Taperleaf Springs	8-22064489-0		-1-	85336	...
97 - 03	Tilt Cab w/19000, 21000, 23000 lb Taperleaf Springs (EXC Low Profile Veh.)	8-22064233-0		-1-	83136	...









FVR Series

- 2009	FVR Models with Hendrickson HAS suspension	12474915		010	83122	89406
		60670-005		010	83137	...
00 - 09	FVR Models with O.E.M. Number	15887728	-1-	83136
		19152843	-1-	83136
90 - 09	FVR Models with 15000, 19000, 21000 lb Multileaf Springs	8-22064232-0		-1-	85071	...
		88982686		-1-	85071	...
97 - 02	FVR Models with 11000, 13500, 15000 lb Taperleaf Springs	8-22064231-0		-1-	85324	...
97 - 02	FVR Models with 14575 lb Axle	8-22064806-0	-1-	83136
97 - 02	FVR Models with 16900 lb Taperleaf Springs	8-22064489-0		-1-	85336	...
97 - 02	FVR Models with 19000, 21000, 23000 lb Taperleaf Springs (EXC Low Profile Veh.)	8-22064233-0		-1-	83136	...
97 - 02	FVR Models with 5000 to 11000 lb Axle	8-22064807-0	-1-	83136
86 - 96	FVR Models	1-51630-167-0		-1-	83613	...
86 - 96	FVR Short & Middle Chassis	1-51630-160-0	-10	83162

NPR Series

86 - 17	NPR, NPR-HD Models with 11000 lb & 13000 lb Suspension	8-94454-987-0	-10	83515
		8-97083-027-0	-10	83515
		8-97083-029-0	-10	83515
		8-97253-620-0	-10	83515
		8-97253-620-1	-10	83515
		8-98098-125-0	-10	83515
		8982326710	-10	83515
		8-98232671-0	-10	83515

APPLICATION GUIDE - TRUCKS, TRAILERS, AND BUSES

Year	Model	OEM #	Front		Rear	
						
						
			Fleetline	GasSLX	Fleetline	GasSLX

ISUZU(Cont'd.)





NPR Series(Cont'd.)

86 - 17	NPR, NPR-HD Models with 11000 lb & 13000 lb Suspension	8-98232671-1 94454987 97083027 97083029 97253620 98098125 98232671	-10	83515
			-10	83515
			-10	83515
			-10	83515
			-10	83515
			-10	83515
			-10	83515
03 - 17	NPR, NPR-HD Models with O.E.M Number	8-97253-665-0 8-98098-058-0 8-98098-058-1 898098-0581 8-98098-059-0 8-98098-059-1 8-98316227-0 8-98316-228-0 97253665 98098058 98098059 98316227		010	83159	...
				010	83159	...
				010	83159	...
				010	83159	...
				010	83159	...
				010	83159	...
				010	83159	...
				010	83159	...
				010	83159	...
				010	83159	...
				010	83159	...
01 - 07	NPR, NPR-HD (Diesel Models)	8-97253-651-2 97253651		010	83404	...
				010	83404	...
03 - 08	NPR, NPR-HD (Gas Models)	8-97253-651-2 97253651		010	83404	...
				010	83404	...
95 - 02	NPR, NPR-HD (Gas & Diesel Models)	8-97253-664-0 97253664		010	83159	...
				010	83159	...
86 - 95	NPR Models (NPC & NPN)	51630666 8-94454-647-1 8-94454-986-0 8-94454-987-0 8-97083-029-0 94454986 9-51630-666-0 9-51630-666-2 97083029		010	85012	89413
			-10	83515
			-10	83515
			-10	83515
			-10	83515
			-10	83515
				010	85012	89413
			-10	83515
89 - 92	NPR Models Flatlow	9-51630-666-0 9-51630-666-2		010	85012	89413
				010	85012	89413
89 - 90	NPR Models Flatlow	51630647 9-51630-647-1	-10	83515
			-10	83515

NQR Series

03 - 17	NQR Models with O.E.M. Number	8-97253-620-0 8-97253-665-0 8-98098-059-0 8-98098-059-1 8-98098-127-0 8982326720 8-98232672-0 8-98232672-1 8-98316-228-0 8-98343986-0 97253620 97253665 98098059 98098127 98232672	-10	83515
				010	83159	...
				010	83159	...
				010	83159	...
			-10	83515
			-10	83515
			-10	83515
			-10	83515
				010	83159	...
				010	83159	...
			-10	83515
				010	83159	...
				010	83159	...
			-10	83515
			-10	83515

APPLICATION GUIDE - TRUCKS, TRAILERS, AND BUSES

Year	Model	OEM #	Front		Rear	
			 Fleetline	 GasSLX	 Fleetline	 GasSLX

ISUZU(Cont'd.)

NQR Series(Cont'd.)

03 - 17	NQR Models with O.E.M. Number	98343986	OIO	83159	...
2002	NQR (Diesel)	8-97253-664-0	OIO	83159	...
		97253664	OIO	83159	...
95 - 97	NQR (Diesel)	8-97253-664-0	OIO	83159	...
		97253664	OIO	83159	...

NRR Series

02 - 17	NRR Models with O.E.M. Number	8-97253-620-0	-IO	83515	...	OIO	83159	...
		8-97253-665-0		OIO	83159	...
		8-98098-059-0		OIO	83159	...
		8-98098-059-1		OIO	83159	...
		8-98098-127-0	-IO	83515
		8982326720	-IO	83515
		8-98232672-0	-IO	83515
		8-98232672-1	-IO	83515
		8-98316-228-0		OIO	83159	...
		8-98343986-0		OIO	83159	...
		97253620	-IO	83515
		97253665		OIO	83159	...
		98098059		OIO	83159	...
		98098127	-IO	83515
98232672	-IO	83515		
98343986		OIO	83159	...		
88 - 99	NRR Models (All)	1-51630-217-0	-IO	83114
		1-51630-217-1	-IO	83114
		1-51630-219-1	-IO	83114
		51630217	-IO	83114

Additional Applications





95 - 03	FRR Models (All)	1-51630-219-0	-IO	83114	...	OIO	85012	89413
		1-51630-219-1	-IO	83114
		51630219	-IO	83114
1985	KS22 Models (All)	8-97083-027-0	-IO	83515
		9-51630-666-0		OIO	85012	89413
		9-51630-666-2		OIO	85012	89413
	Models with O.E.M. Number	8-22064-231-0		-I-	85324	...
		8-22064-232-0		-I-	85071	...
		8-22064-233-0	-I-	83136
		8-22064-489-0		-I-	85336	...
		8-22064-804-0	-I-	83136
		8-22064-805-0	-I-	83136
		8-22064-806-0	-I-	83136
		8-22064-807-0	-I-	83136
		8-51630-666-0		OIO	85012	89413
		8972019600	-IO	83515
		8-97253-616-0	-IO	83515
		8-97253-621-0	-IO	83515
		8-97253-623-0	-IO	83515
		898098-1250	-IO	83515
		898098-1270	-IO	83515
94033786	-IO	83114		

ITASCA

Class A MotorHomes

2006	Ellipse Series MotorHomes with Freightliner XC Chassis ADL200 Suspension w/ 20K Rear	16-16873-000	OIO	85029	...
------	---	--------------	-----	-----	-----	-------	-----

APPLICATION GUIDE - TRUCKS, TRAILERS, AND BUSES





Year	Model	OEM #	Front		Rear	
			 Fleetline	 GasSLX	 Fleetline	 GasSLX

ITASCA(Cont'd.)

Class A MotorHomes(Cont'd.)

	AS120 Front Suspension Rear Shock with O.E.M. Number ZF - IFS Front Suspension with 23,000 lb GVW or Greater	141700131810	010	83160
		16-16737-000	010	83160
		16-16874-000	010	83160
		141700131809		010	85029	...
		16-16736-000		010	85029	...
		16-18103-000	-1-	85900
		481700000493	-1-	85900
04 - 06	Horizon Series MotorHomes with Freightliner XC Chassis ADL200 Suspension w/ 20K Rear AS120 Front Suspension Rear Shock with O.E.M. Number ZF - IFS Front Suspension with 23,000 lb GVW or Greater	16-16873-000		010	85029	...
		141700131810	010	83160
		16-16737-000	010	83160
		16-16874-000	010	83160
		141700131809		010	85029	...
		16-16736-000		010	85029	...
		16-18103-000	-1-	85900
481700000493	-1-	85900		
02 - 06	Meridian Series MotorHomes with Freightliner XC Chassis ADL200 Suspension w/ 20K Rear AS120 Front Suspension Rear Shock with O.E.M. Number ZF - IFS Front Suspension with 23,000 lb GVW or Greater	16-16873-000		010	85029	...
		141700131810	010	83160
		16-16737-000	010	83160
		16-16874-000	010	83160
		141700131809		010	85029	...
		16-16736-000		010	85029	...
		16-18103-000	-1-	85900
481700000493	-1-	85900		
	Models with Workhorse UFO Chassis with Hendrickson Softek Front Suspension	66153-002	010	83124	89407	
		F4-BE5-C832-MO	010	83124	89407	
99 - 15	SunCruiser Series MotorHomes with Ford F53 Chassis with 16,000 lb GVW to 22,000 lb GVW	1C34-18045-AA	010	83209	89414	
		1C34-18045-JA	010	83209	89414	
		9U94-18045-AA	010	83209	89414	
		9U94-18080-AA		010	83122	89406
		9U9Z-18124-A	010	83209	89414	
		9U9Z-18125-A		010	83122	89406
		ASH-1022	010	83209	89414	
		ASH-1023		010	83122	89406
		ASH-1205	010	83209	89414	
		ASH-1206		010	83122	89406
		ASH-1228	010	83209	89414	
		ASH-1229	010	83209	89414	
		ASH-1230		010	83122	89406
		ASH-137		010	83122	89406
		ASH-25822	010	83209	89414	
		ASH-25823	010	83209	89414	
		ASH-25824		010	83122	89406
ASH-294	010	83209	89414			
AT-620	010	83209	89414			
AT-621		010	83122	89406		
AT-766	010	83209	89414			
03 - 04	SunCruiser Series MotorHomes with W20 , W22, & W24 Workhorse Chassis	24-153249	010	85125
		24-186537		01-	85126	...
		24-186629	010	85125
		F4-BE5-A011-HO		01-	85126	...
		F4-BE5-A832-MO	010	85125

APPLICATION GUIDE - TRUCKS, TRAILERS, AND BUSES

Year	Model	OEM #	Front		Rear	
						
			Fleetline	GasSLX	Fleetline	GasSLX

ITASCA(Cont'd.)

Class A MotorHomes(Cont'd.)

03 - 04	SunCruiser Series MotorHomes with W20 , W22, & W24 Workhorse Chassis	F4-BE5-B492-HO	010	85125
			010	85125
			010	85125
			010	85125
05 - 14	Sunova Models with W20 , W22, & W24 WorkHorse MotorHome Chassis	24-153256		- -	85124	...
		F4-BE5-F325-HO		- -	85124	...
		W0005663		- -	85124	...
98 - 14	Sunova Models with W20 , W22, & W24 WorkHorse MotorHome Chassis	24-153249	010	85125
		F4-BE5-A832-MO	010	85125
		F4-BE5-F324-HO	010	85125
		W0005662	010	85125
		W0006254	010	85125

Class C MotorHomes

06 - 19	Cambria Series Motorhomes with Ford E450 Chassis	8C24-18045-DA	-10	83177
		8C24-18080-DB		-10	83178	...
		8C2Z-18124-D	-10	83177
		8C2Z-18125-D		-10	83178	...
		ASH-1136		-10	83178	...
		ASH-1154	-10	83177
		AT-163G	-10	83177
		AT-164G		-10	83178	...
07 - 14	Impulse Series Motorhomes with Ford E450 Chassis	8C24-18045-DA	-10	83177
		8C24-18080-DB		-10	83178	...
		8C2Z-18124-D	-10	83177
		8C2Z-18125-D		-10	83178	...
		ASH-1136		-10	83178	...
		ASH-1154	-10	83177
		AT-163G	-10	83177
		AT-164G		-10	83178	...
01 - 19	Spirit Series Motorhomes with Ford E450 Chassis	8C24-18045-DA	-10	83177
		8C24-18080-DB		-10	83178	...
		8C2Z-18124-D	-10	83177
		8C2Z-18125-D		-10	83178	...
		ASH-1136		-10	83178	...
		ASH-1154	-10	83177
		AT-163G	-10	83177
		AT-164G		-10	83178	...

JAY MADSEN

	Additional O.E.M. Interchanges	3166657	010	85700	
		3192333	010	85700	

JAYCO RV INC

Class A MotorHomes

15 - 19	Alante Series MotorHomes with Ford F53 Chassis with 16,000 lb GVW to 22,000 lb GVW	ASH-1229	010	83209	89414	
		ASH-25822	010	83209	89414	
		ASH-25823	010	83209	89414	
		ASH-25824		010	83122	89406
14 - 19	Precept Series MotorHomes with Ford F53 Chassis with 16,000 lb GVW to 22,000 lb GVW	ASH-1229	010	83209	89414	
		ASH-25822	010	83209	89414	
		ASH-25823	010	83209	89414	

APPLICATION GUIDE - TRUCKS, TRAILERS, AND BUSES

Year	Model	OEM #	Front			Rear		
			Fleetline	GasSLX		Fleetline	GasSLX	

JAYCO RV INC(Cont'd.)

Class A MotorHomes(Cont'd.)

14 - 19	Precept Series MotorHomes with Ford F53 Chassis with 16,000 lb GVW to 22,000 lb GVW	ASH-25824		010	83122	89406
---------	---	-----------	--	-----	-----	-----	-------	-------

Class C MotorHomes

	Designer Series MotorHomes with Ford E350 & E450 Chassis	ASH-1136		-10	83178	...
		ASH-1154	-10	83177
03 - 06	Escapade Series MotorHomes with Ford E350 & E450 Chassis	ASH-1136		-10	83178	...
		ASH-1154	-10	83177
02 - 06	Granite Ridge Series MotorHomes with Ford E350 & E450 Chassis	ASH-1136		-10	83178	...
		ASH-1154	-10	83177
02 - 19	Greyhawk Series MotorHomes with Ford E350 & E450 Chassis	ASH-1136		-10	83178	...
		ASH-1154	-10	83177
07 - 15	Melbourne Series MotorHomes with Ford E350 & E450 Chassis	ASH-1136		-10	83178	...
		ASH-1154	-10	83177
04 - 19	Redhawk Series MotorHomes with Ford E350 & E450 Chassis	ASH-1136		-10	83178	...
		ASH-1154	-10	83177

JIFFLOX

	Truck Dolly	CP-5222	010	85315
--	-------------	---------	-----	-------	-----	--	-----	-----

JOHN DEERE

	Models with O.E.M. Number	4036892	010	G63605
--	---------------------------	---------	-----	--------	-----	--	-----	-----

Motorhome Chassis

73 - 81	M & R-300, 400, 500 Motorhome Chassis	3638112		010	G63183	...
---------	---------------------------------------	---------	--	-----	-----	-----	--------	-----

KENWORTH





C500, C500B, C500K, C540 & C550

	All with Air Glide 100 Suspension with 8 air bags, 4 units required	K374-29		-1-	85310	89423
		K374-32		-1-	85310	89423
	All with Air Glide 200 with 40,000 lb Suspension with 8 air bags, 4 units required	665903		-1-	85900	...
		665944		-1-	85900	...
		70701		-1-	85900	...
01 - 16	Models with Air Glide 380 (AG380) Rear Air Suspension	C71-1002		010	85067	89451
		C71-1016		010	85067	89451
	Models with Dual Steering Front Axle and Torsion Bar Bogey Rear Suspension	K374-28		010	85314	89425
		K374-4		010	85314	89425
- 2009	Models with Multiple Leaf Springs on Front Axle	B71-1003	010	83312	89409	
		K374-3	010	83312	89409	
		K374-33	010	83312	89409	
	Models with Neway ADZ Rear Suspension	471700004423		010	85109	...
		90045605		010	85109	...
87 - 16	Models with Taper Leaf Springs on Front Axle	B71-1002	010	85001	89410	
		K374-16	010	85001	89410	
		K374-26	010	85001	89410	
		K374-27	010	85001	89410	
	All with Air Glide 200 with 46,000 lb Suspension with 8 air bags, 4 units required	665906		-1-	85902	...
		665945		-1-	85902	...

ICON 900

16 - 17	Models with 10,000 lb to 14,600 lb Taperleaf Springs and Set Back Front Axles	B71-6019	010	85989
16 - 17	Models with Air Glide 380 (AG380) Rear Air Suspension	C71-1016		010	85067	89451
		C71-6015		010	85067	89451
16 - 17	Models with Air Glide 400 (AG400) Rear Air Suspension	C71-1014		01-	85936	89456

APPLICATION GUIDE - TRUCKS, TRAILERS, AND BUSES

Year	Model	OEM #	Front		Rear	
						
			Fleetline	GasSLX	Fleetline	GasSLX

KENWORTH(Cont'd.)

ICON 900(Cont'd.)

16 - 17	Models with Air Glide 460 (AG460) Rear Air Suspension	C71-1015		0 -	85937	...
		C71-1015 PLUS		0 -	85937	...
16 - 17	Models with Taper Leaf Springs on Front Axle	B71-1002	0 0	85001	89410	

K100, K100E, K125

	All with Air Glide 100 Suspension with 8 air bags, 4 units required	K374-29		- -	85310	89423
		K374-32		- -	85310	89423
	All with Air Glide 200 with 40,000 lb Suspension with 8 air bags, 4 units required	665903		- -	85900	...
		665944		- -	85900	...
		70701		- -	85900	...
	All with Air Glide 200 with 46,000 lb Suspension with 8 air bags, 4 units required	665906		- -	85902	...
		665945		- -	85902	...
	Models with Dual Steering Front Axle and Torsion Bar Bogey Rear Suspension	K374-28		0 0	85314	89425
		K374-4		0 0	85314	89425
	Models with Multiple Leaf Springs on Front Axle	B71-1003	0 0	83312	89409	
		K374-3	0 0	83312	89409	
		K374-33	0 0	83312	89409	
	Models with Set Back Front Axle	665331	0 -	85740
		K374-13	0 -	85740
		K374-13-1	0 -	85740
87 - 06	Models with Taper Leaf Springs on Front Axle	B71-1002	0 0	85001	89410	
		K374-16	0 0	85001	89410	
		K374-26	0 0	85001	89410	
		K374-27	0 0	85001	89410	

K270, K370

13 - 19	Models with 10,000 lb or 12,000 lb Front Axle	1707378PAC	- -	85182
		BFRG 072	- -	85182
13 - 19	Models with 21,000 to 23,000 lb Reyco Spring Suspension	19495-01		0 0	83126	89440
		TK19679		0 0	83126	89440
13 - 18	Models with Hendrickson HAS - 210L or HAS - 230L Rear Air Suspension	60670-008		0 0	83123	89405
		60670-008L		0 0	83123	89405
13 - 18	Models with Reyco 102 or 79KB Suspension (Drive Axle)	16725-01		0 0	83126	...
		19495-01		0 0	83126	...

K300

	All with Air Glide 100 Suspension with 8 air bags, 4 units required	K374-29		- -	85310	89423
		K374-32		- -	85310	89423
	All with Air Glide 200 with 40,000 lb Suspension with 8 air bags, 4 units required	665903		- -	85900	...
		665944		- -	85900	...
		70701		- -	85900	...
	All with Air Glide 200 with 46,000 lb Suspension with 8 air bags, 4 units required	665906		- -	85902	...
		665945		- -	85902	...
	K300 COE Medium Duty	665565	0 0	85007	89412	
	Models with 12,000 lb Taper Leaf Front Springs (5/8" Top Mounting bolt)	665617	0 0	85031
		B71-1000	0 0	85031
	Models with Hendrickson Rear Air Suspension	47902-19		0 0	83123	89405
	Models with Multiple Leaf Springs on Front Axle (3/4" Mounting bolts)	B71-1003	0 0	83312	89409	
		K374-3	0 0	83312	89409	
		K374-33	0 0	83312	89409	
	Models with Reyco 102 or 79KB Suspension (Drive Axle)	16725-01		0 0	83126	...

APPLICATION GUIDE - TRUCKS, TRAILERS, AND BUSES

Year	Model	OEM #	Front			Rear		
			○ ○	Fleetline	GasSLX	○ ○	Fleetline	GasSLX

KENWORTH(Cont'd.)

K300(Cont'd.)

	Models with Reyco 102 or 79KB Suspension (Drive Axle)	19495-01		○ ○	83126	...
	Models with Reyco 1209 or 1212 Suspension (Steer Axle)	19495-01	○ ○	83126	89440	
	Models with Taper Leaf Springs on Front Axle (1" Mounting bolts)	B71-1002	○ ○	85001	89410	
		K374-16	○ ○	85001	89410	
		K374-26	○ ○	85001	89410	
		K374-27	○ ○	85001	89410	
	Models with Woodhead Shock (Stamping Number ACHB 966)	ACHB966		- -	83136	...

T170

08 - 13	Models with 8,000 lb Taper Leaf Front Springs	665617	○ ○	85031
08 - 18	Models with Reyco 79KB Rear Suspension	16725-01		○ ○	83126	...
		19495-01		○ ○	83126	...





T270, T370

10 - 14	Models with 10,000 lb to 12,000 lb Front Axle	B71-6005	○ ○	85084	89460	
15 - 19	Models with 10,000 lb to 14,600 lb Taperleaf Springs and Set Back Front Axles	B71-6019	○ ○	85989
08 - 10	Models with 12,000 lb Front Axle	665617	○ ○	85031
10 - 14	Models with 13,200 lb to 14,600 lb Front Axle	B71-6006	○ ○	85084	89460	
15 - 19	Models with 16,000 lb to 20,000 lb Taperleaf Springs and Set Back Front Axles	B71-6020	○ ○	85989
10 - 14	Models with 8,000 lb Front Axle	B71-6004	○ ○	85084	89460	
10 - 19	Models with AG210L Rear Air Suspension	C71-1011		- -	85069	89455
		C71-1017		- -	85069	89455
10 - 19	Models with Air Glide 400L (AG400L) Rear Air Suspension	C71-1011		- -	85069	89455
		C71-1017		- -	85069	89455
08 - 19	Models with Hendrickson HAS - 210L or HAS - 230L Rear Air Suspension	60670-008		○ ○	83123	89405
		60670-008L		○ ○	83123	89405
08 - 14	Models with Hendrickson HAS - 400 (Standard) Rear Air Suspension	60670-005		○ ○	83137	...
		60670-005L		○ ○	83137	...
08 - 19	Models with Hendrickson HMX 400/460 Haulmax (with 16.5" Saddle)	60680-004		○ -	83143	...
		60680-004L		○ -	83143	...
		64178-001		○ -	83143	...
08 - 19	Models with Reyco 102 or 79KB Suspension (Drive Axle)	16725-01		○ ○	83126	...
		19495-01		○ ○	83126	...
		TK19679		○ ○	83126	...

T300

	All with Air Glide 100 Suspension with 8 air bags, 4 units required	K374-29		- -	85310	89423
		K374-32		- -	85310	89423
	All with Air Glide 200 with 40,000 lb Suspension with 8 air bags, 4 units required	665903		- -	85900	...
		665944		- -	85900	...
		70701		- -	85900	...
	All with Air Glide 200 with 46,000 lb Suspension with 8 air bags, 4 units required	665906		- -	85902	...
		665945		- -	85902	...
11 - 18	Models with 10,000 lb to 14,600 lb Taperleaf Springs and Set Back Front Axles	B71-6019	○ ○	85989
99 - 10	Models with 12,000 lb Taper Leaf Front Springs (5/8" Top Mounting bolt)	665617	○ ○	85031
		B71-1000	○ ○	85031
12 - 18	Models with Air Glide 400L (AG400L) Rear Air Suspension	C71-1011		- -	85069	89455
		C71-1017		- -	85069	89455
07 - 18	Models with Hendrickson HAS - 210L or HAS - 230L Rear Air Suspension	60670-008		○ ○	83123	89405
		60670-008L		○ ○	83123	89405

APPLICATION GUIDE - TRUCKS, TRAILERS, AND BUSES

Year	Model	OEM #	Front		Rear	
						
			Fleetline	GasSLX	Fleetline	GasSLX

KENWORTH(Cont'd.)

T300(Cont'd.)

	Models with Hendrickson Rear Air Suspension	47902-19 60670-004		010	83123	89405
				010	83123	89405
	Models with Multiple Leaf Springs on Front Axle (3/4" Mounting bolts)	B71-1003	010	83312	89409	
		K374-3	010	83312	89409	
		K374-33	010	83312	89409	
	Models with Reyco 102 or 79KB Suspension (Drive Axle)	16725-01 19495-01		010	83126	...
				010	83126	...
- 2018	Models with Reyco 1209 or 1212 Suspension (Steer Axle)	19495-01	010	83126	89440	
	Models with Taper Leaf Springs on Front Axle (1" Mounting bolts)	B71-1002	010	85001	89410	
		K374-16	010	85001	89410	
		K374-26	010	85001	89410	
		K374-27	010	85001	89410	
	Models with Woodhead Shock (Stamping Number ACHB 966)	ACHB966		-1-	83136	...

T400, T400B, T450B

	All with Air Glide 100 Suspension with 8 air bags, 4 units required	K374-29 K374-32		-1-	85310	89423
				-1-	85310	89423
	All with Air Glide 200 with 40,000 lb Suspension with 8 air bags, 4 units required	665903 665944 70701		-1-	85900	...
				-1-	85900	...
				-1-	85900	...
	All with Air Glide 200 with 46,000 lb Suspension with 8 air bags, 4 units required	665906 665945		-1-	85902	...
				-1-	85902	...
	Models with Multiple Leaf Springs on Front Axle	B71-1003	010	83312	89409	
		K374-3	010	83312	89409	
		K374-33	010	83312	89409	
89 - 16	Models with Taper Leaf Springs on Front Axle	B71-1002	010	85001	89410	
		K374-16	010	85001	89410	
		K374-26	010	85001	89410	
		K374-27	010	85001	89410	
	Models with Torsion Bar Bogey (2 rear axles) and KW Air Ride Suspension (with 4 air bags)	K374-28 K374-4		010	85314	89425
				010	85314	89425

T440

12 - 19	Models with 12,000 to 20,000 lb Taperleaf Front Suspension	665858 B71-1001	010	85070	89459	
			010	85070	89459	
12 - 19	Models with 21,000 to 23,000 lb Reyco Spring Suspension	19495-01 TK19679		010	83126	89440
				010	83126	89440
12 - 17	Models with Air Glide 380 (AG380) Rear Air Suspension	C71-1002 C71-1016 C71-6015		010	85067	89451
				010	85067	89451
				010	85067	89451
12 - 19	Models with Air Glide 400 (AG400) Rear Air Suspension	671962 C71-1014		01-	85936	89456
				01-	85936	89456
12 - 19	Models with Air Glide 400L (AG400L) Rear Air Suspension	C71-1011 C71-1017		-1-	85069	89455
				-1-	85069	89455
12 - 19	Models with Air Glide 460 (AG460) Rear Air Suspension	671963 C71-1015 C71-1015 PLUS		01-	85937	...
				01-	85937	...
				01-	85937	...
12 - 18	Models with Chalmers 40,000 lb Rear Suspension	665174		010	85060	...
12 - 17	Models with Hendrickson HAS - 230 Rear Air Suspension	60670-005		010	83137	...
12 - 19	Models with Hendrickson HMX 400/460 Haulmax with 16.5" Saddle	60680-004 60680-004L		01-	83143	...
				01-	83143	...

APPLICATION GUIDE - TRUCKS, TRAILERS, AND BUSES

Year	Model	OEM #	Front			Rear		
			Fleetline	GasSLX	Fleetline	GasSLX	Fleetline	GasSLX

KENWORTH(Cont'd.)









T440(Cont'd.)

12 - 18	Models with Hendrickson HMX 400/460 Haulmax with 17.5" & 18.5" Saddle	60680-005	01-	83142	...
		60680-005L	01-	83142	...
12 - 18	Models with Hendrickson Primaax 230, 460 and 690 Air Suspension (8-1/2" to 10" Ride Height)	60657-003	010	85072	...
		60657-003L	010	85072	...
12 - 18	Models with Hendrickson Primaax EX 232, 462 and 692 Air Suspension (8-1/2" to 10" Ride Height)	60657-003	010	85072	...
		60657-003L	010	85072	...
12 - 17	Models with Hendrickson Primaax EX 262S or 522S Rear Air Suspension (10" Ride Height)	60665-011	010	85967	...
12 - 16	Models with Neway AD-123 or AD-246 Models Air Suspension with - Shock stamping	90045068	-10	...	89441
		90045099	010	85906	89407
		90045132	010	85909	...
12 - 17	Models with Neway ADZ Rear Suspension	471700004423	010	85109	...
		90045605	010	85109	...
12 - 17	Models with Reyco 102 or 79KB Suspension (Drive Axle)	16725-01	010	83126	...
		19495-01	010	83126	...

T470

10 - 18	Models with 12,000 to 20,000 lb Taperleaf Front Suspension	665858	010	85070	89459
		B71-1001	010	85070	89459
10 - 19	Models with 21,000 to 23,000 lb Reyco Spring Suspension	19495-01	010	83126	89440
		TK19679	010	83126	89440
10 - 16	Models with Air Glide 230 (AG230) Rear Air Suspension	671656	01-	85985	...
		C71-1013	01-	85985	...
10 - 17	Models with Air Glide 380 (AG380) Rear Air Suspension	C71-1002	010	85067	89451
		C71-1016	010	85067	89451
		C71-6015	010	85067	89451
10 - 17	Models with Air Glide 400 (AG400) Rear Air Suspension	671962	01-	85936	89456
		C71-1014	01-	85936	89456
12 - 19	Models with Air Glide 400L (AG400L) Rear Air Suspension	C71-1011	-1-	85069	89455
		C71-1017	-1-	85069	89455
10 - 19	Models with Air Glide 460 (AG460) Rear Air Suspension	671963	01-	85937	...
		C71-1015	01-	85937	...
		C71-1015 PLUS	01-	85937	...
10 - 18	Models with Chalmers 40,000 lb Rear Suspension	665174	010	85060	...
10 - 16	Models with Hendrickson HAS - 230 Rear Air Suspension	60670-005	010	83137	...
10 - 19	Models with Hendrickson HMX 400/460 Haulmax with 16.5" Saddle	60680-004	01-	83143	...
		60680-004L	01-	83143	...
10 - 18	Models with Hendrickson HMX 400/460 Haulmax with 17.5" & 18.5" Saddle	60680-005	01-	83142	...
		60680-005L	01-	83142	...
10 - 18	Models with Hendrickson Primaax 230, 232, 460, 462, 690 and 692 Air Suspension (8-1/2" to 10" Ride Height)	60657-003	010	85072	...
		60657-003L	010	85072	...
10 - 16	Models with Neway AD-123 or AD-246 Models Air Suspension with - Shock stamping	90045068	-10	...	89441
		90045099	010	85906	89407
		90045132	010	85909	...
10 - 17	Models with Neway ADZ Rear Suspension	471700004423	010	85109	...
		90045605	010	85109	...
10 - 18	Models with Reyco 102 or 79KB Suspension (Drive Axle)	16725-01	010	83126	...
		19495-01	010	83126	...

APPLICATION GUIDE - TRUCKS, TRAILERS, AND BUSES

Year	Model	OEM #	Front		Rear	
						
						
			Fleetline	GasSLX	Fleetline	GasSLX

KENWORTH(Cont'd.)

T600, T600A, T600B, T602(Cont'd.)

	All with Air Glide 100 Suspension with 8 air bags, 4 units required	K374-29		- -	85310	89423
		K374-32		- -	85310	89423
	All with Air Glide 200 with 40,000 lb Suspension with 8 air bags, 4 units required	665903		- -	85900	...
		665944		- -	85900	...
		70701		- -	85900	...
	All with Air Glide 200 with 46,000 lb Suspension with 8 air bags, 4 units required	665906		- -	85902	...
		665945		- -	85902	...
2006 -	Models with 13,000 lb Front Axle	665858	0 0	85070	89459	
		B71-1001	0 0	85070	89459	
01 - 07	Models with Air Glide 380 (AG380) Rear Air Suspension	C71-1002		0 0	85067	89451
		C71-1016		0 0	85067	89451
01 - 07	Models with Air Glide 400 (AG400) Rear Air Suspension	671962		0 -	85936	89456
		C71-1014		0 -	85936	89456
- 2007	Models with Air Glide 460 (AG460) Rear Air Suspension	671963		0 -	85937	...
	Models with Hendrickson Rear Air Suspension	47902-19		0 0	83123	89405
		47902-24		0 0	83137	...
	Models with Multiple Leaf Springs on Front Axle	B71-1003	0 0	83312	89409	
		K374-3	0 0	83312	89409	
		K374-33	0 0	83312	89409	
	Models with Reyco 102 or 79KB Suspension (Drive Axle)	16725-01		0 0	83126	...
		19495-01		0 0	83126	...
- 2007	Models with Reyco 1209 or 1212 Suspension (Steer Axle)	19495-01	0 0	83126	89440	
86 - 07	Models with Taper Leaf Springs on Front Axle	B71-1002	0 0	85001	89410	
		K374-16	0 0	85001	89410	
		K374-26	0 0	85001	89410	
		K374-27	0 0	85001	89410	





T660

	Carhauler with O.E.M. Number	K374-36	0 0	...	89432	
08 - 18	Models with 12,000 or 13,200 lb Front Axle	665858	0 0	85070	89459	
		B71-1001	0 0	85070	89459	
08 - 17	Models with 40,000 lb Low Air leaf Suspension	C71-1011		- -	85069	89455
		C71-1017		- -	85069	89455
08 - 17	Models with Air Glide 230 (AG230) Rear Air Suspension	671656		0 -	85985	...
		C71-1013		0 -	85985	...
08 - 17	Models with Air Glide 380 (AG380) Rear Air Suspension	C71-1002		0 0	85067	89451
		C71-1016		0 0	85067	89451
		C71-6015		0 0	85067	89451
13 - 17	Models with Air Glide 400 (AG400) Rear Air Suspension	671962		0 -	85936	89456
		C71-1014		0 -	85936	89456
08 - 17	Models with Air Glide 400L (AG400L) Rear Air Suspension	03-08781		- -	85069	89455
		C71-1011		- -	85069	89455
		C71-1017		- -	85069	89455
08 - 17	Models with Air Glide 460 (AG460) Rear Air Suspension	671963		0 -	85937	...
		C71-1015		0 -	85937	...
		C71-1015 PLUS		0 -	85937	...
13 - 17	Models with O.E.M. Number	B71-6012	0 0	85119

T680

13 - 14	Models with 10,000 lb to 13,200 lb Front Axle	B71-6005	0 0	85084	89460	
14 - 19	Models with 10,000 lb to 14,600 lb Taperleaf Springs and Set Back Front Axles	B71-6019	0 0	85989
14 - 19	Models with 16,000 lb to 20,000 lb Taperleaf Springs and Set Back Front Axles	B71-6020	0 0	85989
13 - 19	Models with 21,000 to 23,000 lb Reyco Spring Suspension	19495-01		0 0	83126	89440

APPLICATION GUIDE - TRUCKS, TRAILERS, AND BUSES

Year	Model	OEM #	Front			Rear		
							Fleetline	GasSLX

KENWORTH(Cont'd.)

T680(Cont'd.)

13 - 19	Models with 21,000 to 23,000 lb Reyco Spring Suspension	TK19679		010	83126	89440
13 - 19	Models with Air Glide 380 (AG380) Rear Air Suspension	C71-1002		010	85067	89451
		C71-1016		010	85067	89451
		C71-6015		010	85067	89451
13 - 19	Models with Air Glide 400 (AG400) Rear Air Suspension	671962		01-	85936	89456
		C71-1014		01-	85936	89456
13 - 19	Models with Air Glide 400L (AG400L) Rear Air Suspension	C71-1011		-1-	85069	89455
		C71-1017		-1-	85069	89455
13 - 19	Models with Air Glide 460 (AG460) Rear Air Suspension	671963		01-	85937	...
		C71-1015		01-	85937	...
		C71-1015 PLUS		01-	85937	...
13 - 19	Models with Hendrickson HMX 400/460 Haulmax with 16.5" Saddle	60680-004		01-	83143	...
		60680-004L		01-	83143	...
13 - 19	Models with Hendrickson HMX 400/460 Haulmax with 17.5" & 18.5" Saddle	60680-005		01-	83142	...
		60680-005L		01-	83142	...
13 - 19	Models with Hendrickson Primaax EX 462 Air Suspensions Standard with 12 1/2" - 14 3/8" - 15 1/2" Ride Height Standard with 8 1/2" to 10" Ride Height	60665-011		010	85967	...
		60657-003		010	85072	...
		60657-003L		010	85072	...
13 - 19	Models with Neway ADZ Rear Suspension	471700004423		010	85109	...
		90045605		010	85109	...
13 - 18	Models with O.E.M. Number	B71-6012	010	85119	
13 - 19	Models with Reyco 102 or 79KB Suspension (Drive Axle)	16725-01		010	83126	...
		19495-01		010	83126	...
13 - 19	Models with Watson & Chalin SL Series Steerable Lift Axle (8,000 to 13,500 lb)	11418		010	646177	...





T700

11 - 16	Models with 13,000 lb Front Axle	665858	010	85070	89459	
		B71-1001	010	85070	89459	
11 - 16	Models with Air Glide 230 (AG230) Rear Air Suspension	671656		01-	85985	...
		C71-1013		01-	85985	...
11 - 16	Models with Air Glide 380 (AG380) Rear Air Suspension	C71-1002		010	85067	89451
		C71-1016		010	85067	89451
		C71-6015		010	85067	89451
11 - 16	Models with Air Glide 400 (AG400) Rear Air Suspension	671962		01-	85936	89456
		C71-1014		01-	85936	89456
11 - 16	Models with Air Glide 400L (AG400L) Rear Air Suspension	03-08781		-1-	85069	89455
		C71-1011		-1-	85069	89455
		C71-1017		-1-	85069	89455

T800, T800B, T800B(8x4), T800SH, T800H, T800W

	All with Air Glide 100 Suspension with 8 air bags, 4 units required	K374-29		-1-	85310	89423
		K374-32		-1-	85310	89423
	All with Air Glide 200 with 40,000 lb Suspension with 8 air bags, 4 units required	665903		-1-	85900	...
		665944		-1-	85900	...
		70701		-1-	85900	...
	All with Air Glide 200 with 46,000 lb Suspension with 8 air bags, 4 units required	665906		-1-	85902	...
		665945		-1-	85902	...
05 - 18	Models with 12,000 to 20,000 lb Front Axles	665858	010	85070	89459	
		B71-1001	010	85070	89459	
06 - 18	Models with Air Glide 230 (AG230) Rear Air Suspension	671656		01-	85985	...
		C71-1013		01-	85985	...
01 - 18	Models with Air Glide 380 (AG380) Rear Air Suspension	C71-1002		010	85067	89451

APPLICATION GUIDE - TRUCKS, TRAILERS, AND BUSES

Year	Model	OEM #	Front		Rear	
						
			Fleetline	GasSLX	Fleetline	GasSLX

KENWORTH(Cont'd.)





T800, T800B, T800B(8x4), T800SH, T800H, T800W(Cont'd.)

01 - 18	Models with Air Glide 380 (AG380) Rear Air Suspension	C71-1016		OIO	85067	89451
		C71-6015		OIO	85067	89451
07 - 18	Models with Air Glide 400 (AG400) Rear Air Suspension	671962		OI-	85936	89456
		C71-1014		OI-	85936	89456
14 - 19	Models with Air Glide 400L (AG400L) Rear Air Suspension	C71-1017		-I-	85069	89455
07 - 19	Models with Air Glide 460 (AG460) Rear Air Suspension	671963		OI-	85937	...
		C71-1015		OI-	85937	...
		C71-1015 PLUS		OI-	85937	...
87 - 18	Models with Chalmers 40,000 lb Rear Suspension	665174		OIO	85060	...
02 - 19	Models with Hendrickson HMX 460 Haulmax with 16.5" Saddle	60680-004		OI-	83143	...
		60680-004L		OI-	83143	...
02 - 19	Models with Hendrickson HMX 460 Haulmax with 17.5" & 18.5" Saddle	60680-005		OI-	83142	...
		60680-005L		OI-	83142	...
10 - 18	Models with Hendrickson Primaax EX 232, 462 and 692 Air Suspension (8-1/2" to 10" Ride Height)	60657-003		OIO	85072	...
		60657-003L		OIO	85072	...
	Models with Hendrickson Rear Air Suspension	47902-19		OIO	83123	89405
		47902-24		OIO	83137	...
	Models with Multiple Leaf Springs on Front Axle	B71-1003	OIO	83312	89409	
		K374-3	OIO	83312	89409	
		K374-33	OIO	83312	89409	
- 2019	Models with Neway ADZ Rear Suspension	471700004423		OIO	85109	...
		90045605		OIO	85109	...
	Models with Neway Rear Air Suspension	90044089		OIO	83124	89407
-2018	Models with Neway Rear Air Suspension (AD123-, AD246-)	90045132		OIO	85909	...
-2018	Models with Reyco 102 or 79KB Suspension (Drive Axle)	16725-01		OIO	83126	...
		19495-01		OIO	83126	...
- 2019	Models with Reyco 1209 or 1212 Suspension (Steer Axle)	19495-01	OIO	83126	89440	
88 - 18	Models with Taper Leaf Springs on Front Axle	B71-1002	OIO	85001	89410	
		K374-16	OIO	85001	89410	
		K374-26	OIO	85001	89410	
		K374-27	OIO	85001	89410	
	Models with Torsion Bar Bogey (2 rear axles) and KW Air Ride Suspension (with 4 air bags)	K374-28		OIO	85314	89425
		K374-4		OIO	85314	89425

T880

14 - 19	Models with 10,000 lb to 14,600 lb Taperleaf Springs and Set Back Front Axles	B71-6019	OIO	85989
14 - 19	Models with 16,000 lb to 20,000 lb Taperleaf Springs and Set Back Front Axles	B71-6020	OIO	85989
14 - 19	Models with Air Glide 380 (AG380) Rear Air Suspension	C71-1002		OIO	85067	89451
		C71-1016		OIO	85067	89451
		C71-6015		OIO	85067	89451
14 - 19	Models with Air Glide 400 (AG400) Rear Air Suspension	671962		OI-	85936	89456
		C71-1014		OI-	85936	89456
14 - 19	Models with Air Glide 400L (AG400L) Rear Air Suspension	C71-1017		-I-	85069	89455
14 - 19	Models with Air Glide 460 (AG460) Rear Air Suspension	671963		OI-	85937	...
		C71-1015		OI-	85937	...
		C71-1015 PLUS		OI-	85937	...
14 - 19	Models with Hendrickson HMX 400/460 Haulmax with 16.5" Saddle	60680-004		OI-	83143	...
		60680-004L		OI-	83143	...
14 - 19	Models with Hendrickson HMX 400/460 Haulmax with 17.5" & 18.5" Saddle	60680-005		OI-	83142	...
		60680-005L		OI-	83142	...

APPLICATION GUIDE - TRUCKS, TRAILERS, AND BUSES

Year	Model	OEM #	Front			Rear		
							Fleetline	GasSLX

KENWORTH(Cont'd.)

T880(Cont'd.)

14 - 19	Models with Hendrickson Primaax EX 462 Air Suspensions (Standard with 12 1/2" - 14 3/8" - 15 1/2" Ride Height)	60665-011		010	85967	...
14 - 19	Models with Hendrickson Primaax EX 462 Air Suspensions (Standard with 8 1/2" to 10" Ride Height)	60657-003		010	85072	...
		60657-003L		010	85072	...
14 - 19	Models with Neway ADZ Rear Suspension	471700004423		010	85109	...
		90045605		010	85109	...
	Models with O.E.M. Number	C71-1015A		01-	85937	...
14 - 16	Models with O.E.M. Number	B71-6012	010	85119
14 - 19	Models with Reyco 102 or 79KB Suspension (Drive Axle)	16725-01		010	83126	...
		19495-01		010	83126	...
14 - 19	Models with Watson & Chalin SL Series Steerable Lift Axle (8,000 to 13,500 lb)	11418		010	646177	...





T2000

97 - 11	All with Air Glide 100 Suspension with 8 air bags, 4 units required	K374-29		- -	85310	89423
		K374-32		- -	85310	89423
97 - 11	All with Air Glide 200 with 40,000 lb Suspension with 8 air bags, 4 units required	665903		- -	85900	...
		665944		- -	85900	...
		70701		- -	85900	...
97 - 11	All with Air Glide 200 with 46,000 lb Suspension with 8 air bags, 4 units required	665906		- -	85902	...
		665945		- -	85902	...
06 - 11	Models with 13,000 lb Front Axle	665858	010	85070	89459	
		B71-1001	010	85070	89459	
01 - 11	Models with Air Glide 380 (AG380) Rear Air Suspension	C71-1002		010	85067	89451
		C71-1016		010	85067	89451
05 - 11	Models with Air Glide 400 (AG400) Rear Air Suspension	671962		01-	85936	89456
		C71-1014		01-	85936	89456
05 - 11	Models with Air Glide 460 (AG460) Rear Air Suspension	671963		01-	85937	...
	Models with Multiple Leaf Springs on Front Axle	B71-1003	010	83312	89409	
		K374-3	010	83312	89409	
		K374-33	010	83312	89409	
97 - 11	Models with Taper Leaf Springs on Front Axle	B71-1002	010	85001	89410	
		K374-16	010	85001	89410	
		K374-26	010	85001	89410	
		K374-27	010	85001	89410	

W900, W900B, W900L, W900S

	All with Air Glide 100 Suspension with 8 air bags, 4 units required	K374-29		- -	85310	89423
		K374-32		- -	85310	89423
	All with Air Glide 200 with 40,000 lb Suspension with 8 air bags, 4 units required	665903		- -	85900	...
		665944		- -	85900	...
		70701		- -	85900	...
	All with Air Glide 200 with 46,000 lb Suspension with 8 air bags, 4 units required	665906		- -	85902	...
		665945		- -	85902	...
	Carhauler with O.E.M. Number	K374-36	010	...	89432	
05 - 18	Models with 12,000 or 13,200 lb Front Axle	665858	010	85070	89459	
		B71-1001	010	85070	89459	
2010	Models with 46,000 lb Neway Rear Air Suspension	90045132		010	85909	...
06 - 18	Models with Air Glide 230 (AG230) Rear Air Suspension	671656		01-	85985	...
		C71-1013		01-	85985	...
01 - 18	Models with Air Glide 380 (AG380) Rear Air Suspension	C71-1002		010	85067	89451
		C71-1016		010	85067	89451
		C71-6015		010	85067	89451

APPLICATION GUIDE - TRUCKS, TRAILERS, AND BUSES

Year	Model	OEM #	Front		Rear	
						
			Fleetline	GasSLX	Fleetline	GasSLX

KENWORTH(Cont'd.)

W900, W900B, W900L, W900S(Cont'd.)

05 - 18	Models with Air Glide 400 (AG400) Rear Air Suspension	671962		01-	85936	89456
		C71-1014		01-	85936	89456
08 - 19	Models with Air Glide 400L (AG400L) Rear Air Suspension	C71-1011		-1-	85069	89455
		C71-1017		-1-	85069	89455
05 - 19	Models with Air Glide 460 (AG460) Rear Air Suspension	671963		01-	85937	...
		C71-1015		01-	85937	...
		C71-1015 PLUS		01-	85937	...
- 2019	Models with Hendrickson HMX 400/460 Haulmax with 16.5" Saddle	60680-004		01-	83143	...
		60680-004L		01-	83143	...
- 2018	Models with Hendrickson HMX 400/460 Haulmax with 17.5" & 18.5" Saddle	60680-005		01-	83142	...
		60680-005L		01-	83142	...
	Models with Hendrickson Rear Air Suspension	47902-19		010	83123	89405
		47902-24		010	83137	...
	Models with Multiple Leaf Springs on Front Axle	B71-1003	010	83312	89409	
		K374-3	010	83312	89409	
		K374-33	010	83312	89409	
- 2018	Models with Neway ADZ Rear Suspension	471700004423		010	85109	...
		90045605		010	85109	...
- 2018	Models with Reyco 102 or 79KB Suspension (Drive Axle)	16725-01		010	83126	...
		19495-01		010	83126	...
- 2019	Models with Reyco 1209 or 1212 Suspension (Steer Axle)	19495-01	010	83126	89440	
87 - 19	Models with Taper Leaf Springs on Front Axle	B71-1002	010	85001	89410	
		K374-16	010	85001	89410	
		K374-26	010	85001	89410	
		K374-27	010	85001	89410	
	Models with Torsion Bar Bogey (2 rear axles) and KW Air Ride Suspension (with 4 air bags)	K374-28		010	85314	89425
		K374-4		010	85314	89425

Additional O.E.M. Interchanges

	Models with Hendrickson Primaax 260 or 520 Rear Air Suspension (10" Ride Height-Disc Brakes only)	60665-015		010	85966	...
	Models with Hendrickson Primaax 260 or 520 Rear Air Suspension (10" Ride Height-Drum Brakes only)	60665-013		010	85965	...
	Models with Hendrickson Primaax EX 262 or 522 Rear Air Suspension (10" Ride Height)	60665-013		010	85965	...
	Models with Hendrickson Primaax EX 262S or 522S Rear Air Suspension (10" Ride Height)	60665-011		010	85967	...
	OE PLUS Shock Stamping Number	02-02736PLUS	010	85302	89420	
		02-02737PLUS	010	85062	89408	
		02-02738PLUS	010	85012	89413	
		02-02739PLUS	010	85013	89414	
		03-04176PLUS		010	85308	89422
		03-06084PLUS		-10	85033	89427
		03-07421PLUS		-10	85311	89424
		03-07423PLUS		-10	85033	89427
		10-12032-002PLUS	010	85320	89429	
		10-12542-000PLUS	010	85901
		16-13947-000PLUS		-10	85319	89428
		2018987C1PLUS		010	85003	89411
		47902-13PLUS		010	83122	89406
		60670-005PLUS		010	83137	...
		60670-008PLUS		010	83123	89405
		665565PLUS		010	85007	89412
		671962PLUS		01-	85936	89456
70701PLUS		-1-	85900	...		

APPLICATION GUIDE - TRUCKS, TRAILERS, AND BUSES









Year	Model	OEM #	Front		Rear	
			Fleetline	GasSLX	Fleetline	GasSLX

KENWORTH(Cont'd.)

Additional O.E.M. Interchanges(Cont'd.)

OE PLUS Shock Stamping Number	8086053PLUS		OIO	85047	89435
	90044025PLUS	OIO	83209	89414	
	90044089PLUS		OIO	83124	89407
	B71-6015	OIO	85012	89413	
	C71-1002PLUS		OIO	85067	89451
	C71-1011PLUS		- -	85069	89455
	K374-26PLUS	OIO	85001	89410	
	K374-28PLUS		OIO	85314	89425
	K374-29PLUS		- -	85310	89423
	K374-33PLUS	OIO	83312	89409	
TruckMaster Shock Stamping Number	665632	OIO	85013	89414	
	665633		- O	85033	89427
	665783		OIO	83123	89405
	665784		OIO	83122	89406
	665785		OIO	83137	...
	665844		- -	85069	89455
	665918		- -	85900	...
	665926		OIO	85047	89435
	665927	OIO	85901
	665928	OIO	85062	89408	
	665930	OIO	85001	89410	
	665931	OIO	83312	89409	
	665932	OIO	85012	89413	
	665950		- -	85902	...
	671052	OIO	85070	89459	
	671654		O -	85936	89456
	671699		O -	85937	...
	671794		OIO	85067	89451
	680237		85303	...	OIO	85303	89422
	680239		- -	85310	89423
	680240		OIO	85302	89420
	680242		OIO	85308	89422
	680253		OIO	85314	89425
	680261	OIO	85062	89408	
	680279	OIO	83209	89414	
	680280		OIO	85906	89407
	680281		OIO	85003	89411
	680283	O -	85740
	680303		OIO	85007	89412
	680425	OIO	85320	89429	
	680435		- O	85033	89427
	680473		- O	85319	89428
All with Air Glide 100 Suspension with 8 air bags, 4 units required	K374-C7		- -	85310	89423
Models with Multiple Leaf Springs on Front Axle	K374-14	OIO	83312	89409	
	K374-5	OIO	83312	89409	
Models with O.E.M. Number	665453	OIO	85001	89410	
	665670	OIO	85001	89410	
	665680	OIO	83312	89409	
	665788		OIO	85000	89436
	665828		OIO	85067	89451
	671962SPL		O -	85936	89456
	675122	OIO	85001	89410	
	680241		- O	85311	89424
	680475		OIO	85314	89425

APPLICATION GUIDE - TRUCKS, TRAILERS, AND BUSES

Year	Model	OEM #	Front		Rear	
						
						
			Fleetline	GasSLX	Fleetline	GasSLX

KENWORTH(Cont'd.)

Additional O.E.M. Interchanges(Cont'd.)

	Models with O.E.M. Number	680476		- -	85310	89423	
		680486		- -	85310	89423	
		680586		- O	85311	89424	
		B71-6000	O O	85959
		B71-6002	O O	85012	89413		
		B71-6003	O O	85029
		B71-6007	O O	85062	89408		
		B71-6008	O O	83312	89409		
		B71-6010	O O	85023 or 89415			
		B71-6011	O O	85062	89408		
		B71-6013	O O	85012	89413		
		B71-6016	O O	85012	89413		
		B71-6017	O O	85910
		B71-6018	O O	85012	89413		
		C71-1011SPL		- -		85069	89455
		C71-6003		- O		85988	...
		C71-6004		- O		85343	...
		C71-6005		- -		85069	89455
		K374-7		- -		85310	89423
		K374-9		- -		85310	89423
		K374-C31	O O	83312	89409		
		R71-6006	O O					83063	
		R71-6007	O O					83008	
		R71-6008	O O					83035	
		S-20126		O O		85323	89436
	Models with Taper Leaf Springs on Front Axle	K374-11	O O	85001	89410		
	Additional O.E.M. Interchanges	3166657	O O			85700			
665092		O O			83312 or 89409				
665118		O O			83312 or 89409				
K374-10		O O			83362				
K374-3-1		O O			83312 or 89409				

KENWORTH CAB SHOCKS

Aerocab

	Models with 38" Sleepers with Link Cabmate Models KWK1T03 or KWCSA 01-06	1202-1264	O O	83031
	Models with 62" and 74" Sleepers with O.E.M. Number	1202-1164	O O	83031
	Models with 72" Sleepers with Link Cabmate Models KWK1T02 or KWCSA 01-06	1202-1065	O O	83002
08 - 16	Models with 86" Sleepers with O.E.M. Number	1202-1286	O O	83056
		1202K286	O O	83056
		T71-1003	O O	83056

C-500B

	Models with Link Cabmate KWB500 Air Suspension	1202-0044	O O	83025
--	--	-----------	-----	-------





COE Models

	90" and 112" E Models with Link Cabmate KWE90112-B Air Suspension	1202K064	O O	83024
		R71-1005	O O	83024
	Models with Link Cabmate KW1102-B Air Suspension (Does not fit Non-Sleeper cabs)	1202-0032	O O	83016
	Models with Link Cabmate KWE90112-A Air Suspension	1202-0032	O O	83016

ICON 900

2016	Models with 86" Sleepers with O.E.M. Number	T71-1003	O O	83056
2016	Models with O.E.M. Number	T71-1002	O O	83002

APPLICATION GUIDE - TRUCKS, TRAILERS, AND BUSES

Year	Model	OEM #	Front		Rear	
						
			Fleetline	GasSLX	Fleetline	GasSLX

KENWORTH CAB SHOCKS(Cont'd.)

T400A(Cont'd.)

06/92 -	Models with Link Cabmate Air Suspension KWB689-A with rear cab support Kenworth P/N K235-1646	1202-0012	010	83023
- 05/92	Models with Link Cabmate KWB400-A Air Suspension	1202-0012	010	83023
05/92 -	Models with Link Cabmate KWB689-B or KWB689-C Air Suspension	1201-1043	010	83025
06/92 -	Models with Link Cabmate KWB689-B or KWB689-C Air Suspension	1202-1043	010	83025

T440

	Models with Link Cabmate KWB689-D and Severe service crossmembers	1201-1046	010	83049
		1202-1046	010	83049
		1202K046	010	83049
		R71-1004	010	83049

T450

06/92 -	Models with Link Cabmate Air Suspension KWB689-A with rear cab support Kenworth P/N K235-1646	1202-0012	010	83023
- 05/92	Models with Link Cabmate KWB400-A Air Suspension	1202-0012	010	83023
05/92 -	Models with Link Cabmate KWB689-B or KWB689-C Air Suspension	1201-1043	010	83025
06/92 -	Models with Link Cabmate KWB689-B or KWB689-C Air Suspension	1202-1043	010	83025
	Models with Link Cabmate KWB689-D and Severe service crossmembers	1202K046	010	83049
		R71-1004	010	83049

T600

	Models with Link Cabmate KWMC642 Air Suspension	1202-0054	010	83021
--	---	-----------	-----	-------

T600A

	Models with Link Cabmate KWB689-A Air Suspension and rear cab mount Kenworth P/N K235-1436 or K235-1488	1202-0012	010	83023
	Models with Link Cabmate KWB689-B or KWB689-C Air Suspension and rear cab mount Kenworth part # K235-1436 or K235-1488	1201-1043	010	83025
		1202-1043	010	83025
	Models with Link Cabmate KWB689-D and Severe service crossmembers	1202K046	010	83049
		R71-1004	010	83049

T660

08 - 17	Models with 86" Sleepers with O.E.M. Number	1202-1286	010	83056
		1202K286	010	83056
		T71-1003	010	83056
06 - 10	Models with Link Cab Suspension	1202-1065	010	83002

T680

13 - 18	Models with Sleepers with O.E.M. Number	1201-8002	010	83081
		R71-6009	010	83081









T700

11 - 16	DayCab Models with O.E.M. Number	R71-6000	010	83067
		R71-6010	010	83067
08 - 16	Models with 86" Sleepers with O.E.M. Number	1202-1286	010	83056
		1202K286	010	83056
		T71-1003	010	83056
11 - 16	Models with Extended Sleeper Cab	1202-1064	010	83024
		1202K064	010	83024
		R71-1005	010	83024

T800 / T800A

- 2012	Models with Link Cab Suspension	1202-1046	010	83049
	Models with Link Cabmate KWB689-A Air Suspension and rear cab mount Kenworth P/N K235-1436 or K235-1488	1202-0012	010	83023

APPLICATION GUIDE - TRUCKS, TRAILERS, AND BUSES

Year	Model	OEM #	Front		Rear	
						
						
			Fleetline	GasSLX	Fleetline	GasSLX

KENWORTH CAB SHOCKS(Cont'd.)

T800 / T800A(Cont'd.)

	Models with Link Cabmate KWB689-B or KWB689-C Air Suspension and rear cab mount Kenworth part # K235-1436 or K235-1488	1201-1043	OIO	83025
		1202-1043	OIO	83025
	Models with Link Cabmate KWB689-D and Severe service crossmembers	1202K046	OIO	83049
- 2014	Models with Link Cabmate KWB689-D and Severe service crossmembers	R71-1004	OIO	83049
	Models with Link Cabmate KWMC642 Air Suspension	1202-0054	OIO	83021

T880

14 - 18	Sleeper cab Models with Link Cab Suspension	1202-1046	OIO	83049
---------	---	-----------	-----	-------

W900L

06 - 17	Models with O.E.M. Number	1202K065	OIO	83002
		T71-1002	OIO	83002

T2000

97 - 11	Models with Link Cabmate KWT2000-A Air Suspension	1202-1064	OIO	83024
		1202K064	OIO	83024
		R71-1005	OIO	83024
07/98 -	Models with PowerPacker Cab Suspension after 6/28/98	PP2582870	OIO	83012
- 06/98	Models with PowerPacker Cab Suspension prior to 6/28/98	96027-10545	OIO	83011

W-900 / W-900B

	Models with Link Cabmate KWB689-A Air Suspension and rear cab mount Kenworth P/N K235-1436 or K235-1488	1202-0012	OIO	83023
	Models with Link Cabmate KWB689-B or KWB689-C Air Suspension and rear cab mount Kenworth part # K235-1436 or K235-1488	1201-1043	OIO	83025
		1202-1043	OIO	83025
	Models with Link Cabmate KWB689-D and Severe service crossmembers	1202K046	OIO	83049
		R71-1004	OIO	83049
	Models with Link Cabmate KWMC642 Air Suspension	1202-0054	OIO	83021

Additional Applications

	60" Sleeper with Link Cab Suspension	1202-0043	OIO	83032
- 1982	Conventional Tractors with A-Model cabs & Link Cabmate Model KWA900	1201-0012	OIO	83023
		1202-0012	OIO	83023
1986 -	Kenworth Sleepers with Link Cabmate KWS60-A Air Suspension and round cornered doors.	1201-1044	OIO	83025
	Models with Link Cab Suspension	1202-0042	OIO	83025
	Models with O.E.M. Number	1202-K065	OIO	83002
		1202K164	OIO	83031
		1202K264	OIO	83031
		PP1058870	OIO	83059
		R71-6005	OIO	83042
		T71-1000	OIO	83031
		T71-1001	OIO	83031

KIMBLE MIXER CO





	Rear Discharge Mixers with Self - Steering Axle Shock	T91-00002-00	OIO	646155	...
--	---	--------------	-----	-----	-----	--------	-----

KING OF THE ROAD

Class A MotorHomes

04 - 06	Genesis Series MotorHomes with Freightliner XC Chassis ADL200 Suspension w/ 20K Rear AS120 Front Suspension	16-16873-000					
		141700131810	OIO	83160
		16-16737-000	OIO	83160
		16-16874-000	OIO	83160
		141700131809				OIO	85029
	Rear Shock with O.E.M. Number						

APPLICATION GUIDE - TRUCKS, TRAILERS, AND BUSES

Year	Model	OEM #	Front		Rear	
						
			Fleetline	GasSLX	Fleetline	GasSLX

KING OF THE ROAD(Cont'd.)

Class A MotorHomes(Cont'd.)

04 - 06	ADL200 Suspension w/ 20K Rear ZF - IFS Front Suspension with 23,000 lb GVW or Greater	16-16736-000 16-18103-000 481700000493		010	85029	...
			-1-	85900
			-1-	85900

KRYSTAL BUS

- 2019	Krystal E-450 Shuttle bus	ASH-1136 ASH-1154		-10	83178	...
			-10	83177
	Krystal F-650 Shuttle bus - Refer to Ford section for detailed information on F-650 models							

KWK-LOC (JIFFLOX)

	Truck Dolly	522217 CP-5222	010	85315
			010	85315

LEYLAND TRUCK

	Models with Air Trac Suspension (38000 or 40000 lb)	1456033		-10	85311	89424
--	---	---------	--	-----	-----	-----	-------	-------









LGE COACHWORKS

- 2019	All Shuttle buses with Ford E350 and E450 Chassis	ASH-1136 ASH-1154		-10	83178	...
			-10	83177
	Models with Freightliner M2 Chassis - See Freightliner section for proper year and model information						

LINK MANUFACTURING CAB SHOCKS

	Models with Link Cab Suspension	1202-1046	010	83049			
06 - 13	Peterbilt 335 Day Cab models with Link Number	1202P055	010	83061			
	Models with Link Cab Suspension	1201-0012	010	83023			
		1201-0154	010	83051			
		1201-0254	010	83051			
		1201-1043	010	83025			
		1201-1044	010	83025			
		1201-1046	010	83049			
		1201-1049	010	83025			
		1201-1212	010	83013			
		1201-1213	01-	83005			
		1201-9001	010	83052			
		1201-9002	010	83052			
		1201-9003	010	83052			
		1201-9007	010	83054			
		1201-9008	010	83054			
		1201-9009	010	83054			
		1201-9010	010	83053			
		1201-9011	010	83053			
		1201-9013	01-	83062			
		1201-9014	01-	83062			
		1201-9018	01-	83062			
		1201-9021	01-	83062			
		1202-0012	010	83023			
		1202-0032	010	83016			
		1202-0042	010	83025			
		1202-0043	010	83032			
		1202-0044	010	83025			
		1202-0052	010	83021			
		1202-0054	010	83021			
		1202-1042	010	83025			

APPLICATION GUIDE - TRUCKS, TRAILERS, AND BUSES

Year	Model	OEM #	Front		Rear	
						
						
			Fleetline	GasSLX	Fleetline	GasSLX

LINK MANUFACTURING CAB SHOCKS(Cont'd.)

Models with Link Cab Suspension	1202-1043	010	83025
	1202-1044	010	83025
	1202-1064	010	83024
	1202-1065	010	83002
	1202-1164	010	83031
	1202-1212	010	83013
	1202-1213	01-	83005
	1202-1286	010	83056
	1202K065	010	83002
	1202K164	010	83031
	1202K264	010	83031
	1202K286	010	83056
	632129	010	83023
	635705	010	83016
	654669	010	83021
	654799	010	83025
	654811	010	83024
	654833	010	83021
	654847	010	83002
	654849	010	83031
	654867	010	83025
	LG40450	010	83016
	LG40470	010	83016
	R71-1004	010	83049
	R71-1005	010	83024
T71-1000	010	83031	
T71-1001	010	83031	
T71-1002	010	83002	

LINK MANUFACTURING LTD.

(See Specialty Application Section Also)							
	Sterling Models with Link Rear Air Suspension	1210-0528	010	85904	...
	Models with O.E.M. Number	1210-0005	010	85734	...
		671093	010	85904	...

LION BUS

Bus Chassis With Hendrickson HTS 210 Suspension (Type C School Bus Applications)	60665-025	010	85036	89405
	60665-025L	010	85036	89405
Buses with Hendrickson Softek Suspension with Drum and Disc Brakes	58913-009	010	85959
	58913-009L	010	85959

LODAL, INC.

Refuse Truck	9960257	010	83122	89406
--------------	---------	-----	-------	-------	-----	-----

M.A.N. BUS

Americana Bus with O.E.M. Numbers	25-1700-106-654	-1-	85708	...
	81-43701-6543	-1-	85708	...
	81-43701-6572	-1-	85708
	81-43701-6573	-1-	85722
Articulating Bus - Drive Axle	81-43701-6537	-1-	85709	...
Articulating Bus - Front Axle	81-43701-6538	-1-	85708
Articulating Bus - Trailing Axle	81-43701-6539	-1-	85708	...
Models with O.E.M. Number	134	-1-	85709	...
	81-43701-6609	-1-	85709	...

APPLICATION GUIDE - TRUCKS, TRAILERS, AND BUSES

Year	Model	OEM #	Front		Rear	
			Fleetline	GasSLX	Fleetline	GasSLX

M.A.N. BUS(Cont'd.)

Models with O.E.M. Number	9020M-1042		- -	85709	...
---------------------------	------------	--	-----	-----	-----	-------	-----

MAC TRAILER MFG., INC.

Identification of the trailer suspension is necessary to determine what section of the catalog to refer to. Some possible options can be Chalmers, Hendrickson, Neway, Ridewell, Reyco.							
---	--	--	--	--	--	--	--

MACK





ANTHEM Series

18 - 19	Anthem 64T Models with 13,200 lb Front Axles	141700005839 21436096	OIO	85098
				85098
18 - 19	Anthem 64T Models with 40,000 lb Rear Air Suspensions	22202560 471700009647		OIO	85088	...
				OIO	85088	...
18 - 19	Anthem 64T Models with Hendrickson HAS 400 or 460 Series Rear Suspension	60675-001 60675-001L 8083872		OIO	85978	...
				OIO	85978	...
				OIO	85978	...
18 - 19	Models with Hendrickson HMX 400/460 Haulmax with 16.5" Saddle	60680-004 60680-004L H60680004		OI-	83143	...
				OI-	83143	...
				OI-	83143	...
18 - 19	Models with Hendrickson HMX 400/460 Haulmax with 17.5" or 18.5" Saddle Height	60680-005 60680-005L H60680005		OI-	83142	...
				OI-	83142	...
				OI-	83142	...
18 - 19	Models with Hendrickson HN - 522 Rear Suspension	60680-003 60680-003L		OI-	83112	...
				OI-	83112	...

CH Series

	CH Models with Hendrickson HA Series Air Suspension	14QK-410M2 14QK-410M3 25625254		OIO	83137	...
				OIO	83125	...
				OIO	83125	...
	CH600 Models with 12000 lb Taperleaf Spring	14QK-392AM 14QK-392AM3 14QK-392BM 14QK-392BM3 14QK-396 14QK-396M 25625743	OIO	85005	89430	
				85005	89430	
				85005	89430	
				85005	89430	
				85005	89430	
				85005	89430	
	CH600 Models with AL Suspension	14QK-393M		OIO	85010	...
	CH600 Models with ALV Hendrickson Suspension	14QK-413M5 14QK-413M6 14QK-413M7 25622221 25625223 57241-006 57241-006L		OI-	83138	...
				OI-	83111	...
				OI-	83111	...
				OI-	83111	...
				OI-	83111	...
				OI-	83111	...
	CH600 Models with HAS400 MACK Air Suspension	14QK-410M 25625234 47902-25		OIO	83125	...
				OIO	83125	...
				OIO	83125	...
	CH600 Models with Hendrickson AL-405 Rear Suspension	14QK-413M7 25625223 57241-006 57241-006L		OI-	83111	...
				OI-	83111	...
				OI-	83111	...
				OI-	83111	...
	CH600 Models with Hendrickson HAS-40LH Air Suspension (O.E. Number 57241-4)	14QK-413M4 57241-4		OI-	83110	...
				OI-	83110	...
	CH600 Models with Hendrickson HN-2 Series Suspension	14QK-415M 14QK-415M7		OI-	83112	...
				OI-	83112	...

APPLICATION GUIDE - TRUCKS, TRAILERS, AND BUSES

Year	Model	OEM #	Front		Rear	
						
			Fleetline	GasSLX	Fleetline	GasSLX

MACK(Cont'd.)

CH Series(Cont'd.)

	CH600 Models with Hendrickson HN-2 Series Suspension	25624241	OI-	83112	...
		60680-003	OI-	83112	...
		60680-003L	OI-	83112	...
	CH600 Models with Hendrickson Rear Air Suspension	14QK-393AM	OIO	83123	89405
		47902-9	OIO	83123	89405
	CH600 Models with Neway AD Air Suspension Shock w/ extended length of 21.70" w/ extended length of 24.30"	14QK-414M	OIO	85906	89407
		90045099	OIO	85906	89407
		14QK-414M2	OIO	85909	...
		25624351	OIO	85909	...
	CH600 Models with ST34 Suspension	14QK-2133M	OIO	85001	89410
		25622466	OIO	85001	89410
	Models with O.E.M. Number	14QK-2113P6	OIO	85007	89412
		14QK-421M	OIO	85014
		47170000426	OIO	85014

CHN - Series

04 - 07	CHN-613 Models w/ MACK Air Suspension	14QK-3101M	OIO	85066	89448
		471700000431	OIO	85066	89448
		SDA471700000431	OIO	85066	89448
04 - 07	CHN-613 Models with 12,000 lb Front Axle	14QK-3107M	OIO	85061	89450
		20973993	OIO	85061	89450
04 - 07	CHN-613 Models with 14,600 lb Front Axle	14QK-434M	OIO	85014
04 - 07	CHN-613 Models with Camelback Rear Suspension (SS34 & 38)	20998401	OIO	85014
		25625091	OIO	83215	...





CHU - Pinnacle Series

08 - 19	CHU-613 Models with 12,000 lb or 14,600 lb Front Axle	14QK-434M	OIO	85014
		20625775	OIO	85014
		20998401	OIO	85014
		471700002861	OIO	85014
		SDA471700002861	OIO	85014
11 - 17	CHU-613 Models with 40,000 lb Rear Air Suspensions	22202560	OIO	85088	...
		471700009647	OIO	85088	...
- 2019	CHU-613 Models with Camelback Rear Suspension (SS34 & 38)	14QK-2107P2	OIO	83215	...
		25625091	OIO	83215	...
08 - 14	CHU-613 Models with Hendrickson 38,000 lb Rear Air Suspension	14QK-424M	OIO	83147	...
		20570098	OIO	83147	...
		60670-006	OIO	83147	...
		60670-006L	OIO	83147	...
- 2019	CHU-613 Models with Hendrickson HAS 400 or 460 Series Rear Suspension	60675-001	OIO	85978	...
		60675-001L	OIO	85978	...
		8083872	OIO	85978	...

CL Series

	CL600, CL700 Models with ALV Hendrickson Suspension	14QK-413M5	OI-	83138	...
		14QK-413M6	OI-	83111	...
		14QK-413M7	OI-	83111	...
		25622221	OI-	83111	...
		25625223	OI-	83111	...
		57241-006	OI-	83111	...
		57241-006L	OI-	83111	...
			CL600, CL700 Models with HAS400 MACK Air Suspension	14QK-410M	OIO
25625234	OIO	83125	...
47902-25	OIO	83125	...

APPLICATION GUIDE - TRUCKS, TRAILERS, AND BUSES

Year	Model	OEM #	Front			Rear		
								
				Fleetline	GasSLX		Fleetline	GasSLX

MACK(Cont'd.)

CL Series(Cont'd.)

	CL600, CL700 Models with Hendrickson HA Series Air Suspension	14QK-410M2	010	83137	...
		14QK-410M3	010	83125	...
		25625254	010	83125	...
	CL600, CL700 Models with Hendrickson HN-2 Series Suspension	14QK-415M	01-	83112	...
		14QK-415M7	01-	83112	...
		25624241	01-	83112	...
		60680-003	01-	83112	...
		60680-003L	01-	83112	...
	CL600, CL700 Models with Hendrickson Rear Air Suspension	14QK-393AM	010	83123	89405
		47902-9	010	83123	89405
	CL600, CL700 Models with Multileaf Spring Suspension	14QK-392AM2	010	83123	89405
		14QK-392BM2	010	85321
	CL600, CL700 Models with Neway AD Air Suspension Shock w/ extended length of 21.70" w/ extended length of 24.30"	14QK-414M	010	85906	89407
		90045099	010	85906	89407
		14QK-414M2	010	85909	...
		25624351	010	85909	...
	CL600, CL700 Models with ST34 Suspension	14QK-2113	010	85001	89410
		14QK-2133M	010	85001	89410
		25621955	010	85001	89410
		25622466	010	85001	89410
		25632145	010	85001	89410
	CL600, CL700 Models with Steering Axle & Taperleaf Spring	14QK-392AM	010	85005	89430
		14QK-392AM3	010	85005	89430
		14QK-392BM	010	85005	89430
		25625743	010	85005	89430

CS, MS - Mid - Liner Series

	CS Models Mid-Liner with O.E.M Number	4103-5000447861	-10	83105
		4103-5000546892	-10	83105
		V10234121	-10	83105
		V10242320	-10	83105
	MS200, MS300 Models Mid-Liner	V10234121	-10	83105





CT, CTX Series

	Models with O.E.M. Number	14QK-3108	01-	85080
		14QK-3108M	01-	85080
		14QK-3116M	010	83101
		14QK-427M	01-	85080
		14QK-428M	01-	85080

CV - Series

02 - 08	CV-713 Models with 18,000 lb Front Axles	14QK-366	010	85036	89405
		25625151	010	85036	89405
02 - 08	CV-713 Models with Hendrickson HN-2 Models Suspension	14QK-415M	01-	83112	...
		14QK-415M7	01-	83112	...
		25624241	01-	83112	...
		60680-003	01-	83112	...
		60680-003L	01-	83112	...
02 - 08	Models with Hendrickson HMX 400/460 Haulmax with 16.5" Saddle	60680-004	01-	83143	...
		60680-004L	01-	83143	...
		H60680004	01-	83143	...
02 - 08	Models with Hendrickson HMX 400/460 Haulmax with 17.5" or 18.5" Saddle Height	60680-005	01-	83142	...
		60680-005L	01-	83142	...
		H60680005	01-	83142	...

APPLICATION GUIDE - TRUCKS, TRAILERS, AND BUSES

Year	Model	OEM #	Front		Rear	
						
					Fleetline	GasSLX

MACK(Cont'd.)





CX Series - Vision(Cont'd.)

	CX Vision Models w/ Hendrickson Air Suspension	14QK-431M		010	85061	89450
	CX Vision Models w/ Hendrickson HA Models Air Suspension	14QK-410M2		010	83137	...
		14QK-410M3		010	83125	...
		25625254		010	83125	...
	CX Vision Models w/ Hendrickson HN-2 Models Suspension	14QK-415M		01-	83112	...
		14QK-415M7		01-	83112	...
		25624241		01-	83112	...
		60680-003		01-	83112	...
		60680-003L		01-	83112	...
	CX Vision Models w/ Parabolic Spring	14QK-431M		010	85061	89450
	CX Vision Models with Neway AD Air Suspension Shock w/ extended length of 21.70"	14QK-414M		010	85906	89407
		90045099		010	85906	89407
	CX Vision Models with Neway AD Air Suspension Shock w/ extended length of 24.30"	14QK-414M2		010	85909	...
		25624351		010	85909	...
	CX Vision Models w/ ALV Hendrickson Suspension	14QK-413M5		01-	83138	...
		14QK-413M6		01-	83111	...
		25622221		01-	83111	...
		25625223		01-	83111	...
	CX Vision Models w/ MACK Air Suspension	14QK-3101M		010	85066	89448
		471700000431		010	85066	89448
		SDA471700000431		010	85066	89448
	Models with 12000 lb Taperleaf Front Suspension	14QK-392BM3	010	85005	89430	
	Models with HAS400 MACK Air Suspension	14QK-410M		010	83125	...
		25625234		010	83125	...
		47902-25		010	83125	...
	Models with Hendrickson Air Suspension (Stamping No. 57241-4)	14QK-413M4		01-	83110	...
		25624341		01-	83110	...
	Models with MAC AL405 Suspension	14QK-413M7		01-	83111	...
		25625223		01-	83111	...
		57241-006		01-	83111	...
		57241-006L		01-	83111	...
	Models with O.E.M. Number	141700000373	010	85061	89450	
		20513881	010	85061	89450	

CXN Series

05 - 07	CXN-613 Models w/ MACK Air Suspension	14QK-3101M		010	85066	89448
		SDA471700000431		010	85066	89448
11 - 14	CXN-613 Models with 12,000 - 14,600 lb Front Axles	141700005839	010	85098
		21436096	010	85098
	CXN-613 Models with 12,000 lb Front Axles	14QK-3114M	010	85061	89450	
		20973993	010	85061	89450	
		SDA141700000380	010	85061	89450	
08 - 10	CXN-613 Models with 40,000 lb Rear Air Suspensions	14QK-2136M		010	85061	89450
		20897198		010	85061	89450
11 - 14	CXN-613 Models with 40,000 lb Rear Air Suspensions	21462382		010	85088	...
		471700006039		010	85088	...
05 - 14	CXN-613 Models with Hendrickson 38,000 lb Rear Air Suspension	14QK-424M		010	83147	...
		20570098		010	83147	...
		60670-006		010	83147	...
		60670-006L		010	83147	...
	CXN-613 Models with Hendrickson AirTek Front Air Suspension	14QK-322M	010	85933	89454	
		14QK-422M	010	85933	89454	
		20485633	010	85933	89454	

APPLICATION GUIDE - TRUCKS, TRAILERS, AND BUSES

Year	Model	OEM #	Front		Rear	
						
			Fleetline	GasSLX	Fleetline	GasSLX

MACK(Cont'd.)

CXN Series(Cont'd.)

	CXN-613 Models with Hendrickson AirTek Front Air Suspension	64838-002	OIO	85933	89454	
	Models with O.E.M. Number	14QK-421M	OIO	85014
		471700000426	OIO	85014

CXP Series

06 - 07	CXP-613 Models with 12,000 lb Front Axles	14QK-3114M	OIO	85061	89450	
		20973993	OIO	85061	89450	
		SDA141700000380	OIO	85061	89450	
06 - 07	CXP-613 Models with 40,000 lb Rear Air Suspensions	14QK-2136M		OIO	85061	89450
		20897198		OIO	85061	89450
		471700002626		OIO	85061	89450

CXU - Pinnacle Series

11 - 18	CXU-613 Models with 12,000 - 14,600 lb Front Axles	141700005839	OIO	85098
		21436096	OIO	85098
08 - 10	CXU-613 Models with 12,000 lb Front Axles	141700000380	OIO	85061	89450	
		14QK-3114M	OIO	85061	89450	
		20973993	OIO	85061	89450	
		SDA141700000380	OIO	85061	89450	
08 - 10	CXU-613 Models with 40,000 lb Rear Air Suspensions	14QK-2136M		OIO	85061	89450
		20897198		OIO	85061	89450
		471700002626		OIO	85061	89450
11 - 18	CXU-613 Models with 40,000 lb Rear Air Suspensions	21462382		OIO	85088	...
		21462384		OIO	85088	...
		22202559		OIO	85088	...
		22202560		OIO	85088	...
		471700006039		OIO	85088	...
		471700009646		OIO	85088	...
		471700009647		OIO	85088	...

DM Series

	Models with O.E.M. Number	14QK-2100P8	OIO	83242
		25622345	OIO	83242





F Series

	F Models - Eastern	OIO	83221
	F Models (exc. Eastern)	OIO	83207	89407	OIO	83215	...
	F Models with Standard Suspension	OIO	85305	...
	Fire Truck		85302	...	OIO	85302	89420
	FL Models - Western	14QK-143	OIO	83207	89407	
		14QK-2100D-P4	OIO	83207	89407	

Granite Series

18 - 19	Granite 64BR & 64FR Models with 20,000 lb Front Axle	21010744	OIO	83101
18 - 19	Granite 64BR & 64FR Models with 46,000 lb Mack Mride Rear Suspension	21979343		OIO	85065	...
12 - 17	GU-432 or GU-533 Models with 12,000 lb or 14,600 lb Front Axle	14QK-434M	OIO	85014
		20998401	OIO	85014
12 - 18	GU-432 or GU-533 Models with 14,600 lb to 18,000 lb Multi-Leaf Front Springs	21010744	OIO	83101
12 - 18	GU-432 or GU-533 Models with Hendrickson HAS 400 or 460 Series Rear Suspension	60675-001		OIO	85978	...
		60675-001L		OIO	85978	...
		8083872		OIO	85978	...
	GU-713 or GU-813 Models O.E.M. Number	21687170	OIO	85120
08 - 19	GU-713 or GU-813 Models with 14,600 lb to 18,000 lb Multi-Leaf Front Springs	14QK-3116M	OIO	83101
		21010744	OIO	83101
08 - 10	GU-713 or GU-813 Models with 20,000 lb Front Axles	14QK-3108M	OIO	85080

APPLICATION GUIDE - TRUCKS, TRAILERS, AND BUSES

Year	Model	OEM #	Front		Rear	
						
			Fleetline	GasSLX	Fleetline	GasSLX

MACK(Cont'd.)

Granite Series(Cont'd.)

08 - 10	GU-713 or GU-813 Models with 20,000 lb Front Axles	14QK-427M 20863239 25626048 47170000445	○ -	85080
			○ -	85080
			○ -	85080
			○ -	85080
08 - 19	GU-713 or GU-813 Models with Hendrickson 38,000 lb Rear Air Suspension	14QK-424M 20570098 60670-006 60670-006L		○ ○	83147	...
				○ ○	83147	...
				○ ○	83147	...
				○ ○	83147	...
08 - 18	GU-713 or GU-813 Models with Hendrickson HAS 400 or 460 Series Rear Suspension	60675-001 60675-001L 8083872		○ ○	85978	...
				○ ○	85978	...
				○ ○	85978	...
08 - 18	GU-713 or GU-813 Models with Hendrickson HAS Series Rear Suspension	22314111 60675-13		○ ○	85036	89405
				○ ○	85036	89405
- 2019	Models with Hendrickson HMX 400/460 Haulmax with 16.5" Saddle	60680-004 60680-004L H60680004		○ -	83143	...
				○ -	83143	...
				○ -	83143	...
- 2019	Models with Hendrickson HMX 400/460 Haulmax with 17.5" or 18.5" Saddle Height	60680-005 60680-005L H60680005		○ -	83142	...
				○ -	83142	...
				○ -	83142	...
	Models with O.E.M. Number	21979343 471700008934		○ -	85065	...

LE & LEU Series

	LE & LEU 613 Models with Ridewell RD-202S HD Tandem Drive Truck Suspension	1252607B000		○ ○	85702	...
01 - 06	LE 613 Models with O.E.M Number	14QK-366P4 25625187	○ ○	83209	89414	
			○ ○	83209	89414	
2009	LEU 613 Models with 18,000 lb Front Axle	14QK-372M2 25632561	○ ○	83209	89414	
			○ ○	83209	89414	
10 - 16	LEU 613 Models with 20,000 lb Front Axle	21002497	○ ○	85972
	Models with Hendrickson HMX 400/460 Haulmax with 16.5" Saddle	60680-004 60680-004L H60680004		○ -	83143	...
				○ -	83143	...
				○ -	83143	...
	Models with Hendrickson HMX 400/460 Haulmax with 17.5" or 18.5" Saddle Height	60680-005 60680-005L H60680005		○ -	83142	...
				○ -	83142	...
				○ -	83142	...

MH Series

	MH Models - 4" Wide Springs	14QK-373 14QK-378M 25623321	○ ○	83215
			○ ○	83215
			○ ○	83215
	MH Models with Camelback Rear Suspension (SS34 & 38)	14QK-2107P1 14QK-2107P2 25625091		○ ○	83215	...
				○ ○	83215	...
				○ ○	83215	...
	MH Models with Neway ARD-234 Air Suspension	14QK-375M		○ ○	83123	89405
	MH Models with O.E.M. Number	14QK-2113P5 14QK-2133M 14QK-2133M2 14QK-377M 14QK-392AM 25622466	○ ○	85001	89410	
			○ ○	85001	89410	
			○ ○	85001	89410	
			○ ○	83215
			○ ○	85005	...	○ ○	85005	89430
	MH Models with Taperleaf Rear Suspension	14QK-2113P4		○ ○	85007	89412

APPLICATION GUIDE - TRUCKS, TRAILERS, AND BUSES

Year	Model	OEM #	Front			Rear		
			Fleetline	GasSLX				

MACK(Cont'd.)

MR Series(Cont'd.)

- 2019	MRU613 Models with 20,000 lb Front Axle	14QK-3115M 21002497	OIO	85972
			OIO	85972
	MRU613 Models with O.E.M. Number	14QK-366P4 25625187	OIO	83209	89414
			OIO	83209	89414
- 2019	MRU613 Models with O.E.M. Number	21979343 47170008934		OIO	85065
				OIO	85065

R Series

	R, RU, RD600 Models-3 1/2" Wide springs	14QK-366P1	OIO	85036	89405
	R, U Models	OIO	83221	...	OIO	83215
	R, U, RD 600 Models	14QK-2115 14QK-29302 25632147	OIO	85305
			OIO	83207	89407
			OIO	85305
	R, U, RD 600 Models/ MR600 Models with Front Taperleaf Springs	14QK-366 14QK-366P1 25625151	OIO	85036	89405
			OIO	85036	89405
			OIO	85036	89405
	RB 600 Models (Drive Axle)	14QK-2107 14QK-393M		OIO	83215
				OIO	85010
	RD Models with ST34 Suspension	14QK-2133M 25622466	OIO	85001	89410
			OIO	85001	89410
	RD800 Models with Shock Absorbers & Tapertleaf Suspension (SWT & SWTL 561)(ST-34)	14QK-2110	OIO	85305

RW Series

	RW Models - 4" Wide Springs	14QK-373 14QK-378M 25623321	OIO	83215	
			OIO	83215	
			OIO	83215	
	RW Models with Camelback Rear Suspension (SS34 & 38)	14QK-2107P1 14QK-2107P2 25625091		OIO	83215	
				OIO	83215	
				OIO	83215	
	RW Models with Neway ARD-234 Air Suspension	14QK-375M		OIO	83123	
	RW Models with O.E.M. Number	14QK-2113P5 14QK-2133M 14QK-2133M2 14QK-377M 14QK-392AM 25622466	OIO	85001	89410	
			OIO	85001	89410	
			OIO	85001	89410	
			OIO	83215	
			OIO	85005	...	OIO	85005	89430
			OIO	85001	89410	
	RW Models with Taperleaf Rear Suspension	14QK-2113P4		OIO	85007	





TD - Titan Series

08 - 10	TD-713 Models with 20,000 lb Front Axle	14QK-493M 21155033	OIO	83101
			OIO	83101
10 - 15	TD-713 Models with Hendrickson 38,000 lb Rear Air Suspension	14QK-424M 20570098 60670-006 60670-006L		OIO	83147
				OIO	83147
				OIO	83147
				OIO	83147
- 2016	TD-713 Models with Hendrickson 40,000 lb Pimaax EX and FireMaax EX Air Suspension	20782199 60657-007		OIO	85072
				OIO	85072
- 2017	TD-713 Models with Hendrickson HAS 400 or 460 Series Rear Suspension	60675-001 60675-001L 8083872		OIO	85978
				OIO	85978
				OIO	85978
- 2017	TD-713 Models with Hendrickson HAS Series Rear Suspension	22314111 60675-13		OIO	85036
				OIO	85036

TERRAPRO Series

2019	Models with 20,000 lb Front Axle	14QK-3115M	OIO	85972
------	----------------------------------	------------	-----	-------	-----	-----	-----

APPLICATION GUIDE - TRUCKS, TRAILERS, AND BUSES

Year	Model	OEM #	Front		Rear	
						
			Fleetline	GasSLX	Fleetline	GasSLX

MACK(Cont'd.)





TERRAPRO Series(Cont'd.)

2019	Models with 20,000 lb Front Axle	21002497	010	85972
Additional Applications								
	B Models	14QK-142		010	85305	...
	CF Fire Chassis	14QK-2102		010	85304	...
	CM 422 Tractor	14QK-390	-10	83105
		V10242320	-10	83105
	DM Models	010	83209	89414	010	83215	...
	MB Models	010	83221	...	010	83215	...
		14QK-2100P4	010	83207	89407	
	Model 75 Bogie Axle	010	83215	...
06 - 16	Models with Hendrickson 40,000 lb Primaax, Pimaax EX and FireMaax EX Air Suspension	60657-007		010	85072	...
	Models with Hendrickson AirTek Front Air Suspension	14QK-422M	010	85933	89454	
		20469001	010	85933	89454	
		20469002	010	85933	89454	
		20485632	010	85933	89454	
		20485633	010	85933	89454	
		471700131921	010	85933	89454	
		64838-002	010	85933	89454	
	Models with Hendrickson HAS-40LH Air Suspension (O.E. Number 57241-4)	14QK-413M4		01-	83110	...
	Models with Inverted Camelback Spring Suspension	14QK-142P1	010	83215
	Models with MAC AL405 Suspension	14QK-413M		01-	83111	...
	Models with Meritor AirLink Suspension	14QK-3100		010	85739	...
		446-51-211		010	85739	...
	Models with Neway Rear Suspension (With O.E.Stamping 90045099)	25633154		010	85906	89407
75 - 79	W Models - Western	010	83207	89407	010	83215	...

Additional O.E.M. Interchanges

	Models with O.E.M. Number	14QK-1200P4	010	83207	89407	
		14QK-140	010	85304
		14QK-142AP1	010	83215
		14QK-145	010	85307
		14QK-2100P2	010	83209	89414	
		14QK-2100P3	010	83207	89407	
		14QK-2100P5	010	83221
		14QK-2100P6	010	85036	89405	
		14QK-2100P7	010	83221
		14QK-2105	010	83209	89414	
		14QK-2107P3	010	83215
		14QK-2108	010	83203	89436	
		14QK-2108P1	010	83203	89436	
		14QK-2113P3	010	85001	89410	
		14QK-288-P1	010	85007	89412	
		14QK-29001P2	010	85303	89422	
		14QK-29301P1	010	83207	89407	
		14QK-29301P2	010	83207	89407	
		14QK-366P2	010	85036	89405	
		14QK-366P3	010	85036	89405	
		14QK-372M3	010	83122	89406	
		14QK-378	010	83215
		14QK-423M		010	85978	...
		14QK-428	01-	85080
		14QK-428M	01-	85080
		25621571	010	83215

APPLICATION GUIDE - TRUCKS, TRAILERS, AND BUSES

Year	Model	OEM #	Front		Rear	
						
			Fleetline	GasSLX	Fleetline	GasSLX

MACK(Cont'd.)

Additional O.E.M. Interchanges(Cont'd.)

	Models with O.E.M. Number	25626149	01-	85080
		471700000451	01-	85080
		57241-004		01-	83110	...
		5966-90044025	010	83209	89414	
		651103	010	85036	89405	
	Additional O.E.M. Interchanges	14QK-140P1	010	83225				
		14QK-20001P2	010	85308 or 89422				
		14QK-2100	010	83221				
		14QK-2100P1	010	83221				
		14QK-2110P1	010	85305				
		14QK-282P1	010	83216				
		14QK-282P3	010	83216				
		14QK-288P2	010	83217				
		14QK-29302P1	010	83207 or 89407				
		14QK-372M	010	83221				
		14QK-392M	010	85005 or 89430				
		25624365	010	83217				
		4940654	010	83216				
		5533699	010	85302 or 89420				
		5554184	010	85302 or 89420				
		650102	010	85001 or 89410				
		650107	-10	85316 or 89426				
		650107MT	-10	85316 or 89426				
		650400MT	-10	85033 or 89427				
		650402	-10	85311 or 89424				
		650402MT	-10	85311 or 89424				
		650404	-1-	85310 or 89423				
		650404MT	-1-	85310 or 89423				
		650405	010	85023 or 89415				
		650405MT	010	85023 or 89415				
		650406	010	85024				
		650408	-10	85319 or 89428				
650408MT	-10	85319 or 89428						
651012	010	83221						
651151	010	83209 or 89414						
70042	010	85302 or 89420						

MACK CAB SHOCKS

CH Series

	Models with O.E.M. Number	14QK-411	010	83007
		14QK-411AM	010	83007
		14QK-411M	010	83007
		25631922	010	83007





CHN - Series

05 - 07	CHN-613 Models with O.E.M. Number	14QK-3103M	01-	83050
		20874147	01-	83050

CHU - Pinnacle Series

- 2017	CHU-613 DayCab Models with O.E.M. Number	22662259	010	83901
- 2018	CHU-613 DayCab Models with O.E.M. Number	22662254	010	83901
- 2019	CHU-613 DayCab Models with O.E.M. Number	21490486	010	83066
- 2017	CHU-613 Models with Hi - Roof Sleeper Cabs with O.E.M. Number	25625636	01-	83045
- 2019	CHU-613 Models with O.E.M. Number	21345869	010	83066
		23145372	010	83066
08 - 19	CHU-613 Models with O.E.M. Number	14QK-303M	01-	83050

APPLICATION GUIDE - TRUCKS, TRAILERS, AND BUSES

Year	Model	OEM #	Front		Rear	
						
			Fleetline	GasSLX	Fleetline	GasSLX

MACK CAB SHOCKS(Cont'd.)

CHU - Pinnacle Series(Cont'd.)

08 - 19	CHU-613 Models with O.E.M. Number	14QK-3103M	01-	83050
		20874147	01-	83050

CL Series

	Models with O.E.M. Number	14QK-391AM	01-	83041
		14QK-391AM2	01-	83041

CT, CTX - Series

	Models with O.E.M. Number	14QK-303M	01-	83050
		14QK-3103M	01-	83050
		20874147	01-	83050

CX (Vision) Series

	Models with Sleeper Cabs w/O.E.M. Numbers	14QK-399M	01-	83045
		14QK-399M2	01-	83045
		14QK-399M3	01-	83045
		25625635	01-	83045
		25625636	01-	83045
		25625637	01-	83045

CXN Series

05 - 08	CXN-613 Models with O.E.M. Number	14QK-3103M	01-	83050
		20874147	01-	83050
	DayCab Models with O.E.M. Number	21345869	010	83066
- 2014	Models with Sleeper Cabs w/O.E.M. Numbers	25625635	01-	83045

CXP - Series

06 - 07	CXP-613 Day Cab Models	14QK-3103M	01-	83050
		20874147	01-	83050
06 - 07	CXP-613 Models with Sleeper Cabs	25625636	01-	83045

CXU - Pinnacle Series

2008 - 17	CXU-613 Models with Hi - Roof Sleeper Cabs with O.E.M. Number	25625636	01-	83045
2011 - 16	CXU-613 Models with Mid - Roof Sleeper Cabs with O.E.M. Number	25625635	01-	83045
	CXU-613 Models with O.E.M. Number	22662259	010	83901
- 2018	CXU-613 Models with O.E.M. Number	22662254	010	83901
- 2019	CXU-613 Models with O.E.M. Number	21345869	010	83066
		21490486	010	83066
		23145372	010	83066
08 - 11	CXU-613 Models with O.E.M. Number	14QK-303M	01-	83050
		14QK-3103M	01-	83050
		20874147	01-	83050









Granite Series

18 - 17	Granite 64BR & 64FR Models with O.E.M. Number	22662259	010	83901
12 - 17	GU 432 and GU 533 Models with O.E.M. Number	22662259	010	83901
08 - 17	GU 713 and GU 813 Models with O.E.M. Number	21345869	010	83066
		21490486	010	83066
		21490486	010	83066
		22662259	010	83901
08 - 18	GU 713 and GU 813 Models with O.E.M. Number	22662254	010	83901
08 - 19	GU 713 and GU 813 Models with O.E.M. Number	20873442	01-	83050
2008 -	GU 713 and GU 813 Models with O.E.M. Number	14QK-432M	01-	83050

R - Series

	R 600 Tractors with Link Cabmate Model MCR600	1201-0012	010	83023
		1202-0012	010	83023
	R, RD Models	14QK-382	01-	83018
		14QK-382-P2	01-	83018
	R, RD400 & 600 Models with Cab Air suspension	14QK-2111-P4	01-	83019
	RS & Superliner Tractors with Link Cabmate Model MCRS600	1201-0012	010	83023

APPLICATION GUIDE - TRUCKS, TRAILERS, AND BUSES

Year	Model	OEM #	Front		Rear	
						
						
			Fleetline	GasSLX	Fleetline	GasSLX

MACK CAB SHOCKS(Cont'd.)

R - Series(Cont'd.)

	RS & Superliner Tractors with Link Cabmate Model MCRS600	1202-0012	010		83023
--	--	-----------	-----	--	-------

TD - Titan Series

- 2017	TD - Titan Models with O.E.M. Number	14QK-440M	01-		83058
		21154397	01-		83058

Additional Applications

02 - 07	CV-713 Models with O.E.M number	14QK-391BM	01-		83041
	MH Models with Air Cab	14QK-374	-10		83003
		14QK-376	-10		83003
	Models with Link Cab Suspension	1202-0012	010		83023
		1202-0032	010		83016
	Models with O.E.M. Number	14QK-2111	01-		83019
		14QK-2111-P2	01-		83019
		14QK-391BM2	01-		83041
		14QK-391M	01-		83041
		14QK-391M2	01-		83041
		14QK-397AM	010		83905
		14QK-439M	01-		83050
		21154393	01-		83050
		21345868	010		83066
		25622373	010		83905
		25622612	01-		83041
		25622613	01-		83041
		25624837	01-		83041

MAECO

	Bus with O.E.M. Number	1668722		85030	...	010	85030	89440
	FedEx Trucks with O.E.M. Number	16950	010	83118
	UPS Trucks with O.E.M. Number	16949		01-	83120	...
	Additional O.E.M. Interchanges	1085	010				83214	
		12608	010				83125	
		12788	010				83216	
		12866	010				83207 or 89407	
		16385	010				83215	
		16720	010				83107	
		16767	010				85013 or 89414	
		16768	010				83217	
		16769	010				83221	
		16770	010				83209 or 89414	
		16771	010				83126 or 89430	
		16772	010				83122 or 89406	
		16773	010				85005 or 89430	
		16774	010				83215	
		16775	010				83207 or 89407	
		16776	010				83122 or 89406	
		16777	010				85006	
		16778	010				83203 or 89436	
		16779	010				83126 or 89440	
		16780	010				83123 or 89405	
		16781	010				85006	
		16787	010				85030 or 89440	
		6025	010				83122 or 89406	
		6026	010				83204	
		70018	010				85303 or 89422	
		70021	010				85303 or 89422	

APPLICATION GUIDE - TRUCKS, TRAILERS, AND BUSES

Year	Model	OEM #	Front		Rear	
			Fleetline	GasSLX	Fleetline	GasSLX

MAECO(Cont'd.)





	Additional O.E.M. Interchanges	70029	010	85308 or 89422
		70034	010	85302 or 89420
		70039	010	85303 or 89422
		70041	010	85305
		70042	010	85302 or 89420
		70088	010	85307
		70123	010	85716
		70127	010	85006 or 89401
		70128	010	85006 or 89401
		70162	010	85716
		70163	010	85302 or 89420
		70164	010	85716
		70300	010	85320 or 89429
		70312	010	85001 or 89410
		70315	010	85063
		70317	010	89432
		70331	010	85314 or 89425
		70332	010	83314
		70334	-10	85316 or 89426
		70397	010	85006
		70402	010	85305
		70642	010	85300 or 89419
		70644	010	85334
		70646	010	85313
		70648	010	89414
		70650	010	89440
		70651	010	85013 or 89414
		70652	010	85030 or 89440
		70663	010	85013 or 89414
		70691	010	85007 or 89412
		70720	010	85934
		70721	010	83125
		74039	010	85303 or 89422
		OE10881	-10	85711
OE10882	01-	85740		
OE10883	010	85339		
OE12425	010	83214		
SC-2920	010	83176		

MANDALAY COACH

Class A MotorHomes

04 - 06	Mandalay Series MotorHomes with Freightliner XC Chassis ADL200 Suspension w/ 20K Rear AS120 Front Suspension Rear Shock with O.E.M. Number ZF - IFS Front Suspension with 23,000 lb GVW or Greater	16-16873-000						
		010	85029	...		
		141700131810	010	83160		
		16-16737-000	010	83160		
		16-16874-000	010	83160		
		141700131809		010	85029	...
		16-16736-000		010	85029	...
		16-18103-000	-1-	85900	
481700000493	-1-	85900			
2006	Presidio & Valencia Series MotorHomes with Freightliner XC Chassis AS120 Front Suspension Rear Shock with O.E.M. Number	141700131810	010	83160		
		16-16737-000	010	83160		
		16-16874-000	010	83160		
		141700131809		010	85029	...

APPLICATION GUIDE - TRUCKS, TRAILERS, AND BUSES

Year	Model	OEM #	Front		Rear	
						
			Fleetline	GasSLX	Fleetline	GasSLX

MANDALAY COACH(Cont'd.)

Class A MotorHomes(Cont'd.)

2006	AS120 Front Suspension	16-16736-000		010	85029	...
	ZF - IFS Front Suspension with 23,000 lb GVW or Greater	16-18103-000	-1-	85900
		48170000493	-1-	85900

MARMON

Models with O.E.M. Number	1-7001	010	83216
	37-1-1	010	83122	89406	
	51-139-28		010	85003	89411
	51-163-7		010	83123	89405
	576451	010	83122	89406	
	665147	010	83216

MARMON CAB SHOCKS

1981 -	Conventional Tractors with Link Cabmate Model MARC57-B	1202-0054	010	83021			
--------	--	-----------	-----	-------	--	--	--





MATSON SCHOOL BUS

	Models with O.E.M. Number	5392387	010	85303	89422	
--	---------------------------	---------	-----	-------	-------	--	-----	-----

MC NEILUS TRUCK & MAN.

Mc Neilus part number	1139039 MTM	010	85334
	1139046 MTM		01-	83112	...
	1139059 MTM		010	83207	89407
	1139069 MTM		010	83209	89414
	12405FX1 MTM		85303	...	010	85303	89422
	1323106 MTM		010	85305	...
	1333575 MTM		010	85072	...
	1340975 MTM		01-	83142	...
	1340976 MTM	010	85919
	1340979 MTM		01-	83143	...
	1360386 MTM		010	85323	89436
	1367383 MTM		010	83147	...
	1396513 MTM	010	85959
	1398980 MTM		010	83127	...
	1404068 MTM		010	85980	...
	1404068 MTM		010	85087	...
	1410046 MTM	010	85919
	1411765 MTM		010	83148	...
	1412744 MTM		010	85966	...
	1429317 MTM	010	85919		
	1431085 MTM		010	85738	...
	1432386 MTM		010	85965	...
	1433009 MTM		010	85962	...
	1468783 MTM		010	85345	...
	1485576 MTM		010	85979	...
	1491909 MTM		010	83128	89436
	1KK552 MTM		010	85967	...
	2218640 MTM	010	83009		
	3215395 MTM		01-	83112	...
	3HR582 MTM		010	85013	89414
	3HR582 MTM		010	85013	89414
	3HR916 MTM		010	83207	89407
	4HA569 MTM	010	85932	89453	
4KP398 MTM	010	85933	89454		
5HA994 MTM		010	85916	89430	
5HB645 MTM		01-	83109	...	

APPLICATION GUIDE - TRUCKS, TRAILERS, AND BUSES

Year	Model	OEM #	Front		Rear	
						
			Fleetline	GasSLX	Fleetline	GasSLX

MC NEILUS TRUCK & MAN.(Cont'd.)

Mc Neilus part number	5KK247 MTM	01-	85977	...
	64442AX MTM	010	83128	89436
	6HA961 MTM	010	83123	89405
	6HB390 MTM	010	83137	...
	6HD720 MTM	010	85909	...
	6HS773 MTM	010	83122	89406
	6KP857 MTM	010	85000	89436
	7HS237 MTM	010	83122	89406
	7HS534 MTM	010	85906	89407
	8KK524 MTM	010	83168	...
	9HB362 MTM	010	85976	...
	9KK464 MTM	010	85079	...
	Models with O.E.M. Number	217330	010	85303 or 89422		

MERITOR

Air Link Suspensions with O.E.M. Number	14QK-3100	010	85739	...
	446-51-211	010	85739	...
AL460 Air Link Suspension	700115	010	85712	...
AL520 Air Link Suspension	700115	010	85712	...
RC S 9L Suspension	21228392	010	86201	...
	671500	010	86201	...
RFS 23T / 25T / 30T Trailer Air Suspensions	21227751	010	87015	...
	A-7805L-1026	010	87015	...

FlexAir 9NB Suspension

FlexAir 9NB Suspension with O.E.M. Number	21224745	010	86203	...
	21224778	010	86202	...
	671502	010	86202	...
	671503	010	86203	...

FS230 Trailer Suspension

FS230 Trailer Suspension (Light Duty)	680705	010	85737	...
	A-7805P-1030	010	85737	...
FS230 Trailer Suspension (Std Duty)	671507	010	87015	...
	A-7805L-1026	010	87015	...
FS230T	21227751	010	87015	...
	671020	010	87015	...
Meritor Kit 11210 includes washers and nuts (For Shock only)	KIT11210	010	87015	...

MTA 25T / MTA 30T Trailer Air Suspension

Meritor Kit 11375 includes other components (For Shock only)	KIT11375	010	86200	...
Meritor Kit 11376 includes other components (For Shock only)	KIT11376	010	86200	...
Meritor Kit 11389 includes other components (For Shock only)	KIT11389	010	86200	...
Meritor Kit 11402 includes other components (For Shock only)	KIT11402	010	86200	...
MTA 25T / MTA 30T Trailer Air Suspension	671506	010	86200	...
	7805-F-1020	010	86200	...
	A-7805F-1020	010	86200	...

RHP Trailer Suspension

1997 -	RHP11, RHP55 and RideSentry Trailer Suspension	202447	010	85919	...
		A-3280-M-9711	010	85919	...
2001 -	RHP11, RHP55 and RideSentry Trailer Suspension	671907	010	85919	...
		A-7805L-1000	010	85919	...

MITSUBISHI-FUSO

FE Series

07/86 -	FE434, FE439, FE444, FE450	MB025382	
		MB161497	010	G63299	...
96 - 97	FE639, FE639SP, FE639HDT	MC114595	010	G63405	...

APPLICATION GUIDE - TRUCKS, TRAILERS, AND BUSES

Year	Model	OEM #	Front			Rear		
			Fleetline	GasSLX		Fleetline	GasSLX	

MITSUBISHI-FUSO(Cont'd.)

FF Series(Cont'd.)

86 - 87	FF415	MC813511	- -	G63398
---------	-------	----------	-----	--------	-----	-----	-----	-----

FH Series

10/87 - 96	FH100 Suspension (All)	MC809390	- -	- -	83103	...
				MC826268	- o	G63610

FK Series

11/85 - 11/86	FK414	MC813511	- -	G63398
06/88 - 02/91	FK455	MC814614	- o	85009
03/91 - 06/93	FK457	MC814614	- o	85009

FM Series

06/88 - 02/91	FM555	MC814614	- o	85009
11/85 - 05/88	FM555	MC813135	- -	83456	89447
05/89 - 06/93	FM557	MC814614	- o	85009

MOHAWK

Additional O.E.M. Interchanges	01-0100-905	o o	85303 or 89422
	020273544	o o	83203 or 89436
	050134508	o o	85732
	10134504	o o	85715
	10134506	o o	85715
	10234503	o o	85715
	10234504	o o	85717
	1235233	o o	85736
	22012082	o o	85702
	22012114	o o	85700
	4968853	o o	83216
	6-367-7	o o	85305
	680323	o o	85700
	680485	o -	85733
	695195	- -	85707
	695196	- -	85707
	97-2201-00007	- o	85703
	97-2201-00011	o o	85704
	97-9999-02320	o o	85704
	MM-6886	o o	83207 or 89407
	MM-6957	o o	83225
	MM-74029	o o	85308 or 89422

MONACO

01 - 10	Monarch and LaPalma Models with W20 & W22 Workhorse Motorhome Chassis	24-186629	o o	85125
		F4-BE5-B492-HO	o o	85125
05 - 10	Monarch and LaPalma Models with W20 & W22 Workhorse Motorhome Chassis	24-153256		- -	85124	...
		F4-BE5-F325-HO		- -	85124	...
		W0005663		- -	85124	...
01 - 04	Monarch and LaPalma Models with W20 & W22 Workhorse Motorhome Chassis	24-186537		o -	85126	...
		F4-BE5-A011-HO		o -	85126	...
01 - 04	Vacationer Models with W20 & W22 Workhorse Motorhome Chassis	24-186629	o o	85125
		F4-BE5-B492-HO	o o	85125
		24-186537		o -	85126	...

APPLICATION GUIDE - TRUCKS, TRAILERS, AND BUSES

Year	Model	OEM #	Front		Rear	
			Fleetline	GasSLX	Fleetline	GasSLX

MONACO(Cont'd.)

01 - 04	Vacationer Models with W20 & W22 Workhorse Motorhome Chassis	F4-BE5-A011-HO		01-	85126	...
98 - 14	All Models with W20 & W22 Workhorse Motorhome Chassis	24-186629	010	85125
		F4-BE5-B492-HO	010	85125
95 - 99	MotorHomes with Freightliner XC Chassis (22,000 to 26,000 lb GVW)	010	83160	...	010	85029	...
	Models with Workhorse UFO Chassis with Hendrickson Softek Front Suspension	66153-002	010	83124	89407	
		F4-BE5-C832-MO	010	83124	89407	

Class A MotorHomes

90 - 97	Monarch and LaPalma Models with F53 Motorhome Chassis (7.5 L, Gas V8)	010	83209	89414	010	85097	...
99 - 14	Monarch and LaPalma Series MotorHomes with Ford F53 Chassis with 16,000 lb GVW to 22,000 lb GVW	1C34-18045-AA	010	83209	89414	
		1C34-18045-JA	010	83209	89414	
		9U94-18045-AA	010	83209	89414	
		9U94-18080-AA		010	83122	89406
		9U9Z-18124-A	010	83209	89414	
		9U9Z-18125-A		010	83122	89406
		ASH-1022	010	83209	89414	
		ASH-1023		010	83122	89406
		ASH-1205	010	83209	89414	
		ASH-1206		010	83122	89406
		ASH-1228	010	83209	89414	
		ASH-1229	010	83209	89414	
		ASH-1230		010	83122	89406
		ASH-137		010	83122	89406
		ASH-25822	010	83209	89414	
		ASH-25823	010	83209	89414	
ASH-25824		010	83122	89406		
ASH-294	010	83209	89414			
AT-620	010	83209	89414			
AT-621		010	83122	89406		
AT-766	010	83209	89414			

MOR-RYDE SUSPENSION

Bus Suspension	- -	83103	...
	U0109-006		010	G63866	...
Recreational Vehicle	U0109-014		- -	83400	...
	U0109-018		010	G63866	...
Trailer Rear	U0109-007		010	G63183	...

MOTOR COACH INDUSTRIES

Additional Applications

Drive Axle	12J-5-2		01-	85733	...
	12J-5-4		01-	85733	...
	12L-5-71		- -	85708	...
	T14-1081		01-	85729	...
Low Floor Bus Models with O.E.M. Number	12L-5-99		010	85339	...
MC5, MC7, MC8	12B-5-1		85735	...	010	85735	...
	3178157		85700	...	010	85700	...
	680323		85700	...	010	85700	...
RTS Bus with "V" Drive Rear	G1101590GS		010	85713	...
RTS Bus with Regular Rear	G1011822		010	85702	...
RTS Bus with Solid Front Axle	22024673	- 0	85710
Steering - Tag Axle	12L-4-170		010	83158	...
	654789		010	83158	...

APPLICATION GUIDE - TRUCKS, TRAILERS, AND BUSES

Year	Model	OEM #	Front		Rear	
			Fleetline	GasSLX	Fleetline	GasSLX

MOTOR COACH INDUSTRIES(Cont'd.)





Additional Applications(Cont'd.)

	Tag Axle	12-05-6068		- -	85727	...
		12J-5-11		0 0	85313	...
		12J-5-3		0 0	85313	...
		T14-1082		- -	85727	...

D - Series Coaches

	D 4000 Coach (Drive Axle)	12-05-1177		0 -	85729	...
		12-05-1261		0 -	85729	...
		12-05-1328		0 -	85729	...
	(Front Axle)	12-05-1176	- -	85728
		12-05-1260	- -	85728
		12-05-1327	- -	85728
	(Trailing Axle)	12L-5-97	- -	85728
		12-05-1178		0 0	85339	...
		12-05-1194		0 0	85339	...
12L-5-99			0 0	85339	...	
	D 4005 Coach (Drive Axle)	12-05-1177		0 -	85729	...
		12-05-1261		0 -	85729	...
		12-05-1328		0 -	85729	...
	(Front Axle)	12-05-1176	- -	85728
		12-05-1260	- -	85728
		12-05-1327	- -	85728
	(Trailing Axle)	12L-5-97	- -	85728
		12-05-1194		0 0	85339	...
		12L-5-99		0 0	85339	...
			0 0	85339	...	
	D 4500 Coach (Drive Axle)	12-05-1177		0 -	85729	...
		12-05-1328		0 -	85729	...
		12L-5-88		0 -	85729	...
	(Front Axle)	85729		0 -	85729	...
		12-05-1176	- -	85728
		12-05-1327	- -	85728
	(Trailing Axle)	12L-5-67	- -	85728
		12-05-1179		- -	85727	...
		12-05-1262		- -	85727	...
		12-05-1264		- -	85727	...
		12-05-1329		- -	85727	...
12L-5-114		- -	85727	...		
	D 4505 Coach (Drive Axle)	12-05-1177		0 -	85729	...
		12-05-1328		0 -	85729	...
		12L-5-88		0 -	85729	...
	(Front Axle)	12-05-1176	- -	85728
		12-05-1327	- -	85728
		12L-5-67	- -	85728
	(Trailing Axle)	12-05-1179		- -	85727	...
		12-05-1262		- -	85727	...
		12-05-1264		- -	85727	...
		12-05-1329		- -	85727	...
		12L-5-114		- -	85727	...
	DL3 Bus	12-05-1327		-	-			-
		12-05-1328		0 -	85729	...
		12L-5-88		0 -	85729	...

APPLICATION GUIDE - TRUCKS, TRAILERS, AND BUSES

Year	Model	OEM #	Front		Rear	
			 Fleetline	 GasSLX	 Fleetline	 GasSLX

MOTOR COACH INDUSTRIES(Cont'd.)

D - Series Coaches(Cont'd.)

DL3 Bus	12L-5-89		01-	85729	...
	12L-5-96	-1-	85728
	12L-5-97	-1-	85728
DL3 Bus -Drive Axle	12J-5-10		01-	85733	...
DL3 Bus -Tag Axle	01-205219		-1-	85727	...
	12-05-1262		-1-	85727	...
	12-05-1264		-1-	85727	...
	12-05-1329		-1-	85727	...
	12L-5-100		-1-	85727	...
	12L-5-114		-1-	85727	...
	T12-1208		-1-	85727	...

E - Series Coaches

E 4500 Coach (Drive Axle)	12-05-1022		01-	85970	...	
	12-05-1102		01-	85970	...	
	12-05-1138		01-	85970	...	
	12-05-1148		01-	85970	...	
	12-05-1188		01-	85970	...	
	(Front Axle)	12-05-1150	-10	85711	
	(Trailing Axle)	12-05-1165	-10	85711	
		12-05-1139		01-	85341	...
		12-05-1147		01-	85341	...
		12-05-1166		01-	85341	...

G - Series Coaches

G 4500 Coach Drive Axle	12-05-6001		01-	85740	...	
	12-05-6054		01-	85740	...	
	Front Axle	12-05-6000	-10	85711	
		12-05-6053	-10	85711	
		1497835	-10	85711	
	Tag Axle	1498565		010	85339	...
	Trailing Axle	12-05-6002		010	85339	...
		12-05-6033		010	85339	...
		12-05-6055		010	85339	...





J - Series Coaches

J 4500 Coach (Drive Axle)	12-05-1022		01-	85970	...	
	12-05-1138		01-	85970	...	
	12-05-1148		01-	85970	...	
	12-05-1188		01-	85970	...	
	(Front Axle with OEM Number)	12-05-1137	01-	85340	
		12-05-1142	01-	85340	
		12-05-1146	01-	85340	
		12-05-1150	-10	85711	
		12-05-1165	-10	85711	
	(Trailing Axle)	12-05-1228	-10	85711	
		12-05-1139		01-	85341	...
		12-05-1147		01-	85341	...
		12-05-1166		01-	85341	...

Additional O.E.M. Interchanges

Models with O.E.M. Number	12-05-1021	01-	85340
	12-05-1023		01-	85341
	12-05-1101	01-	85340
	12-05-1103		01-	85341

APPLICATION GUIDE - TRUCKS, TRAILERS, AND BUSES









Year	Model	OEM #	Front		Rear	
						
			Fleetline	GasSLX	Fleetline	GasSLX

MOTOR COACH INDUSTRIES(Cont'd.)

Additional O.E.M. Interchanges(Cont'd.)

Year	Model	OEM #	Front	Rear
	Models with O.E.M. Number	12-05-1170	01- 85340
		12-05-1199	01- 85729
		12-05-1242	-1- 85728
		12-05-1243	01- 85729
		12-05-1244	-1- 85727
		12-5-1-G	010 85700
		12-5-1-GS	010 85700
		12B-5-1-G	010 85700
		12B-5-1-GS	010 85700
		12J-5-10GS	01- 85733
		12L-5-58	-1- 85728
		12L-5-69	010 85700
		12L-5-98	010 85339
		12T-1-13	85303	010 85303 89422
		12TA-01-013	85303	010 85303 89422
		1498200	01- 85740
		22012067	010 85700
		22024061	010 85704
		22045526	010 85702
		22046485	-10 85710
		3178154	010 85735
		5316984	85313	010 85313
		63-0127GS	85303	010 85303 89422
		680231	010 85313
		680232	01- 85733
		680322	010 85704
		680323	010 85700
		680350	-10 85710
		680369	-1- 85708
		680374	-1- 85728
		680441	01- 85729
		680452	010 85339
		680462	-1- 85728
		680470	010 85713
		680482	-1- 85727
		680485	01- 85733
		680544	-10 85711
		680546	010 85339
		680602	010 85339
		680677	-1- 85728
		680680	01- 85729
		680681	-1- 85727
		695125	010 85704
		97-9999-02585	01- 85723
		G1101590	010 85713
		G1201338	-10 85710
		G1201339	010 85702
		G5008069	010 85700
		OE10086S	010 85702
		OE10881	-10 85711
		OE10882	01- 85740
		OE10883	010 85339
		T14-1045GS	010 85700
		T14-1048	010 85302 89420
		T14-1080	-1- 85728

APPLICATION GUIDE - TRUCKS, TRAILERS, AND BUSES

Year	Model	OEM #	Front		Rear	
						
						
			Fleetline	GasSLX	Fleetline	GasSLX

MOTOR COACH INDUSTRIES(Cont'd.)

Additional O.E.M. Interchanges(Cont'd.)

	Additional O.E.M. Interchanges	12G-5-1	010		85700
		12J-5-6	010		85313
		12J-5-7	01-		85733
		12J-5-71	01-		85733
		12J-5-9	010		85700
		12L-5-70	010		85700
		12L-5-72	010		85709
		22012066	-1-		85707
		22052014	010		85702
		6314933	-1-		85708
		680333	-1-		85708
		690029	010		85700
		97-2201-00151	010		85700
		97-2210-00164	-1-		85708
		97-9999-02514	010		85700
		97-9999-02634	01-		85733

MUNCIE RECLAMATION

Additional O.E.M. Interchanges

	Models with O.E.M. Number	665459			
		665568	
		H53-20415-006		010	89447
		MR6394	01-	010	85051
				85723	...
	Additional O.E.M. Interchanges	665569	010		85045
		680334	-1-		85709
		97-2210-00164	-1-		85708
		H53-21144-004	010		85045
		MR1623	010		85700
		MR1710	010		85713
		MR1751	010		85713
		MR1763	010		85300 or 89419
		MR1765	010		85713
		MR25767	010		85702
		MR2960	010		85702
		MR2996	010		85704
		MR2997	-10		85703
		MR3303	-1-		85709
		MR3304	-10		85710
		MR3304H	-1-		85709
		MR3306	-1-		85705 or 89447
		MR3307	-1-		85707
		MR3650	-1-		85707
		MR6535	-1-		85708
		MR6536	-1-		85722
		MR7388	-10		85710

NATIONAL COACH CORP





	Eldorado Coach RE-29	C800853	010	83207	89407	
--	----------------------	---------	-----	-------	-------	--	-----	-----

NATIONAL RV INC.

Class A MotorHomes

99 - 08	Models with Ford F53 Chassis with 16,000 lb GVW to 22,000 lb GVW	1C34-18045-AA	010	83209	89414	
		1C34-18045-JA	010	83209	89414	
		9U94-18045-AA	010	83209	89414	

APPLICATION GUIDE - TRUCKS, TRAILERS, AND BUSES

Year	Model	OEM #	Front		Rear	
						
			Fleetline	GasSLX	Fleetline	GasSLX

NATIONAL RV INC.(Cont'd.)

Class A MotorHomes(Cont'd.)

99 - 08	Models with Ford F53 Chassis with 16,000 lb GVW to 22,000 lb GVW	9U94-18080-AA		010	83122	89406
		9U9Z-18124-A	010	83209	89414	
		9U9Z-18125-A		010	83122	89406
		ASH-1022	010	83209	89414	
		ASH-1023		010	83122	89406
		ASH-1205	010	83209	89414	
		ASH-1206		010	83122	89406
		ASH-1228	010	83209	89414	
		ASH-1229	010	83209	89414	
		ASH-1230		010	83122	89406
		ASH-137		010	83122	89406
		ASH-25822	010	83209	89414	
		ASH-25823	010	83209	89414	
		ASH-25824		010	83122	89406
		ASH-294	010	83209	89414	
		AT-620	010	83209	89414	
		AT-621		010	83122	89406
AT-766	010	83209	89414			
05 - 08	Models with Workhorse W20 , W22, & W24 MotorHome Chassis with O.E.M. Number	24-153256		-1-	85124	...
		F4-BE5-F325-HO		-1-	85124	...
		W0005663		-1-	85124	...
98 - 04	Models with Workhorse W20 , W22, & W24 MotorHome Chassis with O.E.M. Number	24-186537		01-	85126	...
		F4-BE5-A011-HO		01-	85126	...
98 - 08	Models with Workhorse W20 , W22, & W24 MotorHome Chassis with O.E.M. Number	24-153249	010	85125
		24-186629	010	85125
		F4-BE5-A832-MO	010	85125
		F4-BE5-B492-HO	010	85125
		F4-BE5-F324-HO	010	85125
		W0005662	010	85125
		W0006254	010	85125









NAVISTAR - SEE INTERNATIONAL (NAVISTAR)

--	--	--	--	--	--	--	--	--

NEOPLAN BUS

	Mini-Bus	24-1700-106-149		010	83216	...
		24-1700-999-362	-10	85009
		BN1002002	-10	85009
		BT1002011		010	83216	...
	Model 40	25-1700-101-426		85705	...	-1-	85705	89447
		DT1002002		85707	...	-1-	85707	...
	Model 80B	CL1002003		85705	...	-1-	85705	89447
		DZ1002002		85705	...	-1-	85705	89447
	Models with O.E.M. Number	680307		85705	...	-1-	85705	89447
		680308		85706	...	-1-	85706	...
		AA1002002		85705	...	-1-	85705	89447
		AA1002003		85705	...	-1-	85705	89447
		AA1802002		85705	...	-1-	85705	89447
		AC1002002		85705	...	-1-	85705	89447
		AC1002002GS		85705	...	-1-	85705	89447
		AC1002003		85705	...	-1-	85705	89447
		DT1802002		85705	...	-1-	85705	89447

APPLICATION GUIDE - TRUCKS, TRAILERS, AND BUSES

Year	Model	OEM #	Front		Rear	
						
						
			Fleetline	GasSLX	Fleetline	GasSLX

NEOPLAN BUS(Cont'd.)

	Models with O.E.M. Number	GJ1002002		85706	...	- -	85706	...
		GJ1002003		85705	...	- -	85705	89447
		MM1002002		85705	...	- -	85705	89447
		MM1002003		85705	...	- -	85705	89447
	Additional O.E.M. Interchanges	97-9999-02519	- -	85707				
		CI 1002003	- -	85705 or 89447				

NEW FLYER

	Diesel Low Floor Coach	015813		- -	85708	...
01 - 11	Transit Buses (Low Profile) with O.E.M. Number	203398	- -	85346
		204428		- -	85347	...
1991 -	Transit Buses (Low Profile) with O.E.M. Number	009863	- -	85722
		016415	- -	85722
		680346	- -	85722
2002 -	Transit Buses (Low Profile) with O.E.M. Number	152959		- -	85708	...
		680671		- -	85708	...
	Models with O.E.M. Number	69536140Y	- 0	87016
		G1011823	- 0	85710
	Additional O.E.M. Interchanges	015915	- 0	85711				
		064845	- 0	85711				
		68027440Y	0 0	85716				
		68035041Y	- 0	85710				
		680352	- 0	85711				
		68037840B	0 0	85720				
		68050440X	0 0	85716				
		68050640Y	0 0	85732				
		690102	- 0	85711				
		69536640Y	0 0	85732				
		97-2210-00164	- -	85708				

NEWAY (HOLLAND) SUSPENSION SYSTEMS - SEE SAF HOLLAND





Refer to SAF Holland Section for application information

NEWMAR CORP

Class A MotorHomes

13 - 19	Bay Star, Bay Star Sport & Canyon Star Series MotorHomes with Ford F53 Chassis with 16,000 lb GVW to 22,000 lb GVW	ASH-1229	0 0	83209	89414	
		ASH-25822	0 0	83209	89414	
		ASH-25823	0 0	83209	89414	
		ASH-25824		0 0	83122	89406
02 - 04	Dutch Star & Moundain Aire Series MotorHomes with Freightliner XC Chassis	AS120 Front Suspension						
		141700131810	0 0	83160
		16-16737-000	0 0	83160
		16-16874-000	0 0	83160
		Rear Shock with O.E.M. Number						
		141700131809		0 0	85029	...
		16-16736-000		0 0	85029	...
ZF - IFS Front Suspension with 23,000 lb GVW or Greater		- -	85900	
481700000493	- -	85900		
02 - 05	Kountry Star Series MotorHomes with Freightliner XC Chassis	AS120 Front Suspension						
		141700131810	0 0	83160
		16-16737-000	0 0	83160
		16-16874-000	0 0	83160
		Rear Shock with O.E.M. Number						
		141700131809		0 0	85029	...
16-16736-000		0 0	85029	...		
ZF - IFS Front Suspension with 23,000 lb GVW or Greater		- -	85900	

APPLICATION GUIDE - TRUCKS, TRAILERS, AND BUSES

Year	Model	OEM #	Front		Rear	
			 Fleetline	 GasSLX	 Fleetline	 GasSLX

NEWMAR CORP(Cont'd.)

Class A MotorHomes(Cont'd.)

02 - 05	AS120 Front Suspension	48170000493	- -	85900	
2006	Ventana Series MotorHomes with Freightliner XC Chassis AS120 Front Suspension	141700131810	0 0	83160	
		16-16737-000	0 0	83160	
		16-16874-000	0 0	83160	
		Rear Shock with O.E.M. Number	141700131809		0 0	85029	...
		16-16736-000			0 0	85029	...
		ZF - IFS Front Suspension with 23,000 lb GVW or Greater	16-18103-000	- -	85900
		48170000493	- -	85900	

NEXUS RV

Class A MotorHomes

16 - 19	Maybach Series MotorHomes with Ford F53 Chassis with 16,000 lb GVW to 22,000 lb GVW	ASH-1229	0 0	83209	89414	
		ASH-25822	0 0	83209	89414	
		ASH-25823	0 0	83209	89414	
		ASH-25824		0 0	83122	89406

Class C MotorHomes

11 - 19	Phantom Series MotorHomes with Ford E350 & E450 Chassis	ASH-1136		- 0	83178	...
		ASH-1154	- 0	83177
11 - 12	Scenic Traveler Series MotorHomes with Ford E450 Chassis	ASH-1136		- 0	83178	...
		ASH-1154	- 0	83177
12 - 19	Viper Series MotorHomes with Ford E350 & E450 Chassis	ASH-1136		- 0	83178	...
		ASH-1154	- 0	83177

NISSAN

UD 1200 Series

99 - 04	U D 1200 Models with O.E.M. Number	561000T825	- 0	83515
		E61000T825	- 0	83515

UD 1300 Series

05 - 07	U D 1300 Models with O.E.M. Number	561000T825	- 0	83515
		E61000T825	- 0	83515
	UD 1300 Models Steer Axle	56110-T8123	- 0	G63432
		56110-T8129	- 0	G63432
		66400	- 0	G63432

UD 1400 Series

94 - 10	U D 1400 Models with O.E.M. Number	561000T825	- 0	83515
		E61000T825	- 0	83515





UD 1800 Series

11 - 13	Models with 19.5" Tires	56101-30Z01	- 0	83161
		56110-30Z01	- 0	83161
95 - 98	Models with 19.5" Tires	56101-30Z01	- 0	83161
		56110-30Z01	- 0	83161
11 - 13	Models with 22.5" Tires	56101-30Z02	0 -	G63610
		56110-30Z02	0 -	G63610
95 - 98	Models with 22.5" Tires	56101-30Z02	0 -	G63610
		56110-30Z02	0 -	G63610
89 - 94	Models with O.E.M. Number	56101-Z5008	- 0	83114
		56110-Z5008	- 0	83114

UD 18CS Series

05 - 10	Models with 19.5" Tires	56101-30Z01	- 0	83161
		56110-30Z01	- 0	83161
99 - 04	Models with O.E.M. Number	56101-Z5008	- 0	83114
		56110-Z5008	- 0	83114

APPLICATION GUIDE - TRUCKS, TRAILERS, AND BUSES

Year	Model	OEM #	Front		Rear	
						
			Fleetline	GasSLX	Fleetline	GasSLX

NISSAN(Cont'd.)

UD 18CS Series(Cont'd.)

99 - 04	Models with O.E.M. Number	56201-Z5001		- -	85085	...
		56210-Z5001		- -	85085	...

UD 18HD Series

99 - 10	Models with 19.5" Tires	56101-30Z01	- 0	83161
		56110-30Z01	- 0	83161
99 - 10	Models with 22.5" Tires	56101-30Z02	0 -	G63610
		56110-30Z02	0 -	G63610

UD 2000 Series

95 - 13	Models with 19.5" Tires	56101-30Z01	- 0	83161
		56110-30Z01	- 0	83161
	Models with 22.5" Tires	56110-Z5011	- 0	G63610
95 - 13	Models with 22.5" Tires	56101-30Z02	0 -	G63610
		56110-30Z02	0 -	G63610
89 - 94	U D 2000 Models with O.E.M. Number	56101-Z5008	- 0	83114
		56110-Z5008	- 0	83114

UD 23DH Series

95 - 13	Models with 19.5" Tires	56101-30Z01	- 0	83161
		56110-30Z01	- 0	83161
95 - 13	Models with 22.5" Tires	56101-30Z02	0 -	G63610
		56110-30Z02	0 -	G63610

UD 23LP Series

95 - 13	Models with 19.5" Tires	56101-30Z01	- 0	83161
		56110-30Z01	- 0	83161
95 - 13	Models with 22.5" Tires	56101-30Z02	0 -	G63610
		56110-30Z02	0 -	G63610

UD 2600 Series

89 - 13	U D 2600 Models with O.E.M. Number	56101-Z5014	- 0	83162
		56101-Z5017	- 0	83162
		56110-Z5014	- 0	83162
		56110-Z5017	- 0	83162
92 - 94	U D 2600 Models with O.E.M. Number	56201-Z5001		- -	85085	...
		56210-Z5001		- -	85085	...

UD 2800 Series

89 - 94	U D 2800 Models with O.E.M. Number	56101-Z5014	- 0	83162
		56101-Z5017	- 0	83162
		56110-Z5014	- 0	83162
		56110-Z5017	- 0	83162
92 - 94	U D 2800 Models with O.E.M. Number	56201-Z5001		- -	85085	...
		56210-Z5001		- -	85085	...

UD 3000 Series

89 - 91	U D 3000 Models with O.E.M. Number	56101-Z5014	- 0	83162
		56101-Z5017	- 0	83162
		56110-Z5014	- 0	83162
		56110-Z5017	- 0	83162
95 - 00	U D 3000 Models with O.E.M. Number	56101-Z5014	- 0	83162
		56101-Z5017	- 0	83162
		56110-Z5014	- 0	83162
		56110-Z5017	- 0	83162
89 - 94	U D 3300 Models with O.E.M. Number	56101-Z5014	- 0	83162
		56101-Z5017	- 0	83162
		56110-Z5014	- 0	83162
		56110-Z5017	- 0	83162
92 - 94	U D 3300 Models with O.E.M. Number	56201-Z5001		- -	85085	...
		56210-Z5001		- -	85085	...

APPLICATION GUIDE - TRUCKS, TRAILERS, AND BUSES

Year	Model	OEM #	Front			Rear		
			Fleetline	GasSLX				

NISSAN(Cont'd.)

UD 3000 Series(Cont'd.)

99 - 13	U D 3300 Models with O.E.M. Number	56101-Z5014	-10	83162
		56101-Z5017	-10	83162
		56110-Z5014	-10	83162
		56110-Z5017	-10	83162
		56201-Z5001		-1-	85085	...
		56210-Z5001		-1-	85085	...





Additional Applications

92 - 94	30HD Models with O.E.M. Number	56101-Z5014	-10	83162
		56101-Z5017	-10	83162
		56110-Z5014	-10	83162
		56110-Z5017	-10	83162
		56201-Z5001		-1-	85085	...
		56210-Z5001		-1-	85085	...
92 - 94	30SD Models with O.E.M. Number	56101-Z5014	-10	83162
		56101-Z5017	-10	83162
		56110-Z5014	-10	83162
		56110-Z5017	-10	83162
		56201-Z5001		-1-	85085	...
		56210-Z5001		-1-	85085	...
89 - 91	500T Models with O.E.M. Number	56101-Z5014	-10	83162
		56101-Z5017	-10	83162
		56110-Z5014	-10	83162
		56110-Z5017	-10	83162
92 - 94	600T Models with O.E.M. Number	56101-Z5014	-10	83162
		56101-Z5017	-10	83162
		56110-Z5014	-10	83162
		56110-Z5017	-10	83162
		56201-Z5001		-1-	85085	...
		56210-Z5001		-1-	85085	...

NOVA BUS

	Classic Bus with O.E.M. Number	97-2201-00151		85700	...	010	85700	...
	Low Floor Bus Models with O.E.M. Number	481700131250	010	85377
		481700131252		010	85378	...
		680480	010	85377
		695393	010	85377
		N16248	010	85377
		N16249		010	85378	...
		N21543		010	85378	...
		N31830		010	85378	...
		N31831	010	85377
			RTS Bus	22045526		010
22052014				010	85702	...
G1011822				010	85702	...
G1203223				010	85702	...
G1205763	010			87019
G1205763-001	010			87019
OE 10086S				010	85702	...
	RTS Bus with "V" Drive	G1011823	-10	85710
		G1101590		010	85713	...
	RTS Bus with Solid Front Axle	22024673	-10	85710
	Models with O.E.M. Number	12J-5-10		01-	85733	...
		12J-5-11		010	85313	...
		680231		010	85313	...

APPLICATION GUIDE - TRUCKS, TRAILERS, AND BUSES

Year	Model	OEM #	Front		Rear	
						
			Fleetline	GasSLX	Fleetline	GasSLX

NOVA BUS(Cont'd.)

	Models with O.E.M. Number	680232		01-	85733	...
		680323	010	85700
		680326	010	85700
		680470		010	85713	...
		680481		010	85378	...
		G1201338	-10	85710
		G1201339		010	85702	...
		G5008070	010	85700
		N22212	010	85700
		Additional O.E.M. Interchanges		97-9999-02514	010	85700		

OLE GRANNING

	Models with O.E.M. Number	1086	010	83217
--	---------------------------	------	-----	-------	-----	--	-----	-----

ONEIDA PRODUCTS

	School Bus w/Heavy Duty Suspension		85307	...	010	85307	...
	School Bus w/Standard Suspension		83216	...	010	83216	...





OPTIMA BUS CORP

	Buses with Ridewell RAS - 227 Models Steer Axle Air Suspension w/ O.E.M. Number	1260008		010	87017	...
		90-2610-SP1		010	87017	...

ORION BUS INDUSTRIES

	Orion 1	010134505-4	010	85715
		010134509	010	85717
		010234503-4		010	85308	89422
		010234506		010	85715	...
	Orion 102	050134501-4	010	85716
		050230501		010	85716	...
		050231505		010	85716	...
		680504		010	85716	...
	Orion II	010134505-4	010	85715
		010234503-4		010	85308	89422
		020117504	010	85720
		020273541	010	83203	89436	
		020273541-4		010	85000	89436
		020273544	010	83203	89436	
		20117501	010	85720
		20117503	010	85720
		20117504	010	85720
		20117505	010	85720
	Orion V	010134508-4	010	85732
		050134502-4	010	85732
		050134506-4	010	85732
		050134509	010	85732
		050134510	010	85732
		050134513	010	85732
		050231505		010	85716	...
		680504		010	85716	...
		695347	010	85732
	Orion VI (Low Floor)	060231508	010	85717
	Orion VI (M Axle) with O.E.M. Number	060131507	-10	87016
		060131508	-10	87016
	Orion VII - 30 ft Rear	070231527		01-	85729	...
	Orion VII with O.E.M. Number	070131502	-10	87016

APPLICATION GUIDE - TRUCKS, TRAILERS, AND BUSES

Year	Model	OEM #	Front		Rear	
						
			Fleetline	GasSLX	Fleetline	GasSLX





ORION BUS INDUSTRIES(Cont'd.)

	Orion VII with O.E.M. Number	070131506 070231514	-10	87016
				01-	85729	...
	Models with O.E.M. Number	680271 680274 680328 680378 695327 695343 695366 695389 695420 695421 695440		010	85715	...
				010	85716	...
			010	85717
			010	85720
			010	85732
			010	85732
			010	85732
			010	85732
			-10	87016
				01-	85729	...
			-10	87016
				01-	85729	...
	Additional O.E.M. Interchanges	010134501-4 010134504-4 010134506-4 050134508 0501345-11 050231502-4 050231507 680091 680102 680352 680501 680502 680505 680506 690102 97-9999-02635 97-9999-02636 A-4890 OB020570 OB020764 OB3166657	010 010 010 010 010 010 010 010 010 -10 010 010 010 010 010 010 010 010 010 -10 010 010 010				85307 85715 85717 85732 85732 85716 85716 85303 or 89422 85712 85711 85715 85715 85717 85732 85711 85732 85716 85712 85711 85716 85716	

OSHKOSH MOTORS

	Mobile Home - ForeTravel	1583470		010	85051	...
	Models with 16" Long Shock Absorber w/1" Mounting Pins	010	85303	89422	
	Models with 3/4" Mounting Pins	010	83122	89406	
	Models with Neway Air Suspension	90044448		010	85051	...
	Motor Homes with O.E.M. Number	1398980 GBL654875 RW24285		83127	...	010	83127	...
				010	83117	...
			010	83119
	V - Line Coach	1573280		010	83221	...
	Models with O.E.M. Number	12405F 12405F-1 1583470 3638112 4036892 5353054 5361994 651444 665040 690049 GBL654918	010 010 010 010 010 010 010 010 010 010 010 010	85734 85303 G63605 85303 85734 ... 85303 85303 83118	... 89422 89422 89422 89422 ...	010 010 010 010 010 010 010 010 010 010 010	85051 G63183 83221

APPLICATION GUIDE - TRUCKS, TRAILERS, AND BUSES

Year	Model	OEM #	Front		Rear	
			 Fleetline	 GasSLX	 Fleetline	 GasSLX

OSHKOSH MOTORS(Cont'd.)

	Models with O.E.M. Number	P117099		OI-	83120	...
		P117146	OIO	83118
	Additional O.E.M. Interchanges	12405FX1	OIO	85303 or 89422				
		1445910	OIO	85300 or 89419				
		1573270	OIO	83207 or 89407				
		1745500	OIO	89430				
		2173340	OIO	85303 or 89422				
		26228-A	OIO	83122 or 89406				
		2JD137	OIO	83119				
		40-0242	OIO	83312 or 89409				
		40-4845	OIO	85304				
		40-4951	-IO	85316 or 89426				
		40-5348	OIO	85058 or 89431				
		40-6967	OIO	85030 or 89440				
		665060	OIO	83122 or 89406				

OSHKOSH MOTORS CAB SHOCKS

	Models with Link Cabmate Model OKTP with O.E.M. Number	1202-0054	OIO	83021				
	Models with O.E.M. Number	2218640	OIO	83009				

OSTERLUND TRUCK

	Models with O.E.M. Number	59011	OIO	83214
		680117	OIO	85300	89419	
	Additional O.E.M. Interchanges	220-S5-10		OIO	85712	...

OTTAWA TRUCK

	Yard Tractor	59009		83217	...	OIO	83217	...
	Models with O.E.M. Number	59011	OIO	83214
		680117	OIO	85300	89419	
	Additional O.E.M. Interchanges	53540451	OIO	85300 or 89419				
		90013787	-I-	85310 or 89423				
		9007342	OIO	85303 or 89422				
	Yard Tractor	90027577	OIO	85720

PACCAR

Additional Applications

	TruckMaster Shock Stamping Number	665633		-IO	85033	89427
--	-----------------------------------	--------	--	-----	-----	-----	-------	-------

PACIFIC TRUCK & TRAILER

	Additional O.E.M. Interchanges	3178157C	OIO	85735				
		507202C1	OIO	85030 or 89440				





PAGE SUSPENSION

	Model with LM-2000 Models Lift Axle Suspension	1080099		OIO	83203	89436
	Model with Trailmaster Air Spring Suspension	1081933		OIO	83204	...
		A-2212		OIO	85029	...
	Models with O.E.M. Number	665133		OIO	83203	89436
		665267		OIO	85029	...

PAI CORP

	Models with O.E.M. Number	HSA-5067	OIO	85305
		HSA-5080	OIO	83221
		HSA-5095	OIO	83215

APPLICATION GUIDE - TRUCKS, TRAILERS, AND BUSES

Year	Model	OEM #	Front		Rear	
						
			Fleetline	GasSLX	Fleetline	GasSLX

PEERLESS TRAILER

Models with Air Suspension	72-61		OIO	83125	...
Models with O.E.M. Number	120-1		OIO	83125	...

PETERBILT

210 Series

Models with Reyco 79KB Rear Steel Spring Suspension	16725-01		OIO	83126	...
	19495-01		OIO	83126	...

220 Series

07 - 12	Models with 12,000 lb Front Axle	02-02738	OIO	85012	89413	
				85012	89413	
13 - 19	Models with 12,000 lb Front Axle	1707378PAC	- -	85182
		BFRG072	- -	85182
07 - 19	Models with Hendrickson HAS - 210L or HAS - 230L Rear Air Suspension	60670-008	OIO	OIO	83123	89405
		60670-008L	OIO	OIO	83123	89405
07 - 19	Models with Reyco 102AR (Standard) Rear Air Suspension	12887-01	OIO	OIO	85013	89414
		12887-02	OIO	OIO	85013	89414
07 - 19	Models with Reyco 21,000 lb Spring Suspension	19495-01	OIO	OIO	83126	89440
07 - 19	Models with Reyco 79KB Rear Steel Spring Suspension	16725-01	OIO	OIO	83126	...
		19495-01	OIO	OIO	83126	...

270 Series

Models with Woodhead Shock (Stamping Number ACHB 966)	ACHB966		- -	83136	...
---	---------	--	-----	-----	-----	-------	-----

320 Series

87 - 18	Models with 12,000 lb to 14,600 lb Taperleaf Spring Suspension and Set Forward Front Axle.	02-01787	OIO	85062	89408
		02-02737	OIO	85062	89408
		B71-6009	OIO	85062	89408
01 - 19	Models with 18,000 lb to 23,000 lb Taperleaf Front Spring Suspension and Set Forward Front Axle.	02-02742	OIO	85062	89408
		B71-6011	OIO	85062	89408
87 - 13	Models with Air Trac Suspension	03-07421	- O	85311	89424
14 - 18	Models with Air Trac Suspension (40,000 lb)	C71-6003	- O	85988	...
14 - 18	Models with Air Trac Suspension (46,000 lb)	C71-6002	- O	85311	89424
01 - 19	Models with Hendrickson HMX 400/460 Haulmax with 16.5" Saddle	60680-004	O -	83143	...
		60680-004L	O -	83143	...
01 - 19	Models with Hendrickson HMX 400/460 Haulmax with 17.5" & 18.5" Saddle	60680-005	O -	83142	...
		60680-005L	O -	83142	...
		Models with Neway AD-252-10 Tandem Axle	90045132	OIO	85909
	Models with Neway ADZ Rear Suspension	471700004423	OIO	85109	...
		90045605	OIO	85109	...
02 - 18	Models with Peterbilt Low Air Leaf Suspension	03-08781	- -	85069	89455
		C71-1011	- -	85069	89455
		C71-1017	- -	85069	89455
	Models with Quadraflex 4 Spring Rear Suspension	03-07420	- -	85336	...
	Models with Reyco 102AR (Standard) Rear Air Suspension	12887-01	OIO	85013	89414
		12887-02	OIO	85013	89414
	Models with Reyco 79KB Rear Steel Spring Suspension	16725-01	OIO	83126	...
		19495-01	OIO	83126	...





325 Series

08 - 19	Models with 21,000 lb Reyco Spring Suspension	19495-01		OIO	83126	89440
08 - 15	Models with 8,000 lb Front Axle	B71-6004	OIO	85084	89460

330 Series

16 - 19	Models with 10,000 lb to 14,600 lb Taperleaf Springs and Set Back Front Axles	B71-6019	OIO	85989
95 - 16	Models with 12000 lb Set Back Front Axle	02-02738	OIO	85012	89413

APPLICATION GUIDE - TRUCKS, TRAILERS, AND BUSES

Year	Model	OEM #	Front		Rear	
						
				Fleetline	GasSLX	Fleetline

PETERBILT(Cont'd.)

330 Series(Cont'd.)

95 - 16	Models with 12000 lb Set Back Front Axle	B71-6016	○ ○	85012	89413	
		B71-6016A	○ ○	85012	89413	
- 2018	Models with 21,000 lb Reyco Spring Suspension	19495-01		○ ○	83126	89440
87 - 13	Models with Air Trac Suspension	03-07421		- ○	85311	89424
14 - 19	Models with Air Trac Suspension (40,000 lb)	C71-6003		- ○	85988	...
14 - 19	Models with Air Trac Suspension (46,000 lb)	C71-6002		- ○	85311	89424
95 - 02	Models with Peterbilt 40000 lb Low Air Leaf Suspension	03-07423		- ○	85033	89427
03 - 19	Models with Peterbilt Low Air Leaf Suspension	03-08781		- -	85069	89455
		C71-1011		- -	85069	89455
		C71-1017		- -	85069	89455
	Models with Reyco 102AR (Standard) Rear Air Suspension	12887-01		○ ○	85013	89414
		12887-02		○ ○	85013	89414
- 2018	Models with Reyco 79KB Rear Steel Spring Suspension	16725-01		○ ○	83126	...
		19495-01		○ ○	83126	...
	Models with O.E.M. Number	02-03020	○ ○	85910
		B71-6017	○ ○	85910

335 Series

05 - 10	Models with 12000 lb Set Back Front Axle	02-02738	○ ○	85012	89413	
		02-02741	○ ○	85012	89413	
		B71-6016	○ ○	85012	89413	
		B71-6016A	○ ○	85012	89413	
05 - 10	Models with Air Trac Suspension	03-07421		- ○	85311	89424
05 - 10	Models with Peterbilt Low Air Leaf Suspension	03-08781		- -	85069	89455
		C71-1011		- -	85069	89455
		C71-1017		- -	85069	89455

337 Series

10 - 14	Models with 10,000 lb to 12,000 lb Front Axle	B71-6005	○ ○	85084	89460	
15 - 18	Models with 10,000 lb to 14,600 lb Taperleaf Springs and Set Back Front Axles	B71-6019	○ ○	85989
10 - 14	Models with 13,200 lb to 14,600 lb Front Axle	B71-6006	○ ○	85084	89460	
10 - 13	Models with Air Trac Suspension	03-07421		- ○	85311	89424
14 - 19	Models with Air Trac Suspension (40,000 lb)	C71-6003		- ○	85988	...
14 - 19	Models with Air Trac Suspension (46,000 lb)	C71-6002		- ○	85311	89424
10 - 19	Models with Peterbilt Low Air Leaf Suspension	03-08781		- -	85069	89455
		C71-1011		- -	85069	89455
		C71-1017		- -	85069	89455
10 - 16	Models with Reyco 102AR (Standard) Rear Air Suspension	12887-01		○ ○	85013	89414
		12887-02		○ ○	85013	89414
10 - 18	Models with Reyco 79KB Rear Steel Spring Suspension	16725-01		○ ○	83126	...
		19495-01		○ ○	83126	...









340 Series

07 - 10	Models with 12000 lb Set Back Front Axle	02-02738	○ ○	85012	89413	
		02-02741	○ ○	85012	89413	
		B71-6016	○ ○	85012	89413	
		B71-6016A	○ ○	85012	89413	
07 - 10	Models with Air Trac Suspension	03-07421		- ○	85311	89424

348 Series

12 - 13	Models with 10,000 lb to 12,000 lb Front Axle	B71-6005	○ ○	85084	89460	
14 - 18	Models with 10,000 lb to 14,600 lb Taperleaf Springs and Set Back Front Axles	B71-6019	○ ○	85989
14 - 19	Models with 20,000 lb Taperleaf Springs and Set Back Front Axles	B71-6020	○ ○	85989
10 - 13	Models with Air Trac Suspension	03-07421		- ○	85311	89424
14 - 19	Models with Air Trac Suspension (40,000 lb)	C71-6003		- ○	85988	...
14 - 19	Models with Air Trac Suspension (46,000 lb)	C71-6002		- ○	85311	89424

APPLICATION GUIDE - TRUCKS, TRAILERS, AND BUSES

Year	Model	OEM #	Front		Rear	
						
						
			Fleetline	GasSLX	Fleetline	GasSLX

PETERBILT(Cont'd.)

348 Series(Cont'd.)

10 - 19	Models with Hendrickson HMX 400/460 Haulmax with 16.5" Saddle	60680-004 60680-004L	01-	83143	...
			01-	83143	...
10 - 19	Models with Hendrickson HMX 400/460 Haulmax with 17.5" & 18.5" Saddle	60680-005 60680-005L	01-	83142	...
			01-	83142	...
10 - 19	Models with Neway ADZ Rear Suspension	471700004423 90045605	010	85109	...
			010	85109	...
15 - 16	Models with O.E.M. Number	B71-6012	010	85119
10 - 19	Models with Reyco 102AR (Standard) Rear Air Suspension	12887-01 12887-02	010	85013	89414
			010	85013	89414
10 - 19	Models with Reyco 79KB Rear Steel Spring Suspension	16725-01 19495-01	010	83126	...
			010	83126	...

349 Series

84 - 87	349 Conventional Models with 12000 lb capacity	02-00376 02-00495 02-02736	010	85302	89420
			010	85302	89420
			010	85302	89420

353 Series

81 - 93	353 Conventional Models with 12000 lb capacity	02-00376 02-00495 02-02736	010	85302	89420
			010	85302	89420
			010	85302	89420





357 Series

	Conventional Models with Front Air Suspension and Set Back Front Axle.	02-02739	010	85013	89414	
	Conventional Models with Front Air Suspension and without Set Back Front Axle.	02-02740	010	85036	89405	
87 - 08	Conventional Models with Spring Suspension and with Set Back Front Axle.	02-01890	010	85012	89413	
		02-02738	010	85012	89413	
		02-02741	010	85012	89413	
		B71-6016	010	85012	89413	
		B71-6016A	010	85012	89413	
87 - 08	Models with 12,000 lb to 14,600 lb Taperleaf Spring Suspension and Set Forward Front Axle.	02-02737	010	85062	89408	
		B71-6007	010	85062	89408	
		B71-6009	010	85062	89408	
87 - 08	Models with 18,000 lb to 23,000 lb Taperleaf Front Spring Suspension and Set Forward Front Axle.	02-02742	010	85062	89408	
		B71-6011	010	85062	89408	
87 - 08	Models with Air Trac Suspension	03-07421		-10	85311	89424
97 - 08	Models with Air Track Tandem with TRD8000 Pusher Axle	03-08350		-10	85343	...
		C71-6004		-10	85343	...
87 - 08	Models with Chalmers 40,000 lb Rear Suspension	665174		010	85060	...
		800670		010	85060	...
02 - 08	Models with Hendrickson HMX 400/460 Haulmax with 16.5" Saddle	60680-004		01-	83143	...
		60680-004L		01-	83143	...
02 - 08	Models with Hendrickson HMX 400/460 Haulmax with 17.5" & 18.5" Saddle	60680-005		01-	83142	...
		60680-005L		01-	83142	...
87 - 08	Models with Neway ARD 125/244-8 Models Rear Air Suspension	90044011		010	85004	...
02 - 08	Models with Peterbilt Low Air Leaf Suspension	03-08781		-1-	85069	89455
		C71-1017		-1-	85069	89455
87 - 01	Models with Peterbilt Low Air Leaf Suspension	03-07423		-10	85033	89427
		665633		-10	85033	89427

359 Series

81 - 87	359 Conventional Models with 12000 lb capacity	02-00376	010	85302	89420
---------	--	----------	-----	--------------	--------------	-----	-----

APPLICATION GUIDE - TRUCKS, TRAILERS, AND BUSES

Year	Model	OEM #	Front		Rear	
						
				Fleetline	GasSLX	Fleetline

PETERBILT(Cont'd.)

359 Series(Cont'd.)

81 - 87	359 Conventional Models with 12000 lb capacity	02-00495 02-02736	○ ○	85302	89420	
			○ ○	85302	89420	
81 - 87	Models with Peterbilt Air Leaf Suspension	03-07421		- ○	85311	89424

362 Series

	C.O.E. Models with 12000 lb capacity	02-02736	○ ○	85302	89420	
	C.O.E. Models with 14600 lb Taper Leaf Springs and Set Back Front Axle	02-02740	○ ○	85036	89405	
81 - 06	C.O.E. Models with Progressive Springs	02-02738 B71-6016 B71-6016A	○ ○	85012	89413	
			○ ○	85012	89413	
			○ ○	85012	89413	
81 - 06	C.O.E. Models without Set Back Front Axle	02-00376 02-00495	○ ○	85302	89420	
			○ ○	85302	89420	
81 - 06	Models with Air Trac Suspension	03-07421		- ○	85311	89424
- 11/82	Models with Air Trac Suspension (38000 or 40000 lb)	03-04176		○ ○	85308	89422
81 - 06	Models with Chalmers 40,000 lb Rear Suspension	665174 800670		○ ○	85060	...
				○ ○	85060	...
81 - 06	Models with Neway ARD 125/244-8 Models Rear Air Suspension	90044011		○ ○	85004	...
02 - 06	Models with Peterbilt Low Air Leaf Suspension	03-08781 C71-1017		- -	85069	89455
				- -	85069	89455
81 - 01	Models with Peterbilt Low Air Leaf Suspension	03-07423 665633		- ○	85033	89427
				- ○	85033	89427

365 Series

08 - 18	Models with 12,000 lb to 14,600 lb Taperleaf Spring Suspension and Set Forward Front Axle.	B71-6007	○ ○	85062	89408	
08 - 15	Models with 12,000 lb to 16,000 lb Taperleaf Front Suspension (Set-Back Axle)	B71-6002 B71-6013	○ ○	85012	89413	
			○ ○	85012	89413	
08 - 18	Models with 18,000 lb to 23,000 lb Taperleaf Front Spring Suspension and Set Forward Front Axle.	02-02742 B71-6011	○ ○	85062	89408	
			○ ○	85062	89408	
08 - 13	Models with Air Trac Suspension	03-07421		- ○	85311	89424
14 - 19	Models with Air Trac Suspension (40,000 lb)	C71-6003		- ○	85988	...
14 - 19	Models with Air Trac Suspension (46,000 lb)	C71-6002		- ○	85311	89424
08 - 19	Models with Chalmers 40,000 lb Rear Suspension	665174 800670		○ ○	85060	...
				○ ○	85060	...
08 - 19	Models with FlexAir Suspension (38000 lb)	C71-1002 C71-1016 C71-6000 C71-6015		○ ○	85067	89451
				○ ○	85067	89451
				○ ○	85067	89451
				○ ○	85067	89451
08 - 19	Models with Hendrickson HMX 400/460 Haulmax with 16.5" Saddle	60680-004 60680-004L		○ -	83143	...
				○ -	83143	...
08 - 19	Models with Hendrickson HMX 400/460 Haulmax with 17.5" & 18.5" Saddle	60680-005 60680-005L		○ -	83142	...
				○ -	83142	...
- 2019	Models with Neway ADZ Rear Suspension	471700004423 90045605		○ ○	85109	...
				○ ○	85109	...
08 - 19	Models with Peterbilt Low Air Leaf Suspension	03-08781 C71-1011 C71-1017 C71-6005		- -	85069	89455
				- -	85069	89455
				- -	85069	89455
				- -	85069	89455
08 - 12	Models with Quadraflex 4 Spring Rear Suspension	03-07420		- -	85336	...
10 - 19	Models with Reyco 102AR (Standard) Rear Air Suspension	12887-01 12887-02		○ ○	85013	89414
				○ ○	85013	89414
10 - 19	Models with Reyco 79KB Rear Steel Spring Suspension	16725-01 19495-01		○ ○	83126	...
				○ ○	83126	...

APPLICATION GUIDE - TRUCKS, TRAILERS, AND BUSES

Year	Model	OEM #	Front		Rear	
			Fleetline	GasSLX	Fleetline	GasSLX

PETERBILT(Cont'd.)

367 Series(Cont'd.)

08 - 16	Models with 10,000 lb to 16,000 lb Taperleaf Front Spring Suspension and with Set Back Front Axle.	B71-6002	010	85012	89413	
		B71-6016	010	85012	89413	
14 - 18	Models with 12,000 lb to 14,600 lb Taperleaf Spring Suspension and Set Forward Front Axle.	B71-6009	010	85062	89408	
08 - 18	Models with 18,000 lb to 23,000 lb Taperleaf Front Spring Suspension and Set Forward Front Axle.	02-02742	010	85062	89408	
		B71-6007	010	85062	89408	
		B71-6011	010	85062	89408	
08 - 13	Models with Air Trac Suspension	03-07421		-10	85311	89424
14 - 19	Models with Air Trac Suspension (40,000 lb)	C71-6003		-10	85988	...
14 - 19	Models with Air Trac Suspension (46,000 lb)	C71-6002		-10	85311	89424
	Models with Air Track Tri Drive Suspension	03-08350		-10	85343	...
		C71-6004		-10	85343	...
08 - 19	Models with Chalmers 40,000 lb Rear Suspension	665174		010	85060	...
		800670		010	85060	...
08 - 19	Models with FlexAir Suspension (38000 lb)	C71-1002		010	85067	89451
		C71-1016		010	85067	89451
		C71-6000		010	85067	89451
		C71-6015		010	85067	89451
08 - 19	Models with Hendrickson HMX 400/460 Haulmax with 16.5" Saddle	60680-004		01-	83143	...
		60680-004L		01-	83143	...
08 - 19	Models with Hendrickson HMX 400/460 Haulmax with 17.5" & 18.5" Saddle	60680-005		01-	83142	...
		60680-005L		01-	83142	...
- 2019	Models with Neway ADZ Rear Suspension	471700004423		010	85109	...
		90045605		010	85109	...
08 - 19	Models with Peterbilt Low Air Leaf Suspension	03-08781		-1-	85069	89455
		C71-1011		-1-	85069	89455
		C71-1017		-1-	85069	89455
08 - 10	Models with Quadraflex 4 Spring Rear Suspension	03-07420		-1-	85336	...





372 Series

89 - 93	C.O.E. Models with Front Air Suspension	02-02739	010	85013	89414	
89 - 93	C.O.E. Models with Front Spring Suspension	02-02738	010	85012	89413	
		B71-6016	010	85012	89413	
		B71-6016A	010	85012	89413	
89 - 93	Models with Air Trac Suspension	03-07421		-10	85311	89424
89 - 93	Models with Chalmers 40,000 lb Rear Suspension	665174		010	85060	...
		800670		010	85060	...
89 - 93	Models with Neway ARD 125/244-8 Models Rear Air Suspension	90044011		010	85004	...
89 - 93	Models with Peterbilt Low Air Leaf Suspension	03-07423		-10	85033	89427
		665633		-10	85033	89427

375 Series

87 - 96	Conventional Models with Front Air Suspension and Set Back Front Axle.	02-02739	010	85013	89414	
87 - 96	Conventional Models with Front Air Suspension and without Set Back Front Axle.	02-02740	010	85036	89405	
87 - 96	Conventional Models with Spring Suspension and with Set Back Front Axle.	02-02738	010	85012	89413	
		02-02741	010	85012	89413	
		B71-6016	010	85012	89413	
		B71-6016A	010	85012	89413	
87 - 96	Models with 12,000 lb to 14,600 lb Taperleaf Spring Suspension and Set Forward Front Axle.	02-02737	010	85062	89408	
		B71-6007	010	85062	89408	
		B71-6009	010	85062	89408	

APPLICATION GUIDE - TRUCKS, TRAILERS, AND BUSES

Year	Model	OEM #	Front		Rear	
						
				Fleetline	GasSLX	Fleetline

PETERBILT(Cont'd.)

375 Series(Cont'd.)

87 - 96	Models with 18,000 lb to 23,000 lb Taperleaf Front Spring Suspension and Set Forward Front Axle.	02-02742	○ ○	85062	89408	
		B71-6011	○ ○	85062	89408	
87 - 96	Models with Air Trac Suspension	03-07421		- ○	85311	89424
87 - 96	Models with Chalmers 40,000 lb Rear Suspension	665174		○ ○	85060	...
		800670		○ ○	85060	...
87 - 96	Models with Neway ARD 125/244-8 Models Rear Air Suspension	90044011		○ ○	85004	...
87 - 96	Models with Peterbilt Low Air Leaf Suspension	03-07423		- ○	85033	89427
		665633		- ○	85033	89427

376 Series

88 - 03	Conventional Models with Front Air Suspension and Set Back Front Axle.	02-02739	○ ○	85013	89414	
88 - 03	Conventional Models with Front Air Suspension and without Set Back Front Axle.	02-02740	○ ○	85036	89405	
88 - 03	Conventional Models with Spring Suspension and with Set Back Front Axle.	02-02738	○ ○	85012	89413	
		02-02741	○ ○	85012	89413	
		B71-6016	○ ○	85012	89413	
		B71-6016A	○ ○	85012	89413	
88 - 03	Models with 12,000 lb to 14,600 lb Taperleaf Spring Suspension and Set Forward Front Axle.	02-02737	○ ○	85062	89408	
		B71-6007	○ ○	85062	89408	
		B71-6009	○ ○	85062	89408	
88 - 03	Models with 18,000 lb to 23,000 lb Taperleaf Front Spring Suspension and Set Forward Front Axle.	02-02742	○ ○	85062	89408	
		B71-6011	○ ○	85062	89408	
88 - 03	Models with Air Trac Suspension	03-07421		- ○	85311	89424
88 - 03	Models with Chalmers 40,000 lb Rear Suspension	665174		○ ○	85060	...
		800670		○ ○	85060	...
88 - 03	Models with Neway ARD 125/244-8 Models Rear Air Suspension	90044011		○ ○	85004	...
88 - 03	Models with Peterbilt Low Air Leaf Suspension	03-07423		- ○	85033	89427
		665633		- ○	85033	89427

377 Series

87 - 01	Conventional Models with Front Air Suspension and Set Back Front Axle.	02-02739	○ ○	85013	89414	
87 - 01	Conventional Models with Front Air Suspension and without Set Back Front Axle.	02-02740	○ ○	85036	89405	
87 - 01	Conventional Models with Spring Suspension and with Set Back Front Axle.	02-02738	○ ○	85012	89413	
		02-02741	○ ○	85012	89413	
87 - 01	Models with 12,000 lb to 14,600 lb Taperleaf Spring Suspension and Set Forward Front Axle.	02-02737	○ ○	85062	89408	
		B71-6007	○ ○	85062	89408	
		B71-6009	○ ○	85062	89408	
87 - 01	Models with 18,000 lb to 23,000 lb Taperleaf Front Spring Suspension and Set Forward Front Axle.	02-02742	○ ○	85062	89408	
87 - 01	Models with 18,000 lb to 23,000 lb Taperleaf Spring Suspension and Set Forward Axles	B71-6011	○ ○	85062	89408	
87 - 01	Models with Air Trac Suspension	03-07421		- ○	85311	89424
87 - 01	Models with Chalmers 40,000 lb Rear Suspension	665174		○ ○	85060	...
		800670		○ ○	85060	...
87 - 01	Models with Neway ARD 125/244-8 Models Rear Air Suspension	90044011		○ ○	85004	...
87 - 01	Models with Peterbilt Low Air Leaf Suspension	03-07423		- ○	85033	89427
		665633		- ○	85033	89427

378 Series

	Conventional Models with Front Air Suspension and Set Back Front Axle.	02-02739	○ ○	85013	89414	
--	--	----------	-----	-------	-------	--	-----	-----

APPLICATION GUIDE - TRUCKS, TRAILERS, AND BUSES

Year	Model	OEM #	Front		Rear	
			Fleetline	GasSLX	Fleetline	GasSLX

PETERBILT(Cont'd.)





378 Series(Cont'd.)

	Conventional Models with Front Air Suspension and without Set Back Front Axle.	02-02740	010	85036	89405	
88 - 07	Conventional Models with Spring Suspension and with Set Back Front Axle.	02-02738	010	85012	89413	
		02-02741	010	85012	89413	
		B71-6016	010	85012	89413	
		B71-6016A	010	85012	89413	
88 - 07	Models with 12,000 lb to 14,600 lb Taperleaf Spring Suspension and Set Forward Front Axle.	02-02737	010	85062	89408	
		B71-6007	010	85062	89408	
		B71-6009	010	85062	89408	
88 - 07	Models with 18,000 lb to 23,000 lb Taperleaf Front Spring Suspension and Set Forward Front Axle.	02-02742	010	85062	89408	
		B71-6011	010	85062	89408	
88 - 07	Models with Air Trac Suspension	03-07421		-10	85311	89424
88 - 07	Models with Chalmers 40,000 lb Rear Suspension	665174		010	85060	...
		800670		010	85060	...
99 - 07	Models with FlexAir Suspension (38000 lb)	C71-1002		010	85067	89451
		C71-6000		010	85067	89451
88 - 07	Models with Neway ARD 125/244-8 Models Rear Air Suspension	90044011		010	85004	...
- 2003	Models with Peterbilt Low Air Leaf Suspension	03-07423		-10	85033	89427
		665633		-10	85033	89427
03 - 07	Models with Peterbilt Low Air Leaf Suspension	03-08781		-1-	85069	89455
		C71-1017		-1-	85069	89455

379 Series

	Conventional Models with Front Air Suspension and Set Back Front Axle.	02-02739	010	85013	89414	
	Conventional Models with Front Air Suspension and without Set Back Front Axle.	02-02740	010	85036	89405	
85 - 09	Conventional Models with Spring Suspension and with Set Back Front Axle.	02-01890	010	85012	89413	
		02-02738	010	85012	89413	
		02-02741	010	85012	89413	
		B71-6016	010	85012	89413	
		B71-6016A	010	85012	89413	
85 - 09	Models with 12,000 lb to 14,600 lb Taperleaf Spring Suspension and Set Forward Front Axle.	02-01787	010	85062	89408	
		02-02737	010	85062	89408	
		B71-6007	010	85062	89408	
		B71-6009	010	85062	89408	
85 - 09	Models with 18,000 lb to 23,000 lb Taperleaf Front Spring Suspension and Set Forward Front Axle.	02-02742	010	85062	89408	
		B71-6011	010	85062	89408	
85 - 09	Models with Air Trac Suspension	03-07421		-10	85311	89424
		03-07421SPL		-10	85311	89424
85 - 09	Models with Chalmers 40,000 lb Rear Suspension	665174		010	85060	...
		800670		010	85060	...
99 - 09	Models with FlexAir Suspension (38000 lb)	C71-1002		010	85067	89451
		C71-6000		010	85067	89451
	Models with Neway ARD 125/244-8 Models Rear Air Suspension	90044011		010	85004	...
03 - 09	Models with Peterbilt Low Air Leaf Suspension	03-08781		-1-	85069	89455
		C71-1011		-1-	85069	89455
		C71-1017		-1-	85069	89455
85 - 02	Models with Peterbilt Low Air Leaf Suspension	03-07423		-10	85033	89427
		665633		-10	85033	89427

APPLICATION GUIDE - TRUCKS, TRAILERS, AND BUSES

Year	Model	OEM #	Front		Rear	
						
			Fleetline	GasSLX	Fleetline	GasSLX

PETERBILT(Cont'd.)

382 Series(Cont'd.)

2011 -	Models with 10,000 lb to 12,000 lb Front Axle	B71-6005	010	85084	89460	
2011 -	Models with 12,000 lb to 14,600 lb Taperleaf Spring Suspension and Set Forward Front Axle.	02-02737	010	85062	89408	
		B71-6009	010	85062	89408	
11 - 13	Models with Air Trac Suspension	03-07421		-10	85311	89424
14 - 17	Models with Air Trac Suspension (46,000 lb)	C71-6002		-10	85311	89424
11 - 17	Models with FlexAir Suspension (38000 lb)	C71-1002		010	85067	89451
		C71-1016		010	85067	89451
		C71-6000		010	85067	89451
		C71-6015		010	85067	89451
11 - 17	Models with Peterbilt Low Air Leaf Suspension	03-08781		-1-	85069	89455
		C71-1011		-1-	85069	89455
		C71-1017		-1-	85069	89455
11 - 17	Models with Quadraflex 4 Spring Rear Suspension	03-07420		-1-	85336	...
11 - 17	Models with Reyco 102AR (Standard) Rear Air Suspension	12887-01		010	85013	89414
		12887-02		010	85013	89414
11 - 17	Models with Reyco 79KB Rear Steel Spring Suspension	16725-01		010	83126	...
		19495-01		010	83126	...





384 Series

08 - 12	Models with 12,000 lb to 14,600 lb Taperleaf Spring Suspension and Set Forward Front Axle.	02-02737	010	85062	89408	
13 - 14	Models with 12,000 lb to 14,600 lb Taperleaf Spring Suspension and Set Forward Front Axle. (Std Duty)	B71-6009	010	83219	89408	
		B71-6009	010	85062	89408	
08 - 13	Models with Air Trac Suspension	03-07421		-10	85311	89424
14 - 16	Models with Air Trac Suspension (46,000 lb)	C71-6002		-10	85311	89424
08 - 16	Models with FlexAir Suspension (38000 lb)	C71-1002		010	85067	89451
		C71-1016		010	85067	89451
		C71-6000		010	85067	89451
		C71-6015		010	85067	89451
08 - 16	Models with Peterbilt Low Air Leaf Suspension	03-08781		-1-	85069	89455
		C71-1011		-1-	85069	89455
		C71-1017		-1-	85069	89455
2008 -	Models with Quadraflex 4 Spring Rear Suspension	03-07420		-1-	85336	...

385 Series

- 2007	Conventional Models with Spring Suspension and with Set Back Front Axle.	02-02738	010	85012	89413	
		02-02741	010	85012	89413	
		B71-6016	010	85012	89413	
		B71-6016A	010	85012	89413	
- 2007	Models with 12,000 lb to 14,600 lb Taperleaf Spring Suspension and Set Forward Front Axle.	02-02737	010	85062	89408	
		B71-6007	010	85062	89408	
		B71-6009	010	85062	89408	
- 2007	Models with 18,000 lb to 23,000 lb Taperleaf Front Spring Suspension and Set Forward Front Axle.	02-02742	010	85062	89408	
		B71-6011	010	85062	89408	
95 - 08	Models with Air Trac Suspension	03-07421		-10	85311	89424
	Models with Chalmers 40,000 lb Rear Suspension	665174 800670		010	85060	...
95 - 08	Models with FlexAir Suspension (38000 lb)	C71-1002		010	85067	89451
		C71-6000		010	85067	89451
	Models with Neway ARD 125/244-8 Models Rear Air Suspension	90044011		010	85004	...
- 2003	Models with Peterbilt Low Air Leaf Suspension	03-07423		-10	85033	89427
		665633		-10	85033	89427

APPLICATION GUIDE - TRUCKS, TRAILERS, AND BUSES

Year	Model	OEM #	Front		Rear	
			 Fleetline	 GasSLX	 Fleetline	 GasSLX

PETERBILT(Cont'd.)

385 Series(Cont'd.)

04 - 07	Models with Peterbilt Low Air Leaf Suspension	03-08781	- -	85069	89455
		C71-1017	- -	85069	89455
	Models with Quadraflex 4 Spring Rear Suspension	03-07420	- -	85336	...





386 Series

2006 -	Conventional Models with Front Air Suspension and Set Back Front Axle.	02-02739	0 0	85013	89414	
2006 -	Conventional Models with Front Air Suspension and without Set Back Front Axle.	02-02740	0 0	85036	89405	
13 - 14	Conventional Models with Spring Suspension and with Set Back Front Axle.	B71-6016	0 0	85012	89413	
		B71-6016A	0 0	85012	89413	
2006 -	Conventional Models with Spring Suspension and with Set Back Front Axle.	02-02738	0 0	85012	89413	
		02-02741	0 0	85012	89413	
		02-04010	0 0	85012	89413	
		B71-6018	0 0	85012	89413	
06 - 12	Models with 12,000 lb to 14,600 lb Taperleaf Spring Suspension and Set Forward Front Axle.	02-02737	0 0	85062	89408	
		B71-6009	0 0	85062	89408	
2006 -	Models with 12,000 lb to 14,600 lb Taperleaf Spring Suspension and Set Forward Front Axle.	B71-6007	0 0	85062	89408	
2006 -	Models with 18,000 lb to 23,000 lb Taperleaf Front Spring Suspension and Set Forward Front Axle.	02-02742	0 0	85062	89408	
		B71-6011	0 0	85062	89408	
06 - 16	Models with FlexAir Suspension (38000 lb)	C71-1002		0 0	85067	89451
		C71-1016		0 0	85067	89451
		C71-6000		0 0	85067	89451
		C71-6015		0 0	85067	89451
06 - 16	Models with Peterbilt Air Leaf Suspension	03-07421		- 0	85311	89424
		C71-6002		- 0	85311	89424
06 - 16	Models with Peterbilt Low Air Leaf Suspension	03-08781		- -	85069	89455
		C71-1011		- -	85069	89455
		C71-1017		- -	85069	89455

387 Series

- 2009	Conventional Models with Front Air Suspension and Set Back Front Axle.	02-02739	0 0	85013	89414	
- 2009	Conventional Models with Front Air Suspension and without Set Back Front Axle.	02-02740	0 0	85036	89405	
- 2011	Conventional Models with Spring Suspension and with Set Back Front Axle.	02-02738	0 0	85012	89413	
		02-02741	0 0	85012	89413	
		02-04010	0 0	85012	89413	
		B71-6016	0 0	85012	89413	
		B71-6016A	0 0	85012	89413	
- 2011	Models with 12,000 lb to 14,600 lb Taperleaf Spring Suspension and Set Forward Front Axle.	02-02737	0 0	85062	89408	
		B71-6007	0 0	85062	89408	
		B71-6009	0 0	85062	89408	
- 2011	Models with 18,000 lb to 23,000 lb Taperleaf Front Spring Suspension and Set Forward Front Axle.	02-02742	0 0	85062	89408	
		B71-6011	0 0	85062	89408	
00 - 11	Models with FlexAir Suspension (38000 lb)	C71-1002		0 0	85067	89451
		C71-6000		0 0	85067	89451
00 - 11	Models with Peterbilt Air Leaf Suspension	03-07421		- 0	85311	89424
- 2003	Models with Peterbilt Low Air Leaf Suspension	03-07423		- 0	85033	89427
		665633		- 0	85033	89427
03 - 11	Models with Peterbilt Low Air Leaf Suspension	03-08781		- -	85069	89455
		C71-1011		- -	85069	89455

APPLICATION GUIDE - TRUCKS, TRAILERS, AND BUSES

Year	Model	OEM #	Front		Rear	
						
			Fleetline	GasSLX	Fleetline	GasSLX

PETERBILT(Cont'd.)

387 Series(Cont'd.)

03 - 11	Models with Peterbilt Low Air Leaf Suspension	C71-1017		- -	85069	89455
---------	---	----------	--	-----	-----	-----	-------	-------





388 Series

08 - 16	Conventional Models with Front Air Suspension and Set Back Front Axle.	02-02739	010	85013	89414	
		85013A0C	010	85013	89414	
2008 -	Conventional Models with Front Air Suspension and without Set Back Front Axle.	02-02740	010	85036	89405	
2008 -	Conventional Models with Spring Suspension and with Set Back Front Axle.	02-04010	010	85012	89413	
		B71-6018	010	85012	89413	
08 - 17	Models with 12,000 lb to 14,600 lb Taperleaf Spring Suspension and Set Forward Front Axle.	B71-6007	010	85062	89408	
13 - 17	Models with 12,000 lb to 14,600 lb Taperleaf Spring Suspension and Set Forward Front Axle. (Heavy Duty) (Std Duty)	B71-6009	010	85062	89408	
		B71-6009	010	83219	89408	
08 - 17	Models with 18,000 lb to 23,000 lb Taperleaf Front Spring Suspension and Set Forward Front Axle.	02-02742	010	85062	89408	
		B71-6011	010	85062	89408	
08 - 17	Models with Air Trac Suspension	03-07421		- 0	85311	89424
14 - 17	Models with Air Trac Suspension (40,000 lb)	C71-6003		- 0	85988	...
14 - 17	Models with Air Trac Suspension (46,000 lb)	C71-6002		- 0	85311	89424
08 - 17	Models with FlexAir Suspension (38000 lb)	C71-1002		010	85067	89451
		C71-1016		010	85067	89451
		C71-6000		010	85067	89451
		C71-6015		010	85067	89451
	Models with Hendrickson HMX 400/460 Haulmax with 16.5" Saddle	60680-004		01-	83143	...
		60680-004L		01-	83143	...
	Models with Hendrickson HMX 400/460 Haulmax with 17.5" & 18.5" Saddle	60680-005		01-	83142	...
		60680-005L		01-	83142	...
08 - 17	Models with Peterbilt Air Leaf Suspension	03-07421		- 0	85311	89424
		03-07421PLUS		- 0	85311	89424
08 - 17	Models with Peterbilt Low Air Leaf Suspension	03-08781		- -	85069	89455
		C71-1011		- -	85069	89455
		C71-1017		- -	85069	89455

389 Series

2008 -	Conventional Models with Front Air Suspension and Set Back Front Axle.	02-02739	010	85013	89414	
2008 -	Conventional Models with Front Air Suspension and without Set Back Front Axle.	02-02740	010	85036	89405	
2008 -	Conventional Models with Spring Suspension and with Set Back Front Axle.	02-04010	010	85012	89413	
		B71-6018	010	85012	89413	
08 - 19	Models with 12,000 lb to 14,600 lb Taperleaf Spring Suspension and Set Forward Front Axle.	02-02737	010	85062	89408	
		B71-6007	010	85062	89408	
		B71-6009	010	85062	89408	
08 - 19	Models with 18,000 lb to 23,000 lb Taperleaf Front Spring Suspension and Set Forward Front Axle.	02-02742	010	85062	89408	
		B71-6011	010	85062	89408	
14 - 19	Models with Air Trac Suspension (40,000 lb)	C71-6003		- 0	85988	...
14 - 19	Models with Air Trac Suspension (46,000 lb)	C71-6002		- 0	85311	89424
08 - 19	Models with FlexAir Suspension (38000 lb)	C71-1002		010	85067	89451
		C71-1016		010	85067	89451
		C71-6000		010	85067	89451
		C71-6015		010	85067	89451

APPLICATION GUIDE - TRUCKS, TRAILERS, AND BUSES

Year	Model	OEM #	Front			Rear		
							Fleetline	GasSLX

PETERBILT(Cont'd.)

389 Series(Cont'd.)

08 - 19	Models with Hendrickson HMX 400/460 Haulmax with 16.5" Saddle	60680-004	01-	83143	...
		60680-004L	01-	83143	...
08 - 19	Models with Hendrickson HMX 400/460 Haulmax with 17.5" & 18.5" Saddle	60680-005	01-	83142	...
		60680-005L	01-	83142	...
08 - 19	Models with Hendrickson HN - 522 Rear Suspension	60680-003	01-	83112	...
		60680-003L	01-	83112	...
14 - 19	Models with Neway ADZ Rear Suspension	471700004423	010	85109	...
		90045605	010	85109	...
08 - 13	Models with Peterbilt Air Leaf Suspension	03-07421	-10	85311	89424
08 - 19	Models with Peterbilt Low Air Leaf Suspension	03-08781	-1-	85069	89455
		C71-1011	-1-	85069	89455
		C71-1017	-1-	85069	89455





520 Series

17 - 19	Models with 18,000 lb to 23,000 lb Taperleaf Front Spring Suspension and Set Forward Front Axle.	B71-6011	010	85062	89408
17 - 19	Models with Air Trac Suspension (40,000 lb)	C71-6003	-10	85988	...
17 - 19	Models with Air Trac Suspension (46,000 lb)	C71-6002	-10	85311	89424
17 - 19	Models with Hendrickson HMX 400/460 Haulmax with 16.5" Saddle	60680-004	01-	83143	...
		60680-004L	01-	83143	...
17 - 19	Models with Hendrickson HMX 400/460 Haulmax with 17.5" & 18.5" Saddle	60680-005	01-	83142	...
		60680-005L	01-	83142	...
17 - 19	Models with Neway AD-252-10 Tandem Axle	90045132	010	85909	...
17 - 19	Models with Neway ADZ Rear Suspension	471700004423	010	85109	...
		90045605	010	85109	...
17 - 19	Models with Peterbilt Low Air Leaf Suspension	C71-1011	-1-	85069	89455
		C71-1017	-1-	85069	89455
17 - 19	Models with Reyco 102AR (Standard) Rear Air Suspension	12887-01	010	85013	89414
		12887-02	010	85013	89414
17 - 19	Models with Reyco 79KB Rear Steel Spring Suspension	16725-01	010	83126	...
		19495-01	010	83126	...

567 Series

14 - 17	Models with 10,000 lb to 14,600 lb Taperleaf Springs and Set Back Front Axles	B71-6019	010	85989
14 - 18	Models with 12,000 lb to 14,600 lb Taperleaf Spring Suspension and Set Forward Front Axle.	B71-6009	010	85062	89408
14 - 19	Models with 18,000 lb to 23,000 lb Taperleaf Spring Suspension and Set Forward Axles	B71-6011	010	85062	89408
14 - 19	Models with 20,000 lb Taperleaf Springs and Set Back Front Axles	B71-6020	010	85989
14 - 19	Models with Air Trac Suspension (40,000 lb)	C71-6003	-10	85988	...
14 - 19	Models with Air Trac Suspension (46,000 lb)	C71-6002	-10	85311	89424
14 - 19	Models with Chalmers 40,000 lb Rear Suspension	665174	010	85060	...
		800670	010	85060	...
14 - 19	Models with FlexAir Suspension (38000 lb)	C71-1016	010	85067	89451
		C71-6015	010	85067	89451
14 - 19	Models with Hendrickson HMX 400/460 Haulmax with 16.5" Saddle	60680-004	01-	83143	...
		60680-004L	01-	83143	...
14 - 19	Models with Hendrickson HMX 400/460 Haulmax with 17.5" & 18.5" Saddle	60680-005	01-	83142	...
		60680-005L	01-	83142	...
14 - 19	Models with Neway ADZ Rear Suspension	471700004423	010	85109	...
		90045605	010	85109	...
14 - 19	Models with Peterbilt Low Air Leaf Suspension	C71-1017	-1-	85069	89455

APPLICATION GUIDE - TRUCKS, TRAILERS, AND BUSES

Year	Model	OEM #	Front		Rear	
						
			Fleetline	GasSLX	Fleetline	GasSLX

PETERBILT(Cont'd.)

567 Series(Cont'd.)

14 - 19	Models with Peterbilt Low Air Leaf Suspension	C71-6005		- -	85069	89455
---------	---	----------	--	-----	-----	-----	-------	-------

579 Series

13 - 16	Day Cab Models with 10,000 lb to 12,000 lb Front Axle	B71-6005	0 0	85084	89460	
13 - 17	Models with 10,000 lb to 14,600 lb Taperleaf Springs and Set Back Front Axles	B71-6019	0 0	85989
13 - 18	Models with 12,000 lb to 14,600 lb Taperleaf Spring Suspension and Set Forward Front Axle.	02-02737	0 0	85062	89408	
		B71-6009	0 0	85062	89408	
2013	Models with Air Trac Suspension	03-07421		- 0	85311	89424
14 - 19	Models with Air Trac Suspension (40,000 lb)	C71-6003		- 0	85988	...
14 - 19	Models with Air Trac Suspension (46,000 lb)	C71-6002		- 0	85311	89424
13 - 19	Models with FlexAir Suspension (38000 lb)	C71-1002		0 0	85067	89451
		C71-1016		0 0	85067	89451
		C71-6000		0 0	85067	89451
		C71-6015		0 0	85067	89451
13 - 18	Models with Neway ADZ Rear Suspension	471700004423		0 0	85109	...
		90045605		0 0	85109	...
2013 -	Models with Peterbilt Front Air Leaf Suspension	B71-6000	0 0	85959
13 - 19	Models with Peterbilt Low Air Leaf Suspension	03-08781		- -	85069	89455
		C71-1011		- -	85069	89455
		C71-1017		- -	85069	89455
		C71-6005		- -	85069	89455
13 - 19	Models with Reyco 102AR (Standard) Rear Air Suspension	12887-01		0 0	85013	89414
		12887-02		0 0	85013	89414
13 - 19	Models with Reyco 79KB Rear Steel Spring Suspension	16725-01		0 0	83126	...
		19495-01		0 0	83126	...

587 Series

11 - 16	Models with 12,000 lb to 14,600 lb Taperleaf Spring Suspension and Set Forward Front Axle.	02-02737	0 0	85062	89408	
		B71-6009	0 0	85062	89408	
11 - 13	Models with Air Trac Suspension	03-07421		- 0	85311	89424
14 - 18	Models with Air Trac Suspension (46,000 lb)	C71-6002		- 0	85311	89424
11 - 18	Models with FlexAir Suspension (38000 lb)	C71-1002		0 0	85067	89451
		C71-1016		0 0	85067	89451
		C71-6000		0 0	85067	89451
		C71-6015		0 0	85067	89451
11 - 13	Models with Peterbilt Front Air Leaf Suspension	B71-6000	0 0	85959
11 - 18	Models with Peterbilt Low Air Leaf Suspension	03-08781		- -	85069	89455
		C71-1011		- -	85069	89455
		C71-1017		- -	85069	89455
11 - 18	Models with Quadraflex 4 Spring Rear Suspension	03-07420		- -	85336	...
11 - 18	Models with Reyco 102AR (Standard) Rear Air Suspension	12887-01		0 0	85013	89414
		12887-02		0 0	85013	89414
11 - 18	Models with Reyco 79KB Rear Steel Spring Suspension	16725-01		0 0	83126	...
		19495-01		0 0	83126	...

Additional Applications

	OE PLUS Shock Stamping Number	02-02736PLUS	0 0	85302	89420	
		02-02737PLUS	0 0	85062	89408	
		02-02738PLUS	0 0	85012	89413	
		02-02739PLUS	0 0	85013	89414	
		03-04176PLUS		0 0	85308	89422
		03-06084PLUS		- 0	85033	89427
		03-07421PLUS		- 0	85311	89424
		03-07423PLUS		- 0	85033	89427
		10-12032-002PLUS	0 0	85320	89429	

APPLICATION GUIDE - TRUCKS, TRAILERS, AND BUSES









Year	Model	OEM #	Front		Rear	
			Fleetline	GasSLX	Fleetline	GasSLX

PETERBILT(Cont'd.)

Additional Applications(Cont'd.)

	OE PLUS Shock Stamping Number	10-12542-000PLUS	O10	85901
		16-13947-000PLUS		-10	85319	89428
		2018987C1PLUS		O10	85003	89411
		47902-13PLUS		O10	83122	89406
		60670-005PLUS		O10	83137	...
		60670-008PLUS		O10	83123	89405
		665565PLUS		O10	85007	89412
		671962PLUS		O1-	85936	89456
		70701PLUS		-1-	85900	...
		8086053PLUS		O10	85047	89435
		90044025PLUS	O10	83209	89414	
		90044089PLUS		O10	83124	89407
		B71-6015	O10	85012	89413	
		C71-1002PLUS		O10	85067	89451
		C71-1011PLUS		-1-	85069	89455
		K374-26PLUS	O10	85001	89410	
		K374-28PLUS		O10	85314	89425
		K374-29PLUS		-1-	85310	89423
		K374-33PLUS	O10	83312	89409	
			TruckMaster Shock Stamping Number	665632	O10	85013	89414	
665783				O10	83123	89405
665784				O10	83122	89406
665785				O10	83137	...
665844				-1-	85069	89455
665918				-1-	85900	...
665926				O10	85047	89435
665927	O10			85901
665928	O10			85062	89408	
665930	O10			85001	89410	
665931	O10			83312	89409	
665932	O10			85012	89413	
665950				-1-	85902	...
671052	O10			85070	89459	
671654				O1-	85936	89456
671699				O1-	85937	...
671794				O10	85067	89451
680237				O10	85303	89422
680239				-1-	85310	89423
680240				O10	85302	89420
680242				O10	85308	89422
680253				O10	85314	89425
680261	O10			85062	89408	
680279	O10			83209	89414	
680280				O10	85906	89407
680281				O10	85003	89411
680303				O10	85007	89412
680425	O10			85320	89429	
680435				-10	85033	89427
680473				-10	85319	89428
	Models with O.E.M. Number	02-01759	O10	83312	89409	
		02-01890	O10	85012	89413	
		02-02061	O10	85013	89414	
		02-02142	O10	85036	89405	
		02-02225	O10	85012	89413	
		03-01635		O10	85308	89422

APPLICATION GUIDE - TRUCKS, TRAILERS, AND BUSES

Year	Model	OEM #	Front		Rear	
						
						
			Fleetline	GasSLX	Fleetline	GasSLX

PETERBILT(Cont'd.)

Additional Applications(Cont'd.)

	Models with O.E.M. Number	03-04629		-10	85311	89424
		03-05106		-10	85033	89427
		03-05384		-10	85033	89427
		03-06084		-10	85033	89427
		03-07281		-10	85311	89424
		03-07424		-10	85311	89424
		03-07424PLUS		-10	85311	89424
		23-08233		010	85308	89422
		23-10393		010	85308	89422
		23-12262		85012	89413	
		665133		010	83203	89436
		665617		85031
		665655		85062	89408	
		665656		85012	89413	
		665657		85013	89414	
		665658		85036	89405	
		665660		-10	85033	89427
		665662		85012	89413	
		665738		85910
		665752		010	85067	89451
		665762		85012	89413	
		665788		010	85000	89436
		665826		-1-	85069	89455
		665858		85070	89459	
		665876		85959
		665945		-1-	85902	...
		671091		-1-	85069	89455
		671092		85012	89413	
		671962SPL		01-	85936	89456
		671963		01-	85937	...
		680026		010	85302	89420
		680027		010	85308	89422
		680185		010	85308	89422
		680241		-10	85311	89424
		680348		85012	89413	
		680435		-10	85033	89427
		680457		85302	89420	
		680458		-1-	85336	...
		680459		-10	85311	89424
		680586		-10	85311	89424
		B71-1000		85031
		B71-1001		85070	89459	
		B71-1002		85001	89410	
		B71-1003		83312	89409	
		B71-6002		85012	89413	
		B71-6003		85029
		B71-6004		85084	89460	
		B71-6008		83312	89409	
C71-1011SPL		-1-	85069	89455		
C71-1013		01-	85985	...		
C71-1014		01-	85936	89456		
C71-6005		-1-	85069	89455		
2013 -	Models with O.E.M. Number	B71-6010		010	85023 or 89415			
	Models with Quadraflex 4 spring rear suspension	03-04628		-1- 85336 ...		

APPLICATION GUIDE - TRUCKS, TRAILERS, AND BUSES

Year	Model	OEM #	Front		Rear	
			Fleetline	GasSLX	Fleetline	GasSLX

PETERBILT CAB SHOCKS

2018	330 Day Cab models with O.E.M. Number	1202P055	010		83061
06 - 13	335 Day Cab models with O.E.M. Number	1202P055	010		83061
10 - 18	337 Day Cab models with O.E.M. Number	1202P055	010		83061
- 2018	348 Day Cab models with O.E.M. Number	1202P055	010		83061
- 2018	348 Sleepers with O.E.M. Number	1201-8002	010		83081
		R71-6009	010		83081
	357, 375, 376, 377 & 378 Conventional Truck & Tractors with Link Cabmate Models PBC377 & PBC377-A	1202-0054	010		83021
1981 -	362 Cabovers with Link Cabmate Model PB-362-2P	1202-0032	010		83016
1978 -	48" Sleepers with Link Bunkmate Model PBS48-A	1202-1044	010		83025
1978 -	63" Sleepers with Link Bunkmate Model PBS63-A	1202-1044	010		83025
	Models with O.E.M. Number	654782	010		83008
		654812	010		83042
		654919	010		83035
		R71-1004	010		83049
		R71-1005	010		83024
	Models with PowerPacker Cab Suspension	96027-1054	010		83011
		PP1058870	010		83059
		PP1059870	010		83060
		PP2582870	010		83012

348 Series

2018	348 Conventional Day Cab with O.E.M. Number	R71-6005	010		83042
------	---	----------	-----	--	-------

359 Series

81 - 87	359 Conventional Truck & Tractors with Link Cabmate Models PBC379 & PBC379-A	1202-0054	010		83021
81 - 87	359 Models (Older Models) Conventional Tractors with Link Cabmate Model PBCAL359	1201-0012	010		83023
		1202-0012	010		83023

365 Series

08 - 18	365 Conventional Day Cab with O.E.M. Number	20-16755	010		83042
		R71-6005	010		83042

367 Series

08 - 17	367 Conventional Day Cab with O.E.M. Number	20-16755	010		83042
		R71-6005	010		83042
08 - 19	367 Models with 70" Sleepers	29-02455	010		83008
		R71-6007	010		83008

377 & 379 Series

	377 & 379 Conventional Models with Unibuilt Cab	29-02455	010		83008
		R71-6007	010		83008
	379 Conventional Truck & Tractors with Link Cabmate Models PBC379 & PBC379-A	1202-0054	010		83021

384 Series

08 - 16	384 Conventional Day Cab with O.E.M. Number	20-16755	010		83042
		R71-6005	010		83042

386 Series

06 - 16	386 Conventional Day Cab with O.E.M. Number	20-16755	010		83042
		R71-6005	010		83042
06 - 19	386 Models with Sleepers	29-02455	010		83008
		R71-6007	010		83008

387 Series

1999 -	387 Models with 70" Sleepers	29-06032	010		83035
		R71-6008	010		83035
1999 -	387 Models with O.E.M. Number	29-06005	010		83035
08 - 11	DayCab Models with O.E.M. Number	R71-6000	010		83067
		R71-6010	010		83067

APPLICATION GUIDE - TRUCKS, TRAILERS, AND BUSES

Year	Model	OEM #	Front		Rear	
			Fleetline	GasSLX	Fleetline	GasSLX

PETERBILT CAB SHOCKS(Cont'd.)

388 Series(Cont'd.)

08 - 17	388 Conventional Day Cab with O.E.M. Number	20-16755	OIO	83042
		R71-6005	OIO	83042
08 - 17	388 Models with 70" Sleepers	29-02455	OIO	83008
		R71-6007	OIO	83008

389 Series

- 2019	389 Day Cab models with O.E.M. Number	20-19140	OIO	83063
		R71-6006	OIO	83063
08 - 19	389 Models with 70" Sleepers	29-02455	OIO	83008
		R71-6007	OIO	83008

567 Series

16 - 18	Sleeper Cab models with O.E.M. Number (Shocks only)	1201-8006	OIO	83081
		25523024	OIO	83081

579 Series

16 - 18	Sleeper Cab models with O.E.M. Number (Shocks only)	1201-8006	OIO	83081
		25523024	OIO	83081

587 Series

11 - 16	587 Models with 70" Sleepers	29-06032	OIO	83035
		R71-6008	OIO	83035

PHOENIX CRUISER RV

11 - 19	All models with Ford E350 & E450 Chassis	ASH-1136		-IO	83178	...
		ASH-1154	-IO	83177

PIERCE MANUFACTURING INC.

	Pierce FireTrucks with O.E.M. Number	680401	OIO	85307
	Additional O.E.M. Interchanges	1445910	OIO	85300 or 89419				
		40-0242	OIO	83312 or 89409				
		40-4845	OIO	85304				
		40-4951	-IO	85316 or 89426				
		40-5348	OIO	85058 or 89431				
		40-6967	OIO	85030 or 89440				





POWERHOUSE COACH INC.

06 - 10	Models with Volvo VNL780 Chassis with 12,500 - 14,600 lb Front Axle	20433424	OIO	85061	89450	
11 - 18	Models with Volvo VNL780 Chassis with 12,500 - 14,600 lb Front Axle	141700005838	OIO	85098
		21436086	OIO	85098
06 - 11	Models with Volvo VNL780 Chassis with 40,000 lb Rear Air Suspension	20551628		OIO	85066	89448
		471700000443		OIO	85066	89448
11 - 18	Models with Volvo VNL780 Chassis with 40,000 lb Rear Air Suspension	21462380		OIO	85088	...
		471700006040		OIO	85088	...
06 - 16	Models with Volvo VNL780 Chassis with Hendrickson Airtek	20485632	OIO	85933	89454	
		20485633	OIO	85933	89454	
		21137330	OIO	85933	89454	
		471700003832	OIO	85933	89454	
		64838-003	OIO	85933	89454	
	64838-003L	OIO	85933	89454		

POWERPACKER CAB SHOCKS

	Models with PowerPacker Cab Suspension	PP1058870	OIO	83059
		PP1059870	OIO	83060



APPLICATION GUIDE - TRUCKS, TRAILERS, AND BUSES

Year	Model	OEM #	Front		Rear	
			 Fleetline	 GasSLX	 Fleetline	 GasSLX

PREVOST

04 - 09	H3 Bus, H3 VIP Bus Drive and Tag Axle Shocks	630253						
		481700999386						
		630127						
		650407						
		VIP with Independant Front Suspension	48170000208	O1-	85379
			630251	O1-	85379
		With I-Beam Front Suspension	630252	O1O	85329
			481700999376	O1O	85329
			630134	O1O	85329
			680422	O1O	85329
	Intercity Bus with O.E.M. Number	481700999427	O1-	85380	
		630228	O1-	85380	
		680583	O1-	85380	
	LeMirage XL 40 ft, 45 ft, & H Models Coaches with Independant Front Suspension	630136	O1-	85330	
	LeMirage XL 40 ft, 45 ft, & H3-45 VIP Coaches with I-Beam Front Suspension	481700999376	O1O	85329	
		630134	O1O	85329	
	Low Floor Bus Models with O.E.M. Number	N16249		O1O	85378	...
	X3-45 Bus Drive and Tag Axle Shocks	630253						
	With I-Beam Front Suspension	48170000206	O1-	85380	
		630254	O1-	85380	
	With Independant Front Suspension	630136	O1-	85330	
04 - 06	XL II Bus, XL II MTH Bus Drive and Tag Axle Shocks	630253						
		481700999386						
		630127						
		650407						
		With I-Beam Front Suspension	630252	O1O	85329
			481700999376	O1O	85329
			630134	O1O	85329
			680422	O1O	85329
		With Independant Front Suspension	48170000208	O1-	85379
			630251	O1-	85379
	481700999377	O1-	85330		
	630163	O1-	85330		
07 - 09	XL II MTH Bus Drive and Tag Axle Shocks	630253						
		630136	O1-	85330	
89 - 00	XL-45 Coach Drive and Tag Axle Shocks	481700999386						
		630127						
		650407						
		With I-Beam Front Suspension	481700999376	O1O	85329
			630134	O1O	85329
			680422	O1O	85329
			Models with O.E.M. Number	12L-5-89				
		12T-1-13						
		19501288						
		19501289	-1-	85728		
		19501547			
		48170000207	O1O	85329		
		48170000209			
		630103	O1O	85329		

APPLICATION GUIDE - TRUCKS, TRAILERS, AND BUSES

Year	Model	OEM #	Front		Rear	
						
			Fleetline	GasSLX	Fleetline	GasSLX

PREVOST(Cont'd.)

Models with O.E.M. Number	630161		010	85736	...
	630234	010	85329
	630235	01-	85330
	630236	010	85329
	680510	01-	85330
	G5008070	010	85700
Additional O.E.M. Interchanges	01-0100-905	010	85303 or 89422				
	0822045526	010	85702				
	12B-5-1	010	85735				
	19501669	010	85339				
	19502711	010	85702				
	19506846	010	85339				
	196347	-10	85710				
	196533	-1-	85708				
	3166657	010	85700				
	481700999377	01-	85330				
	52001	-1-	85708				
	630001	010	85713				
	630080	010	85713				
	630091	010	85736				
	630163	01-	85330				
	63-1013	010	85329				
	680323	010	85700				
	680492	010	85713				
	680555	01-	85330				
	690060	010	85713				
74939852	010	85308 or 89422					
G1011822	010	85702					
N22212	010	85700					

RAMERIZ TRAILER

Identification of the trailer suspension is necessary to determine what section of the catalog to refer to. Some possible options can be Chalmers, Hendrickson, Neway, Ridewell, Reyco.

Trailer

86 AR / RS 1015, 1035, 3015, 3035 Slider Air Suspension	18165-01		010	85006	...
---	----------	--	-----	-----	-----	-------	-----

RAYDAN MANUFACTURING

Air Link Suspensions with O.E.M. Number	14QK-3100		010	85739	...
	446-51-211		010	85739	...
AL460 Air Link Suspension	700115		010	85712	...
AL520 Air Link Suspension	700115		010	85712	...

RED LION TRAILER

Trailers with Neway Air Susp. RL196-14, -15	90044978		010	85059	...
---	----------	--	-----	-----	-----	-------	-----

REINKE MANUFACTURING COMPANY, INC.

Identification of the trailer suspension is necessary to determine what section of the catalog to refer to. Some possible options can be Chalmers, Hendrickson, Neway, Ridewell, Reyco.

RENEGADE RV

- 2019	All Models with Freightliner Airliner Rear Air Suspension	16-18708-000		010	85724	89443
		SDA471700002809		010	85724	89443
12 - 19	Ikon Series Motorhomes with Freightliner Cascadia Chassis and 12,000 to 13,300 lb Taperleaf Front Suspension	10-13809-000	010	85958
		SDA471400003920	010	85958
09 - 19	Models with Freightliner M2-112 Chassis with 12000 lb to 20000 Front Axle	10-13809-000	010	85958

APPLICATION GUIDE - TRUCKS, TRAILERS, AND BUSES

Year	Model	OEM #	Front		Rear	
			Fleetline	GasSLX	Fleetline	GasSLX

RENEGADE RV(Cont'd.)

09 - 19	Models with Freightliner M2-112 Chassis with 12000 lb to 20000 Front Axle	471700003920	010	85958
06 - 10	Models with Volvo VNL630 Chassis with 12,500 - 14,600 lb Front Axle	20433424	010	85061	89450	
11 - 18	Models with Volvo VNL630 Chassis with 12,500 - 14,600 lb Front Axle	141700005838	010	85098
		21436086	010	85098
06 - 11	Models with Volvo VNL630 Chassis with 40,000 lb Rear Air Suspension	20551628		010	85066	89448
		471700000443		010	85066	89448
11 - 18	Models with Volvo VNL630 Chassis with 40,000 lb Rear Air Suspension	21462380		010	85088	...
		471700006040		010	85088	...
15 - 19	Renegade XL Series Motorhomes with Freightliner Cascadia Chassis and 12,000 to 13,300 lb Taperleaf Front Suspension	10-13809-000	010	85958
		SDA471400003920	010	85958
16 - 19	Verona & Verona LE Series Motorhomes with Freightliner M2-106 Chassis	10-13760-000	010	85959	89503	
		471700002991	010	85959	89503	
		SDA471700002991	010	85959	89503	

REYCO SUSPENSION

Drive Axle

101A, 101AR Models	18166-01		010	85704	...
102 Models	16725-01		010	83126	...
	19495-01		010	83126	...
102AR (Hvy Duty) Models	18286-01		010	...	89414
102AR (Special) Models	17146-01		010	83209	89414
102AR (Standard) Models	12887-01		010	85013	89414
	12887-02		010	85013	89414
102AR for Western Star Models	19824-01		010	85006	...
102AR-7 Models	17794-01		010	83215	...
102AR-LM Models	19623-01		010	83123	89405
102W Drive Models	21497-01		010	85005	89430
200 Models Air Suspension	20129-01		010	85007	89412
200 Models Air Suspension With O.E.M. Number	22062-01		010	85007	89412
21AR - 25000 lb Capacity	12887-01		010	85013	89414
	12887-02		010	85013	89414
240AR Air-Ride Suspension With O.E.M. Number	20125-01		010	85030	89440
	20126-01		010	...	89440
	20129-01		010	85007	89412
74AR - 30000 lb Capacity	12887-01		010	85013	89414
	12887-02		010	85013	89414
79AR Models	12887-02		010	85013	89414
79KB Models	16725-01		010	83126	...
	19495-01		010	83126	...
AirGlide 400 Air Suspension	20129-01		010	85007	89412





Steer Axle

1200 (Spartan Option) Models	21310-01	010	85307
1207 Models	17403-01	010	83122	89406	
1209 (Alternate) Models	17408-01	010	85005	89430	
1209, 1212 Models	17358-01	010	83126	89430	
	19495-01	010	83126	89440	
21B Models	14954-01	010	83217

Trailer

19AR / RS1062 Models with Unit # 700649-01 to -06	700098-01		010	83128	89436
---	-----------	--	-----	-----	-----	-------	-------

APPLICATION GUIDE - TRUCKS, TRAILERS, AND BUSES









Year	Model	OEM #	Front		Rear	
						
			Fleetline	GasSLX	Fleetline	GasSLX

REYCO SUSPENSION(Cont'd.)

Trailer(Cont'd.)

	19AR / RS1062 Models with Unit # 700649-07 to -12	24392-01		010	85051	...
	20 AR / RS 3162 Models with O.E.M. number	18163-01		010	83207	89407
	20AR & 22AR Models with O.E.M. Number	700098-03		010	85052	...
	21B (Special) Models	18800-01		010	83203	89436
	23 ART Models with O.E.M. Number	665748		010	85086	...
	23 ARTB-14A, -15A, 16A or -19A Models	23523-01		010	85086	...
	23 ARTB-14A-FS Models	702135-01		010	85045	...
		702135-01		010	85045	...
		702135-01		010	85045	...
	23 ARTU Models (All except -14A-FS and , -15A-FS)	23523-01		010	85086	...
	23 ARTU-14A-FS and -15A-FS Models	702135-01		010	85045	...
	23 ARTUL Models (All except -14A-FS and , -15A-FS)	23523-01		010	85086	...
	25 ARTB-13A, -14A, -15A, -16A, -17A Models	24392-01		010	85051	...
	25 ARTBL-13A, -14A, -15A, -16A, -17A, -18A, -19A Models	24392-01		010	85051	...
	25 ARTBL-14A-FS, -15A-FS, -16A-FS, -17A-FS Models	702135-01		010	85045	...
	25 ARTBL-18A-FS, -19A-FS, -20A-FS Models	704672-01		010	85938	...
	25 ARTU Models (All except -12A-FS)	24392-01		010	85051	...
	25 ARTU-12A-FS	702136-01		010	85052	...
	25 ARTUL-13A, -13S, -14A, -14S, -15A, -15S, -16A, -16S, -17A, -17S, -18A, -18S, -19A, -19S Models	24392-01		010	85051	...
	25 ARTUL-18A-FS, -19A-FS, -20A-FS, -21A-FS, -22A-FS, -23A-FS, -24A-FS, -18-FS, -19-FS, -20-FS, -21-FS, -22-FS, -23-FS, -24-FS Models	704672-01		010	85938	...
	25 ARUU Models (All except -06-5A-NZ)	23553-01		010	85938	...
	25 ARUU-06-5A-NZ Models	702136-01		010	85052	...
	25 ARUUL-09A, -09A-99, -9S, -09S-99 Models	702135-01		010	85045	...
	25 ARUUL-10A, -10S, -11A, -11S, -12A, -12S, -13A, -13S, -14A, -14S, -15A, -15S Models	23553-01		010	85938	...
	30 ART with O.E.M. Number	23524-01		010	85738	...
	30 ARTB-14A, -15A, -16A, -17A, -18A, -19A, -20A Models	23524-01		010	85738	...
	30 ARTB-19A-FS, -20A-FS Models	23553-01		010	85938	...
	30 ARTBL-15A, -16A, -17A, -18A, -19A Models	23524-01		010	85738	...
	30 ARTBL-19A-FS, -20A-FS Models	23553-01		010	85938	...
	30 ARTU-14A, -14S, -15A, -15S, -16A, -16S, -17A, -17S, -18A, -18S, -19A, -19S, -20A Models	23524-01		010	85738	...
	30 ARTU-20A-FS Models	23553-01		010	85938	...
	30 ARTUL-15A, -15S, -16A, -16S, -17A, -17S, -18A, -19A, -19S, -20A-TTN Models	23524-01		010	85738	...
	30 ARTUL-20A-FS Models	23553-01		010	85938	...
	30 ARUU - 14 and -15 Models	23553-01		010	85938	...
	30 ARUU - 9, -12 and -17 Models	23524-01		010	85738	...
	30 ARUUL - 12 and -17 Models	23524-01		010	85738	...
	30 ARUUL - 9, -14 and -15 Models	23553-01		010	85938	...
	44 AR Models	19623-01		010	83123	89405
	81C Models	12885-03		010	85300	89419
	81LC Models	12885-01		010	85300	89419
	81LM Models	12886-01		010	85334	...
	81S Models	12885-03		010	85300	89419
	86 AR / RS 1015, 1035, 3015, 3035 Slider Air Suspension	18165-01		010	85006	...
	87 for Great Dane Models	18163-01		010	83207	89407
		18164-01		010	83122	89406
	87-14 (Rear Mount) Models	18146-01		010	85313	...
	87-14, -17 Models	16230-01		010	85702	...
	87-14, -17 Slider Models	12885-01		010	85300	89419
	87-6, 87-9 Models	12885-01		010	85300	89419
	87M-12 Models	18146-01		010	85313	...

APPLICATION GUIDE - TRUCKS, TRAILERS, AND BUSES

Year	Model	OEM #	Front		Rear	
						
						
			Fleetline	GasSLX	Fleetline	GasSLX

REYCO SUSPENSION(Cont'd.)

Additional Applications(Cont'd.)

Models with O.E.M. Number	16824-01	010	85006	...
	17142-01	010	85001	89410
	20960-01	010	83204	...
	23106-01	010	85975	...
	23614-01	010	85717	...
	665519	010	...	89414
	665813	010	85051	...
	665830	010	85045	...
	665833	010	85052	...
	671707	010	85323	89436
	680551	010	85738	...
	680552	010	85938	...
	680700	010	85938	...
	702135-01	010	85045	...
	702136-01	010	85052	...
	702209-01	010	85014	...
	704672-01	010	85938	...

RIDEWELL CORPORATION









Bus and R.V. Air-Rides

Mobile Home & RV with Air Suspension	AS563B	010	83203	89436
	S6009B	010	83203	89436
RAS - 227 Models Steer Axles Air Suspension w/ O.E.M. Number	1260008	010	87017	...
	90-2610 SP1	010	87017	...

Trailer Air-Rides

RAR - 244 FeatherRide Light Duty Air Suspension (8,000 lb Capacity)	1270007	010	85045	...	
RAR-210 With Double Convolution Spring	AS789B	010	85014	...	
	S5878B	010	83207	89407	
	With Shock Absorber Bracket 2-1/2" Above Frame Rail	010	85006	...
	With Shock Absorber Bracket 2-7/8" Above Lower Frame Rail	010	83207	89407
	With Shock Absorber Bracket 3" Above Lower Frame Rail	010	85005	89430
RAR-210 For Trailers with 25" Drop	AS546B	010	85006	...	
	1253069B000	010	85005	89430	
	AS30698	010	85005	89430	
RAR-210 Tag Axle	AS3069B	010	85005	89430	
	AS563B	010	83203	89436	
RAR-221 Tag Axle	S6009B	010	83203	89436	
	AS563B	010	83203	89436	
RAR-221 Tag Axle	AS789B	010	85014	...	
	S5878B	010	83207	89407	
	S6009B	010	83203	89436	
RAR-221-11, 12, 13-USW Trailer with Shock Absorber and Hanger	AS563B	010	83203	89436	
	S6009B	010	83203	89436	
RAR-221AS-11-USW, RAR-221AS-11-1-USW Trailer	1253069B000	010	85005	89430	
	AS30698	010	85005	89430	
	AS3069B	010	85005	89430	
RAR-221AS-12-USW, RAR-221AS-12-1-USW Trailer	1250546B000	010	85006	...	
	AS546B	010	85006	...	
RAR-240, RAR-240W (Mono Pivot Trailers with HD Air Suspension)							
With O.E.M. Number	1270563B000	010	85000	89436	

APPLICATION GUIDE - TRUCKS, TRAILERS, AND BUSES

Year	Model	OEM #	Front		Rear	
						
						
			Fleetline	GasSLX	Fleetline	GasSLX

RIDEWELL CORPORATION(Cont'd.)





Trailer Air-Rides(Cont'd.)

	With O.E.M. Number	1270563B003	OIO	85934	...
		1270789B000	OIO	85014	...
	RAR-243 (Mono Pivot Trailers with HD Air Suspension)	1270563B003	OIO	85934	...
	RAR-260 Overslung Air Suspension (25,000 lb Capacity)	1270563B003	OIO	85934	...
	RAR-260 Underslung Air Suspension (25,000 lb and 30,000 lb Capacity)	1270563B003	OIO	85934	...
	RideLite Trailer Air Suspension	1270563B003	OIO	85934	...
	Models with O.E.M. Number	1275943B	OIO	85005	89430
		57645	OIO	85005	89430
		665526	OIO	85014	...

Truck Air-Rides

	Fire Truck with Ridewell Front Suspension	AS 4025B	OIO	85712
	Pusher w/Axle Lift	AS563B	OIO	83203	89436	
		S6009B	OIO	83203	89436	
	RAD-221R Drive Axle	S2607B	OIO	85702	...	
		S5477B	OIO	85307	...	
	RCA-215 Models Air Suspension (RCA-215 LM, RCA-215 MM)	1250789B000	OIO	85014	...	
	RD-202B Tandem Drive Axle	S5478B	OIO	85307	...	
	RD-202S-54-48-BS Tandem Drive Air Suspension	1252607B000	OIO	85702	...	
	RD-202S-54-52T-SR Tandem Drive Air Suspension	1252607B000	OIO	85702	...	
	RSS-236, RSS-236R Self Steering Tag/Pusher Lift Axle (For 13000 lb & 16000 lb Capacity)	1253069B000	OIO	85005	89430	
		AS30698	OIO	85005	89430	
		AS3069B	OIO	85005	89430	
	RUA-220B-1-, 10, 10.5, 11, 11.5, 12, 12.5, 13 (Lift Tag Axle & Trailer Lift Suspension)	1250789B000	OIO	85014	...	
		AS789B000	OIO	85014	...	
	RUA-220B-1-, 7, 7.5, 8, 8.5, 9, 9.5, 10 (Lift Tag Axle & Trailer Lift Suspension)	1270563B000	OIO	85000	89436	
	Models with O.E.M. Number	1250563B000	OIO	85000	89436	
		1253069B000	OIO	85005	89430	
		1254190B000	OIO	85302	89420	
		1265157B000	OIO	85712	...	
		1266009B000	OIO	83130	...	
		1267120B000	OIO	85734	...	
		1267395B000	OIO	85302	89420	
		1275813B000	OIO	85704	...	
		665198	OIO	85005	89430	
		665267	OIO	85029	...	
		680101	OIO	85702	...	
		70654	OIO	85000	89436	
		90-1813	OIO	85712	...	
		AS575B	OIO	85005	89430	
		S4025B	OIO	85712	...	
		S5813B	OIO	85704	...	
		S7120B	OIO	85304	...	
S7172B	OIO	83207	89407			
S7249B	OIO	85307	...			
S7365B	OIO	85305	...			
	Additional O.E.M. Interchanges	1250005	OIO	85901				
		1254025B000	OIO	85712				
		1265478B000	OIO	85736				
		1267249B000	OIO	85712				

APPLICATION GUIDE - TRUCKS, TRAILERS, AND BUSES

Year	Model	OEM #	Front		Rear	
			 Fleetline	 GasSLX	 Fleetline	 GasSLX

ROADMASTER (MONACO)





Models with AD-123 Models Suspension (AD123-6,-8,-10,-8.75)	90045132	010	85909	...
Models with O.E.M. Number	90045188	010	85910	...

SAF HOLLAND

Trailer Air Suspension

AirLite 2 Model Trailer Air Suspension	90044025	010	83209	89414
AR-120 Models Trailer Air Suspension (AR-120, AR-120-L, AR-120-US, AR-120-US-F) (AR-120-US-L, -1, -2, -3)	90044626 90044625	010	83126	89430
AR-125 Models Trailer Air Suspension (AR-125, AR-125-L, AR-125-US, AR-125-US-F) (AR-125-US-L, -1, -2, -3)	90044626 90044625	010	83126	89430
AR-165-US Models Trailer Air Suspension (AR165-US)	90044626	010	83126	89430
AR-250 Models Trailer Air Suspension (AR-250-12) (AR-250-14, -15) (AR-250-16, -17)	90045054 90044642 90044089	010	85051	...
AR-41 Models Trailer Air Suspension (All)	90044162	010	83128	89436
AR-45 Models Trailer Air Suspension (AR-45, AR-45-1)	90044162	010	83128	89436
AR-50 Models Trailer Air Suspension (AR-50-US, AR-50-US-F,-1,-2)	90044162	010	83128	89436
AR-51 Models Trailer Air Suspension (AR51-US)	90044162	010	83128	89436
AR-70 Models Trailer Air Suspension (AR-70-9, -14, AR-70A-9, 14)	90044626	010	83126	89430
AR-75 Models Trailer Air Suspension (AR-75-12) (AR-75-6, -9, -1-12)	90044625 90044626	010	83125	...
AR-80 Models Trailer Air Suspension (AR-80-6.75) (AR-80-9, -9FM) (AR-80-9-WST)	90044046 90044868 90044626	010	83123	89405
AR-85-A Models Trailer Air Suspension (AR-85-A)	90044625	010	83125	...
AR-90 Models Trailer Air Suspension (AR-90-14, -15, -16, -17)	90044089	010	83124	89407
AR-90-1 Models Trailer Air Suspension (AR-90-1-12, -14, -17) (AR-90-1-15, -16)	90044162 90044448 90045054	010	83128	89436
AR-92 Models Trailer Air Suspension (AR-92-12) (AR-92-14) (AR-92-15) (AR-92-16) (AR-92-17) (AR-92-18)	90044162 90044992 90045040 90044448 90045054 90044794 90044642 90044089 90044769	010	83128	89436
AR-93 Models Trailer Air Suspension (AR-93-14) (AR-93-15)	90044448 90045054 90044794	010	85051	...

APPLICATION GUIDE - TRUCKS, TRAILERS, AND BUSES





Year	Model	OEM #	Front		Rear	
						
			Fleetline	GasSLX	Fleetline	GasSLX

SAF HOLLAND(Cont'd.)

Trailer Air Suspension(Cont'd.)

	(AR-93-16)	90044642	010	83127	...
	(AR-93-17)	90044089	010	83124	89407
		90044769	010	83207	89407
	AR-94 Models Trailer Air Suspension	90045028	010	85907	...
		90045048	010	85905	...
		90045049	010	85905	...
	AR-95 Models Trailer Air Suspension (AR-95-9, -12, -14, -17, All -HD Models, AR-95A-9, -12, -14, -17)	90044625	010	83125	...
	AR-955 Models Trailer Air Suspension (Liftaxle) (AR-955-9, -12, -14, -17)	90044625	010	83125	...
	(AR-955-9HD, -12HD, -14HD, -17HD)	90044625	010	83125	...
	(AR-955A-9, -12, -14, -17)	90044625	010	83125	...
	(AR-955A-9HD, -12HD, -14HD, -17HD)	90044625	010	83125	...
	ARA-93 Models Trailer Air Suspension (ARA-93-14)	90045054	010	85051	...
	ARL20 Models Trailer Air Suspension (ARL20-D, ARL20-D-US)	90044162	010	83128	89436
	ARS112 Models Trailer Air Suspension (ARS112-6)	90045096	010	85916	89430
	ARU-92 Models Trailer Air Suspension (ARU-92-8, -9, -10, -12)	90044642	010	83127	...
	ARU-93 Models Trailer Air Suspension (ARU-93-6)	90045040	010	83130	...
	(ARU-93-7, -8, -9, -10)	90044642	010	83127	...
	ARU-98 Models Trailer Air Suspension (ARU-98-17)	90045054	010	85051	...
	CB 25Y/CBX 25Y Models with Fusion Axle and Beam Assembly (10.0" Ride Height)	90044162	010	83128	89436
	CB 25Y/CBX 25Y Models with Fusion Axle and Beam Assembly (12.0" Ride Height)	90045040	010	83130	...
	CB 25Y/CBX 25Y Models with Fusion Axle and Beam Assembly (7.0" Ride Height)	90044868	010	85045	...
	CB 25Y/CBX 25Y Models with Fusion Axle and Beam Assembly (8.0" Ride Height)	90045381	010	83150	...
	CB 25Y/CBX 25Y Models with Fusion Axle and Beam Assembly (9.0" Ride Height)	90045608	010	83363	...
	CB-2300 Models Trailer Air Suspension (CB-2300-14)	90044868	010	85045	...
	(CB-2300-15)	90045381	010	83150	...
	CB-2300 Models Trailer Air Suspension (16.0" & 17.0" Ride Height)	90045298	010	83363	...
	CB-400/4000 Models Trailer Air Suspension 15.5" & 16.0" Ride Height (CB-400-15.5, CB-400-16.0)	90045298	010	83363	...
	16.5" & 17.0" Ride Height (CB-400-16.5, CB-400-17.0)	90044162	010	83128	89436
	18.0" Ride Height (CB-400-18.0)	90045040	010	83130	...
	CBX 23 & CBX 25 Models Trailer Air Suspension (16.0" & 17.0" Ride Height)	90045298	010	83363	...
	CBX 23 Models Trailer Air Suspension (CBX 23-14)	90044868	010	85045	...
	(CBX 23-15)	90045381	010	83150	...
	CBX 23 Models with 245 or 317 Fusion Axle and Beam Assembly For Bracket Type #1, 3, 4, & 5 - 15.0" Ride Height	90045608	010	83363	...
	CBX 23 with 245 or 317 Fusion Axle and Beam Assembly For Bracket Type #1, 3, 4, & 5 - 16.0" & 17.0" Ride Height	90045299	010	83389	89436
	CBX 23U Models with 342 Fusion Axle and Beam Assembly (8.0" Ride Height)	90045608	010	83363	...
	CBX 25 Models Trailer Air Suspension (CBX 25-14)	90045607	010	83150	...
	(CBX 25-16, CBX 25-17)	90045040	010	83130	...

APPLICATION GUIDE - TRUCKS, TRAILERS, AND BUSES





Year	Model	OEM #	Front		Rear	
			 Fleetline	 GasSLX	 Fleetline	 GasSLX

SAF HOLLAND(Cont'd.)

Trailer Air Suspension(Cont'd.)

CBX 25 Models with 245 or 338 Fusion Axle and Beam Assembly (15.0" Ride Height)	90045608	010	83363	...
CBX 25 with 245 Fusion Axle and Beam Assembly (16.0" & 17.0" Ride Height)	90045299	010	83389	89436
CBX 25U-4 Models with 342 Fusion Axle and Beam Assembly (9.0" Ride Height)	90045608	010	83363	...
CBX 30 Models with 245 or 338 Fusion Axle and Beam Assembly (15.0" Ride Height)	90045608	010	83363	...
CBX 30 with 245 Fusion Axle and Beam Assembly (16.0" & 17.0" Ride Height)	90045299	010	83389	89436
CBX 40 Models Trailer Air Suspension (CBX 40 -16.5, CBX 40 -17.0) (CBX 40-18.0)	90044162	010	83128	89436
	90045040	010	83130	...
CBX 40 Models with 265 Fusion Axle and Beam Assembly (15.5" & 16.0" Ride Height)	90045298	010	83363	...
CBX 46 Models Trailer Air Suspension (16" Ride Height)	90045298	010	83363	...
CBX 46 Models Trailer Air Suspension (16.5" & 17.0" Ride Height)	90044162	010	83128	89436
CBX 50 Models Trailer Air Suspension (16" Ride Height)	90045298	010	83363	...
CBX 50 Models Trailer Air Suspension (16.5" & 17.0" Ride Height)	90044162	010	83128	89436
CBX 69 Trailer Air Suspension	90045669	010	83389	89436
NL-200 Models Non Steer - Auxiliary Lift Air Suspension (NL-200-1S, NL-200-2S)	90044162	010	83128	89436
NS-190 Models Trailer Air Suspension (NS-190-16.0) (NS-190-16.5, NS-190-17.0) (NS-190-18.0)	90044162	010	83128	89436
	90045040	010	83130	...
	90045054	010	85051	...
NS-400 Models Trailer Air Suspension (NS-400-16.0) (NS-400-16.5) (NS-400-18.0)	90045298	010	83363	...
	90044162	010	83128	89436
	90045040	010	83130	...
NS-400 Models Trailer Air Suspension (17.0" Ride Height)	90045299	010	83389	89436
NS-450 Models Trailer Air Suspension (NS-450-16.0) (NS-450-16.5) (NS-450-18.0)	90045298	010	83363	...
	90044162	010	83128	89436
	90045040	010	83130	...
NS-450 Models Trailer Air Suspension (17.0" Ride Height)	90045299	010	83389	89436
RL-196 Models Trailer Air Suspension (RL-196-12) (RL-196-14, -15) (RL-196-16, -17)	90044977	010	83115	...
	90044978	010	85059	...
	90044979	010	83113	...
RL-196A Models Trailer Air Suspension (RL-196A-12) (RL-196A-14, -15) (RL-196A-16, -17)	90044162	010	83128	89436
	90045040	010	83130	...
	90044794	010	83127	...
RL-228 Models Trailer Air Suspension (RL-228-12-3) (RL-228-14-3, -14-4, -15-3, -16-3) (RL-228-17-3)	90044162	010	83128	89436
	90044642	010	83127	...
	90044089	010	83124	89407
RL-230 Models Trailer Air Suspension (RL-230-12-3) (RL-230-14-3, -15-3) (RL-230-16-3, -17-3)	90045381	010	83150	...
	90044642	010	83127	...
	90044089	010	83124	89407
RL-230 Models Trailer Air Suspension (Hanger Mounted Shock) (RL-230-14-3, -15-4) (RL-230-16-4)	90045381	010	83150	...
	90045299	010	83389	89436

APPLICATION GUIDE - TRUCKS, TRAILERS, AND BUSES









Year	Model	OEM #	Front		Rear	
						
			Fleetline	GasSLX	Fleetline	GasSLX

SAF HOLLAND(Cont'd.)

Trailer Air Suspension(Cont'd.)

	(RL-230-17-4)	90045040	010	83130	...
	RL-230 Models Trailer Air Suspension (Single Stud Air Spring)						
	(RL-230-14-3, -15-4, -16-4)	90044642	010	83127	...
	(RL-230-17-4)	90044089	010	83124	89407
	RL-250 Models Trailer Air Suspension (Shock Below Frame)						
	(RL-250-14-3, -15-4)	90045040	010	83130	...
	(RL-250-16-4, -17-4)	90045299	010	83389	89436
	RL-250 Models Trailer Air Suspension (Std Suspension)						
	(RL-250-12)	90045054	010	85051	...
	(RL-250-14.0, -15.0)	90044642	010	83127	...
	(RL-250-16.0, -17.0)	90044089	010	83124	89407
	RL-300 Models Trailer Air Suspension (Offset Stud Air Spring)						
	(RL-300-13)	90045054	010	85051	...
	(RL-300-14, -15, -16, -17)	90045338	010	85060	...
	RL-300 Models Trailer Air Suspension (Std Suspension)						
	(RL-300-12, -13)	90045054	010	85051	...
	(RL-300-14, -15, -16, -17)	90045338	010	85060	...
	RLSA Models Trailer Air Suspension (RLSA-4212, -4812)	90044977	010	83115	...
	RLSA Models Trailer Air Suspension (RLSA-4214, -4215, -4814, -4815)	90044978	010	85059	...
	RLSA Models Trailer Air Suspension (RLSA-4216, -4217, -4816, -4817)	90044979	010	83113	...
	RLSA228 Models Trailer Air Suspension (RLSA-228-4214, -4215, -4216, -4814, -4815, -4816)	90044642	010	83127	...
	RLSA228 Models Trailer Air Suspension (RLSA-228-4217, -4817)	90044089	010	83124	89407
	RLU-228 Models Trailer Air Suspension						
	(RLU-228-10-3)	90044089	010	83124	89407
	(RLU-228-6-3)	90045040	010	83130	...
	(RLU-228-7-3)	90044642	010	83127	...
	(RLU-228-8-3, RLU-228-9-3)	90044626	010	83126	89430
	RLU-228 Models Trailer Air Suspension (Axle Mounted Shock Suspension)						
	(RLU-228-8-3)	90044162	010	83128	89436
	(RLU-228-9-3, RLU-228-10-3, RLU-228-12-3)	90044642	010	83127	...
	RLU-228 Models Trailer Air Suspension (Current Production - w/3" Axle Travel Up)						
	(RLU-228-10-3, RLU-228-12-3)	90044642	010	83127	...
	(RLU-228-6-3)	90045298	010	83363	...
	(RLU-228-7-3)	90044162	010	83128	89436
	(RLU-228-8-3)	90045040	010	83130	...
	(RLU-228-9-3)	90045054	010	85051	...
	RLU-228 Models Trailer Air Suspension (Current Production - w/4" Axle Travel Up)						
	(RLU-228-10-4)	90044642	010	83127	...
	(RLU-228-8-4)	90044162	010	83128	89436
	(RLU-228-9-4, RLU-228-12-4)	90044626	010	83126	89430
	RLU-228 Models Trailer Air Suspension (Current Production - w/4" Axle Travel Up) HVY DTY						
	(RLU-228-8-4)	90045337	010	85911	...
	RLU-250 Models Trailer Air Suspension						
	(RLU-250-12)	90044642	010	83127	...
	(RLU-250-6.5)	90045381	010	83150	...
	(RLU-250-9)	90044162	010	83128	89436
	RLU-250 Models Trailer Air Suspension (Frame Mount Suspension)						
	(RLU-250-12-FMT)	90045054	010	85051	...
	(RLU-250-6.5-FMT)	90045381	010	83150	...

APPLICATION GUIDE - TRUCKS, TRAILERS, AND BUSES

Year	Model	OEM #	Front		Rear	
						
						
			Fleetline	GasSLX	Fleetline	GasSLX

SAF HOLLAND(Cont'd.)





Trailer Air Suspension(Cont'd.)

	(RLU-250-9-FMT)	90044162	010	83128	89436
	RLU-300 Models Trailer Air Suspension (Std Suspension)						
	(RLU-300-6.5)	90045471	010	83150	...
	(RLU-300-9)	90045337	010	85911	...
	Trailer Air Suspension (RL196-16,-17)	90044979	010	83113	...
	Models with O.E.M. Number						
		665454	010	85045	...
		671931	010	85916	89430
		680234	010	85906	89407
		680268	010	85323	89436
		90044980	010	85907	...
		90045000	010	85906	89407
		90045001	010	85323	89436
		90045002	010	85906	89407
		90045003	010	85323	89436
		90045080	010	85912	...
		90045083	010	85910	...
		90045188	010	85910	...
		90045207	010	...	89405
		90045433	010	85916	89430
		90045563	010	85014	...
		90045564	010	83128	89436
		90045572	010	85045	...
		90045574	010	83130	...
		90045575	010	85051	...
		90045576	010	83150	...
		90045665	010	85029	...
		90045667	010	85060	...
		XB-SPN-053-36	010	83125	...
	Models with O.E.M. Number (Hvy Duty)	90045666	010	85051	...
	Models with O.E.M. Number (STD)	90045666	010	83130	...

Truck & Tractor Air Suspension (Tag Axle)

	Models with O.E.M. Number						
		57639	010	85000	89436
		57643	010	85013	89414
		6025	010	83122	89406
		6026	010	83204	...
		665197	010	85051	...
		665514	010	83127	...
		665969	010	...	89430
		90044001	010	85005	89430
		90044071	010	85000	89436
		90044081	010	85000	89436
		90044086	010	85000	89436
		90044089C	010	83124	89407
		90044095	010	83203	89436
		90044679	010	83122	89406
		90044680	010	83125	...
		90044681	010	83204	...
		90044682	010	83209	89414
		90044683	010	83122	89406
		90044684	010	83124	89407
		90044685	010	83389	89436
		90044686	010	85051	...
		90044687	010	83125	...
		90044688	010	83122	89406

APPLICATION GUIDE - TRUCKS, TRAILERS, AND BUSES

Year	Model	OEM #	Front		Rear	
						
			Fleetline	GasSLX	Fleetline	GasSLX

SAF HOLLAND(Cont'd.)





Truck & Tractor Air Suspension (Tag Axle)(Cont'd.)

Model	OEM #						
Models with O.E.M. Number	90044770	010	83207	89407	
	90044833	010	85052	...	
	90044834	010	85052	...	
	90044878	01-	83635	...	
	90044915	010	83127	...	
	90044981	010	85000	89436	
	90044982	010	85000	89436	
	90044991	010	85000	89436	
	90045110	010	83137	...	
	90045175	010	85916	89430	
	90045384	010	...	89430	
	AR-1008	010	85006	...	
	AR-1141	010	83204	...	
	AR-1141-C	010	83204	...	
	AR-1202	010	85300	89419	
	AR-134-C	010	85005	89430	
	AR-1404	010	85301	...	
	AR-1425	010	85301	...	
	AR-1434	010	83203	89436	
	AR-1654	010	83209	89414	
	AR-1822	010	85304	...	
	AR-2451	010	83203	89436	
	AR-2598	010	83123	89405	
	AR-718-C	010	83203	89436	
	AR-718-C-HD	010	85000	89436	
	AR-781	010	83203	89436	
	AR-958	010	83207	89407	
	AR-995	010	85734	...	

Truck, Bus & Motorhome Air Suspensions

AD-123 Models Truck and Tractor Air Suspension (AD123-6,-8,-10,-8.75)	90045068	-10	...	89441	
AD-123 Models Truck and Tractor Air Suspension (AD123-6,-8,-10,-8.75)							
Shock Mount approx. 2-1/2" above bottom of frame	90045132	010	85909	...	
Shock Mount flush with bottom of frame	90045099	010	85906	89407	
AD-130 Models Truck and Tractor Air Suspension (AD123-6,-8,-10,-8.75)	90045466	010	...	89406	
AD-130 Models Truck and Tractor Air Suspension W/ OEM Number	90045432	010	85321	...	
AD-150 Models Truck & Tractor Air Suspension	90045075	010	85911	...	
AD-200 Models Truck & Tractor Air Suspension (AD-200-7, -8, -9, -11)	90045138	010	85910	...	
AD-246 Models Truck & Tractor Air Suspension (AD246 -6, -8, -10, -8.75)	90045099	010	85906	89407	
	90045132	010	85909	...	
00 - AD-246 Models with 10" Ride Height	90045504	010	85030	89440	
AD-252-10 Tandem Axle	90045132	010	85909	...	
00 - AD-369 Models with 10" Ride Height	90045504	010	85030	89440	
ADZ-123 Models Truck and Bus Air Suspension	90045605	010	85109	...	
ADZ-126 Models Truck and Bus Air Suspension	90045605	010	85109	...	
ADZ-246 Models Truck and Bus Air Suspension	90045605	010	85109	...	
ADZ-252 Models Truck and Bus Air Suspension	90045605	010	85109	...	
ADZ-369 Models Truck and Bus Air Suspension	90045605	010	85109	...	
ADZ-378 Models Truck and Bus Air Suspension	90045605	010	85109	...	
ARD-120 Models Truck & Tractor Air Suspension (ARD-120-6)	90044025	010	83209	89414	

APPLICATION GUIDE - TRUCKS, TRAILERS, AND BUSES









Year	Model	OEM #	Front		Rear	
			 Fleetline	 GasSLX	 Fleetline	 GasSLX

SAF HOLLAND(Cont'd.)

Truck, Bus & Motorhome Air Suspensions(Cont'd.)

ARD-125 Models Truck & Tractor Air Suspension (ARD-125-6 use on Ford, GM, International (Navistar), Mack, White, Western Star, Freightliner) (ARD-125-8 use on Freightliner, White, Western Star) (ARD-125-8 use on Mack)	90044025		010	83209	89414
	90044011		010	85004	...
	90044016		010	85300	89419
ARD-165 Models Truck & Tractor Air Suspension (ARD-165-A, ARD-165-B)	90044011		010	85004	...
ARD-190 Models Truck & Tractor Air Suspension (ARD-190-B)	90044016		010	85300	89419
ARD-234 Models Truck & Tractor Air Suspension (ARD-234-6)	90044046		010	83123	89405
ARD-238 Models Truck & Tractor Air Suspension (ARD-238-6)	90044025		010	83209	89414
ARD-244 Models Truck & Tractor Air Suspension (ARD-244-6 use on Ford, GM, International (Navistar), Mack, White, Western Star, Freightliner) (ARD-244-8 use on Freightliner, White, Western Star) (ARD-244-8 use on Mack)	90044025		010	83209	89414
	90044011		010	85004	...
	90044016		010	85300	89419
ARDAB-120 Models Truck & Tractor Air Suspension (ARDAB-120-5)	90044907		01-	83635	...
ARDAB-238-5 Models Truck & Tractor Air Suspension	90044907		01-	83635	...
ARDAB-240 Models Truck & Tractor Air Suspension (ARDAB-240-5)	90044907		01-	83635	...
ARDST-123 Models Truck & Tractor Air Suspension (ARDST-123-6, ARDSTM/L-123-6)	90044025		010	83209	89414
ARDST-244 Models Truck & Tractor Air Suspension (ARDST-244-6)	90044025		010	83209	89414
ARDST-246 Models Truck & Tractor Air Suspension (ARDST-246-6, ARDSTM/L-246-6)	90044025		010	83209	89414
ARDST-250-6 Models Truck & Tractor Air Suspension	90044025		010	83209	89414
ARDTB-125 Models Bus Air Suspension (ARDTB-125-6A)	90044448		010	85051	...
ARDTB-125 Models Bus Air Suspension (ARDTB-125-6B)	90045031		010	85968	...
ARDTB-125-6A (Note: Front shock)	90045050	010	85914
ARDTB-125-6A (Note: Rear shock)	90045053		010	85908	...
ART-500 Models Truck & Tractor Tag Axle Air Suspension (ART-500-B, ART-500-B-1) (ART-500-US, ART-500-US-A)	90044162		010	83128	89436
	90044008		010	85000	89436
ART-505 Models Truck & Tractor Tag Axle Air Suspension (ART-505-B, -1, ART-505-C, -1)	90044162		010	83128	89436
ART-541 Models Truck & Tractor Tag Axle Air Suspension (ART-541B)	90044162		010	83128	89436
ART-550 Models Truck & Tractor Tag Axle Air Suspension (ART-550-US-1, -2, -3)	90044012		010	85006	...
ART-551 Models Truck & Tractor Tag Axle Air Suspension (ART-551-B-1) (ART-551-B-2, -3, ART-551-US-1, -2, -3)	90044162		010	83128	89436
	90044017		010	83204	...
ART-555 Models Truck & Tractor Tag Axle Air Suspension (ART-555-B-1, ART-555-C-1) (ART-555-B-2, -3, ART555C-2, -3)	90044162		010	83128	89436
	90044642		010	83127	...
Models with O.E.M. Number	471700000433		010	85099	...
	471700000436		010	85030	89440
	471700000458		010	85014	...
	471700000459		010	85030	89440
	471700000460		010	85097	...
	471700000461		010	...	89414
	481700000483		010	85975	...
	481700000484		010	85974	...
	481700000485		010	85975	...
	665002		010	85004	...
	665003		010	85300	89419

APPLICATION GUIDE - TRUCKS, TRAILERS, AND BUSES

Year	Model	OEM #	Front		Rear	
						
						
			Fleetline	GasSLX	Fleetline	GasSLX

SAF HOLLAND(Cont'd.)

Truck, Bus & Motorhome Air Suspensions(Cont'd.)

Models with O.E.M. Number	671921	010	85916	89430
	671922	010	...	89405
	671923	010	...	89440
	680645	010	85321	...
	90045084	010	85968	...
	90045277	010	85030	89440
	90045336	010	85014	...
	90045418	010	85916	89430
	90045419	010	...	89405
	90045420	010	...	89440
	90045455	010	85909	...
	90045499	010	85974	...
	90045500	010	85975	...
	90045503	010	85975	...
	90045504	010	85030	89440
	90045532	010	85030	89440
	90045533	010	85099	...
	90045534	010	85014	...
	90045535	010	85097	...
	90045536	010	...	89414
90045568	010	85060	...	

SEAGRAVE FIRE APPARATUS LLC

Models with O.E.M. Number	680117	010	85300	89419
	P0025500	010	85300	89419

SHASTA RV

All models with Ford E350 & E450 Chassis	ASH-1136	-10	83178	...
	ASH-1154	-10	83177

SHOWHAULER MOTORHOMES

Models with Cascadia Chassis - See Freightliner section for proper year and model information
Models with Kenworth Chassis - See Kenworth section for proper year and model information
Models with Lonestar Chassis - See International section for proper year and model information
Models with VNL Chassis - See Volvo section for proper year and model information

SICARD

Models with O.E.M. Number	3166657		85700	...	010	85700	...
---------------------------	---------	--	-------	-----	-----	-------	-----

SOUTHERN COACH

Early Model Air Suspension		85304	...	010	85304	...
Late Model Air Suspension		83217	...	010	83217	...
U.S. Army Coaches		83217	...	010	83217	...

SPARTAN MOTORS

97 - 00	Alpine / Summit MotorHome Chassis with O.E.M. Number	0377-SS5	010	85029	...
		B46-1725	010	85029	...
	Buses with Hendrickson Softek Suspension with Drum and Disc Brakes	471700000456	010	85959
		58913-009	010	85959
		58913-009L	010	85959
	Chassis With Hendrickson HTS 210 Suspension (Type C School Bus Applications)	60665-025		010	85036 89405

APPLICATION GUIDE - TRUCKS, TRAILERS, AND BUSES

Year	Model	OEM #	Front			Rear		
			Fleetline	GasSLX		Fleetline	GasSLX	

SPARTAN MOTORS(Cont'd.)

	Chassis With Hendrickson HTS 210 Suspension (Type C School Bus Applications)	60665-025L		010	85036	89405
	Fire Truck with O.E.M. Number	0272-SS5	010	85712
1986	Fire Truck with Ridewell Front Suspension	AS 4025B	010	85712
97 - 00	K2 / K3/ MountainMaster with O.E.M. Number	B46-2151		010	85007	89412
91 - 95	K2 / K3/ MountainMaster with Tuthill 102 AR Air Suspension	0346-SS5		010	85013	89414
		B46-1594		010	85013	89414
	Models with Reyco 1200 Steer Option)	21310-01	010	85307
	Motorhome chassis with Ridewell Front Suspension	AS 4025B	010	85712
	Models with O.E.M. Number	59011	010	83214
	Additional O.E.M. Interchanges	78068	010	85304				

STARCRAFT BUS CO.









Allstar XL & XLT - Series

00 - 15	Models with F-650 chassis with 10,000 lb Front Suspension	3584116C1	010	83175
		3584116C2	010	83175
		4C4Z-18124-QA	010	83175
		AA-616	010	83175
00 - 15	Models with F-650 chassis with 12,000 & 13,200 lb Front Springs	3584118C2	010	85928
		4C4Z-18124-JB	010	85928
		4C4Z-18124-RA	010	85928
		AA-617	010	85928
		AT-812	010	85928
July/2015 - 19	Models with F-650 chassis with 13,500, 15,500 & 19,000 lb Multi-leaf Rear Springs	471700011531		010	85180	...
		ASH-24660		010	85180	...
		FC44-18080-AB		010	85180	...
		FC4Z-18125-A		010	85180	...
July/2015 - 19	Models with F-650 chassis with 19.5" or 22.5" Wheels (22,000 lb GVW)	471700011530	010	85181
		ASH-24658	010	85181
		ASH-24659	010	85181
		FC44-18045-BB	010	85181
		FC4Z-18124-A	010	85181
		FC4Z-18124-B	010	85181
- 2015	Models with F-650 chassis with 21,000 lb Rear Air Suspension	3578858C1		010	85926	...
		3578858C2		010	85926	...
		4C4Z-18125-DA		010	85926	...
04 - 11	Models with F-650 chassis with 22,000 lb Multi-leaf Rear Springs	4C4Z-18125-B		-10	83317	...
		501906C92		-10	83317	...

E350 & E450 Ford Chassis Models

- 2019	Allstar Series Shuttle buses with Ford E350 & E450 Chassis	ASH-1136		-10	83178	...
		ASH-1154	-10	83177
- 2019	MVP Series Shuttle buses with Ford E450 Chassis	ASH-1136		-10	83178	...
		ASH-1154	-10	83177
- 2019	Starlite Series Shuttle buses with Ford E350 & E450 Chassis	ASH-1136		-10	83178	...
		ASH-1154	-10	83177
- 2019	Starquest Series Shuttle buses with Ford E350 & E450 Chassis	ASH-1136		-10	83178	...
		ASH-1154	-10	83177
- 2019	Ultra Star Series Shuttle buses with Ford E450 Chassis	ASH-1136		-10	83178	...
		ASH-1154	-10	83177
- 2019	Xpress Series Shuttle buses with Ford E350 & E450 Chassis	ASH-1136		-10	83178	...
		ASH-1154	-10	83177

APPLICATION GUIDE - TRUCKS, TRAILERS, AND BUSES

Year	Model	OEM #	Front		Rear	
						
						
			Fleetline	GasSLX	Fleetline	GasSLX

STERLING TRUCK

A - Line 9500 Series (SilverStar)

1998 -	A9513, A9522, AT9513, AT9522 (113" & 122" BBC) Models with 8500 or 9000 lb Axle and 54" Taperleaf Spring	F6HT-18045-HB	010	85054	89438	
		F6HT-18045-HC	010	85054	89438	
1998 -	A9513, A9522, AT9513, AT9522 (113" & 122" BBC) Models with 8500, 9000 or 10000 lb Axle and 54" Multileaf Spring	F6HT-18045-KA	010	83200	89402	
1998 -	All Models with 10000 lb or 12000 lb Axle and 54" Taperleaf Spring	F6HT-18045-AC	010	85054	89438	
1998 -	All Models with 12000 lb or 13200 lb Axle and 54" Multileaf Spring	F6HT-18045-BC	010	85047	89435	
1998 -	All Models with 12000 lb, 13200 lb or 14600 lb Axle and 60" Taperleaf Spring	F6HT-18045-EB	010	85055	89439	
		F6HT-18045-EC	010	85055	89439	
1998 -	All Models with 13200 lb or 14600 lb Axle and 54" Taperleaf Spring	F6HT-18045-GC	010	85030	89440	
1998 -	All Models with 14600 lb or 16000 lb Axle and 54" Multi-leaf Spring	F6HT-18045-CC	010	85055	89439	
1998 -	All Models with 23000 lb Axle and 52" Taperleaf Softride Rear Suspension	F6HT-18080-CA		010	85314	89425
1998 -	All Models with Hendrickson 40LH Tandem Axle	57241-2		01-	83109	...
1998 -	All Models with Hendrickson HAS Rear Air Suspension	47902-28		010	85013	89414
		F6HT-18080-FC		010	85013	89414
1998 -	Models with FAS II Rear Air Suspension	16-15817-000		010	85724	89443
98 - 03	Models with O.E.M. Number	10-13205-000	010	85918	89449	
		471700131646	010	85918	89449	

ACTERRA

	All Models with Freightliner TufTrac Rear Air Suspension	16-15770-000		010	85956	...
		481700125969		010	85956	...
09 - 10	Models with 10000 to 12000 lb. Front Axle and 3" Taper-leaf Suspension	10-13592-000	010	85959
		SDA471700000440	010	85959
2003 -	Models with 10000 to 12000 lb. Taper-leaf Spring Suspension	10-12390-000	010	85920	89503	
		Models with 11000 to 12000 lb Front axle	6803230300	010	85006
	Models with 15000 lb Rear Suspension	6803260000		01-	83120	...
- 2002	Models with 6000 to 9000 lb Front axle	6803230200	010	85043
03 - 08	Models with 6000 to 9000 lb Front axle	10-12388-000	010	85920	89503	
03 - 10	Models with FAS II Rear Air Suspension	16-15817-000		010	85724	89443
		16-18708-000		010	85724	89443
		471700002809		010	85724	89443
		481700006848		010	85724	89443
		680611		010	85724	89443
		SDA471700002809		010	85724	89443
- 04/09	Models with Hendrickson Airtek Suspension	58913-003	010	85932	89453	
		58913-003L	010	85932	89453	

Cargo Line

1998	SC-7000 or SC-8000 Models with 12000 or 13000 lb. Axles	F6HT-18045-LA	010	85376
1998	SC-7000 or SC-8000 Models with 16000 lb. Multileaf Spring	F6HT-18045-AA	010	85054	89438	

L - Line 7500 Series - Short Haul Tractor

	Models with 10000 lb Front Axle	F6HT-18045-KA	010	83200	89402	
--	---------------------------------	---------------	-----	-------	-------	--	-----	-----

L - Line 8500 Series - Conventional Cab

1998	All Models with 10000 lb or 12000 lb Axle and 54" Taperleaf Spring	F6HT-18045-AC	010	85054	89438	
1998 -	All Models with 12000 lb or 13200 lb Axle and 54" Multileaf Spring	F6HT-18045-BC	010	85047	89435	
1998 -	All Models with 12000 lb, 13200 lb or 14600 lb Axle and 60" Taperleaf Spring	F6HT-18045-EB	010	85055	89439	
		F6HT-18045-EC	010	85055	89439	
1998 -	All Models with 13200 lb or 14600 lb Axle and 54" Taperleaf Spring	F6HT-18045-GC	010	85030	89440	

APPLICATION GUIDE - TRUCKS, TRAILERS, AND BUSES

Year	Model	OEM #	Front		Rear	
			Fleetline	GasSLX	Fleetline	GasSLX

STERLING TRUCK(Cont'd.)

L - Line 8500 Series - Conventional Cab(Cont'd.)

1998 -	All Models with 14600 lb or 16000 lb Axle and 54" Multi-leaf Spring	F6HT-18045-CC	010	85055	89439	
1998 -	All Models with 23000 lb Axle and 52" Taperleaf Softride Rear Suspension	F6HT-18080-CA		010	85314	89425
1998	All with Hendrickson HAS Rear Air Suspension	47902-28		010	85013	89414
		F6HT-18080-FC		010	85013	89414
1998	LT-8000 Models with 12000 or 13000 lb Axles	F6HT-18045-LA	010	85376
1998	LT-8000 Models with 16000 lb. Multileaf Spring	F6HT-18045-AA	010	85054	89438	
1998	LT-8501 (101" BBC) Models with 8500 or 9000 lb Axle and 54" Multileaf Spring	F6HT-18045-JB	010	83200	89402	
		F6HT-18045-JC	010	83200	89402	
	LT-8501 (101" BBC) Models with 8500 or 9000 lb Axle and 54" Taperleaf Spring	F6HT-18045-HB	010	85054	89438	
		F6HT-18045-HC	010	85054	89438	
99 - 10	Models with FAS II Rear Air Suspension	16-15817-000		010	85724	89443
		680611		010	85724	89443
1998	Models with Hendrickson 40LH Tandem Axle	57241-2		01-	83109	...





L - Line 9500 Series - Conventional Cab

1998	All Models with 10000 lb or 12000 lb Axle and 54" Taperleaf Spring	F6HT-18045-AC	010	85054	89438	
1998 -	All Models with 12000 lb or 13200 lb Axle and 54" Multileaf Spring	F6HT-18045-BC	010	85047	89435	
1998 -	All Models with 12000 lb, 13200 lb or 14600 lb Axle and 60" Taperleaf Spring	F6HT-18045-EB	010	85055	89439	
		F6HT-18045-EC	010	85055	89439	
1998 -	All Models with 13200 lb or 14600 lb Axle and 54" Taperleaf Spring	F6HT-18045-GC	010	85030	89440	
1998 -	All Models with 14600 lb or 16000 lb Axle and 54" Multi-leaf Spring	F6HT-18045-CC	010	85055	89439	
1998 -	All with 23000 lb Axle and 52" Taperleaf Softride Rear Suspension	F6HT-18080-CA		010	85314	89425
1998 -	All with Hendrickson HAS Rear Air Suspension	47902-28		010	85013	89414
		F6HT-18080-FC		010	85013	89414
1998 -	LT-9501, LT-9511, LT-9513 or LT-9513 (113" & 122" BBC) Models with 8500 or 9000 lb Axle and 54" Multileaf Spring	F6HT-18045-JB	010	83200	89402	
		F6HT-18045-JC	010	83200	89402	
1998 -	LT-9501, LT-9511, LT-9513 or LT-9513 (113" & 122" BBC) Models with 8500 or 9000 lb Axle and 54" Taperleaf Spring	F6HT-18045-HB	010	85054	89438	
		F6HT-18045-HC	010	85054	89438	
99 - 10	Models with FAS II Rear Air Suspension	16-13957-000		010	85724	89443
		XC45-18080-BA		010	85724	89443
1998 -	Models with Hendrickson 40LH Tandem Axle	57241-2		01-	83109	...

Additional O.E.M. Interchanges

	Models with Link Rear Air Suspension	1210-0528		010	85904	...
	Models with Neway Rear Suspension	90045099		010	85906	89407
	Models with O.E.M. Number	16-15770-000		010	85956	...
		4C4Z-18124-N	010	85957
		4C4Z-18125-DA		010	85926	...
		6E7Z-18125-A		010	83146	...
		AT-560	010	G63809
		AX-267A	010	83309	89446	
		AX-310		010	83215	...
		C4HZ-18124-E	010	83309	89446	
		C4TZ-18124-AB	010	83308
		D8HZ-18124-A	010	85301
		E6HZ-18124-A	010	85301
		E6HZ-18124-D	010	85301
		E6HZ-18125-D		010	83215	...
E7HZ-18124-A	010	85301		

APPLICATION GUIDE - TRUCKS, TRAILERS, AND BUSES

Year	Model	OEM #	Front		Rear	
			 Fleetline	 GasSLX	 Fleetline	 GasSLX

STERLING TRUCK(Cont'd.)

Additional O.E.M. Interchanges(Cont'd.)

Models with O.E.M. Number	OEM #					
E7XZ-18124-A	-10	G63386
E7XZ-18125-B		-10	G63387	...
E9HZ-18124-A	010	83309	89446	
F0HZ-18124-B	010	85006
F1HZ-18124-A	010	83309	89446	
F1HZ-18124-B	010	83308
F1HZ-18124-D	010	85006	89401	
F1HZ-18124-E	010	85006	89401	
F1HZ-18124-H	010	85040
F1HZ-18124-J	010	83308
F1HZ-18124-K	010	...	89402	
F2HZ-18124-A	010	85376
F2HZ-18124-B	010	85301
F4HT-18080-AB		010	85314	89425
F4HT-18080-BA		010	85001	89410
F5HZ-18124-A	010	83314
F5HZ-18124-B	010	83107
F5HZ-18124-C	010	85063
F5HZ-18124-D	010	83125
F5HZ-18125-A		010	85314	89425
F5HZ-18125-B		010	85001	89410
F6HT-18045-GB	010	85030	89440	
F6HT-18080-B		01-	83109	...
F6HT-18080-DA		01-	83109	...
F6HT-18080-EA		010	85906	89407
F6HT-18124-JC	010	83200	89402	
F6HT-18124-KA	010	83200	89402	
F6HZ-18124-A	010	85054	89438	
F6HZ-18124-B	010	83308
F6HZ-18124-C	010	85055	89439	
F6HZ-18124-D	010	85055	89439	
F6HZ-18124-E	010	85055	89439	
F6HZ-18124-F	010	85055	89439	
F6HZ-18124-G	010	85054	89438	
F6HZ-18124-H	010	85054	89438	
F6HZ-18124-J	010	83200	89402	
F6HZ-18125-B		01-	83109	...
F6HZ-18125-D		010	85013	89414
F81A-18045-AGB	010	G63809
XC45-18045-AA	010	83216





STERLING TRUCK CAB SHOCKS

8500 & 9500 Models with 113" & 122" BBC Conventional Tractors with Link Cabmate Models FH1322 & FH1322-A	1202-1043	010	83025
AT-9500 Models with O.E.M. Number	F6HZ-5K407-BA	010	83033
	F8HT-5K407-AA	010	83033
L8501 & L9501 Models with 101" BBC Conventional Tractors with Link Cabmate Model FH101	1202-1043	010	83025
LT-9500 Models with O.E.M. Number	F6HZ-5K407-AB	010	83034
Models with O.E.M. Number	18-45067-000	010	83034

ACTERRA

03 - 10	Acterra Models with O.E.M. Number	18-43504-000	010	83057
		18-60768-000	010	83057
		18-814903003484	010	83057

APPLICATION GUIDE - TRUCKS, TRAILERS, AND BUSES

Year	Model	OEM #	Front		Rear	
			 Fleetline	 GasSLX	 Fleetline	 GasSLX

STOUGHTON TRAILERS INC.

	Trailers with Hendrickson HT190T, HT190U, & HS190T Models Air Suspension	HTA20001		010	83128	89436
	Trailers with Hendrickson HT230T Models Air Suspension	HTA20002		010	85000	89436
	Trailers with Neway AR-90-1-12, -14, -17 Models Air Suspension	NW90044162		010	83128	89436
	Trailers with Neway AR-90-1-15, -16 Models Air Suspension	NW90044448		010	85051	...
	Trailers with Neway RL-196-14, -15, Models Air Suspension	NW90044978		010	85059	...
	Trailers with Neway RL-196-16, -17, Models Air Suspension	NW90044979		010	83113	...
	Trailers with Reyco 86AR/RS1015 Air Ride Suspension	RT18165-01		010	85006	...
	Trailers with Reyco 86AR/RS1035 Anti-Dock Walk Air Suspension	RT18165-01		010	85006	...

SUSPENSYS

	FS230 Trailer Suspension (Light Duty)	218004872		010	85737	...
--	---------------------------------------	-----------	--	-----	-----	-----	-------	-----





THE BINKLEY COMPANY

1997	Trailers with Binkley AirLite Suspension	16965		010	85006	...
		6898		010	83125	...

THOMAS SCHOOL BUS

	Buses with Neway Tandem Air Suspension	61310232		010	85000	89436
	Buses with O.E.M. Number	16-19138-000	010	85058	89431	
	Model MVP	61310101		85736	...	010	85736	...
06 - 18	Models with B2 Bus Chassis with FAS II Rear Air Suspension	16-15817-000		010	85724	89443
		16-18708-000		010	85724	89443
- 2018	Models with Freightliner B2 Bus Chassis & 15000 lb Rear Suspension	6803260000		01-	83120	...
06 - 15	Models with Freightliner CC B2 Bus Chassis	10-13634-000	010	85918	89449	
06 - 18	Models with Freightliner CC B2 Bus Chassis	10-13211-000	010	85918	89449	
	ROC Front, SAF-T-Liner	61300285	-1-	83102
		GBL651442	-1-	83102
	SAF-T-Liner HDX Models with Hendrickson Comfort Air Rear Air Suspension	471700131545		010	85006	...
		60998-001		010	85006	...
		60998-003		010	85006	...
	SAF-T-Liner School Bus MVP-ER & MVP-EF	61300219	010	85091
		61300222	010	85091
		61300223	010	85091
		70445	010	85091
2009	SAF-T-Liner School Bus with SAF Holland AD-246 Suspension	90045504	010	85030	89440	
2009	SAF-T-Liner School Bus with SAF Holland AD-369 Suspension	90045504	010	85030	89440	
	School Bus	300-0614966		010	85307	...
		614966		010	85307	...
		614974	010	85304
		680010	010	85304
		680054		010	85307	...
07 - 12	Type C Conventional Buses (65 capacity) with 12000 lb Taperleaf Front Suspension	10-13634-000	010	85918	89449	
- 2017	Type C Conventional Buses (65 capacity) with FAS II Rear Air Suspension	16-15817-000		010	85724	89443
		16-18708-000		010	85724	89443
		61310434		010	85724	89443
		61310478		010	85724	89443
2003	Type C Conventional School buses (65 capacity) with O.E.M. Number	680-323-0300	010	85006
		GBL665538	010	85006
09-12	Type C School bus chassis with O.E.M. Number	16-18713-000		01-	85122	...
		471700003070		01-	85122	...

APPLICATION GUIDE - TRUCKS, TRAILERS, AND BUSES

Year	Model	OEM #	Front		Rear	
						
			Fleetline	GasSLX	Fleetline	GasSLX

THOMAS SCHOOL BUS(Cont'd.)

	Models with Hendrickson Comfort Air Rear Air Suspension	60670-006 60670-006L		010	83147	...
				010	83147	...
	Models with O.E.M. Number	128745	-1-	83102
		61300112	-1-	83613
		61300224	010	85918	89449	
		61300240	010	85918	89449	
		61310102		010	85308	89422
		61310103		010	85308	89422
		651442	-1-	83102
		659287	-1-	83102
		680-326-0000		01-	83120	...
		GBL654725		01-	83120	...
	Additional O.E.M. Interchanges	6130-0114	010				89437	
		6130029	010				85712	
		61310104	010				85713	
		63-0001	010				85713	
		680088	010				85713	
		680102	010				85712	
		728802	010				85736	
		87002	010				85736	
		A-4890	010				85712	

Type A School Bus









92 - 19	Minotour Type A School bus with Ford E350 Chassis	8C24-18045-DA	-10	83177
		8C2Z-18124-D	-10	83177
		ASH-1154	-10	83177
		AT-163G	-10	83177
		8C24-18080-DB		-10	83178	...
		8C2Z-18125-D		-10	83178	...
		ASH-1136		-10	83178	...
		AT-164G		-10	83178	...
00 - 19	Minotour Type A School bus with Ford E450 Chassis	8C24-18045-DA	-10	83177
		8C2Z-18124-D	-10	83177
		ASH-1154	-10	83177
		AT-163G	-10	83177
		8C24-18080-DB		-10	83178	...
		8C2Z-18125-D		-10	83178	...
		ASH-1136		-10	83178	...
		AT-164G		-10	83178	...

THOR MOTOR COACH

Class A MotorHomes

12 - 19	ACE Series MotorHomes with Ford F53 Chassis with 16,000 lb GVW to 22,000 lb GVW	ASH-1229	010	83209	89414			
		ASH-25822	010	83209	89414			
		ASH-25823	010	83209	89414			
		ASH-25824		010	83122	89406		
2006	Astoria Series MotorHomes with Freightliner XC Chassis ADL200 Suspension w/ 20K Rear AS120 Front Suspension	16-16873-000		010	85029	...		
		141700131810	010	83160		
		16-16737-000	010	83160		
		16-16874-000	010	83160		
		Rear Shock with O.E.M. Number		141700131809		010	85029	...
				16-16736-000		010	85029	...
		ZF - IFS Front Suspension with 23,000 lb GVW or Greater		16-18103-000	-1-	85900
				481700000493	-1-	85900
14 - 19	Axis Series MotorHomes with Ford E450 Chassis	ASH-1136		-10	83178	...		

APPLICATION GUIDE - TRUCKS, TRAILERS, AND BUSES

Year	Model	OEM #	Front		Rear	
						
						
			Fleetline	GasSLX	Fleetline	GasSLX

THOR MOTOR COACH(Cont'd.)

Class A MotorHomes(Cont'd.)

14 - 19	Axis Series MotorHomes with Ford E450 Chassis	ASH-1154	- 0	83177	
05 - 19	Challenger Series MotorHomes with Ford F53 Chassis with 16,000 lb GVW to 22,000 lb GVW	ASH-1229	0 0	83209	89414	
		ASH-25822	0 0	83209	89414	
		ASH-25823	0 0	83209	89414	
		ASH-25824		0 0	83122	89406
02 - 05	Escaper Series MotorHomes with Freightliner XC Chassis ADL200 Suspension w/ 20K Rear AS120 Front Suspension Rear Shock with O.E.M. Number ZF - IFS Front Suspension with 23,000 lb GVW or Greater	16-16873-000		0 0	85029	...
		141700131810	0 0	83160	
		16-16737-000	0 0	83160	
		16-16874-000	0 0	83160	
		141700131809		0 0	85029	...
		16-16736-000		0 0	85029	...
		16-18103-000	- -	85900	
		481700000493	- -	85900	
04 - 19	Hurricane Series MotorHomes with Ford F53 Chassis with 16,000 lb GVW to 22,000 lb GVW	ASH-1229	0 0	83209	89414	
		ASH-25822	0 0	83209	89414	
		ASH-25823	0 0	83209	89414	
		ASH-25824		0 0	83122	89406
14 - 19	Miramar Series MotorHomes with Ford F53 Chassis with 16,000 lb GVW to 22,000 lb GVW	ASH-1229	0 0	83209	89414	
		ASH-25822	0 0	83209	89414	
		ASH-25823	0 0	83209	89414	
		ASH-25824		0 0	83122	89406
07 - 19	Outlaw Series MotorHomes with Ford F53 Chassis with 16,000 lb GVW to 22,000 lb GVW	ASH-1229	0 0	83209	89414	
		ASH-25822	0 0	83209	89414	
		ASH-25823	0 0	83209	89414	
		ASH-25824		0 0	83122	89406
2006	Tuscany Series MotorHomes with Freightliner XC Chassis ADL200 Suspension w/ 20K Rear AS120 Front Suspension Rear Shock with O.E.M. Number ZF - IFS Front Suspension with 23,000 lb GVW or Greater	16-16873-000		0 0	85029	...
		141700131810	0 0	83160	
		16-16737-000	0 0	83160	
		16-16874-000	0 0	83160	
		141700131809		0 0	85029	...
		16-16736-000		0 0	85029	...
		16-18103-000	- -	85900	
		481700000493	- -	85900	
02 - 05	UltraSport Series MotorHomes with Freightliner XC Chassis ADL200 Suspension w/ 20K Rear AS120 Front Suspension Rear Shock with O.E.M. Number ZF - IFS Front Suspension with 23,000 lb GVW or Greater	16-16873-000		0 0	85029	...
		141700131810	0 0	83160	
		16-16737-000	0 0	83160	
		16-16874-000	0 0	83160	
		141700131809		0 0	85029	...
		16-16736-000		0 0	85029	...
		16-18103-000	- -	85900	
		481700000493	- -	85900	
14 - 19	Vegas Series MotorHomes with Ford E450 Chassis	ASH-1136		- 0	83178	...
		ASH-1154	- 0	83177	
06 - 19	WindSport Series MotorHomes with Ford F53 Chassis with 16,000 lb GVW to 22,000 lb GVW	ASH-1229	0 0	83209	89414	
		ASH-25822	0 0	83209	89414	
		ASH-25823	0 0	83209	89414	
		ASH-25824		0 0	83122	89406

APPLICATION GUIDE - TRUCKS, TRAILERS, AND BUSES

Year	Model	OEM #	Front			Rear		
			Fleetline	GasSLX		Fleetline	GasSLX	

THOR MOTOR COACH(Cont'd.)

Class C MotorHomes(Cont'd.)

08 - 13	Chateau Citation Series MotorHomes with Ford E350 & E450 Chassis	ASH-1136		-10	83178	...
		ASH-1154	-10	83177
99 - 19	Chateau Series MotorHomes with Ford E350 & E450 Chassis	ASH-1136		-10	83178	...
		ASH-1154	-10	83177
01 - 14	Citation Series MotorHomes with Ford E350 & E450 Chassis	ASH-1136		-10	83178	...
		ASH-1154	-10	83177
01 - 19	Four Winds Series MotorHomes with Ford E350 & E450 Chassis	ASH-1136		-10	83178	...
		ASH-1154	-10	83177
10 - 19	Freedom Elite Series MotorHomes with Ford E350 & E450 Chassis	ASH-1136		-10	83178	...
		ASH-1154	-10	83177
12 - 14	Majestic Series MotorHomes with Ford E350 & E450 Chassis	ASH-1136		-10	83178	...
		ASH-1154	-10	83177
16 - 19	Outlaw Series MotorHomes with Ford E350 & E450 Chassis	ASH-1136		-10	83178	...
		ASH-1154	-10	83177
16 - 19	Quantum Series MotorHomes with Ford E350 & E450 Chassis	ASH-1136		-10	83178	...
		ASH-1154	-10	83177

TIFFIN MOTORHOMES INC

Models with Freightliner Chassis - See Freightliner section for proper year and model information							
Models with Hendrickson Softek Suspension	58913-009	010	85959	
	58913-009L	010	85959	
Models with Workhorse Chassis - See Workhorse section for proper year and model information							

TIMBREN INDUSTRIES

Additional O.E.M. Interchanges	665804							
--------------------------------	--------	--	--	--	--	--	--	--

TRAIL KING INDUSTRIES

Identification of the trailer suspension is necessary to determine what section of the catalog to refer to. Some possible options can be Chalmers, Hendrickson, Neway, Ridewell, Reyco.								
---	--	--	--	--	--	--	--	--

TRAILMOBILE CANADA CORP.

Trailers with Granning Air Susp. T-350A	43-8-022							
Trailers with Hendrickson Air Susp. HT230T (23,000 lb Capacity)	43-6-118		010	85000	89436	
Trailers with Hendrickson Air Susp. HT250U, HT250U-Y	A-2212		010	85029	...	
Trailers with Hendrickson Air Susp. T23-RL-17	43-8-011		010	83207	89407	
Trailers with Hendrickson Air Susp. T23-US-6 (Non-Liftable)	43-8-015		010	85006	...	
Trailers with Hendrickson Air Susp. T23-US-9 (Liftable & Non-Liftable)	43-8-014		010	85013	89414	
Trailers with Hendrickson Air Susp. T30-US-9, -12, -14, -17	43-8-013		010	85000	89436	
Trailers with Neway Air Susp. AR90-1-14, AR90-1-17	90044089		010	83124	89407	
Trailers with Neway Air Susp. AR90-14, -17,	90044089		010	83124	89407	
Trailers with Neway Air Susp. AR92-14	90044992		010	85000	89436	
Trailers with Neway Air Susp. AR92-17	90044642		010	83127	...	
Trailers with Neway Air Susp. AR93-14	90045054		010	85051	...	
Trailers with Neway Air Susp. AR93-17	90044089		010	83124	89407	
Trailers with Neway Air Susp. AR95-9-HD, -12-HD, -14-HD, 17-HD	90044625		010	83125	...	
Trailers with Neway Air Susp. RL196-12	90044977		010	83115	...	
Trailers with Neway Air Susp. RL196-14, -15	90044978		010	85059	...	
Trailers with Neway Air Susp. RL196-16, -17	90044979		010	83113	...	
Trailers with Reyco Air Susp. Model # 21AR (25,000 LB Capacity)	43-8-002		010	83209	89414	

APPLICATION GUIDE - TRUCKS, TRAILERS, AND BUSES

Year	Model	OEM #	Front			Rear		
			Fleetline	GasSLX		Fleetline	GasSLX	

TRAILMOBILE CANADA CORP.(Cont'd.)

Trailers with Reyco Air Susp. Model # 74AR (30,000 LB Capacity)	43-8-002		010	83209	89414
Trailers with Reyco Air Susp. Model # 86AR	43-8-015		010	85006	...
Models with O.E.M. Number	43-4-235		010	85051	...
	43-4-236		010	85029	...
	43-4-237		010	85000	89436
	43-4-239		010	83207	89407
	43-4-241		010	85006	...
	43-4-277		010	85000	89436
	43-4-278		010	85059	...
	43-4-279		010	83204	...
	43-6-028		010	85000	89436
	43-6-137		010	85006	...
	43-6-158		010	85013	89414
	43-6-164		010	83207	89407
43-8-031		010	85029	...	

TRANSPORTATION MFG. CORP

City Cruiser	12TA-01-13		85303	...	010	85303	89422
Drive Axle	12J-5-10		01-	85733	...
	12J-5-2		01-	85733	...
	12J-5-4		01-	85733	...
G 4500 Coach (Front) 45 ft Coach -Tag Axle Tag Axle	12-05-6000	-10	85711
	12-05-6033		010	85339	...
	12-05-6002		010	85339	...
Low Floor Bus Models with O.E.M. Number	12L-5-99		010	85339	...
RTS Bus with "V" Drive Rear	G1101590		010	85713	...
RTS Bus with Regular Rear	22045526		010	85702	...
	22052014		010	85702	...
	G1011822		010	85702	...
RTS Bus with Solid Front Axle	22024673	-10	85710
	22046485	-10	85710
	680350	-10	85710
	695273	-10	85710
	695279	-10	85710
Tag Axle	12J-5-11		010	85313	...
	12J-5-3		010	85313	...
	12J-5-6		010	85313	...
	12J-5-9		010	85700	...
Models with O.E.M. Number	12B-5-1		010	85735	...
	12G-5-1	010	85700
	12T-1-13		85303	...	010	85303	89422
	680349		010	85702	...
	680470		010	85713	...
Additional O.E.M. Interchanges	12L-5-69	010	85700				
	12L-5-70	010	85700				





TRINITY TRAILER MFG., INC.

Identification of the trailer suspension is necessary to determine what section of the catalog to refer to. Some possible options can be Chalmers, Hendrickson, Neway, Ridewell, Reyco.

TURNER-QUICK LIFT - SEE HENDRICKSON SUSPENSION

--	--	--	--	--	--	--	--

APPLICATION GUIDE - TRUCKS, TRAILERS, AND BUSES

Year	Model	OEM #	Front		Rear	
						
			Fleetline	GasSLX	Fleetline	GasSLX

TURTLETOP BUS

- 2019	Odyssey Series Shuttle buses with Ford E450 Chassis	ASH-1136		-10	83178	...
		ASH-1154	-10	83177
- 2019	Terra Transit Series Shuttle buses with Ford E350 & E450 Chassis	ASH-1136		-10	83178	...
		ASH-1154	-10	83177
- 2019	Vanterra Series Shuttle buses with Ford E350 Chassis	ASH-1136		-10	83178	...
		ASH-1154	-10	83177

TUTHILL TECHNOLOGIES

Drive Axle

101A, 101AR Models	18166-01		010	85704	...
102AR (Hvy Duty) Models	18286-01		010	...	89414
102AR (Special) Models	17146-01		010	83209	89414
102AR (Standard) Models	12887-02		010	85013	89414
102AR for Western Star Models	19824-01		010	85006	...
102AR-7 Models	17794-01		010	83215	...
102AR-LM Models	19623-01		010	83123	89405
200 Models Air Suspension	20129-01		010	85007	89412
240AR Air-Ride Suspension With O.E.M. Number	20125-01		010	85030	89440
	20126-01		010	...	89440
74AR - 30000 lb Capacity	12887-01		010	85013	89414
79KB Models	16725-01		010	83126	...
	19495-01		010	83126	...

Steer Axle

1207 Models	17403-01	010	83122	89406	
1209 (Alternate) Models	17408-01	010	85005	89430	
1209, 1212 Models	17358-01	010	83126	89430	
	19495-01	010	83126	89440	
21B Models	14954-01	010	83217

Trailer

21B (Special) Models	18800-01		010	83203	89436
25 ART Models with O.E.M. Number	24392-01		010	85051	...
25 ARU Models with O.E.M. Number	23553-01		010	85938	...
30 ARUUL - 12 and -17 Models	23524-01		010	85738	...
81S Models	12885-03		010	85300	89419
86 AR / RS 1015, 1035, 3015, 3035 Slider Air Suspension	18165-01		010	85006	...
87 for Great Dane Models	18163-01		010	83207	89407
	18164-01		010	83122	89406
87-14 (Rear Mount) Models	18146-01		010	85313	...
87-14, -17 Models	16230-01		010	85702	...
87-6, 87-9 Models	12885-01		010	85300	89419
Models with O.E.M. Number	1085		010	83214	...
	16824-01		010	85006	...
	17142-01		010	85001	89410
	20960-01		010	83204	...
	21497-01		010	85005	89430
	23614-01		010	85717	...
	2697		010	85712	...
	680162		010	85300	89419
	702135-01		010	85045	...
	702136-01		010	85052	...
	702209-01		010	85014	...
	OE12425		010	83214	...

APPLICATION GUIDE - TRUCKS, TRAILERS, AND BUSES

Year	Model	OEM #	Front			Rear		
			Fleetline	GasSLX		Fleetline	GasSLX	

TWIN COACH

	Models with O.E.M. Number	90044089 90044089C 90044162 AR-718-C-HD AR-958		OIO	83124	89407
				OIO	83124	89407
				OIO	83128	89436
				OIO	85000	89436
				OIO	83207	89407

UNITED MANUFACTURING

	Models with O.E.M. Number	K-96-41		OIO	85304	...
--	---------------------------	---------	--	-----	-----	-----	-------	-----

UNIVERSAL COACH

	Models with O.E.M. Number	12-05-1199 680777		OI-	85729	...
				OI-	85729	...

UPS TRUCK

	Models with O.E.M. Number	P117099 P117146		OI-	83120	...
			OIO	83118

UTILITY TRAILER MANUFACTURING COMPANY

Identification of the trailer suspension is necessary to determine what section of the catalog to refer to. Some possible options can be Chalmers, Hendrickson, Neway, Ridewell, Reyco.								
---	--	--	--	--	--	--	--	--

Flatbeds

	4000A Model Trailers with Hendrickson AANT 23K Intraax Air Ride (High Damping) (Hvy Duty) (Limited Rebound) (Standard)	B-24023 B-24125 B-23361 B-23566		OIO	85738	...
				OIO	85323	89436
				OIO	85911	...
				OIO	85000	89436
	Drop Deck Trailers with Hendrickson AANL 23K Intraax Air Ride with 12" to 17" Ride Height - High Damping with 6.5" to 9" Ride Height - High Damping with 6.5" to 9" Ride Height - Standard	B-25515 B-24579 B-23651		OIO	85338	...
				OIO	85939	...
				OIO	85045	...
				OIO	85045	...





Reefers & Dry Vans

	3000R Multi-Temp Trailers with Hendrickson HKANT 40K Vantraax Air Ride Heavy Duty Standard	B-24088 S-24088 B-24088 S-24088		OIO	85000	89436
				OIO	85000	89436
				OIO	83128	89436
				OIO	83128	89436
	4000D Trailers with Hendrickson HKANT 40K Vantraax Air Ride Heavy Duty Standard	B-24088 S-24088 B-24088 S-24088		OIO	85000	89436
				OIO	85000	89436
				OIO	83128	89436
				OIO	83128	89436
	4000D-X Composite Trailers with Hendrickson HKANT 40K Vantraax Air Ride Heavy Duty Standard	B-24088 S-24088 B-24088 S-24088		OIO	85000	89436
				OIO	85000	89436
				OIO	83128	89436
				OIO	83128	89436

VAN HOOL

00 - 09	T2145 and T2150 Buses with O.E.M. Number (Front & Tag Axle)	10685703 624314570 90-2291		- -	695406	...
				- -	695406	...
				- -	695406	...
	T811, T812, T813, T814 Buses	6243-14040		85708	...	- -	85708	...

APPLICATION GUIDE - TRUCKS, TRAILERS, AND BUSES

Year	Model	OEM #	Front		Rear	
						
			Fleetline	GasSLX	Fleetline	GasSLX

VAN HOOL(Cont'd.)

	T811, T812, T813, T814 Buses	665563		85708	...	- -	85708	...
	T815 4D Buses	6243-14040		- -	85708	...
		665563		- -	85708	...
00 - 09	T940 and T945 Buses	624314570		- -	695406	...
		90-2291		- -	695406	...
	TL 13/14 Buses	6243-13790		85708	...	- -	85708	...
		665562		85708	...	- -	85708	...

VOLVO

FE Series

	FE6 Models	6857668	- O	83105
		6876828	- O	83105
	FE611, FE614 Front after CH419306	6794358	O O	85040
	FE614 Tractor	6790756		O O	83215	...
		6794358	O O	85040
	FE615, FE715	6772218	O O	85040
		6775412	O O	85040
	FE7 Models up to Chassis No. 20855	1505190		- -	85722	...
	FE7 Models with over 6.5 Front Axle (Ton)	1590439	O O	83104
	FE7 Models with Rear Air Suspension (Drive Axle)	1591501		- -	85722	...
	FE715 with Rear Parabolic Spring	6790756		O O	83215	...
	Models with Rear Air Suspension and O.E.M. Number	8056892		O O	85023	89415

N Series

	N10 with 5.5 Ton Front Axle	1593843	O O	83215
	N11 Models	1-0200-32-888-1	O O	83104
		1591735	O O	83104
		1593843	O O	83215
	N12 Models	1-0200-32-888-1	O O	83104
		1591735	O O	83104
		1593843	O O	83215
	N12 with over 6.5 Ton Front Axle	1590439	O O	83104

VAH Series

	VAH 430 Models with Hendrickson HAS 400 or 460 Series Rear Suspension	60675-001		O O	85978	...
		60675-001L		O O	85978	...
		8083872		O O	85978	...
2014	VAH 430 Models with O.E.M. Number	141700005838	O O	85098
		21436086	O O	85098









VHD - Series

08 - 17	Models with 12,000 to 22,000 lb Front Axles	20353932	O -	85081
		20414440	O -	85081
		20433426	O -	85081
		20434880	O -	85081
		471700131258	O -	85081
		SDA471700131258	O -	85081
- 2017	Models with Hendrickson 40,000 lb Pimaax EX and FireMaax EX Air Suspension	20782199		O O	85072	...
		60657-007		O O	85072	...
	Models with Neway ADZ Rear Suspension	471700004423		O O	85109	...
		90045605		O O	85109	...
08 - 17	Models with T-Ride Rear Suspension	20433427		O -	85065	...
		471700131256		O -	85065	...

VN Series - 2200

05/99 -	Models built after May 1999	20433425		O O	85066	89448
		471700002627		O O	85066	89448
		8086651		O O	85066	89448

APPLICATION GUIDE - TRUCKS, TRAILERS, AND BUSES

Year	Model	OEM #	Front		Rear	
						
						
			Fleetline	GasSLX	Fleetline	GasSLX

VOLVO(Cont'd.)





VN Series - 2200(Cont'd.)

	Models with O.E.M. Number	20433424	010	85061	89450	
		20513881	010	85061	89450	
		20551628		010	85066	89448
		47170000443		010	85066	89448
		665607		010	85047	89435
		8077874		010	85047	89435
		8077874-P01		010	85047	89435
		8078195	010	85061	89450	
		8086053		010	85047	89435
		8169859		010	85047	89435

VNL Series

06 - 16	300 Models with Hendrickson 40,000 lb Pimaax EX and FireMaax EX Air Suspension	20782199		010	85072	...
		60657-007		010	85072	...
06 - 10	300, 300U Models with 12,000 - 13,200 lb Front Axles	20433424	010	85061	89450	
11 - 19	300, 300U Models with 12,000 - 13,200 lb Front Axles	141700005838	010	85098
		21436086	010	85098
06 - 11	300, 300U Models with 40,000 lb Rear Air Suspension	20433425		010	85066	89448
		20551628		010	85066	89448
		47170000443		010	85066	89448
		471700002627		010	85066	89448
11 - 17	300, 300U Models with 40,000 lb Rear Air Suspension	21462378		010	85088	...
		471700006038		010	85088	...
06 - 14	300, 300U Models with Hendrickson Airtek	20485632	010	85933	89454	
		20485633	010	85933	89454	
		21137330	010	85933	89454	
		471700003832	010	85933	89454	
		64838-003	010	85933	89454	
		64838-003L	010	85933	89454	
11 - 18	430 Models with 12,500 - 14,600 lb Front Axle	141700005838	010	85098
		21436086	010	85098
06 - 10	430 Models with 13,200 lb Front Axle	20433424	010	85061	89450	
05 - 11	430 Models with 40,000 lb Rear Air Suspension	20433425		010	85066	89448
		20551628		010	85066	89448
		47170000443		010	85066	89448
		471700002627		010	85066	89448
11 - 18	430 Models with 40,000 lb Rear Air Suspension	21462380		010	85088	...
		471700006040		010	85088	...
05 - 14	430 Models with Hendrickson Airtek	20485632	010	85933	89454	
		20485633	010	85933	89454	
		21137330	010	85933	89454	
		471700003832	010	85933	89454	
		64838-003	010	85933	89454	
		64838-003L	010	85933	89454	
11 - 18	630 & 670 Models with 12,500 - 14,600 lb Front Axle	141700005838	010	85098
		21436086	010	85098
06 - 10	630 & 670 Models with 13,200 lb Front Axle	20433424	010	85061	89450	
06 - 11	630 & 670 Models with 40,000 lb Rear Air Suspension	20551628		010	85066	89448
		47170000443		010	85066	89448
11 - 18	630 & 670 Models with 40,000 lb Rear Air Suspension	21462380		010	85088	...
		471700006040		010	85088	...
06 - 16	630 & 670 Models with Hendrickson Airtek	20485632	010	85933	89454	
		20485633	010	85933	89454	
		21137330	010	85933	89454	
		471700003832	010	85933	89454	

APPLICATION GUIDE - TRUCKS, TRAILERS, AND BUSES

Year	Model	OEM #	Front		Rear	
						
			Fleetline	GasSLX	Fleetline	GasSLX

VOLVO(Cont'd.)

VNL Series(Cont'd.)

06 - 16	630 & 670 Models with Hendrickson Airtek	64838-003	010	85933	89454	
		64838-003L	010	85933	89454	
06 - 16	64T-830 Models with Hendrickson 40,000 lb Pimaax EX and FireMaax EX Air Suspension	20782199		010	85072	...
06 - 16	64T-830 Models with Hendrickson 40,000 lb Primaax, Pimaax EX and FireMaax EX Air Suspension	60657-007		010	85072	...
11 - 18	730 & 780 Models with 12,500 - 14,600 lb Front Axle	141700005838	010	85098
		21436086	010	85098
06 - 10	730 & 780 Models with 13,200 lb Front Axle	20433424	010	85061	89450	
06 - 11	730 & 780 Models with 40,000 lb Rear Air Suspension	20551628		010	85066	89448
		471700000443		010	85066	89448
11 - 18	730 & 780 Models with 40,000 lb Rear Air Suspension	21462380		010	85088	...
		471700006040		010	85088	...
				010	85088	...
06 - 16	730 & 780 Models with Hendrickson Airtek	20485632	010	85933	89454	
		20485633	010	85933	89454	
		21137330	010	85933	89454	
		471700003832	010	85933	89454	
		64838-003	010	85933	89454	
		64838-003L	010	85933	89454	
2018 - 19	740 Models with 12,500 - 14,600 lb Front Axle	141700005838	010	85098
		21436086	010	85098
2018 - 19	740 Models with 40,000 lb Rear Air Suspension	21462380		010	85088	...
		471700006040		010	85088	...
2018 - 19	740 Models with Hendrickson Airtek	21137330	010	85933	89454	
		471700003832	010	85933	89454	
		64838-003	010	85933	89454	
		64838-003L	010	85933	89454	
2018 - 19	760 Models with 12,500 - 14,600 lb Front Axle	141700005838	010	85098
		21436086	010	85098
2018 - 19	760 Models with 40,000 lb Rear Air Suspension	21462380		010	85088	...
		471700006040		010	85088	...
2018 - 19	860 Models with 12,500 - 14,600 lb Front Axle	141700005838	010	85098
		21436086	010	85098
2018 - 19	860 Models with 40,000 lb Rear Air Suspension	21462380		010	85088	...
		471700006040		010	85088	...
06 - 10	All Models with 12,000 - 13,200 lb Front Axles	20433424	010	85061	89450	
		8071881	010	85061	89450	
05/99 -	Models with 38,000 lb Rear Air Suspension built after May 1999	20433425		010	85066	89448
		471700002627		010	85066	89448
- 2018	Models with Neway ADZ Rear Suspension	471700004423		010	85109	...
		90045605		010	85109	...

VNM Series

- 2017	200 Models with 12,000 lb Front Axles	21436086	010	85098
- 2016	200 Models with 46,000 lb T-Ride Rear Suspension	20433427		01-	85065	...
- 2017	430 Models with 12,500 lb Front Axle	21436086	010	85098
- 2017	630 Models with 12,500 lb Front Axle	21436086	010	85098
- 2017	630 Models with 38,000 lb Rear Air Suspension	21462378		010	85088	...
		21462380		010	85088	...

VNR Series

2018	400 Models with 12,500 lb Front Axle	21436086	010	85098
2018	400 Models with 38,000 lb Rear Air Suspension	21462380		010	85088	...
2018 - 19	Models with Hendrickson Airtek	21137330	010	85933	89454	
		471700003832	010	85933	89454	
		64838-003	010	85933	89454	
		64838-003L	010	85933	89454	

APPLICATION GUIDE - TRUCKS, TRAILERS, AND BUSES

Year	Model	OEM #	Front			Rear		
			Fleetline	GasSLX				

VOLVO(Cont'd.)

VNR Series(Cont'd.)

2018	Models with Hendrickson HAS 400 or 460 Series Rear Suspension	60675-001		OIO	85978	...
		60675-001L		OIO	85978	...
		8083872		OIO	85978	...

VNX - Series

	Models with 12,500 - 14,600 lb Front Axle	141700005838	OIO	85098
		21436086	OIO	85098
	Models with 40,000 lb Rear Air Suspension	21462380		OIO	85088	...
		471700006040		OIO	85088	...
	Models with Neway ADZ Rear Suspension	471700004423		OIO	85109	...
		90045605		OIO	85109	...

Vocational Trucks

	Models with T-Ride Rear Suspension	20433427		OI-	85065	...
		8060026		OI-	85065	...
		8073212		OI-	85065	...
		8075257		OI-	85065	...
	WX, WXR, WG, AC Models with Hendrickson HN-402 Rear Suspension	57241-3		OI-	83112	...
		60680-003		OI-	83112	...
		60680-003L		OI-	83112	...
	WX, WXLL, WXR, WG, AC Models With Hendrickson HAS-400 Rear Air Suspension With Hendrickson HAS-460 Rear Air Suspension With Hendrickson HN-462 Rear Suspension	47902-24		OIO	83137	...
		47902-24		OIO	83137	...
		57241-3		OI-	83112	...
		60680-003		OI-	83112	...
		60680-003L		OI-	83112	...

VT Series

06 - 10	64T-830 Models with 40,000 lb Rear Air Suspension	20551628		OIO	85066	89448
		471700000443		OIO	85066	89448
06 - 10	64T-830 Models with Hendrickson 40,000 lb Primaax, Pimaax EX and FireMaax EX Air Suspension	60657-007		OIO	85072	...
06 - 10	64T-880 Models with Hendrickson 40,000 lb Pimaax EX and FireMaax EX Air Suspension	20782199		OIO	85072	...
06 - 10	All Models with 12,000 - 13,200 lb Front Axles	20433424	OIO	85061	89450	
		8071881	OIO	85061	89450	

WCA & WIA Series

1995 -	All with O.E.M. Number and after V.I.N. Number 723506	8169859		OIO	85047	89435
		Models with Front Dual Shocks	02-7005976	-I-	83400
		3082284	
93 - 95	Models with O.E.M. Number and after V.I.N. Number 657841	8026658		OIO	85046	89434
- 1992	Models with O.E.M. Number and up to V.I.N. Number 657250	8071524		OIO	85024	...
	Models with O.E.M. Number	37301-0016	OI-	85026	89417	
		37301-0021	OI-	85026	89417	
		37301-3201	-I-	85027	89418	
		37301-3202	OI-	85026	89417	
		4975549	OIO	83216
		8065787	OI-	85026	89417	

WG Series

	Models with O.E.M. Number	35901-3201		OIO	85024	...
		37301-3201	-I-	85027	89418	
		665623		OIO	85046	89434
- 1992	Models with O.E.M. Number	8065787	OI-	85026	89417	
		8071524		OIO	85024	...
93 - 95	Models with O.E.M. Number	8026658		OIO	85046	89434

APPLICATION GUIDE - TRUCKS, TRAILERS, AND BUSES

Year	Model	OEM #	Front		Rear	
			 Fleetline	 GasSLX	 Fleetline	 GasSLX

VOLVO(Cont'd.)

WH Series(Cont'd.)

	WHS, WHR, WHL or WHE Models with Front Dual Shocks	02-7005976 3082284	- -	83400
	WHS, WHR, WHL or WHE Models with Front Single Shocks	37301-0021	0 -	85026	89417	
- 1992	WHS, WHR, WHL or WHE Models with O.E.M. Number	35901-3201 8071524		0 0	85024	...
1995 -	WHS, WHR, WHL or WHE Models with O.E.M. Number	8169859		0 0	85047	89435
93 - 95	WHS, WHR, WHL or WHE Models with O.E.M. Number	8026658		0 0	85046	89434





Additional Applications

	1500 Models		83122	...	0 0	83122	89406
	1500 Models Models with Rear Suspension Models with Velvet Ride Suspension	35901-0005 530596		0 0	83219	...
	3000, 4000 & 9000 Models - Special Unit - Four Shock Absorbers Required Per Axle	5554959 676081 676082	0 0 0 0 0 0	83401
	3014, 3015, 3016, 3020 C.O.E. and 1500	0 0	83122	89406	
	9000 Models	0 0	83122	89406	
	Brigadier Models	22012065 22046483 22052336	0 0 0 0 0 0	85304
	Models with Hendrickson HN - 400 Rear suspension	3971703		0 -	83112	...
78 - 83	RC2	0 0	83122	89406
	Road Boss, Road Boss II, Road Commander II, Road Expeditor - (Four Shocks per Axle)	3946210	- -	83103
	Road Boss, Road Boss II, Road Commander, Road Commander II, Road Expeditor II - (Four Shocks per Axle)	02-7005976 02-7005977 4975479 4975480	- - - - - - - -	83400
	Models with Hendrickson Airtex	20469001 20469002 471700131920 471700131921 64838-001 64838-002	0 0 0 0 0 0 0 0 0 0 0 0	85933	89454	

Additional O.E.M. Interchanges

	Additional O.E.M. Interchanges	03-1106460	0 0	85005 or 89430				
		20863239	0 -	85080				
		35901-0003	0 0	85301				
		35901-0004	0 0	83219				
		35901-0011	0 0	83123 or 89405				
		35901-0017	0 0	83314				
		35901-0022	0 -	83635				
		35901-3406	0 0	85305				
		35901-3409	0 0	85304				
		35901-3410	0 0	85307				
		35901-3413	0 0	85006				
		35901-3420	0 0	85303 or 89422				
		37001-5	0 0	83401				
		37301-0001	0 0	85013 or 89414				
		37301-0018	0 0	85005 or 89430				
		3953643	0 0	85040				
		4940640	0 0	83216				
		494-660	0 0	83219				

APPLICATION GUIDE - TRUCKS, TRAILERS, AND BUSES





Year	Model	OEM #	Front		Rear	
						
			Fleetline	GasSLX	Fleetline	GasSLX

VOLVO(Cont'd.)

Additional O.E.M. Interchanges(Cont'd.)

Additional O.E.M. Interchanges			
	5322338	010	83214
	5513989	010	83216
	5531435	010	85307
	5531436	010	85307
	5531437	010	85307
	5534430	010	85303 or 89422
	5534447	010	85303 or 89422
	5549899	010	83207 or 89407
	5549925	010	85304
	629398	010	85307
	629501	010	85307
	646220	010	85734
	66010-0016	01-	85025
	668302	010	83216
	6771501	010	85040
	6775411	010	85040
	1091347	010	83125
	1091348	010	83122 or 89406
	1091349	010	83204
	1091350	010	83207 or 89407
	1091351	010	83209 or 89414
	1091353	010	83215
	1091354	010	83216
	1091355	010	83217
	1091357	010	83219
	1091358	- -	83456 or 89447
	1091359	010	83123 or 89405
	1091360	010	83303
	1091361	010	83304
	1091362	010	83309 or 89446
	1091363	010	83221
	1091364	010	83312 or 89409
	1091365	- -	83400
	1091366	010	83401
	1091367	010	85000 or 89436
	1091368	010	85003 or 89411
	1091370	010	85006
	1091371	010	85300 or 89419
	1091372	010	85301
	1091373	010	85302 or 89420
	1091374	010	85303 or 89422
	1091375	010	85304
	1091376	010	85305
	1091377	010	85307
	1091378	010	85308 or 89422
	1091379	- -	85310 or 89423
	1091384	010	85735
	1093100	- -	85027 or 89418
	1093176	010	85024
	1093177	01-	85025
	1093178	01-	85026 or 89417
	1093180	010	85030 or 89440
	1716824	010	85304
	19501669	010	85339
	19502711	010	85702

APPLICATION GUIDE - TRUCKS, TRAILERS, AND BUSES





Year	Model	OEM #	Front		Rear	
						
			Fleetline	GasSLX	Fleetline	GasSLX

VOLVO(Cont'd.)

Additional O.E.M. Interchanges(Cont'd.)

Additional O.E.M. Interchanges	19506846	010	85339
	3130140	010	85315
	3171696	010	85307
	3172948	010	85303 or 89422
	3199937	-10	85316 or 89426
	3199938	010	85030 or 89440
	3199939	010	85058 or 89431
	3199940	010	85005 or 89430
	3199941	010	85006
	3199942	010	89402
	3199943	010	85012 or 89413
	3199944	010	85006
	3199945	-1-	85027 or 89418
	3199946	-10	85033 or 89427
	3199947	010	85013 or 89414
	3199948	-10	85311 or 89424
	3199949	-1-	85310 or 89423
	3199950	010	85023 or 89415
	3199951	010	85024
	3199952	010	85736
	3199953	-10	85319 or 89428
	3199954	010	85003 or 89411
	3199955	010	85300 or 89419
	3199956	010	85036 or 89405
	3199957	010	83122 or 89406
	3199959	010	85323 or 89436
	3199960	010	85322
	3199961	010	85307
	3199962	010	85314 or 89425
	3199963	010	85315
	3199965	010	85736
	3199966	010	85303 or 89422
	3199967	010	85302 or 89420
	3199968	010	85308 or 89422
	3199972	010	85320 or 89429
	3199973	-1-	85722
	3199974	010	85712
	3199975	010	85700
	3199976	-10	85711
	3199977	-10	85711
3199978	010	85712	
3199979	010	85702	
3199980	-1-	85310 or 89423	
3199982	-10	85703	
3199983	010	85704	
3199984	010	85314 or 89425	
3199985	01-	85723	
3199986	-1-	85318	
3199987	-1-	85705	
3199988	-10	85311 or 89424	
3199989	-1-	85709	
3199990	010	85003 or 89411	
3199991	-1-	85708	
3199992	01-	85733	
3199993	010	85712	

APPLICATION GUIDE - TRUCKS, TRAILERS, AND BUSES

Year	Model	OEM #	Front		Rear	
						
			Fleetline	GasSLX	Fleetline	GasSLX

VOLVO(Cont'd.)

Additional O.E.M. Interchanges(Cont'd.)

Additional O.E.M. Interchanges	3199994	010	85308 or 89422
	3915917	-10	85319 or 89428
	3915947	010	85001 or 89410
	3915948	-10	85311 or 89424
	3916352	010	85013 or 89414
	3919055	010	85007 or 89412
	3919056	010	83203 or 89436
	3919057	010	83225
	3919526	010	83314
	3919561	010	85314 or 89425
	3919565	-1-	83103
	3919567	-1-	83613
	3919569	010	85052
	3919570	010	83128 or 89436
	3919571	01-	83635
	3919572	010	83130
	3919573	010	83123 or 89405
	3919574	010	85006 or 89401
	3919575	01-	83120
	3919582	010	83215
	3919583	010	83100
	3919585	010	83209 or 89414
	3919586	010	83100
	3919587	-10	83105
	3919588	010	83216
	3919589	01-	85026 or 89417
	3919590	010	85042
	3919591	-10	83515
	3919592	010	85024
	3919593	010	83242
	3919594	010	85003 or 89411
	3919596	01-	G63484
	3919598	010	83312 or 89409
	3919900	010	85012 or 89413
	3919901	-1-	83103
	3919902	010	83126 or 89430
	3919903	010	83216
	3919904	010	G63183
	3919906	010	83308
	3919907	010	83309 or 89446
	3919908	010	83104
	3919909	010	G63605
3919910	010	83221	
3919911	010	83124 or 89407	
3919912	010	83215	
3919913	010	83203 or 89436	
3919914	010	83209 or 89414	
3919915	010	83127	
3919916	010	83126 or 89430	
3919917	010	83125	
3919918	010	83401	
3919919	010	G63625	
3919920	010	83303	
3919921	010	83123 or 89405	
3919922	-1-	83318	

APPLICATION GUIDE - TRUCKS, TRAILERS, AND BUSES





Year	Model	OEM #	Front		Rear	
			Fleetline	GasSLX	Fleetline	GasSLX

VOLVO(Cont'd.)

Additional O.E.M. Interchanges(Cont'd.)

	Additional O.E.M. Interchanges	3919923	-10	83301
		3919924	-1-	83456 or 89447
		3919925	-10	83317
		3919926	010	G63403
		3919927	010	83101
		3919928	010	83225
		3919931	010	83126 or 89430
		3919932	010	85062 or 89408
		3919933	010	85001 or 89410
		3919934	010	85320 or 89429
		3919935	01-	85026 or 89417
		3919936	010	83207 or 89407
		3919937	-10	85316 or 89426
		3919938	010	85030 or 89440
		3919939	010	85058 or 89431
		3919940	010	85005 or 89430
		3919941	010	85006
		3919942	010	89402
		3919943	010	85012 or 89413
		3919944	010	85036 or 89405
		3919945	-1-	85027 or 89418
		3919946	-10	85033 or 89427
		3919947	010	85013 or 89414
		3919948	-10	85311 or 89424
		3919949	-1-	85310 or 89423
		3919950	010	83219
		3919951	010	83309 or 89446
		3919952	010	85736
		3919953	-10	85319 or 89428
		3919954	010	85003 or 89411
		3919955	010	85300 or 89419
		3919956	010	85036 or 89405
		3919957	010	83122 or 89406
		3919959	010	85000 or 89436
		3919960	010	85322
		3919961	010	85302 or 89420
		3919962	010	85700
		3919963	010	
		3919964	010	85304
		3919965	010	85702
		3919966	010	85736
		3919967	010	85302 or 89420
		3919968	010	85736
		3919972	010	85320 or 89429
		3919973	010	85956
		3919974	010	85712
		3919975	010	85700
		3919976	-10	85033 or 89427
		3919977	-10	85033 or 89427
		3919978	010	85702
		3919979	010	85702
		3919980	010	85702
		3919982	-10	85703
		3919983	010	85704
		3919984	010	85700

APPLICATION GUIDE - TRUCKS, TRAILERS, AND BUSES





Year	Model	OEM #	Front		Rear	
						
			Fleetline	GasSLX	Fleetline	GasSLX

VOLVO(Cont'd.)

Additional O.E.M. Interchanges(Cont'd.)

Additional O.E.M. Interchanges			
	3919985	01-	85723
	3919987	-1-	85706
	3919988	-10	85311 or 89424
	3919989	-1-	85709
	3919990	010	85003 or 89411
	3919991	-1-	85708
	3919992	01-	85733
	3919993	010	85712
	3919994	-1-	85310 or 89423
	3945806	01-	89417
	3945807	010	
	3945808	010	89407
	3945809	010	89410
	3945810	010	89420
	3945811	010	89409
	3945812	-1-	89423
	3945813	-10	89428
	3945814	-10	89424
	3945815	010	89406
	3945816	010	89430
	3945817	010	89422
	3945818	010	89415
	3945819	010	89411
	3945820	010	89413
	3945821	010	89419
	3946217	010	83125
	3946219	-1-	83400
	662211401	010	83215
	83176191	01-	83019
	83176192	01-	83041
	83176193	01-	83045
	83176194	010	83048
	83176195	-1-	83103
	83176196	01-	83110
	83176197	01-	83111
	83176198	01-	83112
	83176199	010	83123
	83176200	010	83124
	83176201	010	83125
	83176202	010	83126
	83176203	010	83127
	83176204	010	83128 or 89436
	83176205	-1-	83136
	83176206	010	83148
	83176207	010	83203 or 89436
	83176208	010	83209 or 89414
	83176209	010	83215
	83176210	010	83216
	83176211	010	85000 or 89436
	83176212	010	85001 or 89410
	83176213	010	85003 or 89411
	83176214	010	85005 or 89430
	83176215	010	85023 or 89415
	83176216	01-	85026 or 89417
	83176217	-10	85033 or 89427

APPLICATION GUIDE - TRUCKS, TRAILERS, AND BUSES





Year	Model	OEM #	Front		Rear	
						
			Fleetline	GasSLX	Fleetline	GasSLX

VOLVO(Cont'd.)

Additional O.E.M. Interchanges(Cont'd.)

Additional O.E.M. Interchanges	83176218	010	85036 or 89405
	83176219	010	85045
	83176220	010	85046 or 89434
	83176221	010	85047 or 89435
	83176222	010	85052
	83176223	010	85061 or 89450
	83176224	010	85062 or 89408
	83176225	010	85066 or 89448
	83176226	010	85067 or 89451
	83176227	-1-	85069 or 89455
	83176228	010	85070 or 89459
	83176229	010	85303 or 89422
	83176230	-1-	85310 or 89423
	83176231	-10	85311 or 89424
	83176232	010	85320 or 89429
	83176233	010	85321
	83176234	010	85323 or 89436
	83176235	010	85724 or 89443
	83176236	-1-	85900
	83176237	010	85916 or 89430
	83176238	010	85918 or 89449
	83176239	010	85933 or 89454
	83176240	010	646155
	85104186	010	85006
	85106580	010	85918 or 89449
	85137234	010	83125
	85137420	010	85000 or 89436
	RC SA3041	01-	83041
	RC SA3045	01-	83045
	RC SA3048	010	83048
	RC SA3103	-1-	83103
	RC SA3111	01-	83111
	RC SA3112	01-	83112
	RC SA3124	010	83124
	RC SA3125	010	83125
	RC SA3127	010	83127
	RC SA3128	010	83128 or 89436
	RC SA3136	-1-	83136
	RC SA3148	010	83148
	RC SA3203	010	83203 or 89436
	RC SA3216	010	83216
	RC SA5000	010	85000 or 89436
	RC SA5001	010	85001 or 89410
	RC SA5003	010	85003 or 89411
	RC SA5005	010	85005 or 89430
	RC SA5047	010	85047 or 89435
	RC SA5052	010	85052
	RC SA5061	010	85061 or 89450
	RC SA5062	010	85062 or 89408
	RC SA5066	010	85066 or 89448
RC SA5067	010	85067 or 89451	
RC SA5070	010	85070 or 89459	
RC SA5310	-1-	85310 or 89423	
RC SA5320	010	85320 or 89429	
RC SA5724	010	85724 or 89443	

APPLICATION GUIDE - TRUCKS, TRAILERS, AND BUSES

Year	Model	OEM #	Front		Rear	
						
			Fleetline	GasSLX	Fleetline	GasSLX

VOLVO(Cont'd.)

Additional O.E.M. Interchanges(Cont'd.)

Additional O.E.M. Interchanges	RC SA5900	- -	85900				
	RC SA5918	0 0	85918 or 89449				
	RC SA5933	0 0	85933 or 89454				
	RC SA6155	0 0	646155				
	SA3019	0 -	83019				
	SA3041	0 -	83041				
	SA3045	0 -	83045				
	SA3048	0 0	83048				
	SA3103	- -	83103				
	SA3110	0 -	83110				
	SA3111	0 -	83111				
	SA3112	0 -	83112				
	SA3123	0 0	83123				
	SA3124	0 0	83124				
	SA3125	0 0	83125				
	SA3126	0 0	83126				
	SA3127	0 0	83127				
	SA3128	0 0	83128 or 89436				
	SA3136	- -	83136				
	SA3148	0 0	83148				
	SA5000	0 0	85000 or 89436				
	SA5001	0 0	85001 or 89410				
	SA5003	0 0	85003 or 89411				
	SA5005	0 0	85005 or 89430				
	SA5023	0 0	85023 or 89415				
	SA5026	0 -	85026 or 89417				
	SA5033	- 0	85033 or 89427				
	SA5036	0 0	85036 or 89405				
	SA5045	0 0	85045				
	SA5046	0 0	85046 or 89434				
	SA5047	0 0	85047 or 89435				
	SA5052	0 0	85052				
	SA5061	0 0	85061 or 89450				
SA5062	0 0	85062 or 89408					
SA5066	0 0	85066 or 89448					
SA5067	0 0	85067 or 89451					
SA5069	- -	85069 or 89455					
SA5070	0 0	85070 or 89459					
SA5303	0 0	85303 or 89422					
SA5310	- -	85310 or 89423					
SA5311	- 0	85311 or 89424					
SA5320	0 0	85320					
SA5321	0 0	85321					
SA5323	0 0	85323 or 89436					
SA5724	0 0	85724 or 89443					
SA5900	- -	85900					
SA5916	0 0	85916 or 89430					
SA5918	0 0	85918 or 89449					
SA5933	0 0	85933 or 89454					
SA6155	0 0	646155					
Models with O.E.M. Number	14170000373	0 0	85061	89450	
	3092842	0 0	85061	89450	
	35901-0001		0 0	83209	89414
	35901-0008		0 0	85060	...
	37301-0008	- -	83400

APPLICATION GUIDE - TRUCKS, TRAILERS, AND BUSES

Year	Model	OEM #	Front		Rear	
			Fleetline	GasSLX	Fleetline	GasSLX

VOLVO(Cont'd.)

Additional O.E.M. Interchanges(Cont'd.)

	Models with O.E.M. Number	3919958		OIO	85046	89434
		3946239		OIO	85724	89443
		3949240		OIO	85047	89435
		3949241	OIO	85061	89450	
		3972662		OIO	85976	...
		665410	-I-	85027	89418	
		665539	OI-	85026	89417	
		665739		OIO	85047	89435
		70042	OIO	85302	89420	
		8075287		OI-	85065	...
		8174749		OIO	85906	89407
		85104221		OIO	85066	89448
		85107238		OIO	85976	...
		85134402	OIO	85061	89450	

VOLVO CAB SHOCKS

	Aero Models (WCA & WIA Models)	66010-0007	OIO	83004
		66010-0008	OIO	83004
		8162662	OIO	83004
	Link Cabmate Model WRC-2P	1202-0032	OIO	83016
	Models with O.E.M. Number	20874147	OI-	83050
		3945842	OIO	83009
		635869	OIO	83004
		8168617	OIO	83030
		85107095	OIO	83009
2014 -	VAH 430 Models with 42" Sleeper Cabs	20721254	OIO	83048
		22662224	OIO	83048
11 - 17	VNL / VNM & VNX DayCab Models with O.E.M. Number	21368411	OIO	83905
		22662230	OIO	83905
06 - 10	VT Models - All with 60" to 77" Mid - High Roof Sleepers (w/O.E.M. Number)	20721254	OIO	83048
	WG Conventional Tractors with 112" cabs with Link Cabmate Model WWG112-A	1201-0012	OIO	83023
		1202-0012	OIO	83023

VHD - Series

11 - 17	DayCab Models with O.E.M. Number	22662230	OIO	83905
12 - 17	VHD 64T-200 Models - With O.E.M. Number	22662230	OIO	83905
08 - 09	VHD Models - With O.E.M. Number	20704334	OIO	83048
		22662125	OIO	83048









VN Series - 2200

	VN Models - Horizontal Position	20496217	OIO	83029
		8078547	OIO	83029
	VN Models - Vertical Position (w/O.E.M. Number)	20496215	OIO	83048
		20704334	OIO	83048
		20721254	OIO	83048
		21368413	OIO	83048
		22662125	OIO	83048
		8078546	OIO	83028

VNL - Series

06 - 10	VNL 42T-300 Models - With O.E.M. Number	20704334	OIO	83048
		22662125	OIO	83048
2011 -	VNL 42T-300 Models - With O.E.M. Number	22662230	OIO	83905
11 - 17	VNL 64T-300 DayCab Models with O.E.M. Number	21368411	OIO	83905
		22662230	OIO	83905
13 - 16	VNL 64T-430 Models with Flat Top Sleepers	21391412	OIO	83048

APPLICATION GUIDE - TRUCKS, TRAILERS, AND BUSES

Year	Model	OEM #	Front		Rear	
						
						
			Fleetline	GasSLX	Fleetline	GasSLX

VOLVO CAB SHOCKS(Cont'd.)

VNL - Series(Cont'd.)

13 - 16	VNL 64T-630 Models with Flat Top Sleepers	21391412	010		83048
- 2013	VNL 64T-670 Models with High Rise Sleeper Cabs	21368413	010		83048
14 - 17	VNL 64T-670 Models with High Rise Sleeper Cabs	22662235	010		83905
15 - 18	VNL 64T-730 Models with Mid Rise Sleeper Cabs	22662237	010		83905
2018 - 19	VNL 64T-740 Models with High Rise Sleeper Cabs	22662237	010		83905
- 2014	VNL 64T-780 Models with High Rise Sleeper Cabs	20721254	010		83048
		21368413	010		83048
15 - 18	VNL 64T-780 Models with High Rise Sleeper Cabs	22662237	010		83905
2018 - 19	VNL 64T-860 Models with High Rise Sleeper Cabs	22662237	010		83905
06 - 11	VNL Models - All with 60" to 77" Mid - High Roof Sleepers (w/O.E.M. Number)	20721254	010		83048

VNM - Series

2013	VNM 42T-200 Day Cab Models	21368411	010		83905
13 - 17	VNM 64T-200 Day Cab Models	21368411	010		83905
		22662230	010		83905
		22662237	010		83905
2016	VNM 64T-630 Models with High Rise Sleeper Cabs	22662235	010		83905
- 2014	VNM Models - All with 60" to 77" Mid - High Roof Sleepers (w/O.E.M. Number)	21391412	010		83048









VNR - Series

2018	VNR 64T-400 Models with 42" Flat Roof Sleeper	22662235	010		83905
------	---	----------	-----	--	--------------

WABASH NATIONAL

Identification of the trailer suspension is necessary to determine what section of the catalog to refer to. Some possible options can be Chalmers, Hendrickson, Neway, Ridewell, Reyco.								
1997 -	RHP11, RHP55 and RideSentry Trailer Suspension	202447	010	85919		
		203447	010	85919		
	Trailers with Aurora part number	DANSR1VJ100	010	85078		
		FLL83203-071	010	83203	89436	
		FLL83207-071	010	83207	89407	
		FLL85000-071	010	85000	89436	
		FLL85030-071	010	85030	89440	
		FRUUCE1295-1	010	85300	89419	
		FRUUCE1295-901	010	85300	89419	
		FRUUCE2983-1	010	85322		
		FRUUCF8339-1	010	85321		
		HENS-20001	010	83128	89436	
		HENS-20002	010	85000	89436	
		HENS-20126	010	85323	89436	
		HENS-21292	010	85052		
		HENS-23566	010	85000	89436	
		NEW900-44-089	010	83124	89407	
		NEW900-44-162	010	83128	89436	
		NEW900-44-625	010	83125		
		NEW900-44-626	010	83126	89430	
		NEW900-44-642	010	83127		
		NEW900-44-794	010	83127		
		NEW900-44-868	010	85045		
		NEW900-44-978	010	85059		
		NEW900-44-979	010	83113		
NEW900-45-040	010	83130				
NEW900-45-054	010	85051				
NEW900-45-298	010	83128	89436			
NEW900-45-299	010	85000	89436			

APPLICATION GUIDE - TRUCKS, TRAILERS, AND BUSES

Year	Model	OEM #	Front		Rear	
						
						
			Fleetline	GasSLX	Fleetline	GasSLX

WABASH NATIONAL(Cont'd.)

	Trailers with Aurora part number							
	Heavy Duty	HENS-24088	010	85000	89436	
	Standard	HENS-24088	010	83128	89436	

WATSON & CHALIN MFG. INC.

Heavy Duty Trailer Air Suspension

	TA-2590-14, 17 HD	10148	010	83204	...	
	TA-3090-14, -17, -19	10148	010	83204	...	
	TA-550-17	10148	010	83204	...	

Light Weight Trailer Air Suspension

	TA-3175-9	17079	010	85300	89419	
	TA-751-16	10148	010	83204	...	

LWSL-1100-SR Self Steer Axle Suspension

	AL-1100-SR Models	10148	010	83204	...	
	HL-1100-20	10148	010	83204	...	
	HL-1100-20 FL	10147	010	83203	89436	
	SL-1100-LR	12128	010	85005	89430	

Trailer Air Suspension

	TA-2590-12, 14, 15, & 17,	12128	010	85005	89430	
	TA-2590-12-1	10147	010	83203	89436	

WCAL-2200 Series Pusher or Tag Axle Assembly

	AL-2200 Models	10148	010	83204	...	
--	----------------	-------	-----	-----	-----	-------	-----	--

WCTA Series Dump Trailer Air Suspension

	TA-1600-21	11604	010	83125	...	
	TA-1900-15	10147	010	83203	89436	
	TA-1900-16, -17	10148	010	83204	...	
	TA-1900-18, -19	12128	010	85005	89430	
	TA-5000-DB-19, -F-19	12128	010	85005	89430	
	TA-5000-DB-24, -DB-30, -F-24, -F-30,	11724	010	83123	89405	
	TA-525, -DB	10147	010	83203	89436	

WCTA Series Trailer Air Suspension

	TA-2075-6	10148	010	83204	...	
	TA-2075-9	12128	010	85005	89430	
	TA-250-12	10148	010	83204	...	
	TA-250-6, 7.5, 9,	10147	010	83203	89436	
	TA-251-12, -12FS,	10148	010	83204	...	
	TA-251-6.5, -6.5FS,	10147	010	83203	89436	
	TA-251-7.5, -7.5FS	10147	010	83203	89436	
	TA-251-8FS	10147	010	83203	89436	
	TA-251-9.0, -9.0FS, -10,	10147	010	83203	89436	
	TA-255-9	10147	010	83203	89436	
	TA-280-6.5, 7.5, -9.0,	11604	010	83125	...	
	TA-300-9	10147	010	83203	89436	
	TA-380-9	12128	010	85005	89430	

WCTA-1200 Series Trailer Air Suspension

	TA-1000	10634	010	G63357	...	
	TA-1200-5	10147	010	83203	89436	





WCTL-2200 Series Trailer Air Lift

	TL-1600-21	11604	010	83125	...	
10/89 -	TL-2590-12,14,15, & 17	12128	010	85005	89430	

WCWB Series Trailer Air Suspension

	WB-2500-6	10148	010	83204	...	
	WB-2500-7.5, -9,	12128	010	85005	89430	
	WB-251-6.5, 7.5, 9	10147	010	83203	89436	

APPLICATION GUIDE - TRUCKS, TRAILERS, AND BUSES

Year	Model	OEM #	Front		Rear	
						
			Fleetline	GasSLX	Fleetline	GasSLX

WATSON & CHALIN MFG. INC.(Cont'd.)

WCWB Series Trailer Air Suspension(Cont'd.)

	WB-280-9	11604	010	83125	...
	Models with O.E.M. Number	17300	010	85052	...
		3946219	-1-	83400	...
		665727	010	85005	89430
		665769	010	85052	...

Additional O.E.M. Interchanges

	Models with O.E.M. Number	10147HD	010	85000	89436
		17186	010	85323	89436
		17186-01	010	85323	89436
		17218	010	85029	...
		17297	010	85064	...
		17306	010	85938	...
		17317	010	85344	...
		17382	010	85014	...
		17430	010	85321	...
		17474	-10	85009	...
		19036	010	85934	...
		19249	010	85939	...
		19250	010	85382	...
		19603	010	85939	...
		665724	010	85000	89436
		665728	010	85060	...
		665770	010	85064	...
		665862	010	85000	89436
		680547	010	85323	89436
		680584	010	85938	...
		680714	010	85934	...
		727603	010	83203	89436
		727604	010	83204	...
		A-20345	010	85345	...
		B-23649	010	85064	...
		B-23650	010	85052	...
		B-23651	010	85045	...
		B-23743	010	85938	...

WESTERN STAR

	Models with Neway ADZ Rear Suspension	471700004423	010	85109	...
		90045605	010	85109	...









3800 Series - Heritage Class

	3842S, 3864S Models	37390-4401	010	85053	89442
		37390-4402	010	85053	89442
		37390-4403	010	85053	89442
	With Hendrickson Rear Suspension	47902-13	010	83122	89406
		47902-24	010	83137	...
		47902-8	010	83122	89406
	With Neway Rear Suspension	90044025	010	83209	89414
		90044907	01-	83635	...

4700 Series

11 - 19	Models with 18,000 lb - 20,000 lb Flat Leaf Spring and Set Forward Front Axle	10-13684-000	010	85918	89449
		471700000470	010	85918	89449
11 - 19	Models with 20000 lb Set -Back Front Axle	10-13809-000	010	85958
		471700003920	010	85958
11 - 19	Models with FAS II Rear Air Suspension	16-18708-000	010	85724	89443
		471700002809	010	85724	89443

APPLICATION GUIDE - TRUCKS, TRAILERS, AND BUSES

Year	Model	OEM #	Front		Rear	
						
						
			Fleetline	GasSLX	Fleetline	GasSLX

WESTERN STAR(Cont'd.)

4700 Series(Cont'd.)

11 - 19	Models with Freightliner TufTrac Rear Air Suspension	16-15770-000	OIO	85956	...
		481700125969	OIO	85956	...
		SDA481700125969	OIO	85956	...
11 - 19	Models with Hendrickson HMX 400/460 Haulmax with 16.5" Saddle	60680-004	OI-	83143	...
		60680-004L	OI-	83143	...
11 - 19	Models with Hendrickson HMX 400/460 Haulmax with 17.5" & 18.5" Saddle	60680-005	OI-	83142	...
		60680-005L	OI-	83142	...
11 - 19	Models with Hendrickson HN - 462	60680-003	OI-	83112	...
		60680-003L	OI-	83112	...
11 - 19	Models with Hendrickson Primaax EX 462 Air Suspensions Standard with 8 1/2" to 10" Ride Height	60657-003	OIO	85072	...
		60657-003L	OIO	85072	...
11 - 19	Models with Reyco 79KB Rear Steel Spring Suspension	16725-01	OIO	83126	...
		19495-01	OIO	83126	...





4800 & 4900 Series - Constellation Class

	4842FX, 4864FX, 4964EX, 4964EX, 4942SX or 4964SX Constellation Class	37301-3401	OIO	85053	89442
		37301-3404	OIO	85053	89442
		37301-3409	OIO	85053	89442
		37301-3412	OIO	85053	89442
		37390-4401	OIO	85053	89442
		37390-4402	OIO	85053	89442
		37390-4403	OIO	85053	89442
09 - 12	Models w/ Low Profile Rear Air Suspension	16-18706-000	OIO	85331	...
09 - 15	Models with 12000 lb Taperleaf Front Suspension	10-13809-000	OIO	85958
		SDA471700003920	OIO	85958
08 - 19	Models with Freightliner TufTrac Rear Air Suspension	16-15770-000	OIO	85956	...
		SDA481700125969	OIO	85956	...
- 2016	Models with Hendrickson Front Airtek	471700006269	OIO	85932	89453
		471700131331	OIO	85932	89453
		58913-003	OIO	85932	89453
		58913-003L	OIO	85932	89453
		58913-012	OIO	85932	89453
		58913-012L	OIO	85932	89453
	With Hendrickson HAS-40LH Rear Suspension	57241-1	OI-	83111	...
	With Hendrickson Rear Suspension	47902-13	OIO	83122	89406
		47902-24	OIO	83137	...
		47902-8	OIO	83122	89406
	With Neway Rear Suspension	90044025	OIO	83209	89414
		90044907	OI-	83635	...
		90045099	OIO	85906	89407

4800 & 4900 Series - Heritage Class

	4842F, 4864F, 4843S, 4864S, 4942F, 4964F, 4942S or 4964S Heritage Class	37301-3401	OIO	85053	89442
		37301-3404	OIO	85053	89442
		37301-3409	OIO	85053	89442
		37301-3412	OIO	85053	89442
		37390-4401	OIO	85053	89442
		37390-4402	OIO	85053	89442
		37390-4403	OIO	85053	89442
09 - 15	Models with 12000 lb Taperleaf Front Suspension	10-13809-000	OIO	85958
		SDA471700003920	OIO	85958
08 - 19	Models with Freightliner TufTrac Rear Air Suspension	16-15770-000	OIO	85956	...
		SDA481700125969	OIO	85956	...

APPLICATION GUIDE - TRUCKS, TRAILERS, AND BUSES

Year	Model	OEM #	Front		Rear	
						
			Fleetline	GasSLX	Fleetline	GasSLX

WESTERN STAR(Cont'd.)

4800 & 4900 Series - Heritage Class(Cont'd.)

- 2016	Models with Hendrickson Front Airtek	471700006269	010	85932	89453	
		471700131331	010	85932	89453	
		58913-003	010	85932	89453	
		58913-003L	010	85932	89453	
		58913-012	010	85932	89453	
		58913-012L	010	85932	89453	
	With Hendrickson HAS-40LH Rear Suspension	57241-1		01-	83111	...
	With Hendrickson Rear Suspension	47902-13		010	83122	89406
47902-24			010	83137	...	
47902-8			010	83122	89406	
	With Neway Rear Suspension	90044025		010	83209	89414
90044907			01-	83635	...	
90045099			010	85906	89407	









5800 & 5900 Series - Constellation Class

	5842SS, 5864SS, 5942SS or 5964SS Constellation Class	37301-3401	010	85053	89442	
		37301-3404	010	85053	89442	
		37301-3409	010	85053	89442	
		37301-3412	010	85053	89442	
		37390-4401	010	85053	89442	
		37390-4402	010	85053	89442	
		37390-4403	010	85053	89442	
09 - 15		Models with 12000 lb Taperleaf Front Suspension	10-13809-000	010	85958
	SDA471700003920		010	85958
08 - 15	Models with Freightliner TufTrac Rear Air Suspension	16-15770-000		010	85956	...
		SDA481700125969		010	85956	...
	With Hendrickson Rear Suspension	47902-13		010	83122	89406
		47902-24		010	83137	...
		47902-8		010	83122	89406
	With Neway Rear Suspension	90044025		010	83209	89414
		90044907		01-	83635	...
		90045099		010	85906	89407
	With Hendrickson Rear Suspension	57905-2		010	85006	...

5900 & 6900 Series - Heritage Class

	5942S, 5964S, 6964F or 6964S Heritage Class	37301-3401	010	85053	89442	
		37301-3404	010	85053	89442	
		37301-3409	010	85053	89442	
		37301-3412	010	85053	89442	
		37390-4401	010	85053	89442	
		37390-4402	010	85053	89442	
		37390-4403	010	85053	89442	
		All with 4 shock Front System	010	83401
09 - 15	Models with 12000 lb Taperleaf Front Suspension	10-13809-000	010	85958
		SDA471700003920	010	85958
08 - 15	Models with Freightliner TufTrac Rear Air Suspension	16-15770-000		010	85956	...
		SDA481700125969		010	85956	...
- 06/10	Models with Hendrickson Airtek Suspension	58913-003	010	85932	89453	
		58913-003L	010	85932	89453	
07/10 -	Models with Hendrickson Airtek Suspension	471700006269	010	85932	89453	
		58913-012	010	85932	89453	
		58913-012L	010	85932	89453	
	With Hendrickson HAS-40LH Rear Suspension	57241-1		01-	83111	...
	With Hendrickson Rear Suspension	47902-13		010	83122	89406
		47902-24		010	83137	...
		47902-8		010	83122	89406

APPLICATION GUIDE - TRUCKS, TRAILERS, AND BUSES

Year	Model	OEM #	Front		Rear	
						
						
			Fleetline	GasSLX	Fleetline	GasSLX

WESTERN STAR(Cont'd.)

5900 & 6900 Series - Heritage Class(Cont'd.)

	With Hendrickson Rear Suspension	60675-002		OIO	85979	...
		60675-002L		OIO	85979	...
	With Neway Rear Suspension	90044025		OIO	83209	89414
		90044907		OI-	83635	...
		90045099		OIO	85906	89407
				OIO	85906	89407
	Models with O.E.M. Number	02-7005976	-I-	83400
		02-7005977	-I-	83400
		04-9041375		OIO	85315	...
		28R010	OIO	83216
		35066-4413		OIO	83122	89406
		35901-0001		OIO	83209	89414
		35901-4403		OIO	85060	...
		37301-3405	OIO	85053	89442	
		57252	OIO	85308	89422	
		57905-1		OIO	85976	...
		665682	OIO	85053	89442	
		CP-5222		OIO	85315	...
	With Hendrickson Rear Suspension	57905-2		OIO	85006	...
	Additional O.E.M. Interchanges	1011839	OIO	83216
		35901-3406	OIO				85305	
		35901-3409	OIO				85304	
		35901-3410	OIO				85307	
		35901-3413	OIO				85006	
		35901-3420	OIO				85303 or 89422	
		615016	OIO				83401	
		676081	OIO				83401	
		676082	OIO				83401	





WESTERN STAR CAB SHOCKS

	6900 Models	725470	OIO	83010
01 - 15	6900 SX Models	66010-3407	OIO	83065
	Constellation Day Cab Models	18-60772-000	OIO	83026
		66010-3405	OIO	83026
		81-4903003500	OIO	83026
	Constellation Sleeper Cab Models	18-60773-000	OI-	83027
		66010-3406	OI-	83027
		814903003501	OI-	83027
1986 -	Conventional Tractors with Link Cabmate Model WSC4000	1201-0012	OIO	83023
		1202-0012	OIO	83023
	For 4800, 4900, 6900 Heritage & Constellation Day Cab	66010-3402	OIO	83022
		66010-3403	OIO	83022
	Heritage Constellation models	66010-3404	OIO	83022
	Models with Link Cab Suspension	1202-0032	OIO	83016
	Models with O.E.M. Number	617547	OIO	83022
		654846	OI-	83027
		GBL 654916	OIO	83026

WESTERN UNIT "STABILAIRE" SUSPENSION

	Model 893T Trailer Suspension	OIO	85307	...
	Model TDA202, 203, 206, 240, 241, 243 Truck Drive Axle Suspension	OIO	85735	...
	Model TDA204, 205, 242 - Truck Drive Axle Suspension	OIO	85307	...
	Models with O.E.M. Number	101030		OIO	85307	...
		101364		OIO	85305	...
		4939967		OIO	85308	89422

APPLICATION GUIDE - TRUCKS, TRAILERS, AND BUSES

Year	Model	OEM #	Front		Rear	
						
			Fleetline	GasSLX	Fleetline	GasSLX

WESTERN UNIT "STABILAIRE" SUSPENSION(Cont'd.)

Models with O.E.M. Number	80370	010	85304	...
	80600	010	85300	89419

WHEELED COACH IND





Citimedic models with Ford E350 & E450 Chassis	ASH-1136	-10	83178	...
	ASH-1154	-10	83177

WINNEBAGO

Class A MotorHomes

99 - 17	Adventurer Series MotorHomes with Ford F53 Chassis with 16,000 lb GVW to 22,000 lb GVW	1C34-18045-AA	010	83209	89414	
		1C34-18045-JA	010	83209	89414	
		9U94-18045-AA	010	83209	89414	
		9U94-18080-AA	010	010	83122	89406
		9U9Z-18124-A	010	83209	89414	
		9U9Z-18125-A	010	010	83122	89406
		ASH-1022	010	83209	89414	
		ASH-1023	010	010	83122	89406
		ASH-1205	010	83209	89414	
		ASH-1206	010	010	83122	89406
		ASH-1228	010	83209	89414	
		ASH-1229	010	83209	89414	
		ASH-1230	010	010	83122	89406
		ASH-137	010	010	83122	89406
		ASH-25822	010	83209	89414	
		ASH-25823	010	83209	89414	
ASH-25824	010	010	83122	89406		
ASH-294	010	83209	89414			
AT-620	010	83209	89414			
AT-621	010	010	83122	89406		
AT-766	010	83209	89414			
03 - 04	Adventurer Series MotorHomes with Workhorse W22, & W24 MotorHome Chassis with O.E.M. Number	24-186537		01-	85126	...
		F4-BE5-A011-HO		01-	85126	...
03 - 10	Adventurer Series MotorHomes with Workhorse W22, & W24 MotorHome Chassis with O.E.M. Number	24-153249	010	85125	
		24-186629	010	85125	
		F4-BE5-A832-MO	010	85125	
		F4-BE5-B492-HO	010	85125	
		F4-BE5-F324-HO	010	85125	
		W0005662	010	85125	
W0006254	010	85125			
05 - 10	Adventurer Series MotorHomes with Workhorse W22, & W24 MotorHome Chassis with O.E.M. Number	24-153256		-1-	85124	...
		F4-BE5-F325-HO		-1-	85124	...
		W0005663		-1-	85124	...
18 - 19	Intent Series MotorHomes with Ford F53 Chassis with 16,000 lb GVW to 22,000 lb GVW	ASH-1229	010	83209	89414	
		ASH-25822	010	83209	89414	
		ASH-25823	010	83209	89414	
		ASH-25824	010	010	83122	89406
03 - 06	Journey Series MotorHomes with Freightliner XC Chassis ADL200 Suspension w/ 20K Rear AS120 Front Suspension Rear Shock with O.E.M. Number	16-16873-000		010	85029	...
		141700131810	010	83160	
		16-16737-000	010	83160	
		16-16874-000	010	83160	
		141700131809		010	85029	...

APPLICATION GUIDE - TRUCKS, TRAILERS, AND BUSES

Year	Model	OEM #	Front		Rear	
						
			Fleetline	GasSLX	Fleetline	GasSLX

WINNEBAGO(Cont'd.)

Class A MotorHomes(Cont'd.)

03 - 06	ADL200 Suspension w/ 20K Rear ZF - IFS Front Suspension with 23,000 lb GVW or Greater	16-16736-000		010	85029	...
		16-18103-000	-1-	85900
		481700000493	-1-	85900
	Models with Workhorse UFO Chassis with Hendrickson Softek Front Suspension	66153-002	010	83124	89407	
		F4-BE5-C832-MO	010	83124	89407	
11 - 19	Sightseer Series MotorHomes with Ford F53 Chassis with 16,000 lb GVW to 22,000 lb GVW	ASH-1229	010	83209	89414	
		ASH-25822	010	83209	89414	
		ASH-25823	010	83209	89414	
		ASH-25824		010	83122	89406
11 - 19	Sunova Series MotorHomes with Ford F53 Chassis with 16,000 lb GVW to 22,000 lb GVW	ASH-1229	010	83209	89414	
		ASH-25822	010	83209	89414	
		ASH-25823	010	83209	89414	
		ASH-25824		010	83122	89406
11 - 19	SunStar & SunStar LX Series MotorHomes with Ford F53 Chassis with 16,000 lb GVW to 22,000 lb GVW	ASH-1229	010	83209	89414	
		ASH-25822	010	83209	89414	
		ASH-25823	010	83209	89414	
		ASH-25824		010	83122	89406
2006	Tour Series MotorHomes with Freightliner XC Chassis ADL200 Suspension w/ 20K Rear AS120 Front Suspension Rear Shock with O.E.M. Number ZF - IFS Front Suspension with 23,000 lb GVW or Greater	16-16873-000		010	85029	...
		141700131810	010	83160
		16-16737-000	010	83160
		16-16874-000	010	83160
		141700131809		010	85029	...
		16-16736-000		010	85029	...
		16-18103-000	-1-	85900
		481700000493	-1-	85900
04 - 06	Vetra Series MotorHomes with Freightliner XC Chassis ADL200 Suspension w/ 20K Rear AS120 Front Suspension Rear Shock with O.E.M. Number ZF - IFS Front Suspension with 23,000 lb GVW or Greater	16-16873-000		010	85029	...
		141700131810	010	83160
		16-16737-000	010	83160
		16-16874-000	010	83160
		141700131809		010	85029	...
		16-16736-000		010	85029	...
		16-18103-000	-1-	85900
		481700000493	-1-	85900
11 - 19	Vista & Vista LX Series MotorHomes with Ford F53 Chassis with 16,000 lb GVW to 22,000 lb GVW	ASH-1229	010	83209	89414	
		ASH-25822	010	83209	89414	
		ASH-25823	010	83209	89414	
		ASH-25824		010	83122	89406

Class C MotorHomes

07 - 13	Access, Access Premier & Aspect Series MotorHomes with Ford E350 & E450 Chassis	ASH-1136		-10	83178	...
		ASH-1154	-10	83177
05 - 19	Aspect Series MotorHomes with Ford E450 Chassis	ASH-1136		-10	83178	...
		ASH-1154	-10	83177
13 - 19	Cambria Series MotorHomes with Ford E450 Chassis	ASH-1136		-10	83178	...
		ASH-1154	-10	83177
99 - 19	Minnie Winnie Series MotorHomes with Ford E350 & E450 Chassis	ASH-1136		-10	83178	...
		ASH-1154	-10	83177
06 - 19	Outlook Series MotorHomes with Ford E350 & E450 Chassis	ASH-1136		-10	83178	...
		ASH-1154	-10	83177

APPLICATION GUIDE - TRUCKS, TRAILERS, AND BUSES

Year	Model	OEM #	Front		Rear	
			Fleetline	GasSLX	Fleetline	GasSLX

WINNEBAGO(Cont'd.)

Class C MotorHomes(Cont'd.)

15 - 19	Spirit Series MotorHomes with Ford E350 & E450 Chassis	ASH-1136 ASH-1154		- 0	83178	...
			- 0	83177

WORKHORSE

	Models with O.E.M. Number	659223		0 0	G63866	...
		680672		0 0	85919	...
		W0011635	0 0	83221
		W0011636		0 0	G63366	...
	Models with RSAS Rear Suspension	7805-X-1012		0 0	85919	...
	Step Van Models with O.E.M. Number	659222	0 0	83171
		W0007363	0 0	83171
		W0007365		0 0	G63866	...
06 - 11	Step Van Models with W42 Chassis	W8007000	0 0	83171
	UFO Motorhome Chassis with Hendrickson Softek Front Suspension	66153-002	0 0	83124	89407
		F4-BE5-C832-MO	0 0	83124	89407
06 - 09	W16 & W18 MotorHome Chassis with O.E.M. Number	F4-BE5-F324-HO W0005662	0 0	85125
05 - 14	W20 , W22, & W24 MotorHome Chassis with O.E.M. Number	24-153256		- -	85124	...
		F4-BE5-F325-HO		- -	85124	...
		W0005663		- -	85124	...
98 - 04	W20 , W22, & W24 MotorHome Chassis with O.E.M. Number	24-186537		0 -	85126	...
		F4-BE5-A011-HO		0 -	85126	...
98 - 14	W20 , W22, & W24 MotorHome Chassis with O.E.M. Number	24-153249	0 0	85125
		24-186629	0 0	85125
		F4-BE5-A832-MO	0 0	85125
		F4-BE5-B492-HO	0 0	85125
		F4-BE5-F324-HO	0 0	85125
		W0005662	0 0	85125
		W0006254	0 0	85125

WORLD TRANS BUS CO.

	E & G Series Commercial buses on Ford E350 or E450 Chassis	ASH-1136		- 0	83178	...
		ASH-1154	- 0	83177

NUMERICAL LISTING

GABRIEL#	APPLICATION	MTG ACC PKG NO	GABRIEL#	APPLICATION	MTG ACC PKG NO	GABRIEL#	APPLICATION	MTG ACC PKG NO
Shocks for Special Applications			G63398	W FORD MITSUBISHI-FUSO	141138	G63773	W FORD	Not Req'd.
83176	X VARIOUS	Not Req'd.	G63403	W FREIGHTLINER VOLVO	Not Req'd.	G63775	W FORD	Not Req'd.
632147	W CHALLENGE LINK/HIGH-STEER MC NEILUS TRUCK & MAN. WATSON & CHALIN MFG. INC.	Not Req'd.	G63405	W MITSUBISHI-FUSO	140884	G63778	W FORD	142700
646155	A ADVANCE MIXER GRANNING SUSPENSION HENDRICKSON TRAILER SUSPENSION SYSTEMS HENDRICKSON TRUCK SUSPENSION SYSTEMS KIMBLE MIXER CO LINK/HIGH-STEER LONDON MIXER MC NEILUS TRUCK & MAN. REX MIXER RIDEWELL CORPORATION SAF HOLLAND SUSPENSIONS INC. TEREX CORPORATION TUTHILL TECHNOLOGIES WATSON & CHALIN MFG. INC.	Not Req'd.	G63406	W FORD	Not Req'd.	G63808	W FORD	Not Req'd.
646177	A CHALLENGE LINK/HIGH-STEER OSHKOSH MOTORS PIERCE MANUFACTURING INC. SAF HOLLAND SPRING VALLEY WESTPORT AXLE CORP	Not Req'd.	G63409	W FORD	Not Req'd.	G63809	W FORD STERLING TRUCK	Not Req'd.
665472	W INGERSALL MACHINE	Not Req'd.	G63414	W FORD	140780	G63810	W FORD	Not Req'd.
665937	C LINK/HIGH-STEER REYCO SUSPENSION RIDEWELL CORPORATION	Not Req'd.	G63419	W HINO	Not Req'd.	G63811	W FORD	Not Req'd.
Gas Light Truck Applications			G63432	W INTERNATIONAL (NAVISTAR) NISSAN	141349 & 140169	G63837	W FORD	Not Req'd.
G63183	W CHRYSLER DODGE TRUCK FREIGHTLINER HOLIDAY RAMBLER JOHN DEERE MOR-RYDE SUSPENSION OSHKOSH MOTORS VOLVO	Not Req'd.	G63440	W HINO	Not Req'd.	G63866	W MOR-RYDE SUSPENSION WORKHORSE	Not Req'd.
G63299	W FORD INTERNATIONAL (NAVISTAR) MITSUBISHI-FUSO	140885(1)	G63455	W FORD	Not Req'd.	G63929	W FORD	140780
G63306	W FORD INTERNATIONAL (NAVISTAR)	Not Req'd.	G63461	W FORD	Not Req'd.	G63969	W FORD	143146
G63347	W CHEVROLET TRUCK (Also See GMC Truck) GMC TRUCK	Not Req'd.	G63484	W VOLVO	140524	Fleetline Applications		
G63350	W FORD	140126	G63500	W FORD	140780	83001	B FREIGHTLINER CAB SHOCKS	404702(1)
G63355	W CHALMERS SUSPENSION	140702	G63511	W FORD	141353	83002	C KENWORTH CAB SHOCKS LINK MANUFACTURING CAB SHOCKS	Not Req'd.
G63357	W WATSON & CHALIN MFG. INC.	Not Req'd.	G63524	W FORD	Not Req'd.	83003	X MACK CAB SHOCKS	140455(1)
G63366	W WORKHORSE	Not Req'd.	G63525	W FORD	Not Req'd.	83004	W VOLVO CAB SHOCKS	Not Req'd.
G63386	W FORD STERLING TRUCK	140780	G63605	W DODGE TRUCK FREIGHTLINER JOHN DEERE OSHKOSH MOTORS VOLVO	140169	83005	X INTERNATIONAL (NAVISTAR) CAB SHOCKS LINK MANUFACTURING CAB SHOCKS	140455(1)
G63387	W FORD STERLING TRUCK	140126	G63607	W FORD	140719	83006	W FREIGHTLINER CAB SHOCKS	404702(1)
G63396	W FORD	140780	G63608	W FORD	140780	83007	W MACK CAB SHOCKS	404702(2) & 140702(1)
			G63610	W HINO INTERNATIONAL (NAVISTAR) MITSUBISHI-FUSO NISSAN	142389	83008	A KENWORTH PETERBILT CAB SHOCKS	Not Req'd.
			G63614	W FORD	140780	83009	B FREIGHTLINER CAB SHOCKS MC NEILUS TRUCK & MAN. OSHKOSH MOTORS CAB SHOCKS VOLVO CAB SHOCKS	Not Req'd.
			G63622	W FORD	142617	83010	W WESTERN STAR CAB SHOCKS	Not Req'd.
			G63623	W FORD	142617	83011	D KENWORTH CAB SHOCKS PETERBILT CAB SHOCKS	404702(2)
			G63624	W FORD	140780	83012	W KENWORTH CAB SHOCKS PETERBILT CAB SHOCKS	404702(2)
			G63625	W VOLVO	140702	83013	X INTERNATIONAL (NAVISTAR) CAB SHOCKS LINK MANUFACTURING CAB SHOCKS	Not Req'd.
			G63676	W FORD	Not Req'd.	83015	W INTERNATIONAL (NAVISTAR) CAB SHOCKS	140455(1)
			G63678	W FORD	Not Req'd.	83016	W CHEVROLET TRUCK CAB SHOCKS FORD CAB SHOCKS FREIGHTLINER CAB SHOCKS GMC TRUCK CAB SHOCKS INTERNATIONAL (NAVISTAR) CAB SHOCKS KENWORTH CAB SHOCKS LINK MANUFACTURING CAB SHOCKS MACK CAB SHOCKS PETERBILT CAB SHOCKS VOLVO CAB SHOCKS WESTERN STAR CAB SHOCKS	Not Req'd.
			G63679	W FORD	140719			
			G63714	W FORD	142731			
			G63716	W FORD	142731			
			G63772	W FORD	141665			

X = Discontinued once inventory is gone

NUMERICAL LISTING

GABRIEL#	APPLICATION	MTG ACC PKG NO	GABRIEL#	APPLICATION	MTG ACC PKG NO	GABRIEL#	APPLICATION	MTG ACC PKG NO
83017	D FREIGHTLINER CAB SHOCKS	Not Req'd.	83039	W FREIGHTLINER CAB SHOCKS	Not Req'd.	83100	X INTERNATIONAL (NAVISTAR) VOLVO	Not Req'd.
83018	W MACK CAB SHOCKS	140780(1)	83040	W FREIGHTLINER CAB SHOCKS	Not Req'd.	83101	W IC CORPORATION INTERNATIONAL (NAVISTAR) MACK VOLVO	Not Req'd.
83019	W MACK CAB SHOCKS VOLVO	140780(1)	83041	D MACK CAB SHOCKS VOLVO	140780(1)	83102	W THOMAS SCHOOL BUS	145089-000(2)
83020	W FREIGHTLINER CAB SHOCKS	Not Req'd.	83042	D KENWORTH CAB SHOCKS PETERBILT CAB SHOCKS	Not Req'd.	83103	W INTERNATIONAL (NAVISTAR) MITSUBISHI-FUSO MOR-RYDE SUSPENSION VOLVO	145054(2)
83021	C CHEVROLET TRUCK CAB SHOCKS CNH GLOBAL N V FREIGHTLINER CAB SHOCKS GMC TRUCK CAB SHOCKS INTERNATIONAL (NAVISTAR) CAB SHOCKS KENWORTH CAB SHOCKS LINK MANUFACTURING CAB SHOCKS MARMON CAB SHOCKS OSHKOSH MOTORS CAB SHOCKS PETERBILT CAB SHOCKS	Not Req'd.	83044	W FREIGHTLINER CAB SHOCKS	Not Req'd.	83104	W HINO VOLVO	Not Req'd.
83022	W CNH GLOBAL N V WESTERN STAR CAB SHOCKS	Not Req'd.	83045	W MACK CAB SHOCKS VOLVO	140780(1)	83105	W MACK VOLVO	140780(1)
83023	W CHEVROLET TRUCK CAB SHOCKS FORD CAB SHOCKS FREIGHTLINER CAB SHOCKS GMC TRUCK CAB SHOCKS INTERNATIONAL (NAVISTAR) CAB SHOCKS KENWORTH CAB SHOCKS LINK MANUFACTURING CAB SHOCKS MACK CAB SHOCKS PETERBILT CAB SHOCKS VOLVO CAB SHOCKS WESTERN STAR CAB SHOCKS	Not Req'd.	83047	D FREIGHTLINER CAB SHOCKS	404702(1)	83107	W FORD MAECO STERLING TRUCK	145080(2)
83024	D KENWORTH CAB SHOCKS LINK MANUFACTURING CAB SHOCKS PETERBILT CAB SHOCKS	Not Req'd.	83048	C VOLVO VOLVO CAB SHOCKS	Not Req'd.	83109	W FORD HENDRICKSON TRUCK SUSPENSION SYSTEMS MC NEILUS TRUCK & MAN. STERLING TRUCK	145128(1)
83025	C FORD CAB SHOCKS FREIGHTLINER CAB SHOCKS GMC TRUCK CAB SHOCKS INTERNATIONAL (NAVISTAR) CAB SHOCKS KENWORTH CAB SHOCKS LINK MANUFACTURING CAB SHOCKS PETERBILT CAB SHOCKS STERLING TRUCK CAB SHOCKS	Not Req'd.	83049	D KENWORTH CAB SHOCKS LINK MANUFACTURING CAB SHOCKS PETERBILT CAB SHOCKS	Not Req'd.	83110	D HENDRICKSON TRUCK SUSPENSION SYSTEMS MACK VOLVO	145128(1)
83026	W FREIGHTLINER CAB SHOCKS WESTERN STAR CAB SHOCKS	Not Req'd.	83050	W MACK CAB SHOCKS VOLVO CAB SHOCKS	140780(1)	83111	D HENDRICKSON TRUCK SUSPENSION SYSTEMS MACK VOLVO WESTERN STAR	145128(1)
83027	D FREIGHTLINER CAB SHOCKS WESTERN STAR CAB SHOCKS	140126(1)	83051	C INTERNATIONAL (NAVISTAR) CAB SHOCKS LINK MANUFACTURING CAB SHOCKS	Not Req'd.	83112	C ADVANCE MIXER AUTOCAR HENDRICKSON TRUCK SUSPENSION SYSTEMS INTERNATIONAL (NAVISTAR) MACK MC NEILUS TRUCK & MAN. PETERBILT VOLVO WESTERN STAR	145128(1)
83028	C VOLVO CAB SHOCKS	Not Req'd.	83052	X INTERNATIONAL (NAVISTAR) CAB SHOCKS LINK MANUFACTURING CAB SHOCKS	Not Req'd.	83113	W SAF HOLLAND STOUGHTON TRAILERS INC. TRAILMOBILE CANADA CORP. WABASH NATIONAL	Not Req'd.
83029	C VOLVO CAB SHOCKS	Not Req'd.	83053	W INTERNATIONAL (NAVISTAR) CAB SHOCKS LINK MANUFACTURING CAB SHOCKS	Not Req'd.	83114	W CHEVROLET TRUCK (Also See GMC Truck) GMC TRUCK INTERNATIONAL (NAVISTAR) ISUZU NISSAN	140780(1)
83030	W VOLVO CAB SHOCKS	Not Req'd.	83054	W INTERNATIONAL (NAVISTAR) CAB SHOCKS LINK MANUFACTURING CAB SHOCKS	Not Req'd.	83115	X SAF HOLLAND TRAILMOBILE CANADA CORP.	Not Req'd.
83031	C KENWORTH CAB SHOCKS LINK MANUFACTURING CAB SHOCKS	Not Req'd.	83055	W KENWORTH CAB SHOCKS LINK MANUFACTURING CAB SHOCKS	Not Req'd.	83116	W FREIGHTLINER CUSTOM CHASSIS	Not Req'd.
83032	S FREIGHTLINER CAB SHOCKS INTERNATIONAL (NAVISTAR) CAB SHOCKS KENWORTH CAB SHOCKS LINK MANUFACTURING CAB SHOCKS	Not Req'd.	83056	X KENWORTH CAB SHOCKS PETERBILT CAB SHOCKS POWERPACKER CAB SHOCKS	Not Req'd.	83117	W FREIGHTLINER FREIGHTLINER CUSTOM CHASSIS OSHKOSH MOTORS	404702(1)
83033	W FORD CAB SHOCKS FREIGHTLINER CAB SHOCKS STERLING TRUCK CAB SHOCKS	Not Req'd.	83057	X FREIGHTLINER CAB SHOCKS STERLING TRUCK CAB SHOCKS	Not Req'd.	83118	W FREIGHTLINER FREIGHTLINER CUSTOM CHASSIS MAECO OSHKOSH MOTORS UPS TRUCK	Not Req'd.
83034	W FORD CAB SHOCKS FREIGHTLINER CAB SHOCKS STERLING TRUCK CAB SHOCKS	Not Req'd.	83058	X MACK CAB SHOCKS	140780(1)	83119	W FREIGHTLINER CUSTOM CHASSIS OSHKOSH MOTORS	Not Req'd.
83035	C KENWORTH PETERBILT CAB SHOCKS	Not Req'd.	83059	W KENWORTH CAB SHOCKS PETERBILT CAB SHOCKS POWERPACKER CAB SHOCKS	Not Req'd.	83120	W 145089-000(1) & 145143(1) FREIGHTLINER FREIGHTLINER CUSTOM CHASSIS MAECO OSHKOSH MOTORS	
83038	A FREIGHTLINER CAB SHOCKS	404702(1)	83060	X PETERBILT CAB SHOCKS POWERPACKER CAB SHOCKS	Not Req'd.			
			83061	X LINK MANUFACTURING CAB SHOCKS PETERBILT CAB SHOCKS	Not Req'd.			
			83062	W INTERNATIONAL (NAVISTAR) CAB SHOCKS LINK MANUFACTURING CAB SHOCKS	145128(1)			
			83063	N KENWORTH PETERBILT CAB SHOCKS	Not Req'd.			
			83064	N ARVIN MERITOR FREIGHTLINER CAB SHOCKS	Not Req'd.			
			83065	N WESTERN STAR CAB SHOCKS	Not Req'd.			
			83066	N MACK CAB SHOCKS	Not Req'd.			
			83067	N KENWORTH CAB SHOCKS PETERBILT CAB SHOCKS	Not Req'd.			
			83081	N KENWORTH CAB SHOCKS PETERBILT CAB SHOCKS	Not Req'd.			

N = New, S = Superseded, X = Discontinued once inventory is gone

NUMERICAL LISTING

GABRIEL#	APPLICATION	MTG ACC PKG NO	GABRIEL#	APPLICATION	MTG ACC PKG NO	GABRIEL#	APPLICATION	MTG ACC PKG NO
83120	W	145089-000(1) & 145143(1)	83125	B	Not Req'd.	83142	W	145128(1)
	STERLING TRUCK THOMAS SCHOOL BUS UPS TRUCK VOLVO			WABASH NATIONAL WATSON & CHALIN MFG. INC.			AUTOCAR CATERPILLAR FREIGHTLINER HENDRICKSON TRUCK SUSPENSION SYSTEMS INTERNATIONAL (NAVISTAR) KENWORTH MACK MC NEILUS TRUCK & MAN. PETERBILT WESTERN STAR	
83122	D	Not Req'd.	83126	D	Not Req'd.	83143	D	145128(1)
	ALLCO TRAILER AUTOCAR CHEVROLET TRUCK (Also See GMC Truck) COACHMEN RV DAMON MOTOR COACH ENTEGR A COACH FLEETWOOD RV FORD FOREST RIVER INC FREIGHTLINER FRUEHAUF GEORGIE BOY MANUFACTURING GILLIG BROS. GMC TRUCK GREAT DANE TRAILER HENDRICKSON TRUCK SUSPENSION SYSTEMS HOLIDAY RAMBLER ISUZU ITASCA JAYCO RV INC KENWORTH LODAL, INC. MACK MAECO MARMON MC NEILUS TRUCK & MAN. MONACO NATIONAL RV INC. NEWMAR CORP NEXUS RV OSHKOSH MOTORS PETERBILT REYCO SUSPENSION SAF HOLLAND THOR MOTOR COACH TUTHILL TECHNOLOGIES VOLVO WESTERN STAR WINNEBAGO			CHEVROLET TRUCK (Also See GMC Truck) GMC TRUCK HINO INTERNATIONAL (NAVISTAR) KENWORTH MAECO PETERBILT REYCO SUSPENSION SAF HOLLAND TUTHILL TECHNOLOGIES VOLVO WABASH NATIONAL WESTERN STAR			AUTOCAR CATERPILLAR CRANE CARRIER FREIGHTLINER HENDRICKSON TRUCK SUSPENSION SYSTEMS INTERNATIONAL (NAVISTAR) KENWORTH MACK MC NEILUS TRUCK & MAN. PETERBILT WESTERN STAR	
83123	C	Not Req'd.	83127	C	Not Req'd.	83144	W	Not Req'd.
	FORD GILLIG BROS. HENDRICKSON TRUCK SUSPENSION SYSTEMS IC CORPORATION INTERNATIONAL (NAVISTAR) KENWORTH MACK MAECO MARMON MC NEILUS TRUCK & MAN. PETERBILT REYCO SUSPENSION SAF HOLLAND TUTHILL TECHNOLOGIES VOLVO WATSON & CHALIN MFG. INC.			BLUEBIRD SCHOOL BUS FREIGHTLINER FREIGHTLINER CUSTOM CHASSIS HOLIDAY RAMBLER MC NEILUS TRUCK & MAN. OSHKOSH MOTORS SAF HOLLAND TRAILMOBILE CANADA CORP. VOLVO WABASH NATIONAL			HENDRICKSON TRUCK SUSPENSION SYSTEMS INTERNATIONAL (NAVISTAR)	
83124	C	Not Req'd.	83128	A	Not Req'd.	83145	X	Not Req'd.
	BENSON TRUCK BODIES INC. BLUEBIRD SCHOOL BUS COACHMEN RV EAST MANUFACTURING CORP. FOREST RIVER INC GEORGIE BOY MANUFACTURING ITASCA KENWORTH MONACO PETERBILT SAF HOLLAND TRAILMOBILE CANADA CORP. TWIN COACH VOLVO WABASH NATIONAL WINNEBAGO WORKHORSE			EAST MANUFACTURING CORP. FREIGHTLINER GREAT DANE TRAILER HENDRICKSON TRAILER SUSPENSION SYSTEMS MC NEILUS TRUCK & MAN. REYCO SUSPENSION SAF HOLLAND STOUGHTON TRAILERS INC. TWIN COACH UTILITY TRAILER MANUFACTURING COMPANY VOLVO WABASH NATIONAL			FORD	
83125	B	Not Req'd.	83130	D	Not Req'd.	83146	S	Not Req'd.
	CASCADE TRAILER EAST MANUFACTURING CORP. FORD GENERAL TRAILER CO HENDRICKSON TRUCK SUSPENSION SYSTEMS HOLLAND - BINKLEY MACK MAECO PEERLESS TRAILER SAF HOLLAND STERLING TRUCK THE BINKLEY COMPANY TRAILMOBILE CANADA CORP. VOLVO			RIDEWELL CORPORATION SAF HOLLAND VOLVO WABASH NATIONAL			FORD INTERNATIONAL (NAVISTAR) STERLING TRUCK	
83126	B	Not Req'd.	83131	W	Not Req'd.	83147	B	Not Req'd.
	ASCADIA AUTOCAR CHEVROLET TRUCK (Also See GMC Truck) GMC TRUCK HINO INTERNATIONAL (NAVISTAR) KENWORTH MAECO PETERBILT REYCO SUSPENSION SAF HOLLAND TUTHILL TECHNOLOGIES VOLVO WABASH NATIONAL WESTERN STAR			FORD			HENDRICKSON TRUCK SUSPENSION SYSTEMS MACK MC NEILUS TRUCK & MAN. THOMAS SCHOOL BUS	
83127	B	Not Req'd.	83132	W	145054(1)	83148	D	Not Req'd.
	ASCADIA AUTOCAR CHEVROLET TRUCK (Also See GMC Truck) GMC TRUCK HINO INTERNATIONAL (NAVISTAR) KENWORTH MAECO PETERBILT REYCO SUSPENSION SAF HOLLAND TUTHILL TECHNOLOGIES VOLVO WABASH NATIONAL WESTERN STAR			FREIGHTLINER			HENDRICKSON TRUCK SUSPENSION SYSTEMS HINO MC NEILUS TRUCK & MAN. VOLVO	
83128	B	Not Req'd.	83133	C	Not Req'd.	83149	W	Not Req'd.
	ASCADIA AUTOCAR CHEVROLET TRUCK (Also See GMC Truck) GMC TRUCK HINO INTERNATIONAL (NAVISTAR) KENWORTH MAECO PETERBILT REYCO SUSPENSION SAF HOLLAND TUTHILL TECHNOLOGIES VOLVO WABASH NATIONAL WESTERN STAR			FORD IC CORPORATION INTERNATIONAL (NAVISTAR)			HENDRICKSON TRUCK SUSPENSION SYSTEMS	
83129	B	Not Req'd.	83134	C	145054(2)	83150	W	Not Req'd.
	ASCADIA AUTOCAR CHEVROLET TRUCK (Also See GMC Truck) GMC TRUCK HINO INTERNATIONAL (NAVISTAR) KENWORTH MAECO PETERBILT REYCO SUSPENSION SAF HOLLAND TUTHILL TECHNOLOGIES VOLVO WABASH NATIONAL WESTERN STAR			CHAMPION BUS INC CHEVROLET TRUCK (Also See GMC Truck) GMC TRUCK GULF STREAM COACH ISUZU KENWORTH PETERBILT VOLVO			HENDRICKSON TRAILER SUSPENSION SYSTEMS SAF HOLLAND	
83130	B	Not Req'd.	83135	C	Not Req'd.	83151	W	Not Req'd.
	ASCADIA AUTOCAR CHEVROLET TRUCK (Also See GMC Truck) GMC TRUCK HINO INTERNATIONAL (NAVISTAR) KENWORTH MAECO PETERBILT REYCO SUSPENSION SAF HOLLAND TUTHILL TECHNOLOGIES VOLVO WABASH NATIONAL WESTERN STAR			FORD IC CORPORATION INTERNATIONAL (NAVISTAR)			CHEVROLET TRUCK (Also See GMC Truck) GMC TRUCK	
83131	B	Not Req'd.	83136	C	145054(2)	83152	W	145089-000(1)
	ASCADIA AUTOCAR CHEVROLET TRUCK (Also See GMC Truck) GMC TRUCK HINO INTERNATIONAL (NAVISTAR) KENWORTH MAECO PETERBILT REYCO SUSPENSION SAF HOLLAND TUTHILL TECHNOLOGIES VOLVO WABASH NATIONAL WESTERN STAR			CHAMPION BUS INC CHEVROLET TRUCK (Also See GMC Truck) GMC TRUCK GULF STREAM COACH ISUZU KENWORTH PETERBILT VOLVO			FREIGHTLINER CUSTOM CHASSIS	
83132	B	Not Req'd.	83137	D	Not Req'd.	83153	X	Not Req'd.
	ASCADIA AUTOCAR CHEVROLET TRUCK (Also See GMC Truck) GMC TRUCK HINO INTERNATIONAL (NAVISTAR) KENWORTH MAECO PETERBILT REYCO SUSPENSION SAF HOLLAND TUTHILL TECHNOLOGIES VOLVO WABASH NATIONAL WESTERN STAR			AUTOCAR BERING TRUCK CORP. BLUEBIRD SCHOOL BUS CHEVROLET TRUCK (Also See GMC Truck) GMC TRUCK HENDRICKSON TRUCK SUSPENSION SYSTEMS INTERNATIONAL (NAVISTAR) ISUZU KENWORTH MACK MC NEILUS TRUCK & MAN. PETERBILT SAF HOLLAND VOLVO WESTERN STAR			CHEVROLET TRUCK (Also See GMC Truck) GMC TRUCK	
83133	B	Not Req'd.	83138	W	145128(1)	83154	W	Not Req'd.
	ASCADIA AUTOCAR CHEVROLET TRUCK (Also See GMC Truck) GMC TRUCK HINO INTERNATIONAL (NAVISTAR) KENWORTH MAECO PETERBILT REYCO SUSPENSION SAF HOLLAND TUTHILL TECHNOLOGIES VOLVO WABASH NATIONAL WESTERN STAR			MACK			INTERNATIONAL (NAVISTAR)	
83134	B	Not Req'd.	83139	W	415010-802(2) & 145148(2)	83155	W	Not Req'd.
	ASCADIA AUTOCAR CHEVROLET TRUCK (Also See GMC Truck) GMC TRUCK HINO INTERNATIONAL (NAVISTAR) KENWORTH MAECO PETERBILT REYCO SUSPENSION SAF HOLLAND TUTHILL TECHNOLOGIES VOLVO WABASH NATIONAL WESTERN STAR			FORD HINO			CHEVROLET TRUCK (Also See GMC Truck) GMC TRUCK	
83135	B	Not Req'd.	83140	W	415010-802(2) & 145148(2)	83156	W	Not Req'd.
	ASCADIA AUTOCAR CHEVROLET TRUCK (Also See GMC Truck) GMC TRUCK HINO INTERNATIONAL (NAVISTAR) KENWORTH MAECO PETERBILT REYCO SUSPENSION SAF HOLLAND TUTHILL TECHNOLOGIES VOLVO WABASH NATIONAL WESTERN STAR			FORD HINO			IC CORPORATION INTERNATIONAL (NAVISTAR)	
83136	B	Not Req'd.	83141	W	415010-802(2) & 145148(2)	83157	W	Not Req'd.
	ASCADIA AUTOCAR CHEVROLET TRUCK (Also See GMC Truck) GMC TRUCK HINO INTERNATIONAL (NAVISTAR) KENWORTH MAECO PETERBILT REYCO SUSPENSION SAF HOLLAND TUTHILL TECHNOLOGIES VOLVO WABASH NATIONAL WESTERN STAR			HINO			FREIGHTLINER CUSTOM CHASSIS	
83137	B	Not Req'd.	83142	W	145024(1) & 404702(1)	83158	W	Not Req'd.
	ASCADIA AUTOCAR CHEVROLET TRUCK (Also See GMC Truck) GMC TRUCK HINO INTERNATIONAL (NAVISTAR) KENWORTH MAECO PETERBILT REYCO SUSPENSION SAF HOLLAND TUTHILL TECHNOLOGIES VOLVO WABASH NATIONAL WESTERN STAR						MOTOR COACH INDUSTRIES	
83138	B	Not Req'd.	83143	W	145024(1) & 404702(1)	83159	W	TR0027(4)
	ASCADIA AUTOCAR CHEVROLET TRUCK (Also See GMC Truck) GMC TRUCK HINO INTERNATIONAL (NAVISTAR) KENWORTH MAECO PETERBILT REYCO SUSPENSION SAF HOLLAND TUTHILL TECHNOLOGIES VOLVO WABASH NATIONAL WESTERN STAR						GMC TRUCK ISUZU	
83139	B	Not Req'd.	83144	W	145024(1) & 404702(1)	83160	W	Not Req'd.
	ASCADIA AUTOCAR CHEVROLET TRUCK (Also See GMC Truck) GMC TRUCK HINO INTERNATIONAL (NAVISTAR) KENWORTH MAECO PETERBILT REYCO SUSPENSION SAF HOLLAND TUTHILL TECHNOLOGIES VOLVO WABASH NATIONAL WESTERN STAR						COACHMEN RV FLEETWOOD RV FOREST RIVER INC FREIGHTLINER CUSTOM CHASSIS GULF STREAM COACH HOLIDAY RAMBLER ITASCA KING OF THE ROAD MANDALAY COACH MONACO NEWMAR CORP THOR MOTOR COACH WINNEBAGO	
83140	B	Not Req'd.	83145	W	145024(1) & 404702(1)	83161	X	140524(1) & 404702(1)
	ASCADIA AUTOCAR CHEVROLET TRUCK (Also See GMC Truck) GMC TRUCK HINO INTERNATIONAL (NAVISTAR) KENWORTH MAECO PETERBILT REYCO SUSPENSION SAF HOLLAND TUTHILL TECHNOLOGIES VOLVO WABASH NATIONAL WESTERN STAR						FORD GMC TRUCK NISSAN	

S = Superseded, X = Discontinued once inventory is gone

NUMERICAL LISTING

GABRIEL#	APPLICATION	MTG ACC PKG NO	GABRIEL#	APPLICATION	MTG ACC PKG NO	GABRIEL#	APPLICATION	MTG ACC PKG NO
83162	W 140780(1) & 145116 & 406422 & 415010-802(1)		83178	N GLAVAL BUS CO. GOSHEN COACH GRECH MOTORS GULF STREAM COACH HOLIDAY RAMBLER ITASCA JAYCO RV INC KRYSTAL BUS LGE COACHWORKS NEXUS RV PHOENIX CRUISER RV SHASTA RV STARCRAFT BUS CO. THOMAS SCHOOL BUS THOR MOTOR COACH TURTLETOP BUS WHEELED COACH IND WINNEBAGO WORLD TRANS BUS CO.	142095(1)	83209	D FLEETWOOD RV FORD FOREST RIVER INC GEORGIE BOY MANUFACTURING GMC TRUCK HENDRICKSON TRAILER SUSPENSION SYSTEMS HOLIDAY RAMBLER INTERNATIONAL (NAVISTAR) ITASCA JAYCO RV INC KENWORTH MACK MAECO MC NEILUS TRUCK & MAN. MONACO NATIONAL RV INC. NEWMAR CORP NEXUS RV PETERBILT REYCO SUSPENSION SAF HOLLAND THOR MOTOR COACH TRAILMOBILE CANADA CORP. TUTHILL TECHNOLOGIES VOLVO WESTERN STAR WINNEBAGO	Not Req'd.
83163	W IC CORPORATION INTERNATIONAL (NAVISTAR)	Not Req'd.	83180	N INTERNATIONAL (NAVISTAR)	Not Req'd.	83214	W ARVIN MERITOR CHEVROLET TRUCK (Also See GMC Truck) DIAMOND-REO EAST MANUFACTURING CORP. GMC TRUCK GRANNING SUSPENSION MAECO OSTERLUND TRUCK OTTAWA TRUCK SPARTAN MOTORS TUTHILL TECHNOLOGIES VOLVO	401754(4)
83164	W ARVIN MERITOR FREIGHTLINER CUSTOM CHASSIS	Not Req'd.	83200	S ARVIN MERITOR FORD STERLING TRUCK	140149(1)	83215	W ACF BRILL BUS ARVIN MERITOR BROCKWAY SCHOOL BUS CHEVROLET TRUCK (Also See GMC Truck) FORD GMC TRUCK HINO INTERNATIONAL (NAVISTAR) MACK MAECO PAI CORP REYCO SUSPENSION STERLING TRUCK TUTHILL TECHNOLOGIES VOLVO	401754(4)
83166	W HENDRICKSON TRUCK SUSPENSION SYSTEMS HINO	Not Req'd.	83203	B CHANCE COACH CHEVROLET TRUCK (Also See GMC Truck) DURA SUSPENSION FRUEHAUF GMC TRUCK HIGHWAY PRODUCT HUTCHENS SUSPENSION MACK MAECO MOHAWK ORION BUS INDUSTRIES PAGE SUSPENSION PETERBILT REYCO SUSPENSION RIDEWELL CORPORATION SAF HOLLAND TUTHILL TECHNOLOGIES VOLVO WABASH NATIONAL WATSON & CHALIN MFG. INC.	Not Req'd.	83216	W ARVIN MERITOR AUTOCAR BROCKWAY SCHOOL BUS CHEVROLET TRUCK (Also See GMC Truck) FORD GILLIG BROS. GMC TRUCK HINO INTERNATIONAL (NAVISTAR) MACK MAECO MARMON MOHAWK NEOPLAN BUS ONEIDA PRODUCTS STERLING TRUCK VOLVO WESTERN STAR	140149(1)
83167	W INTERNATIONAL (NAVISTAR)	Not Req'd.	83204	W DUPLEX TRUCK DURA SUSPENSION MAECO PAGE SUSPENSION REYCO SUSPENSION SAF HOLLAND TRAILMOBILE CANADA CORP. TUTHILL TECHNOLOGIES VOLVO WATSON & CHALIN MFG. INC.	Not Req'd.	83217	W CHEVROLET TRUCK (Also See GMC Truck) DIAMOND-REO EAST MANUFACTURING CORP. FLXIBLE BUS FORD GMC TRUCK HINO HYSTER MACK MAECO OLE GRANNING OTTAWA TRUCK REYCO SUSPENSION SOUTHERN COACH TUTHILL TECHNOLOGIES VOLVO	401754(4)
83168	W HENDRICKSON TRUCK SUSPENSION SYSTEMS HINO MC NEILUS TRUCK & MAN.	Not Req'd.	83207	C ADVANCE MIXER ARVIN MERITOR BLUEBIRD SCHOOL BUS BROCKWAY SCHOOL BUS CHANCE COACH CHEVROLET TRUCK (Also See GMC Truck) DURA SUSPENSION FORD GILLIG BROS. GMC TRUCK GREAT DANE TRAILER HARDEE MFG HENDRICKSON TRUCK SUSPENSION SYSTEMS HIGHWAY PRODUCT INTERNATIONAL (NAVISTAR) MACK MAECO MC NEILUS TRUCK & MAN. MOHAWK NATIONAL COACH CORP OSHKOSH MOTORS REYCO SUSPENSION RIDEWELL CORPORATION SAF HOLLAND TRAILMOBILE CANADA CORP. TUTHILL TECHNOLOGIES TWIN COACH VOLVO WABASH NATIONAL	Not Req'd.	83219	W ARVIN MERITOR CHEVROLET TRUCK (Also See GMC Truck)	140149(1)
83169	W IC CORPORATION INTERNATIONAL (NAVISTAR)	Not Req'd.	83209	D ADVANCE MIXER ARVIN MERITOR CHEVROLET TRUCK (Also See GMC Truck) COACHMEN RV DAMON MOTOR COACH ENTEGRAL COACH	Not Req'd.			
83171	X ARVIN MERITOR WORKHORSE	Not Req'd.						
83174	X FREIGHTLINER CUSTOM CHASSIS	Not Req'd.						
83175	N FORD GLAVAL BUS CO. INTERNATIONAL (NAVISTAR) STARCRAFT BUS CO.	Not Req'd.						
83176	X MAECO	Not Req'd.						
83177	N 140780(1) & 404702(1)							
	BERKSHIRE COACH BLUEBIRD SCHOOL BUS CHAMPION BUS INC COACH HOUSE RV COACHMEN RV COLLINS BUS CORP DIAMOND COACH DUTCHMEN RV DYNAMAX CORP (COUNTRY COACH) ELDORADO NATIONAL ELKHART COACH ENTEGRAL COACH FEDERAL COACH FLEETWOOD RV FORD FOREST RIVER INC GEORGIE BOY MANUFACTURING GLAVAL BUS CO. GOSHEN COACH GRECH MOTORS GULF STREAM COACH HOLIDAY RAMBLER ITASCA JAYCO RV INC KRYSTAL BUS LGE COACHWORKS NEXUS RV PHOENIX CRUISER RV SHASTA RV STARCRAFT BUS CO. THOMAS SCHOOL BUS THOR MOTOR COACH TURTLETOP BUS WHEELED COACH IND WINNEBAGO WORLD TRANS BUS CO.							
83178	N 142095(1)							

N = New, S = Superseded, X = Discontinued once inventory is gone

NUMERICAL LISTING

GABRIEL#	APPLICATION	MTG ACC PKG NO	GABRIEL#	APPLICATION	MTG ACC PKG NO	GABRIEL#	APPLICATION	MTG ACC PKG NO
83219	W FORD GILLIG BROS. GMC TRUCK PETERBILT VOLVO	140149(1)	83363	N SAF HOLLAND	Not Req'd.	85001	A KENWORTH MACK MAECO PETERBILT REYCO SUSPENSION STERLING TRUCK TUTHILL TECHNOLOGIES VOLVO	401754(4)
83221	D CHEVROLET TRUCK (Also See GMC Truck) GMC TRUCK MACK MAECO OSHKOSH MOTORS PAI CORP VOLVO WORKHORSE	Not Req'd.	83364	N INTERNATIONAL (NAVISTAR)	Not Req'd.	85003	A ARVIN MERITOR IC CORPORATION INTERNATIONAL (NAVISTAR) KENWORTH MARMON PETERBILT VOLVO	Not Req'd.
83225	W ACF BRILL BUS ARVIN MERITOR FORD FREIGHTLINER HENDRICKSON TRUCK SUSPENSION SYSTEMS INTERNATIONAL (NAVISTAR) MACK MOHAWK TRAILMOBILE CANADA CORP. VOLVO	401754(4)	83389	N SAF HOLLAND	Not Req'd.	85004	W ARVIN MERITOR PETERBILT SAF HOLLAND	401754(4)
83242	W ARVIN MERITOR MACK VOLVO	Not Req'd.	83391	N HINO	145177(2)	85005	B ARVIN MERITOR AUTOCAR BLUEBIRD SCHOOL BUS BOYDSTUN EQUIPMENT MANUFACTURING CHEVROLET TRUCK (Also See GMC Truck) CUSH CORPORATION EAST MANUFACTURING CORP. FREIGHTLINER FREIGHTLINER CUSTOM CHASSIS GMC TRUCK HENDRICKSON TRAILER SUSPENSION SYSTEMS HENDRICKSON TRUCK SUSPENSION SYSTEMS INTERNATIONAL (NAVISTAR) MACK MAECO REYCO SUSPENSION RIDEWELL CORPORATION SAF HOLLAND TUTHILL TECHNOLOGIES VOLVO WATSON & CHALIN MFG. INC.	Not Req'd.
83301	W ARVIN MERITOR INTERNATIONAL (NAVISTAR) VOLVO	141083(1)	83395	N INTERNATIONAL (NAVISTAR)	145054(1)	85006	A ARVIN MERITOR BLUEBIRD SCHOOL BUS BUILT RITE DEXTER AXLE FORD FREIGHTLINER FREIGHTLINER CUSTOM CHASSIS GREAT DANE TRAILER HENDRICKSON TRAILER SUSPENSION SYSTEMS HENDRICKSON TRUCK SUSPENSION SYSTEMS MAECO RAMERIZ TRAILER REYCO SUSPENSION RIDEWELL CORPORATION SAF HOLLAND STERLING TRUCK STOUGHTON TRAILERS INC. THE BINKLEY COMPANY THOMAS SCHOOL BUS TRAILMOBILE CANADA CORP. TUTHILL TECHNOLOGIES VOLVO WESTERN STAR	Not Req'd.
83303	W ARVIN MERITOR CHEVROLET TRUCK (Also See GMC Truck) GMC TRUCK VOLVO	140702(1)	83400	W CHEVROLET TRUCK (Also See GMC Truck) FORD GMC TRUCK MOR-RYDE SUSPENSION VOLVO WATSON & CHALIN MFG. INC. WESTERN STAR	140455(2)	85007	W ARVIN MERITOR FREIGHTLINER KENWORTH MACK MAECO PETERBILT REYCO SUSPENSION SPARTAN MOTORS TUTHILL TECHNOLOGIES VOLVO	401754(4)
83304	W ARVIN MERITOR CHEVROLET TRUCK (Also See GMC Truck) GMC TRUCK VOLVO	140702(1)	83401	W CHEVROLET TRUCK (Also See GMC Truck) GMC TRUCK VOLVO WESTERN STAR	404702(2)	85009	W ARVIN MERITOR FREIGHTLINER MITSUBISHI-FUSO NEOPLAN BUS WATSON & CHALIN MFG. INC.	145054(1)
83308	W ARVIN MERITOR CHEVROLET TRUCK (Also See GMC Truck) FORD GMC TRUCK INTERNATIONAL (NAVISTAR) STERLING TRUCK VOLVO	140149(1)	83404	S GMC TRUCK ISUZU	401011(4)	85011	X ARVIN MERITOR FREIGHTLINER	Not Req'd.
83309	W ARVIN MERITOR FORD INTERNATIONAL (NAVISTAR) STERLING TRUCK VOLVO	140149(1)	83456	C IC CORPORATION INTERNATIONAL (NAVISTAR) MITSUBISHI-FUSO VOLVO	142998(2)			
83312	W ARVIN MERITOR FORD KENWORTH OSHKOSH MOTORS PETERBILT PIERCE MANUFACTURING INC. VOLVO	140149(1)	83515	N CHEVROLET TRUCK (Also See GMC Truck) GMC TRUCK ISUZU NISSAN VOLVO	141041(1) & TR0027(2)			
83314	W ARVIN MERITOR FORD GMC TRUCK INTERNATIONAL (NAVISTAR) MAECO STERLING TRUCK VOLVO	140149(1)	83518	N HINO	141041(1) & TR0027(2)			
83317	W DINA BUS FORD GLAVAL BUS CO. IC CORPORATION INTERNATIONAL (NAVISTAR) STARCRAFT BUS CO. VOLVO	141083(1)	83519	N HINO	TR0027(4)			
83318	W ARVIN MERITOR INTERNATIONAL (NAVISTAR) VOLVO	141083(2)	83613	W ARVIN MERITOR INTERNATIONAL (NAVISTAR) ISUZU THOMAS SCHOOL BUS VOLVO	141083(2)			
83362	S HINO KENWORTH	401754(4)	83635	W SAF HOLLAND VOLVO WESTERN STAR	145054(1)			
			83901	N MACK CAB SHOCKS	Not Req'd.			
			83905	N MACK CAB SHOCKS VOLVO CAB SHOCKS	Not Req'd.			
			83906	N FREIGHTLINER CAB SHOCKS	Not Req'd.			
			85000	A ARVIN MERITOR BENSON TRUCK BODIES INC. CUSH CORPORATION EAST MANUFACTURING CORP. FREIGHTLINER GREAT DANE TRAILER HENDRICKSON TRAILER SUSPENSION SYSTEMS KENWORTH MC NEILUS TRUCK & MAN. ORION BUS INDUSTRIES PETERBILT RIDEWELL CORPORATION SAF HOLLAND STOUGHTON TRAILERS INC. THOMAS SCHOOL BUS TRAILMOBILE CANADA CORP. TWIN COACH UTILITY TRAILER MANUFACTURING COMPANY VOLVO WABASH NATIONAL WATSON & CHALIN MFG. INC.	Not Req'd.			
			85001	A ARVIN MERITOR FORD INTERNATIONAL (NAVISTAR)	401754(4)			

N = New, S = Superseded, X = Discontinued once inventory is gone

NUMERICAL LISTING

GABRIEL#	APPLICATION	MTG ACC PKG NO	GABRIEL#	APPLICATION	MTG ACC PKG NO	GABRIEL#	APPLICATION	MTG ACC PKG NO
85012	A ARVIN MERITOR BLUEBIRD SCHOOL BUS BROCKWAY SCHOOL BUS CHANCE COACH CHEVROLET TRUCK (Also See GMC Truck) FORD GMC TRUCK INTERNATIONAL (NAVISTAR) ISUZU KENWORTH PETERBILT VOLVO	145080(2)	85029	B TRAILMOBILE CANADA CORP. WATSON & CHALIN MFG. INC. WINNEBAGO	Not Req'd.	85051	D SAF HOLLAND STOUGHTON TRAILERS INC. TRAILMOBILE CANADA CORP. TUTHILL TECHNOLOGIES WABASH NATIONAL	Not Req'd.
85013	B ARVIN MERITOR BLUEBIRD SCHOOL BUS FORD HENDRICKSON TRAILER SUSPENSION SYSTEMS HENDRICKSON TRUCK SUSPENSION SYSTEMS INTERNATIONAL (NAVISTAR) KENWORTH MAECO MC NEILUS TRUCK & MAN. PETERBILT REYCO SUSPENSION SAF HOLLAND SPARTAN MOTORS STERLING TRUCK TRAILMOBILE CANADA CORP. TUTHILL TECHNOLOGIES VOLVO	Not Req'd.	85030	C ARVIN MERITOR BLUEBIRD SCHOOL BUS CHEVROLET TRUCK (Also See GMC Truck) EAST MANUFACTURING CORP. FORD FRUEHAUF GMC TRUCK HENDRICKSON TRAILER SUSPENSION SYSTEMS HENDRICKSON TRUCK SUSPENSION SYSTEMS INTERNATIONAL (NAVISTAR) MAECO OSHKOSH MOTORS PACIFIC TRUCK & TRAILER PIERCE MANUFACTURING INC. REYCO SUSPENSION SAF HOLLAND STERLING TRUCK THOMAS SCHOOL BUS TUTHILL TECHNOLOGIES VOLVO WABASH NATIONAL	Not Req'd.	85052	A ARVIN MERITOR BLUEBIRD SCHOOL BUS GREAT DANE TRAILER HENDRICKSON TRAILER SUSPENSION SYSTEMS INGERSOLL AXLES REYCO SUSPENSION SAF HOLLAND TUTHILL TECHNOLOGIES VOLVO WABASH NATIONAL WATSON & CHALIN MFG. INC.	Not Req'd.
85014	D ARVIN MERITOR CHANCE COACH CUSH CORPORATION DINA BUS HARDEE MFG HENDRICKSON TRAILER SUSPENSION SYSTEMS INTERNATIONAL (NAVISTAR) MACK REYCO SUSPENSION RIDEWELL CORPORATION SAF HOLLAND TUTHILL TECHNOLOGIES WATSON & CHALIN MFG. INC.	Not Req'd.	85031	D 145147(1) & TR0027(2) KENWORTH PETERBILT		85053	C 145126(2) WESTERN STAR	
85023	D 140149(1) INTERNATIONAL (NAVISTAR) KENWORTH MACK PETERBILT VOLVO		85033	A 145099(1) INTERNATIONAL (NAVISTAR) KENWORTH MACK PACCAR PETERBILT VOLVO		85054	W 145080(2) FORD STERLING TRUCK	
85024	W 140149(1) AUTOCAR INTERNATIONAL (NAVISTAR) MACK VOLVO		85036	D Not Req'd. AUTOCAR BLUEBIRD SCHOOL BUS HENDRICKSON TRUCK SUSPENSION SYSTEMS LION BUS MACK PETERBILT SPARTAN MOTORS VOLVO		85055	W 145080(2) FORD STERLING TRUCK	
85025	W 140169(1) & 145054(1) VOLVO		85040	W 401754(4) FORD STERLING TRUCK VOLVO		85058	B Not Req'd. BLUEBIRD SCHOOL BUS FREIGHTLINER FREIGHTLINER CUSTOM CHASSIS INTERNATIONAL (NAVISTAR) OSHKOSH MOTORS PIERCE MANUFACTURING INC. THOMAS SCHOOL BUS VOLVO	
85026	W 145054(1) ARVIN MERITOR AUTOCAR GMC TRUCK VOLVO		85042	W 401754(4) FREIGHTLINER VOLVO		85059	W Not Req'd. RED LION TRAILER SAF HOLLAND STOUGHTON TRAILERS INC. TRAILMOBILE CANADA CORP. WABASH NATIONAL	
85027	W 145054(2) ARVIN MERITOR AUTOCAR INTERNATIONAL (NAVISTAR) VOLVO		85043	D Not Req'd. FREIGHTLINER FREIGHTLINER CUSTOM CHASSIS HENDRICKSON TRAILER SUSPENSION SYSTEMS STERLING TRUCK		85060	D Not Req'd. AUTOCAR CHALMERS SUSPENSION FREIGHTLINER INTERNATIONAL (NAVISTAR) KENWORTH PETERBILT SAF HOLLAND VOLVO WATSON & CHALIN MFG. INC. WESTERN STAR	
85029	B Not Req'd. ARVIN MERITOR BLUEBIRD SCHOOL BUS COACHMEN RV DURA SUSPENSION EAST MANUFACTURING CORP. FLEETWOOD RV FOREST RIVER INC FREIGHTLINER CUSTOM CHASSIS GULF STREAM COACH HENDRICKSON TRAILER SUSPENSION SYSTEMS HOLIDAY RAMBLER INTERNATIONAL (NAVISTAR) ITASCA KENWORTH KING OF THE ROAD MANDALAY COACH MONACO NEWMAR CORP PAGE SUSPENSION PETERBILT RIDEWELL CORPORATION SAF HOLLAND SPARTAN MOTORS THOR MOTOR COACH		85045	A Not Req'd. ARVIN MERITOR CUSH CORPORATION HENDRICKSON TRAILER SUSPENSION SYSTEMS INGERSOLL AXLES MUNCIE RECLAMATION REYCO SUSPENSION RIDEWELL CORPORATION SAF HOLLAND TUTHILL TECHNOLOGIES UTILITY TRAILER MANUFACTURING COMPANY VOLVO WABASH NATIONAL WATSON & CHALIN MFG. INC.		85061	A Not Req'd. MACK POWERHOUSE COACH INC. RENEGADE RV VOLVO	
			85046	W 140149(1) AUTOCAR VOLVO		85062	A 145080(2) KENWORTH PETERBILT VOLVO	
			85047	C 140149(1) FORD KENWORTH PETERBILT STERLING TRUCK VOLVO		85063	W 145080(2) FORD MAECO STERLING TRUCK	
			85050	S Not Req'd. CHEVROLET TRUCK (Also See GMC Truck) GMC TRUCK		85064	C Not Req'd. CUSH CORPORATION GREAT DANE TRAILER HENDRICKSON TRAILER SUSPENSION SYSTEMS WATSON & CHALIN MFG. INC.	
			85051	D Not Req'd. BLUEBIRD SCHOOL BUS GILLIG BROS. MUNCIE RECLAMATION OSHKOSH MOTORS REYCO SUSPENSION		85065	W 145128(1) MACK VOLVO	
						85066	A Not Req'd. MACK POWERHOUSE COACH INC. RENEGADE RV VOLVO	
						85067	A Not Req'd. KENWORTH PETERBILT VOLVO	
						85069	A 145089-000(2) ARVIN MERITOR KENWORTH PETERBILT VOLVO	

S = Superseded

NUMERICAL LISTING

GABRIEL#	APPLICATION	MTG ACC PKG NO	GABRIEL#	APPLICATION	MTG ACC PKG NO	GABRIEL#	APPLICATION	MTG ACC PKG NO
85070	A KENWORTH PETERBILT VOLVO	401754(2)	85119	N PETERBILT	Not Req'd.	85302	W FWD TRUCK GILLIG BROS. GMC TRUCK KENWORTH MACK MAECO MOTOR COACH INDUSTRIES PETERBILT RIDEWELL CORPORATION VOLVO	401754(4)
85071	W CHEVROLET TRUCK (Also See GMC Truck) GMC TRUCK ISUZU	145054(2)	85120	N MACK	Not Req'd.	85303	C ACF BRILL BUS BROCKWAY SCHOOL BUS BUS & TRUCK CO. CHEVROLET TRUCK (Also See GMC Truck) CONTINENTAL TRAILWAYS-EAGLE INT'L CRANE CARRIER CROWN COACH EAGLE MOTOR COACH GMC TRUCK GREYHOUND BUS HENDRICKSON TRUCK SUSPENSION SYSTEMS INTERNATIONAL (NAVISTAR) KENWORTH MACK MAECO MATSON SCHOOL BUS MC NEILUS TRUCK & MAN. MOHAWK MOTOR COACH INDUSTRIES ORION BUS INDUSTRIES OSHKOSH MOTORS OTTAWA TRUCK PETERBILT PREVOST TRANSPORTATION MFG. CORP VOLVO WESTERN STAR	401754(4)
85072	C AUTOCAR HENDRICKSON TRUCK SUSPENSION SYSTEMS INTERNATIONAL (NAVISTAR) KENWORTH MACK MC NEILUS TRUCK & MAN. VOLVO WESTERN STAR	Not Req'd.	85122	N FREIGHTLINER CUSTOM CHASSIS THOMAS SCHOOL BUS	145089-000(1)	85304	D ARVIN MERITOR BECK BUS BLUEBIRD SCHOOL BUS BROCKWAY SCHOOL BUS CHEVROLET TRUCK (Also See GMC Truck) CONTINENTAL TRAILWAYS-EAGLE INT'L CRANE CARRIER CROWN COACH DIAMOND-REO DIAMOND T EAGLE MOTOR COACH FLXIBLE BUS FORD FRUEHAUF GILLIG BROS. GMC TRUCK MACK OSHKOSH MOTORS PIERCE MANUFACTURING INC. RIDEWELL CORPORATION SAF HOLLAND SOUTHERN COACH SPARTAN MOTORS THOMAS SCHOOL BUS UNITED MANUFACTURING VOLVO WESTERN STAR WESTERN UNIT "STABILAIRE" SUSPENSION	401754(4)
85078	W DANA WABASH NATIONAL	Not Req'd.	85123	N FREIGHTLINER	145090(1)	85305	W ARVIN MERITOR BROCKWAY SCHOOL BUS BUS & TRUCK CO. CHEVROLET TRUCK (Also See GMC Truck) CONTINENTAL TRAILWAYS-EAGLE INT'L EAGLE MOTOR COACH FLXIBLE BUS FORD FRUEHAUF GMC TRUCK HENDRICKSON TRUCK SUSPENSION SYSTEMS MACK MAECO MC NEILUS TRUCK & MAN. MOHAWK PAI CORP RIDEWELL CORPORATION VOLVO WESTERN STAR WESTERN UNIT "STABILAIRE" SUSPENSION	401754(4)
85079	W HENDRICKSON TRAILER SUSPENSION SYSTEMS MC NEILUS TRUCK & MAN.	Not Req'd.	85124	N DAMON MOTOR COACH FLEETWOOD RV HOLIDAY RAMBLER ITASCA MONACO NATIONAL RV INC. WINNEBAGO WORKHORSE	145054(2)	85307	W ACF BRILL BUS ARVIN MERITOR BECK BUS BLUEBIRD SCHOOL BUS BROCKWAY SCHOOL BUS BUS & TRUCK CO. CHEVROLET TRUCK (Also See GMC Truck) CRANE CARRIER FORD FREIGHTLINER	401754(4)
85080	W MACK VOLVO	145054(1)	85125	N DAMON MOTOR COACH FLEETWOOD RV HOLIDAY RAMBLER ITASCA MONACO NATIONAL RV INC. WINNEBAGO WORKHORSE	Not Req'd.			
85081	W VOLVO	145090(1)	85126	N DAMON MOTOR COACH FLEETWOOD RV HOLIDAY RAMBLER ITASCA MONACO NATIONAL RV INC. WINNEBAGO WORKHORSE	145054(1)			
85082	W IC CORPORATION INTERNATIONAL (NAVISTAR)	Not Req'd.	85180	N FORD GLAVAL BUS CO. STARCRAFT BUS CO.	Not Req'd.			
85083	X HENDRICKSON TRUCK SUSPENSION SYSTEMS	145128(1)	85181	N FORD GLAVAL BUS CO. STARCRAFT BUS CO.	Not Req'd.			
85084	D KENWORTH PETERBILT	Not Req'd.	85182	N KENWORTH PETERBILT	145089-200(2)			
85085	X NISSAN	145054(2)	85300	D ARVIN MERITOR CHEVROLET TRUCK (Also See GMC Truck) FREIGHTLINER FRUEHAUF GMC TRUCK GRANNING SUSPENSION HOBBS TRAILERS INTERNATIONAL (NAVISTAR) MAECO MUNCIE RECLAMATION OSHKOSH MOTORS OSTERLUND TRUCK OTTAWA TRUCK PIERCE MANUFACTURING INC. REYCO SUSPENSION SAF HOLLAND SEAGRAVE FIRE APPARATUS LLC TUTHILL TECHNOLOGIES VOLVO WABASH NATIONAL WATSON & CHALIN MFG. INC. WESTERN UNIT "STABILAIRE" SUSPENSION	401754(4)			
85086	W BLUEBIRD SCHOOL BUS REYCO SUSPENSION	Not Req'd.	85301	W BECK BUS CHEVROLET TRUCK (Also See GMC Truck) CLARK EQUIPMENT FLXIBLE BUS FORD FREIGHTLINER GMC TRUCK HENDRICKSON TRAILER SUSPENSION SYSTEMS SAF HOLLAND STERLING TRUCK VOLVO	401754(4)			
85087	W HENDRICKSON TRUCK SUSPENSION SYSTEMS MC NEILUS TRUCK & MAN.	Not Req'd.	85302	W AM GENERAL ARVIN MERITOR CHEVROLET TRUCK (Also See GMC Truck) CRANE CARRIER FORD FREIGHTLINER	401754(4)			
85088	A MACK POWERHOUSE COACH INC. RENEGADE RV VOLVO	Not Req'd.						
85090	W BLUEBIRD SCHOOL BUS	Not Req'd.						
85091	W THOMAS SCHOOL BUS	Not Req'd.						
85092	X FREIGHTLINER CUSTOM CHASSIS	145054(1)						
85097	X FREIGHTLINER CUSTOM CHASSIS HOLIDAY RAMBLER MONACO SAF HOLLAND	Not Req'd.						
85098	B MACK POWERHOUSE COACH INC. RENEGADE RV VOLVO	Not Req'd.						
85099	X SAF HOLLAND	Not Req'd.						
85102	W HENDRICKSON TRUCK SUSPENSION SYSTEMS INTERNATIONAL (NAVISTAR)	Not Req'd.						
85106	W BLUEBIRD SCHOOL BUS	Not Req'd.						
85109	N KENWORTH PETERBILT SAF HOLLAND VOLVO WESTERN STAR	Not Req'd.						
85119	N KENWORTH	Not Req'd.						

N = New, X = Discontinued once inventory is gone

NUMERICAL LISTING

GABRIEL#	APPLICATION	MTG ACC PKG NO	GABRIEL#	APPLICATION	MTG ACC PKG NO	GABRIEL#	APPLICATION	MTG ACC PKG NO
85307	W CLARK EQUIPMENT CONTINENTAL TRAILWAYS-EAGLE INT'L CRANE CARRIER DIAMOND-REO DINA BUS EAGLE MOTOR COACH FLXIBLE BUS FORD GMC TRUCK HENDRICKSON TRUCK SUSPENSION SYSTEMS INTERNATIONAL (NAVISTAR) MACK MAECO ONEIDA PRODUCTS ORION BUS INDUSTRIES PIERCE MANUFACTURING INC. REYCO SUSPENSION RIDEWELL CORPORATION SPARTAN MOTORS THOMAS SCHOOL BUS VOLVO WESTERN STAR WESTERN UNIT "STABILAIRE" SUSPENSION	401754(4)	85316	C OSHKOSH MOTORS PIERCE MANUFACTURING INC. VOLVO	145090(1)	85338	W HENDRICKSON TRAILER SUSPENSION SYSTEMS UTILITY TRAILER MANUFACTURING COMPANY	Not Req'd.
85308	W ACF BRILL BUS ARVIN MERITOR CHEVROLET TRUCK (Also See GMC Truck) EAGLE MOTOR COACH FREIGHTLINER GMC TRUCK INTERNATIONAL (NAVISTAR) KENWORTH MACK MAECO MOHAWK ORION BUS INDUSTRIES PETERBILT PREVOST THOMAS SCHOOL BUS VOLVO WESTERN STAR WESTERN UNIT "STABILAIRE" SUSPENSION	401754(4)	85318	W ARVIN MERITOR GILLIG BROS. HAUSMAN VOLVO	145054(2)	85339	W MAECO MOTOR COACH INDUSTRIES PREVOST TRANSPORTATION MFG. CORP VOLVO	401754(4)
85310	B ARVIN MERITOR INTERNATIONAL (NAVISTAR) KENWORTH MACK OTTAWA TRUCK PETERBILT VOLVO	141108(1)	85319	C FREIGHTLINER INTERNATIONAL (NAVISTAR) KENWORTH MACK PETERBILT VOLVO	145089-000(1)	85340	W MOTOR COACH INDUSTRIES	145089-000(1)
85311	A ARVIN MERITOR FLXIBLE BUS INTERNATIONAL (NAVISTAR) KENWORTH LEYLAND TRUCK MACK PETERBILT VOLVO	141247(1)	85320	A FREIGHTLINER KENWORTH MAECO PETERBILT VOLVO	401754(4)	85341	W MOTOR COACH INDUSTRIES	145089-000(1)
85313	X ARVIN MERITOR FLXIBLE BUS GMC TRUCK GREYHOUND BUS MAECO MOTOR COACH INDUSTRIES NOVA BUS REYCO SUSPENSION TRANSPORTATION MFG. CORP TUTHILL TECHNOLOGIES	401754(4)	85321	W ARVIN MERITOR FRUEHAUF HOLLAND - BINKLEY MACK SAF HOLLAND VOLVO WABASH NATIONAL WATSON & CHALIN MFG. INC.	Not Req'd.	85342	X CHEVROLET TRUCK (Also See GMC Truck) GMC TRUCK	145054(2)
85314	W ARVIN MERITOR AUTOCAR CHALMERS SUSPENSION EAGLE MOTOR COACH FORD KENWORTH MAECO PETERBILT STERLING TRUCK VOLVO	401754(4)	85322	W FRUEHAUF VOLVO WABASH NATIONAL	401754(2)	85343	W KENWORTH PETERBILT	145089-000(1) & 401754(2)
85315	W CLARK EQUIPMENT CUNHA PRODUCTS OHD FORD JIFFLOX KWK-LOC (JIFFLOX) VOLVO WESTERN STAR	401754(4)	85323	A ARVIN MERITOR EAST MANUFACTURING CORP. GREAT DANE TRAILER HENDRICKSON TRAILER SUSPENSION SYSTEMS INGERSOLL AXLES KENWORTH MC NEILUS TRUCK & MAN. REYCO SUSPENSION SAF HOLLAND UTILITY TRAILER MANUFACTURING COMPANY VOLVO WABASH NATIONAL WATSON & CHALIN MFG. INC.	Not Req'd.	85344	W HENDRICKSON TRAILER SUSPENSION SYSTEMS WATSON & CHALIN MFG. INC.	Not Req'd.
85316	C INTERNATIONAL (NAVISTAR) MACK MAECO	145090(1)	85324	X CHAMPION BUS INC CHEVROLET TRUCK (Also See GMC Truck) GMC TRUCK ISUZU	145054(2)	85345	W HENDRICKSON TRAILER SUSPENSION SYSTEMS MC NEILUS TRUCK & MAN. WATSON & CHALIN MFG. INC.	Not Req'd.
			85327	W FRUEHAUF	401754(2)	85346	X NEW FLYER	145090(2)
			85329	W ARVIN MERITOR BLUEBIRD SCHOOL BUS PREVOST	401754(4)	85347	X NEW FLYER	145090(2)
			85330	S PREVOST	145054(1)	85351	N IC CORPORATION INTERNATIONAL (NAVISTAR)	145090(1)
			85331	C FREIGHTLINER FREIGHTLINER CUSTOM CHASSIS WESTERN STAR	Not Req'd.	85376	W FORD STERLING TRUCK	401754(4)
			85332	W IC CORPORATION INTERNATIONAL (NAVISTAR)	145128(1)	85377	W NOVA BUS	Not Req'd.
			85333	W INTERNATIONAL (NAVISTAR)	145128(1)	85378	X NOVA BUS PREVOST	Not Req'd.
			85334	D ADVANCE MIXER MAECO MC NEILUS TRUCK & MAN. REYCO SUSPENSION	401754(4)	85379	X PREVOST	145054(1)
			85335	W FREIGHTLINER	Not Req'd.	85380	X PREVOST	145090(1) & 401754(2)
			85336	W CHEVROLET TRUCK (Also See GMC Truck) GMC TRUCK ISUZU PETERBILT	145054(2)	85382	W HENDRICKSON TRAILER SUSPENSION SYSTEMS WATSON & CHALIN MFG. INC.	Not Req'd.
			85337	W HENDRICKSON TRAILER SUSPENSION SYSTEMS	Not Req'd.	85637	N INTERNATIONAL (NAVISTAR)	Not Req'd.
						85638	N HENDRICKSON TRUCK SUSPENSION SYSTEMS	Not Req'd.
						85639	N INTERNATIONAL (NAVISTAR)	Not Req'd.
						85700	W ABC BUS AM GENERAL ARVIN MERITOR CHEVROLET TRUCK (Also See GMC Truck) FLXIBLE BUS FLYER INDUSTRIES GMC TRUCK GREYHOUND BUS GRUMMAN BUS JAY MADSEN KENWORTH MOHAWK MOTOR COACH INDUSTRIES MUNCIE RECLAMATION NOVA BUS ORION BUS INDUSTRIES PREVOST SICARD TRANSPORTATION MFG. CORP VOLVO	401754(4)
						85702	W ACF BRILL BUS ARVIN MERITOR CHEVROLET TRUCK (Also See GMC Truck) FLXIBLE BUS	401754(4)

N = New, S = Superseded, X = Discontinued once inventory is gone

NUMERICAL LISTING

GABRIEL#	APPLICATION	MTG ACC PKG NO	GABRIEL#	APPLICATION	MTG ACC PKG NO	GABRIEL#	APPLICATION	MTG ACC PKG NO
85702	W	401754(4)	85711	W 145054(1) & 401754(2)		85729	C 145176(1) & 401754(2)	
GMC TRUCK HAUSMAN MACK MOHAWK MOTOR COACH INDUSTRIES MUNCIE RECLAMATION NOVA BUS PREVOST REYCO SUSPENSION RIDEWELL CORPORATION TRANSPORTATION MFG. CORP TUTHILL TECHNOLOGIES VOLVO			TRANSPORTATION MFG. CORP VOLVO			PREVOST UNIVERSAL COACH		
85703	X	141247(1) & 401754(2)	85712	D 401754(4)		85731	X 145054(1) & 401754(2)	
FLXIBLE BUS GRUMMAN BUS MOHAWK MUNCIE RECLAMATION VOLVO			ARVIN MERITOR BLUEBIRD SCHOOL BUS CARPENTER BUS CRANE CARRIER DIAMOND-REO FLUIDRIVE FLXIBLE BUS FORD GILLIG BROS. GRANNING SUSPENSION HENDRICKSON TRAILER SUSPENSION SYSTEMS MERITOR ORION BUS INDUSTRIES OSTERLUND TRUCK RAYDAN MANUFACTURING RIDEWELL CORPORATION SPARTAN MOTORS THOMAS SCHOOL BUS TUTHILL TECHNOLOGIES VOLVO			FLXIBLE BUS		
85704	W	401754(4)	85713	W 401754(4)		85732	W 145116(2)	
ARVIN MERITOR CHEVROLET TRUCK (Also See GMC Truck) FLXIBLE BUS GMC TRUCK GRUMMAN BUS MOHAWK MOTOR COACH INDUSTRIES MUNCIE RECLAMATION REYCO SUSPENSION RIDEWELL CORPORATION TUTHILL TECHNOLOGIES VOLVO			CARPENTER BUS CRANE CARRIER EAGLE MOTOR COACH MOTOR COACH INDUSTRIES MUNCIE RECLAMATION NOVA BUS PREVOST THOMAS SCHOOL BUS TRANSPORTATION MFG. CORP			ABC BUS ARVIN MERITOR FLXIBLE BUS MOHAWK NEW FLYER ORION BUS INDUSTRIES		
85705	W	145090(2)	85715	X 145093(1)		85733	W 145089-000(1)	
ARVIN MERITOR FLXIBLE BUS INTERNATIONAL (NAVISTAR) MUNCIE RECLAMATION NEOPLAN BUS VOLVO			MOHAWK ORION BUS INDUSTRIES			ABC BUS ARVIN MERITOR CHEVROLET TRUCK (Also See GMC Truck) EAGLE MOTOR COACH FLXIBLE BUS GMC TRUCK MOHAWK MOTOR COACH INDUSTRIES NOVA BUS TRANSPORTATION MFG. CORP VOLVO		
85706	X	145090(2)	85716	W 145093(1)		85734	W 401754(4)	
HAUSMAN NEOPLAN BUS VOLVO			CRANE CARRIER DINA BUS FLXIBLE BUS FORD GILLIG BROS. MAECO NEW FLYER ORION BUS INDUSTRIES			BLUEBIRD SCHOOL BUS CHEVROLET TRUCK (Also See GMC Truck) CROWN COACH FLXIBLE BUS GILLIG BROS. GMC TRUCK INTERNATIONAL (NAVISTAR) LINK MANUFACTURING LTD. OSHKOSH MOTORS RIDEWELL CORPORATION SAF HOLLAND VOLVO		
85707	X	145090(2)	85717	S 145093(1)		85735	W 401754(4)	
ARVIN MERITOR FLXIBLE BUS MOHAWK MOTOR COACH INDUSTRIES MUNCIE RECLAMATION NEOPLAN BUS			MOHAWK ORION BUS INDUSTRIES REYCO SUSPENSION TUTHILL TECHNOLOGIES			ABC BUS CHEVROLET TRUCK (Also See GMC Truck) EAGLE MOTOR COACH GMC TRUCK GREYHOUND BUS MOTOR COACH INDUSTRIES PACIFIC TRUCK & TRAILER PREVOST TRANSPORTATION MFG. CORP VOLVO WESTERN UNIT "STABILAIR" SUSPENSION		
85708	D	145090(2)	85720	W 401754(4)		85736	W 401754(4)	
ABC BUS ARVIN MERITOR CHEVROLET TRUCK (Also See GMC Truck) FLXIBLE BUS FLYER INDUSTRIES GILLIG BROS. GMC TRUCK M.A.N. BUS MOTOR COACH INDUSTRIES MUNCIE RECLAMATION NEW FLYER PREVOST VAN HOOL VOLVO			NEW FLYER ORION BUS INDUSTRIES OTTAWA TRUCK			ACF BRILL BUS ARVIN MERITOR BLUEBIRD SCHOOL BUS FLXIBLE BUS MOHAWK PREVOST RIDEWELL CORPORATION THOMAS SCHOOL BUS VOLVO		
85709	W	145090(2)	85722	C 145090(2)		85737	W Not Req'd.	
ABC BUS M.A.N. BUS MOTOR COACH INDUSTRIES MUNCIE RECLAMATION VOLVO			ARVIN MERITOR FLYER INDUSTRIES GILLIG BROS. GMC TRUCK M.A.N. BUS MUNCIE RECLAMATION NEW FLYER VOLVO			MERITOR SUSPENSYS		
85710	X	145054(1) & 401754(2)	85723	W 145075(1)		85738	B Not Req'd.	
CHEVROLET TRUCK (Also See GMC Truck) FLXIBLE BUS GMC TRUCK MOTOR COACH INDUSTRIES MUNCIE RECLAMATION NEW FLYER NOVA BUS PREVOST TRANSPORTATION MFG. CORP			GILLIG BROS. MOTOR COACH INDUSTRIES MUNCIE RECLAMATION VOLVO			EAST MANUFACTURING CORP. HENDRICKSON TRAILER SUSPENSION SYSTEMS MC NEILUS TRUCK & MAN. REYCO SUSPENSION TUTHILL TECHNOLOGIES UTILITY TRAILER MANUFACTURING COMPANY		
85711	W	145054(1) & 401754(2)	85724	A Not Req'd.		85739	W Not Req'd.	
ARVIN MERITOR CHEVROLET TRUCK (Also See GMC Truck) FLXIBLE BUS FLYER INDUSTRIES GMC TRUCK MAECO MOTOR COACH INDUSTRIES NEW FLYER ORION BUS INDUSTRIES			DYNAMAX CORP (COUNTRY COACH) FEDERAL COACH FREIGHTLINER FREIGHTLINER CUSTOM CHASSIS RENEGADE RV STERLING TRUCK THOMAS SCHOOL BUS VOLVO WESTERN STAR			INTERNATIONAL (NAVISTAR) MACK MERITOR RAYDAN MANUFACTURING		
			85727	D 145176(2)		85740	W 145090(1) & 401754(2)	
			ABC BUS MOTOR COACH INDUSTRIES			KENWORTH MAECO MOTOR COACH INDUSTRIES PREVOST		
			85728	D 145176(2)		85745	N 145090(2)	
			MOTOR COACH INDUSTRIES PREVOST			ELDORADO NATIONAL		
			85729	C 145176(1) & 401754(2)		85746	N 145090(2)	
			ABC BUS MOTOR COACH INDUSTRIES ORION BUS INDUSTRIES			ELDORADO NATIONAL		
						85900	B 145054(2)	
						COACHMEN RV FLEETWOOD RV FOREST RIVER INC FREIGHTLINER CUSTOM CHASSIS GULF STREAM COACH		

N = New, S = Superseded, X = Discontinued once inventory is gone

NUMERICAL LISTING

GABRIEL#	APPLICATION	MTG ACC PKG NO	GABRIEL#	APPLICATION	MTG ACC PKG NO	GABRIEL#	APPLICATION	MTG ACC PKG NO
85900	B ITASCA KENWORTH KING OF THE ROAD MANDALAY COACH NEWMAR CORP PETERBILT THOR MOTOR COACH VOLVO WINNEBAGO	145054(2)	85919	B HENDRICKSON TRUCK SUSPENSION SYSTEMS MC NEILUS TRUCK & MAN. MERITOR WABASH NATIONAL WORKHORSE	Not Req'd.	85955	W HENDRICKSON TRUCK SUSPENSION SYSTEMS INTERNATIONAL (NAVISTAR)	Not Req'd.
85901	C FREIGHTLINER KENWORTH PETERBILT RIDEWELL CORPORATION	401754(4)	85920	B FEDERAL COACH FREIGHTLINER STERLING TRUCK	Not Req'd.	85956	D FREIGHTLINER STERLING TRUCK VOLVO WESTERN STAR	Not Req'd.
85902	D KENWORTH PETERBILT	145054(2)	85921	W FREIGHTLINER	145054(1)	85957	C INTERNATIONAL (NAVISTAR) STERLING TRUCK	Not Req'd.
85903	W HENDRICKSON TRUCK SUSPENSION SYSTEMS	Not Req'd.	85923	D INTERNATIONAL (NAVISTAR)	Not Req'd.	85958	A DYNAMAX CORP (COUNTRY COACH) FREIGHTLINER RENEGADE RV WESTERN STAR	Not Req'd.
85904	W FREIGHTLINER HENDRICKSON TRUCK SUSPENSION SYSTEMS LINK MANUFACTURING LTD. STERLING TRUCK	Not Req'd.	85924	B INTERNATIONAL (NAVISTAR)	Not Req'd.	85959	C BLUEBIRD SCHOOL BUS DYNAMAX CORP (COUNTRY COACH) FEDERAL COACH FREIGHTLINER FREIGHTLINER CUSTOM CHASSIS HENDRICKSON TRUCK SUSPENSION SYSTEMS KENWORTH LION BUS MC NEILUS TRUCK & MAN. PETERBILT RENEGADE RV SPARTAN MOTORS STERLING TRUCK TIFFIN MOTORHOMES INC	Not Req'd.
85905	X SAF HOLLAND	401754(2)	85925	W INTERNATIONAL (NAVISTAR)	Not Req'd.	85961	W HENDRICKSON TRUCK SUSPENSION SYSTEMS	Not Req'd.
85906	W FORD KENWORTH MACK MC NEILUS TRUCK & MAN. PETERBILT SAF HOLLAND STERLING TRUCK VOLVO WESTERN STAR	Not Req'd.	85926	D FORD GLAVAL BUS CO. IC CORPORATION INTERNATIONAL (NAVISTAR) STARCRAFT BUS CO. STERLING TRUCK	Not Req'd.	85962	W HENDRICKSON TRUCK SUSPENSION SYSTEMS MC NEILUS TRUCK & MAN.	Not Req'd.
85907	X SAF HOLLAND	Not Req'd.	85927	W FORD INTERNATIONAL (NAVISTAR)	Not Req'd.	85963	W INTERNATIONAL (NAVISTAR)	Not Req'd.
85908	W SAF HOLLAND	Not Req'd.	85928	D FORD GLAVAL BUS CO. INTERNATIONAL (NAVISTAR) STARCRAFT BUS CO.	Not Req'd.	85964	W INTERNATIONAL (NAVISTAR)	Not Req'd.
85909	C FORD FREIGHTLINER HENDRICKSON TRUCK SUSPENSION SYSTEMS KENWORTH MACK MC NEILUS TRUCK & MAN. PETERBILT ROADMASTER (MONACO) SAF HOLLAND	Not Req'd.	85929	W INTERNATIONAL (NAVISTAR)	Not Req'd.	85965	W AUTOCAR HENDRICKSON TRUCK SUSPENSION SYSTEMS INTERNATIONAL (NAVISTAR) KENWORTH MC NEILUS TRUCK & MAN.	Not Req'd.
85910	W BLUEBIRD SCHOOL BUS FREIGHTLINER KENWORTH PETERBILT ROADMASTER (MONACO) SAF HOLLAND	Not Req'd.	85930	X INTERNATIONAL (NAVISTAR)	Not Req'd.	85966	X HENDRICKSON TRUCK SUSPENSION SYSTEMS INTERNATIONAL (NAVISTAR) KENWORTH MC NEILUS TRUCK & MAN.	Not Req'd.
85911	W HENDRICKSON TRAILER SUSPENSION SYSTEMS SAF HOLLAND UTILITY TRAILER MANUFACTURING COMPANY	Not Req'd.	85931	A INTERNATIONAL (NAVISTAR)	Not Req'd.	85967	W AUTOCAR HENDRICKSON TRUCK SUSPENSION SYSTEMS KENWORTH MC NEILUS TRUCK & MAN.	Not Req'd.
85912	X SAF HOLLAND	401754(2)	85932	C FREIGHTLINER HENDRICKSON TRUCK SUSPENSION SYSTEMS MC NEILUS TRUCK & MAN. STERLING TRUCK WESTERN STAR	Not Req'd.	85968	X GILLIG BROS. SAF HOLLAND	401754(4)
85914	W BLUEBIRD SCHOOL BUS SAF HOLLAND	Not Req'd.	85933	B HENDRICKSON TRUCK SUSPENSION SYSTEMS MACK MC NEILUS TRUCK & MAN. POWERHOUSE COACH INC. VOLVO	Not Req'd.	85969	X INTERNATIONAL (NAVISTAR)	Not Req'd.
85916	W HENDRICKSON TRAILER SUSPENSION SYSTEMS HENDRICKSON TRUCK SUSPENSION SYSTEMS MC NEILUS TRUCK & MAN. SAF HOLLAND VOLVO	Not Req'd.	85934	A MAECO RIDEWELL CORPORATION WATSON & CHALIN MFG. INC.	Not Req'd.	85970	W MOTOR COACH INDUSTRIES	145089-000(1)
85918	A DYNAMAX CORP (COUNTRY COACH) FREIGHTLINER FREIGHTLINER CUSTOM CHASSIS STERLING TRUCK THOMAS SCHOOL BUS VOLVO WESTERN STAR	Not Req'd.	85935	W INTERNATIONAL (NAVISTAR)	145090(1)	85971	X BLUEBIRD SCHOOL BUS	Not Req'd.
85919	B BLUEBIRD SCHOOL BUS FREIGHTLINER FREIGHTLINER CUSTOM CHASSIS GREAT DANE TRAILER	Not Req'd.	85936	B KENWORTH PETERBILT	145089-200(1)	85972	W MACK	Not Req'd.
			85937	C KENWORTH PETERBILT	145089-200(1)	85974	X SAF HOLLAND	Not Req'd.
			85938	B ARVIN MERITOR HENDRICKSON TRAILER SUSPENSION SYSTEMS INGERSOLL AXLES REYCO SUSPENSION TUTHILL TECHNOLOGIES WATSON & CHALIN MFG. INC.	Not Req'd.	85975	X BLUEBIRD SCHOOL BUS REYCO SUSPENSION SAF HOLLAND	Not Req'd.
			85939	D ARVIN MERITOR HENDRICKSON TRAILER SUSPENSION SYSTEMS TIMBREN INDUSTRIES UTILITY TRAILER MANUFACTURING COMPANY WATSON & CHALIN MFG. INC.	Not Req'd.	85976	W AUTOCAR BLUEBIRD SCHOOL BUS FORD HENDRICKSON TRUCK SUSPENSION SYSTEMS INTERNATIONAL (NAVISTAR) MC NEILUS TRUCK & MAN. VOLVO WESTERN STAR	Not Req'd.
			85953	W INTERNATIONAL (NAVISTAR)	Not Req'd.			
			85954	A INTERNATIONAL (NAVISTAR)	Not Req'd.			

X = Discontinued once inventory is gone

NUMERICAL LISTING

GABRIEL#	APPLICATION	MTG ACC PKG NO	GABRIEL#	APPLICATION	MTG ACC PKG NO	GABRIEL#	APPLICATION	MTG ACC PKG NO
85977	W HENDRICKSON TRUCK SUSPENSION SYSTEMS MC NEILUS TRUCK & MAN.	145128(1)	646177	A CHALLENGE COOK KENWORTH	Not Req'd.	89407	W DURA SUSPENSION EAST MANUFACTURING CORP. FORD FOREST RIVER INC GEORGIE BOY MANUFACTURING GILLIG BROS. GMC TRUCK GREAT DANE TRAILER HARDEE MFG HENDRICKSON TRUCK SUSPENSION SYSTEMS HIGHWAY PRODUCT INTERNATIONAL (NAVISTAR) ITASCA KENWORTH MACK MAECO MC NEILUS TRUCK & MAN. MOHAWK MONACO NATIONAL COACH CORP OSHKOSH MOTORS PETERBILT REYCO SUSPENSION RIDEWELL CORPORATION SAF HOLLAND STERLING TRUCK TRAILMOBILE CANADA CORP. TUTHILL TECHNOLOGIES TWIN COACH VOLVO WABASH NATIONAL WESTERN STAR WINNEBAGO WORKHORSE	Not Req'd.
85978	D HENDRICKSON TRUCK SUSPENSION SYSTEMS MACK VOLVO	Not Req'd.	665937	C CRANE CARRIER	Not Req'd.	89408	A KENWORTH PETERBILT VOLVO	145080(2)
85979	W HENDRICKSON TRUCK SUSPENSION SYSTEMS MC NEILUS TRUCK & MAN. WESTERN STAR	Not Req'd.	695406	W ABC BUS ARVIN MERITOR VAN HOOL	145090(2)	89409	W ARVIN MERITOR FORD KENWORTH OSHKOSH MOTORS PETERBILT PIERCE MANUFACTURING INC. VOLVO	140149(1)
85980	X HENDRICKSON TRUCK SUSPENSION SYSTEMS MC NEILUS TRUCK & MAN.	Not Req'd.	GasSLX Applications			89410	C ARVIN MERITOR FORD INTERNATIONAL (NAVISTAR) KENWORTH MACK MAECO PETERBILT REYCO SUSPENSION STERLING TRUCK TUTHILL TECHNOLOGIES VOLVO	401754(4)
85984	X FREIGHTLINER	Not Req'd.	89401	W FORD MAECO STERLING TRUCK VOLVO	140149(1)	89411	W ARVIN MERITOR IC CORPORATION INTERNATIONAL (NAVISTAR) KENWORTH MARMON PETERBILT VOLVO	Not Req'd.
85985	W KENWORTH PETERBILT	145089-200(1)	89402	W BLUEBIRD SCHOOL BUS FORD STERLING TRUCK VOLVO	140149(1)	89412	X ARVIN MERITOR FREIGHTLINER KENWORTH MACK MAECO PETERBILT REYCO SUSPENSION SPARTAN MOTORS TUTHILL TECHNOLOGIES VOLVO	401754(4)
85986	N HENDRICKSON TRUCK SUSPENSION SYSTEMS IC CORPORATION	Not Req'd.	89405	W AUTOCAR BLUEBIRD SCHOOL BUS FORD GILLIG BROS. HENDRICKSON TRUCK SUSPENSION SYSTEMS IC CORPORATION INTERNATIONAL (NAVISTAR) KENWORTH LION BUS MACK MAECO MARMON MC NEILUS TRUCK & MAN. PETERBILT REYCO SUSPENSION SAF HOLLAND SPARTAN MOTORS TUTHILL TECHNOLOGIES VOLVO WATSON & CHALIN MFG. INC.	Not Req'd.	89413	D ARVIN MERITOR BLUEBIRD SCHOOL BUS BROCKWAY SCHOOL BUS CHANCE COACH CHEVROLET TRUCK (Also See GMC Truck) FORD GMC TRUCK INTERNATIONAL (NAVISTAR) ISUZU KENWORTH PETERBILT VOLVO	145080(2)
85988	N KENWORTH PETERBILT	145099(1)	89406	W ALLCO TRAILER AUTOCAR CHEVROLET TRUCK (Also See GMC Truck) COACHMEN RV COUNTRY COACH DAMON MOTOR COACH ENTEGR COACH FLEETWOOD RV FORD FOREST RIVER INC FREIGHTLINER FRUEHAUF GEORGIE BOY MANUFACTURING GILLIG BROS. GMC TRUCK GREAT DANE TRAILER HENDRICKSON TRUCK SUSPENSION SYSTEMS HOLIDAY RAMBLER ISUZU ITASCA JAYCO RV INC KENWORTH LODAL, INC. MACK MAECO MARMON MC NEILUS TRUCK & MAN. MONACO NATIONAL RV INC. NEWMAR CORP NEXUS RV OSHKOSH MOTORS PETERBILT REYCO SUSPENSION SAF HOLLAND THOR MOTOR COACH TUTHILL TECHNOLOGIES VOLVO WESTERN STAR WINNEBAGO	Not Req'd.	89414	W ARVIN MERITOR BLUEBIRD SCHOOL BUS	Not Req'd.
85989	D KENWORTH PETERBILT	Not Req'd.				89417	X NEW FLYER ORION BUS INDUSTRIES	
85994	N INTERNATIONAL (NAVISTAR)	Not Req'd.				87015	W ARVIN MERITOR EAST MANUFACTURING CORP. MERITOR	Not Req'd.
85995	N INTERNATIONAL (NAVISTAR)	Not Req'd.				87016	X ORION BUS INDUSTRIES	145116(1) & 145090(1)
85998	N INTERNATIONAL (NAVISTAR)	Not Req'd.				87017	X BLUEBIRD SCHOOL BUS OPTIMA BUS CORP RIDEWELL CORPORATION	Not Req'd.
85999	N INTERNATIONAL (NAVISTAR)	Not Req'd.				87018	W ARVIN MERITOR HENDRICKSON TRAILER SUSPENSION SYSTEMS	Not Req'd.
86200	D MERITOR	Not Req'd.				87019	X NOVA BUS	Not Req'd.
86201	X MERITOR	Not Req'd.				89402	W VOLVO	140149(1)
86202	X MERITOR	Not Req'd.				89414	W MAECO	Not Req'd.
86203	X MERITOR	Not Req'd.				89440	W MAECO	Not Req'd.
87015	W ARVIN MERITOR EAST MANUFACTURING CORP. MERITOR	Not Req'd.				89447	W MUNCIE RECLAMATION	141108(1)
87016	X NEW FLYER ORION BUS INDUSTRIES	145116(1) & 145090(1)				632147	W CHALLENGE COOK	Not Req'd.
87017	X BLUEBIRD SCHOOL BUS OPTIMA BUS CORP RIDEWELL CORPORATION	Not Req'd.				646155	A CHALLENGE COOK KIMBLE MIXER CO VOLVO	Not Req'd.
87018	W ARVIN MERITOR HENDRICKSON TRAILER SUSPENSION SYSTEMS	Not Req'd.						
87019	X NOVA BUS	Not Req'd.						
89402	W VOLVO	140149(1)						
89414	W MAECO	Not Req'd.						
89440	W MAECO	Not Req'd.						
89447	W MUNCIE RECLAMATION	141108(1)						
632147	W CHALLENGE COOK	Not Req'd.						
646155	A CHALLENGE COOK KIMBLE MIXER CO VOLVO	Not Req'd.						

N = New, X = Discontinued once inventory is gone

NUMERICAL LISTING

GABRIEL#	APPLICATION	MTG ACC PKG NO	GABRIEL#	APPLICATION	MTG ACC PKG NO	GABRIEL#	APPLICATION	MTG ACC PKG NO
89414	W CHEVROLET TRUCK (Also See GMC Truck) COACHMEN RV COUNTRY COACH DAMON MOTOR COACH ENTEGR COACH FLEETWOOD RV FORD FOREST RIVER INC GEORGIE BOY MANUFACTURING GMC TRUCK HENDRICKSON TRAILER SUSPENSION SYSTEMS HENDRICKSON TRUCK SUSPENSION SYSTEMS HOLIDAY RAMBLER INTERNATIONAL (NAVISTAR) ITASCA JAYCO RV INC KENWORTH MACK MAECO MC NEILUS TRUCK & MAN. MONACO NATIONAL RV INC. NEWMAR CORP NEXUS RV PETERBILT REYCO SUSPENSION SAF HOLLAND SPARTAN MOTORS STERLING TRUCK THOR MOTOR COACH TRAILMOBILE CANADA CORP. TUTHILL TECHNOLOGIES VOLVO WESTERN STAR WINNEBAGO	Not Req'd.	89422	W BUS & TRUCK CO. CHEVROLET TRUCK (Also See GMC Truck) CONTINENTAL TRAILWAYS-EAGLE INT'L CRANE CARRIER CROWN COACH EAGLE MOTOR COACH FREIGHTLINER GMC TRUCK GREYHOUND BUS HENDRICKSON TRUCK SUSPENSION SYSTEMS INTERNATIONAL (NAVISTAR) KENWORTH MACK MAECO MATSON SCHOOL BUS MC NEILUS TRUCK & MAN. MOHAWK MOTOR COACH INDUSTRIES ORION BUS INDUSTRIES OSHKOSH MOTORS OTTAWA TRUCK PETERBILT PREVOST THOMAS SCHOOL BUS TRANSPORTATION MFG. CORP VOLVO WESTERN STAR WESTERN UNIT "STABILAIRE" SUSPENSION	401754(4)	89430	C HENDRICKSON TRAILER SUSPENSION SYSTEMS HENDRICKSON TRUCK SUSPENSION SYSTEMS HINO INTERNATIONAL (NAVISTAR) MACK MAECO MC NEILUS TRUCK & MAN. OSHKOSH MOTORS REYCO SUSPENSION RIDEWELL CORPORATION SAF HOLLAND TUTHILL TECHNOLOGIES VOLVO WABASH NATIONAL WATSON & CHALIN MFG. INC.	Not Req'd.
89415	W INTERNATIONAL (NAVISTAR) KENWORTH MACK PETERBILT VOLVO	140149(1)	89423	D ARVIN MERITOR INTERNATIONAL (NAVISTAR) KENWORTH MACK OTTAWA TRUCK PETERBILT VOLVO	141108(1)	89431	W BLUEBIRD SCHOOL BUS FREIGHTLINER FREIGHTLINER CUSTOM CHASSIS INTERNATIONAL (NAVISTAR) OSHKOSH MOTORS PIERCE MANUFACTURING INC. THOMAS SCHOOL BUS VOLVO	Not Req'd.
89417	W ARVIN MERITOR AUTOCAR GMC TRUCK VOLVO	145054(1)	89424	C ARVIN MERITOR FLXIBLE BUS INTERNATIONAL (NAVISTAR) KENWORTH LEYLAND TRUCK MACK PETERBILT VOLVO	141247(1)	89432	W KENWORTH MAECO	Not Req'd.
89418	W ARVIN MERITOR AUTOCAR INTERNATIONAL (NAVISTAR) VOLVO	145054(2)	89425	W ARVIN MERITOR AUTOCAR CHALMERS SUSPENSION EAGLE MOTOR COACH FORD KENWORTH MAECO PETERBILT STERLING TRUCK VOLVO	401754(4)	89434	W AUTOCAR VOLVO	140149(1)
89419	W CHEVROLET TRUCK (Also See GMC Truck) FREIGHTLINER FRUEHAUF GMC TRUCK GRANNING SUSPENSION HOBBS TRAILERS INTERNATIONAL (NAVISTAR) MAECO MUNCIE RECLAMATION OSHKOSH MOTORS OSTERLUND TRUCK OTTAWA TRUCK PIERCE MANUFACTURING INC. REYCO SUSPENSION SAF HOLLAND SEAGRAVE FIRE APPARATUS LLC TUTHILL TECHNOLOGIES VOLVO WABASH NATIONAL WATSON & CHALIN MFG. INC. WESTERN UNIT "STABILAIRE" SUSPENSION	401754(4)	89426	W INTERNATIONAL (NAVISTAR) MACK MAECO OSHKOSH MOTORS PIERCE MANUFACTURING INC. VOLVO	145090(1)	89435	W FORD KENWORTH PETERBILT STERLING TRUCK VOLVO	140149(1)
89420	W AM GENERAL ARVIN MERITOR CHEVROLET TRUCK (Also See GMC Truck) CRANE CARRIER FORD FREIGHTLINER FWD TRUCK GILLIG BROS. GMC TRUCK KENWORTH MACK MAECO MOTOR COACH INDUSTRIES PETERBILT RIDEWELL CORPORATION VOLVO	401754(4)	89427	C INTERNATIONAL (NAVISTAR) KENWORTH MACK PACCAR PETERBILT VOLVO	145099(1)	89436	B ARVIN MERITOR BENSON TRUCK BODIES INC. CHANCE COACH CHEVROLET TRUCK (Also See GMC Truck) CUSH CORPORATION DURA SUSPENSION EAST MANUFACTURING CORP. FREIGHTLINER FRUEHAUF GMC TRUCK GREAT DANE TRAILER HENDRICKSON TRAILER SUSPENSION SYSTEMS HIGHWAY PRODUCT HUTCHENS SUSPENSION INGERSOLL AXLES KENWORTH MACK MAECO MC NEILUS TRUCK & MAN. MOHAWK ORION BUS INDUSTRIES PAGE SUSPENSION PETERBILT REYCO SUSPENSION RIDEWELL CORPORATION SAF HOLLAND STOUGHTON TRAILERS INC. THOMAS SCHOOL BUS TRAILMOBILE CANADA CORP. TUTHILL TECHNOLOGIES TWIN COACH UTILITY TRAILER MANUFACTURING COMPANY VOLVO WABASH NATIONAL WATSON & CHALIN MFG. INC.	Not Req'd.
89422	W ACF BRILL BUS ARVIN MERITOR BROCKWAY SCHOOL BUS	401754(4)	89428	W FREIGHTLINER INTERNATIONAL (NAVISTAR) KENWORTH MACK PETERBILT VOLVO	145089-000(1)	89437	W EAST MANUFACTURING CORP. HENDRICKSON TRAILER SUSPENSION SYSTEMS THOMAS SCHOOL BUS	Not Req'd.
			89429	C FREIGHTLINER KENWORTH MAECO PETERBILT VOLVO	401754(4)	89438	W FORD STERLING TRUCK	145080(2)
			89430	C AUTOCAR BLUEBIRD SCHOOL BUS BOYDSTUN EQUIPMENT MANUFACTURING CHEVROLET TRUCK (Also See GMC Truck) EAST MANUFACTURING CORP. FREIGHTLINER FREIGHTLINER CUSTOM CHASSIS GMC TRUCK	Not Req'd.	89439	W FORD STERLING TRUCK	145080(2)
						89440	W ARVIN MERITOR BLUEBIRD SCHOOL BUS CHEVROLET TRUCK (Also See GMC Truck) EAST MANUFACTURING CORP. FORD FRUEHAUF GMC TRUCK HENDRICKSON TRAILER SUSPENSION SYSTEMS	Not Req'd.

N = New, X = Discontinued once inventory is gone

NUMERICAL LISTING

GABRIEL#	APPLICATION	MTG ACC PKG NO	GABRIEL#	APPLICATION	MTG ACC PKG NO	GABRIEL#	APPLICATION	MTG ACC PKG NO
89440	W	Not Req'd.	89457	W	Not Req'd.			
	HENDRICKSON TRUCK SUSPENSION SYSTEMS INTERNATIONAL (NAVISTAR) KENWORTH MAECO OSHKOSH MOTORS PACIFIC TRUCK & TRAILER PETERBILT PIERCE MANUFACTURING INC. REYCO SUSPENSION SAF HOLLAND STERLING TRUCK THOMAS SCHOOL BUS TUTHILL TECHNOLOGIES VOLVO WABASH NATIONAL			INTERNATIONAL (NAVISTAR)				
89441	X	145054(1)	89458	C	Not Req'd.			
	FORD KENWORTH SAF HOLLAND			INTERNATIONAL (NAVISTAR)				
89442	W	145126(2)	89459	C	401754(2)			
	WESTERN STAR			KENWORTH PETERBILT VOLVO				
89443	C	Not Req'd.	89460	W	Not Req'd.			
	DYNAMAX CORP (COUNTRY COACH) FEDERAL COACH FREIGHTLINER FREIGHTLINER CUSTOM CHASSIS RENEGADE RV STERLING TRUCK THOMAS SCHOOL BUS VOLVO WESTERN STAR			KENWORTH PETERBILT				
89446	W	TR0027(4)	89461	W	Not Req'd.			
	ARVIN MERITOR FORD INTERNATIONAL (NAVISTAR) STERLING TRUCK VOLVO			GILLIG BROS.				
89447	W	141108(1)	89503	N	Not Req'd.			
	BLUEBIRD SCHOOL BUS FLXIBLE BUS IC CORPORATION INTERNATIONAL (NAVISTAR) MITSUBISHI-FUSO MUNCIE RECLAMATION NEOPLAN BUS VOLVO			DYNAMAX CORP (COUNTRY COACH) FEDERAL COACH FREIGHTLINER RENEGADE RV STERLING TRUCK				
89448	W	Not Req'd.						
	MACK POWERHOUSE COACH INC. RENEGADE RV VOLVO							
89449	C	Not Req'd.						
	DYNAMAX CORP (COUNTRY COACH) FREIGHTLINER FREIGHTLINER CUSTOM CHASSIS STERLING TRUCK THOMAS SCHOOL BUS VOLVO WESTERN STAR							
89450	W	Not Req'd.						
	MACK POWERHOUSE COACH INC. RENEGADE RV VOLVO							
89451	B	Not Req'd.						
	KENWORTH PETERBILT VOLVO							
89453	W	Not Req'd.						
	FREIGHTLINER HENDRICKSON TRUCK SUSPENSION SYSTEMS MC NEILUS TRUCK & MAN. STERLING TRUCK WESTERN STAR							
89454	W	Not Req'd.						
	HENDRICKSON TRUCK SUSPENSION SYSTEMS MACK MC NEILUS TRUCK & MAN. POWERHOUSE COACH INC. VOLVO							
89455	A	141108(1)						
	ARVIN MERITOR KENWORTH PETERBILT VOLVO							
89456	D	145089-200(1)						
	KENWORTH PETERBILT							

N = New, X = Discontinued once inventory is gone



Fleetline® GasSLX® Interchange

Fleetline	GasSLX
83122	89406
83123	89405
83124	89407
83126	89430
83128	89436
83200	89402
83203	89436
83207	89407
83209	89414
83309	89446
83312	89409
83389	89436
83456	89447
85000	89436
85001	89410
85003	89411
85005	89430
85007	89412
85012	89413
85013	89414
85023	89415
85024	89416
85026	89417
85027	89418
85030	89440
85033	89427
85036	89405
85046	89434
85047	89435
85053	89442
85054	89438
85055	89439

Fleetline	GasSLX
85058	89431
85061	89450
85062	89408
85066	89448
85067	89451
85069	89455
85070	89459
85084	89460
85300	89419
85302	89420
85303	89422
85308	89422
85310	89423
85311	89424
85314	89425
85316	89426
85319	89428
85320	89429
85323	89436
85705	89447
85724	89443
85906	89407
85916	89430
85918	89449
85920	89503
85923	89458
85924	89457
85931	89458
85932	89453
85933	89454
85936	89456



IMPORTANT NOTE: Interchange must only be used for FLEETLINE to GASSLX upgrade. Interchange is **NOT REVERSABLE**.



COMPETITIVE & O.E.M. INTERCHANGE LIST

ABC BUS

O.E.M #	Gabriel	Upgrade	O.E.M #	Gabriel	Upgrade	O.E.M #	Gabriel	Upgrade	O.E.M #	Gabriel	Upgrade
050134513	85732		12L-5-114	85727		6243-13790	85708		90-2291	695406	
10685703	695406		12L-5-72	85709		6243-14040	85708				
12B-5-1	85735		12L-5-88	85729		624314570	695406				
12J-5-10	85733		3166657	85700		680323	85700				

ACF BRILL BUS

O.E.M #	Gabriel	Upgrade	O.E.M #	Gabriel	Upgrade	O.E.M #	Gabriel	Upgrade	O.E.M #	Gabriel	Upgrade
610513	85307		641521	85308	89422	659129	85303	89422	661733	83225	
631237	85308	89422	649648	85308	89422	661732	83215		995891	85307	

ADVANCE MIXER

O.E.M #	Gabriel	Upgrade	O.E.M #	Gabriel	Upgrade	O.E.M #	Gabriel	Upgrade	O.E.M #	Gabriel	Upgrade
12111 ADV	646155		13883	85334		14626 ADV	83209		680087	85334	
13424 ADV	83207	89407	13883 ADV	85334		23458 ADV	83112				

ALLCO TRAILER

O.E.M #	Gabriel	Upgrade	O.E.M #	Gabriel	Upgrade	O.E.M #	Gabriel	Upgrade	O.E.M #	Gabriel	Upgrade
727602	83122	89406									

AM GENERAL

O.E.M #	Gabriel	Upgrade	O.E.M #	Gabriel	Upgrade	O.E.M #	Gabriel	Upgrade	O.E.M #	Gabriel	Upgrade
3166657	85700		5957136	85700		5979484	85302	89420			
4975501	85700		5969438	85700		5979574	85700				
5565748	85700		5978712	85700		5982537	85700				

ARALMEX

Aralmex	Gabriel	Upgrade	Aralmex	Gabriel	Upgrade	Aralmex	Gabriel	Upgrade	Aralmex	Gabriel	Upgrade
2AMG037	G63375		3AMG007	G63357		3AMG023	G63421		3AMG031	G63360	
3AMG001	G63355		3AMG008	G63500		3AMG026	G63455		3AMG032	G63502	
3AMG004	G63306		3AMG009	G63406		3AMG027	G63426		3AMG033	G63614	
3AMG005	G63359		3AMG021	G63409		3AMG029	G63488		3AMG034	G63608	
3AMG006	G63377		3AMG022	G63454		3AMG030	G63818		3AMG035	G63607	

ARVIN MERITOR

O.E.M #	Gabriel	Upgrade	O.E.M #	Gabriel	Upgrade	O.E.M #	Gabriel	Upgrade	O.E.M #	Gabriel	Upgrade
085009	85009		680347	85732		727631	83304		728619	85007	89412
085014	85014		680464	85005		727635	83308		728621	85009	
085321	85321		680518	85700		727636	83309	89446	728622	85010	
654907	85000	89436	680584	85938		727639	83312	89409	728623	85011	
654958	83164		680671	85708		727641	83314		728624	85012	89413
659016	83064		695172	85707		727645	83318		728625	85013	89414
659222	83171		695180	85705		727671	83613		728626	85733	
665044	83209		695181	85707		727672	83242		728627	85313	
665724	85000	89436	695214	85722		728601	85001	89410	728628	85314	89425
665746	85000	89436	695348	87018		728603	85003	89411	728631	85029	
665760	85045		695406	695406		728604	85300		728632	85030	89440
665769	85052		727600	83200		728606	85302	89420	728635	85318	
665804	85939		727607	83207	89407	728608	85304		728639	85026	89417
671091	85069	89455	727609	83209		728609	85305		728640	85027	89418
671092	85012	89413	727614	83214		728611	85307		728800	85711	
671507	87015		727615	83215		728612	85308	89422	728806	85736	
671707	85323	89436	727616	83216		728614	85310	89423	728811	85707	
680102	85712		727619	83219		728615	85311	89424	728812	85705	
680322	85704		727625	83225		728616	85004		7805-N-1002	85329	
680331	85702		727628	83301		728617	85005		7805-S-1007	85329	
680337	85708		727630	83303		728618	85006				

AUTOCAR

O.E.M #	Gabriel	Upgrade	O.E.M #	Gabriel	Upgrade	O.E.M #	Gabriel	Upgrade	O.E.M #	Gabriel	Upgrade
03-1106460	85005	89430	37301-3201	85027	89418	60665-013	85965		60675-003L	85976	
1011839	83216		37301-3202	85026	89417	60665-025	85036	89405			
28CFG-910	83216		60657-003	85072		60665-025L	85036	89405			
28R010	83216		60657-003L	85072		60670-005	83137				
35901-3201	85024		60665-011	85967		60675-003	85976				

Important Note: Competitive Interchanges are to be used for stocking purposes only. Where multiple crosses are identified, please reference the applications section of this catalog.

COMPETITIVE & O.E.M. INTERCHANGE LIST

AUTOCAR... cont'd

O.E.M #	Gabriel	Upgrade	O.E.M #	Gabriel	Upgrade	O.E.M #	Gabriel	Upgrade	O.E.M #	Gabriel	Upgrade
60680-003	83112		60680-004L	83143		660186	83216		8026658	85046	89434
60680-003L	83112		60680-005	83142		800670	85060		8071524	85024	
60680-004	83143		60680-005L	83142		800781	85314	89425	849246	83216	

BATCO

Batco	Gabriel	Upgrade	Batco	Gabriel	Upgrade	Batco	Gabriel	Upgrade	Batco	Gabriel	Upgrade
1083203	83203	89436	1083225	83225		1085005	85005	89430	1085311	85311	89424
1083204	83204		1083310	83221		1085007	85007	89412	1087001	85734	
1083207	83207	89407	1083317	83317		1085300	85300	89419	1087004	85735	
1083209	83209	89414	1085003	85003	89411	1085305	85305		1087006	85736	

BECK BUS

O.E.M #	Gabriel	Upgrade	O.E.M #	Gabriel	Upgrade	O.E.M #	Gabriel	Upgrade	O.E.M #	Gabriel	Upgrade
14QK-140	85304		14QK-2102	85304							

BENSON TRUCK BODIES INC.

O.E.M #	Gabriel	Upgrade	O.E.M #	Gabriel	Upgrade	O.E.M #	Gabriel	Upgrade	O.E.M #	Gabriel	Upgrade
90044089	83124	89407	A-20002	85000	89436						

BERING TRUCK CORP.

O.E.M #	Gabriel	Upgrade	O.E.M #	Gabriel	Upgrade	O.E.M #	Gabriel	Upgrade	O.E.M #	Gabriel	Upgrade
47902-24	83137										

BERKSHIRE COACH

O.E.M #	Gabriel	Upgrade	O.E.M #	Gabriel	Upgrade	O.E.M #	Gabriel	Upgrade	O.E.M #	Gabriel	Upgrade
ASH-1136	83178		ASH-1154	83177							

BILSTEIN

Bilstein	Gabriel	Upgrade	Bilstein	Gabriel	Upgrade	Bilstein	Gabriel	Upgrade	Bilstein	Gabriel	Upgrade
B46-1594	85013	89414	B46-1725	85029		B46-2151	85007	89412			

BLUEBIRD SCHOOL BUS

O.E.M #	Gabriel	Upgrade	O.E.M #	Gabriel	Upgrade	O.E.M #	Gabriel	Upgrade	O.E.M #	Gabriel	Upgrade
00085991	85006		1707405	85005	89430	58913-008	85959		70317		89402
00119797	85959		1722214	85030	89440	58913-008L	85959		70397	85006	
00119798	85106		1722222	85013	89414	58913-009	85959		7805-M-1001	85919	
0014605	85036	89405	1746163	85006		58913-009L	85959		7805-N-1002	85329	
0014985	83137		1750793	85712		58913-010	85106		7805-S-1007	85329	
0015222	85919		1962422	85304		58913-010L	85106		87001-01A	85734	
0020326	85976		1962430	83207	89407	58913-011	85959		8C24-18045-DA	83177	
0040015	85919		2021459	85012	89413	58913-011L	85959		8C24-18080-DB	83178	
0055008	85959		23106-01	85975		59057-001	83137		8C2Z-18124-D	83177	
0055017	85959		300-0614966	85307		59057-002	85036	89405	8C2Z-18125-D	83178	
0075916	85086		300-0614974	85304		59483-000	85919		90-1813	85712	
0085990	85959		300-0823047	85736		60665-005	85919		90-1951-SP1	85734	
0088035	85090		300-0823054	85304		60665-005L	85919		90-1968	85712	
0106303	85106		300-09612284	85734		609180	85304		90-1968-SP1	85712	
0110808	83124	89407	300-1316546	85006		60998-001	85006		90-2610 SP1	87017	
0523047	85736		300-1317767	85029		60998-002	85919		90044448	85051	
0823054	85304		303-1350628	85712		60998-002L	85919		90044915	83127	
1004167	85712		305-0961284	85734		60998-003	85006		90045050	85914	
1217934	85304		471700000428	85006		614958	85307		90045083	85910	
1260008	87017		471700000456	85959		614966	85307		A-4890	85712	
1316546	85006		471700000464	85090		614974	85304		AMS65109	85058	89431
1317767	85029		471700002919	85106		65992-003	85959		AMS65110	85005	89430
1526417	85052		471700131545	85006		65992-004	85106		AMS65119	85029	
1658525	85971		4759272		89447	671933	85919		ASH-1136	83178	
1658533	85010		4760958	85086		680102	85712		ASH-1154	83177	
1667831	85029		481700131438	85919		680155	85712		AT-163G	83177	
1668722	85030	89440	58913-007	85959		680667		89447	AT-164G	83178	
1668730	85013	89414	58913-007L	85959		680783	85304				

Important Note: Competitive Interchanges are to be used for stocking purposes only. Where multiple crosses are identified, please reference the applications section of this catalog.

COMPETITIVE & O.E.M. INTERCHANGE LIST

BOGE

Boge	Gabriel	Upgrade	Boge	Gabriel	Upgrade	Boge	Gabriel	Upgrade	Boge	Gabriel	Upgrade
40-A85-0	85708										

BOYDSTUN EQUIPMENT MANUFACTURING

O.E.M #	Gabriel	Upgrade	O.E.M #	Gabriel	Upgrade	O.E.M #	Gabriel	Upgrade	O.E.M #	Gabriel	Upgrade
1253069B000	85005	89430									

BROCKWAY SCHOOL BUS

O.E.M #	Gabriel	Upgrade	O.E.M #	Gabriel	Upgrade	O.E.M #	Gabriel	Upgrade	O.E.M #	Gabriel	Upgrade
14QK-281P10	85305		152398	85304		515231	85303	89422			
14QK-282P1	83216		152412	83215		530873	83207	89407			
14QK-282P3	83216		508657	85307		532397	85307				

BUILT RITE

O.E.M #	Gabriel	Upgrade	O.E.M #	Gabriel	Upgrade	O.E.M #	Gabriel	Upgrade	O.E.M #	Gabriel	Upgrade
318-06-100	85006										

BUS & TRUCK CO.

O.E.M #	Gabriel	Upgrade	O.E.M #	Gabriel	Upgrade	O.E.M #	Gabriel	Upgrade	O.E.M #	Gabriel	Upgrade
0100-905	85307		680091	85303	89422	70039	85303	89422	70041	85305	

CARPENTER BUS

O.E.M #	Gabriel	Upgrade	O.E.M #	Gabriel	Upgrade	O.E.M #	Gabriel	Upgrade	O.E.M #	Gabriel	Upgrade
0272-SS5	85712		63-0001	85713							

CASCADE TRAILER

O.E.M #	Gabriel	Upgrade	O.E.M #	Gabriel	Upgrade	O.E.M #	Gabriel	Upgrade	O.E.M #	Gabriel	Upgrade
120-1	83125										

CATERPILLAR

O.E.M #	Gabriel	Upgrade	O.E.M #	Gabriel	Upgrade	O.E.M #	Gabriel	Upgrade	O.E.M #	Gabriel	Upgrade
60680-004	83143		60680-004L	83143		60680-005	83142		60680-005L	83142	

CHALLENGE

O.E.M #	Gabriel	Upgrade	O.E.M #	Gabriel	Upgrade	O.E.M #	Gabriel	Upgrade	O.E.M #	Gabriel	Upgrade
632147	632147		632155	646177							

CHALLENGE COOK

O.E.M #	Gabriel	Upgrade	O.E.M #	Gabriel	Upgrade	O.E.M #	Gabriel	Upgrade	O.E.M #	Gabriel	Upgrade
1540212	646155		1540459	646155		632147	632147		632155	646177	

CHALMERS SUSPENSION

O.E.M #	Gabriel	Upgrade	O.E.M #	Gabriel	Upgrade	O.E.M #	Gabriel	Upgrade	O.E.M #	Gabriel	Upgrade
21335	G63355		800781	85314	89425	K880247	85060				
665174	85060		K800199	85060		K880248	85314	89425			
800670	85060		K880233	85060		K880642	85060				

CHAMPION BUS INC

O.E.M #	Gabriel	Upgrade	O.E.M #	Gabriel	Upgrade	O.E.M #	Gabriel	Upgrade	O.E.M #	Gabriel	Upgrade
22064230	83136		22064231	85324		ASH-1136	83178		ASH-1154	83177	

CHANCE COACH

O.E.M #	Gabriel	Upgrade	O.E.M #	Gabriel	Upgrade	O.E.M #	Gabriel	Upgrade	O.E.M #	Gabriel	Upgrade
2021459	85012	89413	59039	83207	89407	6892	83207	89407	728600	83203	89436
270-6708	85014		665017	85014		6893	83203	89436	AS789B	85014	

CHEVROLET TRUCK (Also See GMC Truck)

O.E.M #	Gabriel	Upgrade	O.E.M #	Gabriel	Upgrade	O.E.M #	Gabriel	Upgrade	O.E.M #	Gabriel	Upgrade
1-51630-168-1	83515		15588554	83136		22007703	83303		22012114	85700	
1-51630-217-0	83114		15642943	83136		22007750	83207	89407	22012131	85711	
1-51630-217-1	83114		15740554	83137		22007751	83303		22012166	83126	89430
1-51630-219-1	83114		15887728	83136		22007752	83304		22012169	83221	
12474915	83122	89406	15963161	83122	89406	22007753	83303		22017530	83303	
12474917	83137		19152843	83136		22012065	85304		22017531	83303	
15123676	83136		21998392	85336		22012067	85700		22024673	85710	
15174898	83136		22002293	83126	89430	22012082	85702		22045526	85702	
15174901	85342		22002294	83304		22012083	85711		22046481	85702	
15174902	85071		22002295	83303		22012090	85308	89422			
15174903	85342		22007700	83207	89407	22012091	85303	89422			
15185643	83153		22007701	83126	89430	22012095	83126	89430			
15185644	83155		22007702	83304		22012096	83221				

Important Note: Competitive Interchanges are to be used for stocking purposes only. Where multiple crosses are identified, please reference the applications section of this catalog.

COMPETITIVE & O.E.M. INTERCHANGE LIST

CHEVROLET TRUCK (Also See GMC Truck)... cont'd

O.E.M #	Gabriel	Upgrade	O.E.M #	Gabriel	Upgrade	O.E.M #	Gabriel	Upgrade	O.E.M #	Gabriel	Upgrade
22046483	85304		4940627	83203	89436	5374779	85308	89422	5552209	83215	
22046485	85710		4940640	83216		5374999	85307		5552210	85308	89422
22046489	85303	89422	4940650	83207	89407	5385939	85307		5552244	85308	89422
22046499	85710		4940654	83216		5392387	85303	89422	5552285	83214	
2204683	85304		4940660	83207	89407	5394448	85305		5552286	83217	
22052014	85702		4940662	83126	89430	5394467	85305		5552287	83217	
22052336	85304		4963844	85307		5394468	85735		5552288	83217	
22052424	85710		4963853	83216		5455798	85307		5552451	85308	89422
22064230	83136		4963854	83216		5513489	83216		5552452	85303	89422
22064231	85324		4964853	83217		5513716	85304		5552453	85301	
22064232	85071		4974401	85700		5516459	85305		5552456	85307	
22064233	83136		4975429	85300	89419	5522781	85735		5552527	85735	
22064432	85050		4975467	83207	89407	5522794	85308	89422	5552552	85303	89422
22064489	85336		4975479	83400		5522818	85305		5554184	85302	89420
22064804	83136		4975480	83400		5527001	85300	89419	5554589	85307	
22064805	83136		4975494	83207	89407	5527271	85700		5554596	85303	89422
22064806	83136		4975497	83126	89430	5527272	85700		5554814	85302	89420
22064807	83136		4975510	83221		5527606	85305		5554959	83401	
22065218	G63347		4975516	85702		5531027	85301		5554995	85305	
22065251	85030	89440	4975518	85704		5531435	85307		5559363	83203	89436
22099889	85336		4975538	85700		5531436	85307		5585939	85307	
22165187	83136		4975549	83216		5531437	85307		684280	83209	89414
22165188	83136		4975550	85702		5532026	85304		8-94057-593-0	83114	
22165189	83136		4984526	83216		5532425	83207	89407	8-94454-986-0	83515	
22166442	83136		507-22	85342		5532433	83207	89407	8-94454-987-0	83515	
3171068	83216		507-23	85342		5532675	85307		8-97201-960-0	83515	
3171069	85304		507-24	85336		5534430	85303	89422	88963409	85336	
3171462	83126	89430	507-3	85307		5534439	85304		88982682	83136	
3171696	85307		508-86	83136		5534447	85303	89422	88982684	83136	
3172948	85303	89422	508-88	83153		5544060	85302	89420	88982685	85342	
3175509	85735		508-89	83155		5544112	83216		88982686	85071	
3178157	85700		5171068	83216		5544581	85302	89420	88982687	85342	
3178233	85734		5316784	85700		5544716	85304		88982688	85336	
3178507	85700		5316791	83219		5544717	85304		9-51630-647-1	83515	
3178995	85700		5316792	85305		5544812	83308		9-51630-666-0	85012	89413
3188626	85300	89419	5316793	85305		5544818	85735		9-51630-666-2	85012	89413
3188729	85303	89422	5321920	85307		5549899	83207	89407	94033786	83114	
3192657	83216		5321929	85307		5549924	85700		94051090	83114	
3192890	83126	89430	5348631	83203	89436	5549925	85304		94057593	83114	
3192892	83221		5352858	85305		5552111	85304		94454987	83515	
4939852	85308	89422	5353054	85303	89422	5552112	85307		97-2210-00164	85708	
4939967	85308	89422	5355798	85307		5552114	83216		97-2210-00170	85733	
4940600	83209	89414	5357955	85300	89419	5552205	83217		97083027	83515	
4940601	83216		5357956	85734		5552206	83214		97083029	83515	
4940606	83126	89430	5357959	85300	89419	5552207	83217		97201960	83515	
4940614	83216		5361994	85734		5552208	83217		L-12706	83155	

CHEVROLET TRUCK CAB SHOCKS

O.E.M #	Gabriel	Upgrade	O.E.M #	Gabriel	Upgrade	O.E.M #	Gabriel	Upgrade	O.E.M #	Gabriel	Upgrade
1202-0012	83023		1202-0032	83016		1202-0054	83021				

CHRYSLER

O.E.M #	Gabriel	Upgrade	O.E.M #	Gabriel	Upgrade	O.E.M #	Gabriel	Upgrade	O.E.M #	Gabriel	Upgrade
2961043	G63183		3633744	G63183		3638112	G63183				

CLARK EQUIPMENT

O.E.M #	Gabriel	Upgrade	O.E.M #	Gabriel	Upgrade	O.E.M #	Gabriel	Upgrade	O.E.M #	Gabriel	Upgrade
355778	85315		5532675	85307		680042	85301				

Important Note: Competitive Interchanges are to be used for stocking purposes only. Where multiple crosses are identified, please reference the applications section of this catalog.

COMPETITIVE & O.E.M. INTERCHANGE LIST

CNH GLOBAL N V

O.E.M #	Gabriel	Upgrade	O.E.M #	Gabriel	Upgrade	O.E.M #	Gabriel	Upgrade	O.E.M #	Gabriel	Upgrade
87019546	83022		87268250	83021							

COACH HOUSE RV

O.E.M #	Gabriel	Upgrade	O.E.M #	Gabriel	Upgrade	O.E.M #	Gabriel	Upgrade	O.E.M #	Gabriel	Upgrade
ASH-1136	83178		ASH-1154	83177							

COACHMEN RV

O.E.M #	Gabriel	Upgrade	O.E.M #	Gabriel	Upgrade	O.E.M #	Gabriel	Upgrade	O.E.M #	Gabriel	Upgrade
141700131809	85029		481700000493	85900		ASH-1154	83177		ASH-25824	83122	89406
141700131810	83160		66153-002	83124	89407	ASH-1205	83209	89414	ASH-294	83209	89414
16-16736-000	85029		9U94-18045-AA	83209	89414	ASH-1206	83122	89406	AT-620	83209	89414
16-16737-000	83160		9U94-18080-AA	83122	89406	ASH-1228	83209	89414	AT-621	83122	89406
16-16873-000	85029		9U9Z-18124-A	83209	89414	ASH-1229	83209	89414	AT-766	83209	89414
16-16874-000	83160		9U9Z-18125-A	83122	89406	ASH-1230	83122	89406	F4-BE5-C832-MO	83124	89407
16-18103-000	85900		ASH-1022	83209	89414	ASH-137	83122	89406			
1C34-18045-AA	83209	89414	ASH-1023	83122	89406	ASH-25822	83209	89414			
1C34-18045-JA	83209	89414	ASH-1136	83178		ASH-25823	83209	89414			

COFAP

Cofap	Gabriel	Upgrade	Cofap	Gabriel	Upgrade	Cofap	Gabriel	Upgrade	Cofap	Gabriel	Upgrade
45011	85702		45094	85949		45238	85949		L-12476	85074	
45054	85301		45095	85948		45240	85981		L-12477	85073	
45056	85315		45096	85951		8482	85026	89417	L-12488	85073	
45058	85301		45117	85918	89449	ATG-046	G63457		L-12590	85074	
45058	85941		45137	85948		ATG-051	G63426		L-12601	85077	
45086	85949		45139C-Y	85901		ATG-081	G63502		L-12602	85076	
45087	85943		45160	85946		ATG-084	G63608		L-12687	83030	
45089	85940		45174	85947		ATG-085	G63607		L-12703	85071	
45089	85949		45189	85950		L-12039	85065		L-12706	83155	
45090	85942		45200	85941		L-12040	85073		L-12713	83136	
45091	85944		45235	85946		L-12151	85075		L-13092	85073	

COLLINS BUS CORP

O.E.M #	Gabriel	Upgrade	O.E.M #	Gabriel	Upgrade	O.E.M #	Gabriel	Upgrade	O.E.M #	Gabriel	Upgrade
ASH-1136	83178		ASH-1154	83177							

CONDUMEX

Condumex	Gabriel	Upgrade	Condumex	Gabriel	Upgrade	Condumex	Gabriel	Upgrade	Condumex	Gabriel	Upgrade
43066	83309	89446	58034	85013	89414	69673	83209	89414	69748	85001	89410
43136	83017		58038	85001	89410	69680	83200		69750	85314	89425
43137	83009		58040	85026	89417	69685	83136		69752	85316	89426
43138	83004		58041	83456		69687	83100		69753	85031	
43139	83021		58047	85381		69688	85302	89420	78001	85314	89425
43145	83021		58048	83137		69705	83122	89406	78002	85702	
53010	83136		58049	85323	89436	69711	83207	89407	78003	85308	89422
53018	83317		58050	85061	89450	69712	85013	89414	78005	85310	89423
53019	83456		58055	85003	89411	69713	85046	89434	78007	85307	
53038	85103		58056	83137		69714	83215		78009	85303	89422
53039	85006		58057	83456	89447	69715	85000	89436	78013	85323	89436
53040	85006		58058	85031		69716	85024		78015	85724	89443
53041	85310	89423	58059	85005		69717	85310	89423	78016	85001	89410
53042	83309		58061	83122		69720	85736		78020	85712	
53043	83215		58061	85916		69725	85918	89449	78023	85705	
53059	85051		58062	85096		69726	85319		78025	85009	
53062	83009		58065	85949		69728	85055	89439	78026	85706	
53063	83025		58067	85942		69729	85314	89425	78027	85314	89425
53065	83136		69500	83122	89406	69732	85300	89419	78030	85316	89426
53066	83124	89407	69515	83124	89407	69741	85906		78034	85920	
53078	85940		69669	83123	89405	69743	85061	89450			
53079	85074		69670	85051		69745	85058	89431			
53080	83015		69671	85006		69746	83137				
58012	85314	89425	69672	85043		69747	85003				

Important Note: Competitive Interchanges are to be used for stocking purposes only. Where multiple crosses are identified, please reference the applications section of this catalog.

COMPETITIVE & O.E.M. INTERCHANGE LIST

CONDUMEX... cont'd

Condumex	Gabriel	Upgrade	Condumex	Gabriel	Upgrade	Condumex	Gabriel	Upgrade	Condumex	Gabriel	Upgrade
78039	85311		USA53086	83511		USA53088	83513		USA53092	83509	
USA53085	83512		USA53087	83506		USA53091	83508				

CONTINENTAL TRAILWAYS-EAGLE INT'L

O.E.M #	Gabriel	Upgrade	O.E.M #	Gabriel	Upgrade	O.E.M #	Gabriel	Upgrade	O.E.M #	Gabriel	Upgrade
01-0100-020	85307		5394467	85305		6-05-5	85307		70039	85303	89422
01-0100-905	85303	89422	5532026	85304		680091	85303	89422	70041	85305	

COUNTRY COACH

O.E.M #	Gabriel	Upgrade	O.E.M #	Gabriel	Upgrade	O.E.M #	Gabriel	Upgrade	O.E.M #	Gabriel	Upgrade
89406		89406	89414		89414						

CRANE CARRIER

O.E.M #	Gabriel	Upgrade	O.E.M #	Gabriel	Upgrade	O.E.M #	Gabriel	Upgrade	O.E.M #	Gabriel	Upgrade
1265157B000	85712		277A-12	85304		277A-9	85307		680088	85713	
1310002	665937		277A-13	85302	89420	60680-004	83143		680091	85303	89422
227A-14	85716		277A-14	85304		60680-004L	83143				
277A-1	85307		277A-8	85303	89422	64178-001	83143				

CROWN COACH

O.E.M #	Gabriel	Upgrade	O.E.M #	Gabriel	Upgrade	O.E.M #	Gabriel	Upgrade	O.E.M #	Gabriel	Upgrade
3188729	85303	89422	5532026	85304		5532036	85734				

CUNHA PRODUCTS OHD

O.E.M #	Gabriel	Upgrade	O.E.M #	Gabriel	Upgrade	O.E.M #	Gabriel	Upgrade	O.E.M #	Gabriel	Upgrade
CP-5222	85315										

CUSH CORPORATION

O.E.M #	Gabriel	Upgrade	O.E.M #	Gabriel	Upgrade	O.E.M #	Gabriel	Upgrade	O.E.M #	Gabriel	Upgrade
C0062-D	85000	89436	C0226	85064		C0228	85005				
C0078	85000	89436	C0227	85014		C04045	85045				

DAMON MOTOR COACH

O.E.M #	Gabriel	Upgrade	O.E.M #	Gabriel	Upgrade	O.E.M #	Gabriel	Upgrade	O.E.M #	Gabriel	Upgrade
24-153249	85125		ASH-1229	83209	89414	F4-BE5-A011-HO	85126		F4-BE5-F325-HO	85124	
24-153256	85124		ASH-25822	83209	89414	F4-BE5-A832-MO	85125		W0005662	85125	
24-186537	85126		ASH-25823	83209	89414	F4-BE5-B492-HO	85125		W0005663	85124	
24-186629	85125		ASH-25824	83122	89406	F4-BE5-F324-HO	85125		W0006254	85125	

DANA

O.E.M #	Gabriel	Upgrade	O.E.M #	Gabriel	Upgrade	O.E.M #	Gabriel	Upgrade	O.E.M #	Gabriel	Upgrade
SR1VJ100	85078										

DELCO

Delco	Gabriel	Upgrade	Delco	Gabriel	Upgrade	Delco	Gabriel	Upgrade	Delco	Gabriel	Upgrade
501-13	83318		507-7	85301		508-3	83400		508-68	83209	89414
501-74	83304		507-8	85301		508-30	85005	89430	508-68	85006	
501-75	83303		507-9	85700		508-35	G63306		508-70	G63396	
507-1	85304		508-13	85012	89413	508-35	G63371		508-70	G63416	
507-10	85711		508-14	83216		508-39	G63347		508-71	83314	
507-11	85308	89422	508-14	85012	89413	508-42	G63353		508-71	G63398	
507-12	85701		508-15	83216		508-42	G63389		508-72	G63386	
507-13	85704		508-16	83308	89435	508-47	G63350		508-74	G63511	
507-15	85703		508-17	83312	89409	508-47	G63377		508-78	83400	
507-16	85702		508-18	83309	89446	508-48	G63409		508-79	G63424	
507-17	85304		508-19	83314		508-48	G63427		508-80	G63425	
507-18	85305		508-20	83207	89407	508-5	G63359		508-82	G63410	
507-19	85700		508-21	83214		508-5	G63360		508-86	83136	
507-2	85302	89420	508-22	83217		508-50	G63299		508-87	85071	
507-22	85342		508-23	83217		508-50	G63907		508-88	83153	
507-23	85342		508-23	83225		508-52	G63405		508-89	83155	
507-24	85336		508-24	83215		508-52	G63419		508-9	85000	89436
507-3	85307		508-26	83203	89436	508-52	G63492				
507-4	85303	89422	508-26	85030	89440	508-56	G63605				
507-5	85308	89422	508-28	83207	89407	508-57	83123	89405			
507-6	85314	89425	508-29	85030	89440	508-59	G63183				

Important Note: Competitive Interchanges are to be used for stocking purposes only. Where multiple crosses are identified, please reference the applications section of this catalog.

COMPETITIVE & O.E.M. INTERCHANGE LIST

DELCO... cont'd

Delco	Gabriel	Upgrade	Delco	Gabriel	Upgrade	Delco	Gabriel	Upgrade	Delco	Gabriel	Upgrade
508-90	83136		550-73	83303		550-74	83304		550-77	83221	
550-13	85005	89430	550-73	85005	89430	550-75	83303				

DEXTER AXLE

O.E.M #	Gabriel	Upgrade	O.E.M #	Gabriel	Upgrade	O.E.M #	Gabriel	Upgrade	O.E.M #	Gabriel	Upgrade
18165-01	85006										

DIAMOND COACH

O.E.M #	Gabriel	Upgrade	O.E.M #	Gabriel	Upgrade	O.E.M #	Gabriel	Upgrade	O.E.M #	Gabriel	Upgrade
ASH-1136	83178		ASH-1154	83177							

DIAMOND T

O.E.M #	Gabriel	Upgrade	O.E.M #	Gabriel	Upgrade	O.E.M #	Gabriel	Upgrade	O.E.M #	Gabriel	Upgrade
5549925	85304										

DIAMOND-REO

O.E.M #	Gabriel	Upgrade	O.E.M #	Gabriel	Upgrade	O.E.M #	Gabriel	Upgrade	O.E.M #	Gabriel	Upgrade
220-55-1	83214		220-55-6	83214		220-55-8	83217				
220-55-2	85304		220-55-7	85304		220-S5-10	85712				

DINA BUS

O.E.M #	Gabriel	Upgrade	O.E.M #	Gabriel	Upgrade	O.E.M #	Gabriel	Upgrade	O.E.M #	Gabriel	Upgrade
1520030010	83317		39380353-6	85716		39390340-4	85716				
152E030030	85014		39390339-6	85307							

DODGE TRUCK

O.E.M #	Gabriel	Upgrade	O.E.M #	Gabriel	Upgrade	O.E.M #	Gabriel	Upgrade	O.E.M #	Gabriel	Upgrade
2516009	G63183		2961043	G63183		3633744	G63183		3638631	G63605	
2960707	G63183		3633643	G63183		3638112	G63183		4036892	G63605	

DUPLEX TRUCK

O.E.M #	Gabriel	Upgrade	O.E.M #	Gabriel	Upgrade	O.E.M #	Gabriel	Upgrade	O.E.M #	Gabriel	Upgrade
59024	83204		7604-3371	83204							

DURA SUSPENSION

O.E.M #	Gabriel	Upgrade	O.E.M #	Gabriel	Upgrade	O.E.M #	Gabriel	Upgrade	O.E.M #	Gabriel	Upgrade
1080099	83203	89436	59024	83204		665133	83203	89436	7604-3371	83204	
12866	83207	89407	59030	83203	89436	665267	85029		A-2212	85029	

DUTCHMEN RV

O.E.M #	Gabriel	Upgrade	O.E.M #	Gabriel	Upgrade	O.E.M #	Gabriel	Upgrade	O.E.M #	Gabriel	Upgrade
8C24-18045-DA	83177		8C2Z-18124-D	83177		ASH-1136	83178		AT-163G	83177	
8C24-18080-DB	83178		8C2Z-18125-D	83178		ASH-1154	83177		AT-164G	83178	

DYNAMAX CORP (COUNTRY COACH)

O.E.M #	Gabriel	Upgrade	O.E.M #	Gabriel	Upgrade	O.E.M #	Gabriel	Upgrade	O.E.M #	Gabriel	Upgrade
10-13634-000	85918	89449	471700002809	85724	89443	8C2Z-18124-D	83177		AT-164G	83178	
10-13760-000	85959	89503	471700002991	85959	89503	8C2Z-18125-D	83178		SDA471700002991	85959	89503
10-13809-000	85958		471700003920	85958		ASH-1136	83178				
16-18708-000	85724	89443	8C24-18045-DA	83177		ASH-1154	83177				
471700000449	85918	89449	8C24-18080-DB	83178		AT-163G	83177				

EAGLE MOTOR COACH

O.E.M #	Gabriel	Upgrade	O.E.M #	Gabriel	Upgrade	O.E.M #	Gabriel	Upgrade	O.E.M #	Gabriel	Upgrade
01-0100-020	85307		101364	85305		5394467	85305		690060	85713	
01-0100-905	85303	89422	12B-5-1	85735		5532026	85304		70039	85303	89422
014-0100-905	85308	89422	12J-5-10	85733		6-05-5	85307		70041	85305	
0140100-905	85308	89422	154-0100-514	85314	89425	680091	85303	89422			

EAST MANUFACTURING CORP.

O.E.M #	Gabriel	Upgrade	O.E.M #	Gabriel	Upgrade	O.E.M #	Gabriel	Upgrade	O.E.M #	Gabriel	Upgrade
517-05001-18	87015		517-05010-07	83214		517-05805-20	85000	89436	517-05916-14	83124	89407
517-05001-23	85005	89430	517-05022-07	83217		517-05806-20	85029		A-20002	85000	89436
517-05006-20	85030	89440	517-05110-20	85000	89436	517-05808-20	85738		A-20126	85323	89436
517-05009-14	83125		517-05511-14	83128		517-05809-20		89437			

ELDORADO NATIONAL

O.E.M #	Gabriel	Upgrade	O.E.M #	Gabriel	Upgrade	O.E.M #	Gabriel	Upgrade	O.E.M #	Gabriel	Upgrade
13208701	85746		ASH-1136	83178							
13208801	85745		ASH-1154	83177							

Important Note: Competitive Interchanges are to be used for stocking purposes only. Where multiple crosses are identified, please reference the applications section of this catalog.

COMPETITIVE & O.E.M. INTERCHANGE LIST

ELDORADO NATIONAL... cont'd

ELKHART COACH

O.E.M #	Gabriel	Upgrade	O.E.M #	Gabriel	Upgrade	O.E.M #	Gabriel	Upgrade	O.E.M #	Gabriel	Upgrade
ASH-1136	83178		ASH-1154	83177							

ENTEGR COACH

O.E.M #	Gabriel	Upgrade	O.E.M #	Gabriel	Upgrade	O.E.M #	Gabriel	Upgrade	O.E.M #	Gabriel	Upgrade
ASH-1136	83178		ASH-1229	83209	89414	ASH-25823	83209	89414			
ASH-1154	83177		ASH-25822	83209	89414	ASH-25824	83122	89406			

EUCLID

Euclid	Gabriel	Upgrade	Euclid	Gabriel	Upgrade	Euclid	Gabriel	Upgrade	Euclid	Gabriel	Upgrade
E14009	85933	89454	E83219	83219		E85005	85005	89430	E85313	85313	
E14021	85955		E83221	83221		E85006	85006		E85314	85314	89425
E14022	85955		E83223	83223		E85007	85007	89412	E85318	85318	
E14037	85967		E83225	83225		E85008	85008		E85700	85700	
E14042	85965		E83242	83242		E85010	85010		E85702	85702	
E14043	85966		E83300	83300		E85011	85011		E85703	85703	
E14045	83143		E83301	83301		E85012	85012	89413	E85704	85704	
E14046	83142		E83302	83302		E85013	85013	89414	E85705	85705	
E83200	83200		E83303	83303		E85014	85014		E85706	85706	
E83201	83201		E83304	83304		E85024	85024		E85709	85709	
E83202	83202		E83308	83308	89435	E85026	85026	89417	E85711	85711	
E83203	83203	89436	E83309	83309	89446	E85029	85029		E85712	85712	
E83204	83204		E83310	83221		E85030	85030	89440	E85713	85713	
E83205	83209	89414	E83311	83311		E85300	85300	89419	E87000	85711	
E83206	83206		E83312	83312	89409	E85302	85302	89420	E87001	85734	
E83207	83207	89407	E83314	83314		E85303	85303	89422	E87003	85700	
E83209	83209	89414	E83318	83318		E85304	85304		E87004	85735	
E83213	83213		E83353	85740		E85305	85305		E87006	85736	
E83214	83214		E83400	83400		E85307	85307		E87011	85707	
E83215	83215		E83401	83401		E85308	85308	89422	E87012	85705	
E83216	83216		E85000	85000	89436	E85310	85310	89423	E87013	85706	
E83217	83217		E85001	85001	89410	E85311	85311	89424			
E83218	83122	89406	E85003	85003	89411	E85312	85733				

FEDERAL COACH

O.E.M #	Gabriel	Upgrade	O.E.M #	Gabriel	Upgrade	O.E.M #	Gabriel	Upgrade	O.E.M #	Gabriel	Upgrade
10-12388-000	85920	89503	16-18708-000	85724	89443	ASH-1136	83178				
10-12390-000	85920	89503	471700002809	85724	89443	ASH-1154	83177				
10-13760-000	85959	89503	471700002991	85959	89503	SDA471700002991	85959	89503			

FLEETRITE

Fleetrite	Gabriel	Upgrade	Fleetrite	Gabriel	Upgrade	Fleetrite	Gabriel	Upgrade	Fleetrite	Gabriel	Upgrade
AMS600101	85003	89411	AMS600120	G63605		AMS600147	83216		AMS600169	85051	
AMS600102	85005	89430	AMS600123	G63183		AMS600148	85026	89417	AMS600172	85005	89430
AMS600103	85014		AMS600125	83123	89405	AMS600149	83217		AMS600173	85043	
AMS600104	85000	89436	AMS600126	83400		AMS600150	85009		AMS600174	83125	
AMS600105	83304		AMS600127	83161		AMS600151	85024		AMS600175	83120	
AMS600106	83312	89409	AMS600128	83401		AMS600152	83242		AMS600202	83009	
AMS600107	83309	89446	AMS600129	83317		AMS600153	85003	89411	AMS650101	85062	89408
AMS600108	83209	89414	AMS600130	83204		AMS600154	83104		AMS650102	85001	89410
AMS600109	83217		AMS600131	83318		AMS600155	83103		AMS650103	85320	89429
AMS600110	83303		AMS600132	83215		AMS600156	83103		AMS650104	65104	
AMS600111	83301		AMS600133	83362		AMS600157	83221		AMS650105	85026	89417
AMS600112	83456	89447	AMS600134	83221		AMS600162	83103		AMS650106	65106	
AMS600113	83215		AMS600136	85740		AMS600163	83101		AMS650107	85316	89426
AMS600114	83125		AMS600138	83100		AMS600164	83613		AMS650108	85030	89432
AMS600116	83216		AMS600139	85740		AMS600165	83636				
AMS600117	83308	89435	AMS600142	83209	89414	AMS600166	85052				
AMS600118	83219		AMS600145	85040		AMS600167	83128				
AMS600119	83314		AMS600146	83105		AMS600168	83635				

Important Note: Competitive Interchanges are to be used for stocking purposes only. Where multiple crosses are identified, please reference the applications section of this catalog.

COMPETITIVE & O.E.M. INTERCHANGE LIST

FLEETRITE... cont'd

Fleetrte	Gabriel	Upgrade	Fleetrte	Gabriel	Upgrade	Fleetrte	Gabriel	Upgrade	Fleetrte	Gabriel	Upgrade
AMS650109	85058	89431	AMS650440	85711		AMS660118	85012	89413	AMS660196	G63610	
AMS650110	85005	89430	AMS650441	85704		AMS660119	83314		AMS660197	G63866	
AMS650111	85006		AMS650442	85700		AMS660120	G63605		AMS660198	83007	
AMS650112	89402		AMS650443	85706		AMS660123	G63183		AMS660200	83008	
AMS650113	85012	89413	AMS650444	85311	89424	AMS660125	83123	89405	AMS660201	83308	89435
AMS650114	85006		AMS650445	85731		AMS660126	83400		AMS660202	83009	
AMS650115	85027	89418	AMS650446	85730		AMS660127	83161		AMS660203	83112	
AMS650116	85303	89422	AMS650447	85703		AMS660128	83401		AMS660204	83010	
AMS650118	83215		AMS650448	85700		AMS660129	83317		AMS660205	83003	
AMS650119	85029		AMS650449	85702		AMS660130	83204		AMS660208	G63616	
AMS650120	85010		AMS650451	85029		AMS660131	83318		AMS660209	83014	
AMS650121	89432		AMS650452	85733		AMS660132	83215		AMS660211	83110	
AMS650122	85063		AMS650453	85904		AMS660133	83362		AMS660212	83015	
AMS650123	85054	89438	AMS650454	85713		AMS660134	83221		AMS660213	85009	
AMS650124	85053	89442	AMS650455	85716		AMS660136	85740		AMS660214	83002	
AMS650128	85031		AMS650456	85376		AMS660138	83100		AMS660215	85059	
AMS650129	85701		AMS650458	85908		AMS660142	83209	89414	AMS660216	83123	89405
AMS650130	85061	89450	AMS650459	85043		AMS660145	85040		AMS660218	83137	
AMS650139	85918	89449	AMS650462	85913		AMS660146	83105		AMS660219	83215	
AMS650400	85033	89427	AMS650463	85040		AMS660147	83216		AMS660220	83109	
AMS650401	85013	89414	AMS650464	85716		AMS660148	85026	89417	AMS660223	85055	89439
AMS650402	85311	89424	AMS650465	85914		AMS660149	85042		AMS660224	83111	
AMS650404	85310	89423	AMS650466	85047	89435	AMS660150	G63616		AMS660225	83200	
AMS650405	85023	89415	AMS650468	85069	89455	AMS660153	85003	89411	AMS660232	83114	
AMS650406	85024		AMS650471	85302	89420	AMS660154	83104		AMS660233	83023	
AMS650407	85736		AMS650472	85330		AMS660155	83103		AMS660234	83013	
AMS650408	85319	89428	AMS650473	85329		AMS660157	85030	89440	AMS660236	83025	
AMS650409	85003	89411	AMS650474	85712		AMS660160	83114		AMS660237	83005	
AMS650410	85300	89419	AMS650475	85065		AMS660161	G63610		AMS660238	83101	
AMS650411	85036	89405	AMS650478	85030	89440	AMS660162	83103		AMS660244	83125	
AMS650412	83122	89406	AMS650479	83122	89406	AMS660164	83613		AMS660247	83116	
AMS650413	65413		AMS650480	83109		AMS660165	83636		AMS660247	83118	
AMS650414	65414		AMS650480	83111		AMS660166	85052		AMS660248	83117	
AMS650415	85046	89434	AMS650481	83123	89405	AMS660167	83128		AMS660502	646155	
AMS650416	85323	89436	AMS650482	85006		AMS660168	83635		AMS660504	632147	
AMS650417	85322		AMS650486	85066	89448	AMS660169	85051		AMS700101	85308	89422
AMS650418	85906	89407	AMS65107	85316	89426	AMS660170	83016		AMS700102	85303	89422
AMS650419	85000	89436	AMS65109	85058	89431	AMS660171	83017		AMS700103	85302	89420
AMS650420	85013	89414	AMS65144	85957		AMS660172	83126	89430	AMS700104	85304	
AMS650421	85916		AMS65146	85925		AMS660173	85043		AMS700105	85314	89425
AMS650422	85912		AMS65158	85954		AMS660174	83125		AMS700106	85301	
AMS650423	85907		AMS660102	85005	89430	AMS660175	83120		AMS700107	85307	
AMS650424	85905		AMS660103	85014		AMS660176	83018		AMS700108	85315	
AMS650425	89441		AMS660104	85000	89436	AMS660177	83019		AMS700111	85320	89429
AMS650426	85054	89438	AMS660105	83304		AMS660179	83162		AMS700112	85722	
AMS650427	85903		AMS660106	83312	89409	AMS660182	83004		AMS700113	85736	
AMS650428	85321		AMS660107	83309	89446	AMS660183	85012	89413	AMS700114	85701	
AMS650429	85030	89440	AMS660108	83209	89414	AMS660187	85071		AMS700115	85712	
AMS650430	85712		AMS660109	83217		AMS660188	85045		AMS700116	83136	
AMS650431	85909		AMS660110	83303		AMS660189	83136		AMS700117	85324	
AMS650432	85910		AMS660111	83301		AMS660190	83107		AMS700119	85336	
AMS650433	85910		AMS660112	83456	89447	AMS660191	83216		AMS700120	85332	
AMS650434	85012	89413	AMS660113	83215		AMS660192	85001	89410	AMS700121	83136	
AMS650435	85901		AMS660114	85006		AMS660193	83001		AMS700401	85700	
AMS650436	85900		AMS660116	83216		AMS660194	83207	89407	AMS700402	85310	89423
AMS650439	85732		AMS660117	83308	89435	AMS660195	83130		AMS700403	85702	

Important Note: Competitive Interchanges are to be used for stocking purposes only. Where multiple crosses are identified, please reference the applications section of this catalog.

COMPETITIVE & O.E.M. INTERCHANGE LIST

FLEETRITE... cont'd

Fleetrite	Gabriel	Upgrade	Fleetrite	Gabriel	Upgrade	Fleetrite	Gabriel	Upgrade	Fleetrite	Gabriel	Upgrade
AMS700404	85311	89424	AMS700414	85723		AMS700424	85333		AMS85895	83207	89407
AMS700405	85300	89419	AMS700415	85318		AMS74421	85708		AMS85900	G63386	
AMS700406	85711		AMS700416	85709		AMS85722	83400		AMS85901	G63387	
AMS700407	85712		AMS700418	85003	89411	AMS85736	G63394		AMS85904	G63299	
AMS700408	85704		AMS700419	85708		AMS85768	83209	89414	AMS85905	G63405	
AMS700409	85701		AMS700420	85733		AMS85802	83216		AMS85909	G63398	
AMS700410	85314	89425	AMS700421	85712		AMS85803	G63306		AMS85932	G63398	
AMS700411	85703		AMS700422	85308	89422	AMS85821	G63406		AMS85960	G63366	
AMS700413	85705	89447	AMS700423	85724	89443	AMS85853	G63183				

FLEETWOOD RV

O.E.M #	Gabriel	Upgrade	O.E.M #	Gabriel	Upgrade	O.E.M #	Gabriel	Upgrade	O.E.M #	Gabriel	Upgrade
141700131809	85029		24-186537	85126		ASH-1205	83209	89414	AT-621	83122	89406
141700131810	83160		24-186629	85125		ASH-1206	83122	89406	AT-766	83209	89414
16-16736-000	85029		481700000493	85900		ASH-1228	83209	89414	F4-BE5-A011-HO	85126	
16-16737-000	83160		9U94-18045-AA	83209	89414	ASH-1229	83209	89414	F4-BE5-A832-MO	85125	
16-16873-000	85029		9U94-18080-AA	83122	89406	ASH-1230	83122	89406	F4-BE5-B492-HO	85125	
16-16874-000	83160		9U9Z-18124-A	83209	89414	ASH-137	83122	89406	F4-BE5-F324-HO	85125	
16-18103-000	85900		9U9Z-18125-A	83122	89406	ASH-25822	83209	89414	F4-BE5-F325-HO	85124	
1C34-18045-AA	83209	89414	ASH-1022	83209	89414	ASH-25823	83209	89414	W0005662	85125	
1C34-18045-JA	83209	89414	ASH-1023	83122	89406	ASH-25824	83122	89406	W0005663	85124	
24-153249	85125		ASH-1136	83178		ASH-294	83209	89414	W0006254	85125	
24-153256	85124		ASH-1154	83177		AT-620	83209	89414			

FLUIDRIVE

O.E.M #	Gabriel	Upgrade	O.E.M #	Gabriel	Upgrade	O.E.M #	Gabriel	Upgrade	O.E.M #	Gabriel	Upgrade
2697	85712										

FLXIBLE BUS

O.E.M #	Gabriel	Upgrade	O.E.M #	Gabriel	Upgrade	O.E.M #	Gabriel	Upgrade	O.E.M #	Gabriel	Upgrade
015813	85708		6-05-6	85736		87-2519-00001	85703		97-2210-00009	85704	
06-0367-00151	85700		6-05-7	85736		87-2519-00002	85731		97-2210-00011	85704	
06-0367-00156	85702		6-05-8	85736		87-2519-00003	85703		97-2210-00156	85702	
22012067	85700		6-05-9	85304		87-2519-00004	85731		97-2210-00157	85708	
22012114	85700		6-367-1	85711		87-2520-00001	85704		97-2210-00160	85705	89447
22024061	85704		6-367-11	85711		87-2520-00003	85704		97-2210-00164	85708	
22024506	85703		6-367-12	85700		97-2201-00001	85703		97-2210-00170	85733	
22025066	85703		6-367-14	85700		97-2201-00002	85703		97-9999-00732	85707	
22025067	85704		6-367-16	85700		97-2201-00003	85703		97-9999-00807	85307	
22025305	85704		6-367-17	85700		97-2201-00004	85703		97-9999-02514	85700	
3166657	85700		6-367-2	85736		97-2201-00005	85703		97-9999-02515	85702	
3192333	85700		6-367-3	85304		97-2201-00006	85703		97-9999-02519	85707	
48-1-239	85736		6-367-4	83217		97-2201-00007	85703		97-9999-02592	85710	
48-1-241	85712		6-367-6	85711		97-2201-00008	85731		97-9999-02595	85313	
4975518	85704		6-367-7	85305		97-2201-00009	85703		97-9999-02632	85711	
6-05-1	85736		6-367-8	85700		97-2201-00151	85700		97-9999-02633	85311	89424
6-05-10	85734		6-367-9	85711		97-2210-00001	85704		97-9999-02634	85733	
6-05-13	85304		680029	85301		97-2210-00002	85704		97-9999-02635	85732	
6-05-2	85736		680155	85712		97-2210-00003	85704		97-9999-02636	85716	
6-05-3	85736		680320	85703		97-2210-00004	85704				
6-05-4	85736		695125	85704		97-2210-00005	85704				
6-05-5	85307		74412	85704		97-2210-00006	85704				

FLYER INDUSTRIES

O.E.M #	Gabriel	Upgrade	O.E.M #	Gabriel	Upgrade	O.E.M #	Gabriel	Upgrade	O.E.M #	Gabriel	Upgrade
009863	85722		22012067	85700		3192333	85700		592-6568	85700	
015915	85711		22012114	85700		4975501	85700		5979574	85700	
15813	85708		3166657	85700		4975552	85711				

Important Note: Competitive Interchanges are to be used for stocking purposes only. Where multiple crosses are identified, please reference the applications section of this catalog.

COMPETITIVE & O.E.M. INTERCHANGE LIST

FORD

O.E.M #	Gabriel	Upgrade	O.E.M #	Gabriel	Upgrade	O.E.M #	Gabriel	Upgrade	O.E.M #	Gabriel	Upgrade
0017LA-18080-G	83161		5U2Z-18V124-LA	G63929		ASH-24446	83215		C1TZ-18124-C	83312	89409
1C34-18045-AA	83209	89414	5U2Z-18V125-AE	G63808		ASH-2447	83140		C1TZ-18124-D	83309	89446
1C34-18045-JA	83209	89414	5U2Z-18V125-AF	G63810		ASH-24658	85181		C1TZ-18124-E	83312	89409
1C44-18080-AA	83123	89405	5U2Z-18V125-BDA	G63623		ASH-24659	85181		C1TZ-18124-F	83312	89409
2C4Z-18124-BA	83175		5U2Z-18V125-BGA	G63778		ASH-24660	85180		C1TZ-18124-N	83314	
2C7Z-18125-AA	G63837		5U2Z-18V125-BS	G63607		ASH-247	G63461		C1TZ-18124-P	83312	89409
2C7Z-18125-CA	G63607		5U2Z-18V125-BT	G63525		ASH-25822	83209	89414	C1TZ-18125-B	83217	
3553628C1	85927		5U2Z-18V125-BU	G63524		ASH-25823	83209	89414	C1VT-18080-B	83217	
3553628C2	85927		5U2Z-18V125-F	G63676		ASH-25824	83122	89406	C2TA-18045-A	83216	
3578858C1	85926		5U2Z-18V125-G	G63837		ASH-294	83209	89414	C2TA-18045-B	83308	
3578858C2	85926		5U2Z-18V125-H	G63406		ASH-397	83131		C2TZ-18124-A	83308	
3584116C1	83175		60670-008	83123	89405	ASH-722	85976		C3TA-18045-A	83216	
3584116C2	83175		60670-008L	83123	89405	AT-163G	83177		C3TZ-18124-A	83308	
3584117C2	83135		60675-003	85976		AT-164G	83178		C4HZ-18124-A	83312	89409
3584118C2	85928		60675-003L	85976		AT-610	G63461		C4HZ-18124-B	83309	89446
3U2Z-18124-BAA	G63809		680029	85301		AT-611	G63461		C4HZ-18124-C	83314	
3U2Z-18124-BV	G63614		6C2Z-18124-B	G63929		AT-620	83209	89414	C4HZ-18124-D	83312	89409
3U2Z-18124-BW	G63614		6ETZ-18124-AA	83145		AT-621	83122	89406	C4HZ-18124-E	83309	89446
3U2Z-18124-EA	G63772		6ETZ-18125-A	83146		AT-696	83140		C4HZ-18124-F	83308	
3U2Z-18124-FA	G63608		6U2Z-18V125-B	G63607		AT-766	83209	89414	C4PF-18045-H	83216	
3U2Z-18124-FAA	G63809		6U2Z18V125A	G63837		AT-811	83135		C4TZ-18124-AA	83308	
3U2Z-18124-JAA	G63614		70127	85006	89401	AT-812	85928		C4TZ-18124-AB	83308	
3U2Z-18124-MAA	83131		70128	85006	89401	AX-267A	83309	89446	C4TZ-18124-B	83308	
3U2Z-18124-YAA	G63809		7C34-18045-HB	G63969		AX-310	83215		C5TZ-18124-A	83308	
3U2Z-18125-AD	69575		7C34-18080-DCB	77968		B3Q-18124-A	83219		C6PF-18077-A	G63306	
3U2Z-18125-CA	G63607		7W7Z-18125-B	69574		B3Q-18125-A	83217		C6PF-18077-AC	83161	
3U2Z-18125-DA	G63525		87HU-18045-AA	85301		B3TZ-18125-A	83217		C6PF-18077-DD	83216	
3U2Z-18125-EA	G63524		8C24-18045-DA	83177		B6TZ-18124-A	83219		C6PF-18077-DE	83219	
3U2Z-18125-RA	G63623		8C24-18080-DB	83178		B6TZ-18125-B	83161		C6PF-18077-DL	83312	89409
471700011530	85181		8C2Z-18124-D	83177		B6TZ-18125-C	83161		C6PF-18077-DN	83314	
471700011531	85180		8C2Z-18125-D	83178		B6TZ-18125-E	83161		C6PF-18077-F	83225	
47902-13	83122	89406	90044769	83207	89407	B7C-18125-A	83217		C6TA-18045-U	85301	
47902-28	85013	89414	90044770	83207	89407	B7T-18124-C	83225		C6TA-18045-V	85301	
47902-8	83122	89406	90045068		89441	B7TZ-18124-B	83216		C6TA-18045-Y	85301	
4C4Z-18124-HB	83135		90045099	85906	89407	B7TZ-18124-C	83216		C6TA-18045-Z	85301	
4C4Z-18124-JB	85928		90045132	85909		B7TZ-18124-D	83219		C6TS-18080-A	83217	
4C4Z-18124-P	83135		9U94-18045-AA	83209	89414	B7TZ-18124-E	83217		C6TZ-18124-D	85301	
4C4Z-18124-QA	83175		9U94-18080-AA	83122	89406	B7TZ-18125-C	83217		C6TZ-18124-E	85301	
4C4Z-18124-RA	85928		9U9Z-18124-A	83209	89414	B8Q-18125-A	85307		C6TZ-18124-H	85301	
4C4Z-18125-B	83317		9U9Z-18125-A	83122	89406	B8QZ-18124-A	83312	89409	C6TZ-18124-J	85301	
4C4Z-18125-CA	85976		AA-494	83131		B8TZ-18124-A	83219		C7HZ-18124-A	83312	89409
4C4Z-18125-DA	85926		AA-615	83135		B9TT-18045-C	83219		C7PF-18077-A	83225	
4U2Z-18V124-AA	G63678		AA-616	83175		B9TT-18045-D	83219		C7PF-18077-Z	83217	
501906C92	83317		AA-617	85928		B9TT-18080-B	83161		C7TA-18045-R	83216	
57241-2	83109		ASH-1022	83209	89414	B9TZ-18125-B	83161		C7TA-18045-Z	85301	
57365-111	85006	89401	ASH-1023	83122	89406	C0TT-18045-A	83219		C8HA-18045-A	83312	89409
5C3Z-18124-JA	G63969		ASH-1105	85976		C0TT-18045-D	83216		C8PF-18045-CM	83216	
5C3Z-18125-CF	77969		ASH-1136	83178		C0TZ-18124-A	83216		C8PF-18045-S	83161	
5C3Z-18125-DA	77968		ASH-1154	83177		C1TT-18045-C	83312	89409	C8PF-18045-T	83161	
5U2Z-18V124-AA	G63714		ASH-1205	83209	89414	C1TT-18045-D	G63406		C8TA-18045-AA	G63386	
5U2Z-18V124-AHA	G63622		ASH-1206	83122	89406	C1TT-18045-E	83314		C8TA-18080-Y	83161	
5U2Z-18V124-AU	G63772		ASH-1228	83209	89414	C1TT-18045-G	83216		C8TA-18080-Z	83161	
5U2Z-18V124-BA	G63716		ASH-1229	83209	89414	C1TT-18080-B	83217		C8TZ-18125-D	83161	
5U2Z-18V124-CAA	G63809		ASH-1230	83122	89406	C1TZ-18045-C	83312	89409	D0HA-18045-D	83309	89446
5U2Z-18V124-DB	G63455		ASH-137	83122	89406	C1TZ-18124-A	83217		D0HA-18045-E	83312	89409
5U2Z-18V124-GA	G63809		ASH-23486	G63461		C1TZ-18124-B	83216		D0HZ-18124-A	83309	89446

Important Note: Competitive Interchanges are to be used for stocking purposes only. Where multiple crosses are identified, please reference the applications section of this catalog.

COMPETITIVE & O.E.M. INTERCHANGE LIST

FORD... cont'd

O.E.M #	Gabriel	Upgrade	O.E.M #	Gabriel	Upgrade	O.E.M #	Gabriel	Upgrade	O.E.M #	Gabriel	Upgrade
D0HZ-18124-B	83312	89409	D5TZ-18124-C	83312	89409	E7XZ-18124-B	G63500		F2HZ-18124-C	85006	89401
D0HZ-18124-C	83314		D7HA-18080-AA	83123	89405	E7XZ-18124-C	G63511		F2HZ-18125-A	85712	
D1TF-18045-LA	83312	89409	D7HF-18045-FA	83312	89409	E7XZ-18124-D	G63396		F4HT-18045-AB	83314	
D1TZ-18124-D	83308		D7HF-18080-AA	83215		E7XZ-18124-F	G63398		F4HT-18045-AC	83314	
D1TZ-18124-E	83216		D7HF-18125-AA	83215		E7XZ-18124-G	G63398		F4HT-18045-CB	83107	
D1TZ-18124-F	83312	89409	D7HT-18045-BA	83312	89409	E7XZ-18125-A	G63350		F4HT-18045-DA	85063	
D1TZ-18125-E	83217		D7HT-18045-CA	83314		E7XZ-18125-B	G63387		F4HT-18045-EA	83125	
D2EF-18045-AA	83312	89409	D7HT-18045-DA	83309	89446	E7XZ-18125-C	G63409		F4HT-18080-AA	85314	89425
D2EF-18124-AA	83312	89409	D7HT-18045-EA	83312	89409	E7XZ-18125-D	G63406		F4HT-18080-AB	85314	89425
D2HA-18045-E1A	85304		D7HT-18045-GA	83308		E7XZ-18125-E	G63406		F4HT-18080-BA	85001	89410
D2HA-18045-E1B	85304		D7HT-18045-HA	85012	89413	E7XZ-18125-G	G63811		F4TA-18045-TA	G63455	
D2HA-18045-E2A	85304		D7HT-18045-JA	83308		E7XZ-18125-J	G63299		F4TA-18080-PA	G63461	
D2HA-18045-E2B	85304		D7HT-18045-NA	85301		E9HS-18045-AA	83309	89446	F4TZ-18124-D	G63414	
D2HA-18045-EB	85301		D7HT-18080-AA	83215		E9HS-18080-AA	85716		F4TZ-18124-K	G63455	
D2HA-18045-F1A	85301		D7HT-18080-BA	83225		E9HZ-18124-A	83309	89446	F4TZ-18125-E	G63461	
D2HA-18045-F1B	85301		D7HT-18080-CA	83225		E9HZ-18125-A	85716		F4TZ-18125-L	G63406	
D2HA-18045-F2A	85301		D7HT-18080-DA	83215		E9HZ-18125-AA	85716		F57Z-18125-BB	G63679	
D2HA-18045-F2B	85301		D7HT-18124-BA	83312	89409	F0HS-18045-AA	85006	89401	F5HZ-18124-A	83314	
D2HF-18045-A	83314		D7HT-18124-CA	83314		F0HT-18045-AA	85006	89401	F5HZ-18124-AA	83314	
D2HF-18045-AA	83314		D7HT-18124-DA	83309	89446	F0HT-18045-CA	85006	89401	F5HZ-18124-B	83107	
D2HF-18045-BA	83309	89446	D7HT-18124-EA	83312	89409	F0HT-18080-AA	83122	89406	F5HZ-18124-C	85063	
D2HF-18045-CA	83308		D7HT-18124-FA	83312	89409	F0HZ-18124-A	85006	89401	F5HZ-18124-D	83125	
D2HF-18045-DA	83312	89409	D7HT-18124-GA	83308		F0HZ-18124-B	85006		F5HZ-18124-DA	83125	
D2HF-18124-AA	83314		D7HT-18124-HA	83219		F0HZ-18125-A	83122	89406	F5HZ-18125-A	85314	89425
D2HT-18045-CA	83314		D7HT-18124-JA	83308		F1HT-18045-AA	83309	89446	F5HZ-18125-AA	85314	89425
D2HT-18045-EA	83312	89409	D7HT-18124-KA	85301		F1HT-18045-CA	83308		F5HZ-18125-B	85001	89410
D2HT-18045-GA	83308		D7HT-18125-BA	83217		F1HT-18045-CB	83216		F5HZ-18125-BA	85001	89410
D2HT-18080-HA	83225		D7HT-18125-CA	83217		F1HT-18045-DA	83312	89409	F5HZ-18125-DA	85314	89425
D2HZ-18080-A	83209	89414	D7HT-18125-DA	83215		F1HT-18045-DB	83308		F5TZ-18124-B	G63608	
D2HZ-18125-A	83209	89414	D7HT-18125-FA	83123	89405	F1HT-18045-EA		89402	F5TZ-18125-BC	G63607	
D2HZ-18125-B	83209	89414	D7HZ-18125-A	83215		F1HT-18045-EB		89402	F5UZ-18124-A	G63622	
D2KF-18045-AA	83312	89409	D7KF-18045-EA	83312	89409	F1HT-18045-GA	85006	89401	F5UZ-18124-B	G63622	
D2KF-18124-AA	83312	89409	D7TA-18124-GA	83314		F1HT-18045-GB	85006	89401	F5UZ-18125-A	G63623	
D2TA-18045-AAA	83219		D7TZ-18125-C	83217		F1HT-18045-HB	85006	89401	F5UZ-18125-C	G63624	
D2TA-18045-ZA	83219		D8HZ-18124-A	85301		F1HT-18045-KB	85006	89401	F6HT-18045-AA	85054	89438
D2TF-18045-AA	83312	89409	D8HZ-18125-A	83209	89414	F1HT-18045-LB	85006	89401	F6HT-18045-AC	85054	89438
D2TF-18045-FA	83312	89409	D8HZ-18125-B	83123	89405	F1HT-18045-NA	85040		F6HT-18045-BC	85047	89435
D2TF-18045-GA	83308		E0HT-18045-AA	83309	89446	F1HT-18045-RA		89402	F6HT-18045-CC	85055	89439
D2TF-18080-HA	83225		E0HT-18045-AB	83309	89446	F1HT-18045-RB		89402	F6HT-18045-EB	85055	89439
D2TF-18080-NA	83217		E0HT-18080-AA	83215		F1HZ-18124-A	83309	89446	F6HT-18045-EC	85055	89439
D2TF-18124-F	83309	89446	E0HZ-18124-A	83309	89446	F1HZ-18124-AA	83309	89446	F6HT-18045-GB	85030	89440
D2TZ-18124-A	83308		E1TA-18045-AA	83309	89446	F1HZ-18124-B	83308		F6HT-18045-GC	85030	89440
D2TZ-18124-E	83312	89409	E1TD-18045-AA	83309	89446	F1HZ-18124-C		89402	F6HT-18045-HB	85054	89438
D2TZ-18124-F	83309	89446	E5HT-18045-AA	85301		F1HZ-18124-D	85006	89401	F6HT-18045-HC	85054	89438
D2TZ-18124-G	83314		E5HT-18045-DA	85301		F1HZ-18124-E	85006	89401	F6HT-18045-JB	83200	89402
D2TZ-18124-H	83308		E5HT-18045-EA	85301		F1HZ-18124-F	85006	89401	F6HT-18045-JC	83200	89402
D2TZ-18124-J	83312	89409	E5HT-18080-DA	85315		F1HZ-18124-G	85006	89401	F6HT-18045-KA	83200	89402
D3TA-18045-BA	83219		E5HT-18080-EA	85315		F1HZ-18124-H	85040		F6HT-18045-LA	85376	
D3TZ-18124-B	83219		E6HT-18080-AA	83215		F1HZ-18124-J	83308		F6HT-18045-MA	85006	89401
D3TZ-18125-C	83217		E6HZ-18124-A	85301		F1HZ-18124-K		89402	F6HT-18080-B	83109	
D3TZ-18125-D	83217		E6HZ-18124-D	85301		F2HT-18045-BA	85376		F6HT-18080-CA	85314	89425
D4HA-18080-A	83209	89414	E6HZ-18125-D	83215		F2HT-18045-CA	85376		F6HT-18080-DA	83109	
D4HA-18080-AA	83209	89414	E6HZ-18125-E	85315		F2HT-18045-DA	85006	89401	F6HT-18080-EA	85906	89407
D4TF-18045-AA	83312	89409	E6HZ-18125-F	85315		F2HT-18080-DA	85712		F6HT-18080-FC	85013	89414
D4TZ-18124-J	83308		E7HZ-18124-A	85301		F2HZ-18124-A	85376		F6HT-18080-JA	85305	
D5TZ-18124-B	83308		E7XZ-18124-A	G63386		F2HZ-18124-B	85301		F6HZ-18080-FC	85013	89414

Important Note: Competitive Interchanges are to be used for stocking purposes only. Where multiple crosses are identified, please reference the applications section of this catalog.

COMPETITIVE & O.E.M. INTERCHANGE LIST

FORD... cont'd

O.E.M #	Gabriel	Upgrade	O.E.M #	Gabriel	Upgrade	O.E.M #	Gabriel	Upgrade	O.E.M #	Gabriel	Upgrade
F6HZ-18124-A	85054	89438	F81A-18080-DCA	G63461		LA-18080-F	83161		TDBA-18080-C	83217	
F6HZ-18124-B	83308		F81A-18080-ZC	83140		LA-18080-J	83161		TDBE-18045-A	83219	
F6HZ-18124-C	85055	89439	F81Z-18124-AL	G63622		TAAH-18080-A	83161		TFAA-18045-B	83219	
F6HZ-18124-D	85055	89439	F81Z-18124-BK	G63809		TAAH-18080-A2	83161		TFAA-18045-C	83219	
F6HZ-18124-E	85055	89439	F81Z-18124-PA	85928		TAAH-18080-A3	83161		TFAA-18080-A	85307	
F6HZ-18124-F	85055	89439	F81Z-18125-DC	G63461		TAAK-18080-A	83161		THAB-18045-A	83219	
F6HZ-18124-G	85054	89438	F81Z-18125-ZA	83140		TAAK-18080-A1	83161		THAB-18045-B	83219	
F6HZ-18124-H	85054	89438	F87Z-18125-CA	G63773		TAAK-18080-A2	83161		TQSH-18045-A	83309	89446
F6HZ-18124-J	83200	89402	F87Z-18125-RA	G63775		TACAA-18045-A	83216		XC35-18045-AB	83131	
F6HZ-18124-KA	83200	89402	FC44-18045-BB	85181		TANNA-18045-A	83312	89409	XC35-18045-AD	83131	
F6HZ-18124-MA	85006	89401	FC44-18080-AB	85180		TBAK-18080-A	83161		XC35-18045-JA	83131	
F6HZ-18125-A	85314	89425	FC4Z-18124-A	85181		TBDA-18080-A	83217		XC3Z-18124-JA	83131	
F6HZ-18125-B	83109		FC4Z-18124-B	85181		TBDA-18080-B	83217		XC45-18045-AA	83216	
F6HZ-18125-C		89441	FC4Z-18124-HB	83135		TDAA-18080-A	83161		XL2Z-18124-EA	G63678	
F6HZ-18125-D	85013	89414	FC4Z-18125-A	85180		TDAA-18080-B	83217		XL2Z-18125-BA	G63679	
F6HZ-18125-JA	85305		LA-18080	83161		TDBA-18045-A	83219		XL2Z-18125-CA	G63679	
F7C2Z-18124-BR	G63929		LA-18080-A	83161		TDBA-18045-B	83219		XL2Z-18125-EA	G63679	
F7TA-18045-AA	G63608		LA-18080-B	83161		TDBA-18080-A	83217		YL5Z-18124-AA	G63772	
F7TA-18080-BA	G63607		LA-18080-C	83161		TDBA-18080-B	83217				

FORD CAB SHOCKS

O.E.M #	Gabriel	Upgrade	O.E.M #	Gabriel	Upgrade	O.E.M #	Gabriel	Upgrade	O.E.M #	Gabriel	Upgrade
1201-0012	83023		1202-0012	83023		1202-1043	83025		F6HZ-5K407-BA	83033	
1201-1043	83025		1202-0032	83016		1202-1044	83025		F8HT-5K407-AA	83033	
1201-1044	83025		1202-0042	83025		F6HZ-5K407-AB	83034				

FOREST RIVER INC

O.E.M #	Gabriel	Upgrade	O.E.M #	Gabriel	Upgrade	O.E.M #	Gabriel	Upgrade	O.E.M #	Gabriel	Upgrade
141700131809	85029		481700000493	85900		ASH-1154	83177		ASH-25824	83122	89406
141700131810	83160		66153-002	83124	89407	ASH-1205	83209	89414	ASH-294	83209	89414
16-16736-000	85029		9U94-18045-AA	83209	89414	ASH-1206	83122	89406	AT-620	83209	89414
16-16737-000	83160		9U94-18080-AA	83122	89406	ASH-1228	83209	89414	AT-621	83122	89406
16-16873-000	85029		9U9Z-18124-A	83209	89414	ASH-1229	83209	89414	AT-766	83209	89414
16-16874-000	83160		9U9Z-18125-A	83122	89406	ASH-1230	83122	89406	F4-BE5-C832-MO	83124	89407
16-18103-000	85900		ASH-1022	83209	89414	ASH-137	83122	89406			
1C34-18045-AA	83209	89414	ASH-1023	83122	89406	ASH-25822	83209	89414			
1C34-18045-JA	83209	89414	ASH-1136	83178		ASH-25823	83209	89414			

FREIGHTLINER

O.E.M #	Gabriel	Upgrade	O.E.M #	Gabriel	Upgrade	O.E.M #	Gabriel	Upgrade	O.E.M #	Gabriel	Upgrade
10-12030-002	85320	89429	10-13684-000	85918	89449	16-15770-000	85956		471700000449	85918	89449
10-12032-000	85320	89429	10-13759-000	85006		16-15817-000	85724	89443	471700000470	85918	89449
10-12032-001	85320	89429	10-13760-000	85959	89503	16-16442-000	83134		471700002808	85724	89443
10-12032-002	85320	89429	10-13776-000	85005	89430	16-16486-000	83134		471700002809	85724	89443
10-12032-003	85320	89429	10-13809-000	85958		16-16577-000	85335		471700002990	85007	89412
10-12032-004	85320	89429	10-13859-000	85005	89430	16-16765-000	85006		471700002991	85959	89503
10-12046-000	85320	89429	10-13934-000	85123		16-16826-000	85904		471700002992	85331	
10-12388-000	85920	89503	16-10688-000	85042		16-17211-000	85909		471700002993	85921	
10-12390-000	85920	89503	16-11133-000	85007	89412	16-17759-000	85919		471700002994	83134	
10-12396-000	85918	89449	16-12117-000	85007	89412	16-18705-000	85007	89412	471700002995	83134	
10-12542-000	85901		16-13947-000	85319	89428	16-18706-000	85331		471700002996	85335	
10-12594-000	85984		16-13957-000	85724	89443	16-18707-000	85921		471700003009	85006	
10-12703-000	85918	89449	16-14259-000	85331		16-18708-000	85724	89443	471700003920	85958	
10-13021-000	85918	89449	16-14577-000	85043		16-18709-000	83134		471700006269	85932	89453
10-13051-001	85005	89430	16-14667-000	85005	89430	16-18710-000	83134		471700006929	85123	
10-13063-000	85918	89449	16-14668-000	83127		16-18711-000	85335		471700131155	85918	89449
10-13205-000	85918	89449	16-14669-000	G63403		16-19138-000	85058	89431			
10-13211-000	85918	89449	16-14759-000	85000	89436	3638112	G63183				
10-13592-000	85959	89503	16-15591-000	85043		4036892	G63605				
10-13634-000	85918	89449	16-15765-000	85921		471700000440	85959	89503			

Important Note: Competitive Interchanges are to be used for stocking purposes only. Where multiple crosses are identified, please reference the applications section of this catalog.

COMPETITIVE & O.E.M. INTERCHANGE LIST

FREIGHTLINER... cont'd

O.E.M #	Gabriel	Upgrade	O.E.M #	Gabriel	Upgrade	O.E.M #	Gabriel	Upgrade	O.E.M #	Gabriel	Upgrade
471700131331	85932	89453	650224	83225		680008	85300	89419	6813260200	85011	
471700131646	85918	89449	651352	85042		680009	85302	89420	70029	85308	89422
47902-13	83122	89406	654654	85043		680017	85302	89420	70042	85302	89420
481700006848	85724	89443	654875	83117		6803230200	85043		90044162	83128	89436
481700125969	85956		654918	83118		6803230300	85006		90045083	85910	
535228	85302	89420	659060	85920	89503	6803260000	83120		GBL654725	83120	
58913-003	85932	89453	659062	83134		680339	85724	89443	GBL665538	85006	
58913-003L	85932	89453	659063	83134		680442	85319	89428	H60680004	83143	
58913-012	85932	89453	659300	85005	89430	680511	85331		H60680005	83142	
58913-012L	85932	89453	660235	85042		680611	85724	89443	SDA471400003920	85958	
60680-004	83143		665174	85060		680651	85335		SDA471700000440	85959	89503
60680-004L	83143		665236	85007	89412	680782	85302	89420	SDA471700002809	85724	89443
60680-005	83142		665409	85009		681-323-0900	85009		SDA471700002991	85959	89503
60680-005L	83142		671908	85918	89449	681-323-1100	85301		SDA481700125969	85956	
61300224	85918	89449	671945	85920	89503	681-326-0400	85319	89428			
61300240	85918	89449	671946	85921		6813230900	85009				

FREIGHTLINER CAB SHOCKS

O.E.M #	Gabriel	Upgrade	O.E.M #	Gabriel	Upgrade	O.E.M #	Gabriel	Upgrade	O.E.M #	Gabriel	Upgrade
1201-0012	83023		18-31476-000	83020		18-60765-001	83047		659080	83039	
1201-0054	83021		18-32999-000	83001		18-60765-002	83038		659125	83047	
1201-1043	83025		18-32999-001	83006		18-60766-000	83040		659178	83038	
1201-1044	83025		18-37813-000	83044		18-60767-000	83039		659288	83006	
1202-0012	83023		18-41762-000	83038		18-60768-000	83057		681-891-02-05	83017	
1202-0032	83016		18-41762-001	83047		18-60769-000	83009		814903003482	83040	
1202-0042	83025		18-41762-002	83038		18-60772-000	83026		814903003483	83039	
1202-0043	83032		18-42613-000	83033		18-60773-000	83027		814903003484	83057	
1202-0044	83025		18-43504-000	83057		18-67845-000	83906		814903003486	83047	
1202-0054	83021		18-44321-000	83009		18-69674-000	83906		814903003496	83009	
1202-1043	83025		18-45067-000	83034		654739	83009		814903003528	83038	
1202-1044	83025		18-47349-000	83039		654819	83001		814903012666	83906	
18-29846-000	83009		18-47350-000	83040		654831	83006		814903015188	83906	
18-29846-001	83064		18-60295-000	83006		654841	83020		GBL 650361	83017	
18-30378	83006		18-60764-000	83038		654990	83038				
18-30378-000	83001		18-60765-000	83038		659079	83040				

FREIGHTLINER CUSTOM CHASSIS

O.E.M #	Gabriel	Upgrade	O.E.M #	Gabriel	Upgrade	O.E.M #	Gabriel	Upgrade	O.E.M #	Gabriel	Upgrade
10-13211-000	85918	89449	16-15676-000	85058	89431	16-17361-000	85900		471700003009	85006	
10-13358-000	85097		16-15705-000	83120		16-17684-000	85058	89431	471700003011	85058	89431
10-13634-000	85918	89449	16-15755-000	85043		16-17759-000	85919		471700003070	85122	
10-13759-000	85006		16-15805-000	83120		16-17760-000	85331		471700005079	85005	89430
10-13859-000	85005	89430	16-15817-000	85724	89443	16-18075-000	83174		471700131775	85006	
1398980	83127		16-15934-000	83120		16-18076-000	83160		471700131778	85331	
141700000377	83174		16-16043-000	85043		16-18094-000	85959		471700131974	85029	
141700000378	83160		16-16082-000	85043		16-18095-000	85092		481700000477	85900	
141700131809	85029		16-16083-000	85331		16-18103-000	85900		481700000493	85900	
141700131810	83160		16-16093-000	83160		16-18455-000	85918	89449	481700131919	85900	
141700131975	83160		16-16262-000	83120		16-18456-000	85959		654918	83118	
16-14794-000	83154		16-16542-000	83154		16-18708-000	85724	89443	654953	85058	89431
16-15064-000	83154		16-16736-000	85029		16-18713-000	85122		659104	85097	
16-15089-000	83164		16-16737-000	83160		16-19138-000	85058	89431	659227	85058	89431
16-15394-000	83120		16-16765-000	85006		1745500		89430	665545401		89430
16-15436-000	83154		16-16827-000	85331		471700000447	85919		6803230300	85006	
16-15473-000	83157		16-16836-000	83154		471700000466	85959		6803260000	83120	
16-15474-000	83157		16-16873-000	85029		471700000467	85092		GBL 651375	83119	
16-15475-000	83164		16-16874-000	83160		471700002726	85918	89449	GBL 654870	83116	
16-15592-000	83154		16-17144-000	85900		471700002727	85959		GBL654725	83120	

Important Note: Competitive Interchanges are to be used for stocking purposes only. Where multiple crosses are identified, please reference the applications section of this catalog.

COMPETITIVE & O.E.M. INTERCHANGE LIST

FREIGHTLINER CUSTOM CHASSIS... cont'd

O.E.M #	Gabriel	Upgrade	O.E.M #	Gabriel	Upgrade	O.E.M #	Gabriel	Upgrade	O.E.M #	Gabriel	Upgrade
GBL654875	83117		MAE 16949	83120		P116168	83117		P117253	83116	
GBL654918	83118		MAE 16950	83118		P117099	83120		RW24285	83119	
GBL665538	85006		MAE16950	83118		P117146	83118				

FRUEHAUF

O.E.M #	Gabriel	Upgrade	O.E.M #	Gabriel	Upgrade	O.E.M #	Gabriel	Upgrade	O.E.M #	Gabriel	Upgrade
144-5910	85300	89419	UCA-01113	85304		UCE-1295-901	85300	89419	UCF-8339-001	85321	
5116-117	83122	89406	UCA-5431	85305		UCE-2983-000	85322		UCF-8339-002	85321	
5352858	85305		UCD-006216-001	83203	89436	UCE-2983-001	85322		UEY 1124-001	85030	89440
680117	85300	89419	UCD-6216-1	83203	89436	UCE-2983-1	85322				
680298	85321		UCE-1295-1	85300	89419	UCE-9399-1	83122	89406			

FWD TRUCK

O.E.M #	Gabriel	Upgrade	O.E.M #	Gabriel	Upgrade	O.E.M #	Gabriel	Upgrade	O.E.M #	Gabriel	Upgrade
450739	85302	89420									

GENERAL TRAILER CO

O.E.M #	Gabriel	Upgrade	O.E.M #	Gabriel	Upgrade	O.E.M #	Gabriel	Upgrade	O.E.M #	Gabriel	Upgrade
120-1	83125		12608	83125							

GEORGIE BOY MANUFACTURING

O.E.M #	Gabriel	Upgrade	O.E.M #	Gabriel	Upgrade	O.E.M #	Gabriel	Upgrade	O.E.M #	Gabriel	Upgrade
1C34-18045-AA	83209	89414	ASH-1022	83209	89414	ASH-1229	83209	89414	AT-620	83209	89414
1C34-18045-JA	83209	89414	ASH-1023	83122	89406	ASH-1230	83122	89406	AT-621	83122	89406
66153-002	83124	89407	ASH-1136	83178		ASH-137	83122	89406	AT-766	83209	89414
9U94-18045-AA	83209	89414	ASH-1154	83177		ASH-25822	83209	89414	F4-BE5-C832-MO	83124	89407
9U94-18080-AA	83122	89406	ASH-1205	83209	89414	ASH-25823	83209	89414			
9U9Z-18124-A	83209	89414	ASH-1206	83122	89406	ASH-25824	83122	89406			
9U9Z-18125-A	83122	89406	ASH-1228	83209	89414	ASH-294	83209	89414			

GILLIG BROS.

O.E.M #	Gabriel	Upgrade	O.E.M #	Gabriel	Upgrade	O.E.M #	Gabriel	Upgrade	O.E.M #	Gabriel	Upgrade
1583470	85051		57113	83219		82-21542-000	85716		90044683	83122	89406
200-171	85304		57131	83216		82-30159-000	85708		90044769	83207	89407
53-02132	85723		665568	85051		90-1908	85723		90044770	83207	89407
53-02133-000	85318		680009	85302	89420	90-1951-SP1	85734		90045084	85968	
53-13952-000	85722		680333	85708		90-1968	85712		90F-1912	85318	
53-14005-000	85723		695109	85723		90-2164 SP1	85723		H53-02132-14005	85723	
53-14010	85318		695110	85318		90-2423	85723		H53-20415-006	85051	
53-176	85304		70034	85302	89420	90-2627		89461	MR6394	85723	
53-24685	85723		82-01878	83122	89406	90044046	83123	89405			

GLAVAL BUS CO.

O.E.M #	Gabriel	Upgrade	O.E.M #	Gabriel	Upgrade	O.E.M #	Gabriel	Upgrade	O.E.M #	Gabriel	Upgrade
3578858C1	85926		4C4Z-18124-JB	85928		AA-617	85928		FC44-18045-BB	85181	
3578858C2	85926		4C4Z-18124-QA	83175		ASH-1136	83178		FC44-18080-AB	85180	
3584116C1	83175		4C4Z-18124-RA	85928		ASH-1154	83177		FC4Z-18124-A	85181	
3584116C2	83175		4C4Z-18125-B	83317		ASH-24658	85181		FC4Z-18124-B	85181	
3584118C2	85928		4C4Z-18125-DA	85926		ASH-24659	85181		FC4Z-18125-A	85180	
471700011530	85181		501906C92	83317		ASH-24660	85180				
471700011531	85180		AA-616	83175		AT-812	85928				

GMC TRUCK

O.E.M #	Gabriel	Upgrade	O.E.M #	Gabriel	Upgrade	O.E.M #	Gabriel	Upgrade	O.E.M #	Gabriel	Upgrade
1-51630-168-1	83515		15174903	85342		21998392	85336		22007753	83303	
1-51630-217-0	83114		15185643	83153		22002293	83126	89430	22007757	83304	
1-51630-217-1	83114		15185644	83155		22002294	83304		22012065	85304	
1-51630-219-1	83114		15588554	83136		22002295	83303		22012067	85700	
12474915	83122	89406	15642943	83136		22007701	83126	89430	22012082	85702	
12474917	83137		15740554	83137		22007702	83304		22012083	85711	
15123676	83136		15887728	83136		22007703	83303				
15174898	83136		1591501	85722		22007750	83207	89407			
15174901	85342		15963161	83122	89406	22007751	83303				
15174902	85071		19152843	83136		22007752	83304				

Important Note: Competitive Interchanges are to be used for stocking purposes only. Where multiple crosses are identified, please reference the applications section of this catalog.

COMPETITIVE & O.E.M. INTERCHANGE LIST

GMC TRUCK... cont'd

O.E.M #	Gabriel	Upgrade	O.E.M #	Gabriel	Upgrade	O.E.M #	Gabriel	Upgrade	O.E.M #	Gabriel	Upgrade
22012083GS	85711		3182842	85711		507-23	85342		5544716	85304	
22012090	85308	89422	3188599	85711		507-24	85336		5544717	85304	
22012091	85303	89422	3188626	85300	89419	508-88	83153		5544812	83308	
22012095	83126	89430	3188729	85303	89422	508-89	83155		5544818	85735	
22012096	83221		3189265	85700		5171068	83216		5549899	83207	89407
22012114	85700		3192333	85700		5304059	85700		5549924	85700	
22012131	85711		3192416	85711		5316784	85700		5549925	85304	
22012166	83126	89430	3192657	83216		5316791	83219		5552111	85304	
22012169	83221		3192890	83126	89430	5316792	85305		5552112	85307	
22012196	83221		3192891	83221		5316793	85305		5552114	83216	
22017530	83303		3192892	83221		5316794	85700		5552205	83217	
22017531	83303		35901-0001	83209	89414	5316984	85313		5552206	83214	
22024061	85704		35901-0003	85301		5321920	85307		5552207	83217	
22024673	85710		35901-0004	83219		5321929	85307		5552208	83217	
22025067	85704		35901-0005	83219		5348631	83203	89436	5552209	83215	
22025305	85704		35901-0017	83314		5352857	85700		5552210	85308	89422
22045526	85702		37301-0016	85026	89417	5352858	85305		5552244	85308	89422
22046481	85702		37301-0021	85026	89417	5353054	85303	89422	5552285	83214	
22046483	85304		37301-3202	85026	89417	5355798	85307		5552286	83217	
22046485	85710		4939852	85308	89422	5357955	85300	89419	5552287	83217	
22046489	85303	89422	4939967	85308	89422	5357956	85734		5552288	83217	
22046499	85710		4940600	83209	89414	5357959	85300	89419	5552451	85308	89422
22052014	85702		4940601	83216		5361994	85734		5552452	85303	89422
22052336	85304		4940606	83126	89430	5374779	85308	89422	5552453	85301	
22052424	85710		4940614	83216		5374999	85307		5552454	85302	89420
22064230	83136		4940627	83203	89436	5385939	85307		5552456	85307	
22064231	85324		4940640	83216		5392387	85303	89422	5552527	85735	
22064232	85071		4940650	83207	89407	5394448	85305		5554184	85302	89420
22064233	83136		4940654	83216		5394467	85305		5554589	85307	
22064432	85050		4940660	83207	89407	5394468	85735		5554596	85303	89422
22064489	85336		4940662	83126	89430	5455798	85307		5554814	85302	89420
22064804	83136		4963844	85307		5513489	83216		5554959	83401	
22064805	83136		4963853	83216		5513716	85304		5554995	85305	
22064806	83136		4963854	83216		5516459	85305		5559363	83203	89436
22064807	83136		4964853	83217		5522781	85735		5585939	85307	
22065218	G63347		4974401	85700		5522794	85308	89422	684280	83209	89414
22065251	85030	89440	4975429	85300	89419	5522818	85305		8-51630-666-0	85012	89413
22099889	85336		4975467	83207	89407	5527001	85300	89419	8-94057-593-0	83114	
2212169	83221		4975472	83161		5527271	85700		8-94454-986-0	83515	
22165187	83136		4975479	83400		5527272	85700		8-94454-987-0	83515	
22165188	83136		4975480	83400		5527606	85305		8-97083-029-0	83515	
22165189	83136		4975494	83207	89407	5531027	85301		8-97201-960-0	83515	
22166442	83136		4975497	83126	89430	5531435	85307		8-97253-620-0	83515	
3082284	83400		4975501	85700		5531436	85307		8-97253664-0	83159	
3166657	85700		4975510	83221		5531437	85307		8-97253665-0	83159	
3171068	83216		4975511	83303		5532026	85304		87-2520-00003	85704	
3171069	85304		4975516	85702		5532425	83207	89407	88963409	85336	
3171462	83126	89430	4975518	85704		5532433	83207	89407	88982682	83136	
3171696	85307		4975538	85700		5532675	85307		88982684	83136	
3172948	85303	89422	4975549	83216		5533699	85302	89420	88982685	85342	
3175509	85735		4975550	85702		5534430	85303	89422	88982686	85071	
3178106	85700		4975552	85711		5534439	85304		88982687	85342	
3178157	85700		4984526	83216		5534447	85303	89422	88982688	85336	
3178233	85734		507-16	85702		5544060	85302	89420	898098-0580	83159	
3178507	85700		507-19	85700		5544112	83216		898098-0581	83159	
3178995	85700		507-22	85342		5544581	85302	89420	898098-0590	83159	

Important Note: Competitive Interchanges are to be used for stocking purposes only. Where multiple crosses are identified, please reference the applications section of this catalog.

COMPETITIVE & O.E.M. INTERCHANGE LIST

GMC TRUCK... cont'd

O.E.M #	Gabriel	Upgrade	O.E.M #	Gabriel	Upgrade	O.E.M #	Gabriel	Upgrade	O.E.M #	Gabriel	Upgrade
898098-1250	83515		94051090	83114		97201960	83515		98098058	83159	
898098-1270	83515		94057593	83114		97253616	83515		98098059	83159	
9-51630-647-1	83515		94454987	83515		97253620	83515		98098125	83515	
9-51630-666-0	85012	89413	97-2210-00156	85702		97253621	83515		98098127	83515	
9-51630-666-2	85012	89413	97-2210-00164	85708		97253623	83515		98232671	83515	
90044769	83207	89407	97-2210-00170	85733		97253651	83404		L-12706	83155	
90044770	83207	89407	97083027	83515		97253664	83159		U0109-014	83400	
94033786	83114		97083029	83515		97253665	83159				

GMC TRUCK CAB SHOCKS

O.E.M #	Gabriel	Upgrade	O.E.M #	Gabriel	Upgrade	O.E.M #	Gabriel	Upgrade	O.E.M #	Gabriel	Upgrade
1201-1043	83025		1202-0032	83016		1202-1043	83025				
1202-0012	83023		1202-0054	83021							

GOSHEN COACH

O.E.M #	Gabriel	Upgrade	O.E.M #	Gabriel	Upgrade	O.E.M #	Gabriel	Upgrade	O.E.M #	Gabriel	Upgrade
ASH-1136	83178		ASH-1154	83177							

GRANNING SUSPENSION

O.E.M #	Gabriel	Upgrade	O.E.M #	Gabriel	Upgrade	O.E.M #	Gabriel	Upgrade	O.E.M #	Gabriel	Upgrade
1085	83214		680162	85300	89419	OE12425	83214				
2697	85712		701071-01	646155							

GREAT DANE TRAILER

O.E.M #	Gabriel	Upgrade	O.E.M #	Gabriel	Upgrade	O.E.M #	Gabriel	Upgrade	O.E.M #	Gabriel	Upgrade
18163-01	83207	89407	HENS-20002	85000	89436	HENS-23649	85064		REY18165-01	85006	
18164-01	83122	89406	HENS-20126	85323	89436	HENS-24088	83128	89436			
18165-01	85006		HENS-21292	85052		HENS-24088	85000	89436			
HENS-20001	83128	89436	HENS-23566	85000	89436	MER202447	85919				

GRECH MOTORS

O.E.M #	Gabriel	Upgrade	O.E.M #	Gabriel	Upgrade	O.E.M #	Gabriel	Upgrade	O.E.M #	Gabriel	Upgrade
ASH-1136	83178		ASH-1154	83177							

GREYHOUND BUS

O.E.M #	Gabriel	Upgrade	O.E.M #	Gabriel	Upgrade	O.E.M #	Gabriel	Upgrade	O.E.M #	Gabriel	Upgrade
12B-5-1	85735		3166657	85700		3178157	85700		690029	85700	
12TA-01-013	85303	89422	3178154	85735		3192333	85700		74413	85313	

GRUMMAN BUS

O.E.M #	Gabriel	Upgrade	O.E.M #	Gabriel	Upgrade	O.E.M #	Gabriel	Upgrade	O.E.M #	Gabriel	Upgrade
22024506	85703		690029	85700		97-2201-00004	85703		97-2210-00003	85704	
22025066	85703		97-2201-00001	85703		97-2201-00005	85703		97-2210-00004	85704	
22025067	85704		97-2201-00002	85703		97-2210-00001	85704		97-2210-00005	85704	
22025305	85704		97-2201-00003	85703		97-2210-00002	85704				

GULF STREAM COACH

O.E.M #	Gabriel	Upgrade	O.E.M #	Gabriel	Upgrade	O.E.M #	Gabriel	Upgrade	O.E.M #	Gabriel	Upgrade
141700131809	85029		16-16737-000	83160		16-18103-000	85900		ASH-1154	83177	
141700131810	83160		16-16873-000	85029		481700000493	85900				
16-16736-000	85029		16-16874-000	83160		ASH-1136	83178				

HARDEE MFG

O.E.M #	Gabriel	Upgrade	O.E.M #	Gabriel	Upgrade	O.E.M #	Gabriel	Upgrade	O.E.M #	Gabriel	Upgrade
8030223	83207	89407	AS789B	85014							

HAUSMAN

O.E.M #	Gabriel	Upgrade	O.E.M #	Gabriel	Upgrade	O.E.M #	Gabriel	Upgrade	O.E.M #	Gabriel	Upgrade
695110	85318		695119	85702		695198	85706				

HENDRICKSON TRAILER SUSPENSION SYSTEMS

O.E.M #	Gabriel	Upgrade	O.E.M #	Gabriel	Upgrade	O.E.M #	Gabriel	Upgrade	O.E.M #	Gabriel	Upgrade
57905-2	85006		665246	85043		665532	85013	89414	665698	85911	
60675-004	85006		665267	85029		665533	85005	89430	665733	85045	
654951	85000	89436	665405	85030	89440	665536	85000	89436	665756	85000	89436
659024	85052		665406	85010		665693	85064		665758	85064	
665190	85006		665531	85000	89436	665694	85052		665759	85052	

Important Note: Competitive Interchanges are to be used for stocking purposes only. Where multiple crosses are identified, please reference the applications section of this catalog.

COMPETITIVE & O.E.M. INTERCHANGE LIST

HENDRICKSON TRAILER SUSPENSION SYSTEMS... cont'd

O.E.M #	Gabriel	Upgrade	O.E.M #	Gabriel	Upgrade	O.E.M #	Gabriel	Upgrade	O.E.M #	Gabriel	Upgrade
665760	85045		A-20887	85005	89430	B-23744	85344		S-22312	85939	
665761	85911		A-20889	85323	89436	B-24023	85738		S-2232	85005	89430
665763	85079		A-21292	85052		B-24088	83128	89436	S-22345	85911	
665764	85029		A-2160	85014		B-24088	85000	89436	S-2240	85013	89414
665765	83150		A-2212	85029		B-24125	85323	89436	S-22715	85000	89436
665766	85000	89436	A-2213	85010		B-24579	85939		S-22862	85045	
665767	85045		A-2218	85030	89440	B-25174	85029		S-23013	85000	89436
671779		89414	A-2230	85005	89430	B-25436	85916	89430	S-23014	85738	
671948	85000	89436	A-2232	85005	89430	B-25437	85337		S-23290	83150	
680102	85712		A-2240	85013	89414	B-25515	85338		S-23315	85029	
680341	85323	89436	A-2240-1	85043		B-26652	85000	89436	S-23316	85382	
680463		89440	A-2471	85006		B-27058	83128	89436	S-23361	85911	
680467	85323	89436	A-4084	85005	89430	B-27747	85911		S-23362		89437
680509	85738		A-4089	83209	89414	B-29432	85323	89436	S-23548	85079	
680565	85738		A-4890	85712		B-29678	85911		S-23566	85000	89436
680566	85938		A-6156	85301		B-29826	85338		S-23649	85064	
680568	85323	89436	B-20345	85345		B-33312	85338		S-23650	85052	
680570		89437	B-21553	85738		B-33313	85338		S-23651	85045	
680571	85738		B-21699	87018		NS500699	85005	89430	S-23743	85938	
680573	85939		B-21832	85323	89436	S-10348	85043		S-23744	85344	
680579	85939		B-21936	85064		S-14583	85000	89436	S-24023	85738	
680614	85338		B-21947	85052		S-1667	85000	89436	S-24088	83128	89436
680616		89430	B-21994	85938		S-1668	85000	89436	S-24088	85000	89436
680617	85337		B-21995	85344		S-20001	83128	89436	S-24125	85323	89436
680702	85323	89436	B-22311	85045		S-20002	85000	89436	S-24579	85939	
680756	85323	89436	B-22312	85939		S-20126	85323	89436	S-2471	85006	
680769	85911		B-22345	85911		S-20345	85345		S-25436	85916	89430
680776	85338		B-22715	85000	89436	S-20886	85030	89440	S-25437	85337	
98583-019	85323	89436	B-22862	85045		S-20887	85005	89430	S-25515	85338	
98583-020		89414	B-23013	85000	89436	S-20889	85323	89436	S-26652	85000	89436
A-10023	85000	89436	B-23014	85738		S-21292	85052		S-29432	85323	89436
A-10348	85043		B-23290	83150		S-21553	85738		S-29678	85911	
A-11931	85000	89436	B-23315	85029		S-2160	85014		S-29826	85338	
A-14496	646155		B-23316	85382		S-21699	87018		S-33312	85338	
A-14583	85000	89436	B-23361	85911		S-21832	85323	89436	S-33313	85338	
A-1667	85000	89436	B-23362		89437	S-21936	85064		S-33313L	85338	
A-1668	85000	89436	B-23548	85079		S-21947	85052		S-4084	85005	89430
A-20001	83128	89436	B-23566	85000	89436	S-2212	85029		S-4089	83209	89414
A-20002	85000	89436	B-23649	85064		S-2213	85010		S-4890	85712	
A-20126	85323	89436	B-23650	85052		S-2218	85030	89440			
A-20345	85345		B-23651	85045		S-2230	85005	89430			
A-20886	85030	89440	B-23743	85938		S-22311	85045				

HENDRICKSON TRUCK SUSPENSION SYSTEMS

O.E.M #	Gabriel	Upgrade	O.E.M #	Gabriel	Upgrade	O.E.M #	Gabriel	Upgrade	O.E.M #	Gabriel	Upgrade
12738	83225		47902-25	83125		57241-004	83110		58913-007	85959	
471700000456	85959		47902-26	83144		57241-006	83111		58913-007L	85959	
471700006269	85932	89453	47902-27	83123	89405	57241-006L	83111		58913-008	85959	
471700131545	85006		47902-28	85013	89414	57324-1	85036	89405	58913-008L	85959	
47902-11	83207	89407	47902-29	83149		57324-11	85305		58913-009	85959	
47902-13	83122	89406	47902-3	85005	89430	57324-2	85976		58913-009L	85959	
47902-15	83137		47902-8	83122	89406	57324-3	85916	89430	58913-011	85959	
47902-18	85030	89440	47902-9	83123	89405	57324-5	85903		58913-011L	85959	
47902-19	83123	89405	503610C2	83207	89407	57324-6	85904		58913-012	85932	89453
47902-20	85036	89405	5554596	85303	89422	57905-1	85976				
47902-21	85976		57241-001	83111		58623-1	85978				
47902-22	85916	89430	57241-002	83109		58913-003	85932	89453			
47902-24	83137		57241-003	83112		58913-003L	85932	89453			

Important Note: Competitive Interchanges are to be used for stocking purposes only. Where multiple crosses are identified, please reference the applications section of this catalog.

COMPETITIVE & O.E.M. INTERCHANGE LIST

HENDRICKSON TRUCK SUSPENSION SYSTEMS... cont'd

O.E.M #	Gabriel	Upgrade	O.E.M #	Gabriel	Upgrade	O.E.M #	Gabriel	Upgrade	O.E.M #	Gabriel	Upgrade
58913-012L	85932	89453	60670-004	83123	89405	60680-004L	83143		65992-002L	85955	
59048-001	83148		60670-005	83137		60680-005	83142		65992-003	85959	
59057-001	83137		60670-006	83147		60680-005L	83142		65992-006	85986	
59057-002	85036	89405	60670-006L	83147		60680-009	85083		665816	85072	
59305-1	85979		60670-007	83144		60680-012	85083		665892	85072	
59483-000	85919		60670-007L	83144		60680-012L	85083		671006	85036	89405
59851-1	85976		60670-008	83123	89405	60685-001	85977		671007	83137	
59852-1	85977		60670-008L	83123	89405	60998-001	85006		671009	85919	
59852-2	85977		60670-009	85013	89414	60998-002	85919		671030	85083	
60657-003	85072		60670-010	83149		60998-002L	85919		671063	85083	
60657-003L	85072		60670-011	83148		60998-003	85006		671105	85072	
60657-005	85087		60670-012	83168		64838-001	85933	89454	671603	85919	
60657-005L	85087		60670-013	83148		64838-001L	85933	89454	671606	85955	
60657-006	85102		60670-014	83166		64838-002	85933	89454	671611	85955	
60657-007	85072		60670-017	83148		64838-002L	85933	89454	671704	85904	
60657-010	85102		60670-018	83166		64838-003	85933	89454	671764	85967	
60657-011	85102		60670-019	83166		64838-003L	85933	89454	671792	85965	
60665-003	83137		60670-020	83148		654890	83207	89407	671793	85966	
60665-004	85036	89405	60670-12	83168		654891	83149		671798	85962	
60665-004L	85036	89405	60675-001	85978		654894	83123	89405	672009	85903	
60665-005	85919		60675-001L	85978		654895	83137		680091	85303	89422
60665-005L	85919		60675-002	85979		654896	83147		680600	85305	
60665-008	85978		60675-002L	85979		654897	83144		70018	85303	89422
60665-009	85904		60675-003	85976		654898	83123	89405	70021	85303	89422
60665-011	85967		60675-003L	85976		654899	85013	89414	70088	85307	
60665-013	85965		60675-005	85980		654900	83148		98583-005	83168	
60665-014	85962		60675-005L	85980		654903	83111		98583-006	83148	
60665-015	85966		60675-006	85909		654904	83109		98583-016	83147	
60665-018	85961		60675-006L	85909		654905	83112		98583-032	85072	
60665-018L	85961		60675-014	85978		659000	83148		A-14496	646155	
60665-020	85919		60675-12	85638		659004	83123	89405	AE76164-3	85307	
60665-024	85903		60675-8Q	85976		659048	83143		AE76164-4	83225	
60665-025	85036	89405	60680-001	83111		659049	83142		BE76164-2	85303	89422
60665-025L	85036	89405	60680-001L	83111		659155	83147		BE76164-3	85307	
60670-001	83123	89405	60680-002	83109		659202	83148		BE76164-4	83225	
60670-002	83207	89407	60680-003	83112		659292	83148				
60670-002L	83207	89407	60680-003L	83112		65992-001	85955				
60670-003	83149		60680-004	83143		65992-002	85955				

HIGHWAY PRODUCT

O.E.M #	Gabriel	Upgrade	O.E.M #	Gabriel	Upgrade	O.E.M #	Gabriel	Upgrade	O.E.M #	Gabriel	Upgrade
A1-6-134	83207	89407	A1-6-135	83203	89436						

HINO

O.E.M #	Gabriel	Upgrade	O.E.M #	Gabriel	Upgrade	O.E.M #	Gabriel	Upgrade	O.E.M #	Gabriel	Upgrade
34802	83216		48511-37320	83518		48530-2510	83216		66639	G63610	
48500-1800	83216		48511-80162	83518		48530-3280	G63440		S4850-01941	83141	
48500-1801	83216		48530-1120	83104		48530E0100	83166		S4850-01950	G63610	
48500-1940	83141		48530-1460	83215		48531-37361	83519		S4850-02750	G63610	
48500-1941	83141		48530-1620	83104		48531-37362	83519		S4850-03710	83126	89430
48500-1950	G63610		48530-1770	83215		60670-012	83168		S4850-03720	83140	
48500-2750	G63610		48530-1880	83362		60670-013	83148		S4853-01900	83104	
48500-3710	83126	89430	48530-1890	83104		60670-014	83166		S4853-01910	83216	
48500-3720	83140		48530-1900	83104		60670-018	83166		S4853-02510	83216	
48500-E0420	83391		48530-1910	83216		60670-019	83166		S4853-03280	G63440	
485003710A	83126	89430	48530-2050	83217		60670-020	83148				

Important Note: Competitive Interchanges are to be used for stocking purposes only. Where multiple crosses are identified, please reference the applications section of this catalog.

COMPETITIVE & O.E.M. INTERCHANGE LIST

HOBBBS TRAILERS

O.E.M #	Gabriel	Upgrade	O.E.M #	Gabriel	Upgrade	O.E.M #	Gabriel	Upgrade	O.E.M #	Gabriel	Upgrade
680117	85300	89419									

HOLIDAY RAMBLER

O.E.M #	Gabriel	Upgrade	O.E.M #	Gabriel	Upgrade	O.E.M #	Gabriel	Upgrade	O.E.M #	Gabriel	Upgrade
1C34-18045-AA	83209	89414	9U9Z-18125-A	83122	89406	ASH-137	83122	89406	F4-BE5-B492-HO	85125	
1C34-18045-JA	83209	89414	ASH-1022	83209	89414	ASH-25822	83209	89414	F4-BE5-F324-HO	85125	
24-153249	85125		ASH-1023	83122	89406	ASH-25823	83209	89414	F4-BE5-F325-HO	85124	
24-153256	85124		ASH-1136	83178		ASH-25824	83122	89406	U0109-007	G63183	
24-186537	85126		ASH-1154	83177		ASH-294	83209	89414	W0005662	85125	
24-186629	85125		ASH-1205	83209	89414	AT-620	83209	89414	W0005663	85124	
90044794	83127		ASH-1206	83122	89406	AT-621	83122	89406	W0006254	85125	
9U94-18045-AA	83209	89414	ASH-1228	83209	89414	AT-766	83209	89414			
9U94-18080-AA	83122	89406	ASH-1229	83209	89414	F4-BE5-A011-HO	85126				
9U9Z-18124-A	83209	89414	ASH-1230	83122	89406	F4-BE5-A832-MO	85125				

HOLLAND - BINKLEY

O.E.M #	Gabriel	Upgrade	O.E.M #	Gabriel	Upgrade	O.E.M #	Gabriel	Upgrade	O.E.M #	Gabriel	Upgrade
680298	85321		6898	83125							

HUTCHENS SUSPENSION

O.E.M #	Gabriel	Upgrade	O.E.M #	Gabriel	Upgrade	O.E.M #	Gabriel	Upgrade	O.E.M #	Gabriel	Upgrade
9423-00	83203	89436									

HYSTER

O.E.M #	Gabriel	Upgrade	O.E.M #	Gabriel	Upgrade	O.E.M #	Gabriel	Upgrade	O.E.M #	Gabriel	Upgrade
650150	83217		73516	83217							

IC CORPORATION

O.E.M #	Gabriel	Upgrade	O.E.M #	Gabriel	Upgrade	O.E.M #	Gabriel	Upgrade	O.E.M #	Gabriel	Upgrade
1660846C92	83101		3578858C2	85926		3902993C3	83135		65992-006	85986	
1675455C1	85003	89411	3601600C3	85082		472412C91	83456	89447	H65992-006	85986	
2018987C1	85003	89411	3604282C1	85351		501553C91	85003	89411	OE13402S	83163	
2200327C1	85332		3605735C1	83156		501906C91	83317		OE13424S	83317	
3533356C3	83169		3605735C2	83156		501906C92	83317				
3578105C1	83163		3902993C1	83135		537524C91	83123	89405			
3578105C2	83163		3902993C2	83135		6127088C1	83163				

INGERSALL MACHINE

O.E.M #	Gabriel	Upgrade	O.E.M #	Gabriel	Upgrade	O.E.M #	Gabriel	Upgrade	O.E.M #	Gabriel	Upgrade
665472	665472		665904	665472							

INGERSOLL AXLES

O.E.M #	Gabriel	Upgrade	O.E.M #	Gabriel	Upgrade	O.E.M #	Gabriel	Upgrade	O.E.M #	Gabriel	Upgrade
653511-01	85323	89436	653511-02	85938		653511-03	85045		653511-04	85052	

INTERNATIONAL (NAVISTAR)

O.E.M #	Gabriel	Upgrade	O.E.M #	Gabriel	Upgrade	O.E.M #	Gabriel	Upgrade	O.E.M #	Gabriel	Upgrade
1660846C91	83101		2039549C1	85333		288920C91	83225		320444C91	85012	89413
1660846C92	83101		2039565C1	83100		288921C91	83225		329316C92	85012	89413
1663471C1	83103		204994R91	83225		288921R92	83225		350425C1	85300	89419
1663606C91	85027	89418	206620R91	83216		293009C91	85308	89422	350426C1	85734	
1664149C1	85029		206621R91	83216		294334C91	83216		350426C91	85734	
1664524C1	85935		206621R92	83216		3000070C91	83456	89447	3514952C1	85976	
1664788C2	85316	89426	208664C91	85307		3000098C1	83317		3533356C1	83135	
1667520C1	85058	89431	210533R91	83225		306444C91	85012	89413	3533356C2	83135	
1675455C1	85003	89411	210534R92	83225		3085640C92	83216		3533356C3	83169	
1677707C1	85030	89440	210535R91	83225		308646C91	85012	89413	3533357C1	85957	
1690035C1	85003	89411	210536R91	83225		308648C91	83225		3533357C2	85957	
2015556C1	85316	89426	210537R91	83225		308649C91	83216		3533357C3	85957	
2015557C1	85030	89440	210538R91	83225		308650C91	83216		3541456C1	85929	
2018987C1	85003	89411	210918R91	83215		308650C92	83216		3544766C1	85930	
2018987C2	85003	89411	210919R91	85307		308664C91	85307				
2029200C91	83126	89430	210920R91	85308	89422	308668C91	85012	89413			
2029200C91	85030	89440	2200327C1	85332		308668C92	85012	89413			
2032533C1	85316	89426	287318C91	G63306		308669C91	85012	89413			

Important Note: Competitive Interchanges are to be used for stocking purposes only. Where multiple crosses are identified, please reference the applications section of this catalog.

COMPETITIVE & O.E.M. INTERCHANGE LIST

INTERNATIONAL (NAVISTAR)... cont'd

O.E.M #	Gabriel	Upgrade	O.E.M #	Gabriel	Upgrade	O.E.M #	Gabriel	Upgrade	O.E.M #	Gabriel	Upgrade
3544768C1	85926		3601600C2	85082		3885832C2	83135		472414C91	83318	
3549099C1	85923	89458	3601600C3	85082		3892445C3	85931	89458	474002C91	83308	
3549099C2	85923	89458	3604282C1	85351		3902993C1	83167		477132C1	85303	89422
3549099C3	85923	89458	360444C91	85012	89413	3902993C3	83135		47902-24	83137	
3549100C1	85926		3605735C1	83156		3945165C1	83180		4C4Z-18124-N	85957	
3553628C1	85927		3605735C2	83156		3977759C2	85639		4C4Z-18125-DA	85926	
3553628C2	85927		3606770C1	83163		3991991C1	83135		501506C91	83317	
3553628C3	85927		3606770C2	83163		4050340C1	85931	89458	501553C91	85003	89411
3553628C4	85927		3606857C1	85954		4050340C2	85931	89458	501905C91	83301	
3558089C1	85925		3606857C2	85954		4050443C1	85994		501906C91	83317	
3558089C2	85925		3606857C3	85994		4050443C2	85994		501906C92	83317	
3558089C3	85925		3606859C1	85954		4050444C1	85994		503550C1	83207	89407
3558989C1	85925		3606859C2	85954		4050444C2	85994		503610C1	83207	89407
3558989C2	85925		3606859C3	85994		4070336C1	85058	89431	503610C2	83207	89407
3571711C1	85316	89426	3609178C1	85955		426744R91	85303	89422	507202C1	85030	89440
3571713C1	85333		3609400C1	83317		426744R92	85303	89422	534464C1	85734	
3573265C1	85931	89458	3609400C2	83317		446-51-211	85739		537524C91	83123	89405
3576464C1	85957		3610198C1	85963		452566C91	83225		537525C91	83123	89405
3576464C2	85957		3610199C1	85964		453527C91	85311	89424	540395C91	83613	
3576465C2	85999		3613984C1	85955		453528C91	85311	89424	540395C92	83613	
3578105C1	83163		3620395C1	85931	89458	453531C91	G63306		548532C1	83103	
3578105C2	83163		3626571C1	85072		453556C91	85012	89413	56101 Z1030	85311	89424
3578858C1	85926		3660548C1	85955		453557C91	G63306		56101 Z2000	85311	89424
3578858C2	85926		3660549C1	85955		453561C91	83225		56101 Z5008	83114	
3581106C1	85924	89457	3668566C1	85954		453562C91	83225		56101 Z5011	G63610	
3581106C2	85924	89457	3670156C1	85954		453564C91	85012	89413	56110-T8123	G63432	
3581106C3	85924	89457	3674348C1	85954		453565C91	83225		56110-T8129	G63432	
3581107C1	85924	89457	3688614C1	85923	89458	453566C91	83225		57905-001	85976	
3581107C2	85924	89457	3688616C1	85923	89458	453567C91	83216		60675-003	85976	89447
3581107C3	85924	89457	3688729C1	85931	89458	453568C91	83225		596329C1	85014	
3581109C1	85924	89457	3688732C1	85931	89458	453569C91	83225		60657-003	85072	
3581109C3	85924	89457	3737574C1	85954		453570C91	83216		60657-003L	85072	
3581109C4	85924	89457	3737575C1	85954		453571C91	83216		60657-006	85102	
3584116C1	83175		3737576C1	85931	89458	453572C91	83309	89446	60657-010	85102	
3584116C2	83175		3806341C3	85995		453574C91	85307		60657-011	85102	
3584117C1	83135		3806341C4	85995		453575C91	83308		60665-013	85965	
3584117C2	83135		3810581C3	85995		453576C91	85303	89422	60665-015	85966	
3584118C1	85928		3810581C4	85995		453576C92	85303	89422	60670-007	83144	
3584118C2	85928		3812837C1	85954		453577C91	85308	89422	60670-007L	83144	
3584535C1	85924	89457	3813340C1	85964		453579C91	85308	89422	60675-003	85976	
3584535C2	85924	89457	3813340C2	85964		453597C91	83216		60675-003L	85976	
3584535C3	85924	89457	3813340C3	85964		462557C91	85300	89419	60680-003	83112	
3586883C1	85931	89458	3813340C4	85964		462603C91	85705	89447	60680-003L	83112	
3586902C2	83146		3813341C1	85963		462753C91	83216		60680-004	83143	
3586902C3	83364		3813341C2	85963		463926C91	85705	89447	60680-004L	83143	
3588209C1	85957		3813341C3	85963		467371C91	83225		60680-005	83142	
3588209C2	85957		3813341C4	85963		467372C91	83225		60680-005L	83142	
3588591C1	85953		3816234C1	85999		467980C91	G63306		6127086C1	85637	
3588591C2	85953		3819277C1	85969		467983C91	85012	89413	6127087C1	83364	
3588592C1	85953		3819279C1	85969		467984C91	83216		6127088C1	83163	
3588592C2	85953		3821760C1	85931	89458	467985C91	85012	89413	6127096C1	83180	
3596107C1	85927		383379C91	83308		471201C91	85012	89413	6127688C1	83169	
3596107C2	85927		384435C91	83216		471203C91	83308		6127690C1	85923	89458
3596107C3	85927		3868264C1	85998		472367C91	83318		6127700C1	83395	
3596107C4	85927		3868265C1	85998		472411C91	83456	89447	6127705C1	85924	89457
3601600C1	85082		3885832C1	83135		472412C91	83456	89447	6127713C1	85926	

Important Note: Competitive Interchanges are to be used for stocking purposes only. Where multiple crosses are identified, please reference the applications section of this catalog.

COMPETITIVE & O.E.M. INTERCHANGE LIST

INTERNATIONAL (NAVISTAR)... cont'd

O.E.M #	Gabriel	Upgrade	O.E.M #	Gabriel	Upgrade	O.E.M #	Gabriel	Upgrade	O.E.M #	Gabriel	Upgrade
6127714C1	85928		874695R91	85012	89413	AMS650402	85311	89424	H60665015	85966	
65992-001	85955		874695R92	85012	89413	AMS650404	85310	89423	H60675-003	85976	
65992-002	85955		874696R91	85012	89413	AMS650405	85023	89415	H60675003	85976	
65992-002L	85955		90044025	83209	89414	AMS650406	85024		H60680004	83143	
66400	G63432		90044626	83126	89430	AMS650408	85319	89428	H60680005	83142	
6ETZ-18125-A	83146		AMS 600102	85005	89430	AMS650420	85013	89414	OE 18513	83135	
70334	85316	89426	AMS 600172	83126	89430	H60657-003	85072		OE13402S	83163	
790335C91	83209	89414	AMS 600172	85030	89440	H60657-006	85102		OE13424S	83317	
800670	85060		AMS 650420	85013	89414	H60657-010	85102		OE17103	83167	
873619C92	83314		AMS650102	85001	89410	H60657-011	85102				
873619C93	83314		AMS650107	85316	89426	H60657003	85072				
873622C91	83308		AMS650400	85033	89427	H60665013	85965				

INTERNATIONAL (NAVISTAR) CAB SHOCKS

O.E.M #	Gabriel	Upgrade	O.E.M #	Gabriel	Upgrade	O.E.M #	Gabriel	Upgrade	O.E.M #	Gabriel	Upgrade
1201-0012	83023		1201-9018	83062		2500013C1	83013		2597458C91	83062	
1201-0154	83051		1201-9021	83062		2503529C1	83025		2600491C91	83062	
1201-0254	83051		1202-0012	83023		2507409C1	83052		2601488C91	83062	
1201-1043	83025		1202-0032	83016		2507761C1	83052		2602021C1	83062	
1201-1044	83025		1202-0042	83025		2507763C1	83052		3557165C1	83053	
1201-1049	83025		1202-0043	83032		2507948C1	83054		3557166C1	83052	
1201-1212	83013		1202-0044	83025		2508326C1	83021		3557167C3	83053	
1201-1213	83005		1202-0054	83021		2508327C1	83025		3557169C1	83052	
1201-9001	83052		1202-1043	83025		2509221C91	83054		3557169C2	83052	
1201-9002	83052		1202-1044	83025		2509222C91	83053		3560649C1	83052	
1201-9003	83052		1202-1212	83013		2509223C91	83054		3560649C2	83052	
1201-9007	83054		1202-1213	83005		2509224C91	83053		3560705C2	83054	
1201-9008	83054		2012768C1	83013		2585145C1	83051		AMS66160	83052	
1201-9009	83054		2012769C1	83005		2589922C1	83051		AMS66161	83053	
1201-9010	83053		2012769C2	83005		2590915C1	83062		OE14771	83062	
1201-9011	83053		2023684C1	83015		2590916C1	83062				
1201-9013	83062		2023685C1	83015		2593803C91	83062				
1201-9014	83062		2025790C1	83013		2595314C1	83062				

ISUZU

O.E.M #	Gabriel	Upgrade	O.E.M #	Gabriel	Upgrade	O.E.M #	Gabriel	Upgrade	O.E.M #	Gabriel	Upgrade
1-51630-160-0	83162		8-22064-805-0	83136		8-97253-664-0	83159		9-51630-647-1	83515	
1-51630-167-0	83613		8-22064-806-0	83136		8-97253-665-0	83159		9-51630-666-0	85012	89413
1-51630-168-1	83515		8-22064-807-0	83136		8-98098-058-0	83159		9-51630-666-2	85012	89413
1-51630-217-0	83114		8-22064231-0	85324		8-98098-058-1	83159		94033786	83114	
1-51630-217-1	83114		8-22064232-0	85071		8-98098-059-0	83159		94454986	83515	
1-51630-219-0	83114		8-22064233-0	83136		8-98098-059-1	83159		94454987	83515	
1-51630-219-1	83114		8-22064489-0	85336		8-98098-125-0	83515		97083027	83515	
12474915	83122	89406	8-22064804-0	83136		8-98098-127-0	83515		97083029	83515	
15123676	83136		8-22064805-0	83136		8-98232671-0	83515		97253620	83515	
15174902	85071		8-22064806-0	83136		8-98232671-1	83515		97253651	83404	
15887728	83136		8-22064807-0	83136		8-98232672-0	83515		97253664	83159	
19152843	83136		8-51630-666-0	85012	89413	8-98232672-1	83515		97253665	83159	
51630168	83515		8-94454-647-1	83515		8-98316-228-0	83159		98098058	83159	
51630217	83114		8-94454-986-0	83515		8-98316227-0	83159		98098059	83159	
51630219	83114		8-94454-987-0	83515		8-98343986-0	83159		98098125	83515	
51630647	83515		8-97083-027-0	83515		88982682	83136		98098127	83515	
51630666	85012	89413	8-97083-029-0	83515		88982686	85071		98232671	83515	
60670-005	83137		8-97253-616-0	83515		8972019600	83515		98232672	83515	
8-22064-231-0	85324		8-97253-620-0	83515		898098-0581	83159		98316227	83159	
8-22064-232-0	85071		8-97253-620-1	83515		898098-1250	83515				
8-22064-233-0	83136		8-97253-621-0	83515		898098-1270	83515				
8-22064-489-0	85336		8-97253-623-0	83515		8982326710	83515				
8-22064-804-0	83136		8-97253-651-2	83404		8982326720	83515				

Important Note: Competitive Interchanges are to be used for stocking purposes only. Where multiple crosses are identified, please reference the applications section of this catalog.

COMPETITIVE & O.E.M. INTERCHANGE LIST

ISUZU... cont'd

O.E.M #	Gabriel	Upgrade	O.E.M #	Gabriel	Upgrade	O.E.M #	Gabriel	Upgrade	O.E.M #	Gabriel	Upgrade
98343986	83159										

ITASCA

O.E.M #	Gabriel	Upgrade	O.E.M #	Gabriel	Upgrade	O.E.M #	Gabriel	Upgrade	O.E.M #	Gabriel	Upgrade
141700131809	85029		481700000493	85900		ASH-1154	83177		AT-620	83209	89414
141700131810	83160		66153-002	83124	89407	ASH-1205	83209	89414	AT-621	83122	89406
16-16736-000	85029		8C24-18045-DA	83177		ASH-1206	83122	89406	AT-766	83209	89414
16-16737-000	83160		8C24-18080-DB	83178		ASH-1228	83209	89414	F4-BE5-A011-HO	85126	
16-16873-000	85029		8C2Z-18124-D	83177		ASH-1229	83209	89414	F4-BE5-A832-MO	85125	
16-16874-000	83160		8C2Z-18125-D	83178		ASH-1230	83122	89406	F4-BE5-B492-HO	85125	
16-18103-000	85900		9U94-18045-AA	83209	89414	ASH-137	83122	89406	F4-BE5-C832-MO	83124	89407
1C34-18045-AA	83209	89414	9U94-18080-AA	83122	89406	ASH-25822	83209	89414	F4-BE5-F324-HO	85125	
1C34-18045-JA	83209	89414	9U9Z-18124-A	83209	89414	ASH-25823	83209	89414	F4-BE5-F325-HO	85124	
24-153249	85125		9U9Z-18125-A	83122	89406	ASH-25824	83122	89406	W0005662	85125	
24-153256	85124		ASH-1022	83209	89414	ASH-294	83209	89414	W0005663	85124	
24-186537	85126		ASH-1023	83122	89406	AT-163G	83177		W0006254	85125	
24-186629	85125		ASH-1136	83178		AT-164G	83178				

JAY MADSEN

O.E.M #	Gabriel	Upgrade	O.E.M #	Gabriel	Upgrade	O.E.M #	Gabriel	Upgrade	O.E.M #	Gabriel	Upgrade
3166657	85700		3192333	85700							

JAYCO RV INC

O.E.M #	Gabriel	Upgrade	O.E.M #	Gabriel	Upgrade	O.E.M #	Gabriel	Upgrade	O.E.M #	Gabriel	Upgrade
ASH-1136	83178		ASH-1229	83209	89414	ASH-25823	83209	89414			
ASH-1154	83177		ASH-25822	83209	89414	ASH-25824	83122	89406			

JIFFLOX

O.E.M #	Gabriel	Upgrade	O.E.M #	Gabriel	Upgrade	O.E.M #	Gabriel	Upgrade	O.E.M #	Gabriel	Upgrade
CP-5222	85315										

JOHN DEERE

O.E.M #	Gabriel	Upgrade	O.E.M #	Gabriel	Upgrade	O.E.M #	Gabriel	Upgrade	O.E.M #	Gabriel	Upgrade
3638112	G63183		4036892	G63605							

KENWORTH

O.E.M #	Gabriel	Upgrade	O.E.M #	Gabriel	Upgrade	O.E.M #	Gabriel	Upgrade	O.E.M #	Gabriel	Upgrade
02-02736PLUS	85302	89420	60665-013	85965		665783	83123	89405	671962SPL	85936	89456
02-02737PLUS	85062	89408	60665-015	85966		665784	83122	89406	671963	85937	
02-02738PLUS	85012	89413	60670-004	83123	89405	665785	83137		675122	85001	89410
02-02739PLUS	85013	89414	60670-005	83137		665788	85000	89436	680237	85303	89422
03-04176PLUS	85308	89422	60670-005L	83137		665828	85067	89451	680239	85310	89423
03-06084PLUS	85033	89427	60670-005PLUS	83137		665844	85069	89455	680240	85302	89420
03-07421PLUS	85311	89424	60670-008	83123	89405	665858	85070	89459	680241	85311	89424
03-07423PLUS	85033	89427	60670-008L	83123	89405	665903	85900		680242	85308	89422
03-08781	85069	89455	60670-008PLUS	83123	89405	665906	85902		680253	85314	89425
10-12032-002PLUS	85320	89429	60680-004	83143		665918	85900		680261	85062	89408
10-12542-000PLUS	85901		60680-004L	83143		665926	85047	89435	680279	83209	89414
11418	646177		60680-005	83142		665927	85901		680280	85906	89407
16-13947-000PLUS	85319	89428	60680-005L	83142		665928	85062	89408	680281	85003	89411
16725-01	83126		64178-001	83143		665930	85001	89410	680283	85740	
1707378PAC	85182		665092	83312	89409	665931	83312	89409	680303	85007	89412
19495-01	83126		665118	83312	89409	665932	85012	89413	680425	85320	89429
19495-01	83126	89440	665174	85060		665944	85900		680435	85033	89427
2018987C1PLUS	85003	89411	665331	85740		665945	85902		680473	85319	89428
3166657	85700		665453	85001	89410	665950	85902		680475	85314	89425
471700004423	85109		665565	85007	89412	671052	85070	89459	680476	85310	89423
47902-13PLUS	83122	89406	665565PLUS	85007	89412	671654	85936	89456	680486	85310	89423
47902-19	83123	89405	665617	85031		671656	85985		680586	85311	89424
47902-24	83137		665632	85013	89414	671699	85937				
60657-003	85072		665633	85033	89427	671794	85067	89451			
60657-003L	85072		665670	85001	89410	671962	85936	89456			
60665-011	85967		665680	83312	89409	671962PLUS	85936	89456			

Important Note: Competitive Interchanges are to be used for stocking purposes only. Where multiple crosses are identified, please reference the applications section of this catalog.

COMPETITIVE & O.E.M. INTERCHANGE LIST

KENWORTH... cont'd

O.E.M #	Gabriel	Upgrade	O.E.M #	Gabriel	Upgrade	O.E.M #	Gabriel	Upgrade	O.E.M #	Gabriel	Upgrade
70701	85900		B71-6007	85062	89408	C71-1015 PLUS	85937		K374-3	83312	89409
70701PLUS	85900		B71-6008	83312	89409	C71-1015A	85937		K374-3-1	83312	89409
8086053PLUS	85047	89435	B71-6010	85023	89415	C71-1016	85067	89451	K374-32	85310	89423
90044025PLUS	83209	89414	B71-6011	85062	89408	C71-1017	85069	89455	K374-33	83312	89409
90044089	83124	89407	B71-6012	85119		C71-6003	85988		K374-33PLUS	83312	89409
90044089PLUS	83124	89407	B71-6013	85012	89413	C71-6004	85343		K374-36		89432
90045068		89441	B71-6015	85012	89413	C71-6005	85069	89455	K374-4	85314	89425
90045099	85906	89407	B71-6016	85012	89413	C71-6015	85067	89451	K374-5	83312	89409
90045132	85909		B71-6017	85910		K374-10	83362		K374-7	85310	89423
90045605	85109		B71-6018	85012	89413	K374-11	85001	89410	K374-9	85310	89423
ACHB966	83136		B71-6019	85989		K374-13	85740		K374-C31	83312	89409
B71-1000	85031		B71-6020	85989		K374-13-1	85740		K374-C7	85310	89423
B71-1001	85070	89459	BFRG 072	85182		K374-14	83312	89409	R71-6006	83063	
B71-1002	85001	89410	C71-1002	85067	89451	K374-16	85001	89410	R71-6007	83008	
B71-1003	83312	89409	C71-1002PLUS	85067	89451	K374-26	85001	89410	R71-6008	83035	
B71-6000	85959		C71-1011	85069	89455	K374-26PLUS	85001	89410	S-20126	85323	89436
B71-6002	85012	89413	C71-1011PLUS	85069	89455	K374-27	85001	89410	TK19679	83126	
B71-6003	85029		C71-1011SPL	85069	89455	K374-28	85314	89425	TK19679	83126	89440
B71-6004	85084	89460	C71-1013	85985		K374-28PLUS	85314	89425			
B71-6005	85084	89460	C71-1014	85936	89456	K374-29	85310	89423			
B71-6006	85084	89460	C71-1015	85937		K374-29PLUS	85310	89423			

KENWORTH CAB SHOCKS

O.E.M #	Gabriel	Upgrade	O.E.M #	Gabriel	Upgrade	O.E.M #	Gabriel	Upgrade	O.E.M #	Gabriel	Upgrade
1201-0012	83023		1202-0054	83021		1202K064	83024		R71-6000	83067	
1201-1043	83025		1202-1043	83025		1202K065	83002		R71-6005	83042	
1201-1044	83025		1202-1046	83049		1202K164	83031		R71-6009	83081	
1201-1046	83049		1202-1064	83024		1202K264	83031		R71-6010	83067	
1201-8002	83081		1202-1065	83002		1202K286	83056		T71-1000	83031	
1202-0012	83023		1202-1164	83031		96027-10545	83011		T71-1001	83031	
1202-0032	83016		1202-1264	83031		PP1058870	83059		T71-1002	83002	
1202-0042	83025		1202-1286	83056		PP2582870	83012		T71-1003	83056	
1202-0043	83032		1202-K065	83002		R71-1004	83049				
1202-0044	83025		1202K046	83049		R71-1005	83024				

KIMBLE MIXER CO

O.E.M #	Gabriel	Upgrade	O.E.M #	Gabriel	Upgrade	O.E.M #	Gabriel	Upgrade	O.E.M #	Gabriel	Upgrade
OE10455	646155		T91-00002-00	646155							

KING OF THE ROAD

O.E.M #	Gabriel	Upgrade	O.E.M #	Gabriel	Upgrade	O.E.M #	Gabriel	Upgrade	O.E.M #	Gabriel	Upgrade
141700131809	85029		16-16736-000	85029		16-16873-000	85029		16-18103-000	85900	
141700131810	83160		16-16737-000	83160		16-16874-000	83160		481700000493	85900	

KONI

Koni	Gabriel	Upgrade	Koni	Gabriel	Upgrade	Koni	Gabriel	Upgrade	Koni	Gabriel	Upgrade
090-2209-SP2	85001	89410	30-1606	G63423		82-1970	G63350		88-1457-SP1	83209	89414
30-1348	G63424		30-1607	G63422		82-2158	G63357		88-1458-SP1	83122	89406
30-1350	G63511		30-1614	G63678		82-2246	G63299		88-1458-SP2	83122	89406
30-1351	G63490		30-1624	G63424		82-2345	G63413		88-1468	83209	89414
30-1365	G63611		30-1627	G63690		82-2372	G63609		88-1476	85740	
30-1366	G63610		30-1630	G63425		82-2384	G63488		88-1489	85036	89405
30-1381	G63426		30-1630	G63722		8240-1029	G63386		88-1490	83124	89407
30-1421	G63547		80-2516	G63421		8240-1054	G63375		88-1499	85001	89410
30-1422	G63548		80-2517	G63422		8240-1055	G63454		88-1509	85027	89418
30-1456	G63782		80-2633	G63423		8240-1148	G63720		88-1510	85708	
30-1457	G63781		80-2634	G63422		84-1168	83130		88-1517	85040	
30-1501	G63608		82-1952	G63347		88-1385	83105				
30-1502	G63679		82-1954	G63355		88-1417	83312	89409			
30-1565	G63707		82-1955	G63349		88-1419	83136				
30-1566	G63708		82-1969	G63500		88-1422	85030	89440			

Important Note: Competitive Interchanges are to be used for stocking purposes only. Where multiple crosses are identified, please reference the applications section of this catalog.

COMPETITIVE & O.E.M. INTERCHANGE LIST

KONI... cont'd

Koni	Gabriel	Upgrade	Koni	Gabriel	Upgrade	Koni	Gabriel	Upgrade	Koni	Gabriel	Upgrade
88-1518	85040		8805-1043	83178		90-2089	83165		90-2497S-P1	85712	
88-1520	85040		90-1400	83104		90-2102-SP1	85708		90-2529	85707	
88-1525	85040		90-1409-SP1	85722		90-2148	85304		90-2530	85707	
88-1532	85708		90-1466	85707		90-2164-SP1	85723		90-2563	85006	
88-1540	85051		90-1577-SP1	85310	89423	90-2166	83165		90-2572	85329	
88-1541	85045		90-1608	83104		90-2209	85308	89422	90-2573	85329	
88-1558	85013	89414	90-1811	85301		90-2251	85717		90-2574	85330	
88-1559-SP1	85036	89405	90-1813-SP1	85712		90-2252	85714		90-2575	85700	
88-1560	85062	89408	90-1813-SP3	85968		90-2253-SP2	85732		90-2576	85700	
88-1561	85012	89413	90-1862	85708		90-2254	85720		90-2586	85728	
88-1562	85003	89411	90-1867	85053	89442	90-2255	85719		90-2587	85729	
88-1616	85014		90-1868	85307		90-2256	85732		90-2588	85339	
88-1639	83130		90-1868-SP1	85307		90-2257	85716		90-2589	85727	
88-1641	85029		90-1896	85302	89420	90-2291	695406		90-2610-SP1	87017	
88-1642	83124	89407	90-1897	85303	89422	90-2325	85340		90-2627	89461	
88-1644	85000	89436	90-1898	83215		90-2326	85970		90-2816	85711	
88-1646	83613		90-1907-SP1	85300	89419	90-2327	85341		90-5055-SP2	85318	
88-1647	83317		90-1908-SP1	85723		90-2368	86203		90-5180	85300	89419
88-1668SP1	85097		90-1909-SP1	85722		90-2368-SP1	86203		9005-1018	85970	
88-1704	85030	89440	90-1910	85704		90-2368-SP2	86203		9005-1019	85341	
88-5162	83209	89414	90-1912	85318		90-2396-SP1	85000	89436	9020-1042	85708	
88-5163	83122	89406	90-1922	85900		90-2396-SP1	85323	89436	90F-1235	85700	
8805-1001	85125		90-1943	85307		90-2404	86203		91-2368	86203	
8805-1002	85124		90-1951-SP1	85734		90-2407	85709		91-2400	86203	
8805-1003	85126		90-1951-SP5	85712		90-2416	86202		91-2527	86202	
8805-1018	83209		90-1965	85304		90-2416-SP1	86202		92-1227	85722	
8805-1019	83122	89406	90-1968	85720		90-2433	85710		99B-3178	85179	
8805-1022	85724	89443	90-1974	85311	89424	90-2434	85702				
8805-1023	83136		90-2059	85722		90-2477	85900				
8805-1042	83177		90-2060	85722		90-2478	85902				

KRYSTAL BUS

O.E.M #	Gabriel	Upgrade	O.E.M #	Gabriel	Upgrade	O.E.M #	Gabriel	Upgrade	O.E.M #	Gabriel	Upgrade
ASH-1136	83178		ASH-1154	83177							

KWK-LOC (JIFFLOX)

O.E.M #	Gabriel	Upgrade	O.E.M #	Gabriel	Upgrade	O.E.M #	Gabriel	Upgrade	O.E.M #	Gabriel	Upgrade
522217	85315		CP-5222	85315							

KYB

Kyb	Gabriel	Upgrade	Kyb	Gabriel	Upgrade	Kyb	Gabriel	Upgrade	Kyb	Gabriel	Upgrade
340043	G63909		341627	85006		343403	G63660		344074	G63811	
341302	G63678		341628	85724	89443	344040	G63421		344075	G63413	
341312	G63865		341629	85938		344041	G63422		344076	G63410	
341339	G63918		341630	85052		344042	G63423		344077	G63406	
341343	G63893		341631	646155		344043	G63813		344078	G63683	
341374	G63884		341632	83124	89407	344044	G63907		344079	G63775	
341613	85062	89408	341633	83215		344045	G63492		344080	G63426	
341614	85001	89410	343030	G63949		344046	G63491		344081	G63375	
341615	83215		343127	G63900		344047	G63950		344082	G63454	
341617	85005	89430	343160	G63914		344049	G63414		344083	G63457	
341618	85918	89449	343208	G63909		344050	G63773		344084	G63490	
341619	83136		343209	G63903		344051	G63420		344085	G63306	
341620	85033	89427	343210	G63799		344054	G63444		344086	G63353	
341621	85311	89424	343272	G63860		344055	G63484		344088	G63424	
341622	85023	89415	343353	G63880		344066	G63359		344089	G63425	
341623	85003	89411	343379	G63845		344067	G63347				
341624	85036	89405	343388	G63712		344068	G63355				
341625	85000	89436	343395	G63842		344069	G63500				
341626	85000	89436	343395	G64014		344072	G63349				

Important Note: Competitive Interchanges are to be used for stocking purposes only. Where multiple crosses are identified, please reference the applications section of this catalog.

COMPETITIVE & O.E.M. INTERCHANGE LIST

KYB... cont'd

Kyb	Gabriel	Upgrade	Kyb	Gabriel	Upgrade	Kyb	Gabriel	Upgrade	Kyb	Gabriel	Upgrade
344090	G63492		344399	G63848		349010	G64006		KG5455	G63456	
344091	G63511		344401	G63970		349119	89439		KG5456	G63416	
344092	G63490		344402	G63817		441600	85310	89423	KG5462	G63494	
344093	G63905		344404	G63844		441601	85710		KG5466	G63492	
344094	G63915		344410	G63885		441602	85724	89443	KG5474	G63479	
344095	G63499		344419	G63888		444058	83404		KG5475	G63432	
344096	G63460		344426	G63299		444328	85055		KG5476	G63611	
344097	G63907		344427	G63904		444329	83509		KG5477	G63906	
344098	G63612		344428	G63494		553360	G63937		KG5478	G63489	
344202	G63479		344430	G63611		553361	G63689		KG5479	G63488	
344263	G63488		344431	G63620		554347	G63886		KG5480	G63609	
344264	G63387		344435	G63721		KG4159	G63892		KG5482	G63675	
344265	G63489		344438	G63869		KG4160	G64016		KG5484	G63635	
344266	G63818		344464	G63882		KG4613A	G63909		KG5485	G63639	
344267	G63455		344466	G63879		KG4616	G63798		KG5487	G63525	
344268	G63614		344481	G63894		KG5194	G64000		KG5488	G63403	
344269	G63679		344496	G64012		KG5196	G64013		KG5489	G63614	
344272	G63386		345005	G63694		KG5198A	G63606		KG5491	G63604	
344273	G63638		345022	G63832		KG5401	G63299		KG5494	G63620	
344291	G63873		345023	G63828		KG5406	G63386		KG5495	G63929	
344299	G63710		345024	G63864		KG5417	G63371		KG5496	G63624	
344338	G63776		345030	83304		KG5420	G63366		KG5497	G63622	
344341	G63847		345030	G63394		KG5421	G63387		KG5498	G63623	
344342	G63829		345042	G63883		KG5422	G63183		KG5499	G63621	
344353	G63877		345043	G63878		KG5424	G63187		KG5534	G63610	
344356	G63862		345055	G63872		KG5426	G63396		KG5538	G63484	
344359	G63720		345080	83177		KG5429	G63398		KG5555	G63914	
344364	G63673		345601	83613		KG54300	G63615		KG6001A	83304	
344365	G63662		345602	85052		KG54301	G63616		KG6002A	85030	89440
344366	G63366		345604	85051		KG54302	G63782		KG6003	83309	
344367	G63714		345605	85012	89413	KG54303	G63781		KG6004	85320	89429
344368	G63716		345606	83136		KG54304	G63707		KG6005	83216	
344369	G63624		345607	83130		KG54305	G63640		KG6006	85012	89413
344370	G63622		345608	85060		KG54307	G63812		KG6007	85007	89412
344371	83178		345609	83515		KG54308	G63708		KG6008A	83122	89406
344372	G63661		345611	83120		KG5431	G63511		KG6009A	83303	
344373	G63675		345613	85005	89430	KG54317	G63726		KG6010	83308	89435
344374	G63778		345614	83309	89446	KG54330	G63809		KG6198	G63616	
344375	G63715		345615	83314		KG54331	G63837		KG6199	85012	89413
344377	G63717		345616	83125		KG54333	G63810		KG6201	83456	89447
344380	G63783		345617	83203	89436	KG54335	G63815		KG6403	G63605	
344381	G63803		345618	83126	89430	KG5438	G63492		KG6406	G63183	
344382	G63887		345620	83456	89447	KG5440	G63350		KG6412	G63625	
344385	G63866		345621	85003	89411	KG5442	G63626		KG6413	83177	
344387	G63617		349004	G63886		KG5444	G63904		KG6415	85013	89414
344397	G63772		349009	G63897		KG5446	G63909		KG6416	83123	89405
344398	G63958		349009	G63919		KG5447	G63491				

LEYLAND TRUCK

O.E.M #	Gabriel	Upgrade	O.E.M #	Gabriel	Upgrade	O.E.M #	Gabriel	Upgrade	O.E.M #	Gabriel	Upgrade
1456033	85311	89424									

LGE COACHWORKS

O.E.M #	Gabriel	Upgrade	O.E.M #	Gabriel	Upgrade	O.E.M #	Gabriel	Upgrade	O.E.M #	Gabriel	Upgrade
ASH-1136	83178		ASH-1154	83177							

LINK MANUFACTURING CAB SHOCKS

O.E.M #	Gabriel	Upgrade	O.E.M #	Gabriel	Upgrade	O.E.M #	Gabriel	Upgrade	O.E.M #	Gabriel	Upgrade
1201-0012	83023		1201-0254	83051							
1201-0154	83051		1201-1043	83025							

Important Note: Competitive Interchanges are to be used for stocking purposes only. Where multiple crosses are identified, please reference the applications section of this catalog.

COMPETITIVE & O.E.M. INTERCHANGE LIST

LINK MANUFACTURING CAB SHOCKS... cont'd

O.E.M #	Gabriel	Upgrade	O.E.M #	Gabriel	Upgrade	O.E.M #	Gabriel	Upgrade	O.E.M #	Gabriel	Upgrade
1201-1044	83025		1201-9014	83062		1202-1064	83024		654799	83025	
1201-1046	83049		1201-9018	83062		1202-1065	83002		654811	83024	
1201-1049	83025		1201-9021	83062		1202-1164	83031		654833	83021	
1201-1212	83013		1202-0012	83023		1202-1212	83013		654847	83002	
1201-1213	83005		1202-0032	83016		1202-1213	83005		654849	83031	
1201-9001	83052		1202-0042	83025		1202-1286	83056		654867	83025	
1201-9002	83052		1202-0043	83032		1202K065	83002		LG40450	83016	
1201-9003	83052		1202-0044	83025		1202K164	83031		LG40470	83016	
1201-9007	83054		1202-0052	83021		1202K264	83031		R71-1004	83049	
1201-9008	83054		1202-0054	83021		1202K286	83056		R71-1005	83024	
1201-9009	83054		1202-1042	83025		1202P055	83061		T71-1000	83031	
1201-9010	83053		1202-1043	83025		632129	83023		T71-1001	83031	
1201-9011	83053		1202-1044	83025		635705	83016		T71-1002	83002	
1201-9013	83062		1202-1046	83049		654669	83021				

LINK MANUFACTURING LTD.

O.E.M #	Gabriel	Upgrade	O.E.M #	Gabriel	Upgrade	O.E.M #	Gabriel	Upgrade	O.E.M #	Gabriel	Upgrade
1210-0005	85734		1210-0528	85904		671093	85904				

LINK/HIGH-STEER

O.E.M #	Gabriel	Upgrade	O.E.M #	Gabriel	Upgrade	O.E.M #	Gabriel	Upgrade	O.E.M #	Gabriel	Upgrade
1210-0001	646155		1210-0007	665937		1210-0010	646155		632155	646177	
1210-0002	632147		1210-0009	665937		1210-0012	646155		646168	646155	

LION BUS

O.E.M #	Gabriel	Upgrade	O.E.M #	Gabriel	Upgrade	O.E.M #	Gabriel	Upgrade	O.E.M #	Gabriel	Upgrade
58913-009	85959		58913-009L	85959		60665-025	85036	89405	60665-025L	85036	89405

LODAL, INC.

O.E.M #	Gabriel	Upgrade	O.E.M #	Gabriel	Upgrade	O.E.M #	Gabriel	Upgrade	O.E.M #	Gabriel	Upgrade
9960257	83122	89406									

LONDON MIXER

O.E.M #	Gabriel	Upgrade	O.E.M #	Gabriel	Upgrade	O.E.M #	Gabriel	Upgrade	O.E.M #	Gabriel	Upgrade
MB-37737-30	646155										

M.A.N. BUS

O.E.M #	Gabriel	Upgrade	O.E.M #	Gabriel	Upgrade	O.E.M #	Gabriel	Upgrade	O.E.M #	Gabriel	Upgrade
134	85709		81-43701-6538	85708		81-43701-6572	85708		9020M-1042	85709	
25-1700-106-654	85708		81-43701-6539	85708		81-43701-6573	85722				
81-43701-6537	85709		81-43701-6543	85708		81-43701-6609	85709				

MACK

O.E.M #	Gabriel	Upgrade	O.E.M #	Gabriel	Upgrade	O.E.M #	Gabriel	Upgrade	O.E.M #	Gabriel	Upgrade
1252607B000	85702		14QK-2100P6	85036	89405	14QK-2133M2	85001	89410	14QK-366	85036	89405
141700000373	85061	89450	14QK-2100P7	83221		14QK-2136M	85061	89450	14QK-366P1	85036	89405
141700000380	85061	89450	14QK-2100P8	83242		14QK-282P1	83216		14QK-366P2	85036	89405
141700005839	85098		14QK-2102	85304		14QK-282P3	83216		14QK-366P3	85036	89405
14QK-1200P4	83207	89407	14QK-2105	83209	89414	14QK-288-P1	85007	89412	14QK-366P4	83209	89414
14QK-140	85304		14QK-2107	83215		14QK-288P2	83217		14QK-372M	83221	
14QK-140P1	83225		14QK-2107P1	83215		14QK-29001P2	85303	89422	14QK-372M2	83209	89414
14QK-142	85305		14QK-2107P2	83215		14QK-29301P1	83207	89407	14QK-372M3	83122	89406
14QK-142AP1	83215		14QK-2107P3	83215		14QK-29301P2	83207	89407	14QK-373	83215	
14QK-142P1	83215		14QK-2108	83203	89436	14QK-29302	83207	89407	14QK-375M	83123	89405
14QK-143	83207	89407	14QK-2108P1	83203	89436	14QK-29302P1	83207	89407	14QK-377M	83215	
14QK-145	85307		14QK-2110	85305		14QK-3100	85739		14QK-378	83215	
14QK-20001P2	85308	89422	14QK-2110P1	85305		14QK-3101M	85066	89448	14QK-378M	83215	
14QK-2100	83221		14QK-2113	85001	89410	14QK-3107M	85061	89450	14QK-390	83105	
14QK-2100D-P4	83207	89407	14QK-2113P3	85001	89410	14QK-3108	85080		14QK-392AM	85005	89430
14QK-2100P1	83221		14QK-2113P4	85007	89412	14QK-3108M	85080		14QK-392AM2	83123	89405
14QK-2100P2	83209	89414	14QK-2113P5	85001	89410	14QK-3114M	85061	89450			
14QK-2100P3	83207	89407	14QK-2113P6	85007	89412	14QK-3115M	85972				
14QK-2100P4	83207	89407	14QK-2115	85305		14QK-3116M	83101				
14QK-2100P5	83221		14QK-2133M	85001	89410	14QK-322M	85933	89454			

Important Note: Competitive Interchanges are to be used for stocking purposes only. Where multiple crosses are identified, please reference the applications section of this catalog.

COMPETITIVE & O.E.M. INTERCHANGE LIST

MACK... cont'd

O.E.M #	Gabriel	Upgrade	O.E.M #	Gabriel	Upgrade	O.E.M #	Gabriel	Upgrade	O.E.M #	Gabriel	Upgrade
14QK-392AM3	85005	89430	20513881	85061	89450	25625743	85005	89430	60675-001L	85978	
14QK-392BM	85005	89430	20570098	83147		25626048	85080		60675-13	85036	89405
14QK-392BM2	85321		20625775	85014		25626149	85080		60680-003	83112	
14QK-392BM3	85005	89430	20782199	85072		25632145	85001	89410	60680-003L	83112	
14QK-392M	85005	89430	20863239	85080		25632147	85305		60680-004	83143	
14QK-393AM	83123	89405	20897198	85061	89450	25632561	83209	89414	60680-004L	83143	
14QK-393M	85010		20973993	85061	89450	25633154	85906	89407	60680-005	83142	
14QK-396	85005	89430	20998401	85014		4103-5000447861	83105		60680-005L	83142	
14QK-396M	85005	89430	21002497	85972		4103-5000546892	83105		64838-002	85933	89454
14QK-410M	83125		21010744	83101		446-51-211	85739		650102	85001	89410
14QK-410M2	83137		21155033	83101		471700000426	85014		650107	85316	89426
14QK-410M3	83125		21436096	85098		471700000431	85066	89448	650107MT	85316	89426
14QK-413M	83111		21462382	85088		471700000445	85080		650400MT	85033	89427
14QK-413M4	83110		21462384	85088		471700000451	85080		650402	85311	89424
14QK-413M5	83138		21687170	85120		471700002626	85061	89450	650402MT	85311	89424
14QK-413M6	83111		21979343	85065		471700002861	85014		650404	85310	89423
14QK-413M7	83111		22202559	85088		471700006039	85088		650404MT	85310	89423
14QK-414M	85906	89407	22202560	85088		471700008934	85065		650405	85023	89415
14QK-414M2	85909		22314111	85036	89405	471700009646	85088		650405MT	85023	89415
14QK-415M	83112		25621571	83215		471700009647	85088		650406	85024	
14QK-415M7	83112		25621955	85001	89410	471700131921	85933	89454	650408	85319	89428
14QK-421M	85014		25622221	83111		47902-25	83125		650408MT	85319	89428
14QK-422M	85933	89454	25622345	83242		47902-9	83123	89405	651012	83221	
14QK-423M	85978		25622466	85001	89410	4940654	83216		651103	85036	89405
14QK-424M	83147		25623321	83215		5533699	85302	89420	651151	83209	89414
14QK-427M	85080		25624241	83112		5554184	85302	89420	70042	85302	89420
14QK-428	85080		25624341	83110		57241-004	83110		8083872	85978	
14QK-428M	85080		25624351	85909		57241-006	83111		90045099	85906	89407
14QK-431M	85061	89450	25624365	83217		57241-006L	83111		H60680004	83143	
14QK-434M	85014		25625091	83215		57241-4	83110		H60680005	83142	
14QK-493M	83101		25625151	85036	89405	5966-90044025	83209	89414	SDA141700000380	85061	89450
20469001	85933	89454	25625187	83209	89414	60657-007	85072		SDA471700000431	85066	89448
20469002	85933	89454	25625223	83111		60670-006	83147		SDA471700002861	85014	
20485632	85933	89454	25625234	83125		60670-006L	83147		V10234121	83105	
20485633	85933	89454	25625254	83125		60675-001	85978		V10242320	83105	

MACK CAB SHOCKS

O.E.M #	Gabriel	Upgrade	O.E.M #	Gabriel	Upgrade	O.E.M #	Gabriel	Upgrade	O.E.M #	Gabriel	Upgrade
1201-0012	83023		14QK-391AM	83041		14QK-411M	83007		22662259	83901	
1202-0012	83023		14QK-391AM2	83041		14QK-432M	83050		23145372	83066	
1202-0032	83016		14QK-391BM	83041		14QK-439M	83050		25622373	83905	
14QK-2111	83019		14QK-391BM2	83041		14QK-440M	83058		25622612	83041	
14QK-2111-P2	83019		14QK-391M	83041		20873442	83050		25622613	83041	
14QK-2111-P4	83019		14QK-391M2	83041		20874147	83050		25624837	83041	
14QK-303M	83050		14QK-397AM	83905		21154393	83050		25625635	83045	
14QK-3103M	83050		14QK-399M	83045		21154397	83058		25625636	83045	
14QK-374	83003		14QK-399M2	83045		21345868	83066		25625637	83045	
14QK-376	83003		14QK-399M3	83045		21345869	83066		25631922	83007	
14QK-382	83018		14QK-411	83007		21490486	83066				
14QK-382-P2	83018		14QK-411AM	83007		22662254	83901				

MAECO

O.E.M #	Gabriel	Upgrade	O.E.M #	Gabriel	Upgrade	O.E.M #	Gabriel	Upgrade	O.E.M #	Gabriel	Upgrade
1085	83214		16720	83107		16772	83122	89406	16778	83203	89436
12608	83125		16767	85013	89414	16773	85005	89430	16779	83126	89440
12788	83216		16768	83217		16774	83215				
12866	83207	89407	16769	83221		16775	83207	89407			
16385	83215		16770	83209	89414	16776	83122	89406			
1668722	85030	89440	16771	83126	89430	16777	85006				

Important Note: Competitive Interchanges are to be used for stocking purposes only. Where multiple crosses are identified, please reference the applications section of this catalog.

COMPETITIVE & O.E.M. INTERCHANGE LIST

MAECO... cont'd

O.E.M #	Gabriel	Upgrade	O.E.M #	Gabriel	Upgrade	O.E.M #	Gabriel	Upgrade	O.E.M #	Gabriel	Upgrade
16780	83123	89405	70041	85305		70317		89432	70652	85030	89440
16781	85006		70042	85302	89420	70331	85314	89425	70663	85013	89414
16787	85030	89440	70088	85307		70332	83314		70691	85007	89412
16949	83120		70123	85716		70334	85316	89426	70720	85934	
16950	83118		70127	85006	89401	70397	85006		70721	83125	
6025	83122	89406	70128	85006	89401	70402	85305		74039	85303	89422
6026	83204		70162	85716		70642	85300	89419	OE10881	85711	
70018	85303	89422	70163	85302	89420	70644	85334		OE10882	85740	
70021	85303	89422	70164	85716		70646	85313		OE10883	85339	
70029	85308	89422	70300	85320	89429	70648	89414		OE12425	83214	
70034	85302	89420	70312	85001	89410	70650	89440		SC-2920	83176	
70039	85303	89422	70315	85063		70651	85013	89414			

MANDALAY COACH

O.E.M #	Gabriel	Upgrade	O.E.M #	Gabriel	Upgrade	O.E.M #	Gabriel	Upgrade	O.E.M #	Gabriel	Upgrade
141700131809	85029		16-16736-000	85029		16-16873-000	85029		16-18103-000	85900	
141700131810	83160		16-16737-000	83160		16-16874-000	83160		481700000493	85900	

MARMON

O.E.M #	Gabriel	Upgrade	O.E.M #	Gabriel	Upgrade	O.E.M #	Gabriel	Upgrade	O.E.M #	Gabriel	Upgrade
1-7001	83216		51-139-28	85003	89411	576451	83122	89406			
37-1-1	83122	89406	51-163-7	83123	89405	665147	83216				

MARMON CAB SHOCKS

O.E.M #	Gabriel	Upgrade	O.E.M #	Gabriel	Upgrade	O.E.M #	Gabriel	Upgrade	O.E.M #	Gabriel	Upgrade
1202-0054	83021										

MATSON SCHOOL BUS

O.E.M #	Gabriel	Upgrade	O.E.M #	Gabriel	Upgrade	O.E.M #	Gabriel	Upgrade	O.E.M #	Gabriel	Upgrade
5392387	85303	89422									

MAXPRO

Maxpro	Gabriel	Upgrade	Maxpro	Gabriel	Upgrade	Maxpro	Gabriel	Upgrade	Maxpro	Gabriel	Upgrade
17E-Z10042	85061	89450									

MC NEILUS TRUCK & MAN.

O.E.M #	Gabriel	Upgrade	O.E.M #	Gabriel	Upgrade	O.E.M #	Gabriel	Upgrade	O.E.M #	Gabriel	Upgrade
1139039 MTM	85334		1398980 MTM	83127		1KK552 MTM	85967		600-188206	646155	
1139046 MTM	83112		1404068 MTM	85087		2034140 MTM	646155		64442AX MTM	83128	89436
1139059 MTM	83207	89407	1404068 MTM	85980		217330	85303	89422	6HA961 MTM	83123	89405
1139069 MTM	83209	89414	1410046 MTM	85919		2218640 MTM	83009		6HB390 MTM	83137	
1170719	632147		1411765 MTM	83148		3215395 MTM	83112		6HD720 MTM	85909	
12405FX1 MTM	85303	89422	1412744 MTM	85966		3HR582 MTM	85013	89414	6HS773 MTM	83122	89406
1323106 MTM	85305		1429317 MTM	85919		3HR916 MTM	83207	89407	6KP857 MTM	85000	89436
1333575 MTM	85072		1431085 MTM	85738		4HA569 MTM	85932	89453	7HS237 MTM	83122	89406
1340975 MTM	83142		1432386 MTM	85965		4KP398 MTM	85933	89454	7HS534 MTM	85906	89407
1340976 MTM	85919		1433009 MTM	85962		5HA994 MTM	85916	89430	8KK524 MTM	83168	
1340979 MTM	83143		1468783 MTM	85345		5HB645 MTM	83109		9HB362 MTM	85976	
1360386 MTM	85323	89436	1473224	646155		5KK247 MTM	85977		9KK464 MTM	85079	
1367383 MTM	83147		1485576 MTM	85979		600-115994B	632147				
1396513 MTM	85959		1491909 MTM	83128	89436	600-11599M	632147				

MERITOR

O.E.M #	Gabriel	Upgrade	O.E.M #	Gabriel	Upgrade	O.E.M #	Gabriel	Upgrade	O.E.M #	Gabriel	Upgrade
14QK-3100	85739		671020	87015		680705	85737		A-7805P-1030	85737	
202447	85919		671500	86201		700115	85712		KIT11210	87015	
21224745	86203		671502	86202		7805-F-1020	86200		KIT11375	86200	
21224778	86202		671503	86203		A-3280-M-9711	85919		KIT11376	86200	
21227751	87015		671506	86200		A-7805F-1020	86200		KIT11389	86200	
21228392	86201		671507	87015		A-7805L-1000	85919		KIT11402	86200	
446-51-211	85739		671907	85919		A-7805L-1026	87015				

Important Note: Competitive Interchanges are to be used for stocking purposes only. Where multiple crosses are identified, please reference the applications section of this catalog.

COMPETITIVE & O.E.M. INTERCHANGE LIST

MITSUBISHI-FUSO

O.E.M #	Gabriel	Upgrade	O.E.M #	Gabriel	Upgrade	O.E.M #	Gabriel	Upgrade	O.E.M #	Gabriel	Upgrade
MB161497	G63299		MC809390	83103		MC813511	G63398		MC826268	G63610	
MC114595	G63405		MC813135	83456	89447	MC814614	85009				

MOHAWK

O.E.M #	Gabriel	Upgrade	O.E.M #	Gabriel	Upgrade	O.E.M #	Gabriel	Upgrade	O.E.M #	Gabriel	Upgrade
01-0100-905	85303	89422	10234504	85717		680323	85700		97-9999-02320	85704	
020273544	83203	89436	1235233	85736		680485	85733		MM-6886	83207	89407
050134508	85732		22012082	85702		695195	85707		MM-6957	83225	
10134504	85715		22012114	85700		695196	85707		MM-74029	85308	89422
10134506	85715		4968853	83216		97-2201-00007	85703				
10234503	85715		6-367-7	85305		97-2201-00011	85704				

MONACO

O.E.M #	Gabriel	Upgrade	O.E.M #	Gabriel	Upgrade	O.E.M #	Gabriel	Upgrade	O.E.M #	Gabriel	Upgrade
1C34-18045-AA	83209	89414	9U9Z-18124-A	83209	89414	ASH-1230	83122	89406	AT-766	83209	89414
1C34-18045-JA	83209	89414	9U9Z-18125-A	83122	89406	ASH-137	83122	89406	F4-BE5-A011-HO	85126	
24-153256	85124		ASH-1022	83209	89414	ASH-25822	83209	89414	F4-BE5-B492-HO	85125	
24-186537	85126		ASH-1023	83122	89406	ASH-25823	83209	89414	F4-BE5-C832-MO	83124	89407
24-186629	85125		ASH-1205	83209	89414	ASH-25824	83122	89406	F4-BE5-F325-HO	85124	
66153-002	83124	89407	ASH-1206	83122	89406	ASH-294	83209	89414	W0005663	85124	
9U94-18045-AA	83209	89414	ASH-1228	83209	89414	AT-620	83209	89414			
9U94-18080-AA	83122	89406	ASH-1229	83209	89414	AT-621	83122	89406			

MONROE

Monroe	Gabriel	Upgrade	Monroe	Gabriel	Upgrade	Monroe	Gabriel	Upgrade	Monroe	Gabriel	Upgrade
12872	83219		34685	G63808		34799	G63609		34963	G63406	
16385	83215		34686	G63809		34802	83216		34964	G63456	
16721	83125		34687	G63810		34803	G63306		34972	G63610	
171322	G63679		34690	G63675		34817	G63355		34975	G63511	
171341	G64014		34721	83103		34821	G63406		34983	G63489	
31029	G63798		34722	83400		34822	G63371		34985	61543	
32066	G63900		34729	G63414		34824	G63349		37011	G63414	
32207	G63949		34730	G63386		34828	G63510		37012	G63603	
32217	G63612		34732	G63455		34831	G63359		37013	G63525	
32273	G63782		34733	G63617		34832	61526		37014	G63524	
32274	G63781		34736	G63394		34839	G63671		37015	G63614	
32314	G63604		34741	G63489		34868	61650		37016	G63635	
32341	G63675		34751	G63607		34895	83207	89407	37017	G63639	
32392	G63848		34755	G63812		34899	G63500		37021	G63422	
33049	G63610		34756	G63638		34900	G63386		37022	G63495	
34504	G63817		34759	G63624		34901	G63387		37024	G63610	
34514	G63958		34760	G63622		34904	G63299		37026	G63424	
34515	G63675		34761	G63623		34905	G63405		37027	G63425	
34516	G63848		34762	G63638		34906	G63396		37028	G63904	
34517	G63837		34763	58638		34907	G63511		37029	G63928	
34518	G63809		34767	G63638		34909	G63187		37030	G63547	
34519	G63837		34768	83209	89414	34910	61516		37031	G63404	
34523	G63969		34776	G63661		34911	G63350		37032	G63494	
34524	77968		34777	G63662		34912	83304		37033	G63548	
34530	G63895		34778	G63673		34919	G63411		37035	G63607	
34612	83017		34781	G63675		34920	G63675		37036	G63410	
34617	83019		34782	G63674		34927	G63409		37038	G63461	
34655	G63714		34787	G63615		34928	G63416		37040	G63347	
34656	G63778		34788	G63616		34929	G63403		37041	G63349	
34657	G63716		34791	G63692		34930	G63811		37042	G63906	
34658	G63715		34793	61520		34944	61516		37044	G63488	
34675	G63783		34794	G63360		34954	G63484				
34676	G63662		34796	G63929		34958	G63377				
34677	G63803		34797	G63406		34959	G63432				
34684	G63622		34798	G63609		34960	G63366				

Important Note: Competitive Interchanges are to be used for stocking purposes only. Where multiple crosses are identified, please reference the applications section of this catalog.

COMPETITIVE & O.E.M. INTERCHANGE LIST

MONROE... cont'd

Monroe	Gabriel	Upgrade	Monroe	Gabriel	Upgrade	Monroe	Gabriel	Upgrade	Monroe	Gabriel	Upgrade
37045	G63183		37123	G63690		550020	G63919		557039	85959	
37046	G63389		37128	G63929		550051	43140		557040	85092	
37047	G63902		37129	G63421		551001	83125		5777	G63880	
37048	G63492		37130	G63609		551002	83122	89406	65101	85062	89408
37049	G63355		37131	G63714		553001	79900		65102	85001	89410
37050	G63489		37132	G63778		553002	G56778		65103	85320	89429
37051	G63490		37133	G63716		555004	G63299		65104	85026	89417
37052	G63406		37134	G63715		555005	G63689		65105	85026	89417
37053	G63386		37135	G63722		555006	G63173		65106	85091	
37055	G63455		37144	G63717		555010	77623		65107	85316	89426
37058	G63457		37149	G63783		555011	83119		65108	85030	89432
37060	G63621		37151	G63803		555012	G63183		65109	85058	89431
37061	G63502		37153	G63772		555019	85069	89455	65110	85005	89430
37062	G63818		37155	G63676		555026	83124	89407	65111	85006	
37063	G63375		37156	G63869		555027	83124	89407	65112	89402	
37064	G63454		37157	G63726		555028	83207	89407	65113	85012	89413
37065	G63426		37158	G63712		555029	83144		65114	85036	89405
37066	G63915		37160	G63710		555031	83177		65115	85027	89418
37067	G63460		37161	G63847		555032	83178		65116	85329	
37068	G63905		37162	G63829		555033	G63386		65118	85001	89410
37069	G63499		37163	G63817		555034	G63387		65119	85029	
37070	G63799		37164	G63675		555035	G63357		65120	85010	
37071	G63914		37166	G63866		555036	77403		65121	85971	
37072	G63903		37178	G63803		555037	G63359		65122	85063	
37073	G63907		37191	G63506		555038	G63413		65123	85054	89438
37074	G63620		37198	G63694		555039	G63359		65124	85053	89442
37075	G63606		37199	G63860		555041	G63866		65128	85031	
37076	G63639		37202	G64002		555043	83400		65129	85701	
37077	G63909		37203	G63844		555045	G63394		65130	85061	89450
37080	G63624		37204	G63845		557001	85013	89414	65133	85935	
37082	G63626		37206	G63958		557002	85097		65139	85918	89449
37085	G63896		37217	G63862		557004	G63866		65140	85918	89449
37086	G63897		37218	G63877		557005	83136		65141	85091	
37088	G63500		37231	G63720		557006	83136		65142	83131	
37089	G63350		37238	G63815		557007	85099		65143	83163	
37090	G63357		37240	G63865		557008	85029		65144	85928	
37091	G63413		37241	G63842		557009	85007	89412	65145	85929	
37093	G63359		37242	G64014		557010	83144		65146	85925	
37094	G63353		37243	G63610		557011	83160		65147	85924	89457
37097	G63950		37244	G63864		557012	85029		65148	85918	89449
37099	G63423		37246	G64003		557013	83127		65150	85953	
37100	G63904		37249	G63434		557014	83126	89430	65151	85953	
37101	G63660		37803	G63306		557015	83209	89414	65153	85921	
37102	G63661		38072	83043		557017	85029		65155	83175	
37103	G63662		39052	G63868		557018	83127		65156	85005	
37104	G63673		40209	83161		557020	83123	89405	65157	85954	
37108	G63707		54487	85073		557021	85051		65158	85954	
37109	G63708		54488	85074		557022	85051		65159	85070	89459
37110	G63676		550010	G63375		557023	83144		65160	85080	
37111	G63937		550011	69606		557026	83127		65161	83136	
37112	G63689		550012	G63375		557027	83144		65162	85959	
37113	G64005		550013	69724		557028	85010		65163	85954	
37114	G64004		550016	G63424		557031	85010		65166	85090	
37120	G63511		550017	G63425		557032	85126		65167	G63969	
37121	G63490		550018	69575		557033	85900		65168	77968	
37122	G63678		550019	G63918		557038	85125		65169	85342	

Important Note: Competitive Interchanges are to be used for stocking purposes only. Where multiple crosses are identified, please reference the applications section of this catalog.

COMPETITIVE & O.E.M. INTERCHANGE LIST

MONROE... cont'd

Monroe	Gabriel	Upgrade	Monroe	Gabriel	Upgrade	Monroe	Gabriel	Upgrade	Monroe	Gabriel	Upgrade
65170	85969		65445	85731		65502	85938		66107	83048	
65171	85964		65446	85730		65503	85919		66108	83028	
65172	83153		65447	85703		65504	85072		66109	83048	
65173	85336		65448	85700		65505	85006		66111	83016	
65174	58942		65449	85702		65506	83168		66112	83017	
65175	85084	89460	65450	85701		65507	83143		66113	83050	
65176	85084	89460	65451	85029		65508	83142		66114	83045	
65177	85012	89413	65452	85733		65509	85079		66115	83045	
65178	85998		65453	85904		65510	85052		66116	83018	
65179	85995		65454	85030	89440	65511	85939		66117	83019	
65180	85639		65455	85716		65512	85938		66118	83001	
65183	85181		65456	85376		65513	85338		66120	85006	
65184	85180		65457	85909		65514	85099		66121	83047	
65185	85180		65458	85908		65515	85097		66122	83038	
65400	85033	89427	65459	85043		65516	85013	89414	66123	83004	
65401	85013	89414	65461	85059		65517	83165		66124	83040	
65402	85311	89424	65462	85913		65518	85089		66125	83035	
65404	85310	89423	65463	85040		65519	85060		66126	83051	
65405	85023	89415	65464	85968		65520	85121		6613	83123	89405
65406	85024		65465	85939		65521	85014		66131	83062	
65407	85736		65466	85047	89435	65522	85082		66132	83001	
65408	85319	89428	65467	85054	89438	65523	85937		66135	83905	
65409	85003	89411	65468	85069	89455	65524	85936	89456	6614	83125	
65410	85300	89419	65469	85708		65525	87015		66142	83039	
65411	85036	89405	65470	85708		65526	85956		66143	83007	
65412	83122	89406	65471	85302	89420	65527	85955		66145	83008	
65413	83136		65472	85330		65528	85069	89455	66147	83009	
65414	85324		65473	85329		65529	85984		66149	83022	
65415	85046	89434	65474	85712		65530	85932	89453	6615	83120	
65416	85000	89436	65475	85065		65531	85334		66150	83003	
65417	85322		65476	85736		65532	85967		66152	83012	
65418	85906	89407	65477	85702		65533	85120		66154	83014	
65419	85000	89436	65478	85058	89431	65534	85343		66157	83015	
65420	85013	89414	65479	83122	89406	65535	85954		66159	83031	
65421	85916		65480	83111		65536	85965		66160	83052	
65422	85912		65481	85036	89405	65537	85962		66161	83054	
65423	85907		65482	85006		65538	85966		66162	83025	
65424	85905		65483	85978		65539	85961		66169	83027	
65425	85056	89441	65484	85976		65541	85119		66178	83023	
65426	85054	89438	65485	85972		65542	85102		66179	83013	
65427	85903		65486	85066	89448	65546	85986		66181	83025	
65428	85321		65487	85927		6603	83103		66182	83005	
65429	85030	89440	65488	85926		6604	83101		66189	83041	
65430	85968		65489	85331		6605	83613		66193	83034	
65431	85909		65490	85724	89443	6606	83636		66195	83033	
65432	85910		65491	85930		6607	85052		66196	83027	
65433	85910		65492	85931	89458	6608	83128		66198	83158	
65434	85012	89413	65493	85934		6609	83635		66199	83048	
65435	85901		65494	85061	89450	6610	85051		66200	83066	
65436	85900		65495	85067	89451	66101	83042		66201	83081	
65439	85716		65496	83138		66102	83059		66203	83067	
65440	85711		65497	85933	89454	66102	83063		66204	83024	
65441	85704		65498	85964		66103	83046		66205	83063	
65442	85700		65499	85963		66104	83021		66400	G63432	
65443	85706		65500	85738		66105	83044		66402	83157	
65444	85311	89424	65501	85323	89436	66106	83016		66403	83154	

Important Note: Competitive Interchanges are to be used for stocking purposes only. Where multiple crosses are identified, please reference the applications section of this catalog.

COMPETITIVE & O.E.M. INTERCHANGE LIST

MONROE... cont'd

Monroe	Gabriel	Upgrade	Monroe	Gabriel	Upgrade	Monroe	Gabriel	Upgrade	Monroe	Gabriel	Upgrade
66405	83154		66616	83018		66695	83033		6714	83216	
66406	85920		66617	83019		66697	83164		6715	85026	89417
66407	83134		66618	83159		66699	83113		6716	85042	
66408	83145		66620	83162		66701	83215		6717	G63616	
66409	83146		66623	83004		66707	83215		6718	85024	
66412	83156		66624	83141		66708	83100		6719	83242	
66415	G63918		66625	83162		66710	83209	89414	6720	85003	89411
66416	85085		66626	85071		66712	83100		6721	83103	
66417	G63919		66627	85045		66713	83105		6801	G63484	
66418	85918	89449	66628	83136		66714	83216		6803	G63907	
66419	85931	89458	66629	83107		66715	85026	89417	6811	83312	89409
66422	83163		66630	83216		66716	85042		6817	G63355	
66423	85001	89410	66631	83140		66717	83515		6824	G63349	
66424	85310	89423	66632	83006		66719	83242		6828	83219	
66425	85920		66633	83127		66720	85003	89411	6829	83103	
66426	85924	89457	66634	83203	89436	66801	83161		6831	G63359	
66427	89441		66636	83127		66811	83312	89409	6833	83126	89430
66428	85033	89427	66637	83304		66813	83303		6839	G63357	
66429	85311	89424	66638	83123	89405	66828	83159		6840	83217	
66430	83309		66639	G63610		66829	83103		6841	83216	
66431	85066	89448	66642	G63866		66833	83126	89430	6860	83308	89435
66432	85319	89428	66643	83007		66841	83216		6861	83309	89446
66433	85918	89449	66645	83008		66858	G63183		6863	83314	
66434	85069	89455	66646	83308	89435	66860	83308	89435	6864	83104	
66435	83219		66647	83009		66861	83309	89446	6868	G63360	
66436	85067	89451	66648	83112		66863	83314		6878	83221	
66438	83363		66649	83010		66864	83104		6886	83124	89407
66442	83150		66650	83003		66868	83219		6891	83215	
66443	83150		66653	83515		66871	G63605		6893	83203	89436
66445	83135		66654	83014		66878	83221		6894	83209	89414
66447	83180		66656	83110		66883	83314		6895	83204	
66448	85058		66657	83015		66884	83125		6897	83126	89430
66454	83166		66658	85009		66886	83124	89407	6898	83125	
66455	83166		66659	83002		66891	83215		6900	G63386	
66486	85066	89448	66660	85059		66893	83203	89436	6901	G63387	
66502	646155		66661	83123	89405	66894	83137		6902	83401	
66503	646155		66664	83215		66897	83126	89430	6903	83400	
66504	632147		66665	83109		66898	83125		6910	G63413	
66506	646155		66666	G63671		66902	83401		6911	G63350	
66535	85062	89408	66668	83313	89439	66903	83400		6912	83304	
6658	85009		66669	83111		66912	83304		6913	83303	
66601	83114		66670	83200		66913	83303		6916	83123	89405
66602	83161		66671	83123	89405	66921	83318		6920	G63411	
66603	83103		66672	83209	89414	66922	83301		6921	83318	
66604	83101		66677	83114		66923	83456	89447	6922	83301	
66605	83613		66678	83023		66924	83317		6923	83456	89447
66606	83636		66679	83013		66956	83101		6927	G63409	
66607	85052		66680	83317		66957	83225		6945	G63421	
66608	83128		66681	83025		66966	85740		6956	83101	
66609	83635		66682	83005		66969	83126	89430	6957	83225	
66610	83130		66683	83101		6701	83215		6960	G63366	
66611	83016		66684	85007	89412	6707	83215		6969	83126	89430
66612	83017		66686	85014		6708	83100		6994	83122	89406
66613	83123	89405	66691	83118		6710	83209	89414	70039	85303	89422
66614	83125		66692	83120		6712	85040		70166	85301	
66615	83120		66693	83034		6713	83105		70300	85320	89429

Important Note: Competitive Interchanges are to be used for stocking purposes only. Where multiple crosses are identified, please reference the applications section of this catalog.

COMPETITIVE & O.E.M. INTERCHANGE LIST

MONROE... cont'd

Monroe	Gabriel	Upgrade	Monroe	Gabriel	Upgrade	Monroe	Gabriel	Upgrade	Monroe	Gabriel	Upgrade
70312	85001	89410	74400	85700		74440	85729		911222	G63970	
70331	85314	89425	74402	85711		74441	85339		911228	G63882	
70332	83314		74405	85300	89419	74442	85727		911229	G63884	
70334	85316	89426	74406	85712		74443	85377		911230	G63879	
70402	85305		74408	85702		74444	85378		911251	G63878	
70447	85940		74409	85310	89423	74445	85381		911252	G63883	
70447	85949		74410	85701		74446	85352		911253	G63875	
70448	85943		74411	85703		74451	85711		911255	G63894	
70449	85942		74412	85704		74452	85740		911256	G63893	
70454	85941		74413	85313		74453	85339		911257	G63895	
70459	85948		74414	85723		74454	85314	89425	911258	G63872	
70459	85951		74415	85318		74457	695406		911259	G64016	
70477	85949		74416	85705	89447	74458	695406		911260	G63892	
70720	85934		74417	85311	89424	74461	87019		911265	G64010	
74001	85307		74418	85709		74462	85346		911266	G63886	
74003	85314	89425	74420	85003	89411	74463	85347		911267	G63887	
74004	85315		74421	85708		74464	85318		911268	G63888	
74006	85304		74422	85733		74465	85708		911270	G63885	
74012	85736		74423	85712		74466	85318		911277	G63890	
74024	85308	89422	74424	85308	89422	74467	85723		911278	G64012	
74025	85303	89422	74425	85724	89443	74469	85345		911279	G63889	
74028	85302	89420	74426	85333		74470	89461		911280	G64007	
74029	85308	89422	74427	85308	89422	74471	85736		911508	G64000	
74069	85301		74429	85919		74472	85303	89422	911527	G64001	
74070	85716		74430	85340		74473	85716		911528	G63965	
74073	85320	89429	74431	85341		74475	85746		911533	G63959	
74074	85722		74432	85970		74476	85745		911534	G64011	
74075	85712		74433	85331		74477	83165		911535	G64013	
74076	85706		74434	85711		74478	85089		911536	G64008	
74077	85324		74435	87017		911030	G63479		911538	G63966	
74078	85027	89418	74436	85334		911171	G63813		911539	G63967	
74079	85336		74437	89461		911172	G63491		SC-2920	83176	
74080	85332		74438	85734		911183	G63832				
74081	85727		74439	85728		911184	G63828				

MOR-RYDE SUSPENSION

O.E.M #	Gabriel	Upgrade	O.E.M #	Gabriel	Upgrade	O.E.M #	Gabriel	Upgrade	O.E.M #	Gabriel	Upgrade
U0109-006	G63866		U0109-007	G63183		U0109-014	83400		U0109-018	G63866	

MOTOR COACH INDUSTRIES

O.E.M #	Gabriel	Upgrade	O.E.M #	Gabriel	Upgrade	O.E.M #	Gabriel	Upgrade	O.E.M #	Gabriel	Upgrade
01-205219	85727		12-05-1176	85728		12-05-6000	85711		12J-5-3	85313	
12-05-1021	85340		12-05-1177	85729		12-05-6001	85740		12J-5-4	85733	
12-05-1022	85970		12-05-1178	85339		12-05-6002	85339		12J-5-6	85313	
12-05-1023	85341		12-05-1179	85727		12-05-6033	85339		12J-5-7	85733	
12-05-1101	85340		12-05-1188	85970		12-05-6053	85711		12J-5-71	85733	
12-05-1102	85970		12-05-1194	85339		12-05-6054	85740		12J-5-9	85700	
12-05-1103	85341		12-05-1199	85729		12-05-6055	85339		12L-4-170	83158	
12-05-1137	85340		12-05-1228	85711		12-05-6068	85727		12L-5-100	85727	
12-05-1138	85970		12-05-1242	85728		12-5-1-G	85700		12L-5-114	85727	
12-05-1139	85341		12-05-1243	85729		12-5-1-GS	85700		12L-5-58	85728	
12-05-1142	85340		12-05-1244	85727		12B-5-1	85735		12L-5-67	85728	
12-05-1146	85340		12-05-1260	85728		12B-5-1-G	85700		12L-5-69	85700	
12-05-1147	85341		12-05-1261	85729		12B-5-1-GS	85700		12L-5-70	85700	
12-05-1148	85970		12-05-1262	85727		12G-5-1	85700		12L-5-71	85708	
12-05-1150	85711		12-05-1264	85727		12J-5-10	85733				
12-05-1165	85711		12-05-1327	85728		12J-5-10GS	85733				
12-05-1166	85341		12-05-1328	85729		12J-5-11	85313				
12-05-1170	85340		12-05-1329	85727		12J-5-2	85733				

Important Note: Competitive Interchanges are to be used for stocking purposes only. Where multiple crosses are identified, please reference the applications section of this catalog.

COMPETITIVE & O.E.M. INTERCHANGE LIST

MOTOR COACH INDUSTRIES... cont'd

O.E.M #	Gabriel	Upgrade	O.E.M #	Gabriel	Upgrade	O.E.M #	Gabriel	Upgrade	O.E.M #	Gabriel	Upgrade
12L-5-72	85709		22052014	85702		680470	85713		G1101590	85713	
12L-5-88	85729		3178154	85735		680482	85727		G1101590GS	85713	
12L-5-89	85729		3178157	85700		680485	85733		G1201338	85710	
12L-5-96	85728		5316984	85313		680544	85711		G1201339	85702	
12L-5-97	85728		63-0127GS	85303	89422	680546	85339		G5008069	85700	
12L-5-98	85339		6314933	85708		680602	85339		OE10086S	85702	
12L-5-99	85339		654789	83158		680677	85728		OE10881	85711	
12T-1-13	85303	89422	680231	85313		680680	85729		OE10882	85740	
12TA-01-013	85303	89422	680232	85733		680681	85727		OE10883	85339	
1497835	85711		680322	85704		690029	85700		T12-1208	85727	
1498200	85740		680323	85700		695125	85704		T14-1045GS	85700	
1498565	85339		680333	85708		85729	85729		T14-1048	85302	89420
22012066	85707		680350	85710		97-2201-00151	85700		T14-1080	85728	
22012067	85700		680369	85708		97-2210-00164	85708		T14-1081	85729	
22024061	85704		680374	85728		97-9999-02514	85700		T14-1082	85727	
22024673	85710		680441	85729		97-9999-02585	85723				
22045526	85702		680452	85339		97-9999-02634	85733				
22046485	85710		680462	85728		G1011822	85702				

MOTORCRAFT

Motorcraft	Gabriel	Upgrade	Motorcraft	Gabriel	Upgrade	Motorcraft	Gabriel	Upgrade	Motorcraft	Gabriel	Upgrade
AA-229	G63773		ASH-122	G63614		ASH-684	G63623		AT-568	G63622	
AA-450	G63773		ASH-1228	83209	89414	ASH-69	83175		AT-579	G63809	
AA-456	G63772		ASH-1230	83122	89406	ASH-706	G63614		AT-610	G63461	
AA-457	G63678		ASH-132	G63614		ASH-707	G63614		AT-611	G63461	
AA-483	G63837		ASH-137	83122	89406	ASH-712	69575		AT-620	83209	89414
AA-484	G63837		ASH-23454	G63614		ASH-824	G63929		AT-621	83122	89406
AA-485	G63837		ASH-23458	G63614		ASHV-1	G63678		AT-682	G63678	
AA-486	G63607		ASH-24401	G63809		ASHV-1015	G63622		AT-683	G63679	
AA-494	83131		ASH-24402	85928		ASHV-1025	G63623		AT-684	G63679	
AA-500	G63809		ASH-24433	G63837		ASHV-1028	G63778		AT-685	G63679	
AA-501	G63809		ASH-24434	G63607		ASHV-1046	G63772		AT-696	83140	
AA-502	G63614		ASH-24492	83175		ASHV-1047	G63607		AT-710	G63809	
AA-503	G63614		ASH-24659	85181		ASHV-1048	G63525		AT-713	G63614	
AA-504	G63614		ASH-24660	85180		ASHV-1049	G63524		AT-715	G63614	
AA-615	83135		ASH-25	83309	89446	ASHV-1050	G63608		AT-716	G63809	
AA-616	83175		ASH-29	83314		ASHV-1051	G63837		AT-764	G63678	
AA-617	85928		ASH-294	83209	89414	ASHV-13	G63676		AT-765	G63772	
AS-1086	G63678		ASH-32	83125		ASHV-14	G63837		AT-766	83209	89414
AS-413	G63414		ASH-322	77969		ASHV-3	G63714		AT-811	83135	
AS-433	G63406		ASH-324	77968		ASHV-4	G63716		AX-131A	83217	
AS-485G	G63622		ASH-335	G63969		ASHV-6	G63809		AX-135A	G63406	
AS-498G	G63608		ASH-36	85716		ASHV-864	G63929		AX-267A	83309	89446
AS-500G	G63624		ASH-362	G63607		ASHV-865	G63808		AX-269A	83308	89435
ASH-1022	83209	89414	ASH-363	G63525		ASHV-866	G63810		AX-269A	83312	89409
ASH-1023	83122	89406	ASH-364	G63524		ASHV-867	G63455		AX-277A	83219	
ASH-1130	G63622		ASH-365	G63772		ASHV-868	G63406		AX-282A	85010	
ASH-1131	G63622		ASH-366	G63608		ASHV-871	G63809		AX-310	83215	
ASH-1132	G63622		ASH-38	85314	89425	ASHV-879	G63455		AX-327	G63773	
ASH-1135	G63623		ASH-387	G63809		AST-260	G63929		AX-332	85928	
ASH-1136	83178		ASH-39	85001	89410	AT-163G	83177		AX-79A	83221	
ASH-1154	83177		ASH-391	G63809		AT-164G	83178		AX-79A	85030	89440
ASH-1155	G63623		ASH-394	G63614		AT-504G	G63679		AX-97A	83122	89406
ASH-119	G63809		ASH-397	83131		AT-506G	G63679		AX-97A	85005	89430
ASH-120	G63837		ASH-398	85928		AT-507G	G63607				
ASH-1205	83209	89414	ASH-407	G63809		AT-546	G63678				
ASH-1206	83122		ASH-408	G63809		AT-547	G63775				
ASH-121	G63607		ASH-51	G63773		AT-554	85305				

Important Note: Competitive Interchanges are to be used for stocking purposes only. Where multiple crosses are identified, please reference the applications section of this catalog.

COMPETITIVE & O.E.M. INTERCHANGE LIST

MOTORCRAFT... cont'd

Motorcraft	Gabriel	Upgrade	Motorcraft	Gabriel	Upgrade	Motorcraft	Gabriel	Upgrade	Motorcraft	Gabriel	Upgrade
CAH-001	85307		CAT-777	G63662		CAT-935	G63424		CAX-841	83216	
CAH-001	85711		CAT-778	G63673		CAT-936	G63425		CAX-860	83308	89435
CAH-003	83215		CAT-793	G63414		CAT-944	G63347		CAX-861	83309	89446
CAH-006	85304		CAT-802	G63419		CAT-944	G63908		CAX-863	83314	
CAH-012	85736		CAT-802	G63492		CAT-945	G63421		CAX-878	83221	
CAH-025	85007	89412	CAT-802	G63928		CAT-945	G63457		CAX-886	83207	89407
CAH-028	85302	89420	CAT-803	G63306		CAT-948	G63909		CAX-886	85014	
CAH-029	85308	89422	CAT-817	G63355		CAT-953	G63375		CAX-891	83215	
CAH-069	83219		CAT-824	G63349		CAT-953	G63900		CAX-891	85314	89425
CAH-069	85301		CAT-826	G63187		CAT-953	G63903		CAX-893	83203	89436
CAHL-400	85303	89422	CAT-828	G63494		CAT-955	G63454		CAX-893	85000	89436
CAHL-400	85700		CAT-831	G63359		CAT-958	G63377		CAX-893	85043	
CAHL-405	85300	89419	CAT-832	G63353		CAT-960	G63366		CAX-894	83209	89414
CAHL-406	85004		CAT-839	G63357		CAT-963	G63427		CAX-894	85005	89430
CAHL-409	85310	89423	CAT-853	G63183		CAT-963	G63525		CAX-894	85013	89414
CAHL-417	85311	89424	CAT-854	G63389		CAT-964	G63420		CAX-898	83125	
CAT-722	83400		CAT-868	G63360		CAT-964	G63456		CAX-898	85006	
CAT-729	G63414		CAT-895	83207	89407	CAT-972	G63610		CAX-912	83304	
CAT-730	G63386		CAT-899	G63500		CAT-975	G63511		CAX-913	83303	
CAT-731	G63409		CAT-900	G63386		CAT-976	G63490		CAX-916	83123	89405
CAT-732	G63455		CAT-901	G63387		CAT-977	G63915		CAX-916	85036	89405
CAT-733	G63617		CAT-904	G63299		CAT-978	G63460		CAX-921	83318	
CAT-736	G63394		CAT-905	G63405		CAT-983	G63489		CAX-923	83102	
CAT-737	G63502		CAT-906	G63396		CAT-984	G63609		CAX-923	83456	89447
CAT-739	G63603		CAT-907	G63511		CAT-984	G63818		CAX-924	83317	
CAT-740	G63423		CAT-909	G63398		CAT-985	G63488		CAX-957	83217	
CAT-741	G63489		CAT-910	G63413		CAT-986	G63489		CAX-957	83225	
CAT-745	G63608		CAT-911	G63350		CAT-990	G63906		CAX-969	83221	
CAT-745	G63614		CAT-912	G63625		CAX-001	85307		CAX-969	85011	
CAT-750	G63359		CAT-919	G63411		CAX-707	83215		CAX-969	85030	89440
CAT-751	G63607		CAT-920	G63675		CAX-707	85001	89410	CLT-109	G63614	
CAT-758	G63909		CAT-926	G63410		CAX-710	83209	89414	CLT-112	G63525	
CAT-759	G63624		CAT-927	G63409		CAX-720	85003	89411	CLT-113	G63524	
CAT-760	G63622		CAT-927	G63690		CAX-811	83312	89409	CLT-114	G63635	
CAT-761	G63623		CAT-928	G63410		CAX-828	83207	89407	CLT-116	G63902	
CAT-762	G63638		CAT-929	G63403		CAX-828	85012	89413	CLT-124	G63610	
CAT-768	83209	89414	CAT-930	G63461		CAX-833	83303		CLT-138	G63502	
CAT-776	G63661		CAT-932	G63398		CAX-833	85005	89430			

MUNCIE RECLAMATION

O.E.M #	Gabriel	Upgrade	O.E.M #	Gabriel	Upgrade	O.E.M #	Gabriel	Upgrade	O.E.M #	Gabriel	Upgrade
665459	89447		MR1623	85700		MR2996	85704		MR3650	85707	
665568	85051		MR1710	85713		MR2997	85703		MR6394	85723	
665569	85045		MR1751	85713		MR3303	85709		MR6535	85708	
680334	85709		MR1763	85300	89419	MR3304	85710		MR6536	85722	
97-2210-00164	85708		MR1765	85713		MR3304H	85709		MR7388	85710	
H53-20415-006	85051		MR25767	85702		MR3306	85705	89447			
H53-21144-004	85045		MR2960	85702		MR3307	85707				

NATIONAL COACH CORP

O.E.M #	Gabriel	Upgrade	O.E.M #	Gabriel	Upgrade	O.E.M #	Gabriel	Upgrade	O.E.M #	Gabriel	Upgrade
C800853	83207	89407									

NATIONAL RV INC.

O.E.M #	Gabriel	Upgrade	O.E.M #	Gabriel	Upgrade	O.E.M #	Gabriel	Upgrade	O.E.M #	Gabriel	Upgrade
1C34-18045-AA	83209	89414	24-186629	85125		ASH-1022	83209	89414	ASH-1229	83209	89414
1C34-18045-JA	83209	89414	9U94-18045-AA	83209	89414	ASH-1023	83122	89406			
24-153249	85125		9U94-18080-AA	83122	89406	ASH-1205	83209	89414			
24-153256	85124		9U9Z-18124-A	83209	89414	ASH-1206	83122	89406			
24-186537	85126		9U9Z-18125-A	83122	89406	ASH-1228	83209	89414			

Important Note: Competitive Interchanges are to be used for stocking purposes only. Where multiple crosses are identified, please reference the applications section of this catalog.

COMPETITIVE & O.E.M. INTERCHANGE LIST

NATIONAL RV INC.... cont'd

O.E.M #	Gabriel	Upgrade	O.E.M #	Gabriel	Upgrade	O.E.M #	Gabriel	Upgrade	O.E.M #	Gabriel	Upgrade
ASH-1230	83122	89406	ASH-294	83209	89414	F4-BE5-A832-MO	85125		W0005663	85124	
ASH-137	83122	89406	AT-620	83209	89414	F4-BE5-B492-HO	85125		W0006254	85125	
ASH-25822	83209	89414	AT-621	83122	89406	F4-BE5-F324-HO	85125				
ASH-25823	83209	89414	AT-766	83209	89414	F4-BE5-F325-HO	85124				
ASH-25824	83122	89406	F4-BE5-A011-HO	85126		W0005662	85125				

NEOPLAN BUS

O.E.M #	Gabriel	Upgrade	O.E.M #	Gabriel	Upgrade	O.E.M #	Gabriel	Upgrade	O.E.M #	Gabriel	Upgrade
24-1700-106-149	83216		AA1002002	85705	89447	BN1002002	85009		DZ1002002	85705	89447
24-1700-999-362	85009		AA1002003	85705	89447	BT1002011	83216		GJ1002002	85706	
25-1700-101-426	85705	89447	AA1802002	85705	89447	CI 1002003	85705	89447	GJ1002003	85705	89447
680307	85705	89447	AC1002002	85705	89447	CL1002003	85705	89447	MM1002002	85705	89447
680308	85706		AC1002002GS	85705	89447	DT1002002	85707		MM1002003	85705	89447
97-9999-02519	85707		AC1002003	85705	89447	DT1802002	85705	89447			

NEW FLYER

O.E.M #	Gabriel	Upgrade	O.E.M #	Gabriel	Upgrade	O.E.M #	Gabriel	Upgrade	O.E.M #	Gabriel	Upgrade
009863	85722		203398	85346		68037840B	85720		69536640Y	85732	
015813	85708		204428	85347		68050440X	85716		97-2210-00164	85708	
015915	85711		68027440Y	85716		68050640Y	85732		G1011823	85710	
016415	85722		680346	85722		680671	85708				
064845	85711		68035041Y	85710		690102	85711				
152959	85708		680352	85711		69536140Y	87016				

NEWMAR CORP

O.E.M #	Gabriel	Upgrade	O.E.M #	Gabriel	Upgrade	O.E.M #	Gabriel	Upgrade	O.E.M #	Gabriel	Upgrade
141700131809	85029		16-16737-000	83160		481700000493	85900		ASH-25823	83209	89414
141700131810	83160		16-16874-000	83160		ASH-1229	83209	89414	ASH-25824	83122	89406
16-16736-000	85029		16-18103-000	85900		ASH-25822	83209	89414			

NEXUS RV

O.E.M #	Gabriel	Upgrade	O.E.M #	Gabriel	Upgrade	O.E.M #	Gabriel	Upgrade	O.E.M #	Gabriel	Upgrade
ASH-1136	83178		ASH-1229	83209	89414	ASH-25823	83209	89414			
ASH-1154	83177		ASH-25822	83209	89414	ASH-25824	83122	89406			

NISSAN

O.E.M #	Gabriel	Upgrade	O.E.M #	Gabriel	Upgrade	O.E.M #	Gabriel	Upgrade	O.E.M #	Gabriel	Upgrade
561000T825	83515		56101-Z5017	83162		56110-Z5008	83114		56210-Z5001	85085	
56101-30Z01	83161		56110-30Z01	83161		56110-Z5011	G63610		66400	G63432	
56101-30Z02	G63610		56110-30Z02	G63610		56110-Z5014	83162		E61000T825	83515	
56101-Z5008	83114		56110-T8123	G63432		56110-Z5017	83162				
56101-Z5014	83162		56110-T8129	G63432		56201-Z5001	85085				

NOVA BUS

O.E.M #	Gabriel	Upgrade	O.E.M #	Gabriel	Upgrade	O.E.M #	Gabriel	Upgrade	O.E.M #	Gabriel	Upgrade
12J-5-10	85733		680323	85700		G1011823	85710		N16249	85378	
12J-5-11	85313		680326	85700		G1101590	85713		N21543	85378	
22024673	85710		680470	85713		G1201338	85710		N22212	85700	
22045526	85702		680480	85377		G1201339	85702		N31830	85378	
22052014	85702		680481	85378		G1203223	85702		N31831	85377	
481700131250	85377		695393	85377		G1205763	87019		OE 10086S	85702	
481700131252	85378		97-2201-00151	85700		G1205763-001	87019				
680231	85313		97-9999-02514	85700		G5008070	85700				
680232	85733		G1011822	85702		N16248	85377				

OLE GRANNING

O.E.M #	Gabriel	Upgrade	O.E.M #	Gabriel	Upgrade	O.E.M #	Gabriel	Upgrade	O.E.M #	Gabriel	Upgrade
1086	83217										

OPTIMA BUS CORP

O.E.M #	Gabriel	Upgrade	O.E.M #	Gabriel	Upgrade	O.E.M #	Gabriel	Upgrade	O.E.M #	Gabriel	Upgrade
1260008	87017		90-2610-SP1	87017							

Important Note: Competitive Interchanges are to be used for stocking purposes only. Where multiple crosses are identified, please reference the applications section of this catalog.

COMPETITIVE & O.E.M. INTERCHANGE LIST

ORION BUS INDUSTRIES

O.E.M #	Gabriel	Upgrade	O.E.M #	Gabriel	Upgrade	O.E.M #	Gabriel	Upgrade	O.E.M #	Gabriel	Upgrade
010134501-4	85307		050134508	85732		20117503	85720		695327	85732	
010134504-4	85715		050134509	85732		20117504	85720		695343	85732	
010134505-4	85715		050134510	85732		20117505	85720		695347	85732	
010134506-4	85717		050134513	85732		680091	85303	89422	695366	85732	
010134508-4	85732		050230501	85716		680102	85712		695389	87016	
010134509	85717		050231502-4	85716		680271	85715		695420	85729	
010234503-4	85308	89422	050231505	85716		680274	85716		695421	87016	
010234506	85715		050231507	85716		680328	85717		695440	85729	
020117504	85720		060131507	87016		680352	85711		97-9999-02635	85732	
020273541	83203	89436	060131508	87016		680378	85720		97-9999-02636	85716	
020273541-4	85000	89436	060231508	85717		680501	85715		A-4890	85712	
020273544	83203	89436	070131502	87016		680502	85715		OB020570	85711	
0501345-11	85732		070131506	87016		680504	85716		OB020764	85716	
050134501-4	85716		070231514	85729		680505	85717		OB3166657	85700	
050134502-4	85732		070231527	85729		680506	85732				
050134506-4	85732		20117501	85720		690102	85711				

OSHKOSH MOTORS

O.E.M #	Gabriel	Upgrade	O.E.M #	Gabriel	Upgrade	O.E.M #	Gabriel	Upgrade	O.E.M #	Gabriel	Upgrade
12405F	85734		1745500		89430	40-4951	85316	89426	665060	83122	89406
12405F-1	85303	89422	2034140	646177		40-5348	85058	89431	690049	85303	89422
12405FX1	85303	89422	2173340	85303	89422	40-6967	85030	89440	90044448	85051	
1398980	83127		26228-A	83122	89406	4036892	G63605		GBL654875	83117	
1445910	85300	89419	2JD137	83119		5353054	85303	89422	GBL654918	83118	
1573270	83207	89407	3638112	G63183		5361994	85734		P117099	83120	
1573280	83221		40-0242	83312	89409	651444	83221		P117146	83118	
1583470	85051		40-4845	85304		665040	85303	89422	RW24285	83119	

OSHKOSH MOTORS CAB SHOCKS

O.E.M #	Gabriel	Upgrade	O.E.M #	Gabriel	Upgrade	O.E.M #	Gabriel	Upgrade	O.E.M #	Gabriel	Upgrade
1202-0054	83021		2218640	83009							

OSTERLUND TRUCK

O.E.M #	Gabriel	Upgrade	O.E.M #	Gabriel	Upgrade	O.E.M #	Gabriel	Upgrade	O.E.M #	Gabriel	Upgrade
220-S5-10	85712		59011	83214		680117	85300	89419			

OTTAWA TRUCK

O.E.M #	Gabriel	Upgrade	O.E.M #	Gabriel	Upgrade	O.E.M #	Gabriel	Upgrade	O.E.M #	Gabriel	Upgrade
53540451	85300	89419	59011	83214		90013787	85310	89423	9007342	85303	89422
59009	83217		680117	85300	89419	90027577	85720				

PACCAR

O.E.M #	Gabriel	Upgrade	O.E.M #	Gabriel	Upgrade	O.E.M #	Gabriel	Upgrade	O.E.M #	Gabriel	Upgrade
665633	85033	89427									

PACIFIC TRUCK & TRAILER

O.E.M #	Gabriel	Upgrade	O.E.M #	Gabriel	Upgrade	O.E.M #	Gabriel	Upgrade	O.E.M #	Gabriel	Upgrade
3178157C	85735		507202C1	85030	89440						

PAGE SUSPENSION

O.E.M #	Gabriel	Upgrade	O.E.M #	Gabriel	Upgrade	O.E.M #	Gabriel	Upgrade	O.E.M #	Gabriel	Upgrade
1080099	83203	89436	665133	83203	89436	A-2212	85029				
1081933	83204		665267	85029							

PAI CORP

O.E.M #	Gabriel	Upgrade	O.E.M #	Gabriel	Upgrade	O.E.M #	Gabriel	Upgrade	O.E.M #	Gabriel	Upgrade
HSA-5067	85305		HSA-5080	83221		HSA-5095	83215				

PEERLESS TRAILER

O.E.M #	Gabriel	Upgrade	O.E.M #	Gabriel	Upgrade	O.E.M #	Gabriel	Upgrade	O.E.M #	Gabriel	Upgrade
120-1	83125		72-61	83125							

PETERBILT

O.E.M #	Gabriel	Upgrade	O.E.M #	Gabriel	Upgrade	O.E.M #	Gabriel	Upgrade	O.E.M #	Gabriel	Upgrade
02-00376	85302	89420	02-01787	85062	89408	02-02142	85036	89405			
02-00495	85302	89420	02-01890	85012	89413	02-02225	85012	89413			
02-01759	83312	89409	02-02061	85013	89414						

Important Note: Competitive Interchanges are to be used for stocking purposes only. Where multiple crosses are identified, please reference the applications section of this catalog.

COMPETITIVE & O.E.M. INTERCHANGE LIST

PETERBILT... cont'd

O.E.M #	Gabriel	Upgrade	O.E.M #	Gabriel	Upgrade	O.E.M #	Gabriel	Upgrade	O.E.M #	Gabriel	Upgrade
02-02736	85302	89420	23-10393	85308	89422	665945	85902		B71-1001	85070	89459
02-02736PLUS	85302	89420	23-12262	85012	89413	665950	85902		B71-1002	85001	89410
02-02737	85062	89408	471700004423	85109		671052	85070	89459	B71-1003	83312	89409
02-02737PLUS	85062	89408	47902-13PLUS	83122	89406	671091	85069	89455	B71-6000	85959	
02-02738	85012	89413	60670-005PLUS	83137		671092	85012	89413	B71-6002	85012	89413
02-02738PLUS	85012	89413	60670-008	83123	89405	671654	85936	89456	B71-6003	85029	
02-02739	85013	89414	60670-008L	83123	89405	671699	85937		B71-6004	85084	89460
02-02739PLUS	85013	89414	60670-008PLUS	83123	89405	671794	85067	89451	B71-6005	85084	89460
02-02740	85036	89405	60680-003	83112		671962PLUS	85936	89456	B71-6006	85084	89460
02-02741	85012	89413	60680-003L	83112		671962SPL	85936	89456	B71-6007	85062	89408
02-02742	85062	89408	60680-004	83143		671963	85937		B71-6008	83312	89409
02-03020	85910		60680-004L	83143		680026	85302	89420	B71-6009	83219	89408
02-04010	85012	89413	60680-005	83142		680027	85308	89422	B71-6009	85062	89408
03-01635	85308	89422	60680-005L	83142		680185	85308	89422	B71-6010	85023	89415
03-04176	85308	89422	665133	83203	89436	680237	85303	89422	B71-6011	85062	89408
03-04176PLUS	85308	89422	665174	85060		680239	85310	89423	B71-6012	85119	
03-04628	85336		665565PLUS	85007	89412	680240	85302	89420	B71-6013	85012	89413
03-04629	85311	89424	665617	85031		680241	85311	89424	B71-6015	85012	89413
03-05106	85033	89427	665632	85013	89414	680242	85308	89422	B71-6016	85012	89413
03-05384	85033	89427	665633	85033	89427	680253	85314	89425	B71-6016A	85012	89413
03-06084	85033	89427	665655	85062	89408	680261	85062	89408	B71-6017	85910	
03-06084PLUS	85033	89427	665656	85012	89413	680279	83209	89414	B71-6018	85012	89413
03-07281	85311	89424	665657	85013	89414	680280	85906	89407	B71-6019	85989	
03-07420	85336		665658	85036	89405	680281	85003	89411	B71-6020	85989	
03-07421	85311	89424	665660	85033	89427	680303	85007	89412	BFRG072	85182	
03-07421PLUS	85311	89424	665662	85012	89413	680348	85012	89413	C71-1002	85067	89451
03-07421SPL	85311	89424	665738	85910		680425	85320	89429	C71-1002PLUS	85067	89451
03-07423	85033	89427	665752	85067	89451	680435	85033	89427	C71-1011	85069	89455
03-07423PLUS	85033	89427	665762	85012	89413	680457	85302	89420	C71-1011PLUS	85069	89455
03-07424	85311	89424	665783	83123	89405	680458	85336		C71-1011SPL	85069	89455
03-07424PLUS	85311	89424	665784	83122	89406	680459	85311	89424	C71-1013	85985	
03-08350	85343		665785	83137		680473	85319	89428	C71-1014	85936	89456
03-08781	85069	89455	665788	85000	89436	680586	85311	89424	C71-1016	85067	89451
10-12032-002PLUS	85320	89429	665826	85069	89455	70701PLUS	85900		C71-1017	85069	89455
10-12542-000PLUS	85901		665844	85069	89455	800670	85060		C71-6000	85067	89451
12887-01	85013	89414	665858	85070	89459	8086053PLUS	85047	89435	C71-6002	85311	89424
12887-02	85013	89414	665876	85959		85013A0C	85013	89414	C71-6003	85988	
16-13947-000PLUS	85319	89428	665918	85900		90044011	85004		C71-6004	85343	
16725-01	83126		665926	85047	89435	90044025PLUS	83209	89414	C71-6005	85069	89455
1707378PAC	85182		665927	85901		90044089PLUS	83124	89407	C71-6015	85067	89451
19495-01	83126		665928	85062	89408	90045132	85909		K374-26PLUS	85001	89410
19495-01	83126	89440	665930	85001	89410	90045605	85109		K374-28PLUS	85314	89425
2018987C1PLUS	85003	89411	665931	83312	89409	ACHB966	83136		K374-29PLUS	85310	89423
23-08233	85308	89422	665932	85012	89413	B71-1000	85031		K374-33PLUS	83312	89409

PETERBILT CAB SHOCKS

O.E.M #	Gabriel	Upgrade	O.E.M #	Gabriel	Upgrade	O.E.M #	Gabriel	Upgrade	O.E.M #	Gabriel	Upgrade
1201-0012	83023		20-16755	83042		654919	83035		R71-6005	83042	
1201-8002	83081		20-19140	83063		96027-1054	83011		R71-6006	83063	
1201-8006	83081		25523024	83081		PP1058870	83059		R71-6007	83008	
1202-0012	83023		29-02455	83008		PP1059870	83060		R71-6008	83035	
1202-0032	83016		29-06005	83035		PP2582870	83012		R71-6009	83081	
1202-0054	83021		29-06032	83035		R71-1004	83049		R71-6010	83067	
1202-1044	83025		654782	83008		R71-1005	83024				
1202P055	83061		654812	83042		R71-6000	83067				

Important Note: Competitive Interchanges are to be used for stocking purposes only. Where multiple crosses are identified, please reference the applications section of this catalog.

COMPETITIVE & O.E.M. INTERCHANGE LIST

PHOENIX CRUISER RV

O.E.M #	Gabriel	Upgrade	O.E.M #	Gabriel	Upgrade	O.E.M #	Gabriel	Upgrade	O.E.M #	Gabriel	Upgrade
ASH-1136	83178		ASH-1154	83177							

PIERCE MANUFACTURING INC.

O.E.M #	Gabriel	Upgrade	O.E.M #	Gabriel	Upgrade	O.E.M #	Gabriel	Upgrade	O.E.M #	Gabriel	Upgrade
1445910	85300	89419	40-0242	83312	89409	40-4951	85316	89426	40-6967	85030	89440
2034140	646177		40-4845	85304		40-5348	85058	89431	680401	85307	

POWERHOUSE COACH INC.

O.E.M #	Gabriel	Upgrade	O.E.M #	Gabriel	Upgrade	O.E.M #	Gabriel	Upgrade	O.E.M #	Gabriel	Upgrade
141700005838	85098		20551628	85066	89448	471700000443	85066	89448	64838-003L	85933	89454
20433424	85061	89450	21137330	85933	89454	471700003832	85933	89454			
20485632	85933	89454	21436086	85098		471700006040	85088				
20485633	85933	89454	21462380	85088		64838-003	85933	89454			

POWERPACKER CAB SHOCKS

O.E.M #	Gabriel	Upgrade	O.E.M #	Gabriel	Upgrade	O.E.M #	Gabriel	Upgrade	O.E.M #	Gabriel	Upgrade
PP1058870	83059		PP1059870	83060							

PREVOST

O.E.M #	Gabriel	Upgrade	O.E.M #	Gabriel	Upgrade	O.E.M #	Gabriel	Upgrade	O.E.M #	Gabriel	Upgrade
01-0100-905	85303	89422	481700000206	85380		630127	85736		680323	85700	
0822045526	85702		481700000207	85329		630134	85329		680422	85329	
12B-5-1	85735		481700000208	85379		630136	85330		680492	85713	
12L-5-89	85729		481700000209	85713		630161	85736		680510	85330	
12T-1-13	85303	89422	481700999376	85329		630163	85330		680555	85330	
19501288	85729		481700999377	85330		630228	85380		680583	85380	
19501289	85728		481700999386	85736		630234	85329		690060	85713	
19501547	85740		481700999427	85380		630235	85330		74939852	85308	89422
19501669	85339		52001	85708		630236	85329		G1011822	85702	
19502711	85702		63-1013	85329		630251	85379		G5008070	85700	
19506846	85339		630001	85713		630252	85329		N16249	85378	
196347	85710		630080	85713		630253	85713		N22212	85700	
196533	85708		630091	85736		630254	85380				
3166657	85700		630103	85329		650407	85736				

RAMERIZ TRAILER

O.E.M #	Gabriel	Upgrade	O.E.M #	Gabriel	Upgrade	O.E.M #	Gabriel	Upgrade	O.E.M #	Gabriel	Upgrade
18165-01	85006										

RAYDAN MANUFACTURING

O.E.M #	Gabriel	Upgrade	O.E.M #	Gabriel	Upgrade	O.E.M #	Gabriel	Upgrade	O.E.M #	Gabriel	Upgrade
14QK-3100	85739		446-51-211	85739		700115	85712				

RED LION TRAILER

O.E.M #	Gabriel	Upgrade	O.E.M #	Gabriel	Upgrade	O.E.M #	Gabriel	Upgrade	O.E.M #	Gabriel	Upgrade
90044978	85059										

RENEGADE RV

O.E.M #	Gabriel	Upgrade	O.E.M #	Gabriel	Upgrade	O.E.M #	Gabriel	Upgrade	O.E.M #	Gabriel	Upgrade
10-13760-000	85959	89503	20433424	85061	89450	471700000443	85066	89448	SDA471400003920	85958	
10-13809-000	85958		20551628	85066	89448	471700002991	85959	89503	SDA471700002809	85724	89443
141700005838	85098		21436086	85098		471700003920	85958		SDA471700002991	85959	89503
16-18708-000	85724	89443	21462380	85088		471700006040	85088				

REX MIXER

O.E.M #	Gabriel	Upgrade	O.E.M #	Gabriel	Upgrade	O.E.M #	Gabriel	Upgrade	O.E.M #	Gabriel	Upgrade
102-13441-10	646155										

REYCO SUSPENSION

O.E.M #	Gabriel	Upgrade	O.E.M #	Gabriel	Upgrade	O.E.M #	Gabriel	Upgrade	O.E.M #	Gabriel	Upgrade
12885-01	85300	89419	16230-01	85702		17403-01	83122	89406	18165-01	85006	
12885-03	85300	89419	16725-01	83126		17408-01	85005	89430	18166-01	85704	
12886-01	85334		16824-01	85006		17794-01	83215		18286-01		89414
12887-01	85013	89414	17142-01	85001	89410	18146-01	85313		18800-01	83203	89436
12887-02	85013	89414	17146-01	83209	89414	18163-01	83207	89407	19495-01	83126	
14954-01	83217		17358-01	83126	89430	18164-01	83122	89406	19495-01	83126	89440

Important Note: Competitive Interchanges are to be used for stocking purposes only. Where multiple crosses are identified, please reference the applications section of this catalog.

COMPETITIVE & O.E.M. INTERCHANGE LIST

REYCO SUSPENSION... cont'd

O.E.M #	Gabriel	Upgrade	O.E.M #	Gabriel	Upgrade	O.E.M #	Gabriel	Upgrade	O.E.M #	Gabriel	Upgrade
19623-01	83123	89405	22062-01	85007	89412	665748	85086		700098-01	83128	89436
19824-01	85006		23106-01	85975		665813	85051		700098-03	85052	
20125-01	85030	89440	23523-01	85086		665830	85045		701071-01	665937	
20126-01		89440	23524-01	85738		665833	85052		702135-01	85045	
20129-01	85007	89412	23553-01	85938		671707	85323	89436	702136-01	85052	
20960-01	83204		23614-01	85717		680551	85738		702209-01	85014	
21310-01	85307		24392-01	85051		680552	85938		704672-01	85938	
21497-01	85005	89430	665519		89414	680700	85938				

RIDEWELL CORPORATION

O.E.M #	Gabriel	Upgrade	O.E.M #	Gabriel	Upgrade	O.E.M #	Gabriel	Upgrade	O.E.M #	Gabriel	Upgrade
1250005	85901		1267249B000	85712		665267	85029		AS789B000	85014	
1250546B000	85006		1267395B000	85302	89420	665526	85014		S2607B	85702	
1250563B000	85000	89436	1270007	85045		680101	85702		S4025B	85712	
1250789B000	85014		1270563B000	85000	89436	70654	85000	89436	S5477B	85307	
1252607B000	85702		1270563B003	85934		90-1813	85712		S5478B	85307	
1253069B000	85005	89430	1270789B000	85014		90-2610 SP1	87017		S5813B	85704	
1254025B000	85712		1275813B000	85704		AS 4025B	85712		S5878B	83207	89407
1254190B000	85302	89420	1275943B	85005	89430	AS30698	85005	89430	S6009B	83203	89436
1260008	87017		1310002	665937		AS3069B	85005	89430	S7120B	85304	
1265157B000	85712		1310004	665937		AS546B	85006		S7172B	83207	89407
1265478B000	85736		1317570B001	646155		AS563B	83203	89436	S7249B	85307	
1266009B000	83130		57645	85005	89430	AS575B	85005	89430	S7365B	85305	
1267120B000	85734		665198	85005	89430	AS789B	85014				

ROADMASTER (MONACO)

O.E.M #	Gabriel	Upgrade	O.E.M #	Gabriel	Upgrade	O.E.M #	Gabriel	Upgrade	O.E.M #	Gabriel	Upgrade
90045132	85909		90045188	85910							

SABO

Sabo	Gabriel	Upgrade	Sabo	Gabriel	Upgrade	Sabo	Gabriel	Upgrade	Sabo	Gabriel	Upgrade
690459	86203		8901026	85064		8901032	85901		890165B	85121	
8901020	85300		8901027	85310		8901033	85918		890414	85323	
8901021	85320		8901028	85316		8901037	86202		890449	85300	
8901023	85066	89448	8901029	85319		8901038	86201		890612	86202	
8901024	85314		8901029	85724	89443	8901156	G63299		895315	83009	
8901025	83128	89436	8901030	85323	89436	890120	85300		895316	83002	
8901025	85000	89436	8901031	85900		890164B	85179				

SACHS

Sachs	Gabriel	Upgrade	Sachs	Gabriel	Upgrade	Sachs	Gabriel	Upgrade	Sachs	Gabriel	Upgrade
101892	85708		141700131809	85029		313708	85378		315414	85959	
101968	85708		141700131810	83160		313709	85377		315415	85933	89454
106282	85722		141700131975	83160		315389	85090		315416	85003	89411
106884	85708		170210	83104		315390	85918	89449	315417	85923	
106885	85722		170211	83104		315391	85956		315418	83456	89447
112885	85709		280499	85300	89419	315392	85007	89412	315420	85014	
124693	85708		290146	85012	89413	315393	85331		315421	85088	
141700000373	85061	89450	290460	85005	89430	315394	85921		315423	83127	
141700000377	83174		290465	83125		315395	85724	89443	315424	85067	89451
141700000378	83160		290488	85040		315396	85335		315425	85330	
141700000380	85061	89450	311229	85918	89449	315397	83120		315426	85329	
141700000443	85066	89448	311230	85956		315398	85058	89431	315427	85713	
141700000800	85179		311631	85906	89407	315399	85005	89430	315428	85380	
141700000901	83165		311632	85909		315400	85006		315430	85099	
141700002626	85061	89450	311633	85900		315401	85331		315431	85014	
141700005838	85098		311634	85001	89410	315402	85900		315432	89414	
141700005839	85098		311635	85030	89440	315403	85919				
141700125243	85089		311793	85975		315404	85900				
141700125275	83165		311794	85974		315406	85918	89449			
141700125757	85089		312724	85311		315411	83128				

Important Note: Competitive Interchanges are to be used for stocking purposes only. Where multiple crosses are identified, please reference the applications section of this catalog.

COMPETITIVE & O.E.M. INTERCHANGE LIST

SACHS... cont'd

Sachs	Gabriel	Upgrade	Sachs	Gabriel	Upgrade	Sachs	Gabriel	Upgrade	Sachs	Gabriel	Upgrade
315434	85065		315658	83057		471700000451	85080		481700000207	85329	
315435	85088		315659	83047		471700000458	85014		481700000208	85379	
315540	83613		315660	83009		471700000459	85030	89440	481700000209	85713	
315541	85052		315661	85932	89453	471700000460	85097		481700000477	85900	
315542	83122	89406	40-A85-0	85708		471700000461	89414		481700000483	85975	
315543	83125		410010	83317		471700000464	85090		481700000484	85974	
315544	85014		410011	83173		471700000466	85959		481700000485	85975	
315545	85333		410011	85093		471700000470	85918	89449	481700000493	85900	
315546	85005	89430	410021	83125		471700000802	85121		481700004271	85993	
315547	85924	89457	410022	85006		471700002580	83165		481700004476	85982	
315548	85070	89459	410023	85103		471700002627	85066	89448	481700005414	85179	
315549	85033	89427	410024	85302	89420	471700002726	85918	89449	481700008558	85347	
315550	85311	89424	410025	83215		471700002727	85959		481700008666	87020	
315551	85310	89423	410026	85918	89449	471700002809	85724	89443	481700125969	85956	
315552	83128		410032	85320	89429	471700002861	85014		481700131250	85377	
315553	85900		410035	85001	89410	471700002919	85106		481700131252	85378	
315554	85006		410035	85337		471700002990	85007	89412	481700131438	85919	
315555	83038		410036	85061	89450	471700002991	85959		481700131919	85900	
315556	85314	89425	410037	85081		471700002992	85331		481700999376	85329	
315593	85029		410038	85100		471700002993	85921		481700999377	85330	
315594	85029		410040	85005	89430	471700002994	83134		481700999386	85376	
315597	85959		410042	85310	89423	471700002995	83134		481700999427	85380	
315598	85933	89454	410043	85957		471700002996	85335		510001	85716	
315599	85109		410044	85031		471700003009	85006		510002	85302	89420
315600	85959		410046	83136		471700003011	85058		510002	85983	
315601	85920		410047	85071		471700003832	85933	89454	510003	85004	
315602	85092		410048	83207		471700003920	85958		510004	85307	
315603	83134		410048	83304		471700004270	85117		510005	85303	
315606	85061	89450	410048	85014		471700004423	85109		510006	85705	
315607	85061	89450	410050	85121		471700005079	85005	89430	510006	85706	
315608	85066	89448	410051	85108		471700006039	85088		510009	85711	
315609	85066	89448	410052	85096		471700006040	85088		510011	87020	
315610	83026		410053	85095		471700006048	83165		510014	85352	
315611	85337		410056	85000	89436	471700006269	85932	89453	510017	85323	89436
315612	85006		410057	85013		471700009646	85088		510018	85724	89443
315613	85030	89440	410058	83122		471700009647	85088		510019	85916	
315614	85097		410068	85030	89440	471700011530	85181		510023	85316	89426
315615	83027		410068	85054		471700011531	85180		510024	85381	
315616	83038		410069	83165		471700125245	85089		510039	85982	
315617	85918	89449	410069	85094		471700131155	85918	89449	510040	85110	
315618	83160		410070	85089		471700131256	85065		814903003482	83040	
315619	83160		471700000426	85014		471700131258	85081		814903003483	83039	
315620	85080		471700000428	85006		471700131331	85932	89453	814903003484	83057	
315621	85080		471700000431	85066	89448	471700131545	85006		814903003486	83047	
315622	85081		471700000433	85099		471700131646	85918	89449	814903003496	83009	
315623	85918	89449	471700000436	85030	89440	471700131775	85006		814903003500	83026	
315624	85959		471700000440	85959		471700131778	85331		814903003501	83027	
315625	85975		471700000443	85066	89448	471700131920	85933	89454	814903003528	83038	
315626	85933	89454	471700000445	85080		471700131921	85933	89454	823196420	85100	
315656	83040		471700000447	85919		471700131974	85029				
315657	83039		471700000449	85918	89449	481700000206	85380				

SAF HOLLAND

O.E.M #	Gabriel	Upgrade	O.E.M #	Gabriel	Upgrade	O.E.M #	Gabriel	Upgrade	O.E.M #	Gabriel	Upgrade
471700000433	85099		471700000460	85097		481700000485	85975				
471700000436	85030	89440	471700000461		89414	57639	85000	89436			
471700000458	85014		481700000483	85975		57643	85013	89414			
471700000459	85030	89440	481700000484	85974		6025	83122	89406			

Important Note: Competitive Interchanges are to be used for stocking purposes only. Where multiple crosses are identified, please reference the applications section of this catalog.

COMPETITIVE & O.E.M. INTERCHANGE LIST

SAF HOLLAND... cont'd

O.E.M #	Gabriel	Upgrade	O.E.M #	Gabriel	Upgrade	O.E.M #	Gabriel	Upgrade	O.E.M #	Gabriel	Upgrade
6026	83204		90044681	83204		90045068		89441	90045535	85097	
632155	646177		90044682	83209	89414	90045075	85911		90045536		89414
646201	646177		90044683	83122	89406	90045080	85912		90045563	85014	
665002	85004		90044684	83124	89407	90045083	85910		90045564	83128	89436
665003	85300	89419	90044685	83389	89436	90045084	85968		90045568	85060	
665197	85051		90044686	85051		90045096	85916	89430	90045572	85045	
665454	85045		90044687	83125		90045099	85906	89407	90045574	83130	
665514	83127		90044688	83122	89406	90045110	83137		90045575	85051	
665969		89430	90044769	83207	89407	90045132	85909		90045576	83150	
671921	85916	89430	90044770	83207	89407	90045138	85910		90045605	85109	
671922		89405	90044794	83127		90045175	85916	89430	90045607	83150	
671923		89440	90044833	85052		90045188	85910		90045608	83363	
671931	85916	89430	90044834	85052		90045207		89405	90045665	85029	
680234	85906	89407	90044868	85045		90045277	85030	89440	90045666	83130	
680268	85323	89436	90044878	83635		90045298	83363		90045666	85051	
680645	85321		90044907	83635		90045299	83389	89436	90045667	85060	
90044001	85005	89430	90044915	83127		90045331	646155		90045669	83389	89436
90044008	85000	89436	90044977	83115		90045336	85014		AR-1008	85006	
90044011	85004		90044978	85059		90045337	85911		AR-1141	83204	
90044012	85006		90044979	83113		90045338	85060		AR-1141-C	83204	
90044016	85300	89419	90044980	85907		90045381	83150		AR-1202	85300	89419
90044017	83204		90044981	85000	89436	90045384		89430	AR-134-C	85005	89430
90044025	83209	89414	90044982	85000	89436	90045418	85916	89430	AR-1404	85301	
90044046	83123	89405	90044991	85000	89436	90045419		89405	AR-1425	85301	
90044071	85000	89436	90044992	85000	89436	90045420		89440	AR-1434	83203	89436
90044081	85000	89436	90045000	85906	89407	90045432	85321		AR-1654	83209	89414
90044086	85000	89436	90045001	85323	89436	90045433	85916	89430	AR-1822	85304	
90044089	83124	89407	90045002	85906	89407	90045455	85909		AR-2451	83203	89436
90044089C	83124	89407	90045003	85323	89436	90045466		89406	AR-2598	83123	89405
90044095	83203	89436	90045028	85907		90045471	83150		AR-718-C	83203	89436
90044162	83128	89436	90045031	85968		90045499	85974		AR-718-C-HD	85000	89436
90044448	85051		90045040	83130		90045500	85975		AR-781	83203	89436
90044625	83125		90045048	85905		90045503	85975		AR-958	83207	89407
90044626	83126	89430	90045049	85905		90045504	85030	89440	AR-995	85734	
90044642	83127		90045050	85914		90045532	85030	89440	XB-SPN-053-36	83125	
90044679	83122	89406	90045053	85908		90045533	85099				
90044680	83125		90045054	85051		90045534	85014				

SEAGRAVE FIRE APPARATUS LLC

O.E.M #	Gabriel	Upgrade	O.E.M #	Gabriel	Upgrade	O.E.M #	Gabriel	Upgrade	O.E.M #	Gabriel	Upgrade
680117	85300	89419	P0025500	85300	89419						

SHASTA RV

O.E.M #	Gabriel	Upgrade	O.E.M #	Gabriel	Upgrade	O.E.M #	Gabriel	Upgrade	O.E.M #	Gabriel	Upgrade
ASH-1136	83178		ASH-1154	83177							

SICARD

O.E.M #	Gabriel	Upgrade	O.E.M #	Gabriel	Upgrade	O.E.M #	Gabriel	Upgrade	O.E.M #	Gabriel	Upgrade
3166657	85700										

SPARTAN MOTORS

O.E.M #	Gabriel	Upgrade	O.E.M #	Gabriel	Upgrade	O.E.M #	Gabriel	Upgrade	O.E.M #	Gabriel	Upgrade
0272-SS5	85712		471700000456	85959		60665-025	85036	89405	B46-1594	85013	89414
0346-SS5	85013	89414	58913-009	85959		60665-025L	85036	89405	B46-1725	85029	
0377-SS5	85029		58913-009L	85959		78068	85304		B46-2151	85007	89412
21310-01	85307		59011	83214		AS 4025B	85712				

SPRING VALLEY

O.E.M #	Gabriel	Upgrade	O.E.M #	Gabriel	Upgrade	O.E.M #	Gabriel	Upgrade	O.E.M #	Gabriel	Upgrade
632155	646177										

Important Note: Competitive Interchanges are to be used for stocking purposes only. Where multiple crosses are identified, please reference the applications section of this catalog.

COMPETITIVE & O.E.M. INTERCHANGE LIST

STARCRAFT BUS CO.

O.E.M #	Gabriel	Upgrade	O.E.M #	Gabriel	Upgrade	O.E.M #	Gabriel	Upgrade	O.E.M #	Gabriel	Upgrade
3578858C1	85926		4C4Z-18124-JB	85928		AA-617	85928		FC44-18045-BB	85181	
3578858C2	85926		4C4Z-18124-QA	83175		ASH-1136	83178		FC44-18080-AB	85180	
3584116C1	83175		4C4Z-18124-RA	85928		ASH-1154	83177		FC4Z-18124-A	85181	
3584116C2	83175		4C4Z-18125-B	83317		ASH-24658	85181		FC4Z-18124-B	85181	
3584118C2	85928		4C4Z-18125-DA	85926		ASH-24659	85181		FC4Z-18125-A	85180	
471700011530	85181		501906C92	83317		ASH-24660	85180				
471700011531	85180		AA-616	83175		AT-812	85928				

STERLING TRUCK

O.E.M #	Gabriel	Upgrade	O.E.M #	Gabriel	Upgrade	O.E.M #	Gabriel	Upgrade	O.E.M #	Gabriel	Upgrade
10-12388-000	85920	89503	90045099	85906	89407	F4HT-18080-AB	85314	89425	F6HT-18080-DA	83109	
10-12390-000	85920	89503	AT-560	G63809		F4HT-18080-BA	85001	89410	F6HT-18080-EA	85906	89407
10-13205-000	85918	89449	AX-267A	83309	89446	F5HZ-18124-A	83314		F6HT-18080-FC	85013	89414
10-13592-000	85959		AX-310	83215		F5HZ-18124-B	83107		F6HT-18124-JC	83200	89402
1210-0528	85904		C4HZ-18124-E	83309	89446	F5HZ-18124-C	85063		F6HT-18124-KA	83200	89402
16-13957-000	85724	89443	C4TZ-18124-AB	83308		F5HZ-18124-D	83125		F6HZ-18124-A	85054	89438
16-15770-000	85956		D8HZ-18124-A	85301		F5HZ-18125-A	85314	89425	F6HZ-18124-B	83308	
16-15817-000	85724	89443	E6HZ-18124-A	85301		F5HT-18125-B	85001	89410	F6HZ-18124-C	85055	89439
16-18708-000	85724	89443	E6HZ-18124-D	85301		F6HT-18045-AA	85054	89438	F6HZ-18124-D	85055	89439
471700002809	85724	89443	E6HZ-18125-D	83215		F6HT-18045-AC	85054	89438	F6HZ-18124-E	85055	89439
471700131646	85918	89449	E7HZ-18124-A	85301		F6HT-18045-BC	85047	89435	F6HZ-18124-F	85055	89439
47902-28	85013	89414	E7XZ-18124-A	G63386		F6HT-18045-CC	85055	89439	F6HZ-18124-G	85054	89438
481700006848	85724	89443	E7XZ-18125-B	G63387		F6HT-18045-EB	85055	89439	F6HZ-18124-H	85054	89438
481700125969	85956		E9HZ-18124-A	83309	89446	F6HT-18045-EC	85055	89439	F6HZ-18124-J	83200	89402
4C4Z-18124-N	85957		F0HZ-18124-B	85006		F6HT-18045-GB	85030	89440	F6HZ-18125-B	83109	
4C4Z-18125-DA	85926		F1HZ-18124-A	83309	89446	F6HT-18045-GC	85030	89440	F6HZ-18125-D	85013	89414
57241-2	83109		F1HZ-18124-B	83308		F6HT-18045-HB	85054	89438	F81A-18045-AGB	G63809	
58913-003	85932	89453	F1HZ-18124-D	85006	89401	F6HT-18045-HC	85054	89438	SDA47170000440	85959	
58913-003L	85932	89453	F1HZ-18124-E	85006	89401	F6HT-18045-JB	83200	89402	SDA471700002809	85724	89443
6803230200	85043		F1HZ-18124-H	85040		F6HT-18045-JC	83200	89402	XC45-18045-AA	83216	
6803230300	85006		F1HZ-18124-J	83308		F6HT-18045-KA	83200	89402	XC45-18080-BA	85724	89443
6803260000	83120		F1HZ-18124-K		89402	F6HT-18045-LA	85376				
680611	85724	89443	F2HZ-18124-A	85376		F6HT-18080-B	83109				
6E7Z-18125-A	83146		F2HZ-18124-B	85301		F6HT-18080-CA	85314	89425			

STERLING TRUCK CAB SHOCKS

O.E.M #	Gabriel	Upgrade	O.E.M #	Gabriel	Upgrade	O.E.M #	Gabriel	Upgrade	O.E.M #	Gabriel	Upgrade
1202-1043	83025		18-45067-000	83034		18-814903003484	83057		F6HZ-5K407-BA	83033	
18-43504-000	83057		18-60768-000	83057		F6HZ-5K407-AB	83034		F8HT-5K407-AA	83033	

STOUGHTON TRAILERS INC.

O.E.M #	Gabriel	Upgrade	O.E.M #	Gabriel	Upgrade	O.E.M #	Gabriel	Upgrade	O.E.M #	Gabriel	Upgrade
HTA20001	83128	89436	NW90044162	83128	89436	NW90044978	85059		RT18165-01	85006	
HTA20002	85000	89436	NW90044448	85051		NW90044979	83113				

SUSPENSIONS INC.

O.E.M #	Gabriel	Upgrade	O.E.M #	Gabriel	Upgrade	O.E.M #	Gabriel	Upgrade	O.E.M #	Gabriel	Upgrade
200188	646155										

SUSPENSYS

O.E.M #	Gabriel	Upgrade	O.E.M #	Gabriel	Upgrade	O.E.M #	Gabriel	Upgrade	O.E.M #	Gabriel	Upgrade
218004872	85737										

TEREX CORPORATION

O.E.M #	Gabriel	Upgrade	O.E.M #	Gabriel	Upgrade	O.E.M #	Gabriel	Upgrade	O.E.M #	Gabriel	Upgrade
12111	646155										

THE BINKLEY COMPANY

O.E.M #	Gabriel	Upgrade	O.E.M #	Gabriel	Upgrade	O.E.M #	Gabriel	Upgrade	O.E.M #	Gabriel	Upgrade
16965	85006		6898	83125							

THOMAS SCHOOL BUS

O.E.M #	Gabriel	Upgrade	O.E.M #	Gabriel	Upgrade	O.E.M #	Gabriel	Upgrade	O.E.M #	Gabriel	Upgrade
10-13211-000	85918	89449	128745	83102							
10-13634-000	85918	89449	16-15817-000	85724	89443						

Important Note: Competitive Interchanges are to be used for stocking purposes only. Where multiple crosses are identified, please reference the applications section of this catalog.

COMPETITIVE & O.E.M. INTERCHANGE LIST

THOMAS SCHOOL BUS... cont'd

O.E.M #	Gabriel	Upgrade	O.E.M #	Gabriel	Upgrade	O.E.M #	Gabriel	Upgrade	O.E.M #	Gabriel	Upgrade
16-18708-000	85724	89443	61300223	85091		63-0001	85713		8C24-18080-DB	83178	
16-18713-000	85122		61300224	85918	89449	651442	83102		8C2Z-18124-D	83177	
16-19138-000	85058	89431	61300240	85918	89449	659287	83102		8C2Z-18125-D	83178	
300-0614966	85307		61300285	83102		680-323-0300	85006		90045504	85030	89440
471700003070	85122		6130029	85712		680-326-0000	83120		A-4890	85712	
471700131545	85006		61310101	85736		680010	85304		ASH-1136	83178	
60670-006	83147		61310102	85308	89422	680054	85307		ASH-1154	83177	
60670-006L	83147		61310103	85308	89422	680088	85713		AT-163G	83177	
60998-001	85006		61310104	85713		680102	85712		AT-164G	83178	
60998-003	85006		61310232	85000	89436	6803260000	83120		GBL651442	83102	
6130-0114		89437	61310434	85724	89443	70445	85091		GBL654725	83120	
61300112	83613		61310478	85724	89443	728802	85736		GBL665538	85006	
61300219	85091		614966	85307		87002	85736				
61300222	85091		614974	85304		8C24-18045-DA	83177				

THOR MOTOR COACH

O.E.M #	Gabriel	Upgrade	O.E.M #	Gabriel	Upgrade	O.E.M #	Gabriel	Upgrade	O.E.M #	Gabriel	Upgrade
141700131809	85029		16-16873-000	85029		ASH-1136	83178		ASH-25823	83209	89414
141700131810	83160		16-16874-000	83160		ASH-1154	83177		ASH-25824	83122	89406
16-16736-000	85029		16-18103-000	85900		ASH-1229	83209	89414			
16-16737-000	83160		481700000493	85900		ASH-25822	83209	89414			

TIFFIN MOTORHOMES INC

O.E.M #	Gabriel	Upgrade	O.E.M #	Gabriel	Upgrade	O.E.M #	Gabriel	Upgrade	O.E.M #	Gabriel	Upgrade
58913-009	85959		58913-009L	85959							

TIMBREN INDUSTRIES

O.E.M #	Gabriel	Upgrade	O.E.M #	Gabriel	Upgrade	O.E.M #	Gabriel	Upgrade	O.E.M #	Gabriel	Upgrade
665804	85939										

TRAILMOBILE CANADA CORP.

O.E.M #	Gabriel	Upgrade	O.E.M #	Gabriel	Upgrade	O.E.M #	Gabriel	Upgrade	O.E.M #	Gabriel	Upgrade
43-4-235	85051		43-6-028	85000	89436	43-8-014	85013	89414	90044978	85059	
43-4-236	85029		43-6-118	85000	89436	43-8-015	85006		90044979	83113	
43-4-237	85000	89436	43-6-137	85006		43-8-022	83225		90044992	85000	89436
43-4-239	83207	89407	43-6-158	85013	89414	43-8-031	85029		90045054	85051	
43-4-241	85006		43-6-164	83207	89407	90044089	83124	89407	A-2212	85029	
43-4-277	85000	89436	43-8-002	83209	89414	90044625	83125				
43-4-278	85059		43-8-011	83207	89407	90044642	83127				
43-4-279	83204		43-8-013	85000	89436	90044977	83115				

TRANSPORTATION MFG. CORP

O.E.M #	Gabriel	Upgrade	O.E.M #	Gabriel	Upgrade	O.E.M #	Gabriel	Upgrade	O.E.M #	Gabriel	Upgrade
12-05-6000	85711		12J-5-2	85733		12L-5-99	85339		680349	85702	
12-05-6002	85339		12J-5-3	85313		12T-1-13	85303	89422	680350	85710	
12-05-6033	85339		12J-5-4	85733		12TA-01-13	85303	89422	680470	85713	
12B-5-1	85735		12J-5-6	85313		22024673	85710		695273	85710	
12G-5-1	85700		12J-5-9	85700		22045526	85702		695279	85710	
12J-5-10	85733		12L-5-69	85700		22046485	85710		G1011822	85702	
12J-5-11	85313		12L-5-70	85700		22052014	85702		G1101590	85713	

TRUCKMASTER

Truckmaster	Gabriel	Upgrade	Truckmaster	Gabriel	Upgrade	Truckmaster	Gabriel	Upgrade	Truckmaster	Gabriel	Upgrade
665632	85013	89414	665928	85062	89408	680237	85303	89422	680280	85906	89407
665633	85033	89427	665930	85001	89410	680239	85310	89423	680281	85003	89411
665783	83123	89405	665931	83312	89409	680240	85302	89420	680283	85740	
665784	83122	89406	665932	85012	89413	680241	85311	89424	680303	85007	89412
665785	83137		665950	85902		680242	85308	89422	680348	85012	89413
665844	85069	89455	671052	85070	89459	680243	85001	89410	680385	85311	89424
665918	85900		671654	85936	89456	680253	85314	89425	680425	85320	89429
665926	85047	89435	671699	85937		680261	85062	89408	680435	85033	89427
665927	85901		671794	85067	89451	680279	83209	89414	680473	85319	89428

Important Note: Competitive Interchanges are to be used for stocking purposes only. Where multiple crosses are identified, please reference the applications section of this catalog.

COMPETITIVE & O.E.M. INTERCHANGE LIST

TRUCKMASTER... cont'd

Truckmaster	Gabriel	Upgrade	Truckmaster	Gabriel	Upgrade	Truckmaster	Gabriel	Upgrade	Truckmaster	Gabriel	Upgrade
680586	85311	89424	680601	85012	89413						

TURTLETOP BUS

O.E.M. #	Gabriel	Upgrade	O.E.M. #	Gabriel	Upgrade	O.E.M. #	Gabriel	Upgrade	O.E.M. #	Gabriel	Upgrade
ASH-1136	83178		ASH-1154	83177							

TUTHILL TECHNOLOGIES

O.E.M. #	Gabriel	Upgrade	O.E.M. #	Gabriel	Upgrade	O.E.M. #	Gabriel	Upgrade	O.E.M. #	Gabriel	Upgrade
1085	83214		17358-01	83126	89430	19495-01	83126		23614-01	85717	
12885-01	85300	89419	17403-01	83122	89406	19495-01	83126	89440	24392-01	85051	
12885-03	85300	89419	17408-01	85005	89430	19623-01	83123	89405	2697	85712	
12887-01	85013	89414	17794-01	83215		19824-01	85006		66502	646155	
12887-02	85013	89414	18146-01	85313		20125-01	85030	89440	680162	85300	89419
14954-01	83217		18163-01	83207	89407	20126-01		89440	702135-01	85045	
16230-01	85702		18164-01	83122	89406	20129-01	85007	89412	702136-01	85052	
16725-01	83126		18165-01	85006		20960-01	83204		702209-01	85014	
16824-01	85006		18166-01	85704		21497-01	85005	89430	OE12425	83214	
17142-01	85001	89410	18286-01		89414	23524-01	85738				
17146-01	83209	89414	18800-01	83203	89436	23553-01	85938				

TWIN COACH

O.E.M. #	Gabriel	Upgrade	O.E.M. #	Gabriel	Upgrade	O.E.M. #	Gabriel	Upgrade	O.E.M. #	Gabriel	Upgrade
90044089	83124	89407	90044162	83128	89436	AR-958	83207	89407			
90044089C	83124	89407	AR-718-C-HD	85000	89436						

UNITED MANUFACTURING

O.E.M. #	Gabriel	Upgrade	O.E.M. #	Gabriel	Upgrade	O.E.M. #	Gabriel	Upgrade	O.E.M. #	Gabriel	Upgrade
K-96-41	85304										

UNIVERSAL COACH

O.E.M. #	Gabriel	Upgrade	O.E.M. #	Gabriel	Upgrade	O.E.M. #	Gabriel	Upgrade	O.E.M. #	Gabriel	Upgrade
12-05-1199	85729		680777	85729							

UPS TRUCK

O.E.M. #	Gabriel	Upgrade	O.E.M. #	Gabriel	Upgrade	O.E.M. #	Gabriel	Upgrade	O.E.M. #	Gabriel	Upgrade
P117099	83120		P117146	83118							

UTILITY TRAILER MANUFACTURING COMPANY

O.E.M. #	Gabriel	Upgrade	O.E.M. #	Gabriel	Upgrade	O.E.M. #	Gabriel	Upgrade	O.E.M. #	Gabriel	Upgrade
B-23361	85911		B-24023	85738		B-24125	85323	89436	S-24088	83128	89436
B-23566	85000	89436	B-24088	83128	89436	B-24579	85939		S-24088	85000	89436
B-23651	85045		B-24088	85000	89436	B-25515	85338				

VAN HOOL

O.E.M. #	Gabriel	Upgrade	O.E.M. #	Gabriel	Upgrade	O.E.M. #	Gabriel	Upgrade	O.E.M. #	Gabriel	Upgrade
10685703	695406		6243-14040	85708		665562	85708		90-2291	695406	
6243-13790	85708		624314570	695406		665563	85708				

VARIOUS

O.E.M. #	Gabriel	Upgrade	O.E.M. #	Gabriel	Upgrade	O.E.M. #	Gabriel	Upgrade	O.E.M. #	Gabriel	Upgrade
SC-2920	83176										

VOLVO

O.E.M. #	Gabriel	Upgrade	O.E.M. #	Gabriel	Upgrade	O.E.M. #	Gabriel	Upgrade	O.E.M. #	Gabriel	Upgrade
02-7005976	83400		1091358	83456	89447	1091372	85301		1093180	85030	89440
02-7005977	83400		1091359	83123	89405	1091373	85302	89420	141700000373	85061	89450
03-1106460	85005	89430	1091360	83303		1091374	85303	89422	141700005838	85098	
1-0200-32-888-1	83104		1091361	83304		1091375	85304		1505190	85722	
1091347	83125		1091362	83309	89446	1091376	85305		1590439	83104	
1091348	83122	89406	1091363	83221		1091377	85307		1591501	85722	
1091349	83204		1091364	83312	89409	1091378	85308	89422	1591735	83104	
1091350	83207	89407	1091365	83400		1091379	85310	89423	1593843	83215	
1091351	83209	89414	1091366	83401		1091384	85735		1716824	85304	
1091353	83215		1091367	85000	89436	1093100	85027	89418			
1091354	83216		1091368	85003	89411	1093176	85024				
1091355	83217		1091370	85006		1093177	85025				
1091357	83219		1091371	85300	89419	1093178	85026	89417			

Important Note: Competitive Interchanges are to be used for stocking purposes only. Where multiple crosses are identified, please reference the applications section of this catalog.

COMPETITIVE & O.E.M. INTERCHANGE LIST

VOLVO... cont'd

O.E.M.#	Gabriel	Upgrade	O.E.M.#	Gabriel	Upgrade	O.E.M.#	Gabriel	Upgrade	O.E.M.#	Gabriel	Upgrade
19501669	85339		3199965	85736		3919561	85314	89425	3919935	85026	89417
19502711	85702		3199966	85303	89422	3919565	83103		3919936	83207	89407
19506846	85339		3199967	85302	89420	3919567	83613		3919937	85316	89426
20353932	85081		3199968	85308	89422	3919569	85052		3919938	85030	89440
20414440	85081		3199972	85320	89429	3919570	83128	89436	3919939	85058	89431
20433424	85061	89450	3199973	85722		3919571	83635		3919940	85005	89430
20433425	85066	89448	3199974	85712		3919572	83130		3919941	85006	
20433426	85081		3199975	85700		3919573	83123	89405	3919942	89402	
20433427	85065		3199976	85711		3919574	85006	89401	3919943	85012	89413
20434880	85081		3199977	85711		3919575	83120		3919944	85036	89405
20469001	85933	89454	3199978	85712		3919582	83215		3919945	85027	89418
20469002	85933	89454	3199979	85702		3919583	83100		3919946	85033	89427
20485632	85933	89454	3199980	85310	89423	3919585	83209	89414	3919947	85013	89414
20485633	85933	89454	3199982	85703		3919586	83100		3919948	85311	89424
20513881	85061	89450	3199983	85704		3919587	83105		3919949	85310	89423
20551628	85066	89448	3199984	85314	89425	3919588	83216		3919950	83219	
20782199	85072		3199985	85723		3919589	85026	89417	3919951	83309	89446
20863239	85080		3199986	85318		3919590	85042		3919952	85736	
21137330	85933	89454	3199987	85705		3919591	83515		3919953	85319	89428
21436086	85098		3199988	85311	89424	3919592	85024		3919954	85003	89411
21462378	85088		3199989	85709		3919593	83242		3919955	85300	89419
21462380	85088		3199990	85003	89411	3919594	85003	89411	3919956	85036	89405
22012065	85304		3199991	85708		3919596	G63484		3919957	83122	89406
22046483	85304		3199992	85733		3919598	83312	89409	3919958	85046	89434
22052336	85304		3199993	85712		3919900	85012	89413	3919959	85000	89436
3082284	83400		3199994	85308	89422	3919901	83103		3919960	85322	
3092842	85061	89450	35901-0001	83209	89414	3919902	83126	89430	3919961	85302	89420
3130140	85315		35901-0003	85301		3919903	83216		3919962	85700	
3171696	85307		35901-0004	83219		3919904	G63183		3919964	85304	
3172948	85303	89422	35901-0005	83219		3919906	83308		3919965	85702	
3199937	85316	89426	35901-0008	85060		3919907	83309	89446	3919966	85736	
3199938	85030	89440	35901-0011	83123	89405	3919908	83104		3919967	85302	89420
3199939	85058	89431	35901-0017	83314		3919909	G63605		3919968	85736	
3199940	85005	89430	35901-0022	83635		3919910	83221		3919972	85320	89429
3199941	85006		35901-3201	85024		3919911	83124	89407	3919973	85956	
3199942		89402	35901-3406	85305		3919912	83215		3919974	85712	
3199943	85012	89413	35901-3409	85304		3919913	83203	89436	3919975	85700	
3199944	85006		35901-3410	85307		3919914	83209	89414	3919976	85033	89427
3199945	85027	89418	35901-3413	85006		3919915	83127		3919977	85033	89427
3199946	85033	89427	35901-3420	85303	89422	3919916	83126	89430	3919978	85702	
3199947	85013	89414	37001-5	83401		3919917	83125		3919979	85702	
3199948	85311	89424	37301-0001	85013	89414	3919918	83401		3919980	85702	
3199949	85310	89423	37301-0008	83400		3919919	G63625		3919982	85703	
3199950	85023	89415	37301-0016	85026	89417	3919920	83303		3919983	85704	
3199951	85024		37301-0018	85005	89430	3919921	83123	89405	3919984	85700	
3199952	85736		37301-0021	85026	89417	3919922	83318		3919985	85723	
3199953	85319	89428	37301-3201	85027	89418	3919923	83301		3919987	85706	
3199954	85003	89411	37301-3202	85026	89417	3919924	83456	89447	3919988	85311	89424
3199955	85300	89419	3915917	85319	89428	3919925	83317		3919989	85709	
3199956	85036	89405	3915947	85001	89410	3919926	G63403		3919990	85003	89411
3199957	83122	89406	3915948	85311	89424	3919927	83101		3919991	85708	
3199959	85323	89436	3916352	85013	89414	3919928	83225		3919992	85733	
3199960	85322		3919055	85007	89412	3919931	83126	89430	3919993	85712	
3199961	85307		3919056	83203	89436	3919932	85062	89408	3919994	85310	89423
3199962	85314	89425	3919057	83225		3919933	85001	89410	3945806		89417
3199963	85315		3919526	83314		3919934	85320	89429	3945808		89407

Important Note: Competitive Interchanges are to be used for stocking purposes only. Where multiple crosses are identified, please reference the applications section of this catalog.

COMPETITIVE & O.E.M. INTERCHANGE LIST

VOLVO... cont'd

O.E.M #	Gabriel	Upgrade	O.E.M #	Gabriel	Upgrade	O.E.M #	Gabriel	Upgrade	O.E.M #	Gabriel	Upgrade
3945809		89410	629501	85307		83176205	83136		RC SA3203	83203	89436
3945810		89420	646220	85734		83176206	83148		RC SA3216	83216	
3945811		89409	64838-001	85933	89454	83176207	83203	89436	RC SA5000	85000	89436
3945812		89423	64838-002	85933	89454	83176208	83209	89414	RC SA5001	85001	89410
3945813		89428	64838-003	85933	89454	83176209	83215		RC SA5003	85003	89411
3945814		89424	64838-003L	85933	89454	83176210	83216		RC SA5005	85005	89430
3945815		89406	66010-0016	85025		83176211	85000	89436	RC SA5047	85047	89435
3945816		89430	66221140I	83215		83176212	85001	89410	RC SA5052	85052	
3945817		89422	665410	85027	89418	83176213	85003	89411	RC SA5061	85061	89450
3945818		89415	665539	85026	89417	83176214	85005	89430	RC SA5062	85062	89408
3945819		89411	665607	85047	89435	83176215	85023	89415	RC SA5066	85066	89448
3945820		89413	665623	85046	89434	83176216	85026	89417	RC SA5067	85067	89451
3945821		89419	665739	85047	89435	83176217	85033	89427	RC SA5070	85070	89459
3946210	83103		668302	83216		83176218	85036	89405	RC SA5310	85310	89423
3946217	83125		676081	83401		83176219	85045		RC SA5320	85320	89429
3946219	83400		676082	83401		83176220	85046	89434	RC SA5724	85724	89443
3946239	85724	89443	6771501	85040		83176221	85047	89435	RC SA5900	85900	
3949240	85047	89435	6772218	85040		83176222	85052		RC SA5918	85918	89449
3949241	85061	89450	6775411	85040		83176223	85061	89450	RC SA5933	85933	89454
3953643	85040		6775412	85040		83176224	85062	89408	RC SA6155	646155	
3971703	83112		6790756	83215		83176225	85066	89448	SA3019	83019	
3972662	85976		6794358	85040		83176226	85067	89451	SA3041	83041	
47170000443	85066	89448	6857668	83105		83176227	85069	89455	SA3045	83045	
471700002627	85066	89448	6876828	83105		83176228	85070	89459	SA3048	83048	
471700003832	85933	89454	70042	85302	89420	83176229	85303	89422	SA3103	83103	
471700004423	85109		8026658	85046	89434	83176230	85310	89423	SA3110	83110	
471700006038	85088		8056892	85023	89415	83176231	85311	89424	SA3111	83111	
471700006040	85088		8060026	85065		83176232	85320	89429	SA3112	83112	
471700131256	85065		8065787	85026	89417	83176233	85321		SA3123	83123	
471700131258	85081		8071524	85024		83176234	85323	89436	SA3124	83124	
471700131920	85933	89454	8071881	85061	89450	83176235	85724	89443	SA3125	83125	
471700131921	85933	89454	8073212	85065		83176236	85900		SA3126	83126	
47902-24	83137		8075257	85065		83176237	85916	89430	SA3127	83127	
494-660	83219		8075287	85065		83176238	85918	89449	SA3128	83128	89436
4940640	83216		8077874	85047	89435	83176239	85933	89454	SA3136	83136	
4975479	83400		8077874-P01	85047	89435	83176240	646155		SA3148	83148	
4975480	83400		8078195	85061	89450	85104186	85006		SA5000	85000	89436
4975549	83216		8083872	85978		85104221	85066	89448	SA5001	85001	89410
530596	85308	89422	8086053	85047	89435	85106580	85918	89449	SA5003	85003	89411
5322338	83214		8086651	85066	89448	85107238	85976		SA5005	85005	89430
5513989	83216		8169859	85047	89435	85134402	85061	89450	SA5023	85023	89415
5531435	85307		8174749	85906	89407	85137234	83125		SA5026	85026	89417
5531436	85307		83176191	83019		85137420	85000	89436	SA5033	85033	89427
5531437	85307		83176192	83041		90045605	85109		SA5036	85036	89405
5534430	85303	89422	83176193	83045		RC SA3041	83041		SA5045	85045	
5534447	85303	89422	83176194	83048		RC SA3045	83045		SA5046	85046	89434
5549899	83207	89407	83176195	83103		RC SA3048	83048		SA5047	85047	89435
5549925	85304		83176196	83110		RC SA3103	83103		SA5052	85052	
5554959	83401		83176197	83111		RC SA3111	83111		SA5061	85061	89450
57241-3	83112		83176198	83112		RC SA3112	83112		SA5062	85062	89408
60657-007	85072		83176199	83123		RC SA3124	83124		SA5066	85066	89448
60675-001	85978		83176200	83124		RC SA3125	83125		SA5067	85067	89451
60675-001L	85978		83176201	83125		RC SA3127	83127		SA5069	85069	89455
60680-003	83112		83176202	83126		RC SA3128	83128	89436	SA5070	85070	89459
60680-003L	83112		83176203	83127		RC SA3136	83136		SA5303	85303	89422
629398	85307		83176204	83128	89436	RC SA3148	83148		SA5310	85310	89423

Important Note: Competitive Interchanges are to be used for stocking purposes only. Where multiple crosses are identified, please reference the applications section of this catalog.

COMPETITIVE & O.E.M. INTERCHANGE LIST

VOLVO... cont'd

O.E.M #	Gabriel	Upgrade	O.E.M #	Gabriel	Upgrade	O.E.M #	Gabriel	Upgrade	O.E.M #	Gabriel	Upgrade
SA5311	85311	89424	SA5323	85323	89436	SA5916	85916	89430	SA6155	646155	
SA5320	85320		SA5724	85724	89443	SA5918	85918	89449	SDA471700131258	85081	
SA5321	85321		SA5900	85900		SA5933	85933	89454			

VOLVO CAB SHOCKS

O.E.M #	Gabriel	Upgrade	O.E.M #	Gabriel	Upgrade	O.E.M #	Gabriel	Upgrade	O.E.M #	Gabriel	Upgrade
1201-0012	83023		20874147	83050		22662235	83905		8078547	83029	
1202-0012	83023		21368411	83905		22662237	83905		8162662	83004	
1202-0032	83016		21368413	83048		3945842	83009		8168617	83030	
20496215	83048		21391412	83048		635869	83004		85107095	83009	
20496217	83029		22662125	83048		66010-0007	83004				
20704334	83048		22662224	83048		66010-0008	83004				
20721254	83048		22662230	83905		8078546	83028				

WABASH NATIONAL

O.E.M #	Gabriel	Upgrade	O.E.M #	Gabriel	Upgrade	O.E.M #	Gabriel	Upgrade	O.E.M #	Gabriel	Upgrade
202447	85919		FRUUCE1295-901	85300	89419	HENS-24088	83128	89436	NEW900-44-868	85045	
203447	85919		FRUUCE2983-1	85322		HENS-24088	85000	89436	NEW900-44-978	85059	
DANSR1VJ100	85078		FRUUCF8339-1	85321		NEW900-44-089	83124	89407	NEW900-44-979	83113	
FLL83203-07I	83203	89436	HENS-20001	83128	89436	NEW900-44-162	83128	89436	NEW900-45-040	83130	
FLL83207-07I	83207	89407	HENS-20002	85000	89436	NEW900-44-625	83125		NEW900-45-054	85051	
FLL85000-07I	85000	89436	HENS-20126	85323	89436	NEW900-44-626	83126	89430	NEW900-45-298	83128	89436
FLL85030-07I	85030	89440	HENS-21292	85052		NEW900-44-642	83127		NEW900-45-299	85000	89436
FRUUCE1295-1	85300	89419	HENS-23566	85000	89436	NEW900-44-794	83127				

WATSON & CHALIN MFG. INC.

O.E.M #	Gabriel	Upgrade	O.E.M #	Gabriel	Upgrade	O.E.M #	Gabriel	Upgrade	O.E.M #	Gabriel	Upgrade
10147	83203	89436	17186-01	85323	89436	19250	85382		680714	85934	
10147HD	85000	89436	17218	85029		19603	85939		727603	83203	89436
10148	83204		17297	85064		3946219	83400		727604	83204	
10634	G63357		17300	85052		665724	85000	89436	A-20345	85345	
11418	646155		17306	85938		665727	85005	89430	B-23649	85064	
11604	83125		17317	85344		665728	85060		B-23650	85052	
11724	83123	89405	17382	85014		665769	85052		B-23651	85045	
12128	85005	89430	17430	85321		665770	85064		B-23743	85938	
17069	632147		17474	85009		665862	85000	89436			
17079	85300	89419	19036	85934		680547	85323	89436			
17186	85323	89436	19249	85939		680584	85938				

WESTERN STAR

O.E.M #	Gabriel	Upgrade	O.E.M #	Gabriel	Upgrade	O.E.M #	Gabriel	Upgrade	O.E.M #	Gabriel	Upgrade
02-7005976	83400		35901-3413	85006		47902-13	83122	89406	60680-003L	83112	
02-7005977	83400		35901-3420	85303	89422	47902-24	83137		60680-004	83143	
04-9041375	85315		35901-4403	85060		47902-8	83122	89406	60680-004L	83143	
10-13684-000	85918	89449	37301-3401	85053	89442	481700125969	85956		60680-005	83142	
10-13809-000	85958		37301-3404	85053	89442	57241-1	83111		60680-005L	83142	
1011839	83216		37301-3405	85053	89442	57252	85308	89422	615016	83401	
16-15770-000	85956		37301-3409	85053	89442	57905-1	85976		665682	85053	89442
16-18706-000	85331		37301-3412	85053	89442	57905-2	85006		676081	83401	
16-18708-000	85724	89443	37390-4401	85053	89442	58913-003	85932	89453	676082	83401	
16725-01	83126		37390-4402	85053	89442	58913-003L	85932	89453	90044025	83209	89414
19495-01	83126		37390-4403	85053	89442	58913-012	85932	89453	90044907	83635	
28R010	83216		471700000470	85918	89449	58913-012L	85932	89453	90045099	85906	89407
35066-4413	83122	89406	471700002809	85724	89443	60657-003	85072		90045605	85109	
35901-0001	83209	89414	471700003920	85958		60657-003L	85072		CP-5222	85315	
35901-3406	85305		471700004423	85109		60675-002	85979		SDA471700003920	85958	
35901-3409	85304		471700006269	85932	89453	60675-002L	85979		SDA481700125969	85956	
35901-3410	85307		471700131331	85932	89453	60680-003	83112				

Important Note: Competitive Interchanges are to be used for stocking purposes only. Where multiple crosses are identified, please reference the applications section of this catalog.

COMPETITIVE & O.E.M. INTERCHANGE LIST

WESTERN STAR CAB SHOCKS

O.E.M #	Gabriel	Upgrade	O.E.M #	Gabriel	Upgrade	O.E.M #	Gabriel	Upgrade	O.E.M #	Gabriel	Upgrade
1201-0012	83023		617547	83022		66010-3405	83026		814903003501	83027	
1202-0012	83023		654846	83027		66010-3406	83027		GBL 654916	83026	
1202-0032	83016		66010-3402	83022		66010-3407	83065				
18-60772-000	83026		66010-3403	83022		725470	83010				
18-60773-000	83027		66010-3404	83022		81-4903003500	83026				

WESTERN UNIT ``STABILAIR`` SUSPENSION

O.E.M #	Gabriel	Upgrade	O.E.M #	Gabriel	Upgrade	O.E.M #	Gabriel	Upgrade	O.E.M #	Gabriel	Upgrade
101030	85307		4939967	85308	89422	80600	85300	89419			
101364	85305		80370	85304							

WESTPORT AXLE CORP

O.E.M #	Gabriel	Upgrade	O.E.M #	Gabriel	Upgrade	O.E.M #	Gabriel	Upgrade	O.E.M #	Gabriel	Upgrade
143699-0185	646177		646124	646177							

WHEELED COACH IND

O.E.M #	Gabriel	Upgrade	O.E.M #	Gabriel	Upgrade	O.E.M #	Gabriel	Upgrade	O.E.M #	Gabriel	Upgrade
ASH-1136	83178		ASH-1154	83177							

WINNEBAGO

O.E.M #	Gabriel	Upgrade	O.E.M #	Gabriel	Upgrade	O.E.M #	Gabriel	Upgrade	O.E.M #	Gabriel	Upgrade
141700131809	85029		24-186629	85125		ASH-1206	83122	89406	F4-BE5-A011-HO	85126	
141700131810	83160		481700000493	85900		ASH-1228	83209	89414	F4-BE5-A832-MO	85125	
16-16736-000	85029		66153-002	83124	89407	ASH-1229	83209	89414	F4-BE5-B492-HO	85125	
16-16737-000	83160		9U94-18045-AA	83209	89414	ASH-1230	83122	89406	F4-BE5-C832-MO	83124	89407
16-16873-000	85029		9U94-18080-AA	83122	89406	ASH-137	83122	89406	F4-BE5-F324-HO	85125	
16-16874-000	83160		9U9Z-18124-A	83209	89414	ASH-25822	83209	89414	F4-BE5-F325-HO	85124	
16-18103-000	85900		9U9Z-18125-A	83122	89406	ASH-25823	83209	89414	W0005662	85125	
1C34-18045-AA	83209	89414	ASH-1022	83209	89414	ASH-25824	83122	89406	W0005663	85124	
1C34-18045-JA	83209	89414	ASH-1023	83122	89406	ASH-294	83209	89414	W0006254	85125	
24-153249	85125		ASH-1136	83178		AT-620	83209	89414			
24-153256	85124		ASH-1154	83177		AT-621	83122	89406			
24-186537	85126		ASH-1205	83209	89414	AT-766	83209	89414			

WORKHORSE

O.E.M #	Gabriel	Upgrade	O.E.M #	Gabriel	Upgrade	O.E.M #	Gabriel	Upgrade	O.E.M #	Gabriel	Upgrade
24-153249	85125		66153-002	83124	89407	F4-BE5-C832-MO	83124	89407	W0007363	83171	
24-153256	85124		680672	85919		F4-BE5-F324-HO	85125		W0007365	G63866	
24-186537	85126		7805-X-1012	85919		F4-BE5-F325-HO	85124		W0011635	83221	
24-186629	85125		F4-BE5-A011-HO	85126		W0005662	85125		W0011636	G63366	
659222	83171		F4-BE5-A832-MO	85125		W0005663	85124		W8007000	83171	
659223	G63866		F4-BE5-B492-HO	85125		W0006254	85125				

WORLD TRANS BUS CO.

O.E.M #	Gabriel	Upgrade	O.E.M #	Gabriel	Upgrade	O.E.M #	Gabriel	Upgrade	O.E.M #	Gabriel	Upgrade
ASH-1136	83178		ASH-1154	83177							

Important Note: Competitive Interchanges are to be used for stocking purposes only. Where multiple crosses are identified, please reference the applications section of this catalog.

HOW TO DETERMINE THE CORRECT SHOCK FOR YOUR TRUCK

Part Number: The catalog number for the individual shock absorber.

Extended Length*: The length of the shock absorber when it is fully extended. See "How to Measure" instructions.

Collapsed Length*: The length of the shock absorber when it is fully collapsed. See "How to Measure" instructions

Stroke: This is the approximate length of the stroke of the individual shock absorber being described.

Mounting Codes: Indicates the type of mounting ends for the upper and lower end of each shock absorber.

They are listed as follows:

- Stud type mounts ("S" & "DS")
- Eye ring and bushing mounts ("EB")
- Eye ring and bushing with sleeve mounts ("ES")
- Eye ring and bushing with bar pin mounts ("BP")
- Special mounting codes ("SP")

CONVERSION CHART

Fraction (INCHES)	Decimal (INCHES)	Metric (MM)	Fraction (INCHES)	Decimal (INCHES)	Metric (MM)
1/64	0.016	0.397	33/64	0.516	13.097
1/32	0.031	0.794	17/32	0.531	13.494
3/64	0.047	1.191	35/64	0.547	13.891
1/16	0.063	1.588	9/16	0.563	14.288
5/64	0.078	1.984	37/64	0.578	14.684
3/32	0.094	2.381	19/32	0.594	15.081
7/64	0.109	2.778	39/64	0.609	15.478
1/8	0.125	3.175	5/8	0.625	15.875
9/64	0.141	3.572	41/64	0.641	16.272
5/32	0.156	3.969	21/32	0.656	16.669
11/64	0.172	4.366	43/64	0.672	17.066
3/16	0.188	4.763	11/16	0.688	17.463
13/64	0.203	5.159	45/64	0.703	17.859
7/32	0.219	5.556	23/32	0.719	18.256
15/64	0.234	5.953	47/64	0.734	18.653
1/4	0.250	6.350	3/4	0.750	19.050
17/64	0.266	6.747	49/64	0.766	19.447
9/32	0.281	7.144	25/32	0.781	19.844
19/64	0.297	7.541	51/64	0.797	20.241
5/16	0.313	7.938	13/16	0.813	20.638
21/64	0.328	8.334	53/64	0.828	21.034
11/32	0.344	8.731	27/32	0.844	21.431
23/64	0.359	9.128	55/64	0.859	21.828
3/8	0.375	9.525	7/8	0.875	22.225
25/64	0.391	9.922	57/64	0.891	22.622
13/32	0.406	10.319	29/32	0.906	23.019
27/64	0.422	10.716	59/64	0.922	23.416
7/16	0.438	11.113	15/16	0.938	23.813
29/64	0.453	11.509	61/64	0.953	24.209
15/32	0.469	11.906	31/32	0.969	24.606
31/64	0.484	12.303	63/64	0.984	25.003
1/2	0.500	12.700	1	1.000	25.400

METRIC CONVERSION CHART

(MM)	(INCHES)	(MM)	(INCHES)	(MM)	(INCHES)
1	0.03937	10	0.39370	19	0.74803
2	0.07874	11	0.43307	20	0.78740
3	0.11811	12	0.47244	21	0.82677
4	0.15748	13	0.51181	22	0.86614
5	0.19685	14	0.55118	23	0.90551
6	0.23622	15	0.59055	24	0.94488
7	0.27559	16	0.62992	25	0.98425
8	0.31496	17	0.66929		
9	0.35433	18	0.70866		

HOW TO DETERMINE THE CORRECT SHOCK FOR YOUR TRUCK

STEP 1: Measure the diameter of the dust tube and cylinder to determine the series.

EXTERNAL DIMENSIONS

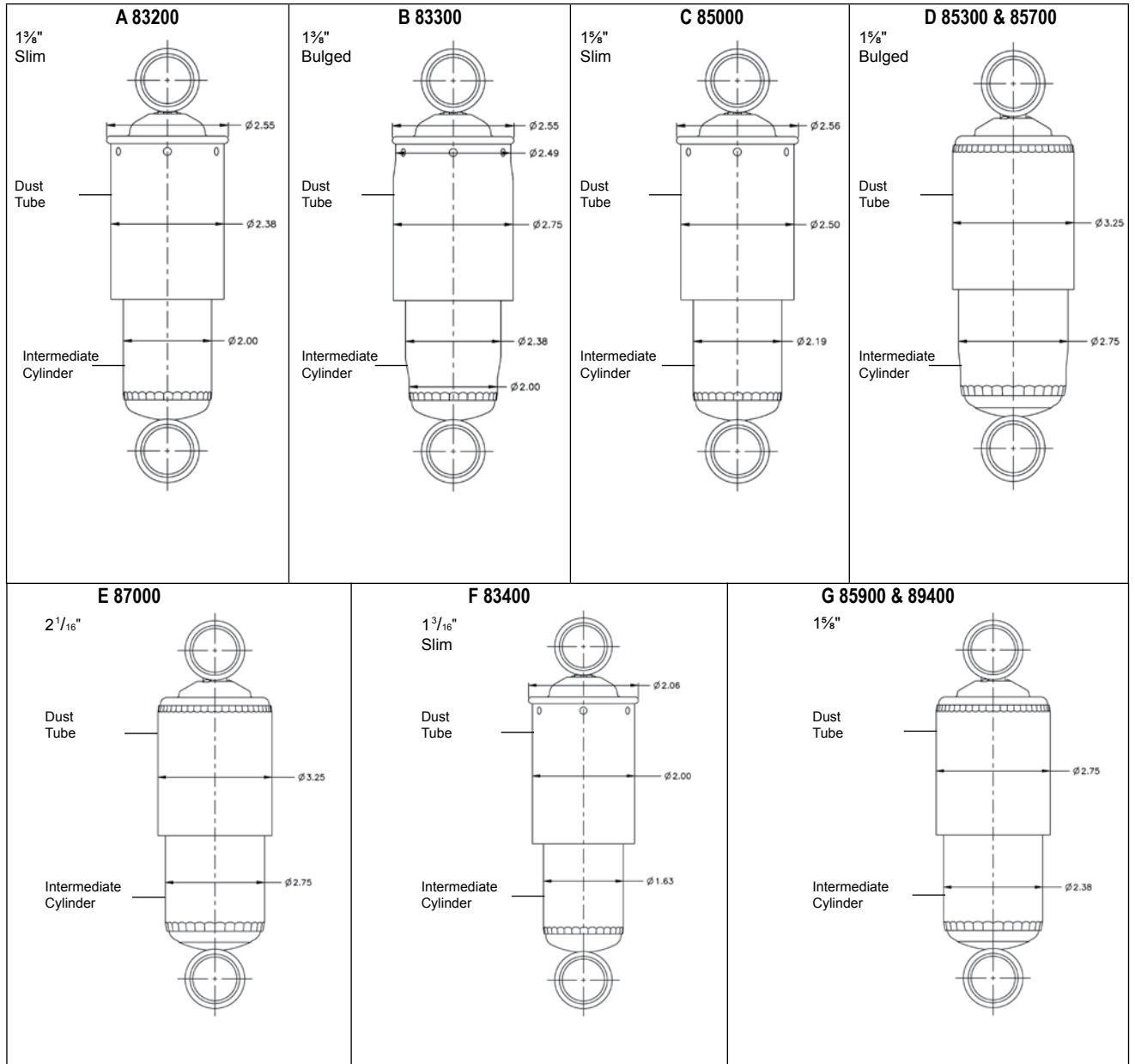

HOW TO DETERMINE THE CORRECT SHOCK FOR YOUR TRUCK

STEP 2: Identify the mounting style. Measure fully extended and fully collapsed lengths at the locations indicated for mounting style.

HOW TO MEASURE EXTENDED & COLLAPSED LENGTHS OF SHOCK ABSORBERS

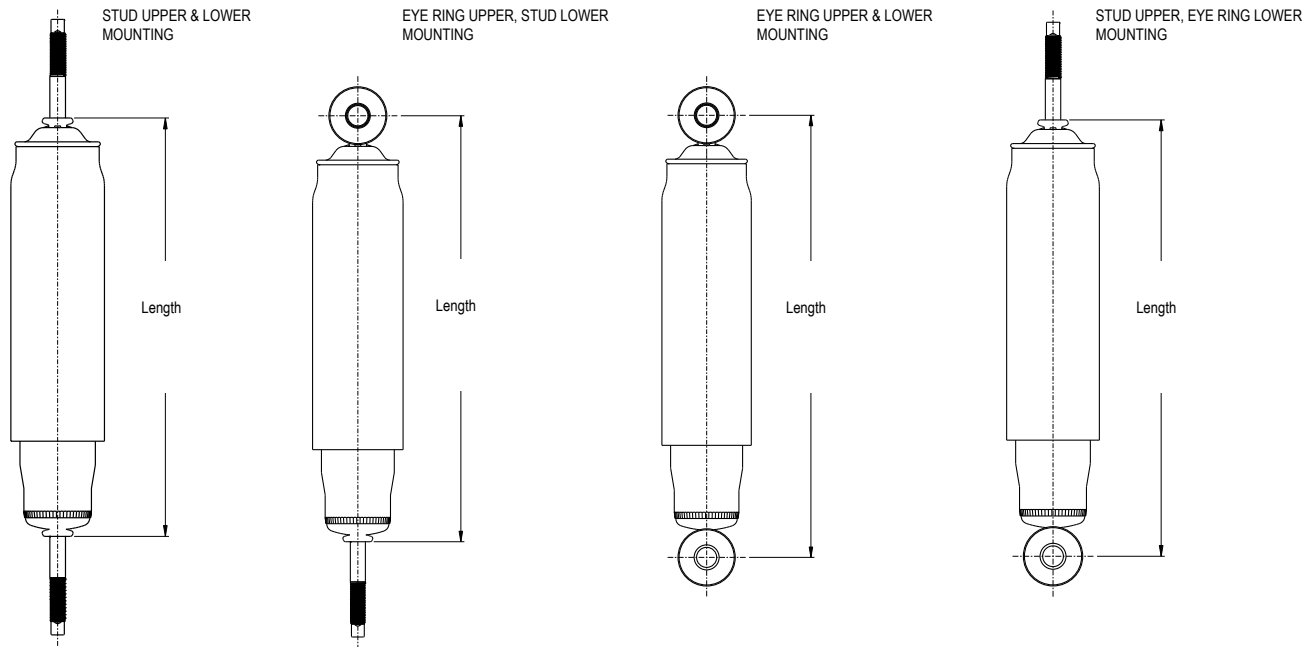

INSTRUCTIONS:

1. Using the proper measuring points as shown above find the nearest replacement shock absorber from the listing by increments of extended length
2. Identify the proper mounting from the mounting codes and match these requirements by carefully measuring the mounting dimensions (top and bottom) of the shock absorber to be replaced.
3. Carefully take note of the following requirements:
 - a. **Dust tubes** - This requirement should be noted in comparison with the shock absorber to be replaced. Shock absorber environment in its application makes this requirement necessary for piston rod protection and extended shock absorber life.
 - b. **Recoil Cutoff and Compression Bumper** - Carefully note these specifications - deviation of length requirements should not exceed $\pm 1/4$ ". These shock absorber designs are footnoted for easy identification.

Note: Shock absorbers used for installations other than those recommended in our catalog are **not subject to warranty**.

HOW TO DETERMINE THE CORRECT SHOCK FOR YOUR TRUCK

STEP 3: Measure end mount diameters, widths, and lengths. Refer to the following end mount tables to determine the appropriate or matching mounting code.

MOUNTING CODE "EB" EYE RING AND BUSHING

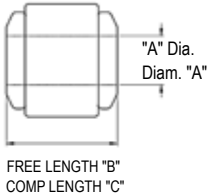
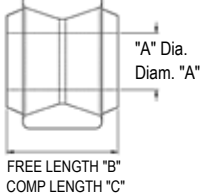
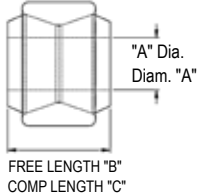
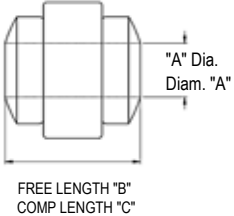
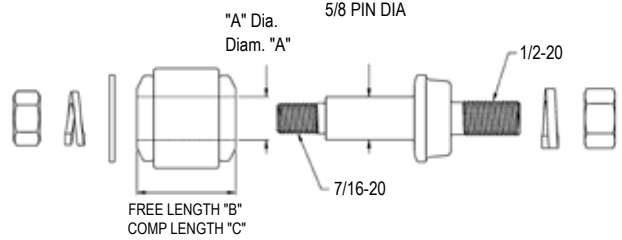
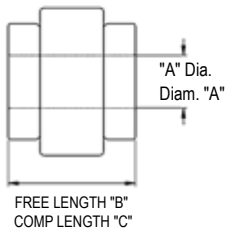
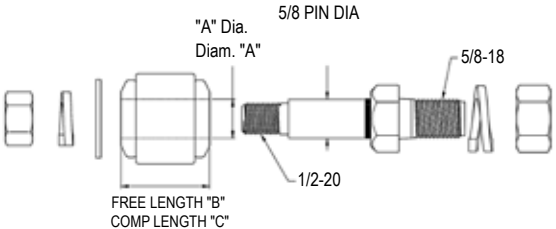
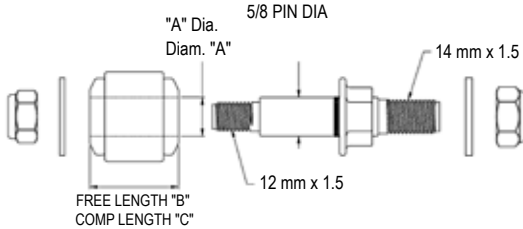
<p>EB1</p>  <p>"A" Dia. Diam. "A"</p> <p>FREE LENGTH "B" COMP LENGTH "C"</p>	<p>EB2</p>  <p>"A" Dia. Diam. "A"</p> <p>FREE LENGTH "B" COMP LENGTH "C"</p>	<p>EB3</p>  <p>"A" Dia. Diam. "A"</p> <p>FREE LENGTH "B" COMP LENGTH "C"</p>	
<p>EB4</p>  <p>"A" Dia. Diam. "A"</p> <p>FREE LENGTH "B" COMP LENGTH "C"</p>	<p>EB6</p>  <p>"A" Dia. Diam. "A"</p> <p>5/8 PIN DIA</p> <p>7/16-20</p> <p>1/2-20</p> <p>FREE LENGTH "B" COMP LENGTH "C"</p>		
<p>EB5</p>  <p>"A" Dia. Diam. "A"</p> <p>FREE LENGTH "B" COMP LENGTH "C"</p>	<p>EB7</p>  <p>"A" Dia. Diam. "A"</p> <p>5/8 PIN DIA</p> <p>1/2-20</p> <p>5/8-18</p> <p>FREE LENGTH "B" COMP LENGTH "C"</p>		
<p>EB8</p>  <p>"A" Dia. Diam. "A"</p> <p>5/8 PIN DIA</p> <p>12 mm x 1.5</p> <p>14 mm x 1.5</p> <p>FREE LENGTH "B" COMP LENGTH "C"</p>			

HOW TO DETERMINE THE CORRECT SHOCK FOR YOUR TRUCK

MOUNTING CODE "EB" EYE RING AND BUSHING (Cont'd)

Mounting Code	"A" Dia.	B Free Length	C Comp. Length	Vehicle Mounting Pin Dia.
EB1	5/8	1.44	1.31	5/8
EB2	3/4	1.75	1.50	3/4
EB3	1.00	1.91	1.75	1.00
EB4	11/16	1.72	1.55	11/16
EB5	5/8	1.51	1.25	5/8
EB6	5/8	1.44	1.31	Mounting pin furnished with shock absorber for 1/2" dia. vehicle mounting hole.
EB7	5/8	1.44	1.31	Mounting pin furnished with shock absorber for 5/8" dia. vehicle mounting hole.
EB8	5/8	1.44	1.31	Mounting pin furnished with shock absorber for 14 mm dia. vehicle mounting hole.
EB9	1	1.75	--	1
EB10	1.00	1.00	--	1.00
EB11	3/8	0.83	--	3/8
EB12	10MM	1.18	--	10MM
EB13	12MM	1.03	--	12MM
EB14	15MM	1.41	--	15MM
EB15	15MM	1.76	--	15MM
EB16	16MM	1.5	--	16MM
EB17	17MM	1.18	--	17MM
EB18	19MM	1.65	--	19MM
EB19	20MM	1.75	--	20MM
EB20	45/64	1.05	--	45/64
EB21	45/64	1.39	--	45/64

HOW TO DETERMINE THE CORRECT SHOCK FOR YOUR TRUCK

MOUNTING CODE "ES" & "CB" EYE RING AND BUSHING WITH STEEL SLEEVE

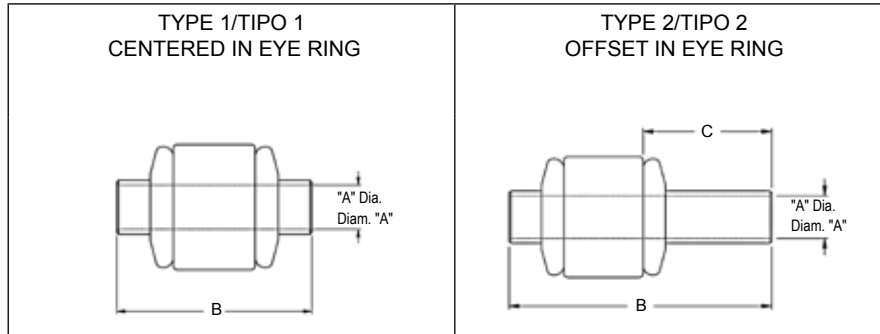

MOUNTING CODE	TYPE	DIMENSION		
		A	B	C
ES1	1	10MM	1.25	--
ES2	1	10MM	1.42	--
ES3	1	10MM	1.56	--
ES4	2	1/2	2.20	0.77
ES5	1	10MM	2.07	--
ES6	1	10MM	2.35	--
ES7	1	9/16	1.25	--
ES8	1	7/16	1.25	--
ES9	1	7/16	1.31	--
ES10	1	7/16	1.38	--
ES11	1	7/16	1.50	--
ES12	1	7/16	1.62	--
ES13	1	9/16	1.89	--
ES14	1	7/16	1.88	--
ES15	1	9/16	2.79	--
ES16	1	7/16	3.15	--
ES17	1	12MM	1.25	--
ES18	1	12MM	1.65	--
ES19	1	12MM	1.88	--
ES20	1	12MM	1.95	--
ES21	1	12MM	2.28	--
ES22	1	1/2	1.25	--
ES23	1	1/2	1.31	--
ES24	1	1/2	1.38	--
ES25	1	1/2	1.50	--
ES26	1	1/2	1.56	--
ES27	1	1/2	1.62	--
ES28	1	9/16	3.15	--
ES29	1	10MM	2.95	--
ES30	1	12MM	2.57	--
ES31	2	1/2	2.25	1.00
ES32	1	1/2	3.34	--
ES33	1	12MM	3.15	--
ES34	1	9/16	1.66	--
ES35	1	5/8	1.38	--
ES36	1	3/4	1.75	--
ES37	1	12MM	1.01	--
ES38	1	7/16	2.18	--
ES39	1	10MM	1.31	--
ES40	1	7/16	3.38	--
ES41	1	12MM	3.48	--
ES42	1	12MM	3.77	--
ES43	1	13MM	1.31	--
ES44	1	10MM	2.28	--
ES45	1	13MM	1.68	--
ES46	1	13MM	1.73	--
ES47	1	13MM	2.50	--

MOUNTING CODE	TYPE	DIMENSION		
		A	B	C
ES48	1	14MM	1.42	--
ES49	1	14MM	1.66	--
ES50	1	14MM	1.81	--
ES51	1	14MM	1.89	--
ES52	1	14MM	1.96	--
ES53	1	10MM	1.38	--
ES54	1	12MM	2.91	--
ES55	1	14MM	2	--
ES56	1	14MM	1.58	--
ES57	1	10MM	1.03	--
ES58	1	14MM	2.13	--
ES59	1	15MM	1.56	--
ES60	1	14MM	1.26	--
ES61	1	12MM	1.76	--
ES62	1	12MM	0.98	--
ES63	1	15MM	2.28	--
ES64	1	16MM	1.25	--
ES65	1	12MM	1.38	--
ES66	1	16MM	1.38	--
ES67	1	16MM	1.56	--
ES68	1	9/16	1.35	--
ES69	1	12MM	1.58	--
ES70	2	7/16	1.88	0.70
ES71	1	15MM	2.15	--
ES72	1	16MM	1.65	--
ES73	1	16MM	1.74	--
ES74	1	16MM	1.93	--
ES75	1	16MM	2.04	--
ES76	1	17/32	1.49	--
ES77	1	20MM	2.35	--
ES78	1	10MM	1.92	--
ES79	1	21/32	1.58	--
ES80	2	25/32	1.69	0.07
ES81	1	31/64	1.26	--
ES82	1	31/64	1.53	--
ES83	1	12MM	1.48	--
ES84	1	10MM	1.62	--
ES85	1	12MM	2.36	--
ES86	1	14MM	2.44	--
ES87	1	31/64	1.65	--
ES88	1	12MM	1.81	--
ES89	1	39/64	2.16	--
ES90	1	5/8	2.00	--
ES91	1	1/2	2.10	--
ES92	2	39/64	2.20	0.88
ES93	2	39/64	2.57	0.79
ES94	1	1/2	2.15	--

MOUNTING CODE	TYPE	DIMENSION		
		A	B	C
ES95	1	41/64	2	--
ES96	1	45/64	1.57	--
ES99	1	14MM	1.42	--
ES102	1	10MM	1.77	--
ES104	1	20MM	1.58	--
ES106	1	10MM	1.48	--
ES107	1	12MM	2.15	--
ES109	1	10MM	0.95	--
ES110	1	16MM	1.61	--
ES111	1	9MM	1.78	--
ES112	1	12MM	1.08	--
ES113	1	16MM	1.49	--
ES114	1	12MM	2.04	--
ES115	1	10MM	2.02	--
ES118	1	12MM	1.31	--
ES120	1	3/4	2.76	--
ES121	1	3/4	2.06	--
ES123	1	16MM	1.57	--
ES126	1	1/2	2.44	--
ES128	1	1/2	1.66	--
ES130	1	1/2	1.56	--
ES133	1	12MM	1.93	--
ES136	1	5/8	1.75	--
ES137	1	1/2	1.73	--
ES138	1	5/8	1.70	--
ES139	1	12MM	1.35	--
ES141	1	12MM	1.61	--
ES142	1	16MM	1.43	--
ES143	1	9/16	1.60	--
ES145	1	7/16	2.25	--
ES146	1	12MM	1.37	--
ES147	1	12MM	1.97	--
ES149	1	1/2	2.36	--
ES150	1	3/4	2.24	--
ES152	1	20MM	1.69	--
ES153	1	14MM	1.55	--
ES157	2	1/2	2.05	0.95
ES158	1	3/4	3.80	--
ES159	2	3/4	3.21	1.03
ES160	1	1.00	2.01	--
ES161	1	16MM	3.95	--
ES162	1	16MM	2.60	--
ES163	1	7/16	2.50	--
ES164	1	1/2	2.26	--
ES165	1	1/2	1.75	--
ES166	1	5/8	2.97	--
ES167	1	14MM	2.31	--

HOW TO DETERMINE THE CORRECT SHOCK FOR YOUR TRUCK

MOUNTING CODE "ES" & "CB" EYE RING AND BUSHING WITH STEEL SLEEVE (Cont'd)

MOUNTING CODE	TYPE	DIMENSION		
		A	B	C
ES168	1	14MM	2.62	--
ES169	1	14MM	1.91	--
ES171	1	1/2	1.88	--
ES172	1	1/2	2.72	--
ES173	1	7/8	2.28	--
ES174	1	5/8	3.25	--
ES175	1	16MM	1.96	--
ES176	1	16MM	3.72	--

MOUNTING CODE	TYPE	DIMENSION		
		A	B	C
ES177	1	16MM	3.55	--
ES178	1	3/4	1.96	--
ES179	1	20MM	1.75	--
ES181	1	7/16	1.98	--
ES182	1	20MM	1.96	--
ES183	1	20MM	3.80	--
ES184	1	20MM	2.44	--
ES185	1	12MM	2.44	--

MOUNTING CODE	TYPE	DIMENSION		
		A	B	C
ES187	1	1.00	1.75	--
ES188	1	16MM	1.81	--
ES190	1	22MM	1.75	--
ES191	1	1.00	2.44	--
ES192	1	24MM	2.44	--
ES193	1	24MM	2.28	--
ES194	1	7/8	2.28	--
ES195	1	20MM	4.07	--

MOUNTING CODE "BP" EYE RING AND BUSHING WITH BAR PIN

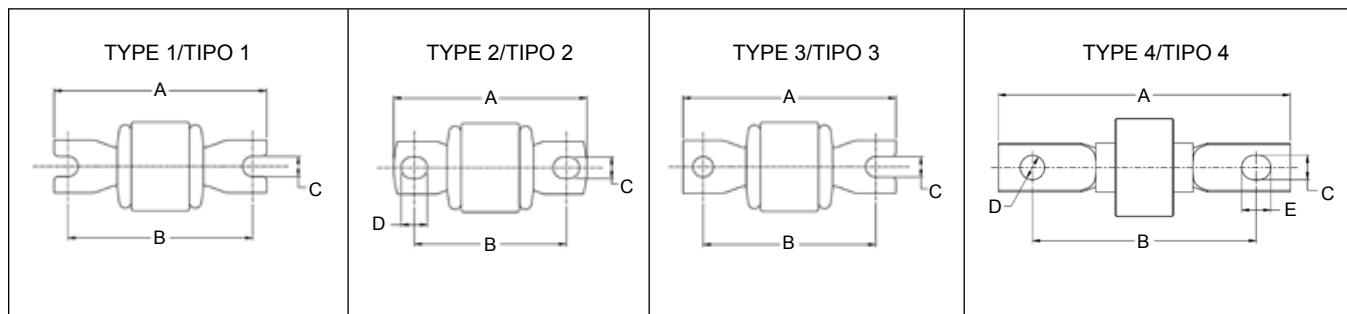

MOUNTING CODE	TYPE	A	B	C	D	E
BP1	1	2.72	2.20	0.33	--	--
BP2	1	3.59	3.12	0.32	--	--
BP3	1	2.82	2.38	0.33	--	--
BP4	1	3.19	2.38	0.33	--	--
BP5	1	3.19	2.75	0.33	--	--
BP6	1	4.25	3.62	0.33	--	--
BP7	2	3.13	2.50	0.35	0.42	--
BP8	2	3.50	2.87	0.35	0.42	--
BP9	1	3.38	2.60	0.35	0.57	--
BP10	2	3.5	2.74	0.50	0.50	--
BP11	1	2.96	2.52	0.33	--	--
BP12	1	3.75	3.14	0.33	--	--
BP13	1	3.45	3.00	0.33	--	--
BP14	2	3.43	2.87	0.45	--	--
BP15	4	4.56	3.62	0.39	0.47	0.39

MOUNTING CODE	TYPE	A	B	C	D	E
BP17	1	3.11	2.61	0.33	--	--
BP18	1	3.75	3.14	0.39	--	--
BP19	1	3.19	2.62	0.33	--	--
BP20	1	3.59	3.12	0.33	--	--
BP26	3	3.06	2.37	0.26	--	--
BP27	2	4.00	2.95	0.52	0.50	--
BP29	2	4.00	2.95	0.37	0.49	--
BP30	1	3.00	2.25	0.34	--	--
BP31	3	3.50	2.87	0.35	--	--
BP32	2	3.45	2.83	0.42	--	--
BP33	2	4.44	3.62	0.39	0.47	--
BP34	1	3.81	2.99	0.41	--	--
BP35	2	3.53	2.73	0.38	0.38	--
BP36	2	4.72	3.38	0.52	0.52	--

HOW TO DETERMINE THE CORRECT SHOCK FOR YOUR TRUCK

MOUNTING CODES "S" & "DS" STUD MOUNTS

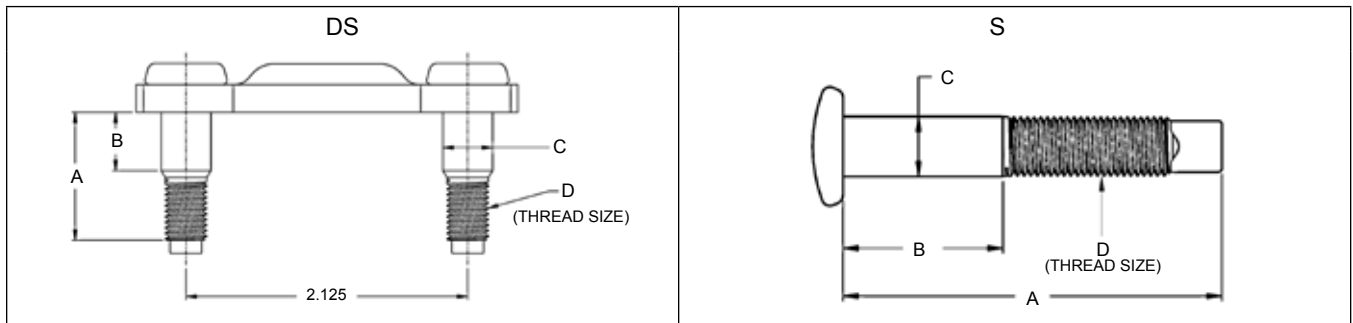

MOUNTING CODE	A	B	C	D
DS1	1.27	0.66	3/8	5/16-24
S1	2.37	1.00	3/8	3/8-24
S2	2.06	1.00	3/8	3/8-24
S3	2.67	1.37	10MM	3/8-16
S4	1.85	1.00	3/8	3/8-24
S5	1.29	1.14	13MM	3/8-24
S6	2.47	1.47	7/16	3/8-24
S7	1.97	1.00	3/8	3/8-24
S8	1.75	1.00	10MM	3/8-24
S9	1.84	1.05	7/16	3/8-24
S10	2.37	1.33	7/16	3/8-24
S11	3.00	1.12	3/8	3/8-24
S12	2.37	1.15	7/16	3/8-24
S13	2.06	1.35	3/8	3/8-24
S14	2.25	1.33	7/16	3/8-24
S15	3.29	1.98	3/8	3/8-24
S16	2.95	1.45	16MM	16MM
S17	2.15	1.03	7/16	3/8-24
S18	2.67	1.81	10MM	M10x1.25
S19	1.34	0.41	7/16	M10x1
S20	1.34	0.41	10MM	M10x1
S21	3.28	1.75	5/8	5/8-18
S22	0.75	0.35	10MM	M10x1
S23	1.84	1.05	3/8	3/8-24
S24	1.22	0.31	11MM	M10x1
S25	1.81	1.50	3/8	M10x1
S26	2.02	0.82	12MM	M10x1
S27	2.36	1.14	10MM	M10x1
S28	2.44	1.37	12MM	M10x1
S29	2.99	1.87	3/8	3/8-24
S30	2.59	1.41	10MM	M10x1
S31	0.79	0.40	17MM	10MM
S32	2.31	1.38	14MM	12MM
S33	3.44	2.17	10MM	M10x1
S34	1.06	0.59	5/16	M8x1.25
S35	2.60	1.12	7/16	3/8-24

MOUNTING CODE	A	B	C	D
S36	2.49	1.33	7/16	3/8-24
S37	3.18	1.41	12MM	M10x1
S38	2.75	1.70	14MM	12MM
S39	2.20	1.31	10MM	10MM
S40	2.52	1.33	7/16	3/8-24
S41	3.48	2.32	5/8	1/2-20
S42	3.50	2.00	5/8	5/8-18
S43	2.75	1.25	5/8	5/8-18
S44	1.57	0.39	10MM	M10x1.25
S45	2.36	1.00	10MM	M10x1.25
S46	1.57	1.18	10MM	M10x1.25
S47	2.20	1.31	10MM	M10x1.25
S48	2.55	1.51	10MM	M10x1.25
S49	2.67	1.29	10MM	M10x1.25
S50	2.95	1.57	10MM	M10x1.25
S51	3.00	1.65	10MM	M10x1.25
S52	1.18	0.74	10MM	M10x1.5
S53	2.16	1.89	10MM	M10x1.5
S54	2.42	1.28	15MM	M10x1.5
S55	2.51	1.39	10MM	M10x1.5
S56	2.67	1.53	11MM	M10x1.5
S57	2.95	1.40	27/64	M10x1.5
S58	2.98	1.68	10MM	M10x1.5
S59	2.98	1.68	12MM	M10x1.5
S60	3.46	1.96	9/16	M10x1.5
S61	3.11	1.45	14MM	M12x1.25
S62	3.24	1.70	9/16	M12x1.25
S63	3.54	2.24	17MM	M12x1.25
S64	2.36	1.18	12MM	M12x1.5
S65	2.89	1.65	12MM	M12x1.5
S66	1.39	0.15	12MM	M12x1.75
S67	2.40	1.53	9/16	M14x1.5
S68	2.95	1.45	5/8	M16x1.5
S69	1.32	1.37	39/64	M16x2
S70	1.88	0.90	7/16	M8x1.25

HOW TO DETERMINE THE CORRECT SHOCK FOR YOUR TRUCK

EXPLANATION OF COLUMN HEADINGS

SHOCK ABSORBER PART NUMBER: The catalog number for the individual shock absorber.
EXTENDED LENGTH:* The length of the shock absorber when it is fully extended. See "How to Measure" instructions.
COLLAPSED LENGTH:* The length of the shock absorber when it is fully compressed. See "How to Measure" instructions.
STROKE: This is the approximate length of the stroke of the individual shock absorber being described.
MOUNTING CODES: Indicates the type of mounting ends for the upper and lower end of each shock absorber. They are listed as follows: Stud Type Mounts ("S" & "DS") Eye Ring and Bushing Mounts ("EB") Eye Ring and Bushing with Sleeve Mounts ("ES") Eye Ring and Bushing with Bar Pin Mounts ("BP") Special Mounting Codes ("SP")
DUST TUBE: Indicates whether the shock absorber is supplied with a dust tube.
MOUNTING ACCESSORY PACKAGE NUMBER: The part number of the Mount Accessory Package supplied with the shock absorber.
*NOTE: All dimensions shown are in inches

STEP 4: Refer to shock absorber specifications by end mount. Start first by finding the appropriate series. Next, match the extended/collapsed length and find the correct mounting codes. Refer to the far left column of the chart for the correct Gabriel shock absorber part number.

SPECIFICATIONS BY END MOUNT

Gabriel	Mounting		Bore	External Diameter Illustration	Lengths			Dust Tube	Recoil Cutoff	Controls*	
	Upper	Lower			Extended	Collapsed	Stroke			Rebound	Compression
83013	BP8	BP8	1-3/16"	2" D/T	7.66	6.63†	1.7	YES	NO	646	480
G63837	BP8	ES83	1-3/8"		28.23	17.95	10.28				
G63679	BP8	ES83	1-3/8"		25	14.97	10.03	YES	NO		
83015	BP8	S1	1-3/8"	A	9.84	7.59	2.25	YES	YES	735	430
83005	BP8	S10	1-3/16"	2" D/T	7.34	5.87	1.47	YES	NO	858	216
83041	BP27	S10	1-3/8"	A	10.51†	8.34†	3.02	YES	YES	486	189
G63607	BP33	ES83	1-3/8"		25.58	15.3	10.28	YES	NO		
83060	EB	BP7	1-3/8"	A	9.76	7.98†	2.25	NO	YES	431	441
83011	EB1	EB1	1-3/8"	A	11.55†	8.48	3.61	YES	YES	738	330
83012	EB1	EB1	1-3/8"	A	11.07†	8.21	3.37	YES	YES	738	330
G63440	EB1	EB1	1-3/8"		26.33	15.55	10.78	NO	NO		
83401	EB1	EB1	1-3/16"	F	24.09	14.26	9.83	YES	NO	341	252
G63419	EB1	EB1	1-3/8"		24.08	14.55	9.53	YES	NO		
G63405	EB1	EB1	1-3/8"		20	12.47	7.53	YES	NO	572	115
83007	EB1	EB1	1-3/8"	A	18.55	11.67	6.87	NO	NO	489	343
G63299	EB1	EB1	1-3/8"		18.08	11.55	6.53	YES	NO	396	109
G63810	EB1	ES83	1-3/8"		31.51	18.48	13.03	YES	NO		
G63808	EB1	ES83	1-3/8"		28.86	17.08	11.78	YES	NO		
G63524	EB1	ES83	1-3/8"		27.08	16.05	11.03	YES	NO		
G63775	EB1	ES83	1-3/8"		27.08	16.05	11.03	YES	NO		
G63461	EB1	ES83	1-3/8"		25.5	15.22	10.28	YES	NO		
G63811	EB1	ES83	1-3/8"		25.5	15.22	10.28	YES	NO		
G63525	EB1	ES83	1-3/8"		23.08	14.05	9.03	YES	NO		
G63773	EB1	ES83	1-3/8"		23.08	14.05	9.03	YES	NO		
G63406	EB1	ES83	1-3/8"		23	13.97	9.03	YES	NO		
G63809	EB1	ES83	1-3/8"		23	13.97	9.03	YES	NO		
G63409	EB1	ES83	1-3/8"		21.58	13.3	8.28	YES	NO		
85063	EB2	EB2	1-5/8"	C	32.01	18.85	13.16	YES	NO	762	174
83107	EB2	EB2	1-3/8"	A	31.66	18.4	13.25	YES	NO	352	77
83314	EB2	EB2	1-3/8"	B	30.64	18.11	12.53	YES	YES	633	143
85024	EB2	EB2	1-5/8"	C	28.77	17.25	11.52	YES	YES	1008	539
83309	EB2	EB2	1-3/8"	B	28.64	17.11	11.53	YES	YES	589	135
89416	EB2	EB2	1-5/8"	G	28.62	17.54	11.08	YES	YES	1155†	514
89401	EB2	EB2	1-5/8"	G	28.41	17.16	11.25	YES	NO	665†	194
89446	EB2	EB2	1-5/8"	G	28.36	17.41	10.95	YES	YES	702†	204
85046	EB2	EB2	1-5/8"	C	27.55	16.62	10.93	YES	YES	1008	539
89409	EB2	EB2	1-5/8"	G	27.13	16.92	10.2	YES	YES	567†	165

*Damping force, in pounds, to either extend or collapse the shock absorber at an average operating velocity.

SPECIFICATIONS BY END MOUNT

Gabriel	Mounting		Bore	External Diameter Illustration	Lengths			Dust Tube	Recoil Cutoff	Controls*	
	Upper	Lower			Extended	Collapsed	Stroke			Rebound	Compression
89434	EB2	EB2	1-5/8"	G	27.12	16.79	10.33	YES	YES	1155‡	514
89403	EB2	EB2	1-5/8"	G	26.86	17.16	9.7	YES	YES	929‡	281
83312	EB2	EB2	1-3/8"	B	26.64	16.11	10.53	YES	YES	527	152
89439	EB2	EB2	1-5/8"	G	25.67	15.79	9.88	YES	NO	518‡	103
85055	EB2	EB2	1-5/8"	C	25.63	15.63	10	YES	NO	577	102
85047	EB2	EB2	1-5/8"	C	25.31	15.52	9.79	YES	YES	1008	539
83308	EB2	EB2	1-3/8"	B	25.14	15.36	9.78	YES	YES	445	180
89435	EB2	EB2	1-5/8"	G	24.92	15.82	9.1	YES	YES	1155‡	514
83200	EB2	EB2	1-3/8"	A	24.51	15.1	9.53	YES	NO	806	370
89402	EB2	EB2	1-5/8"	G	24.41	15.16	9.25	YES	NO	874‡	206
83519	EB2	EB2	1-3/16"	F	23.83	14.35	9.48	YES	NO	292	132
83216	EB2	EB2	1-3/8"	A	23.51	14.48	9.03	YES	YES	776	262
85054	EB2	EB2	1-5/8"	C	23.26	14.37	8.89	YES	NO	602	104
89438	EB2	EB2	1-5/8"	G	23.17	14.54	8.63	YES	NO	583‡	103
83404	EB2	EB2	1-3/16"	F	22.01	13.44	8.58	YES	NO	545	171
83159	EB2	EB2	1-3/8"	A	21.85	13.56	8.29	YES	NO	658	149
85012	EB2	EB2	1-5/8"	C	21.02	13.23	7.79	YES	NO	523	199
89413	EB2	EB2	1-5/8"	G	20.94	13.53	7.41	YES	NO	536‡	201
85023	EB2	EB2	1-5/8"	C	20.27	13	7.27	YES	YES	1008	539
89415	EB2	EB2	1-5/8"	G	20.12	13.29	6.83	YES	YES	1155‡	514
83219	EB2	EB2	1-3/8"	A	20.01	12.73	7.28	YES	YES	299	125
85062	EB2	EB2	1-5/8"	C	19.76	12.6	7.16	YES	NO	523	199
89408	EB2	EB2	1-5/8"	G	19.68	12.9	6.78	YES	NO	536‡	201
G63605	EB2	ES27	1-3/8"		24.24	14.71	9.53	YES	NO		
85025	EB2	S21	1-5/8"	C	23.02	14.01	9.01	YES	NO	1079	539
85376	EB3	EB3	1-5/8"	D	33.27	19.73	13.54	YES	NO	668	134
85301	EB3	EB3	1-5/8"	D	31.92	19.03	12.89	YES	NO	1442	455
85339	EB3	EB3	1-5/8"	D	31.68	19.02	12.66	YES	YES	804	463
85040	EB3	EB3	1-5/8"	C	30.91	18.51	12.4	YES	NO	889	114
85730	EB3	EB3	1-5/8"	D	30.75	18.72	12.03	YES	YES	1517	293
85315	EB3	EB3	1-5/8"	D	29.61	18.07	11.53	YES	NO	380	142
85901	EB3	EB3	1-5/8"	G	29.09	17.68	11.42	YES	NO	1830	418
85704	EB3	EB3	1-5/8"	D	28.75	18.72	10.03	YES	YES	1435	186
83104	EB3	EB3	1-3/8"	A	28.24	17.12	11.12	YES	NO	698	133
85305	EB3	EB3	1-5/8"	D	27.25	16.7	10.55	YES	NO	1120	225
83362	EB3	EB3	1-3/8"	B	27	16.25	10.75	YES	NO	539	202
87004	EB3	EB3	2-1/16"	E	26.76	16.76	10	YES	YES	1158	190

*Damping force, in pounds, to either extend or collapse the shock absorber at an average operating velocity.

SPECIFICATIONS BY END MOUNT

Gabriel	Mounting		Bore	External Diameter Illustration	Lengths			Dust Tube	Recoil Cutoff	Controls*	
	Upper	Lower			Extended	Collapsed	Stroke			Rebound	Compression
85735	EB3	EB3	1-5/8"	D	26.72	16.7	10.02	YES	YES	1288	227
83215	EB3	EB3	1-3/8"	A	26.64	16.36	10.28	YES	YES	697	108
89425	EB3	EB3	1-5/8"	G	26.5	16.93	9.57	YES	YES	1352‡	167
85314	EB3	EB3	1-5/8"	D	26.49	16.46	10.03	YES	YES	1216	169
89410	EB3	EB3	1-5/8"	G	26.34	16.57	9.77	YES	NO	1185‡	182
85001	EB3	EB3	1-5/8"	C	26.3	16.39	9.92	YES	NO	1202	186
85313	EB3	EB3	1-5/8"	D	26.26	16.35	9.91	YES	YES	717	111
87003	EB3	EB3	2-1/16"	E	26.26	16.51	9.75	YES	YES	1332	395
89429	EB3	EB3	1-5/8"	G	26.22	16.57	9.65	YES	NO	941‡	266
85320	EB3	EB3	1-5/8"	D	26.15	16.35	9.8	YES	NO	970	308
85700	EB3	EB3	1-5/8"	D	26.09	16.58	9.51	YES	YES	1446	328
83140	EB3	EB3	1-3/8"	A	25.28	15.53	9.75	YES	NO	738	88
83141	EB3	EB3	1-3/8"	A	25.27	15.52	9.75	YES	NO	408	113
83132	EB3	EB3	1-3/8"	A	25.24	15.5	9.74	YES	NO	828	150
85714	EB3	EB3	1-5/8"	D	25.13	15.85	9.28	YES	YES	1220	175
85715	EB3	EB3	1-5/8"	D	25.13	15.85	9.28	YES	YES	1915	200
85717	EB3	EB3	1-5/8"	D	25.13	15.85	9.28	YES	YES	1915	200
89422	EB3	EB3	1-5/8"	G	25.12	16.3	8.83	YES	YES	794‡	253
85308	EB3	EB3	1-5/8"	D	25.11	15.83	9.28	YES	YES	764	254
85303	EB3	EB3	1-5/8"	D	24.76	15.48	9.29	YES	NO	1019	221
89442	EB3	EB3	1-5/8"	G	24.72	15.74	8.98	YES	NO	1055‡	224
85053	EB3	EB3	1-5/8"	C	24.69	15.52	9.17	YES	NO	1019	227
85329	EB3	EB3	1-5/8"	D	24.52	15.48	9.04	YES	YES	1550	232
85713	EB3	EB3	1-5/8"	D	24.51	15.48	9.04	YES	YES	1157	180
85007	EB3	EB3	1-5/8"	C	24.33	15.4	8.93	YES	YES	1008	171
89412	EB3	EB3	1-5/8"	G	24.26	15.68	8.58	YES	YES	1155‡	169
83225	EB3	EB3	1-3/8"	A	24.14	15.11	9.03	YES	YES	482	159
85307	EB3	EB3	1-5/8"	D	23.98	15.08	8.89	YES	NO	1094	173
85702	EB3	EB3	1-5/8"	D	23.76	15.85	7.91	YES	YES	1093	825
87006	EB3	EB3	2-1/16"	E	23.75	15.25	8.5	YES	YES	1158	272
85736	EB3	EB3	1-5/8"	D	23.61	15.2	8.41	YES	YES	1155	352
87002	EB3	EB3	2-1/16"	E	23.5	15.41	8.09	YES	YES	879	203
89420	EB3	EB3	1-5/8"	G	22.8	14.8	8	YES	NO	862‡	258
83217	EB3	EB3	1-3/8"	A	22.77	14.49	8.28	YES	YES	633	159
85302	EB3	EB3	1-5/8"	D	22.75	14.61	8.14	YES	NO	836	253
85304	EB3	EB3	1-5/8"	D	22.25	14.22	8.03	YES	NO	767	325
85718	EB3	EB3	1-5/8"	D	22.13	15.04	7.09	YES	YES	2506	206

*Damping force, in pounds, to either extend or collapse the shock absorber at an average operating velocity.

SPECIFICATIONS BY END MOUNT

Gabriel	Mounting		Bore	External Diameter Illustration	Lengths			Dust Tube	Recoil Cutoff	Controls*	
	Upper	Lower			Extended	Collapsed	Stroke			Rebound	Compression
85732	EB3	EB3	2-1/16"	E	22.13	15.11	7.03	YES	YES	2632	382
85716	EB3	EB3	1-5/8"	D	21.99	14.33	7.66	YES	YES	1220	175
87001	EB3	EB3	2-1/16"	E	20.76	13.76	7	YES	YES	1158	190
85734	EB3	EB3	1-5/8"	D	20.73	13.7	7.03	YES	YES	1288	227
85004	EB3	EB3	1-5/8"	C	20.68	13.67	7.01	YES	YES	1019	219
85042	EB3	EB3	1-5/8"	C	20.64	13.61	7.03	YES	YES	333	161
85712	EB3	EB3	1-5/8"	D	20.5	13.47	7.04	YES	YES	1435	562
85720	EB3	EB3	1-5/8"	D	20.5	13.47	7.03	YES	YES	1435	562
85968	EB3	EB3	1-5/8"	G	19.87	13.39	6.48	YES	YES	1069	227
83214	EB3	EB3	1-3/8"	A	19.64	12.86	6.78	YES	YES	269	90
89419	EB3	EB3	1-5/8"	G	18.04	12.67	5.36	YES	YES	1352±	636
85300	EB3	EB3	1-5/8"	D	17.98	12.21	5.78	YES	YES	1435	676
85719	EB3	EB3	1-5/8"	D	17.25	11.97	5.28	YES	YES	1517	213
85334	EB3	EB3	1-5/8"	D	14.52	10.48	4.04	YES	YES	1271	319
85912	EB3	ES36	1-5/8"	G	18.68	12.57	6.11	YES	YES	1020	219
85327	EB3	ES160	1-5/8"	D	16.01	12.1	3.91	YES	YES	764	162
85322	EB3	ES160	1-5/8"	D	15.26	11.85	3.41	YES	YES	764	162
83353	EB3	S21	1-3/8"	B	24.84	15.06	9.78	YES	NO	432	214
85740	EB3	S21	1-5/8"	D	24.7	15.15	9.55	YES	YES	848	305
85380	EB3	S21	1-5/8"	D	23.95	14.79	9.15	YES	YES	1568	227
85312	EB3	S21	1-5/8"	D	23.68	14.8	8.88	YES	YES	717	111
85733	EB3	S21	1-5/8"	D	23.57	14.73	8.84	YES	YES	717	111
85379	EB3	S21	1-5/8"	D	22.69	14.4	8.29	YES	YES	1658	176
85330	EB3	S21	1-5/8"	D	22.44	14.16	8.28	YES	YES	1140	176
85729	EB3	S21	1-5/8"	D	21.55	13.77	7.78	YES	YES	783	111
85723	EB3	S21	1-5/8"	D	19.93	12.9	7.03	YES	YES	1318	248
83117	EB4	EB1	1-3/8"	A	23.98	14.47	9.51	YES	NO	354	300
G63183	EB4	EB4	1-3/8"		20.89	13.11	7.78	YES	NO		
83119	EB4	ES165	1-3/8"	A	23.96	14.84	9.12	YES	NO	354	300
G63355	EB7	ES24	1-3/8"		15	9.97	5.03	YES	NO		
83303	EB7	ES36	1-3/8"	B	24.86	15.08	9.78	YES	YES	470	122
83304	EB7	ES36	1-3/8"	B	22.86	14.08	8.78	YES	YES	470	122
G63625	EB7	ES36	1-3/8"		22.48	13.96	8.53	YES	NO		
G63306	ES2	ES24	1-3/8"		19.86	12.58	7.28	YES	NO		
G63347	ES3	ES24	1-3/8"		18.08	11.55	6.53	YES	NO		
G63455	ES8	ES83	1-3/8"		23	13.97	9.03	YES	NO		
83002	ES10	ES10	1-3/8"	A	11.65	8.66	3	YES	YES	3112	590

*Damping force, in pounds, to either extend or collapse the shock absorber at an average operating velocity.

SPECIFICATIONS BY END MOUNT

Gabriel	Mounting		Bore	External Diameter Illustration	Lengths			Dust Tube	Recoil Cutoff	Controls*	
	Upper	Lower			Extended	Collapsed	Stroke			Rebound	Compression
83024	ES10	ES10	1-3/8"	2-1/2" D/T	11.65	8.66	3	YES	YES	811	320
83031	ES10	ES10	1-3/8"	2-1/2" D/T	11.54	8.66	2.88	YES	YES	811	314
83016	ES10	ES10	1"	1-5/8"	11.51	8.14	3.37	NO	YES	506	139
83021	ES10	ES10	1-3/8"	A	9.41	7.4	2.01	YES	YES	745	315
83051	ES10	ES10	1-3/8"	2-1/2" D/T	9.41	7.4	2.01	YES	YES	579	163
83061	ES10	ES10	1-3/8"	2-1/2" D/T	9.41	7.4	2.01	YES	YES	1030	220
83046	ES10	ES181	1-3/16"		9.23†	7.62†	2.73	NO	YES	514	173
83023	ES10	ES181	1"	1-5/8"	8.7	7.09†	2.14	NO	YES	484	157
83045	ES19	S10	1-3/8"	A	11.53†	8.58†	3.81	YES	NO	510	153
83050	ES19	S10	1-3/8"	A	10.43†	8.38†	2.9	YES	YES	599	321
83058	ES19	S10	1-3/8"	A	10.43†	8.38†	2.9	YES	YES	742	243
83158	ES22	ES22	1-3/8"	A	12.96	8.97	4	YES	NO	783	484
83010	ES24	ES24	1"	2" D/T	14.15†	9.33	5.07	YES	YES	188	70
G63357	ES24	ES24	1-3/8"		15	9.97	5.03	YES	NO		
83022	ES24	ES24	1"	2" D/T	14.28	9.33	4.95	YES	NO	840	152
83026	ES24	ES24	1-3/8"	A	13.11	9.12	3.99	YES	YES	602	104
83018	ES24	S10	1-3/8"	A	10.3†	8.42†	3.24	YES	YES	515	174
83027	ES24	S10	1-3/8"	A	13.82	9.2	4.61	YES	YES	602	104
83019	ES24	S10	1-3/8"	A	9.48	8.21†	2.29	YES	YES	509	121
83044	ES27	ES164	1-3/8"	A	10.91	7.93	2.98	YES	YES	789	296
G63366	ES34	ES34	1-3/8"		23.36	14.33	9.03	YES	NO		
G63866	ES34	ES34	1-3/8"		22.81	14.12	8.69				
83153	ES34	ES34	1-3/8"	A	21.69	13.62	8.07	YES	YES	974	206
83155	ES34	ES34	1-3/8"	A	21.69	13.62	8.07	YES	YES	507	80
83059	ES35	ES35	1-3/8"	A	12.06†	8.68	3.88	YES	YES	738	350
83004	ES35	ES136	1"	2" D/T	9.36†	7.29	2.32	YES	YES	539	324
85905	ES36	EB3	1-5/8"	G	23.81	16.16	7.66	YES	YES	1020	219
85913	ES36	EB3	1-5/8"	G	22.56	15.2	7.36	YES	YES	1020	219
85057	ES36	EB3	1-5/8"	C	21.45	14.23	7.22	YES	YES	1216	115
85907	ES36	EB3	1-5/8"	G	21.43	14.2	7.23	YES	YES	1216	251
83113	ES36	EB3	1-3/8"	A	20.47	13.46	7.01	YES	YES	997	238
85059	ES36	EB3	1-5/8"	C	19.09	12.8	6.29	YES	YES	928	151
85915	ES36	EB3	1-5/8"	G	19.06	12.7	6.36	YES	YES	1020	219
83115	ES36	EB3	1-3/8"	A	16.19	13.32	4.87	YES	YES	997	238
83242	ES36	ES36	1-3/8"	A	33.73	20.98	12.75	YES	YES	721	135
85903	ES36	ES36	1-5/8"	G	31.99	19.13	12.86	YES	YES	666	113
85979	ES36	ES36	1-5/8"	G	31.18	18.66	12.52	YES	YES	582	138

*Damping force, in pounds, to either extend or collapse the shock absorber at an average operating velocity.

SPECIFICATIONS BY END MOUNT

Gabriel	Mounting		Bore	External Diameter Illustration	Lengths			Dust Tube	Recoil Cutoff	Controls*	
	Upper	Lower			Extended	Collapsed	Stroke			Rebound	Compression
85972	ES36	ES36	1-5/8"	G	30.78	18.26	12.52	YES	NO	1493	261
83121	ES36	ES36	1-3/8"	A	30.25	18.32	11.93	YES	YES	689	126
83137	ES36	ES36	1-3/8"	A	30.04	17.79	12.25	YES	YES	517	132
85976	ES36	ES36	1-5/8"	G	29.92	18.12	11.8	YES	YES	582	138
85013	ES36	ES36	1-5/8"	C	29.79	17.76	12.04	YES	YES	1019	219
83205	ES36	ES36	1-3/8"	A	29.69	17.69	12	YES	YES	660	76
89414	ES36	ES36	1-5/8"	G	29.65	18.18	11.46	YES	YES	1045‡	217
83209	ES36	ES36	1-3/8"	A	29.64	17.61	12.03	YES	YES	670	78
85337	ES36	ES36	1-5/8"	D	28.72	17.44	11.28	YES	YES	1318	374
85006	ES36	ES36	1-5/8"	C	28.54	17.13	11.41	YES	YES	1019	219
83125	ES36	ES36	1-3/8"	A	28.15	17.16	10.99	YES	YES	625	115
85097	ES36	ES36	1-5/8"	C	27.95	17.11	10.84	YES	YES	1086	109
85043	ES36	ES36	1-5/8"	C	27.63	16.85	10.78	YES	YES	628	163
85904	ES36	ES36	1-5/8"	G	27.61	16.88	10.73	YES	YES	666	113
85010	ES36	ES36	1-5/8"	C	26.8	16.26	10.54	YES	YES	1019	219
83123	ES36	ES36	1-3/8"	A	26.65	16.41	10.24	YES	YES	589	119
83176	ES36	ES36	1-3/8"	A	26.62	15.96	10.66	NO	NO	406	275
85036	ES36	ES36	1-5/8"	C	26.38	16.29	10.09	YES	YES	633	119
89405	ES36	ES36	1-5/8"	G	26.3	16.57	9.73	YES	YES	1009‡	249
85099	ES36	ES36	1-5/8"	C	26.02	15.93	10.09	YES	YES	1152	135
85974	ES36	ES36	1-5/8"	G	26.02	16.11	9.91	YES	YES	3087	230
85321	ES36	ES36	1-5/8"	D	25.38	15.59	9.79	YES	YES	1435	676
83122	ES36	ES36	1-3/8"	A	25.28	15.79	9.49	YES	YES	661	201
83149	ES36	ES36	1-3/8"	A	25.28	15.78	9.49	YES	YES	332	101
83218	ES36	ES36	1-3/8"	A	25.19	15.44	9.75	YES	YES	721	194
665472	ES36	ES36	1-5/8"	G	25.14	15.61	9.53	NO	NO	925	977
85005	ES36	ES36	1-5/8"	C	24.76	15.24	9.52	YES	YES	1019	219
89406	ES36	ES36	1-5/8"	G	24.76	15.82	8.93	YES	YES	658‡	125
85916	ES36	ES36	1-5/8"	G	24.65	15.55	9.1	YES	YES	1149	219
89430	ES36	ES36	1-5/8"	G	24.61	15.66	8.94	YES	YES	1462‡	279
83126	ES36	ES36	1-3/8"	A	24.41	15.27	9.14	YES	YES	625	115
85909	ES36	ES36	1-5/8"	G	24.25	15.19	9.06	YES	YES	700	255
85975	ES36	ES36	1-5/8"	G	24.24	15.15	9.09	YES	YES	1658	219
83310	ES36	ES36	1-3/8"	B	24.06	14.69	9.37	YES	NO	559	153
85030	ES36	ES36	1-5/8"	C	24.05	14.89	9.16	YES	YES	1019	219
83221	ES36	ES36	1-3/8"	A	24.01	14.73	9.28	YES	YES	599	153
89440	ES36	ES36	1-5/8"	G	23.9	15.31	8.59	YES	YES	1498‡	561

*Damping force, in pounds, to either extend or collapse the shock absorber at an average operating velocity.

SPECIFICATIONS BY END MOUNT

Gabriel	Mounting		Bore	External Diameter Illustration	Lengths			Dust Tube	Recoil Cutoff	Controls*	
	Upper	Lower			Extended	Collapsed	Stroke			Rebound	Compression
83144	ES36	ES36	1-3/8"	A	23.78	15.03	8.74	YES	YES	596	93
89432	ES36	ES36	1-5/8"	G	23.42	14.79	8.63	YES	NO	1507‡	561
85050	ES36	ES36	1-5/8"	C	23.28	14.5	9.03	YES	NO	525	138
665937	ES36	ES36	1-5/8"	G	22.91	16.09	6.82	YES	NO		
85058	ES36	ES36	1-5/8"	C	22.67	14.26	8.41	YES	YES	722	114
85044	ES36	ES36	1-5/8"	C	22.63	14.1	8.53	YES	NO	722	212
85971	ES36	ES36	1-5/8"	G	22.56	14.17	8.39	YES	NO	2315	451
85919	ES36	ES36	1-5/8"	G	22.52	14.33	8.19	YES	YES	1265	121
632155	ES36	ES36	1-3/16"		22.45	14.1	8.35	NO	NO		
646155	ES36	ES36	1-3/16"		22.45	14.1	8.35	YES	NO		
646177	ES36	ES36	1-3/16"		22.45	14.1	8.35	NO	NO		
89431	ES36	ES36	1-5/8"	G	22.41	14.16	8.25	YES	NO	751‡	211
85345	ES36	ES36	1-5/8"	D	21.83	13.82	8.01	YES	YES	1093	219
85906	ES36	ES36	1-5/8"	G	21.77	14.05	7.72	YES	YES	700	255
85014	ES36	ES36	1-5/8"	C	21.76	13.74	8.02	YES	YES	1019	219
83124	ES36	ES36	1-3/8"	A	21.65	13.77	7.88	YES	YES	750	137
83207	ES36	ES36	1-3/8"	A	21.64	13.61	8.03	YES	YES	553	143
89407	ES36	ES36	1-5/8"	G	21.61	14.17	7.45	YES	YES	652‡	218
85091	ES36	ES36	1-5/8"	C	21.38	13.56	7.82	YES	NO	1121	331
85910	ES36	ES36	1-5/8"	G	20.79	13.54	7.25	YES	YES	1074	219
85029	ES36	ES36	1-5/8"	C	20.54	13.11	7.43	YES	YES	1019	219
85382	ES36	ES36	1-5/8"	D	20.22	13.07	7.15	YES	YES	1658	420
83127	ES36	ES36	1-3/8"	A	20.16	13.14	7.01	YES	YES	940	218
83204	ES36	ES36	1-3/8"	A	20.14	12.86	7.28	YES	YES	451	110
89437	ES36	ES36	1-5/8"	G	20.12	13.42	6.7	YES	YES	1155‡	514
85060	ES36	ES36	1-5/8"	C	19.79	12.76	7.04	YES	YES	943	405
85338	ES36	ES36	1-5/8"	D	19.47	12.68	6.79	YES	YES	1664	420
85051	ES36	ES36	1-5/8"	C	18.54	12.13	6.41	YES	YES	1019	139
85908	ES36	ES36	1-5/8"	G	18.48	12.25	6.23	YES	YES	1020	219
83130	ES36	ES36	1-3/8"	A	18.03	12.04	5.99	YES	YES	871	177
85934	ES36	ES36	1-5/8"	G	17.8	12.04	5.75	YES	YES	3511	1063
85086	ES36	ES36	1-5/8"	C	17.55	11.63	5.92	YES	YES	2027	389
85738	ES36	ES36	1-5/8"	D	17.46	11.69	5.77	YES	YES	1830	416
85323	ES36	ES36	1-5/8"	D	17.36	11.58	5.78	YES	YES	1085	163
87018	ES36	ES36	2-1/16"	E	17.36	11.71	5.65	YES	YES	2479	1000
83389	ES36	ES36	1-3/8"	A	17.32	11.57	5.75	YES	YES	1084	228
85000	ES36	ES36	1-5/8"	C	17.28	11.5	5.78	YES	YES	1019	219

*Damping force, in pounds, to either extend or collapse the shock absorber at an average operating velocity.

SPECIFICATIONS BY END MOUNT

Gabriel	Mounting		Bore	External Diameter Illustration	Lengths			Dust Tube	Recoil Cutoff	Controls*	
	Upper	Lower			Extended	Collapsed	Stroke			Rebound	Compression
89436	ES36	ES36	1-5/8"	G	17.24	12.04	5.2	YES	YES	998‡	217
83203	ES36	ES36	1-3/8"	A	17.1	11.36	5.74	YES	YES	609	114
83128	ES36	ES36	1-3/8"	A	16.89	11.53	5.36	YES	YES	940	218
85911	ES36	ES36	1-5/8"	G	16.89	11.53	5.36	YES	YES	1020	219
83363	ES36	ES36	1-3/8"	A	16.46	11.35	5.11	YES	YES	1084	201
85938	ES36	ES36	1-5/8"	G	16.06	10.82	5.24	YES	YES	1581	432
85064	ES36	ES36	1-5/8"	C	16.02	10.75	5.27	YES	YES	1481	340
83150	ES36	ES36	1-3/8"	A	15.24	10.43	4.81	YES	YES	940	216
85078	ES36	ES36	1-5/8"	C	14.76	10.12	4.64	YES	YES	1409	282
85045	ES36	ES36	1-5/8"	C	14.52	10.12	4.4	YES	YES	1020	219
85939	ES36	ES36	1-5/8"	G	14.44	10.04	4.41	YES	YES	1719	420
85914	ES36	ES36	1-5/8"	G	14.36	10.25	4.11	YES	YES	1020	219
85052	ES36	ES36	1-5/8"	C	13.26	9.49	3.77	YES	YES	1429	335
85344	ES36	ES36	1-5/8"	D	13.22	9.45	3.77	YES	YES	1581	443
85079	ES36	ES36	1-5/8"	C	12.04	8.87	3.17	YES	YES	1494	325
83157	ES36	ES90	1-3/8"	A	26.38	15.76	10.61	YES	NO	446	303
85102	ES36	ES136	1-5/8"	C	21.52	14.93	6.59	YES	YES	1224	342
83164	ES36	ES165	1-3/8"	C	24.22	14.59	9.63	YES	NO	426	274
85072	ES36	ES176	1-5/8"	C	24.17	14.81	9.36	YES	YES	1387	305
85087	ES36	ES176	1-5/8"	C	22.78	14.7	8.08	YES	YES	1568	403
85109	ES36	ES195	1-5/8"	C	24.21	15.14	9.07	YES	YES	1123	149
83635	ES36	S21	1-3/8"	A	21.74	13.25	8.49	YES	NO	558	119
85977	ES36	S42	1-5/8"	G	26.2	15.91	10.29	YES	YES	582	138
83109	ES36	S42	1-3/8"	A	26.17	15.93	10.24	YES	YES	345	78
83111	ES36	S42	1-3/8"	A	26.17	15.93	10.24	YES	YES	560	141
83138	ES36	S42	1-3/8"	A	23.55	14.42	9.12	YES	YES	997	231
83110	ES36	S42	1-3/8"	A	22.94	14.31	8.63	YES	YES	450	143
83112	ES36	S42	1-3/8"	A	21.52	13.41	8.11	YES	YES	1064	343
83033	ES53	ES53	1-3/8"	A	13.99	10.37	3.62	YES	YES	494	312
G63676	ES69	ES69	1-3/8"		15.58	10.55	5.03	YES	YES		
G63403	ES82	ES82	1-3/8"		24.58	14.8	9.78	YES	NO		
83131	ES83	ES83	1-3/8"	A	27.8	18.18	9.62	YES	NO	212	129
83145	ES83	ES83	1-3/8"	A	19.93	12.32	7.54	YES	NO	479	153
83906	ES85	EB1	1-3/8"	2-1/2" D/T	10.45†	8.41†	3.01	YES	YES	586	320
83905	ES86	ES167	1-3/8"	2-1/2" D/T	9.3†	7.81†	2.21	YES	YES	1105	170
83048	ES86	ES167	1-3/8"	A	9.97	8.43†	2.37	YES	YES	904	415
83028	ES86	ES167	1-3/8"	A	9.96	7.6	2.33	YES	YES	445	531
85639	ES90	ES36	1-5/8"	G	27.08	17.79	9.29	YES	NO	795	109

*Damping force, in pounds, to either extend or collapse the shock absorber at an average operating velocity.

SPECIFICATIONS BY END MOUNT

Gabriel	Mounting		Bore	External Diameter Illustration	Lengths			Dust Tube	Recoil Cutoff	Controls*	
	Upper	Lower			Extended	Collapsed	Stroke			Rebound	Compression
85963	ES90	ES36	1-5/8"	G	25.49	18.68	6.81	YES	YES	1490	206
85964	ES90	ES36	1-5/8"	G	25.49	18.68	6.81	YES	YES	1981	205
85995	ES90	ES36	1-5/8"	G	23.5	14.52	8.98	YES	NO	1830	173
85994	ES90	ES36	1-5/8"	G	21.21	13.4	7.81	YES	NO	1824	263
85637	ES90	ES36	1-5/8"	G	20.74	13.19	7.55	YES	NO	2256	327
85954	ES90	ES36	1-5/8"	G	20.43	13	7.43	YES	NO	1812	148
85924	ES90	ES36	1-5/8"	G	20.39	12.99	7.41	YES	NO	1036	122
89457	ES90	ES36	1-5/8"	G	19.92	13.02	6.89	YES	NO	941‡	156
85969	ES90	ES36	1-5/8"	G	18.38	11.93	6.45	YES	NO	1612	125
83180	ES90	ES83	1-3/8"		30.2	21.24	8.96	YES	NO	909	204
83364	ES90	ES83	1-3/8"	A	24.06	15.07	8.99	YES	YES	855	206
83146	ES90	ES83	1-3/8"	A	24.02	14.68	9.33	YES	YES	479	119
85082	ES90	ES90	1-5/8"	C	28.6	20.64	7.97	YES	YES	1435	266
83636	ES90	ES90	1-3/8"	A	27.72	16.95	10.77	YES	YES	505	148
83100	ES90	ES90	1-3/8"	A	26.6	16.11	10.49	YES	YES	481	142
85926	ES90	ES90	1-5/8"	G	26.5	17.96	8.54	YES	YES	1387	279
85953	ES90	ES90	1-5/8"	G	26.13	15.86	10.27	YES	NO	2001	153
85003	ES90	ES90	1-5/8"	C	25.42	15.63	9.79	YES	YES	437	182
89411	ES90	ES90	1-5/8"	G	25.39	16.06	9.34	YES	YES	436‡	186
85927	ES90	ES90	1-5/8"	G	24.76	15.47	9.3	YES	YES	1288	388
83101	ES90	ES90	1-3/8"	A	24.63	15.13	9.49	YES	YES	481	142
85998	ES90	ES90	1-5/8"	G	22.83	14.17	8.66	YES	NO	1345	178
85925	ES90	ES90	1-5/8"	G	22.56	15.6	6.95	YES	NO	761	144
85957	ES90	ES90	1-5/8"	G	20.78	13.19	7.6	YES	NO	1583	138
85928	ES90	ES90	1-5/8"	G	20.31	13.24	7.07	YES	NO	957	229
85929	ES90	ES90	1-5/8"	G	20.28	13.21	7.08	YES	NO	2214	267
85999	ES90	ES90	1-5/8"	G	19.84	12.79	7.05	YES	NO	2214	259
83135	ES90	ES90	1-3/8"	A	19.49	12.38	7.11	YES	NO	519	121
83167	ES90	ES90	1-3/8"	A	19.49	12.38	7.11	YES	NO	285	90
83156	ES90	ES90	1-3/8"	A	18.55	11.91	6.64	YES	NO	778	135
83169	ES90	ES90	1-3/8"	A	18.55	11.91	6.64	YES	NO	599	171
83020	ES91	ES91	1-3/8"	A	9.41	7.17	2.24	YES	YES	796	255
83034	ES115	ES115	1-3/16"	1-5/8"	10.04†	7.32	2.97	NO	YES	430	129
83634	ES120	ES120	1-3/8"	A	27.48	16.23	11.25	YES	YES	779	157
85011	ES120	ES121	1-5/8"	C	27.49	16.46	11.03	YES	NO	1268	186
85122	ES120	S21	1-5/8"	C	22.22	13.78	8.44	YES	YES	926	162
83120	ES120	S21	1-3/8"	A	22.17	13.66	8.51	YES	YES	779	164
85123	ES120	S21	1-5/8"	C	21.49	13.26	8.23	YES	NO	1809	246

*Damping force, in pounds, to either extend or collapse the shock absorber at an average operating velocity.

SPECIFICATIONS BY END MOUNT

Gabriel	Mounting		Bore	External Diameter Illustration	Lengths			Dust Tube	Recoil Cutoff	Controls*	
	Upper	Lower			Extended	Collapsed	Stroke			Rebound	Compression
83154	ES120	S21	1-3/8"	A	20.78	12.72	8.06	YES	YES	599	140
83081	ES126	ES172	1-3/8"	A	13.39	9.98†	4	YES	YES	1004	232
83160	ES128	ES36	1-3/8"	A	24.31	14.9	9.37	YES	YES	920	161
83174	ES128	ES36	1-3/8"	A	24.31	14.9	9.37	YES	YES	795	160
83042	ES136	ES136	1-3/8"	A	9.89†	8.52†	2.39	YES	YES	954	541
83030	ES136	ES136	1-3/8"	A	9.61†	7.61	2.5	YES	YES	308	87
83008	ES136	ES136	1-3/8"	A	13†	10.13†	4	YES	YES	699	307
83056	ES136	ES136	1-5/8"	C	11.53	8.63	2.89	YES	YES	3830	737
85026	ES136	S21	1-5/8"	C	23.02	14.01	9.01	YES	NO	1079	539
89417	ES136	S21	1-5/8"	G	22.94	14.31	8.63	YES	NO	1226‡	515
83047	ES149	EB1	1-3/8"	A	11.78†	9.74†	3	YES	YES	364	314
83001	ES149	EB1	1-3/8"	A	10.45†	8.41†	3	YES	YES	793	363
83038	ES149	EB1	1-3/8"	A	10.45†	8.41†	3	YES	YES	336	242
83006	ES149	EB1	1-3/8"	A	10.71	8.52†	2.78	YES	YES	525	182
83009	ES149	ES149	1-3/8"	A	10.45†	8.41†	3	YES	YES	793	363
83039	ES149	ES149	1-3/8"	A	10.44†	8.4†	3	YES	YES	876	326
83064	ES149	ES149	1-3/8"	A	10.41†	8.36†	2.99	YES	YES	635	323
83017	ES149	ES149	1-3/8"	A	10.95	8.41†	3.13	YES	YES	353	138
85090	ES150	ES36	1-5/8"	C	25.31	15.52	9.79	YES	YES	943	99
85180	ES150	ES36	1-5/8"	C	20.94	13.83	7.11	YES	YES	681	283
85181	ES150	ES150	1-5/8"	C	26.33	17.06	9.27	YES	YES	681	285
89449	ES150	ES150	1-5/8"	G	23.25	14.9	8.35	YES	NO	1519‡	324
85918	ES150	ES150	1-5/8"	G	22.97	14.58	8.39	YES	NO	1726	412
85958	ES150	ES150	1-5/8"	G	22.89	14.5	8.39	YES	YES	1926	281
89503	ES150	ES150	1-5/8"	G	21.28	13.72	7.56	YES	NO	1033‡	123
85106	ES150	ES150	1-5/8"	C	20.03	12.89	7.14	YES	YES	1054	109
85119	ES150	ES150	1-5/8"	C	21.39	13.81	7.68	YES	YES	1387	185
85922	ES150	ES150	1-5/8"	G	21.19	13.53	7.66	YES	NO	878	185
85920	ES150	ES150	1-5/8"	G	21.16	13.57	7.59	YES	NO	845	49
85959	ES150	ES150	1-5/8"	G	21.16	13.57	7.59	YES	YES	1021	123
85092	ES150	S21	1-5/8"	C	21.95	15.04	6.89	YES	YES	1597	138
83066	ES153	ES153	1-3/8"	A	11.15†	9.2†	2.78	YES	YES	599	221
83901	ES153	ES153	1-3/8"	A	11.15†	9.2†	2.78	YES	YES	509	204
85984	ES158	ES150	1-5/8"	G	25.44	15.96	9.48	YES	YES	2248	1168
85125	ES158	ES159	1-5/8"	C	26.9	16.64	10.26	YES	YES	1479	183
85724	ES158	ES159	1-5/8"	D	22.81	14.51	8.3	YES	YES	1235	454
89443	ES158	ES159	1-5/8"	G	22.19	14.66	7.53	YES	YES	1206‡	466
85331	ES158	ES159	1-5/8"	D	19.62	12.85	6.77	YES	YES	1757	396

*Damping force, in pounds, to either extend or collapse the shock absorber at an average operating velocity.

SPECIFICATIONS BY END MOUNT

Gabriel	Mounting		Bore	External Diameter Illustration	Lengths			Dust Tube	Recoil Cutoff	Controls*	
	Upper	Lower			Extended	Collapsed	Stroke			Rebound	Compression
85335	ES158	ES159	1-5/8"	D	19.62	12.85	6.77	YES	YES	827	107
85126	ES158	S21	1-5/8"	C	21.76	13.63	8.13	YES	YES	1086	215
87019	ES160	ES160	2-1/16"	E	24.84	15.85	8.9	YES	YES	2972	665
87017	ES160	ES160	2-1/16"	E	23.35	15.31	8.07	YES	YES	1876	220
89461	ES160	ES160	1-5/8"	G	19.96	13.58	6.38	YES	YES	897‡	103
85088	ES161	ES162	1-5/8"	C	25.31	15.52	9.79	YES	YES	616	178
85061	ES161	ES162	1-5/8"	C	24.76	15.25	9.51	YES	YES	1216	195
85066	ES161	ES162	1-5/8"	C	24.64	15.25	9.39	YES	YES	812	322
85098	ES161	ES162	1-5/8"	C	24.64	15.24	9.4	YES	YES	747	158
89448	ES161	ES162	1-5/8"	G	24.61	15.66	8.94	YES	YES	782‡	323
89450	ES161	ES162	1-5/8"	G	24.61	15.66	8.94	YES	YES	1282‡	193
85065	ES161	S21	1-5/8"	C	28.05	17	11.05	YES	YES	1059	300
85083	ES162	S42	1-5/8"	C	27.81	16.53	11.28	YES	YES	1429	184
83142	ES162	S42	1-3/8"	A	23.92	14.49	9.43	YES	YES	367	131
83143	ES162	S42	1-3/8"	A	21.92	13.51	8.41	YES	YES	403	137
83025	ES163	ES163	1-3/8"	A	8.02	6.53	1.48	YES	YES	710	230
83049	ES163	ES163	1-3/8"	A	8.02	6.53	1.48	YES	YES	2879	705
83032	ES163	ES163	1-3/8"	A	7.85	6.36	1.49	NO	YES	779	135
83118	ES164	ES90	1-3/8"	A	24.45	14.71	9.74	YES	NO	410	311
83116	ES164	ES165	1-3/8"	A	23.81	14.68	9.12	YES	NO	354	300
83035	ES166	ES136	1-3/8"	A	13.04†	9.33	4.22	YES	YES	320	100
83067	ES166	ES136	1-3/16"	2" D/T	12.33†	9.27	3.56	YES	YES	424	101
83029	ES168	ES169	1-5/8"	C	10.35	7.87	2.41	YES	NO	1303	1349
83040	ES171	ES172	1-3/8"	A	10.44†	8.4†	3	YES	YES	876	326
83057	ES171	ES172	1-3/8"	2-1/2" D/T	10.44†	8.4†	2.99	YES	YES	364	242
87015	ES173	ES173	45MM	E	15.51	11.18	4.33	YES	YES	4950	900
85737	ES173	ES173	1-5/8"	D	15.11	10.84	4.27	YES	YES	3066	782
89459	ES174	EB3	1-5/8"	G	25.63	16.14	9.49	YES	NO	1179‡	314
85070	ES174	EB3	1-5/8"	C	25.59	15.83	9.76	YES	NO	1100	310
85067	ES174	ES136	1-5/8"	C	30.54	18.15	12.39	YES	YES	676	170
89451	ES174	ES136	1-5/8"	G	30.39	18.54	11.86	YES	YES	645‡	172
85989	ES174	ES136	1-5/8"	G	20.78	13.15	7.63	YES	NO	1812	351
85084	ES174	ES136	1-5/8"	C	20.59	13.03	7.57	YES	NO	1145	407
89460	ES174	ES136	1-5/8"	G	20.58	13.03	7.55	YES	NO	997‡	384
85937	ES174	S43	1-5/8"	G	19.04	12.35	6.7	YES	YES	1479	337
85985	ES174	S43	1-5/8"	G	19.04	12.31	6.73	YES	YES	2068	723
85936	ES174	S43	1-5/8"	G	17.27	11.48	5.79	YES	YES	1479	337
89456	ES174	S43	1-5/8"	G	17.04	11.63	5.4	YES	YES	975‡	377

*Damping force, in pounds, to either extend or collapse the shock absorber at an average operating velocity.

SPECIFICATIONS BY END MOUNT

Gabriel	Mounting		Bore	External Diameter Illustration	Lengths			Dust Tube	Recoil Cutoff	Controls*	
	Upper	Lower			Extended	Collapsed	Stroke			Rebound	Compression
83063	ES175	ES136	1-3/8"	A	10.76†	9.26†	3.01	YES	YES	954	541
85955	ES175	ES150	1-5/8"	G	21.25	13.66	7.59	YES	YES	1034	397
85986	ES175	ES150	1-5/8"	G	21.25	13.66	7.59	YES	YES	1754	221
85120	ES175	ES175	1-5/8"	C	23.67	15.06	8.61	YES	NO	2083	519
83163	ES175	ES175	1-3/8"	A	20.75	13.01	7.74	YES	NO	828	98
83175	ES175	ES175	1-3/8"	A	20.48	13.19	7.29	YES	NO	1245	156
85933	ES175	ES175	1-5/8"	G	18.27	12.72	5.54	YES	YES	1089	383
89454	ES175	ES175	1-5/8"	G	18.27	12.91	5.36	YES	YES	938‡	388
85081	ES175	S21	1-5/8"	C	23.44	14.33	9.11	YES	YES	1658	250
85080	ES175	S21	1-5/8"	C	22.51	13.77	8.74	YES	NO	447	138
85031	ES176	EB2	1-5/8"	C	25.63	15.87	9.76	YES	NO	941	257
85923	ES177	ES161	1-5/8"	G	22.52	14.52	8	YES	YES	1940	221
85931	ES177	ES161	1-5/8"	G	22.52	14.52	8	YES	YES	1435	220
89458	ES177	ES161	1-5/8"	G	22.48	14.6	7.88	YES	YES	1575‡	222
85930	ES177	ES161	1-5/8"	G	17.86	12	5.86	YES	YES	1617	342
85932	ES178	ES150	1-5/8"	G	21.26	13.7	7.56	YES	YES	1102	430
89453	ES178	ES150	1-5/8"	G	21.14	13.93	7.21	YES	YES	860‡	435
85965	ES178	ES161	1-5/8"	G	24.24	15.15	9.09	YES	YES	2206	238
85966	ES178	ES161	1-5/8"	G	23.25	14.64	8.62	YES	YES	2206	238
85967	ES178	ES176	1-5/8"	G	23.93	14.86	9.07	YES	YES	2206	238
85961	ES178	ES176	1-5/8"	G	22.83	14.17	8.66	YES	YES	2206	240
85962	ES178	ES176	1-5/8"	G	21.8	13.66	8.15	YES	YES	2206	240
85980	ES179	ES179	1-5/8"	G	31.17	18.66	12.52	YES	YES	582	138
83148	ES179	ES179	1-3/8"	A	30	17.83	12.17	YES	YES	604	149
85978	ES179	ES179	1-5/8"	G	29.84	18.16	11.69	YES	YES	582	138
85638	ES179	ES179	1-5/8"	G	28.58	17.4	11.18	YES	YES	643	138
83147	ES179	ES179	1-3/8"	A	28.54	17.4	11.15	YES	YES	358	128
83166	ES179	ES179	1-3/8"	A	25.28	15.78	9.49	YES	YES	622	132
83168	ES179	ES179	1-3/8"	A	25.28	15.78	9.49	YES	YES	246	88
85377	ES182	ES182	1-5/8"	D	23.8	14.84	8.96	YES	YES	1937	570
85378	ES182	ES182	1-5/8"	D	23.8	14.84	8.96	YES	YES	1110	240
85956	ES183	ES184	1-5/8"	G	30.65	18.77	11.88	YES	YES	979	373
83053	ES185	ES185	1-3/8"	A	10.91	7.93	2.98	YES	YES	968	214
83054	ES185	ES185	1-3/8"	A	10.28	7.56	2.72	YES	YES	1004	184
83052	ES185	ES185	1-3/8"	2-1/2" D/T	9.41	7.19	2.23	YES	NO	1101	149
83062	ES185	S42	1-3/8"	A	12.71	9.18	3.53	YES	NO	704	153
85739	ES187	ES187	1-5/8"	D	20.73	13.54	7.19	YES	YES	3247	334

*Damping force, in pounds, to either extend or collapse the shock absorber at an average operating velocity.

SPECIFICATIONS BY END MOUNT

Gabriel	Mounting		Bore	External Diameter Illustration	Lengths			Dust Tube	Recoil Cutoff	Controls*	
	Upper	Lower			Extended	Collapsed	Stroke			Rebound	Compression
85341	ES188	S21	1-5/8"	D	30.96	18.1	12.86	YES	YES	1807	333
85970	ES188	S21	1-5/8"	G	27.23	16.44	10.79	YES	YES	1092	147
85340	ES188	S21	1-5/8"	D	26.46	15.85	10.61	YES	YES	1807	165
83391	ES190	ES190	1-3/8"	A	25.52	15.61	9.91	YES	NO	590	105
86203	ES193	ES193	45 MM	D	16.88	11.61	5.27	YES	YES	4238	910
86202	ES193	ES193	45 MM	D	14.52	10.43	4.09	YES	YES	4238	688
86201	ES193	ES193	45 MM	D	13.26	9.94	3.32	YES	YES	4238	688
86200	ES194	ES194	45 MM	D	14.24	10.45	3.79	YES	YES	4238	688
83065	ES206	ES171	1-5/8"	G	12.52	9.32	3.2	YES	YES	680	184
83003	S1	BP7	1-3/8"	A	11.76	8.95†	3.4	YES	YES	248	100
G63610	S1	EB1	1-3/8"		21.55	13.27	8.28	YES	NO		
83161	S1	EB1	1-3/8"	A	20.82	12.56	8.25	YES	NO	400	70
83518	S1	EB2	1-3/16"		24.4	14.26	10.14	YES	NO	153	82
83515	S1	EB2	1-3/16"		23.34	13.89	9.45	YES	NO	643	205
G63432	S1	EB2	1-3/8"		21.21	12.93	8.28	YES	NO		
G63387	S1	ES25	1-3/8"		23.33	14.05	9.28	YES	NO		
G63511	S1	ES25	1-3/8"		22.55	13.52	9.03	YES	NO		
G63350	S1	ES25	1-3/8"		18.83	11.8	7.03	YES	NO		
83400	S1	S1	1-3/16"	F	22.02	12.82	9.2	YES	NO	301	120
G63398	S1	S1	1-3/8"		20.52	12.24	8.28	YES	NO		
83014	S1	S1	1-3/8"	A	10.48	7.11	3.37	NO	NO	544	501
G63396	S10	ES25	1-3/8"		16.55	10.77	5.78	YES	NO		
G63778	S12	ES25	1-3/8"		24.55	14.52	10.03	YES	NO		
G63716	S12	ES26	1-3/8"		15.54	10.01	5.53	YES	NO		
83317	S16	ES90	1-3/8"	B	27.03	16	11.34	YES	YES		
83301	S16	ES90	1-3/8"	B	24.52	14.74	9.78	YES	YES	653	86
83318	S16	S16	1-3/8"	B	22.53	13.5	9.03	YES	YES	323	77
83613	S16	S16	1-3/8"	A	21.04	12.76	8.28	YES	YES	601	242
85731	S21	EB3	1-5/8"	D	30.57	18.54	12.03	YES	YES	1517	293
85703	S21	EB3	1-5/8"	D	29.57	18.54	11.03	YES	YES	1435	186
85033	S21	EB3	1-5/8"	C	27.26	17.4	9.86	YES	YES	764	254
89427	S21	EB3	1-5/8"	G	27.19	17.62	9.57	YES	YES	794‡	253
85317	S21	EB3	1-5/8"	D	27.18	17.42	9.76	YES	YES	764	254
85711	S21	EB3	1-5/8"	D	24.54	15.26	9.27	YES	YES	1435	208
87000	S21	EB3	2-1/16"	E	24.46	15.21	9.25	YES	YES	1332	300
85311	S21	EB3	1-5/8"	D	23.95	14.79	9.16	YES	YES	764	254
85988	S21	EB3	1-5/8"	G	23.84	14.87	8.97	YES	YES	1200	138

*Damping force, in pounds, to either extend or collapse the shock absorber at an average operating velocity.

SPECIFICATIONS BY END MOUNT

Gabriel	Mounting		Bore	External Diameter Illustration	Lengths			Dust Tube	Recoil Cutoff	Controls*	
	Upper	Lower			Extended	Collapsed	Stroke			Rebound	Compression
89424	S21	EB3	1-5/8"	G	23.73	15.14	8.59	YES	YES	794‡	253
85710	S21	EB3	1-5/8"	D	23.45	15.1	8.34	YES	YES	994	248
85343	S21	EB3	1-5/8"	D	22.96	14.79	8.17	YES	YES	858	289
87016	S21	EB3	2-1/16"	E	21.17	13.91	7.26	YES	YES	1808	238
85009	S21	ES36	1-5/8"	C	23.56	14.4	9.16	YES	YES	857	144
83134	S21	ES36	1-3/8"	A	22.27	13.51	8.77	YES	NO	430	49
85921	S21	ES36	1-5/8"	G	22.07	13.57	8.5	YES	NO	2053	339
85316	S21	ES36	1-5/8"	D	20.61	12.82	7.8	YES	NO	943	443
85351	S21	ES36	1-5/8"	D	20.61	12.82	7.79	YES	NO	1887	259
89426	S21	ES36	1-5/8"	G	20.46	13.05	7.41	YES	NO	926‡	419
85056	S21	ES36	1-5/8"	C	20.15	12.87	7.28	YES	YES	732	114
89441	S21	ES36	1-5/8"	G	20.14	13.06	7.08	YES	YES	761‡	126
85935	S21	ES36	1-5/8"	G	18.7	11.92	6.78	YES	NO	1054	419
85319	S21	ES150	1-5/8"	D	22.22	13.93	8.3	YES	YES	988	454
89428	S21	ES150	1-5/8"	G	22	14.27	7.72	YES	YES	958‡	446
83395	S21	ES178	1-3/8"	A	27.19	16.28	10.91	YES	NO	616	105
85709	S21	S21	1-5/8"	D	31.64	18.36	13.28	YES	YES	700	203
85727	S21	S21	1-5/8"	D	29.88	17.34	12.54	YES	YES	783	111
83136	S21	S21	1-3/8"	A	29.31	16.8	12.51	YES	NO	914	65
83106	S21	S21	1-3/8"	A	29.25	16.76	12.49	YES	NO	451	80
85048	S21	S21	1-5/8"	C	29.16	16.88	12.28	YES	NO	432	106
85318	S21	S21	1-5/8"	D	27.37	16.36	11.01	YES	YES	1372	192
85722	S21	S21	1-5/8"	D	27.16	16.41	10.76	YES	YES	1264	369
85069	S21	S21	1-5/8"	C	26.31	15.97	10.33	YES	YES	762	255
89455	S21	S21	1-5/8"	G	26.31	16.03	10.28	YES	YES	791‡	276
85328	S21	S21	1-5/8"	D	25.64	15.36	10.28	YES	NO	930	383
85071	S21	S21	1-5/8"	C	25.57	15.02	10.55	YES	NO	610	107
85049	S21	S21	1-5/8"	C	25.53	15	10.53	YES	NO	597	107
85085	S21	S21	1-5/8"	C	24.95	14.67	10.23	YES	NO	970	101
85728	S21	S21	1-5/8"	D	24.37	14.86	9.51	YES	YES	1435	510
83456	S21	S21	1-3/8"	B	24.03	14.25	9.78	YES	YES	566	80
85706	S21	S21	1-5/8"	D	23.65	14.24	9.41	YES	YES	1086	696
85707	S21	S21	2-1/16"	D	23.65	14.4	9.25	YES	YES	1761	986
87011	S21	S21	2-1/16"	E	23.65	14.4	9.25	YES	YES	1750	1050
87012	S21	S21	2-1/16"	E	23.65	14.4	9.25	YES	YES	650	364
87013	S21	S21	2-1/16"	E	23.65	14.4	9.25	YES	YES	1075	585
85325	S21	S21	1-5/8"	D	23.64	14.36	9.28	YES	NO	1024	240
89447	S21	S21	1-5/8"	G	23.63	14.69	8.94	YES	YES	702‡	241

*Damping force, in pounds, to either extend or collapse the shock absorber at an average operating velocity.

SPECIFICATIONS BY END MOUNT

Gabriel	Mounting		Bore	External Diameter Illustration	Lengths			Dust Tube	Recoil Cutoff	Controls*	
	Upper	Lower			Extended	Collapsed	Stroke			Rebound	Compression
85347	S21	S21	1-5/8"	D	23.62	14.22	9.4	YES	YES	961	122
85705	S21	S21	1-5/8"	D	23.62	14.23	9.39	YES	YES	639	436
85342	S21	S21	1-5/8"	D	23.28	13.99	9.29	YES	NO	893	188
83102	S21	S21	1-3/8"	A	22.89	13.54	9.35	YES	YES	513	333
85324	S21	S21	1-5/8"	D	22.14	13.61	8.53	YES	NO	579	114
85346	S21	S21	1-5/8"	D	22.12	13.48	8.64	YES	YES	2016	285
85027	S21	S21	1-5/8"	C	21.59	13.05	8.54	YES	NO	1008	539
89418	S21	S21	1-5/8"	G	21.44	13.19	8.25	YES	NO	1266‡	515
695406	S21	S21	2-1/16"	E	21.39	13.26	8.13	YES	YES	1854	274
85124	S21	S21	1-5/8"	C	20.91	12.9	8.01	YES	YES	1086	222
85708	S21	S21	1-5/8"	D	20.63	12.85	7.78	YES	YES	914	204
85745	S21	S21	1-5/8"	D	19.88	12.34	7.54	YES	YES	3064	231
85746	S21	S21	1-5/8"	D	19.88	12.34	7.54	YES	YES	1754	167
83103	S21	S21	1-3/8"	A	19.66	11.93	7.74	YES	YES	517	301
85326	S21	S21	1-5/8"	D	19.64	12.36	7.28	YES	NO	799	142
85902	S21	S21	1-5/8"	G	19.03	12.09	6.93	YES	YES	1441	267
85336	S21	S21	1-5/8"	D	18.76	11.86	6.9	YES	NO	861	200
89423	S21	S21	1-5/8"	G	18.67	12.21	6.46	YES	YES	1352‡	573
85310	S21	S21	1-5/8"	D	18.63	11.71	6.92	YES	YES	1379	578
85900	S21	S21	1-5/8"	G	17.33	11.23	6.11	YES	YES	1467	337
87007	S21	S21	2-1/16"	E	15.65	10.4	5.25	YES	YES	879	253
85701	S21	S21	1-5/8"	D	15.64	10.36	5.28	YES	YES	914	204
G63500	S28	ES25	1-3/8"		15.09	10.06	5.03	NO	YES		
G63414	S28	ES83	1-3/8"		15.09	10.06	5.03	NO	YES		
G63678	S36	BP7	1-3/8"		18.09	13.56	4.53	YES	NO		
G63622	S36	EB1	1-3/8"		15.42	10.39	5.03	YES	YES		
G63614	S36	EB1	1-3/8"		15.12	10.09	5.03	NO	YES		
G63929	S36	EB1	1-3/8"		14.72	9.71	5.01	YES	YES		
G63608	S36	EB1	1-3/8"		14.58	9.81	4.78	YES	YES		
G63386	S36	ES25	1-3/8"		17.19	11.16	6.03	NO	YES		
G63623	S36	ES83	1-3/8"		22.67	14.39	8.28	YES	YES		
G63624	S36	ES83	1-3/8"		20.17	12.64	7.53	YES	YES		
83178	S38	ES83	1-3/8"	A	21.95	13.26	8.69	YES	NO	690	275
G63484	S4	EB1	1-3/8"		20.05	12.52	7.53	YES	NO		
83177	S40	EB1	1-3/8"	A	14.99†	10.12	5.38	YES	NO	690	275
83114	S40	ES35	1-3/8"	A	23.02	13.78	9.24	YES	NO	450	102
83105	S40	ES179	1-3/8"	A	31.91	18.3	13.61	YES	NO	559	150
83162	S40	ES190	1-3/8"	A	24.35	14.69	9.67	YES	NO	877	52

*Damping force, in pounds, to either extend or collapse the shock absorber at an average operating velocity.

SPECIFICATIONS BY END MOUNT

Gabriel	Mounting		Bore	External Diameter Illustration	Lengths			Dust Tube	Recoil Cutoff	Controls*	
	Upper	Lower			Extended	Collapsed	Stroke			Rebound	Compression
85333	S42	ES36	1-5/8"	D	20.65	12.98	7.67	YES	YES	1241	534
85332	S42	ES36	1-5/8"	D	20.64	12.98	7.66	YES	YES	2351	967
85182	S43	S43	1-5/8"	C	26.86	16.04	10.82	YES	NO	708	232
G63714	S6	BP7	1-3/8"		15.54	10.01	5.53	YES	NO		
G63772	S6	BP35	1-3/8"		13.83	9.55	4.28	YES	YES		
83171		ES36	1-3/8"	A	23.98	14.51	9.47	YES	YES	513	146
630811	0	0	1-3/16"		22.45	14.1	8.35	NO	NO		
632147	0	0	1-3/16"		22.45	14.1	8.35	NO	NO		
G63969	412847	ES34	1-3/8"		20.75	13.31	7.44				

*Damping force, in pounds, to either extend or collapse the shock absorber at an average operating velocity.

SPECIFICATIONS BY PART NUMBER

Gabriel	Mounting		Bore	External Diameter Illustration	Lengths			Dust Tube	Recoil Cutoff	Controls*	
	Upper	Lower			Extended	Collapsed	Stroke			Rebound	Compression
83001	ES149	EB1	1-3/8"	A	10.45†	8.41†	3	YES	YES	793	363
83002	ES10	ES10	1-3/8"	A	11.65	8.66	3	YES	YES	3112	590
83003	S1	BP7	1-3/8"	A	11.76	8.95†	3.4	YES	YES	248	100
83004	ES35	ES136	1"	2" D/T	9.36†	7.29	2.32	YES	YES	539	324
83005	BP8	S10	1-3/16"	2" D/T	7.34	5.87	1.47	YES	NO	858	216
83006	ES149	EB1	1-3/8"	A	10.71	8.52†	2.78	YES	YES	525	182
83007	EB1	EB1	1-3/8"	A	18.55	11.67	6.87	NO	NO	489	343
83008	ES136	ES136	1-3/8"	A	13†	10.13†	4	YES	YES	699	307
83009	ES149	ES149	1-3/8"	A	10.45†	8.41†	3	YES	YES	793	363
83010	ES24	ES24	1"	2" D/T	14.15†	9.33	5.07	YES	YES	188	70
83011	EB1	EB1	1-3/8"	A	11.55†	8.48	3.61	YES	YES	738	330
83012	EB1	EB1	1-3/8"	A	11.07†	8.21	3.37	YES	YES	738	330
83013	BP8	BP8	1-3/16"	2" D/T	7.66	6.63†	1.7	YES	NO	646	480
83014	S1	S1	1-3/8"	A	10.48	7.11	3.37	NO	NO	544	501
83015	BP8	S1	1-3/8"	A	9.84	7.59	2.25	YES	YES	735	430
83016	ES10	ES10	1"	1-5/8"	11.51	8.14	3.37	NO	YES	506	139
83017	ES149	ES149	1-3/8"	A	10.95	8.41†	3.13	YES	YES	353	138
83018	ES24	S10	1-3/8"	A	10.3†	8.42†	3.24	YES	YES	515	174
83019	ES24	S10	1-3/8"	A	9.48	8.21†	2.29	YES	YES	509	121
83020	ES91	ES91	1-3/8"	A	9.41	7.17	2.24	YES	YES	796	255
83021	ES10	ES10	1-3/8"	A	9.41	7.4	2.01	YES	YES	745	315
83022	ES24	ES24	1"	2" D/T	14.28	9.33	4.95	YES	NO	840	152
83023	ES10	ES181	1"	1-5/8"	8.7	7.09†	2.14	NO	YES	484	157
83024	ES10	ES10	1-3/8"	2-1/2" D/T	11.65	8.66	3	YES	YES	811	320
83025	ES163	ES163	1-3/8"	A	8.02	6.53	1.48	YES	YES	710	230
83026	ES24	ES24	1-3/8"	A	13.11	9.12	3.99	YES	YES	602	104
83027	ES24	S10	1-3/8"	A	13.82	9.2	4.61	YES	YES	602	104
83028	ES86	ES167	1-3/8"	A	9.96	7.6	2.33	YES	YES	445	531
83029	ES168	ES169	1-5/8"	C	10.35	7.87	2.41	YES	NO	1303	1349
83030	ES136	ES136	1-3/8"	A	9.61†	7.61	2.5	YES	YES	308	87
83031	ES10	ES10	1-3/8"	2-1/2" D/T	11.54	8.66	2.88	YES	YES	811	314
83032	ES163	ES163	1-3/8"	A	7.85	6.36	1.49	NO	YES	779	135
83033	ES53	ES53	1-3/8"	A	13.99	10.37	3.62	YES	YES	494	312
83034	ES115	ES115	1-3/16"	1-5/8"	10.04†	7.32	2.97	NO	YES	430	129
83035	ES166	ES136	1-3/8"	A	13.04†	9.33	4.22	YES	YES	320	100
83038	ES149	EB1	1-3/8"	A	10.45†	8.41†	3	YES	YES	336	242
83039	ES149	ES149	1-3/8"	A	10.44†	8.4†	3	YES	YES	876	326
83040	ES171	ES172	1-3/8"	A	10.44†	8.4†	3	YES	YES	876	326
83041	BP27	S10	1-3/8"	A	10.51†	8.34†	3.02	YES	YES	486	189

* Damping force, in pounds, to either extend or collapse the shock absorber at an average operating velocity.

SPECIFICATIONS BY PART NUMBER

Gabriel	Mounting		Bore	External Diameter Illustration	Lengths			Dust Tube	Recoil Cutoff	Controls*	
	Upper	Lower			Extended	Collapsed	Stroke			Rebound	Compression
83042	ES136	ES136	1-3/8"	A	9.89†	8.52†	2.39	YES	YES	954	541
83044	ES27	ES164	1-3/8"	A	10.91	7.93	2.98	YES	YES	789	296
83045	ES19	S10	1-3/8"	A	11.53†	8.58†	3.81	YES	NO	510	153
83046	ES10	ES181	1-3/16"		9.23†	7.62†	2.73	NO	YES	514	173
83047	ES149	EB1	1-3/8"	A	11.78†	9.74†	3	YES	YES	364	314
83048	ES86	ES167	1-3/8"	A	9.97	8.43†	2.37	YES	YES	904	415
83049	ES163	ES163	1-3/8"	A	8.02	6.53	1.48	YES	YES	2879	705
83050	ES19	S10	1-3/8"	A	10.43†	8.38†	2.9	YES	YES	599	321
83051	ES10	ES10	1-3/8"	2-1/2" D/T	9.41	7.4	2.01	YES	YES	579	163
83052	ES185	ES185	1-3/8"	2-1/2" D/T	9.41	7.19	2.23	YES	NO	1101	149
83053	ES185	ES185	1-3/8"	A	10.91	7.93	2.98	YES	YES	968	214
83054	ES185	ES185	1-3/8"	A	10.28	7.56	2.72	YES	YES	1004	184
83056	ES136	ES136	1-5/8"	C	11.53	8.63	2.89	YES	YES	3830	737
83057	ES171	ES172	1-3/8"	2-1/2" D/T	10.44†	8.4†	2.99	YES	YES	364	242
83058	ES19	S10	1-3/8"	A	10.43†	8.38†	2.9	YES	YES	742	243
83059	ES35	ES35	1-3/8"	A	12.06†	8.68	3.88	YES	YES	738	350
83060	EB	BP7	1-3/8"	A	9.76	7.98†	2.25	NO	YES	431	441
83061	ES10	ES10	1-3/8"	2-1/2" D/T	9.41	7.4	2.01	YES	YES	1030	220
83062	ES185	S42	1-3/8"	A	12.71	9.18	3.53	YES	NO	704	153
83063	ES175	ES136	1-3/8"	A	10.76†	9.26†	3.01	YES	YES	954	541
83064	ES149	ES149	1-3/8"	A	10.41†	8.36†	2.99	YES	YES	635	323
83065	ES206	ES171	1-5/8"	G	12.52	9.32	3.2	YES	YES	680	184
83066	ES153	ES153	1-3/8"	A	11.15†	9.2†	2.78	YES	YES	599	221
83067	ES166	ES136	1-3/16"	2" D/T	12.33†	9.27	3.56	YES	YES	424	101
83081	ES126	ES172	1-3/8"	A	13.39	9.98†	4	YES	YES	1004	232
83100	ES90	ES90	1-3/8"	A	26.6	16.11	10.49	YES	YES	481	142
83101	ES90	ES90	1-3/8"	A	24.63	15.13	9.49	YES	YES	481	142
83102	S21	S21	1-3/8"	A	22.89	13.54	9.35	YES	YES	513	333
83103	S21	S21	1-3/8"	A	19.66	11.93	7.74	YES	YES	517	301
83104	EB3	EB3	1-3/8"	A	28.24	17.12	11.12	YES	NO	698	133
83105	S40	ES179	1-3/8"	A	31.91	18.3	13.61	YES	NO	559	150
83106	S21	S21	1-3/8"	A	29.25	16.76	12.49	YES	NO	451	80
83107	EB2	EB2	1-3/8"	A	31.66	18.4	13.25	YES	NO	352	77
83109	ES36	S42	1-3/8"	A	26.17	15.93	10.24	YES	YES	345	78
83110	ES36	S42	1-3/8"	A	22.94	14.31	8.63	YES	YES	450	143
83111	ES36	S42	1-3/8"	A	26.17	15.93	10.24	YES	YES	560	141
83112	ES36	S42	1-3/8"	A	21.52	13.41	8.11	YES	YES	1064	343
83113	ES36	EB3	1-3/8"	A	20.47	13.46	7.01	YES	YES	997	238

* Damping force, in pounds, to either extend or collapse the shock absorber at an average operating velocity.

SPECIFICATIONS BY PART NUMBER

Gabriel	Mounting		Bore	External Diameter Illustration	Lengths			Dust Tube	Recoil Cutoff	Controls*	
	Upper	Lower			Extended	Collapsed	Stroke			Rebound	Compression
83114	S40	ES35	1-3/8"	A	23.02	13.78	9.24	YES	NO	450	102
83115	ES36	EB3	1-3/8"	A	16.19	13.32	4.87	YES	YES	997	238
83116	ES164	ES165	1-3/8"	A	23.81	14.68	9.12	YES	NO	354	300
83117	EB4	EB1	1-3/8"	A	23.98	14.47	9.51	YES	NO	354	300
83118	ES164	ES90	1-3/8"	A	24.45	14.71	9.74	YES	NO	410	311
83119	EB4	ES165	1-3/8"	A	23.96	14.84	9.12	YES	NO	354	300
83120	ES120	S21	1-3/8"	A	22.17	13.66	8.51	YES	YES	779	164
83121	ES36	ES36	1-3/8"	A	30.25	18.32	11.93	YES	YES	689	126
83122	ES36	ES36	1-3/8"	A	25.28	15.79	9.49	YES	YES	661	201
83123	ES36	ES36	1-3/8"	A	26.65	16.41	10.24	YES	YES	589	119
83124	ES36	ES36	1-3/8"	A	21.65	13.77	7.88	YES	YES	750	137
83125	ES36	ES36	1-3/8"	A	28.15	17.16	10.99	YES	YES	625	115
83126	ES36	ES36	1-3/8"	A	24.41	15.27	9.14	YES	YES	625	115
83127	ES36	ES36	1-3/8"	A	20.16	13.14	7.01	YES	YES	940	218
83128	ES36	ES36	1-3/8"	A	16.89	11.53	5.36	YES	YES	940	218
83130	ES36	ES36	1-3/8"	A	18.03	12.04	5.99	YES	YES	871	177
83131	ES83	ES83	1-3/8"	A	27.8	18.18	9.62	YES	NO	212	129
83132	EB3	EB3	1-3/8"	A	25.24	15.5	9.74	YES	NO	828	150
83134	S21	ES36	1-3/8"	A	22.27	13.51	8.77	YES	NO	430	49
83135	ES90	ES90	1-3/8"	A	19.49	12.38	7.11	YES	NO	519	121
83136	S21	S21	1-3/8"	A	29.31	16.8	12.51	YES	NO	914	65
83137	ES36	ES36	1-3/8"	A	30.04	17.79	12.25	YES	YES	517	132
83138	ES36	S42	1-3/8"	A	23.55	14.42	9.12	YES	YES	997	231
83140	EB3	EB3	1-3/8"	A	25.28	15.53	9.75	YES	NO	738	88
83141	EB3	EB3	1-3/8"	A	25.27	15.52	9.75	YES	NO	408	113
83142	ES162	S42	1-3/8"	A	23.92	14.49	9.43	YES	YES	367	131
83143	ES162	S42	1-3/8"	A	21.92	13.51	8.41	YES	YES	403	137
83144	ES36	ES36	1-3/8"	A	23.78	15.03	8.74	YES	YES	596	93
83145	ES83	ES83	1-3/8"	A	19.93	12.32	7.54	YES	NO	479	153
83146	ES90	ES83	1-3/8"	A	24.02	14.68	9.33	YES	YES	479	119
83147	ES179	ES179	1-3/8"	A	28.54	17.4	11.15	YES	YES	358	128
83148	ES179	ES179	1-3/8"	A	30	17.83	12.17	YES	YES	604	149
83149	ES36	ES36	1-3/8"	A	25.28	15.78	9.49	YES	YES	332	101
83150	ES36	ES36	1-3/8"	A	15.24	10.43	4.81	YES	YES	940	216
83153	ES34	ES34	1-3/8"	A	21.69	13.62	8.07	YES	YES	974	206
83154	ES120	S21	1-3/8"	A	20.78	12.72	8.06	YES	YES	599	140
83155	ES34	ES34	1-3/8"	A	21.69	13.62	8.07	YES	YES	507	80
83156	ES90	ES90	1-3/8"	A	18.55	11.91	6.64	YES	NO	778	135
83157	ES36	ES90	1-3/8"	A	26.38	15.76	10.61	YES	NO	446	303

* Damping force, in pounds, to either extend or collapse the shock absorber at an average operating velocity.

SPECIFICATIONS BY PART NUMBER

Gabriel	Mounting		Bore	External Diameter Illustration	Lengths			Dust Tube	Recoil Cutoff	Controls*	
	Upper	Lower			Extended	Collapsed	Stroke			Rebound	Compression
83158	ES22	ES22	1-3/8"	A	12.96	8.97	4	YES	NO	783	484
83159	EB2	EB2	1-3/8"	A	21.85	13.56	8.29	YES	NO	658	149
83160	ES128	ES36	1-3/8"	A	24.31	14.9	9.37	YES	YES	920	161
83161	S1	EB1	1-3/8"	A	20.82	12.56	8.25	YES	NO	400	70
83162	S40	ES190	1-3/8"	A	24.35	14.69	9.67	YES	NO	877	52
83163	ES175	ES175	1-3/8"	A	20.75	13.01	7.74	YES	NO	828	98
83164	ES36	ES165	1-3/8"	C	24.22	14.59	9.63	YES	NO	426	274
83166	ES179	ES179	1-3/8"	A	25.28	15.78	9.49	YES	YES	622	132
83167	ES90	ES90	1-3/8"	A	19.49	12.38	7.11	YES	NO	285	90
83168	ES179	ES179	1-3/8"	A	25.28	15.78	9.49	YES	YES	246	88
83169	ES90	ES90	1-3/8"	A	18.55	11.91	6.64	YES	NO	599	171
83171		ES36	1-3/8"	A	23.98	14.51	9.47	YES	YES	513	146
83174	ES128	ES36	1-3/8"	A	24.31	14.9	9.37	YES	YES	795	160
83175	ES175	ES175	1-3/8"	A	20.48	13.19	7.29	YES	NO	1245	156
83176	ES36	ES36	1-3/8"	A	26.62	15.96	10.66	NO	NO	406	275
83177	S40	EB1	1-3/8"	A	14.99†	10.12	5.38	YES	NO	690	275
83178	S38	ES83	1-3/8"	A	21.95	13.26	8.69	YES	NO	690	275
83180	ES90	ES83	1-3/8"		30.2	21.24	8.96	YES	NO	909	204
83200	EB2	EB2	1-3/8"	A	24.51	15.1	9.53	YES	NO	806	370
83203	ES36	ES36	1-3/8"	A	17.1	11.36	5.74	YES	YES	609	114
83204	ES36	ES36	1-3/8"	A	20.14	12.86	7.28	YES	YES	451	110
83205	ES36	ES36	1-3/8"	A	29.69	17.69	12	YES	YES	660	76
83207	ES36	ES36	1-3/8"	A	21.64	13.61	8.03	YES	YES	553	143
83209	ES36	ES36	1-3/8"	A	29.64	17.61	12.03	YES	YES	670	78
83214	EB3	EB3	1-3/8"	A	19.64	12.86	6.78	YES	YES	269	90
83215	EB3	EB3	1-3/8"	A	26.64	16.36	10.28	YES	YES	697	108
83216	EB2	EB2	1-3/8"	A	23.51	14.48	9.03	YES	YES	776	262
83217	EB3	EB3	1-3/8"	A	22.77	14.49	8.28	YES	YES	633	159
83218	ES36	ES36	1-3/8"	A	25.19	15.44	9.75	YES	YES	721	194
83219	EB2	EB2	1-3/8"	A	20.01	12.73	7.28	YES	YES	299	125
83221	ES36	ES36	1-3/8"	A	24.01	14.73	9.28	YES	YES	599	153
83225	EB3	EB3	1-3/8"	A	24.14	15.11	9.03	YES	YES	482	159
83242	ES36	ES36	1-3/8"	A	33.73	20.98	12.75	YES	YES	721	135
83301	S16	ES90	1-3/8"	B	24.52	14.74	9.78	YES	YES	653	86
83303	EB7	ES36	1-3/8"	B	24.86	15.08	9.78	YES	YES	470	122
83304	EB7	ES36	1-3/8"	B	22.86	14.08	8.78	YES	YES	470	122
83308	EB2	EB2	1-3/8"	B	25.14	15.36	9.78	YES	YES	445	180
83309	EB2	EB2	1-3/8"	B	28.64	17.11	11.53	YES	YES	589	135

* Damping force, in pounds, to either extend or collapse the shock absorber at an average operating velocity.

SPECIFICATIONS BY PART NUMBER

Gabriel	Mounting		Bore	External Diameter Illustration	Lengths			Dust Tube	Recoil Cutoff	Controls*	
	Upper	Lower			Extended	Collapsed	Stroke			Rebound	Compression
83310	ES36	ES36	1-3/8"	B	24.06	14.69	9.37	YES	NO	559	153
83312	EB2	EB2	1-3/8"	B	26.64	16.11	10.53	YES	YES	527	152
83314	EB2	EB2	1-3/8"	B	30.64	18.11	12.53	YES	YES	633	143
83317	S16	ES90	1-3/8"	B	27.03	16	11.34	YES	YES		
83318	S16	S16	1-3/8"	B	22.53	13.5	9.03	YES	YES	323	77
83353	EB3	S21	1-3/8"	B	24.84	15.06	9.78	YES	NO	432	214
83362	EB3	EB3	1-3/8"	B	27	16.25	10.75	YES	NO	539	202
83363	ES36	ES36	1-3/8"	A	16.46	11.35	5.11	YES	YES	1084	201
83364	ES90	ES83	1-3/8"	A	24.06	15.07	8.99	YES	YES	855	206
83389	ES36	ES36	1-3/8"	A	17.32	11.57	5.75	YES	YES	1084	228
83391	ES190	ES190	1-3/8"	A	25.52	15.61	9.91	YES	NO	590	105
83395	S21	ES178	1-3/8"	A	27.19	16.28	10.91	YES	NO	616	105
83400	S1	S1	1-3/16"	F	22.02	12.82	9.2	YES	NO	301	120
83401	EB1	EB1	1-3/16"	F	24.09	14.26	9.83	YES	NO	341	252
83404	EB2	EB2	1-3/16"	F	22.01	13.44	8.58	YES	NO	545	171
83456	S21	S21	1-3/8"	B	24.03	14.25	9.78	YES	YES	566	80
83515	S1	EB2	1-3/16"		23.34	13.89	9.45	YES	NO	643	205
83518	S1	EB2	1-3/16"		24.4	14.26	10.14	YES	NO	153	82
83519	EB2	EB2	1-3/16"	F	23.83	14.35	9.48	YES	NO	292	132
83613	S16	S16	1-3/8"	A	21.04	12.76	8.28	YES	YES	601	242
83634	ES120	ES120	1-3/8"	A	27.48	16.23	11.25	YES	YES	779	157
83635	ES36	S21	1-3/8"	A	21.74	13.25	8.49	YES	NO	558	119
83636	ES90	ES90	1-3/8"	A	27.72	16.95	10.77	YES	YES	505	148
83901	ES153	ES153	1-3/8"	A	11.15†	9.2†	2.78	YES	YES	509	204
83905	ES86	ES167	1-3/8"	2-1/2" D/T	9.3†	7.81†	2.21	YES	YES	1105	170
83906	ES85	EB1	1-3/8"	2-1/2" D/T	10.45†	8.41†	3.01	YES	YES	586	320
85000	ES36	ES36	1-5/8"	C	17.28	11.5	5.78	YES	YES	1019	219
85001	EB3	EB3	1-5/8"	C	26.3	16.39	9.92	YES	NO	1202	186
85003	ES90	ES90	1-5/8"	C	25.42	15.63	9.79	YES	YES	437	182
85004	EB3	EB3	1-5/8"	C	20.68	13.67	7.01	YES	YES	1019	219
85005	ES36	ES36	1-5/8"	C	24.76	15.24	9.52	YES	YES	1019	219
85006	ES36	ES36	1-5/8"	C	28.54	17.13	11.41	YES	YES	1019	219
85007	EB3	EB3	1-5/8"	C	24.33	15.4	8.93	YES	YES	1008	171
85009	S21	ES36	1-5/8"	C	23.56	14.4	9.16	YES	YES	857	144
85010	ES36	ES36	1-5/8"	C	26.8	16.26	10.54	YES	YES	1019	219
85011	ES120	ES121	1-5/8"	C	27.49	16.46	11.03	YES	NO	1268	186
85012	EB2	EB2	1-5/8"	C	21.02	13.23	7.79	YES	NO	523	199
85013	ES36	ES36	1-5/8"	C	29.79	17.76	12.04	YES	YES	1019	219
85014	ES36	ES36	1-5/8"	C	21.76	13.74	8.02	YES	YES	1019	219

* Damping force, in pounds, to either extend or collapse the shock absorber at an average operating velocity.

SPECIFICATIONS BY PART NUMBER

Gabriel	Mounting		Bore	External Diameter Illustration	Lengths			Dust Tube	Recoil Cutoff	Controls*	
	Upper	Lower			Extended	Collapsed	Stroke			Rebound	Compression
85023	EB2	EB2	1-5/8"	C	20.27	13	7.27	YES	YES	1008	539
85024	EB2	EB2	1-5/8"	C	28.77	17.25	11.52	YES	YES	1008	539
85025	EB2	S21	1-5/8"	C	23.02	14.01	9.01	YES	NO	1079	539
85026	ES136	S21	1-5/8"	C	23.02	14.01	9.01	YES	NO	1079	539
85027	S21	S21	1-5/8"	C	21.59	13.05	8.54	YES	NO	1008	539
85029	ES36	ES36	1-5/8"	C	20.54	13.11	7.43	YES	YES	1019	219
85030	ES36	ES36	1-5/8"	C	24.05	14.89	9.16	YES	YES	1019	219
85031	ES176	EB2	1-5/8"	C	25.63	15.87	9.76	YES	NO	941	257
85033	S21	EB3	1-5/8"	C	27.26	17.4	9.86	YES	YES	764	254
85036	ES36	ES36	1-5/8"	C	26.38	16.29	10.09	YES	YES	633	119
85040	EB3	EB3	1-5/8"	C	30.91	18.51	12.4	YES	NO	889	114
85042	EB3	EB3	1-5/8"	C	20.64	13.61	7.03	YES	YES	333	161
85043	ES36	ES36	1-5/8"	C	27.63	16.85	10.78	YES	YES	628	163
85044	ES36	ES36	1-5/8"	C	22.63	14.1	8.53	YES	NO	722	212
85045	ES36	ES36	1-5/8"	C	14.52	10.12	4.4	YES	YES	1020	219
85046	EB2	EB2	1-5/8"	C	27.55	16.62	10.93	YES	YES	1008	539
85047	EB2	EB2	1-5/8"	C	25.31	15.52	9.79	YES	YES	1008	539
85048	S21	S21	1-5/8"	C	29.16	16.88	12.28	YES	NO	432	106
85049	S21	S21	1-5/8"	C	25.53	15	10.53	YES	NO	597	107
85050	ES36	ES36	1-5/8"	C	23.28	14.5	9.03	YES	NO	525	138
85051	ES36	ES36	1-5/8"	C	18.54	12.13	6.41	YES	YES	1019	139
85052	ES36	ES36	1-5/8"	C	13.26	9.49	3.77	YES	YES	1429	335
85053	EB3	EB3	1-5/8"	C	24.69	15.52	9.17	YES	NO	1019	227
85054	EB2	EB2	1-5/8"	C	23.26	14.37	8.89	YES	NO	602	104
85055	EB2	EB2	1-5/8"	C	25.63	15.63	10	YES	NO	577	102
85056	S21	ES36	1-5/8"	C	20.15	12.87	7.28	YES	YES	732	114
85057	ES36	EB3	1-5/8"	C	21.45	14.23	7.22	YES	YES	1216	115
85058	ES36	ES36	1-5/8"	C	22.67	14.26	8.41	YES	YES	722	114
85059	ES36	EB3	1-5/8"	C	19.09	12.8	6.29	YES	YES	928	151
85060	ES36	ES36	1-5/8"	C	19.79	12.76	7.04	YES	YES	943	405
85061	ES161	ES162	1-5/8"	C	24.76	15.25	9.51	YES	YES	1216	195
85062	EB2	EB2	1-5/8"	C	19.76	12.6	7.16	YES	NO	523	199
85063	EB2	EB2	1-5/8"	C	32.01	18.85	13.16	YES	NO	762	174
85064	ES36	ES36	1-5/8"	C	16.02	10.75	5.27	YES	YES	1481	340
85065	ES161	S21	1-5/8"	C	28.05	17	11.05	YES	YES	1059	300
85066	ES161	ES162	1-5/8"	C	24.64	15.25	9.39	YES	YES	812	322
85067	ES174	ES136	1-5/8"	C	30.54	18.15	12.39	YES	YES	676	170
85069	S21	S21	1-5/8"	C	26.31	15.97	10.33	YES	YES	762	255

* Damping force, in pounds, to either extend or collapse the shock absorber at an average operating velocity.

SPECIFICATIONS BY PART NUMBER

Gabriel	Mounting		Bore	External Diameter Illustration	Lengths			Dust Tube	Recoil Cutoff	Controls*	
	Upper	Lower			Extended	Collapsed	Stroke			Rebound	Compression
85070	ES174	EB3	1-5/8"	C	25.59	15.83	9.76	YES	NO	1100	310
85071	S21	S21	1-5/8"	C	25.57	15.02	10.55	YES	NO	610	107
85072	ES36	ES176	1-5/8"	C	24.17	14.81	9.36	YES	YES	1387	305
85078	ES36	ES36	1-5/8"	C	14.76	10.12	4.64	YES	YES	1409	282
85079	ES36	ES36	1-5/8"	C	12.04	8.87	3.17	YES	YES	1494	325
85080	ES175	S21	1-5/8"	C	22.51	13.77	8.74	YES	NO	447	138
85081	ES175	S21	1-5/8"	C	23.44	14.33	9.11	YES	YES	1658	250
85082	ES90	ES90	1-5/8"	C	28.6	20.64	7.97	YES	YES	1435	266
85083	ES162	S42	1-5/8"	C	27.81	16.53	11.28	YES	YES	1429	184
85084	ES174	ES136	1-5/8"	C	20.59	13.03	7.57	YES	NO	1145	407
85085	S21	S21	1-5/8"	C	24.95	14.67	10.23	YES	NO	970	101
85086	ES36	ES36	1-5/8"	C	17.55	11.63	5.92	YES	YES	2027	389
85087	ES36	ES176	1-5/8"	C	22.78	14.7	8.08	YES	YES	1568	403
85088	ES161	ES162	1-5/8"	C	25.31	15.52	9.79	YES	YES	616	178
85090	ES150	ES36	1-5/8"	C	25.31	15.52	9.79	YES	YES	943	99
85091	ES36	ES36	1-5/8"	C	21.38	13.56	7.82	YES	NO	1121	331
85092	ES150	S21	1-5/8"	C	21.95	15.04	6.89	YES	YES	1597	138
85097	ES36	ES36	1-5/8"	C	27.95	17.11	10.84	YES	YES	1086	109
85098	ES161	ES162	1-5/8"	C	24.64	15.24	9.4	YES	YES	747	158
85099	ES36	ES36	1-5/8"	C	26.02	15.93	10.09	YES	YES	1152	135
85102	ES36	ES136	1-5/8"	C	21.52	14.93	6.59	YES	YES	1224	342
85106	ES150	ES150	1-5/8"	C	20.03	12.89	7.14	YES	YES	1054	109
85109	ES36	ES195	1-5/8"	C	24.21	15.14	9.07	YES	YES	1123	149
85119	ES150	ES150	1-5/8"	C	21.39	13.81	7.68	YES	YES	1387	185
85120	ES175	ES175	1-5/8"	C	23.67	15.06	8.61	YES	NO	2083	519
85122	ES120	S21	1-5/8"	C	22.22	13.78	8.44	YES	YES	926	162
85123	ES120	S21	1-5/8"	C	21.49	13.26	8.23	YES	NO	1809	246
85124	S21	S21	1-5/8"	C	20.91	12.9	8.01	YES	YES	1086	222
85125	ES158	ES159	1-5/8"	C	26.9	16.64	10.26	YES	YES	1479	183
85126	ES158	S21	1-5/8"	C	21.76	13.63	8.13	YES	YES	1086	215
85180	ES150	ES36	1-5/8"	C	20.94	13.83	7.11	YES	YES	681	283
85181	ES150	ES150	1-5/8"	C	26.33	17.06	9.27	YES	YES	681	285
85182	S43	S43	1-5/8"	C	26.86	16.04	10.82	YES	NO	708	232
85300	EB3	EB3	1-5/8"	D	17.98	12.21	5.78	YES	YES	1435	676
85301	EB3	EB3	1-5/8"	D	31.92	19.03	12.89	YES	NO	1442	455
85302	EB3	EB3	1-5/8"	D	22.75	14.61	8.14	YES	NO	836	253
85303	EB3	EB3	1-5/8"	D	24.76	15.48	9.29	YES	NO	1019	221
85304	EB3	EB3	1-5/8"	D	22.25	14.22	8.03	YES	NO	767	325

* Damping force, in pounds, to either extend or collapse the shock absorber at an average operating velocity.

SPECIFICATIONS BY PART NUMBER

Gabriel	Mounting		Bore	External Diameter Illustration	Lengths			Dust Tube	Recoil Cutoff	Controls*	
	Upper	Lower			Extended	Collapsed	Stroke			Rebound	Compression
85305	EB3	EB3	1-5/8"	D	27.25	16.7	10.55	YES	NO	1120	225
85307	EB3	EB3	1-5/8"	D	23.98	15.08	8.89	YES	NO	1094	173
85308	EB3	EB3	1-5/8"	D	25.11	15.83	9.28	YES	YES	764	254
85310	S21	S21	1-5/8"	D	18.63	11.71	6.92	YES	YES	1379	578
85311	S21	EB3	1-5/8"	D	23.95	14.79	9.16	YES	YES	764	254
85312	EB3	S21	1-5/8"	D	23.68	14.8	8.88	YES	YES	717	111
85313	EB3	EB3	1-5/8"	D	26.26	16.35	9.91	YES	YES	717	111
85314	EB3	EB3	1-5/8"	D	26.49	16.46	10.03	YES	YES	1216	169
85315	EB3	EB3	1-5/8"	D	29.61	18.07	11.53	YES	NO	380	142
85316	S21	ES36	1-5/8"	D	20.61	12.82	7.8	YES	NO	943	443
85317	S21	EB3	1-5/8"	D	27.18	17.42	9.76	YES	YES	764	254
85318	S21	S21	1-5/8"	D	27.37	16.36	11.01	YES	YES	1372	192
85319	S21	ES150	1-5/8"	D	22.22	13.93	8.3	YES	YES	988	454
85320	EB3	EB3	1-5/8"	D	26.15	16.35	9.8	YES	NO	970	308
85321	ES36	ES36	1-5/8"	D	25.38	15.59	9.79	YES	YES	1435	676
85322	EB3	ES160	1-5/8"	D	15.26	11.85	3.41	YES	YES	764	162
85323	ES36	ES36	1-5/8"	D	17.36	11.58	5.78	YES	YES	1085	163
85324	S21	S21	1-5/8"	D	22.14	13.61	8.53	YES	NO	579	114
85325	S21	S21	1-5/8"	D	23.64	14.36	9.28	YES	NO	1024	240
85326	S21	S21	1-5/8"	D	19.64	12.36	7.28	YES	NO	799	142
85327	EB3	ES160	1-5/8"	D	16.01	12.1	3.91	YES	YES	764	162
85328	S21	S21	1-5/8"	D	25.64	15.36	10.28	YES	NO	930	383
85329	EB3	EB3	1-5/8"	D	24.52	15.48	9.04	YES	YES	1550	232
85330	EB3	S21	1-5/8"	D	22.44	14.16	8.28	YES	YES	1140	176
85331	ES158	ES159	1-5/8"	D	19.62	12.85	6.77	YES	YES	1757	396
85332	S42	ES36	1-5/8"	D	20.64	12.98	7.66	YES	YES	2351	967
85333	S42	ES36	1-5/8"	D	20.65	12.98	7.67	YES	YES	1241	534
85334	EB3	EB3	1-5/8"	D	14.52	10.48	4.04	YES	YES	1271	319
85335	ES158	ES159	1-5/8"	D	19.62	12.85	6.77	YES	YES	827	107
85336	S21	S21	1-5/8"	D	18.76	11.86	6.9	YES	NO	861	200
85337	ES36	ES36	1-5/8"	D	28.72	17.44	11.28	YES	YES	1318	374
85338	ES36	ES36	1-5/8"	D	19.47	12.68	6.79	YES	YES	1664	420
85339	EB3	EB3	1-5/8"	D	31.68	19.02	12.66	YES	YES	804	463
85340	ES188	S21	1-5/8"	D	26.46	15.85	10.61	YES	YES	1807	165
85341	ES188	S21	1-5/8"	D	30.96	18.1	12.86	YES	YES	1807	333
85342	S21	S21	1-5/8"	D	23.28	13.99	9.29	YES	NO	893	188
85343	S21	EB3	1-5/8"	D	22.96	14.79	8.17	YES	YES	858	289
85344	ES36	ES36	1-5/8"	D	13.22	9.45	3.77	YES	YES	1581	443

* Damping force, in pounds, to either extend or collapse the shock absorber at an average operating velocity.

SPECIFICATIONS BY PART NUMBER

Gabriel	Mounting		Bore	External Diameter Illustration	Lengths			Dust Tube	Recoil Cutoff	Controls*	
	Upper	Lower			Extended	Collapsed	Stroke			Rebound	Compression
85345	ES36	ES36	1-5/8"	D	21.83	13.82	8.01	YES	YES	1093	219
85346	S21	S21	1-5/8"	D	22.12	13.48	8.64	YES	YES	2016	285
85347	S21	S21	1-5/8"	D	23.62	14.22	9.4	YES	YES	961	122
85351	S21	ES36	1-5/8"	D	20.61	12.82	7.79	YES	NO	1887	259
85376	EB3	EB3	1-5/8"	D	33.27	19.73	13.54	YES	NO	668	134
85377	ES182	ES182	1-5/8"	D	23.8	14.84	8.96	YES	YES	1937	570
85378	ES182	ES182	1-5/8"	D	23.8	14.84	8.96	YES	YES	1110	240
85379	EB3	S21	1-5/8"	D	22.69	14.4	8.29	YES	YES	1658	176
85380	EB3	S21	1-5/8"	D	23.95	14.79	9.15	YES	YES	1568	227
85382	ES36	ES36	1-5/8"	D	20.22	13.07	7.15	YES	YES	1658	420
85637	ES90	ES36	1-5/8"	G	20.74	13.19	7.55	YES	NO	2256	327
85638	ES179	ES179	1-5/8"	G	28.58	17.4	11.18	YES	YES	643	138
85639	ES90	ES36	1-5/8"	G	27.08	17.79	9.29	YES	NO	795	109
85700	EB3	EB3	1-5/8"	D	26.09	16.58	9.51	YES	YES	1446	328
85701	S21	S21	1-5/8"	D	15.64	10.36	5.28	YES	YES	914	204
85702	EB3	EB3	1-5/8"	D	23.76	15.85	7.91	YES	YES	1093	825
85703	S21	EB3	1-5/8"	D	29.57	18.54	11.03	YES	YES	1435	186
85704	EB3	EB3	1-5/8"	D	28.75	18.72	10.03	YES	YES	1435	186
85705	S21	S21	1-5/8"	D	23.62	14.23	9.39	YES	YES	639	436
85706	S21	S21	1-5/8"	D	23.65	14.24	9.41	YES	YES	1086	696
85707	S21	S21	2-1/16"	D	23.65	14.4	9.25	YES	YES	1761	986
85708	S21	S21	1-5/8"	D	20.63	12.85	7.78	YES	YES	914	204
85709	S21	S21	1-5/8"	D	31.64	18.36	13.28	YES	YES	700	203
85710	S21	EB3	1-5/8"	D	23.45	15.1	8.34	YES	YES	994	248
85711	S21	EB3	1-5/8"	D	24.54	15.26	9.27	YES	YES	1435	208
85712	EB3	EB3	1-5/8"	D	20.5	13.47	7.04	YES	YES	1435	562
85713	EB3	EB3	1-5/8"	D	24.51	15.48	9.04	YES	YES	1157	180
85714	EB3	EB3	1-5/8"	D	25.13	15.85	9.28	YES	YES	1220	175
85715	EB3	EB3	1-5/8"	D	25.13	15.85	9.28	YES	YES	1915	200
85716	EB3	EB3	1-5/8"	D	21.99	14.33	7.66	YES	YES	1220	175
85717	EB3	EB3	1-5/8"	D	25.13	15.85	9.28	YES	YES	1915	200
85718	EB3	EB3	1-5/8"	D	22.13	15.04	7.09	YES	YES	2506	206
85719	EB3	EB3	1-5/8"	D	17.25	11.97	5.28	YES	YES	1517	213
85720	EB3	EB3	1-5/8"	D	20.5	13.47	7.03	YES	YES	1435	562
85722	S21	S21	1-5/8"	D	27.16	16.41	10.76	YES	YES	1264	369
85723	EB3	S21	1-5/8"	D	19.93	12.9	7.03	YES	YES	1318	248
85724	ES158	ES159	1-5/8"	D	22.81	14.51	8.3	YES	YES	1235	454
85727	S21	S21	1-5/8"	D	29.88	17.34	12.54	YES	YES	783	111

* Damping force, in pounds, to either extend or collapse the shock absorber at an average operating velocity.

SPECIFICATIONS BY PART NUMBER

Gabriel	Mounting		Bore	External Diameter Illustration	Lengths			Dust Tube	Recoil Cutoff	Controls*	
	Upper	Lower			Extended	Collapsed	Stroke			Rebound	Compression
85728	S21	S21	1-5/8"	D	24.37	14.86	9.51	YES	YES	1435	510
85729	EB3	S21	1-5/8"	D	21.55	13.77	7.78	YES	YES	783	111
85730	EB3	EB3	1-5/8"	D	30.75	18.72	12.03	YES	YES	1517	293
85731	S21	EB3	1-5/8"	D	30.57	18.54	12.03	YES	YES	1517	293
85732	EB3	EB3	2-1/16"	E	22.13	15.11	7.03	YES	YES	2632	382
85733	EB3	S21	1-5/8"	D	23.57	14.73	8.84	YES	YES	717	111
85734	EB3	EB3	1-5/8"	D	20.73	13.7	7.03	YES	YES	1288	227
85735	EB3	EB3	1-5/8"	D	26.72	16.7	10.02	YES	YES	1288	227
85736	EB3	EB3	1-5/8"	D	23.61	15.2	8.41	YES	YES	1155	352
85737	ES173	ES173	1-5/8"	D	15.11	10.84	4.27	YES	YES	3066	782
85738	ES36	ES36	1-5/8"	D	17.46	11.69	5.77	YES	YES	1830	416
85739	ES187	ES187	1-5/8"	D	20.73	13.54	7.19	YES	YES	3247	334
85740	EB3	S21	1-5/8"	D	24.7	15.15	9.55	YES	YES	848	305
85745	S21	S21	1-5/8"	D	19.88	12.34	7.54	YES	YES	3064	231
85746	S21	S21	1-5/8"	D	19.88	12.34	7.54	YES	YES	1754	167
85900	S21	S21	1-5/8"	G	17.33	11.23	6.11	YES	YES	1467	337
85901	EB3	EB3	1-5/8"	G	29.09	17.68	11.42	YES	NO	1830	418
85902	S21	S21	1-5/8"	G	19.03	12.09	6.93	YES	YES	1441	267
85903	ES36	ES36	1-5/8"	G	31.99	19.13	12.86	YES	YES	666	113
85904	ES36	ES36	1-5/8"	G	27.61	16.88	10.73	YES	YES	666	113
85905	ES36	EB3	1-5/8"	G	23.81	16.16	7.66	YES	YES	1020	219
85906	ES36	ES36	1-5/8"	G	21.77	14.05	7.72	YES	YES	700	255
85907	ES36	EB3	1-5/8"	G	21.43	14.2	7.23	YES	YES	1216	251
85908	ES36	ES36	1-5/8"	G	18.48	12.25	6.23	YES	YES	1020	219
85909	ES36	ES36	1-5/8"	G	24.25	15.19	9.06	YES	YES	700	255
85910	ES36	ES36	1-5/8"	G	20.79	13.54	7.25	YES	YES	1074	219
85911	ES36	ES36	1-5/8"	G	16.89	11.53	5.36	YES	YES	1020	219
85912	EB3	ES36	1-5/8"	G	18.68	12.57	6.11	YES	YES	1020	219
85913	ES36	EB3	1-5/8"	G	22.56	15.2	7.36	YES	YES	1020	219
85914	ES36	ES36	1-5/8"	G	14.36	10.25	4.11	YES	YES	1020	219
85915	ES36	EB3	1-5/8"	G	19.06	12.7	6.36	YES	YES	1020	219
85916	ES36	ES36	1-5/8"	G	24.65	15.55	9.1	YES	YES	1149	219
85918	ES150	ES150	1-5/8"	G	22.97	14.58	8.39	YES	NO	1726	412
85919	ES36	ES36	1-5/8"	G	22.52	14.33	8.19	YES	YES	1265	121
85920	ES150	ES150	1-5/8"	G	21.16	13.57	7.59	YES	NO	845	49
85921	S21	ES36	1-5/8"	G	22.07	13.57	8.5	YES	NO	2053	339
85922	ES150	ES150	1-5/8"	G	21.19	13.53	7.66	YES	NO	878	185
85923	ES177	ES161	1-5/8"	G	22.52	14.52	8	YES	YES	1940	221

* Damping force, in pounds, to either extend or collapse the shock absorber at an average operating velocity.

SPECIFICATIONS BY PART NUMBER

Gabriel	Mounting		Bore	External Diameter Illustration	Lengths			Dust Tube	Recoil Cutoff	Controls*	
	Upper	Lower			Extended	Collapsed	Stroke			Rebound	Compression
85924	ES90	ES36	1-5/8"	G	20.39	12.99	7.41	YES	NO	1036	122
85925	ES90	ES90	1-5/8"	G	22.56	15.6	6.95	YES	NO	761	144
85926	ES90	ES90	1-5/8"	G	26.5	17.96	8.54	YES	YES	1387	279
85927	ES90	ES90	1-5/8"	G	24.76	15.47	9.3	YES	YES	1288	388
85928	ES90	ES90	1-5/8"	G	20.31	13.24	7.07	YES	NO	957	229
85929	ES90	ES90	1-5/8"	G	20.28	13.21	7.08	YES	NO	2214	267
85930	ES177	ES161	1-5/8"	G	17.86	12	5.86	YES	YES	1617	342
85931	ES177	ES161	1-5/8"	G	22.52	14.52	8	YES	YES	1435	220
85932	ES178	ES150	1-5/8"	G	21.26	13.7	7.56	YES	YES	1102	430
85933	ES175	ES175	1-5/8"	G	18.27	12.72	5.54	YES	YES	1089	383
85934	ES36	ES36	1-5/8"	G	17.8	12.04	5.75	YES	YES	3511	1063
85935	S21	ES36	1-5/8"	G	18.7	11.92	6.78	YES	NO	1054	419
85936	ES174	S43	1-5/8"	G	17.27	11.48	5.79	YES	YES	1479	337
85937	ES174	S43	1-5/8"	G	19.04	12.35	6.7	YES	YES	1479	337
85938	ES36	ES36	1-5/8"	G	16.06	10.82	5.24	YES	YES	1581	432
85939	ES36	ES36	1-5/8"	G	14.44	10.04	4.41	YES	YES	1719	420
85953	ES90	ES90	1-5/8"	G	26.13	15.86	10.27	YES	NO	2001	153
85954	ES90	ES36	1-5/8"	G	20.43	13	7.43	YES	NO	1812	148
85955	ES175	ES150	1-5/8"	G	21.25	13.66	7.59	YES	YES	1034	397
85956	ES183	ES184	1-5/8"	G	30.65	18.77	11.88	YES	YES	979	373
85957	ES90	ES90	1-5/8"	G	20.78	13.19	7.6	YES	NO	1583	138
85958	ES150	ES150	1-5/8"	G	22.89	14.5	8.39	YES	YES	1926	281
85959	ES150	ES150	1-5/8"	G	21.16	13.57	7.59	YES	YES	1021	123
85961	ES178	ES176	1-5/8"	G	22.83	14.17	8.66	YES	YES	2206	240
85962	ES178	ES176	1-5/8"	G	21.8	13.66	8.15	YES	YES	2206	240
85963	ES90	ES36	1-5/8"	G	25.49	18.68	6.81	YES	YES	1490	206
85964	ES90	ES36	1-5/8"	G	25.49	18.68	6.81	YES	YES	1981	205
85965	ES178	ES161	1-5/8"	G	24.24	15.15	9.09	YES	YES	2206	238
85966	ES178	ES161	1-5/8"	G	23.25	14.64	8.62	YES	YES	2206	238
85967	ES178	ES176	1-5/8"	G	23.93	14.86	9.07	YES	YES	2206	238
85968	EB3	EB3	1-5/8"	G	19.87	13.39	6.48	YES	YES	1069	227
85969	ES90	ES36	1-5/8"	G	18.38	11.93	6.45	YES	NO	1612	125
85970	ES188	S21	1-5/8"	G	27.23	16.44	10.79	YES	YES	1092	147
85971	ES36	ES36	1-5/8"	G	22.56	14.17	8.39	YES	NO	2315	451
85972	ES36	ES36	1-5/8"	G	30.78	18.26	12.52	YES	NO	1493	261
85974	ES36	ES36	1-5/8"	G	26.02	16.11	9.91	YES	YES	3087	230
85975	ES36	ES36	1-5/8"	G	24.24	15.15	9.09	YES	YES	1658	219
85976	ES36	ES36	1-5/8"	G	29.92	18.12	11.8	YES	YES	582	138
85977	ES36	S42	1-5/8"	G	26.2	15.91	10.29	YES	YES	582	138

* Damping force, in pounds, to either extend or collapse the shock absorber at an average operating velocity.

SPECIFICATIONS BY PART NUMBER

Gabriel	Mounting		Bore	External Diameter Illustration	Lengths			Dust Tube	Recoil Cutoff	Controls*	
	Upper	Lower			Extended	Collapsed	Stroke			Rebound	Compression
85978	ES179	ES179	1-5/8"	G	29.84	18.16	11.69	YES	YES	582	138
85979	ES36	ES36	1-5/8"	G	31.18	18.66	12.52	YES	YES	582	138
85980	ES179	ES179	1-5/8"	G	31.17	18.66	12.52	YES	YES	582	138
85984	ES158	ES150	1-5/8"	G	25.44	15.96	9.48	YES	YES	2248	1168
85985	ES174	S43	1-5/8"	G	19.04	12.31	6.73	YES	YES	2068	723
85986	ES175	ES150	1-5/8"	G	21.25	13.66	7.59	YES	YES	1754	221
85988	S21	EB3	1-5/8"	G	23.84	14.87	8.97	YES	YES	1200	138
85989	ES174	ES136	1-5/8"	G	20.78	13.15	7.63	YES	NO	1812	351
85994	ES90	ES36	1-5/8"	G	21.21	13.4	7.81	YES	NO	1824	263
85995	ES90	ES36	1-5/8"	G	23.5	14.52	8.98	YES	NO	1830	173
85998	ES90	ES90	1-5/8"	G	22.83	14.17	8.66	YES	NO	1345	178
85999	ES90	ES90	1-5/8"	G	19.84	12.79	7.05	YES	NO	2214	259
86200	ES194	ES194	45 MM	D	14.24	10.45	3.79	YES	YES	4238	688
86201	ES193	ES193	45 MM	D	13.26	9.94	3.32	YES	YES	4238	688
86202	ES193	ES193	45 MM	D	14.52	10.43	4.09	YES	YES	4238	688
86203	ES193	ES193	45 MM	D	16.88	11.61	5.27	YES	YES	4238	910
87000	S21	EB3	2-1/16"	E	24.46	15.21	9.25	YES	YES	1332	300
87001	EB3	EB3	2-1/16"	E	20.76	13.76	7	YES	YES	1158	190
87002	EB3	EB3	2-1/16"	E	23.5	15.41	8.09	YES	YES	879	203
87003	EB3	EB3	2-1/16"	E	26.26	16.51	9.75	YES	YES	1332	395
87004	EB3	EB3	2-1/16"	E	26.76	16.76	10	YES	YES	1158	190
87006	EB3	EB3	2-1/16"	E	23.75	15.25	8.5	YES	YES	1158	272
87007	S21	S21	2-1/16"	E	15.65	10.4	5.25	YES	YES	879	253
87011	S21	S21	2-1/16"	E	23.65	14.4	9.25	YES	YES	1750	1050
87012	S21	S21	2-1/16"	E	23.65	14.4	9.25	YES	YES	650	364
87013	S21	S21	2-1/16"	E	23.65	14.4	9.25	YES	YES	1075	585
87015	ES173	ES173	45MM	E	15.51	11.18	4.33	YES	YES	4950	900
87016	S21	EB3	2-1/16"	E	21.17	13.91	7.26	YES	YES	1808	238
87017	ES160	ES160	2-1/16"	E	23.35	15.31	8.07	YES	YES	1876	220
87018	ES36	ES36	2-1/16"	E	17.36	11.71	5.65	YES	YES	2479	1000
87019	ES160	ES160	2-1/16"	E	24.84	15.85	8.9	YES	YES	2972	665
89401	EB2	EB2	1-5/8"	G	28.41	17.16	11.25	YES	NO	665‡	194
89402	EB2	EB2	1-5/8"	G	24.41	15.16	9.25	YES	NO	874‡	206
89403	EB2	EB2	1-5/8"	G	26.86	17.16	9.7	YES	YES	929‡	281
89405	ES36	ES36	1-5/8"	G	26.3	16.57	9.73	YES	YES	1009‡	249
89406	ES36	ES36	1-5/8"	G	24.76	15.82	8.93	YES	YES	658‡	125
89407	ES36	ES36	1-5/8"	G	21.61	14.17	7.45	YES	YES	652‡	218
89408	EB2	EB2	1-5/8"	G	19.68	12.9	6.78	YES	NO	536‡	201

* Damping force, in pounds, to either extend or collapse the shock absorber at an average operating velocity.

SPECIFICATIONS BY PART NUMBER

Gabriel	Mounting		Bore	External Diameter Illustration	Lengths			Dust Tube	Recoil Cutoff	Controls*	
	Upper	Lower			Extended	Collapsed	Stroke			Rebound	Compression
89409	EB2	EB2	1-5/8"	G	27.13	16.92	10.2	YES	YES	567‡	165
89410	EB3	EB3	1-5/8"	G	26.34	16.57	9.77	YES	NO	1185‡	182
89411	ES90	ES90	1-5/8"	G	25.39	16.06	9.34	YES	YES	436‡	186
89412	EB3	EB3	1-5/8"	G	24.26	15.68	8.58	YES	YES	1155‡	169
89413	EB2	EB2	1-5/8"	G	20.94	13.53	7.41	YES	NO	536‡	201
89414	ES36	ES36	1-5/8"	G	29.65	18.18	11.46	YES	YES	1045‡	217
89415	EB2	EB2	1-5/8"	G	20.12	13.29	6.83	YES	YES	1155‡	514
89416	EB2	EB2	1-5/8"	G	28.62	17.54	11.08	YES	YES	1155‡	514
89417	ES136	S21	1-5/8"	G	22.94	14.31	8.63	YES	NO	1226‡	515
89418	S21	S21	1-5/8"	G	21.44	13.19	8.25	YES	NO	1266‡	515
89419	EB3	EB3	1-5/8"	G	18.04	12.67	5.36	YES	YES	1352‡	636
89420	EB3	EB3	1-5/8"	G	22.8	14.8	8	YES	NO	862‡	258
89422	EB3	EB3	1-5/8"	G	25.12	16.3	8.83	YES	YES	794‡	253
89423	S21	S21	1-5/8"	G	18.67	12.21	6.46	YES	YES	1352‡	573
89424	S21	EB3	1-5/8"	G	23.73	15.14	8.59	YES	YES	794‡	253
89425	EB3	EB3	1-5/8"	G	26.5	16.93	9.57	YES	YES	1352‡	167
89426	S21	ES36	1-5/8"	G	20.46	13.05	7.41	YES	NO	926‡	419
89427	S21	EB3	1-5/8"	G	27.19	17.62	9.57	YES	YES	794‡	253
89428	S21	ES150	1-5/8"	G	22	14.27	7.72	YES	YES	958‡	446
89429	EB3	EB3	1-5/8"	G	26.22	16.57	9.65	YES	NO	941‡	266
89430	ES36	ES36	1-5/8"	G	24.61	15.66	8.94	YES	YES	1462‡	279
89431	ES36	ES36	1-5/8"	G	22.41	14.16	8.25	YES	NO	751‡	211
89432	ES36	ES36	1-5/8"	G	23.42	14.79	8.63	YES	NO	1507‡	561
89434	EB2	EB2	1-5/8"	G	27.12	16.79	10.33	YES	YES	1155‡	514
89435	EB2	EB2	1-5/8"	G	24.92	15.82	9.1	YES	YES	1155‡	514
89436	ES36	ES36	1-5/8"	G	17.24	12.04	5.2	YES	YES	998‡	217
89437	ES36	ES36	1-5/8"	G	20.12	13.42	6.7	YES	YES	1155‡	514
89438	EB2	EB2	1-5/8"	G	23.17	14.54	8.63	YES	NO	583‡	103
89439	EB2	EB2	1-5/8"	G	25.67	15.79	9.88	YES	NO	518‡	103
89440	ES36	ES36	1-5/8"	G	23.9	15.31	8.59	YES	YES	1498‡	561
89441	S21	ES36	1-5/8"	G	20.14	13.06	7.08	YES	YES	761‡	126
89442	EB3	EB3	1-5/8"	G	24.72	15.74	8.98	YES	NO	1055‡	224
89443	ES158	ES159	1-5/8"	G	22.19	14.66	7.53	YES	YES	1206‡	466
89446	EB2	EB2	1-5/8"	G	28.36	17.41	10.95	YES	YES	702‡	204
89447	S21	S21	1-5/8"	G	23.63	14.69	8.94	YES	YES	702‡	241
89448	ES161	ES162	1-5/8"	G	24.61	15.66	8.94	YES	YES	782‡	323
89449	ES150	ES150	1-5/8"	G	23.25	14.9	8.35	YES	NO	1519‡	324
89450	ES161	ES162	1-5/8"	G	24.61	15.66	8.94	YES	YES	1282‡	193

* Damping force, in pounds, to either extend or collapse the shock absorber at an average operating velocity.

SPECIFICATIONS BY PART NUMBER

Gabriel	Mounting		Bore	External Diameter Illustration	Lengths			Dust Tube	Recoil Cutoff	Controls*	
	Upper	Lower			Extended	Collapsed	Stroke			Rebound	Compression
89451	ES174	ES136	1-5/8"	G	30.39	18.54	11.86	YES	YES	645‡	172
89453	ES178	ES150	1-5/8"	G	21.14	13.93	7.21	YES	YES	860‡	435
89454	ES175	ES175	1-5/8"	G	18.27	12.91	5.36	YES	YES	938‡	388
89455	S21	S21	1-5/8"	G	26.31	16.03	10.28	YES	YES	791‡	276
89456	ES174	S43	1-5/8"	G	17.04	11.63	5.4	YES	YES	975‡	377
89457	ES90	ES36	1-5/8"	G	19.92	13.02	6.89	YES	NO	941‡	156
89458	ES177	ES161	1-5/8"	G	22.48	14.6	7.88	YES	YES	1575‡	222
89459	ES174	EB3	1-5/8"	G	25.63	16.14	9.49	YES	NO	1179‡	314
89460	ES174	ES136	1-5/8"	G	20.58	13.03	7.55	YES	NO	997‡	384
89461	ES160	ES160	1-5/8"	G	19.96	13.58	6.38	YES	YES	897‡	103
89503	ES150	ES150	1-5/8"	G	21.28	13.72	7.56	YES	NO	1033‡	123
630811	0	0	1-3/16"		22.45	14.1	8.35	NO	NO		
632147	0	0	1-3/16"		22.45	14.1	8.35	NO	NO		
632155	ES36	ES36	1-3/16"		22.45	14.1	8.35	NO	NO		
646155	ES36	ES36	1-3/16"		22.45	14.1	8.35	YES	NO		
646177	ES36	ES36	1-3/16"		22.45	14.1	8.35	NO	NO		
665472	ES36	ES36	1-5/8"	G	25.14	15.61	9.53	NO	NO	925	977
665937	ES36	ES36	1-5/8"	G	22.91	16.09	6.82	YES	NO		
695406	S21	S21	2-1/16"	E	21.39	13.26	8.13	YES	YES	1854	274
G63183	EB4	EB4	1-3/8"		20.89	13.11	7.78	YES	NO		
G63299	EB1	EB1	1-3/8"		18.08	11.55	6.53	YES	NO	396	109
G63306	ES2	ES24	1-3/8"		19.86	12.58	7.28	YES	NO		
G63347	ES3	ES24	1-3/8"		18.08	11.55	6.53	YES	NO		
G63350	S1	ES25	1-3/8"		18.83	11.8	7.03	YES	NO		
G63355	EB7	ES24	1-3/8"		15	9.97	5.03	YES	NO		
G63357	ES24	ES24	1-3/8"		15	9.97	5.03	YES	NO		
G63366	ES34	ES34	1-3/8"		23.36	14.33	9.03	YES	NO		
G63386	S36	ES25	1-3/8"		17.19	11.16	6.03	NO	YES		
G63387	S1	ES25	1-3/8"		23.33	14.05	9.28	YES	NO		
G63396	S10	ES25	1-3/8"		16.55	10.77	5.78	YES	NO		
G63398	S1	S1	1-3/8"		20.52	12.24	8.28	YES	NO		
G63403	ES82	ES82	1-3/8"		24.58	14.8	9.78	YES	NO		
G63405	EB1	EB1	1-3/8"		20	12.47	7.53	YES	NO	572	115
G63406	EB1	ES83	1-3/8"		23	13.97	9.03	YES	NO		
G63409	EB1	ES83	1-3/8"		21.58	13.3	8.28	YES	NO		
G63414	S28	ES83	1-3/8"		15.09	10.06	5.03	NO	YES		
G63419	EB1	EB1	1-3/8"		24.08	14.55	9.53	YES	NO		
G63432	S1	EB2	1-3/8"		21.21	12.93	8.28	YES	NO		

* Damping force, in pounds, to either extend or collapse the shock absorber at an average operating velocity.

SPECIFICATIONS BY PART NUMBER

Gabriel	Mounting		Bore	External Diameter Illustration	Lengths			Dust Tube	Recoil Cutoff	Controls*	
	Upper	Lower			Extended	Collapsed	Stroke			Rebound	Compression
G63440	EB1	EB1	1-3/8"		26.33	15.55	10.78	NO	NO		
G63455	ES8	ES83	1-3/8"		23	13.97	9.03	YES	NO		
G63461	EB1	ES83	1-3/8"		25.5	15.22	10.28	YES	NO		
G63484	S4	EB1	1-3/8"		20.05	12.52	7.53	YES	NO		
G63500	S28	ES25	1-3/8"		15.09	10.06	5.03	NO	YES		
G63511	S1	ES25	1-3/8"		22.55	13.52	9.03	YES	NO		
G63524	EB1	ES83	1-3/8"		27.08	16.05	11.03	YES	NO		
G63525	EB1	ES83	1-3/8"		23.08	14.05	9.03	YES	NO		
G63605	EB2	ES27	1-3/8"		24.24	14.71	9.53	YES	NO		
G63607	BP33	ES83	1-3/8"		25.58	15.3	10.28	YES	NO		
G63608	S36	EB1	1-3/8"		14.58	9.81	4.78	YES	YES		
G63610	S1	EB1	1-3/8"		21.55	13.27	8.28	YES	NO		
G63614	S36	EB1	1-3/8"		15.12	10.09	5.03	NO	YES		
G63622	S36	EB1	1-3/8"		15.42	10.39	5.03	YES	YES		
G63623	S36	ES83	1-3/8"		22.67	14.39	8.28	YES	YES		
G63624	S36	ES83	1-3/8"		20.17	12.64	7.53	YES	YES		
G63625	EB7	ES36	1-3/8"		22.48	13.96	8.53	YES	NO		
G63676	ES69	ES69	1-3/8"		15.58	10.55	5.03	YES	YES		
G63678	S36	BP7	1-3/8"		18.09	13.56	4.53	YES	NO		
G63679	BP8	ES83	1-3/8"		25	14.97	10.03	YES	NO		
G63714	S6	BP7	1-3/8"		15.54	10.01	5.53	YES	NO		
G63716	S12	ES26	1-3/8"		15.54	10.01	5.53	YES	NO		
G63772	S6	BP35	1-3/8"		13.83	9.55	4.28	YES	YES		
G63773	EB1	ES83	1-3/8"		23.08	14.05	9.03	YES	NO		
G63775	EB1	ES83	1-3/8"		27.08	16.05	11.03	YES	NO		
G63778	S12	ES25	1-3/8"		24.55	14.52	10.03	YES	NO		
G63808	EB1	ES83	1-3/8"		28.86	17.08	11.78	YES	NO		
G63809	EB1	ES83	1-3/8"		23	13.97	9.03	YES	NO		
G63810	EB1	ES83	1-3/8"		31.51	18.48	13.03	YES	NO		
G63811	EB1	ES83	1-3/8"		25.5	15.22	10.28	YES	NO		
G63837	BP8	ES83	1-3/8"		28.23	17.95	10.28				
G63866	ES34	ES34	1-3/8"		22.81	14.12	8.69				
G63929	S36	EB1	1-3/8"		14.72	9.71	5.01	YES	YES		
G63969	412847	ES34	1-3/8"		20.75	13.31	7.44				

* Damping force, in pounds, to either extend or collapse the shock absorber at an average operating velocity.

MOUNTING ACCESSORY PACKAGES AND COMPONENT PARTS

140126	401006	1	Hex nut	3/8" x 24 UNF thread
	401383	2	Retainer (washer)	3/8 in. I.D. x 1-1/2 in. O.D. x .093 in. thick
	402263	2	Bushing	7/8" centering lip for 3/8" O.D. stud
140149	401011	4	Bushing	EB2 style - for 1-3/4" O.D. eye ring - 3/4" diam. Stud
140169	401011	2	Bushing	EB2 style - for 1-3/4" O.D. eye ring - 3/4" diam. Stud
140357	401164	1	Hex nut	1/2" x 20 UNF Thread
	401166	1	Lock washer	1/2" lock washer
	401174	1	Hex nut	5/8" x 18 thread
	401193	1	Lock washer	5/8" I.D. (thin)
	401266	1	Retainer (washer)	5/8" I.D. x 1-1/4" O.D. x .075" thick
	402519	1	Retainer (washer)	1/2" I.D. x 1-1/4" O.D. x .104" thick
	403050	1	Stud	1/2" x 20 and 5/8" x 18 thread
140455	401006	1	Hex nut	3/8" x 24 UNF thread
	401008	2	Retainer (washer)	3/8 in. I.D. x 1-1/4 in. O.D. x .075 in. thick
	403489	2	Bushing	5/8" centering lip for 3/8" O.D. stud
140524	401006	1	Hex nut	3/8" x 24 UNF thread
	401376	2	Retainer (washer)	3/8 in. I.D. x 1-3/8 in. O.D. x .089 in. thick
	402294	2	Bushing	5/8" lip for 3/8" dia. stud-5/8" or 7/8" holes
140526	403813	2	Boot	
	403815	2	Cotter pin	
	404046	2	Nut	1/2" x 20 UNF Thread
140673	401006	1	Hex nut	3/8" x 24 UNF thread
	401008	2	Retainer (washer)	3/8 in. I.D. x 1-1/4 in. O.D. x .075 in. thick
	403962	2	Bushing	1/2" centering lip for 3/8" O.D. stud
140689	401006	3	Hex nut	3/8" x 24 UNF thread
	402263	2	Bushing	7/8" centering lip for 3/8" O.D. stud
	404001	2	Retainer (washer)	10 mm I.D. x 1-1/2" O.D. x .120" thick
140702	401174	1	Hex nut	5/8" x 18 thread
	401184	1	Lock washer	7/16" Lock washer
	401193	1	Lock washer	5/8" I.D. (thin)
	402844	1	Hex nut	7/16" x 20 UNF Thread
	403878	1	Washer	0.453" I.D. x 1.25" O.D. x .075" thick
	404782	1	Stud	5/8" x 18 and 7/16" x 20
140719	402653-001	2	Lock washer	5/16" I.D. (med.)
	403870-001	2	Bolt	Hex Head 5/16" x 18 x 3/4 in. long
	403871-001	2	Hex nut	5/16" x 18 thread
140780	401006	1	Hex nut	3/8" x 24 UNF thread
	402943	1	Retainer (washer)	0.457" I.D. x 1.68" O.D. x .120" thick
	403298	1	Retainer (washer)	0.390" I.D. x 1.68" O.D. x .120" thick
	403299	2	Bushing	7/8" centering lip for 7/16" O.D. stud
140857	401006	1	Hex nut	3/8" x 24 UNF thread
	401008	1	Retainer (washer)	3/8 in. I.D. x 1-1/4 in. O.D. x .075 in. thick
	401383	1	Retainer (washer)	3/8 in. I.D. x 1-1/2 in. O.D. x .093 in. thick
	403489	2	Bushing	5/8" centering lip for 3/8" O.D. stud
	429680-030	1	Instruction sheet	
140884	401267	1	Retainer (washer)	5/8" I.D. x 1-1/4" O.D. x .075" thick
	402662	1	Spacer	5/8" I.D. x 1-1/4" O.D. x 1/4" thick
	412016	1	Extn nut	7/16" x 20 UNF Thread
	427030	1	Instruction sheet	

MOUNTING ACCESSORY PACKAGES AND COMPONENT PARTS

140885	401267	1	Retainer (washer)	5/8" I.D. x 1-1/4" O.D. x .075" thick
	402662	1	Spacer	5/8" I.D. x 1-1/4" O.D. x 1/4" thick
	403189	2	Spacer	1/2" I.D. x 1-1/4" O.D.
	411012	2	Sleeve	13 mm I.D. x 5/8 in. O.D. x 1-5/16 in. long
	412016	1	Extn nut	7/16" x 20 UNF Thread
	427031	1	Instruction sheet	
140921	401006	1	Hex nut	3/8" x 24 UNF thread
	401007	1	Pal nut	3/8" x 24 UNF thread
	401011	2	Bushing	EB2 style - for 1-3/4" O.D. eye ring - 3/4" diam. Stud
	401377	1	Retainer (washer)	1/2" I.D. x 1-3/8" O.D. x .075" thick
	401383	1	Retainer (washer)	3/8 in. I.D. x 1-1/2 in. O.D. x .093 in. thick
	402267	2	Bushing	9/16" centering lip for 7/16" O.D. stud
140947	401193	1	Lock washer	5/8" I.D. (thin)
	404451	2	Hex nut	16 x 1.5 metric thread
	404452	4	Retainer (washer)	5/8" I.D. x 2-3/4" O.D. x .180" thick
	404453	2	Sleeve	16 mm I.D. x 1-3/16" O.D. x 1-1/2" long
	404454	4	Bushing	1-3/16" centering lip for 13/16" O.D. stud
141041	401006	1	Hex nut	3/8" x 24 UNF thread
	401376	2	Retainer (washer)	3/8 in. I.D. x 1-3/8 in. O.D. x .089 in. thick
	404652	2	Bushing	Used with 5/8" dia. hole or 7/8" dia. Hole
141045	401006	1	Hex nut	3/8" x 24 UNF thread
	401377	1	Retainer (washer)	1/2" I.D. x 1-3/8" O.D. x .075" thick
	401383	1	Retainer (washer)	3/8 in. I.D. x 1-1/2 in. O.D. x .093 in. thick
	402284	2	Bushing	5/8" centering lip for 3/8" O.D. stud
141047	401006	1	Hex nut	3/8" x 24 UNF thread
	401164	1	Hex nut	1/2" x 20 UNF Thread
	401166	1	Lock washer	1/2" lock washer
	401184	1	Lock washer	7/16" Lock washer
	402844	1	Hex nut	7/16" x 20 UNF Thread
	402943	1	Retainer (washer)	0.457" I.D. x 1.68" O.D. x .120" thick
	403298	1	Retainer (washer)	0.390" I.D. x 1.68" O.D. x .120" thick
	403299	2	Bushing	7/8" centering lip for 7/16" O.D. stud
	403877	1	Stud	1/2" x 20 and 7/16" x 20
	403878	1	Washer	0.453" I.D. x 1.25" O.D. x .075" thick
141083	401193	1	Lock washer	5/8" I.D. (thin)
	404451	1	Hex nut	16 x 1.5 metric thread
	404452	2	Retainer (washer)	5/8" I.D. x 2-3/4" O.D. x .180" thick
	404453	1	Sleeve	16 mm I.D. x 1-3/16" O.D. x 1-1/2" long
	404454	2	Bushing	1-3/16" centering lip for 13/16" O.D. stud
141108	401174	2	Hex nut	5/8" x 18 thread
	405360	4	Retainer (washer)	5/8" I.D. x 2-3/16" O.D. x .120" thick
	405361-000	4	Bushing	1" centering lip for 5/8" O.D. stud (1.00" thick)
141137	402812	1	Sleeve	13 mm I.D. x 5/8 in. O.D. x 1-5/16 in. long
141138	401006	2	Hex nut	3/8" x 24 UNF thread
	403489	4	Bushing	5/8" centering lip for 3/8" O.D. stud
	403575	4	Retainer (washer)	25/64" I.D. x 1-1/4" O.D. x .12" thick
	404949	4	Washer	1/2" I.D. x 1-1/2" O.D. x .04" thick

MOUNTING ACCESSORY PACKAGES AND COMPONENT PARTS

141168	401006	1	Hex nut	3/8" x 24 UNF thread
	401008	1	Retainer (washer)	3/8 in. I.D. x 1-1/4 in. O.D. x .075 in. thick
	404350	1	Retainer (washer)	3/8 in. I.D. x 1-5/8 in. O.D. x .119 in. thick
	404985	1	Bushing	5/8" centering lip for 3/8" O.D. stud
	404986	1	Bushing	5/8" centering lip for 3/8" O.D. stud
	429680-015	1	Instruction sheet	
141247	401174	1	Hex nut	5/8" x 18 thread
	401754	2	Bushing	EB3 - style for 2.39 in. O.D. eye ring - 1" diam. Stud
	405360	2	Retainer (washer)	5/8" I.D. x 2-3/16" O.D. x .120" thick
	405361	2	Bushing	1" centering lip for 5/8" O.D. stud
141349	401006	1	Hex nut	3/8" x 24 UNF thread
	401007	1	Pal nut	3/8" x 24 UNF thread
	401376	2	Retainer (washer)	3/8 in. I.D. x 1-3/8 in. O.D. x .089 in. thick
	404652	2	Bushing	Used with 5/8" dia. hole or 7/8" dia. Hole
	429680-030	1	Instruction sheet	
141350	401006	1	Hex nut	3/8" x 24 UNF thread
	401376	2	Retainer (washer)	3/8 in. I.D. x 1-3/8 in. O.D. x .089 in. thick
	402294	2	Bushing	5/8" lip for 3/8" dia. stud-5/8" or 7/8" holes
	411520	1	Jam nut	3/8" x 24 UNF thread
141353	401006	1	Hex nut	3/8" x 24 UNF thread
	401007	1	Jam nut	3/8" x 24 UNF thread
	401383	2	Retainer (washer)	3/8 in. I.D. x 1-1/2 in. O.D. x .093 in. thick
	402263	2	Bushing	7/8" centering lip for 3/8" O.D. stud
141354	401006	1	Hex nut	3/8" x 24 UNF thread
	401007	1	Pal nut	3/8" x 24 UNF thread
	404350	1	Retainer (washer)	3/8 in. I.D. x 1-5/8 in. O.D. x .119 in. thick
	404485	1	Retainer (washer)	0.453" I.D x 1.63" O.D x 0.120" thick
	404959	2	Bushing	3/4" centering lip for 7/16" O.D. stud
141356	401006	1	Hex nut	3/8" x 24 UNF thread
	401007	1	Pal nut	3/8" x 24 UNF thread
	401008	2	Retainer (washer)	3/8 in. I.D. x 1-1/4 in. O.D. x .075 in. thick
	403962	2	Bushing	1/2" centering lip for 3/8" O.D. stud
141368	401006	1	Hex nut	3/8" x 24 UNF thread
	401007	1	Jam nut	3/8" x 24 UNF thread
	401008	1	Retainer (washer)	3/8 in. I.D. x 1-1/4 in. O.D. x .075 in. thick
	401383	1	Retainer (washer)	3/8 in. I.D. x 1-1/2 in. O.D. x .093 in. thick
	403489	2	Bushing	5/8" centering lip for 3/8" O.D. stud
	429680-030	1	Instruction sheet	
141376	401006	1	Hex nut	3/8 in.-24 thread
	401007	1	Pal nut	3/8" x 24 UNF thread
	401008	2	Retainer (washer)	3/8 in. I.D. x 1-1/4 in. O.D. x .075 in. thick
	403489	2	Bushing	5/8" centering lip for 3/8" O.D. stud
141439	401011	2	Bushing	EB2 style - for 1-3/4" O.D. eye ring - 3/4" diam. Stud
	411165	1	Lock nut	12 x 1.25 metric thread
	411445	2	Bushing	Flat Bushing for 9/16" O.D. stud
	411446	2	Retainer (washer)	3/4" I.D. x 1 7/8" O.D. x .047" thick
	411447	1	Retainer (washer)	9/16" I.D. x 1-3/4" O.D. x .087" thick
	412554	1	Retainer (washer)	0.485" O.D x 1.76" O.D. x .089" thick

MOUNTING ACCESSORY PACKAGES AND COMPONENT PARTS

141448	404715	1	Spacer	0.737" I.D x 1.75" O.D. x .120 thick
	411165	1	Lock nut	12 x 1.25 metric thread
	411445	2	Bushing	Flat Bushing for 9/16" O.D. stud
	411446	1	Retainer (washer)	3/4" I.D. x 1 7/8" O.D. x .047" thick
	411447	1	Washer	9/16" I.D. x 1-3/4" O.D. x .087" thick
	412554	1	Retainer (washer)	0.485" O.D x 1.76" O.D. x .089" thick
141514	401006	1	Hex nut	3/8" x 24 UNF thread
	401007	1	Pal nut	3/8" x 24 UNF thread
	401383	2	Retainer (washer)	3/8 in. I.D. x 1-1/2 in. O.D. x .093 in. thick
	404947	2	Bushing	3/8 in. I.D. x 1-3/16 in. x 9/16 in. thick
141537	401006	1	Hex nut	3/8" x 24 UNF thread
	404350	2	Retainer (washer)	3/8 in. I.D. x 1-5/8 in. O.D. x .119 in. thick
	404985	2	Bushing	5/8" centering lip for 3/8" O.D. stud
141665	401006	1	Hex nut	3/8" x 24 UNF thread
	402943	1	Retainer (washer)	0.457" I.D. x 1.68" O.D. x .120" thick
	403298	1	Retainer (washer)	0.390" I.D. x 1.68" O.D. x .120" thick
	404959	2	Bushing	3/4" centering lip for 7/16" O.D. stud
	411520	1	Jam nut	3/8" x 24 UNF thread
142036	411497	1	Lock nut	10 x 1.25 metric thread
142069	411165	2	Lock nut	12 x 1.25 metric thread
	411447	2	Washer	9/16" I.D. x 1-3/4" O.D. x .087" thick
	412103	2	Retainer (washer)	9/16" I.D. x 1-3/4" O.D. x 1/4" thick
	412116	4	Bushing	Flat bushing for 9/16" O.D. Stud
	412554	2	Retainer (washer)	0.485" O.D x 1.76" O.D. x .089" thick
142095	411165	1	Lock nut	12 x 1.25 metric thread
	411447	2	Retainer (washer)	9/16" I.D. x 1-3/4" O.D. x .087" thick
	412103	1	Retainer (washer)	9/16" I.D. x 1-3/4" O.D. x 1/4" thick
	412116	2	Bushing	Flat bushing for 9/16" O.D. Stud
142280	411633	2	Bushing	0.810" centering lip for 7/16" O.D. stud
	411672	1	Retainer (washer)	0.410" I.D. x 2.05" O.D. x 0.175" thick
	412046	1	Lock nut	10 x 1.5 metric thread
	412479	1	Retainer (washer)	0.490" I.D. x 2.15" O.D. x 0.180" thick
142389	404287	2	Retainer (washer)	0.453" I.D x 1.50" O.D x 0.090" thick
	404947	2	Bushing	For 3/8" O.D. stud- no centering lip
	411497	1	Lock nut	10 x 1.25 metric thread
142592	402539	2	Bolt	5/16" x 24 UNF thread x 1" long
	402573	2	Nut	5/16" x 24 UNF thread
	402653	2	Lock washer	5/16" Lock washer
	411385	2	Retainer (washer)	0.355" I.D x 0.74" O.D. x 0.075" thick
142615	401006	1	Hex nut	3/8" x 24 UNF thread
	401376	1	Retainer	3/8 in. I.D. x 1-3/8 in. O.D. x .089 in. thick
	402943	1	Retainer (washer)	0.457" I.D. x 1.68" O.D. x .120" thick
	404652	2	Bushing	Used with 5/8" dia. hole or 7/8" dia. Hole
142617	401006	1	Hex nut	3/8" x 24 UNF thread
	402943	1	Retainer (washer)	0.457" I.D. x 1.68" O.D. x .120" thick
	403298	1	Retainer (washer)	0.390" I.D. x 1.68" O.D. x .120" thick
	412661	2	Bushing	0.790" centering lip for 7/16" O.D. stud

MOUNTING ACCESSORY PACKAGES AND COMPONENT PARTS

142656	411165	1	Lock nut	12 x 1.25 metric thread
	411446	1	Retainer (washer)	3/4" I.D. x 1 7/8" O.D. x .047" thick
	411447	1	Retainer (washer)	9/16" I.D. x 1-3/4" O.D. x .087" thick
	412103	1	Retainer (washer)	9/16" I.D. x 1-3/4" O.D. x 1/4" thick
	412116	2	Bushing	Flat bushing for 9/16" O.D. Stud
	412554	1	Retainer (washer)	0.485" O.D x 1.76" O.D. x .089" thick
142657	411165	2	Lock nut	12 x 1.25 metric thread
	411446	2	Retainer (washer)	3/4" I.D. x 1 7/8" O.D. x .047" thick
	411447	2	Retainer (washer)	9/16" I.D. x 1-3/4" O.D. x .087" thick
	412103	2	Retainer (washer)	9/16" I.D. x 1-3/4" O.D. x 1/4" thick
	412116	4	Bushing	Flat bushing for 9/16" O.D. Stud
	412554	2	Retainer (washer)	0.485" O.D x 1.76" O.D. x .089" thick
142700	401006	1	Hex nut	3/8" x 24 UNF thread
	402943	1	Retainer (washer)	0.457" I.D. x 1.68" O.D. x .120" thick
	403298	1	Retainer (washer)	0.390" I.D. x 1.68" O.D. x .120" thick
	404959	2	Bushing	3/4" centering lip for 7/16" O.D. stud
	411520	1	Jam nut	3/8" x 24 UNF thread
	412682	1	Sleeve	0.479" I.D. x 0.548" O.D. x 1.48" long
	429680-008	1	Instruction sheet	
142731	411165	1	Lock nut	12 x 1.25 metric thread
	411447	1	Retainer (washer)	9/16" I.D. x 1-3/4" O.D. x .087" thick
	412554	1	Retainer (washer)	0.485" O.D x 1.76" O.D. x .089" thick
	412675	2	Bushing	0.950" centering lip for 9/16" O.D. stud
142973	411633	2	Bushing	0.810" centering lip for 7/16" O.D. stud
	411672	1	Retainer (washer)	0.410" I.D. x 2.05" O.D. x 0.175" thick
	412046	1	Lock nut	10 x 1.5 metric thread
	412479	1	Retainer (washer)	0.490" I.D. x 2.15" O.D. x 0.180" thick
142976	401174	1	Hex nut	5/8" x 18 thread
	405360	2	Retainer (washer)	5/8" I.D. x 2-3/16" O.D. x .120" thick
	405361-000	2	Bushing	1" centering lip for 5/8" O.D. stud (1.00" thick)
	429680-031	1	Instruction sheet	
142998	404452	2	Retainer (washer)	5/8" I.D. x 2-3/4" O.D. x .180" thick
	404454	2	Bushing	1-3/16" centering lip for 13/16" O.D. stud
	405862	1	Self locking nut	5/8" x 18 thread
	412872	1	Sleeve	0.643" I.D. x .815" O.D. x 1.44" long
143000	404695	1	Retainer (washer)	0.709" centering lip x 1.97" O.D. x .060" thick
	404715	1	Spacer	0.737" I.D x 1.75" O.D. x .120 thick
	411165	1	Lock nut	12 x 1.25 metric thread
	411447	1	Retainer (washer)	9/16" I.D. x 1-3/4" O.D. x .087" thick
	412116	2	Bushing	Flat bushing for 9/16" O.D. Stud
	412554	1	Retainer (washer)	0.485" O.D x 1.76" O.D. x .089" thick
	429680-033	1	Instruction sheet	
143078	401006	1	Hex nut	3/8" x 24 UNF thread
	404969	1	Sleeve	0.400" I.D. x .620" O.D. x 1.48" long
	412554	2	Retainer (washer)	0.485" O.D x 1.76" O.D. x .089" thick
	412675	2	Bushing	0.950" centering lip for 9/16" O.D. stud
143146	411165	1	Lock nut	12 x 1.25 metric thread
	411447	2	Retainer (washer)	9/16" I.D. x 1-3/4" O.D. x .087" thick
	412675	2	Bushing	0.950" centering lip for 9/16" O.D. stud

MOUNTING ACCESSORY PACKAGES AND COMPONENT PARTS

145054	401174	1	Hex nut	5/8 in. -18 thread
	401175	1	Lock washer	
	405360	2	Retainer (washer)	5/8" I.D. x 2-3/16" O.D. x .120" thick
	405361-000	2	Bushing	1" centering lip for 5/8" O.D. stud (1.00" thick)
145075	401750	1	Retainer (washer)	3/4" I.D. x 2-3/8" O.D. x .105" thick
	401752	1	Retainer (washer)	1" I.D. x 2-3/8" O.D. x .105" thick
	401754	2	Bushing	EB3 - style for 2.39 in. O.D. eye ring - 1" diam. Stud
	405360	2	Retainer (washer)	5/8" I.D. x 2-3/16" O.D. x .120" thick
	405361-000	2	Bushing	1" centering lip for 5/8" O.D. stud (1.00" thick)
	145080	401011	2	Bushing
401429		1	Retainer (washer)	1/2" I.D. x 1-5/8" O.D. x .090" thick
401430		1	Retainer (washer)	3/4" I.D. x 1-5/8" O.D. x .090" thick
145089-000	405360	2	Retainer (washer)	5/8" I.D. x 2-3/16" O.D. x .120" thick
	405361-000	2	Bushing	1" centering lip for 5/8" O.D. stud (1.00" thick)
	405862	1	Self locking nut	5/8" x 18 thread
145089-200	405360	2	Retainer (washer)	5/8" I.D. x 2-3/16" O.D. x .120" thick
	405361-100	2	Bushing	1" centering lip for 5/8" O.D. stud (0.75" thick)
	415196-001	1	Nylon lock nut	5/8" x 18 thread
145090	405643	1	Sleeve	0.645" I.D. x 0.810" O.D. x 2.00" long
	405859	2	Bushing	0.815" I.D. x 2.35" O.D. x 1.05" thick with 1.15" centering lip
	405860	2	Retainer (washer)	0.650" I.D. x 2.75" O.D. x .180" thick
	405862	1	Self locking nut	5/8" x 18 thread
	424276	1	Instruction sheet	
145093	401750	2	Retainer (washer)	3/4" I.D. x 2-3/8" O.D. x .105" thick
	401752	2	Retainer (washer)	1" I.D. x 2-3/8" O.D. x .105" thick
	401754	4	Bushing	EB3 - style for 2.39 in. O.D. eye ring - 1" diam. Stud
145099	401174	1	Hex nut	5/8" x 18 thread
	401175	1	Lock washer	
	401754	2	Bushing	EB3 - style for 2.39 in. O.D. eye ring - 1" diam. Stud
	405360	2	Retainer (washer)	5/8" I.D. x 2-3/16" O.D. x .120" thick
	405361-000	2	Bushing	1" centering lip for 5/8" O.D. stud (1.00" thick)
	424274	1	Instruction sheet	
145112	401164	1	Hex nut	1/2" x 20 UNF Thread
	401165	1	Lock washer	1/2" lock washer
	405360	1	Retainer (washer)	5/8" I.D. x 2-3/16" O.D. x .120" thick
	405361-000	2	Bushing	1" centering lip for 5/8" O.D. stud (1.00" thick)
	405934	1	Retainer (washer)	0.530" I.D. x 2-3/16" O.D. x .120" thick
145116	401750	1	Retainer (washer)	3/4" I.D. x 2-3/8" O.D. x .105" thick
	401752	1	Retainer (washer)	1" I.D. x 2-3/8" O.D. x .105" thick
	415169	2	Bushing	EB3 - style for 2.39 in. O.D. eye ring - 1" diam. Stud
145123	405360	2	Retainer (washer)	5/8" I.D. x 2-3/16" O.D. x .120" thick
	405862	1	Self locking nut	5/8" x 18 thread
	415017-001	2	Bushing	1" centering lip for a 5/8" O.D. stud
145126	401750	2	Retainer (washer)	3/4" I.D. x 2-3/8" O.D. x .105" thick
	401754	2	Bushing	EB3 - style for 2.39 in. O.D. eye ring - 1" diam. Stud
	403752	1	Sleeve	3/4" I.D. x 15/16" O.D. x 1-3/4" long
	415277	1	Spacer	1-3/16" I.D. x 1-1/4" O.D. x .200" thick
	424281	1	Instruction sheet	

MOUNTING ACCESSORY PACKAGES AND COMPONENT PARTS

145128	405360	2	Retainer (washer)	5/8" I.D. x 2-3/16" O.D. x .120" thick
	405361-000	2	Bushing	1" centering lip for 5/8" O.D. stud (1.00" thick)
	415196-001	1	Nylon lock nut	5/8" x 18 thread
145132	415305-000	2	Rubber spacer	0.910" I.D. x 1.58" O.D. x 1.1" long
	415305-001	2	Rubber spacer	0.910" I.D. x 1.58" O.D. x 0.427" long
	424282	1	Instruction sheet	
145140	405360	2	Retainer (washer)	5/8" I.D. x 2-3/16" O.D. x .120" thick
	405862	1	Self locking nut	5/8" x 18 thread
	415326-001	2	Urethane bushing	1" centering lip for 5/8" O.D. stud (replacing Bushing P/N 415017)
145143	415305-001	2	Rubber spacer	0.910" I.D. x 1.58" O.D. x 0.427" long
	424284	1	Instruction sheet	
145144	415305-000	2	Rubber spacer	0.910" I.D. x 1.58" O.D. x 1.1" long
	424284	1	Instruction sheet	
145147	401429	1	Retainer (washer)	1/2" I.D. x 1-5/8" O.D. x .090" thick
	401430	1	Retainer (washer)	3/4" I.D. x 1-5/8" O.D. x .090" thick
145148	401750	1	Retainer (washer)	3/4" I.D. x 2-3/8" O.D. x .105" thick
	401752	1	Retainer (washer)	1" I.D. x 2-3/8" O.D. x .105" thick
145149	401265	1	Retainer (washer)	1/2" I.D. x 1-1/4" O.D. x .075" thick
	401266	1	Retainer (washer)	5/8" I.D. x 1-1/4" O.D. x .075" thick
145168	405643-100	1	Sleeve	0.645" I.D x 0.810" O.D. x 1.50" long
	405859-100	2	Bushing	0.815" I.D. x 2.35" O.D x 0.800" thick with 1.15" centering lip
	405860	2	Retainer (washer)	0.650" I.D. x 2.75" O.D. x .180" thick
	405862	1	Self locking nut	5/8" x 18 thread
	424276	1	Instruction sheet	
145177	401754	2	Bushing	EB3 - style for 2.39 in. O.D. eye ring - 1" diam. Stud
	406422-000	2	Retainer (washer)	22 mm I.D. x 60.2 mm O.D. x 2.7 mm thick
	415010-802	1	Sleeve	22 mm I.D. x 1.00" O.D. x 1-3/4" long
	424296-000	1	Instruction sheet	
401011		1	Bushing	EB2 style - for 1-3/4" O.D. eye ring - 3/4" diam. Stud - Replaced by TR0027
401754		1	Bushing	EB3 - style for 2.39 in. O.D. eye ring - 1" diam. Stud
404702		1	Bushing	EB1 style - 1 pc Spool shaped bushing (5/8" I.D.)
405360		1	Retainer (washer)	5/8" I.D. x 2-3/16" O.D. x .120" thick
405361-000		1	Bushing	1" centering lip for 5/8" O.D. stud (1.00" thick)
406422		1	Retainer (washer)	22 mm I.D. x 60.2 mm O.D. x 2.7 mm thick
415010-802		1	Sleeve	22 mm I.D. x 1.00" O.D. x 1-3/4" long
415015-001		1	Urethane bushing	EB3 - style for 2.39 in. O.D. eye ring - 1" diam. Stud
415017		1	Urethane bushing	1" centering lip for 5/8" O.D. stud
415025-001		1	Urethane bushing	EB2 style for 1-3/4" O.D. eye ring - 3/4" diam. Stud
415326-001		1	Urethane bushing	1" centering lip for 5/8" O.D. stud (replacing Bushing P/N 415017)
TR0027		1	Bushing	EB2 style - for 1-3/4" O.D. eye ring - 3/4" diam. Stud - (Replaces 401011)

MOUNTING ACCESSORY PACKAGES - BUYER'S GUIDE

Kit #	Gabriel #	
140126	34052	
	43099	
	58350	
	58359	
	58360	
	58387	
	61518	
	61523	
	61540	
	61647	
	61650	
	77359	
	G63350	
	G63359	
	G63360	
	G63387	
	G63457	
	14016	
	83027	
	G63350	
	G63359	
	G63360	
	G63387	
	G63457	
	G63881	
	140149	61510
		61699
		61700
		77494
		G63494
83200		
83216		
83219		
83308		
83309		
83312		
83314		
85023		
85024		
85046		
85047		
89401		
89402		

Kit #	Gabriel #
140149 Cont.	89403
	89409
	89415
	89416
	89434
	89435
	G63494
	G63510
	61597
	G63605
	G63639
	G63616
	85025
	G63605
	G63708
	85031
	G63432
	140357
58349	
58438	
61524	
77349	
G63349	
140455	G63438
	G63349
	G63438
	G63349
	G63438
	34051
	58421
	61504
	61509
	69900
	77421
	G63421
G63862	
83003	
83005	
83014	
83015	
83400	
G63421	
G63798	
G63860	
G63862	

Kit #	Gabriel #
140455 Cont.	G63950
140505	69574
	69575
140523	61502
140524	61513
	61552
	61593
	61596
	77479
	G63479
	G63484
	G63635
	83161
	83507
	G63479
	G63484
	G63491
	G63611
	G63635
140629	69604
	69724
	6851SE
140630	43049
	43060
140673	61529
	61606
	77937
	G63900
	G63937
	G63900
	G63937
140702	43111
	58355
	58394
	61525
	77355
	G63355
	G63394
	G63625
	83303
	83304
G63355	
G63394	

MOUNTING ACCESSORY PACKAGES - BUYER'S GUIDE

Kit #	Gabriel #
140702 Cont.	G63625
	83007
140719	43171
	43172
	61590
	61624
	77607
	77679
	G63607
	G63679
	G63607
	G63679
140724	43085
140739	43058
140780	34057
	34058
	34076
	58386
	58414
	58416
	58500
	58609
	58624
	58929
	61520
	61521
	61553
	61561
	61569
	61591
	61595
	77375
	77414
	77608
	77614
	77772
	G63386
	G63396
	G63414
	G63416
	G63445
	G63447
	G63500
	G63603
	G63608
	G63614
	G63621
	G63624
	G63929
	83162
	63432
	63448
140857	61501
	61508
	77902
	G63902
	G63902
140873	43138
	69703

Kit #	Gabriel #
140780 Cont.	G63603
	G63608
	G63614
	G63621
	G63624
	G63929
	G63375
	G63375
	83177
	63130
	63211
	63350
	83018
	83019
	83041
	83045
	83050
	83058
	83105
	83114
	G63386
	G63396
	G63414
	G63416
	G63445
	G63447
	G63500
	G63603
	G63608
	G63614
	G63621
	G63624
	G63929
	83162
	63432
	63448
140857	61501
	61508
	77902
	G63902
	G63902
140873	43138
	69703

Kit #	Gabriel #
140884	77405
	G63405
	G63405
140885	G63299
	63178
	63299
	G63299
140896	G55507
140921	61588
	77726
	G63548
	G63726
	G63548
	G63726
140953	G51760
	G51761
141041	34073
	69675
	G63444
	G63889
	G64004
	G64005
	G64006
	G64007
	83509
	G63444
	G63889
	G64004
	G64005
	G64006
	G64007
	63451
	63548
	83513
	83514
	83515
141047	58410
	61546
	77410
	G63410
	G63446
	63220
	63320

MOUNTING ACCESSORY PACKAGES - BUYER'S GUIDE

Kit #	Gabriel #
141047 Cont.	G63410
	G63446
141058	43093
141083	83301
	83317
	83318
	83613
141108	85310
	89423
	89447
	89455
141137	61506
	61519
	77377
	77492
	G63377
	G63492
	G63377
	G63492
	G63712
141138	G63187
	G63398
	G63187
	G63398
141150	43140
	69606
141191	69861
141247	85703
	85710
	85711
	85311
	85312
	89424
141277	61544
	77489
	G63489
	G63489
141349	61545
	G63404
	G63612
	G63432
	G63404
141350	G63495

Kit #	Gabriel #
141350 Cont.	G63547
	G63495
	G63547
	G63781
	G63782
141353	61535
	61551
	77424
	G63511
	61664
	G63424
	G63847
	77847
	G63847
	G63424
	G63511
141354	G63707
141356	77418
	77904
	G63418
	G63904
	G63418
	G63904
141368	77909
	G63909
	G63909
141376	77903
	G63903
	G63903
141387	85107
141397	6805SE
	6804SE
141405	G63620
141439	G63434
141448	G63506
	G63694
141514	G63799
141537	58489
141665	58783
	58803
	58817
	61615
	61626

Kit #	Gabriel #
141665 Cont.	61641
	61643
	61663
	77783
	77817
	G63721
	G63772
	G63783
	G63803
	G63817
	G63721
	G63772
	G63783
	G63803
141682	G52081
	G52082
141716	G51842
141727	G56807
	G56838
	G56839
141998	6802SE
	6803SE
	6826SE
	6805SE
	6805SE
142000	6805SE
	6805SE
142036	G63884
142037	6801SE
142038	6807SE
142095	63104
	63600
	83178
142101	G51047
142154	G51721
142169	G55948
	G55949
142277	61623
	77678
	G63678
142280	G63885
142387	14017
142389	61662

MOUNTING ACCESSORY PACKAGES - BUYER'S GUIDE

Kit #	Gabriel #
142389 Cont.	77815
	G63813
	G63815
	G63610
	G63865
142467	G51077
142486	77955
142491	85101
142592	77847
	61664
	G63424
	G63847
	G63847
142615	61555
	G63375
	G63375
142617	58622
	58623
	58807
	61646
	77807
	G63622
	G63623
	G63622
	G63623
142656	83512
	G63616
142657	G63615
142700	58715
	58778
	61612
	61638
	77715
	77778
	G63715
	G63778
	G63715
	G63778
142718	6828SE
	6854SE
142731	58673
	58674
	58714

Kit #	Gabriel #
142731 Cont.	58716
	61611
	61613
	61634
	61635
	61680
	61712
	61714
	77623
	77673
	77674
	77714
	77716
	77947
	77948
	77951
	G63674
	G63714
	G63716
	G63848
	G63886
	G64009
	G64011
	G64029
	G64030
	G63674
	G63714
	G63716
	G63848
	G63886
	G64009
	G64011
142973	61711
	G64008
	G64008
142976	G63828
	G63832
142998	83456
143000	58661
	61599
	77949
	G63661
	G63673

Kit #	Gabriel #
143000 Cont.	G63661
	G63673
143008	G51477
143077	6856SE
143078	61685
	G63893
	G63894
	G63895
	G63958
	G64001
143146	77967
	G63969
	G63969
143154	6855SE
143155	6853SE
143156	6856SE
143157	6857SE
143159	6862SE
143160	6861SE
143161	6858SE
143162	6860SE
143163	6848SE
143164	6863SE
143165	6852SE
143166	6859SE
143167	6849SE
143168	6850SE
143172	G56778
143177	6851SE
143248	G57021
143276	61683
	61684
	77803
	77954
	G63893
	G63894
	G63895
	G63958
	G64001
143312	G63884
143340	G64038
145054	85729
	85731

MOUNTING ACCESSORY PACKAGES - BUYER'S GUIDE

Kit #	Gabriel #
145054 Cont.	83103
	83134
	83136
	83635
	85009
	85026
	85027
	85071
	85080
	85085
	85092
	85096
	85318
	85324
	85330
	85336
	85342
	85379
	85701
	85900
	85902
	85921
	89417
	89418
	89441
	85025
145075	85723
145080	83107
	85012
	85054
	85055
	85062
	85063
	89408
	89413
	89438
	89439
145090	85380
	85740
	695406
	85081
	85093
	85103

Kit #	Gabriel #
145090 Cont.	85110
	85117
	85123
	85316
	85346
	85347
	85705
	85706
	85707
	85708
	85709
	85722
	85745
	85746
	85935
	85973
	85982
	85993
	87020
	89426
	85987
	87016
145093	85714
	85715
	85716
	85717
	85718
	85719
145099	83353
	85033
	85988
	89427
145116	87016
	85732
	83162
145126	85053
	89442
145128	85065
	83062
	83109
	83110
	83111
	83112

Kit #	Gabriel #
145128 Cont.	83138
	83142
	83143
	85083
	85332
	85333
	85977
145140	85727
	85728
145143	83120
145144	85065
145148	83140
	83141
145158	63322
145168	83173
	85981
145177	85118
401011	83179
	83404
	83505
	83506
401754	83214
	83215
	83217
	83225
	83362
	85001
	85004
	85007
	85040
	85042
	85070
	85300
	85301
	85302
	85303
	85304
	85305
	85307
	85308
	85313
	85314
	85315

MOUNTING ACCESSORY PACKAGES - BUYER'S GUIDE

Kit #	Gabriel #
401754 Cont.	85320
	85322
	85327
	85329
	85334
	85339
	85376
	85700
	85702
	85704
	85712
	85713
	85720
	85730
	85734
	85735
	85736
	85901
	85905
	85912
	85913
	85940
	85941
	85942
	85943
	85944
	85948
	85949
	85951
	85968
	85983
	89410
	89412
	89419
	89420
	89422
	89425
	89429
	89459
	85703
	85710
	85711
	85729

Kit #	Gabriel #
401754 Cont.	85731
	85343
	85380
	85740
404702	83007
	83001
	83006
	83011
	83012
	83038
	83047
	83117
	83401
	83508
	83510
	83161
	83177
	83509
405360	85727
406422	83162
500498	14040
	6804SE
	6801SE
	6807SE
415010-802	83162
142280	
142280	G63885
145089-000	83120
	85343
	83102
	83154
	85069
	85073
	85122
	85319
	85340
	85341
	85733
	85970
	89428
145089-200	85936
145089-200	85937
145089-200	85985

Kit #	Gabriel #
145089-200 Cont.	89456
145168-000	85996
	85997
415010-802	83140
	83141
	63322
415015-001	85987
	63449
	63449
TR0027	63450
	83159
	83511
	85074
	85077
	89446
	85031
	63432
	63448
	63451
	63548
	83513
	83514
	83515
	83512

Rely only on high-grade performance suspension parts offered on our virtual shelves.