

DEEZEE®

The Quality Truck Accessory People



2016
CATALOG

WHAT'S NEW

NEW



9

6" BRITE-TREAD SIDE STEPS

Also available in a rugged, textured black finish.



43

PULL-HANDLE TOOL BOXES

Dee Zee's Red Label tool boxes, now with an ergonomic pull-handle style latch option.



28

BUMPER GUARD

An aggressive new styling option for your vehicle's grill protection.



38

RED LABEL ENHANCEMENTS

Dee Zee's Red Label Tool Box line; more refined and updated for today's demands.



TABLE OF CONTENTS

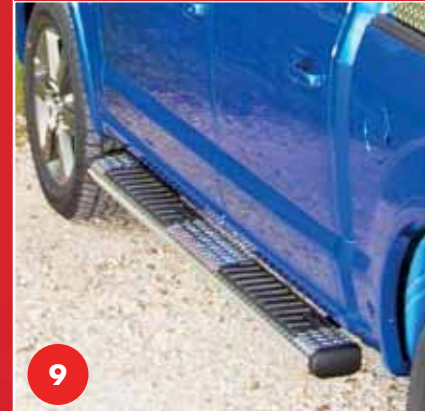

9

VEHICLE ACCESSORIES 24

- Floor Mats 25
- Mud Flaps 26
- RAM® Mounts 27
- NEW - Bumper Guard** 28
- Bull Bars / Grill Guards 29
- Hitch Carriers 30



44

TANKS 44

- Liquid Transfer Tanks 45
- Auxiliary Tanks 52
- Tank Accessories 56

MISC. ACCESSORIES 67

- Logo Shop 68
- Grip Tape / Auto Safe / 69
- Wall Clock
- Replacement Parts / 70
- Accessories 64

- ### SIDE STEPS 4
- NXt Running Boards 5
 - NXc Running Boards 6
 - Rough Steps / 7
 - Brite-Tread Running Boards
 - FX Running Boards 8
 - NEW - 6" Side Steps** 9
 - 4" Nerf Bars 10
 - 3" Nerf Bars 11
 - Universal Nerf Bars 12



29

BED ACCESSORIES 13

- Invis-A-Rack™ 14
- Cab Racks 16
- Tailgate Assist 18
- Flow-Through Tailgate / 19
- Tie-Downs / Side Rails
- Side Bed Caps 20
- Front Bed Caps 21
- Tailgate Protectors 22
- Bed Mats 23

TOOL BOXES 32

- Blue Label 33
- Padlock Boxes 36
- IMPROVED - Red Label** 38
- NEW - Pull Handle** 43
- Tool Boxes**
- Hardware™ (Steel) 44
- Specialty Series 46



38

SIDE STEPS

Running Boards

- NXt (Pickups)
- NXc (Crossovers)
- Rough Steps
- Brite-Tread
- FX Black

Side Steps

- 6" Oval

Nerf Bars

- 4" Oval
- 3" Round
- Universal

5

9

10

10

RUNNING BOARDS

NXt Running Boards

- Lightweight aluminum powder coated frame.
- Full-length aluminum protective accent trim.
- Slip resistant rubber grommets line the wide 6" step area.
- 3 distinct styling options:
 - Black / Black **1**
 - Stainless Steel / Black **2**
 - Black / Chrome **3**
- 3 board lengths cover all listed makes & models.
- No drill installation with custom fit brackets.
- NRT™ powder coated steel braces **sold separately.**

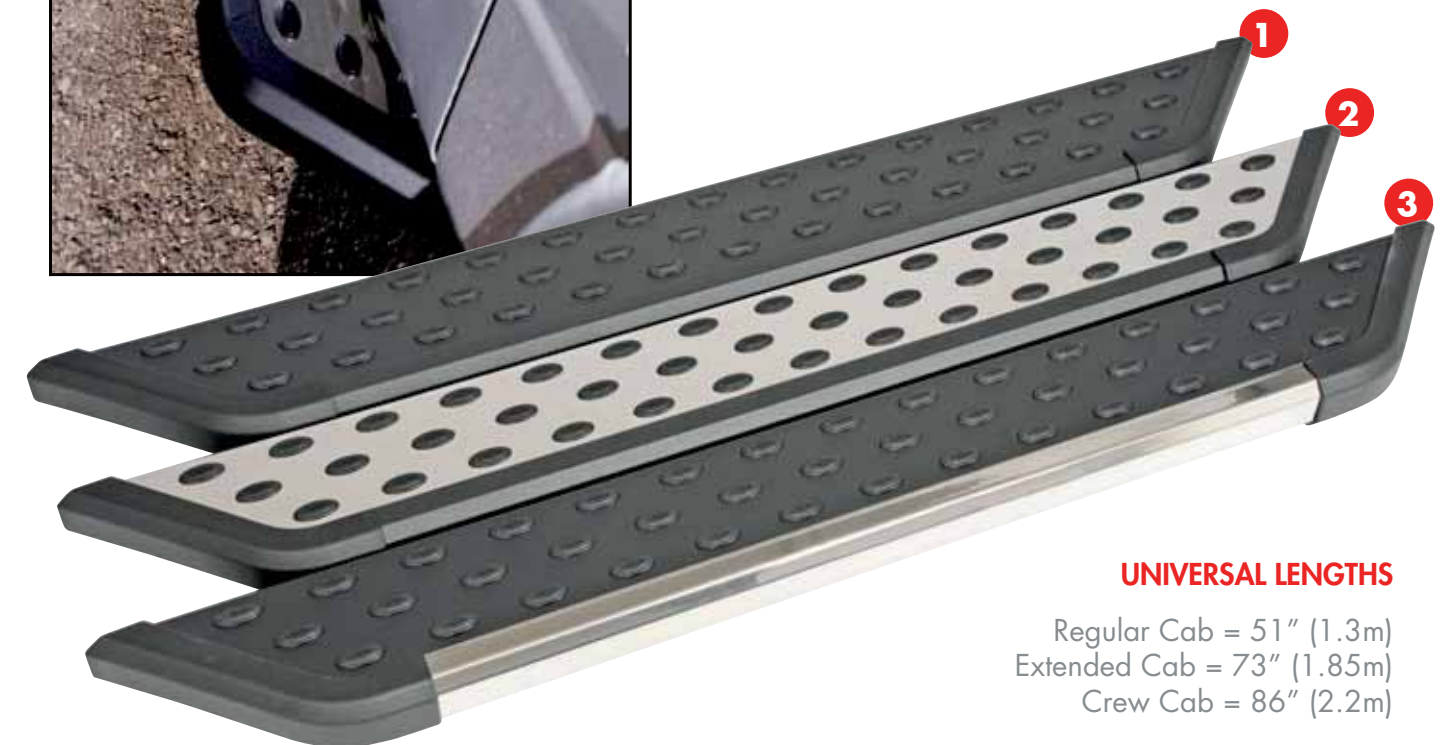

UNIVERSAL LENGTHS

Regular Cab = 51" (1.3m)
Extended Cab = 73" (1.85m)
Crew Cab = 86" (2.2m)



RUNNING BOARDS



RUNNING BOARDS



NXc Running Boards

- Lightweight aluminum powder coated frame.
- Full-length aluminum protective accent trim.
- Slip resistant rubber grommets line the wide 5" step area for superior traction.
- 3 distinct styling options:
 - Black / Black ① #DZ16201
 - Stainless Steel / Black ② #DZ16203
 - Black / Chrome ③ #DZ16202
- 2 board lengths cover all listed makes and models.
- NEW Compact SUV size
- No drill installation with custom fit brackets.
- NRT™ powder coated steel braces *sold separately.*



UNIVERSAL LENGTHS

Standard = 71.5" (1.82m)

Compact = 65.5" (1.66m)



Rough Steps

- Aluminum (NEW) or Steel construction protected by NRT™ powder coating.
- No drill bracing installs easily. *(on most applications) - Sold Separately*
- Unique stepping area offers ultimate traction virtually eliminating slips.



Brite Tread Running Boards

- The classic style that started it all for Dee Zee.
- Non-rusting Brite-Tread aluminum construction with front mud flap.
- Custom-fit applications for quick and easy installation.
- Brackets are coated to help prevent rust and wear.



RUNNING BOARDS

FX Black Running Boards

- Lightweight, extruded aluminum construction.
- Available in multiple finishes:
 - Textured Black (*Late Model Apps Only*)* ①
 - Buffed (*Discontinued; limited stock remaining*)*
 - Gloss Black (*Not available on late models*)* ②
- Step pad and ribbed edge provides secure footing.
- Updated, integrated mud flap design provides protection from debris.

NEW & IMPROVED
FRESH
DESIGN



**see app guide for exact finishes available for your vehicle*

SIDE STEPS

6" Oval Side Steps

- Constructed from tough, 16-gauge steel or **NEW** Brite-Tread aluminum options.
- 3 cab lengths available to fit most trucks.
- Available in polished stainless steel, Brite-Tread aluminum, or with a textured black powder coated finish.
- No drill installation on most applications with custom-fit braces. (*sold separately*)

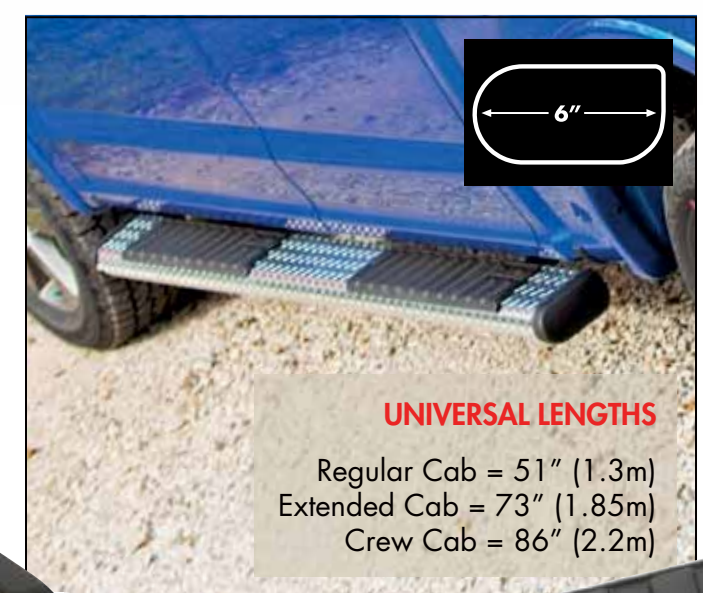

UNIVERSAL LENGTHS
Regular Cab = 51" (1.3m)
Extended Cab = 73" (1.85m)
Crew Cab = 86" (2.2m)





**NERF
BARS**



**NERF
BARS**



4" Oval Nerf Bars

- Constructed from tough, 14-gauge 304 stainless steel material.
- Wide profile step area.
- 90° bends and hidden bracing create a sleek look.
- No drill, custom fit applications for easy installation.
- Molded plastic step pads ensure secure footing.
- Available in polished stainless steel or gloss black powder coated finishes.



Polished Stainless Steel

Gloss Black Steel

3" Round Nerf Bars

- Constructed from tough, 14-gauge 304 stainless steel material.
- Molded plastic step pads ensure secure footing.
- 90° bends and hidden bracing create a sleek look.
- No drill, custom fit applications for easy installation.
- Available in polished stainless steel or gloss black powder coated finishes.



Polished Stainless Steel

Gloss Black Steel



NERF BARS

3" Round / 4" Oval Universal Nerf Bars

- Durable powder coated steel or polished stainless steel construction.
- Universal design fits most full & midsize pickups, when custom-fit applications are unavailable.
- Drilling required for installation.

3" ROUND LENGTHS

Polished Stainless Steel

- 3700303 - 32" (1 step pad)
- 3700293 - 64" (2 step pads)

Black Powder Coated Steel

- 3700301 - 32" (1 step pad)
- 3700291 - 64" (2 step pads)

4" OVAL LENGTHS

Polished Stainless Steel

- 150025 - 48"
- 150026 - 68"

Black Powder Coated Steel

- 151-25 - 48"
- 151-26 - 68"



PICKUP BED ACCESSORIES

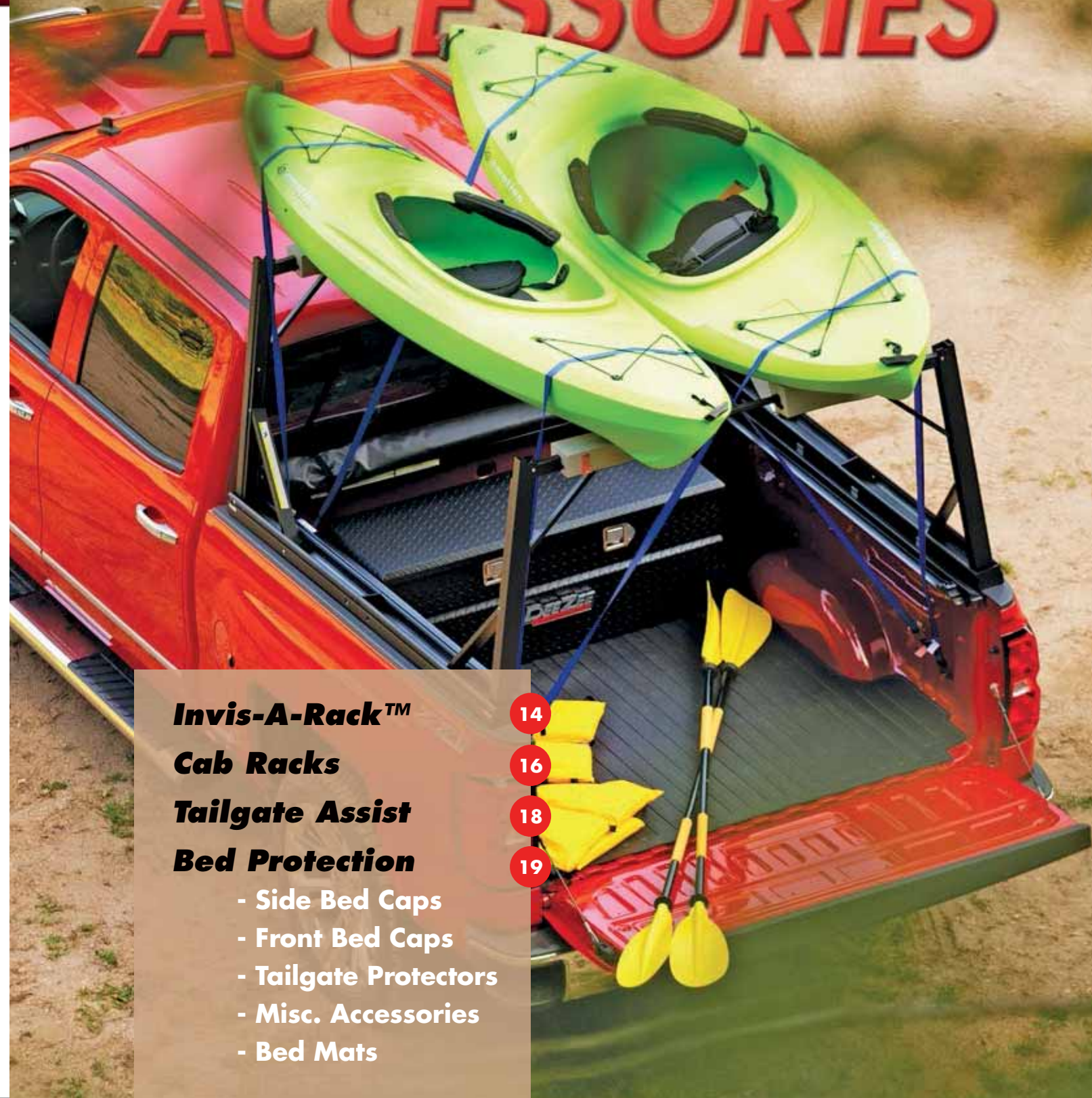

Invis-A-Rack™

Cab Racks

Tailgate Assist

Bed Protection

- Side Bed Caps
- Front Bed Caps
- Tailgate Protectors
- Misc. Accessories
- Bed Mats

14

16

18

19



Invisible to Invaluable...
IN SECONDS!

Invis-A-Rack™ by Dee Zee

- Innovative cargo rack system.
- Uprights hide away when not in use and pop up in seconds for use with ladders, canoes and any longer items.
- More fuel efficient than typical ladder racks because they stow away when you don't need them.
- Installs easily with no drilling.
- Powder coated aluminum. 500 lb. capacity.

<p>FULL SIZE TRUCKS:</p> <p>#DZ951550 Fits 5.5' Beds</p> <p>#DZ951600 Fits 6' & 6.5' Beds</p> <p>#DZ951800 Fits 8' Beds</p>	
<p>MIDSIZE TRUCKS:</p> <p>#DZ951551 5.5' Bed</p> <p>#DZ951601 6' & 6.5' Beds</p>	

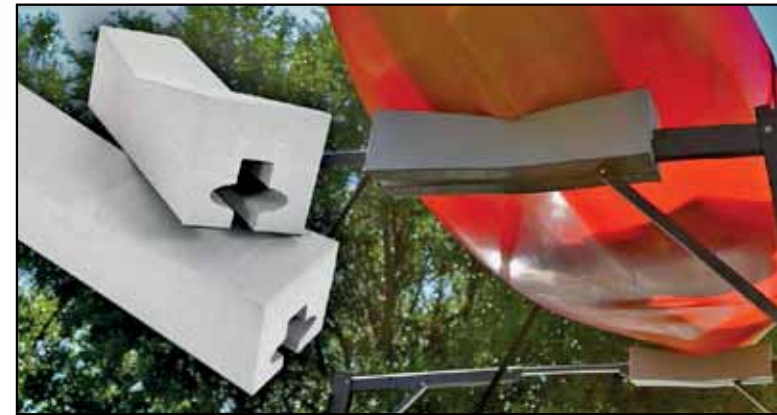

Kayak Stabilizers
(2 pack)

- 16" foam blocks that wrap around the Invis-A-Rack's upper arms and are shaped to perfectly cradle a kayak.
- Also works with most OEM and aftermarket crossbars - round/oval

#DZ951901



Crossbar Pads
(2 pack)

- Transport a variety of items with 16" foam blocks that wrap around the Invis-A-Rack's arms, secured by hook & loop fasteners.
- Also works with most OEM and aftermarket crossbars - round/oval

#DZ951902



See App Guide for custom applications.

Truxedo® Low-Pro QT Tonneau Covers

- The only tonneau cover that works with Invis-A-Rack.
- Features: auto-tension control, a one-finger trigger latch, side and corner sealing to keep the elements out, a low-profile design, and a lifetime warranty.



PICKUP CAB RACKS

PICKUP CAB RACKS

#DZ95050



Aluminum Pickup Cab Racks

- 2.75" octagonal aluminum tubing.
- Integrated channel system offers many accessory possibilities.
- Heavy duty ultra mesh.
- Use two racks for longer items such as ladders.
- Powder coated silver, gloss or textured black.
- No drill installation into bed's stake pockets.
- Includes set of two tie downs.
- 300lb. limit with one rack, 500lb. limit with two.

#DZ95050(B)(TB) - with mesh 1

#DZ95054B - without mesh 2

GM Silverado/Sierra	2016-1973
Ford F150/F-series	2016-1973
Dodge Ram 1500	2012-2009
Dodge 2500/3500 5.5' beds	2012-2010

#DZ95050W(B) - with mesh

#DZ95054WB - without mesh

Ford SuperDuty	2016-1999
----------------	-----------

#DZ95057(B)(TB) - with mesh

Dodge 2500/3500 6' & 8' beds	2012-2010
------------------------------	-----------

#DZ95058(B)(TB) - with mesh

Dodge 2500/3500	2016-2013
-----------------	-----------

Steel Pickup Cab Racks

- Made from 12-gauge steel square tubing.
- One-piece louvers help keep the cab shaded.
- Mounts easily into existing stake pocket holes. Minimal drilling required.
- 2 tie-downs included.
- Integrated slots for attaching lights and other accessories.
- E-coated along with white or black powder coat.
- Mounting brackets **sold separately**.



#DZ95050SL(B)

		Bracket Kit
GM Silverado/Sierra	16-07	DZ950510(B)
Ford F150	14-04	DZ950520(B)
Dodge Ram 1500	16-09	DZ950530(B)
Dodge Ram 25/3500	16-10	DZ950531(B)

#DZ95050WSL(B)

Ford SuperDuty	16-99	DZ950521(B)
----------------	-------	-------------

Cab Rack Accessories

#DZ95002 TIE DOWNS set of 2

Light Mounts

- Black powder-coated mounts designed to work with Dee Zee Pickup Cab Racks.
- Sold individually.

#DZ95060	5" x 1.888" x 2.075"
#DZ95061	7" x 1.888" x 2.575"
#DZ95062	7.274" x 9" x 1.074"
#DZ95063	14.275" x 9" x 1.075"
#DZ95064	5.5" X 7" - Side light mount



*Part numbers with a gloss black powder coat finish denoted with a (B).
 **Part numbers with a textured black powder coat finish denoted with a (TB).

*Part numbers with a texture black powder coat finish denoted with a (B).



TAILGATE ASSIST



PICKUP BED ACCESSORIES

Tailgate Assist

Safely controls the drop of a truck tailgate.

- Custom designed specifically by make/model.
- High quality, extensively tested for heavy use.
- Works in conjunction with factory cables.
- Easy no-drill installation - installs in minutes.
- All hardware is included.
- Installs on driver's side only; only one unit needed per truck.



#DZ43100	Silverado/Sierra	99-06 07 classic
#DZ43102	Silverado/Sierra	07-16 - 2014+ Work Trucks Only
#DZ43200	Ford F-150	04-14 - Not Flareside
#DZ43203	Ford F-150	97-03 - Not Super Crew/Flareside
	Super Duty	99-16
#DZ43204	Ford F-150	16-15
#DZ43300	Ram 1500	02-08
	Ram 2500/3500	03-09
#DZ43301	Ram 1500	09-16
	Ram 2500/3500	10-16



Flow-Through Tailgate

- Louvered tailgate helps improve airflow.
- Made from lightweight aluminum.
- Tailgate Assist included for easy opening. See pg. 18 to learn more!
- BOLT® lock pre-installed, works with your truck key!
- Channeled frame allows attachment of tie-downs and other accessories.
- Notched design allows for fifth wheel trailer access. Insert sold separately (#DZ95700)



#DZ95710(B)	Silverado/Sierra	07-16
#DZ95720(B)	Ford F-150	09-14
#DZ95721(B)	Ford Superduty	08-16
#DZ95730(B)	Dodge Ram	09-16
	1500	
	2500/3500 (2010+)	

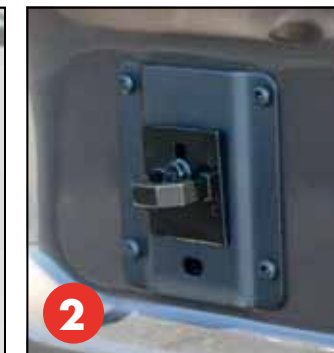

Pickup Bed Tie-Downs

- **#DZ97903** - 2007+ Chevy/GMC ①
- **#DZ97909** - 2015+ Ford F-150 ②
- An easy way to add anchors for securing cargo. Rated for 250lbs, no drill install.
- Made from cast aluminum.
- Sold in pairs.

Stainless Steel Side Rails

- Polished stainless steel construction.
- Thick, 1.9" diameter.
- Custom-fit applications.
- No-drill installation for most applications.





1 Brite-Tread

- Made from Brite-Tread aluminum.
- Custom-fit applications.
- Also available in a non-wrap style.
- Available with or without stake holes.

2 Black-Tread

- Made from Brite-Tread aluminum.
- Powder coated with a Black Tread finish.
- Custom-fit applications.
- Available with or without stake holes.



1 Brite-Tread Front Bed Cap

- Made from non-rusting Brite-Tread aluminum.
- Custom-fit applications.
- Style matches other great Dee Zee aluminum products.



2 Full Front Box Protector

- Offers full protection to the front of your truck's bed.
- Constructed from Brite-Tread aluminum.
- Custom-fit applications.





1 Brite-Tread

- Made from Brite-Tread aluminum.
- Custom-fit applications.

2 Black-Tread

- Made from Brite-Tread aluminum.
- Powder coated with a Gloss Black finish.
- Custom-fit applications.



FULL TAILGATE PROTECTORS



Heavyweight Bed Mat

- Prevent cargo from shifting and damaging your truck's bed.
- Rubber cleats help keep the mat in place and allow water drainage.
- Will not crack, rust or break - even in extreme temperatures.
- Resists most chemical spills.
- Custom-fit applications for most pickups - contours wheel wells.
- Extra thick 3/8" (9.52 mm) tear-resistant rubber construction.
- Universal mats are available in several sizes that fit multiple applications.

Tailgate Mat

- Universal width fits full-size trucks.
- Even fits with spray liners.



Rubber cleats prevent slipping while facilitating water drainage.

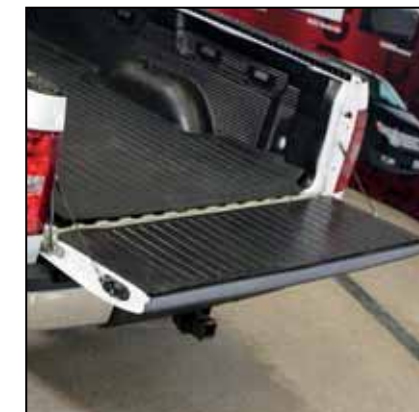

Tailgate Mat
#DZ86700
(sold separately)



#DZ85005B

Universal Bed Mat Packaging
(boxed applications)
Boxed applications: 3/16" thick.

VEHICLE ACCESSORIES

Floor Mats

25

Mud Flaps

26

RAM Mounts

27

Grill Protection

28

- Bumper Guards
- Bull Bars
- Grill Guards



FLOOR MATS

Floor Mats

- Thick, OEM-style rubber.
- Cleated back prevents it from sliding.
- Sold in pairs.
- Various styles to fit most needs.

1 #DZ90709 All Weather Tread Mats

- Brite-Tread aluminum insert.
- 20.5" x 27"

2 #DZ90710 All Weather Floor Mats

- 19" x 28"

3 #DZ90714 All Weather Deep Mats

- Extra deep channels catch more water and debris.
- 19" x 27"

4 #DZ90713 All Weather Rear Mats

- 17" x 17"

5 #DZ90711 All Weather Full-Width Mat

- Sold individually
- 27" x 61"





- 1 #DZ1808(TB)
Universal Brite-Tread**
- 11" x 19" (with radius notch)
 - Available in raw Brite-Tread aluminum or with a textured black finish (TB).

- 2 Custom-Fit Splash Guards**
- Made from OEM-approved material.

- 3 #DZ1998
Stainless Steel**
- 12" x 16"
 - Polished; protective rubber edging.

- 4 #DZ17939
Universal Rubber**
- Composite splash guard fits most trucks, vans, and SUVs. Installs in minutes.
 - 11" x 18"

- 5 #DZ1800
Brite-Tread**
- Classic Brite-Tread styling matches other Dee Zee aluminum products.
 - 12" x 16"
 - Also available in dually width, see app guide for fitment/part numbers.



No-Drill™ Laptop Stand System

- Telescoping feature ranges from 12" to 18".
- Additional adjustment provided by the patented rubber ball and socket joint.
- RAM Tough Tray™ can accommodate 10" to 16" laptops (17" wide screens) with four adjustable retaining arms.
- Hole patterns in the tray allow for mounting of additional RAM accessories.
- No drill installation using existing hardware of the passenger side seat rails.



GM Pickups / SUVs



#RAP-B-166-2-UN7U

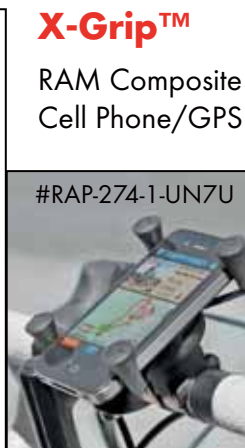

#RAP-274-1-UN7U

X-Grip™
RAM Composite Twist Lock Mount with Universal X-Grip™
Cell Phone/GPS Holder

RAP-B-166-2-UN7U
with suction cup mount

RAP-274-1-UN7U
with EZ-ON bicycle mount



VEHICLE GRILL PROTECTION



VEHICLE GRILL PROTECTION

NEW



Bumper Guard

- Strong aluminum construction.
- Protective and stylish textured black powder coat finish.
- Heavy-duty rubber bumper trim.
- Channeled design allows for mounting lights & accessories. *(sold separately)*
- Custom steel braces for easy install, protected by NRT™ coating. *(sold separately)*



Bull Bars

- 3" diameter heavy duty mandrel-bent steel.
- Available in polished stainless or black powder coat finish.
- Pre-drilled holes for auxilliary lights. *(lights not included)*
- Skid plate offers additional protection.



Bull Bar License Plate Mount
#DZLPMOUNT

Euro-Style Grill Guards

- 1.5" diameter, 18-gauge steel tubing.
- Available in stainless steel or with a protective black powder coat.
- PVC bumper pads protect the steel.
- Custom applications fit most full and mid size trucks - easy install.



Note: Not designed for use with proximity sensors or laser speed control sensors, etc.



HITCH CARGO CARRIERS

Hitch-Mounted Cargo Carriers

- Fits standard Class III (2") trailer hitches.
- Sturdy, powder coated steel construction.
- Reflective safety tape included.
- Additional brake lighting recommended for taller &/or wider loads.



Welded Carrier

- Prefabricated holes for multiple tie-downs.



Hinged Carrier

- Can be folded out of the way when not in use.



Hitch-Mounted Bike Carrier

- Integrated bike rack holds up to 2 bikes.



Cargo Carrier Bag

- Heavy duty canvas with straps for securing.

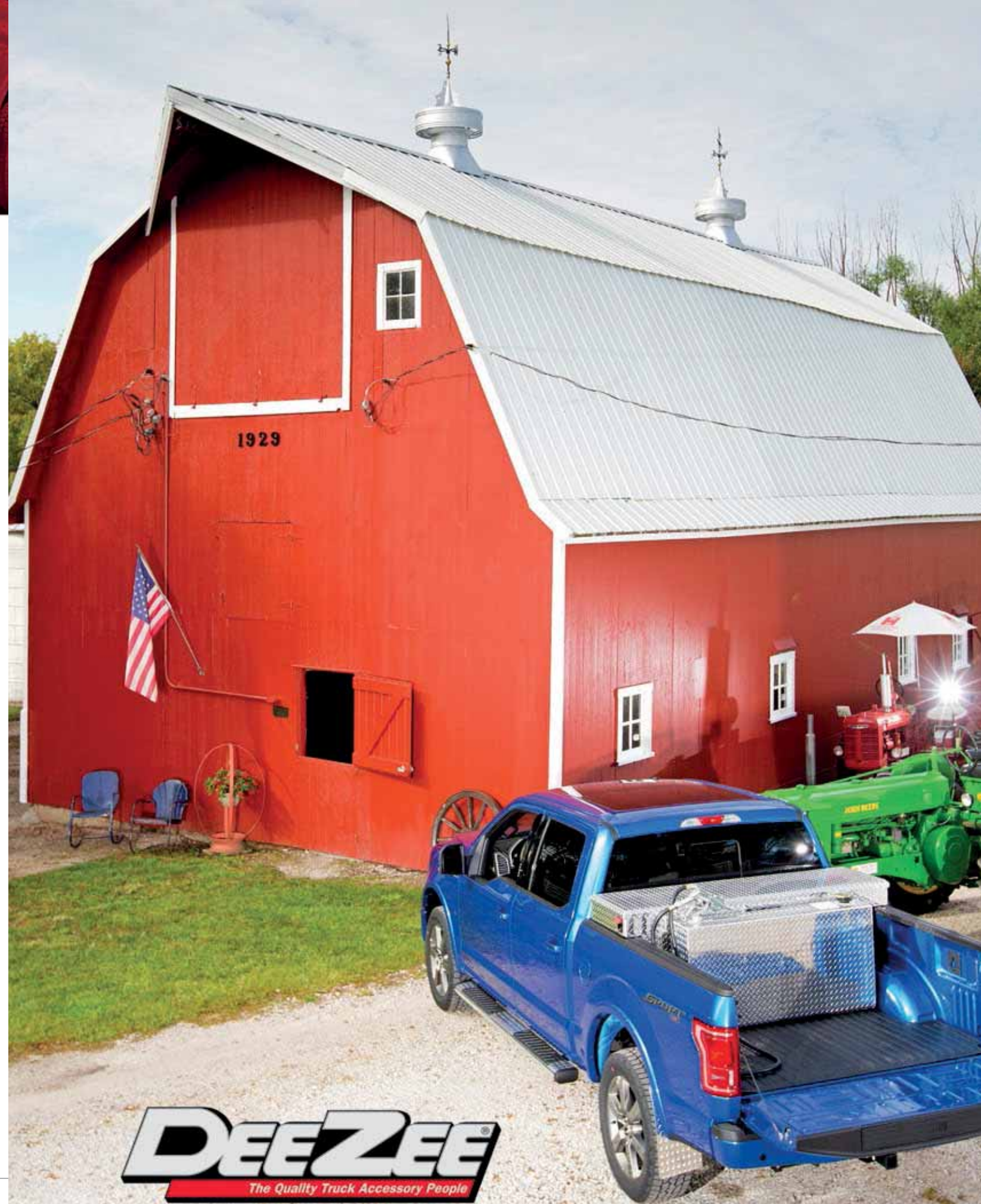

DEEZEE
The Quality Truck Accessory People

TOOL BOXES



Blue Label

33

- Crossovers
- Side Mounts/Chests
- Padlock Boxes

Red Label

38

- Crossovers
- Side Mounts
- Chests
- Pull Handle Boxes

HARDware Steel

44

Specialty Boxes

46



BLUE LABEL TOOL BOXES



CHROMED PLASTIC BADGE

PUSH BUTTON LATHCES

Ergonomically designed for minimum force opening.

SELF-ADJUSTING STRIKERS

Closes tightly no matter how hard you push down.



DAMPENED GAS SHOCKS

Opens at a steady, controlled rate.

HIDDEN HINGE

Full length piano hinge for extra strength.



RUBBER BULB SEAL

Automotive-grade seal helps keep the elements out of the box.

POWDER-COAT

Available in raw Brite-Tread or with a black powder coated finish.



REMOVABLE TOOL TRAY

Perfect for keeping smaller items organized. Select styles only.

3 PIECE BODY

Front, back, and bottom - all one piece for increased body strength.

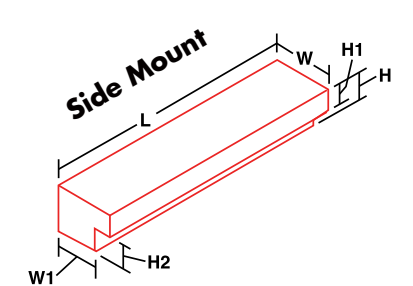
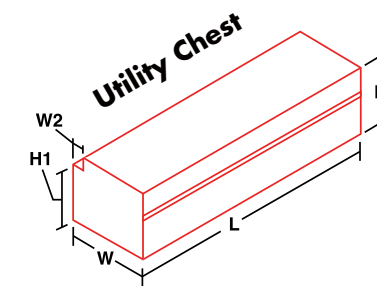
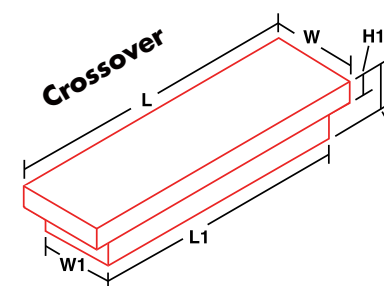



BLUE LABEL TOOL BOXES

Crossover Tool Boxes



#DZ9170(B) 1
Fits full size trucks

L	69.75"	L-1	60.75"	L-2	
W	19.875"	W-1		W-2	
H	17.5"	H-1	5"	H-2	12.5"
Vol	12.8 cu.ft.				

#DZ9170L(B) 2
Fits full size trucks - low profile

L	69.75"	L-1	60.75"	L-2	
W	19.875"	W-1		W-2	
H	17.5"	H-1	2"	H-2	12.5"
Vol	12.5 cu.ft.				

#DZ9170W(B)
Fits full size trucks - wide model

L	69.75"	L-1	60.75"	L-2	
W	25.8"	W-1		W-2	
H	14.6"	H-1	5"	H-2	9.6"
Vol	13.9 cu.ft.				



*Part numbers with a gloss black powder coat finish denoted with a (B).



#DZ9748(B) 3
Side Mount Box - 48"

L	48"	L-1		L-2	
W	14.25"	W-1	10"	W-2	4.25"
H	11"	H-1	5"	H-2	5"
Vol	3.75 cu.ft.				



#DZ9768(B) 4
Side Mount Box - 68"

L	68"	L-1		L-2	
W	14.25"	W-1	10"	W-2	4.25"
H	11"	H-1	5"	H-2	5"
Vol	5.3 cu.ft.				

Side Mounts

Utility Chests

- Portable storage that is perfect for your truck, garage, and home.

#DZ9560(B) 5
Fits full size trucks - 60"

L	60"	L-1		L-2	
W	20.125"	W-1		W-2	1.4"
H	14.2"	H-1	11.4"	H-2	
Vol	9.77 cu.ft.				



*Part numbers with a gloss black powder coat finish denoted with a (B).



PADLOCK TOOL BOXES

Padlock Tool Boxes

- **SECURE.** Locks using a padlock. Designed for use with BOLT® locks (works with your truck key), and most brands with 7/8"-1" shackle height. Recessed placement makes it virtually impossible to cut. *Padlock sold separately.*
- **ONE MOVING PART.** No more buttons or handles binding up, rods bending, or springs breaking.
- **STRONG.** Keyhole latch design takes twice the force to pry open as our standard boxes.*

- **20% THICKER ALUMINUM.** Pick it up and feel the difference!
- **PROFESSIONAL FEATURES.** Includes a steel tool tray** with dividers (Crossover models only), an electrical access point, and a real rubber seal to protect your tools.
- **90° LID OPENING.**

**Sliding latch design is patent pending.*

***Utility chests come with a heavy-duty plastic tray. Side mount models do not come with a tray.*

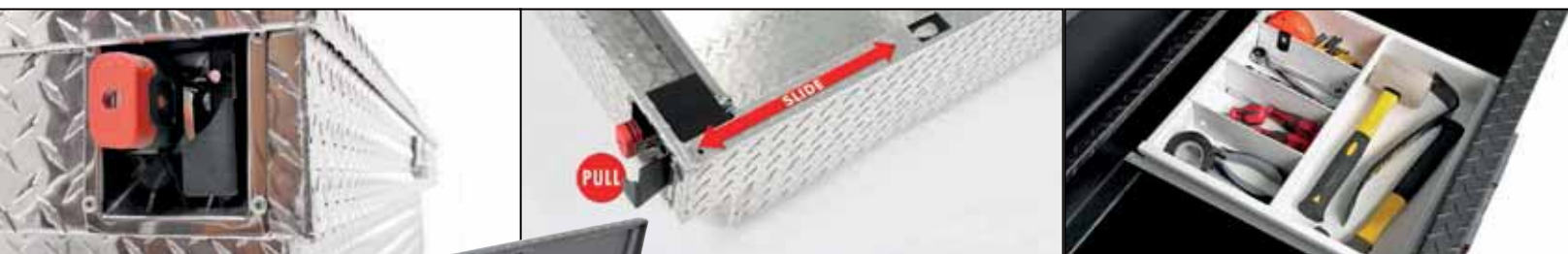

Utility Chests

- Portable storage that is perfect for your truck, garage, and home.

#DZ6546LOCK(TB) 2

Fits all trucks - includes plastic tray

L	46.5"	L-1		L-2	
W	19"	W-1		W-2	2.4"
H	16"	H-1	13.1"	H-2	
Vol	8 cu.ft.				

**Part numbers with a textured black powder coat finish denoted with a (TB).*



PADLOCK TOOL BOXES

Side Mounts

#DZ6748LOCK(TB)

Fits full size trucks
6' bed with crossover

Fits mid/mini size trucks
7' bed w/ crossover or 6' bed w/o crossover

L	48"	L-1		L-2	
W	16"	W-1	12"	W-2	4.25"
H	13"	H-1	8"	H-2	5.14"
Vol	5 cu.ft.				

#DZ6760LOCK(TB) 3

Fits full size trucks

8' bed with crossover or 6' bed w/o crossover

Fits mid/mini size trucks

7' bed with crossover or 6' bed w/o crossover

L	60"	L-1		L-2	
W	16"	W-1	12"	W-2	4.25"
H	13"	H-1	8"	H-2	5.14"
Vol	6.2 cu.ft.				

#DZ6768LOCK(TB)

Fits full size trucks

6' bed w/o crossover or

8' bed with crossover

Fits mid/mini size trucks without crossover

L	68"	L-1		L-2	
W	16"	W-1	12"	W-2	4.25"
H	13"	H-1	8"	H-2	5.14"
Vol	7 cu.ft.				

Crossover Tool Boxes



#DZ6170LOCK(TB) 1

Fits full size trucks - Ford, Chevy, Dodge, Titan (05+), Ford + Chevy 5.5' beds

L	69.75"	L-1	60.75"	L-2	
W	19.875"	W-1	17.125"	W-2	1.44"
H	12.2"	H-1	5"	H-2	7.2"
Vol	8.4 cu.ft.				

Deep Style

#DZ170LOCKD(TB) 4

Fits full size trucks - Ford, Chevy, Dodge, Titan (05+), Ford + Chevy 5.5' beds

L	69.75"	L-1	60.75"	L-2	
W	20"	W-1	17.125"	W-2	1.44"
H	18.25"	H-1	5"	H-2	13.25"
Vol	12 cu.ft.				

Wide Style

#DZ6170LOCKW(TB) 5

Fits full size trucks - Ford, Chevy, Dodge, Titan (05+), Ford + Chevy 5.5' beds

L	69.75"	L-1	60.75"	L-2	
W	25.8"	W-1	23"	W-2	1.44"
H	12.2"	H-1	2"	H-2	7.2"
Vol	10.5 cu.ft.				





REFINED DESIGNS FOR 2016

Chromed Plastic Badge

Sharper looks on the improved boxes.

Self Adjusting Latch Strikers

Close securely no matter how hard you push the lid down.

Full Pan Lid Support

Double 'V' stiffener and 29% material thickness increase for superior rigidity.

Dampened Gas Shocks

Refined placement allows for 85° opening.

Hidden Hinge

Full length piano hinge for extra strength.

Closed Cell Foam Gaskets

Helps keep the elements out of the box.

Paddle Handles with Guide Plate

Lockable, stainless steel handles.

Removable Plastic Tray

Keeps small items organized. *Select styles only.*

3 Piece Body

Front, back, and bottom - all one piece for increased body strength.

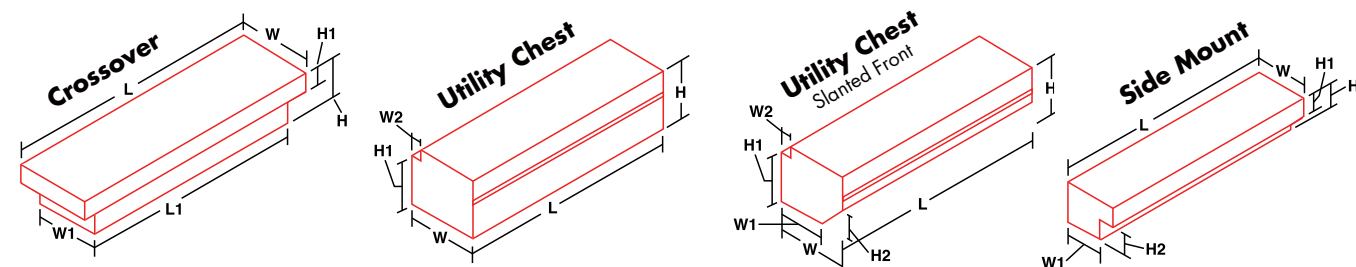

CROSSOVER TOOL BOXES

#DZ8160(B)

Fits mid/minis - not imports with 6' bed

L	60"	L-1	51"	L-2	
W	20"	W-1	17.125"	W-2	1.44"
H	12.2"	H-1	5"	H-2	7.2"
Vol	7.1 cu.ft.				

#DZ8170(B)(TB)

Fits full size trucks - Ford, Chevy, Dodge, Titan (05+), Ford + Chevy 5.5' beds

L	69.75"	L-1	60.75"	L-2	
W	20"	W-1	17.125"	W-2	1.44"
H	12.2"	H-1	5"	H-2	7.2"
Vol	8.4 cu.ft.				

DEEP STYLE

#DZ8170D(B)

Fits full size trucks - Ford, Chevy, Dodge, Titan (05+), Ford + Chevy 5.5' beds

L	69.75"	L-1	60.75"	L-2	
W	20"	W-1	17.125"	W-2	1.44"
H	18.25"	H-1	5"	H-2	13.25"
Vol	12 cu.ft.				



#DZ8170D vs DZ8170

*Part numbers with a gloss black powder coat finish denoted with a (B).
**Part numbers with a textured black powder coat finish denoted with a (TB).





2

LOW-PROFILE CROSSOVER BOXES



1

#DZ8170L(B)(TB) 1

Fits full size trucks

L	69.75"	L-1	60.75"	L-2	
W	20"	W-1	17.125"	W-2	1.44"
H	12.2"	H-1	2"	H-2	7.2"
Vol	8 cu.ft.				

Deep Style

#DZ8170DL(B) 2

Fits full size trucks - not Dodge Ram 6' bed

L	69.75"	L-1	60.75"	L-2	
W	20"	W-1	17.125"	W-2	1.44"
H	18.25"	H-1	2"	H-2	13.25"
Vol	11.7 cu.ft.				

Wide Style

#DZ8170WL(B) 3

Fits full size trucks

L	69.75"	L-1	60.75"	L-2	
W	25.8"	W-1	23"	W-2	1.44"
H	12.2"	H-1	2"	H-2	7.2"
Vol	10.5 cu.ft.				



3

*Part numbers with a gloss black powder coat finish denoted with a (B).
**Part numbers with a textured black powder coat finish denoted with a (TB).



4

DOUBLE-LID CROSSOVER BOXES



4

2 lids hinged in the middle provide easy access from either side.

#DZ8360(B)

Fits mid/minis - not imports with 6' bed

L	60"	L-1	51"	L-2	
W	20"	W-1	17.125"	W-2	
H	12.2"	H-1	5"	H-2	7.2"
Vol	7.1 cu.ft.				

#DZ8370(B)(TB) 4

Fits full size trucks

L	69.75"	L-1	60.75"	L-2	
W	20"	W-1	17.125"	W-2	
H	12.2"	H-1	5"	H-2	7.2"
Vol	8.4 cu.ft.				

SIDE-MOUNT TOOL BOXES



5

#DZ8748 5

Fits full size trucks

6' bed with crossover

Fits mid/mini size trucks

7' bed w/ crossover or 6' bed w/o crossover

L	48"	L-1		L-2	
W	12.75"	W-1	8.5"	W-2	4.25"
H	10"	H-1	5"	H-2	5"
Vol	3 cu.ft.				

#DZ8760

Fits full size trucks

8' bed with crossover or 6' bed w/o crossover

Fits mid/mini size trucks

7' bed with crossover or 6' bed w/o crossover

L	60"	L-1		L-2	
W	12.75"	W-1	8.5"	W-2	4.25"
H	10"	H-1	5"	H-2	5"
Vol	3.7 cu.ft.				

#DZ8768

Fits full size trucks

6' bed w/o crossover or

8' bed with crossover

Fits mid/mini size trucks without crossover

L	68"	L-1		L-2	
W	12.75"	W-1	8.5"	W-2	4.25"
H	10"	H-1	5"	H-2	5"
Vol	4.2 cu.ft.				

*Part numbers with a gloss black powder coat finish denoted with a (B).
**Part numbers with a textured black powder coat finish denoted with a (TB).



NEW & IMPROVED
FRESH
DESIGN

RED LABEL TOOL BOXES



NEW

RED LABEL TOOL BOXES

UTILITY CHEST TOOL BOXES



- Portable storage that is perfect for your truck, garage, and home.
- Sizes available for all pickup styles.

#DZ8537(B) 1

Fits all trucks

L	37.125"	L-1		L-2	
W	19"	W-1		W-2	2.4"
H	16"	H-1	13.1"	H-2	
Vol	6.4 cu.ft.				

#DZ8546(B)(TB) 2

Fits all trucks - 2 latch style

L	46.5"	L-1		L-2	
W	19"	W-1		W-2	2.4"
H	16"	H-1	13.1"	H-2	
Vol	8 cu.ft.				

#DZ8556(B)

Fits full size trucks - no handles/slanted front

L	56"	L-1		L-2	
W	19"	W-1		W-2	2.4"
H	16"	H-1	13.1"	H-2	6.5"
Vol	8.9 cu.ft.				

#DZ8560(B) 3

Fits full size trucks - no handles/slanted front

L	60"	L-1		L-2	
W	19"	W-1		W-2	2.4"
H	16"	H-1	13.1"	H-2	6.5"
Vol	9.5 cu.ft.				

#DZ8560W(B)

Fits full size trucks with 8' beds

L	60"	L-1		L-2	
W	24"	W-1		W-2	2.4"
H	18.1"	H-1	15.4"	H-2	
Vol	14.9 cu.ft.				

PULL HANDLE TOOL BOXES



#DZ10170(TB) 4

Fits full size trucks - Ford, Chevy, Dodge, Titan (05+), Ford + Chevy 5.5' beds

L	69.75"	L-1	60.75"	L-2	
W	20"	W-1	17.125"	W-2	1.44"
H	12.2"	H-1	5"	H-2	7.2"
Vol	8.4 cu.ft.				



#DZ10170L(TB) 5

Low-Profile - Fits full size trucks

L	69.75"	L-1	60.75"	L-2	
W	20"	W-1	17.125"	W-2	1.44"
H	12.2"	H-1	2"	H-2	7.2"
Vol	8 cu.ft.				



#DZ10370(TB) 6

Double-Lid - Fits full size trucks

L	69.75"	L-1	60.75"	L-2	
W	20"	W-1	17.125"	W-2	
H	12.2"	H-1	5"	H-2	7.2"
Vol	8.4 cu.ft.				



#DZ10546(TB) 7

Utility Chest - Fits all trucks - 2 pull-handles

L	46.5"	L-1		L-2	
W	19"	W-1		W-2	2.4"
H	16"	H-1	13.1"	H-2	
Vol	8 cu.ft.				

*Part numbers with a gloss black powder coat finish denoted with a (B).
**Part numbers with a textured black powder coat finish denoted with a (TB).

*Part numbers with a textured black powder coat finish denoted with a (TB).

Storage products built with the contractor in mind but versatile enough for the rest of us.

- Sturdy 20-gauge steel
- NRT™ corrosion resistant coating



CROSSOVER TOOL BOXES



#DZ8160S(B)

Fits mid/minis - not imports with 6' bed

L	60"	L-1	51"	L-2	
W	20"	W-1	17.125"	W-2	1.44"
H	12.2"	H-1	5"	H-2	7.2"
Vol	7.1 cu.ft.				

#DZ8170S(B) 1

Fits full size trucks - Ford, Chevy, Dodge, Titan (05+), Ford + Chevy 5.5' beds

L	69.75"	L-1	60.75"	L-2	
W	20"	W-1	17.125"	W-2	1.44"
H	12.2"	H-1	5"	H-2	7.2"
Vol	8.4 cu.ft.				

#DZ8170DS(B) 2

Fits full size trucks - Ford, Chevy, Dodge, Titan (05+), Ford + Chevy 5.5' beds

L	69.75"	L-1	60.75"	L-2	
W	20"	W-1	17.125"	W-2	1.44"
H	18.25"	H-1	5"	H-2	13.25"
Vol	12 cu.ft.				

DOUBLE-LID CROSSOVERS



#DZ8370S(B) 3

Fits full size trucks

L	69.75"	L-1	60.75"	L-2	
W	20"	W-1	17.125"	W-2	1.44"
H	12.2"	H-1	5"	H-2	7.2"
Vol	8.4 cu.ft.				

4

UTILITY CHEST TOOL BOXES

- Portable storage that is perfect for your truck, garage, and home.

#DZ8546S(B) 4

Fits full size trucks

L	46.5"	L-1		L-2	
W	19"	W-1		W-2	2.4"
H	16"	H-1	13.1"	H-2	
Vol	8 cu.ft.				



SIDE-MOUNT TOOL BOXES

#DZ8748S(B) 5

Fits full size trucks - 6' bed with crossover
Fits mid/mini size trucks - 7' bed with crossover or 6' bed without crossover

L	48"	L-1		L-2	
W	12.75"	W-1	8.5"	W-2	4.25"
H	10"	H-1	5"	H-2	5"
Vol	3 cu.ft.				



#DZ8760S(B)

Fits full size trucks - 8' bed with crossover or 6' bed without crossover
Fits mid/mini size trucks - 7' bed with crossover or 6' bed without crossover

L	60"	L-1		L-2	
W	12.75"	W-1	8.5"	W-2	4.25"
H	10"	H-1	5"	H-2	5"
Vol	3.7 cu.ft.				



*Part numbers with a textured black powder coat finish denoted with a (B).

*Part numbers with a textured black powder coat finish denoted with a (B).

1



SPECIALTY TOOL BOXES

POLY PLASTIC STORAGE



2

#DZ6535P 1 SMALL POLY CHEST

- Rigid frame resists warping.
- Molded locking tabs. (padlock not included)
- Double wall lid for extra support.

L	35"	W	14"	H	13"
Vol	3.6 cu.ft.				



3

#DZ6537P 2 LARGE POLY CHEST

- Generously sized to fit more gear.

L	39"	W	27"	H	17"
Vol	10.4 cu.ft.				

#DZ91717P 3 POLY TRIANGLE TRAILER BOX

- Steel hasp provides security
(padlock not included)

L	36" (back)	L	18" (front)
W	19.5"	H	17.75"
Vol	6 cu.ft.		

#DZ95P 4 POLY WHEEL WELL BOX

- Reversible lid allows mounting on either side.

L	37"	L-1	14"	L-2	
W	7.75"	W-1		W-2	
H	19.5"	H-1		H-2	8.5"
Vol	2.2 cu.ft.				

4



5

SPECIALTY TOOL BOXES

DOG BOXES



6

- Made from Brite-Tread aluminum.
- Improved door design eliminates sharp edges with vents for air circulation.

#DZ91781 5 CHEST STYLE

Fits most trucks

- 2 independent doors for 2 dogs

L	38"	W	29"	H	20"
Vol	12.75 cu.ft.				

#DZ91782 6 SINGLE STYLE

- Bolt together - can be linked.

L	18.75"	W	28"	H	20"
Vol	6 cu.ft.				



7

#DZ91716 SMALL TRIANGLE TRAILER BOX

L	34" (back)	L	16" (front)
W	14.25"	H	18"
Vol	3.71 cu.ft.		

#DZ91717 7 LARGE TRIANGLE TRAILER BOX

L	34" (back)	L	20.75" (front)
W	19"	H	22.75"
Vol	7.24 cu.ft.		



1
WHEEL WELL TOOL BOXES

SPECIALTY TOOL BOXES



5
WHEEL WELL TOOL BOXES

SPECIALTY TOOL BOXES

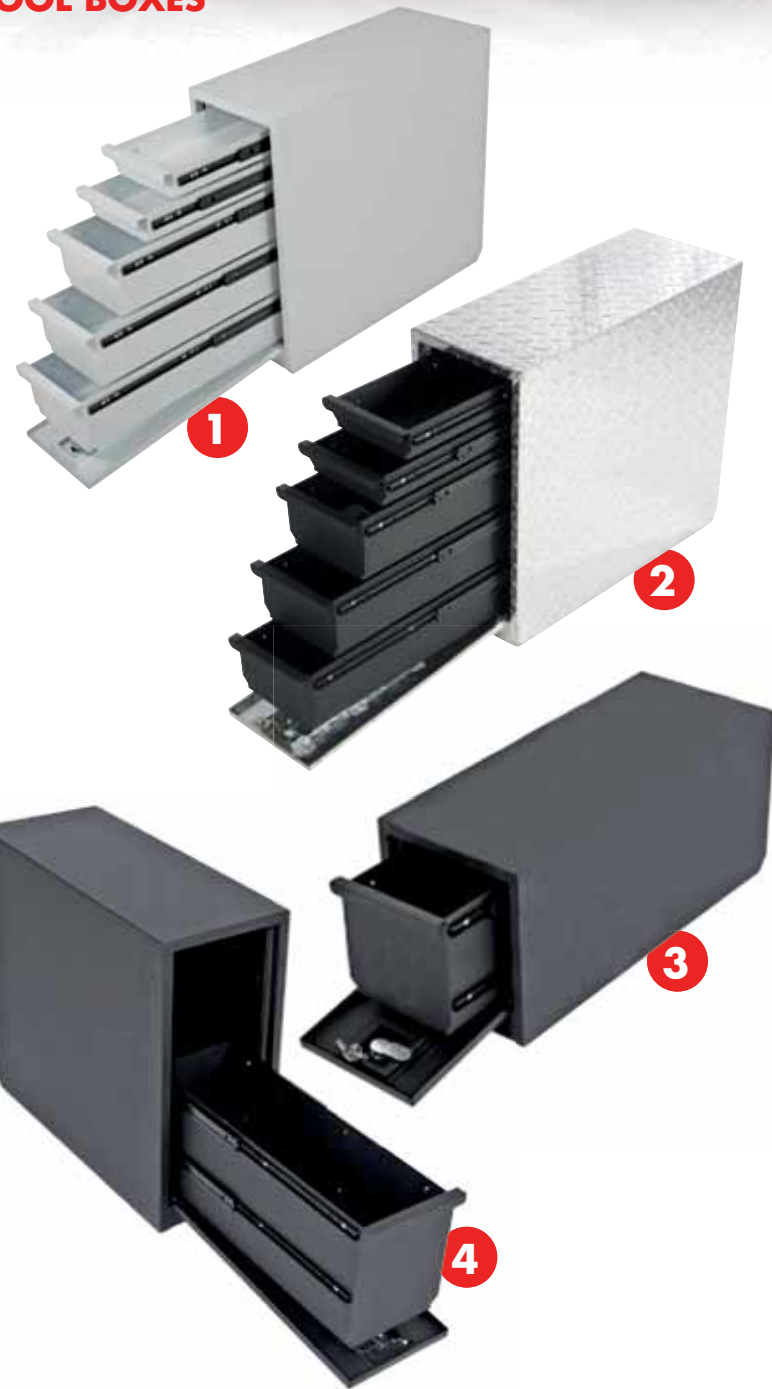

Wheel Well Tool Box with Drawers - Steel

- 5 drawers with single door opening.
- Steel construction with black or white powder coat finish.

#DZ95D(W) 1

L	20.5"	W	8.5"	H	18.88"
Vol	1.9 cu.ft.				

Wheel Well Tool Box with Drawers - Aluminum

- Brite-Tread aluminum body.
- Quick release mounting.

#DZ95DA 2

L	20.5"	W	8.5"	H	18.88"
Vol	1.9 cu.ft.				

Single-Drawer Wheel Well Box - Steel

- Single lockable drawer.
- Quick release mounting.

#DZ95L 3

- Single drawer - low profile.
- Great for SUV's and trunks!
- Can be stacked.

L	20.5"	W	8.5"	H	9.4"
Vol	0.95 cu.ft.				

#DZ95D1 4

- Single drawer - tall design.
- Perfect for locking up taller items.

L	20.5"	W	8.5"	H	18.88"
Vol	1.9 cu.ft.				

*Part numbers with a textured white powder coat finish denoted with a (W).

Poly Plastic Wheel Well Tool Box

#DZ95P 5

- Reversible lid allows mounting on either side.

L	37"	L-1	14"	L-2	
W	7.75"	W-1		W-2	
H	19.5"	H-1		H-2	8.5"
Vol	2.2 cu.ft.				

Aluminum Wheel Well Tool Box

- Lockable lift-up lid on a sturdy piano hinge.
- Fit trucks with 6' and 8' beds.

#DZ94(B) 6 PASSENGER SIDE

#DZ95(B) 7 DRIVER SIDE

L	37"	L-1	14"	L-2	
W	7.75"	W-1		W-2	
H	19.5"	H-1		H-2	8.5"
Vol	2.2 cu.ft.				



6



7

*Part numbers with a gloss black powder coat finish denoted with a (B).



1

NARROW CROSSOVERS



Full width with a narrow profile. Great for today's short bed trucks.

#DZ6160N(B) 1

Fits mid size trucks - not Colorado/ Canyon crew cab

L	60"	L-1	51"	L-2	
W	12"	W-1		W-2	
H	14.25"	H-1	5"	H-2	
Vol	5 cu.ft.				

#DZ6170N(B) 2

Fits full size trucks

L	69.75"	L-1	60.75"	L-2	
W	12"	W-1		W-2	
H	14.25"	H-1	5"	H-2	
Vol	5.75 cu.ft.				

*Part numbers with a gloss black powder coat finish denoted with a (B).

ATV BOXES



3

- Worry free storage for your ATV.
- Black Tread powder coating.
- Mounting hardware included.

#M206 SMALL

L	35"	W	12"	H	9"
Vol	2 cu.ft.				

#M207 LARGE 3

L	35"	W	12"	H	12.5"
Vol	3 cu.ft.				



SPECIALTY TOOL BOXES

TOPSIDER TOOL BOXES



4

- Storage on the top of the truck's bed.
- Drop-down doors for quick access to your tools.
- C-channel and bulb seal helps keep water out.

#DZ70 4

Fits mid/mini size trucks

L	48"	W	12"	H	16"
Vol	5.33 cu.ft.				



5

#DZ79 5

Fits trucks with 6' or 8' bed

L	72"	W	15.5"	H	20"
Vol	12.75 cu.ft.				



6

#DZ71

Fits trucks with 8' bed

L	90"	W	15.5"	H	20"
Vol	16 cu.ft.				

#DZ67 6

Fits trucks with 8' bed

L	96"	W	15.5"	H	20"
Vol	17.22 cu.ft.				

SPECIALTY TOOL BOXES



ALUMINUM UNDERBED BOXES

- Brite-Tread aluminum storage with mounting versatility.
- Water-channel and bulb seal help keep water out.
- T-handle creates a tight barrier when closed.
- Mounting brackets sold separately.

#DZ61 ¹

L	24"	W	18"	H	18"	Vol	4.5 cu.ft.
---	-----	---	-----	---	-----	-----	------------

#DZ74

L	30"	W	20"	H	18"	Vol	5.94 cu.ft.
---	-----	---	-----	---	-----	-----	-------------

#DZ77

L	36"	W	20"	H	18"	Vol	7 cu.ft.
---	-----	---	-----	---	-----	-----	----------

#DZ75 ²

L	48"	W	20"	H	18"	Vol	9.5 cu.ft.
---	-----	---	-----	---	-----	-----	------------

#DZ76 (2 latches)

L	60"	W	20"	H	18"	Vol	11.9 cu.ft.
---	-----	---	-----	---	-----	-----	-------------



SPECIALTY TOOL BOXES

STEEL UNDERBED BOXES

- Made from durable 12-gauge steel.
- 3-point latching system with stainless T-handle.
- Gloss black powder coated finish.
- Mounting brackets sold separately.

#DB-2600 ⁴

L	24"	W	18"	H	18"	Vol	4.5 cu.ft.
---	-----	---	-----	---	-----	-----	------------

#DB-2601 ⁵

L	36"	W	18"	H	18"	Vol	6.75 cu.ft.
---	-----	---	-----	---	-----	-----	-------------

#DB-2602 ³

L	48"	W	18"	H	18"	Vol	9 cu.ft.
---	-----	---	-----	---	-----	-----	----------



Underbed Box Mounting Brackets

- Securely mount underbed and side step boxes.
- Heavy duty welded steel construction.
- Sold in pairs.

#DB-2502 18" x 18"

#DB-2500 24" x 24"



TRANSFER TANKS

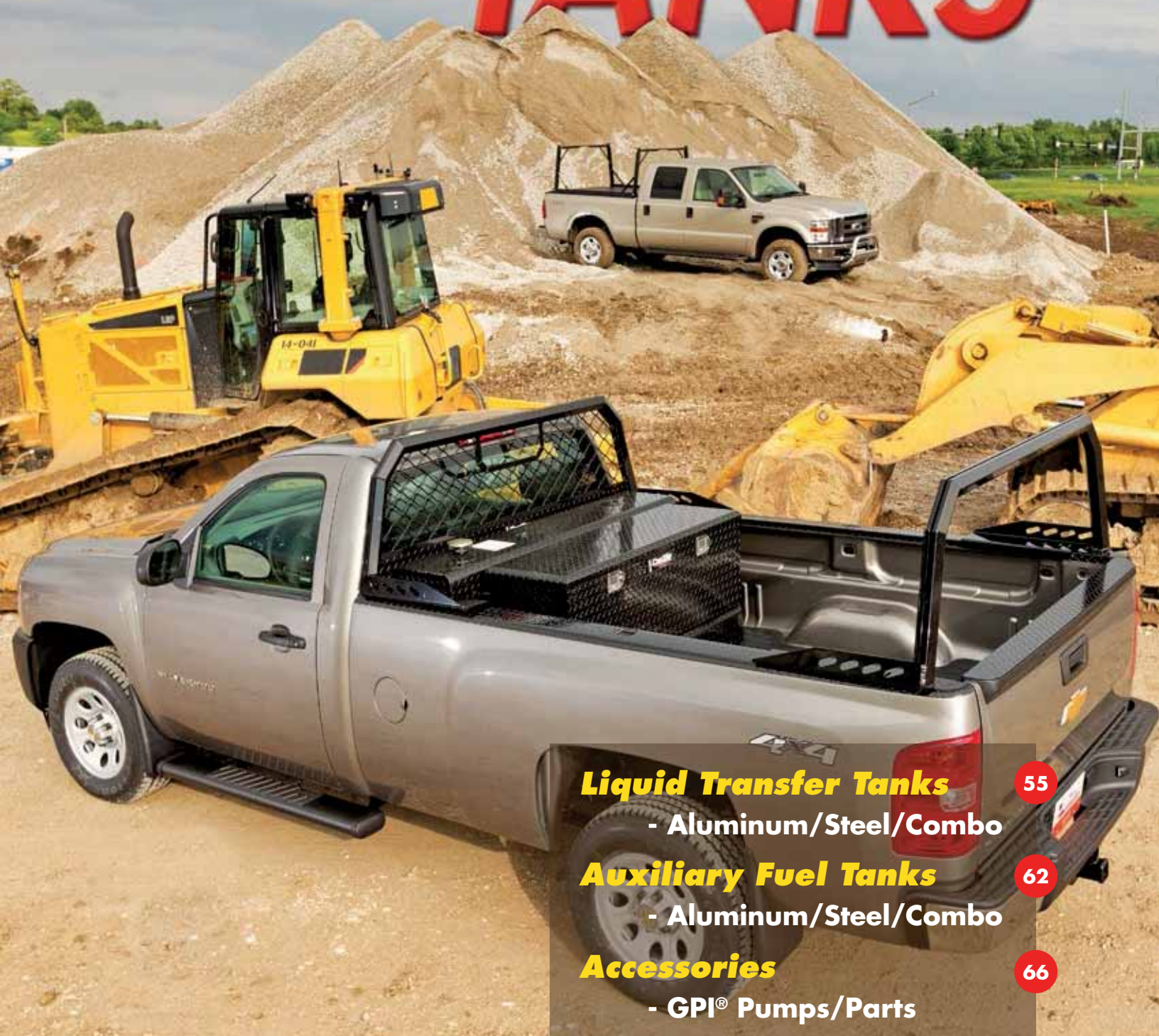

Liquid Transfer Tanks

- Aluminum/Steel/Combo

55

Auxiliary Fuel Tanks

- Aluminum/Steel/Combo

62

Accessories

- GPI® Pumps/Parts

66

TRANSFER TANKS

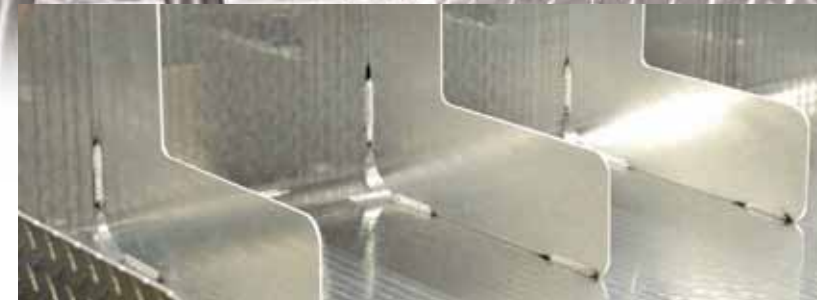

INTERNAL BAFFLES

Creates compartments inside the tank to control the movement of liquid, which eliminates pressure on the outer welds



LOCKABLE BREATHING CAP

The cap allows the tank to breathe, which reduces pressure when liquid is moving in the tank and eliminates the vacuum when pumping out of the tank.



DRAIN PLUGS

Allows the tank to be drained by gravity.



STEEL OR ALUMINUM

Available in steel with either a white or black finish and also available in polished aluminum or black powder coat aluminum.

RADIUS BENDS

Allows liquid to move freely inside the tanks at the corners, which eliminates the pressure on 90° weld points.

COATING

Dee Zee's patented NRT™ additive by DuPont® is superior in rust and corrosion prevention. Available on steel tanks only.

SIZE AND STYLE VARIETY

Multiple sizes and styles work for end user's specific needs.

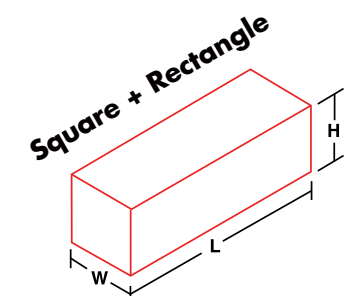
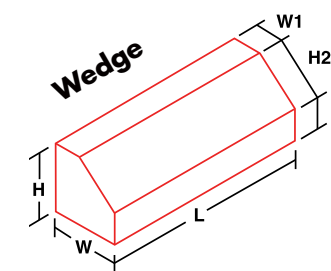
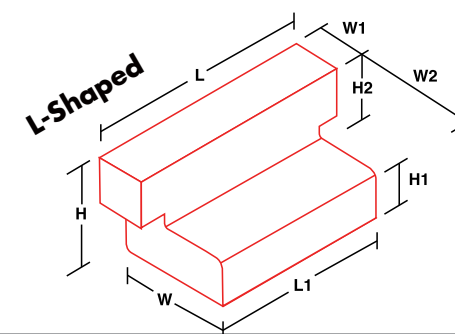



TRANSFER TANKS



ALUMINUM TRANSFER TANKS

- Made from non-rusting Brite-Tread aluminum.
- Tanks include baffles, cap, drainage plug and coupler for venting.
- Used for transporting non-flammable liquids
- L-shaped tanks work great with Dee Zee crossover tool boxes.



#DZ91750 ¹ Square

L	24"	W	24"	H	24"
Vol	55 gallons				

#DZ91747(B) ³ L-Shaped - narrow base

L	60"	L-1	47.63"	L-2	
W	30"	W-1	12"	W-2	18"
H	24"	H-1	6.5"	H-2	17.5"
Vol	84 gallons				

#DZ91751(B) ² L-Shaped - 60" - will not fit Ford SuperDuty

L	60"	L-1		L-2	
W	30"	W-1	9"	W-2	21"
H	24"	H-1	9"	H-2	15"
Vol	100 gallons				

#DZ91767 ⁴ L-Shaped - 48"

L	48"	L-1		L-2	
W	30"	W-1	9"	W-2	21"
H	24"	H-1	9"	H-2	15"
Vol	80 gallons				



Vented caps add 3.5" to overall height. Mounting tabs and drain plugs also alter dimensions slightly. For private use only. Not for commercial applications of interstate commerce. Not designed for use as auxiliary fuel systems as they do not meet title 49 of the United States Federal Register governing transportation. Not for use with gasoline.

Center weighted pumps are highly recommended. Off center pumps must be supported with brackets to ensure tank warranty.

*Part numbers with a gloss black powder coat finish denoted with a (B).



#DZ92751(B) ⁵ L-Shaped - 56"

L	56"	L-1		L-2	
W	30"	W-1	11.5"	W-2	18.5"
H	24"	H-1	9.5"	H-2	14.5"
Vol	100 gallons				

#DZ91752(B) ⁵ Long rectangle

L	60"	W	9"	H	19"
Vol	40 gallons				



#DZ91753 ⁶ Short Rectangle

L	48"	W	24"	L-2	24"
Vol	110 gallons				



#DZ91792(B) ⁷ Wedge Rectangle

L	60"	L-1		L-2	
W	20"	W-1	8.3"	W-2	
H	20"	H-1	8.3"	H-2	
Vol	80 gallons				

Vented caps add 3.5" to overall height. Mounting tabs and drain plugs also alter dimensions slightly. For private use only. Not for commercial applications of interstate commerce. Not designed for use as auxiliary fuel systems as they do not meet title 49 of the United States Federal Register governing transportation. Not for use with gasoline.

Center weighted pumps are highly recommended. Off center pumps must be supported with brackets to ensure tank warranty.

*Part numbers with a gloss black powder coat finish denoted with a (B).

TRANSFER TANKS

The convenience of a Dee Zee Utility Chest bolted onto a Liquid Transfer Tank.

ALUMINUM COMBO CHESTS & TANKS



#DZ91740(B) 1

Fits most pickups - great for Ford SuperDuty

L	54"	L-1		L-2	
W	18"	W-1	9"	W-2	11.5"
H	20"	H-1	6.5"	H-2	12.5"
Vol	50 gallons				

#DZ91741(B) 2

Fits full size trucks with 6' bed

L	48"	L-1		L-2	
W	30"	W-1	9"	W-2	
H	24"	H-1	9"	H-2	15"
Vol	80 gallons				

#DZ91742(B)

Fits full size trucks with 8' bed

L	56"	L-1		L-2	
W	30"	W-1	9"	W-2	
H	24"	H-1	9"	H-2	15"
Vol	92 gallons				

#DZ91759(B) 3

Fits full size trucks

L	60"	L-1	47.63"	L-2	
W	30"	W-1	12"	W-2	
H	24"	H-1	6.5"	H-2	17.5"
Vol	84 gallons				

#DZ92740(B)

Fits most pickups - low profile

Fits under tonneau

L	54"	L-1		L-2	
W	18"	W-1	6.5"	W-2	11.5"
H	16"	H-1	9"	H-2	7"
Vol	43 gallons				

#DZ92741(B)

L	56"	L-1		L-2	
W	30"	W-1	11"	W-2	19"
H	24"	H-1	9.5"	H-2	14.5"
Vol	100 gallons				

Vented caps add 3.5" to overall height. Mounting tabs and drain plugs also alter dimensions slightly. For private use only. Not for commercial applications of interstate commerce. Not designed for use as auxiliary fuel systems as they do not meet title 49 of the United States Federal Register governing transportation. Not for use with gasoline.

Center weighted pumps are highly recommended. Off center pumps must be supported with brackets to ensure tank warranty.

*Part numbers with a gloss black powder coat finish denoted with a (B).

TRANSFER TANKS

STEEL TRANSFER TANKS



Thick, 14-gauge steel, protected by NRT™ anti-corrosion powder coating.

#DZ91750S(B) 4

Square

L	24"	W	24"	H	24"
Vol	55 gallons				

#DZ91747S(B) 5

L-Shaped - narrow base

L	60"	L-1	47.63"	L-2	
W	30"	W-1	12"	W-2	18"
H	24"	H-1	6.5"	H-2	17.5"
Vol	84 gallons				

#DZ91751S(B) 6

L-Shaped - 60" - will not fit Ford SuperDuty

L	60"	L-1		L-2	
W	30"	W-1	9"	W-2	21"
H	24"	H-1	9"	H-2	15"
Vol	100 gallons				

#DZ91754S(B)

L-Shaped - 30"

L	30"	L-1		L-2	
W	31"	W-1	10"	W-2	21"
H	24"	H-1	8"	H-2	16"
Vol	55 gallons				

#DZ91768S(B)

L-Shaped - 56" - great for Ford SuperDuty

L	56"	L-1		L-2	
W	30"	W-1	9"	W-2	21"
H	24"	H-1	9"	H-2	15"
Vol	92 gallons				

Vented caps add 3.5" to overall height. Mounting tabs and drain plugs also alter dimensions slightly. For private use only. Not for commercial applications of interstate commerce. Not designed for use as auxiliary fuel systems as they do not meet title 49 of the United States Federal Register governing transportation. Not for use with gasoline.

Center weighted pumps are highly recommended. Off center pumps must be supported with brackets to ensure tank warranty.

*Part numbers with a textured black powder coat finish denoted with a (B).



TRANSFER TANKS

STEEL TRANSFER TANKS

#DZ92751S(B)
L-Shaped - 56"

L	56"	L-1		L-2	
W	30"	W-1	11"	W-2	19"
H	24"	H-1	9.5"	H-2	14.5"
Vol	100 gallons				



#DZ91752S(B) 1
Long rectangle

L	60"	W	9"	H	19"
Vol	40 gallons				



#DZ91753S(B) 2
Short rectangle

L	48"	W	24"	H	24"
Vol	110 gallons				

The convenience of a Dee Zee Utility Chest bolted onto a Liquid Transfer Tank.

STEEL COMBO CHESTS & TANKS



Tank:
14 gauge steel

Chest:
20 gauge steel

#DZ91740S(B) 3
Fits full size trucks

L	54"	L-1		L-2	
W	18"	W-1	9"	W-2	11.5"
H	20"	H-1	6.5"	H-2	12.5"
Vol	50 gallons				

#DZ92741S(B)

L	56"	L-1		L-2	
W	30"	W-1	11.5"	W-2	18.5"
H	24"	H-1	9.5"	H-2	14.5"
Vol	100 gallons				

#DZ91759S(B) 4
Fits full size trucks

L	60"	L-1	47.63"	L-2	
W	30"	W-1	12"	W-2	
H	24"	H-1	6.5"	H-2	17.5"
Vol	84 gallons				



Vented caps add 3.5" to overall height. Mounting tabs and drain plugs also alter dimensions slightly. For private use only. Not for commercial applications of interstate commerce. Not designed for use as auxiliary fuel systems as they do not meet title 49 of the United States Federal Register governing transportation. Not for use with gasoline.

Center weighted pumps are highly recommended. Off center pumps must be supported with brackets to ensure tank warranty.

*Part numbers with a textured black powder coat finish denoted with a (B).

Vented caps add 3.5" to overall height. Mounting tabs and drain plugs also alter dimensions slightly. For private use only. Not for commercial applications of interstate commerce. Not designed for use as auxiliary fuel systems as they do not meet title 49 of the United States Federal Register governing transportation. Not for use with gasoline.

Center weighted pumps are highly recommended. Off center pumps must be supported with brackets to ensure tank warranty.

*Part numbers with a textured black powder coat finish denoted with a (B).



AUXILIARY TANKS

The same tanks you rely on, now with the ability to feed directly into the fuel line of your diesel vehicle.

- Made from non-rusting aluminum, either polished or with a black powder coat.
- Hydrostatically pressure tested to 29 psi. (federal regulation 178.814)
- Full sized and fully welded baffles add extra strength:

Meets...

- Federal Motor Carrier Safety Administration requirements for auxiliary tanks.
- Federal DOT requirements for UN31B tanks.*

*Always check local rules and regulations before altering your OEM fuel system.

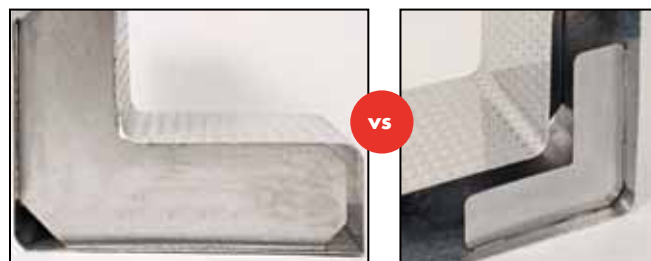

AUXILIARY TANK BAFFLES

STANDARD TANK BAFFLES



CONNECTOR KITS

- Feed diesel directly into your fuel line.
- All hoses and hardware included.
- Some cutting required on the OEM fuel hose.
- Not designed for continuous flow. Flow valve must be closed during vehicle operation.

#DZ97960

2011+ Chevrolet/GMC
99-12 Dodge/Ram
1999+ Ford

#DZ97961

99-10 Chevrolet/GMC

#DZ97962

2013+ Dodge/Ram



1

#DZ91750X(B) 1

Square

L	24"	W	24"	H	24"
Vol	55 gallons				



3



2

#DZ91751X(B) 2

L-Shaped - 60"

- will not fit Ford SuperDuty

L	60"	L-1		L-2	
W	30"	W-1	9"	W-2	21"
H	24"	H-1	9"	H-2	15"
Vol	100 gallons				

#DZ91752X(B) 3

Long rectangle

L	60"	W	9"	H	19"
Vol	40 gallons				



3

#DZ91753X(B) 4

Short Rectangle

L	48"	W	24"	L-2	24"
Vol	110 gallons				

#DZ91767X(B)

L-Shaped - 48"

L	48"	L-1		L-2	
W	30"	W-1	9"	W-2	21"
H	24"	H-1	9"	H-2	15"
Vol	80 gallons				

#DZ91768X(B)

L-Shaped - 56"

L	56"	L-1		L-2	
W	30"	W-1	9"	W-2	21"
H	24"	H-1	9"	H-2	15"
Vol	92 gallons				



4

Vented caps add 3.5" to overall height. Mounting tabs and drain plugs also alter dimensions slightly. For private use only. Not for commercial applications of interstate commerce. Not designed for use as auxiliary fuel systems as they do not meet title 49 of the United States Federal Register governing transportation. Not for use with gasoline.

Center weighted pumps are highly recommended. Off center pumps must be supported with brackets to ensure tank warranty.

*Part numbers with a gloss black powder coat finish denoted with a (B).

#DZ92751X(B)

L-Shaped - 56"

L	56"	L-1		L-2	
W	30"	W-1	11"	W-2	19"
H	24"	H-1	9.5"	H-2	14.5"
Vol	100 gallons				

AUXILIARY TANKS

AUXILIARY TANKS

The convenience of a Dee Zee Utility Chest bolted onto a Liquid Transfer Tank.

ALUMINUM AUXILIARY COMBO CHESTS & TANKS

#DZ91740X(B) ①

Fits most pickups - great for Ford SuperDuty

L	54"	L-1		L-2	
W	18"	W-1	9"	W-2	11.5"
H	20"	H-1	6.5"	H-2	12.5"
Vol	50 gallons				



#DZ91741X(B) ②

Fits full size trucks with 6' bed

L	48"	L-1		L-2	
W	30"	W-1	9"	W-2	
H	24"	H-1	9"	H-2	15"
Vol	80 gallons				



#DZ91742X(B)

Fits full size trucks with 8' bed

L	56"	L-1		L-2	
W	30"	W-1	9"	W-2	
H	24"	H-1	9"	H-2	15"
Vol	92 gallons				

#DZ92741X(B)

L	56"	L-1		L-2	
W	30"	W-1	11"	W-2	19"
H	24"	H-1	9.5"	H-2	14.5"
Vol	100 gallons				



Constructed from thick, 14-gauge steel and protected by NRT™ corrosion-resistant powder coating.

#DZ91750XS(B) ③

Square

L	24"	W	24"	H	24"
Vol	55 gallons				



#DZ91751XS(B) ④

L-Shaped - 60"

- will not fit Ford SuperDuty

L	60"	L-1		L-2	
W	30"	W-1	9"	W-2	21"
H	24"	H-1	9"	H-2	15"
Vol	100 gallons				

#DZ91752XS(B) ⑥

Long rectangle

L	60"	W	9"	H	19"
Vol	40 gallons				



#DZ91753XS(B) ⑤

Short Rectangle

L	48"	W	24"	L-2	24"
Vol	110 gallons				

#DZ92751XS(B)

L-Shaped - 56"

L	56"	L-1		L-2	
W	30"	W-1	11"	W-2	19"
H	24"	H-1	9.5"	H-2	14.5"
Vol	100 gallons				



#DZ92741XS(B)

Combo Chest/Tank - 56"

L	56"	L-1		L-2	
W	30"	W-1	11"	W-2	19"
H	24"	H-1	9.5"	H-2	14.5"
Vol	100 gallons				

Vented caps add 3.5" to overall height. Mounting tabs and drain plugs also alter dimensions slightly. For private use only. Not for commercial applications of interstate commerce. Not designed for use as auxiliary fuel systems as they do not meet title 49 of the United States Federal Register governing transportation. Not for use with gasoline.

Center weighted pumps are highly recommended. Off center pumps must be supported with brackets to ensure tank warranty.

*Part numbers with a textured black powder coat finish denoted with a (B).

TRANSFER TANK ACCESSORIES



#123000-06 ¹
ROTARY HAND PUMP

- Built in strainer and anti-siphon valve.
- Includes pipe and 8' of 3/4" hose.
- UL listed - manual shut-off.



GREAT PLAINS INDUSTRIES, INC.



#137100-01 ²
12 VOLT ELECTRIC PUMP

- Up to 8 gal/minute.
- Includes 3-piece suction pipe & 10' of 5/8" hose.
- For tanks up to 120 gallons.
- UL listed - manual shut-off.

#110000-107 ³
12 VOLT ELECTRIC PUMP

- Up to 15 gallons per minute.
- Standard nozzle hanger
- Includes 2-piece PVC suction pipe and 10' hose.
- UL listed - manual shut-off.



#113255-1 ⁴
ELECTRONIC DIGITAL METER

- Flow range of 3 to 30 GPM.
- Mounts right to the nozzle.
- Powered by 2 AAA batteries.
- Factory calibrated for fuel.



#DZGASCAP

Vented cap/neck for liquid transfer tanks.

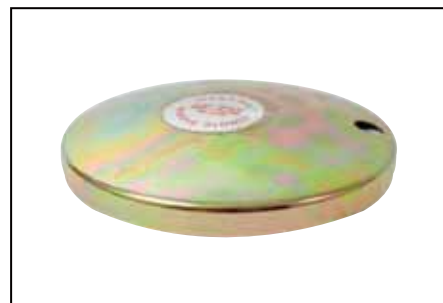

#DZGASCAP2

Replacement cap only.



#DZGASCAP3

Built-in lock, vented cap/neck for liquid transfer tanks.

MISC ACCESSORIES

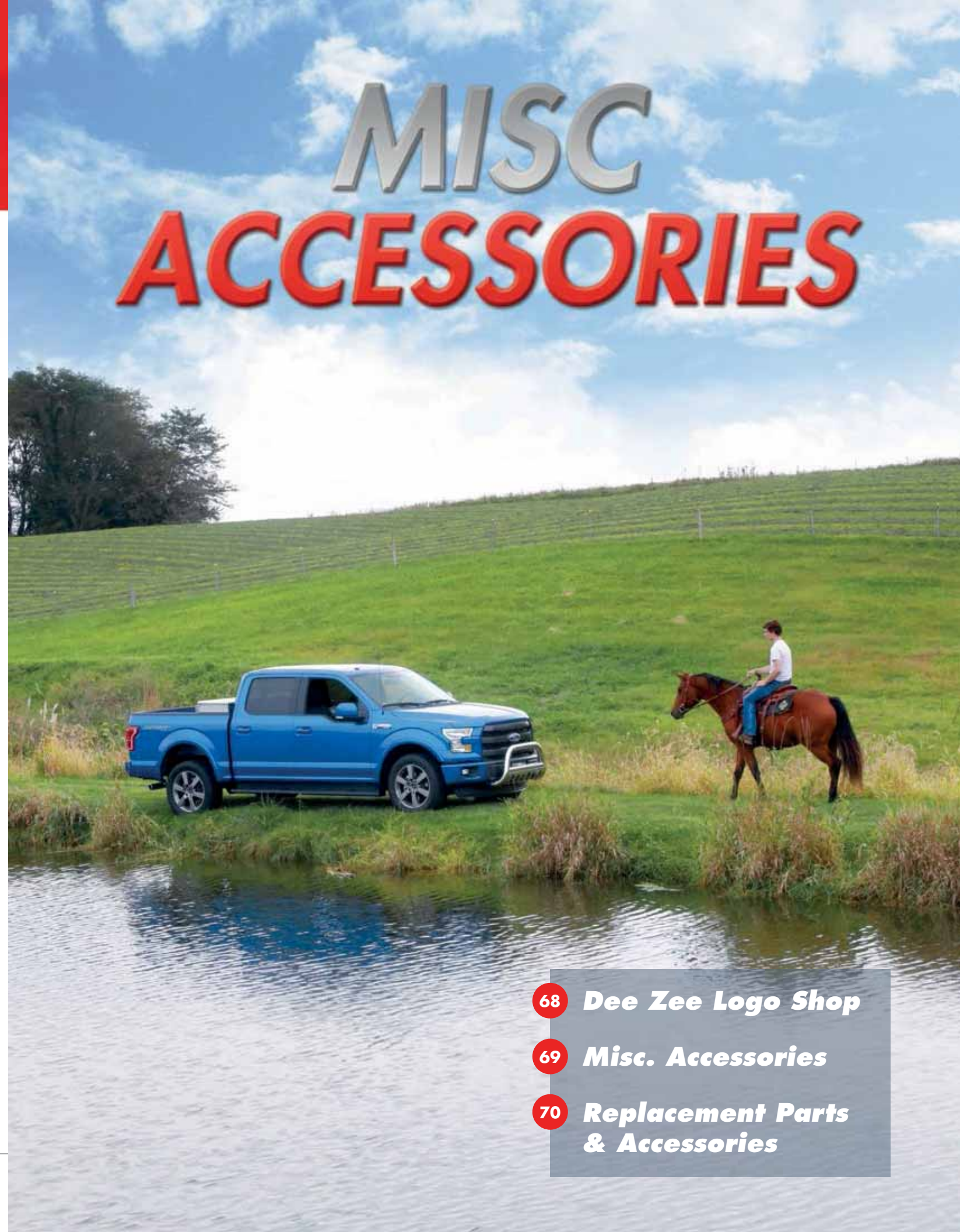

68 *Dee Zee Logo Shop*

69 *Misc. Accessories*

70 *Replacement Parts & Accessories*



Apparel and accessories available with a custom-stitched Dee Zee logo. Check out our wide variety of items by quality brands!

- Polos
- Sweatshirts
- Jackets
- Special Edition T-Shirts
- Hats
- Bags and **MORE!**



Grip Tape
#DZ46

- 2 11/16" X 12' black adhesive tape.
- Use it anywhere for a non-slip surface.
- Full color clam shell can hang on hooks or sit on a shelf.



Portable Auto Safe
#DZ97926

- Keep smaller valuables protected inside your vehicle.
- Keyed entry with steel security cable.
- L: 8" • W: 6" • H: 2.5"

**PROPOSITION 65 WARNING. This product contains a chemical known to the State of California to cause cancer, birth defects, and other reproductive harm.*



Dee Zee Wall Clock
#DZ97930

- Brite-Tread aluminum face.
- Quartz movement.
- One AA battery required. *(not included)*
- 12" Diameter

- Easily display helpful replacement parts for tool boxes from Dee Zee and others.
- Sold individually in clam shell packaging. some exceptions
- Can be hung on Dee Zee grid displays or any retail peg board or slat wall.

REPLACEMENT PARTS



#DZTBLATCH1
Locking - hook style latch



#DZTBLATCH2
Non-locking - hook style latch



#DZTBLATCH3
Locking - post style latch



#DZTBLOCK1
Replacement lock cylinder



#DZTBSTRIKER
Striker/lid catch for post style latches

2pk with rivets



#DZTBLABEL3 - NEW
Chromed plastic tool box label - fits all Dee Zee boxes



#DZDRYPACK - NEW
Help control the humidity inside your tool box with a pair of desiccant packets/holders.



#DZ97907
Protective bumper with integrated eyelets for securing cargo. 100 lb. limit per eyelet.



#DZTBLIGHT2
Battery powered light



#DZTBTRAY1
• Tool box tray
• Molded plastic construction



#DZTBTRAYHD
• Professional steel tool box tray
• Adjustable steel dividers
• White powder coated finish



#DZTBMAT1
• Add an anti-slip rubber mat to the bottom of your tool box.
• 60.25" x 16.5"



#DZTBSHOCK1
10.5" 80 lb. Shock - ball & socket mount



#DZTBSHOCK2
10" 70 lb. Shock - blade/eyelet mount



#DZTBSHOCK3
10.5" 60 lb. Shock - ball & socket mount

Premium Tool Box Mounting Kits



#DZTBMAT2 - NEW
• Non-slip mat with norust™ by Zerust® vapor shield.
• 72" x 20"



#DZ97904
• Premium Mounting Kit
• Replaces standard J-bolt
*Not recommended for Ford Aluminum Beds

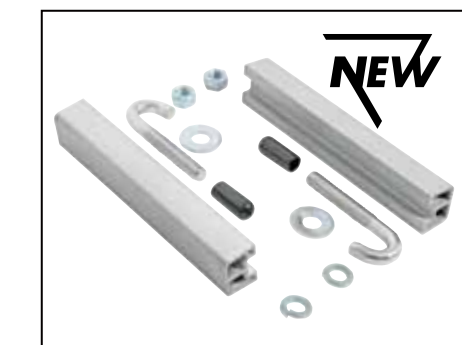

#DZ97910
• **NEW** Ford Aluminum Bed Premium Mounting Kit
• Custom-designed for secure fit