

Installation Instructions for 50-50 Seats

(This Installation will cover the full process of a 50-50 split back with solid bench and a 50-50 split back with split bench that come with or without armrests.)

Before You Begin...

Remove the headrests completely from the seats: There are a couple ways to remove headrests.

- A. Press the button on the base of the post and pull the headrest up until it disengages from the seat.
- B. If there are no buttons, locate small holes on the base. Insert a wire (or an unbent paperclip) until you hear a click, then pull the headrest up.

Note: The covers will be tight and the fabric will cling to your original upholstery.

-- DO NOT USE EXCESSIVE FORCE--

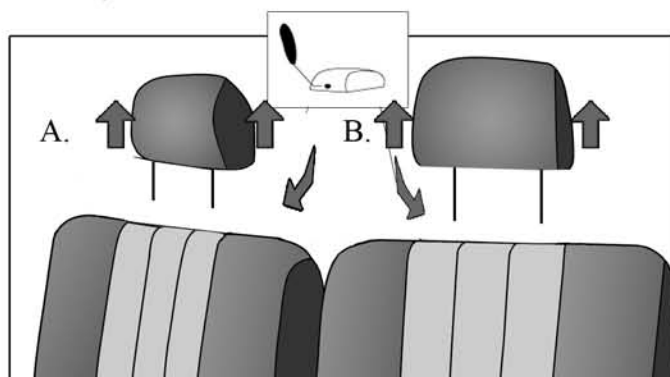

Seat Backs...

1. Find the cover for the Seat Back by matching the cut outs on the seat cover with any levers or knobs on the seat.
2. Make sure the flap with hook and loop fastener is facing the front of the seat, then slide the cover down over the Seat Back. Once it's pulled all the way down insert the hook and loop fastener in between the seat. (See Figure 2)

(Note: A. In some installations, the front flap hook and loop fastener attaches to the original fabric in between the seat.

B. If cover has plastic wedges, they will hook onto the seat once they have been tucked in.

3. Once the cover is secure with a tight snug fit proceed to attaching the hook and loop fastener to the back of the cover. (See Figure 3)

4. Then follow up by pushing the fabric cut outs under the headrest plastic units. (See Figure 4)

Figure 2

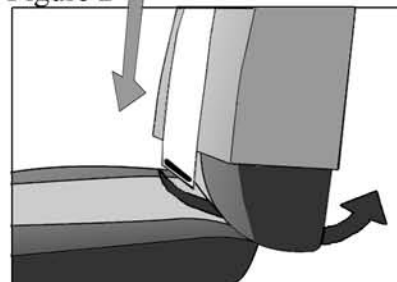

Figure 3

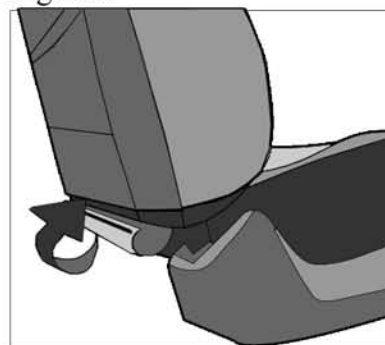
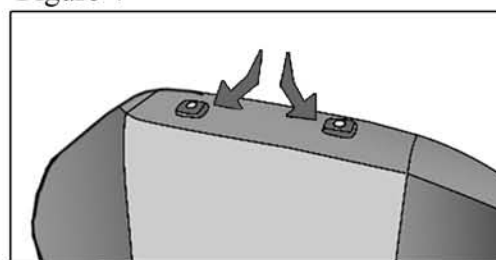

Figure 4



Installation Instructions for 50-50 Seats

(This Installation will cover the full process of a 50-50 split back with solid bench and a 50-50 split back with split bench that come with or without armrests.)

Seat Bottoms...

1. Find the cover for the Seat Bottom by matching the cut outs on the cover with any levers or knobs.
2. Slide the cover over the front of the seat so that the front of the cover is tightly fitted, make sure the straps are facing the front of the seat.
3. Feed the straps under the seat until it reaches the back, if there is a wire beneath your seat, ensure that the straps go above it and doesn't interfere with the movement of the seat. (See Figure 5)
4. Once the cover is applied proceed to attaching the straps to the appropriate buckle. Smooth out the cover with one hand as you do so. (See Figure 6)

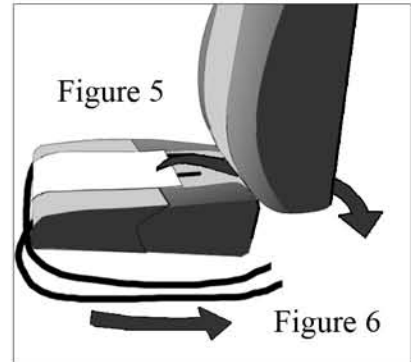

For those of you with 50-50 split backs with solid cushions

5. The Seat Bottom can be removed from the car by simply detaching the clips in each side. Then follow steps 2 - 4. (See Figure 7)

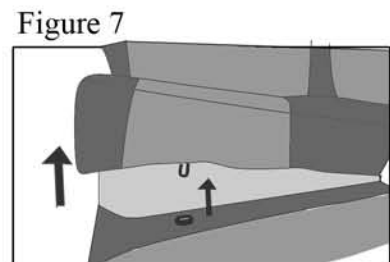

Armrests...

1. To attach the armrest simply slip the arm rest cover through the arm of the chair, keep in mind that some force will be needed to pull the cover all the way through. (See Figure 8)

Figure 8

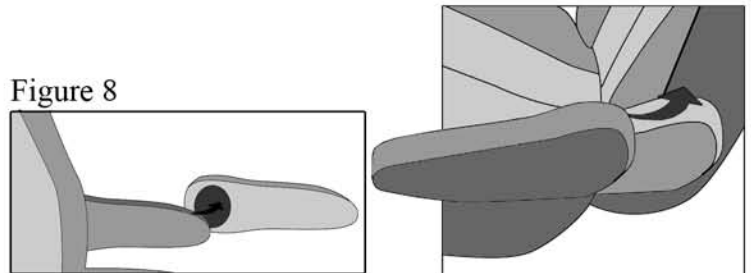

Headrests...

1. Fit the headrest covers over the headrest by working them down.
2. Secure the cover with the hook and loop fastener.
3. Reapply the headrest to the seat.

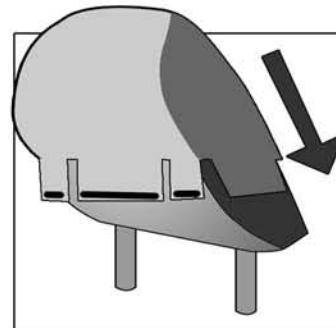

Installation Instructions for 40/60 & 60/40 Seats

(This Installation will cover the full process of a 40-60 split back with solid bench and a 40-60 split back with split bench that come with or without middle console.)

Before You Begin...

Remove the headrests completely from the seats: There are a couple ways to remove headrests.

- A. Press the button on the base of the post and pull the headrest up until it disengages from the seat.
- B. If there are no buttons, locate small holes on the base. Insert a wire (or an unbent paperclip) until you hear a click, then pull the headrest up.

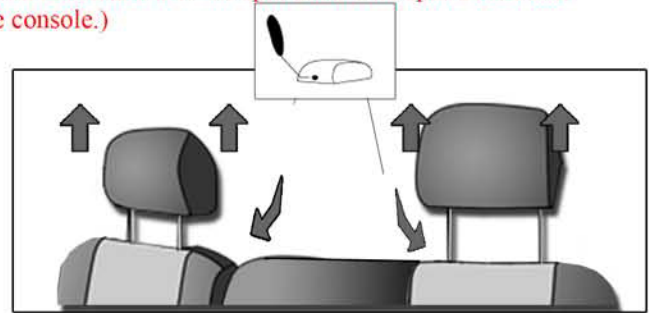

Note: The covers will be tight and the fabric will cling to your original upholstery.

-- DO NOT USE EXCESSIVE FORCE--

Seat Backs...

1. Find the cover for the Seat Back by matching the cut outs on the seat cover with any levers or knobs on the seat.
2. Due to different seat configurations, seat back installations will vary.
 - a. If your seat back is ABLE to fold forward make sure the flap with hook and loop fastener is facing the front of the seat, then slide the cover down over the seat back (Figure 2a)
 - b. If your Seat Back is UNABLE to fold forward your seat cover will come equipped with laces, belts and hook and loop fastener. Slide the laces hook and loop fastener behind the Seat Back until you are able to securely attach them to the belts provided. (Figure 2b)

Figure 2a

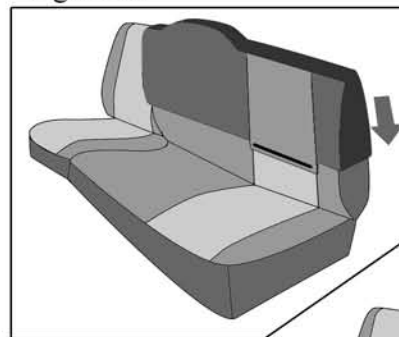
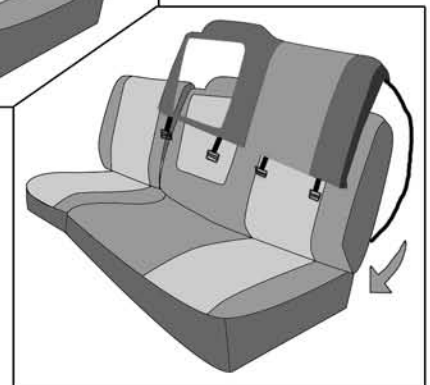

Figure 2b



- (Note: A. In some installations, the front flap hook and loop fastener attaches to the original fabric in between the seat.
B. If cover has plastic wedges, they will hook onto the seat once they have been tucked in.

3. Once the cover is secure with a tight snug fit proceed to insert the hook and loop fastener in between the seat. (See Figure 3)
4. Then proceed to insert the fabric cut outs under the headrest panels. (See Figure 4)

Figure 3

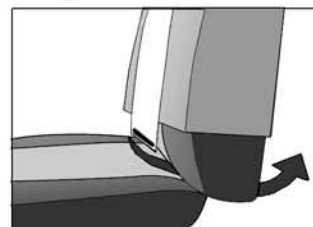

Figure 3

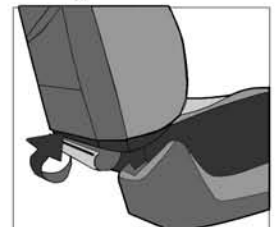
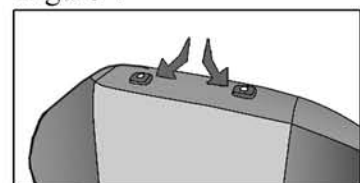

Figure 4



Installation Instructions for 40/60 & 60/40 Seats

(This Installation will cover the full process of a 40-60 split back with solid bench and a 40-60 split back with split bench that come with or with out middle console.)

Seat Bottoms...

1. Find the cover for the seat bottom by matching the cut outs on the seat cover with any levers or knobs on the seat.
2. Due to different seat configurations seat bottoms will vary in installation.
 - a. If your seat bottom is **ABLE** to fold up place the cover over the seat bottom and feed the laces underneath the seat bottom. (See Figure 5)
 - b. If your seat bottom is **UNABLE** to fold up simply place the seat cover over the seat then begin to feed the laces in between the seat. (See Figure)
3. Proceed by attaching the laces to their appropriate belts until you achieve a tight snug fit.

** For Solid Seat Bottoms **

The Seat Bottom can be removed from the car by detaching the clips in each side by pulling the cushion up or pulling the release lever on each side . Then follow steps 2 - 3. (See Figure 6a)

Middle Console...

1. Find the cover for the middle console by matching the cut outs on the seat cover with any levers or knobs or cupholders the seat may have.
2. Slip the cover over the console making sure the fabric with **hook and loop fastener** is facing the front of the seat. Once the cover is pulled all the way down proceed to insert the **hook and loop fastener** in between the seat. (See Figure 7)
3. Once the cover is secure with a tight snug fit proceed to attach the **hook and loop fastener** to the back of the cover.

Arm rests...

1. To attach the armrest simply slip the arm rest cover through the arm of the chair, keep in mind that some force will be needed to pull the cover all the way through. (See Figure 8)

Headrests...

1. Fit the headrest covers over the headrest by working them down.
2. Secure the cover with the **hook and loop fastener**.
3. Reapply the headrest to the seat.

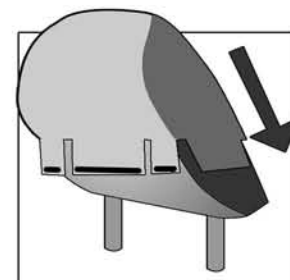
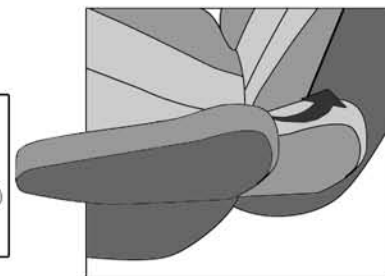
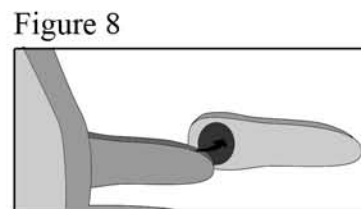
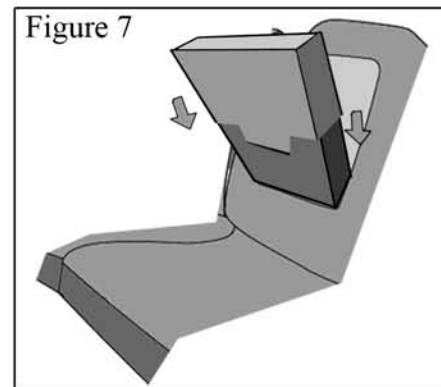
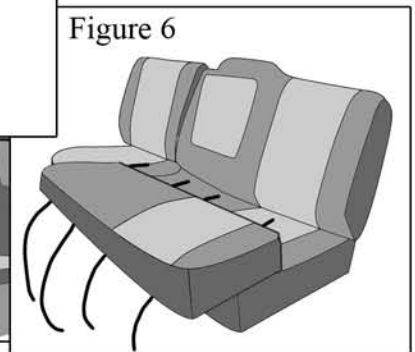
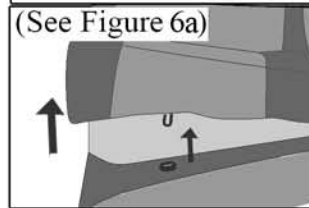
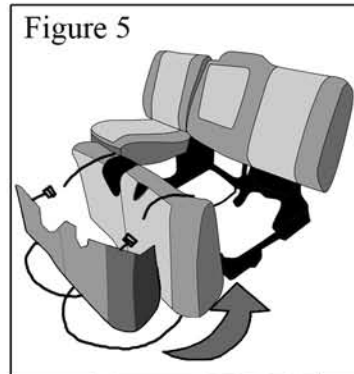

Installation Instructions for the 40-20-40 Seats

(This Installation will cover the full Installation process for a 40-20-40 bench seat with middle console.)

Before You Begin...

Remove the headrests completely from the seats: There are a couple ways to remove headrests.

- A. Press the button on the base of the post and pull the headrest up until it disengages from the seat.
- B. If there are no buttons, locate small holes on the base. Insert a wire(or an unbent paperclip) until you hear a click, then pull the headrest up.

Note: The covers will be tight and the fabric will cling to your original upholstery.

-- DO NOT USE EXCESSIVE FORCE--

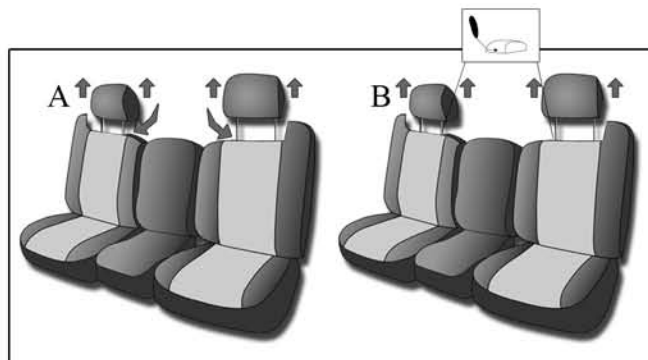

Seat Backs...

1. Find the cover for the Seat Back by matching the cut outs on the seat cover with the levers or knobs on the seat.
2. Make sure the flap with hook and loop fastener is facing the front of the seat, then slide the cover down over the Seat Back. (See Figure 2)
(Note: A. In some installations, the front flap hook and loop fastener attaches to the original fabric in between the seat.
B. If cover has plastic wedges, they will hook onto the seat once they have been tucked in.
3. Once it's pulled all the way down insert the hook and loop fastener in between the seat. (See Figure 3)
4. Once the cover is secure with a tight snug fit proceed to attaching the hook and loop fastener to the back of the cover. (See Figure4)
5. Then follow up by pushing the fabric cut outs under the headrest plastic units.(See Figure 5)

Figure 2

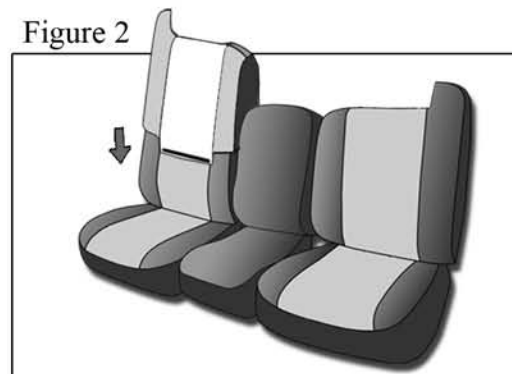

Figure 3

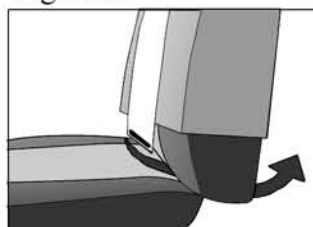

Figure 4

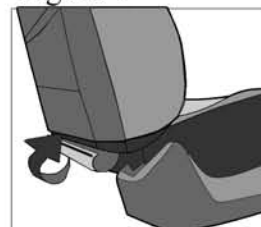
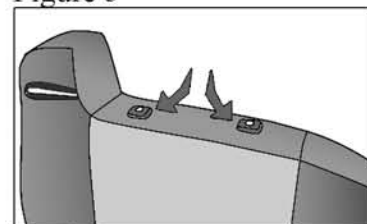

Figure 5



Installation Instructions for the 40-20-40 Seats

(This Installation will cover the full Installation process for a 40-20-40 bench seat with middle console.)

Seat Bottoms...

1. Find the cover for the Seat Bottom by matching the cut outs on the cover with any levers or knobs.
2. Slide the cover over the front of the seat so that the front of the cover is tightly fitted. Make sure the straps are facing the front of the seat. (See Figure 6)

*Note- Some seat covers come with the buckles facing the front instead of the straps.

3. Feed the straps under the seat until it reaches the back, if there is a cable beneath your seat, ensure that the straps go above it and don't interfere with the movement of the seat. (See Figure 7)
4. Once the cover is applied proceed to attaching the straps to the appropriate buckle. Smooth out the cover with one hand as you do so.(See Figure 8)

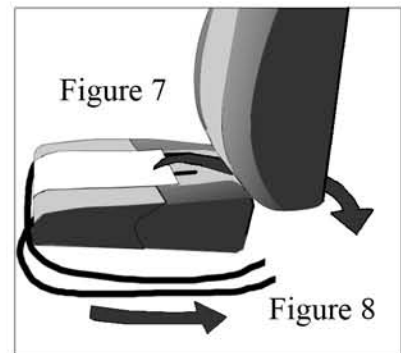
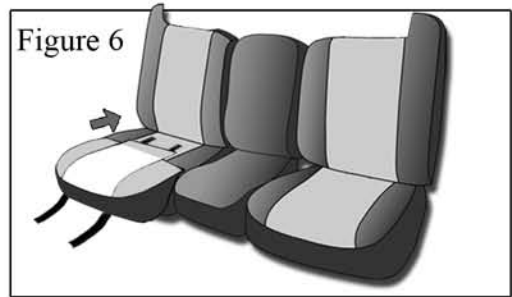

Middle Console...

1. Find the cover for the middle console by matching the cut outs on the cover with any levers or knobs or cup holders.
2. Slide the cover over the middle console making sure the fabric with hook and loop fastener is facing the front of the seat. Once the cover is pulled all the way down proceed to inserting the hook and loop fastener in between the seat. (see figure 9)
3. Once the cover is secure with a tight snug fit proceed to attaching the hook and loop fastener to the back of the cover.
- 4 Find the cover for the seat bottom by matching the cut outs on the cover with any levers or knobs.
5. Slide the cover over the front of the seat so that the front of the cover is tightly fitted, proceed to inserting the hook and loop fastener in between the seat and attaching it to the back of the seat cover. (see figure 10)

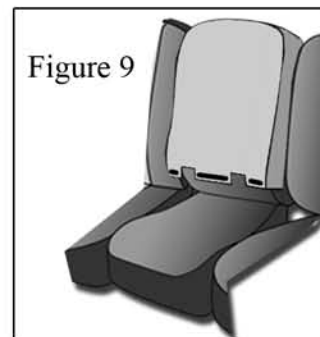

Headrests.

1. Fit the headrest covers over the headrest by working them down.
2. Secure the cover with the hook and loop fastener.
3. Reapply the headrest to the seat.

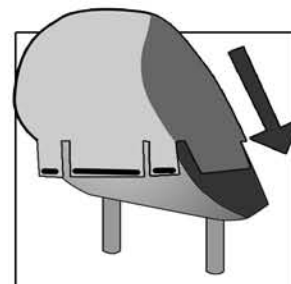

Installation Instructions for Bucket/Sport Seats

(This Installation will cover the full process for a Bucket seat)

Before You Begin...

Remove the headrests completely from the seats: There are a couple ways to remove headrests.

- A. Press the button on the base of the post and pull the headrest up until it disengages from the seat. (See Figure A.)
- B. If there are no buttons, locate small holes on the base. Insert a wire(or an unbent paperclip) until you hear a click, then pull the headrest up. (See Figure B.)

(FIGURE A)

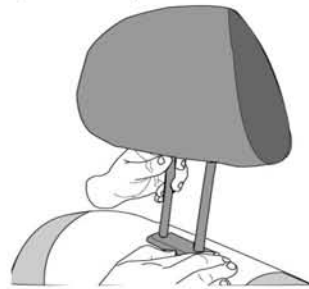

(Figure B)



Note: The covers will be tight and the fabric will cling to your original upholstery.

-- DO NOT USE EXCESSIVE FORCE--

Figure 2a

Seat Backs...

1. Find the cover for the seat back by matching the cut outs on the seat cover with the levers or knobs on the seat.
2. Make sure the flap with hook and loop fastener is facing the front of the seat, then slide the cover down over the seat back. Once it's pulled all the way down insert the hook and loop fastener in between the seat. (Figure 2-2a)
(Note: A. In some installations, the front flap hook and loop fastener attaches to the original fabric in between the seat.
B. If cover has plastic wedges, they will hook onto the seat once they have been tucked in.

Figure 2

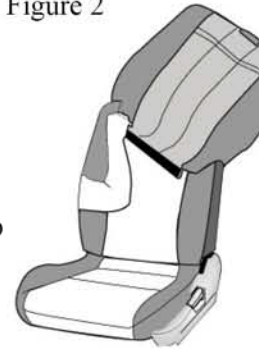

3. Once the cover is secure with a tight snug fit proceed to attaching the hook and loop fastener to the back of the cover.(Figure3)
4. Then follow up by pushing the fabric cut outs under the headrest plastic units.(Figure 4)

Figure 3

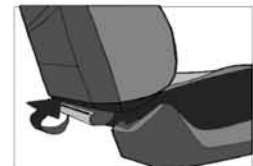

Figure 4



Installation Instructions for Bucket/Sport Seats

(This Installation will cover the full process for a Bucket seat)

Seat Bottoms...

Before you begin installing the bottom portion of the seat cover.

1a. On the bottom of the seat some newer models have a plastic flap. To remove proceed and reach towards the bottom of the seat and you will find an elastic band, remove the band or clips. (see figure 5a)

1. Find the cover for the Seat Bottom by matching the cut outs on the cover with any levers or knobs.
2. Slide the cover over the front of the seat so that the front of the cover is tightly fitted, make sure the straps are facing the front of the seat. (See Figure 5)

*Note- Some seat covers come with the belts facing the front instead of the straps.

3. Feed the straps under the seat until it reaches the back, if there are cables beneath your seat, ensure that the straps go above it and doesn't interfere with the movement of the seat. (See Figure 6)
4. Once the cover is applied proceed to attaching the straps to the appropriate buckle. Smooth out the cover with one hand as you do so.

Headrests.

1. Fit the headrest covers over the headrest by working them down. (See figure 7)
2. Secure the cover with the hook and loop fastener.
3. Reapply the headrest to the seat.

Figure 5a

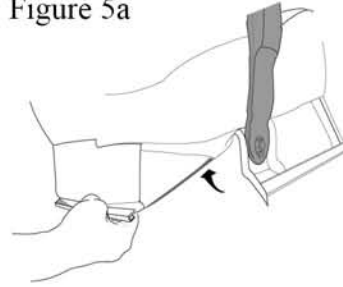

Figure 5



Figure 6

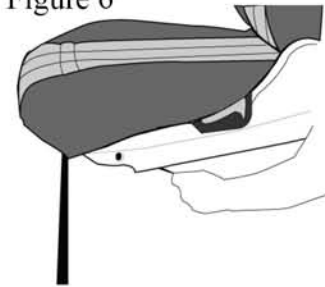

Figure 7



Installation Instructions for the Solid Bench

(This Installation will cover the full process of a Solid Bench)

Before You Begin...

Remove the headrests completely from the seats: There are a couple ways to remove headrests.

- A. Press the button on the base of the post and pull the headrest up until it disengages from the seat.
- B. If there are no buttons, locate small holes on the base. Insert a wire (or an unbent paperclip) until you hear a click, then pull the headrest up.

Note: The covers will be tight and the fabric will cling to your original upholstery.

-- DO NOT USE EXCESSIVE FORCE--

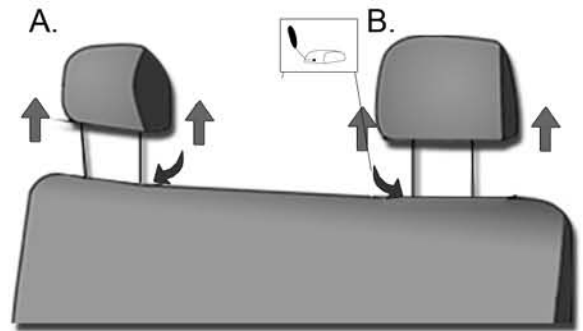

Seat Back...

1. Find the cover for the Seat Back. You can do this by matching the cut outs on the seat cover with the levers or knobs on the seat.
2. Due to various seat configurations "Seat Back" seat covers will vary on installation!
 - a. If your Seat Back is ABLE to fold forward, slide the seat cover over the seat back. (See Figure 2a)
 - b. If your Seat Back is UNABLE to fold forward your seat cover will come equipt with laces and belts and hook and loop fastener. Slide the laces behind the Seat Back until you are able to securely attach them to the belts provided. (See Figure 2b)

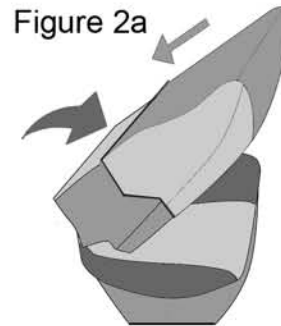
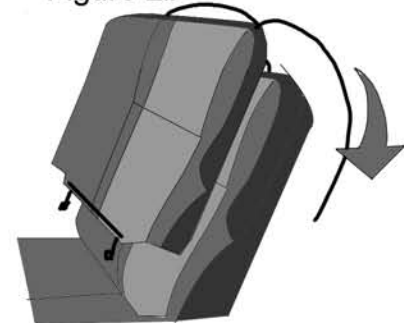

Figure 2b



3. Once the cover is secure with a tight snug fit proceed to attaching the hook and loop fastener to the back of the cover or tightening up the laces. (See Figure 3a & 3b)

(Note: A. In some installations, the front flap hook and loop fastener attaches to the original fabric in between the seat.

- B. If cover has plastic wedges, they will hook onto the seat once they have been tucked in.

4. Follow up by pushing the fabric under the headrest plastic units. (See Figure 4)

Figure 3a

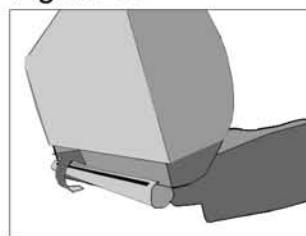

Figure 3b

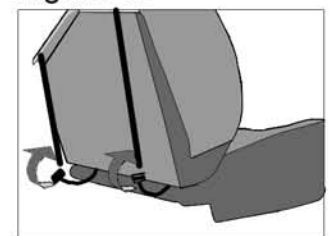
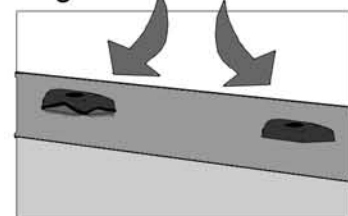

Figure 4



Installation Instructions for the Solid Bench

(This Installation will cover the full process of a Solid Bench)

Seat Bottom...

1. Find the cover for the Seat Bottom by matching the cut outs in the cover with any levers or knobs.
2. With some Seat Bottoms you'll need to remove the entire bottom cushion to apply the cover.

There are two different ways to remove the bottom cushion (See Figure 5)

- a. Pull up on the cushion until it's disengaged from its hinges.
- b. Pull on the release lever located near the hinge and pull up on the cushion.

3. Once the cover is applied proceed to attaching the straps to the appropriate buckle. Smooth out the cover with one hand as you do so. (See Figure 6)

Figure 5

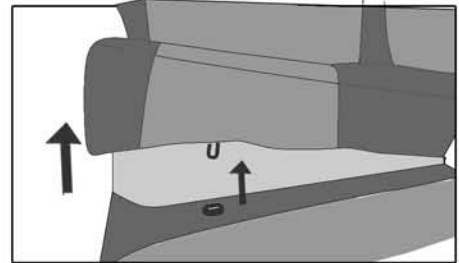
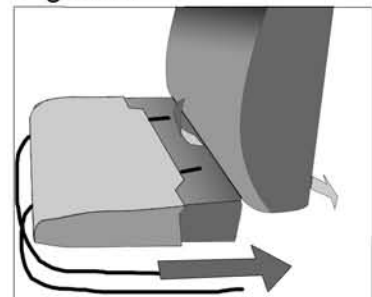

Figure 6



Headrests...

1. Fit the headrest covers over the headrest by working them down.
2. Secure the cover with the hook and loop fastener.
3. Reapply the headrest to the seat.

