

1967-1969 GM F-Body Convertible 1404 Center X-Brace Installation Instructions

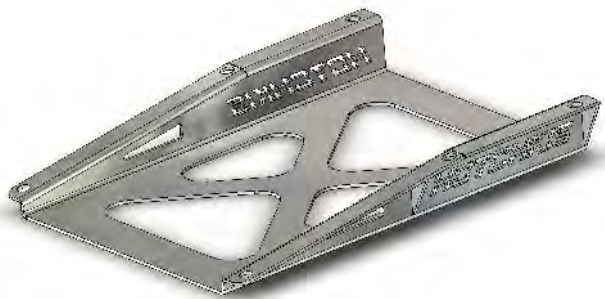

Thank you for your purchase of this Hotchkis Performance product. Your X-Brace was designed with the performance and durability you've come to expect from Hotchkis Performance. This lower profile brace will allow you to run larger exhaust piping while still bracing the center section of your convertible chassis.

Note: Please read the entire installation instructions before starting. Having the right tools will ensure a smooth install process.

X-BRACE INSTALLATION

- 1 Jack the vehicle up and support it on jack stands.
- 2 Creep underneath the car and locate the stock X-Brace and remove it by undoing the 6 bolts that secure it. You may discard the brace and hardware.

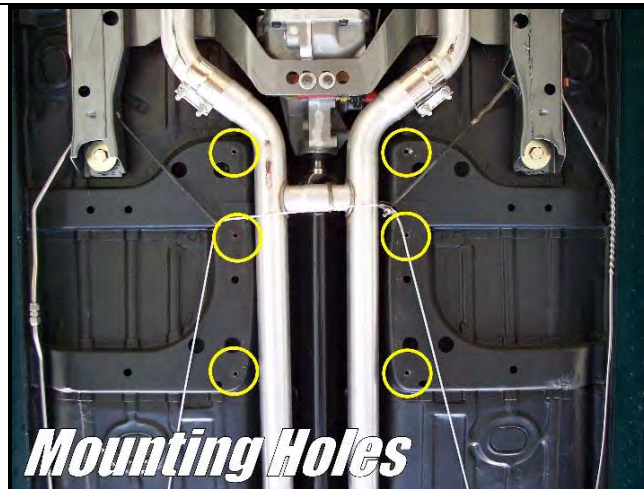

- 3 Using the provided stainless hardware, coat each bolt with a small amount of anti-seize.



- 5 Slide your new Hotchkis Brace into position. Start each bolt by hand then fully tighten.

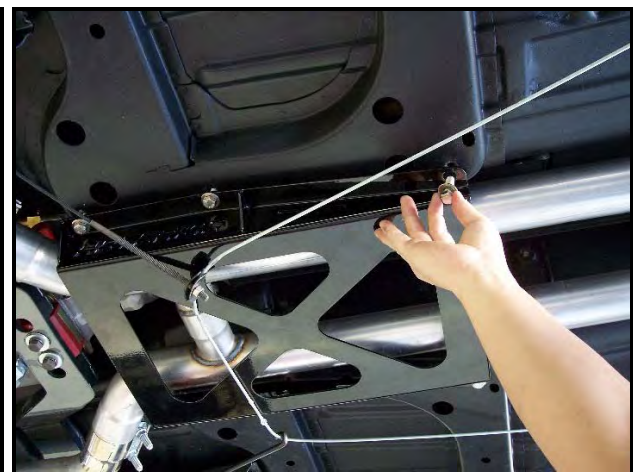



5 You are finished installing your new Hotchkis X-Brace.

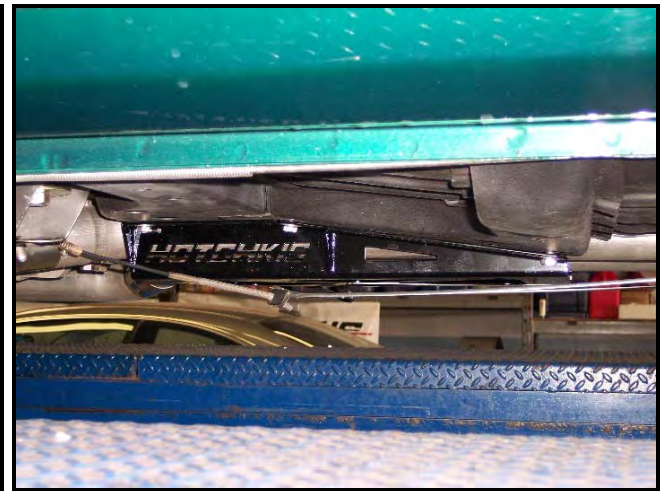
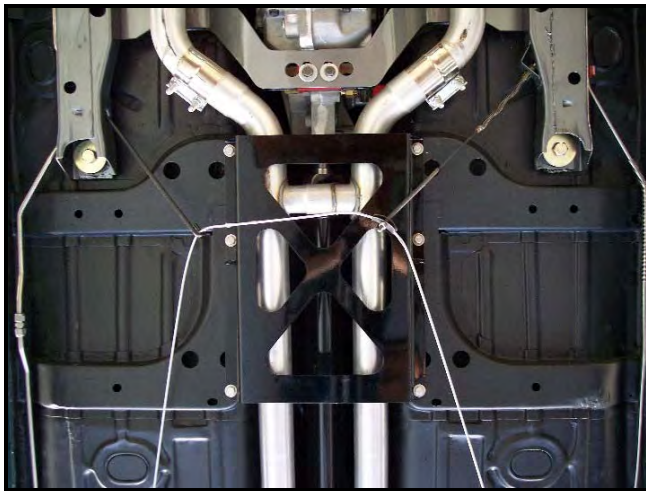

Note:
Hooker Super Comp headers may have clearance issues with this brace or any cross brace due to the header's low profile.

Hotchkis Performance LLC

Return Policy & Limited Warranty

Effective December 1, 2010 all Hotchkis products must be registered to qualify for warranty at www.hotchkis.net or via the mail-in warranty card, included with the product, within 30 days of the original purchase date.

IMPORTANT: This warranty supersedes all other warranties included with this product.

Return Policy

We want you to be completely satisfied with your Hotchkis Performance product. For products, presenting signs of shipping damage please contact the freight carrier immediately. All our products are guaranteed to be free from manufacturer's defects. If your order arrives with a manufacture defect, please contact our Customer Service Department at (562) 907-7757. You will be assigned a Returned Goods Authorization Number (RGA). The package you return must show the RGA on the outside of the package, include the original invoice and be shipped prepaid to our facility. The product has to be unused and in its original packaging materials. Exchanges or refunds made after 30 days will be subject to a 20% restocking charge. **If you purchased your Hotchkis Performance product from an authorized dealer, you are still covered by this return policy. All returns however, should be made to your dealer, not to Hotchkis Performance directly.**

Limited Warranty

Hotchkis Performance offers a Limited Warranty against defects in materials and workmanship for the term of 36 months (3 years) from the date of purchase of this product. This Warranty only applies to the original retail purchaser who retains ownership of the vehicle on which the product was originally installed. If the product is determined to be defective, Hotchkis Performance will repair, replace or refund the purchase price of the defective product at Hotchkis Performance's sole discretion, which shall fully satisfy and discharge any and all warranty claims. Any repaired or replaced product will be returned to the sender excluding the cost of freight. **Products must be registered to qualify for warranty at www.hotchkis.net or via the mail-in warranty card, included with the product, within 30 days of the original purchase date.**

Exclusions from Warranty

Items offered but not manufactured by Hotchkis Performance are warranted according to the manufacturer's terms and are not covered by this limited warranty. Hotchkis Performance shall not be responsible for any labor, removal, installation, re-installation or maintenance costs. This warranty does not cover the cosmetic finish or plating of any product or any normal wear and tear to any product including, but not limited to bushings, brackets, end-links, hardware, steering components, shocks or springs. In addition, this warranty does not apply to any products that have been:

- **Improperly installed or installed by someone other than a qualified, licensed auto mechanic experienced in the installation and removal of suspension products;**
- **Improperly serviced, misused, or modified, altered or subjected to abuse, negligence, accident or collision;**
- **Installed in any vehicle that has been modified;**
- **Installed on any vehicle that has carried loads in excess of automobile manufacturer suggested weight limits; or**
- **Installed on any vehicle that has been subject to abnormal or excessive use, including rallying, racing, or racing-type activities or off-road use.**

Limitation of Warranty

This limited warranty is the entire and only warranty for the products and may not be modified or supplemented by any other person or company in any form. Any description of the products, by anyone, is for the sole purpose of identifying them and is not part of the basis of the bargain, and does not constitute a warranty that the products will conform to that description. The statements of any salesperson do not constitute part of this limited warranty and cannot be relied upon as a warranty.

THERE ARE NO WARRANTIES, EXPRESSED OR IMPLIED, INCLUDING ANY IMPLIED WARRANTIES OF MERCHANTABILITY OR FITNESS FOR A PARTICULAR PURPOSE, WHICH

EXTEND BEYOND THE DESCRIPTION ON THE FACE HEREOF. ANY IMPLIED WARRANTIES ARE DISCLAIMED TO THE FULLEST EXTENT PERMITTED BY LAW. THIS WARRANTY DOES NOT COVER CONSEQUENTIAL DAMAGES, LOSS OF TIME OR REVENUES, INCONVENIENCE, LOSS OF USE OF THE VEHICLE, DAMAGE TO THE VEHICLE OR COMPONENTS OF THE VEHICLE, ANY OTHER TYPE OF CONSEQUENTIAL DAMAGES, OR OTHER INCIDENTAL OR INDIRECT DAMAGES. HOTCHKIS' MAXIMUM LIABILITY UNDER THIS WARRANTY SHALL IN NO EVENT EXCEED THE PURCHASE PRICE OF THE PRODUCT. Some states do not allow limitations on how long an implied warranty lasts or the exclusion or limitation of incidental or consequential damages and in such states the above limitations or exclusions may not apply. This limited warranty gives the purchaser specific legal rights and the purchaser may have other rights that may vary from state to state.

Technical Information

Hotchkis Performance makes every effort to ensure that you are provided with the most accurate and up-to-date technical information. However, all technical information is approximate and may vary upon application. Additional suspension components may be needed in some applications, depending upon the make, model, engine and chassis of the vehicle. Hotchkis Performance is not responsible for any consequences resulting from manufacturer's technical mid-year changes. Hotchkis Performance products should only be installed by a qualified, licensed auto mechanic experienced in the installation of such products.

Warranty Claim Procedure:

The answer to ALL the following questions should be YES before making a warranty claim:

- **Did you register the product at www.hotchkis.net or via the mail-in warranty card within 30 days of purchase?**
- **Is the product appropriate to your application?**
- **Did you carefully and thoroughly read the instructions provided along with the product?**
- **Do you have the original invoice or sales receipt?**
- **Is the return date within 36 months from the purchase date?**
- **Are you the original purchaser?**
- **Was the product properly installed by a qualified, licensed auto mechanic?**
- **Has the product been installed on the original vehicle on which it was installed at all times?**
- **Is the product unmodified and clean?**
- **Is the reason for return a legitimate product defect?**

If the answer to all these questions is YES, please contact our Customer Service Department at (562) 907-7757. You will be given a Returned Goods Authorization Number (RGA) valid for 60 days. You will also be asked to ship the product prepaid to our facility. All shipments MUST be (i) prepaid, (ii) include the original invoice or sales receipt, (iii) show the RGA on the outside of the package and (iv) include your name, address, make and model of the vehicle, and a brief description of the claimed defect, including the circumstances under which the defect occurred. If the warranty claim is deemed valid then Hotchkis will estimate shipping costs to return the repaired or replacement part and contact you for payment. Hotchkis's Limited warranty requires that any repaired or replaced product will be returned to the sender excluding the cost of freight. Warranty related inquiries should be sent to the following address:

**HOTCHKIS PERFORMANCE, LLC
C/O CUSTOMER SERVICE
8633 Sorensen Avenue
SANTA FE SPRINGS, CA 90670**

Hotchkis Performance will not accept product returns without the RGA number, receipt and the information described above. C.O.D. or collect shipments will be refused. Once the returns are received at Hotchkis Performance, we will evaluate the products, verify the sales receipt, and investigate the warranty claim. Any repaired or replaced product will be returned to the sender.

Effective December 1, 2010. This return policy and limited warranty supersedes all previous policy and warranty statements. Policies and warranties are subject to change without notice.
Hotchkis Performance is not responsible for printing errors.



Please read the following key points before installing this kit.

1 – Before performing the subframe connector installation, the vehicle must be completely assembled with all body and component parts installed (e.g. fenders, hood, quarterpanels, trunk, full interior, engine, glass, etc.). Basically, the subframe connectors should be one of the last components installed on your vehicle. Reason being is you want the vehicle settled with all of it's own final weight. The car's body is always in constant tension, with forces pushing or pulling within the chassis & body. You want to make sure these forces don't change after you install the subframe connectors. For example, if you installed subframe connectors before installing the engine and body panels this may result in having misaligned fenders, door panels and/or hood later on. The car must be in it's final state before the subframe connectors are installed.

2 – Make sure your front subframe is aligned with the body before you installed the subframe connectors. This can be done in many ways e.g. use alignment holes in the body (*see pictures*) or using a chassis jig. Note: When using a full chassis jig, the alignment holes for the rear frame rails are needed to square the body and front subframe. If you install the subframe connectors before you do this, you will not have access to these alignment holes. This is one of the reason why you should square the front subframe before installation.

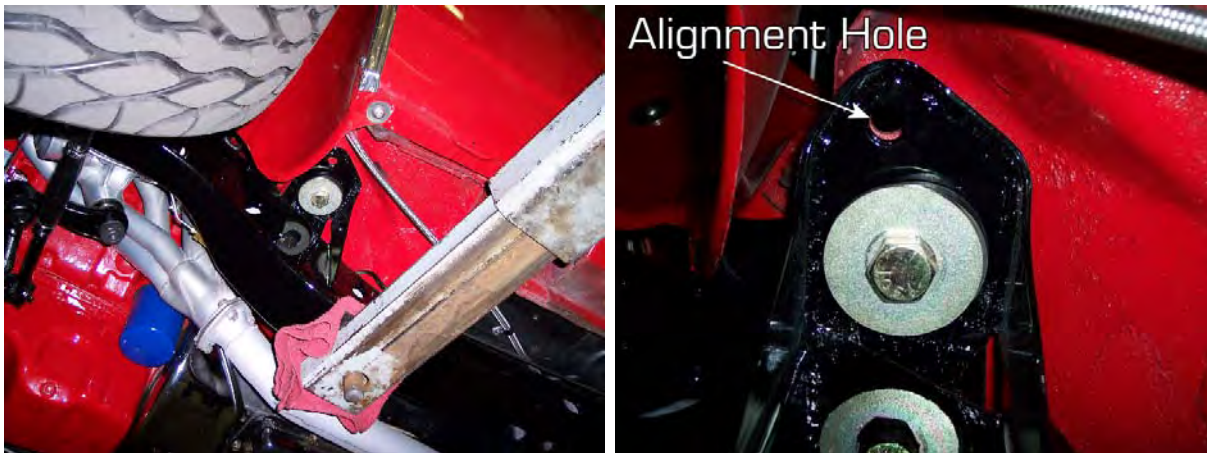

3 – The subframe connectors must be installed on an alignment rack or floor ramps (all 4 wheels). The vehicle must be sitting on it's wheels at ride height in order to install the subframe connectors. Do not use a two-post lift, as this will load the chassis/body in the wrong points causing the chassis to tweak.

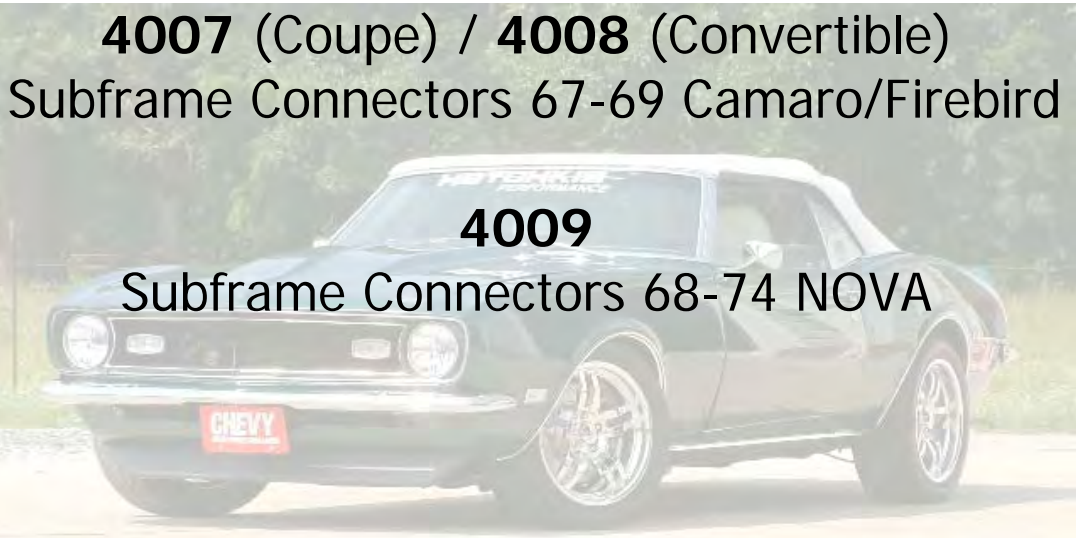

**Thank you for your purchase from our new line of F-Body parts.
Please call us at (877) 4NO - ROLL if you have any questions
regarding the service or installation of your Hotchkis products.
Installation pictures were done on a Camaro. Nova installation is the same.**

Subframe Connectors:

Your new subframe connectors will increase the overall rigidity of your chassis and improve handling and response. These engineered components connect the rear frame rails with the front subframe to simulate a complete full frame chassis.

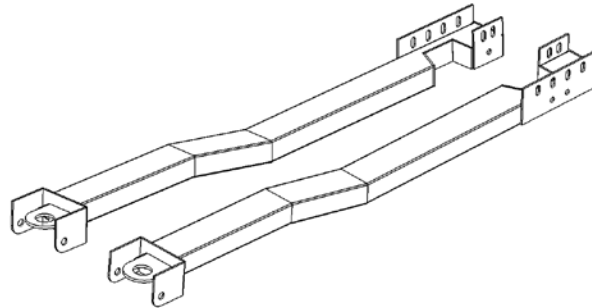

Notes:

The subframe connector is essentially a Weld-In component, effectively connecting itself to the front subframe and rear frame rails. However, you may choose to bolt-in the front connection to allow front subframe removal if need be. Hardware for the bolt-in procedure is included.

Before You Start:

The installation of these subframe connectors will require you to grind and weld. It is recommended that a trained professional install this product. Always wear eye protection when grinding or welding. Please read the entire manual before starting. All images will depict the driver side installation.

1. Raise Vehicle

It is best to install the subframe connectors at ride height. To do this properly, please use a 4-Post lift or alignment rack. Disconnect the negative battery cable.



2. Replace Subframe Body Mount Bushing

Your kit comes with 2 new polyurethane front subframe body mount bushings. Having proper bushings will ensure correct fitment of the subframe connectors.

Remove stock bushings.



Install Hotchkis bushings.





3. Mock up Subframe Connector

Preparation is needed before any welding can begin. First, decide whether you will be welding in the connector to the front subframe or bolting it in.

Install the subframe connector using the provided 5/8" bolt and the thick washer. Use a transmission jack to hold the rear end of the connector up. Fully tighten the 5/8" bolt to see where the connector will position itself. Make sure the rear end of the connector is butted up against the rear frame rails. This mock-up should simulate how the connector will be mounted on the vehicle.

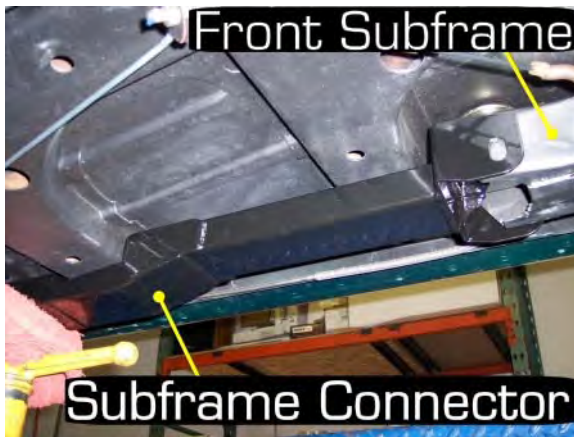

Bolt-In: Mark the front subframe to indicate where your bolt holes will be.



Weld-In: Mark the front subframe to indicate where you should grind/sand the paint for welding. The connector hole will allow you to apply a rosette weld instead of a bolt. You may also want to mark where the leading edge of the connector lies on the subframe so you can run a weld bead there as well.

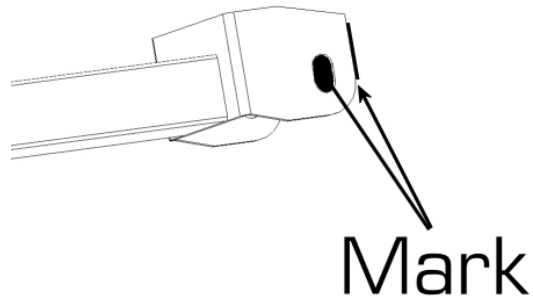

Mark the rear frame rails along the edge of the connector. This will show you where to grind the paint/grime off the frame. Don't forget the outboard tab. This area will be difficult to access since the leaf spring and bracket are in the way.

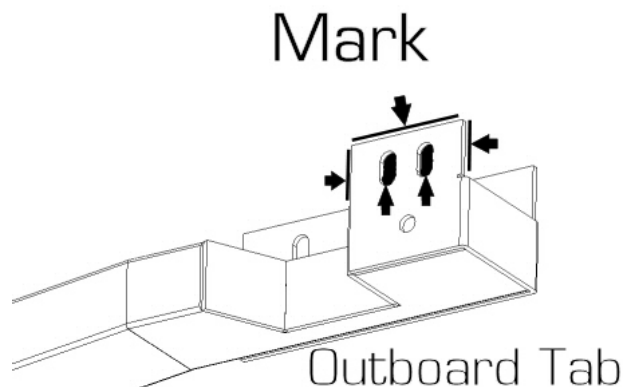
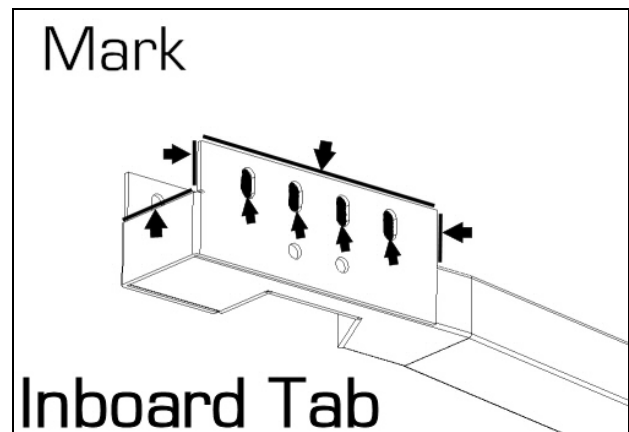

The inboard Tab will need to be bent inward for a tight fit. Do this by using large channel locks and squeeze the tab in. Don't worry if there's a little gap near the bottom. You can fill the gap during welding. Leaf Spring Bracket will need to be detached. See next step.



4. Prepare mounting points for welding/bolting

Remove the connector and start grinding/sanding the paint and grime off of the vehicle's frame rail. Unbolt the leaf spring bracket & lower shock mount and raise the vehicle to access the outboard tab area for grinding. You will have to move the brake and fuel line out of the way. Remove any tube clamps necessary to achieve this.

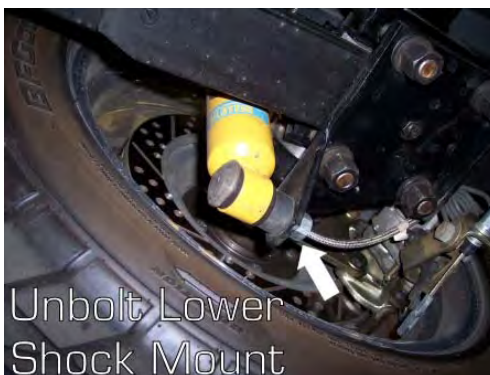
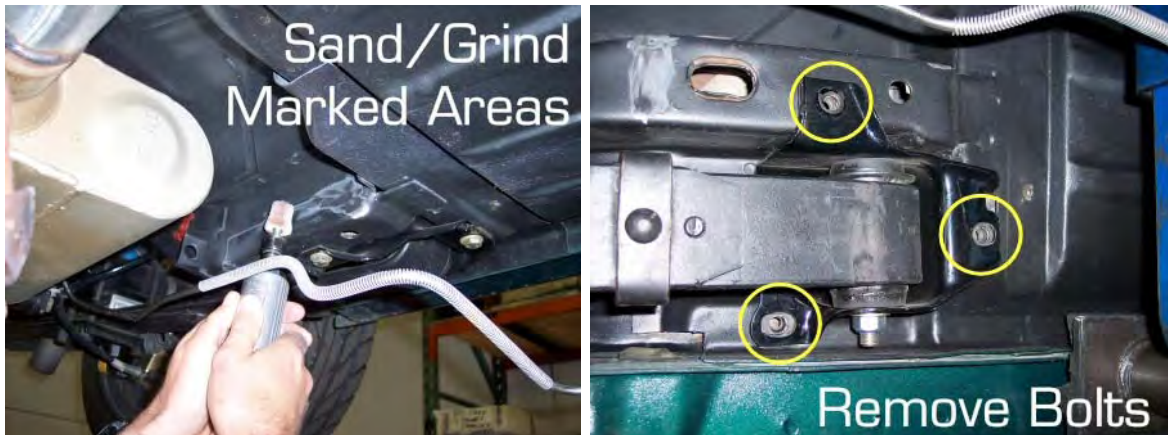

Bolt-in: At this time you can drill a 1/2" hole in the designated mark made earlier on the front subframe. A right angle drill may work the best for this situation.

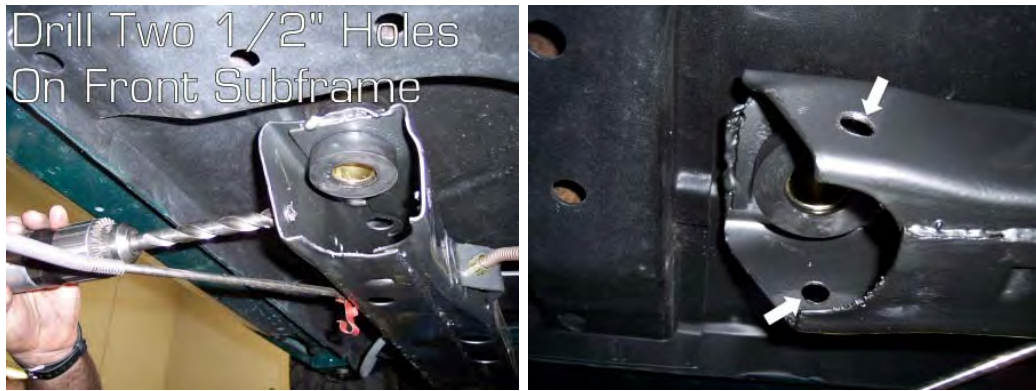

Weld-in: Grind/sand near the designated area marked earlier on the front subframe.

5. Prepare Subframe Connector for Welding.

Grind around all rosette holes on the connector. Grind/sand anywhere on the connector that is going to be welded. Use a "rat tail" file to take the paint off the inner surface of the rosette holes. If you are welding the front, make sure to sand near the 1/2" holes and front edges.



6. Install the Subframe Connectors onto the Vehicle

Make sure the vehicle is returned to ride height. The front leaf spring mount should be positioned to its installed state with the weight of the car on the leaf. You do not need to reinstall the mount bolts at this time. Reinstall the connector like before. Fully tighten the front 5/8" subframe bolt and use the transmission jack to hold up the rear end of the connector.

Bolt-in: Install the 1/2" bolts in subframe holes as shown in the picture. Fully tighten these bolts at this time.



Weld-in: Rosette weld the front hole on each side. Weld a bead along the leading edges of the connector.

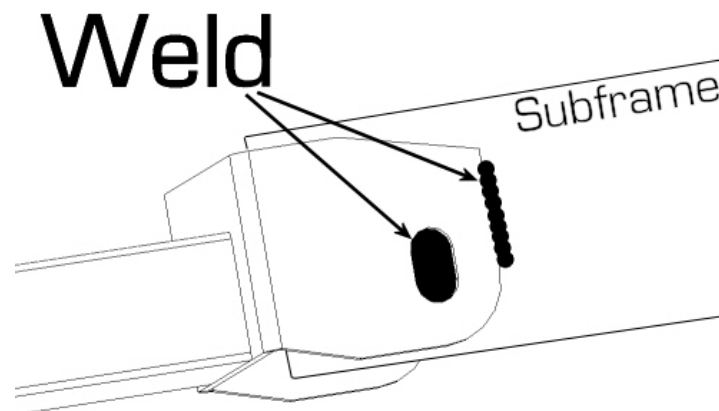

Tack weld 2-3 of the rosette holes on the inboard tab to the frame rails. Tack weld the rear edge of the connector. Once you have these minimum welds complete, you may raise the vehicle again to access the outboard tab. Completely weld both rosettes and any edges. Lower the vehicle back on it's wheels and finish the inboard rosette welds and remaining edges to be welded. To protect the brake line (driver side) and the fuel line (passenger side) from the welding radiation and sparks, cover them with aluminum foil.

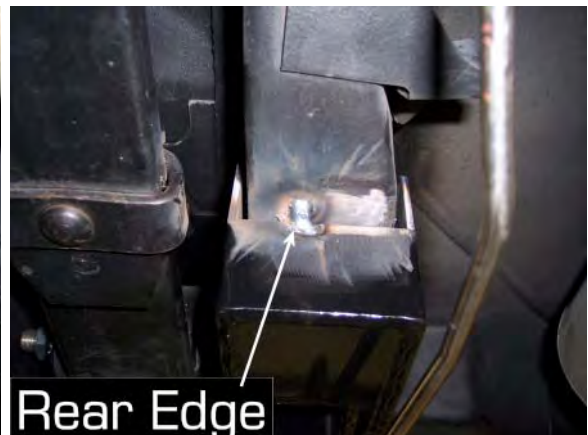
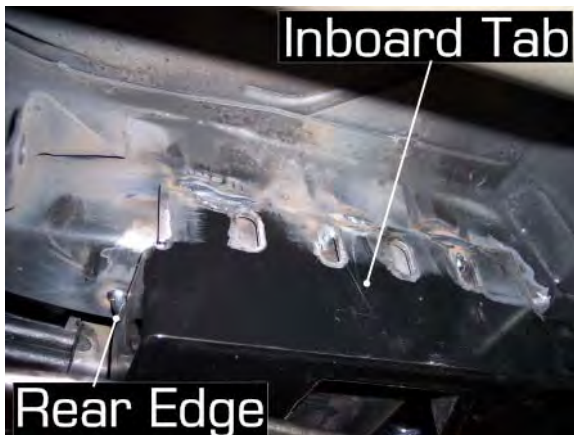

Outboard Tab





7. Optional Metal Finishing

Depending on how pretty your welds turn out, you might want to grind down any "high" welds or weld mistakes before proceeding any further.

8. Paint the Exposed Metal

You may use any paint or undercoat you wish to coat the exposed welded/grinded areas. We recommend Duplicolor's Truck Bed Coating. This coating has the perfect texture and color for this project. It is up to you on how and where you want to mask off for the coating.



9. Reattach Everything

Reattach your brake line and fuel lines. Fasten the 3 bolts on each leaf spring bracket. Reattach the lower Shock mount. Double-check to make sure all hardware is fully tightened.



Hotchkis Performance LLC Return Policy & Limited Warranty

Effective December 1, 2010 all Hotchkis products must be registered to qualify for warranty at www.hotchkis.net or via the mail-in warranty card, included with the product, within 30 days of the original purchase date.

IMPORTANT: This warranty supersedes all other warranties included with this product.

Return Policy

We want you to be completely satisfied with your Hotchkis Performance product. For products, presenting signs of shipping damage please contact the freight carrier immediately. All our products are guaranteed to be free from manufacturer's defects. If your order arrives with a manufacture defect, please contact our Customer Service Department at (562) 907-7757. You will be assigned a Returned Goods Authorization Number (RGA). The package you return must show the RGA on the outside of the package, include the original invoice and be shipped prepaid to our facility. The product has to be unused and in its original packaging materials. Exchanges or refunds made after 30 days will be subject to a 20% restocking charge. **If you purchased your Hotchkis Performance product from an authorized dealer, you are still covered by this return policy. All returns however, should be made to your dealer, not to Hotchkis Performance directly.**

Limited Warranty

Hotchkis Performance offers a Limited Warranty against defects in materials and workmanship for the term of 36 months (3 years) from the date of purchase of this product. This Warranty only applies to the original retail purchaser who retains ownership of the vehicle on which the product was originally installed. If the product is

determined to be defective, Hotchkis Performance will repair, replace or refund the purchase price of the defective product at Hotchkis Performance's sole discretion, which shall fully satisfy and discharge any and all warranty claims. Any repaired or replaced product will be returned to the sender excluding the cost of freight. **Products must be registered to qualify for warranty at www.hotchkis.net or via the mail-in warranty card, included with the product, within 30 days of the original purchase date.**

Exclusions from Warranty

Items offered but not manufactured by Hotchkis Performance are warranted according to the manufacturer's terms and are not covered by this limited warranty. Hotchkis Performance shall not be responsible for any labor, removal, installation, re-installation or maintenance costs. This warranty does not cover the cosmetic finish or plating of any product or any normal wear and tear to any product including, but not limited to bushings, brackets, end-links, hardware, steering components, shocks or springs. In addition, this warranty does not apply to any products that have been:

- **Improperly installed or installed by someone other than a qualified, licensed auto mechanic experienced in the installation and removal of suspension products;**
- **Improperly serviced, misused, or modified, altered or subjected to abuse, negligence, accident or collision;**
- **Installed in any vehicle that has been modified;**
- **Installed on any vehicle that has carried loads in excess of automobile manufacturer suggested weight limits; or**
- **Installed on any vehicle that has been subject to abnormal or excessive use, including rallying, racing, or racing-type activities or off-road use.**

Limitation of Warranty

This limited warranty is the entire and only warranty for the products and may not be modified or supplemented by any other person or company in any form. Any description of the products, by anyone, is for the sole purpose of identifying them and is not part of the basis of the bargain, and does not constitute a warranty that the products will conform to that description. The statements of any salesperson do not constitute part of this limited warranty and cannot be relied upon as a warranty.

THERE ARE NO WARRANTIES, EXPRESSED OR IMPLIED, INCLUDING ANY IMPLIED WARRANTIES OF MERCHANTABILITY OR FITNESS FOR A PARTICULAR PURPOSE, WHICH EXTEND BEYOND THE DESCRIPTION ON THE FACE HEREOF. ANY IMPLIED WARRANTIES ARE DISCLAIMED TO THE FULLEST EXTENT PERMITTED BY LAW. THIS WARRANTY DOES NOT COVER CONSEQUENTIAL DAMAGES, LOSS OF TIME OR REVENUES, INCONVENIENCE, LOSS OF USE OF THE VEHICLE, DAMAGE TO THE VEHICLE OR COMPONENTS OF THE VEHICLE, ANY OTHER TYPE OF CONSEQUENTIAL DAMAGES, OR OTHER INCIDENTAL OR INDIRECT DAMAGES. HOTCHKIS' MAXIMUM LIABILITY UNDER THIS WARRANTY SHALL IN NO EVENT EXCEED THE PURCHASE PRICE OF THE PRODUCT. Some states do not allow limitations on how long an implied warranty lasts or the exclusion or limitation of incidental or consequential damages and in such states the above limitations or exclusions may not apply. This limited warranty gives the purchaser specific legal rights and the purchaser may have other rights that may vary from state to state.

Technical Information

Hotchkis Performance makes every effort to ensure that you are provided with the most accurate and up-to-date technical information. However, all technical information is approximate and may vary upon application. Additional suspension components may be needed in some applications, depending upon the make, model, engine and chassis of the vehicle. Hotchkis Performance is not responsible for any consequences resulting from manufacturer's technical mid-year changes. Hotchkis Performance products should only be installed by a qualified, licensed auto mechanic experienced in the installation of such products.

Warranty Claim Procedure:

The answer to ALL the following questions should be YES before making a warranty claim:

- Did you register the product at www.hotchkis.net or via the mail-in warranty card within 30 days of purchase?
- Is the product appropriate to your application?
- Did you carefully and thoroughly read the instructions provided along with the product?
- Do you have the original invoice or sales receipt?
- Is the return date within 36 months from the purchase date?
- Are you the original purchaser?
- Was the product properly installed by a qualified, licensed auto mechanic?
- Has the product been installed on the original vehicle on which it was installed at all times?
- Is the product unmodified and clean?
- Is the reason for return a legitimate product defect?

If the answer to all these questions is YES, please contact our Customer Service Department at (562) 907-7757. You will be given a Returned Goods Authorization Number (RGA) valid for 60 days. You will also be asked to ship the product prepaid to our facility. All shipments MUST be (i) prepaid, (ii) include the original invoice or sales receipt, (iii) show the RGA on the outside of the package and (iv) include your name, address, make and model of the vehicle, and a brief description of the claimed defect, including the circumstances under which the defect occurred. If the warranty claim is deemed valid then Hotchkis will estimate shipping costs to return the repaired or replacement part and contact you for payment. Hotchkis's Limited warranty requires that any repaired or replaced product will be returned to the sender excluding the cost of freight. Warranty related inquires should be sent to the following address:

**HOTCHKIS PERFORMANCE, LLC
C/O CUSTOMER SERVICE
8633 Sorensen Avenue
SANTA FE SPRINGS, CA 90670**

Hotchkis Performance will not accept product returns without the RGA number, receipt and the information described above. C.O.D. or collect shipments will be refused. Once the returns are received at Hotchkis Performance, we will evaluate the products, verify the sales receipt, and investigate the warranty claim. Any repaired or replaced product will be returned to the sender.

**Effective December 1, 2010. This return policy and limited warranty supersedes all previous policy and warranty statements. Policies and warranties are subject to change without notice.
Hotchkis Performance is not responsible for printing errors.**