



2019 SOFT TOPS & ACCESSORIES FOR JEEP®

JEEP



Adventure fuels the human machine. It ignites our endless thirst of braving the unknown to bask in the unexpected. Bestop® never fears entering these unspoiled territories. Over the last six decades, we climb higher, push harder, and drive further than anyone, knowing we have become the leading manufacturer of premium Jeep® Wrangler® soft tops and off-road accessories for good reason.

We live and breathe the belief there's always more to explore.

You should too.

MADE TO ESCAPE™



Pictured: 2-Door Sun Bikini, Safari Mesh (52402-11), Idaho Springs, Colorado



Ideas never get stuck in neutral. From the sewing machine inside our small upholstery shop, innovations run wild and free into the towering pines and boulder-riddled Rocky Mountain wilderness. We're always discovering. Today we stand as the exclusive supplier of soft tops to Jeep® — a 35-year legacy still going strong.

We're not interested in our history.

We're interested in the story we're writing right now.

MADE TO ESCAPE™



Pictured: Trektop™ Glide™ (54923-17), Superstition Mountain, California

TABLE OF CONTENTS

ALL-NEW JEEP® WRANGLER JL PRODUCTS	7	BUMPERS & ACCESSORIES	56
SOFT TOPS	8	HighRock™ 4x4 Modular Bumpers.....	56
Find the Right Top for your Jeep.....	8	NEW! HighRock™ 4x4 Front 1-Piece Bumpers	58
NEW! Sunrider® for Hardtop	10	HighRock™ 4x4 Bumper Accessories.....	58
ALL-NEW Trektop™	12	HighRock™ 4x4 Rear Bumper System	60
NEW! Supertop® Ultra	14	HighRock™ 4x4 Rear Bumper w/ Tire Carrier.....	60
Trektop™ Glide™	16	HighRock™ 4x4 Oversize Tire Carrier.....	61
ALL-NEW Trektop™ Pro.....	18	STORAGE & SECURITY	62
Supertop®	20	Lock Boxes	62
Supertop® Classic	23	RoughRider® Tailgate Shelf.....	64
Sunrider®	24	RoughRider® Seat Back Organizer.....	65
Halftop™	24	RoughRider® Spare Tire Organizer	65
Tigertop™	25	RoughRider® Soft Storage	66
Premium Color Tops.....	26	Instatrunk™ & Sport Bar Covers	68
OEX Replace-A-Top™	29	All-Weather Trail Cover & Tire Cover	69
Original & Black Twill Replace-A-Top™	30	HOSS™ (Hard Top Storage System)	70
Sailcloth Replace-A-Top™	32	SEATS & SEAT COVERS	72
HARDWARE, DOORS, WINDOWS, & TOP ACCESSORIES	34	TrailMax™ II Pro Seats	73
Identify Your Hardware	34	TrailMax™ II Sport Seats.....	74
Hardware	36	TrailMax™ II Classic & Standard Seats.....	75
Quick Release Bow Knuckles.....	36	Seat Sliders, Adapters & Risers	76
Tailgate Bar Kit	36	TrailMax™ II Fixed Rear Seats.....	77
Factory Style Replacement Header Assembly.....	36	TrailMax™ II Fold & Tumble Seats	77
Windshield Channels.....	37	NEW! Seat Covers	78
Door Surrounds	38	ACCESSORIES	80
Factory Style Bow Kits	39	NEW! Floor & Cargo Liners	80
NEW! Core Doors & Upper OE Style Twill Doors... 40	40	Hood Applique & Latch Kit	82
Element Doors & Enclosure Kits.....	42	Pet Barriers	82
Element Door Uppers & Storage Bags.....	43	Universal Rack Tray	83
2-Piece Doors & Lower Half Doors.....	44	Modular Rack System	83
Upper Fabric Doors & Upper Door Sliders.....	45	Powerboard®	84
Fabric Replacement Door Skins & Door Jackets	46	Trekstep®	84
Paddle Latches & Door Pin Inserts	46	Fabric Care	86
Replacement Mirrors	47	Color/Fabric Details.....	87
BIKINI TOPS & FABRIC ACCESSORIES ...	49	Bestop® Premium Accessories Group	88
Retractable Sunshade	49	BESTOP® FAMILY BRANDS	90
Find the Right Bikini®	50	Baja Designs®	90
NEW! Sun Bikini® Top.....	51	Tuffy® Security Products.....	92
Targa & Safari Bikini®	52	PRP	94
Strapless & Traditional Bikini®	53	Status.....	95
Windjammers™	54	SpeedStrap.....	96
Duster™ Deck Covers.....	55	JOBBER NETWORK	97
Sound Bar Cap	55		



It's the guiding principle we boldly wave our flag for and spear into mountaintops: as Jeep® innovates, Bestop® innovates.

This American icon never rests on its laurels so neither do we. It's our proud privilege to partner with Jeep®. That's why we cannot hit the brakes on manufacturing just soft tops. We cannot sit idle with accessories. With the advent of the all-new Jeep® Wrangler® JL, tanks run full on conviction, grit, and the determination that there are even greater solutions out there.

ALL-NEW JEEP®

WRANGLER JL PRODUCTS



SUNRIDER® FOR HARDTOP PAGE 10

Unlatch, flip and enjoy the open air! Sunrider for Hardtop is an easy to install freedom panel replacement that adds a sunroof to your Wrangler JL.



ALL-NEW TREKTOP™ PAGE 12

The most iconic soft top is now available for the Wrangler JL. In-seat sunroof operation and easier than ever rear window operation sets this All-New Trektop apart from its predecessor.



SUN BIKINI PAGE 51

Enjoy the open air but avoid a sunburn with the Sun Bikini for Wrangler JL. The Sun Bikini installs in minutes and can remain under a hard or soft top for instant enjoyment. It's available in vinyl and mesh as well as targa and safari lengths.



NARROW FRONT BUMPER PAGE 59

A no-frills bumper for those who want maximum tire clearance and approach angles with an integrated winch and fairlead mounts. Optional grille guard available separately.



SEAT COVERS PAGE 79

Keep that new Wrangler JL's seats clean and dry with Bestop's Seat Covers! Available in black, charcoal, and tan.



FLOOR LINERS PAGE 80

Bestop's Floor Liners for JL help to keep mud, snow, and dirt from finding a permanent place in the Wrangler JL.



FIND THE TOP THAT'S RIGHT FOR YOUR JEEP®



SUNRIDER® FOR HARDTOP PAGE 10

- Unique folding design lets you flip the panel back for an instant open sky ride
- All-purpose, all-weather, year-round replacement for bulky Freedom Panels



ALL-NEW TREKTOP™ PAGE 12

- Run as fully-enclosed, all-season soft top or remove the sides and rear window and enjoy as a bikini (options for a variety of window configurations)
- New Sunrider® design allows the top to open from inside the vehicle (Sunrider® hardware is made of high-strength steel and engineered thermoplastic polymer)
- Available in premium color options (page 26)



NEW! SUPERTOP® ULTRA PAGE 14

- Innovative, patented new folding frame design functions like a convertible top – just fold back behind the rear seat for a total open-air ride
- Our most premium, year-round, versatile top
- Fits 2007-2018 JK Unlimited



TREKTOP™ GLIDE™

PAGE 16

- Innovative, patented new folding frame design functions like a convertible top – just fold back behind the rear seat for a total open-air ride
- Zipperless side and rear windows allow for easy installation or removal
- Available in premium color options (page 26)



ALL-NEW TREKTOP™ PRO

PAGE 18

- Industry-first soft top featuring glass windows and zipperless technology
- Bestop's Sunrider™ flip-back panel for open-air driving and all-season capability
- Available in premium color options (page 26)



SUPERTOP®

PAGE 20

- Complete replacement soft top with upgraded features
- Fits 1988-2017 YJ, TJ, TJD, JK and JK Unlimited
- Available in premium color options (page 26)



SUPERTOP® CLASSIC

PAGE 23

- The original premium-quality complete replacement top
- Fits 55-17 CJ5, CJ7, YJ, TJ, 66-77 Ford Bronco and 64-84 FJ40



SUNRIDER®

PAGE 24

- Easy flip-back front panel with adjustable bows for better fit
- Fits 1976-2006 CJ7, YJ and TJ



HALFTOP™

PAGE 24

- Bikini, Windjammer, and Duster all rolled into a complete soft top
- Fits 1992-2002 YJ, TJ



TIGERTOP™

PAGE 25

- For Classic Jeeps with up-to-date quality
- Fits 1941-1986 CJ2A, CJ3A, CJ3B, CJ5, CJ7, Scrambler and Commando



PREMIUM COLOR TOPS

PAGE 26

- Four premium soft tops available in six exciting colors: Black, Crushed Red Pepper, Navy Blue, Granite Grey, Oak Tan, Pebble Beige
- Available colored soft tops for JKs include: Supertop®, Trektop™ Glide™, All-New Trektop™, and Trektop™ Pro



OEX REPLACE-A-TOP™

PAGE 29

- The exact material used in OE production
- Fits JK, JKU



ORIGINAL & BLACK TWILL REPLACE-A-TOP™

PAGE 30

- Factory quality that fits your existing hardware
- Fits 1976-2006 CJ5, CJ7, and TJ



SAILCLOTH REPLACE-A-TOP™

PAGE 32

- Sailcloth fabric that uses your original factory hardware
- Fits 1988-2017 YJ, TJ, TJD, JK and JK Unlimited

NOW AVAILABLE FOR THE
ALL-NEW WRANGLER JL

SUNRIDER® FOR HARDTOP



Pictured: Sunrider® for Hardtop (52452-17), Colorado



1. UNLATCH

When closed and latched, enjoy protection from the elements and bad weather



2. FLIP

Flip back or close from inside the cab



3. ENJOY

Completely folded-back so you can just open up and breathe



2018 Wrangler JL 4-Door Unlimited
52452-17



2012 Wrangler JK 2-Door
52450-17



2018 Wrangler JL 4-Door Unlimited
52452-17



2018 Wrangler JL 4-Door Unlimited
52452-17

SUNRIDER® FOR HARDTOP

- Fits 2007-2018 Wrangler JK and 2018 Wrangler JL models with factory hardtop
- All-purpose, all-weather, year-round replacement for bulky Freedom Panels
- Easy, no-drill installation. Includes all parts necessary
- Unique folding design lets you flip the panel back for an open-sky ride right from your front seat, or simply pull it forward and latch to the windshield header just like the original panels
- Designed for ease-of-use and durability with OEM quality

⚠ California Proposition 65 Warning: Cancer and Reproductive Harm.

YEAR	MODEL	PART #	COLORS
07-18	Wrangler JK 2-Door & Wrangler 4-Door Unlimited	52450	17, 35
18-Current	Wrangler JL 2-Door & Wrangler 4-Door Unlimited	52452	17, 35

Colors: 17-Black Twill, 35-Black Diamond. See page 87 for detailed color/fabric views.



Pictured: All-New Trektop™ (56863-17), Caribou, Colorado



Use of tailgate bar and clips allows hassle-free opening of tailgate



Sunrider® panel provides zippered, mesh pockets for small gear items



Zipperless technology used in key areas to improve fit and installation



OE style door surrounds allow easy installation and operation – all hardware included

ALL-NEW TREKTOP™

- Run as fully-enclosed, all-season soft top or remove the sides and rear window and enjoy as a bikini (options for a variety of window configurations)
- New Sunrider® design allows the top to open from inside the vehicle with an unobstructed view without the front arch bar (Sunrider® hardware is made of high-strength steel and engineered thermoplastic polymer) (except TJ)
- Improved fabric positioning and tension with the Bestop® F.I.T. System (Fabric Install & Tensioning System) only on JK 4-door models
- Hybrid zipper/zipperless design utilizes patented zipperless technology to allow for easy removal of window panels and zippers on rear panel provide security and easy changes in configuration (except TJ)
- Kit includes: soft top fabric, patented factory-exact door surrounds, tinted and replaceable windows, integrated header, tailgate bar, and Sunrider® feature
- Works with all factory full- and half-steel doors as well as Bestop® door kits (sold separately)
- Trektop Family Window Bag 42815-35 available separately

⚠ California Proposition 65 Warning: Cancer and Reproductive Harm.

Black Diamond

- Tough, 28-oz multi-ply, premium grade Sailcloth material offers OEM quality noise reduction and insulation
- Tinted, removable 30 mil thick windows are DOT-approved

Premium Twill

- Premium Twill fabric has superior durability and is featured on high-end sports and luxury cars
- Elegant, smooth and wrinkle-resistant fabric containing no PVCs, is easy to clean, and is more flexible with a softer feel and superior cold-weather performance than Sailcloth fabric
- Industry-leading 40 mil, DOT-approved vinyl side and rear windows have 18% tint to help keep interior cooler in warm weather
- Available in premium Twill (Black, Crushed Red Pepper, Navy Blue, Granite Grey, Oak Tan, or Pebble Beige) or Black Diamond fabric

ALL-NEW TREKTOP™



2015 Wrangler JK Unlimited
56853-17



2017 Wrangler JK 2-Door
56852-17



2015 Wrangler JK Unlimited
56853-17



2018 Wrangler JL Unlimited
56863-17

YEAR	MODEL	PART #	COLORS
97-06	Wrangler	56820	15, 35, 37
04-06	Wrangler Unlimited	56821	35
97-06	Wrangler (excluding Unlimited)	56920	17
07-18	Wrangler JK 2-Door	56852	17, 35, 68, 69, 70, 71, 74
07-18	Wrangler JK Unlimited	56853	17, 35, 68, 69, 70, 71, 74
18-Current	Wrangler JL 2-Door	56862	17, 35, 68, 69, 70, 71, 74
18-Current	Wrangler JL Unlimited	56863	17, 35, 68, 69, 70, 71, 74

All models have 18% tinted windows, door surrounds, tailgate bar, removable DOT-approved windows, and sunroof feature. Doors not included. Black Diamond fabric has 30 mil thick windows. Black Twill fabric has 40 mil thick windows.

Colors: 17-Black Twill, 35-Black Diamond, 68-Crushed Red Pepper Twill, 69-Navy Blue Twill, 70-Granite Grey Twill, 71-Oak Tan Twill, 74-Pebble Beige Twill. See page 87 for detailed color/fabric views.

NEW! SUPERTOP® ULTRA



Pictured: Supertop® Ultra (54724-17), Superior, Colorado



Premium Twill models feature durable 40 mil thick windows



Combination of zippers and zipperless channels makes window install and removal seamless



Innovative guide track (patented pending) makes the Supertop® Ultra easy to operate



Folds easily back behind the rear seat for a total open-air ride



Coor Doors
on pages 40

Pictured: Supertop® Ultra (54724-17), Superior, Colorado

NEW! SUPERTOP® ULTRA

- Our most premium, year-round, versatile soft top
- Run it as a fully enclosed soft top, a Safari style bikini, or fully open
- Our integrated rail system greatly simplifies the transition from fully enclosed to open-air. After removing the side and rear window panels, the top slides easily into the rear cargo area in one fluid motion, and can be operated by one person
- Features traditional square-back profile found in OE soft-tops
- The enhanced Sunrider® feature is simple to open thanks to gas strut assistance and lets in the sunshine over the front and most of the rear seats. Throw it open in a matter of seconds
- Combination of zippers and zipperless channels makes window install and removal seamless
- Folds compactly behind rear seat
- Made of high-grade premium fabric that maintains its shape in all temperatures, is mildew resistant, and contains UV inhibitors

Premium Twill

- 30-oz. triple-layer Premium Twill fabric has superior durability to other fabric used in Jeep soft tops
 - Features a smooth, wrinkle-resistant appearance and contains no PVCs
 - More flexible with softer feel and superior cold-weather performance
 - Industry-leading 40 mil, DOT-approved vinyl side and rear windows have 18% tint to help keep interior cooler in warm weather climates
- ⚠️ California Proposition 65 Warning: Cancer and Reproductive Harm.

YEAR	MODEL	PART #	COLOR
07-18	Wrangler JK 4-Door	54724	17, 35

All models have 18% tinted windows, door surrounds, tailgate bar, removable DOT-approved windows, and sunroof feature. Doors not included. Black Diamond fabric has 30 mil thick windows. Premium Twill fabric has 40 mil thick windows.

Colors: 17-Black Twill, 35-Black Diamond. See page 87 for detailed color/fabric views.

TREKTOP™ GLIDE™



Element Doors
on pages 42-43

Modular Bumpers
on pages 56-57

Pictured: Trektop™ Glide™ (54923-17), Superstition Mountain, California



Includes all soft top fabric, window panels and simplified bows for a no-drill installation



Zipperless side and rear windows allow for easy installation or removal, just like the hybrid Trektop™ Pro soft top



New folding frame design lets the Trektop™ Glide™ fold back behind the rear seat for a total open-air ride or pull forward when you want full coverage



Keep track of your small gear items in the zippered mesh pockets on the Sunrider® panel when you want full coverage



2016 Wrangler JK Unlimited
54923-17

Bumpers on
pages 56-60



2013 Wrangler JK 2-Door
54922-17



2013 Wrangler JK 2-Door
54922-17



2016 Wrangler JK Unlimited
54923-17

TREKTOP™ GLIDE™

- Inspired by the most popular soft top in the market since 2012 – the Trektop™ – the Trektop™ Glide™ brings together versatility, durability, and extreme ease of operation – plus several technologies exclusive to Bestop®. The result is a whole new level of performance and soft top enjoyment
 - Innovative new folding frame design lets the Trektop™ Glide™ function like a convertible top—just fold back behind the rear seat for a total open-air ride. For full coverage, the Trektop™ Glide™ is fast and simple to close
 - Premium Twill features 40 mil, DOT-approved vinyl side and rear windows have 18% tint to help keep interior cooler in warm weather
 - Zipperless side and rear panels allow for easy slide-in and slide-out, just like the ultra-premium Trektop™ Pro soft top
 - Features the popular fastback look
 - Built-in Sunrider® sunroof allows for open air driving and hardware is made of high strength steel and engineered thermoplastic polymer
 - Includes all the soft top fabric, side and rear windows, door surrounds, top arch bar(s), tailgate bar, and all hardware for a no-drill installation
 - Zippered mesh pockets integrated into the Sunrider panel for storage of small gear items
 - Available in premium Twill (Black, Crushed Red Pepper, Navy Blue, Granite Grey, Oak Tan, or Pebble Beige) or Black Diamond fabric
- Trektop Family Window Bag 42815-35 available separately
- ⚠ California Proposition 65 Warning: Cancer and Reproductive Harm.

YEAR	MODEL	PART #	COLORS
07-18	Wrangler JK 2-Door	54922	17, 35, 68, 69, 70, 71, 74
07-18	Wrangler JK 4-Door	54923	17, 35, 68, 69, 70, 71, 74
All models have 18% tinted windows, door surrounds, tailgate bar, removable DOT-approved windows, and sunroof feature. Doors not included. Black Diamond fabric has 30 mil thick windows. Premium Twill fabric has 40 mil thick windows.			
Colors: 17-Black Twill, 35-Black Diamond, 68-Crushed Red Pepper Twill, 69-Navy Blue Twill, 70-Granite Grey Twill, 71-Oak Tan Twill, 74-Pebble Beige Twill. See page 87 for detailed color/fabric views.			

ALL-NEW TREKTOP™ PRO



Bumpers on pages 56-60

Pictured: Trektop™ Pro (54852-17), Rollins Pass, Colorado



Improved Sunrider feature for easier open-air access



Rear glass hatch allows instant access to the cargo area



Defroster grid and connector



Window Storage Portfolio Bag for Wrangler JK 2007-2018



Twill Tire Covers on page 69

Powerboard on pages 84-85

2016 Wrangler JK Unlimited 54863-17

Bumpers on pages 56-60



2013 Wrangler JK 2-Door 54862-17



2016 Wrangler JK 4-Door 54863-17



2016 Wrangler JK 4-Door 54863-17

ALL-NEW TREKTOP™ PRO

- Industry-first hard rear glass hatch allows for easy, one hand operation and accessibility to rear cargo area-no messing with zippers
- Let the sun in with Bestop's exclusive Sunrider® flip-back panel
- Allows easy install or removal of rear hatch and side window panels
- Side windows feature slider panels for extra ventilation in the back
- Easily converts into a Safari Bikini® Top for open-air driving
- Weighs less than a hard top, has all-season capability
- Removes quickly, unlike factory or aftermarket hard tops
- Rear glass hatch has gas assist strut and integrated defroster connect
- Available in premium Twill (Black, Crushed Red Pepper, Navy Blue, Granite Grey, Oak Tan, or Pebble Beige)

California Proposition 65 Warning: Cancer and Reproductive Harm.

APPLICATIONS

YEAR	MODEL	PART #	COLORS
07-18	Wrangler JK 2-Door	54862	17, 68, 69, 70, 71, 74
07-18	Wrangler JK 4-Door Unlimited	54863	17, 68, 69, 70, 71, 74

All models have 18% tinted windows, door surrounds, tailgate bar, 40 mil thick removable windows, and sunroof feature. Doors not included.

Colors: 17-Black Twill, 68-Crushed Red Pepper Twill, 69-Navy Blue Twill, 70-Granite Grey Twill, 71-Oak Tan Twill, 74-Pebble Beige Twill. See page 87 for detailed color/fabric views.

ACCESSORIES

YEAR	MODEL	PART #	COLOR
07-18	Defroster/Rear Wiper Harness for Trektop Pro	54857	01
07-18	Rear Window Wiper Motor Assembly for Trektop Pro	54858	01
07-18	Window Storage Portfolio Bag for Trektop Pro (see pg.16)	42811	01

Color: 01-Black

SUPERTOP



Pictured: Supertop® (54823-17), Rollinsville, Colorado

SUPERTOP®

- Includes soft top fabric, side and rear windows, door surrounds, Top Arch bar(s), tailgate bar, and all hardware for installation
- Features Sunrider® sunroof in TJ, TJD, and JK models for open air driving (YJ models feature original factory hardware design and function)
- Made of high-grade premium fabric that maintains its shape in all temperatures, is mildew-resistant, and contains UV inhibitors
- High strength steel and OEM style thermoplastic polymer hardware
- Folds compactly behind rear seat for convertible top operation and function
- All models (except YJ) include quick-release bow knuckles that help easily remove the hardware from the vehicle
- Includes Bestop® bow mount adjustment plate for tensioning your top on TJ, TJD, and JK models
- Tailgate bar allows you to open tailgate without opening the rear window for trouble-free access
- TJ, TJD, and JK 2-Door applications feature Top Arch bar that spans above the front seat area to keep top tight and helps minimize puddling and retain top shape
- 07-17 Wrangler 4-Door application has 2 removeable Top Arch bars that span across the front and rear seating areas

- Features Bestop's improved door surrounds similar to the OE style door surrounds
- Works with all Bestop door kits (sold separately) including 2-Piece Doors, Upper Doors, Element Doors, and Lower Fabric Half doors (except YJ models)
- YJ works with factory lower hard half steel doors, Bestop Upper Door Sliders (Part #51785) and Bestop Fabric Upper Doors (Part # 51782)
- The only full soft top kit with hardware available for 04-06 Wrangler TJD

Premium Twill

- 30-oz. triple-layer Premium Twill fabric has superior durability to other fabric used in Jeep soft tops
- Features a smooth, wrinkle-resistant appearance and contains no PVCs
- More flexible with softer feel and superior cold-weather performance
- Industry-leading 40 mil, DOT-approved vinyl side and rear windows have 18% tint to help keep interior cooler in warm weather climates
- Available in these premium twill colors: Black, Crushed Red Pepper, Navy Blue, Granite Grey, Oak Tan, or Pebble Beige

⚠ California Proposition 65 Warning: Cancer and Reproductive Harm.



2016 Wrangler JK 4-Door Unlimited
54823-17



2004-2006 Wrangler Unlimited
54721-35



2010 Wrangler JK 2-Door
54822-17



2007 Wrangler JK 4-Door Unlimited
54723-35



Removable and replaceable tinted windows with top-of-the-line YKK scoop count zippers



Patented door surrounds offer factory-exact fit and finish on Wrangler TJ and JK models



Exclusive Top Arch bar(s) support the top fabric to minimize wrinkles and water puddling



Adjustable bow system helps keep fabric taut and includes Bestop® quick-release bow knuckles

YEAR	MODEL	PART #	COLORS
88-95	Wrangler	54601	01, 15, 37
97-06	Wrangler	54720	15, 35, 37
97-06	Wrangler	54820	17
04-06	Wrangler Unlimited	54721	35
07-18	Wrangler JK 2-Door	54722	35
07-18	Wrangler JK 2-Door	54822	17, 68, 69, 70, 71, 74
07-18	Wrangler JK 4-Door Unlimited	54723	35
07-18	Wrangler JK 4-Door Unlimited	54823	17, 68, 69, 70, 71, 74

All Part #s include 18% tinted side and rear windows and are DOT-approved. Doors not included. Black Diamond fabric has 30 mil thick windows. Premium Twill fabric has 40 mil thick windows.

Colors: 01-Black, 15-Black Denim, 17-Black Twill, 35-Black Diamond, 37-Spice, 68-Crushed Red Pepper Twill, 69-Navy Blue Twill, 70-Granite Grey Twill, 71-Oak Tan Twill, 74-Pebble Beige Twill. See page 87 for detailed color/fabric views.



Heritage—the one path we continue to forge with innovation and determination. It's driving forward progress as we deliver high-caliber soft top covers and never steer off course. It's respecting tried-and-true approaches. It's producing modern breakthroughs. After all, it's our 65-year-old legacy at stake every time the rubber hits the road. Because like you, we make every journey count.

Pictured: Supertop® Classic (51599-37) in Spice, Empire, Colorado

SUPERTOP® CLASSIC



92-95 YJ Wrangler
54599-15



1968 Bronco
51533-01



Toyota FJ-40
51464-15



CJ-5
51597-15



CJ-8 Scrambler
54608-15

SUPERTOP® CLASSIC

- Kits include hardware, soft top fabric, and windows (some include soft doors)
- Premium fabric maintains shape in any temperature, is mildew resistant, and contains UV inhibitors and offered in factory-original colors
- Belt-Rail™ attachment system enables fast, easy installation
- Chemically-treated hardware and powder-coated for rust resistance to ensure long life
- Tailgate bar allows you to open the tailgate without opening the rear window for trouble-free access on most applications
- Heavy-duty YKK scoop-counted zippers allow for easy window installation and removal
- Sealed seams for watertight protection
- Industrial-strength thread ensures durable soft top construction
- Replaceable, DOT-approved, heat-sealed vinyl windows in clear or 18% tint meet U.S. and European regulations
- In Supertop® kits containing tinted windows, the door windows are not tinted to meet regulations in all states
- Supertop skins include fabric and either clear or tinted side and rear windows

⚠ California Proposition 65 Warning: Cancer and Reproductive Harm.

SUPERTOP® CLASSIC

YEAR	MODEL	DOORS	WINDOWS	PART #	COLORS
55-75	CJ-5	2-piece soft doors (see pgs. 40-41)	clear	51595	01, 04, 15
51-62	M-38A1	2-piece soft doors (see pgs. 40-41)	clear	51595	01, 04, 15
76-83	CJ-5	2-piece soft doors (see pgs. 40-41)	clear	51597	01, 04, 15
76-95	CJ-7, Wrangler	use factory full doors	clear	51599	01, 15, 37
76-95	CJ-7, Wrangler	use factory full doors	tinted	54599	15, 37
81-85	CJ-8 Scrambler	not included	tinted	54608	15
97-06	Wrangler	use factory full doors	tinted	54709	15, 35, 37
66-77	Ford Bronco	sold separately (see pgs. 40-41)	tinted	51533	01
64-84	Toyota Land Cruiser FJ40	sold separately (see pgs. 40-41)	clear	51464	15

SUPERTOP® CLASSIC SKINS

YEAR	MODEL	DOORS	WINDOWS	PART #	COLORS
76-95	CJ-7, Wrangler 2-Door	sold separately (see pgs. 40-41)	clear	55799	15, 37
76-95	CJ-7, Wrangler 2-Door	sold separately (see pgs. 40-41)	tinted	55729	15, 37
97-06	Wrangler 2-Door	sold separately (see pgs. 40-41)	tinted	55629	15, 35

Colors: 01-Black, 04-Tan, 15-Black Denim, 35-Black Diamond, 37-Spice. See page 87 for detailed color/fabric views.

SUNRIDER® & HALFTOP™



TJ Wrangler
51699-15



1994 YJ Wrangler
51698-37



2002 Wrangler
53809-15

Halftop™ can completely enclose the cab and rear cargo area for all-weather use



The rear window of the Halftop™ zips out; the mesh screen stays in place

SUNRIDER®

- Convenient fold-back sunroof for open-air driving enjoyment
- Premium fabric maintains shape in any temperature, mildew-resistant, contains UV inhibitors and offered in factory original colors
- Patented Belt-Rail™ attachment system (YJ only) allows for fast, easy installation and snug fit
- Chemically-treated hardware and powder-coated for rust resistance ensuring long life
- Tailgate bar allows tailgate to open without opening rear window for trouble-free access
- Heavy-duty molded coil zippers allow for easy window installation and removal
- Sealed seams mean watertight protection
- Industrial-strength thread ensures durable soft top construction
- Heat-sealed, DOT-approved vinyl windows meet U.S. and European regulations
- Fits with a variety of Bestop door kits (see pages 40-45)
- Includes hardware, soft top and windows (doors sold separately)

⚠ California Proposition 65 Warning: Cancer and Reproductive Harm.

YEAR	MODEL	PART #	COLORS
76-95	CJ-7; Wrangler	51698	01,15, 37
97-02	Wrangler	51699	15, 37
03-06	Wrangler	51719	35

Color: 01-Black, 15-Black Denim, 35-Black Diamond, 37-Spice.
See page 87 for detailed color/fabric views.

HALFTOP™

- Combines the best features of the Bikini®, Windjammer™, and Duster™ accessories, sealing entire cockpit from exposure to elements
- Convenient fold-back Sunrider® sunroof allows for open-air driving
- Zip-down DOT-approved rear window, built-in mesh screen for maximum ventilation
- For unsurpassed appearance and durability, the premium fabric maintains its shape in any temperature, is mildew-resistant, and contains UV inhibitors
- Belt-Rail™ attachment system (YJ only) allows fast, easy installation
- Chemically-treated hardware and powder-coated for rust resistance to ensure long life
- Tailgate bar allows you to open the tailgate without opening the rear compartment for trouble-free access
- Industrial-strength thread ensures durable soft top construction
- Fits with a variety of Bestop® door kits (sold separately, see pages 40-45)
- Includes soft top and all hardware

⚠ California Proposition 65 Warning: Cancer and Reproductive Harm.

YEAR	MODEL	DETAILS	PART #	COLOR
92-95	Wrangler	Includes hardware	53818	15
97-02	Wrangler	Vehicles with factory soft top hardware	53809	15
97-02	Wrangler	Vehicles with factory hardtop (includes hardware)	53819	15

Color: 15-Black Denim. See page 87 for detailed color/fabric views.

TIGERTOP™



CJ-2A
51402-01



Rear and side windows roll up for a genuine safari look



Snaps are reinforced for durability and hidden for a clean look



Tigertop installed on CJ-7

TIGERTOP™

- Easily attaches to vehicle with reinforced snaps for classic look
- Premium fabric maintains shape in any temperature, is mildew-resistant, and contains UV inhibitors
- Hardware on select applications is chemically-treated and powder-coated for rust resistance to ensure long life
- Bestop® Tigertop™ hardware parts can be replaced as needed
- Includes soft top, hardware, 1-piece doors (except Jeepster Commando), and clear windows

 California Proposition 65 Warning: Cancer and Reproductive Harm.

YEAR	MODEL	PART #	COLOR
41-49	CJ-2A, MB & WWII	51402	01
48-53	CJ-3A, M-38	51403	01
53-64	CJ-3B	51404	01
55-75	CJ-5	51405	01
51-71	M-38A1	51405	01
76-83	CJ-5	51407	01
76-86	CJ-7	51408	01
56-75	CJ-6	51306	01
67-73	Jeepster Commando	51311	01

Color: 01-Black. See page 87 for detailed color/fabric views.

PREMIUM COLOR TOPS



Element Doors
on pages 42-43

Pictured: Supertop® in Navy Blue Twill (54823-69) and Granite Grey Twill (54823-70), Valley of the Moon, Jacumba, California

PREMIUM TWILL COLOR TOPS

- Four premium soft tops available in six exciting colors: Black, Crushed Red Pepper, Navy Blue, Granite Grey, Oak Tan, Pebble Beige
- Limited Lifetime Warranty. We proudly stand behind the premium quality of our fabric, design of our tops, and superior construction of our products. Our only request is that you be sure of your color choice for this top, since color mismatch is not covered by our return policy
- Available colored soft tops include: Supertop™ (pg. 20), Trektop™ Glide™ (pg. 16), All-New Trektop™ (pg. 12), and Trektop™ Pro (pg. 18)
- Premium acrylic material
- Consumers can customize their tops even more with separately colored window kit options – mix and match for an even more unique look
- **Please note:** Available colors are accent colors only and chosen to complement Jeep® body colors only – not match them exactly. If you would like to request color swatches to determine color options, we're happy to send them.
- See page 87 for detailed color/fabric views
- **Swatch Books available: Part # 39318-00**
- ⚠ California Proposition 65 Warning: Cancer and Reproductive Harm.



68-Crushed Red
Pepper Twill



69-Navy Blue Twill



70-Granite Grey Twill



71-Oak Tan Twill



74-Pebble Beige Twill



Supertop®
2016 Wrangler JK Unlimited
in Navy Blue Twill
54823-69



Supertop®
2016 Wrangler JK Unlimited
in Oak Tan Twill
54823-71



Trektop™ Glide™
2013 JK Wrangler 2-Door
in Pebble Beige Twill
54922-74



All-New Trektop™
2017 Wrangler JK 2-Door
in Granite Grey Twill
56862-70



All-New Trektop™ Pro
2015 Wrangler JK Unlimited
in Crushed Red Pepper Twill
54853-68

SUPERTOP®

YEAR	MODEL	PART #	COLORS
07-18	Wrangler JK 2-Door	54822	17, 68, 69, 70, 71, 74
07-18	Wrangler JK Unlimited	54823	17, 68, 69, 70, 71, 74

ALL-NEW TREKTOP™

YEAR	MODEL	PART #	COLORS
07-18	Wrangler JK 2-Door	56862	17, 68, 69, 70, 71, 74
07-18	Wrangler JK Unlimited	56863	17, 68, 69, 70, 71, 74

TREKTOP™ GLIDE™

YEAR	MODEL	PART #	COLORS
07-18	Wrangler JK 2-Door	54922	17, 68, 69, 70, 71, 74
07-18	Wrangler JK Unlimited	54923	17, 68, 69, 70, 71, 74

ALL-NEW TREKTOP™ PRO

YEAR	MODEL	PART #	COLORS
07-18	Wrangler JK 2-Door	54862	17, 68, 69, 70, 71, 74
07-18	Wrangler JK Unlimited	54863	17, 68, 69, 70, 71, 74

Pictured: OEX Replace-A-Top™ (79349-35), Moab, Utah

PREMIUM SOFT TOP REPLACEMENTS



Soft top fabrics may not look new forever. To keep your journeys strong, put your trust in the leader of premium soft top covers. You'll find the replacement top for your original factory soft top hardware that's still up for thousands of more rides.

OEX REPLACE-A-TOP™ BLACK DIAMOND

Made for 2007-2018 JK 2-Door/4 JKU 4-Door.

With the OEX Replace-A-Top, it's exactly the same fabric and windows we supply as the optional factory Black Diamond top sporting tinted windows.

REPLACE-A-TOP™

Made for CJ5/CJ7/YJ/TJ models, as well as the Tracker and Samurai.

Ideal for older Jeep models, the original denim-based Replace-A-Top gives your original factory soft top hardware a second life.

REPLACE-A-TOP™ BLACK TWILL FOR OEM

Made for 1997-2006 Wrangler TJ and 2007-2018 Wrangler JK.

The premium Black Twill fabric is the toughest and most durable.

SAILCLOTH REPLACE-A-TOP™

Made for 1988-2018 Wrangler YJ/TJ/LJ/JK models.

Sailcloth is a heavier, diamond-textured, multi-ply fabric to conquer the elements. Its tighter design reduces road sounds and absorbs wind noise.

OEX REPLACE-A-TOP™

(FOR OEM HARDWARE)



2011 Wrangler JK Unlimited
79349-35



2-door version of the OEX Replace-A-Top™



Passenger-side rear quarter panel window and rear window close-up



Easy installation, and provides a snug, trim fit.

OEX REPLACE-A-TOP™ (FOR OEM HARDWARE)

- While the competition may claim to have material that is "OE Approved" or "OE Spec", in OEX construction Bestop uses the **exact** same material used in the construction of the original equipment standard soft tops found on JK Wranglers
- The 40-mil DOT-approved vinyl windows are the thickest vinyl windows available on any soft top, are heat-sealed, and tinted at 18%
- Requires factory-original hardware for installation
- See page 34-37 for Replacement Hardware Kits
- For best appearance and durability, the premium fabric maintains its shape in any temperature, is mildew-resistant, and contains UV inhibitors
- Heavy-duty zippers allow for easy window installation, removal, and replacement
- Industrial-strength thread ensures durable soft top construction
- Sealed seams mean water-tight protection
- Built to factory-original quality specifications to ensure a proper fit
- Most Bestop® soft top parts can be replaced individually as needed, extending the value of the original purchase

⚠️ California Proposition 65 Warning: Cancer and Reproductive Harm.

ALL REPLACE-A-TOP™ SOFT TOPS REQUIRE YOUR FACTORY-ORIGINAL HARDWARE, FRAMES, AND BOWS IN GOOD CONDITION FOR INSTALLATION (SEE PAGES 32-33).

YEAR	MODEL	DOORS	WINDOWS	PART #	COLOR
07-09	Wrangler 2-Door	no doors included	tinted side & rear	79338	35
07-09	Wrangler 4-Door Unlimited	no doors included	tinted side & rear	79339	35
10-18	Wrangler JK 2-Door	no doors included	tinted side & rear	79348	35
10-18	Wrangler JK 4-Door Unlimited	no doors included	tinted side & rear	79349	35

Color: 35-Black Diamond. See page 87 for detailed color/fabric views.

REPLACE-A-TOP™

2007 Wrangler JK
79836-35



REPLACE-A-TOP™ (FOR OEM HARDWARE)

OEM Grade Vinyl

- For 1976-2006 CJ5/CJ7/Wrangler; 1986-2002 Samurai/Sidekick/Tracker/Vitara
- Requires factory soft top original hardware in good condition, will not fit aftermarket hardware
- Replace-A-Top™ kits include the soft top fabric, window panels, and door skins (where applicable)
- Some applications offer choice of clear or tinted windows
- For appearance and durability, the premium fabric maintains shape in any temperature
- Built to factory original quality specifications to ensure a proper fit
- Kits with replacement door skins attach over your factory original door frames
- All Bestop® soft top parts can be replaced individually, extending the value of your purchase

Premium Twill

- For 1997-2006 Wrangler TJ and 2007-2017 Wrangler JK
- Requires factory original hardware for installation
- Super-premium 30-oz. triple-layer Black Twill fabric has superior durability and appearance
- Features a smooth, wrinkle-resistant appearance, and contains no PVCs
- More flexible with a softer feel and superior cold-weather performance than Sailcloth fabric
- Built to factory original quality specifications to ensure a proper fit with your factory steel doors
- Industry-leading 40 mil, vinyl side and rear windows have 18% tint to help keep interior cooler in warm weather
- Removable and replaceable windows feature top of the line YKK scoop count zippers for easy removal or installation with extended-surface heat-sealing for strength and protection from climate extremes
- 135 gauge polyester industrial thread used throughout with finished seams for lifelong durability

⚠ California Proposition 65 Warning: Cancer and Reproductive Harm.

SOFT TOP REPLACEMENTS



2005 Wrangler TJ
79841-17



Black Twill has 40 mil, DOT-approved vinyl side and rear windows that attach to existing Belt-Rail system



2011 Wrangler JK Unlimited
79847-17



95-98 Tracker
51364-52



CJ-7
51118-01

ALL REPLACE-A-TOP SOFT TOPS REQUIRE YOUR FACTORY-ORIGINAL HARDWARE, FRAMES, AND BOWS IN GOOD CONDITION FOR INSTALLATION (SEE PAGES 34-35).

YEAR	MODEL	DOORS	WINDOWS	PART #	COLORS
76-83	CJ-5	full door skins	clear	51117	01
76-86	CJ-7	full door skins	clear	51118	01
1987	Wrangler	upper half door skins	clear	51119	01
88-95	Wrangler	upper half door skins	clear	51120	09, 15, 37
88-95	Wrangler	upper half door skins	tinted side & rear	51123	09,15,37
97-02	Wrangler	upper half door skins	clear	51121	15, 37
97-02	Wrangler	upper half door skins	tinted side & rear	51124	15, 33, 37
97-02	Wrangler	for full steel door models only	clear	51127	15, 33, 37
97-02	Wrangler	for full steel door models only	tinted side & rear	51180	15, 33, 37
97-06	Wrangler (excluding Unlimited)	for full steel door models only	tinted side & rear	79841	17
03-06	Wrangler (excluding Unlimited)	upper half door skins	clear	51128	35
03-06	Wrangler (excluding Unlimited)	upper half door skins	tinted side & rear	51129	35
03-06	Wrangler (excluding Unlimited)	for full steel door models only	clear side & rear	51178	35
03-06	Wrangler (excluding Unlimited)	for full steel door models only	tinted side & rear	51193	35
07-09	Wrangler 2-Door	for full steel door models only	tinted side & rear	79836	17
07-09	Wrangler 4-Door Unlimited	for full steel door models only	tinted side & rear	79837	17
10-18	Wrangler JK 2-Door	for full steel door models only	tinted side & rear	79846	17
10-18	Wrangler JK 4-Door Unlimited	for full steel door models only	tinted side & rear	79847	17
88-94	Chevrolet-Geo-Suzuki Tracker/Sidekick	no doors included	clear	51362	15, 52
95-98	Chevrolet-Geo-Suzuki Tracker/Sidekick	no doors included	clear	51364	01, 52
99-04	Chevrolet-Geo-Suzuki Tracker/Vitara	no doors included	clear	51366	01
88-94	Suzuki Samurai	no doors included	clear	51361	01, 15, 52
88-94	Suzuki Samurai Sprint™ Top	no doors included	clear	53361	01

All upper half door skins have clear windows.

Colors: 01-Black, 09-Charcoal, 15-Black Denim, 17-Black Twill, 33-Dark Tan, 35-Black Diamond, 37-Spice, 52-White Denim. See page 87 for detailed color and texture.

SAILCLOTH REPLACE-A-TOP™



1992 Wrangler
79123-01



The Belt-Rail™ system offers ease of installation and provides a snug, trim fit



Wrangler JK Unlimited
79137-35

YEAR	MODEL	DOORS	WINDOWS	PART #	COLORS
88-95	Wrangler	upper half door skins	clear	79120	01, 37
88-95	Wrangler	upper half door skins	tinted side & rear	79123	01, 37
97-02	Wrangler	for full steel doors	clear	79122	01, 37
97-02	Wrangler	for full steel doors	tinted side & rear	79139	01, 37
97-02	Wrangler	upper half door skins	clear	79121	01, 37
97-02	Wrangler	upper half door skins	tinted side & rear	79124	01, 37
03-06	Wrangler	for full steel doors	clear	79125	35
03-06	Wrangler	for full steel doors	tinted side & rear	79141	35
03-06	Wrangler	upper half door skins	tinted side & rear	79129	35
04-06	Wrangler Unlimited	for full steel doors	tinted side & rear	79140	35
07-09	Wrangler 2-Door	for full steel doors	tinted side & rear	79136	35
07-09	Wrangler 4-Door	for full steel doors	tinted side & rear	79137	35
10-18	Wrangler JK 2-Door (cable style)	for full steel doors	tinted side & rear	79146	35
10-18	Wrangler JK 4-Door (cable style)	for full steel doors	tinted side & rear	79147	35

Colors: 01-Black, 35-Black Diamond, 37-Spice. See page 87 for detailed color/fabric views.

SAILCLOTH REPLACE-A-TOP™ (FOR OEM HARDWARE)

- Requires factory original hardware for installation
- Tough, multi-ply, 28 oz. premium-grade fabric dramatically reduces outside noise and enhances insulation for a more comfortable ride
- Kit includes soft top, windows, and optional door skins
- Heat-sealed 30 mil vinyl windows meet U.S. and European regulations
- Built to factory original quality specifications to ensure a snug, proper fit
- Door skins attach by hook-and-loop over factory original door frames for easy installation where applicable
- Optional 18% tinted window feature for customized look on most models



IDENTIFYING

It is important to identify what type of hardware you have. The type of soft top that should be purchased depends on whether your hardware is Factory-Original Equipment or Aftermarket.



YJ '87-'95 SUPERTOP® CLASSIC HARDWARE



YJ '88-'95 FACTORY/SUPERTOP® HARDWARE



TJ '97-'06 SUPERTOP® CLASSIC HARDWARE



TJ '97-'06 FACTORY/SUPERTOP® HARDWARE



YJ '87-'95 SUNRIDER® HARDWARE



TJ '97-'06 SUNRIDER® HARDWARE

YOUR HARDWARE

For older Jeep® models, such as early TJ, YJ, CJ-7 and CJ-5, the original hardware is likely to be damaged or in poor operating condition. Make sure to carefully check its condition (e.g. rust, out of shape, or altered) before ordering a Replace-A-Top.™ Need replacement hardware? See page 36-39 for details.



JK 2-DOOR '07-'18 SUPERTOP® CLASSIC HARDWARE



JK 2-DOOR '07-'09 FACTORY HARDWARE



JK 4-DOOR '07-'18 SUPERTOP® CLASSIC HARDWARE



JK 4-DOOR '07-'09 FACTORY HARDWARE



JK 2-DOOR '10-'18 FACTORY/SUPERTOP® HARDWARE



JK 4-DOOR '10-'18 FACTORY/SUPERTOP® HARDWARE

HARDWARE



QUICK RELEASE BOW KNUCKLES

- Fits factory hardware or Bestop® soft top hardware (not compatible with factory cable-style lift assist on 13-17 Wrangler Unlimited)
- Molded plastic knuckle speeds up top removal
- Set of six

⚠ California Proposition 65 Warning: Cancer and Reproductive Harm.

YEAR	MODEL	PART #	COLOR
97-18	Wrangler TJ (Inc. 04-06 TJD) & JK 2- & 4-door	51290	01

Color: 01-Black. See page 87 for detailed color/fabric views.



TAILGATE BAR KIT

- Replace old or worn out tailgate bar
- Includes one tailgate bar and two retainer mounts

⚠ California Proposition 65 Warning: Cancer and Reproductive Harm.

YEAR	MODEL	PART #	COLOR
97-06	Wrangler; includes tailgate bar & 2 retainer mounts (incl. unlm.)	52600	01
07-18	Wrangler JK 2- & 4-Door; includes tailgate bar & 2 retainer mounts	52601	01

Color: 01-Black. See page 87 for detailed color/fabric views.

2005 Wrangler TJ
55014-01



2010 Wrangler JK
55013-01



FACTORY-STYLE REPLACEMENT HEADER ASSEMBLY

- Replaces factory header and can be used with any OE style soft tops
- OEM style construction, composite polymer header
- 2-piece OEM style construction steel and composite plastic header for JK
- TJ windshield channel attaches to existing OEM hardware just like factory
- Kit includes header assembly with OEM style latches
- Does not work with Bikini® tops

⚠ California Proposition 65 Warning: Cancer and Reproductive Harm.

YEAR	MODEL	PART #	COLOR
97-06	Wrangler (including Unlimited)	55014	01
07-18	Wrangler JK 2- & 4-Door	55013	01

Color: 01-Black. See page 87 for detailed color/fabric views.

Windshield Channel for 97-06 TJ
51238-01



Windshield Channel for 07-18 Wrangler JK
51243-01



2-Piece Channel
51209-01



2-Piece Channel
51210-01



WINDSHIELD CHANNELS

- To attach a Bikini® to your vehicle, you need a windshield channel
- Carefully check the condition of existing channel to make sure it's tightly attached and free of rust or corrosion
- If you have a hardtop on your vehicle, a windshield channel must be installed for the Bikini® to fit
- Some windshield channels require drilling to install

66-77 Ford Bronco (#51206-01)

- Drill-in style. For Bkinis 52542

72-80 IH Scout II (#51207-01)

- Drill-in style. For Traditional Bkinis, this channel fits part numbers 52550

76-95 Jeep CJ-5, CJ-7, Wrangler (#51209-01)

- You do not need to purchase a windshield channel to install a Traditional Bikini or Strapless Bikini if you have a stock windshield that already has the channel built in

97-02 Jeep Wrangler (#51210-01)

- Drill-in style. For Strapless Bkinis, this channel fits part numbers 52521 and 52530

97-06 Jeep Wrangler (#51238-01)

- No-drill style. Part# 51238-01 is a one-piece design. For Header Bkinis, these channels fit part numbers 52525, 52528, 52531, 52532 and 52544

07-18 Jeep Wrangler JK 2- & 4-Door (#51243-01)

- No-drill application. For Header Bkinis, this channel fits part numbers 52580, 52581, 52583, 52584, 52585 and 52586

⚠ California Proposition 65 Warning: Cancer and Reproductive Harm.

YEAR	MODEL	PART #	COLOR
07-18	Wrangler JK 2- & 4-Door (Header No-Drill)	51243	01
97-06	Wrangler (Header No-Drill)	51238	01
97-02	Wrangler (Drill-in style)	51210	01
76-95	CJ-5, CJ-7, Wrangler (Drill-in style)	51209	01
64-84	Land Cruiser FJ40 (Drill-in style)	51209	01
72-80	Scout II (Drill-in Style)	51207	01
66-77	Bronco (Drill-in Style)	51206	01

Color: 01-Black. See page 87 for detailed color/fabric views.

HARDWARE

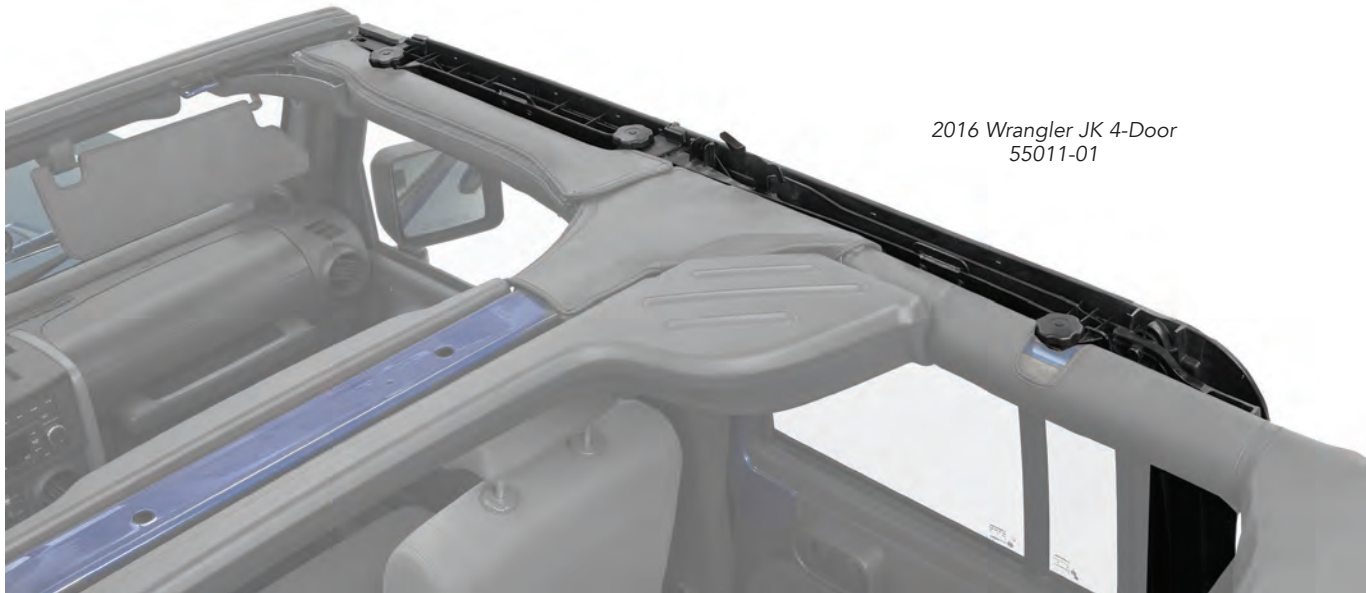

2016 Wrangler JK 4-Door
55011-01

2005 Wrangler TJ
55012-01

Door surrounds feature
OEM-style replacement knobs



2012 Wrangler JK
55010-01

JK Door surround
with Top Arch bar
latching point



TJ DOOR SURROUND KIT

For 1997-2006 Wrangler TJ

- Factory-style, door surrounds provide a superior attachment for tops and sealing surface for doors
 - Made of fiberglass-filled polypropylene and built to last
 - Compatible with OEM soft goods and Bestop's® Replace-A-Top™, Supertop®, and Sailcloth Replace-A-Top™
 - Factory-style door surrounds include latching point for Bestop Top Arch bar
 - Complete kit comes with driver and passenger side door surround, 4-door surround knobs, Top Arch bar, and tailgate bar
- ⚠ California Proposition 65 Warning: Cancer and Reproductive Harm.

JK DOOR SURROUND KIT

For 2007-2018 Wrangler JK

- Factory-style, cable-style Door Surrounds provide a superior attachment for tops and sealing surface for doors
 - Compatible with 2010-2018 hardware
 - Made of fiberglass-filled polypropylene and built to last
 - Compatible with OEM soft goods and Bestop's Sailcloth Replace-A-Top™ and Supertop®
 - Factory-style door surrounds include latching point for Bestop Top Arch bar
 - Complete kit comes with driver and passenger side door surround, 4-door surround knobs, (6 knobs on 4-door model) Top Arch Bar(s), and tailgate bar
- ⚠ California Proposition 65 Warning: Cancer and Reproductive Harm.

YEAR	MODEL	PART #	COLOR
97-06	Wrangler (including Unlimited)	55012	01
07-18	Wrangler JK 2-Door (Door surrounds for Wrangler JK are not compatible with 07-09 Factory Tops)	55010	01
07-18	Wrangler JK 4-Door (Door surrounds for Wrangler JK are not compatible with 07-09 Factory Tops)	55011	01

Color: 01-Black. See page 87 for detailed color/fabric views.



07-18 JK Factory Style
Bow Kit (Cable-Style)
55001-01



97-06 TJ Factory Style Bow Kit
55002-01

Factory Style Bow Kit complete
with Belt-Rail Attachment System
55004-01



FACTORY STYLE BOW KITS

- Designed to replace your factory hardware
- Made of carbon steel and engineered thermoplastic polymer
- Made to meet or exceed all OEM requirements
- YJ Wrangler includes Belt-Rail components, but does not include Top Arch bar, quick release bow knuckles or adjustable bow feature

California Proposition 65 Warning: Cancer and Reproductive Harm.

YEAR	MODEL	PART #	COLOR
88-95	Wrangler	55004	01
97-06	Wrangler	55002	01
04-06	Wrangler Unlimited	55003	01
07-18	Wrangler JK 2-Door*	55000	01
07-18	Wrangler JK 4-Door*	55001	01
Includes replacement hardware, door surrounds, tailgate bar, and retainer clips. * Cable-style hardware to be used with 2010+ style tops.			
Color: 01-Black. See page 87 for detailed color/fabric views.			

DOORS & WINDOWS



Removable center panel



Forward release handles

NEW! CORE DOORS

- The first one-piece cast aluminum door in the Jeep® Wrangler after market
- Precision modeled to fit the Jeep® Wrangler JK model firmly
- Easily removable center panel that does not require tools or the entire door to be removed
- Features forward release handles and lockable latches
- Included check straps prevent the door from contacting the Jeep body
- Mirror sold separately

⚠ California Proposition 65 Warning: Cancer and Reproductive Harm.

YEAR	MODEL	DETAILS	PART #	COLOR
07-18	Wrangler JK 2- & 4-Door	Lower Front Door Set	51730	01
07-18	Wrangler JK 4-Door	Lower Rear Door Set	51731	01

Color: 01-Black. See page 87 for detailed color/fabric views.



NEW! UPPER OE STYLE TWILL DOORS

- Install on Core Doors or OE Half Doors
- Made with Bestop Premium Twill fabric
- Additional colors to match your soft top are coming soon
- Mirror sold separately

⚠️ California Proposition 65 Warning: Cancer and Reproductive Harm.

YEAR	MODEL	DETAILS	PART #	COLOR
07-18	Wrangler JK 2- & 4-Door	Upper Front Door Set	51732	01
07-18	Wrangler JK 4-Door	Upper Rear Door Set	51733	01

Color: 01-Black. See page 87 for detailed color/fabric views.

DOORS & WINDOWS



ELEMENT™ DOORS FOR JEEP CJ7 AND WRANGLER

- Heavy-duty 1¼" tube construction provides security & protection, ventilation, and better trail vision
- Element™ Door Kit includes latches, door restraint strap, threaded holes in mirror mount plate, and dome light shut off bracket
- Pre-threaded mirror mount plate for OEM and Bestop® Replacement Mirrors
- Turn your Element™ Doors into lower half doors with optional enclosure kit, sold separately
- Optional Door Enclosure Kit is made of steel and is paintable for a color matched finish. Attaches to Element™ Door with locator feet and bolts. No drilling required
- Optional heavy-duty storage bags can be positioned for easy access inside or outside of vehicle
- Available in Satin or Matte Finish
- Mirrors sold separately (see page 47)

⚠ California Proposition 65 Warning: Cancer and Reproductive Harm.

ELEMENT™ DOOR ENCLOSURE KIT

- Turn Element™ Doors into half doors
 - Pre-punched for mirror mount bolts
 - Satin black powder-coated steel, ready to paint to match vehicle color, if desired
 - Use with Element™ upper doors for full cab enclosure
- ⚠ California Proposition 65 Warning: Cancer and Reproductive Harm.

ELEMENT™ DOORS

YEAR	MODEL	DETAILS	INCLUDES	SATIN PART #	MATTE PART #	COLOR
76-95	CJ-7, CJ-8 Scrambler & Wrangler	includes paddle handles with wedge-style door strikers	two lower door frames & paddle handles	51807	51823	01
80-95	CJ-7 & Wrangler	use with post-style door strikers	two lower door frames & paddle handles	51808	51824	01
97-06	Wrangler & Unlimited	use with hard door strikers	two lower door frames & paddle handles	51809	51825	01
07-18	Wrangler JK 2- & 4-Door	front doors	two lower door frames & paddle handles	51810	51826	01
07-18	Wrangler JK 4-Door	rear doors	two lower door frames & paddle handles	51811	51827	01

ELEMENT™ DOOR ENCLOSURE KIT

YEAR	MODEL	DETAILS	INCLUDES	PART #	COLOR
80-06	CJ7 & Wrangler	Front; Fits 51807, 51808, 51823, 51824	two steel black powder-coated, paintable door covers	51792	01
07-18	Wrangler JK 2-Door	Front; Fits 51810, 51826	two steel black powder-coated, paintable door covers	51803	01
07-18	Wrangler JK 4-Door	Rear; Fits 51811, 51827	two steel black powder-coated, paintable door covers	51804	01



JK 4-Door
51805 and 51806



JK 4-Door
51813 and 51814

ELEMENT™ DOOR UPPER DOORS

- Installs on Element™ Door
 - Made with same premium fabric as Supertop® and Trektop™ Family
 - Double-bulb weather strip provides good seal against the elements
 - Use hook-&-loop fastening system for tight, secure closure with Element Door
- ⚠ California Proposition 65 Warning: Cancer and Reproductive Harm.

ELEMENT™ DOOR STORAGE BAGS

- Storage Bags put extra storage on your Element™ Doors where there were none
 - Heavy-duty bags have multiple pockets and can be positioned with pockets facing inside the cab or outside the vehicle
 - Includes padding in the armrest area for extra comfort
 - Sold in pairs
- ⚠ California Proposition 65 Warning: Cancer and Reproductive Harm.

ELEMENT™ DOOR UPPER DOORS

YEAR	MODEL	DETAILS	INCLUDES	PART #	COLORS
80-95	CJ-7 & Wrangler	Front; Fits 51808, 51824	two upper soft doors	51795	15
97-06	Wrangler & Unlimited	Front; Fits 51809, 51825	two upper soft doors	51793	35
07-18	Wrangler JK 2- & 4-Door	Front; Fits 51810, 51826	two upper soft doors	51805	17, 35, 68, 69, 70, 71, 74
07-18	Wrangler JK 4-Door	Rear; Fits 51811, 51827	two upper soft doors	51806	17, 35, 68, 69, 70, 71, 74

Colors: 15-Black Denim, 17-Black Twill, 35-Black Diamond, 68-Crushed Red Pepper Twill, 69-Navy Blue Twill, 70-Granite Grey Twill, 71-Oak Tan Twill, 74-Pebble Beige Twill. See page 87 for detailed color/fabric views.

ELEMENT™ DOOR STORAGE BAGS

YEAR	MODEL	DETAILS	INCLUDES	MATTE PART #	COLORS
76-06	CJ-7, CJ-8 Scrambler, Wrangler	Front; sold in pairs	two storage bags with three pockets	51812	15, 35
07-18	Wrangler JK 2- & 4-Door	Front; sold in pairs	two storage bags with three pockets	51813	35
07-18	Wrangler JK 4-Door	Rear; sold in pairs	two storage bags with single pocket	51814	35

Colors: 15-Black Denim, 35-Black Diamond. See page 87 for detailed color/fabric views.

DOORS & WINDOWS



2-PIECE DOORS

- Most versatile door on the market. Bestop's® 2-piece soft door offers full enclosure from the elements or quick upper-half removal for open-air driving
 - 2-piece soft door kits include the passenger and driver side upper and lower soft doors complete with Rotary or Paddle Handle kits
 - 2-piece soft doors are compatible with Supertop®, Sunrider®, Trektop™, Sunrider® for Hardtop, Trektop™ Glide, and Halftop™
 - A snug fit is ensured by using adjustable lower pivot pins and door collars
 - To facilitate a good seal, hook and loop fastens upper and lower doors together and double-bulb weather stripping surrounds the door
 - Exterior fabric color matches Bestop and factory-original soft tops for unsurpassed appearance
- ⚠ California Proposition 65 Warning: Cancer and Reproductive Harm.

LOWER HALF DOORS

- Kits includes pair of lower Half Doors complete with Paddle Handle kits
 - Adjustable lower door pivot pins allow for a snug fit
 - Exterior fabric color matches Bestop and factory-original soft tops for unsurpassed appearance
 - Bestop Half Doors are quickly and easily installed
 - Does not receive Upper Soft Door
- ⚠ California Proposition 65 Warning: Cancer and Reproductive Harm.

2-PIECE DOORS

YEAR	MODEL	POSITION	FITS	PART #	COLORS
76-86	CJ-7	Front	Sunrider (51698), Supertop Classic (51599, 54599); door strikers included	51778	01, 15, 37
80-95	CJ-7 & Wrangler YJ	Front	Sunrider (51698), Supertop Classic (54599) & Halftop (53818); closes on factory hard door striker post	51783	01, 15, 37
97-06	Wrangler & Unlimited	Front	Factory soft tops and all Bestop Soft Tops	51789	15, 35, 37
07-18	Wrangler JK 2 & 4-Door	Front	Factory soft tops and all Bestop Soft Tops	51798	17, 35
07-18	Wrangler JK 4-Door	Rear	Factory soft tops and all Bestop Soft Tops	51799	17, 35
66-77	Ford Bronco	Front	Supertop Classic (51533)	51772	01
64-84	Toyota Land Cruiser FJ40	Front	Supertop Classic (51464)	51774	15

Colors: 01-Black Crush, 15-Black Denim, 17-Black Twill, 35-Black Diamond, 37-Spice. See page 87 for detailed color/fabric views.

LOWER HALF DOORS

YEAR	MODEL	POSITION	INCLUDES	PART #	COLORS
51-62 55-75 55-81	M-38A1 CJ-5 CJ-6	Front	paddle handles and door strikers included	53025	01
76-83	CJ-5	Front	paddle handles and door strikers included	53027	01
76-86	CJ-7 & CJ-8 Scrambler & Wrangler 2-Door	Front	paddle handles and door strikers included	53028	01, 15
80-95	CJ-7 & CJ-8 Scrambler & Wrangler 2-Door	Front	rotary style paddle handles (fits factory hard door striker post)	53038	01, 15
97-06	Wrangler 2-Door	Front	rotary style paddle handles (fits factory hard door striker loop)	53039	15, 35
07-18	Front Half Doors Wrangler JK 2- & 4-Door	Front	rotary style paddle handles (fits factory hard door striker loop)	53040	35
07-18	Rear Half Doors Wrangler JK 4-Door	Rear	rotary style paddle handles (fits factory hard door striker loop)	53041	35
64-84	Half Door Toyota Land Cruiser FJ40	Front	paddle handles and door strikers included	53030	01

Colors: 01-Black Crush, 15-Black Denim, 35-Black Diamond. See page 87 for detailed color/fabric views.



TJ Wrangler Upper Door sliders offer dual sliding glass panels that "click" shut with one hand

UPPER FABRIC DOORS

- Made of the same premium fabric as the Supertop®; include frames
 - Bulb weather stripping around the channel keeps out ice, snow, dirt, debris and provides a good seal to a top
 - Use with lower steel doors to create full cab enclosure
 - Fits factory-original lower steel door
- ⚠ California Proposition 65 Warning: Cancer and Reproductive Harm.

UPPER DOOR SLIDERS

- Fits factory-original lower steel door
 - Kits includes pair of soft upper doors with DOT-approved tempered safety glass windows that slide and latch
 - Double-bulb weather stripping around the channel keeps out ice, snow, dirt, debris and provides a good seal to soft top
 - Exterior fabric color matches Bestop® and factory-original soft tops for unsurpassed appearance
 - TJ Wrangler Upper Door Sliders offer dual sliding glass panels that "click" shut with one hand (excludes YJ models)
- ⚠ California Proposition 65 Warning: Cancer and Reproductive Harm.

UPPER FABRIC DOORS

YEAR	MODELS	POSITION	FITS	PART #	COLORS
88-95	Wrangler	Front	Supertop Classic (51599), Sunrider (51698), or Halftop (53818) - round	51780	01, 15, 37
88-95	Wrangler	Front	Supertop (54601) factory soft top or Replace-A-Top on factory original lower steel half doors - square	51782	01, 15, 37
97-06	Wrangler	Front	fits on factory lower steel half doors with any Bestop Soft Top	51790	15, 35, 37

Colors: 01-Black Diamond (Sailcloth), 15-Black Denim, 35-Black Diamond, 37-Spice. See page 87 for detailed color/fabric views.

UPPER DOOR SLIDERS

YEAR	MODELS	POSITION	FITS	PART #	COLORS
88-95	Wrangler	Front	factory soft top, Supertop (54601), or Replace-A-Top (51120 and 51123 only) - square	51785	15, 37
88-95	Wrangler	Front	Sunrider, Supertop Classic, and Halftops - round	51786	15, 37
97-06	Wrangler	Front	factory soft top and all Bestop soft tops	51787	15, 33, 35, 37

Colors: 15-Black Denim, 33-Dark Tan, 35-Black Diamond, 37-Spice. See page 87 for detailed color/fabric views.

DOORS & WINDOWS

Door Jackets
for Upper Doors
and Full Doors



Paddle
Handle Latches



Door Pin Inserts



Fabric Replacement
Door Skins shown
on YJ OE Upper
Door Frame

DOOR JACKETS

- Durable jackets utilize heavy-duty zippers providing protection during long- or short-term storage
- Each style of Door Jacket is designed with handles to help you easily carry and store your doors
- For added convenience, the full steel Door Jackets can be installed while the door is in place on your vehicle

⚠ California Proposition 65 Warning: Cancer and Reproductive Harm.

PADDLE LATCHES

- Replace lost or broken Paddle Latches for any Bestop® Door
- Sold in pairs

⚠ California Proposition 65 Warning: Cancer and Reproductive Harm.

DOOR PIN INSERTS

- Replace lost or cracked factory door pin inserts
- Exact fit with replacement factory-steel half doors
- Three Pin Inserts per kit

⚠ California Proposition 65 Warning: Cancer and Reproductive Harm.

FABRIC REPLACEMENT DOOR SKINS

- Bestop replacement door skins fit factory door frames using hook-and-loop attachments for quick, precise and easy installation
- A Door Skin kit contains driver and passenger skins
- Exterior fabric color matches Bestop and factory-original soft tops for unsurpassed appearance
- Zippered vinyl window

⚠ California Proposition 65 Warning: Cancer and Reproductive Harm.

FABRIC REPLACEMENT DOOR SKINS

YEAR	MODEL	DETAILS	PART #	COLORS
88-95	Wrangler	require factory upper door frames	53120	15, 37
97-06	Wrangler	require factory upper door frames	53121	15, 35, 37

PADDLE LATCHES

80-95	Wrangler	rotary latch kit; sold in pairs	51251	01
97-06	Wrangler	sold in pairs	51252	01

DOOR PIN INSERTS

87-06	Wrangler	three pin inserts per kit	51247	01
-------	----------	---------------------------	--------------	----

DOOR JACKETS

87-06	Wrangler	for soft upper doors; sold individually	51660	01
76-18	CJ-7, CJ-7, Wrangler All	full steel doors; sold in pairs	51666	01

Colors: 01-Black Crush, 15-Black Denim, 35-Black Diamond, 37-Spice. See page 87 for detailed color/fabric views.



2013 Wrangler JK
51260-01



2013 Wrangler JK with Power Mirror Connection
51266-01



2004 Wrangler TJ
51261-01



2002 Wrangler
51262-01

REPLACEMENT MIRRORS

- Replace worn or missing mirrors with OEM styling and features
- All mirror kits are sold in pairs and come complete with hardware
- All kits available in black; CJ, YJ and early TJ also in chrome finish

- Engineered to fit a wide variety of OE and Bestop door styles
- ⚠ California Proposition 65 Warning: Cancer and Reproductive Harm.

YEAR	MODEL	FITS	PART #	COLORS
07-18	Wrangler JK 2- & 4-Door	without powered mirrors	51260	01
11-13	Wrangler 2- & 4-Door	with electrically-powered mirrors	51266	01
03-06	Solid Arm factory Style	Wrangler 87-06 steel half doors, 94-06 full steel doors, Bestop Element Doors	51261	01
87-06	Open Slot Arm Style	Wrangler 87-06 steel half doors, 94-06 full steel doors, Bestop Element Doors (not recommended for soft doors, use 51261)	51262	00, 01

Colors: 00-Chrome, 01-Black. See page 87 for detailed color/fabric views.

THE ALL-NEW 2019 JEEP JT

Watch for innovative new soft tops, tonneaus, and accessories for the JT in 2019 and beyond.

MADE TO **ESCAPE**[™]

RETRACTABLE SUNSHADE



Fully retracts for your open air enjoyment



Easily pull forward with one hand



Sun protection when locked forward



Sunshade securely latches to footman loops



Overhead view of the 4-door full soft top application



Overhead view of the 2-door Sunrider® for Hardtop application

RETRACTABLE SUNSHADE

- Mesh bikini when you want it – easily retracts when you don't
- Simply unhook the Sunshade from the front and let it roll back and out of sight for open-air experience
- For sun protection, reach above and pull the Sunshade up and over the front seats, hooking it into place behind the visor
- Remains installed under most soft tops (not compatible with All-New Trektop™ and All-New Trektop™ Pro)
- Deployable when your soft top or Sunrider® are open
- Quick installation – no drilling required
- UV-resistant fabric that stands up to the elements and will not fade
- Durable edging designed to resist fraying
- Limited three-year warranty
- Not compatible with factory Freedom Panels
- ⚠️ California Proposition 65 Warning: Cancer and Reproductive Harm.

YEAR	MODEL	FITS	PART #	COLOR
07-18	2- or 4-Door JK Wrangler	Soft Top Application: Sits against sound bar, one-time install, leave in place with soft top (will not work with All-New Trektop™ and All-New Trektop™ Pro)	52405	11
07-18	2- or 4-Door JK Wrangler	Sunrider for Hardtop Application: works only with the Sunrider for Hardtop (will not work with the All-New Trektop™ and All-New Trektop™ Pro)	52406	11
18-Current	2- or 4-Door JL Wrangler	See Bestop for details		

Color: 11-Mesh. See page 87 for detailed color/fabric views.

FIND THE RIGHT BIKINI®

YEAR	MODEL	TRADITIONAL BIKINI PAGE 53	STRAPLESS BIKINI PAGE 53	STRAPLESS SAFARI BIKINI PAGE 52	HEADER BIKINI (TARGA LENGTH) PAGE 52	HEADER BIKINI (SAFARI LENGTH) PAGE 52	CABLE-STYLE SAFARI BIKINI PAGE 52	SUN BIKINI TARGA PAGE 51	SUN BIKINI SAFARI PAGE 51
51-62	Jeep M38A1	52505							
55-75	Jeep CJ5	52505							
76-83	Jeep CJ5	52507							
55-81	Jeep CJ6	52505							
80-86	Jeep CJ7	52508	52518						
80-86	Jeep CJ8 Scrambler	52508	52518						
87-91	Jeep Wrangler	52508	52509						
92-95	Jeep Wrangler		52519	52529					
97-02	Jeep Wrangler		52521	52530	52525	52531		52403	52404
03-06	Jeep Wrangler				52528	52532		52403	52404
04-06	Jeep Wrangler Unlimited TJD					52544		52403	
07-09 / 10-18	Jeep Wrangler JK 2-Door				52580 / 52586	52585 / 52583		52400	52402
07-09 / 10-18	Jeep Wrangler JK 4-Door					52581 / 52584		52400	52401
10-18	Jeep Wrangler JK 2-Door						52593		
10-18	Jeep Wrangler JK 4-Door						52594		
18-Current	Jeep Wrangler JL 2-Door							52410	52412
18-Current	Jeep Wrangler JL 4-Door							52410	52411
66-77	Ford Bronco	52542							
72-80	International Scout II	52550							
88-94	Suzuki Samurai		52561						
88-94	Suzuki Sidekick & Geo Tracker		52570						
95-98	Suzuki Sidekick & Geo Tracker		52562						
64-84	Toyota Landcruiser FJ40	52540							



52400-11



52400-35



52410-11



52410-35



52402-11



52402-35



52411-11



52411-35



52403-11



52403-35



52404-11



52404-35



52401-11



52401-35



SUN BIKINI® TOPS

- Easy roll-back storage that installs in just a couple of minutes
- Fits 1997-2006 Wrangler TJ, 2007-2017 Wrangler JK, and 2018-Current Wrangler JL
- Doesn't need an extra-cost windshield channel to install
- Uses simple hook-n-loop fastener and J-Hook system for no-drill install
- Choose Targa-style standard length or extended Safari length that covers all the way back over rear cargo area
- Choose Mesh fabric for filtered sunlight inside, or solid Black Diamond vinyl fabric that won't let water or light penetrate surface

⚠ California Proposition 65 Warning: Cancer and Reproductive Harm.

YEAR	MODEL	PART #	COLORS
97-06	Targa-style (includes TJD) for TJ Wrangler	52403	11, 35
97-06	Safari-style (excludes TJD) for TJ Wrangler	52404	11, 35
07-18	Targa-style Wrangler JK 2- & 4-Door	52400	11, 35
07-18	Safari-style Wrangler JK 2-Door	52402	11, 35
07-18	Safari-style Wrangler JK 4-Door	52401	11, 35
18-Current	Targa-style Wrangler JL 2- & 4-Door	52410	11, 35
18-Current	Safari-style Wrangler JL 4-Door	52411	11, 35
18-Current	Safari-style Wrangler JL 2-Door	52412	11, 35

Colors: 11-Mesh, 35-Black Diamond. See page 87 for detailed color/fabric views.

BIKINI TOPS & FABRIC ACCESSORIES



2005 TJ Header-Style
Targa Bikini®
52528-35



1999 TJ Header
Safari Bikini®
52531-37

2008 JK Header-Style
Targa Bikini®
52580-35



HEADER & STRAPLESS SAFARI BIKINI® TOPS

- Attaches to windshield with a Bestop® windshield channel (sold separately); header-style Bikinis use no-drill windshield channels
 - Offers full-length protection for both front and rear passengers
- ⚠️ California Proposition 65 Warning: Cancer and Reproductive Harm.

YEAR	MODEL	REQUIRES CHANNEL #	PART #	COLORS
92-95	Strapless Safari Bikini Wrangler	51209	52529	09, 15, 37
97-02	Strapless Safari Bikini Wrangler	51210	52530	15, 37
97-02	Header-style Safari Bikini Wrangler	51238	52531	11, 15, 37
03-06	Header-style Safari Bikini Wrangler	51238	52532	11, 35
04-06	Header-style Safari Bikini Wrangler Unlimited	51238	52544	35
07-09	Header-style Safari Bikini Wrangler 2-Door	51243	52585	35
07-09	Header-style Safari Bikini Wrangler 4-Door	51243	52581	11, 35
10-18	Header-style Safari Bikini Wrangler JK 2-Door	51243	52583	35
10-18	Header-style Safari Bikini Wrangler JK 4-Door	51243	52584	35
10-18	Cable-style Safari Bikini Wrangler JK 2-Door	Included*	52593	11, 35
10-18	Cable-style Safari Bikini Wrangler JK 4-Door	Included*	52594	11, 35

* Require cable factory door surrounds to install, sold separately.

Colors: 09-Charcoal, 11-Mesh, 15-Black Denim, 35-Black Diamond, 37-Spice.
See page 87 for detailed color/fabric views.

TARGA-STYLE HEADER BIKINI® TOPS

- Attaches to windshield with Bestop® no-drill windshield channel (sold separately)
 - Attaches directly to sport bars for a fitted, clean look
 - Designed for use with or without factory door surrounds
 - Premium fabric maintains shape in any temperature, is mildew-resistant, contains UV-inhibitors, and offered in factory original colors
 - High-strength thread at all stress points for durability
 - Industrial-grade webbing helps minimize flapping
 - Heavy-duty composite buckles and fittings for a long life
 - Optional Mesh (Color Code 11) material is tear-resistant
- ⚠️ California Proposition 65 Warning: Cancer and Reproductive Harm.

YEAR	MODEL	REQUIRES CHANNEL #	PART #	COLORS
97-02	Wrangler	51238	52525	15, 37
03-06	Wrangler	51238	52528	35
07-09	Wrangler 2-Door	51243	52580	35
10-18	Wrangler JK 2-Door	51243	52586	35

Colors: 15-Black Denim, 35-Black Diamond, 37-Spice.
See page 87 for detailed color/fabric views.

Ford Bronco
Traditional Bikini Top
52542-01



CJ-7
Traditional Bikini Top
52508-11



1988 YJ
Strapless Bikini Top
52509-01



International Harvester Scout II
Traditional Bikini Top
52550-01

STRAPLESS BIKINI® TOP

- Attaches directly to sport bars for super-clean look
 - Industrial-grade webbing helps minimize flapping; heavy-duty composite buckles and fittings
 - Premium fabric maintains shape in any temperature, is mildew-resistant, contains UV-inhibitors, and offered in factory original colors
 - High-strength thread at all stress points ensures durable construction
- ⚠️ California Proposition 65 Warning: Cancer and Reproductive Harm.

YEAR	MODEL	REQUIRES CHANNEL #	PART #	COLORS
80-86	CJ-7	51209	52518	01, 15
86-91	Wrangler	51209	52509	01, 15
92-95	Wrangler	51209	52519	15, 37
97-02	Wrangler	51210	52521	15, 37
88-94	Tracker/Sidekick	factory windshield channel	52570	15
95-98	Tracker/Sidekick	factory windshield channel	52562	15
86-94	Samurai	factory windshield channel	52561	01, 15

Colors: 01-Black, 15-Black Denim, 37-Spice. See page 87 for detailed color/fabric.

TRADITIONAL BIKINI® TOP

- Classic styling from the originator of the famous Bikini® top
 - Premium fabric maintains shape in any temperature, is mildew-resistant, contains UV-inhibitors, and offered in factory original colors
 - Industrial-grade webbing gives tight fit; high-strength thread at all stress points; heavy-duty composite buckles and fittings for long life
 - Kit includes fabric assembly and footman loops for rear strap tie-down
- ⚠️ California Proposition 65 Warning: Cancer and Reproductive Harm.

YEAR	MODEL	REQUIRES CHANNEL #	PART #	COLORS
51-62 55-75 55-81	M-38A1 CJ-5 CJ-6	factory windshield channel	52505	01
76-83	CJ-5	51209	52507	01, 04
76-91	CJ-7, CJ-8 Scrambler, Wrangler	51209	52508	01, 04, 09, 11
66-77	Ford Bronco	51206	52542	01
72-80	International Harvester Scout II	51207	52550	01
64-84	Toyota Land Cruiser FJ40	51209	52540	01

Colors: 01-Black, 04-Tan, 09-Charcoal, 11-Mesh. See page 87 for detailed color/fabric.

BIKINI TOPS & FABRIC ACCESSORIES



80030-37 (top photo) & 80039-35 (bottom photo)



80041-35

WINDJAMMER™

- Helps divert majority of wind, rain, and dust from entering cab and keeps heat in cockpit
- Easily attaches to center sport bar with straps and buckles; attaches to floor using Belt-Rail™ system for most applications
- Premium fabric maintains shape in any temperature, is mildew-resistant, contains UV-inhibitors, and is offered in factory original colors
- In combination, the Bestop® Windjammer™, Bikini® Top, and Duster™ Deck Cover provide a stylish look while offering protection from the elements
- Windjammer™ features heavy-duty factory original fabric with 30 mil vinyl window. Wraps around the sport bars to better protect the cockpit from dust, wind, and rain

⚠ California Proposition 65 Warning: Cancer and Reproductive Harm.

WRAPAROUND™ WINDJAMMER™

- Completely wraps around sport bars to better protect the cockpit from dust, wind and rain
- Combine with Bestop® Bikini® and Duster™ for a cab enclosure utilizing a 3-part system
- Requires Sound Bar Cap 80040

⚠ California Proposition 65 Warning: Cancer and Reproductive Harm.

WINDJAMMER™

YEAR	MODEL	PRODUCT	REQUIREMENTS	PART #	COLORS
80-95	CJ-5, CJ-7, CJ-8 Scrambler, Wrangler	Windjammer		80028	01, 15, 37
97-02	Wrangler	Windjammer		80030	15, 37
03-06	Wrangler	Windjammer		80032	35
07-18	Wrangler JK 2-Door	Windjammer		80031	35
07-18	Wrangler JK 4-Door	Windjammer	Requires Duster #90031 and Duster Extension #90034 if installing behind front seats	80039	35
95-98	Geo/Suzuki Tracker & Sidekick	Windjammer		80062	15
All	Suzuki Samurai	Windjammer		80061	15

WRAPAROUND WINDJAMMER™

YEAR	MODEL	PRODUCT	REQUIREMENTS	PART #	COLORS
97-02	Wrangler	Wraparound Windjammer	Requires factory door surrounds	80033	15, 37
03-06	Wrangler	Wraparound Windjammer	Requires factory door surrounds	80035	35
07-18	Wrangler JK 2-Door	Wraparound Windjammer	Requires Sound Bar Cap #80040 and factory-style door surrounds	80041	35

Colors: 01-Black, 15-Black Denim, 35-Black Diamond, 37-Spice. See page 87 for detailed color/fabric views.



90033-35

DUSTER™ DECK COVER

- Protects rear of vehicle and contents from sun, rain, and dust
 - Collars seal around rear sport bars preventing leakage
 - Attaches to vehicle utilizing Bestop's Belt-Rail™ system for CJ/YJ applications only
 - Premium fabric maintains shape in any temperature, is mildew-resistant, contains UV-inhibitors, and is offered in factory original colors
 - Design allows tailgate to open without detaching the Duster™ Deck Cover on most models
- ⚠ California Proposition 65 Warning: Cancer and Reproductive Harm.



80040-35

SOUND BAR CAP

- Features heavy-duty factory original fabric to protect the sound bar from the elements
 - Required for the innovative WrapAround™ Windjammer™ for JK 2-Door models
- ⚠ California Proposition 65 Warning: Cancer and Reproductive Harm.

DUSTER DECK COVER

YEAR	MODEL	PRODUCT	WITH	PART #	COLORS
86-91	Wrangler	Duster Deck Cover	With factory soft top bow folded down	90002	15
92-95	Wrangler	Duster Deck Cover	With factory soft top bow folded down	90018	15
97-02	Wrangler	Duster Deck Cover	With factory soft top bow folded down	90019	15, 37
80-91	CJ-7 & Wrangler	Duster Deck Cover	With Supertop bow folded down	90003	01, 15
92-95	Wrangler	Duster Deck Cover	With Supertop bow folded down	90008	15, 37
97-02	Wrangler	Duster Deck Cover	With Supertop bow folded down	90011	15, 37
80-91	CJ-7 & Wrangler	Duster Deck Cover	With factory hardtop removed includes Belt-Rail attachment	90005	01, 15
92-95	Wrangler	Duster Deck Cover	With factory hardtop removed includes Belt-Rail attachment	90010	15, 37
97-02	Wrangler	Duster Deck Cover	With factory hardtop removed	90020	15, 37
03-06	Wrangler	Duster Deck Cover	With factory soft top bow folded down	90012	35
03-06	Wrangler	Duster Deck Cover	With factory hardtop removed	90022	35
04-06	Wrangler Unlimited	Duster Deck Cover	With factory hardtop removed	90024	35
07-18	Wrangler JK 2-Door	Duster Deck Cover	With soft top hardware removed, factory tailgate bar required or Bestop tailgate bar	90033	35
07-18	Wrangler JK 4-Door	Duster Deck Cover	With soft top hardware removed, factory tailgate bar required or Bestop tailgate bar	90031	35
07-18	Wrangler JK 4-Door	Duster Deck Cover Extension	Extension required only if windjammer is installed behind front seats	90034	35
95-98	Geo/Suzuki Tracker & Sidekick	Duster Deck Cover	With factory soft top bow folded down	90029	15
All	Suzuki Samurai	Duster Deck Cover	Installs directly to factory snaps with factory bow folded down	90006	15

SOUND BAR CAP

YEAR	MODEL	PRODUCT	WITH	PART #	COLORS
07-18	Wrangler JK 2-Door	Sound Bar Cap		80040	35

Colors: 01-Black, 15-Black Denim, 35-Black Diamond, 37-Spice. See page 87 for detailed color/fabric views.

HIGHROCK 4X4™ FRONT MODULAR BUMPER



Front Bumper only

HIGHROCK 4X4™ REAR MODULAR BUMPER

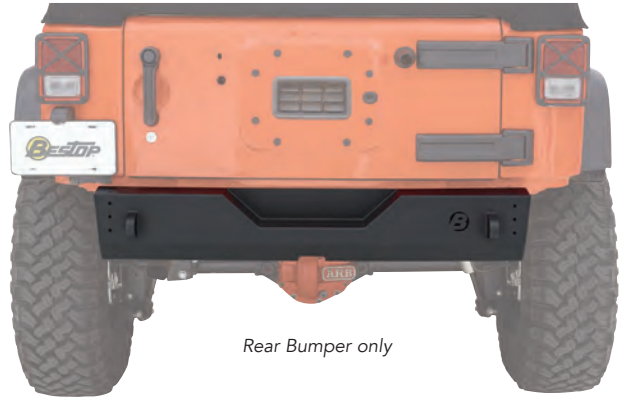

Rear Bumper only



Front Bumper with End Caps, Skid Plate, and Approach/Departure Roller



Rear Bumper with End Caps



Front Bumper with End Caps, Skid Plate, Approach/Departure Roller, Tubular Grille Guard, and Winch (not included)



Rear Bumper with End Caps and Tire Carrier Assembly



Front Bumper
End Caps



Matte Finish



Front Bumper with End Caps, Tubular Grille Guard,
Approach/Departure Roller, and Skid Plate



HIGHROCK 4x4™
BY BESTOP®

HIGHROCK 4x4™ MODULAR BUMPER

- Burly, battle-tested bumper configurable to match the needs of any Wrangler 2-Door or Wrangler Unlimited enthusiast
- E-coat with powdercoat top finish for extra protection and corrosion resistance
- Modular design allows for replacement of individual bumper elements
- Recessed winch configuration
- Advanced design that can be used with factory fog lights for JK models
- Tabbed grille guard bar for light mounts
- Specially-tested for durability, vibration, strength, and resistance to environmental elements
- Accessories not included

⚠ California Proposition 65 Warning: Cancer and Reproductive Harm.

YEAR	MODEL	COMPONENT	MATERIAL	FINISH	FITS	PART #	COLORS
07-18	Wrangler JK 2-Door & Unlimited	Front & Rear Center Section Bumpers	3/16" thick steel	E-coat base layer with matte black powder coat	Front Bumper	44945	01
07-18	Wrangler JK 2-Door & Unlimited	Front & Rear Center Section Bumpers	3/16" thick steel	E-coat base layer with matte black powder coat	Rear Bumper	44940	01
07-18	Wrangler JK 2-Door & Unlimited	End Cap Kits	1/8" thick steel with polymer top cap	E-coat base layer with matte black powder coat	Front Bumper	44946	01
07-18	Wrangler JK 2-Door & Unlimited	End Cap Kits	1/8" thick steel with polymer top cap	E-coat base layer with matte black powder coat	Rear Bumper	44941	01
07-18	Wrangler JK 2-Door & Unlimited	Tire Carrier Assembly	1/8" & 3/16" steel	E-coat base layer with matte black powder coat	Rear Bumper	44943	01
07-18	Wrangler JK 2-Door & Unlimited	Tubular Grille Guard	1/8" thick mandrel-bent tubular steel with forward-leaning design	E-coat base layer with matte black powder coat	Front Bumper	44944	01
07-18	Wrangler JK 2-Door & Unlimited	Tubular Grille Guard	1/8" thick mandrel-bent tubular steel with forward-leaning design	Brushed stainless steel	Front Bumper	42915	00
07-18	Wrangler JK 2-Door & Unlimited	Approach / Departure Roller Kits	3" diameter cold-rolled steel tube	E-coat base layer with matte black powder coat	Front Bumper	44947	01
07-18	Wrangler JK 2-Door & Unlimited	Approach / Departure Roller Kits	3" diameter cold-rolled steel tube	E-coat base layer with matte black powder coat	Rear Bumper	44942	01
07-18	Wrangler JK 2-Door & Unlimited	Skid Plate	1/8" thick 6061-T6 Aluminum one-piece plate with clear-coat anodized finish	Silver with clear coat	Front Bumper	44948	00

Colors: 00-Aluminum Steel, 01-Black

OPTIONAL ACCESSORIES



Approach/Departure Roller
42905-01



Black Grille Guard
42906-01



D-Rings Set
42921-00



D-Ring
42923-00



Chrome Grille Guard
42906-00



2-inch Receiver Recover Hitch Insert with Shackle
42922-01



HIGHROCK 4x4™ 1-PIECE FRONT BUMPERS & ACCESSORIES

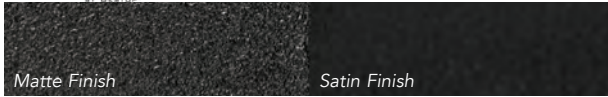

- 3/16" laser cut steel with E-coat and wrinkle-finish powder-coat
- D-Ring attachment ears (sold separately) extend through bumper fully MIG welded on front and inside solidly to frame
- Fairlead plate included

Full Width Front Bumper

- Bumper pre-punched to mount most popular brand winches
- Sturdy winch and fairlead attachment plate accommodate most standard-sized winches
- No-drill installation
- Optional Tubular Grille Guard protects both grill and headlights and available in textured black or stainless steel (two light tabs are already welded to guard)
- Optional approach/departure roller mounts to bumper

High Access Front Bumper

- Heavy-duty bumper with approach angles to get over and around the toughest obstacles
- TJ Bumper measures 59" wide x 8" deep x 8" high
- JK Bumper measures 70" wide x 12" deep x 11.5" high
- Offers pre-punched holes for most Superwinch® and other aftermarket winches

Narrow Front Bumper

- Ends tapered for mastering extreme tire clearance
- TJ bumper measures 35.5" wide x 9" deep x 5.5" high
- JK bumper measures 41.5" wide x 11" deep x 8" high
- Sturdy winch and fairlead attachment plate accommodate many standard size winches
- JK bumper has welded fairlead plate, TJ winch plate comes separately in kit
- JK bumper pre-cut holes and molded plastic light cans easily integrate with OEM lights

Approach/Departure Roller

- Three-inch diameter roller made of tough carbon steel
- 24-inch length
- Fits HighRock 4x4™ front or rear bumpers
- Bolt-on installation

Grille Guard

- Bolt-on installation with all Bestop® front bumpers
- Two light tabs welded to tubular body for strength

D-Rings & Hitch Insert

- D-Ring Shackle set includes 2, 3/4" diameter bolt, 9500-lb. capacity each
- Receiver Recovery Hitch Insert fits all Highrock 4x4™ rear bumpers with 2" receiver, or other 2" receiver hitches (includes one D-Ring Shackle)

⚠ California Proposition 65 Warning: Cancer and Reproductive Harm.

FRONT BUMPER YEAR/MODEL	STYLE	SATIN PART #	MATTE PART #	COLOR
Wrangler, 87-95	full width	42908	44908	01
Wrangler, 97-06 (inc. TJD)	full width	42901	44901	01
Wrangler JK, 2 & 4-Door, 07-18	full width	42910	44910	01
Wrangler, 97-06 (inc. TJD)	high access	42917	44917	01
Wrangler JK, 2 & 4-Door, 07-18	high access	42918	44918	01
Wrangler, 97-06 (inc. TJD)	narrow	42930	44930	01
Wrangler JK, 2- & 4-Door, 07-18	narrow	42933	44933	01
Wrangler JL, 2- & 4-Door, 18-Current	narrow	42933	44933	01
TUBULAR GRILLE GUARDS YEAR/MODEL	STYLE	SATIN PART #	MATTE PART #	COLORS
All Wrangler, 97-06 (inc. TJD)	Front- 3" diam., dual-coated; bolt-on mounting	42906	44906	00, 01
Wrangler JK, 2 & 4-Door, 07-18	Front- 3" diam., dual-coated; bolt-on mounting	42915	44915	00, 01
APPROACH/DEPARTURE ROLLER YEAR/MODEL	STYLE	SATIN PART #	MATTE PART #	COLOR
All HighRock 4x4 Bumpers with roller mounting bosses	3" diameter, 24" wide; includes mounting hardware	42905	--	01
D-RINGS & HITCH INSERT YEAR/MODEL	STYLE	SATIN PART #	MATTE PART #	COLOR
D-Ring Shackles	pair	42921	--	00
D-Ring Shackle	single shackle in one box	42923	--	00
All Receiver Recovery Hitch Insert with Shackle	fits all Highrock 4x4 rear bumpers with 2" receiver, includes one D-Ring Shackle	42922	--	01

Colors: 00-Stainless Steel, 01-Black. See page 87 for detailed color/fabric views.

FULL WIDTH PROFILE



Included Hardware



2006 Wrangler TJ (optional winch)
44901-01

HIGH ACCESS PROFILE



Included Hardware



2007 Wrangler JK
42918-01
(Grille guard and shackles optional)

NARROW PROFILE



Included Hardware (for JK)



2018 Wrangler JL
44933-01
(Winch, grille guard, and off-road spot lights optional)

NOW AVAILABLE FOR THE ALL-NEW WRANGLER JL

BUMPERS & ACCESSORIES



2006 Wrangler TJ
42903-01



2009 Wrangler JK
42911-01
(shackles not included)



2006 Wrangler TJ
44931-01



2010 Wrangler JK
44934-01



REAR BUMPER SYSTEM

- 3/16" laser cut steel with E-coat and wrinkle-finish powder-coat
- Includes a Class 2.5 receiver hitch that accepts many popular 2" hitch mount accessories (Warning: Do not exceed vehicle manufacturer's recommended towing capacity)
- No-drill application
- Optional Departure Roller increases ability to get over the toughest obstacles (see page 54)

⚠ California Proposition 65 Warning: Cancer and Reproductive Harm.

REAR BUMPER WITH TIRE CARRIER

- One hand operation, swings out as a single unit
- 3/16" laser-cut stamped-steel bumper construction with E-coat, powder-coat and textured finish for superior protection
- Tire Carrier arm mounts through bumper on mega-duty spindle, MIG welded steel bracket with heim joints at tailgate
- TJ bumper measures 58" wide x 5" deep x 5" high
- JK bumper measures 72" wide x 5.5" deep x 10" high
- 1" thick D-Ring attachment points
- Tire Carrier can hold up to a 40" tire
- Brake light relocation bracket included
- Includes Hi-Lift jack and fire extinguisher mounting points (Hi-Lift jack and fire extinguisher not included)
- Fits Jeeps with 1" Body Lift Kits

⚠ California Proposition 65 Warning: Cancer and Reproductive Harm.



One hand operation, swings out as single unit

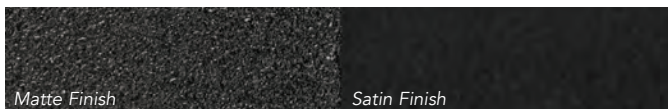

Matte Finish

Satin Finish

YEAR	REAR BUMPER	SATIN PART #	MATTE PART #	COLOR
87-06	Wrangler (inc. TJD) w/o departure roller mounts	42902	44902	01
87-06	Wrangler (inc. TJD) w/ departure roller mounts	42903	44903	01
07-18	Wrangler JK 2- & 4-Door	42911	44911	01
YEAR	REAR BUMPER WITH TIRE CARRIER	SATIN PART #	MATTE PART #	COLOR
97-06	Wrangler (inc. TJD)	42931	44931	01
07-18	Wrangler JK 2- & 4-Door	42934	44934	01

Colors: 01-Black. See page 87 for detailed color/fabric views.



2006 Wrangler TJ
61960-01



2007 Wrangler JK 4-Door
61961-01
Approach/Departure Roller not included



Works with 1986-2006 Jeep® YJ and TJ
61960-01
Body-mounted inner brackets strengthen
the tire carrier for solid installation



Works with 1986-2006 Jeep® YJ and TJ
61960-01
The tire carrier and tailgate swing out as
single unit with one-hand operation



OVERSIZE TIRE CARRIER FOR YJ & TJ

- The convenience of a tailgate mount with the big tire capacity of a swing away
 - Accommodates a tire up to 35" and 200 lbs
 - Carrier and tailgate open and close as single unit
 - Adjustable arm eliminates tailgate sag
 - Heavy tubular steel provides strength
 - Black powder-coat paint with wrinkle-finish protects against corrosion
 - Drilling and assembly required, will not fit Renegade
 - Includes rear brake light relocation bracket
 - Fits Jeeps with body lift kits
- ⚠ California Proposition 65 Warning: Cancer and Reproductive Harm.

YEAR	OVERSIZE TIRE CARRIER MODEL	SATIN PART #	COLOR
86-06	Wrangler (including Unlimited)	61960	01

Color: 01-Black



OVERSIZE TIRE CARRIER FOR JK

- No drill application, secure, lockable tire storage (lock not included)
 - Adjustable height: holds up to 37" tire and up to 200 lbs
 - Includes rear brake light relocation bracket
 - Allows oversized tires to work with tailgate and to clear rear bumper
 - Fits Jeeps with body lift kits
- ⚠ California Proposition 65 Warning: Cancer and Reproductive Harm.

YEAR	OVERSIZE TIRE CARRIER MODEL	SATIN PART #	COLOR
07-18	Wrangler JK 2 & 4-Door	61961	01

Color: 01-Black

STORAGE & SECURITY



*JK Driver-Side Under Seat
Locking Storage Box
42640-01*



*JK Passenger-Side Under Seat
Locking Storage Box
42642-01*



*Wrangler TJ Under Seat
Locking Storage Box
42641-01*



*Wrangler TJ Under Seat
Locking Storage Box
42641-01*



UNDER SEAT LOCKING STORAGE BOX FOR JK & TJ

- Provides lockable hidden storage space
- Custom-designed to fit under driver's seat or passenger seat on JK
- Comes with pick-resistant lock and two keys
- Heavy-duty braided steel cable cord with clear vinyl cover included to securely attach to any location inside vehicle (TJ version)
- Made of heavy-duty, 16-gauge carbon steel with textured black powder coat finish
- Storage space for TJ is 12" x 8" x 3"
- Storage space for JK is 16" x 5 3/4" x 2 7/8"
- Not compatible with TJ factory tilt and flip seat

⚠ California Proposition 65 Warning: Cancer and Reproductive Harm.

YEAR	UNDER SEAT LOCKING BOX	LOCATION	PART #	COLOR
97-06	Wrangler (inc. TJD)	Driver	42641	01
07-10	Wrangler 2-Door	Driver	42640	01
07-18	Wrangler JK 4-Door	Driver	42640	01
08-10	Wrangler 2-Door	Passenger	42642	01
07-18	Wrangler JK 4-Door	Passenger	42642	01

Color: 01-Black. See page 87 for detailed fabric/color views.



Center Console Lock Box
42643-01



CENTER CONSOLE STORAGE LOCK BOX FOR JK

- Fits precisely into interior of factory Wrangler JK console
 - All welded construction with hinged lid
 - Features integrated lock with two keys
 - Openings for the factory electrical point and USB ports
- ⚠️ California Proposition 65 Warning: Cancer and Reproductive Harm.



Universal Storage Lock Box
42644-01



UNIVERSAL STORAGE LOCK BOX

- Can be positioned as free-standing unit on any 10" x 8" surface
 - 16-gauge steel with powder-coat finish
 - Pick-resistant cylinder lid lock with two coded keys
 - Theft-resistant 5-ft. security cable with integrated lock and two keys
 - Full-width piano hinge for easy operation and durability
 - Interior felt padding reduces shifting of contents and rattling
 - Pre-drilled interior mounting holes with self-tapping screws
 - 10.0" l x 8.0" w x 3.25" h
- ⚠️ California Proposition 65 Warning: Cancer and Reproductive Harm.

YEAR	CENTER CONSOLE LOCK BOX	LOCATION	PART #	COLOR
11-18	Wrangler JK 2- & 4-Door	Center Console	42643	01
YEAR	UNIVERSAL LOCK BOX	LOCATION	PART #	COLOR
All	Fits many full size truck/SUV consoles, or vehicles where security cable can be anchored, or even the home and garage	Universal	42644	01

Color: 01-Black. See page 87 for detailed color/fabric views.

STORAGE & SECURITY



Pictured: RoughRider® Tailgate Shelf (54140-01), Coral Canyon, Campo, California



Open or close with one hand

ROUGH RIDER® TAILGATE SHELF

- Patented custom design that fits 2007-2018 Wrangler JK 2-Door and Wrangler Unlimited 4-Door tailgates
- Press & Release latch for quick and easy opening with one free hand
- Polyester mesh removes to create a traditional shelf or work space – perfect for tailgating or camping
- Heavy-duty polymer housing
- No-drill installation
- 25" L x 14" H x 4.5" D (closed) & 276 square inches of table area and 2,969 cubic inches inside the net
- Shelf extends out about 12 inches in down position

⚠️ California Proposition 65 Warning: Cancer and Reproductive Harm.

YEAR	MODEL	PART #	COLOR
07-18	Wrangler JK 2- & 4-Door	54140	01
Color: 01-Black. See page 87 for detailed color/fabric views.			



Use the shelf to temporarily hold your coffee, tools, or gear. The pop-up mesh crate works great for groceries, camp gear, and much more.



ROUGH RIDER® SEAT BACK ORGANIZER

- Tailored fit for Jeep Wranglers
- Made with mildew- and UV-resistant Soft Top fabric for tough as nails durability in any climate
- Requires headrest for installation
- Features four pockets with dividers and two cup holders
- Designed to provide lifelong durability throughout your travels
- Marine-grade thread prevents seams from splitting
- Provides inside and out storage for your Jeep, all accessories sold separately

⚠️ California Proposition 65 Warning: Cancer and Reproductive Harm.

YEAR	MODEL	DETAILS	PART #	COLOR
86-18	Wrangler 2- & 4-Door	Seat Back Org.	54132	35

Color: 35-Black Diamond. See page 87 for detailed color/fabric views.



Spare Tire Organizer has two heavy-duty straps for attachment to the tire, both around the circumference of the tire and across the back side.
54134-35



54134-35

ROUGH RIDER® SPARE TIRE ORGANIZER

- Fit wide range of spare tire diameters: 30"–40" tires
- Features two small/two large pockets on each side and one long front pocket

⚠️ California Proposition 65 Warning: Cancer and Reproductive Harm.

YEAR	MODEL	DETAILS	PART #	COLOR
All	30"–33"	Spare Tire Org.	54133	35
All	34"–37"	Spare Tire Org.	54134	35
All	38"–40"	Spare Tire Org.	54135	35

Color: 35-Black Diamond. See page 87 for detailed color/fabric views.

STORAGE & SECURITY



Convenient storage tucked away under the seat, but available for travel duty away from the Jeep when needed (measures 12x10x6 inches)
54131-35



Small bag measures 11x4x10 inches
Large bag measures 15x4x10 inches
54136-35

ROUGH RIDER® UNDERSEAT ORGANIZER

- Fits conveniently under driver seat or Wrangler Unlimited back seat
- Features two mesh pockets on outside and two dividers on inside
- ⚠ California Proposition 65 Warning: Cancer and Reproductive Harm.

ROUGH RIDER® TAILGATE ORGANIZER

- BeltRail® attachment system for easy slide-in, slide-out convenience
- Easy installation on Wrangler JK tailgates
- ⚠ California Proposition 65 Warning: Cancer and Reproductive Harm.

YEAR	MODEL	DETAILS	PART #	COLOR
07-10	Wrangler 2-Door	Underseat Organizer (measures 12x10x6 inches)	54131	35
07-18	Wrangler JK Unlimited	Underseat Organizer (measures 12x10x6 inches)	54131	35
18-Current	Wrangler JL	Underseat Organizer (measures 12x10x6 inches)	54131	35
87-18	Wrangler YJ, TJ, JK 2- & 4-door	Tailgate Organizer (small bag measures 11x4x10 inches, large bag measures 15x4x10 inches)	54136	35

Color: 35-Black Diamond. See page 87 for detailed color/fabric views.



A must-have for groceries; lots of storage pockets plus internal dividers to keep all your items where you put them
54137-35



On-the-go storage providing easy access to small, frequently used items
54110-35



Convenient storage for your side and rear window while helping to prevent scratches or dings
42811-01

ROUGH RIDER® CARGO TRUNK ORGANIZER

- Individual bag measures 32" long, 12" wide, 6" deep
- Secure to sport bar uprights for easy-access storage
- Outer accessory pockets provide easy access to small, frequently used items
- Premium fabric, color matched with factory colors
- Sold individually; converts to shoulder strap duffel bag for portability
- ⚠ California Proposition 65 Warning: Cancer and Reproductive Harm.

ROUGH RIDER® SADDLE BAGS

- Outer accessory pockets secure with hook and loop for easy access to small, frequently used items
- Converts to shoulder strap duffel bag
- ⚠ California Proposition 65 Warning: Cancer and Reproductive Harm.

WINDOW STORAGE PORTFOLIO

- Holds Trektop™ Pro rear glass hatch and both side window panels
- Made of ballastic nylon material, it has carrying handles and a heavy-duty zipper closure
- Designed to hang from seat headrests inside for quick storage if desired
- ⚠ California Proposition 65 Warning: Cancer and Reproductive Harm.

YEAR	MODEL	DETAILS	PART #	COLORS
All	Any Vehicle	Cargo Trunk Organizer	54137	35
92-06	Wrangler (excludes TJD)	RoughRider® Saddlebag; 6" x 12" x 28"	54108	15
07-18	Wrangler JK 2-Door	RoughRider® Saddlebag; 6" x 12" x 32"	54110	35
07-18	Window Storage Portfolio Bag for Trektop Pro	For Trektop Pro Soft Top	42811	01

Colors: 01-Black, 15-Black Denim, 35-Black Diamond. See page 87 for detailed color/fabric views.

STORAGE & SECURITY



Helps secure and safeguard gear or valuables from prying eyes or potential theft by hiding your valuables
42702-01



2005 Wrangler
80022-35

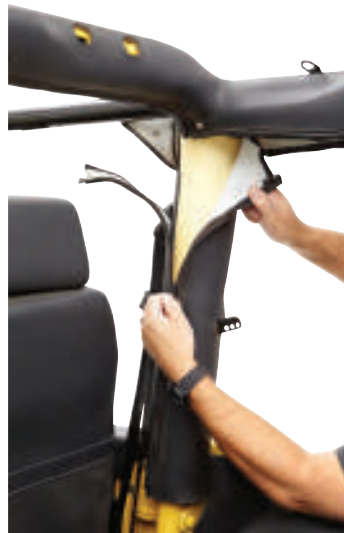

2005 Wrangler
80022-35



2007 Wrangler 4-Door
80025-35

INSTATRUNK™

- Secures and safeguards belongings out of sight
- All steel unit fastens into cargo area behind rear seat
- 2.7 cubic feet of lockable storage space
- Easy to install with mounting hardware included
- ⚠ California Proposition 65 Warning: Cancer and Reproductive Harm.

SPORT BAR COVERS

- Complete replacement kit for worn, faded factory covers
- Sport Bar Covers offer a clean custom look
- Premium fabric maintains shape in any temperature, mildew-resistant, contains UV inhibitors and is offered in factory original colors
- Industrial strength thread ensures durable Sport Bar Cover construction
- Compatible with all Bestop® soft tops and accessories
- ⚠ California Proposition 65 Warning: Cancer and Reproductive Harm.

INSTATRUNK™

YEAR	MODEL	PART #	COLOR
86-95	Wrangler	42700	01
97-06	Wrangler (excludes TJD)	42701	01
07-10	Wrangler 2- & 4-Door	42702	01
11-18	Wrangler JK 2- & 4-Door	42704	01

SPORT BAR COVERS

YEAR	MODEL	PART #	COLORS
80-86	CJ-5, CJ-7 & CJ-8 Scrambler	80007	01, 04, 15
86-90	Wrangler (covers all bars)	80008	15
92-95	Wrangler (covers all bars)	80009	15, 37
97-02	Wrangler (fits without sound bar)	80020	15, 37
03-06	Wrangler (excludes TJD)	80022	35
07-18	Wrangler JK 4-Door	80025	35

Colors: 01-Black Crush, 04-Tan, 15-Black Denim, 35-Black Diamond, 37-Spice.
See page 87 for detailed color/fabric views.



2005 Wrangler TJ
81037-37

2007 Wrangler JK 4-Door
81041-09

Comes with a Stuff Sack to keep your trail cover neatly stored



2007 Wrangler JK 4-Door
61032-17



1998 Wrangler
61030-37

ALL-WEATHER TRAIL COVER

- Protects windshield and interior of Jeep® from harsh affects of sun, wind, and rain
- Provides complete door coverage
- Comes complete with Stuff Sack that keeps Trail Cover neatly stored
- Soft top needs to be removed for proper installation

⚠ California Proposition 65 Warning: Cancer and Reproductive Harm.

TIRE COVER

- Available in eight custom sizes, plus now available in new Black Twill fabric to match Bestop's® Black Twill Soft Tops
- Not designed for use with Wrangler JL back-up camera.
- Industrial strength thread
- Sewn-in elastic band allows for a snug fit
- Premium fabric with cotton backing maintains shape in any temperature, mildew-resistant, contains UV inhibitors and perfectly matches factory original colors

⚠ California Proposition 65 Warning: Cancer and Reproductive Harm.

ALL-WEATHER TRAIL COVER

YEAR	MODEL	PART #	COLORS
76-91	CJ-7 & Wrangler	81035	09
92-95	Wrangler	81036	09, 37
97-06	Wrangler	81037	09, 37
04-06	Wrangler Unlimited	81038	09, 37
07-18	Wrangler JK 2-Door	81040	09
07-18	Wrangler JK 4-Door	81041	09
18-Current	Wrangler JL 2-Door	TBD	09
18-Current	Wrangler JL 4-Door	TBD	09

TIRE SIZE - FOR ALL VEHICLES	PART #	COLORS
26.5" x 7.5"	61026	01
28" x 8"	61028	01, 15, 35, 37
29" x 9"	61029	04, 15, 35, 37
30" x 10"	61030	04, 15, 33, 35, 37
31" x 11"	61031	15, 17, 35, 37
32" x 12"	61032	17, 35
33" x 13"	61033	15, 17, 35, 37
35" x 14"	61035	15, 17, 35

Colors: 01-Black Crush, 09-Charcoal, 15-Black Denim, 17-Black Twill, 33-Dark Tan, 35-Black Diamond, 37-Spice. See page 87 for detailed color/fabric views.

STORAGE & SECURITY



HOSS System includes Hardtop Cart plus Door Cart, and conveniently fits together, reducing floor storage space (hardtop and doors not included)
42801-01



HOSS Hardtop Cart & Door Cart
42801-01

HOSS™ (HARDTOP ORGANIZED STORAGE SYSTEM)

- HOSS™ is the ideal product to have before removing your hardtop for the first time
- HOSS Hardtop Cart and HOSS™ Door Cart feature protective padding
- Sturdy steel Hardtop Cart provides storage for Jeep® Wrangler factory original hardtops
- Features heavy duty casters with locks to roll easily and stay in place
- The HOSS Hardtop Cart quickly attaches to the back of the hardtop while on the vehicle
- Support bar on the HOSS Hardtop Cart protects rear window from opening during removal (no clamps needed)
- HOSS Door Cart accommodates up to three full steel doors, half steel doors, soft upper doors, upper door sliders and Bestop 2-piece doors
- Heavy-duty, water resistant HOSS Cover protects storage items from the elements (sold separately)
- All HOSS covers include a Tool Caddy and Window Storage Duffie for your Bestop soft goods, loose hardtop and soft top parts, as well as locations for Bestop Cleaner and Bestop Protectant

⚠ California Proposition 65 Warning: Cancer and Reproductive Harm.

YEAR	MODEL	DETAILS	PART #	COLORS
07-18	Wrangler JK 2/4-Door	Full HOSS System for 2-pc. & 3-pc. factory hardtops. Includes Hardtop Cart and Door Cart (Door Cart holds up to 3 JK doors)	42805	01
87-06	Wrangler TJ and YJ	Full HOSS System for 1-pc. & 2-pc. hardtops. Includes Hardtop Cart & HOSS™ Door Cart	42801	01
07-18	Wrangler JK 2/4-Door	HARDTOP CART ONLY - Storage for 2-pc. & 3-pc. factory hardtops	42806	01
87-06	Wrangler TJ and YJ	HARDTOP CART ONLY - Storage for 1-pc. & 2-pc. hardtops	42804	01
87-18	Wrangler TJ, YJ and JK	DOOR CART ONLY - Holds up to 4 doors (3 JK steel doors). Includes Door Cart Cover	42814	01
07-18	Wrangler JK 2-Door	HOSS COVER ONLY - Covers 2-pc. hardtop. Includes Window Storage Duffie and Tool Caddy	42807	09
07-18	Wrangler JK 4-Door	HOSS COVER ONLY - Covers 2-pc./3-pc. hardtop. Includes Window Storage Duffie and Tool Caddy	42808	09
18-Current	Wrangler JL 2-Door	HOSS COVER ONLY - Covers 2-pc. hardtop. Includes Window Storage Duffie and Tool Caddy	TBD	09
18-Current	Wrangler JL 4-Door	HOSS COVER ONLY - Covers 2-pc./3-pc. hardtop. Includes Window Storage Duffie and Tool Caddy	TBD	09

Colors: 01-Black, 09-Charcoal. See page 87 for detailed color/fabric views.



The HOSS Door Cart includes its own cover to help provide a protected, water-resistant environment for up to four doors and other items
42814-01



The HOSS Hardtop Cart quickly attaches to the back of the hardtop enabling easy and convenient removal
42804-01



HOSS™ WINDOW STORAGE DUFFLE

- Provides safe and convenient storage. Minimizes scuffing. Fabric is water-resistant and made to protect PVC glass from scratching
- Not compatible with Trektop™ line of tops

⚠ California Proposition 65 Warning: Cancer and Reproductive Harm.

MODEL	PART #	COLOR
most Bestop and factory zip out vinyl windows	42810	09

Colors: 09-Charcoal. See page 87 for detailed color/fabric views.



The optional HOSS COVER helps keep your hardtop and accessories dust-free. Note: Window Storage Duffel and Tool Caddy included with cover
42807-09

FIND YOUR COMFORT ZONE

Every TrailMax™ II seat provides the maximum in seating comfort, durability, and safety. Bestop's® unsurpassed appearance, premium mildew- and UV-fade resistant vinyl fabric maintains its shape in any temperature, and is offered in factory original colors. Our Atlas Frame is sturdy and resists corrosion meeting Federal Motor Vehicle Safety standards (FMVSS 207 & 302). Trailmax™ II Seats also contain Variable Rate of Resistance springs for comfort on the road and support on the trail. The premium quality, high-density closed cell foam minimizes fatigue and maintains the seat shape, ensuring comfort and appearance for years to come.





2005 Wrangler
39451-09 & 39450-09



20-position lever adjustment makes setting your ideal seat position easy and quick



Adjustable Headrest moves up or down, forward and backward for best support

TRAILMAX™ II PRO SEATS

In addition to the benefits listed on the opposite page for all TrailMax™II Seats, TrailMax™II Pro offers the following:

- Recliner lever located on all TrailMax™II Pro seats allows for quick and easy reclining with 20 position adjustments
- 4-way adjustable headrest adjusts up and down, and pivots forward and back for utmost comfort and support
- Enhanced performance bolsters and sculpted lumbar support also provide seating comfort as well as stability
- Elastic mesh map pocket offers handy access storage
- Seats available in automotive-quality all-vinyl upholstery or vinyl with fabric center insert upholstery

⚠️ California Proposition 65 Warning: Cancer and Reproductive Harm.

YEAR	MODEL	POSITION	STYLE	PART #	COLORS
76-06	CJ/Wrangler	Front, Driver Side	High-Back, All Vinyl	39451	01, 09, 15, 37
76-06	CJ/Wrangler	Front, Passenger Side	High-Back, All Vinyl	39450	01, 09, 15, 37
76-06	CJ/Wrangler	Front, Driver Side	High-Back, Vinyl with Fabric Insert	39461	09, 15, 37
76-06	CJ/Wrangler	Front, Passenger Side	High-Back, Vinyl with Fabric Insert	39460	09, 15, 37

NOTE: 97-02 TJ vehicles require adapter bracket no. 51256-01 for each seat. 03-06 vehicles require seat slider and adapter no. 51245-01 (driver) or no. 51248-01 (passenger). See page 72.

Colors: 01-Black, 09-Charcoal, 15-Black Denim, 37-Spice. See page 87 for detailed color/fabric views.



39460-37

39451-09

SEATS & SEAT COVERS



TRAILMAX™ II SPORT SEATS

- In addition to the features listed on page 72 for all TrailMax™ II seats, TrailMax™ II Sport offers the following:
- Rotary recliner dial mounts to either side of the seat allowing use on either driver or passenger side
- Meets Federal Motor Vehicle Safety Standards 207 & 302
- Built-in headrest
- Elastic mesh map pocket offers handy access storage
- Seats also available in complementary vinyl and fabric combinations

California Proposition 65 Warning: Cancer and Reproductive Harm.

YEAR	MODEL	POSITION	STYLE	PART #	COLORS
76-06	CJ/Wrangler	front, either side	high-back, all vinyl	39434	01, 09, 15, 37
76-06	CJ/Wrangler	front, either side	high-back, vinyl with fabric insert	39438	09, 15, 37

TJ vehicles 97-02 require adapter bracket number 51256-01 for each seat. 03-06 vehicles require seat slider with adapter 51245-01 (driver) or 51248-01 (passenger). See page 72.

Colors: 01-Black, 09-Charcoal, 15-Black Denim, 37-Spice. See page 87 for detailed color/fabric views.



39436-37



39436-15



39436-09



39429-37



39429-01

TRAILMAX™ II CLASSIC & STANDARD SEATS

- In addition to the benefits listed on page 68 for all TrailMax™ seats, the standard TrailMax™ offers stationary high-back seat with built-in headrest
- Also available in Classic Low Back
- See page 72 for seat adapters and hardware

 California Proposition 65 Warning: Cancer and Reproductive Harm.

YEAR	MODEL	POSITION	STYLE	PART #	COLORS
76-06	All CJ/Wrangler	front, either side	fixed high-back, all vinyl	39436	01, 09, 15, 37
76-06	All CJ/Wrangler	front, either side	fixed low-back, all vinyl	39429	01, 37

TJ vehicles 97-02 require adapter bracket number 51256-01 for each seat. 03-06 vehicles require seat slider with adapter 51245-01 (driver) or 51248-01 (passenger). See page 76.

Colors: 01-Black, 09-Charcoal, 15-Black Denim, 37-Spice. See page 87 for detailed color/fabric views.

SEATS & SEAT COVERS



51256-01



51255-01



51253-01



51255-01

SEAT SLIDER WITH ADAPTER

- Fits all TrailMax™ II seats
- Relocates seat belt attachment for Wrangler 03-06 models and incorporates Seat Slider
- ⚠ California Proposition 65 Warning: Cancer and Reproductive Harm.

SEAT SLIDER

- Factory-original replacement sliders
- Kit contains 2 sliders, one handle, and a hardware kit to replace the seat slide mechanism on a single seat
- Fits all TrailMax™ II Seats
- ⚠ California Proposition 65 Warning: Cancer and Reproductive Harm.

SEAT ADAPTER BRACKET

- Kit includes 2 brackets (one seat) and instructions for installation for single seat
- Powder-coated brackets allow TrailMax™ II seats to adapt to factory riser on 97-02 Wrangler
- ⚠ California Proposition 65 Warning: Cancer and Reproductive Harm.

SEAT RISERS

- Seat Risers are driver and passenger seat-specific and require no drilling for easy installation
- Risers bolt to Bestop TrailMax™ II and factory-original seats
- Hardware chemically-treated and powder-coated for rust resistance
- Releases forward for easy access to rear of vehicle
- ⚠ California Proposition 65 Warning: Cancer and Reproductive Harm.

YEAR	MODEL	DETAILS	PART #	COLOR
03-06	Wrangler	Seat Slider/Adapter: Driver Side; Attaches seat to factory seat riser hardware. Bolt-on installation	51245	01
03-06	Wrangler	Seat Slider/Adapter: Passenger Side; Attaches seat to factory seat riser hardware. Bolt-on installation	51248	01
76-95	CJ-5, CJ-7 & Wrangler	Seat Slider: For single seat installation of Trailmax II front seat	51255	01
97-02	Wrangler	Seat Adapter Bracket	51256	01
76-95	CJ-5, CJ-7 & Wrangler	Seat Riser: Driver Side; For single seat installation of Trailmax II front seat	51253	01
76-95	CJ-5, CJ-7 & Wrangler	Seat Riser: Passenger Side; For single seat installation of Trailmax II front seat	51254	01

Color: 01-Black. See page 87 for detailed color/fabric views.



39437-01

39437-09

39437-15

39437-37

Fabric front colors: (where applicable)



Attaches to Jeep factory bracket



Fold & Tumble seat



2005 Wrangler
39435-09



39439-09

TRAILMAX™ II FIXED REAR BENCH

- Classic Fixed Rear Bench for 55-95 CJ and YJ Wranglers
- Constructed on a heavy duty Atlas Frame for maximum comfort
- Available in vinyl fabric

⚠ California Proposition 65 Warning: Cancer and Reproductive Harm.

TRAILMAX™ II FOLD AND TUMBLE

- Rear seat folds and tumbles for maximum rear cargo room
- Features dual headrests and Atlas Frame
- Available in all-vinyl upholstery, or vinyl with fabric center insert

⚠ California Proposition 65 Warning: Cancer and Reproductive Harm.

YEAR	MODEL	POSITION	STYLE	PART #	COLORS
55-95	All CJ/Wrangler	rear	Fixed all-vinyl bench	39437	01, 09, 15, 37
55-95	All CJ/Wrangler	rear	Fold and Tumble all-vinyl bench	39440	01, 09, 15, 37
55-95	All CJ/Wrangler	rear	Fold and Tumble vinyl with fabric inset bench	39441	09, 15, 37
97-06	Wrangler	rear	Fold and Tumble all-vinyl bench	39435	01, 09, 15, 37
97-06	Wrangler	rear	Fold and Tumble vinyl with fabric inset bench	39439	09, 15, 37

Colors: 01-Black, 09-Charcoal, 15-Black Denim, 37-Spice. See page 87 for detailed color/fabric views.

SEATS & SEAT COVERS



Durable vinyl-coated material is weather resistant and built for extreme duty
29228-35



Machine washable for extended life
29229-35

SEAT COVERS FOR JEEP '65-'06

- Front seat covers sold in pairs; rear seat covers sold individually
- Elastic attachment for easy installation
- Custom-designed to fit over factory original seats

- Premium vinyl fabric with cotton backing offered in factory-original colors
- ⚠ California Proposition 65 Warning: Cancer and Reproductive Harm.

YEAR	MODEL	DETAILS	PART #	COLORS
65-79	CJ-5, 65-79, CJ-7	low back bucket	29225	15
80-83, 76-86, 87-91	CJ-5, CJ-7, Wrangler	high back bucket	29227	04, 09, 15
92-94	Wrangler	high back bucket	29224	09, 15, 37
97-02	Wrangler	high back bucket	29226	09, 15, 37
03-06	Wrangler, Wrangler Unlimited	high back bucket	29228	35
65-95, 65-83, 76-86	CJ-5, CJ-7, Wrangler	rear bench (fold and tumble)	29223	04, 15
97-02	Wrangler	rear bench	29221	15
03-06	Wrangler, Wrangler Unlimited	rear bench	29229	35

Colors: 04-Tan, 09-Charcoal, 15-Black Denim, 35-Black Diamond, 37-Spice. See page 87 for detailed color/fabric views.



29280-04



29283-35



29281-09



29290-35

NEW! CUSTOM-TAILORED SEAT COVERS FOR WRANGLER JK & JL

- Custom tailored for 2007-2017 Jeep Wrangler JK 2-Door and Wrangler Unlimited factory seats, or 2018-Current Jeep JL 2-Door and Wrangler Unlimited factory seats
- Side-impact airbag-compatible
- UV inhibitors and stabilizers resist fading from sunlight, keeps covers looking brand new
- Special 2-ply, laminated 600-denier polyester top layer with soft white polyester knit backing
- Weatherproof protection includes top layer surface coated with dry water-repellent (DWR) treatment while underside has polyurethane coating
- Tested for fire-resistance
- Strap & Buckle system offers a secure, tight installation with no tools required
- Separate Headrest Covers included
- Front Seat Covers have map pockets on seat back and sold as pair
- Rear Seat Covers have child-seat tether openings
- ⚠️ California Proposition 65 Warning: Cancer and Reproductive Harm.

YEAR	MODEL	POSITION	INCLUDES	PART #	COLORS
07-12	Wrangler 2- & 4-Door	front	separate headrest covers, rear map pocket	29280	04, 09, 35
13-18	Wrangler JK 2- & 4-Door	front	separate headrest covers, rear map pocket	29283	04, 09, 35
07-18	Wrangler JK 2-Door	rear	separate headrest covers	29282	04, 09, 35
08-12	Wrangler 4-Door	rear	separate headrest covers	29281	04, 09, 35
07, 13-18	Wrangler JK 4-Door	rear	separate headrest covers	29284	04, 09, 35
18-Current	Wrangler JL 4-Door	front	buckets with 2 adjustable headrests with airbag flaps and map pocket	29290	04, 09, 35
18-Current	Wrangler JL 2-Door	front	buckets with 2 adjustable headrests with airbag flaps and map pocket	29291	04, 09, 35
18-Current	Wrangler JL 2-Door	back	solid fold-down bench with 2 flip forward headrests	29292	04, 09, 35
18-Current	Wrangler JL 4-Door	back	60/40 split bench with 2 adjustable headrests and fold down armrest	29293	04, 09, 35
18-Current	Wrangler JL 4-Door	back	60/40 split bench with 2 adjustable headrests	29294	04, 09, 35

Colors: 04-Tan, 09-Charcoal, 35-Black Diamond. See page 87 for detailed color/fabric views.

ACCESSORIES



51513-01



51514-01



51510-01



51504-01

NEW! FLOOR LINERS

- Contoured, precise floor liners for Jeep TJ, JK, and JL Wrangler - Front seat, Rear seat and Rear Cargo liner SKUs
- Superior TPE material outperforms cheaper liners and mats in extreme conditions
- Tall 5/16" treads minimize slip, raised edge lip holds up to 40% more liquid, channels mud away from shoes
- Standard floor hook cutouts fit the OE floor hook(s) and have raised walls
- Molded carpet grabbing nibs help secure the floor liner to vehicle's carpet
- Floor Liners sold in pairs, Rear Cargo Liner sold separately, for TJ and JK Models
- Made for Jeepers who really understand that their rig can get dirty

⚠ California Proposition 65 Warning: Cancer and Reproductive Harm.

YEAR	MODEL	POSITION	PART #	COLOR
76-95	CJ7 & Wrangler	front	51511	01
97-06	Wrangler (including TJD)	front	51509	01
07-13	Wrangler 2- & 4-Door	front	51500	01
14-18	Wrangler JK 2- & 4-Door	front	51513	01
97-06	Wrangler TJ (including TJD)	rear	51510	01
07-10	Wrangler 2-Door	rear	51502	01
11-18	Wrangler JK 2-Door	rear	51503	01
07-18	Wrangler JK 4-Door Unlimited (one piece)	rear	51504	01
18-Current	Wrangler JL 2-Door & 4-Door Unlimited	front	51514	01
18-Current	Wrangler JL 4-Door Unlimited	rear	51515	01

Color: 01-Black. See page 87 for detailed color/fabric views.



51512-01



51505-01



51049-01 on 1997 Wrangler

CARGO LINERS

- Contoured, precise fit assures complete coverage and stay-in-place stability
 - Rear Cargo Liners accommodate seat belts if those were original equipment
 - Superior TPE material outperforms cheaper liners and mats in extreme conditions
 - Tall 5/16" treads minimize slip, raised edge lip
 - Made for Jeepers who really understand that their rig can get dirty
- ⚠ California Proposition 65 Warning: Cancer and Reproductive Harm.

HIGHROCK 4X4™ ENTRY GUARDS

- Protect against scuffs and scratches on the door sills or tailgate
 - Attach with 3M® adhesive strip
 - Sold in pairs (#51051 includes 4 pieces)
- ⚠ California Proposition 65 Warning: Cancer and Reproductive Harm.

YEAR	MODEL	POSITION	PART #	COLOR
76-06	Wrangler (excluding TJD)	rear cargo	51512	01
07-10	Wrangler 2- & 4-Door*	rear cargo	51505	01
11-18	Wrangler JK 2- & 4-Door*	rear cargo	51507	01
* with or without subwoofer				
YEAR	MODEL	POSITION	PART #	COLOR
97-06	Wrangler (including TJD)	doors	51049	01
07-18	Wrangler JK 2- & 4-Door	doors	51051	01

Color: 01-Black. See page 87 for detailed color/fabric views.

ACCESSORIES



81713-01



51291-00



51291-01

HOOD APPLIQUE

- No drill installation that forms tight, secure bond to hood with 3M® adhesive backing and existing screws
- Dimensions: 33-3/8" w x 17-5/8" l x 2-3/8" h
- Textured, durable ABS plastic with UV-resistance against fading

⚠ California Proposition 65 Warning: Cancer and Reproductive Harm.

HOOD LATCH KIT

- Replace old or worn out Hood Latches (sold in pairs)

⚠ California Proposition 65 Warning: Cancer and Reproductive Harm.

PET BARRIERS

- For all 2-Door and 4-Door JK models
- Keep your pet safely in the back
- The only Pet Barrier that works with your Wrangler soft top or hard top for a rattle-free fit
- High-quality steel tubing and welded mesh
- Powder-coated Satin Black to provide tough and durable finish able to stand the test of time

⚠ California Proposition 65 Warning: Cancer and Reproductive Harm.



Leaves plenty of room behind rear seat and expertly engineered attachment points allow for an easy 30-minute install

HOOD APPLIQUE

YEAR	MODEL	PART #	COLOR
07-18	Wrangler JK 2-Door & 4-Door	81713	01

HOOD LATCH KIT

YEAR	MODEL	PART #	COLORS
42-95	MB, CJ2A, CJ3B, CJ5, CJ6, CJ7, CJ8, Wrangler YJ	51291	00, 01

PET BARRIERS

YEAR	MODEL	PART #	COLORS
07-18	Wrangler JK 4-Door	42501	01
11-18	Wrangler JK 2-Door	42503	01
07-10	Wrangler 2-Door	42502	01

Colors: 00-Chrome, 01-Black. See page 87 for detailed color/fabric views.



Lower Cargo Rack Bracket attaches to Sport Bars. Universal Tray (sold separately) offers more storage space above the rear cargo area. The Tailgate Rack Bracket gets gear up and out of the way and adjusts to the height of your spare tire

UNIVERSAL RACK TRAY / MODULAR RACK SYSTEM

- One tray, multiple storage options
- No drilling required for installation
- Each bracket attaches with hand-tighten knobs for easy removal
- The Universal Rack Tray is manufactured of sturdy plastic that is lighter than steel, has better impact resistance, and doesn't rust
- The Universal Rack Tray features pre-installed recessed eye-bolts to anchor tie-down straps
- Use the Tailgate Rack Bracket and the Lower Cargo Rack Bracket simultaneously
- Holds up to 75 lbs. of gear, per tray
- ⚠ California Proposition 65 Warning: Cancer and Reproductive Harm.

YEAR	MODEL	STYLE	PART #	COLOR
Any	Attaches to Bestop Rack Bracket, 43" x 23" 4"	universal rack tray	41444	01
92-02	Wrangler	lower cargo rack bracket	41406	01
03-18	Wrangler TJ or JK 2-Door	lower cargo rack bracket	41437	01
87-06	Wrangler (including TJD)	tailgate rack bracket	41411	01
07-18	Wrangler JK 4-Door	tailgate rack bracket	41412	01

Color: 01-Black. See page 87 for detailed color/fabric views.

ACCESSORIES



Retracted Powerboard



Deployed Powerboard



Retracted Powerboard



Powerboard Motor Detail



Powerboard Light Module

POWERBOARD® & POWERBOARD® NX FOR JEEP

- Jeep® Wrangler models feature new Torsion Bar tensioning system that allows a closer, tighter fit against the rocker panel for better appearance and smoother operation
 - Electrically-powered running board hides stealthily underneath your Jeep when doors are closed and extends down to meet your foot when door opens
 - Drops down about 6" and out 2" to create a stair-step into your Jeep
 - Full length board works with both front and rear doors, driver and passenger sides
 - 600 lb. load capacity per side
 - Complete kit includes two full length boards, OEM quality sealed motors, controller, hardware, wiring bundle with weatherproof connectors and LED Light kit
 - Built-in anti-pinch safety features senses pressure to keep board from retracting on your hand and feet
 - Patented high strength, die-cast aluminum linkage built to last in any climate
 - OEM quality sealed motors that perform in any weather
 - Sturdy 6.25 inch wide aluminum running board features ultra-durable, non-slip, powder-coated surface
 - Integrated LED Light Kit mounts to linkage or to body and illuminates board and ground below for easier access in and out of the cab
 - 100,000 mile/3-year limited warranty
- ⚠ California Proposition 65 Warning: Cancer and Reproductive Harm.



Retracted Trekstep
75299-15



Deployed Trekstep
75299-15

TREKSTEP® FOR JEEP

- Provides convenient, stair step access to your Jeep in any weather
 - Spring-loaded and tucks beneath rear bumper for ground clearance and hands-free operation
 - Patented linkage easily extends down 6 inches and to the side with a push of your foot
 - Simple, no drill installation attaches directly to rear bumper in less than 10 minutes
 - Heavy-duty 300 lb. load capacity
 - Slip-resistant aluminum step pad features textured powder coat finish
 - Market leading 3 year/36,000 mile warranty
 - Heavy duty mounting hardware included
- ⚠ California Proposition 65 Warning: Cancer and Reproductive Harm.

POWERBOARD® & TREKSTEP®



Powerboard NX
75652-15



Deployed Trekstep
75299-15



YEAR	MODEL	STYLE	PART #	COLOR
07-18	Wrangler JK 2-Door (Rubicon Rock Rails need to be removed)	Powerboard	75151	15
07-18	Wrangler JK Unlimited (Rubicon Rock Rails need to be removed)	Powerboard	75152	15
07-18	Wrangler JK 2-Door (Rubicon Rock Rails need to be removed)	Powerboard NX WiFi	75651	15
07-18	Wrangler JK Unlimited (Rubicon Rock Rails need to be removed)	Powerboard NX WiFi	75652	15
07-18	Wrangler JK & Wrangler JK Unlimited (works with all Bestop Bumpers)	Trekstep	75299	15

Color: 15-Black. See page 87 for detailed color/fabric views.

FABRIC CARE



Bestop® Fabric Cleaner and Protectant applies with ease. Avoid contact with vinyl glass windows



Bestop® Vinyl Window Cleaner safely cleans and protects soft top windows



VINYL FABRIC CLEANER

- Safely removes the toughest soils and stains
- Anti-oxidant, low pH, no bleach formula, leaves no residue
- Biodegradable and environmentally-friendly
- ⚠ California Proposition 65 Warning: Cancer and Reproductive Harm.



FABRIC CARE KIT

- All three primary fabric care and protectant products in one kit
- Keep one in your Jeep® and another in the garage for year-round use
- ⚠ California Proposition 65 Warning: Cancer and Reproductive Harm.



VINYL WINDOW CLEANER

- Safely cleans and protects for unrivaled appearance of soft top windows
- Helps prevent UV damage, clouding, and cracking
- Easy application-wipe on, buff dry
- ⚠ California Proposition 65 Warning: Cancer and Reproductive Harm.



ZIPPER CLEANER AND LUBRICANT

- Specially-formulated to clean and lubricate all types of metal and plastic zippers
- Contains no silicone or wax
- ⚠ California Proposition 65 Warning: Cancer and Reproductive Harm.



VINYL PROTECTANT

- Safely repels dust, grease, dirt, and mildew
- Developed to minimize fading, cracking, and hardening
- Easy application: wipe on, wipe off
- Not for use on Twill fabric soft tops
- ⚠ California Proposition 65 Warning: Cancer and Reproductive Harm.



BLACK AND COLOR TWILL PROTECTANT

- Formulated specifically for use on any Black and Color Twill soft top
- Safely helps seal out tough soils and stains
- ⚠ California Proposition 65 Warning: Cancer and Reproductive Harm.

FABRIC CARE

Bestop® fabrics used in our Soft Tops for Jeep® and Fabric Accessories are made from the best materials available, the same as Bestop supplies to Jeep on all Wrangler factory soft tops. Though tough and super durable, every fabric needs some TLC every now and then. We have just the product care and protection you need. These fabric and vinyl care products work great on Bestop Tonneau Covers and Bestop Trailmax™ II seats.

CLEANERS/PROTECTANTS	SINGLE IN-A-BOX	6-PACK RETAIL PACKAGE	COLOR
Fabric Cleaner - 16oz. bottle	11211	11201	00
Vinyl Window Cleaner - 8oz. bottle	11213	11203	00
Protectant - 16oz. bottle	11212	11202	00
Fabric Care Kit	11215	11205	00
Zipper Cleaner & Lubricant - 2oz. bottle	11216	11206	00
Twill Protectant - 16oz. bottle	11217	11207	00

All cleaners/protectants will not harm Jeep or Truck finishes when used as directed.

SWATCH GUIDE

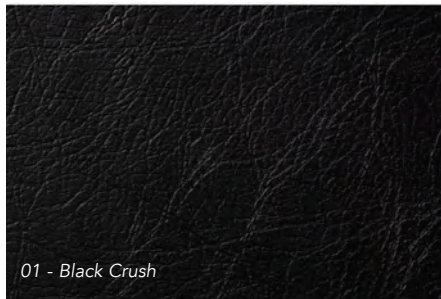

01 - Black Crush



04 - Tan

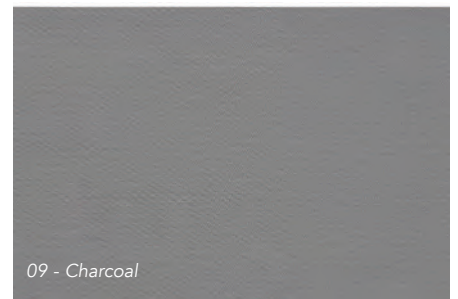

09 - Charcoal

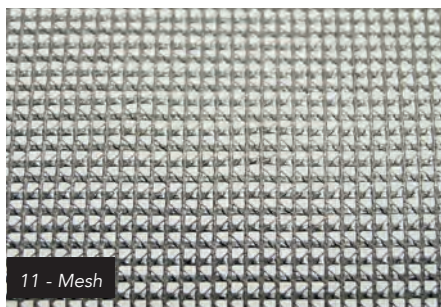

11 - Mesh

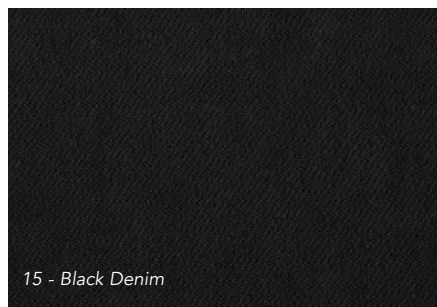

15 - Black Denim

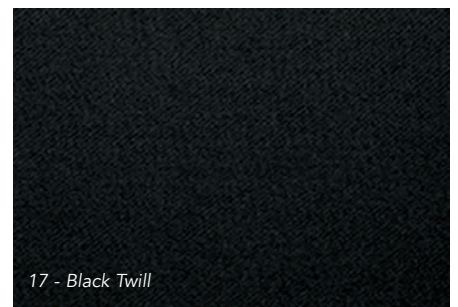

17 - Black Twill

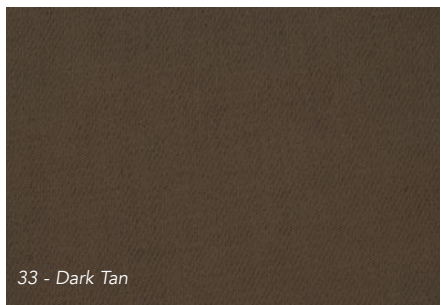

33 - Dark Tan

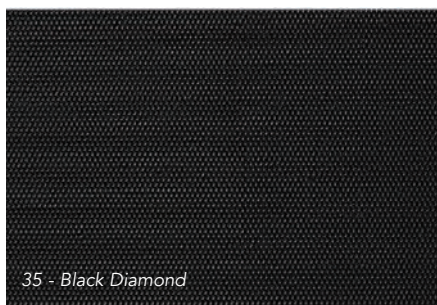

35 - Black Diamond

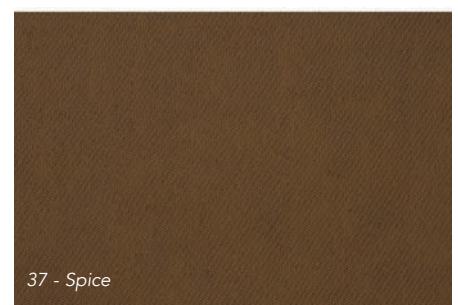

37 - Spice



52 - White Denim



68 - Crushed Red Pepper Twill



69 - Navy Blue Twill



70 - Granite Grey Twill



71 - Oak Tan Twill



74 - Pebble Beige Twill

BESTOP® PREMIUM ACCESSORIES GROUP

Pictured: All-New Trektop™ (56853-17), Moab, Utah



At Bestop®, we strive every day to share our enjoyment of open-air, off- and on-road adventures. We do this by providing the absolute highest quality, innovation, performance, and durability in Jeep® soft tops and accessories.



Revolutionizing industry leading lights is not just a job at Baja Designs, but a lifelong passion for both the founders and employees. For 25+ years, they have engineered revolutionary ways to stay at the forefront of motorcycle, automotive, and UTV lighting. BD is widely recognized as “The Scientists of Lighting” and their products are sought out by professional race teams and hardcore off-roading enthusiasts alike.



Tuffy Security Products delivers serious theft protection to vehicle owners, including off-roading enthusiasts and law enforcement professionals. They produce super high-quality steel security storage solutions in the USA. Their patented locking systems and designs, along with their strict adherence to the highest quality standards, make Tuffy Security Products the strongest option for anybody wanting to securely and safely store their valuables in their vehicle.



STATUS: *SpeedStrap*

For more than a decade, PRP has been best known as the seat of choice for UTVs such as the Polaris® RZR and Can-Am® Maverick X3. Now, they are proud to bring their high performance, fit, comfort, and customization to Jeeps, trucks, and other UTVs. Their sister company, Status Racing, manufactures a full line of specialized racing seats and also offers a wide breadth of customization and personalization. SpeedStrap is the maker of an innovative family of weavable recovery straps, plus premium tie-downs and accessories for off-road vehicles — absolute essentials for any off-roader.



2018 JEEP® JL A-PILLAR SQUADRON KITS

Sportsmen kit: #44-7504

Pro kit: #44-7505

Our Jeep JL A-Pillar mounts make it quick and easy to mount lights onto your rig. They mate up to the JL's factory mounting locations, with no trimming or modification to the vehicle required. These powder coated steel mounts are designed to hold up to whatever elements you throw at them.



JEEP® JL SQUADRON SPORT & 40" S8 DRIVING/COMBO COWL MOUNT

#44-7506

Our Jeep JL Cowl Mounts are the ultimate mounting option for anyone that wants versatility. This bracket can mount one pair Squadron series lights with a 40 inch S8 light bar. These steel mounts are powder coated to last the life of your Jeep.

Includes: brackets, hardware, S8 40" Light Bar Driving/Combo, a pair of Squadron Sport Wide-Cornering lights, and a wiring harness.





Rubicon

Sahara

Sport and Sport-S

JEEP® JL RUBICON SQUADRON-R FOG POCKET KITS

Sportsmen kit: #44-7504

Pro kit: #44-7505

Our JL Rubicon Fog Pocket replacement kit allows enthusiasts to retain factory fit and finish, while taking advantage of premium aftermarket LED output. This kit features a pair of Squadron Sports/Pros, which have a combined output of 4,520/9,800 lumens. Installation is easy — our durable brackets have been designed to retain the stock mounting points. The provided wire adapters attach into the OEM connectors, allowing the user to retain use of the factory fog switch, with no need for splicing or soldering.

Kits also available for the Sport/Sport-S models (#44-7066 Sportsmen, or 44-7067 Pro) and the Sahara modes (#44-7070 Sportsmen or #44-7505 Pro).



JEEP® JK SQUADRON-R LED FOG POCKET KIT

Sportsmen kit: #58-7503

Pro Kit: #59-7503

Whether you're looking for extra light on the trails or just needing some extra comfort lighting for those foggy conditions Baja Designs has you covered with our Jeep Wrangler JK Fog Pocket Kit. This kit has been designed specifically to mount our Squadron Sport/Pro LED lights into the OEM fog pocket location on a Jeep Wrangler JK.



2018 JEEP JL ROCK LIGHT KITS

#44-7055 – RED

#44-7058 – BLUE

#44-7056 – AMBER

#44-7059 – WHITE

#44-7057 – GREEN

Fits all JL models

Our Jeep JL Rock Light Kit takes the guesswork out of buying, wiring, and trying to figure out how to pin relays. All of the lengths are pre-cut to reach all four corners of the JL with some wiggle room on each lead to route the wiring any desired way. This kit includes the rock lights and wiring for a truly turnkey kit.

Includes: Wiring Harness and 4x-Rock lights.



Since 1989, Tuffy Security Products® has been the leading provider of secure vehicle storage products. Our patented locking systems, combined with strict adherence to the highest quality standards, position Tuffy Security Products as the strongest option for anybody wanting to organize and secure their gear.

Tuffy Security Products offers a solution for most vehicle makes and models. Many products are vehicle specific and use existing mounting points with no drilling required. All Tuffy Security Products carry a limited lifetime warranty against defects in workmanship, providing further peace of mind.



SECURITY CONSOLE INSERT

This steel console insert provides security, style, and convenience. Transform your console into a heavy-duty lockable storage area, while maintaining the refined curves of your OEM console. Explore with confidence, while Tuffy's Pry-Guard locking system provides peace of mind.



YEAR	MAKE	MODEL	PART #
19	Chevy/GMC	Trucks and SUVs	356
15-19	Ford	F-Series Trucks	317
18-19	Jeep	Wrangler JL	348
19	Ram	Trucks	354
16-19	Toyota	Tacoma	324
14-19	Toyota	Tundra	323

TRUCK UNDER SEAT LOCK BOXES

Available in 100% and 60% widths to help organize and secure the gear in your truck, these lock boxes come standard with Tuffy®'s Pry-Guard Locking System. They install easily under the seat without drilling, out of sight of opportunistic thieves.



YEAR	MAKE	MODEL	PART #
19	Chevy/GMC	Full-Sized Trucks	352
15-19	Ford	Full-Sized Trucks	316
19	Ram	Full-Sized Trucks	353
14-19	Toyota	Full-Sized Trucks	313



TAILGATE LOCK BOX

This heavy-duty, high-security lock box mounts on the inside of the Jeep® Wrangler tailgate, providing ample secure storage for tools and other gear. Use the door as a work table for cooking or quick access to your gear. Organize the space with two removable shelves.

YEAR	MAKE	MODEL	MOUNTING	PART #
07-18	Jeep	Wrangler JL	Inside Tailgate	349

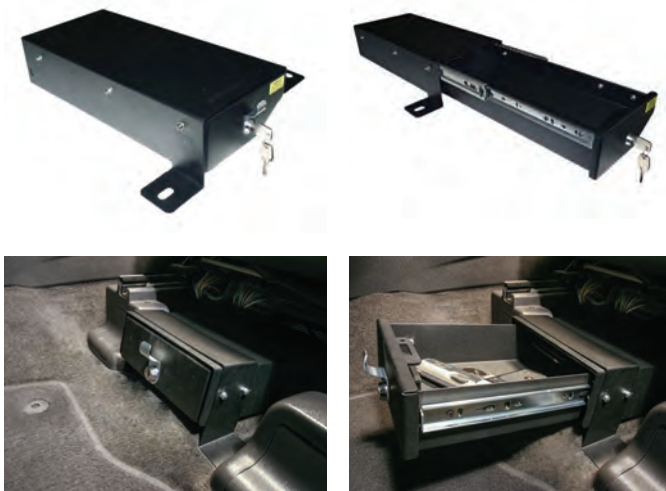

UNDER SEAT SECURITY DRAWERS

Secured with Tuffy® Pry-Guard Locking System and ten tumbler double bitted security key, confidently leave gear under your seat concealed and out of sight. Mounts using the factory hardware with no drilling.

YEAR	MAKE	MODEL	MOUNTING	PART #
11-18	Ford	Explorer	Driver's Side	335
07-18	Jeep	Wrangler JK	Driver's Side	247
07-18	Jeep	Wrangler JK	Passenger's Side	293



SECURITY DECK ENCLOSURES

The Tuffy Security Deck Enclosure secures the rear cargo area in your Jeep Wrangler. Working in conjunction with your Wrangler's locking tailgate, the lid secures shut using Tuffy's patented security system. The lid opens easily and can be removed without tools so larger items can be transported when needed.

YEAR	MAKE	MODEL	MOUNTING	PART #
18-Current	Jeep	Wrangler JL	No subwoofer	345
18-Current	Jeep	Wrangler JL	With subwoofer	351
11-18	Jeep	Wrangler JK	With or without subwoofer	326
07-10	Jeep	Wrangler JK	With or without subwoofer	173



CUSTOM SEAT COVERS FOR JEEP® WRANGLER JL

With a stunning look, PRP's Custom Seat Covers for the new Jeep JL offer an easy way to upgrade the look of your Jeep's interior. With over 50 color and fabric options to choose from, your interior can be customized to match your personal look and style. From marine-grade vinyls to stain-resistant woven materials, PRP's custom JL seat covers are made to last and look great.



ENDURO ELITE

The Enduro Elite is our newest Reclining Suspension Seat, now with Elite Series styling. Designed to replace stock Jeep Wrangler, Jeep XJ, or truck seats, the Enduro supplies additional comfort for taking your daily driver off-roading. Included is a removable, contoured seat cushion for better leg support and longer comfort. The Enduro Elite reclines completely and inclines enough to allow access to the rear seats.



GT3

The best seat in the house just got better. The GT3 is the third generation of our best-selling GT Series. New features include a removable seat cushion, a 5th point harness slot, and all new modern styling. Additional bands allow you to customize the colors and materials of your seat more than ever! The GT3 keeps you contained and comfortable with 7" of containment, and a perfect 12° seating angle. The vinyl-coated nylon suspension liner and dual-density foam decrease the impact on the body, reducing the fatigue you feel after a long day in the dirt or dunes. Improve your ride! Upgrade to the most innovative aftermarket RZR suspension seat!



4.2 HARNESS

Great for your Jeep or UTV, the 4.2 Harness features and automotive style latch getting you on the trails faster. This 2", 4-point seat belt has sewn in pads for comfort, all black hardware for cool styling and quick adjusters on the shoulders. Available in 9 different colors.



5.3 HARNESS

Whether racing, running the dunes, or crawling the Rubicon, the 5.3 Harness will hold you in tight. This 3", 5 point seat belt has sewn in pads for comfort, all black hardware for cool styling and EZ adjusters on the shoulders. The EZ adjusters allow you to adjust your shoulder straps quickly and even if they are dirty or muddy. The seat belt also has a removable sternum strap, and a red latch guard on the lap belt. The lap belt bolts in. The shoulder harness and crotch strap can either bolt down or wrap around a roll bar. SFI 16.1 certified for racing. Don't know which SFI certification you need? Find out here.



DOOR BAG WITH KNEE PAD FOR POLARIS® RZR

The original bag everyone is talking about. Protect your knee and add vital storage to your Polaris RZR with PRP's Door Bag with Knee Pad. This innovative, patent pending storage attaches in minutes to the stock doors on your Polaris RZR XP 1000, S 1000, or S 900 using the factory screws.



DOOR BAG WITH KNEE PAD FOR CAN-AM® MAVERICK X3

Our ground-breaking concept now available for the Can-Am Maverick X3! With storage at a premium in the X3, we developed this convenient storage bag for the stock doors. Attaches quickly and easily with just 4 velcro loops while still allowing you to reach the pull for the door latch.



STATUS:

Alison Tanney

THE RING



The Ring composite seat is the flagship of Status Racing. Fully customizable, the Ring is available with over 60 color and fabric options at no additional charge. The combinations are almost endless. The high-quality fabrics are form fitted to a glossy, black FRP or carbon fiber composite shell. ABS plastic harness pass throughs are inserted to accommodate 3-inch Status Harnesses.

The Ring Composite seat is available in 3 sizes:

- + The Ring: a narrow seat designed for no more than a 32-33 waist size.
- + The Ring GT: a wider seat designed for up to a 32-34 inch waist size.
- + The Ring GT-X: narrow at the shoulders but flaired at the base designed for up to a 38-inch waist size.

CLASSIC SERIES



Classic, comfortable, customizable. With adjustable and fixed back options, Status: Classic Series seats allows your vintage, restomod, or component build to shine even brighter. Each seat is available in multiple widths and heights, with a low back or adjustable headrest, and a number of additional add-on features. With a production time of about 2 weeks, you'll have your customized seat in your build fast.

THE SPA



A customizable, carbon fiber backed recliner for the ultimate in style. The Original Spa seat is available in black, grey, blue, or red suede and black marine-grade vinyl. The NEW Spa Grand Prix offers a sportier style allowing for additional areas of customization.

The seats include a contoured foam cushion as a standard feature as well as padded side bolsters. The high quality fabrics are form fitted to the shell upper and tube frame base. ABS plastic harness grommets accommodate the 3 inch Status Harnesses. Seats are sold individually and require vehicle specific seat brackets. Sliders are built in and standard black plastic reclining knobs are included.

5 POINT, CAM-LOCK HARNESS



Status 5 and 6 point harnesses feature EZ Adjusters on the shoulders which allow you to quickly loosen or tighten your belts, pull up lap belts to give you a better angle to make sure you're as secure as possible, easy to use Cam-Lock closure allows for quick disconnection, and clip-in attachments to easily install and remove the belts. Each harness Includes eye-bolts for clip-in hardware and are FIA approved so you can ensure you are equipping your vehicle with proper safety equipment. Available in Red or Black.



ULTIMATE OFF-ROAD KIT

Featuring a 3,300 lb. Safe Working Load (SWL) and a 10,000 lb. Maximum Rated Capacity (MRC), all 2" tie-downs are built with our signature, wide handle comfort grip and protective end caps on the barrels to protect your rig. This Off-Road Kit provides the ultimate collection of tie-downs for your truck, buggy, or Jeep® and a convenient carrying bag to store them in.



1" SUPERSTRAP WEAVABLE RECOVERY STRAP

This 1" weavable recovery strap is rated at 10,000 lbs. With its unique design, you create an loop at both ends by simply weaving it through itself for a metal-free recovery strap. Just wrap, weave, and pull. When you're done, unweave and store for next time. Available in 15', 20', 25', 30', or 50' lengths and is most commonly used for UTVs, ATVs, Jeeps, and pre-runner trucks.

JOBBER NETWORK

JOIN THE BESTOP® JOBBER NETWORK

In 2019, Bestop® offers its most thorough and personalized support to our Jobber Network. Join today to receive the benefits that over 1,000 Jobbers are using to be successful with Bestop Jeep and Truck accessories.



2' x 4' Sample Wall Mount Display (PART NUMBER: 575.85)



6' x 2' Bestop Banner (PART NUMBER: BAN10)



Access to Bestop marketing materials such as high-resolution photography



Access to Bestop marketing materials such as videos

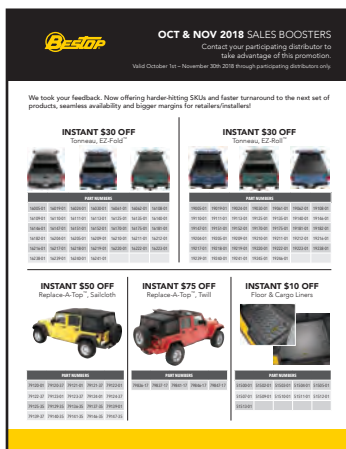

Access to Bestop marketing materials such as quarterly sales boosters



Fabric Swatch Book (PART NUMBER: 39318-00)

MEMBER BENEFITS*:

- Become listed on the Bestop Dealer Locator
- Access to Bestop Marketing Assets including high-resolution photography, video, sell sheets, plug-and-play ads, and print-ready graphics
- Sales Boosters – an advantage specific to brick and mortar shops
- Welcome Kit for new members with POP materials and 2019 literature
- Retail Display options
- Access to full-line catalogs and brochures
- Consultation and special tactics available from our team of sales professionals
- Access to our Jobber-Specific Facebook group

*Benefits vary by membership level

(2018 Samples Shown)