



Our Name Says It All! TM

CHEVROLET & GM BODY PANELS

- **Nova & X-Body**
- **Chevelle & A-Body**
- **Camaro & Firebird**



2015

Our New Chrome Factory!

Our brand new state-of-the-art chrome facility is now running and producing the highest quality bumpers on the market.



The Details make the difference!

Don't settle for incorrect, knock-off parts for your car. Get premium sheet metal parts from the restoration pros at **Auto Metal Direct**. Our panels are made from the proper gauge steel and include all correct-as-original clips, tabs, flanges, bends and seams. Each time a prototype body panel comes off of new tools, we test fit it on a car. The marked up prototype is then used to change and improve the tools, and a new prototype is produced. This procedure might be repeated multiple times, but once the part is finally approved, you can be assured of a quality part.



AMD



Competitor



AMD



Competitor

AMD's quarter skins come complete with door jambs, unlike our competitor's parts

We Install What We Sell!

You already know that you can get premium sheet metal parts for your muscle car from Auto Metal Direct (AMD). Our panels fit and include all correct-as-original clips, tabs, flanges, bends and seams.

We are so confident in the quality and fit of our parts, that we have developed our own installation center! Cars that were formally written off as hopeless have now been given a new lease on life. And since we are actually installing our own parts, we are able to develop parts that fit correctly.



**Auto Metal Direct...
Saving Cars & Preserving History**





Our Name Says It All!™

About



Our Name Says It All!™

Welcome to Auto Metal Direct () — your one stop source for the highest quality body panels on the market. Our staff has extensive experience in the collector car / restoration trade and will be happy to assist you. Check out our extensive inventory and let us help you get your car back in top condition!

, Auto Metal Direct, and our slogan ("Our Name Says it All!™") are registered trademarks and cannot be duplicated or reproduced without written permission. All pictures and information contained in this catalog are property of .



Parts indicated are officially manufactured and licensed under the General Motors Restoration Parts Program. Logos and trademarks of various manufacturers are used under license by  and our suppliers. Any descriptions bearing trade-marked names are for application reference only.

Directions

From Atlanta

Take I-85 North toward Greenville, SC. Merge left onto I-985 N. Take Exit 8 for GA-347 / Friendship Rd. and turn left. Turn right at Atlanta Highway / GA-13 N / Gainesville Highway. Go 1/2 mile. Take Sherwin Parkway on Right.  is in the last building.

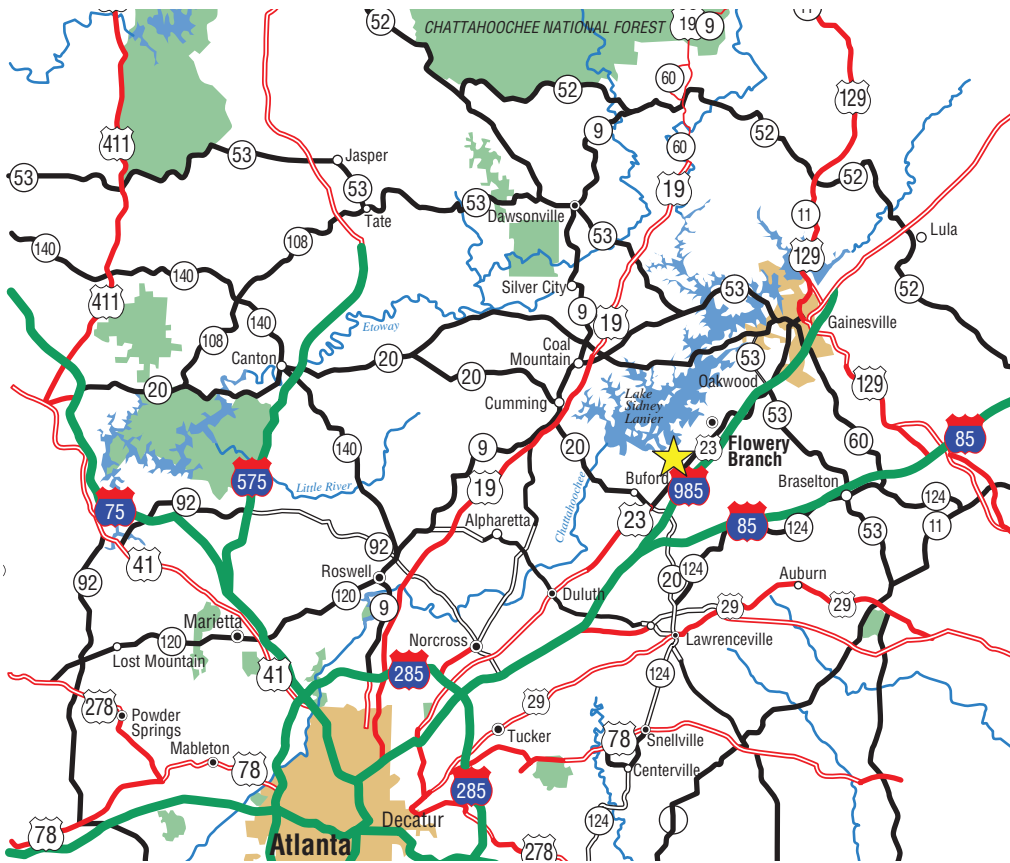

Our Name Says It All!™

Bumpers & Accessories





AMD bumpers are made from heavy gauge steel and feature OE quality chrome finish. All parts feature, depending on application, correct holes for turn signals or back up lamps. Installation is fast and easy as all parts are designed to be a direct bolt-on utilizing OE bumper brackets and hardware. Our bumpers are manufactured on our new, state of the art chrome production line. **Please note that bumpers with a part number starting with "X" (instead of a number) are not made by AMD and do not meet the same quality standards as the bumpers we produce. All bumpers are covered by a 5 year limited rust-through warranty.**

Bumpers, Front & Rear

Nova



Front



62-64	 Restoration Parts	100-3062
65	 Restoration Parts	100-3065
66-67 (pictured)	 Restoration Parts	100-3066
68-69	 Restoration Parts	100-3068
70-72	 Restoration Parts	100-3070

Rear











62-65	 Restoration Parts	990-3062
66-67	 Restoration Parts	990-3066
68-72 (pictured)	 Restoration Parts	990-3068

Chevelle / El Camino

Front



64	 Restoration Parts	100-3464
65	 Restoration Parts	100-3465
66	 Restoration Parts	100-3466
67	 Restoration Parts	100-3467
68	 Restoration Parts	100-3468
69	 Restoration Parts	100-3469
70 Chevelle (pictured)	 Restoration Parts	100-3470
70 El Camino	 Restoration Parts	100-3670
71-72	 Restoration Parts	100-3471

Rear





64-65 Chevelle	 Restoration Parts	990-3464
66 Chevelle	 Restoration Parts	990-3466
66 El Camino	 Restoration Parts	990-3766
67 Chevelle	 Restoration Parts	990-3467
67 El Camino	 Restoration Parts	990-3767
68 Chevelle	 Restoration Parts	990-3468
68-72 El Camino	 Restoration Parts	990-3768
69 Chevelle	 Restoration Parts	990-3469
70 Chevelle	 Restoration Parts	990-3470
71-72 Chevelle, Standard, drill holes for SS Emblem (pictured)	 Restoration Parts	990-3471

Monte Carlo

Front





70 (pictured)	 Restoration Parts	100-3670
71	 Restoration Parts	100-3671
72	 Restoration Parts	100-3672

Rear





70-72	 Restoration Parts	990-3670
-------	---	----------

GTO

Front

65	 Restoration Parts	100-5465
66-67	 Restoration Parts	100-5466

Rear

65	 Restoration Parts	990-5465
66	 Restoration Parts	990-5466
67	 Restoration Parts	990-5467
69	 Restoration Parts	990-5469
70-72	 Restoration Parts	990-5470

Cutlass

Front

68	 Restoration Parts	100-7468
70	 Restoration Parts	100-7470
71-72	 Restoration Parts	100-7471





Rear

70 without Exhaust Tips	 Restoration Parts	990-7470
70 with Exhaust Tips	 Restoration Parts	990-7470-T
71-72 without Exhaust Tips	 Restoration Parts	990-7471
71-72 with Exhaust Tips	 Restoration Parts	990-7471-T

Camaro



Front



67 (pictured)	 Restoration Parts	100-3567
68	 Restoration Parts	100-3568
69	 Restoration Parts	100-3569
70-73 Standard	 Restoration Parts	100-3570
70-73 RS, Pair	 Restoration Parts	100-3570-1P

Rear



67-68 (pictured)	 Restoration Parts	990-3567
69	 Restoration Parts	990-3569
70-73	 Restoration Parts	990-3570

Firebird

Front



67-68 (pictured)	X100-5567
------------------	-----------

Rear

67-68	X990-5567
-------	-----------



AMD All of our own **AMD** parts in this catalog are listed in **Blue, bold-face Type**.

Our Name Says It All!™

Bumper Bolts, Brackets & Accessories

AMD offers new bolts, mounting brackets, bumper guards, and license brackets to complete the installation of your new bumper. You'll find your bumper installation easier when using new parts instead of bent or rusty originals. AMD bumper mounting bolts are precision-manufactured from steel with a chrome finish to match up to AMD's chrome bumpers perfectly. AMD bumper brackets are accurate reproductions of factory originals. Don't waste your time trying to refurbish your rusted and pitted originals.

Bumper Bolt Sets, Front & Rear

Nova

Front

62-65	32-Piece Set101-3062-S
66	24-Piece Set101-3066-S
67	24-Piece Set101-3067-S
68-72	32-Piece Set (pictured)101-3068-S



Rear

62-65	30-Piece Set991-3062-S
66	32-Piece Set991-3066-S
67	32-Piece Set991-3067-S
68-72	32-Piece Set991-3068-S

Chevelle / El Camino

Front

64-66	32-Piece Set101-3464-S
67-69	28-Piece Set (pictured)101-3468-S
1970	32-Piece Set101-3470-1S
71-72	32-Piece Set101-3471-1S



Rear

64-65	32-Piece Set991-3464-S
66	24-Piece Set991-3466-S
67	24-Piece Set991-3467-S
68-69	Chevelle, 31-Piece Set991-3468-S
68-69	El Camino, 39-Piece Set991-3768-S
70-72	Chevelle, 28-Piece Set991-3470-S
70-72	El Camino, 39-Piece Set991-3770-S

Monte Carlo

Front

70-72	32-Piece Set101-3470-1S
-------	--------------	------------------

Rear

70-72	40-Piece Set991-3670-S
-------	--------------	-----------------

Camaro

Front

67	16-Piece Set101-3567-S
68	12-Piece Set101-3568-S
67	Chrome, front & rear, bolt & nuts, 20-Piece Set W-241A
68-69	Chrome, long corner bolts, 2", 22-Piece Set W-240
68-69	Chrome, front & rear, bolt & nuts, 20-Piece Set W-240A
	Chrome, short bolt W-241
69	16-Piece Set101-3569-S
69	Painted, 10-Piece Set101-3569-1S
70-72	Standard, 10-Piece Set (pictured)101-3570-1S
70-72	RS, 8-Piece Set 101-3570-1RS
73	Standard, 18-Piece Set101-3573-1S
73	RS, 10-Piece Set 101-3573-1RS
	Bumper bolt nut with washer W-242



Rear

67-69	12-Piece Set991-3567-S
70-72	14-Piece Set991-3570-S
73	14-Piece Set991-3573-S

Firebird

Front

67-68	12-Piece Set101-5567-S
-------	--------------	-----------------

Rear

67-68	18-Piece Set991-5567-S
-------	--------------	-----------------

Bumper Mounting Brackets, Front & Rear

Nova

Front

62-65	Inner, LH/RH Pair (pictured)C-P2-2250
62-65	Outer, LH/RH PairC-P2-2240
66-67	Inner, LH/RH PairK-N6533











Rear

62-65	LH/RH PairC-P2-2268
66-67	LH (pictured)X970-3066-L
66-67	RHX970-3066-R
68-72	LHX970-3068-L
68-72	RHX970-3068-R





Camaro

Front

67-68	Inner, LHX105-3567-1L
67-68	Inner, RHX105-3567-1R
67-68	Outer, LHX105-3567-2L
67-68	Outer, RHX105-3567-2R
69	Outer Corner, LH/RH Pair (above right) X105-3569
69	Inner, LH (pictured, above left) X105-3569-1L
69	Inner, RH X105-3569-1R
69	Outer, LH X105-3569-2L
69	Outer, RH X105-3569-2R
69	Endura, Inner, LH/RH Pair  K-K36702
69	Endura, Outer, LH/RH Pair  K-K36703
70-72	Standard, 15-Piece Set  W-549
70-72	RS, Inner, LH  W-554B
70-72	RS, Inner, RH  W-554A
70-73	RS, 18-Piece Set W -987
70-73	Standard, Inner, LH  W-554B
70-73	Standard, Inner, RH  W-554A
70-73	Standard & RS, LH/RH Pair  W-580
70-73	Standard & RS, Outer, LH/RH Pair (at right)  W-556



Rear

67-68	4-Piece Set  W-325
69	Inner, Outer, with Center Bracket, 5-Piece Set  W-778
69	Inner & Outer, 4-Piece Set  W-778B
70-72	5-Piece Set (pictured) W-557





Camaro

Nose Bumper Brackets

70-73	RS, LH/RH Pair (pictured)	.. W-986
-------	---------------------------	----------

Center Bracket

67-68	Rear Center Bracket (pictured)  W-604
69	Rear Center Bracket (pictured)  W-778A
68	Center Bumper to Valance CushionK-K129



Front Bumper Extension Bracket Frame Bracket to Bumper

69	LH (pictured) W-378
69	RH W-379



Our Name Says It All!™

Bumper Bolts, Brackets & Accessories

Bumper Mounting Brackets, Front & Rear, continued

Camaro, continued

Hardware

- 70-73 Standard & RS, Inner Bracket Cushion, LH/RH Pair
(pictured)  W-555
- 70-73 RS Front Bumper Mo W-987-1



Chevy Full Size

Front

- 63-64 3-Piece Set, LH
(pictured).....X105-3964-L
- 63-64 3-Piece Set, RHX105-3964-R



Front Bumper Bracket Tube



- 63-64 LHX105-3963-1L
- 63-64 RHX105-3963-1R

Front Bumper Reinforcement



- 64 X109-3964-1

Rear

- 64 LHX970-3964-L
- 64 RH X970-3964-R



Bumper Bracket Hardware

Camaro

- 69 Bumper bracket extension hardware kit G-4269
- 68 Front outer bumper bracket rubber mount with steel sleeve, 2-Piece Set W-232
- 69 Front outer bumper bracket rubber mount with steel sleeve, 2-Piece Set W-233
- 70-73 RS & Standard, front bumper inner bracket cushion, LH/RH Pair W-555

Bumper Guards & Bumperettes, Front & Rear

Chevelle

Front & Rear

- 66 and El Camino, 4-Piece Set
(pictured)X110-3466-S
- 67 4-Piece Set X110-3467-S
- 71-72 Front, LH/RH Pair ...X110-3471-P



Camaro

Front Guards

- 69 Deluxe Set, Pair, with Hardware W-440

Rear Guards

- 67-68 Standard, Chrome, LH/RH Pair X980-3567-P
- 67-68 Deluxe, LH/RH Pair
(pictured)X980-3567-1P
- 69 Standard, LH/RH Pair X980-3569-P
- 69 Deluxe Set (2 Guards, Inserts & Hardware) (pictured) W-599
- 69 Deluxe, Each W-599A
- 70-73 LH/RH Pair  K-K229



Chevy Full Size

Front

- 66 LH/RH PairX110-3966-P

Bumper Guard Inserts

Chevelle

- 67 Front & Rear, 4-Piece Set.....G-BGK170067
- 67 Rear, LH/RH PairG-BGR170067
- 68 Front & Rear, 4-Piece Set.....G-BGK170068
- 68 Rear, LH/RH PairG-BGR170068
- 69 Front & Rear, 4-Piece Set.....G-BGK170069
- 69 Rear, LH/RH PairG-BGR170069
- 70-72 Front & Rear, 4-Piece Set.....G-BGK170070
- 70-72 Rear, LH/RH PairG-BGR170070



Monte Carlo

- 70-72 Front & Rear, 4-Piece Set.....G-BGK170170

Camaro

Front

- 67-69 Deluxe, Sold each (pictured above)..... W-551

Rear

- 67-68 Deluxe, Sold each (pictured above)..... W-551
- 69 Deluxe, Sold each W-599B

Front Bumper Impact Strip

Camaro

- 74-77 K-372955

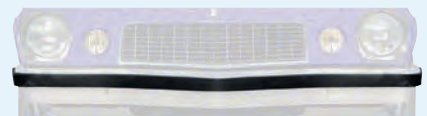

Bumper Guard Brackets

Camaro

- 67-68 Standard, Rear, LH/RH Pair (pictured)981-3567-P
- 69 Deluxe, Front, LH/RH P air W -552
- 69 Deluxe, Rear, LH/RH P air W -128



Front License Plate Brackets

Camaro

- 67-68 (pictured)..... W-307
- 69 W-308
- 70-73 Standard..... W-815



All of our own **AMD** parts in this catalog are listed in **Blue, bold-face Type**.

Our Name Says It All!™

Valances, Headers & Spoilers

AMD grille fillers, front valances, and header panels are a great choice for your next musclecar restoration project! Constructed from durable steel: these panels are EDP coated for rust resistance. AMD panels are direct replacements for the stock pieces so you can be assured that you are getting the right fit for your vehicle. Our plastic grille fillers and front spoilers are injected molded like the originals and are the most accurate on the market.

Front Bumper to Grille Filler Panel

Nova



62-65 (pictured)..... X115-3062
66-67 X115-3066



68-72 LowerPanel, Plastic 115-3068-2
This piece is often broken or missing. An authentic reproduction of the original part and sits on top of steel filler (115-3068-1), below.



72 Steel 115-3068-1

Chevelle / El Camino



67 Chevelle 115-3467
68 (pictured)..... 115-3468
69 115-3469
70 115-3470

Monte Carlo

70-72 115-3470

Camaro

70-73 Standard & RS, LH/RH Pair..... W-596

Chevy Full Size



63 X115-3963
64 (pictured)..... X115-3964

Front Lower Valance Panel

Camaro

67-68 Standard..... X125-3567-1
67 RS X125-3567-2
68 RS X125-3568-2



69 (pictured) 125-3569
70-73 Standard 125-3570-1
70-73 RS 125-3570-2

Firebird

67 X125-5567
68 X125-5568
69 X125-5569

GTO

69 X125-5469

Front Header Panel

Chevelle / El Camino



68-69 130-3468

Camaro



67-68 (pictured) 130-3567
69 130-3569
70-73 Standard 130-3570-1
70-73 RS 130-3570-2

Chevy Full Size

66 X130-3966

Front Spoiler

Camaro



67-68 127-3567



69 127-3569

Front Spoiler Bracket Sets

Camaro



67-68 3-Piece Set (pictured)..... W-221
69 3-Piece Set..... W-222



Our Name Says It All!™

Grilles, Supports & Brackets

New Grilles are the perfect solution for replacement of an original or conversion to a different model. Each high quality reproduction grille is made from injection molded plastic or stamped aluminum as original. We also offer bracket and supports to aid in the installation of your new grille.

Grilles

Nova

63	C-A2-6030
64	C-A2-6040
66	C-A2-6060



67	(pictured).....	C-A2-6070
68-69	Standard.....	C-A2-6080
68-69	SS.....	C-A2-6085
70-72	Standard.....	C-A2-6090
70-72	SS.....	C-A2-6095
73-74	C-A2-7374-1

Chevelle / El Camino



AMD's 70 SS Chevelle Grille is made on new tools and is a faithful reproduction of the original!

70	SS, Black		150-3470
71	C-A-1100	
72	C-A-1110	

Outer Grille Extension

67	Chevelle, LH/RH Pair (pictured).....	X150-3467-P		
68	Extension Set.....	P-A6491A		
68	LH/RH Pair (included in set, above)	P-PZ00267		
68	Lower Molding, LH/RH P air (included in set, above)	P-C880051		



Camaro

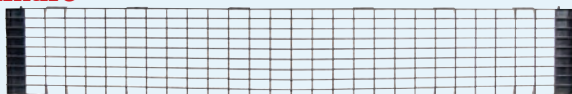

67	Standard, Center.....	W-040
67	RS, Center.....	W-041
67	RS, Grille & Headlamp Door, 3-Piece Set.....	W-047
68	RS, Center, Black (pictured).....	W-043
68	RS, Center, Chrome Ribs.....	W-044
68	RS Grille & Headlamp Door, 3-Piece Set, Black.....	W-048
68	RS, Grille & Headlamp Door, 3-Piece Set, Chrome Ribs.....	W-049
68	Standard, Center.....	W-042
69	RS, Center.....	K-3938641
69	Standard, Black.....	 K-3957062



69	Standard, Silver (pictured).....	 K-3957044
70-71	Standard, Center.....	K-3967175















Grilles, continued

Camaro, continued

70-71	Z/28, Standard, Center, Black.....	K-3967175B
72-73	Standard, Center.....	K-333724
78-79	Standard, Lower, Silver.....	K-459170
78-79	Z/28 & RS, Lower, Black.....	K-468036

Firebird



67	Standard, LH.....	 K-9788857
67	Standard, RH.....	 K-9788856
67	400, LH.....	 K-9789374
67	400, RH.....	 K-9789373
68	LH.....	 K-9793726
68	RH.....	 K-9793725
68	400, LH.....	 K-9793724
68	400, RH.....	 K-9793723
69	Trans Am, LH.....	 K-9795936
69	Trans Am, RH.....	 K-9795935
70-71	Argent Silver, LH.....	 K-478513
70-71	Argent Silver, RH (pictured, left).....	 K-478512
70-71	Trans Am, Black, LH.....	 K-479691
70-71	Trans Am, Black, RH (pictured, right).....	 K-479690

Grille Supports

Nova

68-72	Upper Radiator Support Tie Bar.....	 151-3068
-------	-------------------------------------	---

Chevelle / El Camino

70-72	Radiator Support Tie Bar.....	 151-3470
-------	-------------------------------	---

Camaro

69	Grille Stiffener.....	W-107
----	-----------------------	-------

Grille Support Brackets

Nova

66	Grille Mounting Bracket, 6-Piece Set (top).....	C-A2-6061
----	--	-----------

68-72	LH (pictured).....	 152-3068-L
68-72	RH.....	 152-3068-R

Chevelle / El Camino

68	4-Piece Set (pictured).....	 152-3468-S
69	4-Piece Set.....	 152-3469-S
70	3-Piece Set.....	 152-3470-S



Our Name Says It All!™



All of our own **AMD** parts in this catalog are listed in **Blue, bold-face Type**.

Grille Brackets, Headlamp Bezels

Grille Support Brackets, continued

Camaro

- 68 Standard, Grille Mounting Bracket, LH/RH Pair (pictured, left).. W-695
 70-73 RS, Grille Divider Bracket (pictured, right).....  K-K55

Firebird

- 69 Lower Grille Support Bracket K-9795986

Grille Hardware

Camaro

- 67-68 Grille Fastener, 66-Piece Set K-K559
 69 Grille Fastener, 40-Piece Set K-K558
 69 Grill Mounting Kit, 30-Piece Set H-154

Grille & Headlamp Door Applique Set

Camaro

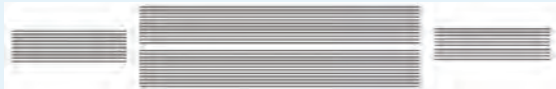

- 68 RS, Chrome W-757

Headlamp Bezels

Nova

- 62-64 LH/RH Pair C-G2-2210
 65 LH=RH, Sold each C-G2-2230
 66 LH=RH, Sold each (pictured) T-3055
 67 LH K-3892281
 67 RH K-3892282



Chevelle / El Camino

- 64 LH/RH Pair P-9564CHB
 65 LH/RH Pair P-9565CHB
 66 LH/RH Pair P-9566CHB
 66 Bezel Extension, LH/RH Pair P-C887815
 67 LH/RH Pair P-9567CHB
 70 LH/RH, 4-Piece Set (pictured) P-K67562
 71 LH/RH Pair P-HLB7101
 72 LH/RH Pair (pictured) P-HLB7201



Camaro











- 67 Standard, LH/RH Pair (pictured, left)  W-151
 67 Standard, LH  W-151B
 67 Standard, RH  W-151A
 67-68 RS, LH/RH Pair (pictured, right)  W-150
 67-68 RS, LH  W-150B
 67-68 RS, RH  W-150A







Headlamp Bezels, continued

Camaro, continued



- 68 Standard, LH/RH Pair (pictured, left)  W-569
 68 Standard, RH W-569A
 68 Standard, LH W-569B
 69 without Trim, LH/RH Pair  W-760
 69 Standard, without Chrome Trim, LH W-602
 69 Standard, without Chrome Trim, RH W-601
 69 Standard, with Chrome Trim, LH/RH Pair  W-755
 69 Standard, with Chrome Trim, LH W-493
 69 Standard, with Chrome Trim, RH W-492
 70-73 LH/RH Pair (pictured, right)  W-746
 70-73 RH W-746A
 70-73 LH W-746B
 74-77 Z/28, LH  K-333796
 74-77 Z/28, RH  K-333797
 74-77 Except Z/28, LH  K-333791
 74-77 Except Z/28, RH  K-333792
 78-81 Standard, LH K-356577
 78-81 Standard, RH K-356578
 78-81 Z/28, LH K-468031
 78-81 Z/28, RH K-468032

Firebird

- 69 LH  K-9784321
 69 RH  K-9784320
 74-76 LH  K-492667
 74-76 RH  K-492666
 79-81 Standard, Chrome, 4 required, Sold each  K-10004292
 79-81 Trans Am, Black, 4 required, Sold each  K-10005236

Headlamp Bezel Hardware

Nova

- 67 Headlamp Bezel Seal, LH/RH Pair (pictured) K-K420
 69 Headlamp Washer Nozzle, 4-Piece Set K-3957029





Chevelle / El Camino

- 67 Headlamp Bezel Retainer, LH/RH Pair P-97CH14
 68-69 Hardware Set, mounts 4 Bezels C-G-1770
 70 Hardware Set, mounts 4 Bezels C-G-1775

Camaro

- 67-68 Headlamp Bezel Nut Set  K-3899847
 67-68 Standard or RS, Headlamp Bezel Barrel Nut, 8-Piece Set W-560
 67-68 Standard, Bezel Screws, 6-Piece Set H-120
 69 Bezel Screws, 6-Piece Set H-122
 69 Bezel "U" Nuts, 6-Piece Set H-123
 Retaining Screws, Pair H-130
 69 Headlamp & Wiper Ground Strap  K-3937657
 69 Headlamp Washer Nozzle, 4-Piece Set K-3957029



Firebird / Trans Am

- 69 Headlamp Bezel Cushion, LH  K-9784328
 69 Headlamp Bezel Cushion, RH  K-9784327
 79-81 Headlamp Bezel Nuts  K-10009690

Headlamp Parts

Headlamp Housings

Camaro

- 67 Standard, LH
(pictured)  K-K866
- 67 Standard, RH
.....  K-K865
- 68 Standard, LH X141-3568-L
- 68 Standard, RH X141-3568-R
- 69 Standard, LH X141-3569-L
- 69 Standard, RH X141-3569-R



Headlamp Mounting Buckets

Nova

- 68-73 LH (pictured, left) W-699
- 68-73 RH (pictured, right) W-698

Monte Carlo

- 70 LH (pictured, left) W-699
- 70 RH (pictured, right) W-698

Camaro

- 67-69 LH (pictured, left) W-699
- 67-69 RH (pictured, right) W-698
- 69 BB,
(pictured, right) W-698
- 69 RS, RH
(pictured, left) W-699



Sealed Beam Bucket

- 70-73 LH W-989
- 70-73 RH W-988

Headlamp Washer Nozzle

Chevy Full Size

- 69 4-Piece Set K-3957029



Headlamp Bucket Mounting Hardware

Camaro

- 67-68 10-Piece Set W-785A
- 69 10-Piece Set W-785B
- 70-73 10-Piece Set W-785C

Firebird

- 67-68 10-Piece Set W-785A

Headlamp Retaining Rings

Nova

- 62-74 (use 2 per car) 146-3062

Camaro

- 67-74 (use 2 per car) 146-3062

Firebird

- 70-73 (use 2 per car) 146-3062

GM

- 69-73 1" with Notch W-770A
- Sealed Beam Retainer Screws, 6-Piece Set H-117



Headlamp Adjusting Hardware

Chevelle / El Camino

- 68-70 Set, Mounts 2 Headlamps C-G-1740

Headlamp Spring

Nova

- 69-74 (pictured)  W-785

Monte Carlo

- 70 (pictured)  W-785

Camaro

- 67-69 W-785
- 70-73 W-785E

Firebird

- 74-78 Headlamp Beam
Adjuster Spring
(pictured) K-496096



Working on a Plymouth or Dodge?

We're the world's largest supplier of reproduction MOPAR licensed sheet metal

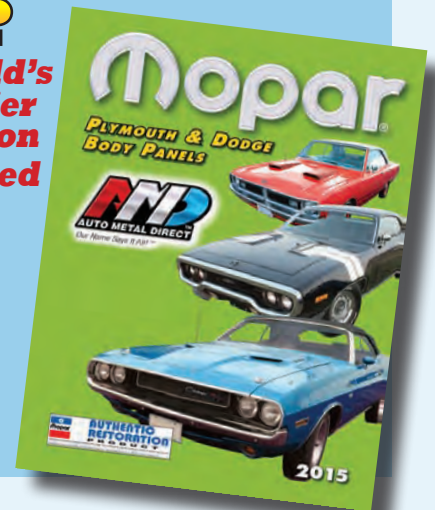

Our Name Says It All!™



All of our own AMD parts in this catalog are listed in Blue, bold-face Type.



Fenders & Accessories

AMD fenders are manufactured using high quality, heavy gauge steel on our exclusive new tools and features correct as original body lines, braces, marker light holes, and antenna cut-out (*certain models only*). Like all AMD parts, these fenders arrive in a black EDP finish and will require standard prep work prior to paint. **Please note that fenders with a part number starting with "X" (instead of a number) are not made by AMD and do not meet the same quality standards as the fenders we produce.**



Fenders

Nova









62-65 LH	X200-3062-L
62-65 RH	X200-3062-R
67 LH	X200-3067-L
67 RH	X200-3067-R
68-69 LH (pictured)	 200-3068-L
68-69 RH	 200-3068-R



70-74 LH (pictured)	 200-3070-L
70-74 RH	 200-3070-R



Chevelle / El Camino

65 LH	X200-3465-L
65 RH	X200-3465-R
66 Chevelle, LH	 200-3466-L
66 Chevelle, RH	 200-3466-R
67 LH	 200-3467-L
67 RH	 200-3467-R
68 LH	X200-3468-L
68 RH	X200-3468-R
69 LH	X200-3469-L
69 RH	X200-3469-R
70 Chevelle, LH	 200-3470-L
70 Chevelle, RH	 200-3470-R
71-72 Chevelle, LH	 200-3471-L
71-72 Chevelle, RH	 200-3471-R

Chevelle Wagon / El Camino











70 LH	X200-3770-L
70 RH	X200-3770-R
71-72 LH	X200-3771-L
71-72 RH	X200-3771-R

GTO

66 LH	X200-5466-L
66 RH	X200-5466-R
67 LH	X200-5467-L
67 RH	X200-5467-R

Camaro



67 Standard, LH with Extension	 200-3567-LS
67 Standard, RH with Extension	 200-3567-RS
67 RS, LH with Extension	 200-3567-1LS
67 RS, RH with Extension	 200-3567-1RS
68 Standard, LH with Extension	 200-3568-LS
68 Standard, RH with Extension	 200-3568-RS
68 RS, LH with Extension	 200-3568-1LS
68 RS, RH with Extension	 200-3568-1RS
69 Standard or RS, LH with Extension (pictured)	 200-3569-LS
69 Standard or RS, RH with Extension	 200-3569-RS
70-77 LH	X200-3570-L
70-77 RH	X200-3570-R
78-81 Standard, LH	X200-3578-L
78-81 Standard, RH	X200-3578-R
78-81 Z/28, LH	X200-3578-1L
78-81 Z/28, RH	X200-3578-1R

Firebird

67-68 LH	X200-5567-L
67-68 RH	X200-5567-R
69 LH	X200-5569-L
69 RH	X200-5569-R

Impala

63 LH	X200-3963-L
63 RH	X200-3963-R

Fender Braces

Nova	
68-72 LH/RH Pair C-P2-3000
Chevelle / El Camino	
66-72 LH/RH Pair (pictured) C-P-3900
Monte Carlo	
70-72 LH/RH Pair (pictured) C-P-3900



Fender Bar Set

Camaro / Firebird	
67-69 with Bolts, Black W-656
67-69 with Bolts, Chrome (pictured) W-653

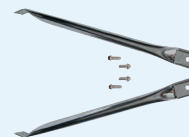

All fenders are shipped
TRUCK FREIGHT.



Our Name Says It All!™

Fenders & Accessories

AMD offers fender patch panels that are manufactured from high-quality steel and are black EDP coated to resist rust, making them perfect if your restoration project only has minor rust in the lower rear sections. We also offer fender extensions and braces to complete your installation.

Lower Rear Fender Patch Panels



Nova

68-74 with Brace, LH (pictured, left)205-3068-L
68-74 with Brace, RH 205-3068-R

Chevelle

70-72 15" High, LH (pictured, right).....205-3470-L
70-72 15" High, RH 205-3470-R

Camaro / Firebird

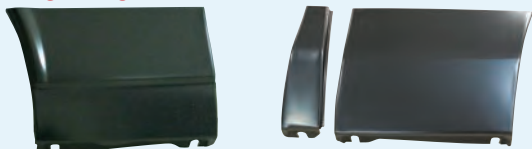

67-68 with Brace, LH (pictured, left)205-3567-L
67-68 with Brace, RH 205-3567-R
69 with Brace, LH (pictured, right)205-3569-L
69 with Brace, RH 205-3569-R

Headlamp Surrounds / Fender Extensions

Chevelle



Headlamp Surround

70 LH (pictured, right)  210-3470-L
70 RH (pictured, left).....  210-3470-R

Camaro

67-68 LH210-3567-L
67-68 RH 210-3567-R



69 LH210-3569-L
69 RH 210-3569-R

Firebird

67 LH210-3567-L
67 RH 210-3567-R

D.I.Y. Videos

Shot in HD, these DVDs combine the clear vision of the helmet cam and the easy teaching style of nationally recognized car builder, Craig Hopkins. No matter what your skill level, these DVDs will help you get professional results!

Sheet Metal Installation Videos

Dodge Dart Quarter Panel Replacement

Dodge Dart Quarter Panel Replacement CHP-1

After Paint... Sanding for Success

After Paint... Sanding for Success CHP-2

Installing Front Sheet Metal

Installing Front Sheet Metal CHP-3

Door Skinning 101

Door Skinning 101 CHP-4

MIG Welding Automotive Sheetmetal

MIG welding automotive sheet metal has just become a lot less frustrating. You quickly learn professional techniques because you see and hear about methods that will improve your welding.

Auto Body MIG Welding CHP-5

Panel Perfect

Panel Perfect CHP-6

Full Floor Install

Full Floor Install CHP-7

Patch Panel Installation

Almost 2 hours of methods and tips that will give you professional results with your "do-it-yourself" project.

Patch Panel Install CHP-8

1967 Chevelle SS Restoration Series

Disc #1 CHP-101

Disc #2 CHP-102

Disc #3 CHP-103

Disc #4 CHP-104

Disc #5 CHP-105



All of our own **AMD** parts in this catalog are listed in **Blue, bold-face Type**.

Our Name Says It All!™

Inner Fenders

Factory inner fenders lead a tough life. Acid dripping from the battery, holes drilled for mounting accessories, rust, and accident damage all take their toll. All of AMD's inner fenders are stamped from heavy gauge steel and EDP coated for protection and licensed through GM's Restoration Parts Program. We offer the only correct '71 & '72 Chevelle inner fenders and we also offer versions for Standard or RS Camaros.

Front Inner Fenders

Nova







- | | | |
|---------------------------------|---|------------|
| 68-74 LH (pictured, left) |  | 250-3068-L |
| 68-74 RH (pictured, right)..... |  | 250-3068-R |

Chevelle / El Camino



- | | | |
|--------------------------------|---|-------------|
| 66 LH (pictured, left) |  | 250-3466-L |
| 66 RH |  | 250-3466-R |
| 67 LH (pictured, right)..... |  | 250-3467-L |
| 67 RH |  | 250-3467-R |
| 68-69 Plastic, LH/RH Pair..... |  | 250-3468-1P |
| 68-69 Plastic, LH |  | 250-3468-1L |
| 68-69 Plastic, RH |  | 250-3468-1R |



- | | | |
|---------------------------------|---|------------|
| 68-70 LH (pictured, left) |  | 250-3468-L |
| 68-70 RH |  | 250-3468-R |
| 71-72 LH (pictured, right)..... |  | 250-3471-L |
| 71-72 RH |  | 250-3471-R |









GTO

- | | |
|----------------|-------------|
| 68-69 LH | X250-5468-L |
| 68-69 RH | X250-5468-R |

Front Inner Fenders, continued

Camaro



- | | | |
|------------------------------------|---|-------------|
| 67-68 LH (pictured, left) |  | 250-3567-L |
| 67-68 RH |  | 250-3567-R |
| 68 LH, with RS Holes Drilled..... |  | 250-3568-1L |
| 68 RH, with RS Holes Drilled |  | 250-3568-1R |
| 69 LH (pictured, right)..... |  | 250-3569-L |
| 69 RH |  | 250-3569-R |
| 69 LH, with RS Holes Drilled..... |  | 250-3569-1L |
| 69 RH, with RS Holes Drilled |  | 250-3569-1R |
| 70-81 LH | X250-3570-L | |
| 70-81 RH | X250-3570-R | |

Firebird

- | | |
|-------------|-------------|
| 69 LH | X250-5569-L |
| 69 RH | X250-5569-R |

Impala

- | | |
|-------------|-------------|
| 64 LH | X250-3964-L |
| 64 RH | X250-3964-R |

Inner Fender to Cowl Brackets

Nova

- | | |
|----------------|-------------|
| 68-74 LH | X260-3567-L |
| 68-74 RH | X260-3567-R |

Camaro

- | | |
|----------------|-------------|
| 67-69 LH | X260-3567-L |
| 67-69 RH | X260-3567-R |



Fender to Firewall Brackets

Chevelle

- | | |
|-----------------------|------------|
| 68-72 LH/RH Pair..... | 261-3468-P |
|-----------------------|------------|



Front Shock Towers

Nova

- | | |
|--------------------------------|-----------|
| 62-67 Chrome, LH/RH Pair | C-M2-3590 |
|--------------------------------|-----------|

Suspension Parts

Control Arms

Control arms include Bushings and Ball Joints.

Chevelle / El Camino / Monte Carlo / GTO / Skylark / Cutlass

Upper Control Arms

- | | |
|----------------|-------------|
| 64-72 LH | X392-3464-L |
| 64-72 RH | X392-3464-R |

Lower Control Arms

- | | |
|--------------------------|-------------|
| 64-72 LH (pictured)..... | X393-3464-L |
| 64-72 RH | X393-3464-R |



Our Name Says It All!™

Hoods

Eliminate the dents, rust and body filler on your old hood with a new AMD hood made on our own tools. AMD offers a wide selection of hoods for many models. All OE style AMD manufactured hoods are GM licensed. All underside braces and brackets are reproductions of originals so each hood has the correct appearance on both sides. All hoods are designed to be a direct bolt-on replacement for your vehicle's stock hood, and utilize your vehicle's stock hinges and latch assembly.

We also offer a large selection of cowl induction hoods that resembled hoods that the factory "should have" offered. **Please note that hoods with a part number starting with "X" (instead of a number) are not made by AMD and do not meet the same quality standards as the hoods we produce.**

Hoods Nova

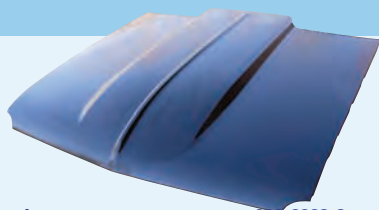



- 62-65 2" Cowl Hood (pictured)300-3062-2
- 66-67 2" Cowl Hood300-3066-2
- 68-72 2" Cowl Hood300-3068-2







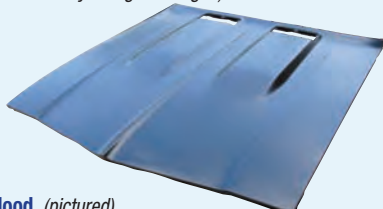

- 68-72 4" Cowl Hood (pictured)300-3068-4
- 68-72 SS Hood  300-3068-1
- 73-74 2" Cowl Hood300-3073-2

Chevelle / Malibu / El Camino



- 66 SS Hood (pictured)  300-3466-1
- 66 2" Cowl Hood300-3466-2
- 67 SS Hood  300-3467-1
- 67 2" Cowl Hood300-3467-2
- 69 2" Cowl Hood
(Fits 68 Models by using 69 Hinges)300-3469-2



- 69 SS Hood (pictured)
(Fits 68 Models by using 69 Hinges)  300-3469-1
- 70 Domed Hood  300-3470-1
- 70 SS, Functional Cowl Hood,
with Hood Pin Holes  300-3470-2
- 71-72 SS, Domed Hood  300-3471-1
- 71-72 SS, Functional Cowl Hood,
with Hood Pin Holes  300-3471-2

Chevelle / Malibu / El Camino, continued

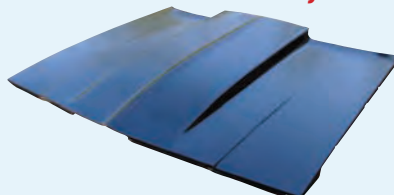

- 78-87 2" Cowl Hood300-3478-2

Monte Carlo

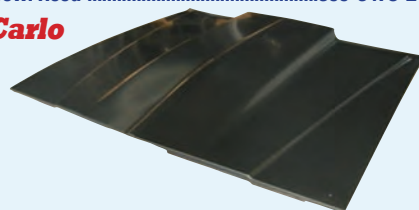

- 81-88 2" Cowl Hood300-3681-2

GTO

- 65-67X300-5465-1
- 68-70 X300-5468

Camaro

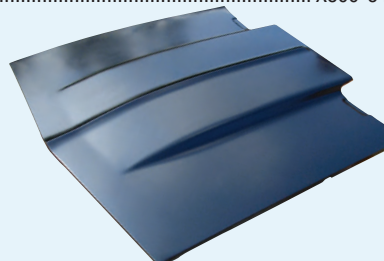

- 67-69 2" Cowl Hood, OE Style (pictured)  300-3569-2
- 67-69 4" Cowl Hood300-3569-4
- 67-69 SS Hood X300-3567
- 70-81 2" Cowl Hood300-3570-2
- 82-92 2" Cowl Hood300-3582-2
- 82-92 4" Cowl Hood300-3582-4

Firebird



- 67-69 400, OE Style Hood (Some 67's
may require later style hood latch)...  300-5567-1

Chevy Full Size

- 63 X300-3963
- 64 X300-3964
- 65-66 X300-3965

All hoods are shipped
TRUCK FREIGHT.



Our Name Says It All!™



All of our own **AMD** parts in this catalog are listed in **Blue, bold-face Type**.

Hood Accessories

When replacing your hood, be sure to replace your vehicle's worn out hood hinges with a brand new set from Auto Metal Direct. Our hood hinges are brand new - not rebuilt like cheaper knock offs. Each hinge features correct as original hood springs. We also offer items like hood latches and bumpers to complete your installation.

Hood Pins

Chevelle / El Camino

70-72 Original Style Hood Pin Set
(pictured).....P-HPK100

Hood Inserts

Nova

68-72 SS Insert Set
(pictured).....320-3567-S

68-72 SS Insert Base Bezel,
Chrome,
LH/RH Pair.....320-3068-1P

Chevelle / El Camino

66 SS Insert, LH/RH Pair
(pictured).....P-H887258

66 SS Insert & Housing,
4-Piece Set
(pictured).....P-C991202

67 Chevelle, SS Louver Insert,
LH/RH PairC-C-1255

68-69 SS Inserts, LH/RH Pair
(pictured).....C-C-1275

Camaro

67-69 SS Insert Set
(pictured above)320-3567-S

67-69 SS Louver Drains K-3903974

68-69 SS 4-Port Insert Set,
LH & RH Inserts, Screens
& Backing Plates
(pictured).....W-485

Firebird



67-69 400 Insert, LH/RH Pair 320-5567-P

Hood Scoops

Can be made to fit any model car or truck

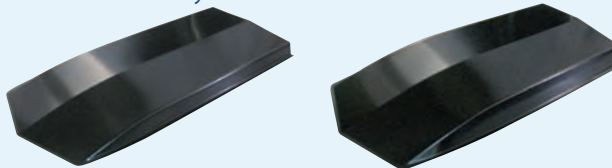

2", Steel Hood Scoop,
53 3/4" x 24" x 2 1/4" (pictured, left).....301-SCOOP-1

4", Steel Hood Scoop,
55 3/8" x 24 7/8" x 5" (pictured, right).....301-SCOOP-2

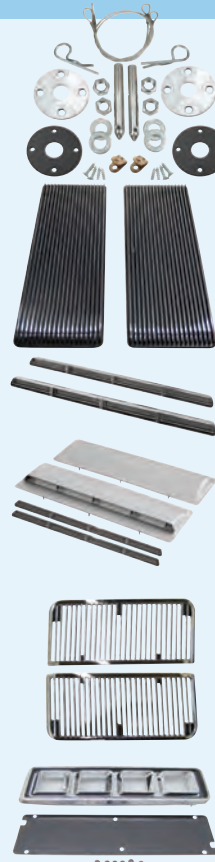

Hood Hinges

Nova

63-65 LHX310-3963-L
63-65 RHX310-3963-R
66-67 LH/RH Pair, Chrome W-955
66-67 OE Quality, LH
(pictured).....W-936
66-67 OE Quality, RH.....W-937
68-74 LH/RH Pair W-996

NEW!
Not Rebuilt



Chevelle / El Camino



64 LH (pictured, left)X310-3963-L
64 RH (pictured, right) X310-3963-R
65-67 LH/RH Pair, Chrome W-955
65-67 OE Quality, LH W-936
65-67 OE Quality, RH.....W-937
68 LH/RH Pair, includes springs W-996
69 LH/RH Pair (springs installed) W-997
70-72 LH/RH Pair (springs installed) W-998



GTO

64 LH (pictured, above left).....X310-3963-L
64 RH (pictured, above right)X310-3963-R
68-72 LHX310-5468-L
68-72 RHX310-5468-R

Camaro / Firebird

67-69 LH/RH Pair, Chrome W-955
67-69 OE Quality, LH
(pictured).....W-936
67-69 OE Quality, RH.....W-937
70-81 LH  K-14034129
70-81 RH  K-14034130



Chevy Full Size

63-64 LHX310-3963-L
63-64 RHX310-3963-R
68 LH/RH Pair, includes
springs (pictured) W-996
69 LH/RH Pair
(springs installed).....W-997
70 LH/RH Pair
(springs installed).....W-998



Hood Hinge Springs

Nova

68-74 9", Standard for Non-SS Models W-999

Chevelle / El Camino / Monte Carlo

64-72 9", Standard for Non-SS Models W-999
64-72 9 3/8", Heavy Duty for SS Models (pictured).....W-759

Camaro

67-69 9 3/8", Heavy Duty for SS Models (pictured).....W-759
70-81 All Models K-3907626

Firebird

70-81 All Models K-3907626



Hood Accessories

Hood Latches

Nova

68-72 (pictured) ...  303-3068

Chevelle / El Camino

68 (pictured) ...  303-3468

69  303-3469

70 (pictured) ...  303-3470

GTO

68-69 X303-5468

Camaro



67 Standard (pictured, left)  W-434

68 Standard (pictured, center)  W-433

67-68 RS (pictured, right)  W-435

69  W-432

70-73 RS  W-535

Firebird

69 X303-5569

Chevy Full Size

63 (right) X303-3963

Hood Latch Pilot Bolt

GM

65-81 Hood Latch Pilot Bolt  K-3857883



Hood Latch Supports

Nova

68-72 Functional for '68 with different appearance  326-3068

Chevelle / El Camino

68 (top)  326-3468

69 (bottom)  326-3469

Camaro

67-68 Original Gauge Steel W-218

69 Original Gauge Steel (pictured) W-220

79-81 Hood Lock Catch Support, LH K-14006369

74-81 Hood Lock Catch Support, RH K-337477



Safety Latch, Pre-Assembled

Chevelle / El Camino

70-72 Non-SS W-035

70-72 SS W-035A

Camaro

67-81  W-829

Hood Latch Safety Spring

Chevelle

68 Stainless (pictured) W-730 9



Camaro

67-70 Stainless (pictured) W-730

Chevy Full Size

65-66 Stainless (pictured) W-730

Hood Adjustment Bumpers

Nova

68-73 6-Piece Set (pictured) 305-3064-S

GTO / Skylark / Cutlass

64-66 LH/RH Pair J-6022

Camaro / Firebird

67-69 6-Piece Set (pictured) 305-3064-S



Our Name Says It All!™

Battery Trays & Accessories

AMD offers correct battery trays for many GM models. All of our battery trays are licensed through the GM Restoration Program. Please note that battery trays with a part number starting with "X" (instead of a number) are not made by AMD and do not meet the same quality standards as the trays we produce.

Correct Battery Trays

- Correct nuts, unlike competitor's parts
- Made on new AMD tools!



AMD

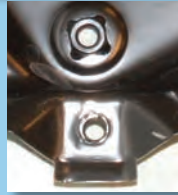

Competitor

Battery Trays

Battery trays for many models being developed!

Nova

- 62-67 X340-3062
 68-74 (at right)  340-3068



Chevelle / El Camino



- 64-65 (pictured, left)  340-3464
 66 (pictured, right)  340-3466



- 67 (pictured, left)  340-3467
 68-72 (pictured, right)  340-3468

Monte Carlo

- 70-72 (above, right)  340-3468

GTO

- 64-67 X340-5464
 68-72 X340-5468

Camaro

- 67-69 (at right)  340-3466
 70-81  340-3570

Firebird

- 67-69 (at right)  340-3466
 70-81  340-5570



Battery Trays, continued

Chevy Full Size



- 62-63 (pictured, left) X340-3962
 64 (pictured, right) X340-3964



- 65 (pictured, left) X340-3965
 66 X340-3966
 67 X340-3967
 68 (pictured, right)  340-3468

Battery Tray Mounting Brace

Nova

- 62-67 X341-3062

Battery Clamps

Nova

- 67-74 (pictured)  341-3466



Chevelle / El Camino

- 67-72 (pictured)  341-3466

Camaro / Firebird

- 67-81 (pictured)  341-3466

Chevy Full Size

- 62-63 Battery Tray Hold Down X341-3962
 64-65 Battery Tray Hold Down X341-3964
 65-81 (pictured)  341-3466

Battery Clamp Bolts

Nova

- 67-74 341-3466-1

Chevelle / El Camino

- 67-72 341-3466-1

Camaro / Firebird

- 67-81 341-3466-1

Chevy Full Size

- 65-71 341-3466-1

Battery Mat

Traps and neutralizes battery acid. Universal, fits all makes & models

- Battery Mat, 8" x 12" J-BATTERYMAT1



Our Name Says It All!™

Radiator Supports

AMD radiator supports are the most correct on the market. Our radiator supports are stamped on heavier grade steel than generic versions on the market and are made for specific applications. **Please note that radiator supports with a part number starting with "X" (instead of a number) are not made by AMD do not meet the same quality standards as the radiator supports we produce.**

Radiator Supports









Nova



68-74 fits SB or BB  350-3068

Chevelle / El Camino



66 (pictured)  350-3466
 67  350-3467
 68 HD Cooling  350-3468-1
 68 Standard  350-3468
 69 HD Cooling  350-3469-1
 69 Standard  350-3469
 70 Heavy Duty with A/C  350-3470-AC
 70 Heavy Duty without A/C  350-3470-1
 71-72 Heavy Duty with or without A/C.  350-3471-AC

GTO

68-70 with Center Bracket (Correct for 70, can be modified for 68-69) X350-5468

Camaro



67-68 (pictured)  350-3567
 69  350-3569
 70-73 X350-3570

Chevy Full Size

62 X350-3962
 63 X350-3963
 64 X350-3964
 65-66 X350-3965-1

There really is a DIFFERENCE in quality! AMD Radiator Core Supports are made on our own steel tools, and are made more correctly than competitive parts.

Check them out for yourself!

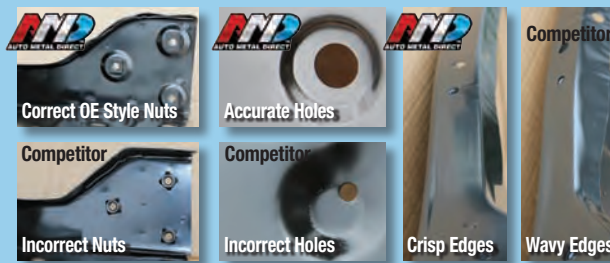

Radiator Support Accessories

We have a complete line of accessories to help with the installation of your radiator support, including top mounting panels, mounting brackets, and mounting bushings.

Radiator Top Mounting Panel

GTO

68-70 Chrome X350-5468-1C
 68-70 Painted X350-5468-1
 68-70 Lower Radiator Support Saddle with Insulator X349-5468-P

Chevy Full Size



63 Upper (pictured) X350-3963-1
 64 Upper X350-3964-1



Our Name Says It All!™

Radiator Support Accessories

Radiator Support Bracket

Chevelle / El Camino

70-72 LH/RH Pair
(pictured)..... 349-3470-P

70-72 LH 349-3470-L
70-72 RH 349-3470-R



349-3470-L
349-3470-R

Radiator Support to Fender Brackets

Chevelle

70 Radiator Support Bracket,
LH/RH Pair
(pictured) .. 259-3470-P



C-P-2690

Frame to Radiator Support Repair Bracket

Chevelle / El Camino

64-67 LH/RH P Pair (pictured) C-P-2690

Radiator Support Bushings

Nova

68-72 Body/Radiator Support Bushing
OE Quality, 12-Piece Set SS-4
68-72 12-Piece Set, Replacement..... W-942
68-72 OE Style, 4-Piece Set,
without Hardware SS-4B
68-72 Replacement Style, with Hardware W-015



Chevelle / El Camino

65-67 without Hardware (pictured, left)..... P-RB0520
65-67 with Hardware P-RB0521
68-72 without Hardware P-RB0522
68-72 with Hardware (pictured, right)..... P-RB0523

Monte Carlo

70-72 without Hardware P-RB0522
70-72 with Hardware (pictured, right)..... P-RB0523

Radiator Support Bushings

GTO

65-67 without Hardware (pictured, left)..... P-RB0520
65-67 with Hardware P-RB0521
68-72 without Hardware P-RB0524
68-72 with Hardware P-RB0525

Cutlass

65-67 without Hardware (pictured, left)..... P-RB0520
65-67 with Hardware P-RB0521
68-72 without Hardware P-RB0522
68-72 with Hardware (pictured, right)..... P-RB0523

Camaro / Firebird

67-72 Body/Radiator Support Bushing
OE Quality, 12-Piece Set SS-4
67-72 12-Piece Set, Replacement..... W-942
67-72 OE Style, 4-Piece Set,
without Hardware SS-4B
67-72 Replacement Style, with Hardware W-015
70-73 Vertical Bushing & Cushion Set, Frame Bracket to
Vertical Mounting Point on Radiator Support W-012

Radiator Retainer Pad

Nova

68-70 Big Block, with 3.08" Cut Out K-6264100
68-74 Small Block K-371189

Camaro

70-72 Big Block, with 3.08" Cut Out K-6264100
70-76 Small Block K-371189
78-80 Small Block K-371189

Radiator Top Seal

Nova

68-70 Big Block J-40603

Radiator Support to Radiator Seal

Camaro / Firebird

68-69 with A/C J-30235

Cowls

Cowl panels are typically rusty from debris falling into the vent panel or under the windshield trim. We offer an extended line to cover many models.

Cowl Panels

Nova



68-74 Upper Plenum 360-3068-1

Chevelle / El Camino



64-67 Lower Section 371-3466-1

Chevelle / El Camino, continued



64-67 Upper Section 371-3466

Camaro / Firebird



67 Lower Panel (pictured) X360-3567
68 Lower Panel X360-3568
69 Lower Panel X360-3569



70-76 Firebird, without A/C (pictured) X360-3570
70-81 Camaro, without A/C (pictured) X360-3570



Our Name Says It All!™

Firewalls



AMD offers several complete firewalls to restore the integrity of your GM's body. These are often bent from accident damage or rusted due to a leaking heater core.

Firewalls

Complete OE Style, includes Braces

Nova



- 68 without A/C (pictured) 370-3068
- 69-72 without A/C..... 370-3069

Chevelle / El Camino



- 64-67 without A/C (pictured) 370-3466
- 68-72 with A/C 370-3468-AC
- 68-72 without A/C..... 370-3468

Camaro / Firebird



- 67 without A/C (pictured) 370-3567
- 68 without A/C..... 370-3568
- 69 without A/C..... 370-3569

Firewall Braces

Chevelle / El Camino

Lower Corner to Frame Brace

- 68-72 LH 372-3468-L
- 67-72 RH 372-3468-R

Camaro / Firebird

- 69 LH X472-3569-L
- 69 RH..... X472-3569-R



Pillar Posts & Hinge Panels

AMD offers several windshield pillar posts, cowl hinge side panels, and cowl patch panels to repair this typically rusted area of GM cars.

Door Hinge Pillar Assembly

Chevelle / El Camino / GTO / Skylark / Cutlass

- 66-67 LH 375-3466-L
- 66-67 RH (pictured) ... 375-3466-R

Windshield Pillar Post

Chevelle / El Camino / GTO / Skylark / Cutlass

Outer Section

- 66-67 LH 375-3466-1L
- 66-67 RH (pictured) ... 375-3466-1R

Inner Section

- 66-67 LH 375-3466-2L
- 66-67 RH..... 375-3466-2R

Door Jamb Lock Pillar Patches

Camaro / Firebird

- 67-69 Front Lower, LH W-959
- 67-69 Front Lower, RH (pictured)..... W-958



Complete Cowl Side Front Panels

Chevelle / El Camino / GTO / Skylark / Cutlass

- 66-67 LH (pictured, left) 376-3466-1L
- 66-67 RH..... 376-3466-1R

Cowl Hinge Panels

Chevelle / El Camino / GTO / Skylark / Cutlass

Side Panel

- 66-67 LH 376-3466-L
- 66-67 RH..... 376-3466-R

Outer Panel

- 66-67 LH (pictured, right) 376-3466-2L
- 66-67 RH..... 376-3466-2R
- 68-72 LH (pictured) 376-3468-L
- 68-72 RH..... 376-3468-R

Lower Reinforcement

- 68-72 LH 376-3468-4L
- 68-72 RH..... 376-3468-4R

Camaro / Firebird

- 67-69 LH (pictured) ... 376-3567-L
- 67-69 RH..... 376-3567-R

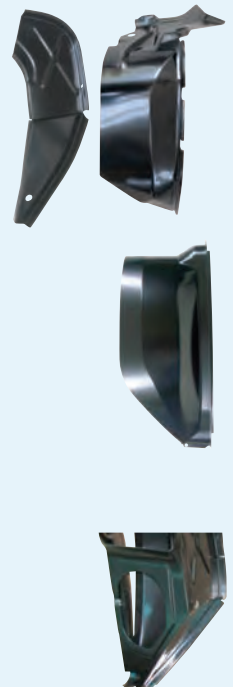

All of our own **AMD** parts in this catalog are listed in **Blue, bold-face Type**.

Our Name Says It All!™

Full Floor Pans

Rusted, cut, or weakened floors should be replaced during any restoration project. AMD's full floor pans are made from heavy gauge steel as original, and feature all correct reinforcing ribs and shapes. Most pans include OEM-style braces, and some feature inner rocker panels, too. Licensed by the GM Restoration Parts program, these full floor pans are top quality reproduction parts for your project.

Full Floor Pans, OE Style





- Nova**
68-74 with Braces.....  400-3068
- Chevelle**
with Braces & Inner Rockers
64-67 (pictured).....  400-3464
68-72  400-3468
- El Camino**
with Braces & Inner Rockers
64-67  400-3464
- GTO / Skylark / Cutlass**
with Braces & Inner Rockers
64-67  400-3464
68-72  400-3468

All full floor pans are shipped **TRUCK FREIGHT.**

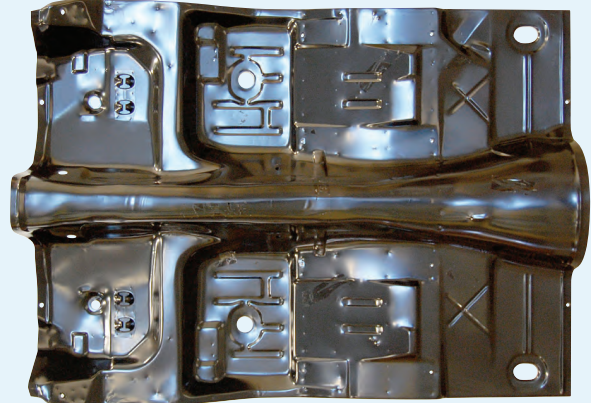

Camaro / Firebird













- 67-69 with Braces (includes
Convertible Plates)  400-3567
70-74 with Braces (pictured).....  400-3570
- Chevy Full Size**
61-64 X400-3961

Floor Pan Halves, Patches & Parts





AMD also offers floor pan halves, and patch panels. For use if your car is not completely disassembled. Made from the same heavy gauge steel, these panels include correct reinforcement ribs and stampings. We also offer many floor pan accessories such as braces, brackets, and seat mounting parts to make your floor pan restoration complete.

Full Length Floor Pan Halves

- Nova**
Includes part of toe board
68-74 LH  405-3068-L
68-74 RH  405-3068-R
- Chevelle / GTO / Skylark / Cutlass**
64-67 LH (pictured)....  05-3464-L
64-67 RH  05-3464-R
68-72 LH  05-3468-L
68-72 RH  405-3468-R
- El Camino**
64-67 LH (pictured)....  405-3464-L
64-67 RH  405-3464-R
- Monte Carlo**
70-72 LH  405-3468-L
70-72 RH  405-3468-R
- Camaro / Firebird**
67-69 LH 405-3567-L
67-69 RH 405-3567-R
70-74 LH 405-3570-L
70-74 RH 405-3570-R



Bottom of Firewall to Front of Back Seat

- Nova**
62-67 LH
(pictured).....  X405-3062-L
62-67 RH  X405-3062-R
- Chevy Full Size**
61-64 LH  X405-3961-L
61-64 RH  X405-3961-R



Floor Pan Halves, Patches & Parts

Front Floor Pan Patch

Nova

Includes part of toe board

- 68-74 LH405-3068-1L
 68-74 RH 405-3068-1R

Chevelle / GTO / Skylark / Cutlass

- 64-67 LH (pictured)405-3464-1L
 64-67 RH 405-3464-1R
 68-72 LH405-3468-1L
 68-72 RH 405-3468-1R

El Camino

- 64-67 LH405-3464-1L
 64-67 RH 405-3464-1R
 68-72 LH
 (pictured)..... 405-3468-1L
 68-72 RH 405-3468-1R

Monte Carlo

- 70-72 LH 405-3468-1L
 70-72 RH 405-3468-1R

Camaro / Firebird





- 70-74 LH (pictured)405-3570-1L
 70-74 RH..... 405-3570-1R



Seat Platforms

Camaro / Firebird



- 67-68 Hardtop, LH (pictured, left)  412-3567-L
 67-68 Hardtop, RH (pictured, right).....  412-3567-R
 69 Hardtop, LH  412-3569-L
 69 Hardtop, RH.....  412-3569-R

Rear Floor Pan Patches

Nova

- 68-74 LH (pictured)410-3068-L
 68-74 RH 410-3068-R

Chevelle / GTO / Skylark / Cutlass



- 64-67 LH (pictured, left)410-3464-L
 64-67 RH (pictured, right)..... 410-3464-R
 68-72 LH410-3468-L
 68-72 RH 410-3468-R

El Camino

- 64-67 LH (pictured)410-3464-L
 64-67 RH (pictured)..... 410-3464-R

Rear Floor Pan Patches, continued



Camaro / Firebird

- 70-81 LH (pictured, left).....410-3570-L
 70-81 RH (pictured, right)..... 410-3570-R

Second generation Camaros & Firebirds were prone to rust underneath and behind the rear seat. These beautiful new reproduction floor pans will fit properly, and are the best way to fix this common problem in 1970-81 F-Body cars.

Under Rear Seat Floor Pan

Camaro / Firebird



- 70-81 LH420-3570-L
 70-81 RH..... 420-3570-R



- 70-81 Behind Rear Seat Floor Panel (pictured)..... 420-3570

Chevy Full Size



- 61-64 Under Rear Seat Pan..... X420-3961

Front Floor Pan Braces

Camaro / Firebird

- 67-69 Convertible (pictured) W-441
 67-69 Convertible,
 MainX425-3567-V
 67-69 Front, LH
 (pair pictured) X425-3567-L
 67-69 Front, RHX425-3567-R



Chevy Full Size

- 61-64 Front (pictured).....X425-3961-1



All of our own **AMD** parts in this catalog are listed in **Blue, bold-face type**.

Our Name Says It All!™

Floor Pan Halves, Patches & Parts

Under Rear Seat Floor Pan Brace

Chevy Full Size



- 61-64 Front, LH (pictured, left)X425-3961-3L
- 61-64 Front, RH (pictured, right) X425-3961-3R
- 61-64 Rear, LH.....X425-3961-4L
- 61-64 Rear, RHX425-3961-4R

Rear Floor Pan Braces

Camaro / Firebird

- 67-69 B-Pillar Support Bracket (pictured).....X426-3567-VS



Chevy Full Size



- 61-64 Rear Underside.....X425-3961-3

Seat Tracks

Chevelle / Monte Carlo / El Camino / GTO / Skylark / Cutlass

- 68-70 Assembly, LH..... X413-3468-L
- 68-70 Assembly, RH..... X413-3468-R



Camaro / Firebird

- 67-69 LHX413-3567-L
- 67-69 RH (pictured)X413-3567-R

Rear Seat Brackets

Camaro / Firebird



- 67-69 LH (pictured)X411-3567-L
- 67-69 RH (pictured)X411-3567-R

Fold Down Seat Bumper

- 67 LH/RH Pair J-30702
- 68-69 LH/RH Pair J-30701

Bucket Seat Bracket Parts

Nova

- 68-74 Mounting Bracket, 6-Piece Set 407-3068-S

Chevelle / El Camino / GTO / Skylark / Cutlass

- 66-70 Conversion Bracket Set (pictured)407-3466-S

Monte Carlo

- 70 Conversion Bracket Set (pictured)407-3466-S



Floor Pan Plugs

All Makes & Models

- 61&Up GM Car & Truck, galvanized, without Notch 427-3961



Shifter Tunnel Components

Nova

- 68-72 Manual Transmission Hump (pictured)..... W-481B

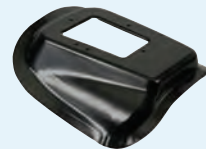

Chevelle / El Camino

- 68-72 Shifter Hump (pictured)..... X415-3468
- 68-72 Console to Floor Plastic Tunnel C-J-1105

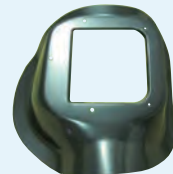

Monte Carlo

- 70-72 Shifter Hump (pictured)..... X415-3468

Cutlass

- 68-72 4-Speed Shift Hump P-C230112

Camaro

Pictured, left to right.



- 67-69 Shift Tunnel Repair Panel W-832
- 67-74 Floor Shifter Floor Hole Reinforcement W-482
- 69 4-Speed Console Shift Tunnel, plastic W-341
- 70-72 3 & 4-Speed Console Shift Tunnel  W-442

Firebird

- 67-69 Shift Tunnel Repair Panel (pictured, above left) W-832



Our Name Says It All!™

Outer & Inner Rocker Panels

Replace rotted, dented, or damaged Outer Rocker Panels with our premium quality reproductions. Rocker panels provide critical structural support for the entire body, and are easily weakened from years of rust and corrosion. Made from heavy gauge steel like original units, our rocker panels are fully licensed by the GM Restoration Parts program. **Please note that rocker panels with a part number starting with "X" (instead of a number) are not made by AMD and do not meet the same quality standards as the rockers we produce.**

Outer Rocker Panels

Nova

68-74 LH (pictured)		450-3068-L
68-74RH		450-3068-R

Chevelle / GTO / Skylark / Cutlass

64-67 LH (pictured)		450-3464-L
64-67 RH		450-3464-R
68-72 LH		450-3468-L
68-72 RH		450-3468-R

Camaro / Firebird

67-69 LH (pictured)	X450-3567-L
67-69 RH	X450-3567-R
70-81 LH	 450-3570-L
70-81 RH	 450-3570-R

Door Hinge Pillar to Rocker Panel Support

Camaro / Firebird

67-69 LH (pictured) ..		440-3567-1L
67-69 RH		440-3567-1R







Inner Rocker Panels





Nova

68-74 LH (pictured)		440-3068-L
68-74 RH		440-3068-R

Chevelle / GTO / Skylark / Cutlass



64-67 LH (pictured)		440-3464-L
64-67 RH		440-3464-R
68-72 LH		440-3468-L
68-72 RH		440-3468-R

Camaro / Firebird

67-69 LH (pictured)		440-3567-L
67-69 RH		440-3567-R
70-81 LH		440-3570-L
70-81 RH		440-3570-R

Inner/Outer Rocker Panel Assembly

Camaro

67-69 Convertible, LH		X450-3569-VL
67-69 Convertible, RH (pictured)		X450-3569-VR

Chevy Full Size



61-64 LH	X440-3961-L
61-64 RH	X440-3961-R

Sill Plates

AMD offers sill plate moldings for most popular Chevy applications. All are officially licensed through the GM Restoration Parts Program. We feature parts from OER, OPGI, and TWE.



Door Sill Plates

Nova

62-67 2-Door, LH/RH Pair, Includes Fasteners		T-3000
62-65 Convertible, LH/RH Pair, Includes Fasteners		T-3001

68-74 2-Door, LH (pictured)		K-7728957
68-74 2-Door, RH		K-7728956



Chevelle / El Camino / GTO / Skylark / Cutlass

64-67 LH/RH Pair		P-CHV4150
68-72 LH/RH Pair		P-K33623

Monte Carlo

70-72 LH/RH Pair		P-K33623
------------------------	---	----------

Camaro

67-69 Includes Fasteners (pictured)		T-6730
70-72 with Riveted Tag, LH/RH Pair, Includes Fasteners		T-6732
73-81 with Stick on Tag, LH/RH Pair, Includes Fasteners		T-6733



All of our own **AMD** parts in this catalog are listed in **Blue, bold-face Type**.

Our Name Says It All!™

Dash Structure

Moisture and debris gather over the years at the base of front windshields, and the rust which results will inevitably reach the lower front area of the dash panel. Moreover, many muscle car owners have mounted tachometers, oversize speakers, and other accessories on the dash, leaving ugly screw-holes. If the dash top on your GM muscle car is damaged, replace it with one of these high quality reproduction Dash Repair Panels from AMD.

Complete Dash Assemblies Camaro / Firebird

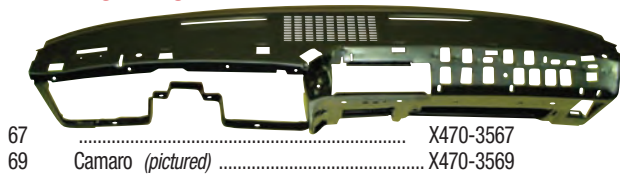

- 67 X470-3567
- 69 Camaro (pictured) X470-3569

Dash Repair Panels Chevelle / El Camino



- 64-67 Lower Windshield Channel
Dash Repair Panel 465-3464



- 66 Dash Top  465-3466



- 67 Dash Top  465-3467



- 68-72 Lower Windshield Channel
Dash Repair Panel 465-3468

Dash Repair Panels, continued GTO / Skylark / Cutlass



- 68-72 Lower Windshield Channel
Dash Repair Panel 465-3468

Camaro / Firebird



- 67 Dash Top, Upper Section 465-3567



- 68 Dash Top, Upper Section 465-3568



- 69 Camaro only, Dash Top, Upper Section. 465-3569

OE Style Door Shells

All door shells are shipped TRUCK FREIGHT. 

AMD's '69 Camaro/Firebird door shell is the highest quality door on the market.

It contains all the internal structure required to mount, glass, window regulators, door handles, etc. Unlike others on the market AMD doors are stamped on OE gauge steel to replace your rusted or damaged door perfectly. Please note that the OE door shells with a part number starting with "X" (instead of a number) are not made by AMD and do not meet the same quality standards as the doors we produce.

OE Style Door Shells Chevelle

- 66-67 LH X500-3466-L
- 66-67 RH X500-3466-R
- 68 LH X500-3468-L
- 68 RH X500-3468-R
- 69 LH X500-3469-L
- 69 RH X500-3469-R

GTO

- 66-67 LH X500-5466-L
- 66-67 RH X500-5466-R
- 68 LH X500-5468-L
- 68 RH X500-5468-R
- 69 LH X500-5469-L
- 69 RH X500-5469-R

El Camino

- 66-67 LH X500-3466-L
- 66-67 RH X500-3466-R

Camaro / Firebird

- 67 LH X500-3567-L
- 67 RH X500-3567-R
- 68 LH X500-3568-L
- 68 RH X500-3568-R



- 69 LH (pictured)  500-3569-L
- 69 RH  500-3569-R
- 70-81 Camaro, LH X500-3570-L
- 70-81 Camaro, RH X500-3570-R
- 70-81 Has early style door handle





Door Skins

AMD has you covered if you need to replace a door skin. Built to factory specifications, these high-quality stamped steel OE style reproductions are the perfect fix to replace old rusted or damaged skins. The door skins produced by AMD are officially licensed through GM's Restoration Parts Program. **Please note that the door skins with a part number starting with "X" (instead of a number) are not made by AMD and do not meet the same quality standards as the door skins we produce.**









Door Skins Nova



62-65 LH	X510-3062-L	
62-65 RH	X510-3062-R	
68-72 LH	 510-3068-L	
68-72 RH (pictured)	 510-3068-R	

Chevelle



64-65 LH	X510-3464-L	
64-65 RH	X510-3464-R	
66-67 LH	 510-3466-L	
66-67 RH	 510-3466-R	
68 LH (pictured)	 510-3468-L	
68 RH	 510-3468-R	
69 LH	 510-3469-L	
69 RH	 510-3469-R	
70-72 LH	 510-3470-L	
70-72 RH	 510-3470-R	

El Camino

64-65 LH	X510-3464-L	
64-65 RH	X510-3464-R	
66-67 LH	 510-3466-L	
66-67 RH	 510-3466-R	

GTO

68 LH	X510-5468-L
68 RH	X510-5468-R
69 LH	X510-5469-L
69 RH	X510-5469-R

Regal GN











82-87 LH	510-6482-L
82-87 RH	510-6482-R

Cutlass

82-88 LH	510-6482-L
82-88 RH	510-6482-R

Camaro / Firebird



67 LH	 510-3567-L
67 RH	 510-3567-R
68 LH	 510-3568-L
68 RH	 510-3568-R
69 LH (pictured)	 510-3569-L
69 RH	 510-3569-R
70-81 Camaro only, LH	 X510-3570-L
70-81 Camaro only, RH	 X510-3570-R
70-81 Firebird only, LH	 X510-5570-L
70-81 Firebird only, RH	 X510-5570-R

70-81 Has early style door handle

Door Hinges & Latches

AMD makes new (*not rebuilt*) door hinges for many GM applications. We also offer hinge rebuild kits, door latch assemblies, and other door hardware to complete your installation.

Upper Door Hinges

Nova

62-66 Sold each	K-7580738
68-74 LH	X520-3569-L
68-74 RH	X520-3569-R



Chevelle / El Camino / GTO / Skylark / Cutlass

64-65 Sold each	C-H-2580
66-67 LH	R-340
66-67 RH	R-341
66-67 Chevelle or GTO, LH or RH, sold each	W-743
68-72 Sold each	R-342

Monte Carlo

70-72 Sold each	R-342
-----------------------	-------

Upper Door Hinges, continued

Camaro / Firebird

67 LH	R-340
67 RH	R-341
67 LH or RH, sold each	W-743
68 LH	X520-3568-L
68 RH	X520-3568-R
69 LH	X520-3569-L
69 RH	X520-3569-R
70-81 LH	K-1706371
70-81 RH	K-1706370

Chevy Full Size

61-64 Front, Sold each	K-K231
71-76 LH	K-1706371
71-76 RH	K-1706370



All of our own **AMD** parts in this catalog are listed in **Blue, bold-face type**.

Our Name Says It All!™

Door Hinges & Latches

Lower Door Hinges

Nova

- 62-67 LH K-4841357
 62-67 RH K-4841356
 68-74 LH (pictured)..... X525-3569-L
 68-74 RH X525-3569-R

Chevelle / El Camino / GTO / Skylark / Cutlass

- 64-65 LH C-H-2590
 64-65 RH C-H-2595
 66-67 LH R-346B
 66-67 RH R-346A
 66-67 Chevelle / GTO, LH/RH
 2-Piece Set W-346
 68-72 LH R-343
 68-72 RH (pictured) R-344

Camaro / Firebird

- 67 LH R-346B
 67 RH R-346A
 67 LH/RH, 2-Piece Set W-346
 68 LH X525-3568-L
 68 RH X525-3568-R
 69 LH (pictured)..... X525-3569-L
 69 RH X525-3569-R
 70-81 Sold each K-9816926

Chevy Full Size

- 61-64 LH (pictured)..... K-K232
 61-64 RH K-K233

Lower Door Hinge Rebuild Kit

Does both Lower Hinges

Nova

- 68-74 (pictured) K-K106

Camaro / Firebird

- 68-69 (does both lower hinges)
 (pictured) K-K106

Door Hinge Pin & Bushing Repair Kit

4 Pins & 8 Bushings

Nova

- 68-74 (pictured) W-314

Camaro / Firebird

- 67-68 K-K400
 69 (pictured) W-314
 70-81 Camaro W-314A
 70-77 Firebird W-314A
 78-81 Firebird K-K403

Hinge Roller Repair

Nova

- 69-74 2-Piece Set (pictured) W-315

Chevelle / El Camino/GTO/ Skylark / Cutlass

- 68-72 Lower Door, 2-Piece Set W-539

Camaro / Firebird

- 68-69 2-Piece Set (pictured) W-315

Lower Door Hinge Dentent Repair Kit

- 67 (2 rollers & 2 bolts) K-K136

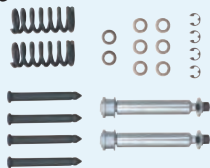

Door Hinge Bolts

Nova

- 68-72 Upper, 14-Piece Set
 (pictured, above) K-K195
 68-72 Lower, 16-Piece Set
 (pictured, below) K-K196
 62-67 Upper or Lower,
 12-Piece Set C-H-2627



Camaro / Firebird

- 68-81 Upper, 14-Piece Set (pictured, above) K-K195
 68-81 Lower, 16-Piece Set (pictured, below) K-K196

Door Latch Assemblies

Nova

- 63-65 2 & 4-Door, LH
 (pictured) X535-3066-L
 63-65 2 & 4-Door RH ...X535-3066-R
 66-67 2-Door, LH X535-3066-L
 66-67 2-Door, RH X535-3066-R
 69-70 LH K-8720402
 69-70 RH K-8720401



Chevelle / GTO / Skylark / Cutlass

- 64-66 LH X535-3464-L
 64-66 RH X535-3464-R
 67 LH X535-3467-L
 67 RH X535-3467-R
 68 LH X535-3468-L
 68 RH X535-3468-R
 69 Chevelle, LH X535-3469-L
 69 Chevelle, RH X535-3469-R
 70-72 Chevelle, LH X535-3470-L
 70-72 Chevelle, RH X535-3470-R

El Camino

- 64-66 LH X535-3464-L
 64-66 RH X535-3464-R
 68 LH X535-3468-L
 68 RH X535-3468-R

Camaro / Firebird

- 67 LH K-7648725
 67 RH K-7648724
 68 LH K-7740485
 68 RH K-7740484
 69 LH K-8720402
 69 RH K-8720401
 70-81 LH X535-3570-L
 70-81 RH X535-3570-R

Chevy Full Size

- 65-66 Impala, LH X535-3965-L
 65-66 Impala, RH X535-3965-R
 68 LH X535-3468-L
 68 RH X535-3468-R
 69 Front, LH X535-3469-L
 69 Front, RH X535-3469-R

Window Regulator Roller

GM

- Fits 63-65 Nova, 64-65 Chevelle / El Camino,
 67-69 Camaro, and 58-65 Chevy Full Size
 63-69 Roller & Rivet (right) W-313



Window Regulator Guide Cam Spacer

Nova

- 62-72 K-9804150

Camaro / Firebird

- 70-81 K-9804150



Our Name Says It All!™

Door Window Regulators

AMD offers many window regulators for the door glass of 2-Door GM vehicles.

Window Regulators

All Regulators are for Front Door, Manual Windows unless otherwise specified.

Chevelle



66-67 LH	X545-5466-L
66-67 RH	X545-5466-R
68 Power Window, LH	X545-3468-L
68 Power Window, RH	X545-3468-R

2-Door Coupe & Convertible

69 LH (pictured, left)	X545-3469-L
69 RH	X545-3469-R
70-72 LH	X545-3470-1L
70-72 RH (pictured, right)	X545-3470-1R

El Camino

66-67 LH	X545-5466-L
66-67 RH	X545-5466-R

GTO

66-67 LH	X545-5466-L
66-67 RH	X545-5466-R
68 LH	X545-5468-L
68 RH	X545-5468-R

2-Door Coupe & Convertible

69 LH (pictured, left)	X545-3469-L
69 RH	X545-3469-R
70-72 LH	X545-3470-1L
70-72 RH (pictured, right)	X545-3470-1R

Door Window Regulators, continued

Skylark / Cutlass









66-67 LH	X545-5466-L
66-67 RH	X545-5466-R

2-Door Coupe & Convertible

69 LH	X545-3469-L
69 RH	X545-3469-R
70-72 LH	X545-3470-1L
70-72 RH	X545-3470-1R

Camaro / Firebird



67 Deluxe Interior, LH	 K-7651904
67 Deluxe Interior, RH (left)	 K-7651903
67 Standard Interior, LH	 K-7681467
67 Standard Interior, RH (right)	 K-7681466
68-69 Deluxe Interior, LH	 K-7726802
68-69 Deluxe Interior, RH	 K-7726801
68-69 Standard Interior, LH	 K-7740412
68-69 Standard Interior, RH	 K-7740411
70-81 except 72-73 Camaro with Deluxe Interior, LH	K-9833311
70-81 except 72-73 Camaro with Deluxe Interior, RH	K-9833310

Quarter Window Regulators

Camaro / Firebird

67-69 LH	X797-3567-L
67-69 RH	X797-3567-R

Roof Panels & Parts

It is often easier to replace the entire roof panel than to repair rusted areas. If you have rust under a vinyl top this item can be a real time saver. Made to OE specifications this skin covers the entire roof area and mates with the A pillars and quarter panels, including the windshield and back glass channels. We also offer additional roof parts including Inner braces, drip rails, and drip rail moldings to complete your installation. **Please note that the roof panels with a part number starting with "X" (instead of a number) are not made by AMD and do not meet the same quality standards as the roofs we produce.**

All roof panels are shipped TRUCK FREIGHT. 



Roof Panels, Complete OE Style

Nova

66-67 2-Door Coupe	X600-3066
--------------------	-------	-----------

Chevelle / GTO / Skylark / Cutlass

66-67 2-Door Coupe (pictured)	 600-3466
68-72 Fastback, Modify for Monte Carlo & Cutlass Supreme	 600-3468

Camaro / Firebird

67-69	 600-3567
70-74	X600-3570

Roof Inner Braces

Camaro / Firebird

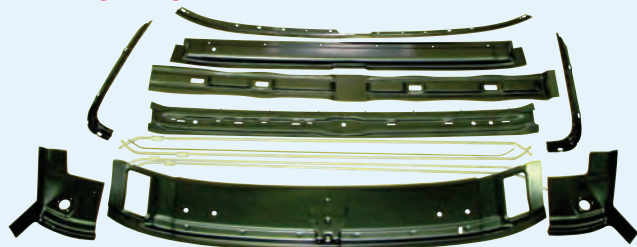

Coupe

67-68 14-Piece Set (pictured)	X610-3567-S
69 14-Piece Set	X610-3569-S



All of our own AMD parts in this catalog are listed in Blue, bold-face Type.

Our Name Says It All!™

Roof Panels & Parts

Roof Drip Rail

Molding attaches to this metal piece



Chevelle

66-67 LH/RH Pair		620-3466-S
68-69 LH/RH Pair (pictured)		620-3468-S
70-72 LH/RH Pair		620-3470-S

Camaro / Firebird

67-69 LH/RH Pair	X620-3567-P
------------------------	-------------



Drip Rail Molding

Nova

66-67 LH/RH Pair	K-K421
68-72 6-Piece Set	K-R1629



Chevelle

64-65 Coupe, 6-Piece Set (pictured)		630-3464-S
66-67 Coupe, LH/RH Pair		630-3466-P
68-69 Coupe, 6-Piece Set		630-3468-S
70-72 Coupe, 6-Piece Set		630-3470-S

Drip Rail Molding, continued

El Camino

68-72 6-Piece Set, does both sides	P-97CH008
--	-----------

GTO

66-67 Coupe, LH/RH P air		630-3466-P
68-72 6-Piece Set	P-NN5629E	

Skylark

66-67 Coupe, LH/RH P air		630-3466-P
68-69 Coupe, 6-Piece Set		630-3468-S
70-72 Coupe, 6-Piece Set		630-3470-S

Camaro / Firebird

67-69 6-Piece Set		W-508
70-81 Front/Top of Door Opening, LH/RH Pair	W-859	
70-81 Rear of Door Opening, LH/RH Pair	W-756	

Package Tray & Accessories

Our package trays provide full OE coverage and replace trays that were cut out for speaker installations or damaged by rust. Please note that the package trays with a part number starting with "X" (instead of a number) are not made by AMD and do not meet the same quality standards as the panels we produce.

Package Tray Panel



Nova

68-72		640-3068
-------------	--	----------

Chevelle

66-67		640-3466
68-72 Coupe (pictured)		640-3468

Camaro / Firebird

67-69	X640-3567	
70-73		640-3570

Package Tray Panel Extensions

Chevelle

Coupe

66-67 LH		640-3466-L
66-67 RH		640-3466-R

Camaro / Firebird

Pictured

70-73 LH		640-3570-L
70-73 RH		640-3570-R



Package Tray Floor X Braces

Chevelle / GTO / Skylark / Cutlass

66-67 2-Piece Set		639-3466-P
-------------------------	--	------------

Package Tray Corner

Camaro / Firebird

67-69 Coupe, LH/RH Pair	W-275
-------------------------------	-------

Rear Seatback Brace

Attaches Package Tray Panel to Under Seat Pan

Camaro / Firebird

67-69 2-Piece Set (pictured)	X639-3567-P
------------------------------------	-------------



Seat Mount Rear Panel

Camaro / Firebird



67-69 Convertible Only	X638-3567
------------------------------	-----------



Our Name Says It All!™

Deck Filler Panels & Accessories

Window channels often fill up with moisture and debris, and eventually rust through at the bottom and corners. The bottom window channel on some GM cars is a part of the Rear Deck Filler Panel. This component usually includes both the lower rear windshield panel and the upper decklid channel. Both channels are subject to moisture retention. Made on our own steel tools, these premium panels are sure to please. **Please note that the deck filler panels with a part number starting with "X" (instead of a number) are not made by AMD and do not meet the same quality standards as the panels we produce.**

Deck Filler Panels

Rear Window to Trunk Lid

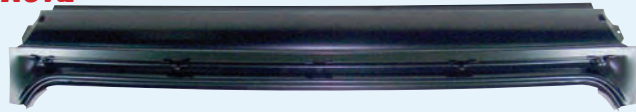

Nova



66-67 2-Door..... X650-3066
 68-74 2-Door Sedan (pictured)  650-3068

Chevelle



66-67 2-Door Coupe  650-3466
 68-72 2-Door Coupe (pictured)  650-3468

Monte Carlo

70-72 2-Door Coupe  650-3468

GTO

68-69 X650-5468

Cutlass

70-72 Supreme Coupe..... P-CAM0710

Grand Prix

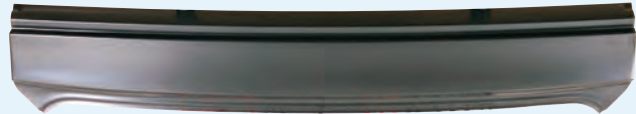



69-70 2-Door Coupe (pictured)  650-3468

Camaro / Firebird



67-69 Convertible X650-3567-V
 67-69 Coupe..... X650-3567-S



67-69 Coupe,anel (pictured)  650-3567
 70-75 Lower  650-3570-2
 70-81 Upper.....  650-3570-1

Deck Filler Panel Lower Plenum & Trunk Torsion Bar Assembly Camaro



67-69 Convertible only..... X656-3567

Deck Filler Panel Trunk Hinge Extensions Camaro / Firebird

67-69 2-Piece Set..... X657-3567-S



Quarter Panel Inner Patch Panels Camaro / Firebird

67-69 Coupe, LH (pictured)..... W-957
 67-69 Coupe, RH W-956



Inner Quarter Panel Reinforcement Assembly Camaro / Firebird

69 LH X712-3569-L
 69 RH (pictured) X712-3569-R



All of our own **AMD** parts in this catalog are listed in **Blue, bold-face Type**.

Our Name Says It All!™

OE Style Quarter Panels

Each AMD full OE style quarter panel is manufactured from high quality, heavy gauge steel on our exclusive new tools and feature correct body lines, marker light holes, door jambs and full sail panels. We use heavier gauge steel than other manufacturers which provides a more durable finished panel. Please note that the quarter panels with a part number starting with "X" (instead of a number) are not made by AMD and do not meet the same quality standards as the panels we produce.

Quarter Panels, Complete OE Style

Nova



66-67 Coupe, LH (pictured) 700-3066-L
 66-67 Coupe, RH..... 700-3066-R

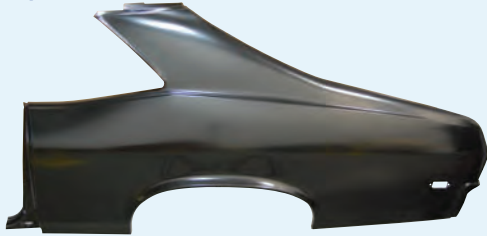

68-69 Coupe, RH..... 700-3068-L
 68-69 Coupe, RH..... 700-3068-R
 70-72 Coupe, LH..... 700-3070-L
 70-72 Coupe, RH..... 700-3070-R

Chevelle

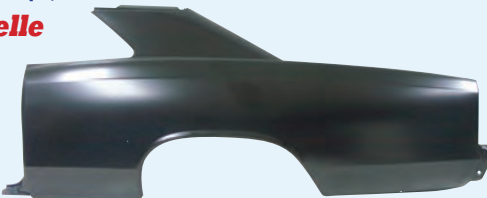

66-67 Coupe, LH (pictured) 700-3466-L
 66-67 Coupe, RH..... 700-3466-R
 68 Coupe, LH..... X700-3468-L
 68 Coupe, RH..... X700-3468-R
 69 Coupe, LH..... 700-3469-L
 69 Coupe, RH..... 700-3469-R

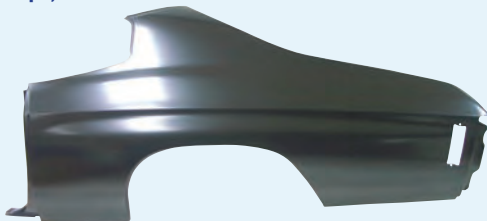

70-72 Coupe, RH..... 700-3470-L
 70-72 Coupe, RH..... 700-3470-R

All quarters & quarter skins are shipped TRUCK FREIGHT.

Monte Carlo



70-72 LH..... 700-3670-L
 70-72 RH..... 700-3670-R

Camaro



67 Coupe, LH (pictured) 700-3567-L
 67 Coupe, RH..... 700-3567-R
 67 Convertible, LH X700-3567-VL
 67 Convertible, RH..... X700-3567-VR
 68 Coupe, LH 700-3568-L
 68 Coupe, RH..... 700-3568-R
 68 Convertible, LH X700-3568-VL
 68 Convertible, RH..... X700-3568-VR
 69 Coupe, LH 700-3569-L
 69 Coupe, RH..... 700-3569-R
 69 Convertible, LH X700-3569-VL
 69 Convertible, RH..... X700-3569-VR
 70-73 LH..... 700-3570-L
 70-73 RH..... 700-3570-R

Firebird

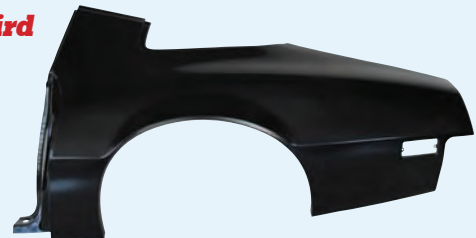

67 Coupe, LH..... X700-5567-L
 67 Coupe, RH X700-5567-R
 67 Convertible, LH X700-5567-VL
 67 Convertible, RH..... X700-5567-VR
 68 Coupe, LH..... X700-5568-L
 68 Coupe, RH X700-5568-R
 68 Convertible, LH X700-5568-VL
 68 Convertible, RH..... X700-5568-VR
 69 Coupe, LH..... X700-5569-L
 69 Coupe, RH X700-5569-R
 69 Convertible, LH X700-5569-VL
 69 Convertible, RH..... X700-5569-VR
 75-81 LH (pictured) 700-5575-L
 75-81 RH..... 700-5575-R

Impala

63 Coupe, LH..... X700-3963-L
 63 Coupe, RH X700-3963-R
 64 Coupe, LH..... X700-3964-L
 64 Coupe, RH X700-3964-R



Our Name Says It All!™

Quarter Panel Skins & Accessories

OEM-Style!

- Cut from the OE version so more accurate than competitor's
- Factory gauge steel
- Extends to mating parts like the OE version
- Include the door jamb (competitor's don't)
- Have pre-drilled holes like OE



Correct holes and flanges

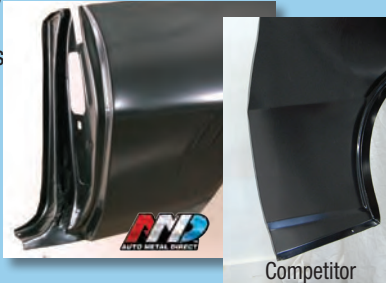

Competitor

Complete with door jambs, unlike competitor's parts

Quarter Panel Skins with Door Jambs

Nova



66-67	LH	710-3066-L
66-67	RH	710-3066-R
68-69	LH	(pictured)710-3068-L
68-69	RH	710-3068-R
70-72	LH	710-3070-L
70-72	RH	710-3070-R

Camaro



67	LH	710-3567-L
67	RH	710-3567-R
68	LH	710-3568-L
68	RH	710-3568-R
69	LH	(pictured)710-3569-L
69	RH	710-3569-R

Quarter Panel Skins without Door Jambs

- New tools
- Economical way to replace quarter panels
- Include marker light holes, where applicable

Chevelle



66-67	LH	(pictured)	709-3466-L
66-67	RH		709-3466-R
69	LH		709-3469-L
69	RH		709-3469-R
70-72	LH		709-3470-L
70-72	RH		709-3470-R

Camaro



67	LH	709-3567-L
67	RH	(pictured)709-3567-R
68	with Side Marker Cutout,	LH709-3568-L
68	with Side Marker Cutout,	RH709-3568-R



69	with Side Marker Cutout,	LH
69	with Side Marker Cutout,	RH	(pictured)709-3569-R

Quarter Window Rear Corner Reinforcement

Camaro / Firebird

67-69	Coupe, LH/RH Pair	W-654
67-69	Coupe, LH	W-654L
67-69	Coupe, RH	W-654R



Trunk Gutter

Chevelle

66-67	2-Piece Set	W-964A
68-72	2-Piece Set	W-965A

Monte Carlo

70-72	2-Piece Set	W-965A
-------	-------------	-------	--------

Camaro / Firebird

67-69	3-Piece Set	825-3567-S
70-81	2-Piece Set	(pictured)	W-965



All quarters & quarter skins are shipped TRUCK FREIGHT.



All of our own **AMD** parts in this catalog are listed in **Blue, bold-face Type**.

Our Name Says It All!™

Outer & Inner Wheelhouses

AMD offers outer and inner wheelhouses for most GM applications. The outer wheelhouses are often overlooked until a rusty quarter panel is removed, revealing a rusted outer lip. Often the inner wheelhouse is rusty, too, especially if the car has a rusty trunk floor. All of the wheelhouses that AMD manufactures is officially licensed through the GM Restoration Parts Program. **Please note that the wheelhouses with a part number starting with "X" (instead of a number) are not made by AMD and do not meet the same quality standards as the panels we produce.**

Rear Outer Wheelhouses

Nova



- 66-65 Coupe / Sedan, LH X770-3062-L
- 62-65 Coupe / Sedan, RH X770-3062-R
- 69-74 LH (pictured, left) 770-3068-L
- 69-74 RH (pictured, right) 770-3068-R

Chevelle



- 66-67 LH (pictured, left) 770-3466-L
- 66-67 RH 770-3466-R
- 68-69 LH 770-3468-L
- 68-69 RH (pictured, right) 770-3468-R
- 70-72 LH X770-3470-L
- 70-72 RH X770-3470-R

El Camino

- 68-69 LH 770-3468-L
- 68-69 RH 770-3468-R

Monte Carlo

- 70-72 LH 770-3670-L
- 70-72 RH 770-3670-R

GTO

- 64-67 LH X770-5464-L
- 64-67 RH X770-5464-R
- 68-69 LH X770-5468-L
- 68-69 RH X770-5468-R

Camaro / Firebird



- 67-68 LH (pictured, left) 770-3567-L
- 67-68 RH (pictured, right) 770-3567-R
- 69 LH X770-3569-L
- 69 RH X770-3569-R
- 70-81 LH 770-3570-L
- 70-81 RH 770-3570-R
- 70-81 Firebird, LH 770-5570-L
- 70-81 Firebird, RH 770-5570-R

Impala

- 65-66 LH X770-3965-L
- 65-66 RH X770-3965-R

Rear Inner Wheelhouses

Nova



- 68-72 LH (pictured, left) 760-3068-L
- 68-72RH (pictured, right) 760-3068-R

Chevelle / GTO / Skylark / Cutlass



- 64-67 LH (pictured, left) 760-3464-L
- 64-67 RH (pictured, right) 760-3464-R
- 68-72 LH 760-3468-L
- 68-72 RH 760-3468-R

Monte Carlo

- 70-72 LH 760-3468-L
- 70-72 RH 760-3468-R

Camaro / Firebird

- 67 LH X760-3567-L
- 67-69 RH X760-3567-R
- 68-69 LH X760-3568-L
- 69 6" Wide, LH X760-3569-2L
- 69 6" Wide, RH X760-3569-2R



- 70-81 LH (pictured, left) 760-3570-L
- 70-81 RH (pictured, right) 760-3570-R

Outer / Inner Wheelhouse Assembly

Camaro / Firebird

- 67 LH X770-3567-1L
- 67 RH X770-3567-1R
- 69 LH X770-3569-SL
- 69 RH X770-3569-SR
- 69 2" Widened Minitub, LH, requires trunk modification X770-3569-2LS
- 69 2" Widened Minitub, RH, requires trunk modification (pictured) X770-3569-2RS



Our Name Says It All!™

Trunk Floors, Braces & Extensions

Providing OE style coverage for replacement of the entire trunk floor, our one-piece pans have all the shapes, contours and holes as original. Depending on model, trunk floors include trunk braces, rear pan support and jack brackets. These high quality floors are made on new AMD tools. Please note that the trunk floors with a part number starting with "X" (instead of a number) are not made by AMD do not meet the same quality standards as the panels we produce.

Full OE Style Trunk Floors

Nova
Pinion Snubber included



68-70 with Braces welded in place  800-3068

Chevelle



66-67 with Braces welded in place  800-3466
68 with Braces welded in place.....  800-3468



69 with Braces welded in place (pictured, left)  800-3469
70 with Braces welded in place.....  800-3470
71-72 with Braces welded in place (pictured, right)  800-3471

1968-72 have Jack Brackets included

GTO

68-72 X800-5468

Camaro / Firebird



67 (pictured, left)  800-3567
68  800-3568
69  800-3569
71-73 (pictured, right)  800-3571

Includes Rear Bumper/Tail Panel Reinforcements and Jack bracket.

74-81 GM F Body 800-3574

Impala

63 X800-3963



All full trunk floors are shipped TRUCK FREIGHT.



Trunk Floor Sections

Nova
68-72 Center, 31" x 38" Wide X806-3068

Impala

61-64 Lower Section  X805-3961
64 Outer Panel.....  X805-3964-1

Trunk Floor Braces

Chevelle / GTO / Skylark / Cutlass



64-67 LH  820-3464-L
64-67 RH  820-3464-R
68-72 LH (pictured, left)  820-3468-L
68-72 RH (pictured, right).....  820-3468-R

Monte Carlo

70-72 LH  820-3468-L
70-72 RH  820-3468-R

Camaro / Firebird

67-68 LH=RH,
Sold each X820-3567
67-68 LH (pictured)..... X820-3569-L
67-68 RH (pictured)..... X820-3569-R



Gas Tank Braces

Chevelle / GTO / Skylark / Cutlass

64-67 Sold each 830-3464
68-72 Sold each (pictured)..... 830-3468



All of our own AMD parts in this catalog are listed in Blue, bold-face Type.

Drop Offs, Gutters & Latch Supports

When replacing or repairing trunk floor pans, don't forget the Trunk Floor Braces, Drop-Offs, and Extensions. AMD makes these GM-licensed high quality reproduction parts from heavy gauge steel. Please note that the trunk drop offs with a part number starting with "X" (instead of a number) are not made by AMD do not meet the same quality standards as the panels we produce.

Trunk Floor to Quarter Panel Extension (Drop Off)



Nova

- 68-72 LH (pictured, left)  840-3068-L
- 68-72 RH (pictured, right).....  840-3068-R

Chevelle



- 66-67 LH  840-3466-L
- 66-67 RH  840-3466-R
- 68 LH  840-3468-L
- 68 RH  840-3468-R
- 69 LH (pictured, left)  840-3469-L
- 69 RH  840-3469-R
- 70-72 LH  840-3470-L
- 70-72 RH (pictured, right).....  840-3470-R



Monte Carlo





- 70-72 LH (pictured, left)  840-3670-L
- 70-72 RH (pictured, right).....  840-3670-R

Camaro / Firebird



- 67-68 LH X840-3567-L
- 67-68 RH X840-3567-R
- 69 LH X840-3569-L
- 69 RH X840-3569-R
- 70-73 Camaro, LH (pictured, left)  840-3570-L
- 70-73 Camaro, RH (pictured, right).....  840-3570-R



- 74-81 Firebird, LH (pictured, left)  840-5574-L
- 74-81 Firebird, RH (pictured, right).....  840-5574-R



Impala



- 63 LH (pictured, left) X840-3963-L
- 63 RH (pictured, right) X840-3963-R
- 64 LH X840-3964-L
- 64 RH X840-3964-R

Trunk Extension End Caps

Nova

- 68-72 LH (pictured)  841-3068-L
- 68-72 RH  841-3068-R

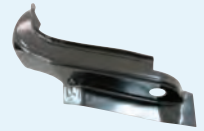

Trunk to Quarter Panel Inner Bumper Brace

Camaro

- 69 Trunk to Quarter Panel Corner Brace, 2-Piece Set..... W-639



Quarter Panel Trunk Opening Stiffener

Camaro / Firebird

- 67-68 LH (pictured, left) W-975L
- 67-68 RH W-975R
- 69 LH W-976L
- 69 RH (pictured, right) W-976R



Look for the Highlighted Parts!

All  exclusive products are made on our own steel tools. All AMD parts are listed in **Blue, Bold Face Type**.

Since we do not yet make every part for every model, we have filled out our line by also selling the finest available parts we can find on the market.



Our Name Says It All!™

Trunk Lids, Accessories & Spoilers

AMD's licensed reproduction Trunk Lids are EDP coated inside and out for a durable, long-lasting finish. All of our trunk lids are officially licensed through the GM Restoration Parts Program. We also carry several trunk accessories including OE style spoilers and trunk latches. Please note that the trunk lids with a part number starting with "X" (instead of a number) are not made by AMD and do not meet the same quality standards as the panels we produce.

Trunk Lids

Nova

62-64 Trunk Lid		850-3062
65 Deck Lid with Backup Holes		850-3065
66-67 Trunk Lid		850-3066
68-74 Trunk Lid (pictured)		850-3068

Chevelle



66-67	X850-3466
68-72 (pictured)		850-3468

Monte Carlo / Skylark

70-72 (pictured)		850-3468
------------------	--	----------

Camaro / Firebird

67-69 with Latch		850-3567
70-81	X850-3570



Impala

63	X850-3963
64 (pictured)	X850-3964-2

Trunk Hinge Bracket

Camaro / Firebird

67-69 Coupe, 4-Piece Set	X852-3567-P
-----------------------------	-------	-------------

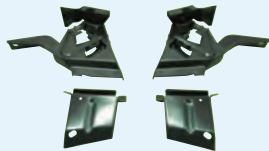

All deck lids are shipped
TRUCK FREIGHT.



Trunk Latches

Nova

62-72 (pictured)	W-029
73-74	K-20291279

Chevelle

64-72 (pictured)	W-029
------------------	-------	-------

Camaro

67-69 (pictured)	W-029
70-81	K-20291279

Firebird

70-81	K-20291279
-------	-------	------------

Chevy Full Size

59-70 (pictured)	W-029
------------------	-------	-------



Trunk Lock Catches

Nova

62-74		854-3959
71-74 (pictured)		854-3471

Chevelle

64-70		854-3959
71-72 (pictured)		854-3471

Camaro / Firebird

67-69	X854-3567
71-81 (pictured)		854-3471



Rear Spoilers

Camaro

67-68 with Templates & Hardware, Best quality Spoilers on the market	851-3567
---	-------	----------

69 with Templates & Hardware, Best quality Spoilers on the market (pictured)	851-3569
---	-------	----------

70-73 LH		K-3990475
70-73 RH		K-3990476
70-81 Center	K-480161
74-81 LH		K-339433
74-81 RH		K-339434

Firebird

67-68 with Templates & Hardware, Not OE, but are a popular addition	851-3567
--	-------	----------

69 with Templates & Hardware (pictured) Not OE, but are a popular addition	851-3569
---	-------	----------

70-78 LH	K-493688
70-78 RH	K-493687
70-81 Center	K-480161

Rear Spoiler Stud Set

Camaro / Firebird

67-69 Rear Spoiler Stud Set	K-E391
-----------------------------	-------	--------



ur Name Says It All!™



All of our own AMD parts in this catalog are listed in Blue, bold-face Type.

OE Style Rear Frame Rails

AMD's Nova rear frame rails all full OE style made of heavy gauge steel and are officially licensed through the GM Restoration Parts Program. Why not replace rusty frame rails when you install your new trunk floor.

OE Style Rear Frame Rails



Nova

68-72 LH  895-3068-L
68-72 RH (pictured)  895-3068-R

OE Style Rear Frame Rails

Camaro / Firebird

67 LH X895-3567-L
67 RH (pictured) X895-3567-R
68-69 (shorten for 68), LH X895-3568-L
68-69 (shorten for 68), RH X895-3568-R



Frame Crossrails & Crossmembers

Next time you're underneath your GM muscle car, take a look at the **Rear Frame Crossmembers** and **Crossrails**. These vital components are crucial to keeping body panels and frame rails supported and aligned correctly. Yet over the years many, many of these fragile components have been damaged by collision, rust, and ill-advised attempts at pushing or towing.

Rear Frame Crossrails

Nova



68-72 Behind Rear Bumper, attaches to Tail Panel  870-3068

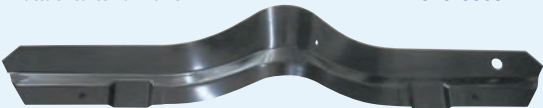

68-72 Mounts Under Rear End of Trunk Floor  870-3068-1

Camaro / Firebird

Rear Inner Valance Panel



67-68 X870-3567
69 870-3569



70-73 (pictured)  870-3570
74-81  870-3574

Rear Frame Crossmember

Chevelle / El Camino / GTO / Skylark / Cutlass

Welds to Frame Rails, often bent or rusted



64-67 (pictured)  870-3464
65 GTO X870-5465



68-72  870-3468

Impala



64 X870-3964

Rear Crossrail Extensions

Nova

68-72 LH (top)  871-3068-L
68-72 RH (bottom)  871-3068-R



Camaro / Firebird

70-73 LH  871-3570-L
70-73 RH  871-3570-R

Transmission Crossmembers

Nova



68-69 All except TH-400 Transmission or Big Block, 4-Speed (pictured, left) W-952
68-72 Big Block, 4-Speed (pictured, right) W-950



68-72 TH-400 Transmission (pictured) W-954

Camaro



67-69 Standard, except TH-400 & Big Block, 4-Speed (pictured, left) W-952
67-69 Big Block, 4-Speed (pictured, right) W-950



67-69 TH-400 Transmission (pictured, left) W-954
70-81 TH-400 Transmission (pictured, right) X395-3570

Firebird

67-69 TH-400 Transmission W-951



Our Name Says It All!™

Rear Body / Taillight Panels

AMD taillight panels are made from quality heavy gauge steel, each panel is built to original OE specs and has been test fitted by the restoration professionals at Auto Metal Direct. Please note that the taillight panels with a part number starting with "X" (instead of a number) are not made by AMD and do not meet the same quality standards as the panels we produce.

Rear Body / Taillight Panels

Nova

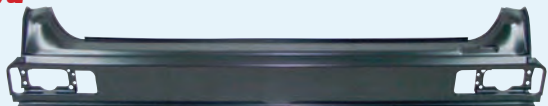

62-64 LH*X900-3062-L	
62-64 RH*X900-3062-R	
68-69 (pictured)	900-3068
70-72	900-3070

* Can be used for 65, tail light shape is different.

Chevelle



66 (pictured)	900-3466
67	900-3467
68	900-3468
69	900-3469
70-72	900-3470

Our 1967-73 Camaro Taillight Panels have the BEST FIT on the Market!

Camaro



67-68 RS	900-3567-1
67-68 Standard	900-3567
69 (pictured)	900-3569



70-73 (pictured)	900-3570
74-77X900-3574	
78-81X900-3578	

Firebird

67-68X900-5567	
69X900-5569	

Impala

63X900-3963	
64X900-3964	

Rear Valance Panel

Chevelle



70	960-3470
----	-------	-----------------

Rear Body Panel Brace / Trunk Latch Support

Nova

68-72 (left)	810-3068
--------------	-------	-----------------

Chevelle

66 Center (bottom)	810-3466
68-69 (right)	810-3468

Camaro / Firebird

67-68X810-3567	
69X810-3569	
70-73K-K251	



Rear Body Panel Inner Brace

Nova

Trunk Gutter Side Brace

68-69 LH	920-3068-L
68-69 RH	920-3068-R
70-72 LH	920-3070-L
70-72 RH	920-3070-R

Chevelle

66 3-Piece Set, includes		
810-3466 (pictured)	920-3466-S
66 LH	920-3466-L
66 RH	920-3466-R
68-69 LH	920-3468-L
68-69 RH	920-3468-R
68-69 2-Piece Set (pictured)	920-3468-S

Camaro

67-68 2 required, Sold each (pictured)	W-638
69 2-Piece Set	W-637

Firebird

74-78 LH	920-5574-L
74-78 RH	920-5574-R
79-81 LH	920-5579-L
79-81 LH	920-5579-L



Rear License Plate Bracket

Nova

68-72 with Hinge	W-309
73-74 (pictured)	945-3570

Chevelle

65 2-Piece (right)X945-3465-S	
66-67	W-991
68-72 with Hinge	W-309

Camaro

69 with Hinge	W-309
70-77 (pictured, top)	945-3570

Firebird

69 with Hinge	W-309
---------------	-------	--------------

Chevy Full Size

65-67 except Wagon	W-991
--------------------	-------	--------------



Our Name Says It All!™



All of our own AMD parts in this catalog are listed in Blue, bold-face Type.

El Camino Tailgate Parts

AMD offers 68-72 El Camino Tailgates and several tailgate accessories to replace rusted or damaged originals. Please note that the tailgates and panels with a part number starting with "X" (instead of a number) are not made by AMD and do not meet the same quality standards as the panels we produce.

Tailgate, Complete El Camino



68 (pictured) X925-3768
 69-72 X925-3769

Tailgate Outer Skin El Camino

64-66 X925-3764-1
 67 X925-3767-1
 68 X925-3768-1
 69-72 X925-3769-1

Inner Tailgate Panel El Camino



68-72 (pictured).....X925-3768-2

Tailgate Latch Set



El Camino

68-72X927-3768-P

Tailgate Handle

El Camino

64-67 (pictured) ...  T-4817
 69-72 Chrome X927-3768



Tailgate Rubber Seals & Bumpers

El Camino

68-72 25-Piece Set.....C-V-1205

Tailgate Hinge Escutcheon

El Camino

64-67 (pictured).....  T-4818

Chevelle Wagon

64-67 (pictured).....  T-4818



Complete Glass Kits

Now, get great fitting glass for your GM muscle car, with premium quality, reproduction glass from the restoration professionals at AMD! All of the glass kits are manufactured on AMD's exclusive tools and features thicker glass than other reproductions on the market. We offer most 2-Door Coupe, Convertible, and 2-Door Sedan (post) GM applications including X, B, and F body applications. Available in clear or factory tint with shaded upper band on windshields.

Complete Glass Kits

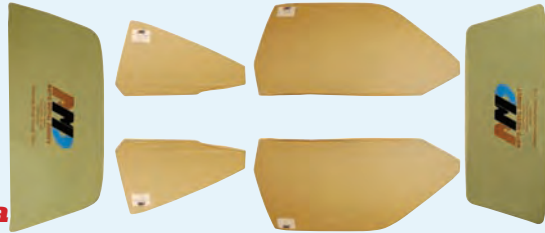

Nova

Sedan		
62-64	Clear	499-3062-CSS
62-64	Tinted	499-3062-TSS
65	Clear	499-3065-CSS
65	Tinted	499-3065-TSS
66-67	Clear	499-3066-CSS
66-67	Tinted	499-3066-TSS
68-72	Clear	499-3068-CS
68-72	Tinted	499-3068-TS
70-72	Clear, with Antenna	499-3070-CS
70-72	Tinted, with Antenna	499-3070-TS

Coupe		
62-65	Clear	499-3062-CS
62-65	Tinted	499-3062-TS
66-67	Clear	499-3066-CS
66-67	Tinted	499-3066-TS

Chevelle

64-65	Clear	499-3464-CSS
64-65	Tinted	499-3464-TSS
66-67	Clear	499-3466-CSS
66-67	Tinted	499-3466-TSS
68-69	Clear	499-3468-CSS
68-69	Tinted	499-3468-TSS

Coming
Soon

Coupe		
64-65	Clear (3 holes)	499-3464-3CS
64-65	Clear (no holes)	499-3464-CS
64-65	Tinted (3 holes)	499-3464-3TS
64-65	Tinted (no holes)	499-3464-TS
66-67	Clear	499-3466-CS
66-67	Tinted	499-3466-TS
68	Clear	499-3468-CS
68	Tinted	499-3468-TS
69	Clear	499-3469-CS
69	Tinted	499-3469-TS
70-72	Clear (8 holes)	499-3470-8CS
70-72	Clear (8 holes) without Antenna	499-3470-1CS
70-72	Tinted (8 holes)	499-3470-8TS
70-72	Tinted (8 holes) without Antenna	499-3470-1TS

All glass kits are shipped
TRUCK FREIGHT.



A SEDAN has a post between the door and quarter glass. COUPES and HARDTOPS have no post. All glass is for 2-Door cars unless noted.

Complete Glass Kits

Chevelle, continued

Convertible		
64-65	Clear (no holes)	499-3464-CVS
64-65	Tinted (no holes)	499-3464-TVS
64-65	Clear (3 holes)	499-3464-3CVS
64-65	Tinted (3 holes)	499-3464-3TVS
66-67	Clear	499-3466-CVS
66-67	Tinted	499-3466-TVS
68	Clear	499-3468-CVS
68	Tinted	499-3468-TVS
69	Clear	499-3469-CVS
69	Tinted	499-3469-TVS
70-72	Clear (8 holes) with Antenna	499-3470-8CVS
70-72	Tinted (8 holes) with Antenna	499-3470-8TVS

El Camino

64-67	Clear	499-3764-CS
64-67	Tinted	499-3764-TS
68-72	Clear, without Antenna	499-3768-CS
68-72	Tinted, without Antenna	499-3768-TS
70-72	Clear, with Antenna	499-3770-CS
70-72	Tinted, with Antenna	499-3770-TS

GTO

Sedan		
64-65	Clear	499-5464-CSS
64-65	Tinted	499-5464-TSS
66-67	Clear	499-5466-CSS
66-67	Tinted	499-5466-TSS
68-72	Clear	499-5468-CSS
68-72	Tinted	499-5468-TSS
70-72	Clear, with Antenna	499-5470-CSS
70-72	Tinted, with Antenna	499-5470-TSS

Coming
Soon

Coupe		
64-65	Clear (no holes)	499-5464-CS
64-65	Tinted (no holes)	499-5464-TS
64-65	Clear (3 holes)	499-5464-3CS
64-65	Tinted (3 holes)	499-5464-3TS
66-67	Clear	499-5466-CS
66-67	Tinted	499-5466-TS
68	Clear	499-5468-CS
68	Tinted	499-5468-TS
69	Clear, without Antenna	499-5469-CS
69	Tinted, without Antenna	499-5469-TS
70-72	Clear (8 Holes) with Antenna	499-5470-CS
70-72	Tinted (8 Holes) with Antenna	499-5470-TS



Our Name Says It All!™

Complete Glass Kits

Complete Glass Kits

GT0, continued

Convertible	
64-65 Clear (no holes)	499-3464-CVS
64-65 Tinted (no holes)	499-3464-TVS
64-65 Clear (3 holes)	499-3464-3CVS
64-65 Tinted (3 holes)	499-3464-3TVS
66-67 Clear	499-3466-CVS
66-67 Tinted	499-3466-TVS
68 Clear	499-3468-CVS
68 Tinted	499-3468-TVS
69 Clear	499-3469-CVS
69 Tinted	499-3469-TVS
70-72 Clear (8 holes) with Antenna	499-3470-8CVS
70-72 Tinted (8 holes) with Antenna	499-3470-8TVS

Monte Carlo

70-72 Clear (8 holes), with Antenna	499-3670-CS
70-72 Tinted (8 holes), with Antenna	499-3670-TS

Grand Prix

69 Clear, without Antenna	499-5669-CS
69 Tinted, without Antenna	499-5669-TS
70 Clear (8 holes) with Antenna	499-5670-CS
70 Tinted (8 holes) with Antenna	499-5670-TS
71-72 Clear (8 holes) with Antenna	499-5671-CS
71-72 Tinted (8 holes) with Antenna	499-5671-TS

Skylark

Sedan	
64-65 Clear	499-5464-CSS
64-65 Tinted	499-5464-TSS
66-67 Clear	499-5466-CSS
66-67 Tinted	499-5466-TSS

Coming
Soon

Coupe	
64-65 Clear (no holes)	499-5464-CS
64-65 Tinted (no holes)	499-5464-TS
64-65 Clear (3 holes)	499-5464-3CS
64-65 Tinted (3 holes)	499-5464-3TS
66-67 Clear	499-5466-CS
66-67 Tinted	499-5466-TS
70-72 Tinted (8 holes) with Antenna	499-6470-TS

Convertible	
64-65 Clear (no holes)	499-3464-CVS
64-65 Tinted (no holes)	499-3464-TVS
64-65 Clear (3 holes)	499-3464-3CVS
64-65 Tinted (3 holes)	499-3464-3TVS
66-67 Clear	499-3466-CVS
66-67 Tinted	499-3466-TVS
68 Clear	499-3468-CVS
68 Tinted	499-3468-TVS
69 Clear	499-3469-CVS
69 Tinted	499-3469-TVS
70-72 Clear (8 holes) with Antenna	499-3470-8CVS
70-72 Tinted (8 holes) with Antenna	499-3470-8TVS



A SEDAN has a post between the door and quarter glass. COUPES and HARDTOPS have no post. All glass is for 2-Door cars unless noted.

Complete Glass Kits

Cutlass

Sedan	
64-65 Clear	499-5464-CSS
64-65 Tinted	499-5464-TSS
66-67 Clear	499-5466-CSS
66-67 Tinted	499-5466-TSS

Coming
Soon

Coupe	
64-65 Clear (no holes)	499-5464-CS
64-65 Tinted (no holes)	499-5464-TS
64-65 Clear (3 holes)	499-5464-3CS
64-65 Tinted (3 holes)	499-5464-3TS
66-67 Clear	499-5466-CS
66-67 Tinted	499-5466-TS
68 Clear	499-7468-CS
68 Tinted	499-7468-TS
69 Clear	499-7469-CS
69 Tinted	499-7469-TS

Fastback	
70-72 Clear (8 Holes) with Antenna	499-7470-CS
70-72 Tinted (8 Holes) with Antenna	499-7470-TS

Supreme	
70-72 Clear (8 Holes) with Antenna	499-7470-1CS
70-72 Tinted (8 Holes) with Antenna	499-7470-1TS

Convertible	
64-65 Clear (no holes)	499-3464-CVS
64-65 Tinted (no holes)	499-3464-TVS
64-65 Clear (3 holes)	499-3464-3CVS
64-65 Tinted (3 holes)	499-3464-3TVS
66-67 Clear	499-3466-CVS
66-67 Tinted	499-3466-TVS
68 Clear	499-3468-CVS
68 Tinted	499-3468-TVS
69 Clear	499-3469-CVS
69 Tinted	499-3469-TVS
70-72 Clear (8 holes) with Antenna	499-3470-8CVS
70-72 Tinted (8 holes) with Antenna	499-3470-8TVS

Camaro / Firebird

Coupe	
67 Clear	499-3567-CS
67 Tinted, with Band	499-3567-TBS
67 Tinted, without Band	499-3567-TS
68-69 Clear	499-3568-CS
68-69 Tinted, with Band	499-3568-TBS
68-69 Tinted, without Band	499-3568-TS
70-74 Clear	499-3570-CS
70-74 Tinted	499-3570-TS
75-81 Tinted	499-3575-TS
75-81 Tinted with Heated Defroster	499-3575-HTS

Convertible	
67 Clear	499-3567-CVS
67 Tinted	499-3567-TVS
68-69 Clear	499-3568-CVS
68-69 Tinted, without Band	499-3568-TVS

All glass kits are shipped
TRUCK FREIGHT.



Our Name Says It All!™

Windshields

All windshields are shipped **TRUCK FREIGHT.**



AMD offers windshields for most GM musclecar applications in both clear and factory style tint with shaded upper section. Be sure not to forget the gasket or ribbon seal to ease installation.

A **SEDAN** has a post between the door and quarter glass. **COUPES** and **HARDTOPS** have no post. All glass is for 2-Door cars unless noted.

Windshields

Nova

62-67 Coupe/Convertible, Clear.....	380-3062-C
62-67 2- & 4-Door Sedan, Clear.....	380-3062-CS
62-67 Coupe/Convertible, Tinted.....	380-3062-T
62-67 2- & 4-Door Sedan, Tinted.....	380-3062-TS
68-72 Clear without Antenna.....	380-3068-C
68-72 Tinted without Antenna.....	380-3068-T
70-72 Clear with Antenna.....	380-3070-C
70-72 Tinted with Antenna.....	380-3070-T

Chevelle



64-65 Clear.....	380-3464-C
64-65 Tinted.....	380-3464-T
66-67 Coupe, Clear.....	380-3466-C
66-67 Coupe, Tinted.....	380-3466-T
Coupe & 2-Door Sedan	
68-72 Clear without Antenna.....	380-3468-C
68-72 Tinted without Antenna.....	380-3468-T
70-72 Clear with Antenna.....	380-3470-C
70-72 Tinted with Antenna (pictured).....	380-3470-T

Windshields, continued

Chevelle, continued

Convertible	
68-72 Clear without Antenna.....	380-3468-VC
68-72 Tinted without Antenna.....	380-3468-VT
70-72 Clear with Antenna.....	380-3470-VC
70-72 Tinted with Antenna.....	380-3470-VT

GTO / Skylark / Cutlass

64-65 All Body Styles, Clear.....	380-3464-C
64-65 All Body Styles, Tinted.....	380-3464-T

Coupe & 2-Door Sedan

66-67 Clear.....	380-3466-C
66-67 Tinted.....	380-3466-T
68-72 Clear without Antenna.....	380-3468-C
68-72 Tinted without Antenna.....	380-3468-T
70-72 Clear with Antenna.....	380-3470-C
70-72 Tinted with Antenna (pictured).....	380-3470-T

Convertible

68-72 Clear without Antenna.....	380-3468-VC
68-72 Tinted without Antenna.....	380-3468-VT
70-72 Clear with Antenna.....	380-3470-VC
70-72 Tinted with Antenna.....	380-3470-VT

Camaro / Firebird

67-69 Coupe, Clear.....	380-3567-C
67-69 Coupe, without Tint Band.....	380-3567-T
67-69 Coupe, with Tint Band.....	380-3567-TB
67-69 Convertible, Clear.....	380-3567-VC
67-69 Convertible, Tinted.....	380-3567-VT
70-81 Clear with Antenna.....	380-3570-C
70-81 Tinted with Antenna.....	380-3570-T

Door Glass

AMD offers door glass for most GM 2 door musclecar applications in both clear and factory style tint. Correct thickness glass helps alignment and ease of installation. AMD carries additional accessories such as regulators and hardware to help finish your installation.

Door Glass

Nova

62-65 Coupe / Convertible, Clear, Sold each.....	550-3062-C
62-65 Coupe / Convertible, Tinted, Sold each.....	550-3062-T
62-67 Sedan, Clear, Sold each.....	550-3062-CS
62-67 Sedan, Tinted, Sold each.....	550-3062-TS
66-67 Coupe, Clear, Sold each.....	550-3066-C
66-67 Coupe, Tinted, Sold each.....	550-3066-T
68-72 Clear, LH.....	550-3068-CL
68-72 Clear, RH.....	550-3068-CR
68-72 Tinted, LH.....	550-3068-TL
68-72 Tinted, RH.....	550-3068-TR

Chevelle

Sedan	
64-67 Clear, LH.....	550-3464-CSL
64-67 Clear, RH.....	550-3464-CSR
64-67 Tinted, LH.....	550-3464-TSL
64-67 Tinted, RH.....	550-3464-TSR
68-69 Clear, LH.....	550-3468-CSL
68-69 Clear, RH.....	550-3468-CSR
68-69 Tinted, LH.....	550-3468-TSL
68-69 Tinted, RH.....	550-3468-TSR



All of our own **AMD** parts in this catalog are listed in **Blue, bold-face Type.**

Door Glass

Door Glass, continued

Chevelle, continued

Coupe

64-65	Clear, LH	550-3464-CL
64-65	Clear, RH	550-3464-CR
64-65	Clear (3 Hole), LH	550-3464-3CL
64-65	Clear (3 Hole), RH	550-3464-3CR
64-65	Tinted, LH	550-3464-TL
64-65	Tinted, RH	550-3464-TR
64-65	Tinted (3 hole), LH	550-3464-3TL
64-65	Tinted (3 hole), RH	550-3464-3TR
66-67	Clear, LH	550-3466-CL
66-67	Clear, RH	550-3466-CR
66-67	Tinted, LH	550-3466-TL
66-67	Tinted, RH	550-3466-TR
68	Clear, LH	550-3468-CL
68	Clear, RH	550-3468-CR
68	Tinted, LH	550-3468-TL
68	Tinted, RH	550-3468-TR
69	Clear, LH	550-3469-CL
69	Clear, RH	550-3469-CR
69	Tinted, LH	550-3469-TL
69	Tinted, RH	550-3469-TR
70-72	Clear (8 holes), LH	550-3470-8CL
70-72	Clear (8 holes), RH	550-3470-8CR
70-72	Tinted (8 holes), LH	550-3470-8TL
70-72	Tinted (8 holes), RH	550-3470-8TR

Convertible

64-65	Clear, LH	550-3464-CVL
64-65	Clear, RH	550-3464-CVR
64-65	Clear (3 hole), LH	550-3464-3CVL
64-65	Clear (3 hole), RH	550-3464-3CVR
64-65	Tinted, LH	550-3464-TVL
64-65	Tinted, RH	550-3464-TVR
64-65	Tinted (3 hole), LH	550-3464-3TVL
64-65	Tinted (3 hole), RH	550-3464-3TVR
66-67	Clear, LH	550-3466-CL
66-67	Clear, RH	550-3466-CR
66-67	Tinted, LH	550-3466-TL
66-67	Tinted, RH	550-3466-TR
68	Clear, LH	550-3468-CL
68	Clear, RH	550-3468-CR
68	Tinted, LH	550-3468-TL
68	Tinted, RH	550-3468-TR
69	Clear, LH	550-3469-CL
69	Clear, RH	550-3469-CR
69	Tinted, LH	550-3469-TL
69	Tinted, RH	550-3469-TR
70-72	Clear (8 holes), LH	550-3470-8CL
70-72	Clear (8 holes), RH	550-3470-8CR
70-72	Tinted (8 holes), LH	550-3470-8TL
70-72	Tinted (8 holes), RH	550-3470-8TR

El Camino

64-67	Clear, LH	550-3764-CL
64-67	Clear, RH	550-3764-CR
64-67	Tinted, LH	550-3764-TL
64-67	Tinted, RH	550-3764-TR
68-72	Clear, LH	550-3768-CL
68-72	Clear, RH	550-3768-CR
68-72	Tinted, LH	550-3768-TL
68-72	Tinted, RH	550-3768-TR

Door Glass, continued

GTO / Skylark / Cutlass

Sedan

64-65	Clear, LH	550-3464-CSL
64-65	Clear, RH	550-3464-CSR
64-65	Tinted, LH	550-3464-TSL
64-65	Tinted, RH	550-3464-TSR
66-67	Clear, LH	550-5466-CSL
66-67	Clear, RH	550-5466-CSR
66-67	Tinted, LH	550-5466-TSL
66-67	Tinted, RH	550-5466-TSR
68-72	Clear, LH	550-3468-CSL
68-72	Clear, RH	550-3468-CSR
68-72	Tinted, LH	550-3468-TSL
68-72	Tinted, RH	550-3468-TSR

Coupe

64-65	Clear, LH	550-3464-CL
64-65	Clear, RH	550-3464-CR
64-65	Clear (3 Hole), LH	550-3464-3CL
64-65	Clear (3 Hole), RH	550-3464-3CR
64-65	Tinted, LH	550-3464-TL
64-65	Tinted, RH	550-3464-TR
64-65	Tinted (3 hole), LH	550-3464-3TL
64-65	Tinted (3 hole), RH	550-3464-3TR
66-67	Clear, LH	550-5466-CL
66-67	Clear, RH	550-5466-CR
66-67	Tinted, LH	550-5466-TL
66-67	Tinted, RH	550-5466-TR
68	Clear, LH	550-3468-CL
68	Clear, RH	550-3468-CR
68	Tinted, LH	550-3468-TL
68	Tinted, RH	550-3468-TR
69	Clear, LH	550-3469-CL
69	Clear, RH	550-3469-CR
69	Tinted, LH	550-3469-TL
69	Tinted, RH	550-3469-TR
70-72	Clear (8 holes), LH	550-3470-8CL
70-72	Clear (8 holes), RH	550-3470-8CR
70-72	Tinted (8 holes), LH	550-3470-8TL
70-72	Tinted (8 holes), RH	550-3470-8TR

Convertible

64-65	Clear, LH	550-3464-CVL
64-65	Clear, RH	550-3464-CVR
64-65	Clear (3 hole), LH	550-3464-3CVL
64-65	Clear (3 hole), RH	550-3464-3CVR
64-65	Tinted, LH	550-3464-TVL
64-65	Tinted, RH	550-3464-TVR
64-65	Tinted (3 hole), LH	550-3464-3TVL
64-65	Tinted (3 hole), RH	550-3464-3TVR
66-67	Clear, LH	550-5466-CL
66-67	Clear, RH	550-5466-CR
66-67	Tinted, LH	550-5466-TL
66-67	Tinted, RH	550-5466-TR
68	Clear, LH	550-3468-CL
68	Clear, RH	550-3468-CR
68	Tinted, LH	550-3468-TL
68	Tinted, RH	550-3468-TR
69	Clear, LH	550-3469-CL
69	Clear, RH	550-3469-CR
69	Tinted, LH	550-3469-TL
69	Tinted, RH	550-3469-TR
70-72	Clear (8 holes), LH	550-3470-8CL
70-72	Clear (8 holes), RH	550-3470-8CR
70-72	Tinted (8 holes), LH	550-3470-8TL
70-72	Tinted (8 holes), RH	550-3470-8TR



Our Name Says It All!™

Door Glass

Door Glass, continued

Grand Prix

69-70	Clear, LH	550-3469-CL
69-70	Clear, RH	550-3469-CR
69-70	Tinted, LH	550-3469-TL
69-70	Tinted, RH	550-3469-TR
70-72	Clear (8 holes), LH	550-3470-8CL
70-72	Clear (8 holes), RH	550-3470-8CR
70-72	Tinted (8 holes), LH	550-3470-8TL
70-72	Tinted (8 holes), RH	550-3470-8TR

Camaro / Firebird

67	Clear, LH	550-3567-CL
67	Clear, RH	550-3567-CR
67	Tinted, LH	550-3567-TL
67	Tinted, RH	550-3567-TR
68-69	Clear, LH	550-3568-CL
68-69	Clear, RH	550-3568-CR

Door Glass, continued

Camaro / Firebird, continued



68-69	Tinted, LH (pictured, left)	550-3568-TL
68-69	Tinted, RH (pictured, right)	550-3568-TR
70-81	Clear, LH	550-3570-CL
70-81	Clear, RH	550-3570-CR
70-81	Tinted, LH	550-3570-TL
70-81	Tinted, RH	550-3570-TR

Full Size Chevy / Pontiac

Coupe		
55-57	Clear, Sold each	550-3955-C
55-57	Tinted, Sold each	550-3955-T
Sedan		
55-57	Clear, Sold each	550-3955-CS
55-57	Tinted, Sold each	550-3955-TS

Vent Window Glass

AMD offers vent glass for most GM 2 door musclecar applications in both clear and factory style tint. Correct thickness glass helps alignment and ease of installation. AMD carries additional accessories such as guides, hardware, and handles to help finish your installation.

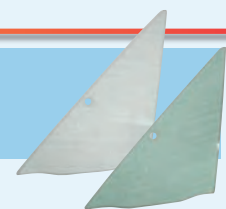

Vent Window Glass

Nova

62-67	Clear, Sold each	560-3062-C
62-67	Tinted, Sold each	560-3062-T
68-72	Clear, LH	560-3068-CL
68-72	Clear, RH	560-3068-CR
68-72	Tinted, LH	560-3068-TL
68-72	Tinted, RH	560-3068-TR

Chevelle

All Body Styles

64-65	Clear, LH	560-3464-CL
64-65	Clear, RH	560-3464-CR
64-65	Tinted, LH	560-3464-TL
64-65	Tinted, RH	560-3464-TR

Sedan

66-67	Clear, LH	560-3464-CL
66-67	Clear, RH	560-3464-CR
66-67	Tinted, LH	560-3464-TL
66-67	Tinted, RH	560-3464-TR
68-69	Clear, LH	560-3468-CSL
68-69	Clear, RH	560-3468-CSR
68-69	Tinted, LH	560-3468-TSL
68-69	Tinted, RH	560-3468-TSR

Coupe / Convertible

66-67	Clear, LH	560-3466-CL
66-67	Clear, RH	560-3466-CR
66-67	Tinted, LH	560-3466-TL
66-67	Tinted, RH	560-3466-TR
68	Clear, LH	560-3468-CL
68	Clear, RH	560-3468-CR
68	Tinted, LH	560-3468-TL
68	Tinted, RH	560-3468-TR

Vent Window Glass

GTO / Skylark / Cutlass

All Body Styles

64-65	Clear, LH	560-3464-CL
64-65	Clear, RH	560-3464-CR
64-65	Tinted, LH	560-3464-TL
64-65	Tinted, RH	560-3464-TR

Sedan

66-67	Clear, LH	560-5466-CSL
66-67	Clear, RH	560-5466-CSR
66-67	Tinted, LH	560-5466-TSL
66-67	Tinted, RH	560-5466-TSR
68-72	Clear, LH	560-3468-CSL
68-72	Clear, RH	560-3468-CSR
68-72	Tinted, LH	560-3468-TSL
68-72	Tinted, RH	560-3468-TSR

Coupe / Convertible

66-67	Clear, LH	560-3466-CL
66-67	Clear, RH	560-3466-CR
66-67	Tinted, LH	560-3466-TL
66-67	Tinted, RH	560-3466-TR
68	Clear, LH	560-3468-CL
68	Clear, RH	560-3468-CR
68	Tinted, LH	560-3468-TL
68	Tinted, RH	560-3468-TR

Camaro / Firebird

67	Clear, LH	560-3567-CL
67	Clear, RH	560-3567-CR
67	Tinted, LH	560-3567-TL
67	Tinted, RH	560-3567-TR



Our Name Says It All!™



All of our own **AMD** parts in this catalog are listed in **Blue, bold-face type**.

Vent Window Glass

Vent Window Glass, continued

Full Size Chevy / Pontiac

Coupe	
55-57 Clear, Sold each	560-3955-C
55-57 Tinted, Sold each	560-3955-T
Sedan	
55-57 Clear, Sold each	560-3955-CS
55-57 Tinted, Sold each	560-3955-TS



Quarter Window Glass

AMD offers quarter glass for most GM 2 door musclecar applications in both clear and factory style tint. Correct thickness glass helps alignment and ease of installation. AMD carries additional accessories such as hardware and regulators to help finish your installation.

Quarter Window Glass

Nova

Sedan	
62-65 Clear, Sold each	795-3062-CS
62-65 Tinted, Sold each	795-3062-TS
66-67 Clear, Sold each	795-3066-CS
66-67 Tinted, Sold each	795-3066-TS
68-72 Clear, LH	795-3068-CL
68-72 Clear, RH	795-3068-CR
68-72 Tinted, LH	795-3068-TL
68-72 Tinted, RH	795-3068-TR
Coupe	
62-65 Clear, Sold each	795-3062-C
62-65 Tinted, Sold each	795-3062-T
66-67 Clear, Sold each	795-3066-C
66-67 Tinted, Sold each	795-3066-T

Chevelle

Sedan	
64-65 Clear, LH	795-3464-CSL
64-65 Clear, RH	795-3464-CSR
64-65 Tinted, LH	795-3464-TSL
64-65 Tinted, RH	795-3464-TSR
66-67 Clear, LH	795-3466-CSL
66-67 Clear, RH	795-3466-CSR
66-67 Tinted, LH	795-3466-TSL
66-67 Tinted, RH	795-3466-TSR
68-69 Clear, LH	795-3468-CSL
68-69 Clear, RH	795-3468-CSR
68-69 Tinted, LH	795-3468-TSL
68-69 Tinted, RH	795-3468-TSR

Coupe	
64-65 Clear, LH	795-3464-CL
64-65 Clear, RH	795-3464-CR
64-65 Tinted, LH	795-3464-TL
64-65 Tinted, RH	795-3464-TR
66-67 Clear, LH	795-3466-CL
66-67 Clear, RH	795-3466-CR
66-67 Tinted, LH	795-3466-TL
66-67 Tinted, RH	795-3466-TR
68-69 Clear, LH	795-3468-CL
68-69 Clear, RH	795-3468-CR
68-69 Tinted, LH	795-3468-TL
68-69 Tinted, RH	795-3468-TR
70-72 Clear, LH	795-3470-CL
70-72 Clear, RH	795-3470-CR
70-72 Tinted, LH	795-3470-TL
70-72 Tinted, RH	795-3470-TR

Quarter Window Glass, continued

Chevelle, continued

Convertible	
64-65 Clear, LH	795-3464-CVL
64-65 Clear, RH	795-3464-CVR
64-65 Tinted, LH	795-3464-TVL
64-65 Tinted, RH	795-3464-TVR
66-67 Clear, LH	795-3466-CVL
66-67 Clear, RH	795-3466-CVR
66-67 Tinted, LH	795-3466-TVL
66-67 Tinted, RH	795-3466-TVR
68-72 Clear, LH	795-3468-CVL
68-72 Clear, RH	795-3468-CVR
68-72 Tinted, LH	795-3468-TVL
68-72 Tinted, RH	795-3468-TVR

Monte Carlo

Coupe	
70-72 Tinted, LH	795-3670-TL
70-72 Tinted, RH	795-3670-TR

GTO

Sedan	
64-65 Clear, LH (pictured, left)	795-5464-CL
64-65 Clear, RH (pictured, left)	795-5464-CR
64-65 Tinted, LH (pictured, right)	795-5464-TL
64-65 Tinted, RH (pictured, right)	795-5464-TR
66-67 Clear, LH	795-5466-CSL
66-67 Clear, RH	795-5466-CSR
66-67 Tinted, LH	795-5466-TSL
66-67 Tinted, RH	795-5466-TSR
68-72 Clear, LH	795-5468-CSL
68-72 Clear, RH	795-5468-CSR
68-72 Tinted, LH	795-5468-TSL
68-72 Tinted, RH	795-5468-TSR

Coupe	
64-65 Clear, LH	795-5464-1CL
64-65 Clear, RH	795-5464-1CR
64-65 Tinted, LH	795-5464-1TL
64-65 Tinted, RH	795-5464-1TR
66-67 Clear, LH	795-3466-CL
66-67 Clear, RH	795-3466-CR
66-67 Tinted, LH	795-3466-TL
66-67 Tinted, RH	795-3466-TR
68-72 Clear, LH	795-5468-CL
68-72 Clear, RH	795-5468-CR
68-72 Tinted, LH	795-5468-TL
68-72 Tinted, RH	795-5468-TR

Coming
Soon
Coming
Soon

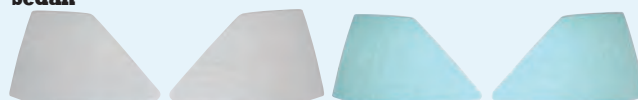

Our Name Says It All!™

Quarter Window Glass

Quarter Window Glass, continued

GTO, continued

Convertible

64-65 Clear, LH.....	795-3464-CVL
64-65 Clear, RH.....	795-3464-CVR
64-65 Tinted, LH.....	795-3464-TVL
64-65 Tinted, RH.....	795-3464-TVR
66-67 Clear, LH.....	795-3466-CVL
66-67 Clear, RH.....	795-3466-CVR
66-67 Tinted, LH.....	795-3466-TVL
66-67 Tinted, RH.....	795-3466-TVR
68-72 Clear, LH.....	795-3468-CVL
68-72 Clear, RH.....	795-3468-CVR
68-72 Tinted, LH.....	795-3468-TVL
68-72 Tinted, RH.....	795-3468-TVR

Skylark

Sedan

64-65 Clear, LH.....	795-5464-CL
64-65 Clear, RH.....	795-5464-CR
64-65 Tinted, LH.....	795-5464-TL
64-65 Tinted, RH.....	795-5464-TR
66-67 Clear, LH.....	795-5466-CSL
66-67 Clear, RH.....	795-5466-CSR
66-67 Tinted, LH.....	795-5466-TSL
66-67 Tinted, RH.....	795-5466-TSR

*Coming
Soon*

*Coming
Soon*

Coupe

64-65 Clear, LH.....	795-5464-1CL
64-65 Clear, RH.....	795-5464-1CR
64-65 Tinted, LH.....	795-5464-1TL
64-65 Tinted, RH.....	795-5464-1TR
70-72 Clear, LH.....	795-3470-CL
70-72 Clear, RH.....	795-3470-CR
70-72 Tinted, LH.....	795-3470-TL
70-72 Tinted, RH.....	795-3470-TR

Convertible

64-65 Clear, LH.....	795-3464-CVL
64-65 Clear, RH.....	795-3464-CVR
64-65 Tinted, LH.....	795-3464-TVL
64-65 Tinted, RH.....	795-3464-TVR
68-72 Clear, LH.....	795-3468-CVL
68-72 Clear, RH.....	795-3468-CVR
68-72 Tinted, LH.....	795-3468-TVL
68-72 Tinted, RH.....	795-3468-TVR

Cutlass

Sedan

64-65 Clear, LH.....	795-5464-CL
64-65 Clear, RH.....	795-5464-CR
64-65 Tinted, LH.....	795-5464-TL
64-65 Tinted, RH.....	795-5464-TR
66-67 Clear, LH.....	795-5466-CSL
66-67 Clear, RH.....	795-5466-CSR
66-67 Tinted, LH.....	795-5466-TSL
66-67 Tinted, RH.....	795-5466-TSR

*Coming
Soon*

*Coming
Soon*

Coupe

64-65 Clear, LH.....	795-5464-1CL
64-65 Clear, RH.....	795-5464-1CR
64-65 Tinted, LH.....	795-5464-1TL
64-65 Tinted, RH.....	795-5464-1TR
66-67 Clear, LH.....	795-3466-CL
66-67 Clear, RH.....	795-3466-CR
66-67 Tinted, LH.....	795-3466-TL
66-67 Tinted, RH.....	795-3466-TR



Quarter Window Glass, continued

Cutlass, continued

Coupe, continued

68-72 except Supreme, Clear, LH.....	795-7468-CL
68-72 except Supreme, Clear, RH.....	795-7468-CR
68-72 except Supreme, Tinted, LH.....	795-7468-TL
68-72 except Supreme, Tinted, RH.....	795-7468-TR
70-72 Supreme Coupe, Tinted, LH.....	795-3670-TL
70-72 Supreme Coupe, Tinted, RH.....	795-3670-TR

Convertible

64-65 Clear, LH.....	795-3464-CVL
64-65 Clear, RH.....	795-3464-CVR
64-65 Tinted, LH.....	795-3464-TVL
64-65 Tinted, RH.....	795-3464-TVR
66-67 Clear, LH.....	795-3466-CVL
66-67 Clear, RH.....	795-3466-CVR
66-67 Tinted, LH.....	795-3466-TVL
66-67 Tinted, RH.....	795-3466-TVR
68-72 Clear, LH.....	795-3468-CVL
68-72 Clear, RH.....	795-3468-CVR
68-72 Tinted, LH.....	795-3468-TVL
68-72 Tinted, RH.....	795-3468-TVR

Gran Prix

69-72 Tinted, LH.....	795-5669-TL
69-72 Tinted, RH.....	795-5669-TR

Camaro / Firebird

Coupe

67 Clear, LH.....	795-3567-CL
67 Clear, RH.....	795-3567-CR
67 Tinted, LH.....	795-3567-TL
67 Tinted, RH.....	795-3567-TR
68-69 Clear, LH.....	795-3568-CL
68-69 Clear, RH.....	795-3568-CR
68-69 Tinted, LH.....	795-3568-TL
68-69 Tinted, RH.....	795-3568-TR

Convertible

67 Clear, LH.....	795-3567-CVL
67 Clear, RH.....	795-3567-CVR
67 Tinted, LH.....	795-3567-TVL
67 Tinted, RH.....	795-3567-TVR
68-69 Clear, LH.....	795-3568-CVL
68-69 Clear, RH.....	795-3568-CVR
68-69 Tinted, LH.....	795-3568-TVL
68-69 Tinted, RH.....	795-3568-TVR

Full Size Chevy / Pontiac

Sedan

55-57 Clear, Sold each.....	795-3955-CS
55-57 Tinted, Sold each.....	795-3955-TS

Coupe

55-57 Clear, Sold each.....	795-3955-C
55-57 Tinted, Sold each.....	795-3955-T



All of our own **AMD** parts in this catalog are listed in **Blue, bold-face Type**.

Our Name Says It All!™

Back Glass

AMD offers back glass for most GM musclecar applications in both clear and factory style tint. Be sure not to forget the gasket or ribbon seal to ease installation.

Back Glass

Nova



Sedan

62-64 Clear.....	660-3062-CS
62-64 Tinted.....	660-3062-TS
65 Clear.....	660-3065-SC
65 Tinted.....	660-3065-ST
66-67 Clear.....	660-3066-SC
66-67 Tinted.....	660-3066-ST
68-72 Clear (pictured, above).....	660-3068-C
68-72 Tinted.....	660-3068-T

Coupe

62-65 Clear.....	660-3062-C
62-65 Tinted.....	660-3062-T
66-67 Clear.....	660-3066-C
66-67 Tinted.....	660-3066-T

Wagon

62-67 Clear.....	660-3062-WC
62-67 Tinted.....	660-3062-WT

Chevelle

Sedan

66-67 Clear.....	660-3466-SC
66-67 Tinted.....	660-3466-ST
68-69 Clear.....	660-3468-C
68-69 Tinted.....	660-3468-T

Coupe

64-65 Clear.....	660-3464-C
64-65 Tinted.....	660-3464-T
66-67 Clear.....	660-3466-C
66-67 Tinted.....	660-3466-T
68-72 Clear.....	660-3468-C
68-72 Tinted.....	660-3468-T

Wagon

64-67 Clear.....	660-3464-WC
64-67 Tinted.....	660-3464-WT
68-72 Clear.....	660-3468-WC
68-72 Tinted.....	660-3468-WT

El Camino

64-67 Clear.....	660-3764-C
64-67 Tinted.....	660-3764-T
68-72 Clear.....	660-3768-C
68-72 Tinted.....	660-3768-T

Monte Carlo

70-72 Clear.....	660-3468-C
70-72 Tinted.....	660-3468-T

Back Glass, continued

GTO

64-65 2-Door, Clear.....	660-5464-C
64-65 2-Door, Tinted.....	660-5464-T
66-67 Coupe & 2-Door Sedan, Clear.....	660-3466-C
66-67 Coupe & 2-Door Sedan, Tinted.....	660-3466-T
68-72 Clear.....	660-5468-C
68-72 Tinted.....	660-5468-T

Skylark

64-65 2-Door, Clear.....	660-5464-C
64-65 2-Door, Tinted.....	660-5464-T
66-67 Coupe & 2-Door Sedan, Clear.....	660-3466-C
66-67 Coupe & 2-Door Sedan, Tinted.....	660-3466-T
68-72 Tinted.....	660-6468-T

Cutlass

64-65 2-Door, Clear.....	660-5464-C
64-65 2-Door, Tinted.....	660-5464-T
66-67 Coupe & 2-Door Sedan, Clear.....	660-3466-C
66-67 Coupe & 2-Door Sedan, Tinted.....	660-3466-T
68-72 Fastback, Clear.....	660-7468-C
68-72 Fastback, Tinted.....	660-7468-T
70-72 Supreme, Clear.....	660-7470-C
70-72 Supreme, Tinted.....	660-7470-T

Grand Prix

69-70 Clear.....	660-3468-C
69-70 Tinted.....	660-3468-T
71-72 Clear.....	660-7470-C
71-72 Tinted.....	660-7470-T

Camaro / Firebird

67-69 Clear.....	660-3567-C
67-69 Tinted.....	660-3567-T
70-74 Clear.....	660-3570-C
70-74 Tinted.....	660-3570-T



75-81 Tinted, with Defrost Wire.....	660-3575-HT
--------------------------------------	-------------

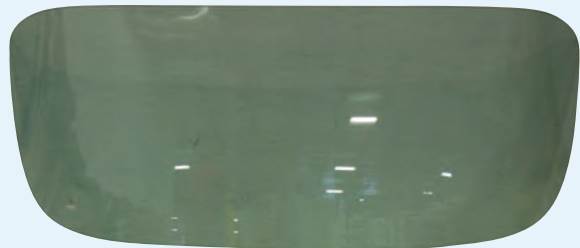

75-81 Tinted, with Defrost Wire.....	660-3575-T
--------------------------------------	------------



Our Name Says It All!™

Window Parts

Glass Stop Clip

Nova

68-74 with Correct Rubber Coating,
2 Required (pictured)..... W-648



Camaro / Firebird

2 Required (pictured)..... W-648
2 Required (pictured)..... W-648

Windshield Glass Support

Camaro / Firebird

70-81 Sold each K-9624995

Window Regulator Roller

Nova

62-72 Front Door
(pictured)..... K-C1072



Camaro

67-69 Front Door (above)..... K-C1072
67-69 & Rivet (pictured)..... W-313 9

Window Regulator Guide Cam Spacer

GM

Fits 62-72 Nova and 70-81 Camaro / Firebird

62-81 K-9804150

Door Glass Mounting Kit

Camaro / Firebird

68-69 (Hardware for Both Doors) W-050

Door Glass Mounting Plate

Camaro / Firebird

68-69 2-Piece Set, LH
(pictured)..... W-052



68-69 2-Piece Set, RH W-051

Door Glass Mounting Plate Gasket

Camaro / Firebird

68-69 LH or RH, 2-Piece Set (does 1 Door) W-053

Door Glass Mounting Plate Stud Assembly

Camaro / Firebird

68-69 3 required per glass W-054

Door Glass Frame

Nova

62-65 Coupe & Convertible, Upper, LH/RH Pair C-T2-1825

Door Window Channels

Nova

62-67 Sedans, 2-Piece Set R-N136
68-72 2-Door Sedan,

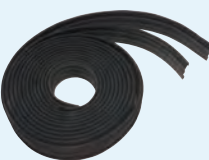

4-Piece Set
(pictured)..... K-PW1098

Chevelle / GTO / Skylark / Cutlass

64-72 Sedans & El Camino, 2-Piece Set..... R-N136

Division Bar Channel

Nova

62-67 LH/RH Pair J-2245
68-72 Sold each J-40403

Chevelle / GTO / Skylark / Cutlass

64-65 Coupe & Convertible, LH/RH Pair J-5100
66-67 Coupe & Convertible, LH/RH Pair J-5101
68 Coupe & Convertible, LH/RH Pair J-3126

Camaro / Firebird

67 LH/RH Pair W-101

Sash Channel

Camaro / Firebird



68-69 Inner, Sold each W-072

68-69 Upper, Sold ...each..... W-603

Sash Stud Assembly

Camaro / Firebird

Mounts Glass to Channel

68-69 2 Required, Sold each W -057

70-81 2 Required, Sold each W -065

Door Glass Plate Stop

Camaro / Firebird

68-69 Rear Mount & Nut, 1 required per glass, Sold each W-055

Door Glass Stop

Camaro / Firebird

70-81 Plated with Coated Ends, Sold each W -063

Door Glass Guide

Nova

62-65 Front Window C-H2-2222



Chevelle / GTO / Skylark / Cutlass

69-72 Coupe, LH/RH Pair (attaches to
roof rail molding) (pictured)  T-4579

Glass Roller & Hardware Kit

Camaro / Firebird

70-81 (mounts LH & RH
door glass).....   W-033

Glass Rollers

Camaro / Firebird

70-81 Front, with Hardware W-021

70-81 Front..... W-021A

70-81 Front Door, Rear..... W-022

Window Roller Guide Washer

Nova

66-68 1 3/8" O.D. K-4491086

Camaro

67-72 1 3/8" O.D. K-4491086



Our Name Says It All!™

Window Parts

Door Glass Stops / Bumpers

Nova

68-69 Stop Bumper (stop for down position) K-9810036

Camaro / Firebird

68-69 Forward Stop Bumper Assembly,
1 required per glass, Sold each W-056
68-69 Front Stop, Steel with Coated Tip, Sold each W-075
68-69 Rear Stops (fasten to rear window track),
LH/RH pair W-059
70-81 Stop Bumper (stop for down position) K-9810036
70-81 Door Glass Guide Plastic Stop Bumper,
LH/RH Pair W-023

Vent Window Glass Assembly

Camaro / Firebird

67 Clear LH
(pictured, left) K-F527C
67 Clear, RH K-F526C
67 Tinted, LH
(pictured, right) K-F527T
67 Tinted, RH K-F526T

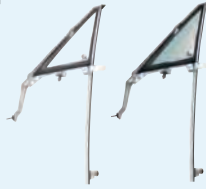

Vent Window Frame

Nova

62-67 LH C-J2-1330
62-67 RH C-J2-1332
68-72 LH C-J2-1335
68-72 RH C-J2-1336

Vent Window Forward Frame

Chevelle / GTO / Skylark / Cutlass

Coupe / Convertible

66-67 Chrome, LH
(pictured) P-CH26802-LH
66-67 Chrome, RH P-CH26802-RH



Vent Frame Adjusting Screw

Camaro / Firebird

67 Lower K-7657975
67 Upper K-7661399

Vent Window Handle

Nova

62-67 LH/RH Pair C-J2-1340
68-72 LH/RH Pair C-J2-1610

Chevelle

64-67 Coupe,
LH/RH Pair C-J2-1340
66-67 Sedan,
LH/RH Pair C-J2-1340
66-67 Coupe, LH/RH Pair (pictured)  T-4350



El Camino / GTO Coupe

66-67 LH/RH Pair (pictured, above)  T-4350

Camaro / Firebird

67 Stud & Handle, 18-Piece Set
(all hardware, does both windows)
(pictured) W-733
67 with Pin, LH/RH Pair W-576



Vent Window Pivot Stud

Chevelle / El Camino / GTO / Skylark / Cutlass

66-67 Assembly, does 1 window
(pictured) W-741



Camaro / Firebird

67 Assembly, does 1 window W-741
67 Chrome Nut W-742

Vent Window Pivot Stud Nut

Chevelle / El Camino / GTO / Skylark / Cutlass

66-67 Chrome W-742

Camaro / Firebird

67 Chrome W-742

Vent Window Bumper

Nova

62-65 Coupe & Convertible, Upper, 2-Piece Set J-4079
66-67 Coupe, Upper, 2-Piece Set J-4078

Quarter Glass Upper Frame

Nova



62-65 Coupe, LH/RH Pair (pictured, left) C-T2-1964
62-65 Convertible, LH/RH Pair (pictured, right) C-T2-1975

Quarter Window Guide

Nova

68-72 2-Piece Set C-T2-2320

Quarter Window Rollers & Parts

Chevelle

68-72 Roller Assembly, Sold each
(pictured, left) W-060
68-82 Roller, Sold each
(right) W-061



Camaro / Firebird

67-69 Roller Assembly, Sold each (pictured, left) W-060
67-69 Roller, Sold each (right) W-061



Our Name Says It All!™

Emblems

AMD offers a wide range of emblems for GM vehicles from manufacturers such as CHQ, OER, OPGI, and Trim Parts. Perfect for replacing your original emblems or upgrading your car's looks to that of the various SS, Z-28, or R/S models. We also offer template kits to determine the location for drilling emblem mounting holes.

Dash Emblems



Nova

- 66 "Super Sport" (pictured, left).....C-J2-2677
- 67 "Nova Chevy II", Lower (pictured, right)..... T-3045
- 67 "Super Sport"C-J2-2675

Chevelle



- 66 "Super Sport" (pictured, left)..... T-4303
- 67 "Super Sport" (pictured, right)..... T-4445

Camaro

- 69 "Camaro" script (pictured) W-864



Glove Box Nameplates

Chevelle

- 64 "Malibu SS", Plastic Chrome..... P-GBC1440
- 64 "Malibu", Plastic Chrome..... P-GBC1449
- 65 "Malibu SS", Plastic Chrome..... P-GBC1442
- 65 "Malibu", Plastic Chrome..... P-GBC1444

El Camino

- 64 "El Camino", Plastic Chrome P-GBC1441
- 65 "El Camino", Plastic Chrome P-GBC1443

Glove Box Chrome Inserts

Chevelle

- 66 "Malibu" Script.....P-KM01204
- 66 "Super Sport" Script.....P-CH24855
- 67 "Malibu" Script..... P-GBC1800
- 67 "Super Sport" Script..... P-CH29099

Glove Box Emblems

Camaro

- 68 "Camaro" (pictured) W-900



Firebird

- 68-69 "Firebird"..... K-9789588

Door Panel Emblems

Nova

- 66-67 "Chevy II", LH/RH Pair..... K-4539568
- 69-72 "Nova", LH/RH Pair..... K-7790751

Camaro



- 67 "Camaro", Deluxe, LH/RH Pair K-7698289
- 67 "Camaro", Standard, LH/RH Pair (pictured, left)..... W-094
- 68-69 "Camaro", Standard, LH/RH Pair (pictured, right)..... W-805
- 68-69 "Camaro", Deluxe, LH/RH Pair, (Camaro script).....W-788
- 78-81 "Camaro", Deluxe, LH/RH Pair K-20092045

Firebird

- 68-69 "Bird Emblem", Deluxe, Sold each .. K-7771090

Grille Emblems

Nova



- 66 "CHEVY II" (pictured, left) K-3874540
- 66 "SS" (pictured, right)..... T-3042



- 67 "CHEVY" (pictured, left)..... T-3051
- 67 "Nova SS" (pictured, right)..... T-3050



- 68-69 "SS" (pictured, left) K-3918871
- 70-72 "SS" (pictured, right)..... K-3940538
- 73-74 "SS"..... K-6258813
- 73-74 Bowtie.....K-6260838

Chevelle



- 66 "CHEVELLE" T-4309
- 66 "SS 396"..... T-4310
- 66 "SS 427" T-4312



- 67 "SS 396"..... K-3904590
- 67 "SS 427"..... T-4413
- 67 Bowtie..... T-4414



- 68 "SS396"..... T-4500
- 68 Bowtie T-4499























All of our own **AMD** parts in this catalog are listed in **Blue, bold-face Type**.

Our Name Says It All!™

Emblems



Grille Emblems, continued Chevelle, continued

			
69	"SS 396"		K-3942781
69	Bowtie		T-4603
			
70	"CHEVELLE"		T-4675
70	Bowtie		T-4674
			
71	"CHEVELLE"		T-4741
71	"SS"		T-4743
			
71-72	"350"		T-9810
71-72	"454"		T-9811
71-72	Bowtie		T-4740
			
72	"CHEVELLE"		T-4760
72	"SS"		T-4770















El Camino

67	Bowtie		T-4414
			
68	"SS 396"		T-4500
68	Bowtie		T-4499
			
69	"SS 396"		K-3942781
70	"CHEVROLET"		T-4860
			
71-72	"350"		T-9810
71-72	"454"		T-9811
71-72	"CHEVROLET"		T-4861





























Monte Carlo

70	Crest		T-1600
71	Crest		T-1654
72	Crest		T-1655

Camaro

			
67	SS, "SS"		K-3918871
67	"SS 350"		W-868
67	Standard, Bowtie		K-3902894
67	Standard, "SS 427"		T-6717
			
67-68	"SS 396"		K-3927599
67-68	RS, "SS 427"		T-6717
67-68	"rs"		W-412
67-68	RS, "SS"		W-867

Grille Emblems, continued Camaro, continued

			
68	RS/SS, "SS"		K-3918871
68	Standard, Bowtie		W-248
68	Standard, "SS"		W-612
68	Standard, "SS 427"		T-6743
			
69	"RS"		W-249
69	RS, "SS"		W-149
69	RS, "SS 396"		T-6768
69	RS, "SS 427"		T-6769
			
69	Standard, Bowtie		W-125
69	Standard, "SS"		W-611
69	Standard, "SS 396"		T-6766
69	Standard, "SS 427"		T-6767
			
69	"Z/28"		W-801
70-71	"Z28"		T-6822
70-73	Standard, "SS" (not pictured)		K-6263015
72-73	"Z28"		T-6823
74	Standard, "Camaro"		T-6840
	Firebird		
67-69	"PONTIAC"		K-485602

Front Bumper Emblem

Firebird



67-68	Arrowhead Logo		K-9747207
-------	----------------------	---	-----------

Header Panel Emblems

Chevelle

68-69	"Chevelle" Script		K-3920825
-------	-------------------------	---	-----------



69	"By Chevrolet"		T-4599
----	----------------------	---	--------

El Camino



68-69	"el Camino"		T-4851
-------	-------------------	---	--------

Camaro



67	"Chevrolet" Script		W-359
67	"camaro"		W-357

Emblems

Header Panel Emblems, continued Camaro, continued



- 68-69 "Camaro BY CHEVROLET" W-361
- 70 "Camaro BY CHEVROLET" W-361A



- 70 "C" & "CAMARO" W-749
- 71-73 "C" & "CAMARO" K-3996683
- 71-74 "Camaro" T-6821
- 75-77 "Camaro" (Red, White & Blue)..... T-6843
- 75-77 "Camaro" (Orange, Black & Red) T-6844

Firebird



- 70-71 Bird K-481543
- 74-76 Bird (Red & Black) T-8550
- 74-76 Bird (Black & Gold)..... T-8550A
- 77-81 Arrow Crest K-499724

Fender Emblems

Nova



- 62-64 6-Cylinder Emblem, Black, LH/RH Pair T-3016
- 62-64 6-Cylinder Emblem, Red, LH/RH Pair T-3018
- 64 "Nova Chevy II", LH/RH Pair T-3022



- 64 283, Emblem, LH/RH Pair T-2161
- 65-67 V-Flag, Sold each W-419
- 65 "283", Sold each K-3865833
- 65-67 "327", Sold each W-263



- 66-67 "350", Sold each K-3905718
- 67-68 Yenko "427", without Bar, tape mounted, Sold each K-K677



- 69 "307", Sold each K-3957933
- 69 "327", Sold each K-3953625
- 69 "427", Sold each K-C119
- 69 Yenko "427", with Bar, stud mounted, Sold each K-K678
- 69-70 "Yenko", Sold each K-K80013

Fender Emblems, continued Nova, continued



- 69-72 "Nova", Sold each K-3953676
- 70-74 "350", Sold each K-3970546
- 73-74 "Nova", Sold each K-6258150

Chevelle



- 64 "V", LH/RH Pair T-4006
- 65-67 V-Flag, Sold each W-419
- 65-67 "327", Sold each W-263
- 65-67 "396 Turbo-Jet" V Flag, LH/RH Pair W-411
- 65-67 "396 Turbo-Jet" Flag, Sold each W-411A



- 70-72 "350", LH/RH Pair T-4651
- 70-71 "400", LH/RH Pair T-4652
- 70-72 "454", Sold each K-3981833

El Camino

- 64 "V", LH/RH Pair T-4006

Camaro



- 67 V-Flag, Sold each W-419
- 67 "327", Sold each W-263
- 67 "350", Sold each W-264
- 67 "350", Sold each K-3905718



- 67 "396 Turbo-Jet" V Flag, LH/RH Pair W-411
- 65-67 "396 Turbo-Jet" Flag, Sold each W-411A
- 67 "camaro", Sold each W-358
- 67 "rs", Sold each W-190
- 67 "SS", Sold each W-265



- 67-68 Yenko, "427", without Bar, tape mounted, Sold each K-K677

- 67-69 "Yenko", Sold each K-K80013

- 68 "327", LH/RH Pair W-246
- 68 "327", LH W-246A
- 68 "327", RH W-246B
- 68 "350", LH/RH Pair W-247
- 68 "350", LH W-247A
- 68 "350", RH W-247B



- 68 "396", LH/RH Pair W-840
- 68 "396" Side W-840A
- 68 "396", Side W-840B
- 68 "rally-sport", Sold each W-360
- 68 "SS", LH/RH Pair W-251
- 68 "Z/28", Sold each K-3947011



All of our own **AMD** parts in this catalog are listed in **Blue, bold-face Type**.

Our Name Says It All!™

Emblems

Fender Emblems, continued Camaro, continued



Camaro 307 307 327

68-69	"Camaro", Sold each		W-362
69	"307", LH/RH Pair.....		W-410
69	"307", Sold each.....		W-410A
69	"307", Sold each.....		K-3957933
69	"327", LH/RH Pair.....		W-355
69	"327", Sold each.....		W-355A





327 350 396 427

69	"327", Sold each		K-3953625
69	"350", LH/RH Pair.....		W-356
69	"350", Sold each.....		W-356A
69	"396", LH/RH Pair.....		W-409
69	"396", Sold each.....		W-409A
69	"427", Sold each.....		K-C119



427 rally-sport Z/28 SS

69	Yenko "427", with Bar stud mounted, Sold each		K-K678
69	"rally-sport", Sold each		K-3953633
69	"Z/28", Sold each.....		W-800
69-72	"SS", Sold each.....		W-266

396 RALLY SPORT Camaro

70-71	"Z-28", Includes Hardware.....		W-024
70-72	"396", LH/RH Pair.....		T-6830
70-73	"RALLY SPORT", Sold each		K-3981852
70-74	"502", LH=RH, Sold each (not pictured)		K-17074502
70-74	"Camaro", Sold each		W-751





350 CAMARO CAMARO

70-75	"350", Sold each.....		K-3984095
75-77	"camaro", Sold each		K-358798
78-81	"camaro".....		K-468580



Firebird

Firebird



67-68	Bird, Sold each		K-9789589
67-69	"Firebird", Sold each		K-9796319
69	"Firebird", LH/RH Pair (above left).....		T-8507
70-73	Bird, LH/RH Sold each (above right).....		K-487708

Firebird FORMULA-400

71-81	"Firebird", Sold each.....		K-486904
72-75	"FORMULA 400", Sold each.....		K-487744





Chevy Full Size





62-63	283 V Emblem, LH/RH Pair		T-2161
63	6-Cylinder Emblem, Black, LH/RH P air.....		T-3016
63	6-Cylinder Emblem, Red, LH/RH P air		T-3018
64	"V", LH/RH Pair		T-4006

Fender Emblems, continued Chevy Full Size continued

283 327 396 TURBO-JET

65-66	"283", Sold each		K-3865833
65-67	"327", Sold each		W-263
65-67	"396 Turbo-Jet" V Flag Emblem, LH/RH Pair		W-411
65-67	"396 Turbo-Jet" Flag, Sold each		W-411A
65-67	V-Flag Emblem, Sold each		W-419



350 350 400

67	"350", Sold each.....		K-3905718
69-70	"350", LH/RH Pair.....		T-4651
70-72	"400", LH/RH Pair.....		T-4652

Hood Emblems



Nova

427 427

67-68	Yenko "427", without Bar, tape mounted		K-K677
69	Yenko "427", with Bar, stud mounted		K-K678
69-72	Bowtie, Hood Edge Emblem		T-3085



Chevelle

CHEVELLE INDUCTION



67	"CHEVELLE"		T-4410
70-72	"COWL INDUCTION", Kit.....		K-K194

El Camino

CHEVROLET CHEVROLET

64	"CHEVROLET" Hood Letters		T-4012
65	"CHEVROLET" Hood Letters		T-4216

El Camino INDUCTION

67	"El Camino".....		T-4836
70-72	"COWL INDUCTION", Kit.....		K-K194

Monte Carlo

70	Hood Spear		T-1605
71	"Chevrolet" Hood Spear		T-1620

Camaro

427 COWL INDUCTION

67-68	Yenko "427", without Bar, tape mounted		K-K677
67-69	"COWL INDUCTION", Kit.....		K-K194

302 427

69	"302", Sold each.....		W-866
69	Yenko "427", with Bar, stud mounted		K-K678

Firebird

400 428 326 400 428

67	"326", LH/RH Pair		T-8502
67-69	"400", LH/RH Pair.....		K-F1251
67-69	"428", LH/RH Pair.....		K-F1250

455 350 455 350

67-69	"455", LH/RH Pair.....		K-F5246
68-69	"350", LH/RH Pair.....		K-F1252



Our Name Says It All!™

Emblems

Quarter Panel Emblems

Nova



- | | | | |
|----|---------------------------------------|--|--------|
| 62 | "Nova Chevy II 400", LH/RH Pair | | T-3015 |
| 63 | "Nova Chevy II", LH/RH Pair | | T-3022 |



- | | | | |
|----|-----------------------------------|--|--------|
| 65 | "Nova Chevy II", LH/RH Pair | | T-3030 |
| 65 | "Nova SS", LH/RH Pair | | T-3031 |



- | | | | |
|-------|-----------------------------------|--|-----------|
| 66-67 | "Super Sport, Soldea....." | | K-4227012 |
| 66-67 | "Nova Chevy II", LH/RH Pair | | T-3040 |
| 69 | "Nova", Sold each | | K-3953676 |

Chevelle



- | | | | |
|----|-------------------------------|--|--------|
| 64 | "Malibu SS", LH/RH Pair | | T-4010 |
| 64 | "Malibu", LH/RH Pair | | T-4011 |



- | | | | |
|----|---------------------------------|--|--------|
| 65 | "Super Sport", LH/RH Pair | | T-4211 |
| 65 | "Malibu SS", LH/RH Pair | | T-4210 |



- | | | | |
|-------|----------------------------|--|-----------|
| 66 | "Malibu", LH/RH Pair | | T-4315 |
| 66-67 | "Malibu", LH/RH Pair | | K-4229716 |



- | | | | |
|----|---------------------------------|--|--------|
| 67 | "Super Sport", LH/RH Pair | | T-4352 |
| 69 | "Malibu", LH/RH Pair | | T-4610 |



- | | | | |
|-------|-----------------------------------|--|-----------|
| 64-67 | "GTO", Sold each (pictured)....." | | P-EM00054 |
|-------|-----------------------------------|--|-----------|

Bedside Emblems

El Camino



- | | | | |
|----|--|--|--------|
| 64 | "El Camino", with Bowtie, LH/RH Pair | | T-4815 |
| 65 | "El Camino", with Bowtie, LH/RH Pair | | T-4825 |



- | | | | |
|----|--|--|--------|
| 66 | "El Camino", with Bowtie, LH/RH Pair | | T-4841 |
| 67 | "El Camino", LH/RH Pair | | T-4837 |

- | | | | |
|-------|-------------------------------|--|--------|
| 68-69 | "el Camino", LH/RH Pair | | T-4850 |
|-------|-------------------------------|--|--------|

Rear Body Emblems

Nova



- | | | | |
|-------|--------------|--|--------|
| 65 | Bowtie | | T-3029 |
| 68-69 | "SS" | | T-3075 |
| 70-72 | "SS" | | T-3090 |

Chevelle



- | | | | |
|----|------------------|--|--------|
| 64 | Bowtie | | T-4004 |
| 66 | "CHEVELLE" | | T-4313 |



- | | | | |
|-------|----------------|--|--------|
| 66 | "SS 396" | | T-4311 |
| 66 | Bowtie | | T-4318 |
| 66-67 | "SS 427" | | T-4312 |



- | | | | |
|----|------------------|--|--------|
| 67 | "CHEVELLE" | | T-4400 |
| 67 | "SS 396" | | T-4405 |

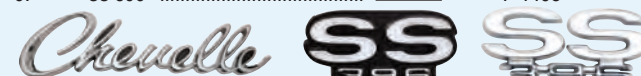

- | | | | |
|----|------------------------|--|--------|
| 68 | "Chevelle" Script..... | | T-4502 |
| 68 | "SS 396" | | T-4501 |
| 69 | "SS 396" | | T-4601 |

Monte Carlo



- | | | | |
|-------|---------------------------------------|--|--------|
| 70 | "BY CHEVROLET" | | T-1635 |
| 70-71 | "Monte Carlo"Script, with studs | | T-1649 |



- | | | | |
|-------|----------------------------|--|--------|
| 70-71 | "Monte Carlo"Script, | | T-1662 |
| 71 | "BY CHEVROLET" | | T-1653 |

Camaro



- | | | | |
|----|----------------|--|--------|
| 69 | "RS" | | W-250 |
| 69 | "SS 396" | | T-6725 |
| 69 | "SS 427" | | T-6726 |



- | | | | |
|----|--------------|--|--------|
| 69 | "SS" | | W-393 |
| 69 | "Z/28" | | W-802 |
| 69 | Bowtie | | T-6770 |

Firebird



- | | | | |
|-------|-------------------------|--|---------|
| 70-73 | "PONTIAC" Letters | | K-K1049 |
|-------|-------------------------|--|---------|



Our Name Says It All!™



All of our own **AMD** parts in this catalog are listed in **Blue, bold-face Type.**

Emblems

Trunk Emblems

Nova

63-64	"Nova SS"		T-3020
65	"Nova SS"		T-3032
68	"CHEVY II BY CHEVROLET"		T-3070
	<i>(pictured)</i>		
68-72	"Nova BY CHEVROLET"		K-8728940

Chevelle

64	"SS"		T-4005
64-65	"CHEVROLET" Letters		T-4149
65	"Malibu"		T-4215
65	Z-16, "Malibu SS 396"		T-4208
66	"CHEVELLE"		T-4314
69	"Chevelle BY CHEVROLET"		T-4640
70	"Chevelle BY CHEVROLET"		T-4676
71-72	"Chevelle BY CHEVROLET"		T-4750

Monte Carlo

71	"SS"		T-1651

Camaro

67	"Chevrolet" Script		W-359
67	"camaro"		W-357
68-69	"Camaro BY CHEVROLET"		W-361
	<i>(pictured, far left)</i>		
70	"Camaro BY CHEVROLET"		W-361A
	<i>(pictured, center left)</i>		
71-72	"Camaro"		K-9869701
75-77	"Camaro" (Orange, Black & Red)		T-6839
	<i>(pictured, center right)</i>		
75-77	"Camaro" (Red, White & Blue)		T-6838
	<i>(pictured, far right)</i>		

Firebird

67-69	"400"		K-7728616
67-69	"PONTIAC" Letters		K-K757
70-73	Bird		K-8704055

Tailgate Emblems

El Camino

64-65	Bowtie		T-4816
64-66	"CHEVROLET" Letters		T-4149
66	Bowtie		T-4840
67	"CHEVROLET"		T-4835
67	Bowtie		T-4834
68	Bowtie		T-4845
68-70	"SS 396"		T-4852
69-70	Bowtie		T-4870
70	"454"		T-4879
70-72	"CHEVROLET"		T-4880

Rear Spoiler Emblem

Camaro

70-73	"Z28"		
	<i>(pictured)</i>		K-3981889

Rear Bumper Emblems

Chevelle

70	SS Bumper Pad, Correct White SS	C-C-2000
70	SS Bumper Pad, Red SS	C-C-2020
71-72	"SS" Rear Bumper Emblem with Steel Insert	
		T-4755

Gas Door Emblems

Camaro

78-79	Bowtie		K-9635455
79	"Z28", Black		K-9636429
80-81	"Z28", Charcoal		T-6951
80-81	"Z28", Blue		T-6952
80-81	"Z28", Green		T-6953
80-81	"Z28", Gold		T-6954
80-81	"Z28", Red		T-6955
80-81	"Z28", Orange		T-6956
80-81	"Z28", Silver		T-6950
80-81	Berlinetta, "Camaro"		K-9637557

Firebird

67	Bird		K-9789710
68	Bird		K-9785962

Moldings

AMD offers a wide range of moldings for GM vehicles from manufacturers such as AMD, CHQ, OER, OPGI, Trim Parts, and TWE. Perfect for replacing your original trim or upgrading your car's looks with optional trim, We also offer template kits to determine the location for drilling trim molding mounting holes.



Headlamp Door Eyebrow Moldings

Nova

- 65 LH/RH Pair
(pictured)..... C-D2-1410
- 68-72 LH/RH Pair..... K-K499



Chevelle / El Camino

with Mounting Hardware

- 64 LH/RH Pair
(pictured)..... P-H444912
- 65 LH/RH Pair..... P-C865239
- 66 LH/RH Pair..... P-A349200
- 68 LH/RH Pair..... P-C210224
- 69 Non-SS,
LH/RH Pair
(pictured)..... P-NN16501
- 69 SS,
LH/RH Pair..... P-C953621

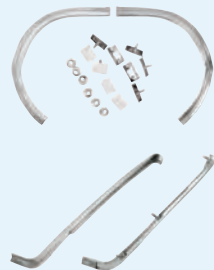

Headlamp Molding

Chevelle / El Camino



- 65 Lower, Under Headlamp, LH/RH Pair,
with Hardware (pictured) P-9507010
- 69 Between Headlamps, 2 required, Sold eachP-CH20419
- 70 Chevelle, Lower Molding, LH/RH Pair C-D-1356

Headlamp Door Molding

Camaro

- 67-68 RS, LH
(pictured)  W-425
- 67-68 RS, RH.....  W-424



Headlamp Insert

Firebird

- 67-68 Between Headlamps.....  T-8509
- 67-68 Grille Insert, LH/RH Pair..... K-9788858

Grille Moldings

Nova







- 66 Lower Grille Molding..... C-D2-1220

Chevelle / El Camino



- 69 Center C-D-1285
- 69 Lower Center C-D-1260
- 70 Chevelle, 10-Piece Set (pictured) W-038
- 71 Horizontal, 3 required, Sold each C-D-1380
- 71 Side, LH/RH Pair C-D-1395
- 72 Non-SS, Center, 2 required, Sold each C-D-1450
- 72 Lower C-D-1440
- 72 Upper C-D-1430

Camaro

- 67 Standard, Lower  W-490
- 67 Standard, Upper  W-489
- 67-68 RS, Lower.....  W-414
- 67-68 RS, Upper (pictured)  W-413
- 68 Standard, Lower  W-488
- 68 Standard, Upper  W-487
- 69 Standard, Molding Set K-3957061
- 69 RS, Center,
with 20-Piece Hardware Set  W-691



Our Name Says It All!™



All of our own **AMD** parts in this catalog are listed in **Blue, bold-face Type**.

Moldings

Grille Molding Extension

Chevelle / El Camino

- 69 Lower Center, LH C-D-1270
- 69 Lower Center, RH C-D-1280

Grille Surround

Camaro

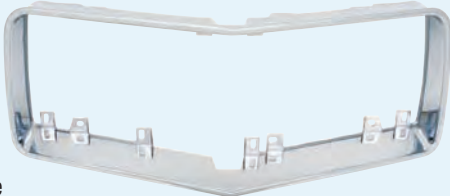

- 70-73 RS, Chrome
(pictured) K-3973942

Grille Guard

Nova

- 62-65 Chrome K-985435



Grille Bars

Firebird



- 67-68 400 (pictured) K-F660

Grille & Headlamp Door Applique Set

Camaro

- 68 RS, Chrome W-757

Front Lower Valance Panel Molding

Chevelle / El Camino

- 66 Center C-D-1150
- 66 2-Piece Set,
End Set (pictured) C-D-1140



Front Header Panel Molding

Chevelle / El Camino

- 68-69 with Mounting Hardware (pictured) P-PZ00168
- 69 Lower Edge End Molding, LH=RH, Sold each C-D-1205

Hood Moldings

Nova

- 66 Front Edge C-D2-1040
- 67 Front Edge C-D2-1050
- 68-72 Hood Lip Molding (pictured) K-3927930

Chevelle / El Camino

- 66 Hood Lip Molding
(Front Edge of Hood) C-D-1100
- 67 Hood Lip Molding C-D-1171

Camaro

- 70-81 Rear Edge (Not For Cowl Hood) K-3998834
Use with parts below (K-3986059 & K-3986060)
- 70-81 Upper Fender, LH
(pictured) K-3986059
- 70-81 Upper Fender,
RH K-3986060



Buick GS

- 70 GS, GSX Hood Molding 330-6470

Hood Spear

Chevelle / El Camino

- 66 Includes Fasteners T-4305



Front Fender Moldings

Nova

- 68-72 LH/RH Pair
(pictured) K-K499



Windshield Header Molding

Camaro / Firebird

Convertible

- 67 Chrome, LH/RH Pair (pictured left) ... W-177
- 68-69 Satin, LH/RH Pair (pictured, right) ... W-177A

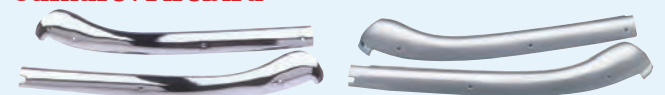

Windshield Moldings

AMD offers several complete windshield molding sets to complement your new windshield installation. Produced in stainless steel like the originals.

Nova

- 68-74 2-Door, 4-Piece Set R-830

Chevelle / GTO / Skylark / Cutlass

- 64-65 Coupe & Convertible, 5-Piece Set P-C990159
- 66-67 Coupe & Convertible, 4-Piece Set P-C990160
- 68-72 Coupe, 3-Piece Set W-974



- 68-72 Lower (pictured) P-CH25857

El Camino

- 64-67 5-Piece Set P-C990159
- 68-72 3-Piece Set W-974
- 68-72 Lower (pictured, above) P-CH25857

Monte Carlo

- 70-72 Coupe, 3-Piece Set W-974
- 70-72 Lower (pictured, above) P-CH25857

Camaro / Firebird

- 67-69 Coupe, 5-Piece Set (pictured) W-838
- 67-69 Coupe, Front Upper, OE W-833
- 67-69 Coupe, Front, LH Side, OE W-834
- 67-69 Coupe, Front, RH Side, OE W-835
- 67-69 Coupe, Fron Lower, LH W-837
- 67-69 Coupe, Front Lower, RH W-836
- 67-69 Convertible, 5-Piece Set W-990



Our Name Says It All!™

Moldings

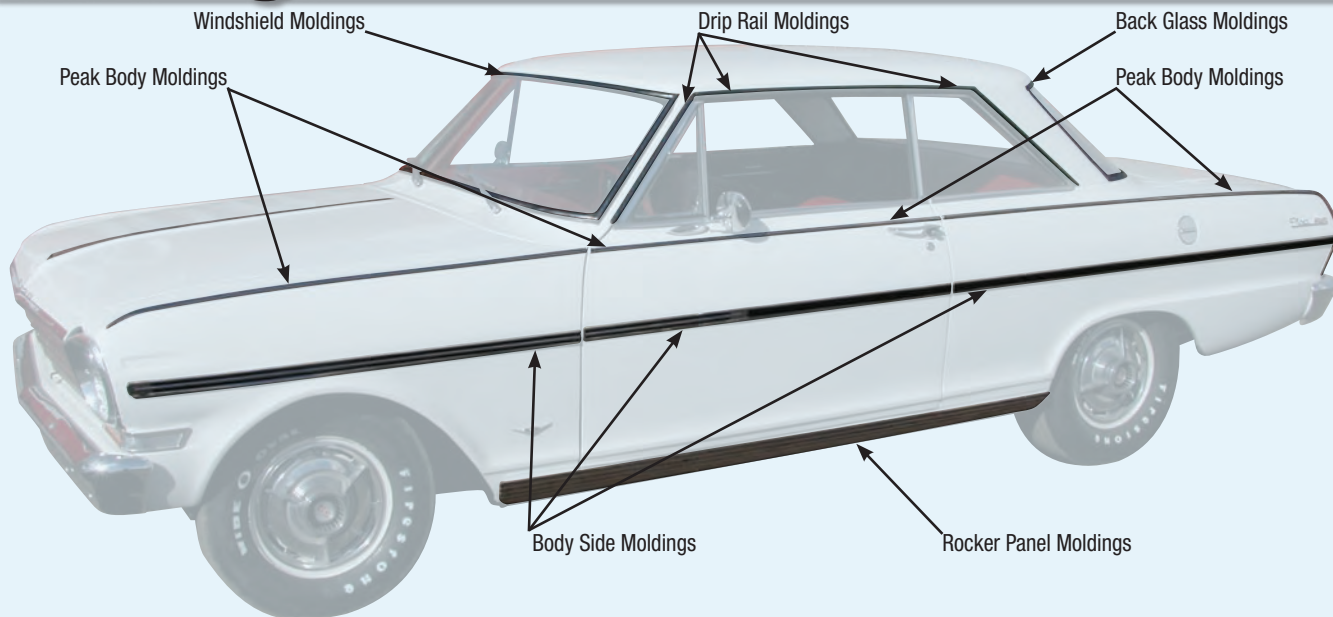

Windshield Molding Clip

Nova

- 62-65 Coupe, also Rear Window
(pictured, top) K-4847515
- 68-75 Lower Front Center,
8-Piece Set (pictured)..... W-605
- 68-75 Lower Front Center W-605A

Camaro / Firebird

- 67-69 Lower Front Center,
8-Piece Set (pictured)..... W-605
- 67-69 Lower Front Center W-605A
- 67-69 Coupe, Lower Outer,
Pair (pictured, left) W-520
- 67-69 Coupe, Upper & Side,
10-Piece Set
(pictured, right) W-526

Chevy Full Size

- 63-64 Lower Front Center, 8-Piece Set
(pictured)..... W-605
- 63-64 Lower Front Center,
each W-605A

Pillar Post Outer Molding

Camaro / Firebird

- 67-69 Convertible, LH (pictured) K-7648739
- 67-69 Convertible, RH K-7648738

Body Side Fender Molding

Nova

- 69-72 LH C-D2-1550
- 69-72 RH C-D2-1560

Peak Body Molding Sets

Nova

- 63-64 SS, 8-Piece Set, with Clips C-D2-1060
- 63-64 SS, LH C-D2-1061
- 63-64 SS, RH C-D2-1062



Body Side Molding Sets

Nova

- 69-72 6-Piece Set C-D2-1600

Chevelle

- 68 SS, 8-Piece Set C-D-1786

Malibu

- 68 6-Piece Set C-D-1783
- 69 8-Piece Set C-D-1789

El Camino

- 68 8-Piece Set C-D-3320
- 69 8-Piece Set C-D-3323
- 70-72 10-Piece Set C-D-3325

Lower Side Molding

Chevelle / El Camino

- 68 Front Section, LH C-D-1680
- 68 Front Section, RH C-D-1690
- 69 Front Section, LH C-D-1740
- 69 Front Section, RH C-D-1750
- 70-72 El Camino, Front Section, LH=RH, Sold each C-D-1670
- 70-72 El Camino, Rear Section, LH C-D-1672
- 70-72 El Camino, Rear Section, RH C-D-1673

Door Moldings

Nova

- 63-64 SS, Door Peak Molding with Clips, LH C-D2-1063
- 63-64 SS, Door Peak Molding with Clips, RH C-D2-1064
- 69-72 Body Side Door Molding, LH C-D2-1570
- 69-72 Body Side Door Molding, RH C-D2-1580

Chevelle

- 68-69 Lower, LH/RH Pair C-D-1700

El Camino

- 68-69 Lower, LH/RH Pair C-D-1700
- 70-72 LH/RH Pair C-D-1674



All of our own **AMD** parts in this catalog are listed in **Blue, bold-face Type**.

Our Name Says It All!™

Moldings

Door Moldings, continued

Camaro







68	Door Ledge Reveal Molding, LH/RH Pair (pictured)		K-K257
70-81	Front Door Reveal Molding, LH		K-9828344
70-81	Front Door Reveal Molding, RH		K-9828343

Wheel Opening Moldings







Chevelle

70-72	Set		R-930
-------	-----------	---	-------

Camaro

67-68	except 68 RS, OE Style, 4-Piece Set		W-932
67-68	except 68 RS, Front, LH, OE Style		W-932A
67-68	except 68 RS, Front, RH, OE Style		W-932C
67-68	except 68 RS, Rear, LH, OE Style		W-932B
67-68	except 68 RS, Rear, RH, OE Style		W-932D
68	RS, OE Style, 4-Piece Set (pictured)		W-933
69	OE Style, 4-Piece Set		W-934

Firebird

67-68	OE Style, 4-Piece Set		W-932
67-68	Front, LH, OE Style		W-932A
67-68	Front, RH, OE Style		W-932C
67-68	Rear, LH, OE Style		W-932B
67-68	Rear, RH, OE Style		W-932D
69	Front, LH		K-9794774
69	Front, RH		K-9794773
70-81	Front, LH (pictured)		K-481537
70-81	Front, RH		K-481536
70-81	Rear, LH		K-8704038
70-81	Rear, RH		K-8704037



Wheel Opening Molding Screws

Camaro / Firebird

67-81	36-Piece Set		K-K606
-------	--------------------	--	--------

Lower Body Molding

Camaro

67	RS, 6-Piece Set		W-452
68	RS, 6-Piece Set (pictured)		W-504

Lower Body Molding Mount Sets

Camaro

67	RS, Hardware of all 6 Moldings (pictured, left)		W-453A
68	RS, correct hardware of all 6 moldings (right)		W-504A
68	RS, OE Style, correct hardware of all 6 moldings		W-504B

Upper Side Reveal Molding Clip

Nova

62-65	8-Piece Set		C-D2-1705
66-67	10-Piece Set		C-D2-1715

Rocker Panel Moldings

Nova

62-63	LH/RH Pair, with Hardware		C-D2-1210
66-67	LH/RH Pair		K-N6601
68-72	LH/RH Pair, with Hardware (pictured)		C-D2-1250

Chevelle / El Camino

64	Non-SS, LH		P-MT58002-LH
64	Non-SS, RH		P-MT58002-RH
65	SS, LH		P-MT58004-LH
65	SS, RH		P-MT58004-RH

Monte Carlo

70-72	LH/RH Pair		P-RP10012
-------	------------------	--	-----------

Camaro

67-69	with Mount & Hardware, LH=RH, Sold each (pictured)		W-765
70-75	Wide, LH		K-481540
70-75	Wide, RH		K-481539
70-81	Standard, Narrow, LH=RH, Sold each		K-481546

Firebird

70-81	Esprit, Wide, LH		K-481540
70-81	Esprit, Wide, RH		K-481539
70-81	Standard, Narrow, LH=RH, Sold each		K-481546

Rocker Panel Extension Moldings

Nova

68-72	LH/RH Pair, with Hardware (pictured)		C-D2-1260
-------	---	--	-----------

Chevelle / El Camino

66	SS, with Clips, LH/RH Pair (pictured)		C-D-3090
----	--	--	----------

Rocker Panel Cap

Chevelle / El Camino

64	SS, Front, Pair		P-SC00210
64	SS, Rear, Pair		P-SC00280

Rocker Panel Molding Clip

Nova

62-74	for 1 3/4" Moldings		K-3886638
66-74	Upper Clip for 3" Moldings		K-3886638

Chevelle / El Camino

64-72		P-PZ00089
65-68	Chevelle, for 1 3/4" Moldings		K-3886638
66-74	Chevelle, Upper Clip for 3" Moldings		K-3886638

Monte Carlo

70-72		P-KM00876
-------	-------	--	-----------

Rocker Panel Molding Retainer

Camaro / Firebird

70-75	1" X 23"		K-3898145
-------	----------------	--	-----------

Rocker Panel Molding Retainer Clip

Camaro / Firebird

70-81		K-4510031
-------	-------	--	-----------

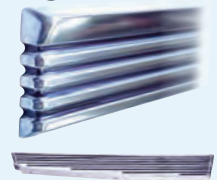
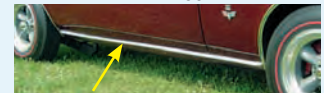
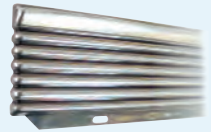

Our Name Says It All!™

Moldings

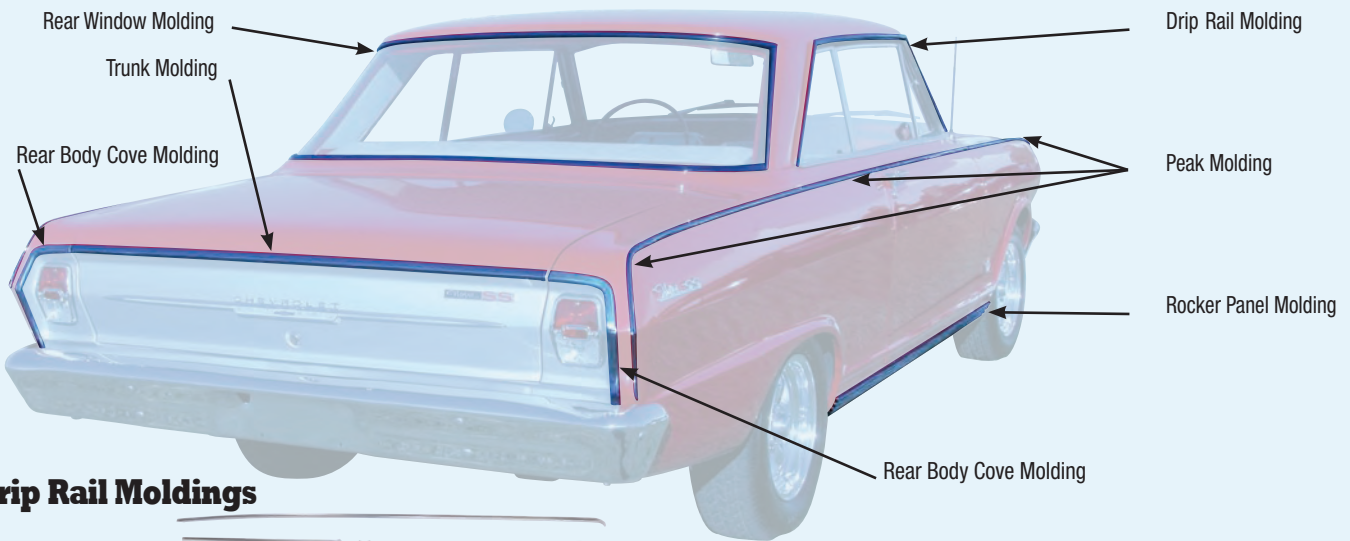

Drip Rail Moldings

Chevelle

64-65 Coupe, 6-Piece Set (pictured).....		630-3464-S
66-67 Coupe, LH/RH Pair		630-3466-P
68-69 Coupe, 6-Piece Set		630-3468-S
70-72 Coupe, 6-Piece Set		630-3470-S

GTO

66-67 Coupe, LH RH Pair (pictured).....		630-3466-P
68-72 6-Piece Set.....		P-NN5629E

Skylark

66-67 Coupe, LH/RH P air		630-3466-P
68-69 Coupe, 6-Piece Set		630-3468-S
70-72 Coupe, 6-Piece Set		630-3470-S

Cutlass

66-67 Coupe, LH/RH P air		630-3466-P
--------------------------------	--	------------

Nova

66-67 LH/RH Pair.....	K-K421
68-72 6-Piece Set.....	K-R1629

El Camino

68-72 6-Piece Set, does both sides.....	P-97CH008
---	-----------

Camaro / Firebird

67-69 6-Piece Set		W-508
70-81 Front/Top of Door Opening, LH/RH Pair		W-859
70-81 Rear of Door Opening, LH/RH Pair		W-756

Vinyl Top Moldings

Chevelle

70-72 LH/RH Pair (pictured)....	C-D-4724
---------------------------------	----------

Rear Corner Molding

68-69 LH/RH P air (pictured).....	C-D-4723
70-72 LH/RH Pair.....	C-D-4725

El Camino

68-72 LH/RH Pair.....	C-D-3455
-----------------------	----------

GTO / Skylark / Cutlass

66-67 4-Piece Set.....	P-G241008
------------------------	-----------

Camaro / Firebird

67-68 with Hardware, LH/RH Pair.....		K-K863
69 Camaro, with Hardware, LH/RH, 4-Piece Set.....		K-K653



Convertible Top Rear Pinchweld Molding

Camaro / Firebird

67-69 LH/RH Pair	W-447
------------------------	-------

Rear Pinchweld Molding Clips

67-69 10-Piece Set (pictured).....	W-182A
------------------------------------	--------



Rear Body Cove Molding

Nova

62-65 LH/RH Pair.....	C-D2-1020
-----------------------	-----------



Quarter Panel Peak Upper & Lower Molding Set

Nova

63-64 SS, with Clips, LH	C-D2-1065
63-64 SS, with Clips, RH	C-D2-1066

Body Side Quarter Panel Molding

Nova

69-72 LH/RH Pair.....	C-D2-1590
-----------------------	-----------

Quarter Panel Lower Side Molding

Chevelle

68 SS, Rear Section, LH/RH Pair.....	C-D-1735
68-69 Front Section, LH/RH Pair.....	C-D-1720
69 Rear Section, LH.....	C-D-1760
69 Rear Section, RH.....	C-D-1770

Quarter Panel Ledge Reveal Molding

Camaro

68 Coupe, LH/RH P air.....		K-K262
68 Convertible, LH/RH P air (pictured)....		K-K263



Quarter Panel Louvers

Camaro

69 2-Piece Set, LH/RH Pair (pictured)....		W-446A
---	--	--------



Our Name Says It All!™

Moldings

Quarter Panel Louver Trim

Firebird

67-68 without Black Stripe,
12-Piece Set..... K-4229997

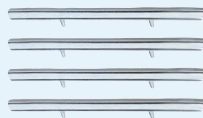

Quarter Window Corner Moldings

Nova

66-67 Corner Molding, LH/RH Pair..... C-D2-1300

Coupe/Convertible Quarter Window Vertical Molding

Nova

66-67 Coupe, Chrome, with Attaching Strip,
LH/RH Pair.....C-T2-2200

Chevelle / GTO / Skylark / Cutlass

64-65 Chrome, LH C-T-1651
64-65 Chrome, RH C-T-1661
66-67 Chrome, LH C-T-1664
66-67 Chrome, RH C-T-1665
68-72 with Attachment Strip, LH/RH Pair W-499

Camaro / Firebird

67-69 Chrome, with Attaching Strip, LH/RH Pair W-495

Back Glass Molding Sets

Nova

68-74 2-Door, 4-Piece Set R-835

Chevelle

64-65 Coupe, 5-Piece Set P-CH26312
66-67 Coupe, 4-Piece Set P-865922
68-72 Coupe, 4-Piece Set P-C990163

El Camino

64-67 4-Piece Set..... P-C990162
68-72 5-Piece Set..... P-K93686

Monte Carlo

70-72 4-Piece Set..... P-C990163

GTO

64-65 2-Door Coupe & Sedan, 5-Piece Set P-G240882
66-67 Coupe, 4-Piece Set P-865922
68-72 2-Door Coupe, 4-Piece Set P-G241311

Skylark

64-65 2-Door Coupe & Sedan, 5-Piece Set P-G240882
66-67 Coupe, 4-Piece Set P-865922

Cutlass

66-67 Coupe, 4-Piece Set P-865922

Back Glass Molding Sets, continued

Camaro / Firebird



67-69 Coupe, 5-Piece Set  W-849

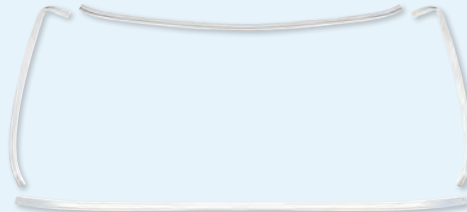

75-81 Chrome K-K139

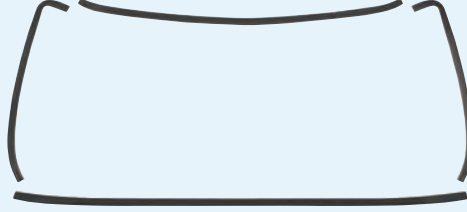

75-81 Black..... K-K138

Rear Window Molding Clip

Camaro / Firebird

67-69 20-Piece Set..... W-525

Rear Body Panel Moldings

Nova



68-69 Non-SS, Plastic Replacement (*pictured, left*) C-C2-1745
68-69 SS, Plastic Replacement (*pictured, right*) C-C2-1740



70-72 SS, Correct (*pictured*)  T-3092



70-72 SS, Correct (*pictured*)  T-3091



70-72 Non-SS, Plastic Replacement (*pictured, left*) C-C2-1755

70-72 SS, Plastic Replacement (*pictured, right*) C-C2-1750

Chevelle

66 Upper or Lower, Sold each C-D-2300
67 Lower P-PZ00129
67 Upper P-PZ00128
68 Lower P-RPM68LW
68 Upper P-RPM68UP
69 Lower C-D-2380
69 Lower, with Mounting Hardware P-PZ00130
69 Upper C-D-2390
69 Upper, with Mounting Hardware P-R701337

Monte Carlo

70-71 2-Piece Molding Set
(Center & LH/RH Outers) C-DM-4620

70-71 Center (*pictured*) C-DM-4600

70-71 Outer Molding, LH/RH Pair C-DM-4610



Our Name Says It All!™

Moldings

C-Shaped Molding Around Tail Lamp

Chevelle

64	LH/RH Pair.....	C-D-2252
65	LH/RH Pair.....	C-D-2286

Trunk Lid Moldings

Nova

62-65	(pictured).....	C-D2-1025
-------	-----------------	-----------

Chevelle

64	Lower.....	C-D-2250
64	Upper.....	C-D-2260
65	Lower.....	P-R000232
65	Upper.....	P-R000231
65	Lower Center.....	C-D-2294
65	Upper Center.....	C-D-2292
67	Trunk Lip Molding with Mounting Hardware....	P-RK00232

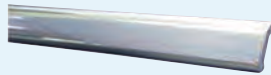

Trunk Spear

Chevy Full Size

64	Center Trunk Molding (pictured).....	 K-3853674
----	---	---

Standard Bed Molding Kit

El Camino



68-72	without Rear Corner to Tail Lamp Moldings	P-BK1028
68-72	with Rear Corner to Tail Lamp Moldings (pictured).....	P-BK1029

Bed Rail Molding

El Camino

Top Edge of Bed

64-67	with Mounting Hardware, Sold each.....	P-PZ00182
68-72	with Mounting Hardware, LH.....	P-PZ00183-LH
68-72	with Mounting Hardware, RH.....	P-PZ00183-RH

Front Bed Molding (Below Rear Window)

El Camino

68-72	with Mounting Hardware.....	P-03M599
-------	-----------------------------	----------

Bedside Side Molding

El Camino

68-69	Front Section, LH/RH Pair.....	C-D-3300
68-69	Rear Section, LH/RH Pair.....	C-D-3301
70-72	Front Section, LH.....	C-D-3302
70-72	Front Section, RH.....	C-D-3304
70-72	Rear Section, LH/RH Pair.....	C-D-3303

Bedside Corner Molding

El Camino

68-72	Front, LH (above).....	C-D-3820
68-72	Front, RH (above).....	C-D-3830
68-72	Lower Rear (above Tail Lamp), LH/RH Pair.....	C-D-3795
68-72	Rear, LH (below).....	C-D-3770
68-72	Rear, RH (below).....	C-D-3780



Corner Top of Bed Molding

El Camino

68-72	Front, LH.....	P-PZ00199-LH
68-72	Front, RH.....	P-PZ00199-RH
68-72	Rear, LH.....	P-PZ00193-LH
68-72	Rear, RH.....	P-PZ00193-RH

Top Edge of Tailgate

El Camino

64-67	with Mounting Hardware.....	P-3380104
68-72	with Mounting Hardware.....	P-03M600

Tailgate Molding

El Camino

68-69	Upper, with Mounting Hardware.....	P-AAR56HA
68-69	Lower, with Mounting Hardware.....	P-AAR56KB
70-72	Upper, with Mounting Hardware.....	P-TG772UP
70-72	Lower, with Mounting Hardware.....	P-TG772LW

Extension Molding

El Camino

68-69	with Mounting Hardware, 2-Piece Set (does one side).....	P-C990194
-------	---	-----------

Rear Corner to Tail Lamp Molding

El Camino

68-72	LH/RH Pair.....	P-PZ00205-PR
-------	-----------------	--------------

El Camino Tailgate Molding Clip Kits

El Camino

64-67	4-Piece Set.....	P-CL5109
68-72	4-Piece Set.....	P-C3037K



Our Name Says It All!™



All of our own **AMD** parts in this catalog are listed in **Blue, bold-face type**.

Gas Tanks & Parts

AMD offers Spectra Premium Industries brand gas tanks for all popular GM applications. These tanks are the best quality on the market, have an OE appearance and are competitively priced. AMD also carries many gas tank accessories including straps, sending units, caps, and hardware.

Gas Tanks

Nova

- 62-67 Filler Neck Sold Separately 890-3062
- 68-69 with Filler Neck.....890-3068-N
- 70 with Filler Neck (No Vent Tube)890-3070-N 9
- 70-72 & 71-72 Ventura, with Filler Neck (3 Vent Tubes)890-3071-N
- 73-74 with Filler Neck..... 890-3073
- 75-79 with Filler Neck..... 890-3075-N



Chevelle

- 64-67 with Filler Neck (1 Vent Tube).....890-3464-1N
- 68-69 with Filler Neck (2 Vent Tubes)890-3468-2N
- 70 with Filler Neck (No Vent Tube).....890-3470-N
- 70 with Filler Neck (2 Vent Tubes)890-3470-2N
- 70 with Filler Neck (3 Vent Tubes)890-3470-3N
- 71-72 with Filler Neck (3 Vent Tubes)890-3471-3N
- 73 with Filler Neck.....890-3473-N
- 74-77 with Filler Neck.....890-3474-N
- 78-88 Malibu, without Filler Neck.....890-3478-N



El Camino

- 64-67 & Chevelle Wagon, with Filler Neck (2 Vent Tubes).....890-3764-1N
- 68-70 with Filler Neck (No Vent Tube) (pictured).....890-3768-N
- 71-72 with Filler Neck (3 Vent Tubes)890-3770-3N
- 75-77 with Filler Neck.....890-3775-N
- 78-87 17 Gallon Tank, with Filler Neck890-3778-17N
- 78-87 22 Gallon Tank, with Filler Neck890-3778-22N

Monte Carlo

- 70 with Filler Neck (2 Vent Tubes)890-3470-2N
- 70 with Filler Neck (3 Vent Tubes)890-3470-3N
- 70 with Filler Neck (No Vent Tube).....890-3670-N
- 71-72 with Filler Neck (3 Vent Tubes)890-3671-3N

GTO

- 64 with Filler Neck (No Vent Tube).....890-5464-N
- 65-67 with Filler Neck (No Vent Tube) (pictured, top).....890-5466-N
- 68 with Filler Neck (2 Vent Tubes)890-5468-2
- 69-70 with Filler Neck (1 Vent Tube).....890-5469-1N
- 70 with Filler Neck (2 Vent Tubes)890-5468-2
- 70 with Filler Neck (3 Vent Tubes)890-5470-3N
- 71-72 with Filler Neck (3 Vent Tubes)890-5471-3N
- 73 with Filler Neck.....890-3473-N
- 74-77 with Filler Neck.....890-3474-N

Skylark

- 64-65 890-6464
- 68-69 with Filler Neck (2 Vent Tubes)890-6468-2N
- 71-72 with Filler Neck (3 Vent Tubes)890-6471-3N

Cutlass

- 66-67 with Filler Neck (2 Vent Tubes)890-7466-2N
- 68-69 with Filler Neck (2 Vent Tubes)890-6468-2N
- 70 with Filler Neck (1 Vent Tube)890-7470-1N
- 70 with Filler Neck (2 Vent Tubes)890-7470-2N

Cutlass, continued

- 70-72 with Filler Neck (3 Vent Tubes)890-3470-3N
- 73 with Filler Neck.....890-3473-N
- 74-77 with Filler Neck.....890-3474-N

Gran Prix

- 69-70 with Filler Neck (1 Vent Tube).....890-5469-1N

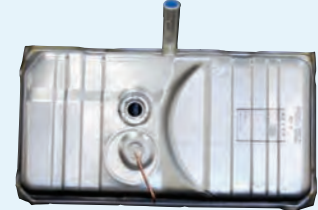

Camaro/Firebird

- 67-68 Filler Neck Sold Separately 890-3567
- 69 with Filler Neck.....890-3569-N
- 70 with Filler Neck (No Vent Tube).....890-3570-N
- 70-73 with Filler Neck (with Vent Tube)890-3570-1N
- 74-77 Camaro, with Filler Neck (pictured).....890-3574-N
- 74-78 Firebird, with Filler Neck (pictured)890-3574-N
- 74-81 without Filler Neck..... 890-3574
- 78-81 Camaro, with Filler Neck890-3578-N
- 79-81 Firebird, with Filler Neck890-3578-N

Chevy Full Size

- 55-56 Round Corners.....890-3955-2
- 55-56 Square Corners.....890-3955-1
- 55-56 Wagon, with Drain Plug 890-3955
- 57 9 Passenger Wagon890-3957-3
- 57 Round Corners.....890-3957-2
- 57 Square Corners.....890-3957-1
- 58 Bel Air & Biscayne, with Filler Neck & Drain Plug890-3958-N

Impala

- 61-64 without Filler Neck..... 890-3961
- 65-66 with Filler Neck (1 Vent Tube).....890-3965-1N
- 67 with Filler Neck (1 Vent Tube).....890-3967-1N

Gas Tank Filler Necks

Nova

- 62-64 with Gasket C-P2-2662
- 65-67 with Gasket C-P2-2665

Camaro

- 67-68W-969

Firebird

- 67-68 Upper (pictured).....K-7693146

Gas Tank Filler Neck Sleeves

El Camino

- 64-67J-5027

Camaro

- 67-68 (pictured)  K-7707772

Firebird

- 67-68 Upper K-7702818



Our Name Says It All!™

Gas Tanks & Parts

Filler Neck Sleeve Clamp

Firebird

67-68 Upper K-7707773

Filler Neck to Body Seal

Nova

62-67 Filler Neck to Body Seal J-40602

Filler Neck Hose

Camaro / Firebird

67-68 K-K630

Gas Tank Straps

Nova

62-67 2-Piece Set 880-3062-P

68-72 & 71-72 Ventura, 2-Piece Set 880-3068-P

73-74 2-Piece Set 880-3073-P

Chevelle / GTO / Skylark / Cutlass

64-67 2-Piece Set 880-3464-P

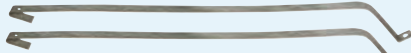

64-67 2-Piece Set 880-3464-P

64-65 Skylark, Pair 880-6464-P

68-72 2-Piece Set 880-3468-P

68-72 2-Piece Set (pictured) W-734

73-77 Cutlass, 2 required, Sold each C-P-7377

El Camino

78-87 2-Piece Set 880-3778-P

Monte Carlo

70-72 2 required, Sold each C-P-7072

73-77 2 required, Sold each C-P-7377

78-83 2-Piece Set 880-3478-P

Malibu

73-77 2 required, Sold each C-P-7377

78-83 2-Piece Set 880-3478-P

78-83 Wagon, 2-Piece Set 880-3478-WP

Gran Prix / Regal

73-77 2 required, Sold each C-P-7377

Camaro / Firebird



67-69 2-Piece Set (pictured) W-616

70-73 2-Piece Set W-522

74-81 2-Piece Set 880-3574-P

Chevy Full Size

55-57 2-Piece Set 880-3955-P

55-57 Wagon, 2-Piece Set 880-3955-WP

Impala

61-64 2-Piece Set 880-3961-P

65-70 2-Piece Set X880-3965-P

Gas Tank Anti-Squeak Pad

GM

59-88 Universal, 5-Piece Set W-862A

Camaro / Firebird

67-69 5-Piece Set W-862

Gas Tank Strap Hardware Kit

GM

62-72 All GM C-P-2643

Gas Caps

Camaro

67 "SS-350" W-259

67-68 "RS" W-257

67-68 "SS" W-258

(pictured) W-258

67-68 Standard (paint to match) W-962

67-68 Bow Tie, Locking (pictured, right) K-K25000



Rear Gas Door

Camaro

78-81 Standard or Z28, with Spring K-5969507

78-81 Berlinetta, with Spring K-5970789

Gas Tank Sending Units

Nova

62-65 5/16" single line 881-3062-5

62-65 3/8" single line 881-3062-3

66-67 5/16" single line K-6426499

66-67 3/8" single line 881-3066-3

68-72 3/8" single line 881-3569-3

75-79 3/8" without return line, non-A/C cars 881-3075-3

75-79 3/8" without return line, A/C cars 881-3075-3A



Chevelle / Malibu

64-67 5/16" single line 881-3464-5

64-67 3/8" with return line 881-3464-3R

64-67 3/8" single line 881-3464-3

68-70 3/8" with return line 881-3470-3R

68-70 3/8" single line 881-3470-3

71-72 3/8" with return line (pictured) 881-3471-3R

71-72 3/8" single line 881-3471-3

73-77 5/16" with 2 outlets 881-3473-52

73-77 3/8" with 3 outlets 881-3473-33

78-83 3/8" with 2 outlets 881-3478-32

78-83 3/8" with 3 outlets 881-3478-33

Monte Carlo

73-77 5/16" with 2 outlets 881-3473-52

73-77 3/8" with 3 outlets 881-3473-33

78-87 3/8" with 2 outlets 881-3478-32

78-87 3/8" with 3 outlets 881-3478-33

GTO / Skylark / Cutlass

64-67 5/16" single line 881-3464-5

64-67 3/8" with return line 881-3464-3R

64-67 3/8" single line 881-3464-3

68-70 3/8" with return line 881-3470-3R

68-70 3/8" single line 881-3470-3

71-72 3/8" with return line 881-3471-3R

71-72 3/8" single line 881-3471-3

Camaro / Firebird

67-68 5/16" with return line 881-3567-5

67-68 3/8" single line 881-3567-3

69 3/8" with return line 881-3569-3R

69 3/8" single line 881-3569-3

70-73 3/8" with return line 881-3570-R

70-73 3/8" single line 881-3570

76-81 Camaro, without A/C, 3/8" single line 881-3574-3

79-81 Firebird, without A/C, 3/8" single line 881-3574-3

76-81 Camaro, with A/C, 3/8" with return line 881-3574-3A



Our Name Says It All!™



All of our own **AMD** parts in this catalog are listed in **Blue, bold-face Type**.

Gas Tanks & Parts

Gas Tank Sending Units, continued

Chevy Full Size

55-56 Wagon, except 9 Passenger, 5/16", without return line	881-3955-5W
55-56 Wagon, except 9 Passenger, 3/8", without return line	881-3955-3W
55-56 9 Passenger Wagon, 5/16" without return line	881-3955-5W9
55-57 5/16" single line	881-3955-5
55-57 3/8" single line	881-3955-3
56-57 Wagon, except 9 Passenger, 3/8" single line	881-3956-3W
65-66 5/16" single line	881-3965-5
65-66 3/8" single line	881-3965-3

Impala

61-64 3/8" with return line	881-3961-3R
61-64 3/8" single line	881-3961-3
67-70 Small Block and Big Block	881-3967

Gas Tank Sending Unit Screen

GM Universal

3/8", Included with sending units	K-K405
5/16", Included with sending units (pictured).....	K-K404



Gas Tank Sending Unit Lock Ring

GM Universal

1 15/16", Included with sending units	K-3774937
---	-----------

Universal Gas Tank Sending Unit Gasket

1 13/16" ID, Included with sending units	K-3825206
--	-----------

OE Style Window Felts

AMD offers RePops brand OE style windowfelts for all popular 2-Door GM applications. These windowfelts are the best quality on the market, have an OE appearance and are competitively priced. Offered in inner and outer kits, or outers only.

OE. Style Window Felts

Reproduction of Original with Correct Bead Chrome for Applicable Models. Warranted for Life to First Retail Purchaser.

Nova



Sedan

62-65 2-Door, Inner & Outer, 8-Piece Set	R-N117A
66-67 2-Door, Inner & Outer, 8-Piece Set	R-N119A
66-67 4-Door, Inner & Outer, 8-Piece Set	R-N120A

2-Door Coupe

62-65 Inner & Outer, 8-Piece Set	R-N115A
66-67 Inner & Outer, 8-Piece Set	R-N118A
66-67 Outer, 4-Piece Set	R-N156A

Convertible

62-63 Inner & Outer, 8-Piece Set	R-N114A
--	---------

Wagon

62-65 2 & 4-Door, Tailgate Window Felt Set	R-N157A
--	---------

All Styles

68-72 2-Door, Inner & Outer, 8-Piece Set	R-N142A
68-72 2-Door, Outer, 4-Piece Set (pictured).....	R-N180A

Chevelle

2-Door Sedan

64 Inner & Outer, 8-Piece Set	R-CH131A
65 Inner & Outer, 8-Piece Set	R-CH136A
66-67 Inner & Outer, 8-Piece Set	R-CH188A
66-67 Outer, 4-Piece Set	R-CH209A
68 Inner & Outer, 8-Piece Set	R-CH193A
69 Inner & Outer, 8-Piece Set	R-CH196A

Chevelle, continued



Coupe

64 Inner & Outer, 8-Piece Set	R-CH128A
64-65 Outer, 4-Piece Set	R-CH175A
65 Inner & Outer, 8-Piece Set	R-CH133A
66-67 Inner & Outer, 8-Piece Set	R-CH185A
66-67 Outer, 4-Piece Set	R-CH177A
68 Inner & Outer, 8-Piece Set	R-CH190A
68 Outer, 4-Piece Set	R-CH179A
69 Inner & Outer, 8-Piece Set	R-CH194A
69 Outer, 4-Piece Set	R-CH181A
70-72 Inner & Outer, 8-Piece Set	R-CH197A
70-72 Outer, 4-Piece Set (pictured).....	R-CH183A

Convertible

64 Inner & Outer, 8-Piece Set	R-CH129A
64-65 Outer, 4-Piece Set	R-CH176A
65 Inner & Outer, 8-Piece Set	R-CH134A
66-67 Inner & Outer, 8-Piece Set	R-CH186A
66-67 Outer, 4-Piece Set	R-CH178A
68 Outer, 4-Piece Set	R-CH180A
68 Inner & Outer, 8-Piece Set	R-CH191A
69 Inner & Outer, 8-Piece Set	R-CH195A
69 Outer, 4-Piece Set	R-CH182A
70-72 Inner & Outer, 8-Piece Set	R-CH198A
70-72 Outer, 4-Piece Set	R-CH184A

Wagon

64 2-Door, Inner & Outer, 4-Piece Set	R-CH130A
64 2-Door, Outer, 2-Piece Set	R-CH212A
64-67 Tailgate Window Felt, 2-Piece Set	R-CH303A
65 Inner & Outer, 4-Piece Set	R-CH135A
68-72 Tailgate Outer Window Felt	R-CH306A



Our Name Says It All!™

OE Style Window Felts

OE Style Window Felts, continued

Reproduction of Original with Correct Bead Chrome for Applicable Models. Warranted for Life to First Retail Purchaser.

El Camino



64	Inner & Outer, 4-Piece Set.....	R-CH130A
64	Outer, 2-Piece Set.....	R-CH212A
65	Inner & Outer, 4-Piece Set.....	R-CH135A
65	Outer, 2-Piece Set.....	R-CH213A
66-67	Inner & Outer, 4-Piece Set.....	R-CH187A
66-67	Outer, 2-Piece Set.....	R-CH214A
68-72	Outer, 2-Piece Set.....	R-CH215A
68-72	Inner & Outer 4-Piece Set (pictured).....	R-CH192A

Monte Carlo

70-72	Inner & Outer, without bolt molding, 8-Piece Set.....	R-MT105A
70-72	with Special Belt Moldings, Inner & Outer, 8-Piece Set.....	R-MT106A
70-72	Outer, without bolt molding, 4-Piece Set	R-MT108A

GTO

2-Door Sedan

64	Inner & Outer, 8-Piece Set.....	R-GT112A
65	Inner & Outer, 8-Piece Set.....	R-GT115A
66-67	Inner & Outer, 8-Piece Set.....	R-GT118A
69-72	Inner & Outer, 8-Piece Set.....	R-GT123A

Coupe

64	2-Door, Inner & Outer, 8-Piece Set	R-GT110A
64	2-Door, Outer, 4-Piece Set	R-GT126A
65	Inner & Outer, 8-Piece Set.....	R-GT113A
65	2-Door, Outer, 4-Piece Set	R-GT128A
66-67	2-Door, Inner & Outer, 8-Piece Set	R-GT116A
66-67	Outer, 4-Piece Set.....	R-GT143A
68	Inner & Outer, 8-Piece Set.....	R-GT119A
68	Outer, 4-Piece Set.....	R-GT145A
69-72	2-Door, Inner & Outer, 8-Piece Set	R-GT121A
69-72	Outer, 4-Piece Set.....	R-GT147A

Convertible

64	Inner & Outer, 8-Piece Set.....	R-GT111A
64	Outer, 4-Piece Set	R-GT127A
65	Inner & Outer, 8-Piece Set.....	R-GT114A
65	Outer, 4-Piece Set	R-GT148A
66-67	Inner & Outer, 8-Piece Set.....	R-GT117A
66-67	Outer, 4-Piece Set	R-GT142A
68	Inner & Outer, 8-Piece Set.....	R-GT120A
68	Outer, 4-Piece Set	R-GT144A
69-72	Inner & Outer, 8-Piece Set.....	R-GT122A
69-72	Outer, 4-Piece Set	R-GT146A

Skylark

2-Door Sedan, Inner & Outer Sets

65	8-Piece Set.....	R-BU117A
66-67	8-Piece Set.....	R-BU120A
66-67	Special Sedan, 8-Piece Set	R-BU156A
67	California Special with Special Molding, 8-Piece Set	R-BU235A
68	California Special, 8-Piece Set	R-BU183A
70-72	8-Piece Set.....	R-BU162A

Skylark, continued

2-Door Coupe, Inner & Outer Sets

64	8-Piece Set.....	R-BU113A
64	Special, 8-Piece Set.....	R-BU155A
65	with Special Moldings, 8-Piece Set	R-BU115A
65	without Special Moldings, 8-Piece Set	R-BU149A
66-67	with Special Moldings, 8-Piece Set	R-BU164A
66-67	without Special Moldings, 8-Piece Set	R-BU118A
68	Inner & Outer, 8-Piece Set.....	R-BU122A
69	with Special Moldings, 8-Piece Set	R-BU154A
69	without Special Moldings, 8-Piece Set	R-BU124A
70-72	8-Piece Set.....	R-BU125A

Convertible, Inner & Outer Sets

64	8-Piece Set.....	R-BU114A
65	with Special Moldings, 8-Piece Set	R-BU233A
65	without Special Moldings, 8-Piece Set	R-BU116A
66-67	without Special Moldings, 8-Piece Set	R-BU119A
66-67	with Special Moldings, 8-Piece Set	R-BU121A
68	with Special Moldings, 8-Piece Set	R-BU123A
68	without Special Moldings, 8-Piece Set	R-BU168A
69	with Special Moldings, 8-Piece Set	R-BU161A
69	without Special Moldings, 8-Piece Set	R-BU112A
70-72	8-Piece Set.....	R-BU111A

Convertible, Outer Sets

69	4-Piece Set.....	R-BU256A
70-72	4-Piece Set.....	R-BU261A

Cutlass

2-Door Sedan

64	Inner & Outer, 8-Piece Set.....	R-OL121A
65	Inner & Outer, 8-Piece Set.....	R-OL171A
66-67	Inner & Outer, 8-Piece Set.....	R-OL165A
68	Outer, 4-Piece Set	R-OL193A
69	Outer, 4-Piece Set	R-OL198A
70-72	Inner & Outer, 8-Piece Set.....	R-OL177A

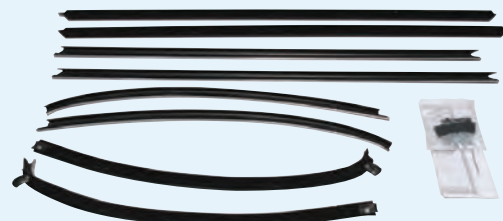

Coupe

65	2-Door, Inner & Outer, 8-Piece Set	R-OL169A
66-67	2-Door, Inner & Outer, 8-Piece Set	R-OL172A
66-67	Supreme, 2-Door, 8-Piece Set	R-OL174A
68	& 442 2-Door, Inner & Outer, 8-Piece Set.....	R-OL164A
69	Fastback, Inner & Outer, 8-Piece Set.....	R-OL199A
69-72	2-Door, Inner & Outer, 8-Piece Set (pictured)	R-OL120A
69-72	Supreme 2-Door, Inner & Outer, 8-Piece Set	R-OL178A
69-72	Supreme 2-Door, Outer, 4-Piece Set	R-OL231A
70-72	2-Door, Outer, 4-Piece Set	R-OL234A9
70-72	S-Body with Special Moldings, Inner & Outer, 8-Piece Set	R-OL196A



Our Name Says It All!™

OE Style Window Felts

OE Style Window Felts, continued

Reproduction of Original with Correct Bead Chrome for Applicable Models. Warranted for Life to First Retail Purchaser.

Cutlass, continued

Convertible

64	Inner & Outer, 8-Piece Set.....	R-OL228A
65	Inner & Outer, 8-Piece Set.....	R-OL170A
65	with Reveal Moldings, Inner & Outer, 8-Piece Set.....	R-OL210A
65	442, Inner & Outer, 8-Piece Set.....	R-OL195A
66-67	Inner & Outer, 8-Piece Set.....	R-OL173A
66-67	with Reveal Moldings, Inner & Outer, 8-Piece Set.....	R-OL175A
68	Inner & Outer, 8-Piece Set.....	R-OL176A
69	Inner & Outer, 8-Piece Set.....	R-OL192A
70-72	Inner & Outer, 8-Piece Set.....	R-OL168A
70-72	Outer, 4-Piece Set.....	R-OL166A

Wagon

66-67	Tailgate, Outer Window Felt.....	R-OL213A
68-71	Tailgate, Outer Window Felt.....	R-OL212A

Tempest

2-Door Sedan

64	Inner & Outer, 8-Piece Set.....	R-TP105A
66-67	Inner & Outer, 8-Piece Set.....	R-TP111A
68	Inner & Outer, 8-Piece Set.....	R-TP108A

2-Door Coupe

65	Inner & Outer, 8-Piece Set.....	R-TP107A
66-67	Inner & Outer, 8-Piece Set.....	R-TP110A

Convertible

64	Inner & Outer, 8-Piece Set.....	R-TP106A
66-67	Inner & Outer, 8-Piece Set.....	R-TP112A

Camaro



Coupe

67	Inner & Outer, 8-Piece Set.....	R-CA168A
67	Outer, 4-Piece Set.....	R-CA154A
68	with Special Belt Moldings & Deluxe Interior, Inner & Outer, 8-Piece Set.....	R-CA161A
68	with Special Belt Moldings & Standard Interior, Inner & Outer, 8-Piece Set.....	R-CA146A
68	with Special Belt Moldings, Outer, 4-Piece Set.....	R-CA158A
68-69	with Deluxe Interior, Inner & Outer, 8-Piece Set.....	R-CA172A
68-69	with Standard Interior, Inner & Outer, 8-Piece Set (pictured).....	R-CA166A
68-69	Outer, 4-Piece Set.....	R-CA156A
70-81	with Special Belt Molding, Inner & Outer, 4-Piece Set.....	R-CA164A
70-81	with Special Belt Molding, Outer, 2-Piece Set.....	R-CA170A
70-81	without Special Belt Molding, Inner & Outer, 4-Piece Set.....	R-CA165A
70-81	without Special Belt Molding, Outer, 2-Piece Set.....	R-CA171A
79-81	Z/28 & Berlinetta, with Round Chrome Bead, Inner & Outer, 4-Piece Set.....	R-CA210A

Camaro, continued

Convertible

67	Inner & Outer, 8-Piece Set.....	R-CA169A
67	Outer, 4-Piece Set.....	R-CA155A
68	with Special Belt Moldings & Deluxe Interior, Inner & Outer, 8-Piece Set.....	R-CA163A
68	with Special Belt Moldings & Standard Interior, Inner & Outer, 8-Piece Set.....	R-CA147A
68	with Special Belt Moldings, Outer, 4-Piece Set.....	R-CA159A
68-69	Deluxe Interior, Inner & Outer, 8-Piece Set.....	R-CA162A
68-69	Standard Interior, Inner & Outer, 8-Piece Set.....	R-CA173A
68-69	Outer, 4-Piece Set.....	R-CA157A

Firebird

Coupe

67	Inner & Outer, 8-Piece Set.....	R-CA168A
67	Outer, 4-Piece Set.....	R-CA154A
68-69	Deluxe Interior, Inner & Outer, 8-Piece Set.....	R-CA172A
68-69	Standard Interior, Inner & Outer, 8-Piece Set.....	R-CA166A
68-69	Outer, 4-Piece Set.....	R-CA156A
70-81	with Special Belt Molding, Inner & Outer, 4-Piece Set.....	R-CA164A
70-81	with Special Belt Molding, Outer, 2-Piece Set.....	R-CA170A
70-81	without Special Belt Molding, Inner & Outer, 4-Piece Set.....	R-CA165A
70-81	without Special Belt Molding, Outer, 2-Piece Set.....	R-CA171A
70-81	Trans Am, with Round Chrome Bead, Inner & Outer, 4-Piece Set.....	R-CA210A

Convertible

67	Inner & Outer, 8-Piece Set.....	R-CA169A
67	Outer, 4-Piece Set.....	R-CA155A
68-69	Deluxe Interior, Inner & Outer, 8-Piece Set.....	R-CA162A
68-69	Standard Interior, Inner & Outer, 8-Piece Set.....	R-CA173A
68-69	Outer, 4-Piece Set.....	R-CA157A

Have a Chevy / GMC Truck?

We've got parts for that, too!



Our Name Says It All!™

Weatherstrip & Rubber Parts

AMD offers Soffseal brand weatherstrips for all popular 2 door GM applications. This product line is extensive and will cover applications on most models.

Sedan Kits:

Kit includes the following illustrated seals:

- 1) Trunk Weatherstrip
- 2) Window Weatherstrip †
- 3) Door Weatherstrip
- 4) Hood to Cowl Seal

Plus: A-Arm Seals, Paint Gasket Set and Bumper Kit

* Kit provides all necessary door, trim and under hood components to complete both driver and passenger side of vehicle. Front and rear seals provided for four-door models.

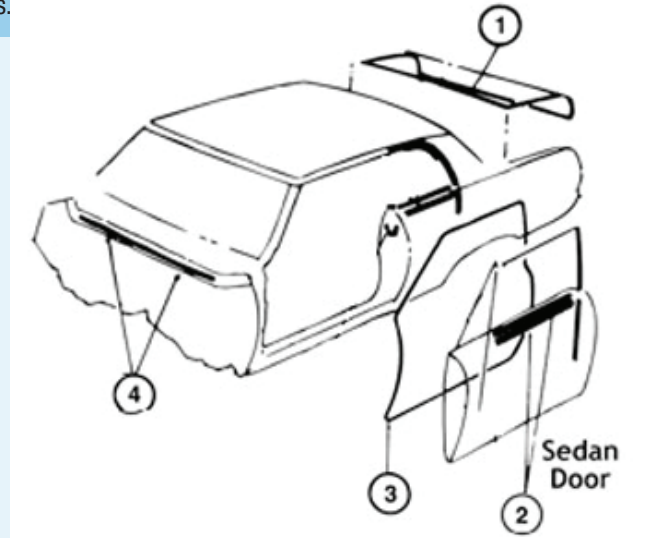

Hardtop Kits:

Kit includes the following illustrated seals:

- 1) Trunk Weatherstrip
- 2) Quarter Window Seals
- 3) Window Weatherstrip †
- 4) Roofrail Weatherstrip
- 5) Door Weatherstrip
- 6) Hood to Cowl Seal

Plus: A-Arm Seals, Door U-Jambs, Paint Gasket Set and Bumper Kit

* Kit provides all necessary door, trim and under hood components to complete both driver and passenger side of vehicle. Front and rear seals provided for four-door models.

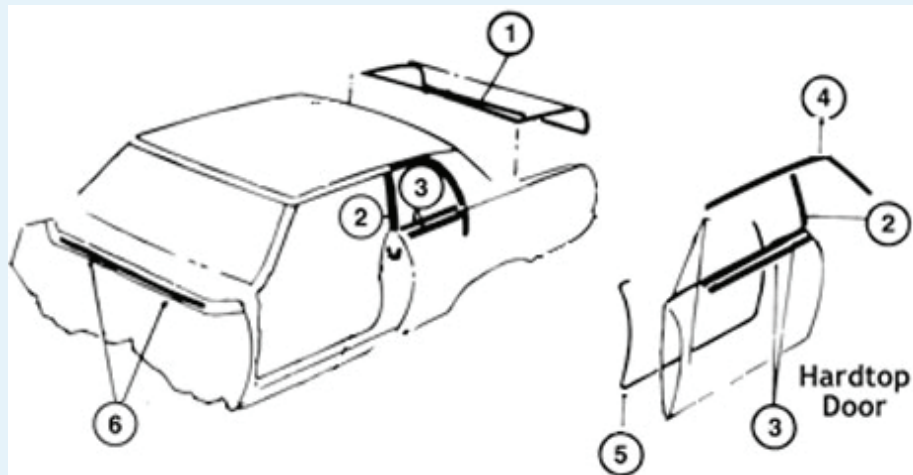

Weatherstrip & Rubber Parts

Weatherstrip & Rubber Bumper Kits

Typical **Coupe Kit includes:** Door, Hood, Trunk, Glove Box & Console Bumpers; Door & Roofrail Weatherstrips; Hood to Cowl Seal; Paint Gasket Kit; Quarter Window Vertical Seals; Door U-Jambs; Trunk Weatherstrip. **Sedan Kits** include Similar Items excluding Coupe Only Items.

We do not offer a Convertible Weatherstrip Kit. If you purchase a majority of Weatherstrip/Rubber Parts for a Convertible we will offer a discount equal to kit price.

Nova

62-63	2-Door Sedan	J-KIT410
62-63	2-Door Coupe	J-KIT405
64	2-Door Sedan	J-KIT411
64	2-Door Coupe	J-KIT406
65	2-Door Sedan	J-KIT412
65	2-Door Coupe	J-KIT407
66	2-Door Sedan	J-KIT413
66	2-Door Coupe	J-KIT408
67	2-Door Sedan	J-KIT414
67	2-Door Coupe	J-KIT409
68	2-Door	J-KIT415
69	2-Door	J-KIT418
70	2-Door	J-KIT416
71-72	2-Door	J-KIT417



Our Name Says It All!™



All of our own **AMD** parts in this catalog are listed in **Blue, bold-face** Type.

Weatherstrip & Rubber Parts

Weatherstrip & Rubber Bumper Kits, continued

Chevelle

64	Sedan.....	J-KIT517
64	Coupe.....	J-KIT505
65	Sedan.....	J-KIT518
65	Coupe.....	J-KIT506
66	Sedan.....	J-KIT519
66	Coupe.....	J-KIT507
67	Sedan.....	J-KIT520
67	Coupe.....	J-KIT508
68	Coupe, with Plastic Inner Fenders.....	J-KIT509
69	Coupe, with Plastic Inner Fenders.....	J-KIT510
70	Coupe, with Plastic Inner Fenders.....	J-KIT511
71-72	Coupe, with Plastic Inner Fenders.....	J-KIT512

64	J-KIT528
65	J-KIT529
66	J-KIT530
67	J-KIT531
68	with Steel Inner Fenders.....	J-KIT532
69	with Steel Inner Fenders.....	J-KIT533
70	with Steel Inner Fenders.....	J-KIT534
71-72	with Steel Inner Fenders.....	J-KIT535

Monte Carlo

70	J-KIT525
71	J-KIT526
72	J-KIT527

Camaro

67	RS.....	J-KIT305A
67	Standard.....	J-KIT305
68	RS.....	J-KIT306A
68	Standard.....	J-KIT306
69	J-KIT307
70-81	J-KIT311

Firebird

67	Coupe.....	J-KIT655
68-69	Coupe.....	J-KIT656
70-81	J-KIT311

Firewall Rubber Seals

Nova



62-67	Master Cylinder Firewall Plug, without Power Brakes.....	C-M2-3000
62-72	Speedometer Cable Firewall Grommet.....	 K-3792008
68-71	Firewall Wiring Gutter with Hardware (pictured).....	W-160
68-74	Firewall Pad Rubber Plug, 4-Piece Set.....	W-272A

Chevelle / El Camino

64-67	Cowl Vent Gasket, Sold each.....	J-5073
64-71	Firewall Wiring Gutter with Hardware.....	W-160
64-72	Firewall Pad Rubber Plug, 4-Piece Set.....	W-272A
66-67	Speedometer Cable Firewall Grommet.....	 K-3792008
64-67	Firewall Clutch Boot Retainer.....	C-V-1511
68-72	Firewall Clutch Boot Retainer.....	C-V-1521

Firewall Rubber Seals, continued

GTO / Skylark / Cutlass

64-67	Cowl Vent Gasket, Sold each.....	J-5073
-------	----------------------------------	--------

Camaro / Firebird

67-69	Camaro & 67-68 Firebird, Firewall Wiring Gutter with Hardware.....	W-160
67-72	Speedometer Cable Firewall Grommet.....	 K-3792008
67-69	Firewall Pad Rubber Plug, 4-Piece Set (pictured).....	W-272A



Chevy Full Size

65-66	Master Cylinder Firewall Plug, without Power Brakes.....	C-M2-3000
65-70	Firewall Wiring Gutter with Hardware.....	W-160
65-70	Speedometer Cable Firewall Grommet.....	 K-3792008

Convertible Pillar Post Weatherstrips

Nova

62-63	Convertible, LH/RH Pair.....	J-4009
-------	------------------------------	--------

Chevelle / GTO / Skylark / Cutlass

64-65	LH/RH Pair.....	J-5039
66-67	LH/RH Pair.....	J-5040
68	LH/RH Pair.....	J-5041
69-72	LH/RH Pair.....	J-5042

Camaro / Firebird

67	Convertible, LH/RH Pair.....	J-3140
68-69	Convertible, LH/RH Pair.....	K-K496

Windshield Gaskets & Seals

GM

Required on any Windshield or Back Glass that does not use a rubber seal/gasket.

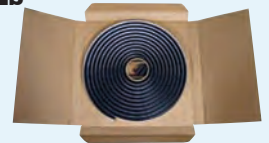

Window Ribbon Seal

5/16" x 15' with 2 Rubber Blocks.....	384-1000-5
3/8" x 15' with 2 Rubber Blocks.....	384-1000-3

Windshield Gasket

Nova

62-67	Coupe, with Trim Slot.....	G-WCRD622
62-67	Sedan & Wagon, with Trim Slot.....	G-WCRD621

Door Weatherstrips

Clips and Molded Ends are Included when Required (will match original part)



Nova

62-67	Sedan, LH/RH Pair.....	J-4000
62-67	Coupe, LH/RH Pair.....	J-4002
68-74	Sedan, LH/RH Pair.....	J-4020

Chevelle

64-65	Wagon, LH/RH Pair.....	J-5001B
64-65	Sedan, LH/RH Pair.....	J-5003
64-65	Coupe & Convertible, LH/RH Pair.....	J-5004
66-67	Sedan, LH/RH Pair.....	J-5000
66-67	Coupe & Convertible, LH/RH Pair.....	J-5007
68	Coupe & Convertible, LH/RH Pair.....	J-5011
68-72	Sedan, LH/RH Pair.....	J-5002
69-72	Hardtop & Convertible, LH/RH Pair (pictured above).....	J-5022



Our Name Says It All!™

Weatherstrip & Rubber Parts

Door Weatherstrips, continued

*Clips and Molded Ends are Included when Required
(will match original part)*

El Camino

- 65 LH/RH PairJ-5030
- 66-67 LH/RH PairJ-5031
- 68-72 LH/RH PairJ-5032

Monte Carlo

- 70-72 Hardtop & Convertible, LH/RH PairJ-5022

GTO / Skylark / Cutlass

- 64-65 Sedan, LH/RH PairJ-5003
- 64-65 Coupe & Convertible, LH/RH PairJ-5004
- 66-67 2-Door Sedan, LH/RH PairJ-5000
- 66-67 Coupe & Convertible, LH/RH PairJ-6407
- 68 GTO, Coupe & Convertible, LH/RH PairJ-6413
- 68 Skylark & Cutlass, Coupe & Convertible, LH/RH PairJ-5011
- 68-72 2-Door Sedan, LH/RH PairJ-5002
- 69-72 GTO, Coupe & Convertible, LH/RH PairJ-6410
- 69-72 Hardtop & Convertible, LH/RH PairJ-5022

Camaro / Firebird

- 67 LH/RH PairJ-3000
- 68-69 LH/RH Pair (pictured)J-3010
- 70-81 LH/RH PairJ-3015



Vent Window Weatherstrips

Nova



- 62-67 Coupe & Convertible, LH/RH Pair (pictured, left) K-N4251
- 62-67 Sedan & Wagon, LH/RH Pair (pictured, right)K-N4252
- 68-72 LH/RH Pair G-VWK121168

Chevelle

- 64-65 Coupe & Convertible, LH/RH Pair P-VWW2500
- 64-67 Sedan & Wagon, LH/RH Pair P-VWW2400
- 66-67 Coupe & Convertible, LH/RH Pair P-VWW2501
- 66-67 Sedan, LH/RH Pair G-VWK121066
- 68 Coupe & Convertible, LH/RH Pair P-VWW2502
- 68-72 Sedan & Wagon, LH/RH Pair P-VWW2700

El Camino

- 64-67 LH/RH Pair G-VWK121064

GTO

- 64-65 Coupe & Convertible, LH/RH Pair P-VWW2500
- 66-67 Coupe & Convertible, LH/RH Pair P-VWW2501
- 66-67 Sedan, LH/RH Pair G-VWK121066
- 68 Coupe & Convertible, LH/RH Pair P-VWW2502

Skylark

- 66-67 Sedan, LH/RH Pair G-VWK121066

Cutlass

- 64-65 Coupe & Convertible, LH/RH Pair P-VWW2500
- 64-67 Sedan & Wagon, LH/RH Pair P-VWW2400
- 66-67 Coupe & Convertible, LH/RH Pair P-VWW2501
- 66-67 Sedan, LH/RH Pair G-VWK121066
- 68 Coupe & Convertible, LH/RH Pair P-VWW2502
- 68-72 Sedan & Wagon, LH/RH Pair P-VWW2700

Camaro / Firebird

- 67 LH/RH Pair (pictured) K-K4167



Hood to Cowl Seal

Nova

- 62-67J-4058
- 68-74J-4055

Chevelle / El Camino / GTO / Cutlass / Skylark

- 64-67J-5070
- 68-72 Dense SealJ-5074
- 68-72 Sponge SealJ-50741

Skylark

- 64-67J-5070

Monte Carlo

- 70-72 Dense SealJ-5074
- 70-72 Sponge SealJ-50741

Camaro

- 67-69J-3023
- 70-81J-30231

Firebird

- 67-69J-3023
- 77-81J-30231

Hood to Cowl Seal Clip Sets

Chevelle / El Camino / GTO / Cutlass / Skylark

- 68-69 SteelJ-5075
- 68-72 PlasticJ-5077

Camaro

- 70-81 PlasticJ-30232

Firebird

- 77-81 PlasticJ-30232

Cowl Seal Sets

Nova

- 68 Cowl Seal SetJ-3030
- 69-74 Cowl Seal SetJ-3032

Camaro / Firebird

- 67 Cowl Seal SetJ-30302
- 68 Cowl Seal SetJ-3030
- 69 Cowl Seal SetJ-3032

Roofrail Weatherstrip

Nova

- 62-64 Coupe, LH/RH Pair (pictured) K-K441
- 65 Coupe, LH/RH PairJ-4031
- 66-67 Coupe, LH/RH PairJ-4005

Chevelle / GTO / Skylark / Cutlass

- 64-65 Coupe, LH/RH PairJ-5005
- 66-67 Coupe, LH/RH PairJ-5009
- 68 Coupe, LH/RH PairJ-5012
- 69-72 Coupe, LH/RH Pair (pictured)J-5024

Camaro / Firebird

- 67 Coupe, LH/RH PairJ-3002
- 67-69 Convertible, 5-Piece Set K-K165
- 68-69 Coupe, LH/RH Pair (pictured)J-3013
- 70-81 LH/RH PairJ-3100

Roofrail Weatherstrip Blow Out Clip

Camaro / Firebird

- 67-69 Coupe, 4-Piece Set (pictured) W-731
- 70-81 2-Piece Set W-973

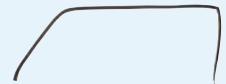

All of our own **AMD** parts in this catalog are listed in **Blue, bold-face Type**.

Weatherstrip & Rubber Parts

Convertible Top Header Seals

Chevelle / GTO / Skylark / Cutlass

64-67 without Molded Ends	J-5091
66-67 with Clips & Molded Ends	J-50911
68-72 without Molded Ends	J-5054
68-72 with Clips & Molded Ends	J-5094

Camaro / Firebird

67-69 without Molded Ends	J-3044A
67-69 with Molded Ends	J-3044

Convertible Top Weatherstrips

Nova

62-63 7-Piece Set	J-4029
-------------------	--------

Chevelle / GTO / Skylark / Cutlass

64-65 5-Piece Set	J-5090
66-67 5-Piece Set	J-5092
68-72 5-Piece Set	J-5093

Camaro / Firebird

67-69 5-Piece Set	 K-K165
-------------------	--

T-Top Weatherstrips for GM Fisher Tops

Camaro / Firebird

Includes Body, Weatherstrip on Top, Auxiliary Strips

78-81 Kit	J-3189
78-81 Weatherstrip on Body	J-3190
78-81 Top Weatherstrip on Top, LH/RH Pair	J-3192
78-81 Auxiliary Seal Strip, LH/RH Pair	J-3192A

Quarter Glass Weatherstrip Kit

Nova

68-72 (Front, Top & Back of Both Windows)	C-T2-2300
---	-----------

Quarter Window Vertical Weatherstrip

Nova

62-65 Coupe, with Steel Splines, LH/RH Pair	J-4033
66-67 Coupe, with Steel Splines, LH/RH Pair	K-K447

Chevelle / GTO / Skylark / Cutlass

64-65 Coupe, with Steel Splines, LH/RH Pair	J-5109M
64-65 Convertible, with Steel Splines, LH/RH Pair	J-5110M
66-67 Coupe/Convertible, with Steel Splines, LH/RH Pair	J-5111M
68-72 Coupe/Convertible, with Steel Insert, LH/RH Pair	J-5112M

Camaro / Firebird

67-69 with Steel Splines, LH/RH Pair (pictured)	 W-381
---	---

Quarter Window Seal

Nova

62-67 2-Door Sedan, Rear Side, LH/RH Pair	J-2244
66-67 2-Door Coupe, LH/RH Pair	J-4032
66-67 Coupe, LH/RH Pair	C-T2-1765

Chevelle

64-67 Rear, LH/RH Pair (Over Convertible Top Hinge)	J-5108
68-72 Rear, LH/RH Pair (Over Convertible Top Hinge)	J-5505

GTO / Skylark / Cutlass

64-67 Rear, LH/RH Pair (Over Convertible Top Hinge)	J-5108
---	--------

Rear Frame to Body Seal

Camaro / Firebird

67-69 Convertible, LH/RH Pair	
-------------------------------	---

Rear Body to Bumper Seals

Nova

62-65	J-4060
68-72	J-40601

Chevelle

64-65 LH/RH Pair	J-5083A
66-67 LH/RH Pair	K-K635

El Camino

64-65 LH/RH Pair	J-5083A
68-72	J-5084

Back Glass Gaskets

Nova

62-64 2 & 4-Door Sedan, without Trim Slot	G-WCRDB3127
62-65 2-Door Coupe, with Trim Slot	G-WCRDB3128

Floor, Firewall or Trunk Plug

All Makes & Models

3/8", Rubber Plug	J-0180
1/2", Rubber Plug	J-0181
5/8", Rubber Plug	J-0182
3/4" Rubber Plug	J-0183
7/8" Rubber Plug	J-0184
1" Rubber Plug	J-0185
1 1/4" Rubber Plug	J-0186

Nova

65-69 Rocker Panel Rear Drain Flap, LH/RH Pair	W-538
--	-------



Chevelle

68-69 Body Plugs, 6-Piece Set (pictured)	W-039
64-68 Rocker Panel Flap Plug, 2 required	J-5013

GTO / Skylark / Cutlass

64-68 Rocker Panel Flap 2 Plug, required	J-5013
--	--------

Camaro / Firebird

67-68 Correct Body Plug, 12-Piece Set	 W-092
69 Correct Body Plug, 12-Piece Set (pictured)	 W-093

71-81 Floor Pan Access Plug	K-9731275
67-69 Rocker Panel Flap Plug, 2 required	J-5013
67-72 Rocker Panel Rear Drain Flap, LH/RH Pair	W-538



Trunk Weatherstrips

Nova

65-74 Trunk Weatherstrip	J-2003
73-74 Hatchback Weatherstrip	J-4013

Chevelle / Monte Carlo / Skylark

64-77	J-2003
-------	--------

Camaro / Firebird

67-81 (pictured)	W-943
------------------	-------

Chevy Full Size

58-76	W-944
-------	-------

Fender / Spoiler Welting Seal

Camaro

80-81 Z/28, 16'	K-1668047
-----------------	-----------

Firebird

70-81 Trans Am, 16'	K-1668047
---------------------	-----------



Our Name Says It All!™

Body Bushings & Bumpers

AMD offers Body bushings and rubber bumpers for all popular GM musclecar applications. Offered in full kits or individual pieces, replacing these parts help with the alignment of your new body panels.

Body Bushing Sets

Nova

- 68-69 12-Piece Set
(pictured)..... K-K3025
- 70-72 12-Piece Set..... K-K3026
- 73-74 12-Piece Set..... K-K3034



Chevelle

Radiator Support Bushings included.

- 64-67 Convertible, without Hardware P-SB0515
- 64-67 Convertible, with Hardware P-SB0515K
- 64-67 Coupe, without Hardware P-SB0514
- 64-67 Coupe, with Hardware P-SB0514K
- 68-72 Convertible, without Hardware P-SB0517
- 68-72 Convertible, with Hardware P-SB0517K
- 68-72 Coupe, without Hardware P-SB0516
- 68-72 Coupe, with Hardware P-SB0516K

Body Bushing Supplement Set

- 64-67 Big Block, without Hardware P-SB0518
- 64-67 Big Block, with Hardware P-SB0518K
- 68-72 Big Block, without Hardware P-SB0519
- 68-72 Big Block, with Hardware P-SB0519K

El Camino

Radiator Support Bushings included.

- 64-67 without Hardware P-SB0514
- 64-67 with Hardware P-SB0514K
- 68-72 without Hardware P-SB0516
- 68-72 with Hardware P-SB0516K

Body Bushing Supplement Set

- 64-67 Big Block, without Hardware P-SB0518
- 64-67 Big Block, with Hardware P-SB0518K
- 68-72 Big Block, without Hardware P-SB0519
- 68-72 Big Block, with Hardware P-SB0519K

Monte Carlo

Radiator Support Bushings included.

- 70-72 without Hardware P-SB0614
- 70-72 with Hardware P-SB0614K

Body Bushing Supplement Set

- 68-72 Big Block, without Hardware P-SB0519
- 68-72 Big Block, with Hardware P-SB0519K

GTO

Radiator Support Bushings included.

- 64-67 Coupe / Convertible, without Hardware P-SB0515
- 64-67 Coupe / Convertible, with Hardware P-SB0515K
- 68-72 Convertible, without Hardware P-SB0715
- 68-72 Convertible, with Hardware P-SB0715K
- 68-72 Coupe, without Hardware P-SB0615
- 68-72 Coupe, with Hardware P-SB0615K

Cutlass

Radiator Support Bushings included.

- 64-67 Convertible, without Hardware P-SB0515
- 64-67 Convertible, with Hardware P-SB0515K
- 64-67 Coupe, without Hardware P-SB0514
- 64-67 Coupe, with Hardware P-SB0514K
- 68-72 Convertible, without Hardware P-SB0517
- 68-72 Convertible, with Hardware P-SB0517K
- 68-72 Coupe, without Hardware P-SB0516
- 68-72 Coupe, with Hardware P-SB0516K

Body Bushing Sets, continued

Camaro

- 67-68 12-Piece Set
(pictured)..... K-K3025
- 69 12-Piece Set K-K3026
- 70-72 12-Piece Set K-K3028
- 73-81 12-Piece Set K-K3088



Firebird

- 71-72 12-Piece Set (pictured)..... K-K3025
- 69 12-Piece Set K-K3026
- 70 12-Piece Set K-K3028
- 73-75 12-Piece Set K-K3088
- 76-81 12-Piece Set  K-K3088F

Body Bumper Sets

Door, Hood, Trunk, Glove Box & Console

Nova

- 62-65 Rubber J-4091
- 66-67 Rubber J-4093
- 68-74 Rubber J-4094



Chevelle / El Camino

- 64 Rubber J-5104
- 65 Rubber J-5105
- 66 Rubber J-5106
- 67 Rubber J-5107
- 68-72 Chevelle, Rubber Bumper Set J-2371

Monte Carlo

- 68-72 Rubber Bumper Set J-2371

Camaro

Door, Hood, Trunk, Ashtray

- 67-69 Rubber Bumpers, 16-Piece Set (pictured) W-400
- Door, Hood, Trunk, Glove Box & Console*
- 70-81 Rubber Bumper Set J-3059

Firebird

Door, Hood, Trunk, Ashtray

- 67-69 Rubber Bumpers, 16-Piece Set W -400

Chevy Full Size

- 66 Rubber Bumper Set J-2371

Body Mount Hardware Set

Nova

- 68-72 K-K3027

Camaro / Firebird

- 67-69 K-K3027

Hood Adjustment Bumpers

Nova

- 68-73 6-Piece Set
(pictured).....305-3064-S

GTO

- 64-66 LH/RH Pair J-6022
- 66-73 LH/RH Pair J-6445

Skylark / Cutlass

- 64-66 LH/RH Pair J-6022

Camaro / Firebird

- 67-69 6-Piece Set (pictured).....305-3064-S



Body Bushings & Bumpers

Hood Side Bumpers

Nova

62-65	4-Piece Set	J-4067
66-67	LH/RH Pair	J-4068
68-74	4-Piece Set (On Fender)	J-2179



Chevelle / El Camino

64	4-Piece Set	J-2181
65	4-Piece Set	J-2182
66	LH/RH Pair	J-5076
68-72	4-Piece Set (On Fender)	J-2179
78-88	Malibu & El Camino	W-223

Monte Carlo

78-88		W-223
-------	--	-------

Camaro

67-69	4-Piece Set (On Fender)	J-2179
70-81	4-Piece Set	J-30241
70-81	Rear Bumper	 K-3984072
70-81	Rubber Bumper	 K-K922

Firebird

67-68	4-Piece Set	J-6832
69	4-Piece Set	J-6831
70-81	4-Piece Set	J-30241
70-81	6-Piece Set	J-6833

Chevy Full Size

63-64	4-Piece Set	J-2181
65	4-Piece Set	J-2182

Hood Bumpers, Miscellaneous

Chevelle / El Camino

Rear Hood Bumper		
68-72	LH/RH Pair (On the Hood)	J-5078
70	Chevelle, Hood Rear Panel Bumper	K-3962891

Monte Carlo

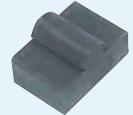

71-72	Rear Panel Bumper	
	(pictured)	K-3962891



GTO

Hood Bumper		
64-67	4-Piece Set	J-6470
68-69	4-Piece Set	J-6447
70	4-Piece Set	J-6446

Camaro

67-81	Inner Hood Adjuster Spring	 K-3857882
70-81	Outer Hood Bumper	 K-3973952

Chevy Full Size

Rear Hood Bumpers		
68-70	LH/RH Pair (On the Hood)	J-5078
69-70	Rear Panel Bumper	K-3962891

Rubber Door Bumpers

Nova

62-67	2-Piece Set	J-2320
68-74	Upper & Lower, 4-Piece Set	J-40511

Chevelle / GTO / Skylark / Cutlass

64-66	4-Piece Set	J-5080
66-67	2-Piece Set	J-2320

El Camino

64-66	4-Piece Set	J-5080
-------	-------------	--------

Door Bottom Drain Hole Seal

Nova / Chevelle / El Camino / Chevy Full Size

62-72		J-2118
-------	--	--------

Lock Cylinder Kits

AMD offers a full range of lock cylinder kits for popular GM models. Available with early and late style keys. Sold in kits or individually.

Ignition, Door, Glove Box & Trunk Lock Cylinder Kits

All coded to the same Key.



Nova

62-64	with GM Octagon Head Keys	CL-295
65	with GM Octagon Head Keys	CL-296
66-67	with GM Octagon Head Keys	CL-288
68	with Case, with GM Octagon Head Keys	CL-336
69-74	with Case, with GM Square Head Keys	CL-337

Chevelle

64	with Case, with GM Octagon Head Keys	CL-291
65	with Case, with GM Octagon Head Keys	CL-292
66	without Case, with GM Octagon Head Keys	CL-293
67	without Case, with GM Octagon Head Keys	CL-294
68	with Case, with GM Octagon Head Keys	CL-336
69	with Case, with GM Square Head Keys	CL-337
70-72	with Case, with GM Square Head Keys	CL-338

Camaro



1967 Camaro Trunk Cylinders have wide notches at 3 & 9 o'clock position. If your original cylinder has notches at 12 & 6 o'clock, or if you are using a reproduction Rear Body Panel, use the 1968 Camaro Cylinder.

67	with GM Octagon Head Keys	CL-288
68	with Octagon Head Keys	CL-289
69	with Square Head Keys (pictured)	CL-290

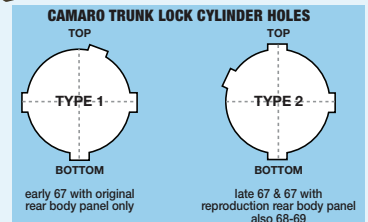

Our Name Says It All!™

Lock Cylinder Kits

Ignition, Door & Trunk Lock Cylinder Kits

All coded to the same Key.

Nova

62-64 with GM Octagon Head Keys.....	CL-266
65 with GM Octagon Head Keys.....	CL-267
66-67 with GM Octagon Head Keys.....	CL-268

Chevelle

64 with GM Octagon Head Keys.....	CL-266
65 with GM Octagon Head Keys.....	CL-267
66 with GM Octagon Head Keys.....	CL-268
67 with GM Octagon Head Keys.....	CL-276

GTO

64-65 with GM Octagon Head Keys.....	CL-267
66-67 with GM Octagon Head Keys.....	CL-268
66-67 with GM Octagon Head Keys.....	CL-276

Cutlass

64-65 with GM Octagon Head Keys.....	CL-267
66-67 with GM Octagon Head Keys.....	CL-268

Ignition & Door Lock Cylinder Kits

Nova

62-64 with GM Octagon Head Keys.....	CL-142A
62-64 with GM Square Head Keys.....	CL-142
65 with GM Octagon Head Keys.....	CL-143A
66-67 with GM Square Head Keys.....	CL-104
67 with GM Octagon Head Keys.....	CL-104A
68 with GM Square Head Keys.....	CL-105
68 with GM Octagon Head Keys.....	CL-105A
69-74 with GM Square Head Keys (pictured).....	CL-106

Chevelle / El Camino

64 with GM Octagon Head Keys.....	CL-142A
64 with GM Square Head Keys.....	CL-142
65 with GM Octagon Head Keys.....	CL-143A
66-67 with GM Square Head Keys.....	CL-104
66-67 with GM Octagon Head Keys.....	CL-104A
68 with GM Square Head Keys.....	CL-105
68 with GM Octagon Head Keys.....	CL-105A
69-72 with GM Square Head Keys (pictured).....	CL-106

GTO

64-65 with GM Octagon Head Keys.....	CL-143A
66-67 with GM Square Head Keys.....	CL-142

Skylark

64 with GM Octagon Head Keys.....	CL-142A
65 with GM Octagon Head Keys.....	CL-143A
66 with GM Square Head Keys.....	CL-142

Cutlass

65 with GM Octagon Head Keys.....	CL-143A
-----------------------------------	---------

Camaro

67 with GM Square Head Keys.....	CL-104
67 with GM Octagon Head Keys.....	CL-104A
68 with GM Square Head Keys.....	CL-105
68 with GM Octagon Head Keys.....	CL-105A
69-70 with GM Square Head Keys, 7/32" Short Shaft Door Lock Cylinder (pictured)	CL-106
70-78 with GM Square Head Keys, 3/8" Medium Shaft Door Lock Cylinder.....	CL-107
79-81 with GM Square Head Keys.....	CL-108



Ignition & Door Lock Cylinder Kits, continued

Firebird

67 with GM Square Head Keys.....	CL-104
67 with GM Octagon Head Keys.....	CL-104A
68 with GM Octagon Head Keys.....	CL-105A
69-78 with GM Square Head Keys (pictured).....	CL-106
79-82 with GM Square Head Keys.....	CL-184

Ignition Lock Cylinder Kits

Does not include ignition switch

Nova

62-64 with GM Octagon Head Keys.....	CL-161
62-64 with Non-GM Octagon Head Keys.....	CL-157
65 with Non-GM Octagon Head Keys.....	CL-158
65 with GM Octagon Head Keys.....	CL-158A
66-67 with GM Square Head Keys.....	CL-100
66-67 with GM Octagon Head Keys.....	CL-100A
68 with GM Square Head Keys.....	CL-101
68 with GM Octagon Head Keys.....	CL-101A

Chevelle

62-64 with Non-GM Octagon Head Keys.....	CL-157
64 with GM Octagon Head Keys.....	CL-161
65 with Non-GM Octagon Head Keys.....	CL-158
65 with GM Octagon Head Keys.....	CL-158A
66-67 with GM Square Head Keys.....	CL-100
66-67 with GM Octagon Head Keys.....	CL-100A
68 with GM Square Head Keys.....	CL-101
68 with GM Octagon Head Keys.....	CL-101A
69-72 with GM Square Head Keys (pictured).....	CL-102

El Camino

62-64 with Non-GM Octagon Head Keys.....	CL-157
64 with GM Octagon Head Keys.....	CL-161
65 with Non-GM Octagon Head Keys.....	CL-158
65 with GM Octagon Head Keys.....	CL-158A

GTO

64-65 with Non-GM Octagon Head Keys.....	CL-158
64-65 with GM Octagon Head Keys.....	CL-158A

Skylark

64 with GM Octagon Head Keys.....	CL-161
65 with Non-GM Octagon Head Keys.....	CL-158
65 with GM Octagon Head Keys.....	CL-158A

Cutlass

65 with Non-GM Octagon Head Keys.....	CL-158
65 with GM Octagon Head Keys.....	CL-158A

Camaro / Firebird

67 with GM Square Head Keys.....	CL-100
67 with GM Octagon Head Keys.....	CL-100A
68 with GM Square Head Keys.....	CL-101
68 with GM Octagon Head Keys.....	CL-101A
69-78 with GM Square Head Keys (pictured).....	CL-102
79-82 with GM Square Head Keys.....	CL-103



All of our own **AMD** parts in this catalog are listed in **Blue, bold-face Type**.

Our Name Says It All!™

Lock Cylinder Kits

Glove Box, Trunk & Door Lock Cylinder Kits

Nova

- 62-65 with Case,
with GM Round Head Keys CL-170
- 62-65 with Case, with GM Pear Head Keys CL-170A
- 66-67 with Case, with GM Round Head Keys CL-128A
- 66-67 with Case, with GM Pear Head Keys CL-128A
- 68 with Case, with Pear Head Keys CL-155A
- 68-74 with Case, with Round Head Keys
Glove Box Knob is Top Hat design CL-155

Chevelle

- 64-65 with Case, with GM Round Head Keys CL-152
- 64-65 with Case, with GM Pear Head Keys CL-152A
- 66 without Case, with GM Round Head Key CL-153
- 66 without Case, with GM Pear Head Key CL-153A
- 67 without Case, with GM Round Head Key CL-154
- 67 without Case, with GM Pear Head Keys CL-154A
- 68 with Case, with Pear Head Keys CL-155A
- 68-69 with Case, with Round Head Keys
Glove Box Knob is Top Hat design CL-155
- 70-72 with Case, with Round Head Keys CL-156

GTO

- 64-65 with Case, with GM Round Head Keys C L-200
- 64-65 with Case, with GM Pear Head Keys C L-200A
- 66-67 with Case, with GM Round Head Keys C L-201
- 66-67 with Case, with GM Pear Head Keys C L-201A
- 69 with Case, with GM Round Head Keys C L-202
- 70-72 with Case, with GM Round Head Keys C L-203

Skylark

- 64 without Case, with GM Round Head Key CL-153
- 64 without Case, with GM Pear Head Key CL-153A
- 65 with Case, with Pear Head Keys CL-450
- 66 with Case, with GM Round Head Keys C L-201
- 66 with Case, with GM Pear Head Keys C L-201A
- 67 with Case, with Pear Head Keys CL-450
- 68-70 without Case, with GM Round Head Keys,
Glove Box Knob is Top Hat design CL-155B
- 71-72 with Case, with Round Head Keys
Glove Box Knob is Top Hat design CL-155

Camaro

1967 Camaro Trunk Cylinders have wide notches at 3 & 9 o'clock position. If your original cylinder has notches at 12 & 6 o'clock, or if you are using a reproduction Rear Body Panel, use the 1968 Camaro Cylinder.

- 67 with Case, with GM Round Head Keys CL-128
- 67 with Case, with GM Pear Head Keys CL-128A
- 68 with Case, with Round Head Keys CL-129
- 68 with Case, with Pear Head Keys CL-129A
- 69 with Case, with GM Round Head Keys (pictured) CL-130
- 70 with Case, with Round Head Keys,
7/32" Short Shaft Door Lock Cylinder CL-263
- 70-73 with Case, with Round Head Keys,
3/4" Long Shaft Door Lock Cylinder CL-131
- 74-77 with Case, with Round Head Keys,
3/4" Long Shaft Door Lock Cylinder CL-132
- 78 with Case, with Round Head Keys CL-253
- 79-81 with Case, with Round Head Keys CL-133



Glove Box, Trunk & Door Lock Cylinder Kits, continued

Firebird

- 67-68 with Case, with Round Head Keys CL-129
- 67-68 with Case, with Pear Head Keys CL-129A
- 69 without Case, with Round Head Keys CL-190
- 70-71 with Case, with Round Head Keys CL-191
- 72-73 with Case, with Round Head Keys CL-192
- 74-78 with Case, with Round Head Keys CL-193
- 79-81 with Case, with Round Head Keys CL-156

Glove Box & Trunk Lock Cylinder Kits

Nova

- 62-65 with Case, with Round Head Keys CL-164
- 62-65 with Case, with Pear Head Keys CL-164A
- 66-67 with Case, with GM Round Head Keys CL-121
- 66-67 with Case, with GM Pear Head Keys CL-121A
- 68 with Case, with GM Pear Head Keys CL-150A

Chevelle

- 64-65 with Case, with GM Pear Head Keys CL-162A
- 64-65 with Case, with GM Round Head Keys CL-162
- 66 without Case, with GM Round Head Keys CL-148
- 66 without Case, with GM Pear Head Keys CL-148A
- 67 without Case, with GM Round Head Keys CL-149
- 67 without Case, with GM Pear Head Keys CL-149A
- 68 with Case, with GM Pear Head Keys CL-150A
- 68-69 with Case, with GM Round Head Keys
Glove Box Knob is Top Hat design CL-150
- 70-72 with Case, with GM Round Head Keys CL-151

Monte Carlo

- 70-72 with Case, with GM Round Head Keys CL-151

GTO

- 64-65 with Case, with GM Round Head Keys CL-172
- 64-65 with Case, with GM Pear Head Keys CL-172A
- 66-67 with Case, with GM Round Head Keys CL-196
- 66-67 with Case, with GM Pear Head Keys CL-196A
- 68-69 without Case, with GM Round Head Keys CL-197
- 70-72 with Case, with GM Round Head Keys CL-198

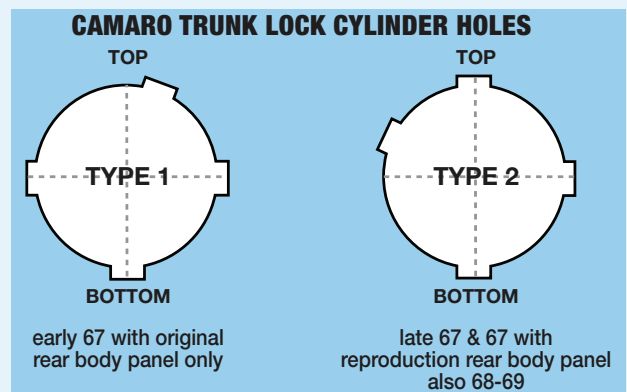

Our Name Says It All!™

Lock Cylinder Kits

Glove Box & Trunk Lock Cylinder Kits, continued



Skylark

- 64 without Case, with GM Round Head Keys CL-148
- 64 without Case, with GM Pear Head Keys CL-148A
- 65 with Case, with GM Round Head Keys CL-171
- 65 with Case, with GM Pear Head Keys CL-171A
- 66 with Case, with GM Round Head Keys CL-196
- 66 with Case, with GM Pear Head Keys CL-196A
- 67 with Case, with GM Round Head Keys CL-171
- 67 with Case, with GM Pear Head Keys CL-171A
- 68-70 without Case, with GM Round Head Keys,
Glove Box Knob is Top Hat design CL-150B
- 71-72 with Case, with GM Round Head Keys,
Glove Box Knob is Top Hat design CL-150

Cutlass

- 64-67 without Case, with GM Round Head Keys CL-197
- 64-67 without Case, with GM Pear Head Keys CL-148A
- 64-67 without Case, with GM Round Head Keys CL-148
- 69-72 with Case, with GM Round Head Keys,
Glove Box Knob is Top Hat design CL-150

Camaro

1967 Camaro Trunk Cylinders have wide notches at 3 & 9 o'clock position. If your original cylinder has notches at 12 & 6 o'clock, or if you are using a reproduction Rear Body Panel, use the 1968 Camaro Cylinder.

- 67 with Case, with GM Pear Head Keys CL-121A
- 67 with Case, with GM Round Head Keys CL-121
- 68 with Case, with GM Round Head Keys CL-122
- 68 with Case, with GM Pear Head Keys CL-122A
- 69 with Case, with GM Round Head Keys (pictured) CL-123
- 70-73 with Case, with GM Round Head Keys CL-124
- 78-81 with Case, with GM Round Head Keys CL-126

Firebird

- 67-68 with Case, with GM Round Head Keys CL-122
- 67-68 with Case, with GM Pear Head Keys CL-122A
- 69 without Case, with GM Round Head Keys CL-186
- 70-71 with Case, with GM Round Head Keys CL-187
- 72-73 with Case, with GM Round Head Keys CL-188
- 74-78 with Case, with GM Round Head Keys CL-189
- 79-81 with Case, with GM Round Head Keys CL-151

Door & Trunk Lock Cylinder Kits

Nova

- 62-68 with GM Pear Head Keys CL-135A
- 62-74 with GM Round Head Keys CL-135

Chevelle

- 64-66 with GM Pear Head Keys CL-135A
- 64-66 with GM Round Head Keys CL-135
- 67 with GM Pear Head Keys CL-136A
- 67 with GM Round Head Key CL-136
- 68 with GM Pear Head Keys CL-135A
- 68-72 with GM Round Head Keys CL-135

Monte Carlo

- 64-66 with GM Round Head Keys CL-135
- 68-72 with GM Round Head Keys CL-135

GTO

- 64-65 with GM Pear Head Keys CL-135A
- 64-65 with GM Round Head Keys CL-135
- 66-67 with GM Pear Head Keys CL-136A
- 66-67 with GM Round Head Keys CL-136
- 68 with GM Pear Head Keys CL-135A
- 68-72 with GM Round Head Keys CL-135

Skylark

- 64-65 with GM Round Head Keys CL-135
- 64-66 with GM Pear Head Keys CL-135A
- 66 with GM Pear Head Keys CL-136A
- 66 with GM Round Head Keys CL-136
- 67-72 with GM Round Head Keys CL-135

Cutlass

- 65-68 with GM Pear Head Keys CL-135A
- 65-72 with GM Round Head Keys CL-135

Camaro

1967 Camaro Trunk Cylinders have wide notches at 3 & 9 o'clock position. If your original cylinder has notches at 12 & 6 o'clock, or if you are using a reproduction Rear Body Panel, use the 1968 Camaro Cylinder.

- 67 with GM Pear Head Keys CL-135A
- 67 with GM Round Head Keys CL-135
- 68 with GM Pear Head Keys CL-136A
- 68-69 with GM Round Head Keys CL-136
- 70 with GM Round Head Key,
7/32" Short Shaft Door Lock Cylinder CL-185
- 70-73 with GM Round Head Key,
7/32" Short Shaft Door Lock Cylinder CL-137
- 74-77 with GM Round Head Key,
3/4" Long Shaft Door Lock Cylinder CL-138
- 78 with GM Round Head Key CL-286
- 79-81 with GM Round Head Key,
3/8" Medium Shaft Door Lock Cylinder CL-139

Firebird

- 67-68 with GM Round Head Keys CL-136
- 67-68 with GM Pear Head Keys CL-135A
- 69 with GM Round Head Keys CL-474
- 70-73 with GM Round Head Keys CL-194
- 74-78 with GM Round Head Keys CL-136
- 79-81 with GM Round Head Keys CL-135

CAMARO TRUNK LOCK CYLINDER HOLES

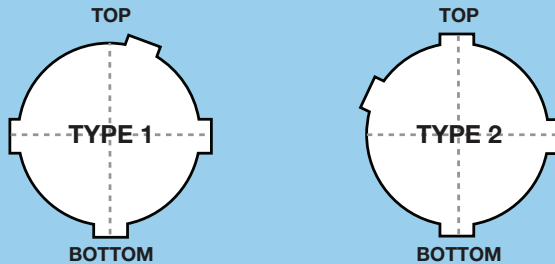

early 67 with original rear body panel only

late 67 & 67 with reproduction rear body panel also 68-69



Our Name Says It All!™



All of our own **AMD** parts in this catalog are listed in **Blue, bold-face Type**.

Lock Cylinder Kits

Door Lock Cylinder Kits

For Both Doors

Nova

- 62-66 with GM Pear Head Keys..... CL-109B
- 62-68 with GM Round Head Keys..... CL-109
- 67-68 with GM Pear Head Keys..... CL-109A

Chevelle

- 62-66 with GM Pear Head Keys..... CL-109B
- 65-72 with GM Round Head Keys, Also fits 64 Chevelle... CL-109
- 67-68 with GM Pear Head Keys..... CL-109A

El Camino

- 62-66 with GM Pear Head Keys..... CL-109B
- 67-68 with GM Pear Head Keys..... CL-109A

GTO

- 62-66 with GM Pear Head Keys..... CL-109B

Skylark

- 64-68 with GM Pear Head Keys..... CL-109A

Cutlass

- 65-72 with GM Pear Head Keys..... CL-109A

Camaro / Firebird

- 67-82 with GM Round Head Keys,
7/32" Short Shaft for 69-70 Camaro..... CL-109
- 67-68 with GM Pear Head Keys..... CL-109A
- 70-78 with GM Round Head Keys, 3/4" Long Shaft CL-110
- 70-81 with GM Round Head Keys, 3/8" Medium Shaft CL-111

Trunk Lock Cylinder Kits

Nova

- 62-74 with Non-GM Round Head Keys..... CL-1575
Includes Keys, Cylinder, Spring, Shaft, Bracket & Gasket
- 62-67 with GM Pear Head Keys..... CL-112A
- 62-74 with GM Round Head Keys..... CL-112
- 68 with GM Pear Head Keys..... CL-112B

Chevelle

- 64-66 with GM Pear Head Keys..... CL-112A
- 64-66 with Non-GM Round Head Keys..... CL-1575
Includes Keys, Cylinder, Spring, Shaft, Bracket & Gasket
- 67 with GM Pear Head Key CL-113A
- 67 with GM Round Head Key CL-113
- 67 with Non-GM Round Head Keys..... CL-1576
Includes Keys, Cylinder, Spring, Shaft, Bracket & Gasket
- 68 with GM Pear Head Keys..... CL-112B
- 68-72 with GM Round Head Keys..... CL-112
- 68-72 with Non-GM Round Head Keys..... CL-1575
Includes Keys, Cylinder, Spring, Shaft, Bracket & Gasket

GTO

- 64-65 with GM Pear Head Keys..... CL-112A
- 64-65 with GM Round Head Keys..... CL-112
- 66-67 with GM Pear Head Key CL-113A
- 66-67 with GM Round Head Key CL-113
- 66-67 with Non-GM Round Head Keys..... CL-1576
Includes Keys, Cylinder, Spring, Shaft, Bracket & Gasket
- 68-72 with GM Pear Head Keys..... CL-112A
- 68-72 with GM Round Head Keys..... CL-112
- 68-72 with Non-GM Round Head Keys..... CL-1575
Includes Keys, Cylinder, Spring, Shaft, Bracket & Gasket



Trunk Lock Cylinder Kits, continued

Skylark

- 64-65 with GM Pear Head Keys..... CL-112A
- 64-65 with GM Round Head Keys..... CL-112
- 64-65 with Non-GM Round Head Keys..... CL-1575
Includes Keys, Cylinder, Spring, Shaft, Bracket & Gasket
- 66 with GM Pear Head Key CL-113A
- 66 with GM Round Head Key CL-113
- 66 with Non-GM Round Head Keys..... CL-1576
Includes Keys, Cylinder, Spring, Shaft, Bracket & Gasket
- 67-68 with GM Pear Head Keys..... CL-112A
- 67-72 with GM Round Head Keys..... CL-112
- 67-72 with Non-GM Round Head Keys..... CL-1575
Includes Keys, Cylinder, Spring, Shaft, Bracket & Gasket



Cutlass

- 64-68 with GM Pear Head Keys..... CL-112A
- 64-72 with GM Round Head Keys..... CL-112

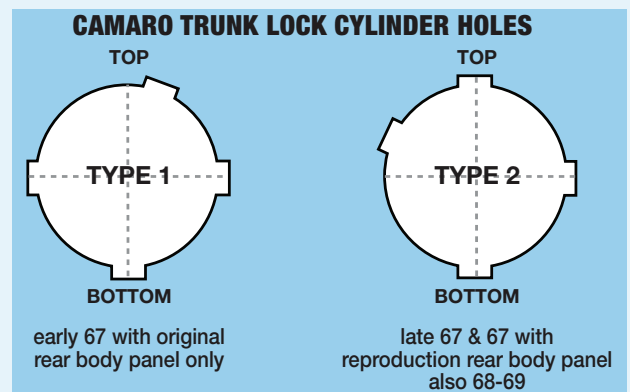

Camaro

1967 Camaro Cylinders have wide notches at 3 & 9 o'clock position. If your original cylinder has notches at 12 & 6 o'clock, or if you are using a reproduction Rear Body Panel, use the 1968 Camaro Cylinder.

- 67 with GM Pear Head Keys..... CL-112A
- 67 with GM Round Head Keys CL-112
- 67 with Non-GM Round Head Keys..... CL-1575
Includes Keys, Cylinder, Spring, Shaft, Bracket & Gasket
- 68 with GM Pear Head Key CL-113A
- 68-69 with GM Round Head Key CL-113
- 68-69 with Non-GM Round Head Keys..... CL-1576
Includes Keys, Cylinder, Spring, Shaft, Bracket & Gasket
- 70-73 with GM Round Head Key CL-114
- 74-77 with GM Round Head Keys..... CL-115
- 78-81 with GM Round Head Key CL-116

Firebird

- 67-68 with GM Pear Head Key CL-113A
- 67-68 with GM Round Head Key CL-113
- 67-68 with Non-GM Round Head Keys..... CL-1576
Includes Keys, Cylinder, Spring, Shaft, Bracket & Gasket
- 69 with GM Round Head Key CL-473
- 70-73 with GM Round Head Keys..... CL-115
- 74-78 with GM Round Head Key CL-113
- 74-78 with Non-GM Round Head Keys..... CL-1576
Includes Keys, Cylinder, Spring, Shaft, Bracket & Gasket
- 79-81 with GM Round Head Keys..... CL-112
- 79-81 with Non-GM Round Head Keys..... CL-1575
Includes Keys, Cylinder, Spring, Shaft, Bracket & Gasket



Our Name Says It All!™

Lock Cylinder Kits

Glove Box Lock Cylinders



Nova

- 62-65 with Case, with GM Round Head Keys CL-163
- 62-65 with Case, with GM Pear Head Keys CL-163A
- 66-67 with Case, with GM Pear Head Keys CL-118A
- 66-67 with Case, with GM Round Head Keys CL-118
- 68 with Case, with GM Pear Head Keys CL-119A
- 68-74 with Case, with GM Round Head Keys CL-119

Chevelle / El Camino

- 64-65 with Case, with GM Round Head Keys CL-145
- 64-65 with Case, with GM Pear Head Keys CL-145A
- 66-67 without Case, with GM Round Head Keys CL-146
- 66-67 without Case, with GM Pear Head Keys CL-146A
- 68 with Case, with GM Pear Head Keys CL-119A
- 68-69 with Case, with GM Round Head Keys CL-119
- 70-72 with Case, with GM Round Head Keys CL-120

GTO

- 68-69 without Case, with GM Round Head Keys CL-146
- 70-72 with Case, with GM Round Head Keys CL-183

Skylark

- 64 without Case, with GM Round Head Keys CL-146
- 64 without Case, with GM Pear Head Keys CL-146A
- 68-70 without Case, with GM Round Head Keys CL-119B
- 71-72 with Case, with GM Round Head Keys CL-119

Cutlass

- 64-67 without Case, with GM Round Head Keys CL-146
- 69-72 with Case, with GM Round Head Keys
(Top Hat Style Knob) CL-119

Camaro

- 67 with Case, with GM Pear Head Keys CL-118A
- 67-68 with Case, with GM Round Head Keys CL-118
- 68 with Case, with GM Pear Head Keys CL-118B
- 70-81 with Case, with GM Round Head Keys CL-120

Firebird

- 67-68 with Case, with GM Pear Head Keys CL-118A
- 67-68 with Case, with GM Round Head Keys CL-118
- 69 without Case, with GM Round Head Keys CL-146
- 70-71 with Case, with GM Round Head Keys CL-183
- 72-81 with Case, with GM Round Head Keys CL-120



Glove Box Lock Assembly

Camaro

- 70-81 without Key (pictured)..... K-3957092

Firebird

- 70-81 without Key (pictured)..... K-3957092



Console Lock Cylinder

Chevelle / El Camino / Monte Carlo

- 70-72 with GM Round Head Keys..... CL-287

GTO

- 64-67 with GM Pear Head Keys..... CL-165A
- 64-67 with GM Round Head Keys..... CL-168
- 68-72 with GM Round Head Keys..... CL-477

Console Keyless Push Button Lock

GTO

- 64-67 CL-490



All of our own **AMD** parts in this catalog are listed in **Blue, bold-face** Type.

Our Name Says It All!™

Hardware Kits

We offer AMK hardware kits to complete your restoration. They have developed many kits consisting of exact copies of original design fasteners. Kits are offered for the body, chassis, and underhood areas of most popular GM models. Hardware is individually bagged and marked for each component section.

AMK Master Body Hardware Sets

Typical kit includes fasteners to attach: back-up lamps, battery tray, bumpers & brackets & guards, bumper filler panel, cowl panel, door latches, fenders & braces & extensions & splash shields, grille & brackets & mouldings, headlamp bezels, housings & adjusters, header panel, hood & hinges, hood levelers, hood catch & lock plate, hood catch support, hood mouldings, license plate brackets, marker lamps, nameplates, parking lamps, taillamps, trunk striker, trunk lid, valance, wheelhouses & latch & brackets.



Nova

64	376-Piece Set.....	H-64NB
65	383-Piece Set.....	H-65NB
66	383-Piece Set.....	H-66NB
67	384-Piece Set.....	H-67NB
68	332-Piece Set.....	H-68NB
69	327-Piece Set.....	H-69NB
70	317-Piece Set.....	H-70NB
71-72	314-Piece Set.....	H-71NB

Chevelle

64	435-Piece Set.....	H-64AB
65	397-Piece Set.....	H-65AB
66	444-Piece Set.....	H-66AB
67	406-Piece Set.....	H-67AB
68	449-Piece Set.....	H-68AB
69	473-Piece Set.....	H-69AB
70	408-Piece Set.....	H-70AB
71-72	374-Piece Set.....	H-71AB

Monte Carlo

70	441-Piece Set.....	H-70MB
71-72	439-Piece Set.....	H-71MB

El Camino

64	456-Piece Set.....	H-64EB
65	426-Piece Set.....	H-65EB
66	469-Piece Set.....	H-66EB
67	409-Piece Set.....	H-67EB
68	444-Piece Set.....	H-68EB
69	477-Piece Set.....	H-69EB
70	444-Piece Set.....	H-70EB
71-72	404-Piece Set.....	H-71EB

Camaro

67	421-Piece Set.....	H-67FB-S
67	RS, 460-Piece Set	H-67FB-RS
68	Standard, 490-Piece Set.....	H-68FB-S
68	RS, 442-Piece Set	H-68FB-RS
69	Standard, 417-Piece Set.....	H-69FB-S
69	RS, 445-Piece Set	H-69FB-RS
70-72	Standard, 368-Piece Set.....	H-70FB-S
70-72	RS, 403-Piece Set	H-70FB-RS
73	Standard, 360-Piece Set.....	H-73FB-S
73	RS, 414-Piece Set	H-73FB-RS
74-76	556-Piece Set.....	H-74FB
77	515-Piece Set.....	H-77FB

AMK Master Body Hardware Sets

Camaro, continued

78	486-Piece Set.....	H-78FB
79	489-Piece Set.....	H-79FB
80-81	491-Piece Set.....	H-80FB

Firebird

67-68	393-Piece Set.....	H-67HB
69	513-Piece Set.....	H-69HB

Master Chassis Hardware Sets

Typical kit includes fasteners to attach: accelerator lever & support; axle housing, springs, and retainer plates; brake booster, hose, brake cables, brake plates, brake hose retainers & brackets, brake valve & pressure switch, calipers, brackets & shields; upper & lower control arms, control arm bushings; differential cover; driveshaft; engine mounts; fuel filler neck cover; fuel hoses; gas tank; grease fittings; idler arm; leaf spring hangers & front eye; master cylinder & push rod; parking brake control; pitman arm; radius rod & bracket & bumper; shackles (nuts); shocks & brackets; stabilizer bar brackets & end links (includes rubber); steering gear & rag joint; steering linkage & ball joints; speedometer cable, trans, suspension bumper; trans crossmember & insulator; wheel cylinders.



Nova

64-65	283/327 with Drum Brakes, 448-Piece Set.....	H-64NS-SB
66	283/327 with Drum Brakes, 443-Piece Set	H-66NS-SB
67	283/327 with Disc Brakes, 454-Piece Set.....	H-67NS-DCSB
67	283/327 with Drum Brakes, 449-Piece Set.....	H-67NS-DRSB

with Drum Brakes & Mono-Leaf Springs

68	307/327/350, 338-Piece Set	H-68NS-DRSB1
69	307/350, 348-Piece Set.....	H-69NS-DRSB1
70	307/350, 346-Piece Set.....	H-70NS-DRSB1
71-72	307/350, 346-Piece Set.....	H-71NS-DRSB1

with Drum Brakes & Multi-Leaf Springs

68	307/327/350, 336-Piece Set	H-68NS-DRSB4
68	307/327/350, 343-Piece Set	H-68NS-DCSB4
69	307/350, 352-Piece Set.....	H-69NS-DRSB4
70	307/350, 350-Piece Set.....	H-70NS-DRSB4
71-72	307/350, 350-Piece Set.....	H-71NS-DRSB4

with Disc Brakes & Mono-Leaf Springs

68	307/327/350, 345-Piece Set	H-68NS-DCSB1
69	307/350, 345-Piece Set.....	H-69NS-DCSB1
70	307/350, 344-Piece Set.....	H-70NS-DCSB1
71-72	307/350, 344-Piece Set.....	H-71NS-DCSB1

with Disc Brakes & Multi-Leaf Springs

68	396, 344-Piece Set.....	H-68NS-BB
69	307/350, 351-Piece Set.....	H-69NS-DCSB4
69	396, 352-Piece Set.....	H-69NS-BB
70	307/350, 374-Piece Set.....	H-70NS-DCSB4
70	396, 375-Piece Set.....	H-70NS-BB
71-72	307/350, 374-Piece Set.....	H-71NS-DCSB4



Our Name Says It All!™

Hardware Kits

Master Chassis Hardware Sets, continued

Chevelle

with Drum Brakes

64-67	283/327, 331-Piece Set.....	H-64AS-SB
65-67	396, 339-Piece Set.....	H-65AS-BB
68	307/327, 341-Piece Set.....	H-68AS-DRSB
69	307/350, 339-Piece Set.....	H-69AS-DRSB
70	307/350, 335-Piece Set.....	H-70AS-DRSB
71-72	307/350, 337-Piece Set.....	H-71AS-DRSB

with Disc Brakes

67	283/327, 340-Piece Set.....	H-67AS-DCSB
67	396, 338-Piece Set.....	H-67AS-BB
68	307/327, 345-Piece Set.....	H-68AS-DCSB
68	396, 345-Piece Set.....	H-68AS-BB
69	307/350, 337-Piece Set.....	H-69AS-DCSB
69	396, 349-Piece Set.....	H-69AS-BB
70	307/350, 333-Piece Set.....	H-70AS-DCSB
70	396/454, 349-Piece Set.....	H-70AS-BB
71-72	307/350, 337-Piece Set.....	H-71AS-DCSB
71-72	396/454, 349-Piece Set.....	H-71AS-BB

Monte Carlo

with Disc Brakes

70	307/350, 331-Piece Set.....	H-70MS-SB
70	396/454, 346-Piece Set.....	H-70MS-BB
71-72	307/350, 332-Piece Set.....	H-71MS-SB
71-72	396/454, 347-Piece Set.....	H-71MS-BB

Camaro

with Drum Brakes & Mono-Leaf Springs

67	327/350, 343-Piece Set.....	H-67FS-DRSB
68	327/350, 341-Piece Set.....	H-68FS-DRSB1
69	307/327/350, 356-Piece Set.....	H-69FS-DRSB1

with Drum Brakes & Multi-Leaf Springs

68	327/350, 339-Piece Set.....	H-68FS-DRSB4
69	307/327/350, 354-Piece Set.....	H-69FS-DRSB4

with Disc Brakes & Mono-Leaf Springs

67	327/350, 351-Piece Set.....	H-67FS-DCSB
67	396, 352-Piece Set.....	H-67FS-BB
67	396HP, 375-Piece Set.....	H-67FS-L78
67	Z-28, 374-Piece Set.....	H-67FS-Z28
68	327/350, 349-Piece Set.....	H-68FS-DCSB1
69	307/327/350, 346-Piece Set.....	H-69FS-DCSB1

with Disc Brakes & Multi-Leaf Springs

68	302/327/350, 347-Piece Set.....	H-68FS-DCSB4
68	396, 348-Piece Set.....	H-68FS-BB
69	307/327/350, 354-Piece Set.....	H-69FS-DCSB4
69	396, 361-Piece Set.....	H-69FS-BB
70-71	307/350, 347-Piece Set.....	H-70FS-SB
70-71	307/350, with Sway, 347-Piece Set.....	H-70FS-F41SB
70-71	396, with Sway, 350-Piece Set.....	H-70FS-BB
72	307/350, 339-Piece Set.....	H-72FS-SB
72	307/350, with Sway, 357-Piece Set.....	H-72FS-F41SB
72	396, with Sway, 360-Piece Set.....	H-72FS-BB
73	307/350, 345-Piece Set.....	H-73FS-SB
73	307/350, with Sway, 363-Piece Set.....	H-73FS-F41SB

Underhood Detailing Hardware Kit, Large

Typical kit includes fasteners to attach items common to every engine bay: accelerator lever & support, battery hold-down clamp, brake booster, clutch push rod seal, control arm bushings, fender tie bar, fender to firewall & radiator support, fuel vapor canister, grille brackets & mouldings, headlamp grounds, heater box, heater hose clips (included) at wheelhouse & alternator bracket, hood catch & lock plate, hood and hinges, hood levelers, horn and relay, master cylinder, radiator & fan shroud, radio ground straps, vacuum hoses, voltage regulator & ground wire, wiper motor (includes insulators), washer bottle & bracket, washer nozzles, wheel-houses to fenders, wiring at blower motor, wiring gutter at firewall, wiring harness to radiator support & wheelhouse.



Nova

64	167-Piece Set.....	H-64N-UH
65	175-Piece Set.....	H-65N-UH
66	166-Piece Set.....	H-66N-UH
67	171-Piece Set.....	H-67N-UH
68	154-Piece Set.....	H-68N-UH
69	161-Piece Set.....	H-69N-UH
70	150-Piece Set.....	H-70N-UH
71	140-Piece Set.....	H-71N-UH
72	145-Piece Set.....	H-72N-UH

Chevelle / El Camino

64	152-Piece Set.....	H-64A-UH
65	154-Piece Set.....	H-65A-UH
66	143-Piece Set.....	H-66A-UH
67	159-Piece Set.....	H-67A-UH
68	131-Piece Set.....	H-68A-UH
69	113-Piece Set.....	H-69A-UH
70	118-Piece Set.....	H-70A-UH
71	121-Piece Set.....	H-71A-UH
72	119-Piece Set.....	H-72A-UH

Monte Carlo

70	118-Piece Set.....	H-70A-UH
71	121-Piece Set.....	H-71A-UH
72	119-Piece Set.....	H-72A-UH

Camaro

67	RS, 136-Piece Set.....	H-67F-RUH
67	Standard, 141-Piece Set.....	H-67F-UH
68	RS, 154-Piece Set.....	H-68F-RUH
68	Standard, 151-Piece Set.....	H-68F-UH
69	RS, 177-Piece Set.....	H-69F-RUH
69	Standard, 157-Piece Set.....	H-69F-UH
70	111-Piece Set.....	H-70F-UH
71	101-Piece Set.....	H-71F-UH
72	102-Piece Set.....	H-72F-UH
73	RS, 137-Piece Set.....	H-73F-RUH
73	Standard, 114-Piece Set.....	H-73F-UH



Our Name Says It All!™



All of our own **AMD** parts in this catalog are listed in **Blue, bold-face Type**.

Hardware Kits & Hardware

Underhood Detailing Hardware Kit, Small

Typical kit includes fasteners to attach items common to every engine bay: battery holddown clamp, headlamp grounds, heater box, heater hose clips (included) at wheelhouse & alternator bracket, horn & relay, radiator & fan shroud, radio ground straps, vacuum hoses, voltage regulator & ground wire, wiper motor (includes insulators), washer bottle & bracket, washer nozzles, wiring at blower motor, wiring gutter at firewall, wiring harness, radiator support & wheelhouse.

Nova

64-66	58-Piece Set.....	H-64N-XU
67	61-Piece Set.....	H-67N-XU
68	61-Piece Set.....	H-68N-XU
69	60-Piece Set.....	H-69N-XU
71	48-Piece Set.....	H-71N-XU
72	50-Piece Set.....	H-72N-XU

Chevelle / El Camino

64	59-Piece Set.....	H-64A-XU
65	59-Piece Set.....	H-65A-XU
66	64-Piece Set.....	H-66A-XU
67	66-Piece Set.....	H-67A-XU
68	59-Piece Set.....	H-68A-XU
69	61-Piece Set.....	H-69A-XU
70	55-Piece Set.....	H-70A-XU
72	53-Piece Set.....	H-72A-XU

Monte Carlo

70	55-Piece Set.....	H-70A-XU
72	53-Piece Set.....	H-72A-XU

Camaro

67	RS, 66-Piece Set	H-67F-RXU
67	Standard, 62-Piece Set.....	H-67F-XU
68	RS, 74-Piece Set	H-68F-RXU
68	Standard, 64-Piece Set.....	H-68F-XU
69	RS, 85-Piece Set	H-69F-RXU
69	Standard, 62-Piece Set.....	H-69F-XU
70	52-Piece Set.....	H-70F-XU
71	49-Piece Set.....	H-71F-XU
72	50-Piece Set.....	H-72F-XU
73	62-Piece Set.....	H-73F-XU

Hardware

3/16" Speed Nut, Sold each	K-11501047
1/8" Speed Nut, Sold each	K-11502547
5/16" Speed Nut Kit, Set of 4	K-K423
5/16" Sped Nut Kit, Set of 8 (pictured).....	K-K424
GM Door Latch Attaching Screws, Set of 3	C-H2-2238
GM Hex Head Door Hinge Bolt	C-H-2618
GM Flat Head Countersunk Door Hinge Bolt	C-H-2628
GM Screws, Armrest Base to Door Panel, 25-Piece Set	C-J-2198
Window Clip and Molding Stud, Replacement, 10-Piece Set	H-137



El Camino

64-72 Tailgate & Rear Bed Panel Fasteners, 28-Piece Set.....	P-TLK010
---	----------

Miscellaneous

Headliner Installation Tool	W-758
Window & Door Handle Removal Tool	W-312

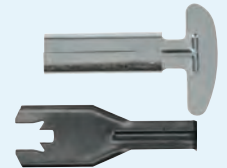

Steel Patch

36" X 21 1/2", .050 or 18 to 19 Gauge Uncoated Steel Sheet.....	PATCH-2
36" X 43", .050 or 18 to 19 Gauge Uncoated Steel Sheet.....	PATCH-1

Poster

69 Camaro Pace Car Poster	W-159
---------------------------------	-------

Adhesives

3M Weatherstrip Adhesive, Black	J-3M08008
Sticky Stuff Spray Adhesive, for Heat & Sound	J-INSULADH



Our Name Says It All!™

Parking Lamps & Parts

AMD offers a wide selection of parking lamps, lenses, housings, gaskets, and hardware. Most have the correct Guide markings and are officially licensed through the GM Restoration Parts Program. AMD features parts from CHQ, OER, OPGI, Soff Seal, Trim Parts, and TWE.

Parking Lamp Assemblies

Nova

- 62 LH (pictured).....C-E-2140
- 62 RH C-E-2142
- 63-64 Amber Lens, LH
(pictured)C-E-2145
- 63-64 Amber Lens, RH C-E-2147
- 65 Amber Lens, LH C-E-2150
- 65 Amber Lens, RH..... C-E-2154
- 66-67 Amber Lens, LH
(pictured)C-E-2160
- 66-67 Amber Lens, RH..... C-E-2164
- 68-69 LH=RH, Sold each C-E-2170
- 70 Clear, LH=RH, Sold each (pictured)C-E-2190
- 71-72 LH=RH, Sold each C-E-2195



Chevelle / El Camino

- 65 LH (pictured)C-E-2300
- 65 RH C-E-2304
- 66 LHC-E-2340
- 66 RH C-E-2344
- 67 LH C-E-2351
- 67 RH C-E-2352
- 68 LH=RH, Sold each C-E-23589
- 69 non-SS, LH C-E-2372
- 69 non-SS, RH C-E-23739
- 69 SS, LH (pictured)C-E-2366
- 69 SS, RH C-E-2367
- 70 Chevelle, Non-SS,
LH=RH, Sold eachC-E-2361



Camaro

- 67 Standard, LH
(pictured) W-280
- 67 Standard,
RH W-279
- 68 Standard,
Sold each .. W-510
- 69 Standard, Add W-121 Trim for
RS Option, Sold each W-496
- 70-73 Standard, LH (pictured)..... K-917169
- 70-73 Standard, RH K-917170
- 70-73 RS, Sold each K-917034
- 74-77 Sold each K-928168
- 78-81 Standard, Lens / Housing, Sold each..... K-913641
- 78-81 Z/28, Lens / Housing, Sold each..... K-913361



Firebird

- 77-78 LH (right) T-A8570
- 77-78 RH T-A8571



Parking Lamp Housings

Camaro

- 67 Standard, with Socket &
Ground Wire, LH W-438
- 67 Standard, with Socket &
Ground Wire, RH W-439
- 67 RS, LH
(pictured).... W-291
- 67 RH... W-290
- 68 Standard, with Ground Wire,
Sold each
(pictured).... W-510A
- 68 RS, with Bumper,
LH W-350
- 68 RS, with Bumper,
RH W-351



Parking Lamp Lenses

Nova

- 62 Clear, LH/RH Pair (pictured, left) T-A3043
- 63-64 Amber, LH/RH Pair (pictured, right)..... T-A3044
- 65 Amber, LH/RH Pair T-A3045
- 66-67 Amber, LH/RH Pair T-A3046
- 68-69 Amber, LH/RH Pair T-A3055
- 70 Clear, LH/RH Pair T-A3060
- 71-72 Amber, LH/RH Pair T-A3061
- 73-74 with Hardware, LH=RH, Sold each C-A2-7374-2



Chevelle

- 64 Amber, LH/RH Pair (pictured, left) T-A4247
- 64 Clear, LH/RH Pair, Correct for Acadian
(pictured, right) T-A4247C
- 65 Amber, LH/RH Pair T-A4248
- 66 Amber, LH/RH Pair T-A4249
- 66 Clear, LH/RH Pair T-A4249C
- 67 Amber, LH/RH Pair T-A4250
- 67 Clear, LH/RH Pair T-A4250C
- 68 Amber, LH/RH Pair T-A4505
- 68 Clear, LH/RH Pair T-A4505C
- 69 Clear, without Trim & Paint,
LH/RH Pair T-A4252
- 69 SSber, LH/RH Pair T-A4275



- 70 SS, Clear, LH/RH Pair (far left) T-A4278
- 71 LH/RH Pair (pictured, center left)..... T-A4280
- 72 Amber, First Design, LH/RH Pair
(pictured, center right) T-A4300
- 72 Clear, Second Design, LH/RH Pair
(pictured, far right) T-A4310



Parking Lamp Lenses, continued



Our Name Says It All!™



All of our own **AMD** parts in this catalog are listed in **Blue, bold-face Type**.

Parking Lamps & Parts

El Camino



- | | | | |
|----|--|--|----------|
| 64 | Amber, LH/RH Pair | | T-A4247 |
| 64 | Clear, LH/RH Pair,
Correct for Acadian | | T-A4247C |
| 65 | Amber, LH/RH Pair | | T-A4248 |
| 66 | Amber, LH/RH Pair | | T-A4249 |
| 67 | Amber, LH/RH Pair | | T-A4250 |
| 70 | LH/RH Pair (pictured, far left)..... | | T-A4820 |
| 71 | LH/RH Pair (pictured, center left)..... | | T-A4825 |
| 72 | Amber, 1st Design, LH/RH Pair
(center, right) | | T-A4850 |
| 72 | Clear, 2nd Design, LH/RH Pair
(far right) | | T-A4860 |

Camaro



- | | | | |
|-------|---|--|---------|
| 67 | Standard, Round with Chrome Center,
Sold each (pictured, left) | | W-145 |
| 67-68 | RS, LH/RH Pair | | W-115 |
| 68 | Standard, with Stainless Trim, Sold each
(pictured, right) | | W-437 |
| 69 | Standard, add W-121 Trim for
RS Option, Sold each | | W-494 |
| 70-73 | Standard, LH/RH Pair | | K-K332 |
| 70-73 | Except RS, LH/RH Pair..... | | T-A6751 |
| 70-73 | RS, with Trim, LH/RH Pair..... | | T-A6750 |

Firebird

- | | | | |
|----|------------------|--|-----------|
| 68 | LH (right) | | K-5960531 |
| 68 | RH | | K-5960532 |



Parking Lamp Bezels

Nova

- | | | | |
|-------|---|--|-------------|
| 62-64 | LH/RH Pair | | K-K116 |
| 73-74 | Sold each | | C-A2-7374-3 |
| 62-64 | Bezel Extension | | |
| 62-64 | Bezel Extension Molding,
LH/RH Pair (pictured) | | C-D2-1150 |



Chevelle

- | | | | |
|----|----------|--|----------|
| 71 | LH | | C-G-1430 |
| 71 | RH | | C-G-1440 |
| 72 | LH | | C-G-1470 |
| 72 | RH | | C-G-1480 |

El Camino

- | | | | |
|----|--------------------|--|----------|
| 71 | LH (pictured)..... | | C-G-1450 |
| 71 | RH | | C-G-1460 |
| 72 | LH | | C-G-1490 |
| 72 | RH | | C-G-1495 |



Camaro

- | | | | |
|-------|-------------------------------|--|----------|
| 78-81 | Standard, LH (pictured) | | K-459153 |
| 78-81 | Standard, RH | | K-459154 |
| 78-81 | Z/28, Black, LH | | K-468033 |
| 78-81 | Z/28, Black, RH | | K-468034 |

Firebird

- | | | | |
|-------|----------------------------|--|-----------|
| 69-73 | Sold each (pictured) | | K-5960557 |
|-------|----------------------------|--|-----------|

Parking Lamp Trim

Camaro

- | | | | |
|-------|--|--|----------|
| 69 | RS, Stainless, LH/RH Pair
(pictured)..... | | W-121 |
| 70-73 | Standard, LH/RH Pair | | K-K393 |
| 74-77 | Sold each | | K-337452 |



Parking Lamp Lens Gaskets

Nova

- | | | | |
|-------|-------------------|--|--------|
| 62-64 | LH/RH P air | | J-4150 |
| 65-67 | LH/RH P air | | J-4151 |
| 68-69 | LH/RH P air | | J-4157 |
| 70-72 | LH/RH P air | | J-4160 |

Chevelle

- | | | | |
|-------|------------------------|--|--------|
| 64 | LH/RH P air | | J-2168 |
| 65 | LH/RH P air | | J-4151 |
| 67-68 | LH/RH P air | | J-5191 |
| 69 | LH/RH P air | | J-5198 |
| 70 | LH/RH P air | | J-5200 |
| 71-72 | LH/RH P air | | J-5203 |
| 71-72 | Wagon, LH/RH Pair..... | | J-5202 |

El Camino

- | | | | |
|-------|-------------------|--|---------|
| 64 | LH/RH P air | | J-2168 |
| 65 | LH/RH P air | | J-4151 |
| 67-68 | LH/RH P air | | J-5191 |
| 69 | LH/RH P air | | J-51991 |
| 70 | LH/RH P air | | J-5238 |
| 71-72 | LH/RH P air | | J-5202 |

Monte Carlo

- | | | | |
|----|-------------------|--|--------|
| 70 | LH/RH P air | | J-5238 |
| 72 | LH/RH P air | | J-5242 |

Camaro



- | | | | |
|-------|---|--|--------|
| 67 | Standard, LH/RH Pair | | W-281 |
| 67 | RS, Housing Seal, LH/RH Pair | | W-207 |
| 67-68 | RS, LH/RH Pair (pictured, left)..... | | W-227 |
| 68 | Standard, LH/RH Pair
(pictured, right) | | W-282 |
| 69 | Standard & RS, LH/RH Pair..... | | W-283 |
| 70-73 | Standard, LH/RH Pair | | J-3053 |
| 70-73 | RS, Lens to Housing Gasket,
LH/RH Pair | | W-020 |

Firebird

- | | | | |
|----|------------------|--|--------|
| 68 | LH/RH Pair | | J-6461 |
|----|------------------|--|--------|

Chevy Full Size

- | | | | |
|----|------------------|--|--------|
| 64 | LH/RH Pair | | J-2168 |
|----|------------------|--|--------|



Our Name Says It All!™

Parking Lamps & Parts

Parking Lamp Hardware

Nova

70-74 Screws, 4-Piece Set K-K5241

Camaro

Brackets

67 RS, Brackets, LH/RH Pair . W-224

Screw Sets

67-68 RS, 4-Piece Set
(pictured, top) W-226

68-69 Standard, 4-Piece Set... K-K5241

69 Standard & RS, 6-Piece Set
(pictured, bottom)..... W-292A

70-73 Standard, Set..... K-596269E

70-73 RS, 4-Piece Set K-K5241

Bolt Set

68 Standard, H-147



Parking Lamp Hardware, continued

Camaro

Miscellaneous

67 RS or Standard, Nuts, 4-Piece Set..... H-146

67-69 RS, 2 Hole Wiring Grommet..... W-516

68 RS, Housing Rubber Bumper, Sold each W-351B

Chevy Full Size

67-69 Screws, 4-Piece Set K-K5241

GM

Screws, 1 1/4" Long, Package of 25 C-E-5016

Screws, 1" Long, Package of 25 C-E-5012

Screws, 3/4" Long, Package of 25 C-E-5010

Screws, 5/8" Long, Package of 25 C-E-5014

Rally Sport Hide-Away Headlamps

AMD carries all of the parts that you need to add the desirable Rally Sport hide-away headlamp option to your first generation Camaro. We offer every part from a complete kit to the fender adapter kit... all from CHQ. Adds beauty and value to your Camaro.

Headlamp System

Camaro



67 RS, LH/RH Set (pictured) W-906

67 RS, LH/RH Set, without Chrome Edge W-907

68 RS, LH/RH Set, with Chrome Edge W-908

69 RS, LH/RH Set..... W-909

Headlamp Assembly

Camaro



67 RS, LH (pictured, left) W-473

67 RS, RH W-472

68 RS, Black, LH (pictured, right) W-475

68 RS, Black, RH..... W-474

68 RS, with Chrome Door Edge, LH..... W-681

68 RS, with Chrome Door Edge, RH..... W-680

69 RS, LH W-501

69 RS, RH W-500

Headlamp Housing

Camaro



67 RS, LH (pictured, left) W-469

67 RS, RH W-468

68 RS, LH (pictured, center)..... W-471

68 RS, RH W-470

69 RS, LH (pictured, right) W-252B

69 RS, RH W-252A



Our Name Says It All!™



All of our own **AMD** parts in this catalog are listed in **Blue, bold-face Type**.

Rally Sport Hide-Away Headlamps

Headlamp Door Cover

Camaro

- 67 RS, Black, LH (pictured) W-925
- 67 RS, Back, RH..... W-924
- 68 RS, with Chrome Edges,
LH/RH Pair W-921
- 68 RS, Black, LH..... W-923
- 68 RS, Black, RH..... W-922



Headlamp Door

Camaro

- 67-68 RS, Inner, LH (pictured, left).....W-2622
- 67-68 RS, Inner, RH.....W-261
- 69 RS, Inner, LH (pictured, right).....W-172B
- 69 RS, Inner, RH.....W-172A

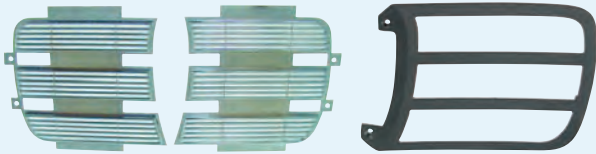

- 69 RS, Inner, Chrome, LH/RH Pair (pictured, left) W-579
- 69 RS, Inner, Chrome, LH..... W-579B
- 69 RS, Inner, Chrome, RH..... W-579A
- 69 RS, Outer, LH (pictured, right)..... W-102B
- 69 RS, Outer, RH..... W-102A

Headlamp Door Hinge

Camaro

- 69 RS, sold each
(pictured)..... W-189
- 67-69 RS, Hinge Bolt with Nut..... W-164
- 67-68 RS, Headlamp Door Hinge Plate,
LH=RH, Sold each W-389



Headlamp Door Hardware

- 68 RS, Door Stop Bracket, 32-Piece Set
(pictured, left) W-399
- 68-69 RS, Headlamp Door Bumper, 4-Piece Set W-386
- 69 RS, Headlamp Door Stop / Core Support
Bracket, LH/RH Pair (pictured, right) W-809



Headlamp Door Bolt

Camaro

- 67-69 RS, Shouldered W-154
- 67-69 RS, Shouldered, 3-Piece Set W-154B

Headlamp Vacuum Actuator

Camaro

- 68-69 RS,
Sold each ..  W-299



Headlamp Actuator Support Bracket

Camaro

- 69 RS, LH/RH Pair (top) W-103
- 69 RS, LH W-103A
- 69 RS, RH..... W-103B
- 68 RS, Rear, Large
(Fender Well to Extension),
LH/RH Pair (center)..... W-754
- 68 RS, Rear, LH..... W-754B
- 68 RS, Rear, RH..... W-754A
- 68-69 RS, Rear, Small,
2 required (bottom)..... W-105



Headlamp Actuator Shield

Camaro

- 68 RS, LH/RH Pair..... W-137C
- 68 RS, LH W-137A
- 68 RS, RH W-137B
- 69 RS, LH/RH Pair..... W-138C
- 69 RS, LH W-138A
- 69 RS, RH..... W-138B

Headlamp Actuator Parts

Camaro

- 67 RS, Bushing, 10-Piece Set (pictured, left) W-184
(Rebuilds both Headlamps)
- 67 RS, Bushing & Motor Friction Disc,
14-Piece Set (center)..... W-184A
(Rebuilds both Headlamps)
- 68-69 RS, Headlamp Bushing, 24-Piece Set
(top, right)W-185
(Includes: bushings, wave washers &
clevis pin bushings)
- 68-69 RS, Dust Boot, Sold each (right) W-299A



- 68-69 RS, Headlamp Actuator Clevis, Front & Rear Pin,
Clips&Bushings, 6-PieceSet (pictured, left) W-195C
- 68-69 RS, Actuator Clevis, Front & Rear,
2-Piece Pin Set (pictured, center) W-195
- 68-69 RS, Headlamp Actuator Pin, 4-Piece Set (right) W-195A



- 68-69 RS, Headlamp Vacuum Tank
(pictured, right) W-348
- 69 RS W-349

Headlamp Vacuum Tank

Camaro

- 68 RS (pictured) W-348
- 69 RS W-349



Our Name Says It All!™

Rally Sport Hide-Away Headlamps

Headlamp Vacuum Hose & Parts

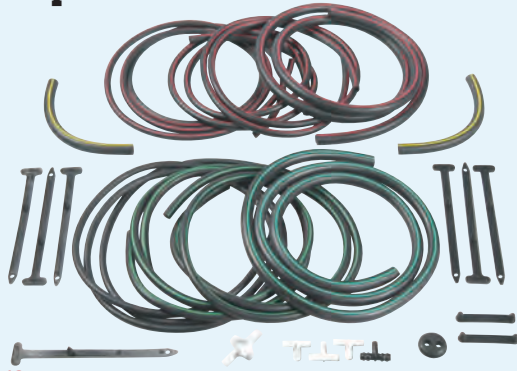

Camaro

- 68 RS, Color Coded Hose Set (pictured) W-337
- 69 RS, Color Coded Hose Set W-336
- 68-69 RS, Hose Firewall Grommet W-326
- 69 RS, Vacuum Line Check Valve W-498

Vacuum Hose In-Line Filter

- 68-69 with AC Logo W-573
- 68-69 without AC Logo W-574

Full Size Chevy

- 68 Headlamp Vacuum Line Check Valve W-498
- 68 Headlamp 2-Port Vacuum Switch W-935
- 68-69 Headlamp Vacuum Relay Valve (pictured) W-776

Vacuum Hose In-Line Filter

- 68-69 with AC Logo W-573
- 68-69 without AC Logo W-574

Headlamp Motor

Camaro

- 67 RS, LH (pictured) W-916
- 67 RS, RH W-917



Headlamp Motor Housing

Camaro

- 67 RS W-136

Headlamp Motor Drive Washers

- 67 RS, Teflon, 4-Piece Set, does both sides W-186
- 67 RS, Steel, 4-Piece Set, does both sides W-187
- 67 RS, Steel, Washer & Nut, 8-Piece Set, does both sides W-187A

Headlamp Motor Hardware

Camaro RS

- 67 Teflon Washers, 4-Piece Set (Does both sides) W-186
- 67 Steel Drive Washers, 4-Piece Set (Does both sides) W-187
- 67 Steel Drive Washer & Nuts, 8-Piece Set (Does both sides) W-187A
- 67 Drive Arm, LH=RH, Sold each W-388

Headlamp Bellcrank

Camaro

- 68 RS, LH/RH Pair (pictured) W-181
- 68 RS, LH W-181B
- 68 RS, RH W-181A



- 69 RS, (Shaft & Lever), LH/RH Pair W-104
- 69 RS, (Shaft & Lever) RH ... W-104A
- 69 RS, (Shaft & Lever) LH W-104B

Headlamp Bellcrank Brackets

Camaro

- 68 RS, End Bracket, 6-Piece Set (No springs, Does both sides) (pictured) W-175
- 68 RS, Over Center Bracket / Spring, 9-Piece Set (pictured) W-175C
- 68 RS, Support Bracket, LH/RH Pair W-161
- 69 RS, Support Bracket, LH/RH Pair (right) W-162



Headlamp Bellcrank Over Center Spring

Camaro

- 68 RS, Black, LH/RH Pair W-175B
- 69 RS, Plated, LH/RH Pair W-175A

Headlamp Limit Switch

Camaro

- 67 RS, with Pigtail (pictured) W-205
- 67 RS, Switch Mounting Hardware, (pictured) W-398
- 67 RS, Switch Mounting Hardware, 32-Piece Set W-398A

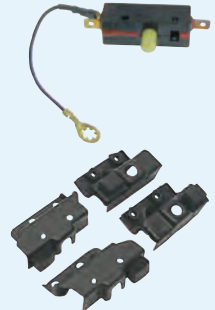

Headlamp Electric Parts

Camaro

- 67 RS, Relay, with Stamped Delco Remy Script W-784
- 67 RS, Relay Board Assembly with Circuit Breaker & Correct Stamping (pictured) W-806
- 67 RS, Relay Mounting Plate W-546
- 67 RS, 10 Amp Circuit Breaker (other GM 10 Amp applications) W-558
- 68-69 RS, 2-Port Vacuum Switch W-935
- 68-69 RS, Vacuum Relay Valve W-776



Headlamp Washer Parts

Camaro

- 69 RS, 4 Nozzles with Hardware (pictured) W-158
- 69 Headlamp Washer Hardware, 8-Piece Set W-158A
- 69 Headlamp Washer Nozzle, 4-Piece Set W-158B



Our Name Says It All!™



All of our own **AMD** parts in this catalog are listed in **Blue, bold-face Type**.

Side Marker Lamps

Side Marker Lamp Assembly Sets

Camaro

Set, Front & Rear

Includes: Lamps, Bezels, Gaskets, Hardware

- 68 20-Piece Set W-948A
- 69 20-Piece Set
(pictured)..... W-768A



Set, Front & Rear

Includes: Lamps & Bezels

- 68 8-Piece Set..... W-948
- 69 8-Piece Set..... W-768



Front Side Marker Lamp Assemblies

Nova

- 68 Clear Lens
(pictured)....  W-946
- 69 Sold each C-E-2353
- 70-74 Amber Lens,
LH/RH Pair..... K-911283



Chevelle

- 68 Clear Lens  W-946
- 69 Amber Lens
(pictured, right)
 W-767
- 70 LH/RH Pair
(pictured, below)..... C-E-2440







El Camino

- 69 Amber Lens
(pictured, above)..... W-767
- 70 LH/RH Pair
(pictured, below)..... C-E-2440



Camaro

- 68 Clear Lens  W-946
- 69 Amber Lens,
(pictured).....  T-A6730
- 70-73 Light Amber, LH/RH Pair.....  T-A6740
- 74-77 Dark Amber, LH/RH Pair  T-A6742
- 78-81 Sold each  K-913180



Firebird

- 70-81 LH
(pictured)....  T-8561
- 70-81 RH  T-8562









Chevy Full Size

- 68 Clear Lens  W-946
- 69 Sold each C-E-2353

Front Marker Lamp Bezels









Nova

- 68-69 Sold each
(pictured)....  W-795
- 68-69 "307",
LH/RH Pair  T-4520
- 68-69 "327", LH/RH Pair.....  T-4521
- 68-69 "350", LH/RH Pair.....  T-4522
- 68-69 "396", LH/RH Pair.....  T-4523
- 68-69 "427", LH/RH Pair.....  T-4524
- 70-74 Sold each  K-3962933







Front Marker Lamp Bezels, continued

Chevelle

- 68 Sold each  W-795
- 68 "307", LH/RH Pair.....  T-4520
- 68 "327", LH/RH Pair.....  T-4521
- 68 "350", LH/RH Pair.....  T-4522
- 68 "396", LH/RH Pair.....  T-4523
- 68 "427", LH/RH Pair.....  T-4524
- 69 Front & Rear, with Centered Studs,
Sold each C-G-1260
- 69 "250", Includes Fasteners  T-4605
- 69 "307", Includes Fasteners  T-4606
- 69 "350", Includes Fasteners  T-4607

El Camino

- 68 "307",
LH/RH Pair  T-4520
- 68 "327",
LH/RH Pair  T-4521
- 68 "350",
LH/RH Pair  T-4522
- 68 "396",
LH/RH Pair  T-4523
- 68 "427",
LH/RH Pair  T-4524

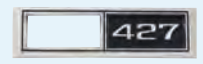

Camaro

- 68 Sold each ..  W-795
- 69 Sold each (pictured)..... W-796
- 78-81 Sold each ..  K-459120



Firebird

- 70-81 LH, Sold each (right).... K-479084
- 70-81 RH, Sold each K-479083



Chevy Full Size

- 68-69 Sold each  W-795

Front Side Marker Lamp Gaskets

Nova

- 68-69 LH/RH Pair
(pictured)..... W-947
- 70-74 Front & rear Set..... J-4161



Chevelle

- 68 LH/RH Pair (pictured) W-947
- 69 4-Piece Set..... W-777

Camaro

- 68 LH/RH Pair W-947
- 69 4-Piece Set..... W-777
- 70-73 Front & Rear Set J-3051
- 74-77  T-A6740G
- 78-81 2-Piece Set..... K-5963134
- Side Marker Stud Gasket..... K-5967657

Firebird





- 70-81 Front or Rear, 2-Piece Set..... K-5963134
- 78-81 Front & Rear Side Marker Stud Gasket..... K-5967657

Chevy Full Size

- 69 LH/RH Pair (pictured)..... W-947

Rear Side Marker Lamp Assembly

Firebird

- Lens, Bezel, Gasket*
- 68 LH/RH Pair  K-K106801
- Lens, Housing, Gasket*
- 69 Sold each ..  K-5961775
- 70-81 LH
(pictured)....  T-8563
- 70-81 RH  T-8564



Our Name Says It All!™

Side Marker Lamps

Rear Side Marker Lamp

Lens & Housing

Nova

- 68-69 Sold each
(pictured) W-945
70-74 LH/RH Pair K-917441

Chevelle

- 68 Sold each W-945
69 Sold each (pictured) W-766
70-72 LH/RH Pair C-E-2460

Camaro

- 68 Sold each (pictured, top) W-945
69 Red, Sold each W-766

Chevy Full Size

- 68 Sold each (pictured, top) W-945



Rear Side Marker Lamp Lens

Camaro

- 70-73 Sold each
(pictured) K-K977

Firebird

- 67 LH/RH Pair K-5960473
68 LH/RH Pair
(pictured) T-A8522



Rear Side Marker Lamp Bezel

Nova

- 70-74 Sold each K-3962934

Chevelle

- 69 Front & Rear, with Centered Studs, Sold each C-G-1260
70-72 LH P-PZ00302-LH
70-72 RH P-PZ00302-RH

Camaro

- 69 Sold each W-797

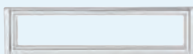

Rear Side Marker Lamp Bezel, continued

Firebird

- 68 LH/RH Pair K-5960475
69 LH/RH Pair K-9796219
70-81 LH (pictured) K-479631
70-81 RH K-479630



Rear Side Marker Lamp Gasket

Chevelle

- 70-72 LH/RH Pair J-5218

GTO

- 68 LH/RH Pair J-6843

Camaro

- 70-77 LH/RH Pair
(pictured) T-A6760G



Firebird

- 68 LH/RH Pair J-6844
69 LH/RH Pair J-6845
70-81 Front or Rear, 2-Piece Set K-5963134
78-81 Front & Rear Side Marker Stud Gasket K-5967657

Side Marker Light Hardware

Chevelle

- 69 Side Marker Pal Nuts, 8-Piece Set W-7774

Camaro

- 68 Side Marker Lamp Pal Nuts,
8-Piece Set
(pictured) W-947A



- 69 Side Marker Pal Nuts, 8-Piece Set W-7774

- 70-81 Side Marker Retainer, Sold each K-3974545

Tail Lamps & Parts

AMD offers a wide selection of tail lamps, lenses, housings, gaskets, and hardware. Most have the correct Guide markings and are officially licensed through the GM Restoration Parts Program. AMD features parts from CHQ, OER, OPGI, Soff Seal, Trim Parts, and TWE

Tail Lamp Assemblies

Nova

- 62-64 LH-RH, Sold each
(Lens, Housing and Gasket)
(pictured) K-899439

- 66-67 Sold each
(pictured) T-3058

- 68-69 LH C-E2-2770

- 68-69 RH C-E2-2775

Early 71 with Small Backup Lens

- 70-71 LH K-5964171

- 70-71 RH K-5964172

Late 71 with Large Backup Lens

- 71-72 LH K-A26026

- 71-72 RH
(pictured) K-A26025



Tail Lamp Housing

Impala

- 63 LH X949-3963-L

- 63 RH X949-3963-R

- 64 Sold each X949-3964

Tail Lamp Mounting Base Seal

Chevelle

- 64 Upper & Lower, LH/RH Set J-5183

Tail Lamp Housing to Body Seal

Nova

- 73-74 LH/RH Pair K-5950233

Chevelle

- 66 LH/RH Pair J-5188

- 66 Inner, LH/RH Pair J-5186

GTO

- 67 LH/RH Pair J-6838



Our Name Says It All!™



All of our own AMD parts in this catalog are listed in Blue, bold-face Type.

Tail Lamps & Parts

Tail Lamp Housing to Body Seal, continued

El Camino

66 LH/RH Pair J-5188

Camaro

67-68 Molded, LH/RH Pair
(pictured) W-467

69 LH/RH Pair
(pictured) K-K997

70-73 Seal Set J-3194

78-81 LH
(pictured) K-5969327

78-81 RH K-5969326



Tail Lamp Housing Seals

Chevelle

67 Housing to Lamp Socket Gasket, Sold each J-5197

68 Inner, LH/RH Pair J-5215

69 Inner, LH/RH Pair J-51981

GTO

68 LH/RH Pair J-6851

69 LH/RH Pair J-6852

Firebird

67-68 LH/RH Pair J-6847

69 LH/RH Pair J-6846

70-73 LH/RH Pair J-6849

Tail Lamp Housing Stud / Nut Set

Camaro

69 (5 Studs with Nuts,
does 1 Housing) W-382



Tail Lamp / Backup Lamp

Nova

62-64 2 Sets Required
per Car K-K663



Reflector Lenses

Nova

62-64 Sold each T-A3038

El Camino / Chevelle Wagon

70-72 LH/RH Pair T-A4869

Tail Lamp Lenses

Nova

65 LH/RH Pair
(pictured) T-A3050

66-67 Sold each K-5957440

68-69 LH/RH Pair
(pictured) T-A3053

Early 71 with Small Backup Lens

70-71 LH K-N5503

70-71 RH (pictured) K-N5503

Late 71 with Large Backup Lens

71-72 LH K-5964513

71-72 RH K-5964514

73-74 Standard, LH K-5965743

73-74 Standard, RH K-5965744



Tail Lamp Lenses

Chevelle

64 LH/RH Pair
(pictured) T-A4200

65 with Chrome Trim,
LH/RH Pair
(pictured) T-A4205

65 without Chrome Trim,
LH/RH Pair T-A4206

66 Inner, Sold each ... T-A4210

66 Outer, Sold each
(pictured) T-A4209

67 LH/RH Pair T-A4215

68 LH/RH Pair
(pictured) T-A4218

69 LH/RH Pair T-A4219

70 LH T-A4260A

70 RH (pictured) T-A4260

71 SS, with Trim, LH T-A4402

71 SS, with Trim, RH
(pictured) T-A4403

71 without Trim, LH .. T-A4400

71 without Trim, RH .. T-A4401

72 SS, with Trim, LH .. T-A4406

72 SS, with Trim, RH
(pictured) T-A4407

72 without Trim, LH .. T-A4404

72 without Trim, RH .. T-A4405

72 without Trim, RH .. T-A4405

72 without Trim, RH .. T-A4405

72 without Trim, RH .. T-A4405

72 without Trim, RH .. T-A4405

72 without Trim, RH .. T-A4405

72 without Trim, RH .. T-A4405

72 without Trim, RH .. T-A4405

72 without Trim, RH .. T-A4405

72 without Trim, RH .. T-A4405

72 without Trim, RH .. T-A4405

72 without Trim, RH .. T-A4405

72 without Trim, RH .. T-A4405

72 without Trim, RH .. T-A4405

72 without Trim, RH .. T-A4405

72 without Trim, RH .. T-A4405

72 without Trim, RH .. T-A4405

72 without Trim, RH .. T-A4405



El Camino / Chevelle Wagon

68-69 LH (left) T-A4865

68-69 RH T-A4865

70-72 LH (right) T-A4870A

70-72 RH T-A4870

GTO

70 LH/RH Pair (pictured, left) P-G240712

71 LH/RH Pair P-G240713

72 LH/RH Pair (pictured, right) P-G240714

72 LH/RH Pair (pictured, right) P-G240714

72 LH/RH Pair (pictured, right) P-G240714

72 LH/RH Pair (pictured, right) P-G240714

72 LH/RH Pair (pictured, right) P-G240714

72 LH/RH Pair (pictured, right) P-G240714

72 LH/RH Pair (pictured, right) P-G240714

72 LH/RH Pair (pictured, right) P-G240714

72 LH/RH Pair (pictured, right) P-G240714

72 LH/RH Pair (pictured, right) P-G240714

72 LH/RH Pair (pictured, right) P-G240714

72 LH/RH Pair (pictured, right) P-G240714

72 LH/RH Pair (pictured, right) P-G240714

72 LH/RH Pair (pictured, right) P-G240714

72 LH/RH Pair (pictured, right) P-G240714

72 LH/RH Pair (pictured, right) P-G240714

72 LH/RH Pair (pictured, right) P-G240714

72 LH/RH Pair (pictured, right) P-G240714

72 LH/RH Pair (pictured, right) P-G240714

72 LH/RH Pair (pictured, right) P-G240714

72 LH/RH Pair (pictured, right) P-G240714

72 LH/RH Pair (pictured, right) P-G240714

72 LH/RH Pair (pictured, right) P-G240714

72 LH/RH Pair (pictured, right) P-G240714

72 LH/RH Pair (pictured, right) P-G240714

72 LH/RH Pair (pictured, right) P-G240714

72 LH/RH Pair (pictured, right) P-G240714

72 LH/RH Pair (pictured, right) P-G240714

72 LH/RH Pair (pictured, right) P-G240714

72 LH/RH Pair (pictured, right) P-G240714

72 LH/RH Pair (pictured, right) P-G240714

72 LH/RH Pair (pictured, right) P-G240714

Tail Lamps & Parts

Tail Lamp Lenses, continued

Camaro, continued





78-81 Standard, LH (pictured).....		K-5969313	
78-81 Standard, RH		K-5969314	
78-81 Z28, LH (pictured).....		K-5930259	
78-81 Z28, RH.....		K-5930260	
79-81 Berlinetta, LH (pictured).....		K-5970777	
79-81 Berlinetta, RH.....		K-5970778	

Firebird







67-68 Sold each		K-5959716
69 Sold each		K-5961294
70-73 LH		K-5964663
70-73 RH		K-5964664

Tail Lamp Gaskets



Nova

65 LH/RH Pair		T-A3050G
66-67 LH/RH Pair		T-A3047G
68-69 LH/RH Pair		T-A3053G
70-71 Sold each		T-A3057G
Early 71 with Small Backup Lens		
71-72 Sold each		T-A3063G
Late 71 with Large Backup Lens		

Chevelle

64 LH/RH Pair		T-A4200G
65 LH/RH Pair		T-A4205G
66 LH/RH Pair		K-K641
67 LH/RH Pair		T-A4215G
68 LH/RH Pair		T-A4218G
69 LH/RH Pair		T-A4219G
71-72 Sold each		T-A4400G





Chevelle Wagon

68-69 Sold each (pictured).....		T-A4865G	
70-72 Sold each ..		T-A4870G	





El Camino

	T-A4865G	
(pictured).....	T-A4870G	

Camaro

		
70-73 4-Piece Set (pictured)		K-K236
78-81 LH (pictured).....		K-5969311
78-81 RH		K-5969312

Firebird

		
67-68 LH/RH Pair (pictured, left)		K-K568
69 LH/RH Pair (pictured, center)		K-K569
70-73 4-Piece Set (pictured, right)		K-FB773

Tail Light Bezels

Chevelle

66 Sold each P-PZ00320

Monte Carlo

70-72 Upper Bezel,
Sold each
(pictured).....  T-1647



Camaro

67 LH/RH Pair		W-738
67 LH		W-738B
67 RH		W-738A
68 LH/RH Pair		W-454
68 LH		W-456
68 RH		W-455

Firebird

70-73 Bezel, LH		K-5963093
70-73 Bezel, RH		K-5963094

Bezel Backing Plate

Camaro

67-68 LH/RH Pair

Bezel Clip Kit

Chevelle

66 P-CHV4320

Tail Lamp Bezel Seals

Nova

66-67 LH/RH Pair	J-4156
68-69 LH/RH Pair	J-41581
70-72 LH/RH Pair	J-41592

Chevelle

66 LH/RH Pair	J-5189
67 LH/RH Pair	J-5196

El Camino

66 LH/RH Pair J-5189



All of our own **AMD** parts in this catalog are listed in **Blue, bold-face Type**.

Our Name Says It All!™

Backup Lamps & Parts

AMD offers a wide selection of backup lamps, lenses, housings, gaskets, and hardware. Most have the correct Guide markings and are officially licensed through the GM Restoration Parts Program. AMD features parts from CHQ, OER, OPGI, Soff Seal, Trim Parts, and TWE

Backup Lamp Assembly

Chevelle

65	LH=RH, Soldeach	C-E-2310
67	LH=RH, Soldeach	C-E-2310
68	Sold each	C-E-2315

El Camino





65	LH=RH, Soldeach	C-E-2310
67	LH=RH, Soldeach	C-E-2310
69-72	Sold each	C-E-2320

Camaro

69	RS, LH	K-K1969L
69	RS, LH	K-K1969R

Backup Lamp Housing

Camaro

67-68	RS, LH (pictured)	 W-287
67-68	RS, RH	 W-286
69	RS, LH (pictured)	 W-289
69	RS, RH	 W-288



Backup Lamp Housing to Body Seal



Camaro

67-68	RS, 2-Piece Set (pictured)	W-467
67-68	RS, 2-Piece Set (pictured)	 W-237











Backup Lamp Lenses

Nova

65	LH/RH Pair (pictured)	 T-A3051
66-67	LH/RH Pair	 K-5957441
68-69	LH/RH Pair	K-K1044







Chevelle

64	with Red Reflector, LH/RH Pair (pictured)	 T-A4225
65	LH/RH Pair (pictured)	 T-A4230
66	LH/RH Pair (pictured)	 T-A4321
67	LH/RH Pair (pictured)	 T-A4230
68	LH/RH Pair (pictured)	 T-A4235
71	without Trim, LH (pictured)	 T-A4420
71	without Trim, RH	 T-A4421
71	SS, with Trim, LH (pictured)	 T-A4422
71	SS, with Trim, RH	 T-A4423





Backup Lamp Lenses, continued

Chevelle, continued

72	without Trim, LH (pictured)	 T-A4424
72	without Trim, RH	 T-A4425
72	SS, with Trim, LH (pictured)	 T-A4426
72	SS, with Trim, RH	 T-A4427
72	without Trim, LH (pictured)	 T-A4404
72	without Trim, RH	 T-A4405



El Camino



65	LH/RH Pair (pictured)	 T-A4230
67	LH/RH Pair (pictured)	 T-A4230
68	LH/RH Pair (pictured)	 T-A4235
69-72	Soldeach	C-E-2321







Monte Carlo

70	Sold each (pictured)	 T-A1601
71-72	Soldeach (pictured)	 T-A1602





Camaro

67	Standard, Soldeach (pictured)	 W-193
67-68	RS, Soldeach (pictured)	 W-116
68	Standard, Soldeach (pictured)	 W-391
69	Soldeach (pictured)	W-509

with Circular Optics

70-71	Early 71, RS, LH	 K-5963067
70-71	Early 71, RS, RH	 K-5963068
70-71	Early 71, Standard, LH	 K-5963055
70-71	Early 71, Standard, RH	 K-5963056

with Pillow Optics

71-73	Late 71, RS, LH	 K-5964531
71-73	Late 71, RS, RH	 K-5964532
71-73	Late 71, Standard, LH	 K-5964523
71-73	Late 71, Standard, RH	 K-5964524

Backup Lamp Lens Gasket

Chevelle

68	LH/RH Pair	J-4157
----	------------------	--------

Camaro

67-68	RS, LH/RH Pair (right)	 W-284
69	RS, LH/RH Pair	W-285



Backup Lens Screw

Camaro

67-69	RS, 4-Piece Set	W-292
69	4-Piece Set	W-226



Our Name Says It All!™

Inner Fender Accessories

To help complete the installation of your new inner fenders, AMD offers many inner fender dust shields with hardware. These are manufactured by Repops and Soff Seal.

A-Arm Dust Shield Sets



Nova

62-67 Set, with Hardware	J-4059
68 Set, with Hardware	R-N106
69 Set, with Hardware	R-N107
70-72 Set, with Hardware	R-N108

Chevelle / El Camino

64-65 Set, with Hardware	R-CH103
66 Set, with Hardware	R-CH104
67 Set, with Hardware	R-CH111
68-72 Chevelle with Steel Inner Fenders, Set, with Hardware (pictured)	R-CH105
69-72 Chevelle with Plastic Inner Fenders, Set, with Hardware	R-CH106

Monte Carlo

70-72 Dust Shield Set, with Hardware	R-MT101
--	---------

Skylark

68-72 Inner Fender A-Arm Dust Shield Set, with Hardware	J-7053
--	--------

A-Arm Dust Shield Sets, continued

Camaro

67-68 Set, with Hardware	R-CA105
69 Set, with Hardware	R-CA106
70-81 Set, with Hardware	R-CA223

Firebird

67-68 Set, with Hardware	R-FB103
70-81 Set, with Hardware	R-CA223

Frame Dust Shield Set

Camaro

67-69 with Hardware	R-CA107
---------------------------	---------

A-Arm & Inner Fender Dust Shield Set

Camaro

67-68 with Hardware	R-CA109
69 with Hardware	R-CA110

Fender to Cowl Dust Shield Set

Camaro

67-69 with Hardware	R-CA108
70-81 with Hardware	R-CA211

Firebird

70-81 with Hardware	R-CA211
---------------------------	---------

Steering Gear Boxes

Remy Racing and Performance Products presents the Delphi 600 series Power Steering Gear made in America. It is a bolt-in replacement steering gear for all GM A, B, F, and X body vehicles from 1965 through the early 1990's. The 600 gear feels "heavier" in your hands and more responsive like a modern day vehicle giving you better driver feed back. The 600 will also eliminate the "wandering" "floating" feeling.

600 Gear Steering Boxes

Nova

68-74 Non-plated, 12.7:1 ratio (2 ½ turns lock to lock) ..	600127
68-74 Non-plated, 14:1 ratio (3 ½ turns lock to lock)	60014
68-74 Plated, 12.7:1 Ratio (2 ½ turns lock to lock) fastest ratio	600127P
68-74 Plated, 14:1 ratio (3 ½ turns lock to lock)	60014P

Chevelle / El Camino /

Skylark / Cutlass / Tempest / Le Mans

64-77 Non-plated, 12.7:1 ratio (2 ½ turns lock to lock) ..	600127
64-77 Non-plated, 14:1 ratio (3 ½ turns lock to lock)	60014
64-77 Plated, 12.7:1 Ratio (2 ½ turns lock to lock) fastest ratio	600127P
64-77 Plated, 14:1 ratio (3 ½ turns lock to lock)	60014P

Monte Carlo / Malibu Classic / Regal / Cutlass Supreme / Grand Prix

78-88 Non-plated, 12.7:1 ratio (2 ½ turns lock to lock) ..	600127
78-88 Non-plated, 14:1 ratio (3 ½ turns lock to lock)	60014
78-88 Plated, 12.7:1 Ratio (2 ½ turns lock to lock) fastest ratio	600127P
78-88 Plated, 14:1 ratio (3 ½ turns lock to lock)	60014P

Camaro / Firebird

67-81 Non-plated, 12.7:1 ratio (2 ½ turns lock to lock) ..	600127
67-81 Non-plated, 14:1 ratio (3 ½ turns lock to lock)	60014
67-81 Plated, 12.7:1 Ratio (2 ½ turns lock to lock) fastest ratio	600127P
67-81 Plated, 14:1 ratio (3 ½ turns lock to lock)	60014P

GM Full Size

65-92 Non-plated, 12.7:1 ratio (2 ½ turns lock to lock) ..	600127
65-92 Non-plated, 14:1 ratio (3 ½ turns lock to lock)	60014
65-92 Plated, 12.7:1 Ratio (2 ½ turns lock to lock) fastest ratio	600127P
65-92 Plated, 14:1 ratio (3 ½ turns lock to lock)	60014P

Non-plated



Plated



Our Name Says It All!™



All of our own **AMD** parts in this catalog are listed in **Blue, bold-face Type**.

Cowl Induction Parts

AMD offers all of the parts that you need to add the desirable cowl induction option to your first generation Camaro or 70-72 Chevelle. We offer every part from a complete kit to mounting hardware. AMD manufactures hoods to add functional cowl induction also. Adds beauty and value to your Chevy.

Complete Cowl Induction System

Includes all Cowl Induction Components except Hood

Camaro



- 69 "302" (pictured) W-677
- 69 "350" W-678
- 69 "396" W-679

Cowl Hood Flapper Parts

Chevelle / El Camino

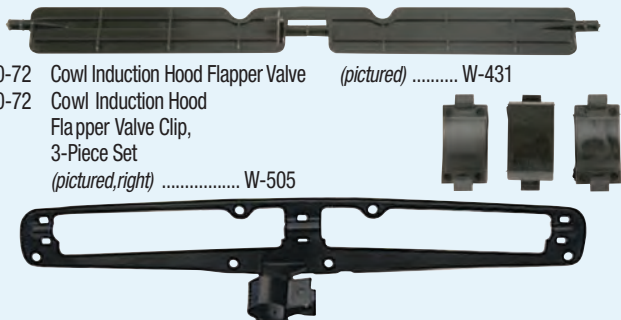

- 70-72 Cowl Induction Hood Flapper Valve (pictured) W-431
- 70-72 Cowl Induction Hood Flapper Valve Clip, 3-Piece Set (pictured, right) W-505

- 70-72 Cowl Induction Hood Flapper Valve Frame..... W-430
- 70-72 Cowl Induction Hood Rear ScreenC-S-1300
- 70-72 Cowl Induction Hood Door Bracket, LH/RH PairC-S-1060
- 70-72 Cowl Induction Hood Flapper Valve Clip, 3-Piece Set W-505
- 70-72 Cowl Induction Hood Flapper Valve Frame..... W-430



Camaro



- 69 Cowl Induction Hood Flapper Valve..... W-431
- 69 Cowl Induction Hood Flapper Valve Clip, 3-Piece Set W-505
- 69 Cowl Induction Hood Flapper Valve Frame..... W-430



Cowl Induction Parts

Chevelle

- 70 Cowl Induction Throttle Switch (right).....  W-176
- 70-72 Cowl Induction Hood Grommet (pictured, top)W-296
- 70-72 Cowl Induction Firewall Relay, OE Quality (pictured, ceter)...  W-771
- 70-72 Cowl Induction Solenoid (pictured bottom)..  W-772
- 70-72 Cowl Induction Bolt/Washer Set for
- 70-72 Cowl Induction Vacuum ActuatorC-S-1100
- 70-72 Cowl Induction Vacuum Actuator Support Bracket.....C-S-1110
- 70-72 Cowl Induction Vacuum In-Line Check Valve (Non-Functional)C-S-1125
- 70-72 Cowl Induction Wiring Harness.....C-S-1230
- 70-72 Cowl Induction Hood Grommet..... W-296
- 70-72 Cowl Induction Firewall Relay, OE Quality..... W-771
- 70-72 Cowl Induction Solenoid W-772
- 69 Cowl Induction Throttle Switch W-176



Camaro

- 69 Cowl Induction Hood Grommet..... W-296
- 69 Cowl Induction Firewall Relay, OE Quality  W-771
- 69 Cowl Induction Solenoid  W-772

Cowl Induction Hardware

GM

- Cowl Induction Pivot Bolts, Correct "P" Marking, 10-Piece Set.....C-S-1081
- Cowl Induction Pivot Bushings, 10-Piece SetC-S-1091

Air Cleaner Spacer (Extension Ring)

Camaro

- 69 302, Cowl Induction (pictured)..... W-293
- 69 350, Cowl Induction..... W-294



Air Cleaner Parts

Chevelle / El Camino

- 70-72 Chevelle, Cowl Induction Air Cleaner Seal..... W-267
- 70-72 Cowl Induction Air Cleaner Flange (pictured, at right) W-295



Camaro

- 69 Cowl Induction Air Cleaner Seal W-267
- 69 Cowl Induction Air Cleaner Flange..... W-295A



Our Name Says It All!™

Air Cleaners & Parts

AMD offers OE style air cleaner assemblies, bases, lids, and elements to replace those missing from your classic Chevy. Air cleaners are manufactured by CHQ and TWE.

Air Cleaner Assemblies

Includes Lid, Filter & Base

Nova

- 62-66 Small Block, 4bbl, AssemblyC-M-3359
- 66 327/L79, Dual Snorkel AssemblyC-M2-3375
- 66-67 Small Block, 4bbl,
Air Cleaner with ElementC-M-3361
- 68-69 396, Open Element Assembly
(pictured)  W-813



Chevelle / El Camino

- 64-65 327/375 & 327/350 L79,
Dual SnorkelC-M-3377
- 64-66 Small Block, 4bbl,
(pictured)C-M-3359
- 66 327/350, Dual SnorkelC-M2-3375
- 66 396/325, 4bbl, Air Cleaner Assembly
(Base, Lid, Element)C-M-3362
- 66-67 Small Block, 4bbl, Air Cleaner with ElementC-M-3361
- 66-67 Air Cleaner AssemblyC-M-3360
- 66-69 Chevelle, 396, Open Element
Air Cleaner Assembly W-813



- 70  Chevelle, 396, Cowl Induction Air Cleaner Assembly

- 70-72 Cowl Induction, Black Lid, Filter W-260
- 70-72 Cowl Induction, Chrome Lid, Filter (right) W-260C

Camaro

- 67 Small Block, 4bbl, Air Cleaner with Element C-M-3361
- 67 396/325, Air Cleaner Assembly C-M-3360
- 67-69 302, 396, Open Element Air Cleaner Assembly W-813
- 69 Cowl Induction Air Cleaner, Black Lid, Filter W-260
- 69 Cowl Induction Air Cleaner, Chrome Lid, Filter W-260C
- 69 Cowl Air Cleaner Assembly, Flat Bottom W-058
- 69 302, Cowl Induction Air Cleaner Assembly
with Black Lid (pictured) ... W-668
- 69 350, Cowl Induction
Air Cleaner Assembly
with Black Lid W-669
- 69 396, Cowl Induction
Air Cleaner Assembly
with Black Lid W-670

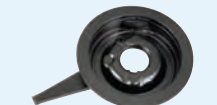

- 70-72 Dual Snorkel Air Cleaner Set, Chrome
(Base, Lid, Element) (pictured, left) W-460
- 70-72 Dual Snorkel Air Cleaner Set, Black
(Base, Lid, Element) (pictured, right) W-460A

Chevy Full Size

- 62-64 Small Block, 4bbl, Air Cleaner Assembly C-M-3359
- 67 Small Block, 4bbl, Air Cleaner with Element C-M-3361

Air Cleaner Lids

Nova



- 66-69 Open Element, Triple Chrome (pictured, left) W-244
- 66-69 Open Element, Black (pictured, right) W-244A
- 66 327/L79, Dual SnorkelC-M2-3372

Chevelle / El Camino

- 64-65 327/375 & 327/350, L79, Dual SnorkelC-M-3373
- 66 327/350, Dual SnorkelC-M2-3372
- 66-67 ChromeC-M-3368
- 66-69 Chevelle, Open Element, Triple Chrome (left) W-244
- 66-69 Chevelle, Open Element, Black (right) W-244A

Camaro

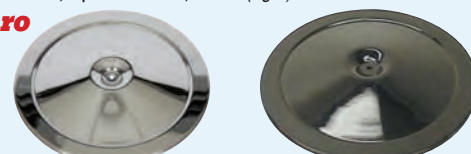

- 67 396/325, ChromeC-M-3368
- 67 Dual Snorkel, Chrome, with Rubber Seal W-461
- 67 Z/28, Dual Snorkel, Black, with Rubber Seal W-462
- 67-69 Open Element, Triple Chrome (pictured, left) W-244
- 67-69 Open Element, Black (pictured, right) W-244A
- 70-72 Dual Snorkel, Chrome, with Rubber Seal W-461
- 70-72 Z/28, Dual Snorkel, Black, with Rubber Seal W-462

Air Cleaner Base

Nova

- 68-69 396, Open Element
(pictured) W-814



Chevelle / El Camino

- 64-66 327/375 & 327/350 L79, Dual SnorkelC-M-3379
- 66-69 Chevelle, 396, Open Element
(pictured)  W-814

Camaro

- 67-69 302, 396, Open Element (pictured) ..  W-814

Air Cleaner Mesh Flame Arrestor

Nova

- 64-67 (pictured) ...  W-513

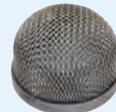

Chevelle

- 64-71 (pictured)  W-513

Monte Carlo

- 71 (pictured)  W-513

Camaro

- 67-69 (pictured)  W-513

Air Cleaner Elements

Nova

- 66-70 14" Open Element W-260H

Chevelle

- 66-72 14" Open Element W-260H

Camaro

- 67-74 14" Open Element W-260H



All of our own **AMD** parts in this catalog are listed in **Blue, bold-face Type**.

Our Name Says It All!™

Valve Covers & Parts

AMD offers OE style valve covers to replace those missing from your classic Chevy. Valve covers are manufactured by CHQ

Valve Covers

Nova



- | | | | |
|----|---|--|-------|
| 67 | SB, Black with "Chevrolet" script, LH/RH Pair
(pictured, left) | | W-541 |
| 68 | Black, LH/RH Pair (below, right) | | W-543 |
| 68 | Chrome, LH/RH Pair (above, right) | | W-542 |

Chevelle

- | | | | |
|----|--|--|-------|
| 67 | SB, Black with "Chevrolet" script, LH/RH Pair (above left) | | W-541 |
| 68 | Black, LH/RH P air (below right) | | W-543 |
| 68 | Chrome, LH/RH P air (above right) | | W-542 |

El Camino

- | | | | |
|----|---|--|-------|
| 67 | SB, Black with "Chevrolet" script, LH/RH Pair (above, left) | | W-541 |
|----|---|--|-------|

Camaro



- | | | | |
|----|--|--|-------|
| 67 | SB, Black with "Chevrolet" script, LH/RH Pair (top left) | | W-541 |
| 67 | SS 350, Chrome, Set with "Chevrolet" script, LH/RH Pair (pictured, left) | | W-540 |
| 68 | SB, Black, LH/RH P air (pictured, right) | | W-543 |
| 68 | Z/28 & SS 350, Chrome, LH/RH Pair (top right) | | W-542 |

Chevy Full Size

- | | | | |
|----|---|--|-------|
| 67 | SB, Black with "Chevrolet" script, LH/RH Pair | | W-541 |
| 68 | Black, LH/RH P air | | W-543 |
| 68 | Chrome, LH/RH P air | | W-542 |

Valve Cover Elbows

Nova

- | | | |
|-------|--------------------------------------|-------|
| 69-70 | Big Block
(pictured, above) | W-608 |
| 69-72 | Small Block | W-609 |



Chevelle / El Camino

- | | | |
|-------|--|-------|
| 66-70 | Big Block | W-608 |
| 69-72 | Small Block
(pictured, below) | W-609 |



Camaro

- | | | |
|-------|-------------------------------------|-------|
| 67-70 | Big Block (pictured, above) | W-608 |
| 69-72 | Small Block (pictured, below) | W-609 |

Chevy Full Size

- | | | |
|-------|-------------------------------------|-------|
| 68-70 | Big Block (pictured, above) | W-608 |
| 69-72 | Small Block (pictured, below) | W-609 |

Valve Cover Parts

Chevelle / El Camino

- | | | |
|-------|---|-------|
| 64-67 | Small Block, 2-Wire Plug Wire Retainer, 4-Piece Set (pictured, below) | W-972 |
|-------|---|-------|

Camaro

- | | | |
|----|---|-------|
| 67 | Small Block, 2-Wire Plug Wire Retainer, 4-Piece Set (pictured, right) | W-972 |
|----|---|-------|



Oil Filler Tube

Nova

- | | | |
|----|---------------------------------------|-----------|
| 66 | 327 / L79, Chrome
(pictured) | C-M2-3710 |
|----|---------------------------------------|-----------|



Chevelle / El Camino

- | | | |
|-------|-------------------------|-----------|
| 66-67 | Chrome (pictured) | C-M2-3710 |
|-------|-------------------------|-----------|

Camaro

- | | | |
|----|-------------------------|-----------|
| 67 | Chrome (pictured) | C-M2-3710 |
|----|-------------------------|-----------|



Fan Shrouds & Parts

AMD offers OE style fan shrouds for many classic GM applications. We also carry hardware to mount the shrouds. Replace that missing or broken fan shroud to restore proper cooling. Fan shrouds are manufactured by CHQ, OER, OPGI, and TWE.

Fan Shrouds

Nova



66-67 V8C-R2-1700

Chevelle / El Camino

64-65 Small BlockP-CH26693
 66-67 Big BlockP-00T216R
 66-67 Small BlockP-00T215R
 68 Big BlockP-00T217R
 68 Small BlockP-00T219R
 69-70 Small Block, 24" Small CoreP-PZ01016
 69-70 Small Block, 31" Small CoreP-00T220R
 69-70 Big Block, without A/CP-PZ01017
 71-72 Big BlockP-00T218R
 71-72 Small BlockP-00T225R

Fan Shroud Bracket

Nova

68-72 Big Block
 (pictured)..... K-3947621

Camaro

67-69 except 69 Big Block,
 Upper, with Hardware W-112
 69 Big Block, with Hardware
 (pictured)..... W-142



Fan Shroud Hardware

Nova

68-74 Lower Fan Shroud Mounting Clip,
 2 Required, Sold each K-K10100

Camaro

67-81 Lower Fan Shroud Mounting Clip,
 2 Required, Sold each K-K10100

Firebird

67-69 Upper Fan Shroud Bracket
 with Hardware
 (pictured)..... W-112
 67-81 Lower Fan Shroud Mounting Clip,
 2 Required,
 Sold each K-K10100



Not all reproductions
 come from the
 same factory...

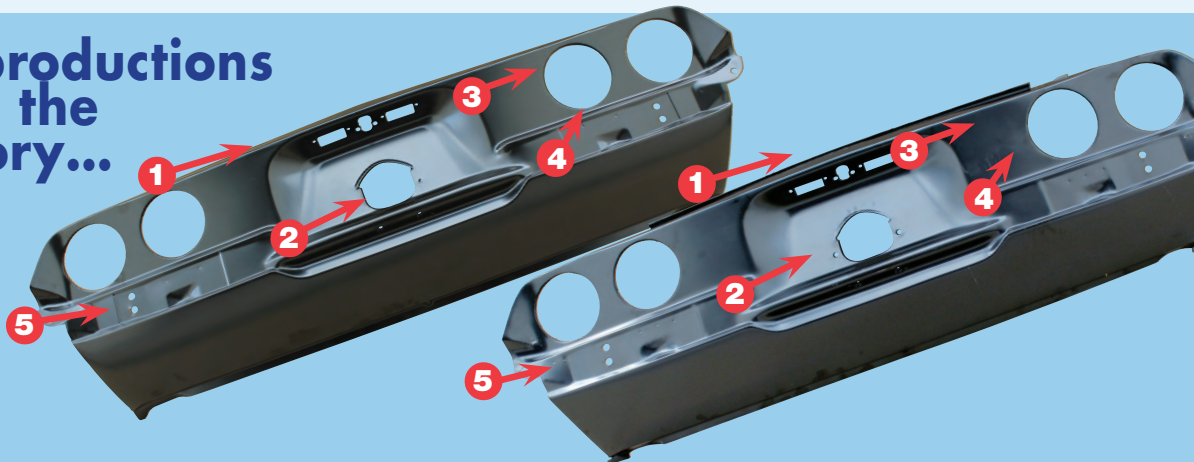

GM Restoration
 Parts

Quality GM Reproduction Automotive Parts



Our Name Says It All!™

Heating & Cooling System

AMD offers many heating and cooling system parts from radiator caps to thermostat housings for many classic GM applications. Manufactured by CHQ

Radiator Caps

Chevy

65-72 Except Cor vette & Corvaair,
Correct RC-15
Radiator Cap  W-853



Water Pump Pulley Reinforcement Plate

Nova

66-68 Small Block W-031

Chevelle / El Camino

64-68 Small Block W-031

Camaro

68 Small Block W-031

Thermostat Housing

Nova

66-73 Aluminum, with Part #
(pictured)  W-544



Chevelle

66-72 Aluminum, with Part# (pictured)  W-544

Camaro

67-69 Aluminum, with Part# (pictured)  W-544

Chevy Full Size

66-73 Aluminum, with Part# (pictured)  W-544

Heater Box Parts

Nova

68-79 SB, Heater Box Firewall Cover, without A/C..... W-960
68-79 Firewall Heater Delete Set (pictured, below) W-808
70 Big Block, Heater Box Cover Assembly, with Seals W-961
70 Big Block Heater Box Tube Flange Plate
(pictured, above) W-631
70 Big Block Heater Box Tube & Firewall
Block Off Seal, 2-Piece Set W-963



Heater Box Parts, continued

Chevelle / El Camino

68-72 SB, Heater Box Firewall Cover, without A/C..... W-960
68-72 Firewall Heater Delete Set W-808

GTO / Cutlass



71-72 Firewall Heater Delete Set (pictured) W-808

Skylark

65-71 SB, Heater Box Firewall Cover, without A/C..... W-960
71-72 Firewall Heater Delete Set (pictured, above) W-808

Camaro / Firebird

67-69 Big Block, Heater Box Cover Assembly, with Seals . W-96167-69
Big Block Heater Box Tube Flange Plate W-631
67-69 Big Block Heater Box Tube & Firewall
Block Off Seal, 2-Piece Set W-963
67-81 SB, Heater Box Firewall Cover, without A/C..... W-960
67-81 Firebird Firewall Heater Delete Set
(pictured, above) W-808

Chevy Full Size

63-65 Heater Box
(pictured) X365-3963



The details make AMD's parts better!

<p>1 Badly formed, rough weatherstrip channel</p>	<p>2 Well-formed, smooth weatherstrip channel</p>	<p>3 Missing, incorrect nuts</p> <p>3/5 Correct nuts</p>	<p>3/5 Uneven surface, faint stamping</p> <p>3/5 Smooth surface, crisp stamping</p>	<p>4 Jagged Edges</p> <p>4 Smooth Edges</p>





Our Name Says It All!™

Cowl, Firewall & Hinge Pillar Parts

AMD offers many rubber parts for the cowl and firewall section of your classic Chevy. AMD features parts from CHQ, OER, Soff Seal, Trim Parts, and TWE

Cowl Grille

Chevelle / El Camino / Monte Carlo & GTO

- 68-72 without A/C, 3-Piece (pictured)  T-4510
- 68-72 with A/C & RH Vacuum Actuator, 3-Piece  T-4511



Camaro / Firebird

- 70-81 Cowl Vent Grille X360-3570-1
- 70-81 Cowl Vent Grille Screen K-8800774

Door Hinge Pillar to Front Subframe Parts

Nova



- 68-74 Subframe Mount Repair Plate 6-Piece Set (pictured, above) W-646
- 68-74 Subframe Mounting Hole Repair, 4-Piece Set (pictured, below) W-696

Camaro / Firebird

- 67-74 Subframe Mount Repair Plate, 6-Piece Set (pictured, above) W-646
- 67-81 Subframe Mounting Hole Repair, 4-Piece Set (pictured, below) W-696





Engine Frame Mounts

AMD offers many engine frame mount for your classic GM musclecar. AMD features parts from CHQ, OER, and TWE



Engine Frame Mounts

Nova





- 68 Big Block, LH/RH Pair (pictured)  W-643
- 68-72 Small Block, Pair  W-992
- 69-70 Big Block, LH/RH Pair  W-649



Chevelle / El Camino

- 64-67 Big Block, Engine Frame Bracket, LH/RH Pair C-M-2534
- 64-67 Small Block, LH/RH Pair  W-993
- 68-72 Big Block & Small Block, LH/RH Pair  W-995

Camaro

- 67-68 Small Block, Pair  W-992
- 67-68 Big Block, LH/RH Pair  W-643
- 69 Big Block, LH/RH Pair (pictured)  W-649
- 69 307/327, Pair  W-992
- 70-72 Big Block, Correct (functional to 81), LH/RH Pair (pictured)  W-324



Firebird

- 67-69 V8, LH/RH, 4-Piece Set K-K576



Our Name Says It All!™



All of our own **AMD** parts in this catalog are listed in **Blue, bold-face type**.

Automatic Transmission Parts



AMD offers many automatic transmission parts including complete shifter assemblies neutral safety switches, to hardware. These parts are manufactured by CHQ.

Shifter Assembly, complete

Chevelle / El Camino

68-72 Ready to install
(pictured)  W-630

Camaro



68-69 Ready to install  W-625
70-72 Ready to install  W-640

Monte Carlo



70-72 Ready to install
(pictured)  W-630

Floor Shifter Handle



Chevelle / El Camino

68-72 Complete Assembly
(pictured, top)  W-624
68-72 with Cover
(center)  W-575
68-72 Shift Handle Pull-Up Set,
Stainless (bottom)  W-622



Monte Carlo

70-72 Complete Assembly
(top)  W-624
70-72 with Cover
(center)  W-575
70-72 Shift Handle Pull Up Set,
Stainless (bottom)  W-622

Camaro / Firebird

68-72 Complete Assembly
(top)  W-624
68-72 Camaro, with Cover
(center)  W-575
68-72 Shift Handle Pull Up Set,
Stainless (bottom)  W-622

Chevy Full Size

68-69 Complete Assembly
(top)  W-624
68-69 with Cover
(center)  W-575
68-69 Shift Handle Pull Up Set,
Stainless (bottom)  W-622

Neutral Safety / Backup Lamp Switch

Nova

68 TH-400 Shifter (pictured, top)..W-373A
68-69 Powerglide Shifter (center).....W-373

Chevelle / El Camino

68-72 Automatic Transmission
(pictured, bottom).....W-373B

Monte Carlo

70-72 Automatic Transmission
(pictured, bottom).....W-373B

Camaro / Firebird

67 Powerglide Shifter
(pictured, center).....W-373
67 TH-400 Shifter (pictured, top)..W-373A
68-72 (pictured, bottom).....W-373B

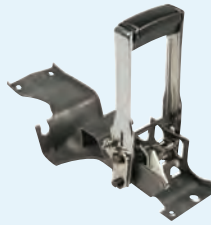

Gear Selector Lever

Chevelle / El Camino

68 TH-350 / TH-400W-632

Camaro / Firebird

68-69 TH-350 / TH-400W-632

Chevy Full Size

68 TH-350 / TH-400W-632



Kickdown Rod

Nova / Chevelle / El Camino / Camaro / Chevy Full Size

67-72 2bbl, Powerglide, with Swivel W-666
67-72 4bbl, Powerglide, with Swivel W-667



Floor Shift Cable

Chevelle / El Camino

68-72 Automatic Transmission, with Grommet..... W-810

Monte Carlo

70-72 with Grommet..... W-810

Camaro

68-72 with Grommet..... W-810

Shift Cable Mounting Bracket

Chevelle / El Camino

69-72 TH-400.....W-971

Camaro / Firebird

68-69 TH-400.....W-971

Chevy Full Size

68-69 TH-400.....W-971



Shift Lever Pin Stud Assembly

Chevelle / El Camino

68-72 TH-350/400,
with Cable ShiftW-682

Monte Carlo

70-72 TH-350/400 with Cable Shift W-682

Camaro / Firebird

68-78 TH-350/400 with Cable Shift W-682



Our Name Says It All!™

Manual Shifter Parts, Floor

AMD offers many manual transmission parts including complete shifter assemblies, boots, balls, and linkages. AMD features parts from CHQ, OER, And others.

Shifter Assembly

Nova

- 68-72 Muncie Shifter Assembly with Console, with Plain Lever (pictured).....X467-3068-1
- 68-72 Muncie Shifter Assembly with Console, with Muncie on Lever  K-3934286

Chevelle / El Camino

- 68-72 Bare (pictured).....X467-3468-1

Camaro

- 67-68 Muncie Shifter Assembly, with Plain Lever (pictured).....X467-3068-1
- 67-68 Muncie Shifter Assembly with Muncie on Lever  K-3934286



Shifter Handle

Chevelle / El Camino



- 68-72 with Console, Chrome (pictured, left).....X467-3468-3
- 68-72 without Console, Chrome (pictured, right).....X467-3468-2
- 69-72 Muncie Reverse Lockout AssemblyC-M-1390

Lockout Bellcrank Assembly

Nova

- 69-72 4-Speed (pictured)..... W-913

Camaro

- 69 4-Speed (pictured)..... W-913



Lockout Linkage Set

Nova

- 69-72 Small Block, Muncie 4-Speed W-914A



Chevelle

- 69-72 Muncie Reverse Lockout Assembly (pictured)C-M-1390

Camaro

- 69 Small Block, Muncie 4-Speed W-914A
- 69 Big Block, Muncie 4-Speed..... W-914B

Lockout Rod

Camaro

- 67-69 Upper, Manual & Automatic Transmissions (pictured)..... W-911
- 69 Big Block, 396/427, 4-Speed W-912
- 69 Small Block, 4-Speed, Lower, #5773 W-910



Shifter Ball, 4-Speed



Nova

- 64-67 without Console, 1/2", White.....C-J-1405
- 64-67 with Console, 1/2", Chrome.....C-J-1400
- 68-71 Black / Chrome, 2-Piece, Muncie, 5/16" thread (pictured, left) W-157B
- 68-74 White, All Hurst Shifters with 3/8" thread (center). W-183A
- 68-74 White, All Hurst Shifters with 5/16" thread (right). W-183B

Chevelle / El Camino

- 64-67 without Console, 1/2", White.....C-J-1405
- 64-67 with Console, 1/2", ChromeC-J-1400
- 68-71 Black / Chrome, 2-Piece, Muncie 5/16" thread (pictured, left) W-157B
- 71-72 White, All Hurst Shifters with 3/8" thread (center). W-183A
- 71-72 White, All Hurst Shifters with 5/16" thread (right) . W-183B

Monte Carlo

- 71-72 White, All Hurst Shifters with 3/8" thread (center). W-183A
- 71-72 White, All Hurst Shifters with 5/16" thread (right) . W-183B

Camaro

- 67-68 Black / Chrome, 2-Piece, Muncie 5/16" thread (pictured, above left)..... W-157B
- 69 White, All Hurst Shifters with 3/8" thread (center). W-183A
- 69 White, All Hurst Shifters with 5/16" thread (right) . W-183B
- 67-70 Black / Chrome, 2-Piece, Hurst Shifter, 3/8" thread..... W-157A
- 69 Chrome, Hurst Shifter, 3/8" thread W-113A
- 69 Chrome, Muncie Shifter, 5/16" thread W-113B

Firebird

- 67 Black / Chrome, 2-Piece, Muncie 5/16" thread (pictured, above left)..... W-157B
- 69 White, All Hurst Shifters with 3/8" thread (pictured, above center) W-183A
- 69 White, All Hurst Shifters with 5/16" thread (pictured, above right)..... W-183B

Chevy Full Size

- 64-67 without Console, 1/2", 4-Speed, White (pictured).... C-J-1405
- 64-67 with Console, 1/2", 4-Speed, Chrome C-J-1400



Shifter Boot, 4-Speed

Nova

- 64-67 with or without ConsoleC-J2-1022
- 68-72 without Console.....C-J2-1057

Chevelle / El Camino

- 64-65 4-Speed, Upper, with Console P-PZ00780
- 64-66 4-Speed, Lower, with or without Console P-PZ00781
- 66-67 3 & 4-Speed, Upper, with Console..... P-PZ00783
- 68-72 4-Speed, without Console..... P-PZ00784
- 68-72 4-Speed, with Console..... P-PZ00785



All of our own **AMD** parts in this catalog are listed in **Blue, bold-face Type**.

Manual Shifter Parts, Floor

Shifter Boot, 4-Speed, continued

Monte Carlo

- 70-72 4-Speed, without Console P-PZ00784
 70-72 4-Speed, with Console P-PZ00785

Camaro

- 69 4-Speed, with or without Console (pictured) W-300
 70-81 3-Speed & 4-Speed, Upper J-3077
 70-81 Molded Rubber, Lower (pictured, below) W-762

Firebird

- 70-81 3-Speed & 4-Speed, Upper J-3077
 70-81 Manual Transmission, Molded Rubber, Lower (pictured) W-762

Shift Plate Assembly

Camaro

- 67-68 without Console W-635

Shift Boot Plate, 4-Speed

Nova

- 62-67 Black (pictured) K-3849851
 62-67 Chrome K-3849852

Shift Boot Retainer

Nova

- 68-72 and Trim Plate, without Console C-J2-1058

Chevelle / El Camino

- 64-67 with or without Console, Lower C-J-1311
 68-72 Manual Transmission, with Console, Lower C-J-1360
 68-72 Manual Transmission, without Console, 2-Piece Shift Boot Retainer & Bezel C-J-1407



Shift Boot Retainer, continued

Monte Carlo

- 70-72 Manual Transmission, with Console, Lower C-J-1360

Camaro

- 67-71 with Console W-256
 69 without Console, Chrome (pictured) W-156A
 69 with Console, Black (pictured) W-156B
 70-81 Lower  W-764

Firebird

- 70-81 Manual Transmission, Lower Shift Boot Retainer (pictured)  W-764

Upper Shift Cover Seal

Chevelle / El Camino

- 68-69 with Console, 3- & 4-Speed (pictured) J-3076

Camaro

- 67 with Console, 3- & 4-Speed (top) J-3076
 68 with Console (pictured, at right) J-30761

Shift Boot Parts, 4-Speed

Nova

- 64-67 Retaining Ring, with or without Console (pictured) C-J2-1050
 65-67 Slider Seal C-J2-1014

Hardware

- 64-81 Hurst 3-Piece Clip Set, Holds shifter rods firmly to levers W-697



Steering Column Parts

AMD offers several steering column parts to help finish your restoration. These parts are manufactured by CHQ.

Steering Column to Floor Boot

Nova

- 68-74 (pictured) W-445

Camaro / Firebird

- 67-69 (pictured) W-445

Turn Signal Lever Knob

Camaro / Firebird

- 67 Black W-216

Turn Signal & Tilt Lever Knob

Camaro

- 68-69 Black W-217



Steering Coupler Repair Set

Nova

- 68-74 (pictured) W-550

Chevelle / GTO

- 68-72 (pictured) W-550

Camaro / Firebird

- 67-69 (pictured) W-550



Our Name Says It All!™

Accelerator Pedal Parts

AMD offers several accelerator parts including complete assemblies, linkages, pad, trim, and hardware for most popular GM applications. These parts are manufactured by CHQ, Soff Seal, and others.

Accelerator Pedal Assemblies

Nova

- 68-72 V8, Thru Firewall, with Pad & Trim (pictured)..... W-572
- 68-72 V8, Thru Firewall, with Pad Only W-584

Chevelle / El Camino

- 68-69 X409-3469
- 70-72 X409-3470

Monte Carlo

- 70-72 X409-3470



Accelerator Pedal Bracket

Chevelle / El Camino

- 68-69 (pictured).....X409-3469-1

Camaro

Thru Firewall

- 67-69 V8X409-3567-1
- 68-69 V8, without Cowl Induction, with Pad & Trim (pictured, above) W-572
- 68-69 V8, without Cowl Induction, with Pad Only..... W-584
- 69 V8, with Cowl Induction, with Pad & Trim W-633
- 69 V8, with Cowl Induction, with Pad Only..... W-585

Firebird

- 67 K-K518

Accelerator Pedal Linkage Assembly

Camaro

- 67-69 V8, Thru Firewall (pictured)..... W-687
- 69 V8, with Cowl Induction, Thru Firewall W-861



Accelerator Pedal Rod

Nova

- 68-72 V8, Thru Firewall (pictured) W-676

Camaro

- 67-69 V8, Thru Firewall (pictured) W-676



Gas Pedal Rod Pin

Nova

- 68-74 (pictured) W-571

Chevelle / El Camino / Monte Carlo

- 68-72 (pictured) W-571

GTO

- 69-72 (pictured) W-571

Camaro

- 67-81 (pictured) W-571

Firebird

- 68-81 (pictured) W-571



Gas Pedal Pads

Nova

- 68-74 PedalJ-3090
- 68-74 (pictured)..... W-143

Chevelle / El Camino / Monte Carlo

- 68-72 (pictured)..... W-143

GTO

- 69-72 (pictured)..... W-143

Camaro / Firebird

- 68-81 (pictured)..... W-143



Gas Pedal Trim

Nova

- 68-74J-3091
- 68-74 (pictured)..... W-132

Chevelle / El Camino / Monte Carlo

- 68-72 (pictured)..... W-132

GTO

- 69-72 (pictured)..... W-132

Camaro / Firebird

- 67-81 (pictured)..... W-132



Gas Pedal Spring

Nova

- 68-74 Correct (pictured) W-565

Chevelle / El Camino / Monte Carlo

- 68-72 Correct (pictured) W-565

GTO

- 69-72 Correct (pictured) W-565

Camaro / Firebird

- 67-81 Correct (pictured) W-565

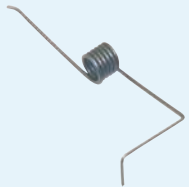

Our Name Says It All!™

Clutch & Brake Pedal Parts

AMD offers several clutch and brake pedal parts including complete assemblies, linkages, pad, trim, and hardware for most popular GM applications. These parts are manufactured by CHQ, OER, TWE, and others.

Clutch & Brake Pedal Assembly



Nova

- 62-65 C-M2-3630
- 66-67 C-M2-3635
- 68-69 Pair (pictured, far left)..... W-598

Chevelle / El Camino

- 64-66 C-M-3900
- 67 C-M-3910
- 68-72 Pair (pictured, center left) W-839

Camaro

- 67-68 Pair (pictured, center right) W-597
- 70-71 Pair (pictured, far right)..... W-327
- 72-81 Pair..... W-328
- 69 Pair (pictured, far left)..... W-598

Firebird

- 67 Pair (pictured, center right) W-597
- 69 Pair (pictured, far left)..... W-598
- 70-71 Pair (pictured, far right)..... W-327
- 72-81 Pair..... W-328

Brake Pedal Assembly

Nova

- 68-72 Automatic Transmission (pictured).....W-831

Camaro/Firebird

- 67-69 Automatic Transmission (pictured).....W-831

Pedal Pad & Trim Set

Camaro



with Automatic Transmission

- 67-68 without Disc Emblem..... W-885
- 67-68 with Disc Emblem (pictured, left)..... W-884
- 69-81 without Disc Emblem..... W-887
- 69-81 with Disc Emblem..... W-886

with Manual Transmission

- 67-68 without Disc Emblem (pictured, right)..... W-881
- 67-68 with Disc Emblem..... W-880
- 69-71 without Disc Emblem..... W-883
- 69-71 with Disc Emblem..... W-882

Brake / Clutch Pedal Pad

Nova

- 62-67 Horizontal Ribs K-6256368
- 62-67 Vertical Ribs K-3988198
- 68-74 (pictured)..... W-191



Chevelle / El Camino

- 64-72 (pictured) W-191

GTO

- 64-72 (pictured) W-191

Camaro

- 67-81 (pictured) W-191

Firebird

- 67-81 (pictured) W-191
- 69 Manual Transmission K-9776819

Brake / Clutch Pedal Pad Trim

Nova

- 68-74 (pictured)..... W-192
- 73-75 Clutch Pedal, Stainless..... W-752



Chevelle / El Camino

- 64-72 (pictured)..... W-192

GTO

- 64-72 (pictured) W-192

Camaro / Firebird

- 67-81 (pictured) W-192
- 73-81 Clutch Pedal, Stainless..... W-752

Brake Pedal Pad

Nova

- 62-67 Automatic Transmission, Manual Brake  K-3745991



- 62-67 Automatic Transmission, Power Brake  K-3746702

- 68-71 Automatic Transmission, with Embossed Disc Brake W-163
- 68-74 Manual Brake, with Disc Brakes Emblem (pictured)..... W-120
- 68-74 Automatic Transmission, Pedal Pad Trim W-133
- 68-77 Automatic Transmission, without Disc Brakes W-236

Chevelle / El Camino

- 67-72 Manual Brake, with Disc Brakes Emblem (pictured)..... W-120

Camaro

- 67-70 Automatic Transmission, with Embossed Disc Brake W-163
- 67-75 Manual Brake, with Disc Brakes Emblem (pictured above)..... W-120
- 67-81 Automatic Transmission, without Disc Brakes W-236

Firebird

- 67-68 Manual Brake, with Disc Brakes Emblem (pictured above)..... W-120
- 67-81 except 69, Automatic Transmission, without Disc Brakes W-236
- 69 Automatic Transmission, Pad K-9774235



Our Name Says It All!™

Clutch & Brake Pedal Parts

Brake Pedal Pad Trim

Camaro

67-81 Automatic Transmission
(pictured)..... W-133



Firebird

67-81 except 69, Automatic Transmission (pictured) W-133
69 Automatic Transmission..... K-9788316

Chevy Full Size

67-70 Automatic Transmission (pictured) W-133

Brake / Clutch Pedal Bushing Set

Nova

62-79 Nylon, 4-Piece Set W-083

Chevelle / El Camino / Monte Carlo

68-72 Chevelle, Nylon, 4-Piece Set W-083

Camaro

67-81 Nylon, 4-Piece Set W-083

Brake / Clutch Pedal to Rod Clip

Nova

63-72 W-597A

Chevelle / GTO / Cutlass

64-72 W-597A

Camaro / Firebird

67-72 W-597A

Power Brake Light Switch Bracket Set

Chevelle / El Camino

70-81 without Cruise W-816

Firebird

70-81 W-816



Parking Brake System

Camaro / Firebird

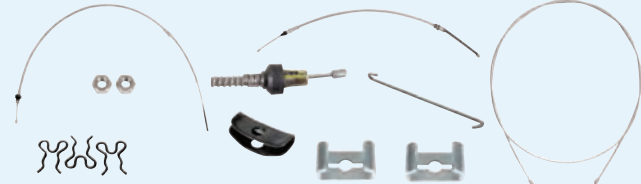

67-69 Correct, Spiral Wound Cables, 13-Piece Set W-863

Parking Brake Assembly

Nova

68-69 (pictured, left) X377-3567

70-74 (pictured, right) X377-3569

Camaro

67-68 (pictured, left) X377-3567

69 (pictured, right) X377-3569



Parking Brake Cable

Nova

68-71 Front, Correct Spiral Wound W-330



68-74 Rear, Replacement Style with Conduit Casing..... W-854

Camaro / Firebird

67-69 Front, Correct Spiral Wound W-330

67-69 Rear, Correct Spiral Wound, Sold each (pictured)..... W-278

67-69 Rear, Replacement Style with Conduit Casing W-854

67-69 Intermediate, 79" (except some 67 Camaro BB)..... W-273

Parking Brake Cable Clips

Chevelle

68-72 3-Piece Set
(pictured)..... W-228A



68-72 Sold each W-228

Camaro / Firebird

67-69 3-Piece Set (pictured) W-228A

67-69 Sold each W-228

Parking Brake Pedal Pad

Nova

68 (pictured, above) W-229

69-77 (pictured, below)..... W-230



Chevelle

64-75 (pictured, above) W-229

GTO

71-72 (pictured, above) W-229

Cutlass

64-72 (pictured, above) W-229

Camaro / Firebird

67-68 (pictured, above) W-229

69-75 Camaro,
(pictured, below) W-230



71-74 Firebird,
(pictured, below) W-230

Parking Brake Pad Trim

Nova

68 (pictured, above) W-108

69-72 Small Stainless
(pictured, below)..... W-122



Chevelle

64-72 not OE this car
(pictured, above)..... W-108

Camaro / Firebird

67-68 (pictured, above)..... W-108

69-81 Small, Stainless
(pictured, below)..... W-122



Chevy Full Size

69-70 Small, Stainless (pictured, below)..... W-122

Parking Brake Release Handle

Chevelle / El Camino /

Monte Carlo /

GTO / Skylark / Cutlass

70-72 (pictured) X441-3470-1



Our Name Says It All!™

Clutch & Brake Pedal Parts

Parking Brake Frame Guide Bar

Nova
68-74 (pictured) W-397

Camaro
67-69 (pictured)..... W-397



Park Brake Equalizer

Nova
68-71 Correct (pictured) W-902

Chevelle
64-69 Correct (pictured) W-902

Camaro
67-71 Correct (pictured) W-902

Chevy Full Size
65-70 Correct (pictured) W-902



Rear Park Brake Connector

Nova
68-79 Correct, 2-Piece
(pictured)..... W-903

Chevelle
64-72 Correct, 2-Piece (pictured) W-903

Camaro
67-81 Correct, 2-Piece (pictured) W-903

Chevy Full Size
65-79 Correct, 2-Piece (pictured) W-903

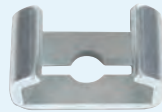

Parking Brake Adjustment Nut

Nova
62-74 Pair (pictured)..... W-904
62-74 Pair (pictured)..... W-904



64-72 Pair (pictured) W-904



Monte Carlo
70-72 Pair (pictured) W-904

Camaro / Firebird
67-78 Pair (pictured) W-904





Front Disc Brake Backing Plates

Nova
68 LH/RH Pair (pictured, left).....  W-416
69-72 LH/RH Pair  W-383A

Chevelle
67-68 LH/RH Pair (pictured, left).....  W-416
69-72 LH/RH Pair (pictured, right).....  W-383

El Camino
69-72 LH/RH Pair (pictured, right).....  W-383

Monte Carlo
70-72 LH/RH Pair (pictured, right).....  W-383

GTO
67-68 LH/RH Pair (pictured, left).....  W-416
69-72 LH/RH Pair (pictured, right).....  W-383

Skylark
69-72 LH/RH Pair (pictured, right).....  W-383

Camaro / Firebird
67-68 LH/RH Pair (pictured, left).....  W-416
69 LH/RH Pair  W-383A



Our Name Says It All!™

Clutch Parts

Clutch Linkage Set



- Nova**
 68-7 Small Block W-685
 68-72 Big Block (pictured) W-781
- Camaro**
 67-69 Small Block W-685
 67-69 Big Block W-781
 70-71 (pictured) W-322
 72-81 W-323

Clutch Bellcrank

- Nova**
 62-67 Assembly (pictured) K-3792909
 68-72 Small Block, Assembly W-686
 68-72 Big Block W-780



- Camaro**
 67-69 Small Block, Assembly W-686
 67-69 Big Block W-780
 70-81 Assembly (pictured) W-316

- Firebird**
 67-69 Small Block, Assembly (pictured) W-686

- Chevy Full Size**
 62-64 6 Cylinder & Small Block, (Z Bar) (pictured) X475-3962

Clutch Bellcrank Pivot

- Nova**
 62-74 4-Piece Set (Seats & Clip) (pictured) W-686A



- Chevelle / El Camino**
 64-72 4-Piece Set (Seats & Clip) (pictured) W-686A

- GTO / Skylark / Cutlass**
 64-72 4-Piece Set (Seats & Clip) (pictured) W-686A

- Monte Carlo**
 70-72 4-Piece Set (Seats & Clip) (pictured) W-686A

- Camaro / Firebird**
 67-81 4-Piece Set (Seats & Clip) (pictured) W-686A

Clutch Bellcrank Felt Seal

- Nova**
 62-74 Pair (pictured) W-686B
- Chevelle / El Camino / GTO / Skylark / Cutlass**
 64-72 Pair (pictured) W-686B
- Monte Carlo**
 70-72 Pair (pictured) W-686B
- Camaro / Firebird**
 67-81 Pair (pictured) W-686B



Frame Side Clutch Bellcrank Bracket

- Camaro / Firebird**
 70-81 W-694

Clutch Fork

- Nova**
 62-67 C-M2-3583
 68-72 (pictured) W-692
- Chevelle / El Camino**
 64-72 (pictured) W-692
- Camaro / Firebird**
 67-72 (pictured) W-692



Bellhousing to Clutch Fork Boot

- Nova**
 68-79 W-478
- Chevelle / El Camino**
 68-79 W-478
- GTO**
 64-72 W-478
- Camaro / Firebird**
 67-81 W-478



Clutch Pushrod

- Nova**
 68-72 Upper (pictured, left) W-194
 68-72 Lower, Adjustable, 3-Piece (pictured, right) W-209



- Chevelle**
 64-67 Lower, Adjustable, 3-Piece (right) W-209
 68-72 Upper W-521

- El Camino**
 68-72 Lower K-9779202

- Monte Carlo**
 70-72 Lower K-9779202

- Camaro**
 67-69 Upper (pictured, left) W-194
 67-81 Lower, Adjustable, 3-Piece (pictured, right) W-209
 70-71 Upper W-276
 72-81 Upper W-277

- Firebird**
 67-69 Upper (pictured, left) W-194
 67-81 Lower, Adjustable, 3-Piece (pictured, right) W-209

- Chevy Full Size**
 71-72 Upper W-276

Pushrod Firewall Boot

- Nova**
 68-75 Upper (pictured) W-239
- Chevelle / El Camino**
 64-67 (pictured) J-50521
 68-72 J-5053
- GTO / Skylark / Cutlass**
 64-67 (pictured) J-50521
 68-72 J-5053
- Monte Carlo**
 70-72 J-5053
- Camaro / Firebird**
 67-69 Upper (pictured) W-239
 70-81 Upper (pictured) W-329



Our Name Says It All!™

Clutch Parts

Clutch Rod Firewall Cover & Seal Set

- Nova**
68-79 (pictured)..... W-769
- Camaro / Firebird**
67-81 (pictured)..... W-769

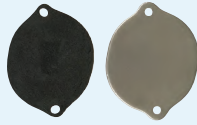

Frame Side Pivot Mounting Bracket

- Nova**
68-74 (pictured, top)..... W-208
- Camaro / Firebird**
67 (pictured, at right)..... W-683
68-69 (pictured, top)..... W-208



Clutch Lower Adjusting Rod

- Nova**
68-72 Big Block, with Swivel (pictured)..... W-783
- Camaro**
67-69 Big Block, with Swivel (pictured)..... W-783

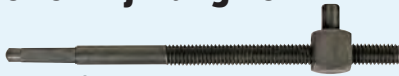

Clutch Extension Rod

- Nova**
68-72 Small Block (pictured) W-146
- Camaro / Firebird**
67-69 Small Block (pictured) W-146



Clutch Pivot / Ball Studs

- Nova**
62-74 Block Side (top)..... W-200
62-72 Frame Side (center). W-201
70-74 Frame Side (bottom)..... W-319
- Chevelle**
64-72 Block Side (top)..... W-200
64-69 Frame Side (center)..... W-201
70 Frame Side (bottom)..... W-319
- El Camino**
64-72 Block Side (top)..... W-200



Monte Carlo

- 70-72 Block Side (pictured, top)..... W-200

GTO

- 65-67 Block Side (pictured, top)..... W-200

Camaro

- 67-81 Block Side (pictured, top)..... W-200
67-69 Frame Side (pictured, center)..... W-201
70-81 Frame Side (pictured, bottom)..... W-319

Chevy Full Size

- 70-73 Frame Side (pictured, bottom)..... W-319

Clutch Return Spring

- Nova**
68-72 Big Block (pictured)..... W-146C
68-72 Big Block, Spring Extension W-782
68-72 Small Block..... W-146A



Chevelle / El Camino

- 68-72 C-M-3460

Monte Carlo

- 70-72 C-M-3460

GTO / Skylark / Cutlass

- 68-72 C-M-3460

Camaro

- 67-69 Small Block W-146A
67-69 Big Block (pictured, above)..... W-146C
67-69 Big Block, Spring Extension W-782
70-72 W-317
73-81 W-318
73-81 K-332521

Firebird

- 67-69 Small Block W-146A
71-72 W-317
73-81 (pictured)..... K-332521



Neutral Safety Switch Linkage Rod Assembly

- Camaro**
69 3 & 4-Speed (pictured)..... W-372



Our Name Says It All!™

Dash Accessories & Parts

AMD offers a comprehensive line of dash parts including bezels, switches, vents, trim, controls, and hardware for most popular GM applications. Most dash parts except for gauges, gloveboxes, and radio parts are found in this section. These parts are manufactured by CHQ, OER, OPGI, Trim Parts, TWE, and others.

Dash Pads

Highest quality Dash Pad on the market



Camaro

- 69 Black, without A/C W-030
- 69 Black, with A/C W-030A

Dash Pad Clips

El Camino

- 64-67 Dog Leg Clip, LH/RH Pair..... W-674

Camaro

- 68 Dog Leg Clip, LH/RH Pair..... W-674
- 69 6-Piece Set W-073
- 69 Sold each W-073A



Firebird

- 68 Dog Leg Clip, LH/RH Pair..... W-674

Dash Trim Set

Nova



- 66 SS, 5-Piece Set (pictured)  T-3052
- 66 5-Piece Set  T-3053

Dash Strip

Chevelle / El Camino



(Lights, Wiper, Ignition)



- 66 with Correct Holes P-GFK0002
- 67 with Correct Holes P-GFK0003

Center Dash Panel

Camaro

- 67-68 without A/C, Correct Black Pebble Grain Material  W-380
- 67-68 with A/C, Correct Black Pebble Grain Material  W-415
- 67-68 without A/C & with Radio Block, Black Pebble Grain W-380B
- 67-68 Custom, Deletes all, no cutouts (pictured)..... W-380C
- 68 Walnut, without A/C W-983
- 68 Walnut, with A/C W-984
- 69 Woodgrain, 3-Piece Set, (Dash, Ashtray, Glove Box)..... W-985
- 69 Woodgrain, 6-Piece Set (Dash and Instrument) W-979







Center Dash Panel, continued

Camaro, continued



- 70-76 Dash Panel Lower Trim, 1st Design (pictured)  K-378718

Firebird

- 67 Walnut, without A/C (pictured, top)  K-K260
- 67 Walnut, with A/C  K-K261
- 67-68 without A/C, Correct Black Pebble Grain Material  W-380
- 67-68 with A/C, Correct Black Pebble Grain Material  W-415
- 67-68 without A/C & with Radio Block, Black Pebble Grain W-380B
- 67-68 Custom, Deletes all, no cutouts (pictured) W-380C
- 68 Burlwood, without A/C (pictured, bottom)..... K-K214
- 68 Burlwood, with A/C K-K215



Dash Bezel Set

Nova

- 66-67 4-Piece Set (Ignition, Lighter, Wiper, Headlamp) C-J2-1640

Center Dash Instrument Lens Assembly

Camaro

- 69 (use with Center Dash Clock & Fuel Gauge)..... W-589

Center Dash Lamp Lens

Camaro

- 69 Green K-3951214

Dash Bezel Sticker Set

Camaro

- 67 Decal Set, Chrome Mylar W -347

Center Dash Retainers

Camaro / Firebird

- 67-68 Dash Bezel Top Retainer W -380A

Dash Panel Trim Plate

Camaro / Firebird

- 69 with Hardware  W-331
- 69 Mounting Hardware  W-331A

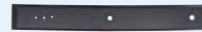

Steering Column Cover

Nova

- 69-74 Lower..... C-J2-4100

Camaro

- 69 Under Column..... W-968
- 69 Under Dash Mounting Hardware H-112



Our Name Says It All!™



All of our own **AMD** parts in this catalog are listed in **Blue, bold-face Type.**

Dash Accessories & Parts

Dash Knobs

Nova



- 69 with Stereo Radio, 7-Piece Set (pictured)..... W-793
- 69 with Mono Radio, 7-Piece Set..... W-794

Camaro

- 69 with Stereo Radio, 7-Piece Set..... W-793
- 69 with Mono Radio, 7-Piece Set..... W-794

Dash Knob Bezel Sets

Camaro

- 68 4-Piece Set..... W-238

Dash Grab Bar Handle

Camaro

- 69 Grab Bar Set with Hardware (pictured) W-858
- 69 Grab Handle with Nuts ... W-869



Firebird

- 67-68 Instrument Panel Assist Handle K-9787527
- 70-81 (pictured)..... K-479872

Dash Grab Bar Handle Bezel

Camaro

- 69 Deluxe, LH/RH P air (pictured) W-807



Firebird

- 67-69 Instrument Panel K-K734
- 70-81 K-479437

Dash Grab Bar Hardware

Camaro

- 69 Grab Bar Backing Plate, LH/RH Pair..... W-865

Ignition Bezel

Nova

- 62-64 Bezel (pictured) T-3023
- 66-67 Bezel T-2493
- 67 Bezel Nut..... W-219



Chevelle

- 65-66 (pictured) T-2493
- 67 T-2495
- 67 Bezel Nut..... W-219



El Camino

- 67 (pictured) T-2493

Camaro / Firebird

- 68 K-3904860

Full Size Chevy

- 65-66 T-2493
- 65-66 Except Impala & Caprice T-2495

Ignition Bezel Nuts

Camaro / Firebird

- 67-68 W-219

Full Size Chevy

- 65-66 W-219

Dash Instrument Bezel Applique

Camaro / Firebird

- 67-68 (pictured)..... W-665

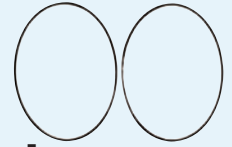

Headlamp Switch Shaft & Knob

Nova

- 67 (pictured)..... W-268
- 69-70 W-353



Chevelle / El Camino

- 67 (pictured)..... W-268
- 69-70 W-353

Camaro

- 67-68 (pictured)..... W-268
- 69-70 W-353

Full Size Chevy

- 69-70 W-353

Headlamp Switch Knob

Nova

- 67-68 (top) K-3886987
- 69-70 (center) K-3954210
- 72-74 (bottom) K-3986886



Chevelle / El Camino

- 69-70 (center) K-3954210
- 71-72 (bottom) K-3986886



Camaro

- 67-68 (top) K-3886987
- 71-78 (bottom) K-3986886



Firebird

- 67-69 K-9797087
- 70-81 K-479773

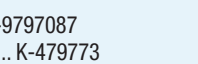

Headlamp Knob Bezel

Firebird

- 69 Bezel / Retainer K-R526
- 70-81 K-482351

Headlamp Switch

Camaro

- 68-69 RS, 7 Pin, without gauges K-1995191
- 68-69 RS, 8 Pin with console gauges (pictured).... K-1995192



Headlamp Switch Hardware

Nova

- 68 Mounting Nut K-3916710
- 69-74 Switch Nut K-3919021

Camaro

- 67-68 Switch Nut K-3904861
- 67-68 Chrome Nut W-078
- 69-81 Switch Nut K-3919021

Firebird

- 67-68 Switch Nut K-1945071
- 70-81 Mounting Nut K-482475



Our Name Says It All!™

Dash Accessories & Parts

Headlamp Switch Dash Plate

Camaro

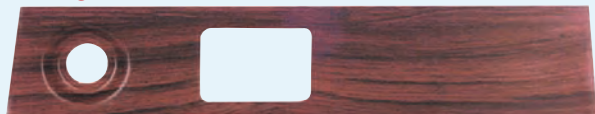

69 Wiper & Headlamp Switch Plate, Woodgrain (Bonded to Steel Mount Plate) W-385

Windshield Wiper Knob

Nova

67 Chrome (above)..... W-214
69-71 (below)..... W-578

Chevelle / El Camino

67 Chrome (above)..... W-214
69-71 Chevelle (below)..... W-578

Camaro

67-68 Chrome (above)..... W-214
69 (below)..... W-578
69-81 Slide Type (left) K-K582

Firebird

70-81 (right)..... K-K525

Full Size Chevy

67 Chrome (top)..... W-214

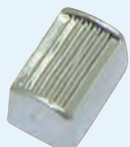

Windshield Wiper Switch

Nova



67 K-1993395
69-71 (pictured)..... K-1993464

Monte Carlo

70-71 (pictured) K-1993464

Camaro

67-68 K-1993395
69 (pictured)..... K-1993464

Wiper Switch Dash Plate

Camaro

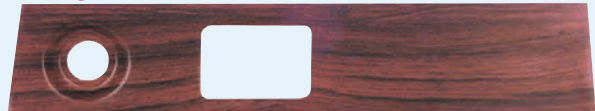

69 Wiper & Headlamp Switch Plate, Woodgrain (Bonded to Steel Mount Plate) W-385

Windshield Wiper Hardware

Camaro

67-68 Wiper Nut, Chrome W-079
67-68 Wiper Nut K-3904859

Firebird

67-68 Wiper Nut K-533012

Windshield Washer Bottle Bracket Support

Camaro

68 RS (pictured)..... W-363
69 RS W-206



Heater Control Assembly

Chevelle / El Camino

71-72 Heater & A/C Control Assembly P-CH25793

Camaro

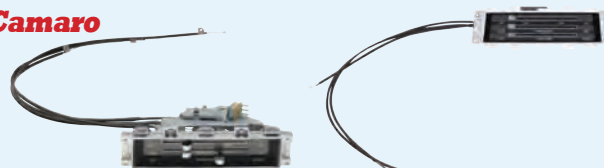

67 without A/C, with Cables (pictured, left) K-3925775C
67 with A/C with Cables K-3891798
69 with A/C, with Cables K-3919582
69 without A/C, with Cables (pictured, right) K-3925776C

Firebird

67 without A/C, with Cables (pictured, left) K-3925775C
67 with A/C with Cables K-3891798
69 with A/C, with Cables K-3919582
69 without A/C, with Cables (pictured, right) K-3925776C
67-68 without A/C, Fan Switch K-3885148

Heater Control Cable Set

Nova

69-74 without A/C (pictured, above)..... K-K572
69-74 with A/C..... K-K573

Camaro

67-68 without A/C..... K-K571
69 without A/C (pictured, above)..... K-K572
69 with A/C..... K-K573

Firebird

67-68 without A/C..... K-K571

Heater Delete Plate

Nova

68-74 Pair, A/C Cars (pictured).... W-899

Camaro

67-69 Pair, A/C Cars (pictured).... W-899

Firebird

67-69 Pair, A/C Cars (pictured)..... W-899

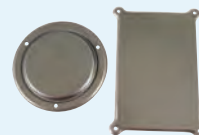

Temperature Control Knobs

Nova

62-74 Chrome, Set of 4 (pictured) T-9579
68-74 Black, Set of 3 T-9579A



Chevelle / El Camino

64-72 Chrome (pictured, top) K-K408
64-72 Black (bottom)..... K-K409



Camaro / Firebird

67-81 Chrome (top)..... K-K408
67-81 Black (bottom)..... K-K409



Dash Accessories & Parts

Heater Control Levers



Chevelle / El Camino



66	Steel, Set of 4 Levers	P-CC17008
67	Steel, Set of 4 Levers (pictured, left)	P-CC17009
66-67	Steel	P-CC17200
64-65	Air Blower, Steel	P-CH26268
68-69	Steel, Set of 3 Levers (pictured, right)	P-CH26269
70-72	Steel, 3 Levers	P-CH26804

Camaro / Firebird

67-68	Dash Heater Lever	 K-K896
-------	-------------------	--

Heater Switches





Nova

68-74	Heater / AC Blower Switch	 K-3929093
69-74	Heater / AC Fan Switch (pictured, below)	 K-3929094
69-74	Heater Fan Switch, without A/C	 K-3967939

Chevelle / El Camino

68-69	without A/C, Fan Switch (pictured)	 K-3885148
-------	---------------------------------------	---

Camaro

67-69	without A/C, Fan Switch (pictured, above)	 K-3885148
69	Heater Fan Switch, without A/C	 K-3967939
69	Heater/AC Blower Switch	 K-3929093
69-74	Heater/AC Fan Switch (pictured)	 K-3929094

Dash Defogger Switch

Camaro

70-78	(pictured)	K-3974093
70-78	Switch	
	Bezel	 K-3973660

Heater Dash Lens

Nova

68	without A/C, with Backing Plate	W-497
68	with A/C, with Backing Plate (pictured, left)	W-497A
69-74	with A/C (right)	K-K598
69-74	without A/C	K-K597

Camaro

67	with A/C (pictured, left)	K-K594
67	without A/C (pictured, right)	K-K593
68	without A/C, with Backing Plate	W-497
68	with A/C, with Backing Plate	W-497A
69	with A/C	K-K598
69	without A/C	K-K597

Heater Dash Lens, continued

Firebird

67	with A/C (pictured, above left)	K-K594
67	without A/C (pictured, above right)	K-K593
68	without A/C, with Backing Plate	W-497
68	with A/C, with Backing Plate	W-497A

A/C Vent Assembly

Nova

70-72	Center Dash (pictured)	 K-3937166
-------	---------------------------	---

Camaro

69	Center Dash (pictured)	 K-3937166
----	------------------------	---

A/C Dash Vent Bezel

Nova

69-72	RH	K-14942
-------	----	---------

Camaro

69-72	RH	K-14942
-------	----	---------

Center A/C Vent Rebuild Set



Chevelle / El Camino

69-72	Center only (pictured, left)	C-J-3241
69-72	Center & Outer (pictured, right)	C-J-3243
70	Center & Outer	C-J-3242

Center A/C Deflector

Chevelle / El Camino

70-72	LH/RH Pair (with Correct Chrome Pattern)	C-J-3240
-------	--	----------

Air Flow Control Cable

GM



65-81	Fits many models, see website for complete list	K-8756278
-------	--	-----------

Vent Shut Off Assembly

Camaro

67-68	LH (pictured)	 K-K290
67-68	RH	 K-K289

Firebird

67-69	LH (pictured)	 K-K290
67-69	RH	 K-K289

Defroster Vent Assembly

Nova

68		 K-3973729
----	--	---

Camaro / Firebird

67-79	(pictured)	 K-3925711
69	Camaro	 K-3973729

Dash Side Air Vent Assembly

Nova

69-72	Sold each (pictured)	W-274
-------	----------------------	-------

Camaro / Full Size Chevy

69	Sold each (pictured)	W-274
----	----------------------	-------



Our Name Says It All!™

Dash Accessories & Parts

Dash Side Vent

Camaro

- 69 without A/C, LH K-3939631
- 69 without A/C, RH K-3939632
- 70-81 without A/C, LH K-6262667
- 70-81 without A/C, RH K-6262668
- 70-81 with A/C, LH
(pictured)..... K-3998407
- 70-81 with A/C, RH K-3998408



Center Air Vent Assembly

Camaro / Firebird

- 67-68 (pictured).... K-3891761



Under Dash Air Door

Chevelle / El Camino

- 68-72 with A/C, RH
(Opened by C-J-3278, Vacuum Pod)C-J-3277

Under Dash Air Door Vacuum Pod

Chevelle / El Camino

- 68-72 with A/C (Activates RH Under Dash Air Door)C-J-3278
- 68-72 with A/C (Activates Cowl Fresh Air)C-J-3279

Vent Tube Deflector Assembly

Chevelle / El Camino

- 70 without A/C,
LH/RH Pair
(pictured).....C-J-3272
- 71-72 without A/C,
LH/RH PairC-J-3274



Dash Air Vent Outlet

Chevelle / El Camino

- 70 Sold each (right).....C-J-3268
- 71-72 Sold eachC-J-3270



Air Duct Deflector

Firebird

- 70-81 K-9790400



Dash Vent Deflector

Camaro

- 70-78 (pictured).... K-3963781



Dash Air Duct Seal Set

Camaro / Firebird

- 68 K-K226
- 69 (pictured)..... K-K227

Full Size Chevy

- 65-68 K-K226
- 69 (pictured)..... K-K227

Center Dash Vent Rubber Plugs

Camaro

- 67-68 K-9776399

Dash Vent Bezels

Camaro / Firebird

- 67-68 LH, Black K-3925743
- 67-68 RH, Black..... K-3925744
- 67-68 LH, Chrome K-3925741
- 67-68 RH, Chrome K-3925742

Dash Vent Bezels, continued

Camaro / Firebird, continued

- 70-81 Lower, LH (pictured) .. K-3967927

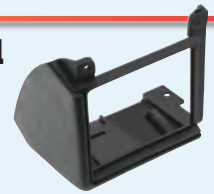

Dash Vent Bezel Retainer Adapter

Camaro

- 67-68 (pictured).... K-3937189

Firebird

- 67-69 (pictured).... K-3937189

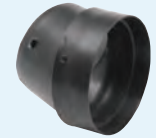

Dash Vent Knobs



Nova

- 63-74 Black, 2-Piece Set (pictured, left) T-4561

Chevelle / El Camino

- 64-72 Black, 2-Piece Set (pictured, left) T-4561
- 68-72 Chrome, 4-Piece (pictured, right)..... T-4560

Camaro

- 67-78 Black, 2-Piece Set (pictured, left) T-4561
- 68 Side Vent, Black, LH/RH Pair W-562
- 68 Side Vent, Black Knob & Clear Ferrule,
4-Piece Set..... W-564
- 68 Side Vent, Black Knob & Black Ferrule,
4-Piece Set..... W-564B
- 68-72 Chrome, 4-Piece T-4560

Firebird

Side Vent

- 68 Black, LH/RH Pair..... W-562
- 68 Black Knob & Clear Ferrule, 4-Piece Set W-564
- 68 Black Knob & Black Ferrule, 4-Piece Set W-564B

Full Size Chevy

- 67-78 Black, 2-Piece Set (above left) T-4561

Dash Vent Knob Ferrules

Camaro / Firebird

- 68 Dash Side Vent, Clear, LH/RH Pair W-563
- 68 Dash Side Vent, Black, LH/RH Pair W-563B

Dash Vent Ball

Firebird

- 69 Dash Vent Ball K-9798556

Side Astro Vent Ball

Chevelle / El Camino

- 66-69 Chrome
(pictured).... W-553

Camaro / Firebird

- 67-68 Chrome (pictured) W-553

Full Size Chevy

- 65-68 Chrome (pictured) W-553



Astro Vent Bezel

Camaro / Firebird

Correct Top Notch for Dash Clearance

- 68 LH W-512
- 68 RH W-568



Our Name Says It All!™



All of our own **AMD** parts in this catalog are listed in **Blue, bold-face Type**.

Dash Accessories & Parts

Astro Vent Bezel Retainer

Chevelle / El Camino

66-69 Dash, with Clip W-566

Camaro

67-68 Dash, with Clip W-566

Firebird

67-69 Dash, with Clip W-566



Astro Vent Ball Seal Set

Nova

70-79 (does both sides) J-3062

Chevelle / El Camino

66-68 (does both sides) J-3060

Camaro

67-68 (does both sides) J-3060

69 (does both sides) J-3062

Ashtray & Lighter

AMD offers a several ashtrays and lighters for most popular GM applications. These parts are manufactured by CHQ.

Ashtray Assembly



Nova

70-79 Rear Armrest (pictured, left) W-641

Chevelle

68-71 Rear Armrest (pictured, right) W-642

70-72 Rear Armrest (pictured, left) W-641

Camaro / Firebird

67 Camaro, Rear Armrest (pictured, right) W-642

68 Walnut, Dash W-982

68 Black, Dash W-982A

68-74 Camaro, Rear Armrest (pictured, left) W-641

68-75 Firebird, Rear Armrest (pictured, left) W-641

Chevy Full Size

68-76 Rear Armrest (pictured, right) W-642

Dash Ashtray Receiver

Nova

69-74 (pictured) W-486

Camaro / Firebird

69 Camaro (pictured) W-486

Ashtray Insert

Nova

70-74 Small, Rear (top) W-255

Chevelle

68-71 Convertible,
Large, Rear (bottom) W-254

70-72 Small, Rear (top) W-255

Camaro / Firebird

67 Large, Rear (bottom) W-254

68-69 Small, Rear (top) W-255

Chevy Full Size

68-76 Large, Rear (bottom) W-254

Console Ashtray

Camaro

67 W-235

68-72 (pictured) W-155

Firebird

67 W-235



Ashtray Lid

Camaro

68-69 Rear Ashtray W-804



Ashtray Parts

Camaro

68-69 Ashtray Insert  K-3919076

68-72 Ashtray Lid Pivot & Clip Set W-514

68-72 Ashtray Lid Spring, Pair W-514A

Rochester Dash Lighter Assembly

Nova

67 (pictured, top) W-298C

69 (pictured, bottom) W-421A

Chevelle / Chevy Full Size

67 (pictured, top) W-298C

Camaro / Firebird

(pictured, top) W-298C

69 (pictured, bottom) W-421A



Rochester Lighter Caseload

Nova

64-68 (pictured) W-421C

Chevelle

64-69 (pictured) W-421C

Camaro / Firebird

67-69 Camaro (pictured) W-421C



Rochester Lighter Receptacle

Nova

62-75 (pictured) W-421E

Chevelle

64-69 (pictured) W-421E

Camaro / Firebird

67-70 Camaro (pictured) W-421E

67-68 Firebird (pictured) W-421E

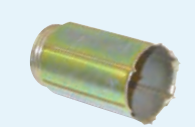

Rochester Type Lighter Knob

Nova

67 (pictured, top) W-298

69 Dash Knob (bottom) W-421

Chevelle / Chevy Full Size

67 (pictured, top) W-298

Camaro / Firebird

67-68 (pictured, top) W-298

69 Dash Knob (bottom) W-421



Rochester Lighter Heating Element

Camaro / Firebird

67-69 Insulator & Shield Assembly
(pictured) W-298B

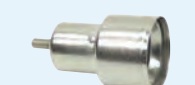

Our Name Says It All!™

Glove Box & Parts

AMD offers a comprehensive line of glove box parts including liners, doors, bumpers, and hardware for most popular GM applications. These parts are manufactured by CHQ, OER, OPGI, RePops, Soff Seal, and TWE

Assembled Glove Box with Hardware

Nova

62-65	R-N101
66-67	R-N102
68	without A/C.....	R-N141
68	with A/C.....	R-N144
69-79	without A/C.....	R-N104
69-79	with A/C.....	R-N103

Chevelle / El Camino

64-65	without A/C.....	R-CH101
64-65	with A/C.....	R-CH109
64-65	with Dealer Installed A/C.....	R-CH118
66-67	without A/C.....	R-CH102
66-67	with A/C.....	R-CH110
68-69	without A/C, Flocked.....	R-CH107FLK

Camaro

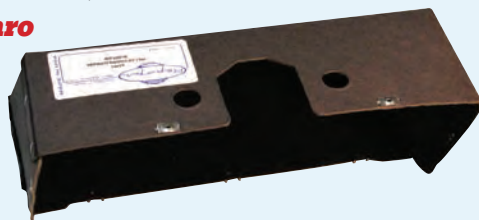

67-68	with A/C.....	R-CA101
67-68	without A/C (pictured).....	R-CA102
69	with A/C.....	R-CA103
69	without A/C.....	R-CA104
70-81	with A/C.....	R-CA138
70-81	with A/C, Flocked.....	R-CA138FLK
70-81	without A/C.....	R-CA139
70-81	without A/C, Flocked.....	R-CA139FLK

Firebird

70	with A/C.....	R-FB110
----	---------------	---------

Chevy Full Size

69	without A/C.....	R-CP179
----	------------------	---------

Glove Box Support Strap

Camaro

70-81	(pictured).....	K-3975885
-------	-----------------	-----------



Glove Box Door

Chevelle / El Camino

70-72	P-CH22081
-------	-------	-----------

Monte Carlo

70-72	P-CH22081
-------	-------	-----------

Camaro



67-68	Drill Emblem Holes for 68.....	 K-3891663
-------	--------------------------------	---

69	Standard Interior, Black (pictured, left).....	K-3939659
----	--	-----------

70-77	with "Camaro" Script (pictured, right).....	 K-3999446
-------	---	---

78-81	with "Camaro" Block Script.....	 K-14003615
-------	---------------------------------	--

Firebird

67-68	Drill Emblem Holes for 68 (pictured).....	K-3891663
-------	---	-----------

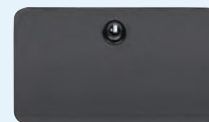

El Camino Storage Box

Chevelle / El Camino

68-72	Behind Drivers Seat.....	P-RPR0260
-------	--------------------------	-----------

Glove Box Catch Plate

Camaro

67-68	with Screws (pictured, top).....	W-139
-------	----------------------------------	-------

67-68	(bottom).....	K-3891672
-------	---------------	-----------

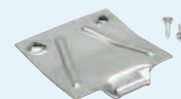

Firebird

67-68	with Screws (top).....	 W-139
-------	------------------------	--

67-68	(pictured).....	 K-3891672
-------	-----------------	--

69	K-9797237
----	-------	-----------



Glove Box Lock Housing Set

Chevelle / El Camino

66-67	Lock Housing Set (Housing, Spring, Bezel, Chrome Nut) (pictured).....	C-J-3350
-------	---	----------



Glove Box Lock Assembly

Camaro

70-81	without Key (pictured).....	K-3957092
-------	-----------------------------	-----------

Firebird

70-81	without Key.....	K-3957092
-------	------------------	-----------



Glove Box Lock Striker

Chevelle / El Camino

66-67	C-J-3351
-------	-------	----------

Camaro

70-81	K-3975839
-------	-------	-----------



Our Name Says It All!™



All of our own **AMD** parts in this catalog are listed in **Blue, bold-face type**.

Glove Box & Parts

Glove Box Lock Retainer

Nova

62-65 (pictured).....C-J2-2315

Glove Box Latch Striker

Nova

62-65C-J2-1310
66-67C-J2-1312

Glove Box Bumper Bracket

Camaro

72-81K-3994597



Glove Box Door Bumper

Nova

62-74 Glove Box Door Bumper, PairJ-1069

Chevelle / El Camino

64-74 Pair.....J-1069

Monte Carlo

70-72 Pair.....J-1069

Camaro / Firebird

67-81 Pair.....J-1069

Glove Box Screws

Camaro / Firebird

67-69 7-Piece Set (pictured).....W-402



Radio & Accessories

AMD offers a comprehensive line of radio parts including cover plates, lenses, knobs, and antennas for many popular GM applications. These parts are manufactured by CHQ, OER, OPGI, and TWE.

Dash Radio Plates



Camaro

67-68 Center Dash, Chrome & Black (pictured, left).....W-297
69 LH/RH Pair, Woodgrain
(Bonded to Steel Mount Plate) (pictured, right).....W-384

Radio Bezels

Nova

66-67 (pictured).....C-J2-2850

Chevelle / El Camino

66P-GBC1446
67P-GBC1447



AM / FM Radio Lens



Nova

71-72 Mono Radio, White Letters, Medium Blue
Top Edge (pictured, left) T-4615
71-72 Stereo Radio, White Letters, Medium Blue
Top Edge (pictured, right) T-4616

Chevelle / El Camino

71-72 Mono Radio, White Letters, Medium Blue
Top Edge (pictured, left) T-4615
71-72 Stereo Radio, White Letters, Medium Blue
Top Edge (pictured, right) T-4616

AM / FM Radio Lens, continued

Camaro

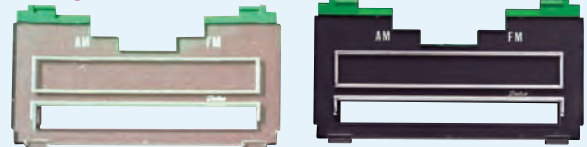

69-70 AM/FM Stereo Radio Lens, Light Green Letters,
Light Green Top Edge
(pictured, left) T-2121
69-70 Mono Radio, White Letters,
Medium Green Top Edge
(pictured, right) T-2120
70 Stereo Radio, White Letters,
Medium Green Top Edge
(pictured, right) T-2120
71-76 Mono Radio Lens, White Letters,
Medium Blue Top Edge (top left) T-4615
71-76 Stereo Radio, White Letters,
Medium Blue Top Edge (top right) T-4616

Firebird

69-70 Stereo Radio Lens, Light Green Letters,
Light Green Top Edge (above left) T-2121
69-70 Mono Radio, White Letters,
Medium Green Top Edge
(above right) T-2120
70 Stereo Radio, White Letters,
Medium Green Top Edge
(above right) T-2120

Chevy Full Size

71-76 Mono Radio, White Letters,
Medium Blue Top Edge (top left) T-4615
71-76 Stereo Radio, White Letters,
Medium Blue Top Edge (top right) T-4616



Our Name Says It All!™

Radio & Accessories

Radio Knobs



Nova

- 67 Radio Volume & Tuner Knob, Chrome, Pair W-213
- 69 Mono Radio, 4-Piece Set (pictured, left) W-860
- 69-70 Stereo Radio, Inner Volume & Tuner Knob Set W-245
- 69-70 Mono Radio, Inner Tone & Dummy Knob Set W-231
- 69-70 Stereo Radio, Inner Tone & Fader Knob Set W-231A
- 69-70 Stereo Radio, 4-Piece Set (pictured, center) W-517

Chevelle / El Camino

- 67-68 Radio Volume & Tuner Knob, Chrome, Pair W-213
- 67-68 Inner Knobs, Black, Pair, Tone & Dummy Knobs W-197
- 67-68 Inner Knobs, Black, Pair, Tone & Fader Knobs W-197A
- 69 Mono Radio, 4-Piece Set (pictured, left) W-860
- 69-70 Stereo Radio, Inner Volume & Tuner Knob Set W-245
- 69-70 Mono Radio, Inner Tone & Dummy Knob Set W-231
- 69-70 Stereo Radio, Inner Tone & Fader Knob Set W-231A
- 69-70 Stereo Radio, 4-Piece Set (pictured, center) W-517

Camaro

- 67-68 Radio Volume & Tuner Knob, Chrome, Pair W-213
- 67-68 Mono Radio, 4-Piece Set W-850
- 67-68 Stereo Radio, 4-Piece Set (pictured, right) W-855
- 67-68 Inner Knobs, Black, Pair Tone & Dummy Knobs W-197
- 67-68 Inner Knobs, Black, Pair Tone & Fader Knobs W-197A
- 69-70 Mono Radio, 4-Piece Set (pictured, left) W-860
- 69-70 Stereo Radio, Inner Volume & Tuner Knob Set W-245
- 69-70 Mono Radio, Inner Tone & Dummy Knob Set W-231
- 69-70 Stereo Radio, Inner Tone & Fader Knob Set W-231A
- 69-70 Stereo Radio, 4-Piece Set (pictured, center) W-517
- 73-78 Radio Control Knobs, Pair K-330107

Firebird

- 67-69 Radio Knobs  K-9786795
- 70-81 8 Track Knob Set K-K574
- 70-81 AM/FM Knobs K-K575

Chevy Full Size

- 67-68 Mono Radio, 4-Piece Set W-850
- 67-68 Stereo Radio, 4-Piece Set (pictured, right) W-855
- 68 Radio Volume & Tuner Knob, Chrome, Pair W-213
- 69-70 Stereo Radio, Inner Volume & Tuner Knob Set W-245
- 69-70 Mono Radio, Inner Tone & Dummy Knob Set W-231
- 69-70 Stereo Radio, Inner Tone & Fader Knob Set W-231A
- 69-70 Stereo Radio, 4-Piece Set (pictured, center) W-517

Radio Control Shaft Nut

Nova

- 63-69 Pair (pictured) W-588

Chevelle / El Camino

- 64-69 Pair (pictured) W-588

Camaro

- 67-72 Pair (pictured) W-588

Chevy Full Size

- 63-69 Pair (pictured) W-588

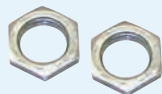

Convertible Speaker Bolt

Camaro / Firebird

- 67-69 4-Piece Set K-K101

Antenna Mast

Nova

- 69-70 AM/FM (pictured) K-3943654

Chevelle

- 70 AM/FM (pictured, above) K-3943654

Camaro / Firebird

- 67 AM (pictured) K-986819
- 69-70 AM/FM (pictured, top) K-3943654

Chevy Full Size

- 69-70 AM/FM (pictured, top) K-3943654

Antenna Body Assembly

Camaro / Firebird

- 67-68 (pictured) K-3880695



Antenna Cable Lead

Nova

- 73-74 with Windshield Antenna (pictured) K-K4424

Camaro / Firebird

- 70-81 with Windshield Antenna (pictured) K-K4424

Antenna Cable

Camaro / Firebird

- 67-69 (pictured) K-469304



Antenna Chrome Bezel

Camaro

- 67-68 (pictured)  K-3897333
- 69  K-3937665
- 73-75  K-3937665



Firebird

- 67-68 (pictured) K-3897333

Antenna Gasket

Nova

- 65-67 Rear (pictured) K-3820672
- 66-67 Front J-4052
- 69 Rear (pictured) K-3820672
- 73-74 Rear (pictured) K-3820672





El Camino

- 68-69 Front (pictured) K-3820672

Chrome Bezel Nut

Camaro / Firebird

- 67-68 for Original Antenna Base  K-3863499
- 67-68 for Reproduction Antenna Base (pictured)  K-3863499B



All of our own **AMD** parts in this catalog are listed in **Blue, bold-face Type**.

Our Name Says It All!™

Instrument Carrier, Lenses & Parts

AMD offers a comprehensive line of instrument parts including carriers, lenses, circuit boards, and more for popular GM applications. These parts are manufactured by CHQ, OER, and OPGI.

Center Dash Bezels / Instrument Carrier Chevelle / El Camino



64 with A/C, with Original Emblem P-CH20440



64 without A/C, with Original Emblem P-CH20441



65 with A/C, with Original Emblem P-C982001



65 without A/C, with Original Emblem .. P-C982002

66-67 Speedometer Bezel, Chrome..... P-GFK0001



69 without A/C & Astro Ventilation (pictured).....P-CH24891

69 without A/C & with Astro Ventilation.....P-CH24892

69 with A/C & Astro Ventilation.....P-CH24929

Camaro



67-68 Assembly K-648076

69 Assembly..... K-6482249

70-72 Carrier with Chrome Trim (pictured, above) K-K968

Firebird

67-68 Assembly K-6480760

Dash Carrier Lens

Camaro / Firebird

67 K-6459869

68 without Console Gauges or Tachometer (pictured) K-6481576

68 with Console Gauges and Tachometer..... K-6481587

70-78 Firebird, Dash Lens Assembly with Warning Lights K-6493584



Instrument Cluster Lens

Nova

63-65 Cluster Lens (pictured) K-6406764



66-67 Bezel Lens (pictured, left).....C-J2-2660

68-76 Bezel Lens (pictured, right).....C-J2-2700

Chevelle

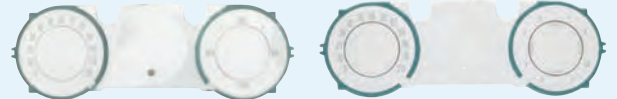

64-65 without Gauges (pictured, left) K-6407659

64-65 with Gauges (pictured, right) K-6407660

69 Lens K-3939692

70-72 SS P-97CH015

El Camino

64-65 without Gauges (pictured, left) K-6407659

69 Lens K-3939692

70-72 SS P-97CH015

Monte Carlo

70-72 P-97CH015

Camaro

70-81 Instrument Panel Lens K-3999485

Firebird

69 (pictured) K-6482772



Instrument Housing Circuit Boards

Camaro / Firebird



67 with Tach (pictured, left) W-523

67-68 without Tach (pictured, left) W-523

68 Camaro, with Tach (pictured, right)..... W-524

Instrument Panel Parts

Chevelle / El Camino

69 Lamp Socket Plate K-6482854

Instrument Carrier Hardware

Camaro

67-68 Screws, 7-Piece Set (pictured)..... W-403

67-68 Dash Carrier Clips K-C68200

69 Dash Carrier Clip Set (pictured)..... K-C69200



Our Name Says It All!™

Dash Gauges, Instruments & Accessories

AMD offers a comprehensive line of gauges and parts including speedometers, tachometers, fuel gauges, amp gauges, and clocks for popular GM applications. These parts are manufactured by CHQ, OER, and OPGI.

Dash Lens Assembly

Camaro

70-78 with Gauges		K-25018346
70-78 with Warning Lights		K-6493584
79-81 without Gauges		K-25047802
79-81 with Gauges		K-25020370

Instrument Cluster Case

Camaro



70-78 with and without gauges,
See website for details.



Instrument Gauge Cluster

Nova

63-64 SS, 4-Gauge Cluster
(pictured)

65 SS, 4-Gauge Cluster		K-2196365
65 SS, 4-Gauge Cluster		K-2196565

Chevelle

69 Tachometer / Gauge Cluster with 5500 RPM Redline		K-6491313
--	---	-----------

Malibu SS

65 Gauge Cluster		K-7196465
------------------------	---	-----------

Instrument Cluster Bezel

Nova

63-65 Instrument Bezel		K-6406763
66		C-J2-2650-1
67		C-J2-2650-2





Firebird

69		K-6482773
----------	---	-----------



Speedometer

Nova









62-64 120 MPH		K-6406815
65 120 MPH		K-6455482
66-67 Standard		K-6459272
69-74 with Console Gauges (pictured)		K-6496617
69-74 without Console Gauges		K-6496615

Chevelle / El Camino





68 without Speed Warning		K-6492545
69 without Speed Warning		K-6492542

Camaro

67 Standard		K-6480794
67 with Speed Warning		K-6480796
68 Standard, 120 MPH, without Speed Warning		K-6481843
68 120 MPH, with Speed Warning		K-6481845
69 120 MPH, without Speed Warning		K-6482887
69 120 MPH, with Speed Warning		K-6482888







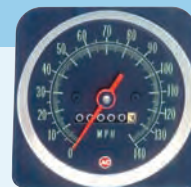

Speedometer

Camaro, continued

69 140 MPH, Calibrated Assembly (pictured)		W-111
69 COPO, 140 MPH, with Speed Warning		K-6492576
70-74 150 MPH		K-6497236
70-78 130 MPH		K-8987263



Firebird

67 Standard		K-6480794
67 with Speed Warning		K-6480796
68 160 MPH, without Gauges		K-6481931
68 160 MPH, with Gauges		K-6481933
69 160 MPH		K-6482799
70-74 160 MPH, without Seat Belt Warning		K-6492882
70-74 160 MPH, with Seat Belt Warning		K-6497947
75-79 100 MPH Speedometer		K-8986779

Speedometer Lenses

Chevelle / El Camino

69		C-J-2787
----------	--	----------

Camaro

67 Speedometer / Fuel / Brake Warning Lens		K-K494
68 Speedometer / Oil / Brake Lamp Lens		K-K492
69 Dash Lens without Tell Tale		K-6482842

Firebird

67 Speedometer / Fuel / Brake Warning Lens		K-K494
--	--	--------

Speedometer Cable

Nova

62-69 55", Thread-On, without Grommet		K-6478125
62-69 73", Thread-On, without Grommet		K-6478128
73-74 69", Push-On, without Grommet		K-6478176
74 24", Thread-On (pictured)		K-6454481



Camaro

67-68 58", with installed Firewall Grommet (pictured)		W-870
67-68 69", with installed Firewall Grommet		W-871
67-68 73", with installed Firewall Grommet		W-872
67-68 Lower, 23.5"		W-873
67-68 Upper, 37.5", with installed Firewall Grommet		W-874
69 62", with installed Firewall Grommet		W-876
69 71", with installed Firewall Grommet		W-877



Our Name Says It All!™

Dash Gauges, Instruments & Accessories

Speed Warning Central Cable

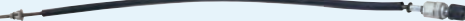
Nova 
68-69 (pictured)..... K-6454841

Camaro
67-68 (pictured)..... K-6454841
69 K-6476813

Speed Warning Cable Bracket

Camaro
69 K-3954257

Speedometer Cable Retainer Clip

Nova
69-74 K-6491006
66-74 4-Speed, Firewall Cable Clip K-HC74

Camaro
69-72 W-090

Speedometer Cable Grommet











GM
67-69 All GM with 1" hole W-875

Tachometer

Nova
68-74 Dash Tach.....  K-5657301

Chevelle / El Camino
67 Original Style, 7000 RPM with 5500 Redline,
White Letters P-BL16755
67 Original Style, 7000 RPM with 6000 Redline,
Green Letters..... P-BL16760





Camaro

67	327, 5000 Redline		K-6468909
67	5500 Redline		K-6468910
67	6000 Redline		K-6468911
68	Tic-Toc Tach, 5000 Redline		K-6468714
68	Tic-Toc Tach, 5500 Redline		K-6468713
68	Tic-Toc Tach, 6000 Redline		K-6468715
69	SS 350, 5 X 7 Tach		K-6469381
69	Z/28, 396/375 HP, 6 X 8 Tach		K-6469384
69	396/325 HP, 5 X 7 Tach		K-6469382
69	396/375 HP, 6 X 7 Tach		K-6469383
70-78			K-5657040

Firebird

Tach/Clock Assembly
73-75  K-5658075
76-78  K-5659065





Hood Tachometer

68	5200 Redline, V8 Point Ignition		K-6468972
68	5500 Redline, 6 Cylinder Point Ignition		K-6468971
68	5500 Redline, V8 Point Ignition		K-6468973
69	5200 Redline, V8 Point Ignition		K-6468974
69	5500 Redline, V8 Point Ignition		K-6468975

Fuel Gauge

Nova
63-64 Standard, with Warning Lights  K-5644638
65 Standard, with Warning Lights  K-5644639
66-67 Standard, Dash  K-6430436
68-74  W-098

Camaro

68	Standard, Dash		K-6431002
69	Standard, Dash		K-6431172
67	Standard		K-6457934
69	Center Dash (pictured)		W-511
70-78	Dash, 2"		K-6431506



Firebird

67	Standard		K-6457934
68	Standard, Dash		K-6431007
69	Standard, Dash		K-6431093
70-79			K-6432039

Fuel Gauge Lens & Bezel

Camaro
69 Dash Bezel & Lens
(pictured)  K-3961554
69 Dash Lens  K-LEN28



Low Fuel Warning Module

Camaro
67  W-610
68-69 (pictured)  W-615



Oil Pressure Gauge

Nova
68-74  W-097

Firebird

Oil Pressure/Water Temperature Gauge
70-78 Rally  K-6493193

Temperature Gauge

Nova
68-74  W-099

Camaro

70-79  K-6489856





Amp Gauge

Nova
68-74  W-100

Camaro

70-75  K-6473741

Gauge Lenses

Camaro
68 Fuel Gauge Gen/Temp
Warning Lens  K-K493
69 Dash Fuel Lens without Tell Tale  K-6482843
70-81 Fuel & Volt Gauge Mounting Plate  K-9743001
76-78 Dash Volt Gauge  K-6474343





Our Name Says It All!™

Dash Gauges, Instruments & Accessories



Clock Nova



- 63-65 Clock (pictured, left)  K-3863796
68-74 Dash Clock (pictured, center)  K-994125



Chevelle



- 68 In-Dash Clock Assembly with Warning Lights (left)  K-3919015
69 Center Dash Clock (right)  K-3948956

Camaro



- 69 Center Dash Clock (pictured, left)  K-3951213
69 Center Dash Panel Clock with Quartz Movement (pictured, center)  W-464
70-78 Dash Clock (pictured, right)  K-3980116

Console Clock

Camaro / Firebird

- 67 (pictured).....  K-3901613





Console Clock Lens

Chevelle / El Camino / Chevy Full Size



- 64-67  T-2394

Clock Parts

Nova

- 63-65 Clock Plug, for cars without Clock ...  K-6406757
68-74 Clock Opening Plate (block off plate), for cars without Clock.....  K-6496824

Camaro

- 69 Center Dash Clock Bezel / Lens  K-3943616
69 Dash Clock Lens  K-LEN27
67-89 and Firebird, Clock Reset Knob Stem  K-14053344



Console & Parts

AMD offers a comprehensive line of consoles and parts including complete console assemblies, housings, doors, gauges, and hardware for popular GM applications. These parts are manufactured by CHQ, OER, OPGI, RePops, Trim Parts, and TWE.

Console Assembly



Nova



- 66-67 SS, Automatic T transmission (original for 66-67, functional for 65) (pictured) C-J2-3560
66-67 SS, 4-Speed (original for 66-67, functional for 65)C-J2-3550

Camaro

- 68 Powerglide & Turbo, Kit..... W-897A
68 4-Speed Manual, Kit.....W-897M
69 Powerglide & Turbo, Kit..... W-898A
69 4-Speed Manual, Kit.....W-898M
68 Manual Transmission, Assembled W-97MK
68 Manual Transmission, Assembled, with Gauges W-97WMK
68 Powerglide, Assembled..... W-97PG
68 Powerglide, Assembled, with Gauges W-97WPG
68 TH 350/400, Assembled W-97TH
68 TH 350/400, Assembled, with Gauges W-97WTH

Camaro, continued



- 69 Manual Transmission, Assembled W-98MK
69 Manual Transmission, Assembled, with Gauges W-98WMK
69 Powerglide, Assembled W-98PG
69 Powerglide, Assembled, with Gauges W-98WPG
69 TH 350/400, Assembled W-98TH
69 TH 350/400, Assembled, with Gauges W-98WTH
70-72 (pictured, above)  K-3975798
73-81 4-Speed  K-469930
73-81 Automatic Transmission.....  K-469937



Our Name Says It All!™

Console & Parts

Console Housing

Nova

68-72 Console Housing W-481

Camaro



68-69 Top Shell & Bottom Housing..... W-896

Console Base



Nova

66-67 Automatic Transmission.....C-J2-3561
66-67 4-Speed (pictured).....C-J2-3553

Chevelle / El Camino

66-67 4-Speed Console P-9507993
66-67 Automatic Transmission..... P-9507992
68-72 P-9508001

Monte Carlo

70-72 P-9508001

Console Base Trim

Chevelle / El Camino

68-72 P-9500063

Monte Carlo

70-72 P-9500063

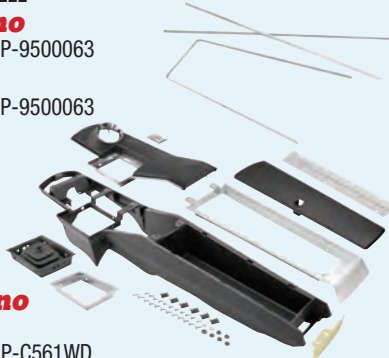

Center Console Set, Complete

Chevelle / El Camino

66-67 4-Speed (pictured).....P-C561WD





66-67 Automatic Transmission.....P-C567WD
68 4-Speed P-C6872A
68 Powerglide P-C6872C
68 Turbo, Green Letters P-C6872J
69 4-Speed P-C6872E
69 Powerglide P-C6872G
69 Turbo, Green Letters P-C6872K
70 Powerglide P-C6872H
70 Turbo, Green Letters P-C6872L
70-72 4-Speed P-C6872F
71-72 Turbo, White Letters..... P-C6872M

Monte Carlo

70 Powerglide P-C6872D
70 Turbo, Green Letters P-C6872I
70-72 4-Speed P-C6872B
71-72 Turbo, White Letters..... P-C6872N

Center Console

Firebird

68-69 Automatic Transmission, Burlwood  K-9793278
68-69 Manual Transmission, Burlwood.....  K-9793279
70-79 Automatic Transmission.....  K-10009290R
70-79 Manual Transmission.....  K-10009289R

Console Top Plate



Nova

66-67 4-Speed (pictured).....C-J2-3552
66-67 Automatic Transmission.....C-J2-3562

Chevelle / El Camino

66-67 Automatic Transmission..... P-9507997
66-67 4-Speed P-9507994
66-67 Automatic Transmission & 4-Speed, Rear P-9507996
68-72 Automatic Transmission..... P-9508002
68-72 4-Speed P-9508031

Monte Carlo

70-72 Automatic Transmission, with Original Burlwood Facing..... P-9508004
70-72 4-Speed, Burlwood Insert Set P-MCK1412
70-72 Automatic Transmission, Burlwood Insert Set. P-MCK1410
70-72 4-Speed, with Burlwood Facing & Chrome/Black Shift Pattern..... P-9508032

Center Console Door



Chevelle / El Camino

66-67 Automatic Transmission & 4-Speed, Correct Black Diecast Metal (pictured, left)..... P-9507998
68 Assembly with Chrome Center Trim (right)..... P-CHV4570



69
70-72 Assembly with Chrome Center Trim (right)..... P-CHV4572





Monte Carlo

70-72 Assembly with Chrome Center Trim (above right)..... P-CHV4572

GTO

68-69 Molded Black Urethane, with Steel Insert for Hinge Mounting (pictured) P-39310BK

Camaro

67 Console Lid (below, left)  K-3893861
68-69 Flocked Underside W-817
70-72 without Button / Latch  K-3972012
70-72 with Button / Latch (pictured)  K-3972012A
70-81 Lid Cover, Black  K-10019554

Firebird

67 (pictured, left)  K-3893861
68-69 Burlwood (pictured, right).....  K-3918723
70-81 Lid Cover, Black.....  K-10019554



Our Name Says It All!™

Console & Parts

Console Door Hinge

Automatic & 4-Speed

Chevelle / El Camino

- 66-67 with Spring
(pictured)..... P-9507995
68-69 without Spring P-9508007
70-72 with Spring P-950807D



Monte Carlo

- 70-72 with Spring P-950807D

Camaro

- 67 Console Lid Hinge
(pictured)..... K-3893866
68-69 Console Door Hinge W-459



Firebird

- 67-69 Console Lid Hinge (pictured)..... K-3893866

Console Door Arm

Camaro

- 68-69 Console Door Arm W-819

Console Door Latch / Button

Camaro

- 70-72 (pictured).....  K-3972993
73-81 Console Lid
Latch / Button..... K-478567
73-81 Console Button Return Spring K-478568



Firebird

- 70-81 Console Lid Latch / Button K-478567
70-81 Console Button Return Spring K-478568

Console Lock Retainer

Chevelle / El Camino

- 70-72 Lock Retainer C-J-8115

Monte Carlo

- 70-72 Lock Retainer C-J-8115

Console Lid Spring

Camaro

- 67 Console Lid Spring K-3899868
68-69 Console Door Spring W-123

Firebird

- 67-69 Console Lid Spring K-3899868

Center Console Chrome Trim

Chevelle / El Camino / Monte Carlo

- 70-72 (pictured).....  T-4573

Console Seal Set

Chevelle / El Camino

- 68-72 Sealing Strips, 4-Piece Set..... P-RCS0561

Monte Carlo

- 70-72 Sealing Strips, 4-Piece Set..... P-RCS0561

Camaro

- 68-69 with Automatic Transmission, Rubber Seal Set J-3081

Console Lid / Ashtray Lid Bumper

Nova

- 68-75 Pair (pictured)..... W-534

Chevelle / El Camino

- 67-72 Pair (pictured)..... W-534

Monte Carlo

- 70-72 Pair (pictured) W-534

Camaro

- 67-69 Pair (pictured) W-534

GM

- Rubber Bumper K-3919070



Inner Console Glove Box Assembly

Camaro

- 73-81  K-478562

Firebird

- 70-81  K-478562

Map Pocket

Firebird

- 70-81 (pictured)..... K-478557

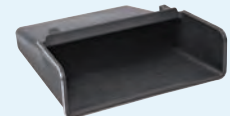

Console Brackets

Nova

- 66-67 4-Speed,
3-Piece Set
(pictured)..... C-J2-3555
66-67 Automatic Transmission,
2-Piece Set..... C-J2-3565
68-74 W-481A



Chevelle / El Camino

- 66-67 Automatic Transmission,
Mounting Bracket Set P-KM02013
66-67 4-Speed, Mounting Bracket Set P-KM02014
68-72 Mounting Bracket P-KM02015

Monte Carlo

- 70-72 Mounting Bracket P-KM02015

Camaro

- 67 Console to Floor Mounting Bracket, with Nuts
(pictured, below) W-364
68-69 Floor Console Mounting, 6-Piece Set W-519
68-69 Mounting Bracket, with Nuts
(pictured, left) W-365
70-72 Bracket Set, with Automatic Transmission
(pictured, right) K-K665



Firebird

- 67-69 Console to Floor Mounting Bracket,
with Nuts (pictured) W-364

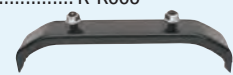

Console Plate

Nova

- 68-74 Forward, Gunstock Walnut R-N138W
68-74 Forward, Rosewood R-N139R

Camaro

- 68 Forward, Walnut Woodgrain W-619
69 Forward, Woodgrain W-620
73-81 Rear  K-478558



Our Name Says It All!™



All of our own **AMD** parts in this catalog are listed in **Blue, bold-face Type**.

Console & Parts

Console Emblem

Nova

66-67 "SS" Console EmblemC-J2-3558

Camaro

68-69 Forward Console Plate Emblem  W-735

Center Console Rear Panel

Chevelle / El Camino

68-72 Includes Lens, Bulb Clips,
Wiring Pigtails & Screws
(pictured)  T-4574

Monte Carlo

70-72 Includes Lens, Bulb Clips,
Wiring Pigtails & Screws
(back
pictured)  T-4574

Firebird

70-79  K-478558



Floor Console Hardware

Camaro

68-69 47-Piece Set W-491

Console Lamp Lens

Chevelle / El Camino

64-65 P-CL34510
66-67 (pictured) P-CL34511

Camaro

67 Rear (pictured) W-131
68-69 Rear W-119
68-69 Rear Reflector W-818

Firebird

67 Rear (pictured) W-131



Console Clock

Camaro / Firebird

67 (pictured)  K-3901613

Console Clock Lens

Chevelle / El Camino / Chevy Full Size

64-67  T-2394



Console Ashtray

Camaro

67 W-235
68-72 (pictured) W-155

Firebird

67 W-235



Ashtray Lid

Camaro

68-69 Rear Ashtray (pictured) W-804



Ashtray Parts

Camaro

68-69 Ashtray Insert  K-3919076
68-72 Ashtray Lid Pivot & Clip Set W-514
68-72 Ashtray Lid Spring, Pair W-514A

Console Seat Belt Pocket

Chevelle / El Camino

70-72 with Stainless Steel
Retainer
(pictured)  T-4575



Monte Carlo

70-72 with Stainless Steel Retainer
(pictured)  T-4575

Chevy Full Size

68-69 with Stainless Steel Retainer
(pictured)  T-4575

Console Seat Belt Clip

Camaro

68-69 W-803

Console Shift Plate



Nova

68-74 Automatic Transmission, 2-Piece (pictured, left) W-841
68-74 4-Speed W-792

Chevelle / El Camino







66-67 (pictured, center) P-SPP4579
68-72 4-Speed (pictured, right)  T-4580

Monte Carlo



70-72 4-Speed (pictured, right)  T-4580

Camaro

Manual Transmission

68 with 4-Speed Pattern (far left)  W-368
68 without Pattern (center left)  W-368A
68-69 4-Speed Shift Pattern
(pictured, center right)  W-371
68-69 5-Speed W-027
68-69 6-Speed W-028
69 with 4-Speed P attern  W-370
69 without 4-Speed Pattern  W-370E
70-71 4-Speed (pictured, far right)  W-476
72 Shift Plate (pictured, below far left)  W-477

Automatic Transmission

67 2-Piece (pictured, at top)  W-841
68 Walnut Woodgrain (pictured, center)  W-345A
68-69 Center Shift Plate (pictured, right) W-343
69 Woodgrain  W-345B



Our Name Says It All!™

Console & Parts

Console Shift Plate, continued

Camaro / Firebird

- 68-72 Rubber Seal, 4-Piece Set W-198
 73-81 Console Shift Plate Screws  K-K491

Firebird

- 68 Automatic Transmission  K-9793256
 70-81 Automatic Transmission K-478569

Console Dial Assembly

Chevelle / El Camino

- 68-72 Automatic (right) P-9508003

Monte Carlo

- 70-72 Automatic Transmission P-9508057

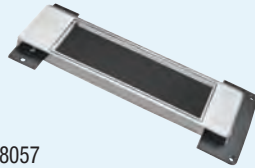

Shifter Boot Trim

Camaro

- 73-81  K-478571

Firebird

- 70-79  K-478571

Shift Indicator

Nova

Pictured, left to right

- 68 Turbo Shift W-127
 68-69 Powerglide W-109
 71-72 Powerglide,
 Blue & White W-811
 71-72 Turbo Shift,
 Blue & White W-812



Chevelle / El Camino

- 66-67 Powerglide Lens P-CL34507
 66-67 Turbo Lens P-CL34506
 68-70 Powerglide Lens P-CL34508
 68-70 Turbo Lens P-CL33519
 71-72 Powerglide Lens P-CL34509

Monte Carlo

- 70 Turbo Lens P-CL34519
 70 Powerglide Lens P-CL34508
 71-72 Powerglide Lens P-CL34509

Camaro

Pictured, left to right

- 67 Powerglide W-109
 67 Turbo Lens W-127
 68-69 Powerglide W-110A
 68-69 Turbo W-110B

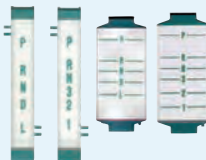

Firebird

- 67 Powerglide Dial W-109
 67 Turbo Lens W-127

Console Shift Lens Backing Plate

Nova

- 68-74 Automatic Transmission W-626

Camaro

- 67 W-626
 68-69 W-342

Shift Plate Slider

Nova

- 68-69 Manual Transmission (pictured) W-374

Chevelle / El Camino

- 68-72 P-CSSP421

Shift Plate Slider, continued

Monte Carlo

- 70-72 Automatic Transmission P-CSSP421

Camaro

- 67 Manual Transmission (pictured) W-374
 68 Manual Transmission W-375

Firebird

- 68-69 Automatic Transmission K-9779566

Shifter Slider Seal

Nova

- 65-67 4 Speed K-3863574
 64-67 Automatic Transmission K-3878480

Impala

- 64-67 Automatic Transmission K-3878480

Shift Plate Slider Retainer

Nova

- 68-74 Automatic or Manual Transmission, Sold each W-340
 68-74 Automatic or Manual Transmission, Pair W-340A

Chevelle / El Camino

- 66-67 Automatic Transmission P-9507999

Shifter Insert Set

Chevelle / El Camino

- 66-67 Automatic Transmission P-CH20448
 68-72 4-Speed, Aluminum Insert Set (pictured, left) ... P-ACK1412
 68-72 Automatic Transmission,
 Aluminum Insert Set (pictured, right) P-ACK1410

Shifter Lamp Parts

Nova

- 68-74 Automatic Transmission, Lamp Holder (pictured) W-627

Camaro

- 68 Lamp Holder W-627
 68-69 Automatic Transmission,
 Shifter Lamp Mounting Plate W-344

Dash Printed Circuit Boards

Nova

- 68-72 C-J2-3340

Chevelle / El Camino

- 70-72 with Factory Gauges C-J-3333
 70-72 without Gauges C-J-3334

Circuit Breakers

Nova

- 67 30 Amp
 (pictured)  W-559

Chevelle

- 64-71 30 Amp (pictured)  W-559

Camaro

- 67-69 30 Amp (pictured)  W-559

Chevy Full Size

- 67-71 30 Amp (pictured)  W-559



Our Name Says It All!™



All of our own **AMD** parts in this catalog are listed in **Blue, bold-face Type**.

Console & Parts



Console Gauges Assemblies

Nova

68-72 Gauge Assembly W-661



Camaro

67 (pictured, left)  K-3952637
 68-69 without Low Fuel Warning
 (pictured, right)  W-660
 68-69 with Low Fuel Warning  W-660A

Firebird

67 (pictured, above left)  K-3952637

Individual Gauge Assemblies



Nova

Oil Gauge Assembly

68-74 (pictured, left)  W-354A

Camaro

Oil Gauge Assembly

67 Black Face (pictured, center)  W-354B
 68-69 Silver Face (pictured, right)  W-354

Fuel Gauge Assembly

67 Black Face
 (at right)  W-406
 68-69 Silver Face.  W-581

Battery Amp Gauge Assembly

67 Black Face.  K-6291987
 68-69 Silver Face.  W-583

Temp Gauge Assembly

68-69 Silver Face  W-582

Firebird

Volt Gauge

70-79 Volt Gauge K-6473693

Gauge Faces

Camaro

Oil Gauge

67 Black Face.  W-354C
 68-69 Silver Face
 (pictured)  W-135

Fuel Gauge

67 Black  W-406A
 68-69 Silver
 (pictured)  W-152

Amp Gauge

68-69 Silver Face  W-153

Temp Gauge

68-69 Silver Face  W-166

Console Gauge Housing

Camaro

67  K-6458139

Gauge Base

Nova

68-74 W-662
 68-74 Green (pictured) W-170

Camaro

68-69 Green (pictured) W-170

Gauge Mounting Plates

Nova

70-74 Front (Fuel & Oil)
 (pictured) W-106A
 70-74 Rear (Amp & Temp) W-106B

Camaro

68-69 Front (Fuel & Oil) (pictured) W-106A
 68-69 Rear (Amp & Temp) W-106B



Gauge Bezels

Nova

68-74 with Chrome Trim W-026
 68-74 Battery & Temp Bezel W-663
 68-74 Fuel and Oil Bezel W-664

Camaro

68-69 Fuel & Oil Bezel
 (pictured, top) W-210
 68-69 Batt & Temp Bezel W-211
 68-69 Console Gauge Bezel
 with Chrome Trim
 (pictured)  W-253



Gauge Lenses

Nova

68-74 Console Gauge Lens, 2 required, Sold each W-188

Camaro

67 Center Console, 3-Piece Set K-K133
 68-69 Camaro Console, 2 required, Sold each W-188

Console Gauge Oil Line Assembly

Camaro

67-69 W-320

Gauge Hardware

Nova

68-74 Console Gauge Connector Set
 with Oil Nut & Ground
 Wire (pictured) W-202
 68-74 Console Gauge Hardware Set W-202A
 68-74 Ceramic Console Fuel Gauge Resistor W-586
 68-74 Ceramic Console Temp Gauge Resistor (below) W-587



Camaro

67-69 Console Gauge Connector Set
 with Oil Nut & Ground Wire (pictured, above) W-202
 67-69 Console Gauge Hardware Set W-202A
 67-69 Ceramic Console Fuel Gauge Resistor W-586
 67-69 Ceramic Console
 Temp Gauge Resistor
 (pictured) W-587
 67-69 Oil Line Block Fitting, Sleeve & Nut W-321
 68-69 Rivet Set for Replacing Silver Gauge Faces,
 10-Piece Set W-134



Our Name Says It All!™

Door Parts & Accessories

AMD offers a comprehensive line of door parts and accessories including inside and outside door handles, opening mechanisms, window crank handles, and hardware for popular GM applications. These parts are manufactured by CHQ, OER, and Trim Parts.

Door Alignment Wedge Set

Nova

- 63 Convertible
(top)  T-5195
66-67 (bottom)  T-4578

Chevelle

- 65-68 Convertible
(bottom)  T-4578

Skylark

- 64-66 Convertible
(top)  T-5195

Camaro / Firebird

- 67-69 Coupe (bottom)  T-4578



Door Jamb Strikers

GM

- Fits 68-75 Nova, 68-72 Chevelle / GTO / Skylark / Cutlass, 67-81 Camaro and 67-74 Firebird
68-75 W-774



Door Lock Rod and Bellcrank

Camaro

- 70-81 W-062

Door Lock Bellcrank Assembly

Nova

- 69-74 (pictured) W-066

Camaro

- 69 (pictured) W-066

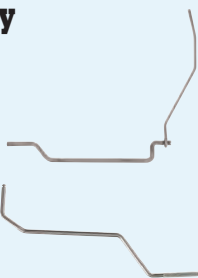

Inner Door Lock Rod



Camaro / Firebird

- 67 (pictured) W-068
68 W-069
70-81 W-074



Door Lock Knobs

Nova

- 67 Chrome, LH/RH P air
(left)  K-K588
68-74 Ribbed Chrome, LH/RH Pair (right)  K-K546

Chevelle / GTO / Skylark / Cutlass

- 67 Chrome, LH/RH P air (left)  K-K588
68-74 Ribbed Chrome, LH/RH Pair (right)  K-K546

Camaro / Firebird

- 67 Chrome, LH/RH P air (left)  K-K588
68-81 Ribbed Chrome, LH/RH Pair (right)  K-K546



Door Lock Ferrules

Nova

- 67 Clear, LH/RH Pair  K-K587
68-74 LH/RH Pair (pictured) W-905

Chevelle / GTO / Skylark / Cutlass

- 67 Clear, LH/RH Pair  K-K587
68-74 LH/RH Pair (pictured) W-905

Camaro / Firebird

- 67 Clear, LH/RH Pair  K-K587
68-81 LH/RH Pair (pictured) W-905

Door Opening Rod

Camaro / Firebird

- 67 Assembly, 8-Piece Set (for both doors) (pictured) W-071
67 4-Piece Assembly, LH W-071B
67 4-Piece Assembly, RH W-071A
68-69 Assembly, LH or RH, does 1 door W-070
70-81 Assembly, LH & RH Set W-019



Door Open Rod Center Guide Clip

Nova

- 68-72 Included with Rod Assembly (pictured) W-070A

Camaro / Firebird

- 67-69 Included with Rod Assembly (pictured) W-070A

Door Open Rod Retaining Clip

- 67-69 2-Piece Set W -070B
67-69 Bulk, Each W -070B-1



Door Bumpers

Nova

- 62-66 Rubber, 4-Piece Set K-4840894
68-74 Upper, Rubber K-20376243

Outer Door Stopper

- 68-74 4-Piece Set K-K130

Camaro / Firebird



- 67-69 Front Door, 2 per door required, Sold each. K-A4441
70-81 Upper, Rubber K-20376243

Chevy Full Size

- 59-64 Rubber, 4-Piece Set K-4840894

Outer Door Handle Assemblies

Nova

- 62-65 2 & 4-Door, Front, LH/RH Set
(pictured)  T-3013
66-67 2 & 4-Door, Front, LH/RH Set  T-3062
68-74 2-Door, LH/RH Set  T-3081



Chevelle

- 64-65 2 & 4-Door, Front, LH/RH Set
(pictured, left)  T-4154
66-67 Front, LH/RH Set (pictured, right)  T-4155
68-69 2 & 4-Door, Front, LH/RH Set  T-4780
68-72 Wagon, LH/RH Set  T-4890
70-72 2 & 4-Door, Front, LH/RH Set  T-4782



El Camino

- 64-65 LH/RH Set
(pictured) T-4154
66-67 LH/RH Set ..  T-4155
68-72 LH/RH Set ..  T-4890



Monte Carlo

- 70-72 LH/RH Set (pictured, above right)  T-4155



Our Name Says It All!™



All of our own **AMD** parts in this catalog are listed in **Blue, bold-face Type**.

Door Parts & Accessories

Outer Door Handle Assemblies, continued

GTO

- 68-72 LH & RH Set  T-8375
 66-67 LH & RH Set  T-4155

Skylark

- 70-72 2 & 4-Door, Front,
 LH & RH Set
 (pictured)  T-4782

Cutlass

- 64-65 2-Door, LH & RH Set T-7600
 68-72 2-Door, LH & RH Set T-7610

Camaro / Firebird

- 67-69 LH & RH Set
 (pictured)  T-6735

Chevy Full Size

- 60 2-Door, LH & RH Set T-2082
 61-62 2 & 4-Door, Front, LH & RH Set T-2115
 63-64 2 & 4-Door, Front, LH & RH Set T-2225



Outer Door Handle

Camaro / Firebird

- 70-74 LH (6 3/8" long, original doors only) K-9827571
 70-74 RH (6 3/8" long, original doors only) K-9827570
 75-81 LH (5 5/8" long, original & repro doors) K-K357
 75-81 RH (5 5/8" long, original & repro doors) K-K358

Door Handle Push Button Kit

Nova

- 62-74 (does 2 handles)  K-R5254

GM

- Fits 64-7 Chevelle / El Camino / GTO / Skylark / Cutlass, 70-72 Monte Carlo, and 67-69 Camaro / Firebird
 64-72 (does 2 handles) (pictured) C-H-2060

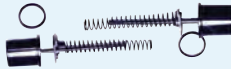

Door Handle & Lock Gasket Sets

Nova

- 62-65 (does both doors) J-41522
 66-72 (does both doors) J-3021

GM

- Fits 66-72 Chevelle / El Camino / GTO / Skylark / Cutlass, 70-72 Monte Carlo, and 67-69 Camaro / Firebird
 66-72 (does both doors) J-3021

Handle Gasket

Camaro / Firebird

- 70-81 LH/RH Pair K-9827572



Door Lock Controls

Nova

- 66 LH (pictured) X535-3066-1L
 66 RH X535-3066-1R
 67 LH X535-3067-1L
 67 RH X535-3067-1R

Inside Door Handles

Nova



- 63-65 Sold each (pictured, left)  K-3764017
 65-67 Sold each (pictured, right) W-618

- 62-63 Double Arm,
 Sold each K-4753532

- 68-74 LH (pictured) W-672

- 68-74 RH (pictured) W-671



Chevelle / El Camino

- 64-65 Sold each (pictured, top left)  K-3764017
 64 Double Arm, Sold each K-4753532

GTO / Skylark / Cutlass

- 64-65 Sold each (pictured, top left)  K-3764017

- 65-67 Sold each (pictured, top right) W-618

- 68-72 LH W-672

- 68-72 RH W-671

Camaro / Firebird

- 67 Standard Interior,
 Sold each W-618

- 67 Deluxe Interior, LH
 (pictured)  W-466

- 67 Deluxe Interior,
 RH  W-465

- 68-69 Deluxe Interior, with Screws,
 LH/RH Pair (pictured)  W-463

- 68-70 Standard Interior, LH W-672

- 68-70 Standard Interior, RH W-671

- 70-74 LH K-9836343

- 70-74 RH K-9836342





Door Open Mechanism



Chevelle / El Camino

- 66-67 LH/RH P air (pictured, left)  W-479

- 68-69 with Silencer, LH/RH Pair
 (pictured, right)  W-901

- 68-69 with Silencer, LH  W-901L

- 68-69 with Silencer, RH  W-901R

GTO / Skylark / Cutlass

- 66-67 LH/RH P air (pictured, left)  W-479

Camaro / Firebird

Standard Interior

- 67 Camaro, LH/RH Pair
 (pictured,
 above left)  W-479

- 68-69 with Silencer, LH  W-901L

- 68-69 with Silencer, RH  W-901R

- 68-69 with Siencer, LH/RH Pair
 (pictured, top right)  W-901

Deluxe Interior

- 67 with Screws,
 LH/RH Pair  W-480

- 68-69 LH (right, above) ...  W-44

- 68-69 RH (right, below) ...  W-443



Our Name Says It All!™

Door Parts & Accessories

Window Regulator Roller

Nova

Fits 63-65 Nova, 64-65 Chevelle / El Camino,
67-69 Camaro, and 58-65 Chevy Full Size
67-69 Roller & Rivet
(pictured)..... W-313



Window Regulator Guide Cam Spacer

Nova

62-72 K-9804150

Camaro / Firebird

70-81 K-9804150

Door Window Crank Handles

Nova



63-64 Single Arm, Black Knob
(pictured, left) K-4619388
63-64 Double Arm, Black Knob K-4807923
63-64 Double Arm, Clear Knob K-4753531
65-67 Black Knob K-K348200
65-67 Clear Knob K-K037597
68-72 Black Knob W-926
68-72 Clear Knob (pictured, right)..... W-926A

Chevelle / El Camino

64 Single Arm, Black Knob (left) K-4619388
64 Double Arm, Black Knob K-4807923
64 Double Arm, Clear Knob K-4753531
65-67 Chevelle, Black Knob K-K348200
65-67 Chevelle, Clear Knob K-K037597
68-72 Black Knob W-926
68-72 Clear Knob (above, right)..... W-926A

GTO / Skylark / Cutlass

68-72 Clear Knob (above right)..... W-926A

Camaro



67 Black Knob (pictured, left)..... W-595
67 Clear Knob (pictured, right)..... W-595A
68-70 except 69 Rear, Black Knob W-926
68-70 except 69 Rear, Clear Knob W-926A
69 Rear, Black Knob W-927
69 Rear, Clear Knob W-927A



69 Front & Rear, 4-Piece Set, Black Knob (left)..... W-929
69 Front & Rear, 4-Piece Set, Clear Knob (right)..... W-928



70-72 Black Knob (pictured, left)..... W-927
70-72 Clear Knob (pictured, right)..... W-927A

Firebird

67 Black Knob (pictured, top left) W-595
67 Clear Knob (pictured, top right) W-595A
70-74 Black Knob (pictured, left)..... W-927
70-74 Clear Knob (pictured, right)..... W-927A

Window Crank Handle Spring

GM

Fits 62-64 Nova, 62-72 Chevelle / El Camino,
64-72 GTO / Skylark / Cutlass, and 67-81 Camaro
62-74 K-4078002

Window Crank Handle Plastic Washer

GM

Fits 62-74 Nova, 62-72 Chevelle / El Camino,
62-72 GTO / Skylark / Cutlass, and 67-81 Camaro
62-74 K-20393850

Door Panel Top Rail



Camaro / Firebird

68-69 Standard Interior, 2-Piece, LH & RH Set (pictured)... W-775

Door Panel Cup Mounting Bracket

Camaro / Firebird

67 Deluxe Interior, 2-Piece,
LH & RH Set (right)..... W-420



Door Grab Handle & Parts

Camaro / Firebird



Deluxe Interior

68-69 Sold each (pictured, left) W-919
68-69 Bezel, LH & RH, 2-Piece Set (right) W-634
68-69 Screws, 4-Piece Set W-405

Armrest Bases & Parts



Nova

65-67 Chrome, LH/RH Pair (pictured)..... W-518

Chevelle / El Camino / Cutlass

68-72 Black, LH W-076
68-72 Black, RH W-077

Monte Carlo

70-72 Black, LH W-076
70-72 Black, RH W-077

Camaro / Firebird

67 Standard Interior, Chrome, LH/RH Pair (pictured)..... W-518

Armrest Base Screws

Nova

68-72 6-Piece Set (pictured)..... W-404



Chevelle

66-67 4-Piece Set W-404A
68-72 6-Piece Set (pictured) W-404
67 Standard Interior, 4-Piece Set W-404A
68-69 Standard Interior, 6-Piece Set (pictured) W-404



Our Name Says It All!™

Outside Mirrors

AMD offers mirrors for most popular Chevy applications. These parts are manufactured by OER.

Outside Mirrors

GM

66-72 with Bowtie Logo, Ribbed Base
(pictured)..... K-CM3006

Nova

63-72 Round, Non-Bowtie,
LH/RH, Sold each
(pictured)..... K-3909197
68-72 Rectangular, LH..... K-3914753
68-72 Rectangular, RH..... K-3914754

Chevelle / El Camino

64-68 Round, Non-Bowtie,
LH/RH, Sold each..... K-3909197
68-72 Rectangular, LH
(pictured)..... K-3914753
68-72 Rectangular, RH..... K-3914754



Monte Carlo

70-72 Rectangular, LH K-3914753
70-72 Rectangular, RH
(pictured)..... K-3914754

Camaro / Firebird

67 Round Non-Bowtie, LH/RH,
Sold each..... K-3909197
68-69 Rectangular, LH K-3914753
68-69 Rectangular, RH K-3914754
70-81 Bullet, Remote Mirror, LH K-9865801
70-81 Bullet, Manual Mirror, RH K-20154908



Door Jamb Parts

AMD offers strikers, rubber U-seals, and vent louvers for popular GM applications. These parts are manufactured by CHQ, OER, Soff Seal, TWE.

Door Jamb Strikers

GM

Fits 68-75 Nova, 68-72 Chevelle / GTO / Skylark /
Cutlass, 67-81 Camaro and 67-74 Firebird
68-75 W-774



Door Jamb Rubber U-Seals

Nova

62-65 LH/RH Pair K-N180
66-67 LH/RH Pair K-N179

Chevelle / GTO / Skylark / Cutlass

64-65 LH/RH Pair J-5113
66-67 LH/RH Pair J-51131
68-72 LH/RH Pair J-51132
68-72 GTO, LH/RH Pair J-6508

Door Jamb Rubber U-Seals

Monte Carlo

70-72 LH/RH Pair J-51132

Camaro / Firebird

67-69 LH/RH P air W-129

Door Jamb Vent Louvers

Chevelle

69 Coupe/Convertible, with Seal, LH/RH Pair C-J-3250
70-72 Coupe/Convertible, with Seal, LH/RH Pair C-J-3260

Camaro / Firebird

68-69 Complete OE Style Door Jamb Vent,
Sold each W-613
70-81 Sold each W-025P

The Details make the difference!

Don't settle for incorrect, knock-off parts for your car. Get premium sheet metal parts from the restoration pros at **Auto Metal Direct**. Our panels are made from the proper gauge steel and include all correct-as-original clips, tabs, flanges, bends and seams. Each time a prototype body panel comes off of new tools, we test fit it on a car. The marked up prototype is then used to change and improve the tools, and a new prototype is produced. This procedure might be repeated multiple times, but once the part is finally approved, you can be assured of a quality part.



AMD

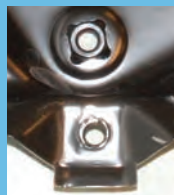

Competitor



AMD



Competitor

AMD's quarter skins come complete with door jambs, unlike our competitor's parts



Our Name Says It All!™

Convertible Top Parts

AMD offers several convertible top parts including the top frame, weatherstrip sets, header bows, tack strips, boot clips, and other hardware for popular GM applications. These parts are manufactured by CHQ, OER, OPGI, Soff Seal, Trim Parts, and TWE.

Convertible Top Frame



Camaro / Firebird
67-69 Top Frame Assembly (pictured).....X605-3567-S

Convertible Top Weatherstrips

Nova
62-63 7-Piece Set.....J-4029

Chevelle / GTO / Skylark / Cutlass
64-65 5-Piece Set.....J-5090
66-67 5-Piece Set.....J-5092
68-72 5-Piece Set.....J-5093

Camaro / Firebird
67-69 5-Piece Set  K-K165

Top Tack Strip



67-69 3-Piece Set (pictured) K-7755256

Top Pivot & Bolt Set

Camaro / Firebird
67-69 (pictured).....X615-3567-1S
67-69 Pivot Bolt, 3-Piece Set X605-3567-1S



Top Frame Rubber Stopper

Camaro / Firebird
67-69 LH/RH Pair K-4680380

Well Rain Gutter

Camaro / Firebird
67-69  K-7678186
67-69 Rain Gutter Mounting Bolt Set..... K-K723A

Convertible Top Header Bow

Camaro
67-69 X381-3567

Header Bow Bumper

Camaro
67-69 2-Piece Set (pictured)..... W-744



Top Latch with Fasteners

Nova
62-63 LH (pictured)  T-2147
62-63 RH (pictured)  T-2148

Impala
61-64 LH (pictured)  T-2147
61-64 RH (pictured)  T-2148



Top Frame Front Latch Assemblies

Camaro / Firebird
67-69 LH/RH Pair.....X615-3567-S

Top Latch Receptacle

Chevelle / GTO / Cutlass
68-72 LH/RH Pair
(pictured)..... P-C240183



Top Latch Knuckle Assemblies

Chevelle & Chevy Full Size
64-72 2-Piece Set (pictured)..... W-212

Camaro
67-69 2-Piece Set (pictured)..... W-212



Convertible Top Hold Down Cable

Camaro / Firebird
67-69 2-Piece Set..... W-144
67-69 LH/RH Pair..... K-7639095

Top Cable

Nova
62-63 2-Piece Set..... K-14724

Rear Well Hold Down Latches

Camaro / Firebird
67-69 Manual Top,
LH/RH Pair (at right) K-K134



Hold Down Bracket

Camaro / Firebird
67-69 Manual Top,
LH/RH Pair (at right)..... W-169







Convertible Top Hooks





Chevelle / GTO / Cutlass / Skylark
64-72 LH/RH Pair (at right)..... W-352A

Camaro / Firebird
67-69 LH/RH P(pictured) W-352A



Convertible Power Top Switch

Chevelle
64-66 with Housing  W-080A
64-66 (top)  W-080
69 with Housing
(bottom)  W-081A
69  W-081

Camaro / Firebird
67-68 wit Housing  W-080A
67-68 (top)  W-080
69 Camaro, with Housing  W-081A
69 Camaro
(bottom)  W-081



All of our own **AMD** parts in this catalog are listed in **Blue, bold-face Type**.

Our Name Says It All!™

Convertible Top Parts

Convertible Top Boot Clip / Retainer

Chevelle / GTO

- 66-67 Clip / Retainer, 16-Piece Set (pictured)..... W-310B
- 66-67 Clip..... W-126



Camaro / Firebird

- 67-69 Clip / Retainer, 16-Piece Set (pictured)..... W-310B
- 67-69 Clip..... W-126

Convertible Top Clips

Camaro / Firebird

- 67-69 Top Binding End Clip K-7614749

Convertible Top Molding Clips

Nova

- 62-63 Top Molding Clip, Sold each..... C-E2-1722

Camaro / Firebird

- 67-69 Rear Molding Clip W-182
- 67-69 Top Well Molding Clip (pictured)  K-7672609
- 67-69 Rear Pinchwell Molding Clips 10-Piece Set (right)..... W-182A



Dome Lamp

AMD offers dome lamp assemblies and hardware for popular GM applications. Assemblies include Base, Lens, Wire, and Leads. These parts are manufactured by CHQ, OER, Trim Parts, TWE.

Dome Lamp Assemblies

Assemblies include Base, Lens, Wire & Leads

Nova

- 62-70 Assembly..... P-DLK001
- 71-74 Assembly..... P-DLK006

Chevelle

- 64-67 Assembly..... P-DLK001
- 68-70 Assembly..... P-CHV452
- 71-72 Assembly..... P-DLK006

El Camino

- 64-67 Assembly P-DLK002
- 68-72 Assembly..... P-DLK004

Monte Carlo

- 70 Assembly..... P-CHV452
- 71-72 Assembly..... P-DLK006

GTO / Skylark / Cutlass

- 64-67 GTO /Skylark, Assembly P-DLK005
- 67 Cutlass, Assembly P-DLK005
- 68 Assembly..... P-CHV452
- 69-72 Assembly..... P-DLK006

Dome Lamp Assemblies, continued

Camaro

- 67 Coupe, Rear Quarter Assembly (pictured)  T-2194A
- 67-69 Standard Interior, Assembly..... P-DLK001
- 70-81 Assembly..... P-DLK006



Firebird

- 68-69 Standard Interior, Assembly P-DLK001
- 70-81 Assembly..... P-DLK006

Rear Quarter Lamp Socket

Camaro

- 67 Coupe..... K-4234956



Dome Lamp Wiring Harness Clip

Camaro / Firebird

- 70-81 9-Piece Set..... W-064

Sunvisor Supports

AMD offers sunvisor supports and hardware for popular GM applications. These parts are manufactured by CHQ.

Sunvisor Supports

GM

Fits 65-73 Nova, 64-72 Chevelle / El Camino / GTO / Skylark / Cutlass, 67-69 Camaro / Firebird

- 65-73 Sold each (pictured)..... W-339

Camaro / Firebird

- 67 Chrome, LH/RH Pair (pictured)  W-740
- 67-69 Coupe, Sold each W-339
- 68-69 Convertible, Satin, LH/RH Pair  W-745



Sunvisor Support Screw Sets

GM

Fits 65-73 Nova, 64-72 Chevelle / El Camino / GTO / Skylark / Cutlass, 67-69 Camaro / Firebird Coupe

- 65-73 Support Screw Set W-606



Our Name Says It All!™

Trunk Floor Components

AMD offers a comprehensive line of trunk floor components including weatherstrips, hinge parts, spare tire and jack parts, and hardware for popular GM applications. These parts are manufactured by CHQ, OER, Soff Seal, Trim Parts, and TWE.

Spare Tire Hold-Down Components

Nova

- 67-74 Spare Tire Hold Down Nut K-9785616
- 65-74 Spare Tire Anchor Plate  K-20066400
- 67-74 Spare Tire Hold Down Rod (pictured, above)..... K-364993

Camaro / Firebird

- 67-81 Spare Tire Hold Down Nut..... K-9785616
- 65-74 Spare Tire Anchor Plate  K-20066400
- 67-81 Spare Tire Hold Down Rod (pictured, above)..... K-364993

Bumper Jack Assembly

Nova

- 67-70 (left).....  K-3909108

Chevelle

- 67 (left)..... K-3909108

Camaro

- 67-70 (left)..... K-3909108

Jack Adaptor

(Pictured at right from top to bottom)

Camaro

- 67  W-141A
- 68 W-141B
- 69  W-173

Trunk Weatherstrips

Nova

- 65-74 Trunk Weatherstrip J-2003
- 73-74 Hatchback Weatherstrip..... J-4013

Chevelle / Monte Carlo / Skylark

- 64-77 J-2003

Camaro / Firebird

- 67-81 (pictured)..... W-943

Chevy Full Size

- 58-76 W-944

Trunk Lid Torsion Spring

Camaro / Firebird

- 67-69 with Spoiler, LH/RH pair W-693P
- 67-69 with Spoiler, RH W-693

Trunk Hinge Torque Rod

Camaro / Firebird

- 70-81 LH K-9868539
- 70-81 with Spoiler, RH K-9868540
- 70-81 without Spoiler, RH K-9868538

Trunk Lid Rubber Stopper

Nova

- 62-67 2-Piece Set (pictured) K-4721222

Chevelle

- 64-67 2-Piece Set (pictured) K-4721222

Camaro / Firebird

- 67-69 2-Piece Set (pictured) K-4721222

Trunk Lock Parts

Note: See Lock Cylinder Section on Pages 71-76 for Complete Coded Lock Cylinder Kits with Keys, Bezels & Clip

Trunk Lock Bezel

Monte Carlo

- 71 Includes Fasteners (left)  T-1652
- 72 Includes Fasteners (right)  T-1660

Firebird

- 69  K-8742310

Lock Bezel Gasket

Camaro

- 70-73 (pictured)....  K-K946

Trunk Lock Cylinder Retainer

Nova

- 62-65 C-H2-3110
- 68-72 C-H2-3130

Trunk Lock Cylinder Gasket

Nova

- 65-71 (pictured)..... K-4471426

Camaro

- 67-69 (pictured)..... K-4471426

Firebird

- 67-68 (pictured) K-4471426

Chevy Full Size

- 65-71 (pictured) K-4471426

Trunk Lock Gasket

Nova

- 67-74  K-K941

Camaro / Firebird



- 67-81  K-K941

Trunk Lock Retainer

Chevelle

- 68-72 C-H-1650

Camaro / Firebird

- 67-68  K-4544749
- 69  K-8733875

Trunk Lock Retainer Seal

Chevelle

- 68-69 J-5086



All of our own **AMD** parts in this catalog are listed in **Blue, bold-face Type**.

AUTO METAL DIRECT™ Our Name Says It All!™

License Plate & Lamp

AMD offers license plate bumpers and lamps for popular GM applications. These parts are manufactured by CHQ, OER, and TWE

Rear License Plate Bumper

Nova

62-65 4-Piece Set..... K-K132
66-73 3-Piece Set (pictured)..... W-536

Chevelle

66-75 3-Piece Set (pictured) W-536

Camaro

67-68 3-Piece Set (pictured) W-536

Chevy Full Size

67-74 3-Piece Set (pictured) W-536



Rear License Plate Lamp Assemblies

Nova

62-65C-E2-2500
66-72 (pictured)..... W-773

Chevelle

64-65 2 required, Sold each.....C-E-2610
66-69 (pictured)..... W-773
70-72 W-684

El Camino

64-65 2 required, Sold each.....C-E-2610

Monte Carlo

70-72 (pictured)..... W-773

Camaro

67-69 (pictured)..... W-773
70-73 2-Piece Set..... W-016

Firebird

67-69 (pictured)..... W-773

Chevy Full Size

70-71 W-684



Exhaust Parts

AMD offers Chevelle exhaust tips and exhaust hanger brackets for Camaro and Firebirds. These parts are manufactured by CHQ and TWE

Exhaust Tips

Chevelle

69-72 Big Block, 2 1/2", Chrome,
LH/RH Pair (pictured).....C-H-1915



Exhaust Hanger Mounting Plate

Camaro / Firebird

69 LH  W-673

Paint Gasket Kits

AMD offers paint gasket kits for popular GM applications. Typical kits include door handle, lock cylinder, outside mirror, antenna, park lamp, tail lamp, and side marker gaskets. Includes most gaskets that would need to be replaced after repainting your car. These parts are manufactured by RePops and Soff Seal

Paint Gasket Kits

Typical Kit Includes Door Handle, Lock Cylinder, Outside Mirror, Antenna, Park Lamp, Tail Lamp & Side Marker Lamp Gaskets

Nova

62-63R-N124
64R-N125
65R-N126
66-67R-N127
68-69R-N128
70R-N129
71-72R-N130

Chevelle

64R-CH152
65R-CH154
66R-CH156
67R-CH158
68R-CH160
69 Non-SSR-CH162
69 SSR-CH163
70R-CH165
71-72R-CH167

El Camino

64R-CH153
65R-CH155
66R-CH157
67R-CH159
68R-CH161
69R-CH164
70R-CH166
71-72R-CH168

Monte Carlo

70J-52381
71J-52382
72J-52383

Camaro

67 Standard.....R-CA127
67-68 RS Supplement (add to CA127 or CA128)R-CA130
Standard.....R-CA128
Standard & RS (pictured)R-CA129



Our Name Says It All!™

Templates Kits

AMD offers template kits for popular GM applications. Templates are available to determine correct placement for emblems, moldings, and R/S inner fender holes and back up lamps. These templates are manufactured by CHQ.

Templates are used to determine correct placement of emblems, molding, antennas, etc.

Emblem Template Kits

Nova

Fender Emblem Template Kits

62-64	6 Cylinder Emblem	W-1222
62-65	283 Flag Emblem	W-1228
64	SS Emblem.....	W-1226
64	V Emblem.....	W-1224
65	230/250 Emblem.....	W-1232
66-67	Standard V8 Flag Emblem.....	W-1238
66-67	Standard V8 Flag	W-1237
66-67	Standard V8 Flag/Engine Emblem.....	W-1239
70	350 Emblem.....	W-1242

Quarter Panel Emblem Template Kits

62-63	300 Emblem.....	W-1223
62-63	400 Emblem.....	W-1220
63	SS Emblem.....	W-1221
64	Plain Emblem	W-1227
64	Standard Emblem.....	W-1225
65	SS Emblem.....	W-1231
65	Standard Emblem.....	W-1230
66-67	SS Emblem.....	W-1236
66-67	Standard Emblem.....	W-1235

Trunk Emblem Template Kit

70	Emblem.....	W-1241
----	-------------	--------

Camaro

67	RS 327 Emblem	W-701
67	SS-350 Emblem	W-702
67	SS-396 Emblem	W-703
67	Standard 327 Emblem	W-700
68	RS 327 Emblem	W-706
68	SS-350 Emblem	W-707
68	SS-396 Emblem	W-708
68	Standard 327 Emblem	W-705
68	Z-28 Emblem	W-709
68	Z-28/RS Emblem	W-710
69	302 Cowl Hood Emblem	W-723
69	RS 307 Emblem	W-718
69	RS 327 Emblem	W-717
69	RS 350 Emblem	W-716
69	SS-350 Emblem	W-720
69	SS-396 Emblem	W-719
69	Standard 250 Emblem	W-714
69	Standard 307 Emblem	W-712
69	Standard 327 Emblem	W-715
69	Standard 350 Emblem.....	W-713
69	Z-28 Emblem	W-722
69	Z-28/RS Emblem.....	W-721

Firebird

Fender Script Template Kit

67-68	W-828
-------	-------	-------

Trunk Lid Template Kit

67-68	"PONTIAC"	W-827
69	400	W-821

Emblem Template Kits, continued

Firebird, continued

Tailpan Letters Template Kit

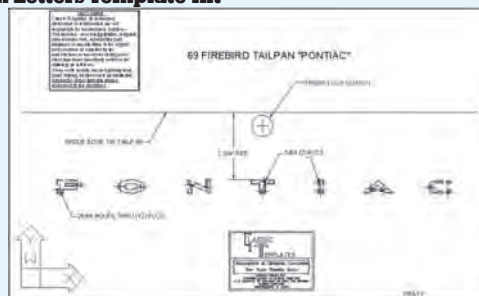

69 "PONTIAC"	W-820
--------------------	-------

Molding Template Kits

Nova

Fender Molding Template Kits

66	W-1233
----	-------	--------

Trunk Template Kits

Nova

65	SS Trim.....	W-1229
66	Trunk Lid Trim.....	W-1234
67	Coupe, Trunk Trim.....	W-1240

Camaro

Lower Body Molding Template Kits

67 RS	W-704
68	W-711

Quarter Panel Louver Template Kit

Camaro

69	W-725
----	-------	-------

Lamp Side Marker Template Kits

Camaro

Side Marker Lamp Template Kits

68	Rear	W-826
----	------------	-------

Backup Lamp Template Kits

67-68	RS	W-724
69 RS	W-727

Fenderwell Template Kit

Camaro

68 RS	W-878
69 RS	W-879

Antenna Template Kits

Nova

62-65	Front, Passenger Side	W-1246
62-65	Rear, Driver Side	W-1245
62-65	Rear, Passenger Side	W-1247
66-67	Front, Passenger Side	W-1248
66-67	Rear, Passenger Side	W-1249
68-72	Front, Passenger Side	W-1250

Camaro

67-68	Front.....	W-728
67-69	Rear	W-726
69	Front.....	W-729



Our Name Says It All!™

Stencils, Stripe & Decal Kits

AMD offers stencils, stripes, and decals for Chevelles and Camaros. These templates are manufactured by OER and TWE.

Stencil Kits

Chevelle

70-72 SS Stripe Stencil Kit (Includes: Stencils, Tape, Squeegee, Instructions)C-H-1950

El Camino

70-72 SS Stripe Stencil Kit (Includes: Stencils, Tape, Squeegee, Instructions)C-H-1960

Stripe Kits

Camaro



69 SYC YENKO Stripe Set, Black  K-SK301
 69 SYC YENKO Stripe Set, White (pictured).....  K-SK310

Decals



Camaro

67 INDY 500 Pace Car, Door Decal Set (pictured)..... K-PC012
 69 YENKO SYC Headrest Decals  K-SK302

Our Products

Many of our products are advertised and packaged with the GM Restoration Parts logo. This logo indicates that the product is no longer available from General Motors, but is manufactured to GM's specifications and licensed by GM as an official GM Restoration Part. Such products represent a prestigious class of restoration parts that are nearly identical to the products offered by GM, and are made from the original GM tooling whenever possible.

We have filled out our line by also selling the finest available parts we can find on the market. Below are some of the manufacturers whose products are now in our inventory:

Classic Headquarters - for over 30 years the world's premier manufacturer for high quality, technically correct restoration products for General Motors Muscledcars including - Camaro, Chevelle, Nova, Pontiac, Full size, Corvette and Chevy Truck.

Original Equipment Reproduction® is the restoration parts manufacturer who set the standard by which all other restoration parts are measured. Making their name in the industry by focusing on the details of their products and supplying highly demanded parts not elsewhere available, OER® brand products represent countless man-hours invested in a process of analyzing, developing, and refining. Products advertised with the OER® logo uphold the standard and tradition that consumers and installers have come to expect.

TrimParts, Inc. manufactures GM licensed restoration parts for Chevrolet and other GM cars and trucks. They are dedicated to manufacturing the highest quality products offered in the restoration industry by using the original GM tooling under licensing from GM when tooling is available. Otherwise, TrimParts engineers and builds in-house tooling to meet the original GM Specifications and TrimParts Quality.

SoffSeal, Inc., is the industry leader in manufacturing quality weatherstripping and rubber detail items. Their tooling capabilities include both sponge and dense extrusions. They can bond molded parts to extrusions, both sponge and dense. Additionally, they make rubber parts such as pedal pads, bushings, grommets, seals and other related items. They can also manufacture custom molded parts. Their specialty has been in weatherstripping and sealing products for the restoration and Street Rod markets, as well as custom OEM applications and universal-use sealing products.



Our Name Says It All!™

Production

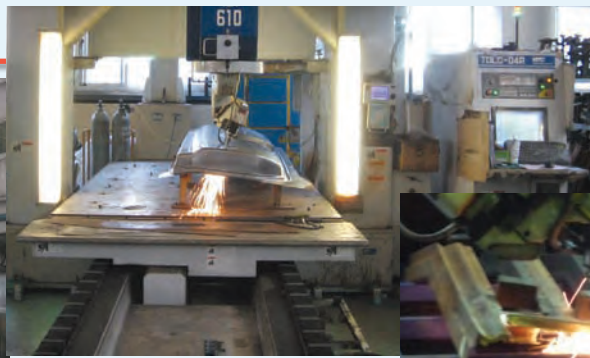

Manufacturing automotive body panels has been our primary business for a long time. Our success in this very-demanding market can be attributed to our attention to quality control, our reputation for on-time delivery, and our effective system of cost-efficiency. This enduring program has resulted in very satisfied clients. And that is our simple business philosophy.



Warehouse

Our huge new warehouse is jammed full of beautiful new sheet metal panels. If you live in the southeastern US, why not come on by and pick up your body panels in person? Save those shipping dollars to buy parts you'll need to finish your car!



Learn more about Hoods Components we have.