



2021 PARTS CATALOG



PERFECTED • TRUSTED • CHOICE



OVER THREE DECADES OF AIR SUSPENSION EXCELLENCE

As the trusted leader in aftermarket air suspension parts and accessories for luxury cars, pick-up trucks and SUV's, Arnott has grown into a global brand with +/- 500 SKU's for more than 800 applications that are sold by leading distributors world-wide.

Founded by the Arnott family in Punta Gorda, Florida, Arnott has always focused on ensuring customer satisfaction by manufacturing high-quality, aftermarket products that offer OE form, fit and function at an affordable price.

For more than three decades, Arnott has demonstrated a commitment to developing exceptional air suspension technology and earning the trust of distributors, installers and end users. Arnott's long list of innovations and patents has cemented our position as a global leader in aftermarket air suspension replacement solutions.

THE BROADEST COVERAGE OF QUALITY AIR SUSPENSION PRODUCTS & OPTIONS

Arnott offers more than 450 quality aftermarket air suspension products covering over 800 applications including remanufactured OE air struts, Arnott-designed new air struts, magnetic shocks, innovative air springs, OES air suspension compressors, coil spring conversion kits, valve blocks and ride height sensors.

THE ARNOTT ADVANTAGE

Since 1989, Arnott Air Suspension has been the trusted industry leader in aftermarket air suspension parts and accessories for luxury cars, pick-up trucks and SUVs.

Arnott delivers exceptional innovation to the global aftermarket industry. Our state-of-the-art manufacturing and remanufacturing processes are driven by decades of extensive research and development, now housed in a 6,000 square meter R&D facility. With a trusted global network of premier auto parts distributors, Arnott products have unparalleled availability in the marketplace. Our leadership in the industry is the result of unwavering dedication to:

- ▲ High quality aftermarket products that offer OE form, fit and function at an affordable price
- ▲ Professional, multi-lingual customer service
- ▲ Demonstrated engineering, manufacturing & management expertise
- ▲ Present in TecDoc
- ▲ Fully functioning TecCom
- ▲ Extensive product installation manuals and videos available online

DOING BUSINESS WITH ARNOTT

Our global team works every day to build on the trust and quality the Arnott name has signified to our customers for 30 years. We forge meaningful relationships with every customer and strive to support their continued success. By offering a comprehensive product line at an exceptional value backed by best-in-class support and a trusted global distribution network, Arnott gives its distributors, resellers and installers the necessary tools to maximize their growth opportunities.



Table of Contents	
About Arnott	2
Why Choose Arnott	3
OEM Cross Reference Table	88-100
Product Features	100-105
Contact Arnott	Back Cover

Anatomy of Air Suspension	
Overview	17
Air Springs	33
New Air Struts	48
Compressors	75
Remanufactured Air Struts	87

Arnott Air Suspension Products for:			
Acura*	4	Lincoln*	44-47
Audi*	4-10	Maybach*	49
Bentley*	11	Mercedes-Benz*	50-72
BMW*	12-15	Mercury*	73
Buick*	16	Nissan*	74
Cadillac*	18-23	Oldsmobile*	74
Chevrolet*	24-26	Opel*	76
Citroën*	27	Peugeot*	76
Ford*	28-29	Pontiac*	76
GMC*	30-32	Porsche*	77-79
Hummer*	34	Ram*	80
Infiniti*	34	Renault*	81
Iveco*	34	Saab*	81
Jaguar*	35	Tesla*	82
Jeep*	36	Toyota*	83
Land Rover*	37-41	Volkswagen*	84-85
Lexus*	42-43	Volvo*	86

WHY CHOOSE ARNOTT

INFORMATION WITHIN REACH:



Get the specs you need instantly with detailed product information on our website. Arnott products can also be found in standardized industry data feeds via TecDoc. Cannot find what you are looking for? Contact us and our team can help you out.













RELIABLE DISTRIBUTION:

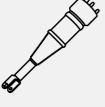

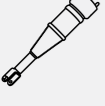

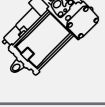
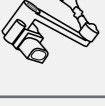
Having multiple Arnott warehouses and partnerships with the industry's foremost distributors, we provide broad coverage worldwide. This extensive network means that there is always an Arnott distributor nearby enabling fast and dependable deliveries, often from your regular wholesaler.

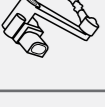









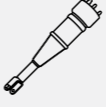

SEAMLESS INSTALLATION:

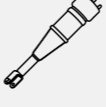

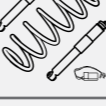

We provide the know-how needed to remove faulty OE products and quickly install Arnott replacement products. Arnott's expert Technical Support is complemented by detailed installation manuals and professional installation videos, making installation easy for technicians of all skill levels.

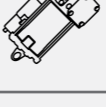

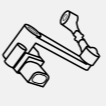

ACURA					
Part #	Product Type	Position	Model Information	Vehicle Attributes	Product Attributes
YD2					
C-3020			2006-2013 MDX	3.7 AWD, w/EDC, w/Advance & Sports Packages, w/Active Suspension Dampers	

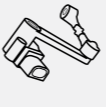
AUDI					
Part #	Product Type	Position	Model Information	Vehicle Attributes	Product Attributes
4G					
A-3294			2010-2018 A7 Sportback	1.8 TFSI, 2.0 TFSI/TFSI quattro, 2.8 FSI/FSI quattro, 3.0 TDI/TDI quattro/TFSI quattro, RS7 quattro/performance quattro, S7 quattro	
A-3295			2010-2018 A7 Sportback	1.8 TFSI, 2.0 TFSI/TFSI quattro, 2.8 FSI/FSI quattro, 3.0 TDI/TDI quattro/TFSI quattro, RS7 quattro/performance quattro, S7 quattro	
AS-3309			2010-2018 A7 Sportback	1.8 TFSI, 2.0 TFSI/TFSI quattro, 2.8 FSI/FSI quattro, 3.0 TDI/TDI quattro/TFSI quattro, RS7 quattro/performance quattro, S7 quattro	> New > Eibach Shock Absorber
AS-3312			2010-2018 A7 Sportback	1.8 TFSI, 2.0 TFSI/TFSI quattro, 2.8 FSI/FSI quattro, 3.0 TDI/TDI quattro/TFSI quattro, RS7 quattro/performance quattro, S7 quattro	> Remanufactured
P-3483			2010-2018 A7 Sportback	1.8 TFSI, 2.0 TFSI/TFSI quattro, 2.5 FSI, 2.8 FSI/FSI quattro, 3.0 TDI/TDI quattro/TFSI quattro, RS7 quattro/performance quattro, S7 quattro	> WABCO OES
RH-3587			2010-2018 A7 Sportback	1.8 TFSI, 2.0 TFSI/TFSI quattro, 2.8 FSI/FSI quattro, 3.0 TDI/TDI quattro/TFSI quattro, RS7 quattro/performance quattro, S7 quattro	
RH-3588			2010-2018 A7 Sportback	1.8 TFSI, 2.0 TFSI/TFSI quattro, 2.8 FSI/FSI quattro, 3.0 TDI/TDI quattro/TFSI quattro, RS7 quattro/performance quattro, S7 quattro	
VB-3491			2010-2018 A7 Sportback	1.8 TFSI, 2.0 TFSI/TFSI quattro, 2.8 FSI/FSI quattro, 3.0 TDI/TDI quattro/TFSI quattro, RS7 quattro/performance quattro, S7 quattro	









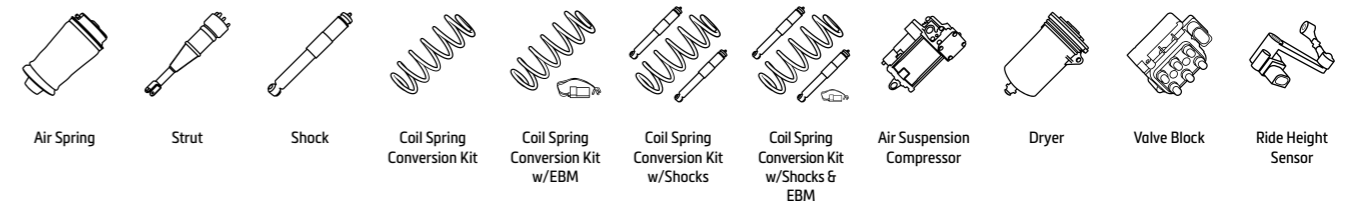





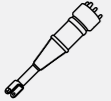

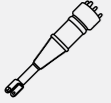

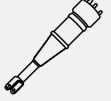
4LB					
A-2523			2006-2015 Q7	3.0 TDI quattro/TFSI quattro, 3.6 FSI quattro, 4.2 FSI quattro/TDI quattro, 6.0 TDI quattro	
A-2571			2006-2015 Q7	3.0 TDI quattro/TFSI quattro, 3.6 FSI quattro, 4.2 FSI quattro/TDI quattro, 6.0 TDI quattro	

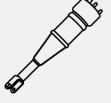



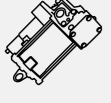
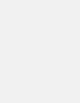
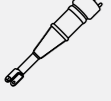

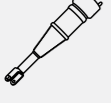

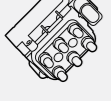
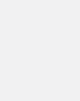



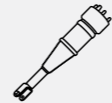

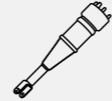
AUDI					
Part #	Product Type	Position	Model Information	Vehicle Attributes	Product Attributes
4LB					
A-2572			2006-2015 Q7	3.0 TDI quattro/TFSI quattro, 3.6 FSI quattro, 4.2 FSI quattro/TDI quattro, 6.0 TDI quattro	
AS-3164			2006-2015 Q7	3.0 TDI quattro/TFSI quattro, 3.6 FSI quattro, 4.2 FSI quattro/TDI quattro, 6.0 TDI quattro	
AS-3165			2006-2015 Q7	3.0 TDI quattro/TFSI quattro, 3.6 FSI quattro, 4.2 FSI quattro/TDI quattro, 6.0 TDI quattro	
C-2616			2006-2015 Q7	w/o PDCC, w/o Diesel Engine, w/o Adaptive Headlights	3.0 TFSI quattro, 3.6 FSI quattro, 4.2 FSI quattro > Gas Engine Only
C-3419			2006-2015 Q7		3.0 TDI quattro/TFSI quattro, 3.6 FSI quattro, 4.2 FSI quattro/quattro/TDI quattro, 6.0 TDI quattro
P-2496			2006-2015 Q7		3.0 TDI quattro/TFSI quattro, 3.6 FSI quattro, 4.2 FSI quattro/TDI quattro, 6.0 TDI quattro > WABCO OES
VB-3470			2006-2015 Q7		3.0 TDI quattro/TFSI quattro, 3.6 FSI quattro, 4.2 FSI quattro/quattro/TDI quattro, 6.0 TDI quattro

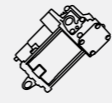
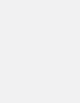
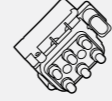
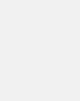
8RB, FYB					
RH-3459			2008--> Q5 2012--> SQ5	2.0 Hybrid quattro/TDI/TDI quattro/TFSI Hybrid quattro/TFSI quattro, 3.0 TDI quattro/TFSI quattro, 3.2 FSI quattro, 35 TDI quattro, 40 TDI quattro, 45 TFSI Mild Hybrid quattro, 50 TDI quattro, 55 TFSI e quattro, SQ5 TDI Mild Hybrid quattro/TDI quattro/TFSI quattro	
RH-3460			2008--> Q5 2012--> SQ5	2.0 Hybrid quattro/TDI/TDI quattro/TFSI Hybrid quattro/TFSI quattro, 3.0 TDI quattro/TFSI quattro, 3.2 FSI quattro, 35 TDI quattro, 40 TDI quattro, 45 TFSI Mild Hybrid quattro, 50 TDI quattro, 55 TFSI e quattro, SQ5 TDI Mild Hybrid quattro/TDI quattro/TFSI quattro	







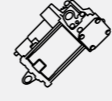
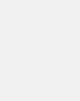

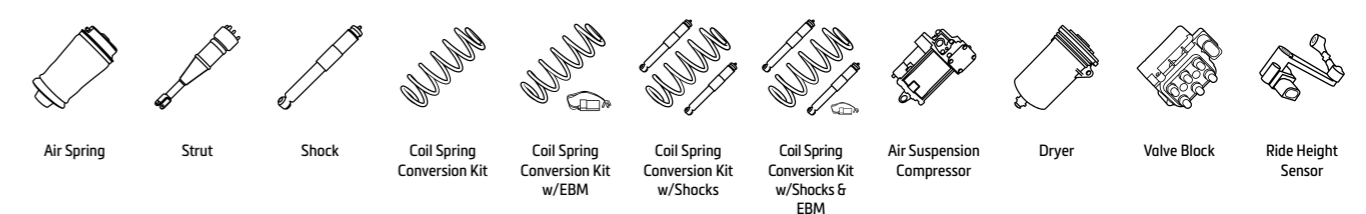

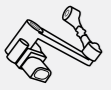

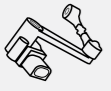

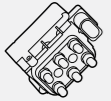
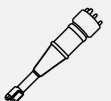

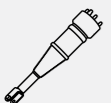

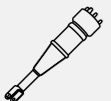

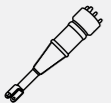

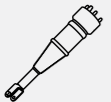
C5					
A-2133			1998-2005 A6 Avant 2000-2005 Allroad	4B5, 4B8 - 2.5 TDI quattro, 2.7 quattro/T quattro, 4.2 quattro, 4.6 quattro/V8 quattro, S6 quattro	
A-2731			1998-2005 A6 Avant 2000-2005 Allroad	4B5, 4B8 - 2.5 TDI quattro, 2.7 quattro/T quattro, 4.2 quattro, 4.6 quattro/V8 quattro, S6 quattro	> Generation II

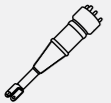

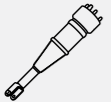

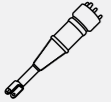

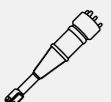



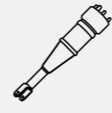

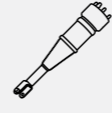

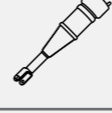

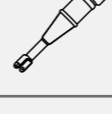
AUDI					
Part #	Product Type	Position	Model Information	Vehicle Attributes	Product Attributes
C5					
A-2869			2000-2005 Allroad	4BH - 2.5 TDI quattro, 2.7 quattro/T quattro, 4.2 V8 quattro	
A-2885			2000-2005 Allroad	4BH - 2.5 TDI quattro, 2.7 quattro/T quattro, 4.2 V8 quattro	> Generation II
AS-3222			1997-2005 A6	4B2, 4B5, 4BH - 1.8, 1.8 T/T quattro, 1.9 TDI, 2.0, 2.4, 2.4 quattro, 2.5 TDI/TDI quattro, 2.7 quattro/T/T quattro, 2.8, 2.8 quattro, 3.0, 3.0 quattro, 3.6, 3.7 quattro, 4.2 quattro/V8 quattro, RS6 plus quattro/quattro, S6 quattro	> New
			1997-2005 A6 Avant		
			2000-2005 Allroad		
AS-3223			1997-2005 A6	4B2, 4B5, 4BH - 1.8, 1.8 T/T quattro, 1.9 TDI, 2.0, 2.4, 2.4 quattro, 2.5 TDI/TDI quattro, 2.7 quattro/T/T quattro, 2.8, 2.8 quattro, 3.0, 3.0 quattro, 3.6, 3.7 quattro, 4.2 quattro/V8 quattro, RS6 plus quattro/quattro, S6 quattro	> New
			1997-2005 A6 Avant		
			2000-2005 Allroad		
AS-3230			1997-2005 A6	4B2, 4B5, 4BH - 1.8, 1.8 T/T quattro, 1.9 TDI, 2.0, 2.4, 2.4 quattro, 2.5 TDI/TDI quattro, 2.7 quattro/T/T quattro, 2.8, 2.8 quattro, 3.0, 3.0 quattro, 3.6, 3.7 quattro, 4.2 quattro/V8 quattro, RS6 plus quattro/quattro, S6 quattro	> New > Generation II
			1997-2005 A6 Avant		
			2000-2005 Allroad		
AS-3231			1997-2005 A6	4B2, 4B5, 4BH - 1.8, 1.8 T/T quattro, 1.9 TDI, 2.0, 2.4, 2.4 quattro, 2.5 TDI/TDI quattro, 2.7 quattro/T/T quattro, 2.8, 2.8 quattro, 3.0, 3.0 quattro, 3.6, 3.7 quattro, 4.2 quattro/V8 quattro, RS6 plus quattro/quattro, S6 quattro	> New > Generation II
			1997-2005 A6 Avant		
			2000-2005 Allroad		
C-2718			2000-2005 Allroad	4BH - 2.5 TDI quattro, 2.7 quattro/T quattro, 4.2 V8 quattro	
P-2134			1998-2005 A6 Avant	4B5, 4BH - 2.5 TDI quattro, 2.7 quattro/T quattro, 4.2 quattro, 4.6 quattro/V8 quattro, S6 quattro	> WABCO OES
			2000-2005 Allroad		
SK-2779			2000-2005 Allroad	4BH - 2.5 TDI quattro, 2.7 quattro/T quattro, 4.2 V8 quattro	> New > Shock Only
SK-2805			1997-2005 A6 Avant	4B5, 4BH - 1.8 T quattro, 2.4 quattro, 2.5 TDI quattro, 2.7 quattro/T quattro, 2.8 quattro, 3.0 quattro, 3.7 quattro, 4.2 quattro/V8 quattro, RS6 plus quattro/quattro, S6 quattro	> New > Shock Only
			2000-2005 Allroad		
VB-3265			1999-2005 A6	4B2, 4B5, 4BH - 1.9 TDI, 2.0, 2.4, 2.4 quattro, 2.5 TDI/TDI quattro, 2.7 quattro/T/T quattro, 2.8, 2.8 quattro, 3.0, 3.0 quattro, 3.6, 3.7 quattro, RS6 quattro, S6 quattro	
			2000-2005 Allroad		

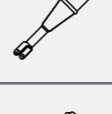
AUDI					
Part #	Product Type	Position	Model Information	Vehicle Attributes	Product Attributes
C6					
A-2960			2004-2011 A6	4F2, 4F5, 4FH - 2.0 TDI/TFSI, 2.4, 2.4 quattro, 2.7 TDI/TDI quattro, 2.8 FSI/FSI quattro, 3.0, 3.0 quattro/TDI/TDI quattro/TFSI quattro, 3.2 FSI/FSI quattro, 4.2 FSI quattro/quattro, RS6 quattro, S6 quattro	
			2004-2011 A6 Avant		
			2006-2011 A6 Allroad		
AS-3363			2004-2011 A6	4F2, 4F5, 4FH - 2.0 TDI/TFSI, 2.4, 2.4 quattro, 2.7 TDI/TDI quattro, 2.8 FSI/FSI quattro, 3.0, 3.0 quattro/TDI/TDI quattro/TFSI quattro, 3.2 FSI/FSI quattro, 4.2 FSI quattro/quattro, RS6 quattro, S6 quattro	> New
			2004-2011 A6 Avant		
			2006-2011 A6 Allroad		
AS-3369			2004-2011 A6	4F2, 4F5, 4FH - 2.0 TDI/TFSI, 2.4, 2.4 quattro, 2.7 TDI/TDI quattro, 2.8 FSI/FSI quattro, 3.0, 3.0 quattro/TDI/TDI quattro/TFSI quattro, 3.2 FSI/FSI quattro, 4.2 FSI quattro/quattro, RS6 quattro, S6 quattro	> New
			2004-2011 A6 Avant		
			2006-2011 A6 Allroad		
P-2984			2004-2011 A6	4F2, 4F5, 4FH - 2.0 TDI/TFSI, 2.4, 2.4 quattro, 2.7 TDI/TDI quattro, 2.8 FSI/FSI quattro, 3.0, 3.0 quattro/TDI/TDI quattro/TFSI quattro, 3.2 FSI/FSI quattro, 4.2 FSI quattro/quattro, RS6 quattro, S6 quattro	> WABCO OES
			2004-2011 A6 Avant		
			2006-2011 A6 Allroad		
VB-3265			2004-2011 A6	4F2, 4FH - 2.0 TDI/TFSI, 2.4, 2.4 quattro, 2.7 TDI/TDI quattro, 2.8 FSI/FSI quattro, 3.0, 3.0 quattro/TDI quattro/TFSI quattro, 3.2 FSI/FSI quattro, 4.2 FSI quattro/quattro, RS6 quattro, S6 quattro	
			2006-2011 A6 Allroad		
C7					
A-3294			2010-2018 A6	4G2, 4G5, 4GA, 4GC, 4GD, 4GF, 4GH, 4GJ - 1.8 TFSI, 2.0 TDI/TDI quattro/TFSI/FSI hybrid/TFSI quattro, 2.8 FSI/FSI quattro, 3.0 TDI/TDI quattro/TFSI quattro, RS6 performance quattro/quattro, S6 quattro	
			2011-2018 A6 Avant		
			2012-2018 S6		
A-3295			2010-2018 A6	4G2, 4G5, 4GA, 4GC, 4GD, 4GF, 4GH, 4GJ - 1.8 TFSI, 2.0 TDI/TDI quattro/TFSI/FSI hybrid/TFSI quattro, 2.8 FSI/FSI quattro, 3.0 TDI/TDI quattro/TFSI quattro, RS6 performance quattro/quattro, S6 quattro	
			2011-2018 A6 Avant		
			2012-2018 S6		
AS-3309			2010-2018 A6	4G2, 4G5, 4GC, 4GD - 1.8 TFSI, 2.0 TDI/TDI quattro/TFSI/FSI hybrid/TFSI quattro, 2.8 FSI/FSI quattro, 3.0 TDI/TDI quattro/TFSI quattro, RS6 performance quattro/quattro, S6 quattro	> New > Eibach Shock Absorber
			2011-2018 A6 Avant		
			2012-2018 S6		
AS-3312			2010-2018 A6	4G2, 4G5, 4GA, 4GC, 4GD, 4GF - 1.8 TFSI, 2.0 TDI/TDI quattro/TFSI/FSI hybrid/TFSI quattro, 2.8 FSI/FSI quattro, 3.0 TDI/TDI quattro/TFSI quattro, RS6 performance quattro/quattro, S6 quattro	> Remanufactured
			2011-2018 A6 Avant		
			2012-2018 S6		
P-3483			2010-2018 A6	4G2, 4G5, 4GA, 4GC, 4GD, 4GF, 4GH, 4GJ - 1.8 TFSI, 2.0 TDI/TDI quattro/TFSI/FSI hybrid/TFSI quattro, 2.8 FSI/FSI quattro, 3.0 TDI/TDI quattro/TFSI quattro, RS6 performance quattro/quattro, S6 quattro	> WABCO OES
			2011-2018 A6 Avant		
			2012-2018 A6 Allroad		

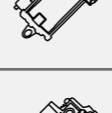
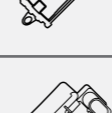
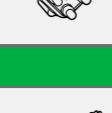
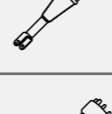

AUDI					
Part #	Product Type	Position	Model Information	Vehicle Attributes	Product Attributes
C7					
RH-3587			2010-2018 A6 2012-2018 S6	4G2, 4G5, 4GA, 4GC, 4GD, 4GF - 1.8 TFSI, 2.0 TDI/TDI quattro/TFSI/TFSI hybrid/TFSI quattro, 2.8 FSI/FSI quattro, 3.0 TDI/TDI quattro/TFSI quattro, RS6 performance quattro/quattro, S6 quattro	
RH-3588			2010-2018 A6 2010-2018 S6	4G2, 4G5, 4GA, 4GC, 4GD, 4GF - 1.8 TFSI, 2.0 TDI/TDI quattro/TFSI/TFSI hybrid/TFSI quattro, 2.8 FSI/FSI quattro, 3.0 TDI/TDI quattro/TFSI quattro, RS6 performance quattro/quattro, S6 quattro	
VB-3491			2010-2018 A6 2012-2018 S6	4G2, 4GC - 1.8 TFSI, 2.0 TDI/TDI quattro/TFSI/TFSI hybrid/TFSI quattro, 2.8 FSI/FSI quattro, 3.0 TDI/TDI quattro/TFSI quattro, S6 quattro	
D3					
AS-2560			2002-2010 A8	w/o Sport Suspension	4E2, 4E8 - 2.8 FSI, 3.0, 3.0 quattro/TDI quattro, 3.2 FSI/FSI quattro, 3.7 quattro, 4.0 TDI quattro, 4.2 FSI quattro/quattro/TDI quattro, 6.0 W12 quattro, S8 quattro
AS-2561			2002-2010 A8	w/o Sport Suspension	4E2, 4E8 - 2.8 FSI, 3.0, 3.0 quattro/TDI quattro, 3.2 FSI/FSI quattro, 3.7 quattro, 4.0 TDI quattro, 4.2 FSI quattro/quattro/TDI quattro, 6.0 W12 quattro, S8 quattro
AS-2562			2002-2010 A8	w/Sport Suspension	4E2, 4E8 - 3.0, 3.0 quattro/TDI quattro, 3.2 FSI/FSI quattro, 3.7 quattro, 4.0 TDI quattro, 4.2 FSI quattro/quattro/TDI quattro, 6.0 W12 quattro, S8 quattro
AS-2563			2002-2010 A8	w/Sport Suspension	4E2, 4E8 - 3.0, 3.0 quattro/TDI quattro, 3.2 FSI/FSI quattro, 3.7 quattro, 4.0 TDI quattro, 4.2 FSI quattro/quattro/TDI quattro, 6.0 W12 quattro, S8 quattro
AS-2775			2002-2010 A8	w/o Sport Suspension	4E2, 4E8 - 2.8 FSI, 3.0, 3.0 quattro/TDI quattro, 3.2 FSI/FSI quattro, 3.7 quattro, 4.0 TDI quattro, 4.2 FSI quattro/quattro/TDI quattro, 6.0 W12 quattro, S8 quattro
AS-2776			2002-2010 A8	w/o Sport Suspension	4E2, 4E8 - 2.8 FSI, 3.0, 3.0 quattro/TDI quattro, 3.2 FSI/FSI quattro, 3.7 quattro, 4.0 TDI quattro, 4.2 FSI quattro/quattro/TDI quattro, 6.0 W12 quattro, S8 quattro
AS-2777			2002-2010 A8	w/Sport Suspension	4E2, 4E8 - 3.0, 3.0 quattro/TDI quattro, 3.2 FSI/FSI quattro, 3.7 quattro, 4.0 TDI quattro, 4.2 FSI quattro/quattro/TDI quattro, 6.0 W12 quattro, S8 quattro
AS-2778			2002-2010 A8	w/Sport Suspension	4E2, 4E8 - 3.0, 3.0 quattro/TDI quattro, 3.2 FSI/FSI quattro, 3.7 quattro, 4.0 TDI quattro, 4.2 FSI quattro/quattro/TDI quattro, 6.0 W12 quattro, S8 quattro
AS-2958			2002-2010 A8	w/o Sport Suspension	4E2, 4E8, 4H2, 4H8, 4HC, 4HL - 2.8 FSI, 3.0, 3.0 quattro/TDI quattro, 3.2 FSI/FSI quattro, 3.7 quattro, 4.0 TDI quattro, 4.2 FSI quattro/quattro/TDI quattro, 6.0 W12 quattro, S8 quattro

AUDI					
Part #	Product Type	Position	Model Information	Vehicle Attributes	Product Attributes
D3					
AS-2959			2002-2010 A8	w/o Sport Suspension	4E2, 4E8, 4H2, 4H8, 4HC, 4HL - 2.8 FSI, 3.0, 3.0 quattro/TDI quattro, 3.2 FSI/FSI quattro, 3.7 quattro, 4.0 TDI quattro, 4.2 FSI quattro/quattro/TDI quattro, 6.0 W12 quattro, S8 quattro
AS-2965			2002-2010 A8	w/Sport Suspension	4E2, 4E8 - 3.0, 3.0 quattro/TDI quattro, 3.2 FSI/FSI quattro, 3.7 quattro, 4.0 TDI quattro, 4.2 FSI quattro/quattro/TDI quattro, 6.0 W12 quattro, S8 quattro
AS-2966			2002-2010 A8	w/Sport Suspension	4E2, 4E8 - 3.0, 3.0 quattro/TDI quattro, 3.2 FSI/FSI quattro, 3.7 quattro, 4.0 TDI quattro, 4.2 FSI quattro/quattro/TDI quattro, 6.0 W12 quattro, S8 quattro
AS-3030			2002-2010 A8	w/o Sport Suspension	4E2, 4E8 - 2.8 FSI, 3.0, 3.0 quattro, 3.0 TDI quattro, 3.2 FSI, 3.2 FSI quattro, 3.7 quattro, 4.0 TDI quattro, 4.2 FSI quattro, 4.2 quattro, 4.2 TDI quattro, 6.0 W12 quattro
AS-3031			2002-2010 A8	w/o Sport Suspension	4E2, 4E8 - 2.8 FSI, 3.0, 3.0 quattro, 3.0 TDI quattro, 3.2 FSI, 3.2 FSI quattro, 3.7 quattro, 4.0 TDI quattro, 4.2 FSI quattro, 4.2 quattro, 4.2 TDI quattro, 6.0 W12 quattro
P-2539			2002-2010 A8	w/ & w/o Sport Suspension V8 Gas Engine Only	4E2, 4E8 - 2.8 FSI, 3.0, 3.0 quattro, 3.2 FSI/FSI quattro, 3.7 quattro, 4.2 FSI quattro/quattro, 6.0 W12 quattro, S8 quattro
P-2599			2003-2010 A8 Quattro	w/ & w/o Sport Suspension Diesel Engine Only	4E2, 4E8 - 3.0 TDI quattro, 4.0 TDI quattro, 4.2 TDI quattro
VB-3265			2002-2010 A8 2006-2010 S8	w/ & w/o Sport Suspension w/Sport Suspension	4E2, 4E8 - 2.8 FSI, 3.0, 3.0 quattro/TDI quattro, 3.2 FSI/FSI quattro, 3.7 quattro, 4.0 TDI quattro, 4.2 FSI quattro/quattro/TDI quattro, 6.0 W12 quattro, S8 quattro
D4					
AS-2864			2009-2018 A8	w/o Sport Suspension	4H2, 4H8, 4HC, 4HL - 2.0 TFSI hybrid/quattro, 2.5 TFSI, 3.0 TDI/TDI quattro/TFSI quattro, 4.0 TFSI quattro, 4.2 FSI quattro/TDI quattro, 6.3 W12 quattro
AS-2865			2009-2018 A8	w/Sport Suspension	4H2, 4H8, 4HC, 4HL - 2.0 TFSI hybrid/quattro, 2.5 TFSI, 3.0 TDI/TDI quattro/TFSI quattro, 4.0 TFSI quattro, 4.2 FSI quattro/TDI quattro, 6.3 W12 quattro, S8 quattro/plus quattro

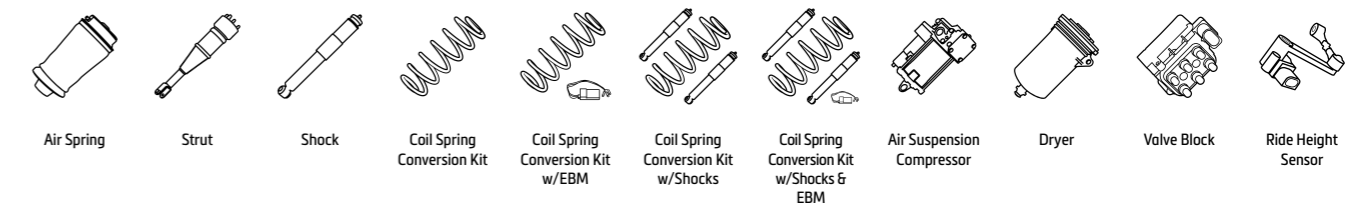

AUDI					
Part #	Product Type	Position	Model Information	Vehicle Attributes	Product Attributes
D4					
AS-3121			2009-2018 A8	w/o Sport Suspension	4H2, 4H8, 4HC, 4HL - 2.0 TFSI hybrid/ quattro, 2.5 TFSI, 3.0 TDI/TDI quattro/ TFSI quattro, 4.0 TFSI quattro, 4.2 TDI quattro, 6.3 W12 quattro › New › Eibach Shock Absorber
AS-3123			2009-2018 A8	w/o Sport Suspension	4H2, 4H8, 4HC, 4HL - 2.0 TFSI hybrid/ quattro, 2.5 TFSI, 3.0 TDI/TDI quattro/ TFSI quattro, 4.0 TFSI quattro, 4.2 FSI quattro/TDI quattro, 6.3 W12 quattro › New › Eibach Shock Absorber
P-2986			2009-2018 A8	w/ & w/o Sport Suspension	4H2, 4H8, 4HC, 4HL - 2.0 TFSI hybrid/ quattro, 2.5 TFSI, 3.0 TDI/TDI quattro/ TFSI quattro, 4.0 TFSI quattro, 4.2 FSI quattro/TDI quattro, 6.3 W12 quattro, S8 quattro/plus quattro › WABCO OES
			20012-2018 S8	w/Sport Suspension	
RH-3587			2009-2018 A8	w/ & w/o Sport Suspension	4H2, 4H8, 4HC, 4HL - 2.0 TFSI hybrid/ quattro, 2.5 TFSI, 3.0 TDI/TDI quattro/ TFSI quattro, 4.0 TFSI quattro, 4.2 FSI quattro/TDI quattro, 6.3 W12 quattro, S8 quattro/plus quattro
			2012-2018 S8	w/Sport Suspension	
RH-3588			2009-2018 A8	w/ & w/o Sport Suspension	4H2, 4H8, 4HC, 4HL - 2.0 TFSI hybrid/ quattro, 2.5 TFSI, 3.0 TDI/TDI quattro/ TFSI quattro, 4.0 TFSI quattro, 4.2 FSI quattro/TDI quattro, 6.3 W12 quattro, S8 quattro/plus quattro
			2012-2018 S8	w/Sport Suspension	
VB-3491			2009-2018 A8	w/ & w/o Sport Suspension	4H2, 4H8, 4HC, 4HL - 2.0 TFSI hybrid/ quattro, 2.5 TFSI, 3.0 TDI/TDI quattro/ TFSI quattro, 4.0 TFSI quattro, 4.2 FSI quattro/TDI quattro, 6.3 W12 quattro, S8 quattro/plus quattro
			2012-2018 S8	w/Sport Suspension	

ARNOTT NEW AIR STRUT









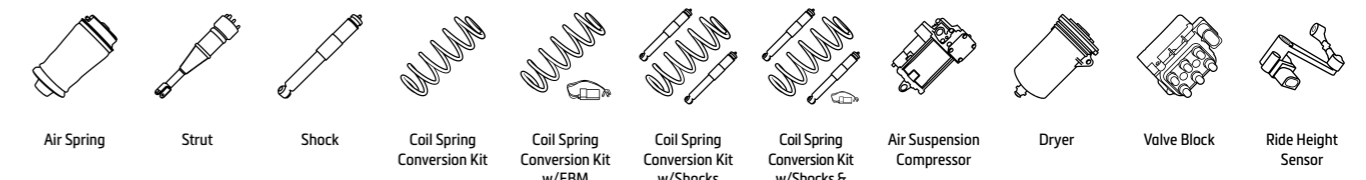





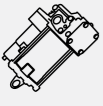





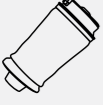

- New front air strut for Audi A6/S6 C7 and A7/S7 C7
- Continental ContiTech air sleeve
 - › Premium multi-ply, cross-corded construction
 - › Longer-lasting design using advanced materials
- Precision-tuned to mimic OE ride
- Universal strut - fits right and left side
- Designed, assembled & tested in the USA
- AS-3309



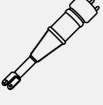

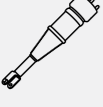

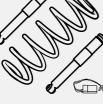



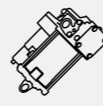
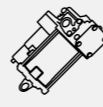

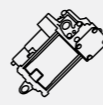
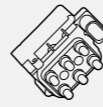
AS-3309

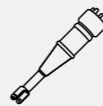



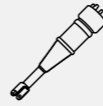

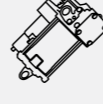

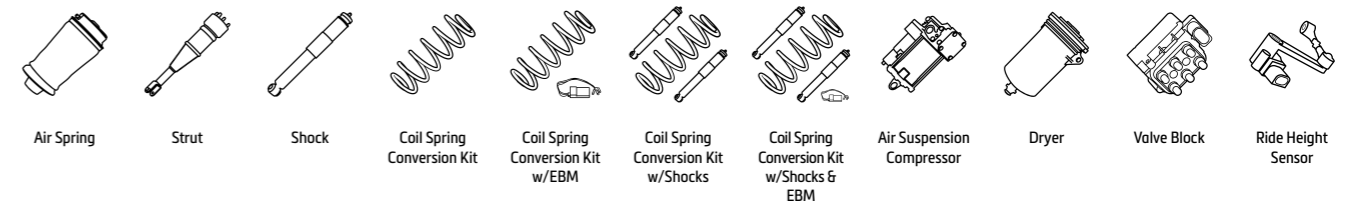
BENTLEY					
Part #	Product Type	Position	Model Information	Vehicle Attributes	Product Attributes
D1					
AS-2580			2003--> Continental Coupe	3W_ 393/4 - 4.0, 4.0 AWD/FLEX/FLEX AWD/GT, 6.0, 6.0 AWD/CS ISR/FLEX/FLEX AWD/Supersports AWD	› Remanufactured
			2005-2010 Continental Flying Spur	3W_ - 6.0, 6.0 Flex	
			2006--> Continental Convertible	3W_ 393/4 - 4.0, 4.0 AWD/FLEX/FLEX AWD/GT, 6.0, 6.0 AWD/CS ISR/FLEX/FLEX AWD/Supersports AWD	
AS-2581			2003--> Continental Coupe	3W_ 393/4 - 4.0, 4.0 AWD/FLEX/FLEX AWD/GT, 6.0, 6.0 AWD/CS ISR/FLEX/FLEX AWD/Supersports AWD	› Remanufactured
			2005-2010 Continental Flying Spur	3W_ - 6.0, 6.0 Flex	
			2006--> Continental Convertible	3W_ 393/4 - 4.0, 4.0 AWD/FLEX/FLEX AWD/GT, 6.0, 6.0 AWD/CS ISR/FLEX/FLEX AWD/Supersports AWD	
AS-2892			2003--> Continental Coupe	3W_ 393/4 - 4.0, 4.0 AWD/FLEX/FLEX AWD/GT, 6.0, 6.0 AWD/CS ISR/FLEX/FLEX AWD/Supersports AWD	› New
			2005-2010 Continental Flying Spur	3W_ - 6.0, 6.0 Flex	
			2006--> Continental Convertible	3W_ 393/4 - 4.0, 4.0 AWD/FLEX/FLEX AWD/GT, 6.0, 6.0 AWD/CS ISR/FLEX/FLEX AWD/Supersports AWD	
AS-2893			2003--> Continental Coupe	3W_ 393/4 - 4.0, 4.0 AWD/FLEX/FLEX AWD/GT, 6.0, 6.0 AWD/CS ISR/FLEX/FLEX AWD/Supersports AWD	› New
			2005-2010 Continental Flying Spur	3W_ - 6.0, 6.0 Flex	
			2006--> Continental Convertible	3W_ 393/4 - 4.0, 4.0 AWD/FLEX/FLEX AWD/GT, 6.0, 6.0 AWD/CS ISR/FLEX/FLEX AWD/Supersports AWD	
AS-2968			2003--> Continental Coupe	3W_ 393/4 - 4.0, 4.0 AWD/FLEX/FLEX AWD/GT, 6.0, 6.0 AWD/CS ISR/FLEX/FLEX AWD/Supersports AWD	› Remanufactured
			2005-2010 Continental Flying Spur	3W_ - 6.0, 6.0 Flex	
			2006--> Continental Convertible	3W_ 393/4 - 4.0, 4.0 AWD/FLEX/FLEX AWD/GT, 6.0, 6.0 AWD/CS ISR/FLEX/FLEX AWD/Supersports AWD	
AS-2969			2003--> Continental Coupe	3W_ 393/4 - 4.0, 4.0 AWD/FLEX/FLEX AWD/GT, 6.0, 6.0 AWD/CS ISR/FLEX/FLEX AWD/Supersports AWD	› Remanufactured
			2005-2010 Continental Flying Spur	3W_ - 6.0, 6.0 Flex	
			2006--> Continental Convertible	3W_ 393/4 - 4.0, 4.0 AWD/FLEX/FLEX AWD/GT, 6.0, 6.0 AWD/CS ISR/FLEX/FLEX AWD/Supersports AWD	
AS-3127			2003--> Continental Coupe	3W_ 393/4 - 4.0, 4.0 AWD/FLEX/FLEX AWD/GT, 6.0, 6.0 AWD/CS ISR/FLEX/FLEX AWD/Supersports AWD	› New › Eibach Shock Absorber
			2005-2010 Continental Flying Spur	3W_ - 6.0, 6.0 Flex	
			2006--> Continental Convertible	3W_ 393/4 - 4.0, 4.0 AWD/FLEX/FLEX AWD/GT, 6.0, 6.0 AWD/CS ISR/FLEX/FLEX AWD/Supersports AWD	
AS-3128			2003--> Continental Coupe	3W_ 393/4 - 4.0, 4.0 AWD/FLEX/FLEX AWD/GT, 6.0, 6.0 AWD/CS ISR/FLEX/FLEX AWD/Supersports AWD	› New › Eibach Shock Absorber
			2005-2010 Continental Flying Spur	3W_ - 6.0, 6.0 Flex	
			2006--> Continental Convertible	3W_ 393/4 - 4.0, 4.0 AWD/FLEX/FLEX AWD/GT, 6.0, 6.0 AWD/CS ISR/FLEX/FLEX AWD/Supersports AWD	
AS-3129			2003--> Continental Coupe	3W_ 393/4 - 4.0, 4.0 AWD/FLEX/FLEX AWD/GT, 6.0, 6.0 AWD/CS ISR/FLEX/FLEX AWD/Supersports AWD	› New › Eibach Shock Absorber
			2005-2010 Continental Flying Spur	3W_ - 6.0, 6.0 Flex	
			2006--> Continental Convertible	3W_ 393/4 - 4.0, 4.0 AWD/FLEX/FLEX AWD/GT, 6.0, 6.0 AWD/CS ISR/FLEX/FLEX AWD/Supersports AWD	
AS-3130			2003--> Continental Coupe	3W_ 393/4 - 4.0, 4.0 AWD/FLEX/FLEX AWD/GT, 6.0, 6.0 AWD/CS ISR/FLEX/FLEX AWD/Supersports AWD	› New › Eibach Shock Absorber
			2005-2010 Continental Flying Spur	3W_ - 6.0, 6.0 Flex	
			2006--> Continental Convertible	3W_ 393/4 - 4.0, 4.0 AWD/FLEX/FLEX AWD/GT, 6.0, 6.0 AWD/CS ISR/FLEX/FLEX AWD/Supersports AWD	
P-2740			2003--> Continental Coupe	3W_ 393/4 - 4.0, 4.0 AWD/FLEX/FLEX AWD/GT, 6.0, 6.0 AWD/CS ISR/FLEX/FLEX AWD/Supersports AWD	› WABCO OES
			2005-2010 Continental Flying Spur	3W_ - 6.0, 6.0 Flex	
			2006--> Continental Convertible	3W_ 393/4 - 4.0, 4.0 AWD/FLEX/FLEX AWD/GT, 6.0, 6.0 AWD/CS ISR/FLEX/FLEX AWD/Supersports AWD	

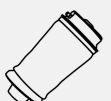

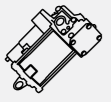
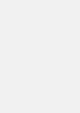
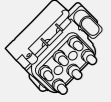
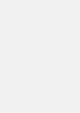
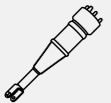

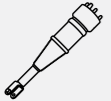
BMW						
Part #	Product Type	Position	Model Information	Vehicle Attributes	Product Attributes	
E39						
A-2737			1996-2004 5 Series	Wagon Only, w/Auto-Leveling	520 d/i, 523 i, 525 d/i/tds, 528 i, 530 d/i, 540 i	
A-2738			1996-2004 5 Series	Wagon Only, w/Auto-Leveling	520 d/i, 523 i, 525 d/i/tds, 528 i, 530 d/i, 540 i	
P-2469			1996-2004 5 Series	Wagon Only, w/Auto-Leveling, w/Rear Air Suspension Only	520 d/i, 523 i, 525 d/i/tds, 528 i, 530 d/i, 540 i	> WABCO OES
E53						
A-2501			2000-2006 X5	w/Auto-Leveling, w/o Sport Suspension	3.0 d/i, 4.4 i, 4.6 is, 4.8 is	
A-2502			2000-2006 X5	w/Auto-Leveling, w/o Sport Suspension	3.0 d/i, 4.4 i, 4.6 is, 4.8 is	
A-2503			2000-2006 X5	w/Auto-Leveling, w/Sport Suspension	3.0 d/i, 4.4 i, 4.6 is, 4.8 is	
A-2504			2000-2006 X5	w/Auto-Leveling, w/Sport Suspension	3.0 d/i, 4.4 i, 4.6 is, 4.8 is	
A-2861			2000-2006 X5	w/4-Corner Air Leveling, w/ & w/o Sport Suspension	3.0 d/i, 4.4 i, 4.6 is, 4.8 is	> New Air Spring Only, Reuse Factory Shock
A-2862			2000-2006 X5	w/4-Corner Air Leveling, w/ & w/o Sport Suspension	3.0 d/i, 4.4 i, 4.6 is, 4.8 is	> New Air Spring Only, Reuse Factory Shock
AS-2764			2000-2006 X5	w/4-Corner Air Leveling, w/ & w/o Sport Suspension	3.0 d/i, 4.4 i, 4.6 is, 4.8 is	> New
AS-2765			2000-2006 X5	w/4-Corner Air Leveling, w/ & w/o Sport Suspension	3.0 d/i, 4.4 i, 4.6 is, 4.8 is	> New
C-2664			2000-2006 X5	w/ & w/o Sport Suspension	3.0 d/i, 4.4 i, 4.6 is, 4.8 is	

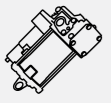
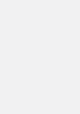
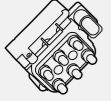
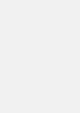
BMW						
Part #	Product Type	Position	Model Information	Vehicle Attributes	Product Attributes	
E53						
P-2469			2000-2006 X5	w/Rear Leveling Only, w/ & w/o Sport Suspension	3.0 d/i, 4.4 i, 4.6 is, 4.8 is	> WABCO OES
P-2494			2000-2006 X5	w/4-Corner Air Leveling, w/ & w/o Sport Suspension	3.0 d/i, 4.4 i, 4.6 is, 4.8 is	> WABCO OES
E61						
A-2755			2004-2010 5 Series	Wagon Only, w/Auto-Leveling	520 d/i, 523 i, 525 d/d xDrive/i/i xDrive/xd/xi, 530 d/d xDrive/i/i xDrive/xd/xi, 535 d, 545 i, 550 i	
P-3220			2004-2010 5 Series	Wagon Only, w/Auto-Leveling	520 d, 520 i, 523 i, 525 d/d xDrive/i/i xDrive/xd/525 xi, 530 d/d xDrive/i/i xDrive/xd/xi, 535 d, 545 i, 550 i, M5	> Plug & Play Complete Assembly
VB-2897			2004-2010 5 Series	Wagon Only, w/Auto-Leveling	520 d/i, 523 i, 525 d/d xDrive/i/i xDrive/xd/xi, 530 d/d xDrive/i/i xDrive/xd/xi, 535 d, 545 i, 550 i	
E65, E66						
AS-2978			2002-2008 7 Series	w/EDC	730 d/i/Li/Ld, 735 i/Li, 740 d/i/Li, 745 d/i/Li, 750 i/Li, 760 i/Li	> New
AS-2979			2002-2008 7 Series	w/EDC	730 d/i/Li/Ld, 735 i/Li, 740 d/i/Li, 745 d/i/Li, 750 i/Li, 760 i/Li	> New
AS-2980			2002-2008 7 Series	w/o EDC	730 d/i/Li/Ld, 735 i/Li, 740 d/i/Li, 745 d/i/Li, 750 i/Li, 760 i/Li	> New
AS-2981			2002-2008 7 Series	w/o EDC	730 d/i/Li/Ld, 735 i/Li, 740 d/i/Li, 745 d/i/Li, 750 i/Li, 760 i/Li	> New
P-2469			2002-2008 7 Series	w/ & w/o EDC	730 d/i/Li/Ld, 735 i/Li, 740 d/i/Li, 745 d/i/Li, 750 i/Li, 760 i/Li	> WABCO OES

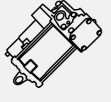
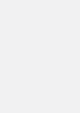
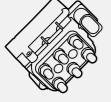
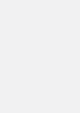



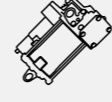
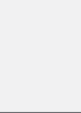
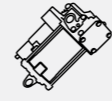
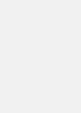





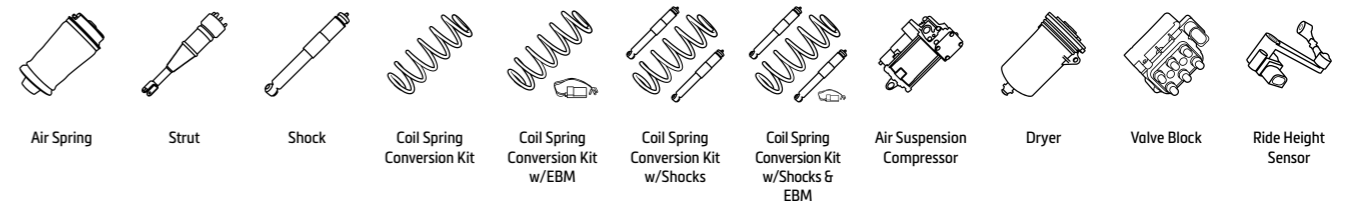

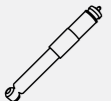

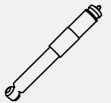

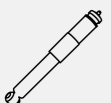

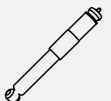
BMW						
Part #	Product Type	Position	Model Information	Vehicle Attributes	Product Attributes	
E70/71						
A-2642			2006-2013 X5	w/Adaptive Drive, Comfort or Sport Suspension	3.0 d/sd/si, 4.8 i xDrive, M, M 50 d, xDrive (30 d/i, 35 d/i, 40 d/i, 48 i, 50 i)	
			2007-2014 X6	w/Adaptive Drive, Comfort or Sport Suspension	ActiveHybrid, Active Hybrid xDrive, M, M 50 d, xDrive (30 d, 35 d/i, 40 d, 50 i)	
P-3221			2006-2013 X5	3.0 d/sd/si, 4.8 i xDrive, M, M 50 d, xDrive (30 d/i, 35 d/i, 40 d/i, 48 i, 50 i)	Plug & Play Complete Assembly	
			2007-2014 X6	ActiveHybrid, Active Hybrid xDrive, M, M 50 d, xDrive (30 d, 35 d/i, 40 d, 50 i)		
VB-2898			2006-2013 X5	3.0 d/sd/si, 4.8 i xDrive, M, M 50 d, xDrive (30 d/i, 35 d/i, 40 d, 48 i, 50 i)	Plug & Play Complete Assembly	
			2007-2014 X6	M, M 50 d, xDrive (30 d, 35 d/i, 40 d, 50 i)		
F01/02/04						
AS-2823			2008-2015 7 Series		730 d/d xDrive/i/Li, 740 d/d xDrive/i/Li/Li xDrive, 750 d xDrive/i/i xDrive, 760 i, Active Hybrid 7	Remanufactured w/FlexRay Technology
AS-2824			2008-2015 7 Series		730 d/d xDrive/i/Li, 740 d/d xDrive/i/Li/Li xDrive, 750 d xDrive/i/i xDrive, 760 i, Active Hybrid	Remanufactured w/FlexRay Technology
P-2985			2008-2015 7 Series		730 d/d xDrive/i/Li, 740 d/d xDrive/i/Li/Li xDrive, 750 d xDrive/i/i xDrive, 760 i, Active Hybrid	WABCO OES
VB-3502			2008-2015 7 Series		730 d/d xDrive/i/Li, 740 d/d xDrive/i/Li/Li xDrive, 750 d xDrive/i/i xDrive, 760 i, Active Hybrid	
F07/11						
A-2780			2009-2017 5 Series GT	w/Auto-Leveling, AWD & RWD	520 d, 528 i, 530 d/d xDrive, 535 d/d xDrive/i/i xDrive, 550 i/i xDrive	
			2009-2017 5 Series Wagon		518 d, 520 d/d xDrive/i, 523 i, 525 d/d xDrive, 528 i/i xDrive, 530 d/d xDrive/i, 535 d/d xDrive/i/i xDrive, 550 i	
P-2985			2009-2017 5 Series GT	w/Auto-Leveling, AWD & RWD	520 d, 528 i, 530 d/d xDrive, 535 d/d xDrive/i/i xDrive, 550 i/i xDrive	WABCO OES
			2009-2017 5 Series Wagon		518 d, 520 d/d xDrive/i, 523 i, 525 d/d xDrive, 528 i/i xDrive, 530 d/d xDrive/i, 535 d/d xDrive/i/i xDrive, 550 i, M 550 d xDrive	
VB-3502			2009-2017 5 Series GT	w/Auto-Leveling, AWD & RWD	520 d, 528 i, 530 d/d xDrive, 535 d/d xDrive/i/i xDrive, 550 i/i xDrive	
			2009-2017 5 Series Wagon		518 d, 520 d/d xDrive/i, 523 i, 525 d/d xDrive, 528 i/i xDrive, 530 d/d xDrive/i, 535 d/d xDrive/i/i xDrive, 550 i, M 550 d xDrive	

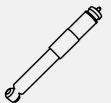
BMW						
Part #	Product Type	Position	Model Information	Vehicle Attributes	Product Attributes	
F15/16						
A-2642			2013-2018 X5	w/Adaptive Drive, Comfort or Sport Suspension	M, M 50 d, sDrive 25 d, xDrive (25 d, 30 d, 35 i, 40 d/e, 50 i)	
			2014-2019 X6	w/Adaptive Drive, Comfort or Sport Suspension	M, M 50 d, xDrive (30 d, 35 i, 40 d, 50 i)	
P-3279			2013-2018 X5	w/Adaptive Drive, Comfort or Sport Suspension	M, M 50 d, sDrive 25 d, xDrive (25 d, 30 d, 35 i, 40 d/e, 50 i)	WABCO OES
			2014-2019 X6	w/Adaptive Drive, Comfort or Sport Suspension	M, M 50 d, xDrive (28 i, 30 d, 35 i, 40 d, 50 i)	
G11/12						
P-3471			2015--> 7 Series		725 d, Ld, 730 d/d Mild-Hybrid xDrive/d xDrive/Ld Mild-Hybrid/Ld Mild-Hybrid xDrive/Ld xDrive/Li, 740 d, Ld Mild-Hybrid xDrive/Ld xDrive/e, Le/i/Li/Le xDrive/Li xDrive, 745 e/Le Plug-in-Hybrid/Le Plug-in-Hybrid xDrive, 750 d, Ld xDrive/i/Li/Li xDrive, M 760 i/Li xDrive	WABCO OES

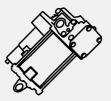
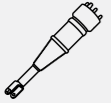
ARNOTT REMANUFACTURED AIR STRUTS

- Rear air struts for BMW 7 Series (F01/02/04 Chassis)
- Tested for FlexRay functionality
- Recharged with high performance shock oil
- Dyno-test to ensure OE performance
- Continental ContiTech air sleeve
 - › Premium multi-ply, cross-corded construction
 - › Longer-lasting design using advanced materials
- Works with vehicle's active damping & auto leveling functionality
- Remanufactured & tested in the USA



BUICK					
Part #	Product Type	Position	Model Information	Vehicle Attributes	Product Attributes
G Platform					
AS-2190			1995-1999 Riviera		> New > Sold in Pairs
			199-2005 Park Avenue	3.8 Supercharged	
			1999-2005 LeSabre	3.8	
SK-2189			2000-2005 LeSabre	3.8	> New > Sold in Pairs
F55					
AS-2950			2006-2011 Lucerne	w/MagneRide, w/Sport Suspension	> New
MR-3447			2006-2011 Lucerne	w/MagneRide	> New > Magentic Shocks
MR-3448			2006-2011 Lucerne	w/MagneRide	> New > Magentic Shocks
P-2982			2006-2011 Lucerne		
SK-2952			2006-2011 Lucerne	w/MagneRide, w/Sport Suspension	> New
GMT360					
A-2610			2004-2007 Rainier		> Generation II > Crimped Assembly, Improved Design
C-2137			2004-2007 Rainier		

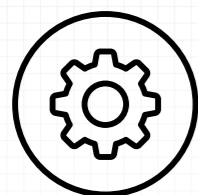

Innovative Engineering

Arnott's commitment to OE quality form, fit and function begins with exhaustive engineering. Arnott's advanced designs are not only more durable, but many are also easier to install than their OE counterparts.

AIR SUSPENSION BASICS





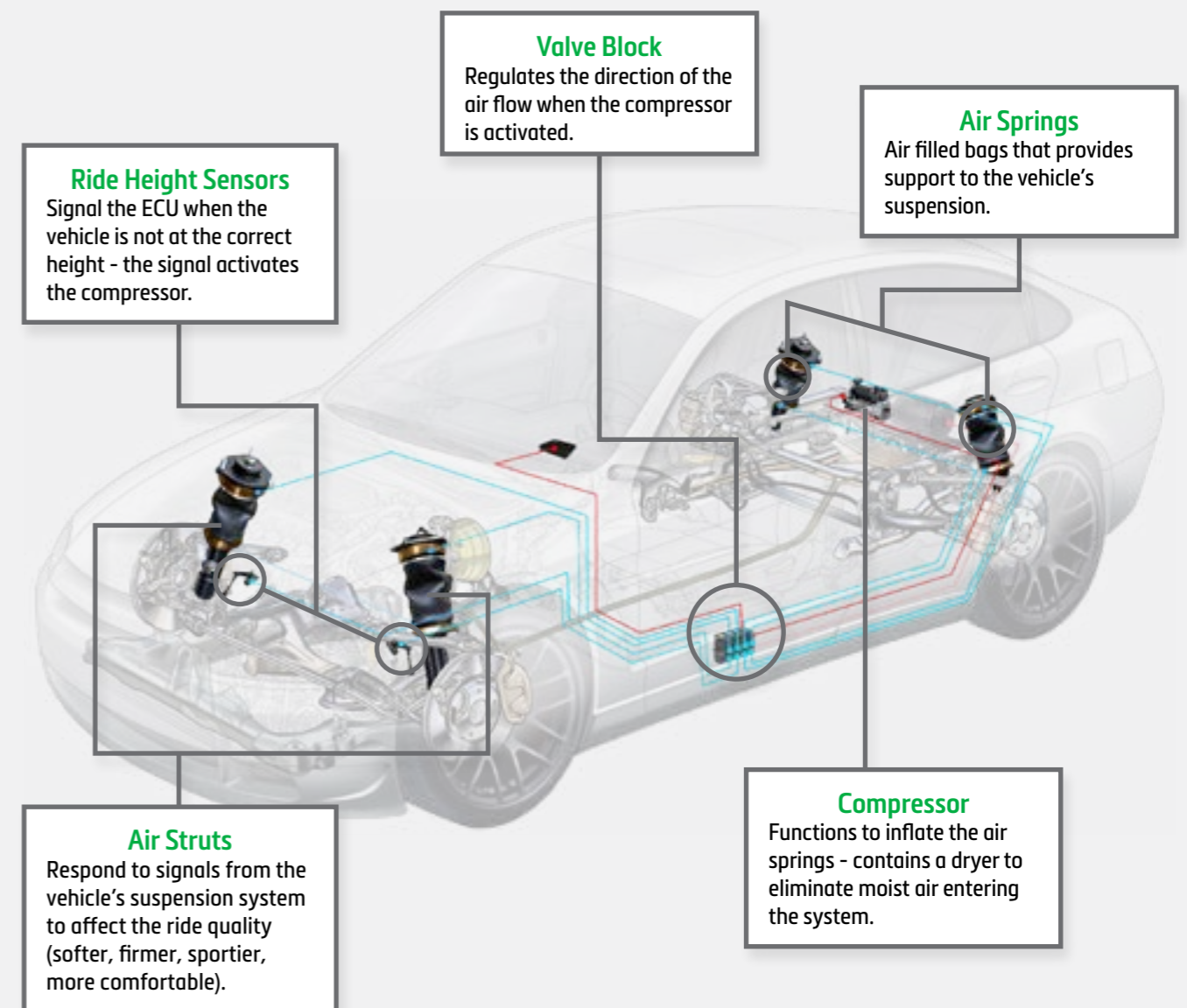





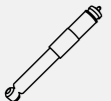

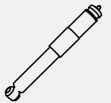

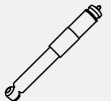



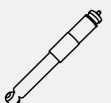

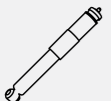
Air suspension systems use a compressor to inflate rubber air springs which may be separate from the shock absorber or combined with the damper as an air suspension strut. Height sensors give the ECU (Electronic Control Unit) a signal when the vehicle is not at a predetermined height and the compressor then pumps air into the air springs until the proper height is reached.

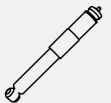

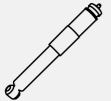

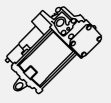
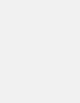













Like all rubber components, air springs and struts are wear and tear parts. Typically, the rubber will dry rot and small cracks form where the air bladder rolls upon itself. On average, an air suspension part will need to be replaced in six to ten years. Mileage, climate, driving conditions and off-road usage also influence the replacement rate.











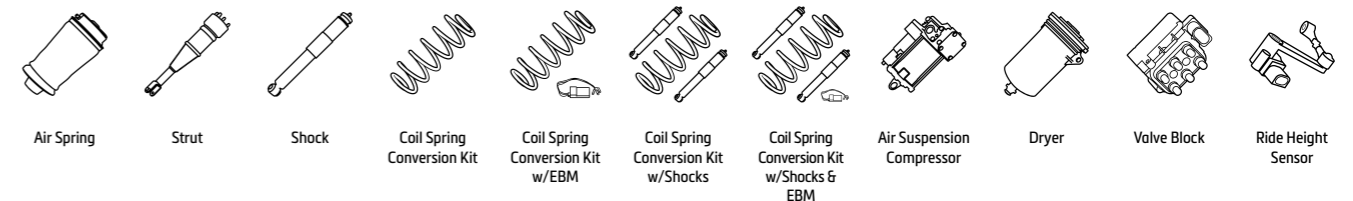

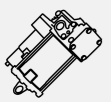
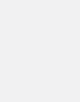



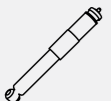

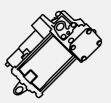
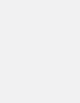
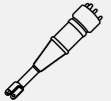

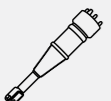
THE ARNOTT ADVANTAGE

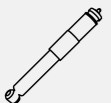





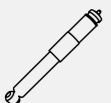



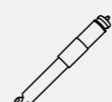









- > Trusted for more than 30 years
- > Custom-tuned to specific the application
- > Arnott-owned R&D and test facilities
- > Manufactured with the latest technology using premium components
- > Broadest aftermarket coverage
- > Expert technical support available

CADILLAC						
Part #	Product Type	Position	Model Information	Vehicle Attributes	Product Attributes	
E-body, G-body, K-body						
AS-2121			1998-2001 Seville	SLS & STS	4.6 V8	> New > Sold in Pairs
			2000-2005 DeVille	DTS Only	4.6	
AS-2125			1993 Eldorado	All Models (Excl. ETC)	4.6	> New > Sold in Pairs
			1993 Seville	SLS	4.6 V8	
			1994-1995 DeVille	Base Model	4.6, 4.9	
AS-2163			1993-1995 Eldorado	ETC Model	4.6	> New > Sold in Pairs
			1993-1994 Seville	SLS & STS	4.6 V8	
			1994-1995 DeVille	Concours	4.6	
			1994-1996 Eldorado	Base Model	4.6	
			1995-1996 Seville	SLS	4.6 V8	
			1996 DeVille	Base Model	4.6	
AS-2177			1996-1999 DeVille	Concours	4.6	> New > Sold in Pairs
			1996-2002 Eldorado	ETC Model	4.6	
			1996 Seville	STS	4.6 V8	
			1997 Seville	SLS & STS	4.6 V8	
AS-2185			1997-1999 DeVille	Base Model	4.6, 4.9	> New > Sold in Pairs
			1997-2002 Eldorado	Base Model	4.6	
AS-2190			2000-2005 DeVille	All Models (Excl. DTS)	4.6	> New > Sold in Pairs
			2002-2003 Seville	SLS & STS	4.6 V8	
			2004 Seville	SLS	4.6 V8	
MR-3447			2006-2011 DTS	w/MagneRide		> New > Magentic Shocks
MR-3448			2006-2011 DTS	w/MagneRide		> New > Magentic Shocks
P-3021			1998-2004 Seville	4.6 V8		> WABCO OES
			2000-2005 DeVille	4.6, 4.9		
SK-2111			1993 Allante	4.6		> New > Sold in Pairs
E-body, G-body, K-body						
SK-2118			1995 DeVille	Base Model	4.6, 4.9	> New > Sold in Pairs





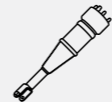



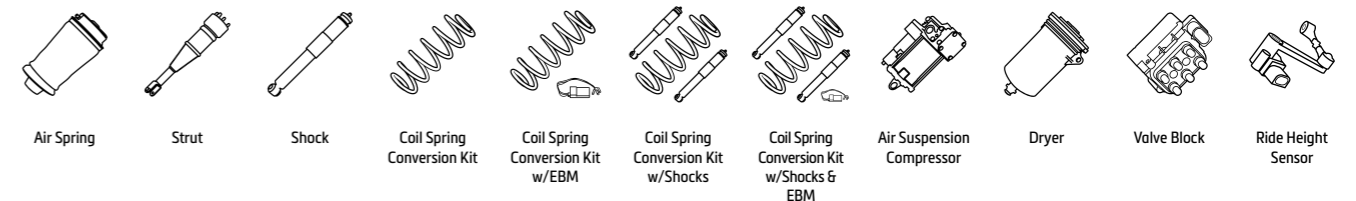

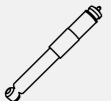

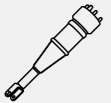

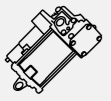
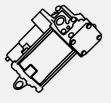

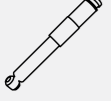

CADILLAC						
Part #	Product Type	Position	Model Information	Vehicle Attributes	Product Attributes	
E-body, G-body, K-body						
SK-2162			1993 Allante	4.6		> New > Sold in Pairs
			1993-1994 Eldorado	ETC Model	4.6	
			1993 Seville	STS	4.6 V8	
			1994 DeVille	Concours	4.6	
			1994 Eldorado	Base Model	4.6	
			1994 Seville	SLS & STS	4.6 V8	
SK-2167			1995 DeVille	Concours	4.6	> New > Sold in Pairs
			1995 Eldorado	Base & ETC Models	4.6	
			1996 Eldorado	Base Model	4.6	
			1995 Seville	SLS & STS	4.6 V8	
			1996 Seville	STS	4.6 V8	
			1996 DeVille	Base Model	4.6	
SK-2176			1996 DeVille	Concours	4.6	> New > Sold in Pairs
			1996 Eldorado	Base Model	4.6	
			1996 Seville	STS	4.6 V8	
SK-2178			1997-1999 DeVille	Concours	4.6	> New > Sold in Pairs
			1997-2002 Eldorado	ETC Model	4.6	
			1997 Seville	SLS & STS	4.6 V8	
SK-2183			1997-1999 DeVille	Base Model	4.6, 4.9	> New > Sold in Pairs
			1997-2002 Eldorado	Base Model	4.6	
SK-2186			1998-2001 Seville	SLS & STS	4.6 V8	> New > Sold in Pairs
			2000-2001 DeVille	DTS Only	4.6	
SK-2189			2000-2005 DeVille	All Models (Excl. DTS)	4.6	> New > Sold in Pairs
			2002-2003 Seville	SLS & STS	4.6 V8	
			2004 Seville	SLS	4.6 V8	
SK-2264			1993 Seville	SLS	4.6 V8	> New > Sold in Pairs
			1994 DeVille	Base Model	4.6, 4.9	
Epsilon II						
A-3233			2013-2019 XTS	w/ & w/o AWD		

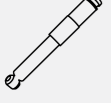

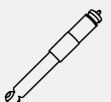





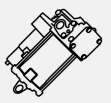



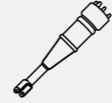



CADILLAC						
Part #	Product Type	Position	Model Information	Vehicle Attributes		Product Attributes
Epsilon II						
P-3243			2013-2019 XTS			
SK-3357			2013-2019 XTS			
SK-3433			2013-2019 XTS			
F55						
AS-2950			2006-2011 DTS	w/MagneRide, w/Sport Suspension	4.6	> New
P-2982			2006-2011 DTS		4.6	
SK-2952			2006-2011 DTS	w/MagneRide, w/Sport Suspension	4.6	> New
GMT265						
MR-3441			2004-2009 SRX	w/MagneRide		> New > Magnetic Strut
MR-3442			2004-2009 SRX	w/MagneRide		> New > Magnetic Shock
GMT806, GMT820, GMT830, GMT926, GMT936, GMT946						
AS-2700			2002-2014 Escalade	Short Wheelbase & Long Wheelbase (ESV, EXT)	5.7 AWD, 6.0, 6.0 AWD, 6.2, 6.2 AWD/FLEXFUEL/ FLEXFUEL AWD	> New
AS-2708			2002-2014 Escalade	Short Wheelbase & Long Wheelbase (ESV, EXT)	5.7 AWD, 6.0, 6.0 AWD, 6.2, 6.2 AWD/FLEXFUEL/ FLEXFUEL AWD	> Remanufactured
AS-2715			2002-2014 Escalade	Short Wheelbase & Long Wheelbase (ESV, EXT)	5.7 AWD, 6.0, 6.0 AWD, 6.2, 6.2 AWD/FLEXFUEL/ FLEXFUEL AWD	> New > Value

CADILLAC						
Part #	Product Type	Position	Model Information	Vehicle Attributes		Product Attributes
GMT806, GMT820, GMT830, GMT926, GMT936, GMT946						
AS-3430			2002-2006 Escalade	Short Wheelbase & Long Wheelbase (ESV, EXT), w/Autoride Suspension	5.7 AWD, 6.0, 6.0 AWD, 6.2, 6.2 AWD/FLEXFUEL/ FLEXFUEL AWD	> New
			2007-2014 Escalade	Short Wheelbase & Long Wheelbase (ESV, EXT), w/Autoride Suspension, w/MagneRide		
C-2666			2002-2006 Escalade	Short Wheelbase	5.7 AWD, 6.0, 6.0 AWD, 6.2, 6.2 AWD/FLEXFUEL/ FLEXFUEL AWD	> Value
C-2667			2002-2006 Escalade	Long Wheelbase (ESV, EXT)	5.7 AWD, 6.0, 6.0 AWD, 6.2, 6.2 AWD/FLEXFUEL/ FLEXFUEL AWD	> Value
C-2835			2007-2014 Escalade	Short Wheelbase	6.0 Hybrid/Hybrid AWD, 6.2, 6.2 AWD/FLEXFUEL/ FLEXFUEL AWD/Flex/ Flex AWD	> Value
C-2836			2007-2014 Escalade	Long Wheelbase (ESV, EXT)	6.0 Hybrid/Hybrid AWD, 6.2, 6.2 AWD/FLEXFUEL/ FLEXFUEL AWD/Flex/ Flex AWD	> Value
C-3182			2002-2006 Escalade	Short Wheelbase	5.7 AWD, 6.0, 6.0 AWD	> Eibach Shock Absorbers
C-3183			2002-2006 Escalade	Long Wheelbase (ESV, EXT)	5.7 AWD, 6.0, 6.0 AWD	> Eibach Shock Absorbers
C-3184			2007-2014 Escalade	Short Wheelbase	6.0 Hybrid/Hybrid AWD, 6.2, 6.2 AWD/FLEXFUEL/ FLEXFUEL AWD/Flex/ Flex AWD	> Eibach Shock Absorbers
C-3185			2007-2014 Escalade	Long Wheelbase (ESV, EXT)	6.0 Hybrid/Hybrid AWD, 6.2, 6.2 AWD/FLEXFUEL/ FLEXFUEL AWD/Flex/ Flex AWD	> Eibach Shock Absorbers
D-2803			2002-2014 Escalade	Short Wheelbase & Long Wheelbase (ESV, EXT)	5.7 AWD, 6.0, 6.0 AWD, 6.2, 6.2 AWD/FLEXFUEL/ FLEXFUEL AWD	
MR-3435			2007-2014 Escalade	Short Wheelbase & Long Wheelbase (ESV, EXT)	5.7 AWD, 6.0, 6.0 AWD, 6.2, 6.2 AWD/FLEXFUEL/ FLEXFUEL AWD	> New > Magnetic Strut

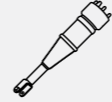









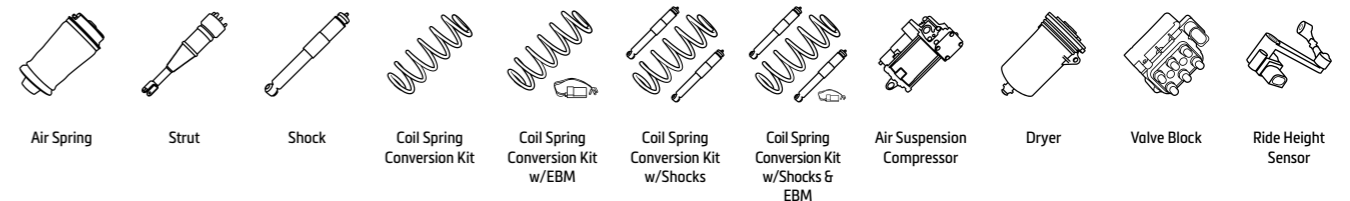







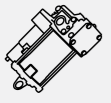

CADILLAC					
Part #	Product Type	Position	Model Information	Vehicle Attributes	Product Attributes
GMT806, GMT820, GMT830, GMT926, GMT936, GMT946					
MR-3436			2007-2014 Escalade	Short Wheelbase & Long Wheelbase (ESV, EXT) 5.7 AWD, 6.0, 6.0 AWD, 6.2, 6.2 AWD/FLEXFUEL/FLEXFUEL AWD	› New › Magnetic Shock
MR-3568			2007-2014 Escalade	Short Wheelbase & Long Wheelbase (ESV, EXT) 5.7 AWD, 6.0, 6.0 AWD, 6.2, 6.2 AWD/FLEXFUEL/FLEXFUEL AWD	› New › Magnetic Strut › Coil-Over Strut
P-2793			2002-2014 Escalade	Short Wheelbase & Long Wheelbase (ESV, EXT) 5.7 AWD, 6.0, 6.0 AWD, 6.2, 6.2 AWD/FLEXFUEL/FLEXFUEL AWD	› Plug & Play Complete Assembly
P-3242			2002-2014 Escalade	Short Wheelbase & Long Wheelbase (ESV, EXT)	› Plug & Play Complete Assembly
SK-2760			2002-2006 Escalade	Short Wheelbase & Long Wheelbase (ESV, EXT) 5.7 AWD, 6.0, 6.0 AWD, 6.2, 6.2 AWD/FLEXFUEL/FLEXFUEL AWD	› New › Value
SK-2806			2007-2014 Escalade	Short Wheelbase & Long Wheelbase (ESV, EXT) 6.0 Hybrid/Hybrid AWD, 6.2, 6.2 AWD/FLEXFUEL/FLEXFUEL AWD/Flex/Flex AWD	› New › Value
SK-2954			2007-2014 Escalade	Short Wheelbase & Long Wheelbase (ESV, EXT) (Excl. Hybrids) 5.7 AWD, 6.0, 6.0 AWD, 6.2, 6.2 AWD/FLEXFUEL/FLEXFUEL AWD	› New
SK-3062			2002-2006 Escalade	Short Wheelbase & Long Wheelbase (ESV, EXT)	› New › Eibach Shock Absorber
GMTK2XL					
AS-3066			2015-2020 Escalade	Incl. ESV	› New › Eibach Shock Absorber
C-3416			2015-2020 Escalade	Excl. ESV	› Eibach Shock Absorbers
C-3432			2015-2020 Escalade	ESV	› Eibach Shock Absorbers
P-3242			2015-2019 Escalade	Incl. ESV	› Plug & Play Complete Assembly



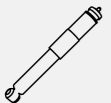













CADILLAC					
Part #	Product Type	Position	Model Information	Vehicle Attributes	Product Attributes
GMTK2XL					
SK-3354			2015-2018 Escalade	ESV w/MagneRide	› New › Eibach Shock Absorber › Coil-Over Shock
GMX295					
MR-3437			2007-2010 STS	w/MagneRide, w/AWD	› New › Magnetic Strut
MR-3438			2007-2010 STS	w/MagneRide, w/RWD	› New › Magnetic Strut
MR-3439			2007-2010 STS	w/MagneRide, w/AWD or RWD	› New › Magnetic Shock
MR-3440			2007-2010 STS	w/MagneRide, w/AWD or RWD	› New › Magnetic Shock
GMX322					
MR-3443			2009-2015 CTS 2009-2015 CTS-V	w/MagneRide	› New › Magnetic Strut
MR-3444			2009-2015 CTS 2009-2015 CTS-V	w/MagneRide	› New › Magnetic Shock

BENEFITS OF USING ARNOTT AIR SUSPENSION

- ▶ Trusted for over three decades
- ▶ Highest quality with superior support
- ▶ Broadest aftermarket coverage
- ▶ Simplified diagnosis & installation
- ▶ Additional sales & profit
- ▶ Additional savings available for workshops

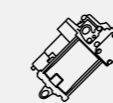

CHEVROLET						
Part #	Product Type	Position	Model Information	Vehicle Attributes	Product Attributes	
GMT360, GMT370						
A-2610			2002-2006 Trailblazer EXT	129" Wheelbase, 4.2 AWD	<ul style="list-style-type: none"> > Generation II > Crimped Assembly, Improved Design 	
			2002-2009 Trailblazer	113" Wheelbase, 4.2 AWD		
C-2137			2002-2009 Trailblazer	113" Wheelbase, 4.2 AWD		
C-2285			2002-2006 Trailblazer EXT	129" Wheelbase, 4.2 AWD		
P-2863			2002-2006 Trailblazer EXT	129" Wheelbase, 4.2 AWD	<ul style="list-style-type: none"> > WABCO OES > Remanufactured > Plug & Play Complete Assembly 	
GMT805, GMT820, GMT830, GMT921, GMT931, GMT941						
AS-2700			2000-2006 Tahoe 1500	4x2, 4x4 (w/Autoride Suspension)	4.8 V8, 5.3, 5.3 AWD/V8 AWD, 6.0 V8	<ul style="list-style-type: none"> > New
			2000-2014 Suburban 1500		5.3 AWD/Flex-Fuel 4WD, 8.1 AWD	
			2002-2014 Avalanche 1500		2.3 AWD/Flex-Fuel/Flex-Fuel AWD, 8.1	
			2007-2014 Tahoe 1500		5.3	
AS-2708			2000-2006 Tahoe 1500	4x2, 4x4 (w/Autoride Suspension)	4.8 V8, 5.3, 5.3 AWD/V8 AWD, 6.0 V8	<ul style="list-style-type: none"> > Remanufactured
			2000-2014 Suburban 1500		5.3 AWD/Flex-Fuel 4WD, 8.1 AWD	
			2002-2014 Avalanche 1500		2.3 AWD/Flex-Fuel/Flex-Fuel AWD, 8.1	
			2007-2014 Tahoe 1500		5.3	
AS-2715			2000-2006 Tahoe 1500	4x2, 4x4 (w/Autoride Suspension)	4.8 V8, 5.3, 5.3 AWD/V8 AWD, 6.0 V8	<ul style="list-style-type: none"> > New > Value
			2000-2014 Suburban 1500		5.3 AWD/Flex-Fuel 4WD, 8.1 AWD	
			2002-2014 Avalanche 1500		2.3 AWD/Flex-Fuel/Flex-Fuel AWD, 8.1	
			2007-2014 Tahoe 1500		5.3	
AS-3430			2000-2006 Suburban 1500	4x2, 4x4 (w/Autoride Suspension)		<ul style="list-style-type: none"> > New
			2000-2006 Tahoe 1500		4.8 V8, 5.3, 5.3 AWD/V8 AWD, 6.0 V8	
			2002-2006 Avalanche 1500		5.3 AWD, 8.1	
			2007-2013 Avalanche 1500		2.3 AWD/Flex-Fuel/Flex-Fuel AWD, 8.1	
			2007-2014 Suburban 1500		5.3 AWD/Flex-Fuel 4WD, 8.1 AWD	
			2007-2014 Tahoe 1500	5.3		
C-2666			2000-2006 Tahoe 1500	4x2, 4x4 (w/Autoride Suspension)	4.8 V8, 5.3, 5.3 AWD/V8 AWD, 6.0 V8, 8.1	<ul style="list-style-type: none"> > Value
C-2667			2000-2006 Suburban 1500	4x2, 4x4 (w/Autoride Suspension)	5.3 AWD, 8.1 AWD	<ul style="list-style-type: none"> > Value
			2002-2006 Avalanche 1500	4x2, 4x4 (w/Electronic Suspension)		

CHEVROLET						
Part #	Product Type	Position	Model Information	Vehicle Attributes	Product Attributes	
GMT805, GMT820, GMT830, GMT921, GMT931, GMT941						
C-2835			2007-2014 Tahoe 1500	4x2, 4x4 (w/Electronic Suspension)	2.3, 6.0 Flex/Hybrid 4WD	<ul style="list-style-type: none"> > Value
C-2836			2007-2014 Avalanche 1500	4x2, 4x4 (w/Electronic Suspension)		<ul style="list-style-type: none"> > Value
			2007-2014 Suburban 1500	4x2, 4x4 (w/Autoride Suspension)		
C-3182			2000-2006 Tahoe 1500	4x2, 4x4 (w/Autoride Suspension)	4.8 V8, 5.3, 5.3 AWD/V8 AWD, 6.0 V8	<ul style="list-style-type: none"> > Eibach Shock Absorbers
C-3183			2000-2006 Suburban 1500	4x2, 4x4 (w/Autoride Suspension)		<ul style="list-style-type: none"> > Eibach Shock Absorbers
			2002-2006 Avalanche 1500	4x2, 4x4 (w/Electronic Suspension)		
C-3184			2007-2014 Tahoe 1500	4x2, 4x4 (w/Electronic Suspension)	5.3, 5.3 Flex-Fuel/Flex-Fuel AWD, 6.0 Flex/Hybrid 4WD	<ul style="list-style-type: none"> > Eibach Shock Absorbers
C-3185			2007-2014 Avalanche 1500	4x2, 4x4 (w/Electronic Suspension)		<ul style="list-style-type: none"> > Eibach Shock Absorbers
			2007-2014 Suburban 1500	4x2, 4x4 (w/Autoride Suspension)		
D-2803			2001-2006 Tahoe 1500	4x2, 4x4 (w/Autoride Suspension)	4.8 V8, 5.3, 5.3 AWD/V8 AWD, 6.0 V8	<ul style="list-style-type: none"> > Magnetic Strut
			2001-2014 Suburban 1500		5.3 AWD/Flex-Fuel 4WD	
			2002-2014 Avalanche 1500		5.3 AWD/Flex-Fuel/Flex-Fuel AWD, 8.1	
			2007-2014 Tahoe 1500		5.3	
MR-3435			2007-2014 Suburban 1500	4x2, 4x4 (w/Autoride Suspension)		<ul style="list-style-type: none"> > Magnetic Strut
			2007-2014 Avalanche 1500	4x2, 4x4 (w/Electronic Suspension)		
			2007-2014 Tahoe 1500			
MR-3436			2007-2014 Suburban 1500	4x2, 4x4 (w/Autoride Suspension)		<ul style="list-style-type: none"> > Magnetic Shock
			2007-2014 Avalanche 1500	4x2, 4x4 (w/Electronic Suspension)		
			2007-2014 Tahoe 1500			
P-2793			2001-2006 Tahoe 1500	4x2, 4x4 (w/Autoride Suspension)	4.8 V8, 5.3, 5.3 AWD/V8 AWD, 6.0 V8	<ul style="list-style-type: none"> > Plug & Play Complete Assembly
			2001-2014 Suburban 1500		5.3 AWD/Flex-Fuel 4WD	
			2002-2014 Avalanche 1500		5.3 AWD/Flex-Fuel/Flex-Fuel AWD, 8.1	
			2007-2014 Tahoe 1500		5.3	

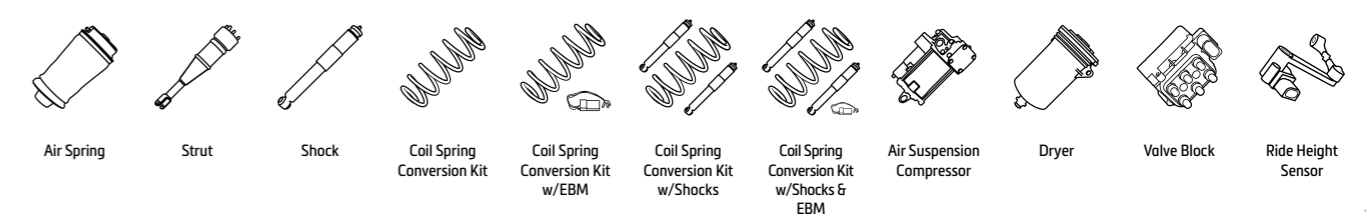









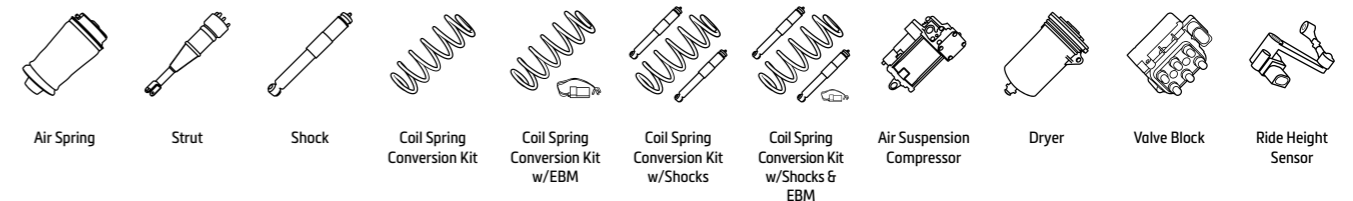









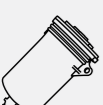
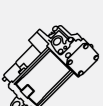
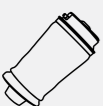

CHEVROLET						
Part #	Product Type	Position	Model Information	Vehicle Attributes	Product Attributes	
GMT805, GMT820, GMT830, GMT921, GMT931, GMT941						
P-3242			2001-2006 Tahoe 1500	4x2, 4x4 (w/Autoride Suspension)	4.8 V8, 5.3, 5.3 AWD/V8 AWD, 6.0 V8	› Plug & Play Complete Assembly
			2001-2014 Suburban 1500		5.3 AWD/Flex-Fuel 4WD	
			2002-2014 Avalanche 1500	4x2, 4x4 (w/Electronic Suspension)	5.3 AWD/Flex-Fuel/Flex-Fuel AWD, 8.1	
			2007-2014 Tahoe 1500		5.3	
SK-2760			2000-2006 Suburban 1500	4x2, 4x4 (w/Autoride Suspension)	4.8 V8, 5.3, 5.3 AWD/V8 AWD, 6.0 V8	› New › Value
			2000-2006 Tahoe 1500			
			2002-2006 Avalanche 1500	4x2, 4x4 (w/Electronic Suspension)	5.3 AWD, 8.1	
SK-2806			2007-2014 Avalanche 1500	4x2, 4x4 (w/Electronic Suspension)	5.3 Flex-Fuel/Flex-Fuel AWD	› New › Value
			2007-2014 Suburban 1500	4x2, 4x4 (w/Autoride Suspension)		
			2007-2014 Tahoe 1500	4x2, 4x4 (w/Electronic Suspension)	5.3, 6.0 Flex/Hybrid 4WD	
SK-2954			2007-2014 Avalanche 1500	4x2, 4x4 (w/Electronic Suspension) (Excl. Hybrids)	5.3 Flex-Fuel, 5.3 Flex-Fuel AWD	› New
			2007-2014 Suburban 1500	4x2, 4x4 (w/Autoride Suspension)	5.3 Flex-Fuel 4WD	
			2007-2014 Tahoe 1500	4x2, 4x4 (w/Electronic Suspension)	5.3	
SK-3062			2000-2006 Suburban 1500	4x2, 4x4 (w/Autoride Suspension)		› New › Eibach Shock Absorber
			2000-2006 Tahoe 1500			
			2002-2006 Avalanche 1500	4x2, 4x4 (w/Electronic Suspension)		
GMTK2UC, GMTK2YC						
AS-3066			2015-2020 Suburban 1500			› New › Eibach Shock Absorber
			2015-2020 Tahoe 1500			
C-3416			2015-2020 Tahoe 1500			› Eibach Shock Absorbers
C-3432			2015-2020 Suburban 1500			› Eibach Shock Absorbers
P-3242			2015-2019 Suburban 1500			› Plug & Play Complete Assembly
			2015-2019 Tahoe 1500			
SK-3354			2015-2018 Suburban 1500	w/MagneRide		› New › Eibach Shock Absorber › Coil-Over Shock
			2015-2018 Tahoe 1500			
GMTK2HC						
P-3242			2015-2019 Silverado			› Plug & Play Complete Assembly
			2015-2019 Cheyenne			
SK-3354			2015-2018 Silverado	w/MagneRide		› New › Eibach Shock Absorber › Coil-Over Shock













CITROËN						
Part #	Product Type	Position	Model Information	Vehicle Attributes	Product Attributes	
PF2						
A-2939			2006-2013 C4 Grand Picasso	1.2 THP 130, 1.6 16V/BlueHDi 100/BlueHDi 120/BlueHDi 115/HDi/HDi 90/HDi 110/THP 140/THP 150/THP 155/THP 165/VTI 120, 1.8 Bifuel/i 16V, 2.0 BlueHDi 135/BlueHDi 150/HDi 138/HDi 150/HDi 165/i 16V		
			2013--> Grand Picasso II	1.2 THP 130, 1.6 16V/BlueHDi 100/BlueHDi 120/BlueHDi 115/HDi/HDi 90/HDi 110/THP 140/THP 150/THP 155/THP 165/VTI 120, 1.8 Bifuel/i 16V, 2.0 BlueHDi 135/BlueHDi 150/HDi 138/HDi 150/HDi 165/i 16V		
P-2854			2006-2013 C4 Grand Picasso	1.6 16V/HDi/HDi 110/THP 140/THP 155/VTI 120, 1.8 Bifuel/i 16V/i 16V CNG/i 16V Flex, 2.0 HDi 138/HDi 150/HDi 165/i 16V		› WABCO OES
VF7						
P-2851			2007--> Jumpy	1.6 HDi 90 16V/8V, 2.0 HDi 120/HDi 125/HDi 140/HDi 165/HDi 95/i		› WABCO OES

ARNOTT NEW AIR SPRING

- Rear air spring for Citroën C4 Picasso (PF2)
- Continental ContiTech air sleeve
 - › Premium multi-ply, cross-corded construction
 - › Longer-lasting design using advanced materials
- High impact resin top mount and bottom piston
- Universal fit
- Engineered by Arnott for easy installation
- A-2939

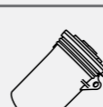
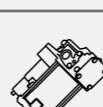
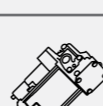

FORD					
Part #	Product Type	Position	Model Information	Vehicle Attributes	Product Attributes
Panther					
A-2105			1992-2011 Crown Victoria	4.6 Liter V8	
A-2220			1992-2011 Crown Victoria	4.6 Liter V8	> Heavy Duty for Limousine Use
C-2614			1992-2002 Crown Victoria	4.6 Liter V8	
C-2615			2003-2011 Crown Victoria	4.6 Liter V8	
D-2171			1992-2011 Crown Victoria	4.6 Liter V8	
P-2936			1992-2011 Crown Victoria	4.6 Liter V8	
U93, U222, U324					
A-2143			2003-2006 Expedition	2 Wheel Drive & 4 Wheel Drive	> New Air Spring Only, Reuse Factory Shock
A-2148			1997-2002 Expedition	2 Wheel Drive	
A-2153			1997-2002 Expedition	4 Wheel Drive	
A-2647			2007-2014 Expedition	2 Wheel Drive & 4 Wheel Drive	
A-2735			2003-2006 Expedition	2 Wheel Drive & 4 Wheel Drive	> New Air Spring Only, Reuse Factory Shock
AS-2139			2003-2006 Expedition	2 Wheel Drive & 4 Wheel Drive	> New > Strut, Air Spring & Upper Mount Assembly









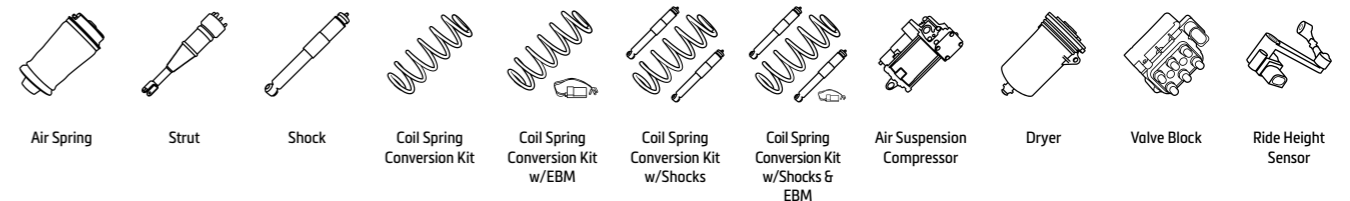







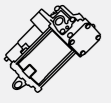
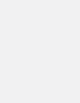
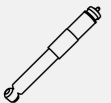

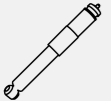

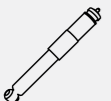

FORD					
Part #	Product Type	Position	Model Information	Vehicle Attributes	Product Attributes
U93, U222, U324					
C-2140			2003-2006 Expedition	2 Wheel Drive & 4 Wheel Drive	
C-2529			2007-2014 Expedition	2 Wheel Drive & 4 Wheel Drive (AWD/RWD)	
C-2607			1997-2002 Expedition	2 Wheel Drive (RWD)	
C-2608			1997-2002 Expedition	4 Wheel Drive (4WD)	
D-2155			1997-2006 Expedition	2 Wheel Drive & 4 Wheel Drive	
P-2932			1997-2006 Expedition	2 Wheel Drive & 4 Wheel Drive	
P-2937			2007-2017 Expedition	2 Wheel Drive & 4 Wheel Drive	
SK-2723			2003-2006 Expedition	2 Wheel Drive & 4 Wheel Drive	> New
WIN88, WIN126					
C-2175			1995-2003 Windstar	w/Load Leveling Rear Air Suspension 3.0 V6, 3.8, 3.8 V6	

















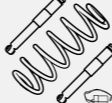

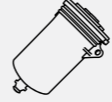
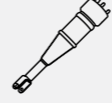
Comprehensive Quality Assurance



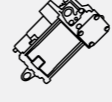
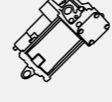





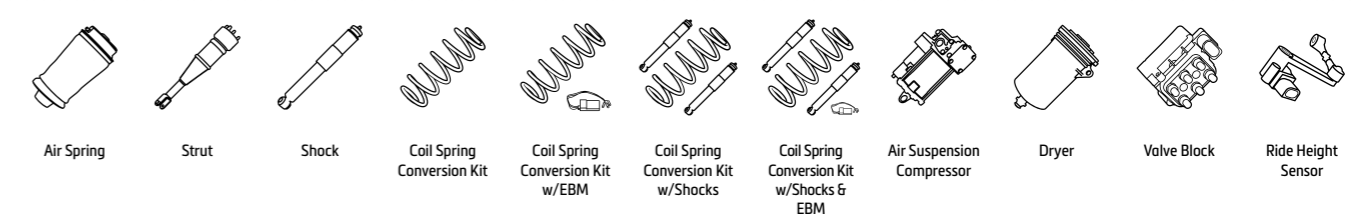

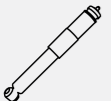

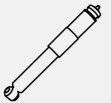

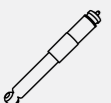
Arnott's Quality Assurance Team is part of the process from development to production. At every step, they make sure that Arnott's high standards of quality, engineering and manufacturing are maintained.

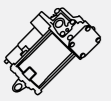

GMC						
Part #	Product Type	Position	Model Information	Vehicle Attributes	Product Attributes	
GMT305, GMT360, GMT370						
A-2610			2002-2006 Envoy XL 2002-2006 Envoy XUV 2002-2009 Envoy	129" Wheelbase 113" Wheelbase	<ul style="list-style-type: none"> > Generation II > Crimped Assembly, Improved Design 	
C-2137			2002-2009 Envoy	113" Wheelbase		
C-2285			2002-2006 Envoy XL 2002-2006 Envoy XUV	129" Wheelbase		
P-2863			2002-2006 Envoy XL 2002-2006 Envoy XUV	129" Wheelbase	<ul style="list-style-type: none"> > WABCO OES > Remanufactured > Plug & Play Complete Assembly 	
GMT820, GMT830, GMT922, GMT932						
AS-2700			2000-2013 Yukon 1500 2000-2014 Yukon XL 1500	All Models w/Autoride, Incl. Denali 6.2 4WD	> New	
AS-2708			2000-2013 Yukon 1500 2000-2014 Yukon XL 1500	All Models w/Autoride, Incl. Denali 6.2 4WD	> Remanufactured	
AS-2715			2000-2013 Yukon 1500 2000-2014 Yukon XL 1500	All Models w/Autoride, Incl. Denali 6.2 4WD	<ul style="list-style-type: none"> > New > Value 	
AS-3430			2000-2006 Yukon 1500 2000-2006 Yukon XL 1500 2007-2013 Yukon 1500 2007-2014 Yukon XL 1500	All Models w/Autoride, Incl. Denali All Models w/Autoride, Incl. Denali, w/MagneRide 6.2 4WD 5.3, 6.2, 6.2 4WD 6.0, 6.0 4WD	> New	
C-2666			2000-2006 Yukon 1500	All Models w/Autoride, Incl. Denali	> Value	
C-2667			2000-2006 Yukon XL 1500	All Models w/Autoride, Incl. Denali	> Value	
C-2835			2007-2013 Yukon 1500	All Models w/Autoride, Incl. Denali 5.3, 6.2, 6.2 4WD	> Value	
C-2836			2007-2014 Yukon XL 1500	All Models w/Autoride, Incl. Denali 6.0, 6.0 4WD	> Value	

GMC						
Part #	Product Type	Position	Model Information	Vehicle Attributes	Product Attributes	
GMT820, GMT830, GMT922, GMT932						
C-3182			2000-2006 Yukon 1500	All Models w/Autoride, Incl. Denali	> Eibach Shock Absorbers	
C-3183			2000-2006 Yukon XL 1500	All Models w/Autoride, Incl. Denali	> Eibach Shock Absorbers	
C-3184			2007-2013 Yukon 1500	All Models w/Autoride, Incl. Denali 5.3, 6.2, 6.2 4WD	> Eibach Shock Absorbers	
C-3185			2007-2014 Yukon XL 1500	All Models w/Autoride, Incl. Denali 6.0, 6.0 4WD	> Eibach Shock Absorbers	
D-2803			2000-2013 Yukon 1500 2000-2014 Yukon XL 1500	All Models w/Autoride, Incl. Denali 6.2 4WD		
MR-3435			2007-2013 Yukon 1500 2007-2014 Yukon XL 1500	All Models w/Autoride, Incl. Denali	<ul style="list-style-type: none"> > New > Magnetic Strut 	
MR-3436			2007-2013 Yukon 1500 2007-2014 Yukon XL 1500	All Models w/Autoride, Incl. Denali	<ul style="list-style-type: none"> > New > Magnetic Shock 	
P-2793			2001-2013 Yukon 1500 2001-2014 Yukon XL 1500	All Models w/Autoride, Incl. Denali 6.2 4WD	> Plug & Play Complete Assembly	
P-3242			2000-2014 Yukon 1500 2000-2014 Yukon XL 1500	All Models w/Autoride, Incl. Denali	> Plug & Play Complete Assembly	
SK-2760			2000-2006 Yukon 1500 2000-2006 Yukon XL 1500	All Models w/Autoride, Incl. Denali	<ul style="list-style-type: none"> > New > Value 	
SK-2806			2007-2013 Yukon 1500 2007-2014 Yukon XL 1500	All Models w/Autoride, Incl. Denali	<ul style="list-style-type: none"> > New > Value 	

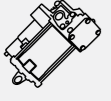
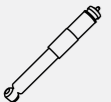

GMC						
Part #	Product Type	Position	Model Information	Vehicle Attributes	Product Attributes	
GMT820, GMT830, GMT922, GMT932						
SK-2954			2007-2013 Yukon 1500	All Models w/Autoride, Incl. Denali (Excl. Hybrids)	6.2 4WD	› New
			2007-2014 Yukon XL 1500			
SK-3062			2000-2006 Yukon 1500	All Models w/Autoride, Incl. Denali		› New › Eibach Shock Absorber
			2000-2006 Yukon XL 1500			
GMTK2UG, GMTK2YG						
AS-3066			2015-2019 Yukon 1500			› New › Eibach Shock Absorber
			2015-2019 Yukon XL 1500			
C-3416			2015-2020 Yukon 1500			› Eibach Shock Absorbers
C-3432			2015-2020 Yukon XL 1500			› Eibach Shock Absorbers
P-3242			2015-2019 Yukon 1500			› Plug & Play Complete Assembly
			2015-2019 Yukon XL 1500			
SK-3354			2015-2018 Yukon 1500	w/MagneRide		› New › Eibach Shock Absorber › Coil-Over Shock
			2015-2018 Yukon XL 1500			
GMTK2HG						
P-3242			2015-2020 Sierra			› Plug & Play Complete Assembly
SK-3354			2015-2018 Sierra	w/MagneRide		› New › Eibach Shock Absorber › Coil-Over Shock

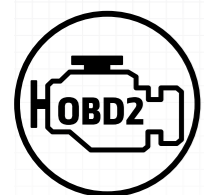

TECH TIP: WARNING LIGHTS

A dashboard warning light typically indicates an air suspension problem such as a failed compressor. Another common indicator for an air suspension problem is that the car is no longer leveled in the morning.

Air springs in a vehicle's suspension are durable rubber sleeves that are inflated and deflated through electronic inputs to create a smooth, controlled ride. An air spring can be connected to a vehicle's axle or integrated onto the suspension strut.

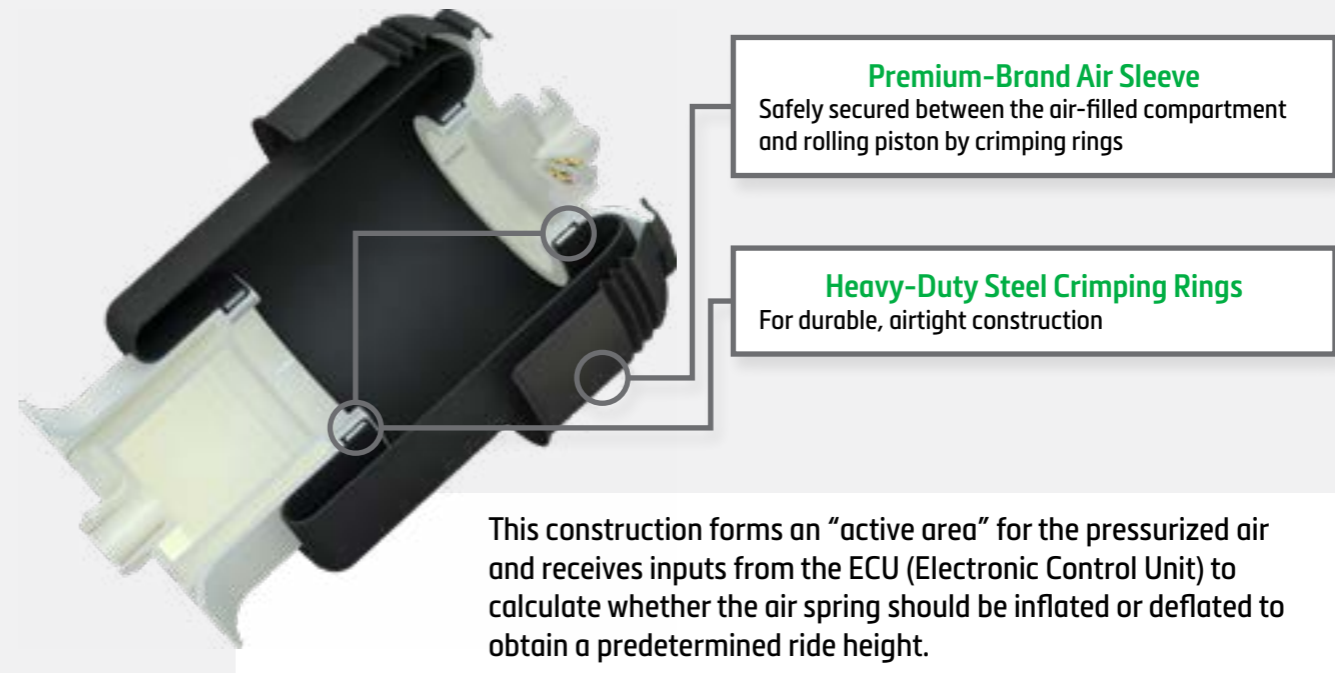

TECH TIP: LEAKS

Most air suspension problems occur because one or more of a vehicle's air springs have deteriorated and developed leaks. Thin rubber air sleeves and seals combined with weak crimping rings are common problems in many low-quality knock-offs and some stock air springs.











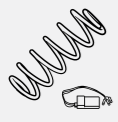

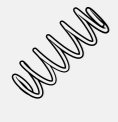
An air suspension leak is easy to find by spraying the air springs, struts and fittings with a soap and water solution. Bubbles will indicate where the leak or leaks are.

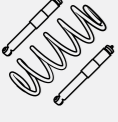

Arnott air springs feature multi-ply sleeves manufactured by industry-leading companies and are engineered to address the common problems many springs develop.

THE ARNOTT ADVANTAGE

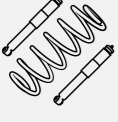
- ▶ Long-lasting, premium-brand, multi-ply air sleeve manufactured by industry-leading companies
- ▶ Improved design installs up to 90% faster than OE
- ▶ Quick, economical repair option

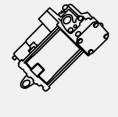
HUMMER						
Part #	Product Type	Position	Model Information	Vehicle Attributes		Product Attributes
GMT820						
C-2987			2003-2007 H2 Series	w/Rear Air Suspension	6.0/6.2 AWD	
C-2988			2008-2009 H2 Series	w/Rear Air Suspension	6.2 Flex AWD	

INFINITI						
Part #	Product Type	Position	Model Information	Vehicle Attributes		Product Attributes
JA60						
AS-3284			2003-2010 QX56	5.6 4WD		> New
C-3421			2003-2009 QX56	4 Wheel Drive (4WD)	5.6 4WD	
C-3434			2003-2010 QX56	Rear Wheel Drive (RWD)	5.6	
P-3277			2003-2009 QX56	5.6 4WD		

IVECO						
Part #	Product Type	Position	Model Information	Vehicle Attributes		Product Attributes
A-3276			1999-2015 Daily 35/50, Daily III, IV, V, VI, EcoDaily	35 (C 14, C 15, C10 K, C12, C13K, C13DKP, C15, C15 V, C15 V/P, C18) 40 (C 10 (AE)B14A1), C 11, C 13, C 14, C 15, C10, C10 V, C11 V, C11, C11 D, C12, C12 V, C14 V/P, C13 V, C13 V/P, C13, C13/P, C14 G, C14 G/P, C14 GV, C14 GV/P, C14 K, C14 DK, C14 V, C14 V/P, C14, C14 /P, C15, C15 V, C15 V/P, C17 K, C17 DK, C17 V, C17 V/P, C17, C17/P, C18, C18 V, C18 V/P) 50 (C 11, C 11 Natural Power (CNG), C 13, C 14, C 15, C 17, C Electric, C14 G, C14 G/P, C14 GD, C14 GD/P, C14 GV, C14 GV/P, C14 K, C14 DK, C14 Natural Power, C14 V, C14 V/P, C14, C14/P, C15, C15 V, C15 V/P, C17 K, C17 DK, C17 V, C17 V/P, C17, C17/P, C18, C18 V, C18 V/P)		



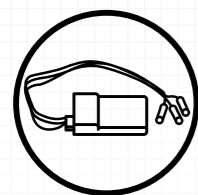





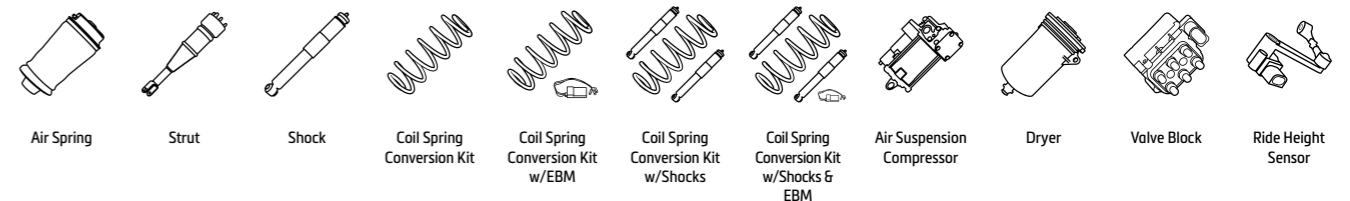

JAGUAR						
Part #	Product Type	Position	Model Information	Vehicle Attributes		Product Attributes
X350, X358						
AS-2888			2003-2009 XJ Series	w/Comfort Suspension	3.0, 3.6, 4.2, D 2.7, R 4.2	> New
AS-2889			2003-2009 XJ Series	w/Comfort Suspension	3.0, 3.6, 4.2, D 2.7, R 4.2	> New
AS-2890			2003-2009 XJ Series	w/Sport Suspension	3.0, 3.6, 4.2, D 2.7, R 4.2	> New
AS-2891			2003-2009 XJ Series	w/Sport Suspension	3.0, 3.6, 4.2, D 2.7, R 4.2	> New
C-2745			2003-2009 XJ Series	3.0, 3.6, 4.2, D 2.7, R 4.2		> Eibach Shock Absorbers
C-3270			2003-2009 XJ Series	3.0, 3.6, 4.2, D 2.7, R 4.2		> Eibach Shock Absorbers
P-2291			2003-2009 XJ Series	3.0, 3.6, 4.2, D 2.7, R 4.2		> WABCO OES
X351						
AS-3234			2009--> XJ Series	w/AWD or RWD, Short Wheelbase & Long Wheelbase	2.0 T14, 3.0 SCV6/SCV6 AWD/SDV6/V6, 5.0 SCV8/SCV8 R575/V8	> New > Eibach Shock Absorber
P-3244			2009--> XJ Series	w/AWD or RWD, Short Wheelbase & Long Wheelbase	2.0 T14, 3.0 SCV6/SCV6 AWD/SDV6/V6, 5.0 SCV8/SCV8 R575/V8	> Plug & Play Complete Assembly



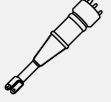

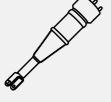

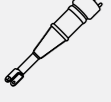







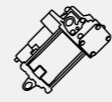

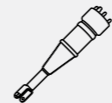

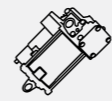
Warning Lights







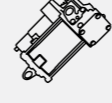

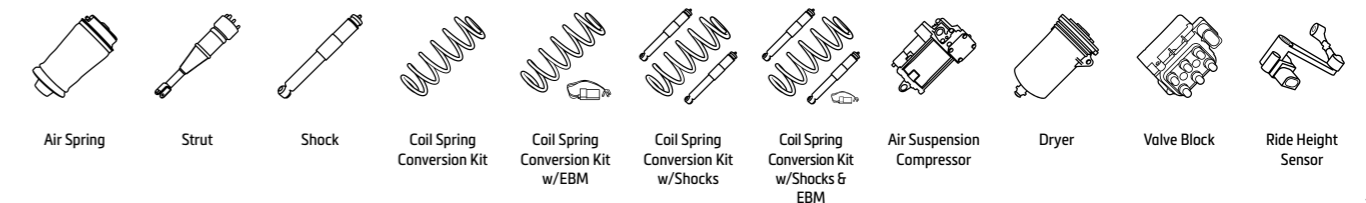

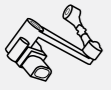

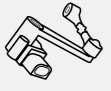





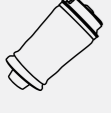

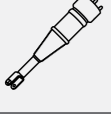

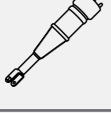

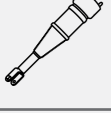
Arnott's patented Electronic Bypass Module is available for most kits and installs easily to turn off any dashboard warning lights once an Arnott Coil Spring Conversion Kit is installed.

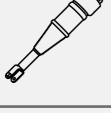

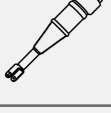

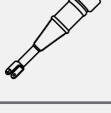





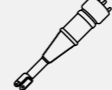

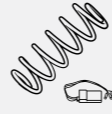

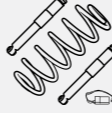



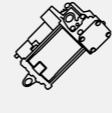
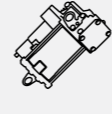
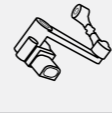

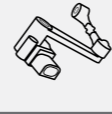
JEEP					
Part #	Product Type	Position	Model Information	Vehicle Attributes	Product Attributes
WK2					
A-3010			2010--> Grand Cherokee	3.0 4x4/CRD/CRD V6 4x4, 3.6 V6 4x4/V6 FlexFuel 4x4/VVT 4x4, 5.7 V8 4x4, 6.4 SRT8 4x4	
AS-3248			2016--> Grand Cherokee	w/Quadra-Lift, w/o SRT Suspension	3.6 VVT 4x4, 6.2 4x4, 6.2 i V8 4x4 > New
AS-3249			2016--> Grand Cherokee	w/Quadra-Lift, w/o SRT Suspension	3.6 VVT 4x4, 6.2 4x4, 6.2 i V8 4x4 > New
AS-3250			2016--> Grand Cherokee	w/Quadra-Lift, w/o SRT Suspension	3.6 VVT 4x4, 6.2 4x4, 6.2 i V8 4x4 > New > Eibach Shock Absorber
AS-3251			2016--> Grand Cherokee	w/Quadra-Lift, w/o SRT Suspension	3.6 VVT 4x4, 6.2 4x4, 6.2 i V8 4x4 > New > Eibach Shock Absorber
AS-3289			2010-2015 Grand Cherokee	w/Quadra-Lift, w/o SRT Suspension	3.0 4x4/CRD/CRD V6 4x4, 3.6 V6 4x4/V6 FlexFuel 4x4, 5.7 4x4/V8 4x4, 6.4 SRT8 4x4 > New
AS-3290			2010-2015 Grand Cherokee	w/Quadra-Lift, w/o SRT Suspension	3.0 4x4/CRD/CRD V6 4x4, 3.6 V6 4x4/V6 FlexFuel 4x4, 5.7 4x4/V8 4x4, 6.4 SRT8 4x4 > New
AS-3323			2010-2015 Grand Cherokee	w/Quadra-Lift, w/o SRT Suspension	3.0 4x4/CRD/CRD V6 4x4, 3.6 V6 4x4/V6 FlexFuel 4x4/VVT 4x4, 5.7 4x4/V8 4x4, 6.2 4x4/i V8 4x4 > New > Eibach Shock Absorber
AS-3324			2010-2015 Grand Cherokee	w/Quadra-Lift, w/o SRT Suspension	3.0 4x4/CRD/CRD V6 4x4, 3.6 V6 4x4/V6 FlexFuel 4x4/VVT 4x4, 5.7 4x4/V8 4x4, 6.2 4x4/i V8 4x4 > New > Eibach Shock Absorber
P-3245			2010--> Grand Cherokee		3.0 4x4/CRD/CRD V6 4x4/TD V6 4x4/V6 4x4, 3.6 V6/V6 4x4/V6 FlexFuel 4x4/VVT/VVT 4x4, 5.7 4x4/V8 4x4, 6.2 4x4/i V8 4x4, 6.4 SRT8 4x4 > OES
SK-3394			2010--> Grand Cherokee	w/Quadra-Lift, w/o SRT Suspension	3.0 4x4/CRD/CRD V6 4x4, 3.6 V6 4x4/V6 FlexFuel 4x4/VVT 4x4, 5.7 4x4/V8 4x4, 6.2 4x4/i V8 4x4, 6.4 SRT8 4x4 > New > Eibach Shock Absorber
VB-3266			2010--> Grand Cherokee		3.0 4x4/CRD/CRD V6 4x4, 3.6 V6 4x4/V6 FlexFuel 4x4/VVT 4x4, 5.7 V8 4x4, 6.4 SRT8 4x4

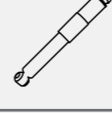







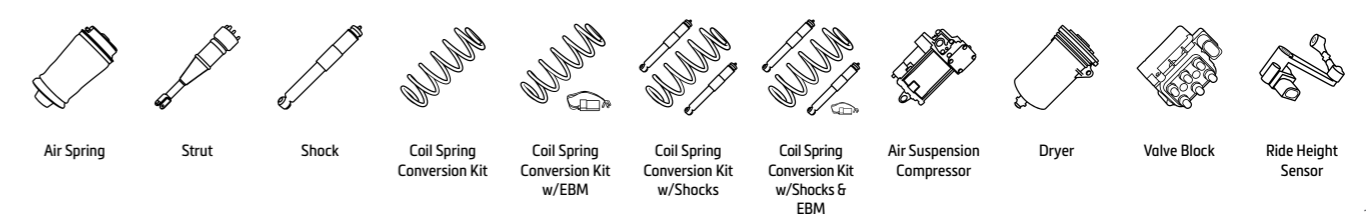

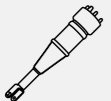

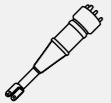

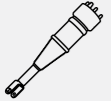

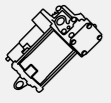



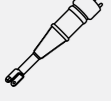

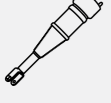
LAND ROVER					
Part #	Product Type	Position	Model Information	Vehicle Attributes	Product Attributes
L318					
A-2202			1998-2004 Discovery II	2.5 Td5 4x4, 4.0 V8 4x4	
C-2203			1998-2004 Discovery II	2.5 Td5, 4.0 V8	
P-2495			1998-2004 Discovery II	2.5 Td5, 4.0 V8	> WABCO OES
L319					
AS-2534			2004-2009 Discovery LR3	2.7 TD 4x4, 4.0 4x4/V6 4x4, 4.4 4x4	> New
			2009-2018 Discovery LR4	2.7 TD 4x4, 3.0 4x4/SDV6 4x4/TD 4x4, 4.0 4x4, 5.0 V8 4x4	
AS-2809			2004-2009 Discovery LR3	2.7 TD 4x4, 4.0 4x4/V6 4x4, 4.4 4x4	> New
			2009-2018 Discovery LR4	2.7 TD 4x4, 3.0 4x4/SDV6 4x4/TD 4x4, 4.0 4x4, 5.0 V8 4x4	
P-3431			2004-2009 Discovery LR3	2.7 TD 4x4, 4.0 4x4/V6 4x4, 4.4 4x4	
			2009-2018 Discovery LR4	2.7 TD 4x4, 3.0 4x4/SDV6 4x4/TD 4x4, 4.0 4x4, 5.0 V8 4x4	
L320					
AS-2534			2005-2013 Range Rover Sport	Incl. Supercharged	2.7 D 4x4, 3.0 D 4x4, 3.6 D 4x4, 4.2 4x4, 4.4 4x4, 5.0 4x4 > New
AS-2761			2009-2013 Range Rover Sport	w/VDS, Supercharged	3.0 D 4x4 > New
AS-2762			2009-2013 Range Rover Sport	w/VDS, Supercharged	3.0 D 4x4 > New
AS-2809			2005-2013 Range Rover Sport	Incl. Supercharged	2.7 D 4x4, 3.0 D 4x4, 3.6 D 4x4, 4.2 4x4, 4.4 4x4, 5.0 4x4 > New
P-3431			2005-2013 Range Rover Sport	Incl. Supercharged	2.7 D 4x4, 3.0 D 4x4, 3.6 D 4x4, 4.2 4x4, 4.4 4x4, 5.0 4x4
			2009-2013 Range Rover Sport	w/VDS	

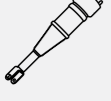

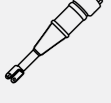

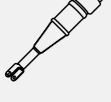

LAND ROVER						
Part #	Product Type	Position	Model Information	Vehicle Attributes	Product Attributes	
L320						
RH-3454			2005-2013 Range Rover Sport	w/VDS	2.7 D 4x4, 3.0 D 4x4, 3.6 D 4x4, 4.2 4x4, 4.4 4x4, 5.0 4x4	
RH-3455			2005-2013 Range Rover Sport	w/VDS	2.7 D 4x4, 3.0 D 4x4, 3.6 D 4x4, 4.2 4x4, 4.4 4x4, 5.0 4x4	
L322						
A-2831			2002-2012 Range Rover	w/o VDS, w/o VDS Incl. Supercharged w/VDS, Incl. Supercharged	3.0 D 4x4, 3.6 D 4x4, 4.2 4x4, 4.4 4x4/D 4x4, 5.0 4x4	
A-2933			2002-2012 Range Rover	w/o VDS w/o VDS, Incl. Supercharged w/VDS, Incl. Supercharged	3.0 D 4x4, 3.6 D 4x4, 4.2 4x4, 4.4 4x4/D 4x4, 5.0 4x4	
A-2934			2002-2012 Range Rover	w/o VDS w/o VDS, Incl. Supercharged w/VDS, Incl. Supercharged	3.0 D 4x4, 3.6 D 4x4, 4.2 4x4, 4.4 4x4/D 4x4, 5.0 4x4	
AS-2757			2009-2012 Range Rover	w/VDS, Incl. Supercharged	3.0 D 4x4, 3.6 D 4x4, 4.2 4x4, 4.4 4x4/D 4x4, 5.0 4x4	> Remanufactured
AS-2758			2009-2012 Range Rover	w/VDS, Incl. Supercharged	3.0 D 4x4, 3.6 D 4x4, 4.2 4x4, 4.4 4x4/D 4x4, 5.0 4x4	> Remanufactured
AS-2795			2006-2012 Range Rover	w/o VDS, Supercharged	3.0 D 4x4, 3.6 D 4x4, 4.2 4x4, 4.4 4x4/D 4x4, 5.0 4x4	> New
AS-2796			2006-2012 Range Rover	w/o VDS, Supercharged	3.0 D 4x4, 3.6 D 4x4, 4.2 4x4, 4.4 4x4/D 4x4, 5.0 4x4	> New
AS-2797			2009-2012 Range Rover	w/VDS, Incl. Supercharged	3.0 D 4x4, 3.6 D 4x4, 4.2 4x4, 4.4 4x4/D 4x4, 5.0 4x4	> New
AS-2798			2009-2012 Range Rover	w/VDS, Incl. Supercharged	3.0 D 4x4, 3.6 D 4x4, 4.2 4x4, 4.4 4x4/D 4x4, 5.0 4x4	> New
AS-2961			2002-2005 Range Rover 2006-2012 Range Rover	w/o VDS w/o VDS, Incl. Supercharged	3.0 D 4x4, 3.6 D 4x4, 4.2 4x4, 4.4 4x4/D 4x4, 5.0 4x4	> New

LAND ROVER						
Part #	Product Type	Position	Model Information	Vehicle Attributes	Product Attributes	
L322						
AS-2962			2002-2005 Range Rover 2006-2012 Range Rover	w/o VDS w/o VDS, Incl. Supercharged	3.0 D 4x4, 3.6 D 4x4, 4.2 4x4, 4.4 4x4/D 4x4, 5.0 4x4	> New
C-2518			2002-2005 Range Rover	w/o VDS	3.0 D 4x4, 3.6 D 4x4, 4.4 4x4	
C-2967			2009-2012 Range Rover	w/VDS, Incl. Supercharged	3.0 D 4x4, 3.6 D 4x4, 4.2 4x4, 4.4 4x4/D 4x4, 5.0 4x4	
C-2989			2006-2012 Range Rover 2009-2012 Range Rover	w/o VDS, Incl. Supercharged w/VDS, Incl. Supercharged	3.0 D 4x4, 3.6 D 4x4, 4.2 4x4, 4.4 4x4/D 4x4, 5.0 4x4	
P-2462			2002-2005 Range Rover	w/o VDS	3.0 D 4x4, 4.2 4x4, 4.4 4x4	> WABCO OES
P-3232			2006-2012 Range Rover 2009-2012 Range Rover	w/o VDS, Incl. Supercharged w/VDS, Incl. Supercharged	3.0 D 4x4, 3.6 D 4x4, 4.2 4x4, 4.4 4x4/D 4x4, 5.0 4x4	
RH-3378			2009-2012 Range Rover	w/VDS, Incl. Supercharged	3.0 D 4x4, 3.6 D 4x4, 4.2 4x4, 4.4 4x4/D 4x4, 5.0 4x4	
RH-3379			2009-2012 Range Rover	w/VDS, Incl. Supercharged	3.0 D 4x4, 3.6 D 4x4, 4.2 4x4, 4.4 4x4/D 4x4, 5.0 4x4	
SK-3122			2002-2005 Range Rover 2006-2012 Range Rover	w/o VDS w/o VDS, Incl. Supercharged	3.0 D 4x4, 3.6 D 4x4, 4.2 4x4, 4.4 4x4/D 4x4, 5.0 4x4	> New
SK-3382			2009-2012 Range Rover	w/VDS	3.0 D 4x4, 3.6 D 4x4, 4.2 4x4, 4.4 4x4/D 4x4, 5.0 4x4	> New
L405						
A-3025			2012--> Range Rover	2.0 P400e Hybrid 4x4, 3.0 P400 MHEV 4x4/SCV6 4x4/SDV6 Hybrid 4x4/TDV6 4x4, 4.4 SDV8 4x4, 5.0 SCV8 4x4/V8 4x4		



LAND ROVER					
Part #	Product Type	Position	Model Information	Vehicle Attributes	Product Attributes
L405					
AS-3067			2012--> Range Rover	w/CVD	2.0 P400e Hybrid 4x4, 3.0 P400 MHEV 4x4/SCV6 4x4/SDV6 Hybrid 4x4/TDV6 4x4, 4.4 SDV8 4x4, 5.0 SCV8 4x4/V8 4x4 › Remanufactured
AS-3068			2012--> Range Rover	w/CVD	2.0 P400e Hybrid 4x4, 3.0 P400 MHEV 4x4/SCV6 4x4/SDV6 Hybrid 4x4/TDV6 4x4, 4.4 SDV8 4x4, 5.0 SCV8 4x4/V8 4x4 › Remanufactured
AS-3355			2012--> Range Rover	w/CVD	2.0 P400e Hybrid 4x4, 3.0 P400 MHEV 4x4/SCV6 4x4/SDV6 Hybrid 4x4/TDV6 4x4, 4.4 SDV8 4x4, 5.0 SCV8 4x4/V8 4x4 › New › Eibach Shock Absorber
P-3280			2012--> Range Rover	2.0 P400e Hybrid 4x4, 3.0 P400 MHEV 4x4/SCV6 4x4/SDV6 Hybrid 4x4/TDV6 4x4, 4.4 SDV8 4x4, 5.0 SCV8 4x4/V8 4x4	› WABCO OES
SK-3384			2012--> Range Rover	2.0 P400e Hybrid 4x4, 3.0 P400 MHEV 4x4/SCV6 4x4/SDV6 Hybrid 4x4/TDV6 4x4, 4.4 SDV8 4x4, 5.0 SCV8 4x4/V8 4x4	› New › Eibach Shock Absorber
L494					
A-3027			2013--> Range Rover Sport	w/o CVD	2.0 P400e PHEV 4x4/SD4 4x4/Si4 4x4, 3.0 P400 MHEV 4x4/SCV6 4x4/SDV6 Hybrid 4x4/TDV6 4x4, 4.4 SDV8 4x4, 5.0 SCV8 4x4
AS-3069			2013--> Range Rover Sport	w/o CVD	2.0 P400e PHEV 4x4/SD4 4x4/Si4 4x4, 3.0 P400 MHEV 4x4/SCV6 4x4/SDV6 Hybrid 4x4/TDV6 4x4, 4.4 SDV8 4x4, 5.0 SCV8 4x4 › Remanufactured
AS-3070			2013--> Range Rover Sport	w/o CVD	2.0 P400e PHEV 4x4/SD4 4x4/Si4 4x4, 3.0 P400 MHEV 4x4/SCV6 4x4/SDV6 Hybrid 4x4/TDV6 4x4, 4.4 SDV8 4x4, 5.0 SCV8 4x4 › Remanufactured
AS-3204			2013--> Range Rover Sport	w/CVD	2.0 SD4 4x4, 3.0 SCV6 4x4/SDV6 Hybrid 4x4/TDV6 4x4, 4.4 SDV8 4x4, 5.0 SCV8 4x4 › Remanufactured
AS-3205			2013--> Range Rover Sport	w/CVD	2.0 SD4 4x4, 3.0 SCV6 4x4/SDV6 Hybrid 4x4/TDV6 4x4, 4.4 SDV8 4x4, 5.0 SCV8 4x4 › Remanufactured
AS-3362			2013--> Range Rover Sport	w/o CVD	2.0 P400e PHEV 4x4/SD4 4x4/Si4 4x4, 3.0 P400 MHEV 4x4/SCV6 4x4/SDV6 Hybrid 4x4/TDV6 4x4, 4.4 SDV8 4x4, 5.0 SCV8 4x4 › New › Eibach Shock Absorber
AS-3368			2013--> Range Rover Sport	w/CVD	2.0 P400e PHEV 4x4/SD4 4x4/Si4 4x4, 3.0 P400 MHEV 4x4/SCV6 4x4/SDV6 Hybrid 4x4/TDV6 4x4, 4.4 SDV8 4x4, 5.0 SCV8 4x4 › New › Eibach Shock Absorber

LAND ROVER					
Part #	Product Type	Position	Model Information	Vehicle Attributes	Product Attributes
L494					
P-3280			2013--> Range Rover Sport	2.0 P400e PHEV 4x4/SD4 4x4/Si4 4x4, 3.0 P400 MHEV 4x4/SCV6 4x4/SDV6 Hybrid 4x4/TDV6 4x4, 4.4 SDV8 4x4, 5.0 SCV8 4x4	› WABCO OES
SK-3385			2013--> Range Rover Sport	w/o CVD	2.0 P400e PHEV 4x4/SD4 4x4/Si4 4x4, 3.0 P400 MHEV 4x4/SCV6 4x4/SDV6 Hybrid 4x4/TDV6 4x4, 4.4 SDV8 4x4, 5.0 SCV8 4x4 › New › Eibach Shock Absorber
SK-3386			2013--> Range Rover Sport	w/CVD	2.0 P400e PHEV 4x4/SD4 4x4/Si4 4x4, 3.0 P400 MHEV 4x4/SCV6 4x4/SDV6 Hybrid 4x4/TDV6 4x4, 4.4 SDV8 4x4, 5.0 SCV8 4x4 › New › Eibach Shock Absorber
P38A					
A-2611			1994-2002 Range Rover	2.5 D 4x4, 3.9 4x4, 4.0 4x4, 4.6 4x4	› Generation II › Extended Travel & Improved Design
A-2612			1994-2002 Range Rover	2.5 D 4x4, 3.9 4x4, 4.0 4x4, 4.6 4x4	› Generation II › Extended Travel & Improved Design
A-2691			1994-2002 Range Rover	2.5 D 4x4, 3.9 4x4, 4.0 4x4, 4.6 4x4	› Generation III
A-2692			1994-2002 Range Rover	2.5 D 4x4, 3.9 4x4, 4.0 4x4, 4.6 4x4	› Generation III
C-2227			1994-2002 Range Rover	2.5 D, 4x4 4.0 4x4, 4.6 4x4	
P-2514			1994-2002 Range Rover	2.5 D, 4x4 4.0 4x4, 4.6 4x4	

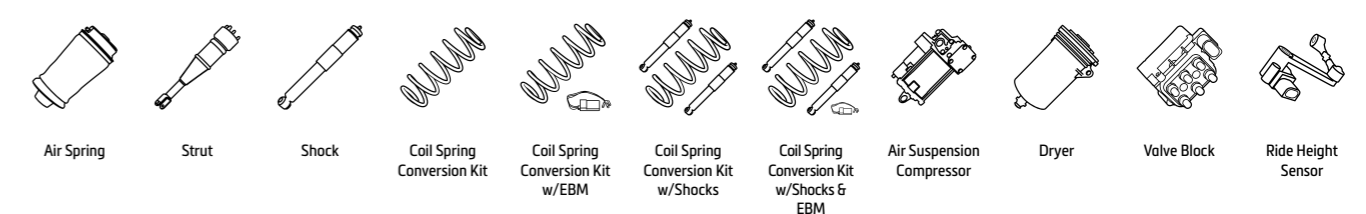



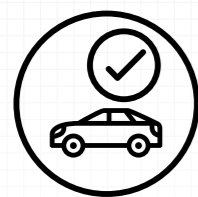





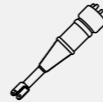

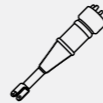
LEXUS						
Part #	Product Type	Position	Model Information	Vehicle Attributes		Product Attributes
AL10						
P-3194			2008-2015 RX 450H	450h (GYL10_)/AWD (GYL15_)		
J120						
A-2949			2001-2009 GX 470	w/ & w/o Kinetic Dynamic Suspension	UZJ120	
C-2410			2001-2009 GX 470	UZJ120		
P-3192			2001-2009 GX 470	UZJ120		> OES
SK-2812			2001-2009 GX 470	UZJ120		> New
SK-2813			2001-2009 GX 470	UZJ120		> New
J150						
A-3331			2010--> GX 460	w/ & w/o Kinetic Dynamic Suspension	4WD (URJ150)	
A-3332			2010--> GX 460	w/ & w/o Kinetic Dynamic Suspension	4WD (URJ150)	
P-3191			2010--> GX 460	4WD (URJ150)		> OES

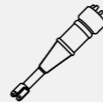

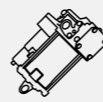
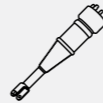
Quality Checked

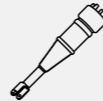
Arnett computer-tests remanufactured shocks and struts as well as compressors for durability and OE functionality.

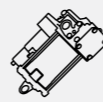







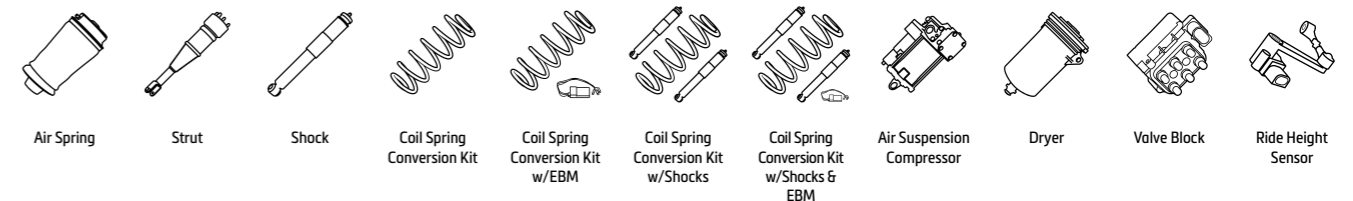







LEXUS						
Part #	Product Type	Position	Model Information	Vehicle Attributes		Product Attributes
UCF30						
AS-2894			2000-2006 LS 430	XF30		> New
AS-3073			2000-2006 LS 430	XF30		> New
AS-3074			2000-2006 LS 430	XF30		> New
P-3187			2000-2006 LS 430	XF30		> OES
USF40, USF41, USF45, USF46, UVF45, UVF46						
AS-2855			2006-2012 LS 460	w/RWD, Short Wheelbase & Long Wheelbase		> New
AS-2856			2006-2012 LS 460	w/AWD or RWD, Short Wheelbase & Long Wheelbase		> New
			2006-2012 LS 600	Short Wheelbase, Hybrid		
			2006-2012 LS 600h L	Long Wheelbase, Hybrid		
P-3188			2006-2017 LS 460	w/AWD or RWD, Short Wheelbase & Long Wheelbase		> OES
			2008-2016 LS 600	Short Wheelbase, Hybrid		
			2008-2016 LS 600h L	Long Wheelbase, Hybrid		







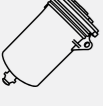
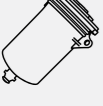
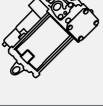
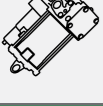





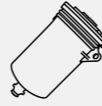
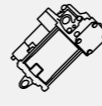

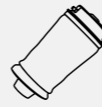
TECH TIP: SOFTWARE UPDATES

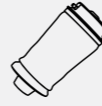



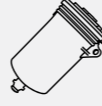
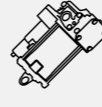
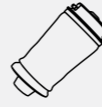



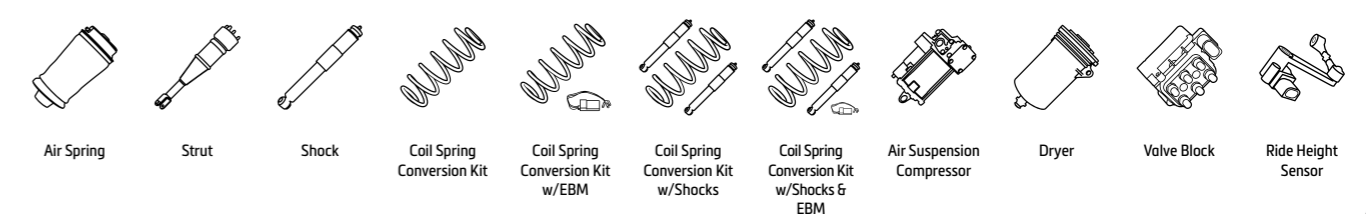



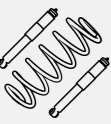

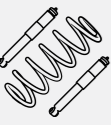

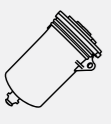
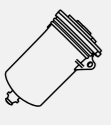
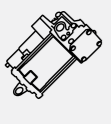
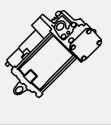
Arnett compressors for Land Rover LR3, LR4 and Range Rover Sport may need a software update after installation. Since Land Rover moved away from Hitachi to another compressor supplier, the software update is mandatory. Without this update, the compressor may not function well and this could void the warranty.











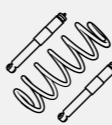

LINCOLN					
Part #	Product Type	Position	Model Information	Vehicle Attributes	Product Attributes
D186					
A-2106			1984-1987 Continental	5.0 Liter V8	
A-2107			1984-1987 Continental	5.0 Liter V8	
A-2173			1995-2002 Continental	4.6 Liter V8	
A-2174			1995-1996 Continental	4.6 Liter V8	> New Air Spring Only, Reuse Factory Shock
A-2212			1995-2002 Continental	4.6 Liter V8	
C-2180			1997-2002 Continental	4.6 Liter V8	
C-2224			1984-1987 Continental	5.0 Liter V8	
D-2155			1984-1987 Continental	5.0 Liter V8	
D-2171			1995-2002 Continental	4.6 Liter V8	
P-2211			1995-2002 Continental	4.6 Liter V8	
P-2231			1984-1987 Continental	5.0 Liter V8	
FN10					
A-2108			1993-1998 Mark VIII	4.6 Liter V8	

LINCOLN					
Part #	Product Type	Position	Model Information	Vehicle Attributes	Product Attributes
FN10					
C-2236			1993-1998 Mark VIII	4.6 Liter V8	
D-2155			1993-1998 Mark VIII	4.6 Liter V8	
P-2210			1993-1998 Mark VIII	4.6 Liter V8	
SK-2225			1993-1998 Mark VIII	4.6 Liter V8	> New > Sold in Pairs
Fox					
A-2106			1984-1992 Mark VII	5.0 Liter V8	
A-2107			1984-1992 Mark VII	5.0 Liter V8	
C-2224			1984-1992 Mark VII	5.0 Liter V8	
D-2155			1984-1992 Mark VII	5.0 Liter V8	
P-2231			1984-1992 Mark VII	5.0 Liter V8	
Panther					
A-2105			1990-1997 Town Car	4.6 Liter V8, 5.0 Liter V8	
			1998-2011 Town Car	4.6 Liter V8	

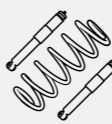

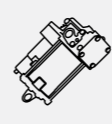
LINCOLN					
Part #	Product Type	Position	Model Information	Vehicle Attributes	Product Attributes
Panther					
A-2220			1990-1997 Town Car	4.6 Liter V8, 5.0 Liter V8	› Heavy Duty for Limousine Use
			1998-2011 Town Car	4.6 Liter V8	
C-2614			1990-1997 Town Car	4.6 Liter V8, 5.0 Liter V8	
			1998-2002 Town Car	4.6 Liter V8	
C-2615			2003-2011 Town Car	4.6 Liter V8	
D-2155			1998-2002 Town Car	4.6 Liter V8	
D-2171			1990-1997 Town Car	4.6 Liter V8, 5.0 Liter V8	
			2003-2011 Town Car	4.6 Liter V8	
P-2935			1998-2002 Town Car	4.6 Liter V8	
P-2936			1990-1997 Town Car	4.6 Liter V8, 5.0 Liter V8	
			2003-2011 Town Car	4.6 Liter V8	
U173, U228, U326					
A-2143			2003-2006 Navigator	2 Wheel Drive & 4 Wheel Drive	› New Air Spring Only, Reuse Factory Shock
A-2148			1998-2002 Navigator	2 Wheel Drive	
A-2153			1998-2002 Navigator	4 Wheel Drive	
A-2647			2007-2014 Navigator	2 Wheel Drive & 4 Wheel Drive	
A-2735			2003-2006 Navigator	2 Wheel Drive & 4 Wheel Drive	› New Air Spring Only, Reuse Factory Shock

LINCOLN					
Part #	Product Type	Position	Model Information	Vehicle Attributes	Product Attributes
U173, U228, U326					
AS-2139			2003-2006 Navigator	2 Wheel Drive & 4 Wheel Drive	› New › Strut, Air Spring & Upper Mount Assembly
U173, U228, U326					
C-2140			2003-2006 Navigator	2 Wheel Drive & 4 Wheel Drive	
C-2529			2007-2014 Navigator	2 Wheel Drive & 4 Wheel Drive (AWD/RWD)	
C-2607			1998-2002 Navigator	2 Wheel Drive (RWD)	
C-2608			1998-2002 Navigator	4 Wheel Drive (4WD)	
D-2155			1998-2006 Navigator	2 Wheel Drive & 4 Wheel Drive	
P-2932			1998-2006 Navigator	2 Wheel Drive & 4 Wheel Drive	
P-2937			2007-2017 Navigator	2 Wheel Drive & 4 Wheel Drive	
SK-2723			2003-2006 Navigator	2 Wheel Drive & 4 Wheel Drive	› New

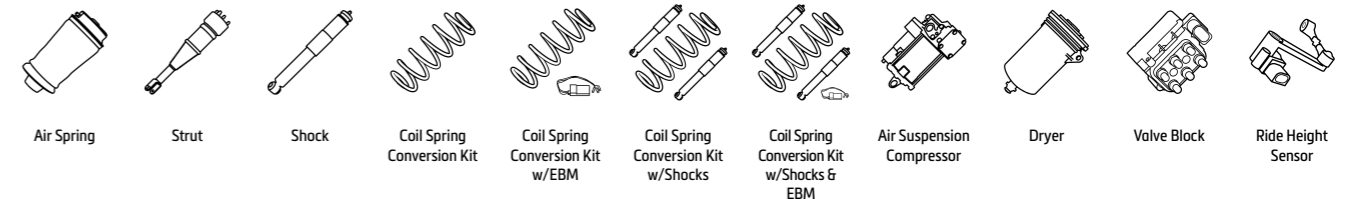

Arnott's engineers apply more than 30 years of remanufacturing experience and knowledge to every new strut they design and continually improve their ability to design new air struts that replicate the OE-like ride drivers expect.

Weaknesses in the OE design are improved and Arnott's new struts are built with Tier 1 components, including longer-lasting seals, new polyurethane bump stops, premium brand air sleeves, heavy-duty crimping rings and name-brand, dust baffles.



THE ARNOTT ADVANTAGE









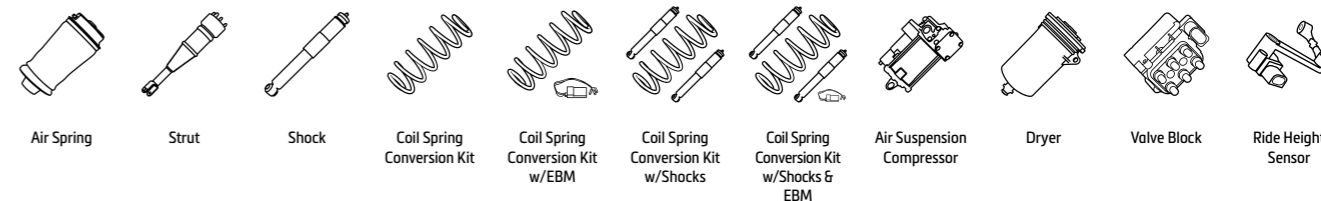

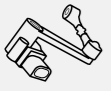

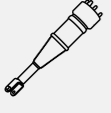

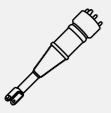

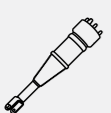

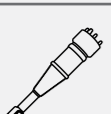



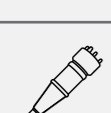

- ▲ Precision-tuned, monotube damper in many applications
- ▲ Premium brand air sleeves, bump stop & dust boot
- ▲ Works with vehicle's auto-leveling functionality
- ▲ Improved seals to prevent leaks
- ▲ Designed, assembled & tested in the USA

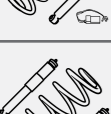

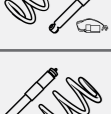

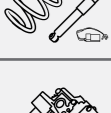

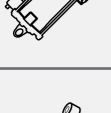



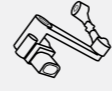

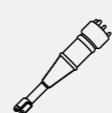





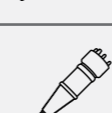

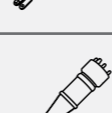

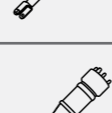
MAYBACH						
Part #	Product Type	Position	Model Information	Vehicle Attributes	Product Attributes	
W240						
AS-2746			2002-2012 57	Base & S Models	5.5 (240.078), 6.0, 6.0 (240.079), S 6.0 (240.079, 240.077)	› Remanufactured
			2002-2012 62			
AS-2747			2002-2012 57	Base & S Models	5.5 (240.078), 6.0, 6.0 (240.079), S 6.0 (240.079, 240.077)	› Remanufactured
			2002-2012 62			
P-2192			2002-2012 57	Base & S Models	5.5 (240.078), 6.0, 6.0 (240.079), S 6.0 (240.079, 240.077)	› WABCO OES
			2002-2012 62			
RH-3500			2002-2012 57	Base & S Models	5.5 (240.078), 6.0, 6.0 (240.079), S 6.0 (240.079, 240.077)	
			2002-2012 62	Base & S Models	5.5 (240.178), 6.0 S (240.177), S 6.0 (240.179)	

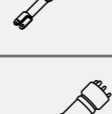
ARNOTT NEW RIDE HEIGHT SENSOR

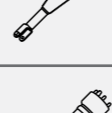

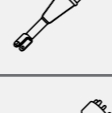

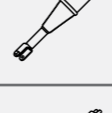



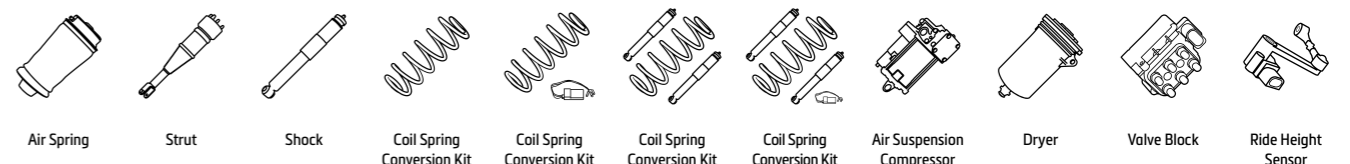

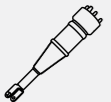

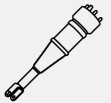

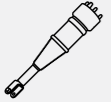

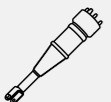

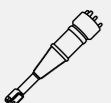

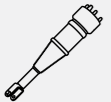

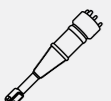
- Front or rear ride height sensor for 98-11 Mercedes-Benz CLS/E/S-Class and 02-12 Maybach
- Lab tested to 1 million cycles
- Road tested for function and fitment
- Direct fit for fast plug & play installation
- Quality components
 - › Hardware and mounting points for long service life
- RH-3500



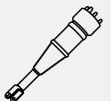

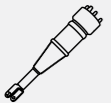









MERCEDES-BENZ						
Part #	Product Type	Position	Model Information	Vehicle Attributes	Product Attributes	
A/C/W208, A/C209						
RH-3501			1997-2002 CLK-Class	200/Kompressor, 230 Kompressor, 320, 430, 55 AMG	› For vehicles w/LED or Bi-Xenon Intelligent Lighting Systems	
			1998-2002 CLK-Class Convertible	200/Kompressor, 230 Kompressor, 320, 430, 55 AMG		
			2002-2009 CLK-Class	200 CGI/Kompressor, 220 CDI, 240, 270 CDI, 280, 320/CDI, 350, 500, 55 AMG, 63 AMG, DTM AMG		
			2002-2010 CLK-Class Convertible	CLK 200 CGI/Kompressor, CLK 240, CLK 280, CLK 320/320 CDI, CLK 350 CLK 500, CLK 55 AMG, CLK 63 AMG, CLK AMG DTM		
C215, W220						
AS-2193			1998-2005 S-Class	w/AIRMATIC & ADS, w/o 4MATIC	S 280, S 320/CDI, S 350, S 400 CDI, S 430, S 500, S 600	› Remanufactured
AS-2194			1998-2001 S-Class	w/AIRMATIC & ADS, w/o 4MATIC	S 280, S 320/CDI, S 350/4-matic, S 400 CDI, S 430, S 430 4-matic, S 500/4-matic, S 600	› Remanufactured
			2002-2005 S-Class	w/AIRMATIC & ADS, w/ & w/o 4MATIC		
AS-2605			1998-2005 S-Class	w/AIRMATIC & ADS, w/o 4MATIC	S 280, S 320/CDI, S 350, S 400 CDI, S 430, S 500, S 600	› New
AS-2783			2002-2005 S-Class	w/AIRMATIC & ADS, w/4MATIC	S 350 4-matic, S 430 4-matic, S 500 4-matic	› New
AS-2784			2002-2005 S-Class	w/AIRMATIC & ADS, w/4MATIC	S 350 4-matic, S 430 4-matic, S 500 4-matic	› New
AS-2884			1998-2001 S-Class	w/AIRMATIC & ADS, w/o 4MATIC	S 280, S 320/CDI, S 350/4-matic, S 400 CDI, S 430, S 430 4-matic, S 500/4-matic, S 600	› New
			2002-2005 S-Class	w/AIRMATIC & ADS, w/ & w/o 4MATIC		
C-2242			1998-2005 S-Class	w/AIRMATIC & ADS, w/o 4MATIC	S 280, S 320/CDI, S 350, S 400 CDI, S 430, S 500, S 600	
C-2271			2002-2005 S-Class	w/AIRMATIC & ADS, w/4MATIC	S 350 4-matic, S 430 4-matic, S 500 4-matic	
C-3269			1998-2005 S-Class	w/AIRMATIC & ADS, w/o 4MATIC	S 280, S 320/CDI, S 350, S 400 CDI, S 430, S 500, S 600	› Eibach Shock Absorbers
P-2192			1998-2001 S-Class	w/AIRMATIC & ADS, w/o 4MATIC	S 280, S 320/CDI, S 350/4-matic, S 400 CDI, S 430, S 430 4-matic, S 500/4-matic, S 600	› WABCO OES
			2002-2005 S-Class	w/AIRMATIC & ADS, w/ & w/o 4MATIC		
RH-3500			1998-2001 S-Class	w/AIRMATIC & ADS, w/o 4MATIC	S 280, S 320/CDI, S 350/4-matic, S 400 CDI, S 430/4-matic, S 500/4-matic, S 55 AMG/AMG Kompressor, S 600, S 63 AMG, S 65 AMG	
			2002-2005 S-Class	w/AIRMATIC & ADS, w/ & w/o 4MATIC		

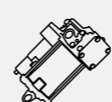

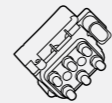
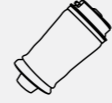





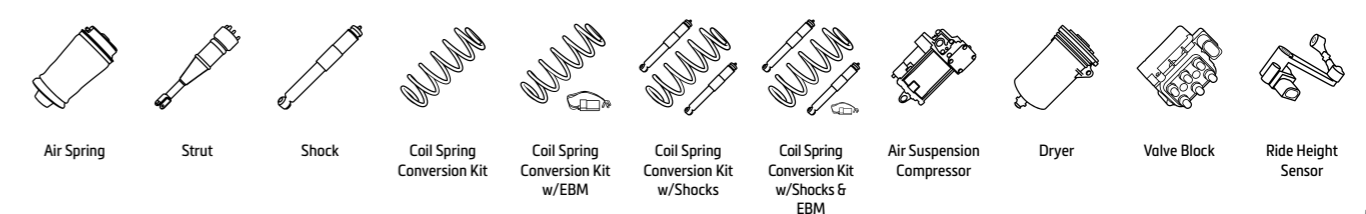

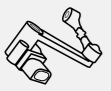

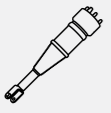

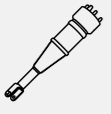

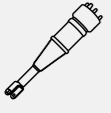

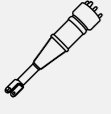

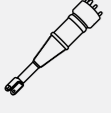
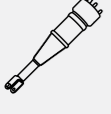
MERCEDES-BENZ						
Part #	Product Type	Position	Model Information	Vehicle Attributes	Product Attributes	
C215, W220						
RH-3501			1998-2005 S-Class	w/AIRMATIC & ADS, w/ & w/o 4MATIC	S 280, S 320/CDI, S 350/4-matic, S 400 CDI, S 430/4-matic, S 500/4-matic, S 55 AMG/AMG Kompressor, S 600, S 63 AMG, S 65 AMG	› For vehicles w/LED or Bi-Xenon Intelligent Lighting Systems
			1999-2006 CL-Class/S-Class Coupe	CL 500, CL 55 AMG/AMG Kompressor, CL 600, CL 63 AMG, CL 65 AMG		
SK-2422			1998-2005 S-Class	From VIN #290214 w/ABC Suspension, Non-AMG	S 400 CDI, S 430/4-matic, S 500/4-matic, S 600	› Remanufactured
			1999-2006 CL-Class/S-Class Coupe	From VIN #032100 w/ABC Suspension, Non-AMG	CL 500, CL 600	
SK-2423			1998-2005 S-Class	From VIN #290214 w/ABC Suspension, Non-AMG	S 400 CDI, S 430/4-matic, S 500/4-matic, S 600	› Remanufactured
			1999-2006 CL-Class/S-Class Coupe	From VIN #032100 w/ABC Suspension, Non-AMG	CL 500, CL 600	
SK-2454			1999-2005 S-Class	To VIN #290213 w/ABC Suspension, Incl. AMG	S 55 AMG/AMG Kompressor	› Remanufactured
			1999-2006 CL-Class/S-Class Coupe	To VIN #032099 w/ABC Suspension, Incl. AMG	CL 500, CL 55 AMG/AMG Kompressor, CL 600, CL 63 AMG, CL 65 AMG	
SK-2455			1999-2005 S-Class	To VIN #290213 w/ABC Suspension, Incl. AMG	S 55 AMG/AMG Kompressor	› Remanufactured
			1999-2006 CL-Class/S-Class Coupe	To VIN #032099 w/ABC Suspension, Incl. AMG	CL 500, CL 55 AMG/AMG Kompressor, CL 600, CL 63 AMG, CL 65 AMG	
SK-2456			1998-2005 S-Class	From VIN #290214 w/ABC Suspension, Incl. AMG	S 400 CDI, S 430, S 500, S 55 AMG/AMG Kompressor, S 600	› Remanufactured
			1999-2006 CL-Class/S-Class Coupe	To VIN #032099 w/ABC Suspension, Incl. AMG	CL 500, CL 55 AMG/AMG Kompressor, CL 600, CL 63 AMG, CL 65 AMG	
SK-2457			1998-2005 S-Class	From VIN #290214 w/ABC Suspension, Incl. AMG	S 400 CDI, S 430, S 500, S 55 AMG/AMG Kompressor, S 600	› Remanufactured
			1999-2006 CL-Class/S-Class Coupe	To VIN #032099 w/ABC Suspension, Incl. AMG	CL 500, CL 55 AMG/AMG Kompressor, CL 600, CL 63 AMG, CL 65 AMG	
SK-2458			1999-2005 S-Class	From VIN #372602 w/ABC Suspension, AMG	S 55 AMG/AMG Kompressor, S 600, S 63 AMG, S 65 AMG	› Remanufactured
			1999-2006 CL-Class/S-Class Coupe	From VIN #032562 w/ABC Suspension, AMG	CL 500, CL 55 AMG/AMG Kompressor, CL 600, CL 63 AMG, CL 65 AMG	
SK-2459			1999-2005 S-Class	From VIN #372602 w/ABC Suspension, AMG	S 55 AMG/AMG Kompressor, S 600, S 63 AMG, S 65 AMG	› Remanufactured
			1999-2006 CL-Class/S-Class Coupe	From VIN #032562 w/ABC Suspension, AMG	CL 500, CL 55 AMG/AMG Kompressor, CL 600, CL 63 AMG, CL 65 AMG	
SK-2460			1999-2005 S-Class	From VIN #372602 w/ABC Suspension, AMG	S 55 AMG/AMG Kompressor, S 600, S 63 AMG, S 65 AMG	› Remanufactured
			1999-2006 CL-Class/S-Class Coupe	From VIN #032562 w/ABC Suspension, AMG	CL 500, CL 55 AMG/AMG Kompressor, CL 600, CL 63 AMG, CL 65 AMG	
SK-2461			1999-2005 S-Class	From VIN #372602 w/ABC Suspension, AMG	S 55 AMG/AMG Kompressor, S 600, S 63 AMG, S 65 AMG	› Remanufactured
			1999-2006 CL-Class/S-Class Coupe	From VIN #032562 w/ABC Suspension, AMG	CL 500, CL 55 AMG/AMG Kompressor, CL 600, CL 63 AMG, CL 65 AMG	

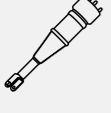

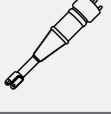

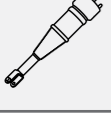

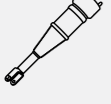



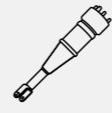

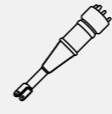

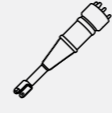

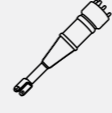

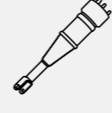
MERCEDES-BENZ					
Part #	Product Type	Position	Model Information	Vehicle Attributes	Product Attributes
C216, W221					
AS-2540			2005-2013 S-Class	w/AIRMATIC & ADS, w/o 4MATIC	S 250 CDI, S 280, S 300, S 320 CDI, S 350/BlueTec/CDI/CGI, S 400 Hybrid, S 420 CDI, S 450/CDI, S 500/CGI, S 600 › Remanufactured
AS-2547			2008-2013 CL-Class/S-Class Coupe 2005-2013 S-Class	w/AIRMATIC & ADS, w/4MATIC	CL 500 4-matic › Remanufactured S 320 CDI 4-matic, S 350 4-matic/BlueTEC 4-matic/CGI 4-matic, S 450 4-matic, S 500 4-matic/CGI 4-matic
AS-2548			2008-2013 CL-Class/S-Class Coupe 2005-2013 S-Class	w/AIRMATIC & ADS, w/4MATIC	CL 500 4-matic › Remanufactured S 320 CDI 4-matic, S 350 4-matic/BlueTEC 4-matic/CGI 4-matic, S 450 4-matic, S 500 4-matic/CGI 4-matic
AS-2603			2008-2013 CL-Class/S-Class Coupe 2005-2013 S-Class	w/AIRMATIC & ADS, w/ & w/o 4MATIC	CL 500 4-matic › Remanufactured S 250 CDI, S 280, S 300, S 320 CDI/CDI 4-matic, S 350/4-matic/BlueTec/BlueTEC 4-matic/CDI/CGI/CGI 4-matic, S 400 Hybrid, S 420 CDI, S 450/4-matic, S 500/4-matic/CGI/CGI 4-matic, S 600
AS-2604			2008-2013 CL-Class/S-Class Coupe 2005-2013 S-Class	w/AIRMATIC & ADS, w/ & w/o 4MATIC	CL 500 4-matic › Remanufactured S 250 CDI, S 280, S 300, S 320 CDI/CDI 4-matic, S 350/4-matic/BlueTec/BlueTEC 4-matic/CDI/CGI/CGI 4-matic, S 400 Hybrid, S 420 CDI, S 450/4-matic, S 500/4-matic/CGI/CGI 4-matic, S 600
AS-2820			2005-2013 S-Class	w/AIRMATIC & ADS, w/o 4MATIC	S 250 CDI, S 280, S 300, S 320 CDI, S 350/BlueTec/CDI/CGI, S 400 Hybrid, S 420 CDI, S 450/CDI, S 500/CGI, S 600 › New
AS-2821			2008-2013 CL-Class/S-Class Coupe 2005-2013 S-Class	w/AIRMATIC & ADS, w/ & w/o 4MATIC	CL 500 4-matic › New S 250 CDI, S 280, S 300, S 320 CDI/CDI 4-matic, S 350/4-matic/BlueTec/BlueTEC 4-matic/CDI/CGI/CGI 4-matic, S 400 Hybrid, S 420 CDI, S 450/4-matic, S 500/4-matic/CGI/CGI 4-matic, S 600
AS-2822			2008-2013 CL-Class/S-Class Coupe 2005-2013 S-Class	w/AIRMATIC & ADS, w/ & w/o 4MATIC	CL 500 4-matic › New S 250 CDI, S 280, S 300, S 320 CDI/CDI 4-matic, S 350/4-matic/BlueTec/BlueTEC 4-matic/CDI/CGI/CGI 4-matic, S 400 Hybrid, S 420 CDI, S 450/4-matic, S 500/4-matic/CGI/CGI 4-matic, S 600
AS-2852			2008-2013 CL-Class/S-Class Coupe 2005-2013 S-Class	w/AIRMATIC & ADS, w/4MATIC	CL 500 4-matic › New S 320 CDI 4-matic, S 350 4-matic/BlueTEC 4-matic/CGI 4-matic, S 450 4-matic, S 500 4-matic/CGI 4-matic
AS-2853			2008-2013 CL-Class/S-Class Coupe 2005-2013 S-Class	w/AIRMATIC & ADS, w/4MATIC	CL 500 4-matic › New S 320 CDI 4-matic, S 350 4-matic/BlueTEC 4-matic/CGI 4-matic, S 450 4-matic, S 500 4-matic/CGI 4-matic
C-2609			2005-2013 S-Class	w/AIRMATIC & ADS, w/o 4MATIC	S 250 CDI, S 280, S 300, S 320 CDI, S 350/BlueTec/CDI/CGI, S 400 Hybrid, S 420 CDI, S 450, S 500/CGI, S 600









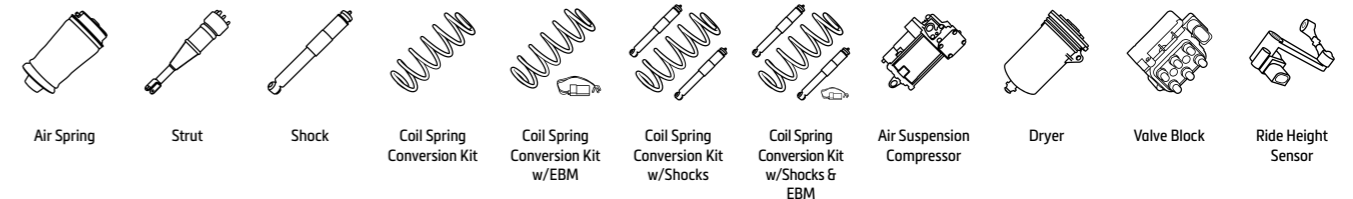





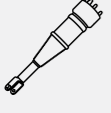

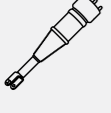
MERCEDES-BENZ					
Part #	Product Type	Position	Model Information	Vehicle Attributes	Product Attributes
C216, W221					
C-2956			2005-2013 S-Class 2008-2013 CL-Class/S-Class Coupe	w/AIRMATIC & ADS, w/4MATIC	S 320 CDI 4-matic, S 350 4-matic/BlueTEC 4-matic/CGI 4-matic, S 450 4-matic, S 500 4-matic/CGI 4-matic CL 500 4-matic
C-3271			2005-2013 S-Class	w/AIRMATIC & ADS, w/o 4MATIC	S 250 CDI, S 280, S 300, S 320 CDI, S 350/BlueTec/CDI/CGI, S 400 Hybrid, S 420 CDI, S 450/CDI, S 500/CGI, S 600, S 63 AMG, S 65 AMG › Eibach Shock Absorbers
C-3272			2005-2013 S-Class	w/AIRMATIC & ADS, w/4MATIC	S 320 CDI 4-matic, S 350 4-matic/BlueTEC 4-matic/CGI 4-matic, S 450 4-matic, S 500 4-matic/CGI 4-matic › Eibach Shock Absorbers
P-3246			2008-2013 CL-Class/S-Class Coupe 2005-2013 S-Class	w/AIRMATIC & ADS, w/ & w/o 4MATIC	CL 500 4-matic › Remanufactured S 250 CDI, S 280, S 300, S 320 CDI/CDI 4-matic, S 350/4-matic/BlueTec/BlueTEC 4-matic/CDI/CGI/CGI 4-matic, S 400 Hybrid, S 420 CDI, S 450/4-matic, S 500/4-matic/CGI/CGI 4-matic, S 600
RH-3501			2005-2013 S-Class 2006-2013 CL-Class/S-Class Coupe	w/AIRMATIC & ADS, w/ & w/o 4MATIC	S 250 CDI, S 280, S 300, S 320 CDI/CDI 4-matic, S 350/4-matic/BlueTec/BlueTEC 4-matic/CDI/CDI 4-matic/CGI/CGI 4-matic, S 400 Hybrid, S 420 CDI, S 450/4-matic/CDI, S 500/4-matic/CGI/CGI 4-matic, S 600, S 63 AMG, S 65 AMG › For vehicles w/LED or Bi-Xenon Intelligent Lighting Systems
VB-3267			2006-2013 CL-Class/S-Class Coupe 2005-2013 S-Class	w/AIRMATIC, w/ & w/o ADS, Incl. AMG	CL 500/4-matic, CL 600, CL 63 AMG, CL 65 AMG › New S 250 CDI, S 280, S 300, S 320 CDI/CDI 4-matic, S 350/4-matic/BlueTec/BlueTEC 4-matic/CDI/CDI 4-matic/CGI/CGI 4-matic, S 400 Hybrid, S 420 CDI, S 450/4-matic/CDI, S 500/4-matic/CGI/CGI 4-matic, S 600, S 63 AMG, S 65 AMG
C257					
A-3313			2017--> CLS-Class	w/AIRMATIC, w/ & w/o 4MATIC, Incl. Hybrid, Incl. AMG	AMG CLS 53 EQ Boost 4-matic+, CLS 220 d, CLS 300 d, CLS 350 d/d 4-matic/EQ Boost/EQ Boost 4-matic, CLS 400 d 4-matic, CLS 450 EQ Boost 4-matic
A-3314			2017--> CLS-Class	w/AIRMATIC, w/ & w/o 4MATIC, Incl. Hybrid, Incl. AMG	AMG CLS 53 EQ Boost 4-matic+, CLS 220 d, CLS 300 d, CLS 350 d/d 4-matic/EQ Boost/EQ Boost 4-matic, CLS 400 d 4-matic, CLS 450 EQ Boost 4-matic

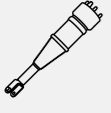

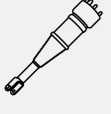

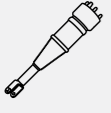

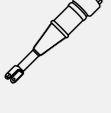



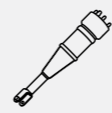

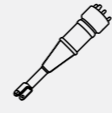

MERCEDES-BENZ						
Part #	Product Type	Position	Model Information	Vehicle Attributes	Product Attributes	
CL/CLC/S/W/203						
RH-3501			2000-2007 C-Class	3.5, C 180/Kompressor, C 200 CDI/CGI Kompressor/Kompressor, C 220 CDI, C 230/Kompressor, C 240/4-matic, C 270 CDI, C 280/4-matic, C 30 CDI AMG, C 32 AMG Kompressor, C 320/4-matic/CDI, C 350/4-matic, C 55 AMG	› For vehicles w/LED or Bi-Xenon Intelligent Lighting Systems	
			2001-2007 C-Class T-Model	C 180/Kompressor, C 200 CDI/CGI Kompressor/Kompressor, C 220 CDI, C 230/Kompressor, C 240/4-matic, C 270 CDI, C 280/4-matic, C 30 CDI AMG, C 32 AMG Kompressor, C 320/4-matic/CDI, C 350/4-matic, C 55 AMG		
			2001-2008 C-Class Coupe	C 160 Kompresso, C 180/Kompressor, C 200 CDI/CGI Kompressor/Kompressor, C 220/CDI, C 230/Kompressor, C 30 CDI AMG, C 32 AMG Kompressor, C 320, C 350		
			2008-2011 CLC-Class	CLC 160, CLC 180 Kompressor, CLC 200 CDI/Kompressor, CLC 220 CDI, CLC 230, CLC 250, CLC 350		
R230						
SK-2412			2001-2006 SL-Class	w/ABC Suspension, Non-AMG	350, 500, 600	› Remanufactured
SK-2413			2001-2006 SL-Class	w/ABC Suspension, Non-AMG	350, 500, 600	› Remanufactured
SK-2414			2001-2006 SL-Class	w/ABC Suspension, Non-AMG	350, 500, 600	› Remanufactured
SK-2415			2001-2006 SL-Class	w/ABC Suspension, Non-AMG	350, 500, 600	› Remanufactured
SK-2417			2001-2006 SL-Class	w/ABC Suspension, SL55/66, AMG	55 AMG Kompressor, 65 AMG	› Remanufactured
SK-2418			2001-2006 SL-Class	w/ABC Suspension, SL55/66, AMG	55 AMG Kompressor, 65 AMG	› Remanufactured
SK-2419			2001-2006 SL-Class	w/ABC Suspension, SL55/66, AMG	55 AMG Kompressor, 65 AMG	› Remanufactured
SK-2420			2001-2006 SL-Class	w/ABC Suspension, SL55/66, AMG	55 AMG Kompressor, 65 AMG	› Remanufactured
SK-2470			2007-2012 SL-Class	w/ABC Suspension, Non-AMG	280, 300, 350, 500, 600	› Remanufactured
SK-2471			2007-2012 SL-Class	w/ABC Suspension, Non-AMG	280, 300, 350, 500, 600	› Remanufactured

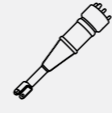
MERCEDES-BENZ						
Part #	Product Type	Position	Model Information	Vehicle Attributes	Product Attributes	
R230						
SK-2472			2007-2012 SL-Class	w/ABC Suspension, Non-AMG	280, 300, 350, 500, 600	› Remanufactured
SK-2473			2007-2012 SL-Class	w/ABC Suspension, Non-AMG	280, 300, 350, 500, 600	› Remanufactured
SK-2482			2007-2012 SL-Class	w/ABC Suspension, SL55/66, AMG	55 AMG/AMG Kompressor, 63 AMG, 65 AMG/AMG Black Series	› Remanufactured
SK-2483			2007-2012 SL-Class	w/ABC Suspension, SL55/66, AMG	55 AMG/AMG Kompressor, 63 AMG, 65 AMG/AMG Black Series	› Remanufactured
SK-2484			2007-2012 SL-Class	w/ABC Suspension, SL55/66, AMG	55 AMG/AMG Kompressor, 63 AMG, 65 AMG/AMG Black Series	› Remanufactured
SK-2485			2007-2012 SL-Class	w/ABC Suspension, SL55/66, AMG	55 AMG/AMG Kompressor, 63 AMG, 65 AMG/AMG Black Series	› Remanufactured
S/W210						
RH-3501			1995-2002 E-Class	E 200/CDI/D/Kompressor, E 220 CDI/D, E 230, E 240, E 250 D/Turbo-D, E 270 CDI, E 280/4-matic, E 290 Turbo-D, E 300 D/Turbo-D, E 320/4-matic/CDI, E 36 AMG, E 420, E 430/4-matic, E 50 AMG, E 55 AMG	› For vehicles w/LED or Bi-Xenon Intelligent Lighting Systems	
			1996-2003 E-Class T-Model	E 200 T/Kompressor, E 220 T CDI, E 230 T, E 240 T, E 250 T D/T Turbo-D, E 270 T CDI, E 280 T/T 4-matic, E 290 T Turbo-D, E 300 T Turbo-D, E 320 T/T 4-mati/CDI, E 420 T, E 430 T/T 4-matic, E 55 T AMG		
S/W211, C/W219						
A-2724			2002-2008 E-Class	w/AIRMATIC & ADS, w/ & w/o 4MATIC, Non-AMG	E 200 CDI/Kompressor/NGT, E 220 CDI, E 230, E 240/4-matic, E 270, E 280/4-matic/CDI/CDI 4-matic, E 300 BlueTEC, E 320/4-matic/CDI/CDI 4-matic, E 350/4-matic/CGI, E 400 CDI, E 420 CDI, E 500/4-matic	› Must Be Replaced in Pairs
			2003-2009 E-Class T-Model	350 CGI, E 200 CDI/Kompressor/T Kompressor, E 220 CDI/T CDI, E 230 T, E 240 T/T 4-matic, E 270 T CDI, E 280 T/T 4-matic/T CDI/T CDI 4-matic, E 320 T/T 4-matic/T CDI/T CDI 4-matic, E 350 T/T 4-matic, E 500 T/T 4-matic		
			2004-2010 CLS-Class	w/AIRMATIC & ADS, Non-AMG	CLS 280, CLS 300, CLS 320 CDI, CLS 350/CDI, CLS 500	

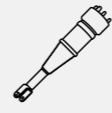

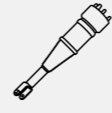
MERCEDES-BENZ						
Part #	Product Type	Position	Model Information	Vehicle Attributes	Product Attributes	
S/W211, C/W219						
A-2725			2002-2008 E-Class 2003-2009 E-Class T-Model 2005-2010 CLS-Class	w/AIRMATIC & ADS, AMG E 55 AMG Kompressor, E 63 AMG E 55 T AMG Kompressor, E 63 AMG CLS 55 AMG, CLS 63 AMG	> Must Be Replaced in Pairs	
A-2726			2003-2009 E-Class T-Model	Wagon Only, w/AIRMATIC, w/o ADS, incl. AMG 350 CGI, E 200 CDI/Kompressor/T Kompressor, E 220 CDI/T CDI, E 230 T, E 240 T/T 4-matic, E 270 T CDI, E 280 T/T 4-matic/T CDIT CDI 4-matic, E 320 T/T 4-matic/T CDI/T CDI 4-matic, E 350 T/T 4-matic, E 500 T/T 4-matic	> Must Be Replaced in Pairs	
AS-2245			2002-2008 E-Class 2003-2009 E-Class T-Model 2004-2010 CLS-Class	w/AIRMATIC & ADS, w/o 4MATIC, Non-AMG E 200 CDI/Kompressor/NGT, E 220 CDI, E 230, E 240, E 270 CDI, E 280/CDI, E 300 BlueTEC, E 320/CDI, E 350/CGI, E 400 CDI, E 420 CDI, E 500 350 CGI, E 200 CDI/Kompressor/T Kompressor, E 220 CDI/T CDI, E 230 T, E 240 T, E 270 T CDI, E 280 T/T CDI, E 320 T/T CDI, E 350 T, E 500 T w/AIRMATIC & ADS, Non-AMG CLS 280, CLS 300, CLS 320 CDI, CLS 350/CDI, CLS 500	> Remanufactured	
AS-2246			2002-2008 E-Class 2003-2009 E-Class T-Model 2004-2010 CLS-Class	w/AIRMATIC & ADS, w/o 4MATIC, Non-AMG E 200 CDI/Kompressor/NGT, E 220 CDI, E 230, E 240, E 270 CDI, E 280/CDI, E 300 BlueTEC, E 320/CDI, E 350/CGI, E 400 CDI, E 420 CDI, E 500 350 CGI, E 200 CDI/Kompressor/T Kompressor, E 220 CDI/T CDI, E 230 T, E 240 T, E 270 T CDI, E 280 T/T CDI, E 320 T/T CDI, E 350 T, E 500 T w/AIRMATIC & ADS, Non-AMG CLS 280, CLS 300, CLS 320 CDI, CLS 350/CDI, CLS 500	> Remanufactured	
AS-2294			2003-2008 E-Class 2003-2009 E-Class T-Model	w/AIRMATIC & ADS, w/4MATIC, Non-AMG E 240 4-matic, E 280 4-matic/CDI 4-matic, E 320 4-matic/CDI 4-matic, E 350 4-matic, E 500 4-matic E 240 T 4-matic, E 280 T 4-matic/T CDI 4-matic, E 320 T 4-matic/T CDI 4-matic, E 350 T 4-matic, E 500 T 4-matic	> Remanufactured	
AS-2295			2003-2008 E-Class 2003-2009 E-Class T-Model	w/AIRMATIC & ADS, w/4MATIC, Non-AMG E 240 4-matic, E 280 4-matic/CDI 4-matic, E 320 4-matic/CDI 4-matic, E 350 4-matic, E 500 4-matic E 240 T 4-matic, E 280 T 4-matic/T CDI 4-matic, E 320 T 4-matic/T CDI 4-matic, E 350 T 4-matic, E 500 T 4-matic	> Remanufactured	
AS-2300			2002-2008 E-Class 2003-2009 E-Class T-Model 2005-2010 CLS-Class	w/AIRMATIC & ADS, AMG E 55 AMG Kompressor, E 63 AMG E 55 T AMG Kompressor, E 63 AMG CLS 55 AMG, CLS 63 AMG	> Remanufactured	
AS-2301			2002-2008 E-Class 2003-2009 E-Class T-Model 2005-2010 CLS-Class	w/AIRMATIC & ADS, AMG E 55 AMG Kompressor, E 63 AMG E 55 T AMG Kompressor, E 63 AMG CLS 55 AMG, CLS 63 AMG	> Remanufactured	

MERCEDES-BENZ						
Part #	Product Type	Position	Model Information	Vehicle Attributes	Product Attributes	
S/W211, C/W219						
AS-2785			2002-2008 E-Class 2003-2009 E-Class T-Model 2004-2010 CLS-Class	w/AIRMATIC & ADS, w/o 4MATIC, Non-AMG E 200 CDI/Kompressor/NGT, E 220 CDI, E 230, E 240, E 270 CDI, E 280/CDI, E 300 BlueTEC, E 320 CDI, E 350/CGI, E 400 CDI, E 420 CDI, E 500 350 CGI, E 200 CDI/Kompressor/T Kompressor, E 220 CDI/T CDI, E 230 T, E 240 T, E 270 T CDI, E 280 T/T CDI, E 320 T/T CDI, E 350 T, E 500 T w/AIRMATIC & ADS, Non-AMG CLS 280, CLS 300, CLS 320 CDI, CLS 350/CDI, CLS 500	> New	
AS-2786			2002-2008 E-Class 2003-2009 E-Class T-Model 2004-2010 CLS-Class	w/AIRMATIC & ADS, w/o 4MATIC, Non-AMG E 200 CDI/Kompressor/NGT, E 220 CDI, E 230, E 240, E 270 CDI, E 280/CDI, E 300 BlueTEC, E 320 CDI, E 350/CGI, E 400 CDI, E 420 CDI, E 500 350 CGI, E 200 CDI/Kompressor/T Kompressor, E 220 CDI/T CDI, E 230 T, E 240 T, E 270 T CDI, E 280 T/T CDI, E 320 T/T CDI, E 350 T, E 500 T w/AIRMATIC & ADS, Non-AMG CLS 280, CLS 300, CLS 320 CDI, CLS 350/CDI, CLS 500	> New	
AS-2787			2002-2008 E-Class 2003-2009 E-Class T-Model 2005-2010 CLS-Class	w/AIRMATIC & ADS, AMG E 55 AMG Kompressor, E 63 AMG E 55 T AMG Kompressor, E 63 AMG CLS 55 AMG, CLS 63 AMG	> New	
AS-2788			2002-2008 E-Class 2003-2009 E-Class T-Model 2005-2010 CLS-Class	w/AIRMATIC & ADS, AMG E 55 AMG Kompressor, E 63 AMG E 55 T AMG Kompressor, E 63 AMG CLS 55 AMG, CLS 63 AMG	> New	
AS-3000			2003-2008 E-Class 2003-2009 E-Class T-Model	w/AIRMATIC & ADS, w/4MATIC, Non-AMG E 240 4-matic, E 280 4-matic/CDI 4-matic, E 320 4-matic/CDI 4-matic, E 350 4-matic, E 500 4-matic E 240 T 4-matic, E 280 T 4-matic/T CDI 4-matic, E 320 T 4-matic/T CDI 4-matic, E 350 T 4-matic, E 500 T 4-matic	> New	
AS-3001			2003-2008 E-Class 2003-2009 E-Class T-Model	w/AIRMATIC & ADS, w/4MATIC, Non-AMG E 240 4-matic, E 280 4-matic/CDI 4-matic, E 320 4-matic/CDI 4-matic, E 350 4-matic, E 500 4-matic E 240 T 4-matic, E 280 T 4-matic/T CDI 4-matic, E 320 T 4-matic/T CDI 4-matic, E 350 T 4-matic, E 500 T 4-matic	> New	



Road Tested

From Audi to Porsche, Range Rover to BMW and Mercedes, Arnott has more than 40 test vehicles to ensure that the products they engineer provide the luxury ride and durability that owners expect.

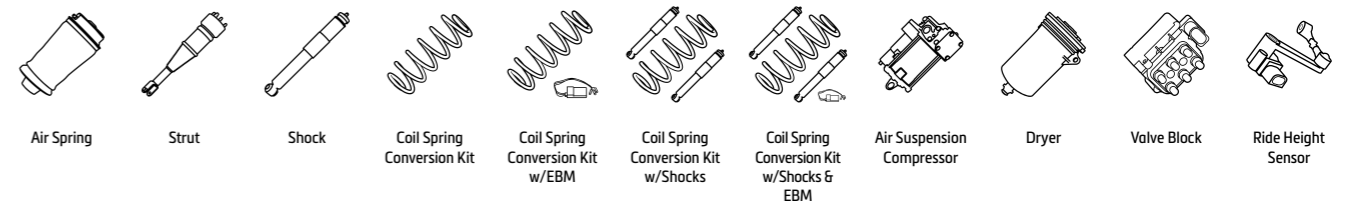

MERCEDES-BENZ						
Part #	Product Type	Position	Model Information	Vehicle Attributes	Product Attributes	
S/W211, C/W219						
C-2278			2002-2008 E-Class	Sedan Only, w/AIRMATIC & ADS, AMG E 200 CDI/Kompressor/NGT, E 220 CDI, E 230, E 240, E 270 CDI, E 280/CDI, E 300 BlueTEC, E 320/CDI, E 350/CGI, E 400 CDI, E 420 CDI, E 500		
			2003-2009 E-Class T-Model	Sedan Only, w/AIRMATIC & ADS, w/o 4MATIC, AMG 350 CGI, E 200 CDI/Kompressor/T Kompressor, E 220 CDI/220 T CDI, E 230 T, E 240 T, E 270 T CDI, E 280 T/T CDI, E 320 T/T CDI, E 350 T, E 500 T		
			2004-2010 CLS-Class	w/AIRMATIC & ADS, Incl. AMG CLS 280, CLS 300, CLS 320 CDI, CLS 350/CDI, CLS 500, CLS 55 AMG, CLS 63 AMG		
C-2663			2002-2009 E-Class	E 200 CDI/Kompressor/NGT, E 220 CDI, E 230, E 240/4-matic, E 270 CDI, E 280/4-matic/CDI/CDI 4-matic, E 300 BlueTEC, E 320/4-matic/CDI/CDI 4-matic, E 350/4-matic/CGI, E 400 CDI, E 420 CDI, E 500/4-matic		
			2003-2009 E-Class T-Model	Wagon Only, w/AIRMATIC & ADS, w/4MATIC 350 CGI, E 200 CDI/Kompressor/T Kompressor, E 220 CDI/T CDI, E 230 T, E 240 T/T 4-matic, E 270 T CDI, E 280 T/T 4-matic/T CDI/T CDI 4-matic, E 320 T/T 4-matic/T CDI/T CDI 4-matic, E 350 T/T 4-matic, E 500 T/T 4-matic		
C-3080			2003-2009 E-Class T-Model	Wagon Only, w/AIRMATIC, w/o ADS, Incl. AMG 350 CGI, E 200 CDI/Kompressor/T Kompressor, E 220 CDI/T CDI, E 230 T, E 240 T/T 4-matic, E 270 T CDI, E 280 T/T 4-matic/T CDI/T CDI 4-matic, E 320 T/T 4-matic/T CDI/T CDI 4-matic, E 350 T/T 4-matic, E 500 T/T 4-matic		
P-2192			2002-2008 E-Class	w/AIRMATIC & ADS, AMG E 200 CDI/Kompressor/NGT, E 220 CDI, E 230, E 240/4-matic, E 270 CDI, E 280/4-matic/CDI/CDI 4-matic, E 300 BlueTEC, E 320/4-matic/CDI/CDI 4-matic, E 350/4-matic/CGI, E 400 CDI, E 420 CDI, E 500/4-matic, E 55 AMG Kompressor, E 63 AMG		
				Wagon Only, w/AIRMATIC & ADS, w/o 4MATIC, Incl. AMG		
			2003-2009 E-Class T-Model	w/AIRMATIC & ADS, AMG 350 CGI, E 200 CDI/Kompressor/T Kompressor, E 220 CDI/T CDI, E 230 T, E 240 T/T 4-matic, E 270 T CDI, E 280 T/T 4-matic/T CDI/T CDI 4-matic, E 320 T/T 4-matic/T CDI/T CDI 4-matic, E 350 T/T 4-matic, E 500 T/T 4-matic, E 55 T AMG Kompressor, E 63 AMG		> WABCO OES
				Wagon Only, w/AIRMATIC, w/o ADS, Incl. AMG		
2004-2010 CLS-Class	w/AIRMATIC & ADS, Incl. AMG CLS 280, CLS 300, CLS 320 CDI, CLS 350/CDI, CLS 500, CLS 55 AMG, CLS 63 AMG					
RH-3500			2002-2008 E-Class	w/AIRMATIC & ADS, AMG E 200 CDI/Kompressor/NGT, E 220 CDI, E 230, E 240/4-matic, E 270 CDI, E 280/4-matic/CDI/CDI 4-matic, E 300 BlueTEC, E 320/4-matic/CDI/CDI 4-matic, E 350/4-matic/CGI, E 400 CDI, E 420 CDI, E 500/4-matic, E 55 AMG Kompressor, E 63 AMG		
			2003-2009 E-Class T-Model	w/AIRMATIC & ADS, w/ & w/o 4MATIC, Non-AMG		
				w/AIRMATIC & ADS, AMG		
2004-2010 CLS-Class	w/AIRMATIC & ADS, Incl. AMG CLS 280, CLS 300, CLS 320 CDI, CLS 350/CDI, CLS 500, CLS 55 AMG, CLS 63 AMG					



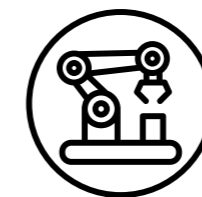





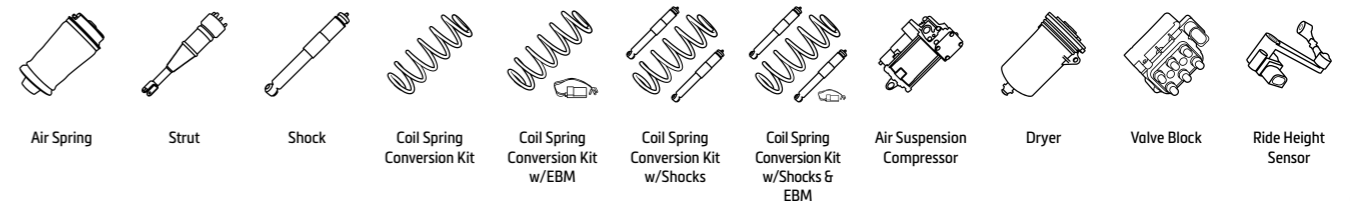



MERCEDES-BENZ							
Part #	Product Type	Position	Model Information	Vehicle Attributes	Product Attributes		
S/W211, C/W219							
RH-3501			2002-2008 E-Class	w/AIRMATIC & ADS, AMG E 200 CDI/Kompressor/NGT, E 220 CDI, E 230, E 240/4-matic, E 270 CDI, E 280/4-matic/CDI/CDI 4-matic, E 300 BlueTEC, E 320/4-matic/CDI/CDI 4-matic, E 350/4-matic/CGI, E 400 CDI, E 420 CDI, E 500/4-matic, E 55 AMG Kompressor, E 63 AMG		> For vehicles w/LED or Bi-Xenon Intelligent Lighting Systems	
				w/AIRMATIC & ADS, w/ & w/o 4MATIC, Non-AMG			
			2003-2009 E-Class T-Model	w/AIRMATIC & ADS, AMG 350 CGI, E 200 CDI/Kompressor/T Kompressor, E 220 CDI/T CDI, E 230 T, E 240 T/T 4-matic, E 270 T CDI, E 280 T/T 4-matic/T CDI/T CDI 4-matic, E 320 T/T 4-matic/T CDI/T CDI 4-matic, E 350 T/T 4-matic, E 500 T/T 4-matic, E 55 T AMG Kompressor, E 63 AMG			
				w/AIRMATIC & ADS, w/ & w/o 4MATIC, Non-AMG			
2004-2010 CLS-Class	w/AIRMATIC & ADS, Incl. AMG CLS 280, CLS 300, CLS 320 CDI, CLS 350/CDI, CLS 500, CLS 55 AMG, CLS 63 AMG						
	SK-3012			2002-2008 E-Class	Sedan Only, w/AIRMATIC & ADS, AMG E 200 CDI/Kompressor/NGT, E 220 CDI, E 230, E 240, E 270 CDI, E 280/CDI, E 300 BlueTEC, E 320/CDI, E 350/CGI, E 400 CDI, E 420 CDI, E 500, E 55 AMG Kompressor, E 63 AMG	> New	
2004-2010 CLS-Class				w/AIRMATIC & ADS, Incl. AMG CLS 280, CLS 300, CLS 320 CDI, CLS 350/CDI, CLS 500, CLS 55 AMG, CLS 63 AMG			
SK-3039			2002-2009 E-Class	w/o AIRMATIC, w/o ADS, w/ & w/o 4MATIC, Non-AMG E 200 CDI/Kompressor/NGT, E 230, E 240/4-matic, E 270 CDI, E 280/4-matic/CDI/CDI 4-matic, E 300 BlueTEC, E 320/4-matic/CDI/CDI 4-matic, E 350/4-matic/CGI, E 400 CDI, E 420 CDI, E 500/500 4-matic		> New	
			2004-2011 CLS-Class	w/o AIRMATIC, w/o ADS, Non-AMG CLS 280, CLS 300, CLS 320 CDI, CLS 350/CDI, CLS 500			
SK-3197			2002-2008 E-Class	Sedan Only, w/AIRMATIC & ADS, AMG E 200 CDI/Kompressor/NGT, E 220 CDI/CDI, E 230, E 240, E 270 CDI, E 280/CDI, E 300 BlueTEC, E 320/CDI, E 350/CGI, E 400 CDI, E 420 CDI, E 500, E 55 AMG Kompressor, E 63 AMG		> Remanufactured	
			2004-2010 CLS-Class	w/AIRMATIC & ADS, Incl. AMG CLS 280, CLS 300, CLS 320 CDI, CLS 350/CDI, CLS 500, CLS 55 AMG, CLS 63 AMG			
SK-3199			2002-2008 E-Class	w/AIRMATIC & ADS, AMG E 55 AMG Kompressor, E 63 AMG		> Remanufactured	
			2005-2010 CLS-Class	CLS 55 AMG, CLS 63 AMG			

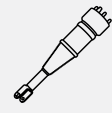

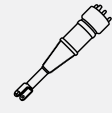

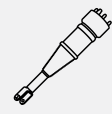

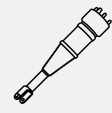



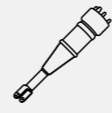

Precision Production

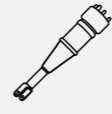
Our precise production processes ensure the highest quality products are built every time, and that our discerning customers only receive the best parts for their vehicles. With facilities in North America and Europe, Arnott has over 30,000 square meters of manufacturing floor space which includes multiple Mazak 5-Axis CNC machines, advanced recharging stations, automated painting and state of the art warehousing.

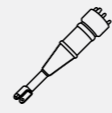

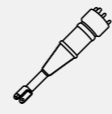
MERCEDES-BENZ						
Part #	Product Type	Position	Model Information	Vehicle Attributes	Product Attributes	
S/W211, C/W219						
SK-3311			2002-2008 E-Class	E 200 CDI/Kompressor/NGT, E 220 CDI, E 230, E 240/4-matic, E 270 CDI, E 280/4-matic/CDI/CDI 4-matic, E 300 BlueTEC, E 320/4-matic/CDI/CDI 4-matic, E 350/4-matic/CGI, E 400 CDI, E 420 CDI, E 500/4-matic, E 55 AMG Kompressor, E 63 AMG	w/o ADS	New
			2003-2009 E-Class T-Model	350 CGI, E 200 CDI/Kompressor/T Kompressor, E 220 CDI/T CDI, E 230 T, E 240 T/T 4-matic, E 270 T CDI, E 280 T/T 4-matic/T CDI/T CDI 4-matic, E 320 T/T 4-matic/T CDI/T CDI 4-matic, E 350 T/T 4-matic, E 500 T/T 4-matic, E 55 T AMG Kompressor, E 63 AMG		
			2004-2010 CLS-Class	CLS 280, CLS 300, CLS 320 CDI, CLS 350/CDI, CLS 500, CLS 55 AMG, CLS 63 AMG		
S/W212, C/W/X218						
A-2790			2009-2016 E-Class	w/AIRMATIC & ADS, w/ & w/o 4MATIC	E 200, E 200 CDI/BlueTEC/CGI/NGT, E 220 BlueTEC/BlueTEC 4-matic/CDI, E 250, E 250 CDI/BlueTEC/BlueTEC 4-matic/CGI, E 300, E 300 4-matic/CDI/BlueTEC/Hybrid/BlueTEC Hybrid, E 350, E 350 4-matic/BlueTEC/BlueTEC 4-matic/CDI/CDI 4-matic/CGI, E 400, E 400 4-matic, E 500, E 500 4-matic, E 63 AMG, E 63 AMG 4-matic	New
				w/AIRMATIC, w/o ADS, w/4MATIC, Non-AMG		
			2009-2016 E-Class T-Model	w/AIRMATIC, w/ & w/o ADS, w/ & w/o 4MATIC, Non-AMG	E 220 BlueTEC/BlueTEC 4-matic/CDI, E 250, E 250 CDI/BlueTEC/BlueTEC 4-matic/CGI, E 300, E 300 4-matic/CDI/BlueTEC/Hybrid/BlueTEC Hybrid, E 350, E 350 4-matic/BlueTEC/BlueTEC 4-matic/CDI/CDI 4-matic/CGI, E 400, E 400 4-matic, E 500, E 500 4-matic, E 63 AMG, E 63 AMG 4-matic	
				w/AIRMATIC, w/ & w/o ADS, w/ & w/o 4MATIC, Incl. AMG	CLS 220 BlueTEC/d, CLS 250 CDI/BlueTEC/d, CLS 350/BlueTEC/d/BlueTEC 4-matic/d 4-matic/CDI/d/CDI 4-matic/d 4-matic, CLS 400/4-matic, CLS 500/4-matic, CLS 63 AMG/AMG 4-matic	
S/W212, C/W/X218						
AS-3237			2009-2016 E-Class	w/AIRMATIC & ADS, w/4MATIC	E 220 BlueTEC 4-matic, E 250 CDI/BlueTEC 4-matic, E 300 4-matic, E 350 BlueTEC 4-matic/CDI 4-matic, E 500 4-matic, E 63 AMG 4-matic	Remanufactured
			2011-2017 CLS-Class	w/AIRMATIC & ADS, w/4MATIC, Incl. AMG	CLS 250 BlueTEC/d 4-matic, CLS 350 BlueTEC 4-matic/CDI 4-matic/d 4-matic, CLS 400 4-matic, CLS 500 4-matic, CLS 63 AMG 4-matic	
AS-3238			2009-2016 E-Class	w/AIRMATIC & ADS, w/4MATIC	E 220 BlueTEC 4-matic, E 250 CDI/BlueTEC 4-matic, E 300 4-matic, E 350 BlueTEC 4-matic/CDI 4-matic, E 500 4-matic, E 63 AMG 4-matic	Remanufactured
			2011-2017 CLS-Class	w/AIRMATIC & ADS, w/4MATIC, Incl. AMG	CLS 250 BlueTEC/d 4-matic, CLS 350 BlueTEC 4-matic/CDI 4-matic/d 4-matic, CLS 400 4-matic, CLS 500 4-matic, CLS 63 AMG 4-matic	
AS-3239			2009-2016 E-Class	w/AIRMATIC & ADS, w/o 4MATIC, Non-AMG	E 180, E 200/CDI/BlueTEC/CGI/NGT, E 220 BlueTEC/CDI/BlueTEC, E 250/CDI/BlueTEC/CGI, E 300/CDI/BlueTEC/Hybrid/BlueTEC Hybrid, E 350/BlueTEC/CDI/CGI, E 400, E 500	Remanufactured
AS-3240			2009-2016 E-Class	w/AIRMATIC & ADS, w/o 4MATIC, Non-AMG	E 180, E 200/CDI/BlueTEC/CGI/NGT, E 220 BlueTEC/CDI/BlueTEC, E 250/CDI/BlueTEC/CGI, E 300/CDI/BlueTEC/Hybrid/BlueTEC Hybrid, E 350/BlueTEC/CDI/CGI, E 400, E 500	Remanufactured



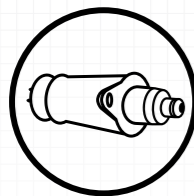





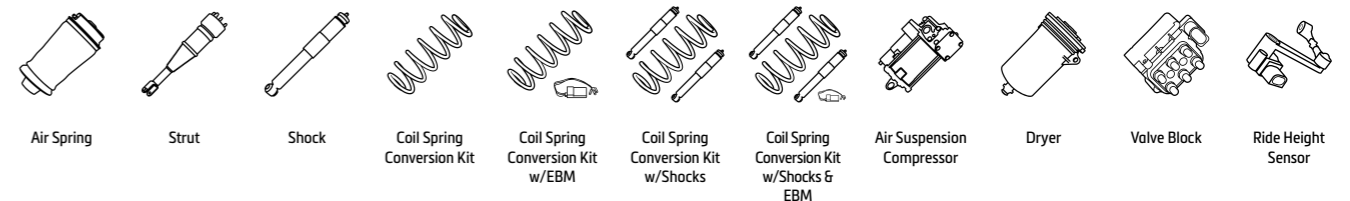

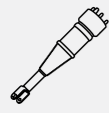

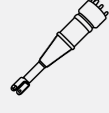
MERCEDES-BENZ						
Part #	Product Type	Position	Model Information	Vehicle Attributes	Product Attributes	
S/W212, C/W/X218						
A-2791			2009-2016 E-Class	w/AIRMATIC & ADS, w/ & w/o 4MATIC	E 200, E 200 CDI/BlueTEC/CGI/NGT, E 220 BlueTEC/BlueTEC 4-matic/CDI, E 250, E 250 CDI/BlueTEC/BlueTEC 4-matic/CGI, E 300, E 300 4-matic/CDI/BlueTEC/Hybrid/BlueTEC Hybrid, E 350, E 350 4-matic/BlueTEC/BlueTEC 4-matic/CDI/CDI 4-matic/CGI, E 400, E 400 4-matic, E 500, E 500 4-matic, E 63 AMG, E 63 AMG 4-matic	New
			2009-2016 E-Class T-Model	w/AIRMATIC, w/ & w/o ADS, w/ & w/o 4MATIC, Non-AMG	E 220 BlueTEC/BlueTEC 4-matic/CDI, E 250, E 250 CDI/BlueTEC/BlueTEC 4-matic/CGI, E 300, E 300 4-matic/CDI/BlueTEC/Hybrid/BlueTEC Hybrid, E 350, E 350 4-matic/BlueTEC/BlueTEC 4-matic/CDI/CDI 4-matic/CGI, E 400, E 400 4-matic, E 500, E 500 4-matic, E 63 AMG, E 63 AMG 4-matic	
			2011-2017 CLS-Class	w/AIRMATIC, w/ & w/o ADS, w/ & w/o 4MATIC, Incl. AMG	CLS 220 BlueTEC/d, CLS 250 CDI/BlueTEC/d, CLS 350/BlueTEC/d/BlueTEC 4-matic/d 4-matic/CDI/d/CDI 4-matic/d 4-matic, CLS 400/4-matic, CLS 500/4-matic, CLS 63 AMG/AMG 4-matic	
S/W212, C/W/X218						
AS-3237			2009-2016 E-Class	w/AIRMATIC & ADS, w/4MATIC	E 220 BlueTEC 4-matic, E 250 CDI/BlueTEC 4-matic, E 300 4-matic, E 350 BlueTEC 4-matic/CDI 4-matic, E 500 4-matic, E 63 AMG 4-matic	Remanufactured
			2011-2017 CLS-Class	w/AIRMATIC & ADS, w/4MATIC, Incl. AMG	CLS 250 BlueTEC/d 4-matic, CLS 350 BlueTEC 4-matic/CDI 4-matic/d 4-matic, CLS 400 4-matic, CLS 500 4-matic, CLS 63 AMG 4-matic	
AS-3238			2009-2016 E-Class	w/AIRMATIC & ADS, w/4MATIC	E 220 BlueTEC 4-matic, E 250 CDI/BlueTEC 4-matic, E 300 4-matic, E 350 BlueTEC 4-matic/CDI 4-matic, E 500 4-matic, E 63 AMG 4-matic	Remanufactured
			2011-2017 CLS-Class	w/AIRMATIC & ADS, w/4MATIC, Incl. AMG	CLS 250 BlueTEC/d 4-matic, CLS 350 BlueTEC 4-matic/CDI 4-matic/d 4-matic, CLS 400 4-matic, CLS 500 4-matic, CLS 63 AMG 4-matic	
AS-3239			2009-2016 E-Class	w/AIRMATIC & ADS, w/o 4MATIC, Non-AMG	E 180, E 200/CDI/BlueTEC/CGI/NGT, E 220 BlueTEC/CDI/BlueTEC, E 250/CDI/BlueTEC/CGI, E 300/CDI/BlueTEC/Hybrid/BlueTEC Hybrid, E 350/BlueTEC/CDI/CGI, E 400, E 500	Remanufactured
AS-3240			2009-2016 E-Class	w/AIRMATIC & ADS, w/o 4MATIC, Non-AMG	E 180, E 200/CDI/BlueTEC/CGI/NGT, E 220 BlueTEC/CDI/BlueTEC, E 250/CDI/BlueTEC/CGI, E 300/CDI/BlueTEC/Hybrid/BlueTEC Hybrid, E 350/BlueTEC/CDI/CGI, E 400, E 500	Remanufactured

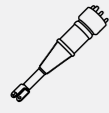

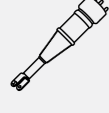

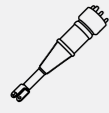

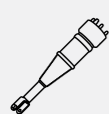

Superior Components

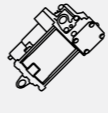
Through the use of OE parts and quality Tier 1 components such as leak-resistant seals, CNC-machined parts, premium name-brand rubber air sleeves and VOSS air line fittings, Arnott delivers on the superior quality customers can expect with each Arnott part.











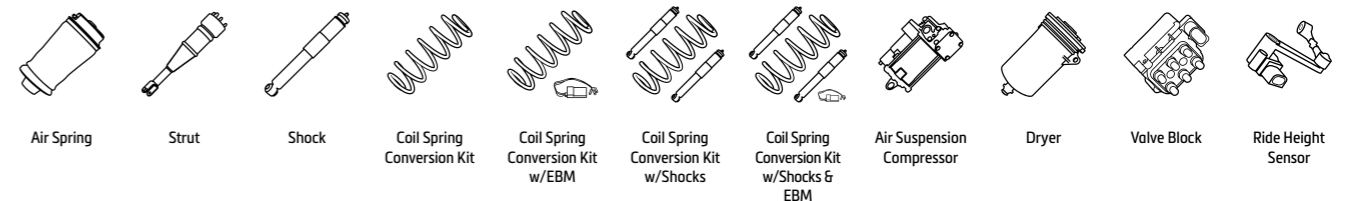



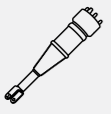

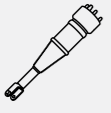

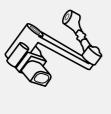

MERCEDES-BENZ						
Part #	Product Type	Position	Model Information	Vehicle Attributes	Product Attributes	
S/W212, C/W/X218						
AS-3414			2011-2017 CLS-Class 2012-2017 CLS-Class Shooting Brake	w/AIRMATIC & ADS, w/o 4MATIC, Incl. AMG	CLS 220 BlueTEC/d, CLS 250 CDI/BlueTEC/d, CLS 350/BlueTEC/d/CDI, CLS 400, CLS 500, CLS 63 AMG CLS 220 BlueTEC/d, CLS 250 CDI/BlueTEC/d, CLS 350/BlueTEC/d/CDI, CLS 400, CLS 500, CLS 63 AMG	> New
AS-3415			2011-2017 CLS-Class 2012-2017 CLS-Class Shooting Brake	w/AIRMATIC & ADS, w/o 4MATIC, Incl. AMG	CLS 220 BlueTEC/d, CLS 250 CDI/BlueTEC/d, CLS 350/BlueTEC/d/CDI, CLS 400, CLS 500, CLS 63 AMG CLS 220 BlueTEC/d, CLS 250 CDI/BlueTEC/d, CLS 350/BlueTEC/d/CDI, CLS 400, CLS 500, CLS 63 AMG	> New
AS-3422			2009-2016 E-Class	w/AIRMATIC & ADS, w/o 4MATIC, Incl. AMG	E 180, E 200/CDI/BlueTEC/CGI/NGT, E 220 BlueTEC/CDI/BlueTEC, E 250/CDI/BlueTEC/CGI, E 300/CDI/BlueTEC/Hybrid/BlueTEC Hybrid, E 350/BlueTEC/CDI/CGI, E 400, E 500, E 63 AMG	> New
AS-3423			2009-2016 E-Class	w/AIRMATIC & ADS, w/o 4MATIC, Incl. AMG	E 180, E 200/CDI/BlueTEC/CGI/NGT, E 220 BlueTEC/CDI/BlueTEC, E 250/CDI/BlueTEC/CGI, E 300/CDI/BlueTEC/Hybrid/BlueTEC Hybrid, E 350/BlueTEC/CDI/CGI, E 400, E 500, E 63 AMG	> New
AS-3424			2009-2016 E-Class 2011-2017 CLS-Class	w/AIRMATIC & ADS, w/4MATIC w/AIRMATIC & ADS, w/4MATIC, Incl. AMG	E 220 BlueTEC 4-matic, E 250 CDI/BlueTEC 4-matic, E 300 4-matic, E 350 BlueTEC 4-matic/CDI 4-matic, E 500 4-matic, E 63 AMG 4-matic CLS 250 BlueTEC/d 4-matic, CLS 350 BlueTEC 4-matic/CDI 4-matic/d 4-matic, CLS 400 4-matic, CLS 500 4-matic, CLS 63 AMG 4-matic	> New
AS-3425			2009-2016 E-Class 2011-2017 CLS-Class	w/AIRMATIC & ADS, w/4MATIC w/AIRMATIC & ADS, w/4MATIC, Incl. AMG	E 220 BlueTEC 4-matic, E 250 CDI/BlueTEC 4-matic, E 300 4-matic, E 350 BlueTEC 4-matic/CDI 4-matic, E 500 4-matic, E 63 AMG 4-matic CLS 250 BlueTEC/d 4-matic, CLS 350 BlueTEC 4-matic/CDI 4-matic/d 4-matic, CLS 400 4-matic, CLS 500 4-matic, CLS 63 AMG 4-matic	> New



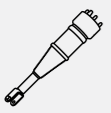

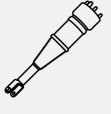

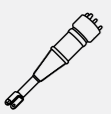



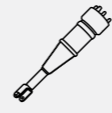

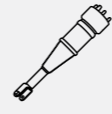
MERCEDES-BENZ						
Part #	Product Type	Position	Model Information	Vehicle Attributes	Product Attributes	
S/W212, C/W/X218						
P-2830			2009-2016 E-Class 2009-2016 E-Class T-Model 2011-2017 CLS-Class 2012-2017 CLS-Class Shooting Brake	w/AIRMATIC & ADS, w/ & w/o 4MATIC, Non-AMG w/AIRMATIC, w/ & w/o ADS, w/ & w/o 4MATIC, Non-AMG w/AIRMATIC, w/ & w/o ADS, w/ & w/o 4MATIC, Incl. AMG	E 200/CDI/BlueTEC/CGI/NGT, E 220 BlueTEC/BlueTEC 4-matic/CDI, E 250, E 250 CDI/BlueTEC/BlueTEC 4-matic/CGI, E 300/4-matic/CDI/BlueTEC/Hybrid/BlueTEC Hybrid, E 350/4-matic/BlueTEC/BlueTEC 4-matic/CDI/CDI 4-matic/CGI, E 400/4-matic, E 500/4-matic, E 63 AMG/AMG 4-matic E 200/CDI/BlueTEC/CGI/NGT, E 220 BlueTEC/BlueTEC 4-matic/CDI, E 250, E 250 CDI/BlueTEC/BlueTEC 4-matic/CGI, E 300/4-matic/CDI/BlueTEC/Hybrid/BlueTEC Hybrid, E 350/4-matic/BlueTEC/BlueTEC 4-matic/CDI/CDI 4-matic/CGI, E 400/4-matic, E 500/4-matic, E 63 AMG/AMG 4-matic CLS 220 BlueTEC/d, CLS 250 BlueTEC 4-matic/d 4-matic/CDI/BlueTEC/d, CLS 350/BlueTEC/d/BlueTEC 4-matic/d 4-matic/CDI/CDI 4-matic, CLS 400/4-matic, CLS 500/4-matic, CLS 63 AMG/AMG 4-matic CLS 220 BlueTEC/d, CLS 250 BlueTEC 4-matic/d 4-matic/CDI/BlueTEC/d, CLS 350/BlueTEC/d/BlueTEC 4-matic/d 4-matic/CDI/d 4-matic/CDI/d 4-matic, CLS 400/4-matic, CLS 500/4-matic, CLS 63 AMG 4-matic	> WABCO OES
S/W213						
A-3313			2016--> E-Class	w/AIRMATIC, w/ & w/o 4MATIC, Incl. Hybrid, Incl. AMG	AMG E 43 4-matic/E 53, EQ Boost 4-matic+/E 63 4-matic+/E 63 S 4-matic+, E 180, E 200/4-matic/d/EQ Boost/EQ Boost 4-matic, E 220 d/d 4-matic, E 250, E 300/d/de/e/EQ Boost, E 350 d/d 4-matic/e/EQ Boost, E 400 4-matic/d/d 4-matic, E 450 4-matic	
A-3314			2016--> E-Class	w/AIRMATIC, w/ & w/o 4MATIC, Incl. Hybrid, Incl. AMG	AMG E 43 4-matic/E 53, EQ Boost 4-matic+/E 63 4-matic+/E 63 S 4-matic+, E 180, E 200/4-matic/d/EQ Boost/EQ Boost 4-matic, E 220 d/d 4-matic, E 250, E 300/d/de/e/EQ Boost, E 350 d/d 4-matic/e/EQ Boost, E 400 4-matic/d/d 4-matic, E 450 4-matic	
A-3329			2016--> E-Class T-Model 2017--> E-Class All-Terrain	w/AIRMATIC, w/ & w/o 4MATIC, Incl. AMG	AMG E 43 4-matic/S3 EQ Boost 4-matic+/63 4-matic+/63 S 4-matic+, E 200/4-matic/d/EQ Boost/EQ Boost 4-matic, E 220 d/d 4-matic, E 250, E 300 d/de/EQ Boost, E 350 d/d 4-matic, E 400 4-matic/d/d 4-matic, E 450 4-matic E 220 d 4-matic, E 350 d 4-matic, E 400 d 4-matic	

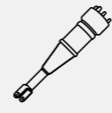
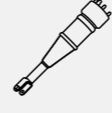
ARNOTT REMANUFACTURED AIR STRUTS

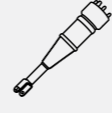

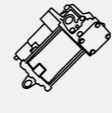
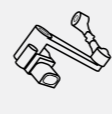





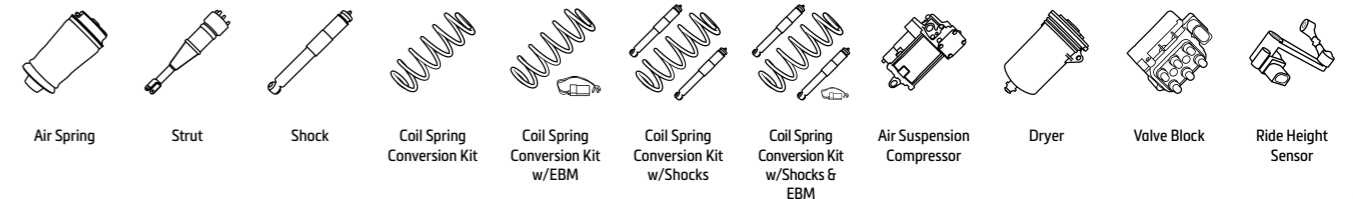

- Rear air struts for Mercedes-Benz S-Class W222
- Continental ContiTech air sleeve
 - > Premium multi-ply, cross-corded construction
 - > Longer-lasting design using advanced materials
- Works with vehicle's active damping & auto leveling functionality
- Remanufactured & tested in the USA
- AS-3360 (right) & AS-3361 (left)



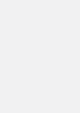

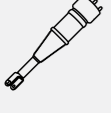

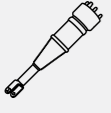





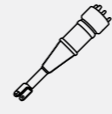

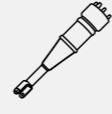

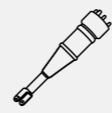
MERCEDES-BENZ						
Part #	Product Type	Position	Model Information	Vehicle Attributes	Product Attributes	
S/W213						
A-3330			2016--> E-Class T-Model	w/AIRMATIC, w/ & w/o 4MATIC, Incl. AMG	AMG E 43 4-matic/53 EQ Boost 4-matic-/63 4-matic-/63 S 4-matic-, E 200/4-matic/d/EQ Boost/ EQ Boost 4-matic, E 220 d/d 4-matic, E 250, E 300 d/de/EQ Boost, E 350 d/d 4-matic, E 400 4-matic/d/d 4-matic, E 450 4-matic	
			2017--> E-Class All-Terrain		E 220 d 4-matic, E 350 d 4-matic, E 400 d 4-matic	
AS-3577			2016--> E-Class	w/AIRMATIC, w/4MATIC, E43 AMG	AMG E 43 4-matic	> Remanufactured
AS-3578			2016--> E-Class	w/AIRMATIC, w/4MATIC, E43 AMG	AMG E 43 4-matic	> Remanufactured
W163						
RH-3501			1998-2005 ML-Class	ML 230, ML 270 CDI, ML 320, ML 350, ML 400 CDI, ML 430, ML 500, ML 55 AMG		> For vehicles w/LED or Bi-Xenon Intelligent Lighting Systems
W164, X164						
A-2575			2005-2011 ML-Class	w/AIRMATIC, w/ & w/o ADS, Incl. AMG	ML 280 CDI 4-matic, ML 300 4-matic/CDI 4-matic, ML 350 4-matic/ CDI 4-matic, ML 450 CDI 4-matic, ML 500 4-matic, ML 63 AMG 4-matic	> New Air Spring Only, Reuse Factory Shock
			2006-2012 GL-Class	w/AIRMATIC, w/ & w/o ADS	GL 320 CDI/CDI 4-matic, GL 350 BlueTEC 4-matic/ CDI 4-matic, GL 420 CDI 4-matic, GL 450 4-matic/ CDI 4-matic, GL 500 4-matic	
A-2596			2005-2011 ML-Class	w/AIRMATIC & ADS, Incl. AMG	ML 280 CDI 4-matic, ML 300 4-matic/CDI 4-matic, ML 350 4-matic/ CDI 4-matic, ML 450 CDI 4-matic, ML 500 4-matic, ML 63 AMG 4-matic	
			2006-2012 GL-Class	w/AIRMATIC, w/ & w/o ADS	GL 320 CDI/CDI 4-matic, GL 350 BlueTEC 4-matic/ CDI 4-matic, GL 420 CDI 4-matic, GL 450 4-matic/ CDI 4-matic, GL 500 4-matic	
AS-2450			2005-2011 ML-Class	w/AIRMATIC & ADS, Non-AMG	ML 280 CDI 4-matic, ML 300 4-matic/CDI 4-matic, ML 350 4-matic/ CDI 4-matic, ML 450 CDI 4-matic, ML 500 4-matic	> Remanufactured
			2006-2012 GL-Class	w/AIRMATIC & ADS	GL 320 CDI/CDI 4-matic, GL 350 BlueTEC 4-matic/ CDI 4-matic, GL 420 CDI 4-matic, GL 450 4-matic/ CDI 4-matic, GL 500 4-matic	
AS-2463			2006-2011 ML-Class	w/AIRMATIC & ADS, AMG	ML 63 AMG 4-matic	> Remanufactured
AS-2792			2005-2011 ML-Class	w/AIRMATIC & ADS, Non-AMG	ML 280 CDI 4-matic, ML 300 4-matic/CDI 4-matic, ML 350 4-matic/ CDI 4-matic, ML 450 CDI 4-matic, ML 500 4-matic	> New
			2006-2012 GL-Class	w/AIRMATIC & ADS	GL 320 CDI/CDI 4-matic, GL 350 BlueTEC 4-matic/ CDI 4-matic, GL 420 CDI 4-matic, GL 450 4-matic/ CDI 4-matic, GL 500 4-matic	

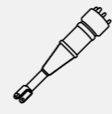



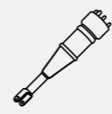

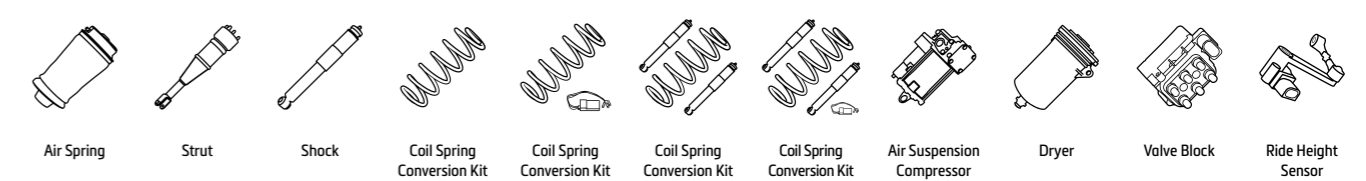

MERCEDES-BENZ						
Part #	Product Type	Position	Model Information	Vehicle Attributes	Product Attributes	
W164, X164						
AS-2802			2006-2011 ML-Class	w/AIRMATIC & ADS, AMG	ML 63 AMG 4-matic	> New
AS-3005			2006-2012 GL-Class	w/AIRMATIC, w/o ADS	GL 320 CDI/CDI 4-matic, GL 350 BlueTEC 4-matic/ CDI 4-matic, GL 420 CDI 4-matic, GL 450 4-matic/ CDI 4-matic, GL 500 4-matic	> New
AS-3058			2005-2011 ML-Class	w/AIRMATIC, w/o ADS, Non-AMG	ML 280 CDI 4-matic, ML 300 4-matic/CDI 4-matic, ML 350 4-matic/ CDI 4-matic, ML 450 CDI 4-matic, ML 500 4-matic	> New
			2006-2012 GL-Class	w/AIRMATIC, w/o ADS	GL 320 CDI/CDI 4-matic, GL 350 BlueTEC 4-matic/ CDI 4-matic, GL 420 CDI 4-matic, GL 450 4-matic/ CDI 4-matic, GL 500 4-matic	> Eibach Shock Absorber
AS-3088			2005-2011 ML-Class	w/AIRMATIC & ADS, Non-AMG	ML 280 CDI 4-matic, ML 300 4-matic/CDI 4-matic, ML 350 4-matic/ CDI 4-matic, ML 450 CDI 4-matic, ML 500 4-matic	> New
			2006-2012 GL-Class	w/AIRMATIC & ADS	GL 320 CDI/CDI 4-matic, GL 350 BlueTEC 4-matic/ CDI 4-matic, GL 420 CDI 4-matic, GL 450 4-matic/ CDI 4-matic, GL 500 4-matic	> Eibach Shock Absorber
AS-3089			2006-2011 ML-Class	w/AIRMATIC & ADS, AMG	ML 63 AMG 4-matic	> New
						> Eibach Shock Absorber
P-3214			2005-2011 ML-Class	w/AIRMATIC, w/ & w/o ADS, Incl. AMG	ML 280 CDI 4-matic, ML 300 4-matic/CDI 4-matic, ML 350 4-matic/ CDI 4-matic, ML 450 CDI 4-matic, ML 500 4-matic, ML 63 AMG 4-matic	
			2006-2012 GL-Class	w/AIRMATIC, w/ & w/o ADS	GL 320 CDI/CDI 4-matic, GL 350 BlueTEC 4-matic/ CDI 4-matic, GL 420 CDI 4-matic, GL 450 4-matic/ CDI 4-matic, GL 500 4-matic	
RH-3501			2005-2011 ML-Class	w/AIRMATIC, w/ & w/o ADS	ML 280 CDI 4-matic, ML 300 4-matic/CDI 4-matic, ML 350 4-matic/ CDI 4-matic, ML 450 CDI 4-matic, ML 500 4-matic, ML 63 AMG 4-matic	> For vehicles w/LED or Bi-Xenon Intelligent Lighting Systems
			2006-2012 GL-Class	w/AIRMATIC, w/ & w/o ADS	GL 320 CDI/CDI 4-matic, GL 350 BlueTEC 4-matic/ CDI 4-matic, GL 420 CDI 4-matic, GL 450 4-matic/ CDI 4-matic, GL 500 4-matic	
SK-2867			2005-2011 ML-Class	w/AIRMATIC & ADS, Non-AMG	ML 280 CDI 4-matic, ML 300 4-matic/CDI 4-matic, ML 350 4-matic/ CDI 4-matic, ML 450 CDI 4-matic, ML 500 4-matic	> New
			2006-2012 GL-Class	w/AIRMATIC & ADS	GL 320 CDI/CDI 4-matic, GL 350 BlueTEC 4-matic/ CDI 4-matic, GL 420 CDI 4-matic, GL 450 4-matic/ CDI 4-matic, GL 500 4-matic	

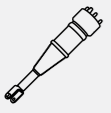

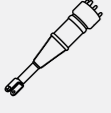

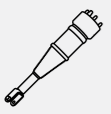

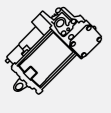
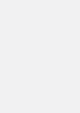

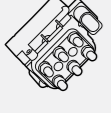
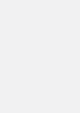





MERCEDES-BENZ						
Part #	Product Type	Position	Model Information	Vehicle Attributes	Product Attributes	
W164, X164						
SK-2868			2005-2011 ML-Class	w/AIRMATIC, w/o ADS	ML 280 CDI 4-matic, ML 300 4-matic/CDI 4-matic, ML 350 4-matic/CDI 4-matic, ML 450 CDI 4-matic, ML 500 4-matic	New
			2006-2012 GL-Class		GL 320 CDI/CDI 4-matic, GL 350 BlueTEC 4-matic/CDI 4-matic, GL 420 CDI 4-matic, GL 450 4-matic/CDI 4-matic, GL 500 4-matic	
SK-3029			2005-2011 ML-Class	w/AIRMATIC & ADS, Non-AMG	ML 280 CDI 4-matic, ML 300 4-matic/CDI 4-matic, ML 350 4-matic/CDI 4-matic, ML 450 CDI 4-matic, ML 500 4-matic	Remanufactured
			2006-2012 GL-Class	w/AIRMATIC & ADS	GL 320 CDI/CDI 4-matic, GL 350 BlueTEC 4-matic/CDI 4-matic, GL 420 CDI 4-matic, GL 450 4-matic/CDI 4-matic, GL 500 4-matic	
VB-3267			2005-2011 ML-Class	w/AIRMATIC & ADS, Incl. AMG	ML 280 CDI 4-matic, ML 300 4-matic/CDI 4-matic, ML 350 4-matic/CDI 4-matic, ML 450 CDI 4-matic, ML 500 4-matic, ML 63 AMG 4-matic	Remanufactured
			2006-2012 GL-Class	w/AIRMATIC, w/ & w/o ADS	GL 320 CDI/CDI 4-matic, GL 350 BlueTEC 4-matic/CDI 4-matic, GL 420 CDI 4-matic, GL 450 4-matic/CDI 4-matic, GL 500 4-matic	
W166, X166						
A-2596			2011-2015 ML-Class	w/AIRMATIC & ADS, Incl. AMG	ML 250 CDI/BlueTEC 4-matic, ML 300 4-matic, ML 350/4-matic/BlueTEC 4-matic/CDI 4-matic, ML 400 4-matic, ML 500 4-matic, ML 63 AMG 4-matic	New
			2012-2015 GL-Class	w/AIRMATIC, w/ & w/o ADS, Incl. AMG	GL 350 CDI/BlueTEC 4-matic, GL 400 4-matic, GL 500 4-matic, GL 63 AMG 4-matic	
			2015-2018 GLE-Class	w/AIRMATIC & ADS, Incl. AMG	250 d/d 4-matic, 320 4-matic, 350 d 4-matic, 400 4-matic, 450 AMG 4-matic, 500 4-matic/e 4-matic, AMG 43 4-matic/63 4-matic/63 S 4-matic	
			2015-2019 GLS-Class	w/AIRMATIC, w/ & w/o ADS, Incl. AMG	350 d 4-matic, 400 4-matic, AMG 63 4-matic	
AS-3060			2011-2015 ML-Class	w/AIRMATIC & ADS, Non-AMG, Excl. GLE Coupe (292), Excl. ADS Plus	ML 250 CDI/BlueTEC 4-matic, ML 300 4-matic, ML 350/4-matic/BlueTEC 4-matic/CDI 4-matic, ML 400 4-matic, ML 500 4-matic	Remanufactured
			2012-2015 GL-Class	w/AIRMATIC & ADS, Non-AMG, Excl. ADS Plus	GL 350 CDI/BlueTEC 4-matic, GL 400 4-matic, GL 500 4-matic	
			2015-2018 GLE-Class	w/AIRMATIC & ADS, Non-AMG, Excl. GLE Coupe (292), Excl. ADS Plus	250 d/d 4-matic, 320 4-matic, 350 d 4-matic, 400 4-matic, 500 4-matic/e 4-matic	
			2015-2019 GLS-Class	w/AIRMATIC & ADS, Non-AMG, Excl. ADS Plus	350 d 4-matic, 400 4-matic	
AS-3061			2011-2015 ML-Class	w/AIRMATIC & ADS, Non-AMG, Excl. GLE Coupe (292), Excl. ADS Plus	ML 250 CDI/BlueTEC 4-matic, ML 300 4-matic, ML 350/4-matic/BlueTEC 4-matic/CDI 4-matic, ML 400 4-matic, ML 500 4-matic	Remanufactured
			2012-2015 GL-Class	w/AIRMATIC & ADS, Non-AMG, Excl. ADS Plus	GL 350 CDI/BlueTEC 4-matic, GL 400 4-matic, GL 500 4-matic	
			2015-2018 GLE-Class	w/AIRMATIC & ADS, Non-AMG, Excl. GLE Coupe (292), Excl. ADS Plus	250 d/d 4-matic, 320 4-matic, 350 d 4-matic, 400 4-matic, 500 4-matic/e 4-matic	
			2015-2019 GLS-Class	w/AIRMATIC & ADS, Non-AMG, Excl. ADS Plus	350 d 4-matic, 400 4-matic	





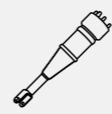



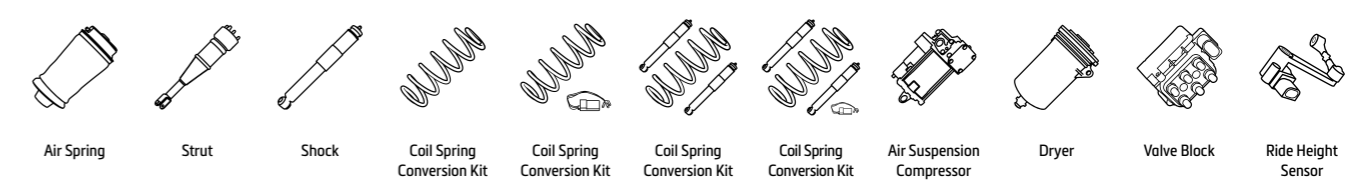

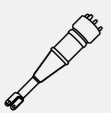

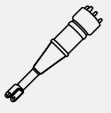
MERCEDES-BENZ						
Part #	Product Type	Position	Model Information	Vehicle Attributes	Product Attributes	
W166, X166						
AS-3085			2012-2015 GL-Class	w/AIRMATIC, w/o ADS, Incl. AMG	GL 350 CDI/BlueTEC 4-matic, GL 400 4-matic, GL 500 4-matic, GL 63 AMG 4-matic	Remanufactured
			2015-2019 GLS-Class		350 d 4-matic, 400 4-matic, AMG 63 4-matic	
AS-3086			2012-2015 GL-Class	w/AIRMATIC, w/o ADS, Incl. AMG	GL 350 CDI/BlueTEC 4-matic, GL 400 4-matic, GL 500 4-matic, GL 63 AMG 4-matic	Remanufactured
			2015-2019 GLS-Class		350 d 4-matic, 400 4-matic, AMG 63 4-matic	
AS-3153			2011-2015 ML-Class	w/AIRMATIC & ADS, Non-AMG, Excl. GLE Coupe (292), Excl. ADS Plus	ML 250 CDI/BlueTEC 4-matic, ML 300 4-matic, ML 350/4-matic/BlueTEC 4-matic/CDI 4-matic, ML 400 4-matic, ML 500 4-matic	New
			2012-2015 GL-Class	w/AIRMATIC & ADS, Non-AMG, Excl. ADS Plus	GL 350 CDI/BlueTEC 4-matic, GL 400 4-matic, GL 500 4-matic	
			2015-2018 GLE-Class	w/AIRMATIC & ADS, Non-AMG, Excl. GLE Coupe (292), Excl. ADS Plus	250 d/d 4-matic, 320 4-matic, 350 d 4-matic, 400 4-matic, 500 4-matic/e 4-matic	
AS-3154			2011-2015 ML-Class	w/AIRMATIC & ADS, Non-AMG, Excl. GLE Coupe (292), Excl. ADS Plus	ML 250 CDI/BlueTEC 4-matic, ML 300 4-matic, ML 350/4-matic/BlueTEC 4-matic/CDI 4-matic, ML 400 4-matic, ML 500 4-matic	New
			2012-2015 GL-Class	w/AIRMATIC & ADS, Non-AMG, Excl. ADS Plus	GL 350 CDI/BlueTEC 4-matic, GL 400 4-matic, GL 500 4-matic	
			2015-2019 GLS-Class	w/AIRMATIC & ADS, Non-AMG, Excl. ADS Plus	350 d 4-matic, 400 4-matic	
AS-3155			2012-2015 GL-Class	w/AIRMATIC, w/o ADS	GL 350 CDI/BlueTEC 4-matic, GL 400 4-matic, GL 500 4-matic	New
			2015-2019 GLS-Class	w/AIRMATIC & ADS, Non-AMG, Excl. ADS Plus	350 d 4-matic, 400 4-matic	
AS-3156			2012-2015 GL-Class	w/AIRMATIC, w/o ADS	GL 350 CDI/BlueTEC 4-matic, GL 400 4-matic, GL 500 4-matic	New
			2015-2019 GLS-Class	w/AIRMATIC & ADS, Non-AMG, Excl. ADS Plus	350 d 4-matic, 400 4-matic	
AS-3408			2011-2015 ML-Class	w/AIRMATIC & ADS, Incl. AMG	ML 250 CDI/BlueTEC 4-matic, ML 300 4-matic, ML 350/4-matic/BlueTEC 4-matic/CDI 4-matic, ML 400 4-matic, ML 500 4-matic, ML 63 AMG 4-matic	New
			2012-2015 GL-Class	w/AIRMATIC, w/ & w/o ADS, Incl. AMG	GL 350 CDI/BlueTEC 4-matic, GL 400 4-matic, GL 500 4-matic, GL 63 AMG 4-matic	
			2015-2018 GLE-Class	w/AIRMATIC & ADS, Incl. AMG	250 d/d 4-matic, 320 4-matic, 350 d 4-matic, 400 4-matic, 450 AMG 4-matic, 500 4-matic/e 4-matic, AMG 43 4-matic/63 4-matic/63 S 4-matic	
			2015-2019 GLS-Class	w/AIRMATIC, w/ & w/o ADS, Incl. AMG	350 d 4-matic, 400 4-matic, AMG 63 4-matic	

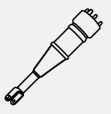

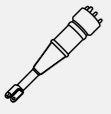

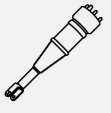

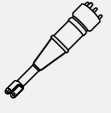

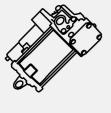
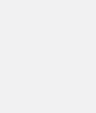

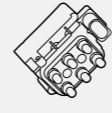
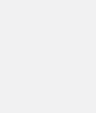
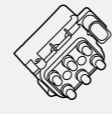
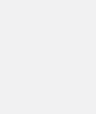

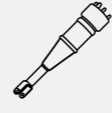

MERCEDES-BENZ						
Part #	Product Type	Position	Model Information	Vehicle Attributes	Product Attributes	
W166, X166						
AS-3409			2011-2015 ML-Class	w/AIRMATIC & ADS, Incl. AMG	ML 250 CDI/BlueTEC 4-matic, ML 300 4-matic, ML 350/4-matic/BlueTEC 4-matic/CDI 4-matic, ML 400 4-matic, ML 500 4-matic, ML 63 AMG 4-matic	New
			2012-2015 GL-Class	w/AIRMATIC, w/ & w/o ADS, Incl. AMG	GL 350 CDI/BlueTEC 4-matic, GL 400 4-matic, GL 500 4-matic, GL 63 AMG 4-matic	
			2015-2018 GLE-Class	w/AIRMATIC & ADS, Incl. AMG	250 d/d 4-matic, 320 4-matic, 350 d 4-matic, 400 4-matic, 450 AMG 4-matic, 500 4-matic/e 4-matic, AMG 43 4-matic/63 4-matic/63 S 4-matic	
			2015-2019 GLS-Class	w/AIRMATIC, w/ & w/o ADS, Incl. AMG	350 d 4-matic, 400 4-matic, AMG 63 4-matic	
AS-3410			2012-2015 GL-Class	w/AIRMATIC, w/o ADS	GL 350 CDI/BlueTEC 4-matic, GL 400 4-matic, GL 500 4-matic, GL 63 AMG 4-matic	New
			2015-2019 GLS-Class		350 d 4-matic, 400 4-matic, AMG 63 4-matic	
AS-3411			2012-2015 GL-Class	w/AIRMATIC, w/o ADS	GL 350 CDI/BlueTEC 4-matic, GL 400 4-matic, GL 500 4-matic, GL 63 AMG 4-matic	New
			2015-2019 GLS-Class		350 d 4-matic, 400 4-matic, AMG 63 4-matic	
P-3258			2011-2015 ML-Class	w/AIRMATIC & ADS, Incl. AMG	ML 250 CDI/BlueTEC 4-matic, ML 300 4-matic, ML 350/4-matic/BlueTEC 4-matic/CDI 4-matic, ML 400 4-matic, ML 500 4-matic, ML 63 AMG 4-matic	
			2012-2015 GL-Class	w/AIRMATIC, w/ & w/o ADS, Incl. AMG	GL 350 CDI/BlueTEC 4-matic, GL 400 4-matic, GL 500 4-matic, GL 63 AMG 4-matic	
			2015-2018 GLE-Class	w/AIRMATIC & ADS, Incl. AMG	250 d/d 4-matic, 320 4-matic, 350 d 4-matic, 400 4-matic, 450 AMG 4-matic, 500 4-matic/e 4-matic, AMG 43 4-matic/63 4-matic/63 S 4-matic	
			2015-2019 GLS-Class	w/AIRMATIC, w/ & w/o ADS, Incl. AMG	350 d 4-matic, 400 4-matic, AMG 63 4-matic	
SK-3268			2011-2015 ML-Class	w/AIRMATIC & ADS, Non-AMG	ML 250 CDI/BlueTEC 4-matic, ML 300 4-matic, ML 350 4-matic/BlueTEC 4-matic/CDI 4-matic, ML 400 4-matic, ML 500 4-matic	Remanufactured
			2012-2015 GL-Class		GL 400 4-matic, GL 500 4-matic	
			2015-2018 GLE-Class		250 d/d 4-matic, 320 4-matic, 350 d 4-matic, 400 4-matic, 500 e 4-matic	
			2015-2019 GLS-Class		350 d 4-matic, 400 4-matic	
VB-3267			2011-2015 ML-Class	w/AIRMATIC & ADS, Incl. AMG	ML 250 CDI/BlueTEC 4-matic, ML 300 4-matic, ML 350/4-matic/BlueTEC 4-matic/CDI 4-matic, ML 400 4-matic, ML 500 4-matic, ML 63 AMG 4-matic	
			2012-2015 GL-Class	w/AIRMATIC, w/ & w/o ADS, Incl. AMG	GL 350 CDI/BlueTEC 4-matic, GL 400 4-matic, GL 500 4-matic, GL 63 AMG 4-matic	
			2015-2018 GLE-Class	w/AIRMATIC & ADS, Incl. AMG	250 d/d 4-matic, 320 4-matic, 350 d 4-matic, 400 4-matic, 450 AMG 4-matic, 500 4-matic/e 4-matic, AMG 43 4-matic/63 4-matic/63 S 4-matic	

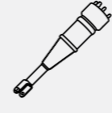

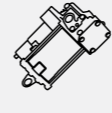
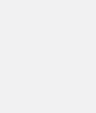
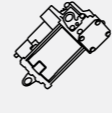
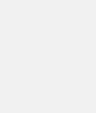

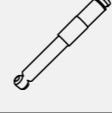



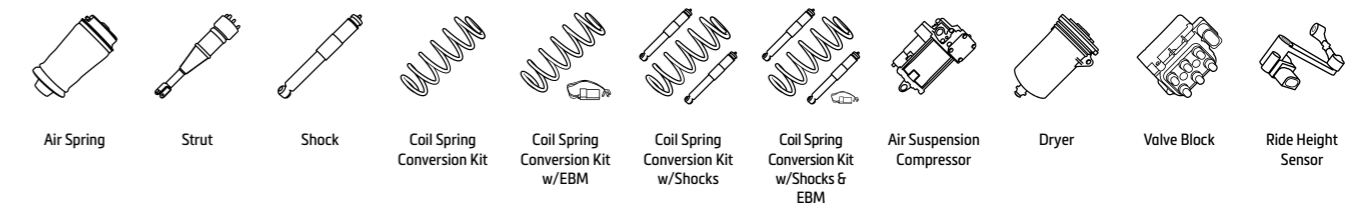

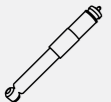
MERCEDES-BENZ						
Part #	Product Type	Position	Model Information	Vehicle Attributes	Product Attributes	
W205						
A-3329			2013--> C-Class	w/ & w/o 4MATIC, Incl. AMG, Excl. C350e	AMG C 43 4-matic/63, C 160, C 180, C 180 BlueTEC/d, C 200 4-matic/BlueTEC/d/ EQ Boost/EQ Boost 4-matic, C 220 BlueTEC/d/d 4-matic, C 250, C 250 BlueTEC/d/d 4-matic, C 300, C 300 BlueTEC Hybrid/h/d/d 4-matic, C 400 4-matic, C 450 AMG 4-matic	
A-3330			2013--> C-Class	w/ & w/o 4MATIC, Incl. AMG, Excl. C350e	AMG C 43 4-matic/63, C 160, C 180, C 180 BlueTEC/d, C 200 4-matic/BlueTEC/d/ EQ Boost/EQ Boost 4-matic, C 220 BlueTEC/d/d 4-matic, C 250, C 250 BlueTEC/d/d 4-matic, C 300, C 300 BlueTEC Hybrid/h/d/d 4-matic, C 400 4-matic, C 450 AMG 4-matic	
SK-3389			2013--> C-Class	w/AIRMATIC, w/ & w/o 4MATIC, Incl. AMG, Excl. C350e	AMG C 43 4-matic/63/63 S, C 160, C 180/BlueTEC/d, C 200/4-matic/BlueTEC/d/ EQ Boost/EQ Boost 4-matic, C 220 BlueTEC/d/d 4-matic, C 250/BlueTEC/d/BlueTEC 4-matic/d 4-matic, C 300/4-matic/BlueTEC Hybrid/h/d/d 4-matic/de/e 4-matic/EQ Boost/EQ Boost 4-matic, C 400 4-matic, C 450 AMG 4-matic	New Eibach Shock Absorber
SK-3390			2013--> C-Class	w/AIRMATIC, w/ & w/o 4MATIC, Incl. AMG, Excl. C350e	AMG C 43 4-matic/63/63 S, C 160, C 180/BlueTEC/d, C 200/4-matic/BlueTEC/d/ EQ Boost/EQ Boost 4-matic, C 220 BlueTEC/d/d 4-matic, C 250/BlueTEC/d/BlueTEC 4-matic/d 4-matic, C 300/4-matic/BlueTEC Hybrid/h/d/d 4-matic/de/e 4-matic/EQ Boost/EQ Boost 4-matic, C 400 4-matic, C 450 AMG 4-matic	New Eibach Shock Absorber
W/V/X222						
AS-3160			2013--> S-Class 2014--> Maybach	w/AIRMATIC, w/4MATIC, w/o ABC, Excl. AMG	S 350 BlueTEC 4-matic/d 4-matic, S 350 d 4-matic, S 400 4-matic/d 4-matic/Maybach 4-matic, S 450 4-matic/EQ Boost 4-matic/Maybach 4-matic/Maybach EQ Boost 4-matic, S 500 4-matic/L 4-matic/LEQ Boost 4-matic/Maybach/Maybach 4-matic, S 560 4-matic/Maybach 4-matic, S 600	New Eibach Shock Absorber
AS-3161			2013--> S-Class 2014--> Maybach	w/AIRMATIC, w/4MATIC, w/o ABC, Excl. AMG	S 350 BlueTEC 4-matic/d 4-matic, S 350 d 4-matic, S 400 4-matic/d 4-matic/Maybach 4-matic, S 450 4-matic/EQ Boost 4-matic/Maybach 4-matic/Maybach EQ Boost 4-matic, S 500 4-matic/L 4-matic/LEQ Boost 4-matic/Maybach/Maybach 4-matic, S 560 4-matic/Maybach 4-matic, S 600	New Eibach Shock Absorber

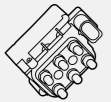

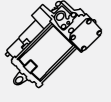







MERCEDES-BENZ						
Part #	Product Type	Position	Model Information	Vehicle Attributes	Product Attributes	
W/V/X222						
AS-3162			2013--> S-Class	w/AIRMATIC, w/o 4MATIC, w/o ABC, Incl. AMG	AMG S 63, S 300 BlueTEC Hybrid/h, S 320, S 350 BlueTEC/d, S 400/d/Hybrid/h, S 450/EQ Boost, S 500/EQ Boost/Hybrid/e/Maybach, S 560/e/Maybach, S 600/Maybach, S 63 AMG, S 65 AMG, S 650 Maybach	<ul style="list-style-type: none"> > New > Eibach Shock Absorber
			2014--> Maybach			
AS-3163			2013--> S-Class	w/AIRMATIC, w/o 4MATIC, w/o ABC, Incl. AMG	AMG S 63, S 300 BlueTEC Hybrid/h, S 320, S 350 BlueTEC/d, S 400/d/Hybrid/h, S 450/EQ Boost, S 500/EQ Boost/Hybrid/e/Maybach, S 560/e/Maybach, S 600/Maybach, S 63 AMG, S 65 AMG, S 650 Maybach	<ul style="list-style-type: none"> > New > Eibach Shock Absorber
			2014--> Maybach			
AS-3360			2013--> S-Class	w/AIRMATIC, w/ & w/o 4MATIC, w/o ABC, Non-AMG	S 300 BlueTEC Hybrid/h, S 320, S 350 BlueTEC/d/BlueTEC 4-matic/d 4-matic, S 400/4-matic/d/d 4-matic/Hybrid/h, S 450/4-matic/EQ Boost/EQ Boost 4-matic/Maybach 4-matic, S 500/4-matic/EQ Boost/Hybrid/e/Maybach/Maybach 4-matic, S 560/4-matic/e/Maybach/Maybach 4-matic, S 600/Maybach, S 650 Maybach	<ul style="list-style-type: none"> > Remanufactured
			2014--> Maybach			
AS-3361			2013--> S-Class	w/AIRMATIC, w/ & w/o 4MATIC, w/o ABC, Non-AMG	S 300 BlueTEC Hybrid/h, S 320, S 350 BlueTEC/d/BlueTEC 4-matic/d 4-matic, S 400/4-matic/d/d 4-matic/Hybrid/h, S 450/4-matic/EQ Boost/EQ Boost 4-matic/Maybach 4-matic, S 500/4-matic/EQ Boost/Hybrid/e/Maybach/Maybach 4-matic, S 560/4-matic/e/Maybach/Maybach 4-matic, S 600/Maybach, S 650 Maybach	<ul style="list-style-type: none"> > Remanufactured
			2014--> Maybach			
AS-3364			2013--> S-Class	w/AIRMATIC, w/ & w/o 4MATIC, w/o ABC, Non-AMG	S 300 BlueTEC Hybrid/h, S 320, S 350 BlueTEC/d/BlueTEC 4-matic/d 4-matic, S 400/4-matic/d/d 4-matic/Hybrid/h, S 450/4-matic/EQ Boost/EQ Boost 4-matic/Maybach 4-matic, S 500/4-matic/EQ Boost/Hybrid/e/Maybach/Maybach 4-matic, S 560/4-matic/e/Maybach/Maybach 4-matic, S 600/Maybach, S 650 Maybach	<ul style="list-style-type: none"> > New
			2014--> Maybach			
AS-3365			2013--> S-Class	w/AIRMATIC, w/ & w/o 4MATIC, w/o ABC, Non-AMG	S 300 BlueTEC Hybrid/h, S 320, S 350 BlueTEC/d/BlueTEC 4-matic/d 4-matic, S 400/4-matic/d/d 4-matic/Hybrid/h, S 450/4-matic/EQ Boost/EQ Boost 4-matic/Maybach 4-matic, S 500/4-matic/EQ Boost/Hybrid/e/Maybach/Maybach 4-matic, S 560/4-matic/e/Maybach/Maybach 4-matic, S 600/Maybach, S 650 Maybach	<ul style="list-style-type: none"> > New
			2014--> Maybach			
P-3282			2013--> S-Class	w/AIRMATIC, w/ & w/o 4MATIC, w/o ABC, Incl. AMG	AMG S 63/4-matic+, S 300 BlueTEC Hybrid/h, S 320, S 350 BlueTEC/d/BlueTEC 4-matic/d 4-matic, S 400/4-matic/d/d 4-matic/Hybrid/h, S 450/4-matic/EQ Boost/EQ Boost 4-matic/Maybach 4-matic, S 500/4-matic/EQ Boost/Hybrid/e/Maybach/Maybach 4-matic, S 560/4-matic/e/Maybach/Maybach 4-matic, S 600/Maybach, S 63 AMG/AMG 4-matic, S 65 AMG, S 650 Maybach	<ul style="list-style-type: none"> > New
			2014--> Maybach			

MERCEDES-BENZ						
Part #	Product Type	Position	Model Information	Vehicle Attributes	Product Attributes	
W/V/X222						
VB-3267			2013--> S-Class	w/AIRMATIC, w/ & w/o 4MATIC, Incl. AMG	AMG S 63 4-matic+, S 300 BlueTEC Hybrid/h, S 320, S 350 BlueTEC/d/BlueTEC 4-matic/d 4-matic, S 400/4-matic/d/d 4-matic/Hybrid/h, S 450/4-matic/EQ Boost/EQ Boost 4-matic/Maybach/Maybach 4-matic, S 500/4-matic/EQ Boost/Hybrid/e/Maybach/Maybach 4-matic, S 560/4-matic/e/Maybach/Maybach 4-matic, S 600/Maybach, S 63 AMG/AMG 4-matic, S 65 AMG, S 650 Maybach	<ul style="list-style-type: none"> > New
			2014--> Maybach			
VB-3427			2013--> S-Class	w/ & w/o 4MATIC, Incl. AMG	AMG S 63, S 300 BlueTEC Hybrid/h, S 320, S 350 BlueTEC/d, S 400/d/Hybrid/h, S 450/EQ Boost, S 500/EQ Boost/Hybrid/e/Maybach, S 560/e/Maybach, S 600/Maybach, S 63 AMG, S 65 AMG, S 650 Maybach	<ul style="list-style-type: none"> > New
			2014--> Maybach			
W/V251						
A-2587			2005-2014 R-Class	w/AIRMATIC & ADS, w/ & w/o 4MATIC, Incl. AMG	R 280/4-matic/CDI/CDI 4-matic, R 300/CDI/CDI 4-matic, R 320 CDI 4-matic, R 350/4-matic/CDI 4-matic/CGI 4-matic, R 500 4-matic, R 63 AMG 4-matic	<ul style="list-style-type: none"> > New Air Spring Only, Reuse Factory Shock
A-2597			2005-2014 R-Class	w/AIRMATIC, w/ & w/o ADS, w/ & w/o 4MATIC, Incl. AMG	R 280/4-matic/CDI/CDI 4-matic, R 300/CDI/CDI 4-matic, R 320 CDI 4-matic, R 350/4-matic/CDI 4-matic/CGI 4-matic, R 500 4-matic, R 63 AMG 4-matic	<ul style="list-style-type: none"> > New
AS-2394			2005-2014 R-Class	w/AIRMATIC & ADS, w/ & w/o 4MATIC, Incl. AMG	R 280/4-matic/CDI/CDI 4-matic, R 300/CDI/CDI 4-matic, R 320 CDI 4-matic, R 350/4-matic/CDI 4-matic/CGI 4-matic, R 500 4-matic	<ul style="list-style-type: none"> > Remanufactured
AS-2833			2005-2014 R-Class	w/AIRMATIC & ADS, w/ & w/o 4MATIC, Incl. AMG	R 280/4-matic/CDI/CDI 4-matic, R 300/CDI/CDI 4-matic, R 320 CDI 4-matic, R 350/4-matic/CDI 4-matic/CGI 4-matic, R 500 4-matic	<ul style="list-style-type: none"> > New
P-3215			2005-2014 R-Class	w/4-Corner leveling, w/ AIRMATIC & ADS, w/ & w/o 4MATIC, Incl. AMG	R 280/4-matic/CDI/CDI 4-matic, R 300/CDI/CDI 4-matic, R 320 CDI 4-matic, R 350/4-matic/CDI 4-matic/CGI 4-matic, R 500 4-matic, R 63 AMG 4-matic	<ul style="list-style-type: none"> > New
P-3281			2005-2014 R-Class	w/Rear leveling, w/ AIRMATIC, w/ & w/o ADS, w/ & w/o 4MATIC, Incl. AMG	R 280/4-matic/CDI/CDI 4-matic, R 300/CDI/CDI 4-matic, R 320 CDI 4-matic, R 350/4-matic/CDI 4-matic/CGI 4-matic, R 500 4-matic, R 63 AMG 4-matic	<ul style="list-style-type: none"> > New
SK-3217			2005-2014 R-Class	w/AIRMATIC & ADS, w/ & w/o 4MATIC, Non-AMG	R 320 CDI 4-matic, R 350/4-matic/CDI 4-matic/CGI 4-matic, R 500 4-matic	<ul style="list-style-type: none"> > New
SK-3218			2005-2014 R-Class	w/o AIRMATIC, w/o ADS, w/ & w/o 4MATIC, Incl. AMG	R 320 CDI 4-matic, R 350/4-matic/CDI 4-matic/CGI 4-matic, R 500 4-matic	<ul style="list-style-type: none"> > New

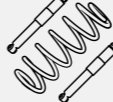

MERCEDES-BENZ						
Part #	Product Type	Position	Model Information	Vehicle Attributes	Product Attributes	
W/V251						
SK-3262			2005-2014 R-Class	w/AIRMATIC & ADS, w/4MATIC, Non-AMG	R 280/4-matic/CDI/CDI 4-matic, R 300/CDI/CDI 4-matic/CDI 4-matic, R 350/4-matic/CDI 4-matic/CGI 4-matic, R 500 4-matic	> Remanufactured
VB-3267			2010-2014 R-Class	w/AIRMATIC, w/ & w/o ADS, w/ & w/o 4MATIC, Incl. AMG	R 350 CDI 4-matic	
VB-3499			2005-2014 R-Class	w/o AIRMATIC, w/ & w/o 4MATIC, Incl. AMG	R 280/4-matic/CDI/CDI 4-matic, R 300/CDI/CDI 4-matic/CDI 4-matic, R 350/4-matic/CDI 4-matic/CGI 4-matic, R 500 4-matic	
W638						
P-2219			1996-2003 V-Class		V 200/CDI, V 220 CDI, V 230/TD, V 280	
W639						
A-2801			2003--> V-Class		3.0, 3.2, 3.5, 3.7, CDI 2.0/4-matic, CDI 2.2/4-matic, CDI 3.0	
X253						
A-3313			2015--> GLC-Class	w/AIRMATIC, w/ & w/o 4MATIC, Incl. Hybrid, Incl. AMG	200 d/d 4-matic/EQ Boost/EQ Boost 4-matic, 220 d/d 4-matic, 250 4-matic/d 4-matic, 300 4-matic/d 4-matic/EQ Boost 4-matic, 350 d 4-matic, 400 d 4-matic, AMG 434-matic/63 4-matic+/63 S 4-matic+	
A-3314			2015--> GLC-Class	w/AIRMATIC, w/ & w/o 4MATIC, Incl. Hybrid, Incl. AMG	200 d/d 4-matic/EQ Boost/EQ Boost 4-matic, 220 d/d 4-matic, 250 4-matic/d 4-matic, 300 4-matic/d 4-matic/EQ Boost 4-matic, 350 d 4-matic, 400 d 4-matic, AMG 434-matic/63 4-matic+/63 S 4-matic+	

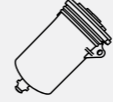
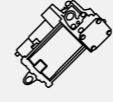
MERCURY						
Part #	Product Type	Position	Model Information	Vehicle Attributes	Product Attributes	
Panther						
A-2105			1992-2011 Grand Marquis		4.6 Liter V8	
A-2220			1992-2011 Grand Marquis		4.6 Liter V8	> Heavy Duty for Limousine Use
C-2614			1992-2002 Grand Marquis		4.6 Liter V8	
C-2615			2003-2011 Grand Marquis		4.6 Liter V8	
D-2171			1992-2011 Grand Marquis		4.6 Liter V8	
P-2936			1992-2011 Grand Marquis		4.6 Liter V8	

AIR SUSPENSION DRYER

- New two-hole air suspension dryer assembly for the Mercury Grand Marquis
- Manufactured with the highest-quality components
- Maintenance-free
- D-2171





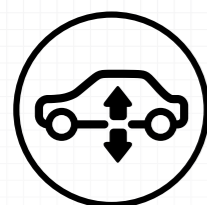
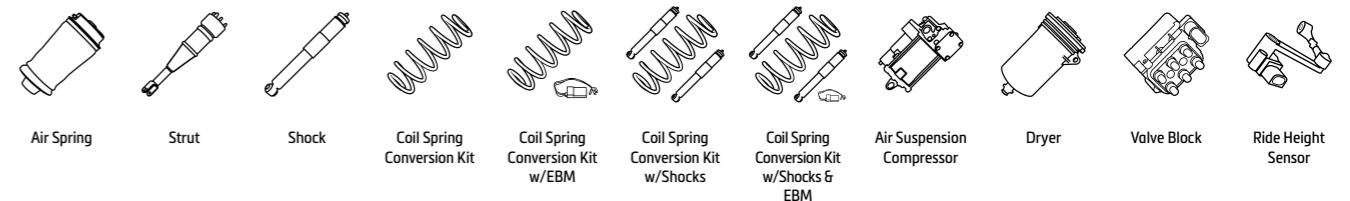







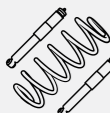



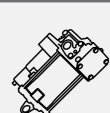
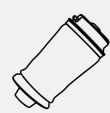

D-2171

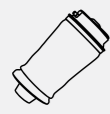

TECH TIP: CAR HEIGHT

The height of the car is not determined by the air spring, but by the height sensors.

NISSAN						
Part #	Product Type	Position	Model Information	Vehicle Attributes		Product Attributes
WA60						
AS-3284			2003-2006 Armada	4 Wheel Drive (4WD)	5.6 4x4	> New
C-3421			2003-2015 Armada	4 Wheel Drive (4WD)	5.6 4x4	
C-3434			2006-2015 Armada	Rear Wheel Drive (RWD)	5.6	
P-3277			2003-2015 Armada	4 Wheel Drive (4WD) & Rear Wheel Drive (RWD)	5.6, 5.6 4x4	
X70						
A-3292			2002-2010 Interstar Box/Bus	dCi 100, dCi 115, dCi 120, dCi 140, dCi 150, dCi 80, dCi 90		

OLDSMOBILE						
Part #	Product Type	Position	Model Information	Vehicle Attributes		Product Attributes
G Platform						
AS-2190			1995-2003 Aurora			> New > Sold in Pairs
SK-2189			1998-2003 Aurora			> New > Sold in Pairs
GMT360						
A-2610			2002-2004 Bravada			> Generation II > Crimped Assembly, Improved Design
C-2137			2002-2004 Bravada			

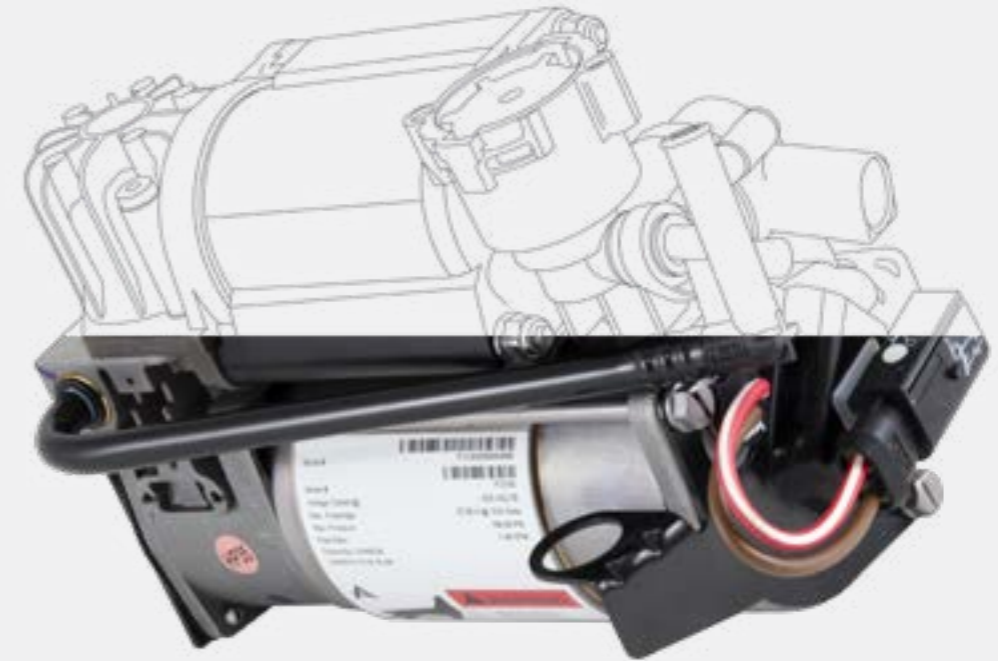

Air suspension compressors inflate or deflate air spring bags to maintain a vehicle's factory designated height. Compressor burnout is one of the most frequent air suspension system problems and is often due to overuse caused by leaking air springs or air struts. When the vehicle is not at the correct height due to leaks in the system, the compressor repeatedly cycles to maintain pressure - ultimately leading to its failure.

Arnott's compressors are direct OE replacements and are vigorously tested to ensure a long life and reduced failure rates.





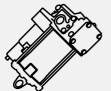

THE ARNOTT ADVANTAGE

- ▲ Meets OE specifications
- ▲ Electrocoated epoxy finish to prevent corrosion
- ▲ Maintenance-free integrated air dryers
- ▲ Most Arnott compressors are fully assembled, including application-specific air lines, wiring harness & brackets
- ▲ Assembled & tested in the USA & EU
- ▲ Includes thermal overload protection
- ▲ Fast, flawless plug & play installation

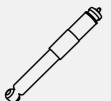
OPEL					
Part #	Product Type	Position	Model Information	Vehicle Attributes	Product Attributes
X70					
A-3292			1999-2010 Movano Combi	JD - 1.9 DTI, 2.2 DTI, 2.5 CDTI/D/DTI, 2.8 DTI, 3.0 DTI	
			1998-2010 Movano Platform/Chassis	ED, HD, UDO, UD4 - 2.2 DTI, 2.5 CDTI/D/DTI, 2.8 DTI, 3.0 DTI	
			1998-2010 Movano Box	FD - 1.9 DTI, 2.2 DTI, 2.5 CDTI/D/DTI, 2.8 DTI, 3.0 DTI	
			1999-2010 Movano Dump Truck	ED, HD, UDO, UD4 - 2.2 DTI, 2.5 CDTI/D/DTI, 2.8 DTI, 3.0 DTI	

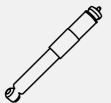









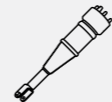

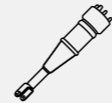



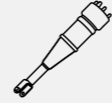

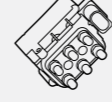

PEUGEOT					
Part #	Product Type	Position	Model Information	Vehicle Attributes	Product Attributes
VF3X_					
P-2851			2007--> Expert Tepee	1.6 HDi 90 16V/8V, 2.0 16V/HDi 120/HDi 120 4x4/HDi 140/HDi 165	> WABCO OES

PONTIAC					
Part #	Product Type	Position	Model Information	Vehicle Attributes	Product Attributes
G Platform					
AS-2190			2000-2004 Bonneville		> New > Sold in Pairs
SK-2189			2000-2004 Bonneville		> New > Sold in Pairs





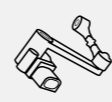



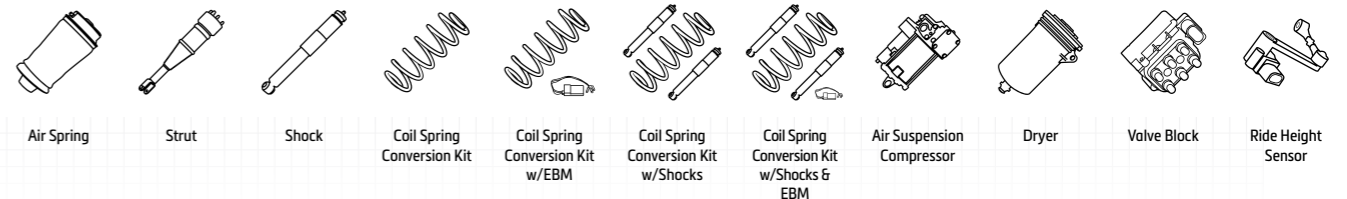

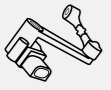



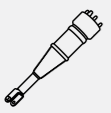

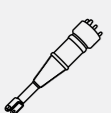

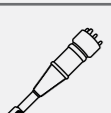

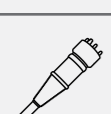

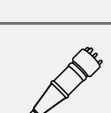

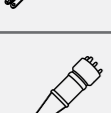

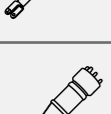

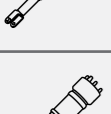

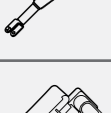
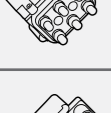

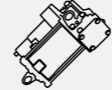

Extensive Testing

Arnott's engineers test every product for form, fit and functionality in both a lab setting and on the company's extensive fleet of vehicles.

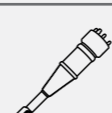

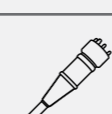



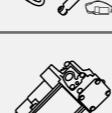
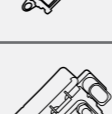

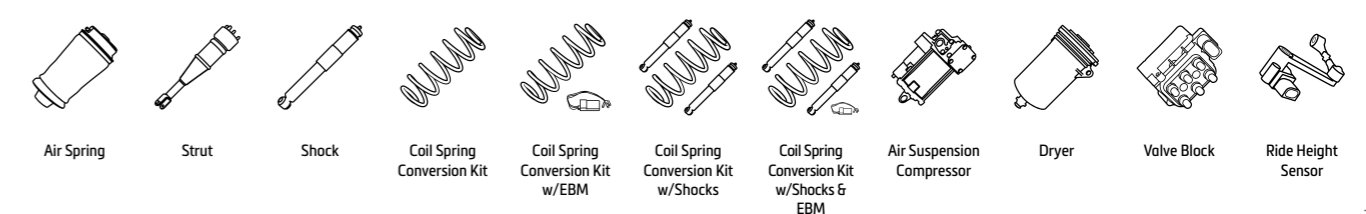
PORSCHE						
Part #	Product Type	Position	Model Information	Vehicle Attributes	Product Attributes	
92A						
AS-3056			2010--> Cayenne	w/Auto Leveling	3.0 Diesel/S E-Hybrid, 3.6/GTS/S, 4.2 S Diesel, 4.8 GTS/S/Turbo/Turbo S	> Remanufactured
AS-3057			2010--> Cayenne	w/Auto Leveling	3.0 Diesel/S E-Hybrid, 3.6/GTS/S, 4.2 S Diesel, 4.8 GTS/S/Turbo/Turbo S	> Remanufactured
AS-3166			2010--> Cayenne	w/Auto Leveling	3.0 Diesel/S E-Hybrid, 3.6/GTS/S, 4.2 S Diesel, 4.8 GTS/S/Turbo/Turbo S	> New > Eibach Shock Absorber
AS-3167			2010--> Cayenne	w/Auto Leveling	3.0 Diesel/S E-Hybrid, 3.6/GTS/S, 4.2 S Diesel, 4.8 GTS/S/Turbo/Turbo S	> New > Eibach Shock Absorber
AS-3235			2010-->Cayenne	w/Auto Leveling	3.0 Diesel/S E-Hybrid, 3.6/GTS/S, 4.2 S Diesel, 4.8 GTS/S/Turbo/Turbo S	> New > Extended Travel & Improved Design
AS-3236			2010--> Cayenne	w/Auto Leveling	3.0 Diesel/S E-Hybrid, 3.6/GTS/S, 4.2 S Diesel, 4.8 GTS/S/Turbo/Turbo S	> New > Extended Travel & Improved Design
VB-3470			2010--> Cayenne	w/Auto Leveling	3.0 Diesel/S E-Hybrid, 3.6/GTS/S, 4.2 S Diesel, 4.8 GTS/S/Turbo/Turbo S	
95B						
A-3327			2014--> Macan	w/Auto Leveling	2.0, 3.0 GTS/S/S Diesel, 3.6 Turbo	
A-3328			2014--> Macan	w/Auto Leveling	2.0, 3.0 GTS/S/S Diesel, 3.6 Turbo	
AS-3351			2014--> Macan	w/Auto Leveling	2.0, 3.0 GTS/S/S Diesel, 3.6 Turbo	> New > Eibach Shock Absorber
RH-3459			2014--> Macan		2.0, 3.0 GTS/S/S Diesel, 3.6 Turbo	

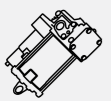
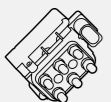

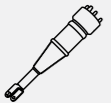

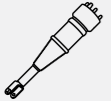

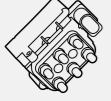

PORSCHE					
Part #	Product Type	Position	Model Information	Vehicle Attributes	Product Attributes
95B					
RH-3460			2014--> Macan	2.0, 3.0 GTS/S/S Diesel, 3.6 Turbo	
970					
A-3306			2009-2016 Panamera	3.0 4S/D/S/S E-Hybrid, 3.6/4, 4.8 4S/GTS/S/Turbo/Turbo S	
AS-3035			2009-2013 Panamera	3.0 D/S E-Hybrid, 3.6/4, 4.8 4S/GTS/S/Turbo/Turbo S	> Remanufactured
AS-3036			2009-2013 Panamera	3.0 D/S E-Hybrid, 3.6/4, 4.8 4S/GTS/S/Turbo/Turbo S	> Remanufactured
AS-3037			2013-2016 Panamera	3.0 4S/D/S/S E-Hybrid, 3.6/4, 4.8 GTS/Turbo/Turbo S	> Remanufactured
AS-3038			2013-2016 Panamera	3.0 4S/D/S/S E-Hybrid, 3.6/4, 4.8 GTS/Turbo/Turbo S	> Remanufactured
AS-3345			2009-2013 Panamera	w/ & w/o AWD 3.0 D/S E-Hybrid, 3.6/4, 4.8 4S/GTS/S/Turbo/Turbo S	> New > Eibach Shock Absorber
AS-3346			2009-2013 Panamera	w/ & w/o AWD 3.0 D/S E-Hybrid, 3.6/4, 4.8 4S/GTS/S/Turbo/Turbo S	> New > Eibach Shock Absorber
AS-3376			2013-2016 Panamera	3.0 4S/D/S/S E-Hybrid, 3.6/4, 4.8 GTS/Turbo/Turbo S	> New > Eibach Shock Absorber
AS-3377			2013-2016 Panamera	3.0 4S/D/S/S E-Hybrid, 3.6/4, 4.8 GTS/Turbo/Turbo S	> New > Eibach Shock Absorber
VB-3470			2009-2016 Panamera	3.0 4S/D/S/S E-Hybrid, 3.6/4, 4.8 4S/GTS/S/Turbo/Turbo S	
VB-3489			2009-2016 Panamera	Excl. Hybrid 3.0 4S/D/S/S E-Hybrid, 3.6/4, 4.8 4S/GTS/S/Turbo/Turbo S	

PORSCHE					
Part #	Product Type	Position	Model Information	Vehicle Attributes	Product Attributes
971					
P-3477			2016--> Panamera	2.9 4, 2.9 4 E-Hybrid, 2.9 4S, 3.0, 3.0 4, 4.0 GTS, 4.0 S 4 Diesel, 4.0 Turbo, 4.0 Turbo S E-Hybrid	> WABCO OES
			2017--> Panamera Sport Turismo	2.9 4, 2.9 4 E-Hybrid, 2.9 4S, 3.0, 3.0 4, 4.0 GTS, 4.0 S 4 Diesel, 4.0 Turbo, 4.0 Turbo S E-Hybrid	
9PA					
A-2523			2002-2010 Cayenne	3.0 TDI, 3.2, 3.6, GTS 4.8, S 4.5/4.8, Turbo 4.5/S 4.5/S 4.8	
A-2571			2002-2010 Cayenne	3.0 TDI, 3.2, 3.6, GTS 4.8, S 4.5/4.8, Turbo 4.5/S 4.5/S 4.8	
A-2572			2002-2010 Cayenne	3.0 TDI, 3.2, 3.6, GTS 4.8, S 4.5/4.8, Turbo 4.5/S 4.5/S 4.8	
AS-3164			2002-2010 Cayenne	3.0 TDI, 3.2, 3.6, GTS 4.8, S 4.5/4.8, Turbo 4.5/S 4.5/S 4.8	> New
AS-3165			2002-2010 Cayenne	3.0 TDI, 3.2, 3.6, GTS 4.8, S 4.5/4.8, Turbo 4.5/S 4.5/S 4.8	> New
C-2616			2002-2010 Cayenne	w/o PDCC, w/o Diesel Engine, w/o Adaptive Headlights 3.2, 3.6, GTS 4.8, S 4.5/4.8, Turbo 4.5/S 4.5/S 4.8	> Gas Engine Only
P-2496			2002-2010 Cayenne	3.0 TDI, 3.2, 3.6, GTS 4.8, S 4.5/4.8, Turbo 4.5/S 4.5/S 4.8	> WABCO OES
VB-3470			2002-2010 Cayenne	3.0 TDI, 3.2, 3.6, GTS 4.8, S 4.5/4.8, Turbo 4.5/S 4.5/S 4.8	

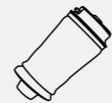

RAM						
Part #	Product Type	Position	Model Information	Vehicle Attributes	Product Attributes	
D2, DJ						
P-3480			2010--> 3500	Crew Cab Pickup Extended Cab Pickup Standard Cab Pickup	6.7 D 4WD	
VB-3496			2010--> 2500 2010--> 3500	Crew Cab Pickup Extended Cab Pickup Standard Cab Pickup Crew Cab Pickup Standard Cab Pickup	5.7 4WD/CNG 4WD, 6.7 D 4WD 5.7 4WD, 6.7 D 4WD 5.7 CNG 4WD 6.7 D 4WD	
DS						
A-3016			2010--> 1500	Crew Cab Pickup Standard Cab Pickup	3.6 4WD, 5.7 4WD 3.0 TD/3.6 4WD, 5.7 4WD	
AS-3017			2010--> 1500	Crew Cab Pickup Extended Cab Pickup Standard Cab Pickup	3.6/5.7 4WD 3.0 TD 4WD, 5.7 4WD 3.6/5.7 4WD	> New > Eibach Shock Absorber
AS-3618			2013--> 1500 Rebel	Crew Cab Pickup Extended Cab Pickup Standard Cab Pickup	3.0 TD 4WD, 3.6 4WD 3.0 TD 4WD 3.0 TD 4WD, 3.6, 3.6 4WD	> New > Eibach Shock Absorber
SK-3556			2010--> 1500	Crew Cab Pickup Extended Cab Pickup Standard Cab Pickup	3.6/5.7 4WD 3.0 TD 4WD, 5.7 4WD 3.6/5.7 4WD	> New > Eibach Shock Absorber
VB-3496			2010--> 1500	Crew Cab Pickup Extended Cab Pickup Standard Cab Pickup	3.6 4WD, 5.7/4WD 3.0 TD 4WD, 5.7/4WD 3.0 TD/3.6 4WD, 5.7/4WD	

RENAULT						
Part #	Product Type	Position	Model Information	Vehicle Attributes	Product Attributes	
ED, FD, HD, JD, UD						
A-3292			1998-2010 Master II Box 1998-2010 Master II Bus 1998-2010 Master II Platform/Chassis	1.9 dCi 80/dTi, 2.2 dCi 90, 2.5 D/dCi/dCi 100 (FD0U, FD0V)/dCi 120, 2.8 dTi, 3.0 dCi 140 (HD0S, FD0S, HD1S) 1.9 dCi 80/dTi, 2.2 dCi 90, 2.5 D/dCi/dCi 100 (JD0V)/dCi 120, 2.8 dTi, 3.0 dCi 140 (JD0T) 2.2 dCi 90, 2.5 D/dCi/dCi 100 (ED4V, ED8V)/dCi 120, 2.8 dTi, 3.0 dCi 140 (ED0S, UD0S)		

SAAB						
Part #	Product Type	Position	Model Information	Vehicle Attributes	Product Attributes	
GMT360						
A-2610			2004-2012 9-7X		4.2/5.3 AWD	> Generation II > Crimped Assembly, Improved Design
C-2137			2004-2012 9-7X		4.2/5.3 AWD	

WABCO AIR SUSPENSION COMPRESSOR





- Replacement air suspension compressor for RAM 3500
- Includes integrated air dryer
- Quiet operation
- P-3480



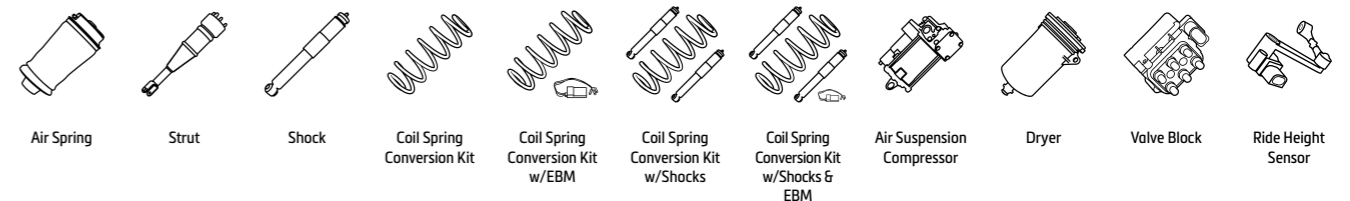

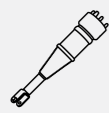

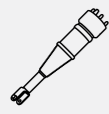

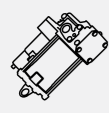

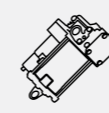
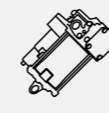

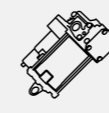

ARNOTT NEW AIR SPRING

- Rear air spring for Renault Master II
- Universal air spring - fits left and right
- OE quality air sleeve
- Heavy-duty crimping rings
- A-3292

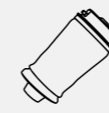

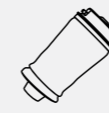
TESLA					
Part #	Product Type	Position	Model Information	Vehicle Attributes	Product Attributes
5YJS					
AS-3380			2016--> Model S	w/AWD 60/75/100/P100D AWD	> New > Eibach Shock Absorber
AS-3381			2016--> Model S	60, 75, 60/75/100/P100D AWD	> New > Eibach Shock Absorber
P-3509			2015--> Model S	60, 60D AWD, 70, 70D, 70D AWD, 75, 75D AWD, 85, 85D, P85D, 90D AWD, P90D AWD, 100D AWD, P100D AWD	> WABCO OES

TOYOTA					
Part #	Product Type	Position	Model Information	Vehicle Attributes	Product Attributes
1st Generation					
P-3190			2000-2007 Sequoia	4.6/4.7/5.7, 4.7/5.7 4WD	> OES
2nd Generation					
P-3189			2007--> Sequoia	4.6, 4.7/4WD, 5.7/4WD/FLEX 4WD	> OES
J120					
A-2949			2002-2010 Land Cruiser Prado	3.0 D/D-4D, 4.0/ V6 VVT-i	
			2002-2009 4 Runner	4.0, 4.7	
C-2410			2002-2010 Land Cruiser Prado	3.0 D/D-4D, 4.0	
P-3192			2002-2010 Land Cruiser Prado	3.0 D/D-4D, 4.0/ V6 VVT-i	> OES
SK-2812			2002-2010 Land Cruiser Prado	3.0 D/D-4D, 4.0	> New
SK-2813			2002-2010 Land Cruiser Prado	3.0 D/D-4D, 4.0	> New
J15					
A-3331			2009-->Land Cruiser Prado	2.7, 2.8 D-4D, 3.0 D/D-4D/TDi, 3.5, 4.0 V6 Dual VVTi/V6 VVTi	
			2010--> 4 Runner	2.7, 4.0	
A-3332			2009--> Land Cruiser Prado	2.7, 2.8 D-4D, 3.0 D/D-4D/TDi, 3.5, 4.0 V6 Dual VVTi/V6 VVTi	
			2010--> 4 Runner	2.7, 4.0	

ARNOTT NEW AIR STRUTS

- Front and rear air struts for Tesla Model S
- New custom-tuned damper
 - > Precision-tuned to mimic an OE ride
- Continental ContiTech air sleeve
 - > Premium multi-ply, cross-corded construction
 - > Longer-lasting design using advanced materials
- Designed and assembled in the USA
- AS-3380 (front) & AS-3381 (rear)

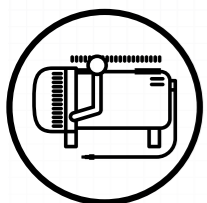

TECH TIP: COMPRESSOR PROBLEMS









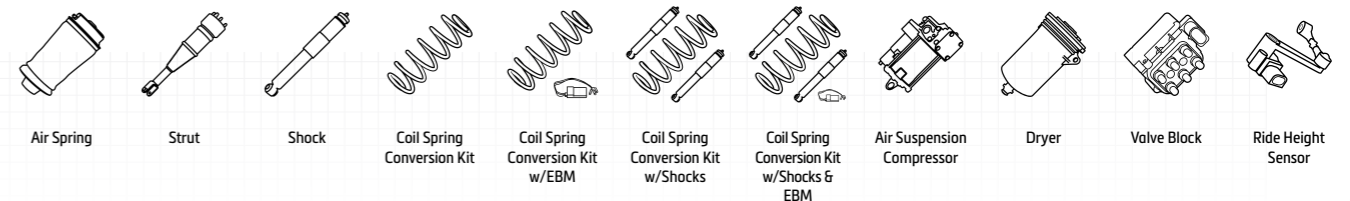

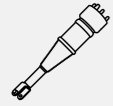

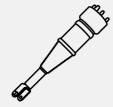

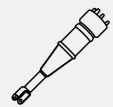

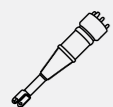

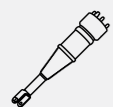

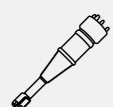

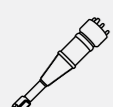

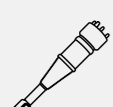

An air suspension compressor failure is usually caused by a leak in the system. After replacement, check the air springs and other components and immediately replace any leaking components or the pump will fail again, voiding the warranty.



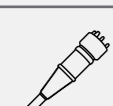

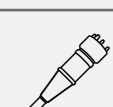





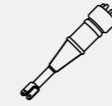

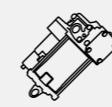
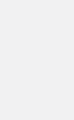







TECH TIP: LEAKS





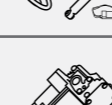
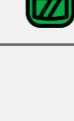
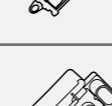

An air suspension leak is easy to find by spraying the air springs, struts and fittings with a soap and water solution. Bubbles will indicate where the leak or leaks are.

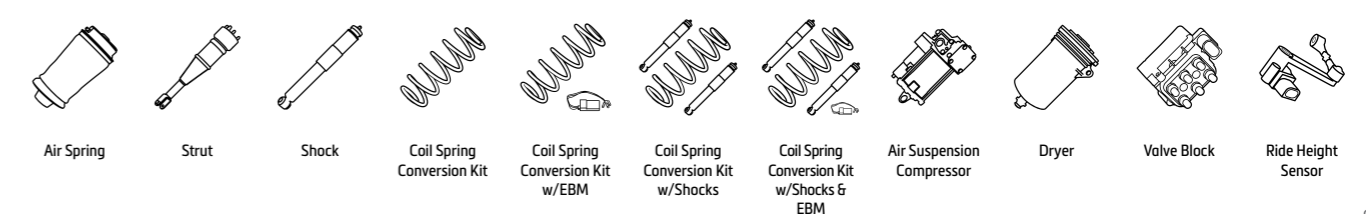

VOLKSWAGEN					
Part #	Product Type	Position	Model Information	Vehicle Attributes	Product Attributes
7P5, 7P6					
AS-3056			2010-2018 Touareg	w/Auto Leveling 3.0 V6 TDI/TSI Hybrid/ FSI, 4.2 V8 FSI/TDI	> Remanufactured
AS-3057			2010-2018 Touareg	w/Auto Leveling 3.0 V6 TDI/TSI Hybrid/ FSI, 4.2 V8 FSI/TDI	> Remanufactured
AS-3235			2010-2018 Touareg	w/Auto Leveling 3.0 V6 TDI/TSI Hybrid/ FSI, 4.2 V8 FSI/TDI	> New > Extended Travel & Improved Design
AS-3236			2010-2018 Touareg	w/Auto Leveling 3.0 V6 TDI/TSI Hybrid/ FSI, 4.2 V8 FSI/TDI	> New > Extended Travel & Improved Design
D1					
AS-2580			2002-2016 Phaeton	3D1, 3D2, 3D3, 3D4, 3D6, 3D7, 3D8, 3D9 - 3.0 V6 TDI 4motion, 3.2 V6/V6 4motion, 4.2 V8 4motion, 5.0 V10 TDI 4motion, 6.0 W12 4motion	> Remanufactured
AS-2581			2002-2016 Phaeton	3D1, 3D2, 3D3, 3D4, 3D6, 3D7, 3D8, 3D9 - 3.0 V6 TDI 4motion, 3.2 V6/V6 4motion, 4.2 V8 4motion, 5.0 V10 TDI 4motion, 6.0 W12 4motion	> Remanufactured
AS-2892			2002-2016 Phaeton	3D1, 3D2, 3D3, 3D4, 3D6, 3D7, 3D8, 3D9 - 3.0 V6 TDI 4motion, 3.2 V6/V6 4motion, 4.2 V8 4motion, 5.0 V10 TDI 4motion, 6.0 W12 4motion	> New
AS-2893			2002-2016 Phaeton	3D1, 3D2, 3D3, 3D4, 3D6, 3D7, 3D8, 3D9 - 3.0 V6 TDI 4motion, 3.2 V6/V6 4motion, 4.2 V8 4motion, 5.0 V10 TDI 4motion, 6.0 W12 4motion	> New
AS-2968			2002-2016 Phaeton	3D1, 3D2, 3D3, 3D4, 3D6, 3D7, 3D8, 3D9 - 3.0 V6 TDI 4motion, 3.2 V6/V6 4motion, 4.2 V8 4motion, 5.0 V10 TDI 4motion, 6.0 W12 4motion	> Remanufactured
AS-2969			2002-2016 Phaeton	3D1, 3D2, 3D3, 3D4, 3D6, 3D7, 3D8, 3D9 - 3.0 V6 TDI 4motion, 3.2 V6/V6 4motion, 4.2 V8 4motion, 5.0 V10 TDI 4motion, 6.0 W12 4motion	> Remanufactured
AS-3127			2002-2016 Phaeton	3D1, 3D2, 3D3, 3D4, 3D6, 3D7, 3D8, 3D9 - 3.0 V6 TDI 4motion, 3.2 V6/V6 4motion, 4.2 V8 4motion, 5.0 V10 TDI 4motion, 6.0 W12 4motion	> New > Eibach Shock Absorber
AS-3128			2002-2016 Phaeton	3D1, 3D2, 3D3, 3D4, 3D6, 3D7, 3D8, 3D9 - 3.0 V6 TDI 4motion, 3.2 V6/V6 4motion, 4.2 V8 4motion, 5.0 V10 TDI 4motion, 6.0 W12 4motion	> New > Eibach Shock Absorber
AS-3129			2002-2016 Phaeton	3D1, 3D2, 3D3, 3D4, 3D6, 3D7, 3D8, 3D9 - 3.0 V6 TDI 4motion, 3.2 V6/V6 4motion, 4.2 V8 4motion, 5.0 V10 TDI 4motion, 6.0 W12 4motion	> New > Eibach Shock Absorber

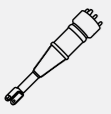
VOLKSWAGEN					
Part #	Product Type	Position	Model Information	Vehicle Attributes	Product Attributes
D1					
AS-3130			2002-2016 Phaeton	3D1, 3D2, 3D3, 3D4, 3D6, 3D7, 3D8, 3D9 - 3.0 V6 TDI 4motion, 3.2 V6/V6 4motion, 4.2 V8 4motion, 5.0 V10 TDI 4motion, 6.0 W12 4motion	> New > Eibach Shock Absorber
P-2740			2002-2016 Phaeton	3D1, 3D2, 3D3, 3D4, 3D6, 3D7, 3D8, 3D9 - 3.0 V6 TDI 4motion, 3.2 V6/V6 4motion, 4.2 V8 4motion, 5.0 V10 TDI 4motion, 6.0 W12 4motion	> WABCO OES
7L					
A-2523			2002-2010 Touareg	7LA, 7L6, 7L7 - 2.5 R5 TDI, 3.0 TDI/V6 TDI, 3.2 V6, 3.6 V6 FSI, 4.2 V8/V8 FSI, 5.0 R50 TDI/V10 TDI, 6.0 W12	
A-2571			2002-2010 Touareg	7LA, 7L6, 7L7 - 2.5 R5 TDI, 3.0 TDI/V6 TDI, 3.2 V6, 3.6 V6 FSI, 4.2 V8/V8 FSI, 5.0 R50 TDI/V10 TDI, 6.0 W12	
A-2572			2002-2010 Touareg	7LA, 7L6, 7L7 - 2.5 R5 TDI, 3.0 TDI/V6 TDI, 3.2 V6, 3.6 V6 FSI, 4.2 V8/V8 FSI, 5.0 R50 TDI/V10 TDI, 6.0 W12	
AS-3164			2002-2010 Touareg	7LA, 7L6, 7L7 - 2.5 R5 TDI, 3.0 TDI/V6 TDI, 3.2 V6, 3.6 V6 FSI, 4.2 V8/V8 FSI, 5.0 R50 TDI/V10 TDI, 6.0 W12	> New
AS-3165			2002-2010 Touareg	7LA, 7L6, 7L7 - 2.5 R5 TDI, 3.0 TDI/V6 TDI, 3.2 V6, 3.6 V6 FSI, 4.2 V8/V8 FSI, 5.0 R50 TDI/V10 TDI, 6.0 W12	> New
C-2616			2002-2010 Touareg	w/o PDCC, w/o Diesel Engine, w/o Adaptive Headlights	3.2 V6, 3.6 V6 FSI, 4.2 V8/ V8 FSI, 6.0 W12 > Gas Engine Only
C-3419			2002-2010 Touareg	7LA, 7L6, 7L7 - 2.5 R5 TDI, 3.0 TDI/V6 TDI, 3.2 V6, 3.6 V6 FSI, 4.2 V8/V8 FSI, 5.0 R50 TDI/V10 TDI, 6.0 W12	
P-2496			2002-2010 Touareg	7LA, 7L6, 7L7 - 2.5 R5 TDI, 3.0 TDI/V6 TDI, 3.2 V6, 3.6 V6 FSI, 4.2 V8/V8 FSI, 5.0 R50 TDI/V10 TDI, 6.0 W12	> WABCO OES
VB-3470			2002-2010 Touareg	7LA, 7L6, 7L7 - 2.5 R5 TDI, 3.0 TDI/V6 TDI, 3.2 V6, 3.6 V6 FSI, 4.2 V8/V8 FSI, 5.0 R50 TDI/V10 TDI, 6.0 W12	

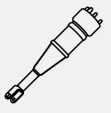

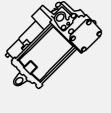
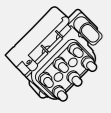
VOLVO						
Part #	Product Type	Position	Model Information	Vehicle Attributes	Product Attributes	
SPA Platform						
A-3307			2014--> XC90	w/Auto Leveling, Excl. Hybrid	2.0 T5/T6 AWD, D4/AWD, D5 AWD, T5 AWD, T6 AWD/Polestar AWD	
			2016--> V90 Cross Country		2.0 D3/D3 AWD/D4/D4 AWD/D5 AWD/Polestar AWD/T4/T5/T5 AWD/T6 AWD/T6 Polestar AWD	
			2017--> XC60		2.0 D3/D4/D4 AWD/D4 Polestar AWD/D5 AWD/T4/T5/T5 AWD/T5 Polestar AWD/T6 AWD/T6 Polestar AWD	
AS-3343			2014--> XC90	w/Auto Leveling, Excl. Hybrid	2.0 D5 Polestar AWD/T5 AWD/T6 AWD, D4/AWD, D5 AWD, T5 AWD/Polestar AWD, T6 AWD/Polestar AWD, T8 Twin Engine AWD	> New > Eibach Shock Absorber
AS-3344			2014--> XC90	w/Auto Leveling, Excl. Hybrid	2.0 D5 Polestar AWD/T5 AWD/T6 AWD, D4/AWD, D5 AWD, T5 AWD/Polestar AWD, T6 AWD/Polestar AWD, T8 Twin Engine AWD	> New > Eibach Shock Absorber
P-3476			2014--> XC90	w/Auto Leveling, Excl. Hybrid	2.0 D5 Polestar AWD/T5 AWD/T6 AWD, D4/AWD, D5 AWD, T5 AWD/Polestar AWD, T6 AWD/Polestar AWD, T8 Twin Engine AWD	
			2016--> S90		2.0/D3/D4/D4 AWD/D5 AWD/D5 Polestar AWD/T4/T4 Polestar/T5/T5 Drive-E Polestar/T6 AWD/T6 Drive-E Polestar AWD, D4 Drive-E Polestar	
			2016--> V90 Cross Country		2.0 D3/D3 AWD/D4/D4 AWD/D4 Polestar/D5 AWD/Polestar AWD/T4/T4 Polestar/T5/T5 AWD/T5 Polestar/T5 Polestar AWD/T6 AWD/T6 Polestar AWD	
			2017--> XC60		2.0 D3/D4/D4 AWD/D4 Polestar/D4 Polestar AWD/D5 AWD/D5 Polestar AWD/T4/T5/T5 AWD/T5 Polestar AWD/T6 AWD/T6 Polestar AWD, T4/S Polestar, T5/6 Polestar AWD	
VB-3498			2014--> XC90	w/Auto Leveling, Excl. Hybrid	2.0 T5/T6 AWD, D4/AWD, D5 AWD, T5 AWD, T6 AWD/Polestar AWD	
			2017--> XC60		2.0 D3/D4/D4 AWD/D4 Polestar AWD/D5 AWD/T4/T5/T5 AWD/T5 Polestar AWD/T6 AWD/T6 Polestar AWD	

Arnott's multi-step remanufacturing process not only ensures that the remanufactured strut is made to our exacting standards, but includes multiple quality checks along the way.

1. Each strut is inspected, disassembled, steam cleaned and spin blasted to bare metal. Our proprietary process replaces old, used oil with new high-performance shock oil.
2. The worn internal components are replaced and the recharged shock is sealed with a new CNC-machined aluminum top.
3. Each shock is computer Dyno-tested to ensure OE durability and performance.
4. Arnott adds a protective, professional finish with corrosion-inhibiting paint and Arnott's skilled assemblers rebuild each strut by hand.
5. New, longer-lasting seals, a multi-ply name-brand air sleeve, heavy-duty crimping rings and other Tier 1 components round out the remanufacturing process.

Only the best are delivered to our customers.

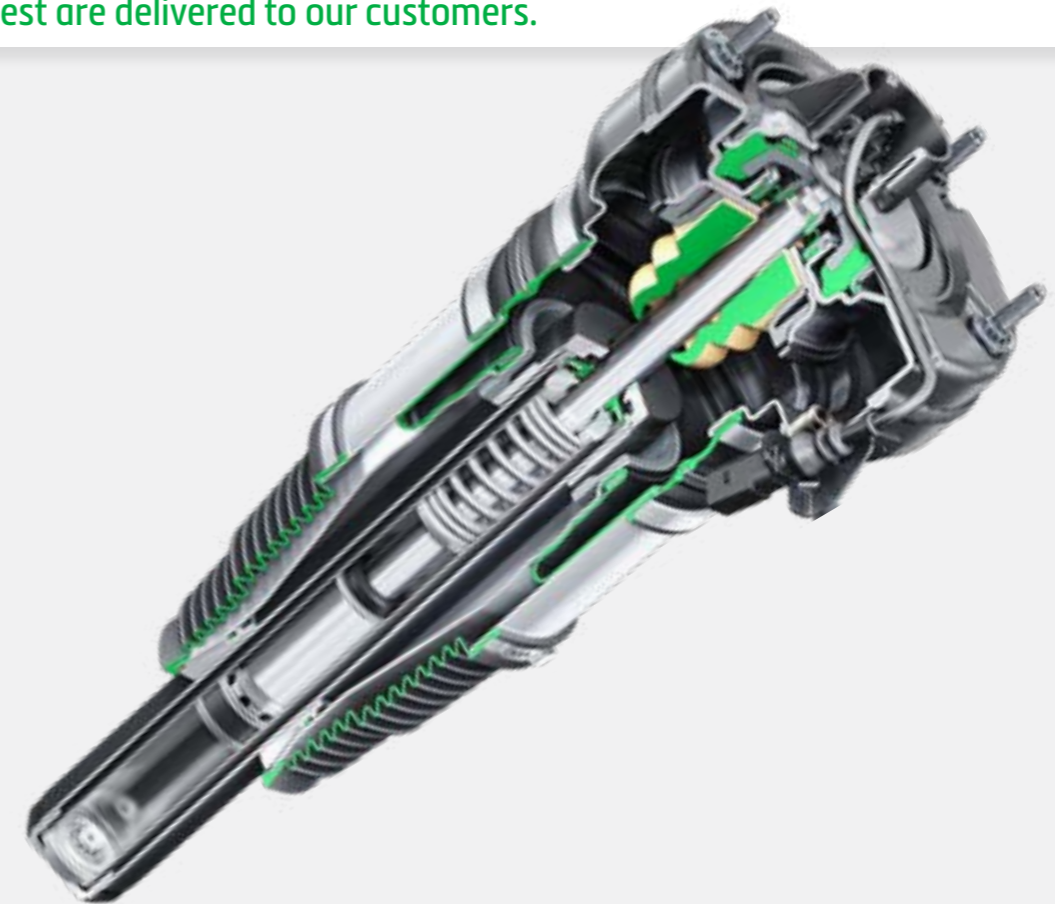

ARNOTT NEW AIR STRUTS

- Front left & right air struts for Volvo XC90 (SPA)
- Eibach monotube damper
 - > Precision-tuned to mimic an OE ride
- Continental ContiTech air sleeve
 - > Premium multi-ply, cross-corded construction
 - > Longer-lasting design using advanced materials
- Designed, assembled & tested in the USA



THE ARNOTT ADVANTAGE

- ▲ Works with vehicle's auto damping & leveling system
- ▲ Exact fit & functionality of OE
- ▲ Arnott-engineered to improve strut longevity
- ▲ Plug & play installation is identical to OE

OEM CROSS REFERENCE TABLE

Arnott Item #	OEM #									
Audi										
A-2133	4Z7616051A	4Z7616052A								
A-2523	95535850300	95535850310	95535850320	95535850321	95535850322	95535850330	95535850331	95535850332	7L6616503	7L6616503A
	7L6616503B	7L6616503B								
A-2571	95535840400	95535840410	95535840420	95535840421	95535840430	95535840431	7L5616404	7L5616404B	7L5616404E	7L6616404
	7L6616404A	7L6616404B	7L8616404A	7L8616404B	7L8616404D	7L8616404G	7L8616404H	7L8616404	7L8616404A	7L8616404B
A-2572	95535840300	95535840310	95535840320	95535840321	95535840330	95535840331	7L5616403	7L5616403B	7L5616403E	7L6616403
	7L6616403A	7L6616403B	7L8616039A	7L8616039B	7L8616039D	7L8616039G	7L8616039H	7L8616403	7L8616403A	7L8616403B
A-2731	4Z7616051A (LT)	4Z7616052A (RT)								
A-2869	4Z7616051	4Z7616051B	4Z7616051D							
A-2885	4Z7616051	4Z7616051B	4Z7616051D							
A-2960	4F0616001	4F0616001J								
A-3294	4G0616001	4G0616001AA	4G0616001K	4G0616001Q	4G0616001R	4G0616001S	4G0616001T			
A-3295	4G0616002	4G0616002AA	4G0616002K	4G0616002Q	4G0616002R	4G0616002S	4G0616002T			
AS-2560	4E0616040AB	4E0616040AF	4E0616040AH	4E0616040AM	4E0616040R	4E0616040T	4E0616040AB			
AS-2561	4E0616039AB	4E0616039AF	4E0616039AH	4E0616039AM	4E0616039R	4E0616039T				
AS-2562	4E0616040AA	4E0616040AC	4E0616040AE	4E0616040AG	4E0616040AJ	4E0616040AK	4E0616040AN	4E0616040AP	4E0616040S	
AS-2563	4E0616039AA	4E0616039AC	4E0616039AE	4E0616039AG	4E0616039AJ	4E0616039AK	4E0616039AN	4E0616039AP	4E0616039S	
AS-2775	4E0616040AB	4E0616040AF	4E0616040AH	4E0616040AM	4E0616040R	4E0616040T	4E0616040AB			
AS-2776	4E0616039AB	4E0616039AF	4E0616039AH	4E0616039AM	4E0616039R	4E0616039T				
AS-2777	4E0616040AA	4E0616040AC	4E0616040AE	4E0616040AG	4E0616040AJ	4E0616040AK	4E0616040AN	4E0616040AP	4E0616040S	
AS-2778	4E0616039AA	4E0616039AC	4E0616039AE	4E0616039AG	4E0616039AJ	4E0616039AK	4E0616039AN	4E0616039AP	4E0616039S	
AS-2864	4G0616039AD	4G0616039L	4G0616039N	4H0616039AB	4H0616039AD	4H0616039AK	4H0616039AP	4H0616039E	4H0616039F	4H0616039G
	4H0616039H	4H0616039M	4H0616039P	4H0616039R	4H0616039T	4H6616039E	4H6616039F	4H6616039G		
AS-2865	4H0616039A	4H0616039AA	4H0616039AC	4H0616039AE	4H0616039AF	4H0616039AH	4H0616039AJ	4H0616039AQ	4H0616039AR	4H0616039C
	4H0616039J	4H0616039S								
AS-2958	4E0616002	4E0616002D	4E0616002E	4E0616002G	4E0616002K	4E0616002M	4E0616002N	4E0616002Q	4E0616002R	
AS-2959	4E0616001	4E0616001D	4E0616001E	4E0616001G	4E0616001K	4E0616001M	4E0616001N	4E0616001Q	4E0616001R	
AS-2965	4E0616002A	4E0616002F	4E0616002H	4E0616002L	4E0616002P	4E0616002S	4E0616002T			
AS-2966	4E0616001A	4E0616001F	4E0616001H	4E0616001L	4E0616001P	4E0616001S	4E0616001T			
AS-3030	4E0616002	4E0616002D	4E0616002E	4E0616002G	4E0616002K	4E0616002M	4E0616002N	4E0616002Q	4E0616002R	
AS-3031	4E0616001	4E0616001D	4E0616001E	4E0616001G	4E0616001K	4E0616001M	4E0616001N	4E0616001Q	4E0616001R	
AS-3121	4H0616001AB	4H0616001AH	4H0616001AM	4H0616002AB	4H0616002AH	4H0616002M				
AS-3123	4G0616039AD	4G0616039L	4G0616039N	4H0616039AB	4H0616039AD	4H0616039AK	4H0616039AP	4H0616039E	4H0616039F	4H0616039G
	4H0616039H	4H0616039M	4H0616039P	4H0616039R	4H0616039T	4H6616039E	4H6616039F	4H6616039G		
AS-3164	7L6412021AG	7L6616039A	7L6616039D							
AS-3165	7L6412022AG	7L6616040A	7L6616040D							
AS-3222	4Z7413031	4Z7413031A	4Z7413032	4Z7616051	4Z7616051B	4Z7616051D				
AS-3223	4Z7513031	4Z7513031A	4Z7513032	4Z7513032A	4Z7616051A	4Z7616052A				
AS-3230	4Z7413031	4Z7413031A	4Z7413032	4Z7616051	4Z7616051B	4Z7616051D				
AS-3231	4Z7513031	4Z7513031A	4Z7513032	4Z7513032A	4Z7616051A	4Z7616052A				
AS-3309	4G0616039AB	4G0616039AC	4G0616039AD	4G0616039AF	4G0616039AK	4G0616039AL	4G0616039AM	4G0616039T		
AS-3312	4G0616039AB	4G0616039AC	4G0616039AD	4G0616039AF	4G0616039AK	4G0616039AL	4G0616039AM	4G0616039T		
AS-3363	4F0616040	4F0616040AA	4F0616040J	4F0616040M	4F0616040N	4F0616040P	4F0616040Q	4F0616040R	4F0616040S	4F0616040T
AS-3369	4F0616039	4F0616039AA	4F0616039J	4F0616039M	4F0616039N	4F0616039P	4F0616039Q	4F0616039R	4F0616039S	4F0616039T
P-2134	4Z7616007	4Z7616007A								
P-2496	95535890101	95535890102	95535890103	95535890104	95535890105	4L0698007	4L0698007A	4L0698007B	4L0698007C	7L0698007
	7L0698007A	7L0698007B	7L0698007D	7L0698007E						
P-2539	4E0616005D	4E0616005F	4E0616005H	4E0616007	4E0616007A	4E0616007B	4E0616007C	4E0616007D	4E0616007E	
P-2599	4E0616005E	4E0616005G	4E0616007A	4E0616007C	4E0616007E					
P-2984	4F0616005E	4F0616005F	4F0616006	4F0616006A	4F0616007					
P-2986	4H0616005A	4H0616005B	4H0616005C	4H0616005D	4H0616006					
P-3483	4G0616005D									
RH-3459	8R0941286D	9A794128600								
RH-3460	8R0941285D	9A794128500								
RH-3587	4H0941286G									
RH-3588	4H0941285G									
SK-2779	4Z7413031	4Z7413031A	4Z7413032							
SK-2805	4Z7513031	4Z7513031A	4Z7513032	4Z7513032A						

OEM CROSS REFERENCE TABLE

Arnott Item #	OEM #									
Audi										
VB-3265	4F0616013	4Z7616013								
VB-3470	95535903001	95835890300	7L0698014							
VB-3491	4H0616013	4H0616013A	4H0616013B							
Bentley										
AS-2580	3D0616002H	3D0616002J	3D0616002K	3D0616002M	3D0616002N	3W0616040	3W0616040C	3W0616040D	3W0616040H	3W0616040J
	3W0616040K	3W0616040M	3W5616040	3W7616040	3W7616040E	3W7616040F	3W7616040G	3W8616040	3W8616040B	3W8616040C
	4W0616040									
AS-2581	3D0616001H	3D0616001J	3D0616001K	3D0616001M	3D0616001N	3W0616039	3W0616039C	3W0616039D	3W0616039H	3W0616039J
	3W0616039K	3W0616039M	3W5616039	3W7616039	3W7616039E	3W7616039F	3W7616039G	3W7810654	3W7810654A	3W8616039
	3W8616039B	3W8616039C	4W0616039							
AS-2892	3D0616002H	3D0616002J	3D0616002K	3D0616002M	3D0616002N	3W0616040	3W0616040C	3W0616040D	3W0616040H	3W0616040J
	3W0616040K	3W0616040M	3W5616040	3W7616040	3W7616040E	3W7616040F	3W7616040G	3W8616040	3W8616040B	3W8616040C
	4W0616040									
AS-2893	3D0616001H	3D0616001J	3D0616001K	3D0616001M	3D0616001N	3W0616039	3W0616039C	3W0616039D	3W0616039H	3W0616039J
	3W0616039K	3W0616039M	3W5616039	3W7616039	3W7616039E	3W7616039F	3W7616039G	3W7810654	3W7810654A	3W8616039
	3W8616039B	3W8616039C	4W0616039							
AS-2968	3W0616001	3W0616001E	3W5616001	3W5616001A	3W5616001C	3W5616001D	3W7616001	3W7616001A	3W7616001C	3W7616001E
	3W8616001	3W8616001B	3W8616001C	3W8616001D						
AS-2969	3W0616001	3W0616001E	3W5616001	3W5616001A	3W5616001C	3W5616001D	3W7616001	3W7616001A	3W7616001C	3W7616001E
	3W8616001	3W8616001B	3W8616001C	3W8616001D						
AS-3127	3D0616002H	3D0616002J	3D0616002K	3D0616002M	3D0616002N	3W0616040	3W0616040C	3W0616040D	3W0616040H	3W0616040J
	3W0616040K	3W0616040M	3W5616040	3W7616040	3W7616040E	3W7616040F	3W7616040G	3W8616040	3W8616040B	3W8616040C
	4W0616040									
AS-3128	3D0616001H	3D0616001J	3D0616001K	3D0616001M	3D0616001N	3W0616039	3W0616039C	3W0616039D	3W0616039H	3W0616039J
	3W0616039K	3W0616039M	3W5616039	3W7616039	3W7616039E	3W7616039F	3W7616039G	3W7810654	3W7810654A	3W8616039
	3W8616039B	3W8616039C	4W0616039							
AS-3129	3W0616001	3W0616001E	3W5616001	3W5616001A	3W5616001C	3W5616001D	3W7616001	3W7616001A	3W7616001C	3W7616001E
	3W8616001	3W8616001B	3W8616001C	3W8616001D						
AS-3130	3W0616001	3W0616001E	3W5616001	3W5616001A	3W5616001C	3W5616001D	3W7616001	3W7616001A	3W7616001C	3W7616001E
	3W8616001	3W8616001B	3W8616001C	3W8616001D						
P-2740	3D0616005H	3D0616005K	3D0616005L	3D0616005M	3D0616005P	3D0616005Q	3D061			

OEM CROSS REFERENCE TABLE

Arnott Item #	OEM #									
BMW										
P-3279	372068751703									
P-3471	3720686188206									
VB-2897	2283100	6765094	6769082	6775015	6777827	6785505	6789937	37106769082	37106775015	37106777827
	37106785505	37202283100	37206765094	37206789937						
VB-2898	6775479	6785506	6789938	6799419	6859714	37206789938	37206799419	37206859714	37226775479	37226785506
VB-3502	6784137	6789165	6789450	6794465	6864215	6875176	37206784137	37206789165	37206789450	37206794465
	37206864215	37206875176								
Buick										
A-2610	15089028	15090620	15125532	15159630	15183657	15183661	15276029	25815604		
AS-2190	19257784	19299843								
AS-2950	15211375	15211376	19302768	19302769						
MR-3447	15211376	19302769								
MR-3448	15211375	19302768								
P-2982	15811960	20794301	20827740	25806015	25994396					
SK-2189	22064764									
SK-2952	15211374	19300024								
Cadillac										
A-3233	2778104	23126011	23467662	84104206	84252215	84252216				
AS-2121	22064872 (LT)	22064873 (RT)								
AS-2125	22064565									
AS-2163	22400526									
AS-2177	22064727									
AS-2185	19257784	19299843								
AS-2190	19257784	19299843								
AS-2700	15756926	15852159	15869656	15869658	15918525	15924688	15945872	19300040	19300046	19300069
	19300071	19300072	22187152	22187156	22187158	22400885	25885467	25885469	25885470	25979391
	25979393	25979394	88965338	88965458						
AS-2708	15756926	15852159	15869656	15869658	15918525	15924688	15945872	19300040	19300046	19300069
	19300071	19300072	22187152	22187156	22187158	22400885	25885467	25885469	25885470	25979391
	25979393	25979394	88965338	88965458						
AS-2715	15756926	15852159	15869656	15869658	15918525	15924688	15945872	19300040	19300046	19300069
	19300071	19300072	22187152	22187156	22187158	22400885	25885467	25885469	25885470	25979391
	25979393	25979394	88965338	88965458						
AS-2950	15211375	15211376	19302768	19302769						
AS-3066	23151122	23290661	84176675							
AS-3430	15756926	15852159	15869656	15869658	15918525	15924688	15945872	19300040	19300045	19300046
	19300069	19300071	19300072	19302786	19331451	19331452	19368450	19368459	19368462	19368463
	22187152	22187156	22187158	22400885	23487280	25871432	25885467	25885469	25885470	25979391
	25979393	25979394	88965338	88965458						
MR-3435	19300066	19353951	25940740							
MR-3436	19302786	23487280	25871432							
MR-3437	19150444	19300029								
MR-3438	19150442	19300028								
MR-3439	15148390	19302766								
MR-3440	15148389	19302765								
MR-3441	19150593	19300030								
MR-3442	15145221	19302764								
MR-3443	19181636	19302773								
MR-3444	19302785	19355571	25849150							
MR-3445	19302784	19355570	25849149							
MR-3447	15211376	19302769								
MR-3448	15211375	19302768								
MR-3568	19300066	19353951	25940740							
P-2793	10395825	15056494	15070878	15101577	15254590	15296756	15949881	19299545	20837299	20930288
	22941806	25913289	10395825	15056494	15070878	15101577	15254590	15296756	15949881	19299545
	20837299	20930288	22941806	25913289						
P-2982	15811960	20794301	20827740	25806015	25994396					
P-3021	12494809	12494811	22153457	22177671	22197188	22197188				

OEM CROSS REFERENCE TABLE

Arnott Item #	OEM #									
Cadillac										
P-3242	10395825	15056494	15070878	15101577	15254590	15296756	15949881	19299545	20837299	20930288
	22797525	22941806	23282712	23316154	25913289					
P-3243	22936012	22983463	23129283	23168660	23353754	23446561	23468864	84160004	84219810	84355910
SK-2111	15147082	15219513								
SK-2118	22189452	22400389								
SK-2162	22400521									
SK-2167	22400524 (LT)	22400525 (RT)								
SK-2176	22064594 (LT)	22064595 (RT)								
SK-2178	22064728 (LT)	22064729 (RT)								
SK-2183	22064723 (LT)	22064724 (RT)								
SK-2186	22064765 (LT)	22064766 (RT)								
SK-2189	22064764									
SK-2264	2240522	22400521								
SK-2760	19300047	22187151	22187155	22187157	22187159	22400248	22400884	88965339		
SK-2806	19209555	19353945	20810270							
SK-2952	15211374	19300024								
SK-2954	15886465	15909491	15911938	15918522	15939374	19209555	19353945	20810270	25845438	25845446
	25845447	25888675	25888683	25888684						
SK-3062	22187159									
SK-3354	23151123	23312167	23464589	84061228	84176631					
SK-3357	19302783	20903683	22961782	23457035	84235851	84326294				
SK-3433	19302782	20903682	22961781	23457034	84235850	84326293				
Chevrolet										
A-2610	15089028	15090620	15125532	15159630	15183657	15183661	15276029	25815604		
A-2700	15756926	15852159	15869656	15869658	15918525	15924688	15945872	19300040	19300046	19300069
	19300071	19300072	22187152	22187156	22187158	22400885	25885467	25885469	25885470	25979391
	25979393	25979394	88965338	88965458						
AS-2708	15756926	15852159	15869656	15869658	15918525	15924688	15945872	19300040	19300046	19300069
	19300071	19300072	22187152	22187156	22187158	22400885	25885467	25885469	25885470	25979391
	25979393	25979394	88965338	88965458						
AS-2715	15756926	15852159	15869656	15869658	15918525	15924688	15945872	19300040	19300046	19300069
	19300071	19300072	22187152	22187156	22187158	22400885	25885467	25885469	25885470	25979391
	25979393	25979394	88965338	88965458						
AS-3066	23151122	23290661	84176675							
AS-3430	15756926	15852159	15869656	15869658	15918525	15924688	15945872	19300040	19300045	19300046
	19300069	19300071	19300072	19302786	19331451	19331452	19368450	19368459	19368462	19368463
	22187152	22187156	22187158	22400885	23487280	25871432	25885467	25885469	25885470	25979391
	25979393	25979394	88965338	88965458						
MR-3435	19300066	19353951	25940740							
MR-3436	19302786	23487280	25871432							
MR-3568	19300066	19353951	25940740							
P-2793	10395825	15056494	15070878	15101577	15254590	15296756	15949881	19299545	20837299	20930288
	22941806	25913289	10395825	15056494	15070878	15101577	15254590	15296756	15949881	19299545
	20837299	20930288	22941806	25913289						
P-2863	15145231	15187100	15745306	19177907	19329771	25805727				
P-3242	10395825	15056494	15070878	15101577	15254590	15296756	15949881	19299545	20837299	20930288
	22797525	22941806	23282712	23316154	25913289					
SK-2760	19300047	22187151	22187155	22187157	22187159	22400248	22400884	88965339		
SK-2806	19209555	19353945	20810270							
SK-2954	15886465	15909491	15911938	15918522	15939374	19209555	19353945	20810270	25845438	25845446
	25845447	25888675	25888683	258						

OEM CROSS REFERENCE TABLE

Arnott Item #	OEM #									
Ford										
A-2105	3U2Z5580AA	3U2Z5580BA	3U2Z5580PA	6W1Z5560AA	FOVY5560A					
A-2143	6L1Z3C199AA									
A-2148	3U2Z5580KA									
A-2153	3U2Z5580LA									
A-2220	3U2Z5580AA	3U2Z5580BA	3U2Z5580PA	6W1Z5560AA						
A-2647	7L1Z5A891B	8L1Z5A891B								
A-2735	4L1Z5A891AA									
AS-2139	3L1Z18124CA	3L1Z18124DA	6L1Z3C199AA	AU2Z18124F	AU2Z18124J	AU2Z18124K				
P-2932	1L1Z5319AA	1L1Z5319BA	6L1Z5319AA							
P-2936	8W1Z5319A	F1VY5319A	F6AZ5319AA	F8VZ5319AA						
P-2937	7L1Z5319AE									
SK-2723	5L1Z18125AA	6L7Z18124AD	6L7Z18124BC	AU2Z18124C	AU2Z18124D	AU2Z18124G	AU2Z18124H			
GMC										
A-2610	15089028	15090620	15125532	15159630	15183657	15183661	15276029	25815604		
AS-2700	15756926	15852159	15869656	15869658	15918525	15924688	15945872	19300040	19300046	19300069
	19300071	19300072	22187152	22187156	22187158	22400885	25885467	25885469	25885470	25979391
	25979393	25979394	88965338	88965458						
AS-2708	15756926	15852159	15869656	15869658	15918525	15924688	15945872	19300040	19300046	19300069
	19300071	19300072	22187152	22187156	22187158	22400885	25885467	25885469	25885470	25979391
	25979393	25979394	88965338	88965458						
AS-2715	15756926	15852159	15869656	15869658	15918525	15924688	15945872	19300040	19300046	19300069
	19300071	19300072	22187152	22187156	22187158	22400885	25885467	25885469	25885470	25979391
	25979393	25979394	88965338	88965458						
AS-3066	23151122	23290661	84176675							
AS-3430	15756926	15852159	15869656	15869658	15918525	15924688	15945872	19300040	19300046	19300069
	19300069	19300071	19300072	19302786	19331451	19331452	19368450	19368459	19368462	19368463
	22187152	22187156	22187158	22400885	23487280	25871432	25885467	25885469	25885470	25979391
	25979393	25979394	88965338	88965458						
MR-3435	19300066	19353951	25940740							
MR-3436	19302786	23487280	25871432							
MR-3568	19300066	19353951	25940740							
P-2793	10395825	15056494	15070878	15101577	15254590	15296756	15949881	19299545	20837299	20930288
	22941806	25913289	10395825	15056494	15070878	15101577	15254590	15296756	15949881	19299545
	20837299	20930288	22941806	25913289						
P-2863	15145231	15187100	15745306	19177907	19329771	25805727				
P-3242	10395825	15056494	15070878	15101577	15254590	15296756	15949881	19299545	20837299	20930288
	22797525	22941806	23282712	23316154	25913289					
SK-2760	19300047	22187151	22187155	22187157	22187159	22400248	22400884	88965339		
SK-2806	19209555	19353945	20810270							
SK-2954	15886465	15909491	15911938	15918522	15939374	19209555	19353945	20810270	25845438	25845446
	25845447	25888675	25888683	25888684						
SK-3062	22187159									
SK-3354	23151123	23312167	23464589	84061228	84176631					
Infiniti										
AS-3284	56200-ZV50A	56200-ZV60A								
P-3277	5340075600	53400-75600								
Iveco										
A-3276	504035755	504035756								
Jaguar										
AS-2888	C2C20162	C2C2244	C2C23699	C2C23699E	C2C24412	C2C25696	C2C28409	C2C28533	C2C30763	C2C31016
	C2C39763	C2C41339	C2C41347	C2C41349						
AS-2889	C2C24410	C2C25694	C2C28407	C2C28531	C2C31014	C2C39765	C2C41341	C2C41343		
AS-2890	C2C20163	C2C2245	C2C23700	C2C24413	C2C25697	C2C28410	C2C28534	C2C31017	C2C39764	C2C41352
	C2C41354									
AS-2891	C2C20165	C2C2261	C2C24411	C2C25695	C2C28408	C2C28532	C2C31015	C2C39766	C2C41344	C2C41346
AS-3234	C2D11404	C2D11405	C2D18898	C2D31982	C2D33847					
P-2291	C2C22825	C2C2450	C2C27702	C2C27702E						
P-3244	C2D26813	C2D31933	C2D34552	C2D42519	C2D47540	C2D5825				

OEM CROSS REFERENCE TABLE

Arnott Item #	OEM #									
Jeep										
A-3010	68029911AB	68029912AC	68029912AD	68029912AE	68258355AA	68258355AB				
AS-3248	68253204AA	68253204AB	68253204AC	68253204AD	68253204AE	68253204AF	68253204AH	68253206AA	68253206AB	68253206AC
	68253206AD	68253206AE	68303268AA	68303268AB	68303268AC	6830334AAA	6830334AB	6830334AC		
AS-3249	68253205AA	68253205AB	68253205AC	68253205AD	68253205AE	68253205AF	68253205AH	68253207AA	68253207AB	68253207AC
	68253207AD	68253207AE	68303269AA	68303269AB	68303269AC	6830335AAA	6830335AB	6830335AC		
AS-3250	68253204AA	68253204AB	68253204AC	68253204AD	68253204AE	68253204AF	68253204AH	68253206AA	68253206AB	68253206AC
	68253206AD	68253206AE	68303268AA	68303268AB	68303268AC	6830334AAA	6830334AB	6830334AC		
AS-3251	68253205AA	68253205AB	68253205AC	68253205AD	68253205AE	68253205AF	68253205AH	68253207AA	68253207AB	68253207AC
	68253207AD	68253207AE	68303269AA	68303269AB	68303269AC	6830335AAA	6830335AB	6830335AC		
AS-3289	68029902AA	68029902AB	68029902AC	68029902AD	68029902AE	68029902AF	68029902AH	68059904AA	68059904AB	68059904AC
	68059904AD	68059904AE	68080194AA	68080194AB	68080194AC	68231882AA	68231882AB	68231882AC	68231884AA	68231884AB
	68231884AC									
AS-3290	68029903AA	68029903AB	68029903AC	68029903AD	68029903AE	68029903AF	68029903AH	68059905AA	68059905AB	68059905AC
	68059905AD	68059905AE	68080195AA	68080195AB	68080195AC	68231883AA	68231883AB	68231883AC	68231885AA	68231885AB
	68231885AC									
AS-3323	68029902AA	68029902AB	68029902AC	68029902AD	68029902AE	68029902AF	68029902AH	68059904AA	68059904AB	68059904AC
	68059904AD	68059904AE	68080194AA	68080194AB	68080194AC	68231882AA	68231882AB	68231882AC	68231884AA	68231884AB
AS-3324	68029903AA	68029903AB	68029903AC	68029903AD	68029903AE	68029903AF	68029903AH	68059905AA	68059905AB	68059905AC
	68059905AD	68059905AE	68080195AA	68080195AB	68080195AC	68231883AA	68231883AB	68231883AC	68231885AA	68231885AB
	68231885AC									
P-3245	68041137AD	68041137AG	68204730AF	68204730AG	68204730AH	68204730AI				
SK-3394	68069680AB	68069680AC	68069680AD	68069680AE	68069680AF	68069680AG	68069680AH			
VB-3266	00K68087233AA	68087233AA								
Land Rover										
A-2202	RKB101200									
A-2611	ANR4684	REB101740								
A-2612	RKB101460									
A-2691	ANR4684	REB101740								
A-2692	RKB101460									
A-2831	RKB000150	RKB000151	RKB500080	RKB500080K	RKB500082	RKB500130	RKB500240			
A-2933	LR032563	LR051700	RNB000060	RNB000740	RNB500540	RNB501340	RNB501400	RNB501520		
A-2934	LR032570	LR051702	RNB000070	RNB000750	RNB500550	RNB501350	RNB501410	RNB501530		
A-3025	LR034262									
A-3027	LR044853	LR052171								
AS-2534	LR014195	LR016418	LR016420	LR032650	LR034287	LR038096	LR041110	RPD501020	RPD501040	RPD501100
AS-2757	LR012859	LR012860	LR032560							
AS-2758	LR012885	LR012886	LR032567							
AS-2761	LR018172	LR018190	LR018191	LR018376	LR019993	LR019994	LR032647	LR032648	LR052647	LR052866
	LR052867									
AS-2762	LR015018	LR015020	LR016419	LR020000	LR020001	LR023234	LR023235	LR032651	LR032652	LR034288
	RPD501030	RPD501110								
AS-2795	LR032563	LR032566	RNB500540	RNB501340	RNB501400	RNB501520	RNB501540			
AS-2796	LR032570	LR032575	RNB500550	RNB501350	RNB501410	RNB501530	RNB501550			
AS-2797	LR012859	LR012860	LR032560							
AS-2798	LR012885	LR012886	LR032567							
AS-2809	LR016414	LR016415	LR016416	LR034282	LR034283	LR041108	RNB000855	RNB000856	RNB000857	RNB000858
	RNB501180	RNB501250	RNB501460	RNB501470	RNB501580	RNB501590	RNB501600	RNB501610	RNB501620	
AS-2961	LR032563	LR051700	RNB000060	RNB000740	RNB500540	RNB501340	RNB501400	RNB501520		
AS-2962	LR032570	LR051702	RNB000070	RNB000750	RNB500550	RNB501350	RNB501410	RNB501530		
AS-3067	LR038800	LR038801	LR038802	LR038803	LR052773	LR052774	LR057250	LR057251	LR060132	LR060135
	LR072445	LR072447	LR079515	LR087081						
AS-3068	LR038805	LR038807	LR052776	LR057257	LR060137	LR072460	LR087092			
AS-3069	LR044851	LR057252	LR052783	LR060154	LR072449	LR087082				
AS-3070	LR045101	LR052786	LR057258	LR060155	LR072441	LR087093				
AS-3204	LR045100	LR052784	LR057253	LR060399	LR072450	LR087083				
AS-3205	LR044852	LR052787	LR057259	LR060401	LR072440	LR087094				

OEM CROSS REFERENCE TABLE

Arnott Item #	OEM #									
Land Rover										
AS-3355	LR038800	LR038801	LR038802	LR038803	LR038805	LR038807	LR052773	LR052774	LR052776	LR057250
	LR057251	LR057257	LR060132	LR060135	LR060137	LR072445	LR072447	LR072460	LR079515	LR087081
	LR087092									
AS-3362	LR044851	LR052783	LR057252	LR060154	LR072449	LR087082				
AS-3368	LR045100	LR052784	LR057253	LR060399	LR072450	LR087083				
P-2462	LR006201	RQC000020	RQG000020	RQL000010	RQL000011	RQL000014				
P-2495	ANR4868	RQG100041								
P-2514	ANR3731									
P-3232	LR010375	LR011839	LR015089	LR025111	LR033311	LR038109	LR038110	LR038112	LR038113	LR038147
	LR041777	RQG500040	RQG500041	RQG500100	RQG500140	RQU500731				
P-3280										
P-3431	LR006200	LR010376	LR010414	LR011837	LR012705	LR015303	LR023964	LR032902	LR037065	LR038114
	LR038115	LR038116	LR038117	LR038118	LR038148	LR041776	LR044360	LR045251	LR061663	LR072537
	LR10414	RQG500015	RQG500016	RQG500018	RQG500019	RQG500040	RQG500070	RQG500071	RQG500072	RQG500080
	RQG500090	RQG500130	RQG500150	RQG500160						
RH-3378	LR010828	LR023652								
RH-3379	LR010803	LR023654								
RH-3454	LR014585	LR023649								
RH-3455	LR014587	LR023650								
SK-3122	RPD000060	RPD500260	RPD500270	RPD500470	RPD500600	RPD500940				
SK-3382	LR012995	LR012997	LR020528	LR020529	LR023573	LR023580				
SK-3384	LR034270	LR034271	LR098792	LR098795	LR104031					
SK-3385	LR045269									
SK-3386	LR045270	LR047132	LR062385	LR103602						
Lexus										
A-2949	4808035010	4808035011	4808035020	4809035010	4809035011	4809035020				
A-3331	4808060020									
A-3332	4809060020									
AS-2855	4801050150	4801050152	4801050153	4801050251	4801050253	4801050254	4801050260	4801050261	4801050262	4801050270
	4801050271	4801050290	4801050291	4802050150	4802050152	4802050153	4802050251	4802050253	4802050254	4802050260
	4802050261	4802050262	4802050270	4802050271	4802050290	4802050291				
AS-2856	4808050150	4808050152	4808050153	4808050160	4808050161	4808050163	4808050164	4808050240	4808050241	4808050260
	4808050261	4808050270	4808050271	4808050310	4808050311	4809050150	4809050152	4809050153	4809050160	4809050161
	4809050163	4809050164	4809050240	4809050241	4809050260	4809050261	4809050270	4809050271	4809050310	4809050311
AS-2894	4801050110	4801050120	4801050130							
AS-3073	4808050110	4808050130								
AS-3074	4809050110	4809050130								
P-3187	4891050050	48910-50050								
P-3188	48914-50030	48914-50031								
P-3191	4891060040	4891060041	4891060042	48910-60040	48910-60041	48910-60042				
P-3192	4891060020	4891060021	48910-60020	48910-60021						
P-3194	4891048020	4891048021	48910-48020	48910-48021						
SK-2812	4851060121	4851069195	4851069415							
SK-2813	4853060071	4853069185	4853069205	4853069485						
Lincoln										
A-2105	3U2Z5580AA	3U2Z5580BA	3U2Z5580PA	6W1Z5560AA	FOVY5560A					
A-2106	E9AZ5310R	F1LY5310A	F1LY5310B							
A-2107	F1LY5560A	F1LY5560B								
A-2108	3U2Z5580FA									
A-2143	6L1Z3C199AA									
A-2148	3U2Z5580KA									
A-2153	3U2Z5580LA									
A-2173	3U2Z5580HA	3U2Z5580MA								
A-2174	3U2Z5310CA	3U2Z5310DA								
A-2212	3U2Z5580JA	3U2Z5580NA								
A-2220	3U2Z5580AA	3U2Z5580BA	3U2Z5580PA	6W1Z5560AA						
A-2647	7L1Z5A891B	8L1Z5A891B								
A-2735	4L1Z5A891AA									

OEM CROSS REFERENCE TABLE

Arnott Item #	OEM #									
Lincoln										
AS-2139	3L1Z18124CA	3L1Z18124DA	6L1Z3C199AA	AU2Z18124F	AU2Z18124J	AU2Z18124K				
P-2210	F7LZ5319AA									
P-2211	F50Y5319A	F70Y5319B								
P-2231	F0LY5319-A									
P-2932	1L1Z5319AA	1L1Z5319BA	6L1Z5319AA							
P-2935	F8VZ5319AA									
P-2936	8W1Z5319A	F1VY5319A	F6AZ5319AA	F8VZ5319AA						
P-2937	7L1Z5319AE									
SK-2225	3U2Z18125JA	F3LY18125A	F5LY19E616A							
SK-2723	5L1Z18125AA	6L7Z18124AD	6L7Z18124BC	AU2Z18124C	AU2Z18124D	AU2Z18124G	AU2Z18124H			
Maybach										
AS-2746	2403202013	2403201013								
AS-2747	2403201913	2403200913								
P-2192	2113200304	2203200104	2193200004	2113200104	211320030480					
RH-3500	105427617									
Mercedes-Benz										
A-2575	1643204313	1643204413	1643204513	1643204613	1643205813	1643205913	1643206013	1643206113	164320581339	164320581380
	164320591339	164320591380	164320601339	164320601380	164320611339	164320611380				
A-2587	2513203013	2513203113	2513205613	2513205713	251320301380	251320311380	251320561380	251320571380		
A-2596	1643200225	1643200425	1643200625	1643200725	1643200825	1643200925	1643201025	1663200325	1663200625	
A-2597	2513200025	2513200325	2513200425							
A-2724	2113200725	2113200825	2113201525	2113201625	211320072580	211320082580	211320152580	211320162580		
A-2725	2113201225	2113201325	211320122580	211320132580	211320133580					
A-2726	2113200925	211320092580								
A-2790	2123200825	2123203825	2123204025	2123204425						
A-2791	2123200725	2123203725	2123203925	2123204325						
A-2801	6393280101	6393280201	6393280301							
A-3313	2133200225									
A-3314	2133200125									
A-3329	2053200225									
A-3330	2053200125									
AS-2193	2203202438	2203205113	220320243880							
AS-2194	2203202338	2203205013	220320501380							
AS-2245	2113205513	2113206113	2113209313	2193201113	211320551380	211320611380	219320111380			
AS-2246	2113205413	2113206013	2113209413	2193201213	211320221328	211320541380	211320601380	219320121380		
AS-2294	2113202813	2113209613	211320961380							
AS-2295	2113201938	2113202713	2113209513	211320951338	211320951380	211320951389				
AS-2300	2113205213	2113205438	2113205638	2113206213	2113208413	211320543880	211320563880			
AS-2301	2113205338	2113205538	2113206313	2113206513	2113208313	211320533880	211320553880			
AS-2394	2513203013	2513203113	2513205613	2513205713	251320301380	251320311380	251320561380	251320571380		
AS-2450	1643204313	1643204413	1643204613	1643205813	1643205913	1643206013	164320581339	164320581380	164320591339	164320591380
	164320601339	164320601380								
AS-2463	1643202213	1643205213	164320521360	164320521380	164320521388					
AS-2540	2213204913	2213205113	2213207313	2213209313	2213209713	221320931380				
AS-2547	2213200038	2213200538	2213201838	2213205213	2213205413	2213207413	2213209813	221320053880	221320183880	
AS-2548	2213200438	2213201738	2213205313	221320043880	221320173880					
AS-2603	2213205613	2213205813	221320561380	221320581380						
AS-2604	2213205513	2213205713	221320551380	221320571380						
AS-2605	2203202438	2203205113	220320243880							
AS-2783	2203201438	2203202238	2203202338	2203205013	220320223880	220320501380				
AS-2784	2203201338	2203202138	220320213880							
AS-2785	2113205413	2113206013	2113209413	2193201213	211320221328	211320541380	211320601380	219320121380		
AS-2786	2113205513	2113206113	2113209313	2193201113	211320551380	211320611380	219320111380			
AS-2787	2113205213	2113205438	2113205638	2113206213	2113208413	211320543880	211320563880			
AS-2788	2113205338	2113205538	2113206313	2113206513	2113208313	211320533880	211320553880			
AS-2792	1643204313	1643204413	1643204613	1643205813	1643205913	1643206013	164320581339	164320581380	164320591339	164320591380
	164320601339	164320601380								
AS-2802	1643202213	1643205213	164320521360	164320521380	164320521388					

OEM CROSS REFERENCE TABLE

Arnott Item #	OEM #									
Mercedes-Benz										
AS-2820	2213204913	2213205113	2213207313	2213209313	2213209713	221320931380				
AS-2821	2213205613	2213205813	221320561380	221320581380						
AS-2822	2213205513	2213205713	221320551380	221320571380						
AS-2833	2513203013	2513203113	2513205613	2513205713	251320301380	251320311380	251320561380	251320571380		
AS-2852	2213200038	2213200538	2213201838	2213205213	2213205413	2213207413	2213209813	221320053880	221320183880	
AS-2853	2213200438	2213201738	2213205313	221320043880	221320173880					
AS-2884	2203202338	2203205013	220320501380							
AS-3000	2113202813	2113209613	211320961380							
AS-3001	2113201938	2113202713	2113209513	211320951338	211320951380	211320951389				
AS-3005	1643204513	1643206113	164320611339	164320611380						
AS-3058	1643204513	1643206113	164320451380	164320611339	164320611380					
AS-3060	1663201413	1663201468	1663202838	1663205266	1663205466	1663205666	1663206813	1663206866	1663207013	1663207213
	166320146880	166320526680	166320546680	166320566680						
AS-3061	1663201313	1663205166	1663205366	1663205566	1663206713	1663206913	1663207113	166320516680	166320536660	166320536680
	166320556680									
AS-3085	1663202613	1663205066	1663207413	1663233100	166320506680					
AS-3086	1663202513	1663204966	1663207313	16623231700	166320496680					
AS-3088	1643204313	1643204413	1643204613	1643205813	1643205913	1643206013	164320581339	164320581380	164320591339	164320591380
	164320601339	164320601380								
AS-3089	1643202213	1643205213	164320521360	164320521380	164320521388					
AS-3153	1663201413	1663201468	1663202838	1663205266	1663205466	1663205666	1663206813	1663206866	1663207013	1663207213
	166320146880	166320526680	166320546680	166320566680						
AS-3154	1663201313	1663205166	1663205366	1663205566	1663206713	1663206913	1663207113	166320516680	166320536660	166320536680
	166320556680									
AS-3155	1663202613	1663205066	1663207413	166320506680						
AS-3156	1663202513	1663204966	1663207313	166320496680						
AS-3160	2223201038	2223201638	2223202200	2223202600	2223203201	2223205013	2223208213	222320821389		
AS-3161	2223200938	2223201538	2223202100	2223202500	2223203101	2223204913	2223208113	222320811389		
AS-3162	2223202000	2223202400	2223204813	2223208813	222320481389	222320881389				
AS-3163	2223201900	2223202300	2223204713	2223208713	222320471389					
AS-3237	2123202038	2123203438	2123208213	212320343880						
AS-3238	2123201938	2123203338	2123208113	212320333880						
AS-3239	2123200813	2123201838	2123202338	2123203238	212320323880					
AS-3240	2123200913	2123201738	2123202238	2123203138	212320313880					
AS-3360	2223205213	2223207413	222320741389							
AS-3361	2223205313	2223207313	222320731389							
AS-3364	2223205213	2223207413	222320741389							
AS-3365	2223205313	2223207313	222320731389							
AS-3408	1663201413	1663205266	1663205466	1663205666	1663206813	1663206866	1663207013	1663207213		
AS-3409	1663201313	1663205166	1663205366	1663205566	1663206713	1663206766	1663206913	1663207113		
AS-3410	1663202613	1663205066	1663207413	166320506680						
AS-3411	1663202513	1663204966	1663207313	166320496680						
AS-3414	2183206613									
AS-3415	2183206513									
AS-3422	2123200813	2123201838	2123202338	2123203238	212320323880					
AS-3423	2123200913	2123201738	2123202238	2123203138	212320313880					
AS-3424	2123202038	2123203438	2123208213	212320343880						
AS-3425	2123201938	2123203338	2123208113	212320333880						
AS-3577	2133200800									
AS-3578	2133200700									
P-2192	2113200104	2113200304	2193200004	2203200104	211320030480					
P-2219	6383280202	6383280302	6383280402	6383280502						
P-2830	2123200104	2123200404	212320040480							
P-3214	1643200004	1643200204	1643200304	1643200504	1643200904	1643201104	1643201204	164320050480	164320090480	164320120480
P-3215	2513200104	2513200604	2513200804	2513201304	2513202704	251320130428	251320210405	251320270405	251320270480	
P-3246	2213200304	2213200704	2213200904	2213201604	2213201704	221320030480	221320070480	221320090480	221320160480	221320170480
P-3258	1663200104	166320010480								
P-3281	2513201204	2513202004	2513202604	251320120428	251320260480					

OEM CROSS REFERENCE TABLE

Arnott Item #	OEM #									
Mercedes-Benz										
P-3282	993200104	2223200604	222320060480							
RH-3500	105427617									
RH-3501	105427717									
SK-2412	2303202813	2303208813	230320881380							
SK-2413	2303200013	2303208713	230320871380							
SK-2414	2303200513	230320051380								
SK-2415	2303200213	230320021380								
SK-2417	2303203013	2303204413	230320441380							
SK-2418	2303202913	2303204513	230320451380							
SK-2419	2303204613	230320461380								
SK-2420	2303204713	230320471380								
SK-2422	2203200138	2203200238	2203208413	2203208613	220320841380	220320861380				
SK-2423	2203200138	2203208313	2203208513	220320831380	220320851380					
SK-2454	2203200438	2203200638	2203200813	2203204913	2203205413	2203205513	220320491380	220320541380	220320551380	
SK-2455	2203200338	2203200538	2203200713	2203205713	2203205813	2203205913	220320571380	220320581380		
SK-2456	2203201813	2203205613	2203206213	2203209013	2203209213	220320561380	220320621380	220320921380		
SK-2457	2203200913	2203206013	2203206113	2203208913	2203209113	220320601380	220320611380	220320911380		
SK-2458	2153200413	2203201638	215320041380	220320163880						
SK-2459	2153200513	2203201538	215320051380	220320153880						
SK-2460	2203201838	220320183880								
SK-2461	2203201738	220320173880								
SK-2470	2303204438	2303208613	230320861380							
SK-2471	2303204338	2303206113								
SK-2472	2303200438	2303204638	2303205813	230320043880						
SK-2473	2303200338	2303204538	2303205513	230320033880						
SK-2482	2303202438	2303202838	2303204038							
SK-2483	2303202338	2303202738	2303203938							
SK-2484	2303202638	2303203438	2303205213	2303207213						
SK-2485	2303202538	2303203338	2303205313	2303207113						
SK-2867	1643200731	1643201131	1643202031	1643202131	1643202731	1643202831	1643203031	1643203131		
SK-2868	1643200631	1643200931	1643201231	1643201331	1643201531	1643201631	1643202231	1643202431	1643202531	1643202631
	1643202631									
SK-3012	2113200631	2113200731	2113201525	2113201625	2113260100	2113262400	2113262800	2193260300	2193260400	21132062588
	21132600631	211320152560	211320152580	211320152588	211320162560	211320162580				
SK-3029	1643200731	1643201131	1643202031	1643202131	1643202731	1643202831	1643203031	1643203131		
SK-3039	2113200631	2113260200	2113260300	2113265100	2113265400	2115400409				
SK-3197	2113200631	2113200731	2113201525	2113201625	2113260100	2113262400	2113262800	2193260300	2193260400	21132062588
	21132600631	211320152560	211320152580	211320152588	211320162560	211320162580				
SK-3199	2113262700	2113266800	2193260300	219						

OEM CROSS REFERENCE TABLE

Arnott Item #	OEM #									
Oldsmobile										
A-2610	15089028	15090620	15125532	15159630	15183657	15183661	15276029	25815604		
AS-2190	19257784	19299843								
SK-2189	22064764									
Opel										
A-3292	8200026090	82000-26090								
Peugeot										
P-2851	9677839180	5277G5	5277P8							
Pontiac										
AS-2190	19257784	19299843								
SK-2189	22064764									
Porsche										
A-2523	95535850300	95535850310	95535850320	95535850321	95535850322	95535850330	95535850331	95535850332	7L6616503	7L6616503A
	7L6616503B	7L8616503B								
A-2571	95535840400	95535840410	95535840420	95535840421	95535840430	95535840431	7L5616404	7L5616404B	7L5616404E	7L6616404
	7L6616404A	7L6616404B	7L8616404A	7L8616404B	7L8616404D	7L8616404G	7L8616404H	7L8616404	7L8616404A	7L8616404B
A-2572	95535840300	95535840310	95535840320	95535840321	95535840330	95535840331	7L5616403	7L5616403B	7L5616403E	7L6616403
	7L6616403A	7L6616403B	7L8616403A	7L8616403B	7L8616403D	7L8616403G	7L8616403H	7L8616403	7L8616403A	7L8616403B
A-3306	37033353311	37033353312	37033353313	37033353314	37033353315	37033353316	37033353317	37033353318	37033353319	37033353320
	37033353321									
A-3327	958616002A	958616002B	958616002C	958616002D	958616002F					
A-3328	958616001B	958616001F	958616002H							
AS-3035	97034305207	97034305208	97034305209	97034305210	97034305211	97034305212	97034305214	97034305215	97034305216	97034305217
	97034305218	97034305220	97034305221	97034305222	97034305223					
AS-3036	97034305107	97034305108	97034305109	97034305110	97034305111	97034305112	97034305114	97034305115	97034305116	97034305117
	97034305118	97034305120	97034305121	97034305122	97034305134					
AS-3037	97034305223	97034305234	97034305235							
AS-3038	97034305134	97034305135	97034305137							
AS-3056	95835804000	95835804001	95835804002	95835804003	95835804004	95835804005	95835804010	95835804011	95835804012	95835804013
	95835804014	95835804015	95835804016	95835804020	95835804021					
AS-3057	95835803900	95835803901	95835803902	95835803903	95835803904	95835803905	95835803910	95835803911	95835803912	95835803913
	95835803916	95835803917	95835803920	95835803921	95835803914					
AS-3164	95534303422	95534303445	95534303451							
AS-3165	95534303322	95534303345	95534303351							
AS-3166	95835802008	95835802017	95835802020	95835802025	95835802027	95835802032	95835802042	95835802051		
AS-3167	95835801908	95835801917	95835801920	95835801925	95835801927	95835801932	95835801942	95835801951		
AS-3235	95835804000	95835804001	95835804002	95835804003	95835804004	95835804005	95835804010	95835804011	95835804012	95835804013
	95835804014	95835804015	95835804016	95835804020	95835804021					
AS-3236	95835803900	95835803901	95835803902	95835803903	95835803904	95835803905	95835803910	95835803911	95835803912	95835803913
	95835803916	95835803917	95835803920	95835803921	95835803914					
AS-3345	97034305207	97034305208	97034305209	97034305210	97034305211	97034305212	97034305214	97034305215	97034305216	97034305217
	97034305218	97034305220	97034305221	97034305222	97034305223					
AS-3346	97034305107	97034305108	97034305109	97034305110	97034305111	97034305112	97034305114	97034305115	97034305116	97034305117
	97034305118	97034305120	97034305121	97034305122	97034305134					
AS-3351	958616039	958616039A	958616039B	958616039C	958616039D	958616039E	958616039F	958616039H	958616039J	
AS-3376	97034305223	97034305234	97034305235							
AS-3377	97034305134	97034305135	97034305137							
P-2496	95535890101	95535890102	95535890103	95535890104	95535890105	4L0698007	4L0698007A	4L0698007B	4L0698007C	7L0698007
	7L0698007A	7L0698007B	7L0698007D	7L0698007E						
P-3477	971616006D									
RH-3459	8R0941286D	9A794128600								
RH-3460	8R0941285D	9A794128500								
Ram										
A-3016	4877136AB									
AS-3017	4877146AA (RT)	4877146AB (RT)	4877146AC (RT)	4877146AD (RT)	4877146AE (RT)	4877146AF (RT)	4877146AG (RT)	4877146AH (RT)	4877147AB (LT)	4877147AC (LT)
	4877147AD (LT)	4877147AE (LT)	4877147AF (LT)	4877147AG (LT)	4877147AH (LT)					
AS-3618	4877146AA (RT)	4877146AB (RT)	4877146AC (RT)	4877146AD (RT)	4877146AE (RT)	4877146AF (RT)	4877146AG (RT)	4877146AH (RT)	4877147AB (LT)	4877147AC (LT)
	4877147AD (LT)	4877147AE (LT)	4877147AF (LT)	4877147AG (LT)	4877147AH (LT)					
P-3480	68239571AB	68239571AB								

OEM CROSS REFERENCE TABLE

Arnott Item #	OEM #									
Ram										
SK-3556	68232278AA	68232278AB	68232278AC							
VB-3496	68204398AA									
Renault										
A-3292	8200026090	82000-26090								
Saab										
A-2610	15089028	15090620	15125532	15159630	15183657	15183661	15276029	25815604		
Tesla										
AS-3380	1067361	1067361-25-C	1067361-77-C							
AS-3381	1067461-25-C	1067466-25-C								
P-3509	4154063290									
Toyota										
A-2949	4808035010	4808035011	4808035020	4809035010	4809035011	4809035020				
A-3331	4808060020									
A-3332	4809060020									
P-3189	4891434020	4891434021	48914-34020	48914-34021						
P-3190	4891434010	4891434011	48914-34010	48914-34011						
P-3192	4891060020	4891060021	48910-60020	48910-60021						
SK-2812	4851060121	4851069195	4851069415							
SK-2813	4853060071	4853069185	4853069205	4853069485						
Volkswagen										
A-2523	95535850300	95535850310	95535850320	95535850321	95535850322	95535850330	95535850331	95535850332	7L6616503	7L6616503A
	7L6616503B	7L8616503B								
A-2571	95535840400	95535840410	95535840420	95535840421	95535840430	95535840431	7L5616404	7L5616404B	7L5616404E	7L6616404
	7L6616404A	7L6616404B	7L8616404A	7L8616404B	7L8616404D	7L8616404G	7L8616404H	7L8616404	7L8616404A	7L8616404B
A-2572	95535840300	95535840310	95535840320	95535840321	95535840330	95535840331	7L5616403	7L5616403B	7L5616403E	7L6616403
	7L6616403A	7L6616403B	7L8616403A	7L8616403B	7L8616403D	7L8616403G	7L8616403H	7L8616403	7L8616403A	7L8616403B
AS-2580	3D0616002H	3D0616002J	3D0616002K	3D0616002M	3D0616002N	3D0616004	3D0616040AA	3D0616040AB	3D0616040AC	3D0616040AD
	3D0616040G	3D0616040L	3D0616040M	3D0616040N	3D0616040P	3D0616040Q	3D0616040S	3D0616040T	3D5616040	3D7616040
	3W0616040C	3W0616040D	3W0616040H	3W0616040J	3W0616040K					
AS-2581	3D0616001H	3D0616001J	3D0616001K	3D0616001M	3D0616001N	3D0616039	3D0616039AA	3D0616039AB	3D0616039AC	3D0616039AD
	3D0616039G	3D0616039L	3D0616039M	3D0616039N	3D0616039P	3D0616039Q	3D0616039S	3D0616039T	3D5616039	3D7616039
	3W0616039C	3W0616039D	3W0616039H	3W0616039J	3W0616039K					
AS-2892	3D0616002H	3D0616002J	3D0616002K	3D0616002M	3D0616002N	3D0616040	3D0616040AA	3D0616040AB	3D0616040AC	3D0616040AD
	3D0616040G	3D0616040L	3D0616040M	3D0616040N	3D0616040P	3D0616040Q	3D0616040S	3D0616040T	3D5616040	3D7616040
	3W0616040C	3W0616040D	3W0616040H	3W0616040J	3W0616040K					
AS-2893	3D0616001H	3D0616001J	3D0616001K	3D0616001M	3D0616001N	3D0616039	3D0616039AA	3D0616039AB	3D0616039AC	3D0616039AD
	3D0616039G	3D0616039L	3D0616039M	3D0616039N	3D0616039P	3D0616039Q	3D0616039S	3D0616039T	3D5616039	3D7616039
	3W0616039C	3W0616039D	3W0616039H	3W0616039J	3W0616039K					
AS-2968	3W0616001	3W0616001E	3W5616001	3W5616001A	3W5616001C	3W5616001D	3W7616001	3W7616001A	3W7616001C	3W7616001E
	3W8616001	3W8616001B	3W8616001C	3W8616001D						
AS-2969	3W0616001	3W0616001E	3W5616001	3W5616001A	3W5616001C					

OEM CROSS REFERENCE TABLE

Arnott Item #	OEM #									
Volkswagen										
P-2496	95535890101	95535890102	95535890103	95535890104	95535890105	4L0698007	4L0698007A	4L0698007B	4L0698007C	7L0698007
	7L0698007A	7L0698007B	7L0698007D	7L0698007E						
P-2740	3D0616005H	3D0616005K	3D0616005L	3D0616005M	3D0616005P	3D0616005Q	3D0616007C	3D0616007D	3D0616007E	
VB-3470	95535903001	95835890300	7L0698014							
Volvo										
A-3307	31360714	31360717	31451887	31451888	31476427	31476428	32246194	32246195		
AS-3343	31451834	31476851								
AS-3344	31451833	31476850								
P-3476	31360720	32315091								
VB-3498	31360723									

MAGNETIC RIDE SHOCKS

Magnetic Ride Shocks are now offered in Arnott's aftermarket suspension product line. Designed as a direct replacement for GM SUVs with the magnetorheological damper system Z95 RPO, Arnott's OES magnetic shocks provide the same adaptive ride as the OE.

What are Magnetic Ride Shocks?

Magnetic Ride Shocks consist of a monotube damper filled with a combination of synthetic hydrocarbon oil and readily magnetized iron particles (the sum of which is known as magnetorheological fluid) as well as electromagnetic coils. Maintaining the system are a sensor set and an Electronic Control Unit (ECU).

How do Magnetic Ride Shocks work?

If the vehicle sensors detect a change in road conditions, a signal is sent to the ECU. The ECU then determines the electromagnetic current strength required for each shock. When activated, the electromagnetic coils create a magnetic field that instantly magnetizes the iron particles, increasing the viscosity of the magnetorheological fluid and suspension stiffness.

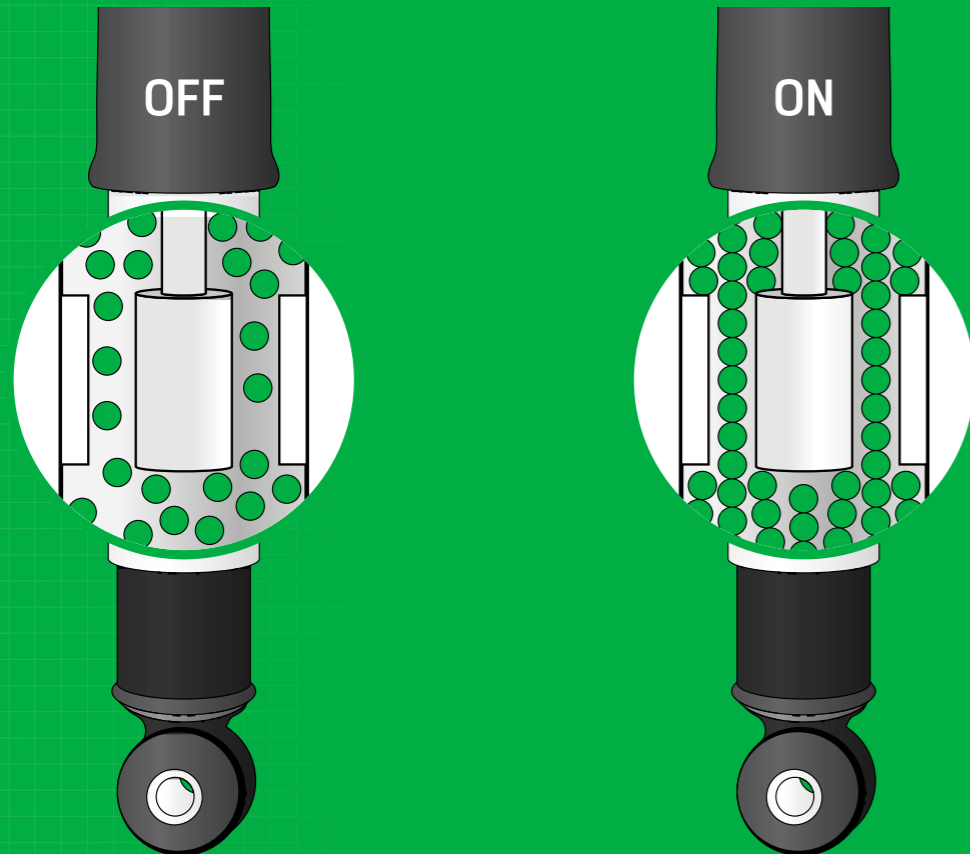

AIR SPRINGS

- Premium name-brand air sleeve
- Faster, easier installation
- Engineered & assembled in the USA & EU
- Compatible with OE struts, air line & leveling system
- High-impact polyurethane or aircraft-quality aluminum tops



AIR SUSPENSION COMPRESSORS

- Compressors meet OE specifications
- Includes thermal overload protection
- Electrocoated epoxy finish to prevent corrosion
- Extensive life-cycle testing
- Most mate with OE lines & plugs for ease of installation



ARNOTT-DESIGNED NEW AIR STRUTS

- Custom-valved shock adapts to driving style
- Premium brand air sleeve, bump stop & dust boot
- Works with vehicle's auto leveling functionality
- CNC-machined aluminum or stamped steel top
- Improved seals to prevent leaks
- Many connect to ADS system to eliminate warning lights
- Engineered & assembled in the USA



Innovative
Engineering



Precision
Production



Extensive
Testing



Superior
Components

REMANUFACTURED AIR STRUTS

- Tested, cleaned & recharged OE shock
- New sealing cap & air line fitting
- Works with vehicle's auto damping & leveling system
- Premium air sleeve, bump stop, air fitting & dust boot
- OE top mount & sensor
- Remanufactured in the USA



Comprehensive
Quality Assurance



COIL SPRING CONVERSION KITS

- Patented Electronic Bypass Module (EBM) eliminates fault codes
- Custom-valved shock absorbers
- Durable American-made, powder-coated coil springs
- Pre-assembled for easy & safe installation
- OE fit with no modifications needed



SOLENOID VALVE BLOCKS

- Distributes air pressure within the air suspension system
- Direct OE replacement
- Designed to meet or exceed OE
- Helps restore original air suspension system
- Growing product category



RIDE HEIGHT SENSORS

- Determines vehicle height
- Tested to 1 million cycles
- Road tested for function & fitment
- Direct fit for fast plug & play installation
- Quality components including hardware & mounting points for long service life

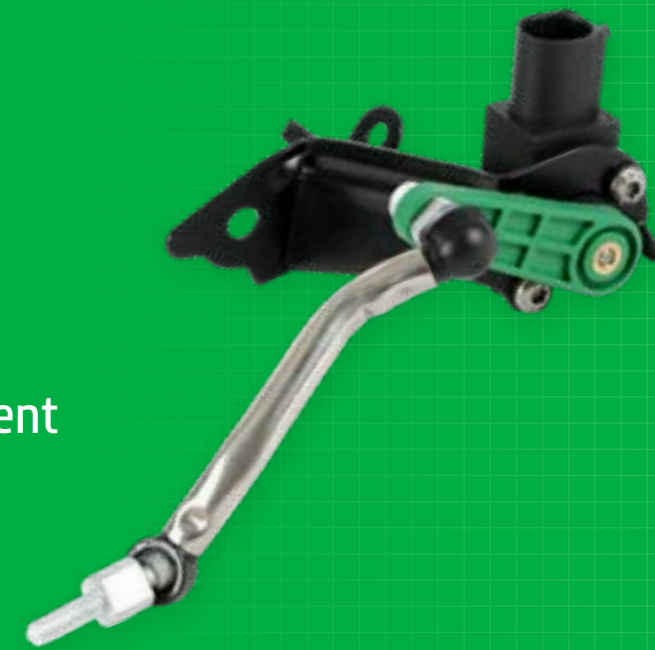

Learn more about performance suspension parts we have.