

AP

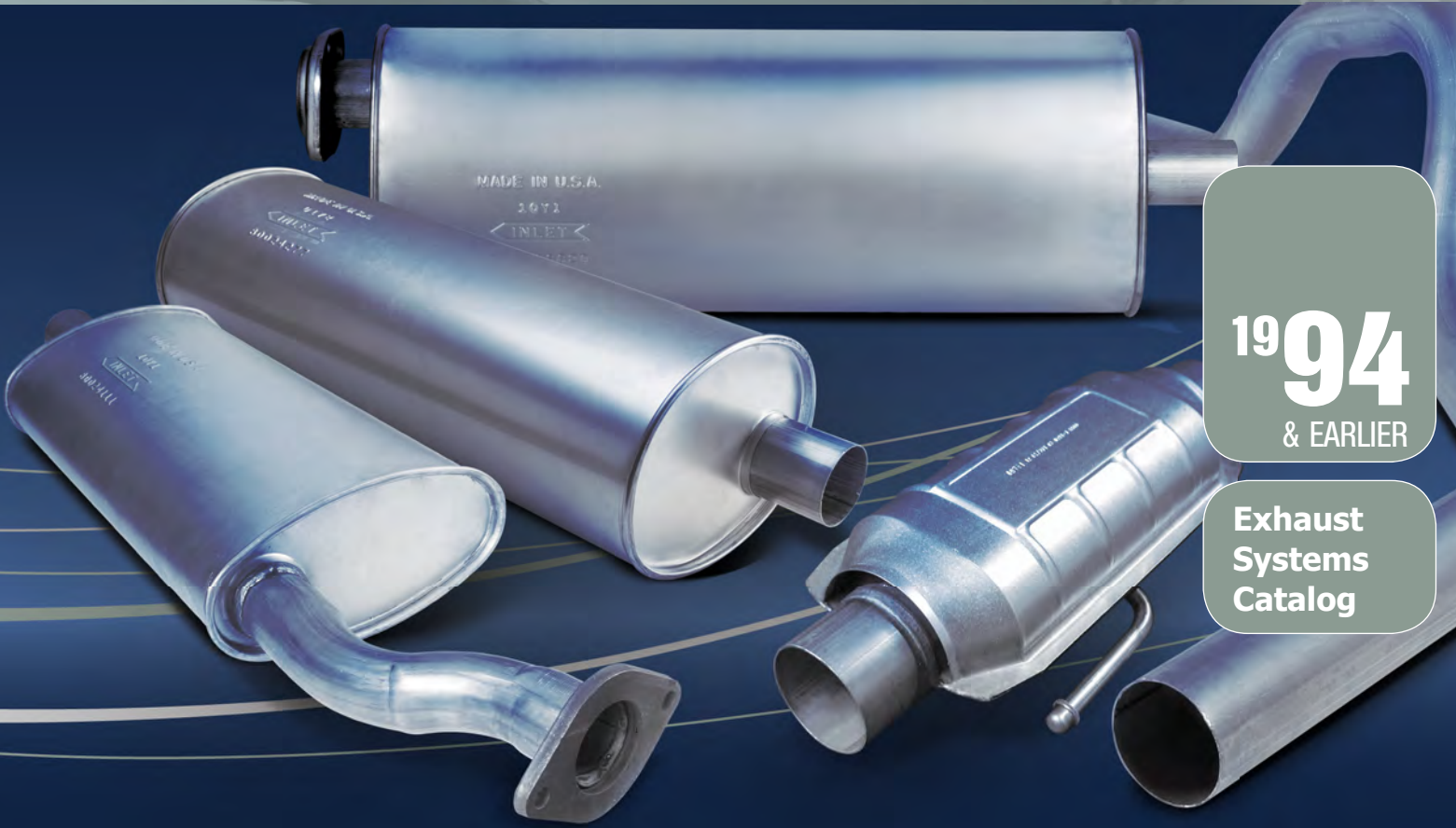

EXHAUST TECHNOLOGIES®



1994
& EARLIER

Exhaust
Systems
Catalog

:: Mufflers :: Exhaust Pipes :: Catalytic Converters :: Accessories ::

MADE IN U.S.A.
INLET

Be Car Care Aware™



THE MANUFACTURING PROCESS

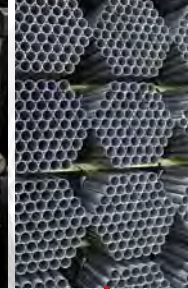

ENGINEERING

ENGINEERING

AP Exhaust Technologies is recognized as one of the world's most innovative producers of aftermarket exhaust and emission systems. At AP, development of these products begins in our engineering technical center

where application research, and the use of state-of-the-art CAD systems, connect with prototyping, and tooling design processes for quicker development and release of new exhaust and emission products.

AP

EXHAUST TECHNOLOGIES®

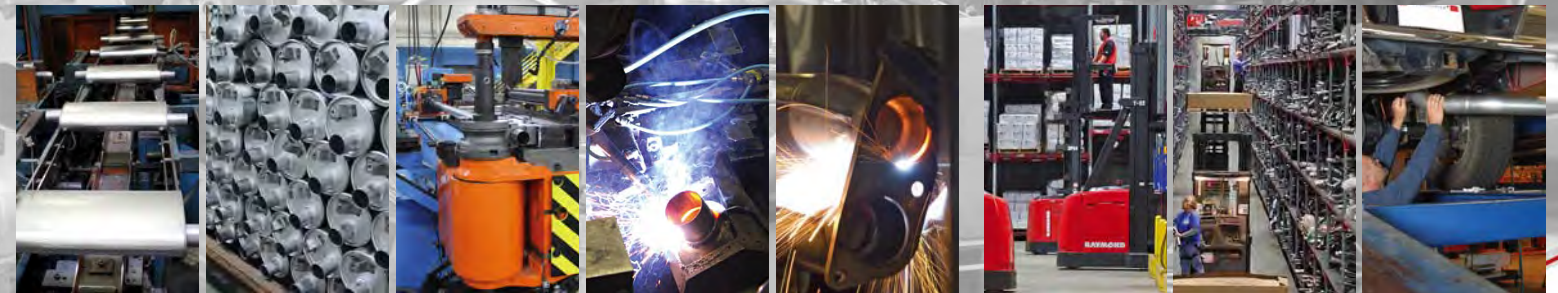

MANUFACTURING

MANUFACTURING

The minute a part is sold, the process begins for replenishment. AP deploys throughout its 440,000 ft² manufacturing facility a linked production system that consistently produces parts for an on-time delivery to our distribution center. Advanced automation, robotics, and computer controlled equipment assure that quality parts are in position at the right time.

With multiple production areas ranging from steel coil processing, muffler assembly, pipe bending, and catalytic converter welding this modern approach to manufacturing reduces production lead times, and improves the quality of the products and accentuates the responsiveness to AP customer needs.

DISTRIBUTION

DISTRIBUTION

AP's strength is in our consistently high order fill rate maintained across all product lines. From our 250,000 ft² distribution center, daily shipments are processed quickly and accurately assuring that AP customers have the products they need in stock at all times. Using the latest in distribution processes and equipment, AP is leading the way in customer service and delivery.



COMPREHENSIVE PRODUCT ASSORTMENT

OE REPLACEMENT



WELDED ASSEMBLIES



CATALYTIC CONVERTERS



PREBENT PIPES



PERFORMANCE



HEAVY DUTY



MADE IN USA

1211



HOW TO USE THIS CATALOG

Revised format:

The format of the exhaust application section of this catalog has been enhanced to simplify the look-up process. All specific vehicle application diagrams are listed in order by make, model, and then year, sequenced first by numbers then by letter.

To find your exhaust application quickly, follow these easy steps:

1. Locate the vehicle make and model in the Table of Contents section and proceed to the page number listed.
2. Applications are listed in order by newest to oldest model years. The first application listed will contain the newest year of coverage available, then going from the smallest to the largest model engine.
3. Appropriate footnote explanations will appear at the bottom of each page.
4. When optional parts are available, the information will appear at the bottom of each exhaust diagram image.

HOW TO IDENTIFY MODEL YEAR

Making The Vehicle VIN Work For You

Since 1981 models, Vehicle Identification Numbers have been in a 17-character format.

Each character or group of characters explains a particular trait of that vehicle. To properly identify vehicle applications in this catalog, you will need to familiarize yourself with the following 3 characters:

Character #5 - Engine Code

Character #10 - Model Year

Character #11 - Assembly Plant location.

A=1980	L=1990	Y=2000	A=2010
B=1981	M=1991	1=2001	B=2011
C=1982	N=1992	2=2002	C=2012
D=1983	P=1993	3=2003	D=2013
E=1984	R=1994	4=2004	E=2014
F=1985	S=1995	5=2005	F=2015
G=1986	T=1996	6=2006	G=2016
H=1987	V=1997	7=2007	H=2017
J=1988	W=1998	8=2008	J=2018
K=1989	X=1999	9=2009	K=2019

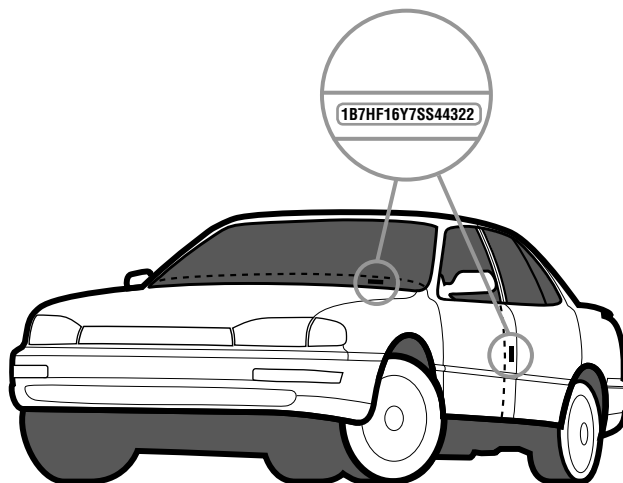

VIN Locations:

- Lower driver's side dashboard corner of windshield
- OR**
- On doorpost where driver's door latch meets.

On-Line VIN Decoding Help

Using Keywords:

- > Free VIN Check
- > Free VIN Decoder
- > Free VIN History
- > Free VIN Search

MODEL IDENTIFICATIONS



Pickup
Camionnette



Van
Furgoneta
Fourgonnette

	1/2 Ton	3/4 Ton	1 Ton	1-1/2 Ton	2 Ton	2-1/2 Ton	3 Ton
CHEVROLET							
Luv							
Astro Van							
Blazer	K10						
Van	G10	G20	G30				
Suburban	C10, R10, C1500						
S10/T10							
Pickup	C10, R10, C1500	C20, R20 C2500	C30, R30, C3500				
4 Wheel Drive	K10, V10, K1500	K20, V20, K2500	K30, V30, K3500				
Forward Control	P10	P20	P30				
Conventional Cab				C40, C50	C60	C70	C65, C80
Tilt Cab				C40, C50	C60		C65
Tandem				C50	C60		C65
DODGE							
Dakota							
Raider							
Ramcharger	AD100, AW100						
Van	A100, B100 Caravan	B200	B300				
Pickup	D100, R1500	D200, R2500	D300, D3500				
Forward Control		P200	P300	P400			
4 Wheel Drive	W100, R1500	W200, R2500	W300, R3500		W500	W600	
Conventional Cab				D400	D500	D600	
Tilt Cab						L600	
Low Cab Forward					C500	C600	
Motor Home			M300	M400			
PLYMOUTH							
Trail Duster	PD100, PW100						
Van	B100 Voyager	B200	B300				
4 Wheel Drive	W100						
FORD							
Aerostar Van	A						
Bronco	U100, U150						
Bronco II	B						
Courier							
Econoline Van	E100, E150	E200, E250	E300, E350				
Explorer	B						
Ranger	R						
Pickup	F100, F150	F250	F350				
Forward Control	P100	P350	P400	P500			
Conventional Cab				F500, N500	F600, N600		
Tilt Cab				C500, C550, C600			
GMC							
Caballero/Sprint	Utility						
Jimmy/Yukon	K1500						
Safari Van							
S15/T15 Sonoma							
Van	G1500 G1600, G1630	G1000, G2500 G2630	G3500				

MODEL IDENTIFICATIONS



Panel



Crew
Compartment
Pickup

	1/2 Ton	3/4 Ton	1 Ton	1-1/2 Ton	2 Ton	2-1/2 Ton	3 Ton
GMC							
Pickup	C1500, R1500	C2500, R2500	C3500, R3500				
Forward Control	P1000	P2500	P3500	P4500			
4 Wheel Drive	K1500, V1500	K2500, V2500	K3500, V3500				
Conventional Cab	1001, 1002, 1502	2500	3500	4000	5500		6500
Tilt Cab			L3500		5500		6500
INTERNATIONAL HARVESTER							
Pickup	900, 1000, 1100	1200	1300				
Travelall	1000, 1100	1200					
Step Van	1100	1200	1400	1500		1600	
Platform				1500			
Conventional Cab						1600	
Tilt Cab						1600	
Scout	80						

- CLASS I** Up to 6,000 Lbs. G.V.W.
- CLASS II** 6,001-10,000 Lbs. G.V.W.
- CLASS III** 10,001-14,000 Lbs. G.V.W.
- CLASS IV** 14,001-16,000 Lbs. G.V.W.
- CLASS V** 16,001-19,500 Lbs. G.V.W.
- CLASS VI** 19,501-26,000 Lbs. G.V.W.
- CLASS VII** 26,001-33,000 Lbs. G.V.W.
- CLASS VIII** 33,000 Lbs. & Up G.V.W.

- CLASSE I** Jusqu'à 6 000 lb PTAC
- CLASSE II** 6 001-10 000 lb PTAC
- CLASSE III** 10 001-14 000 lb PTAC
- CLASSE IV** 14 001-16 000 lb PTAC
- CLASSE V** 16 001-19 500 lb PTAC
- CLASSE VI** 19 501-26 000 lb PTAC
- CLASSE VII** 26 001-33 000 lb PTAC
- CLASSE VIII** 33 000 lb et plus PTAC

- CLASE I** hasta 6.000 libras de TARA
- CLASE II** entre 6.001 y 10.000 libras de TARA
- CLASE III** entre 10.001 y 14.000 libras de TARA
- CLASE IV** entre 14.001 y 16.000 libras de TARA
- CLASE V** entre 16.001 y 19.500 libras de TARA
- CLASE VI** entre 19.501 y 26.000 libras de TARA
- CLASE VII** entre 26.001 y 33.000 libras de TARA
- CLASE VIII** 33.000 libras y superior de TARA

HOW TO DETERMINE ENGINE SIZE AND MODEL YEAR

IN MANY APPLICATION LISTINGS IN THE CATALOG, IT IS REQUIRED FOR YOU TO KNOW THE PROPER ENGINE SIZE.

The following information will allow you to determine proper model year and engine size:

FOR	MODEL YEAR	ENGINE TYPE
ACURA	86-06	10th DIGIT
		NOT IDENTIFIED IN VIN EXC. FOR 96-99 SLX
AMC	81-88	10th DIGIT
	75-80	2nd DIGIT
		4th DIGIT
		7th DIGIT
AUDI	81-06	10th DIGIT
		NOT IDENTIFIED IN VIN
BMW	81-06	10th DIGIT
		NOT IDENTIFIED IN VIN
BUICK	81-08	10th DIGIT
		8th DIGIT
CADILLAC	81-08	10th DIGIT
CHEVROLET	81-08	10th DIGIT
	75-80	6th DIGIT
		8th DIGIT
		5th DIGIT
CHEVROLET TRUCK	81-08	10th DIGIT
	75-80	6th DIGIT
		8th DIGIT
		3rd DIGIT
CHRYSLER	81-08	10th DIGIT
	75-80	6th DIGIT
		8th DIGIT
		5th DIGIT
DAIHATSU	88-92	10th DIGIT
		8th DIGIT

FOR	MODEL YEAR	ENGINE TYPE	
DODGE	81-99	10th DIGIT	8th DIGIT
	75-80	6th DIGIT	5th DIGIT
DODGE TRUCK	81-89	10th DIGIT	8th DIGIT
	75-80	6th DIGIT	5th DIGIT
EAGLE	88-98	10th DIGIT	8th DIGIT
FIAT	79-85	NOT IDENTIFIED IN VIN	NOT IDENTIFIED IN VIN
FORD (EXC. FIESTA)	81-09	10th DIGIT	8th DIGIT
	75-80	1st DIGIT	5th DIGIT
FORD TRUCK (EXC. COURIER)	81-09	10th DIGIT	8th DIGIT
	75-80	NOT IDENTIFIED IN VIN	4th DIGIT
FORD COURIER		5th DIGIT	4th DIGIT
GEO	89-97	10th DIGIT	8th DIGIT
GMC TRUCK	81-08	10th DIGIT	8th DIGIT
	75-80	6th DIGIT	3rd DIGIT
HONDA	80-04	10th DIGIT	NOT IDENTIFIED IN VIN (8th Digit Passport)
HYUNDAI	86-05	10th DIGIT	8th DIGIT
INFINITI	90-05	10th DIGIT	4th DIGIT - 90 to 99 Models only
ISUZU	81-04	10th DIGIT	8th DIGIT
JEEP	89-07	10th DIGIT	8th DIGIT
	81-88	10th DIGIT	6th DIGIT
	75-80	2nd DIGIT	7th DIGIT
KIA	96-05	10th DIGIT	8th DIGIT
	94-95	10th DIGIT	NOT IDENTIFIED IN VIN
LEXUS	90-04	10th DIGIT	4th DIGIT - 90 to 99 Models only
LINCOLN	81-09	10th DIGIT	8th DIGIT
	75-80	1st DIGIT	5th DIGIT
MAZDA	81-06	10th DIGIT	NOT IDENTIFIED IN VIN
	75-80	NOT IDENTIFIED IN VIN	4th DIGIT
MERCURY	81-09	10th DIGIT	8th DIGIT
MERCEDES-BENZ	81-04	10th DIGIT	NOT IDENTIFIED IN VIN
	75-80	NOT IDENTIFIED IN VIN	NOT IDENTIFIED IN VIN
MERKUR	85-90	10th DIGIT	8th DIGIT
MITSUBISHI	83-04	10th DIGIT	8th DIGIT
NISSAN	81-05	NOT IDENTIFIED IN VIN	NOT IDENTIFIED IN VIN
OLDSMOBILE	81-04	10th DIGIT	8th DIGIT
	75-80	6th DIGIT	8th DIGIT
PLYMOUTH	81-01	10th DIGIT	8th DIGIT
	75-80	6th DIGIT	5th DIGIT
PLYMOUTH TRUCK	81-00	10th DIGIT	8th DIGIT
	75-80	6th DIGIT	5th DIGIT
PONTIAC	81-08	10th DIGIT	8th DIGIT
	75-80	6th DIGIT	5th DIGIT
PORSCHE	81-04	10th DIGIT	NOT IDENTIFIED IN VIN
	80	3rd DIGIT	NOT IDENTIFIED IN VIN
	75-79	4th DIGIT	NOT IDENTIFIED IN VIN
RANGE ROVER/LAND ROVER	87-98	10th DIGIT	7th DIGIT
RENAULT	83-87	10th DIGIT	4th or 5th DIGIT
	75-80	NOT IDENTIFIED IN VIN	NOT IDENTIFIED IN VIN

ENGINE SYSTEM CERTIFICATION

All exhaust system parts listed in this catalog comply with the exhaust system certification regulations of the state of California except as noted.

REAR CONVERTERS CUT-OFF INSTRUCTIONS

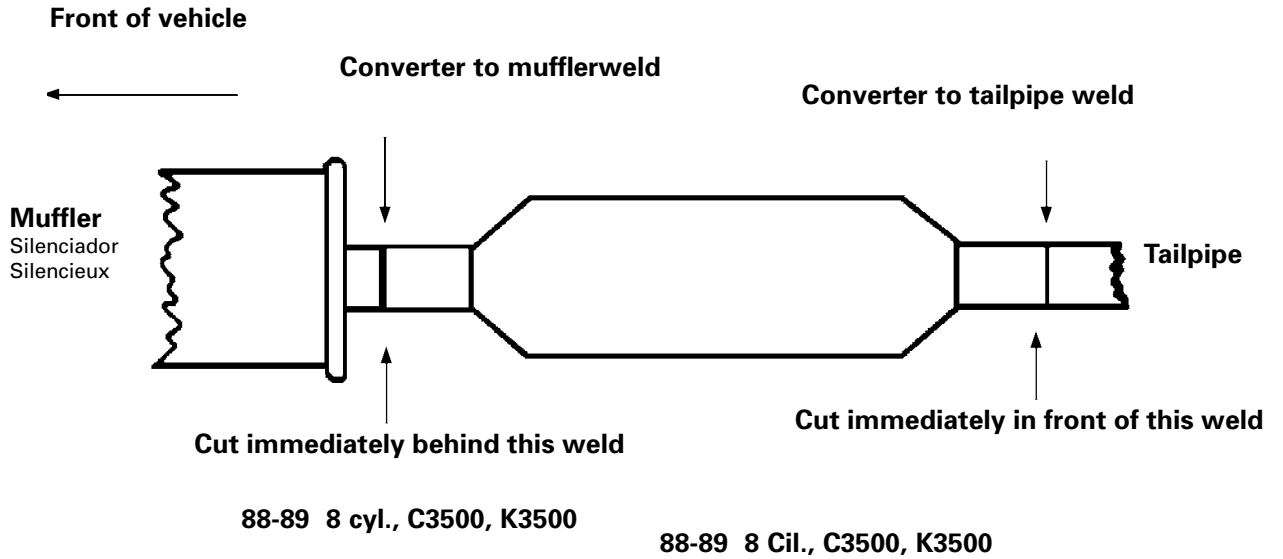

GM CATALYTIC CONVERTER IDENTIFICATION

GM cars were produced with various size catalytic converters. The drawings below show dimensions of the various converters available.

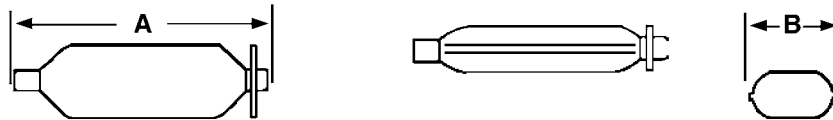

GM Dual Bed Monolithic Converter		
	Dim. A	Dim. B
Full & Mid-Size Cars	18"	6½"
Chevette & T1000	15½"	6½"

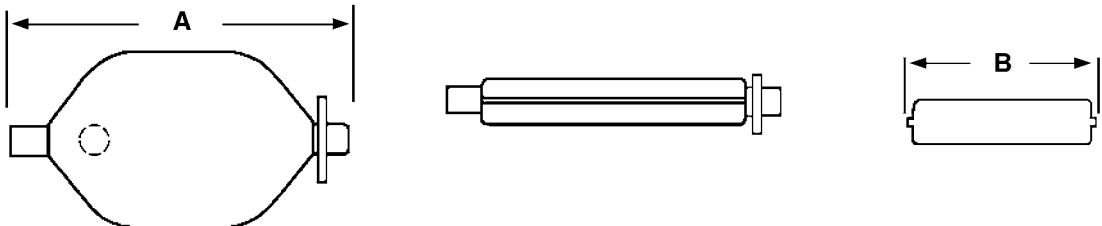

GM Single Bed Monolithic Converter		
	Dim. A	Dim. B
Full & Mid-Size Cars	18"	12½"
Chevette & T1000	15½"	8½"

OBD II

A GENERAL DESCRIPTION

OBD II refers to the On Board Diagnostics Generation Two Emissions System. This system first came into use on some 1995 passenger cars and all 1996 passenger cars and light duty trucks (generally, trucks with a G.V.W. of less than 8,500 lbs.)

OBD II systems monitor all emission control related devices on the vehicle. The functions monitored are as follows:

- Catalyst Efficiency
- Oxygen Sensor Response
- Engine Misfire
- Evaporative Emission Leaks
- Fuel System Supply
- EGR System
- Secondary Air Injection System
- Engine Sensor Output

When a component or a system fails, the **MIL** (Malfunction Indicator Light), **Check Engine** light or **Service Engine** light will illuminate, alerting the driver that the vehicle needs servicing.

As for catalyst efficiency the system functions are as described below:

The OBD II system uses a rear or post converter oxygen sensor to monitor the percent content of oxygen leaving the catalyst as the engine fuel system cycles from rich to lean in response to the before catalyst (Pre-converter) oxygen sensor signal. The catalyst washcoat stores some oxygen during the lean cycles to aid in the oxidation process and releases it during the rich cycles. The rear oxygen sensor will produce a steady voltage signal if the catalyst oxygen storage capacity is correct. A fluctuating signal is an indication that the catalyst is not functioning properly and the **MIL** will come on.

Diagnosing is done with an OBD II scanner or through conventional sensor testing. Currently only the state of California prohibits the use of aftermarket converters for use on OBD II vehicles unless they have been shown to meet California Air Resources Board requirements. The United States Environmental Protection Agency does allow for aftermarket converter use and a copy of their position is shown on the following page.



UNITED STATES ENVIRONMENTAL PROTECTION AGENCY
WASHINGTON, D.C. 20460

August 2, 2000

OFFICE OF
AIR AND RADIATION

This is in response to your recent request for clarification concerning the sale of aftermarket converters for use on OBDII vehicles.

At the present time, the aftermarket converter policy does not specifically address the sale and/or use of aftermarket converters for OBDII vehicles. Therefore, at this time, my opinion is that companies can market and install aftermarket converters if they meet all the requirements of our policy, specify that their use will meet the requirements of the policy for these type of vehicles, specify which specific vehicles they can be used on, and provide the required warranty for the required time periods. The required aftermarket converter warranty should cover any converters in which the MIL illuminates because of a catalyst failure so manufacturers should only market aftermarket converters for those vehicles which are also good enough that the catalyst monitor will not detect a problem for the required 25,000 mile performance period. Thus, the liability for a catalyst failure within the required warranty period would be on the converter manufacturer and the installer if they market or install the aftermarket converters for those applications.

There are still restrictions that aftermarket converters can only be installed on vehicles under certain limited circumstances such as only after the emissions control warranty (8/80 for catalysts on 1995 and newer vehicles) expires, etc. Therefore, at this time, I see a limited need for these installations. However, this will obviously be more of an issue in the future.

I hope this responds to your questions. Please feel free to contact me if you have further questions, comments, or suggestions concerning this issue.

Sincerely,

Steve Albrink
Certification & Compliance Division
Office of Transportation and Air Quality

GENERAL INFO

FORD AEROSTAR

(26452) 90-94 6 Cyl. Aerostar; 4.0L Engine

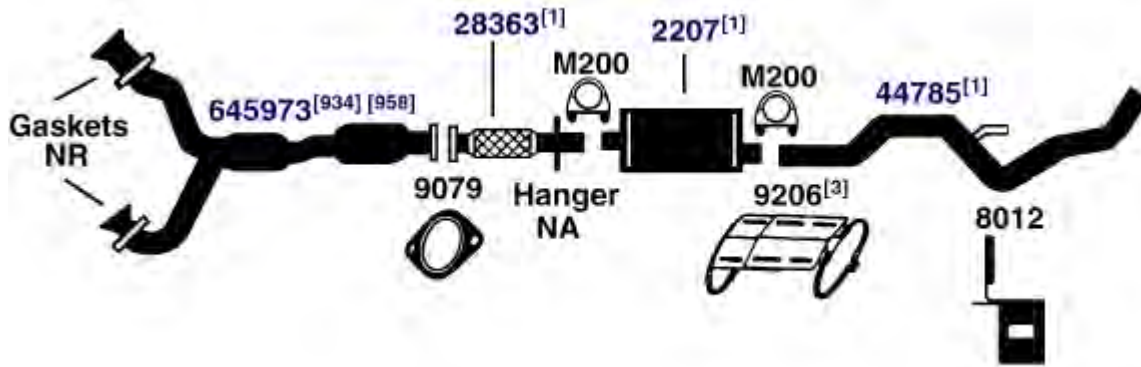

DIRECT FIT MSL/MAXIMUM Muffler... 700044, UNIVERSAL FIT MSL/MAXIMUM Muffler... 709013, 709014, 700021, Silentone DIY Muffler... 5503

(26453) 86-89 6 Cyl. Aerostar; 3.0L Engine

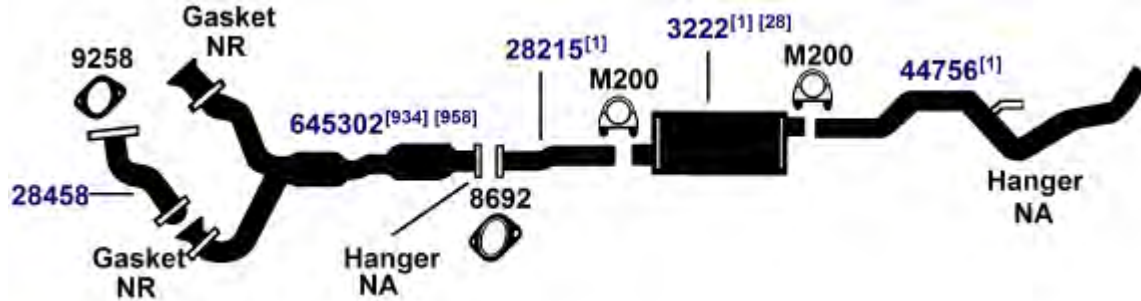

DIRECT FIT MSL/MAXIMUM Muffler... 700002, UNIVERSAL FIT MSL/MAXIMUM Muffler... 6529, 709993, Silentone DIY Muffler... 5551

(26451) 86-87 4 Cyl. Aerostar, 140 (2.3L) Engine

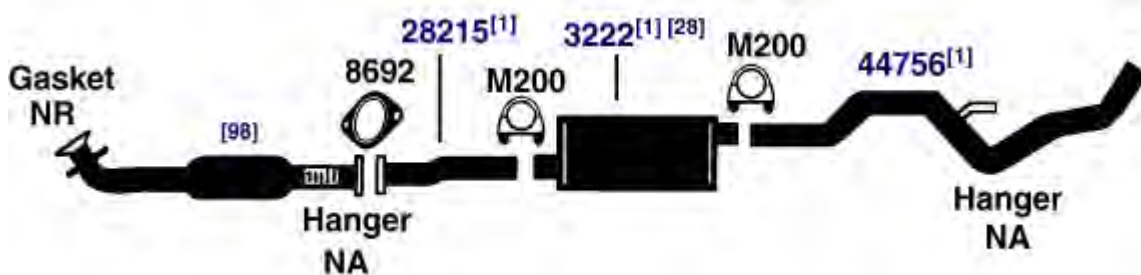

DIRECT FIT MSL/MAXIMUM Muffler... 700002, UNIVERSAL FIT MSL/MAXIMUM Muffler... 6529, 709993, Silentone DIY Muffler... 5551

NA-Not Available. NR-Not Required. FL-Remove and Re-Use Old Flange. ● Golden Warehouse. O.E.-Original Equipment.
Airtube Kit [4948] may be required to complete installation. EFI-Electronic Fuel Injection.

[1] OE system was a welded assembly. It is recommended that all parts noted [1] should be replaced.

[3] Required for installation.

[28] Remove and re-use grass shield, if required.

[98] Refer to current Catalytic Converter catalog or Website catalog for availability.

[934] Replaces multiple OE Converters. Only failed converters may be replaced.

[958] Federal & California Emission vehicles. Not legal for sale for vehicles licensed in California.

FORD AEROSTAR

1986 6 Cyl. Aerostar, 170 (2.8L) Engine

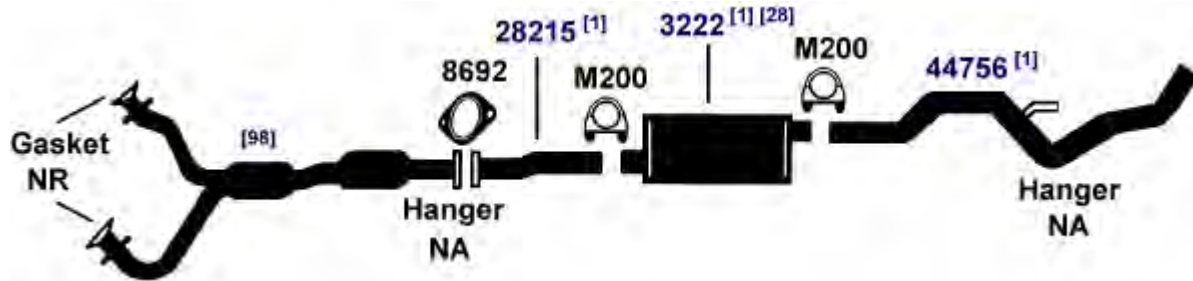
(26450)

DIRECT FIT MSL/MAXIMUM Muffler... 700002, UNIVERSAL FIT MSL/MAXIMUM Muffler... 6529, 709993, Silentone DIY Muffler... 5551

FORD ASPIRE

1994 4 Cyl. Aspire, 1.3L Engine

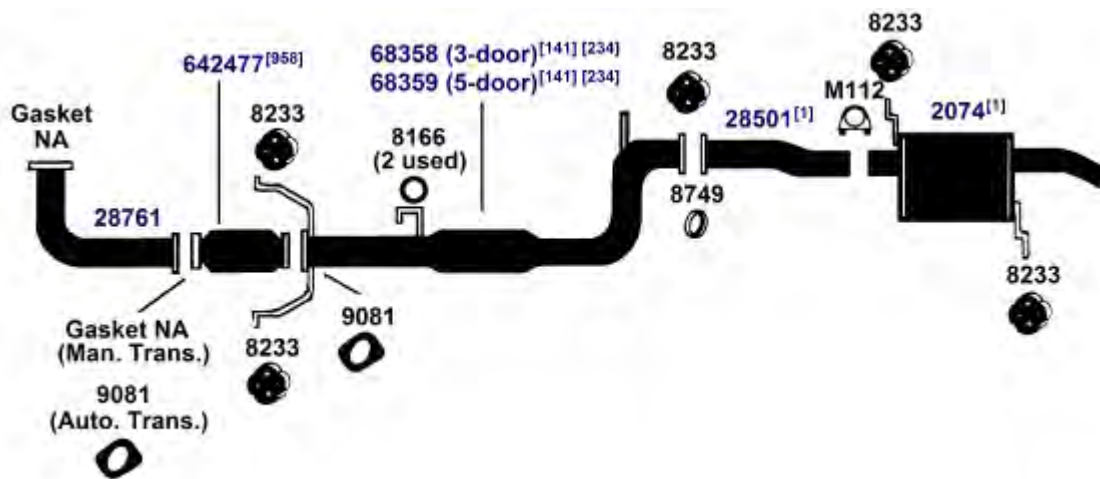
(14575)

DIRECT FIT MSL/MAXIMUM Muffler... 700224

NA-Not Available. NR-Not Required. FL-Remove and Re-Use Old Flange. ● Golden Warehouse. O.E.-Original Equipment.
 # Airtube Kit [4948] may be required to complete installation. EFI-Electronic Fuel Injection.

- [1] OE system was a welded assembly. It is recommended that all parts noted [1] should be replaced.
 [28] Remove and re-use grass shield, if required.
 [98] Refer to current Catalytic Converter catalog or Website catalog for availability.

- [141] Remove and re-use O.E. heat shield.
 [234] For models equipped with O2 sensor, plug must be removed from adapter.
 [958] Federal & California Emission vehicles. Not legal for sale for vehicles licensed in California.

FORD BRONCO

(27711) 87-94 8 Cyl. Bronco; 5.0L Engine

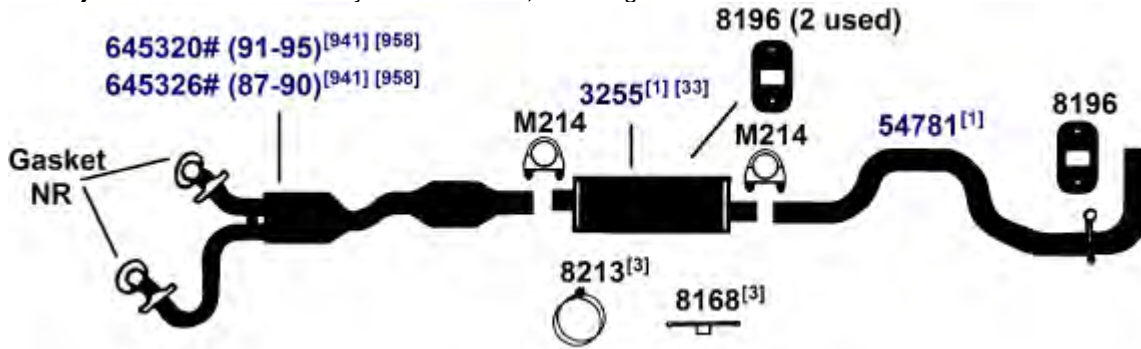

DIRECT FIT MSL/MAXIMUM Muffler... 6592, UNIVERSAL FIT MSL/MAXIMUM Muffler... 6571, 709019, Silentone DIY Muffler... 5557

(27713) 92-94 8 Cyl. Bronco; 5.8L Engine

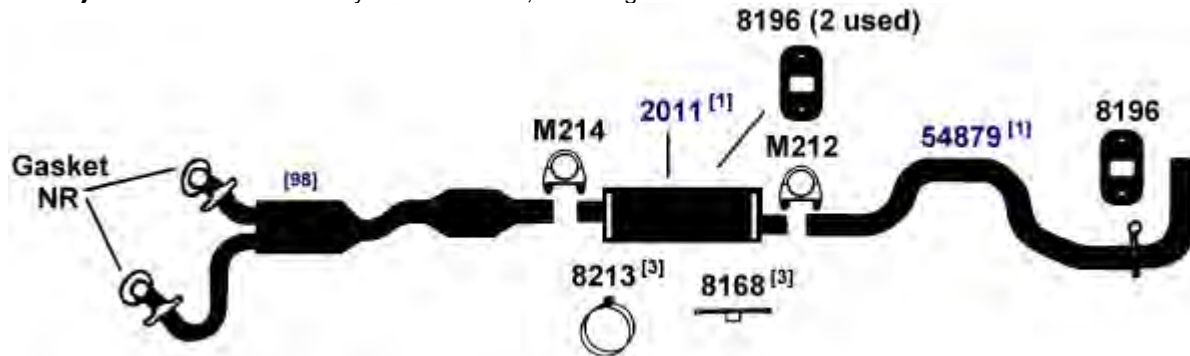

UNIVERSAL FIT MSL/MAXIMUM Muffler... 6592, 709019, Silentone DIY Muffler... 5557

(26610) 87-93 6 Cyl. Bronco; 4.9L Engine

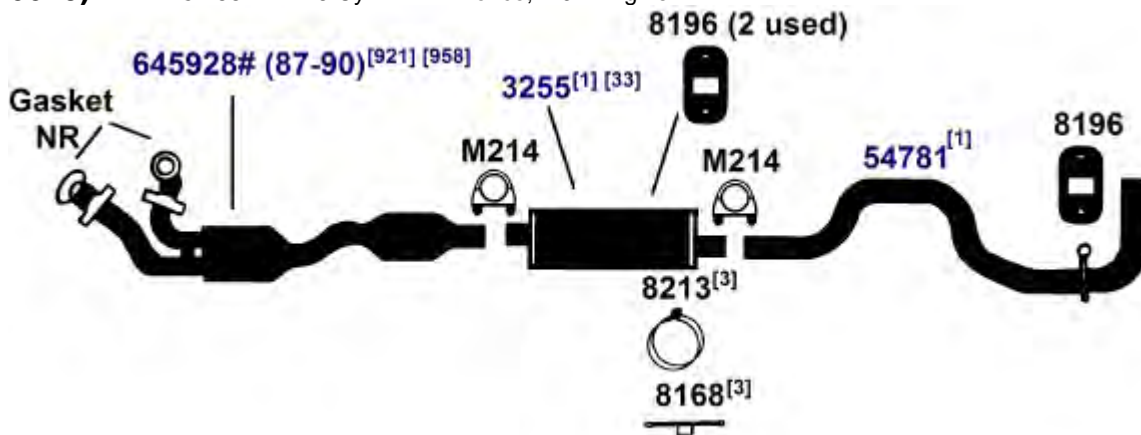

DIRECT FIT MSL/MAXIMUM Muffler... 6592, UNIVERSAL FIT MSL/MAXIMUM Muffler... 6571, 709019, Silentone DIY Muffler... 5557

NA-Not Available. NR-Not Required. FL-Remove and Re-Use Old Flange. ● Golden Warehouse. O.E.-Original Equipment.
Airtube Kit [4948] may be required to complete installation. EFI-Electronic Fuel Injection.

- [1] OE system was a welded assembly. It is recommended that all parts noted [1] should be replaced.
- [3] Required for installation.
- [33] Remove and re-use O.E. heat shield.

- [98] Refer to current Catalytic Converter catalog or Website catalog for availability.
- [941] Replaces both front and rear converters. Only failed converters may be replaced.
- [958] Federal & California Emission vehicles. Not legal for sale for vehicles licensed in California.

87-91 8 Cyl. Bronco; 351 (5.8L); Engine; with Converter (27712)
 85-86 8 Cyl. Bronco; 351 (5.8L); Engine; 4-Barrel; with Converter

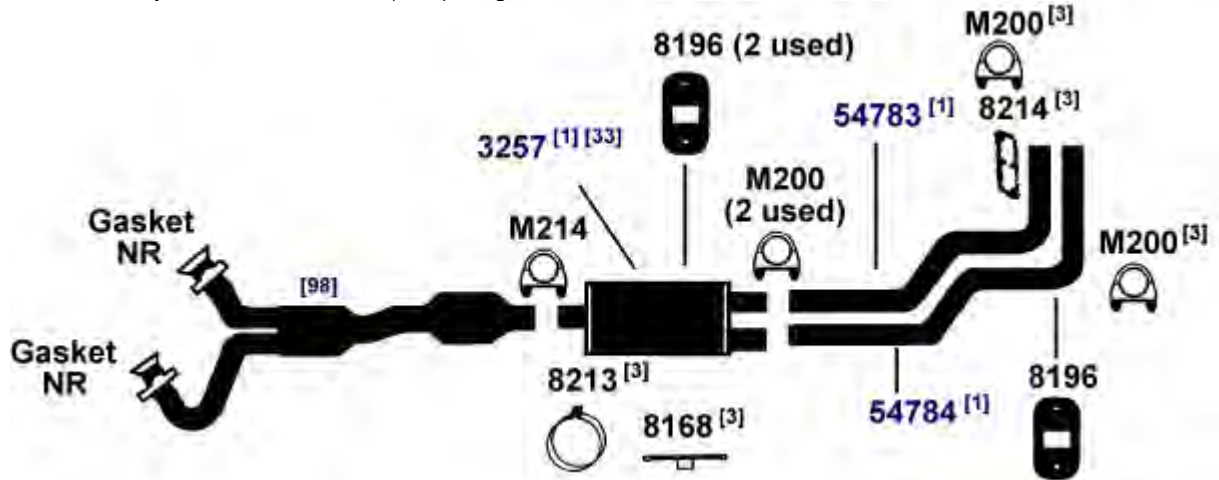

DIRECT FIT MSL/MAXIMUM Muffler... 700099, UNIVERSAL FIT MSL/MAXIMUM Muffler... 6585

85-86 6 Cyl. Bronco; 300 (4.9L) Engine; with Converter (26607)

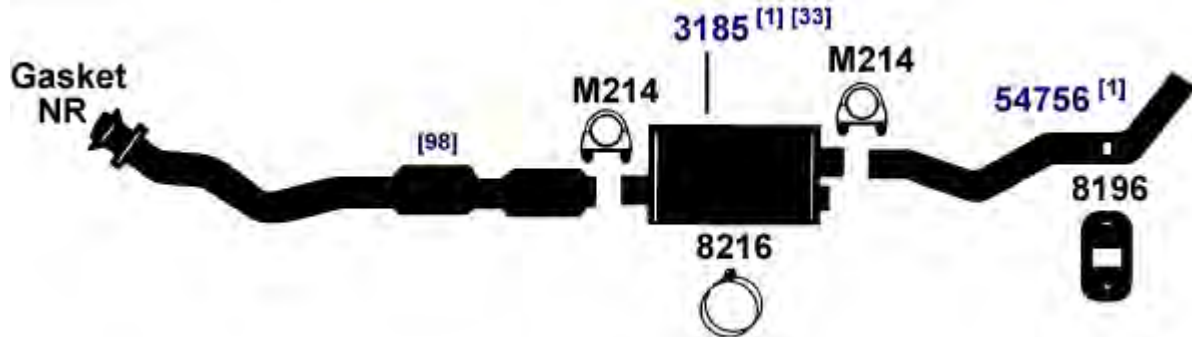

UNIVERSAL FIT MSL/MAXIMUM Muffler... 6539, 709019, Silentone DIY Muffler... 5567

85-86 6 Cyl. Bronco; 300 (4.9L) Engine; without Converter (26608)

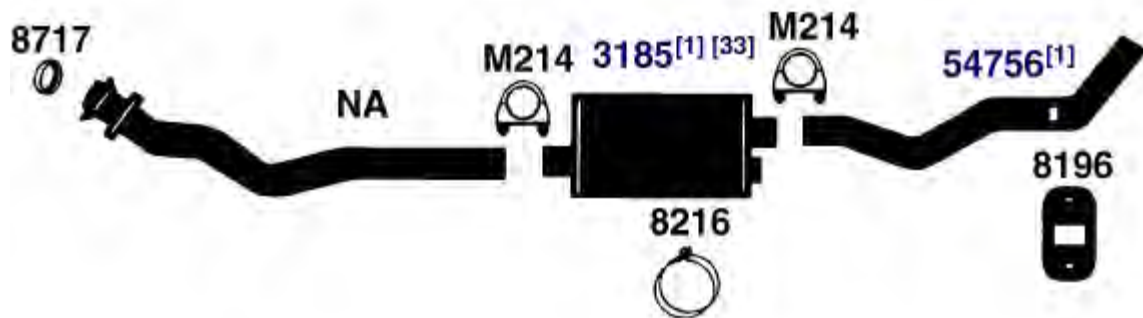

UNIVERSAL FIT MSL/MAXIMUM Muffler... 6539, 709019, Silentone DIY Muffler... 5567

NA-Not Available. NR-Not Required. FL-Remove and Re-Use Old Flange. ● Golden Warehouse. O.E.-Original Equipment.
 # Airtube Kit [4948] may be required to complete installation. EFI-Electronic Fuel Injection.

- [1] OE system was a welded assembly. It is recommended that all parts noted [1] should be replaced.
- [3] Required for installation.
- [33] Remove and re-use O.E. heat shield.
- [98] Refer to current Catalytic Converter catalog or Website catalog for availability.
- [958] Federal & California Emission vehicles. Not legal for sale for vehicles licensed in California.

FORD BRONCO

(27709) 85-86 8 Cyl. Bronco; 302 (5.0L) Engine, including EFI; with Converter
 1985 8 Cyl. Bronco; 351 (5.8L); Engine; with Converter

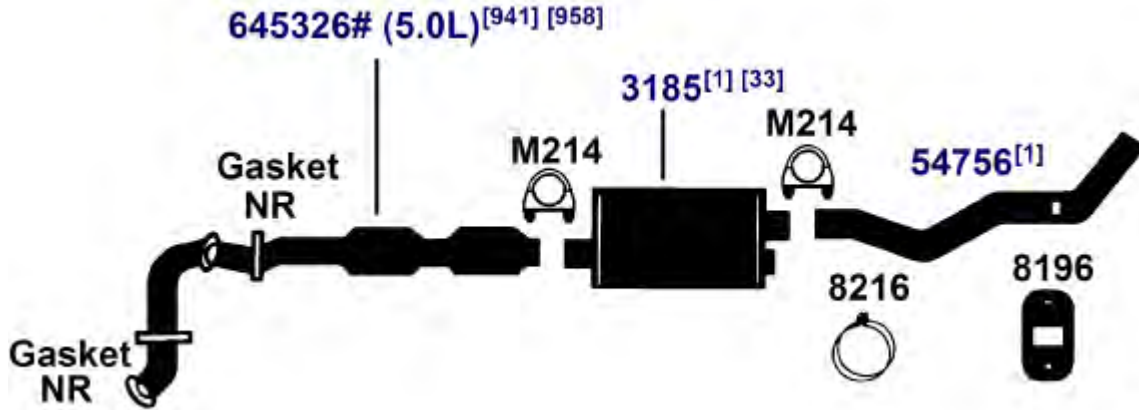

UNIVERSAL FIT MSL/MAXIMUM Muffler... 6539, 709019, Silentone DIY Muffler... 5567

(27710) 85-86 8 Cyl. Bronco; 302 (5.0L) Engine, including EFI; without Converter
 1985 8 Cyl. Bronco; 302, 351 2-Barrel (5.0L, 5.8L) Engine, without Converter

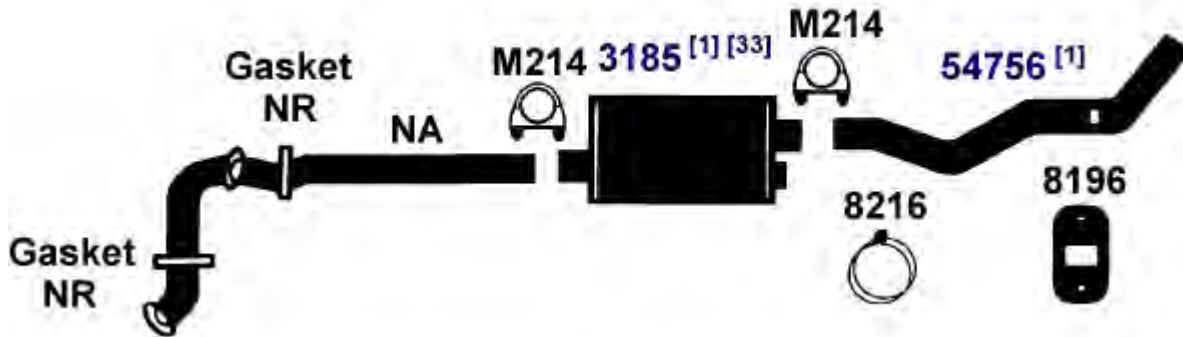

UNIVERSAL FIT MSL/MAXIMUM Muffler... 6539, 709019, Silentone DIY Muffler... 5567

(26607E) 1984 6 Cyl. Bronco; 300 (4.9L) Engine; with Converter

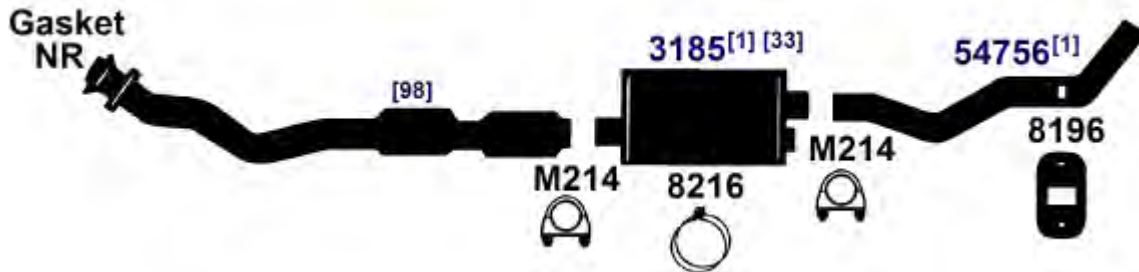

UNIVERSAL FIT MSL/MAXIMUM Muffler... 6539, 709019, Silentone DIY Muffler... 5567

NA-Not Available. NR-Not Required. FL-Remove and Re-Use Old Flange. ● Golden Warehouse. O.E.-Original Equipment.
 # Airtube Kit [4948] may be required to complete installation. EFI-Electronic Fuel Injection.

[1] OE system was a welded assembly. It is recommended that all parts noted [1] should be replaced.

[33] Remove and re-use O.E. heat shield.

[98] Refer to current Catalytic Converter catalog or Website catalog for availability.

[941] Replaces both front and rear converters, Only failed converters may be replaced.

[958] Federal & California Emission vehicles. Not legal for sale for vehicles licensed in California.

1984 6 Cyl. Bronco; 300 (4.9L) Engine; without Converter

(26608E)

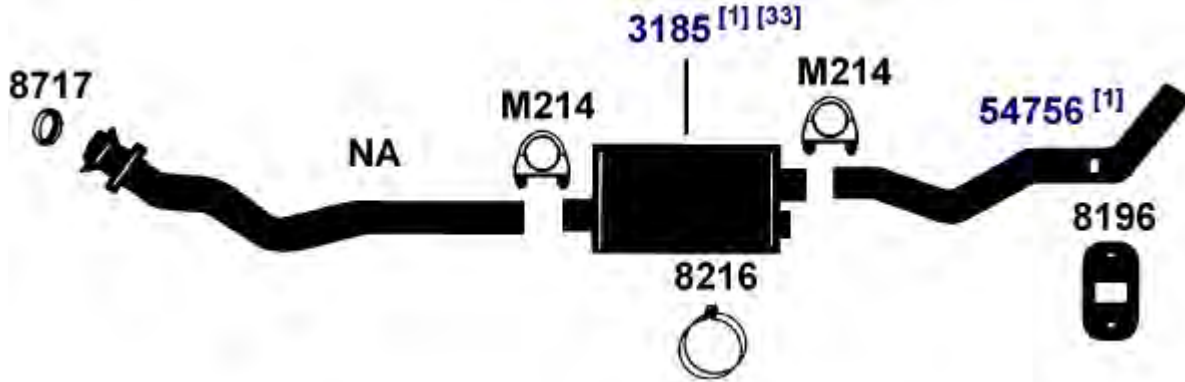

UNIVERSAL FIT MSL/MAXIMUM Muffler... 6539, 709019, Silentone DIY Muffler... 5567

1984 8 Cyl. Bronco; 302, 351 2-Barrel (5.0L, 5.8L) Engine; with Converter

(27709E)

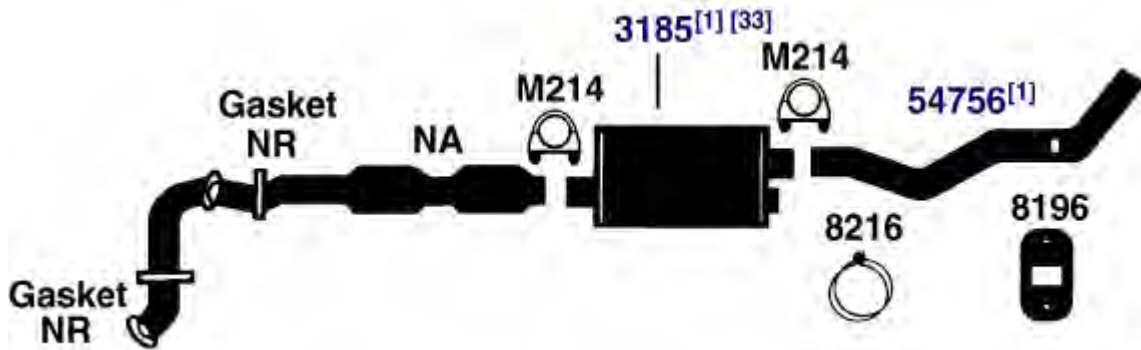

UNIVERSAL FIT MSL/MAXIMUM Muffler... 6539, 709019, Silentone DIY Muffler... 5567

1984 8 Cyl. Bronco; 351 (5.8L); Engine; 4-Barrel; with Converter

(27712E)

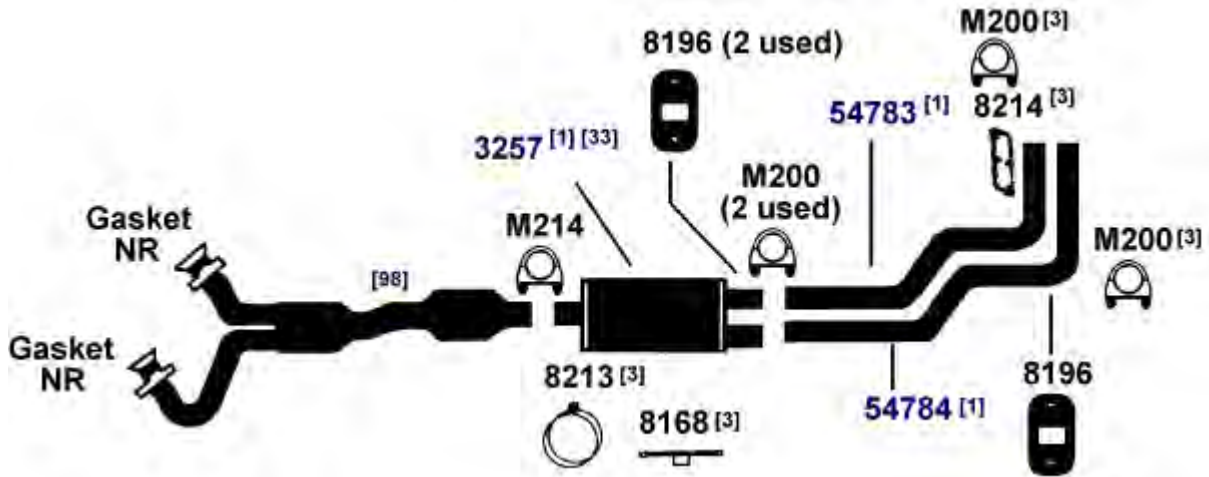

DIRECT FIT MSL/MAXIMUM Muffler... 700099, UNIVERSAL FIT MSL/MAXIMUM Muffler... 6585

NA-Not Available. NR-Not Required. FL-Remove and Re-Use Old Flange. ● Golden Warehouse. O.E.-Original Equipment.
Airtube Kit [4948] may be required to complete installation. EFI-Electronic Fuel Injection.

- [1] OE system was a welded assembly. It is recommended that all parts noted [1] should be replaced.
- [2] Refer to current Catalytic Converter catalog or Website catalog for availability.
- [3] Required for installation.
- [33] Remove and re-use O.E. heat shield.
- [98] Federal & California Emission vehicles. Not legal for sale for vehicles licensed in California.
- [958]

FORD BRONCO

(27710E) 1984 8 Cyl. Bronco; 302, 351 2-Barrel (5.0L, 5.8L) Engine, without Converter

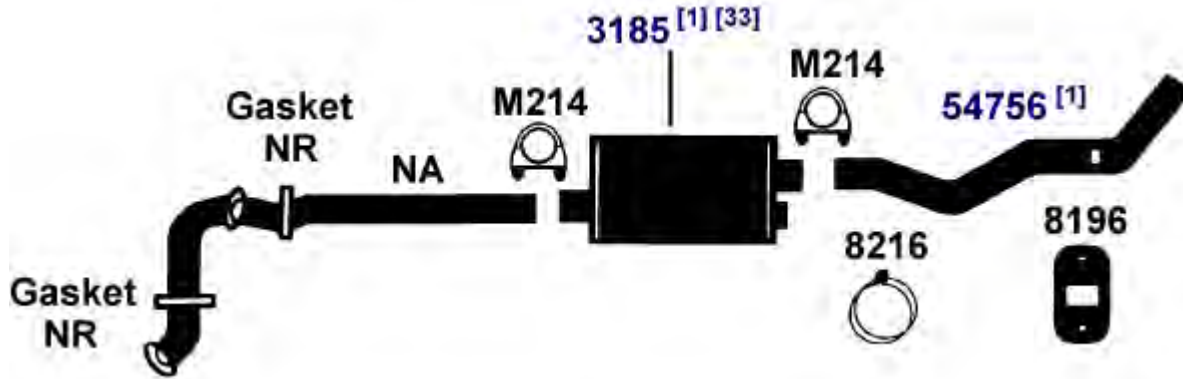

UNIVERSAL FIT MSL/MAXIMUM Muffler... 6539, 709019, Silentone DIY Muffler... 5567

(27707) 1983 8 Cyl. Bronco; 302, 351 (5.0L, 5.8L) Engine; with Converter

93964
(302 Eng.) (exc. Calif.)

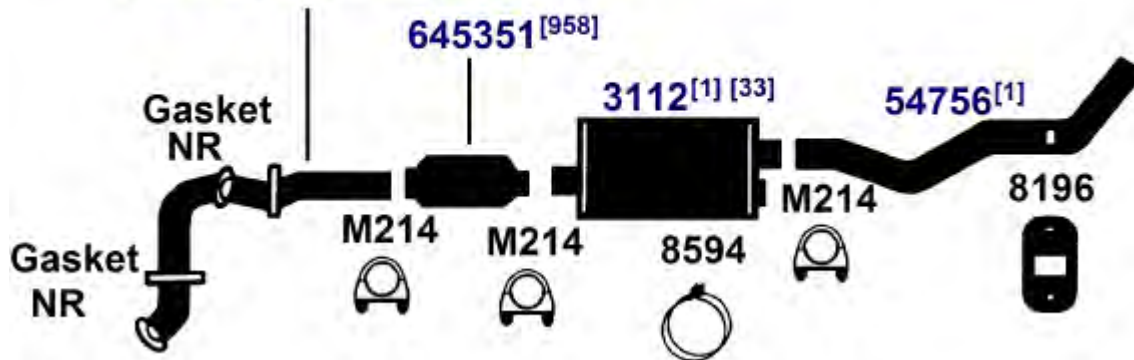

DIRECT FIT MSL/MAXIMUM Muffler... 700001, UNIVERSAL FIT MSL/MAXIMUM Muffler... 6539, 709019, Silentone DIY Muffler... 5534

NA-Not Available. NR-Not Required. FL-Remove and Re-Use Old Flange. ● Golden Warehouse. O.E.-Original Equipment.
Airtube Kit [4948] may be required to complete installation. EFI-Electronic Fuel Injection.

- [1] OE system was a welded assembly. It is recommended that all parts noted [1] should be replaced. [958] Federal & California Emission vehicles. Not legal for sale for vehicles licensed in California.
- [33] Remove and re-use O.E. heat shield.

FORD BRONCO

(26602) 80-83 6 Cyl. Bronco; 300 (4.9L) Engine; with Converter

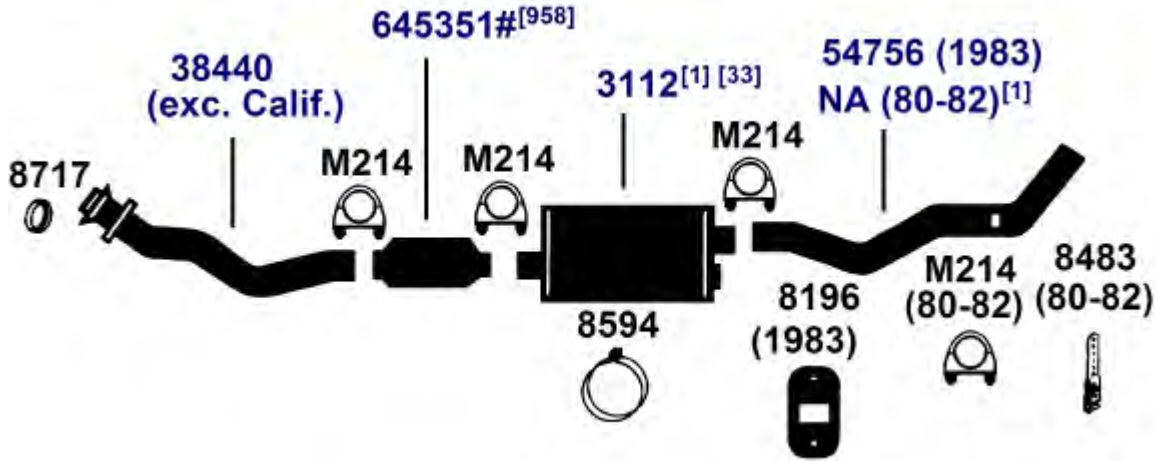

DIRECT FIT MSL/MAXIMUM Muffler... 700001, UNIVERSAL FIT MSL/MAXIMUM Muffler... 6539, 709019, Silentone DIY Muffler... 5534

(27706) 80-82 8 Cyl. Bronco; 302, 351 (5.0L, 5.8L) Engine; with Converter

NA (80-81, 351M Eng.) (exc. Calif.)
93963 (302 Eng.) (exc. Calif.)

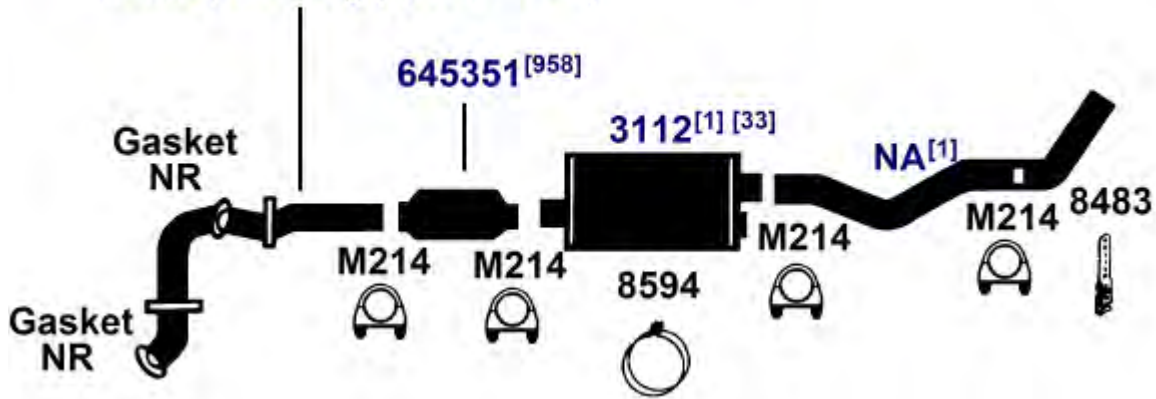

DIRECT FIT MSL/MAXIMUM Muffler... 700001, UNIVERSAL FIT MSL/MAXIMUM Muffler... 6539, 709019, Silentone DIY Muffler... 5534

NA-Not Available. NR-Not Required. FL-Remove and Re-Use Old Flange. ● Golden Warehouse. O.E.-Original Equipment.
 # Airtube Kit [4948] may be required to complete installation. EFI-Electronic Fuel Injection.

- [1] OE system was a welded assembly. It is recommended that all parts noted [1] should be replaced.
- [33] Remove and re-use O.E. heat shield.
- [958] Federal & California Emission vehicles. Not legal for sale for vehicles licensed in California.

FORD BRONCO II

(26609) 86-89 6 Cyl. Bronco II; 177 (2.9L) Engine

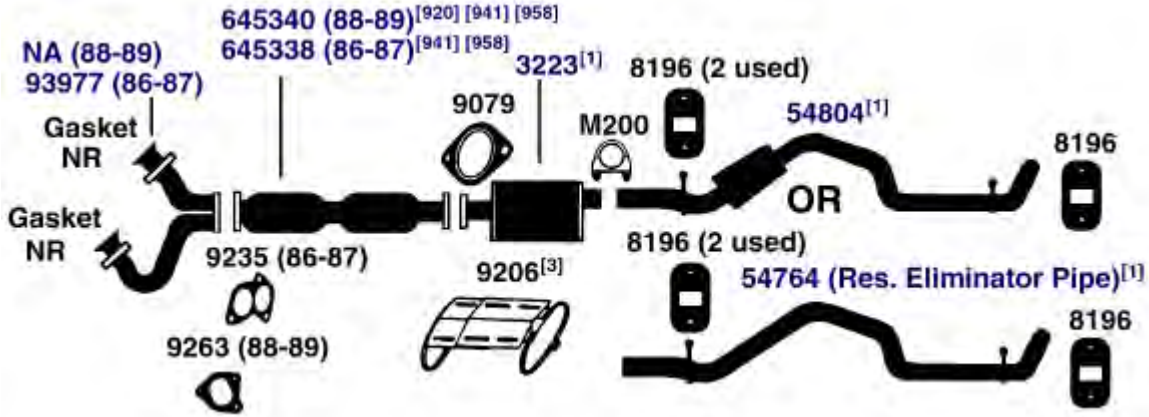

DIRECT FIT MSL/MAXIMUM Muffler... 6586, UNIVERSAL FIT MSL/MAXIMUM Muffler... 6536, 709007, 709010

(26606) 1985 6 Cyl. Bronco II; 170 (2.8L) Engine

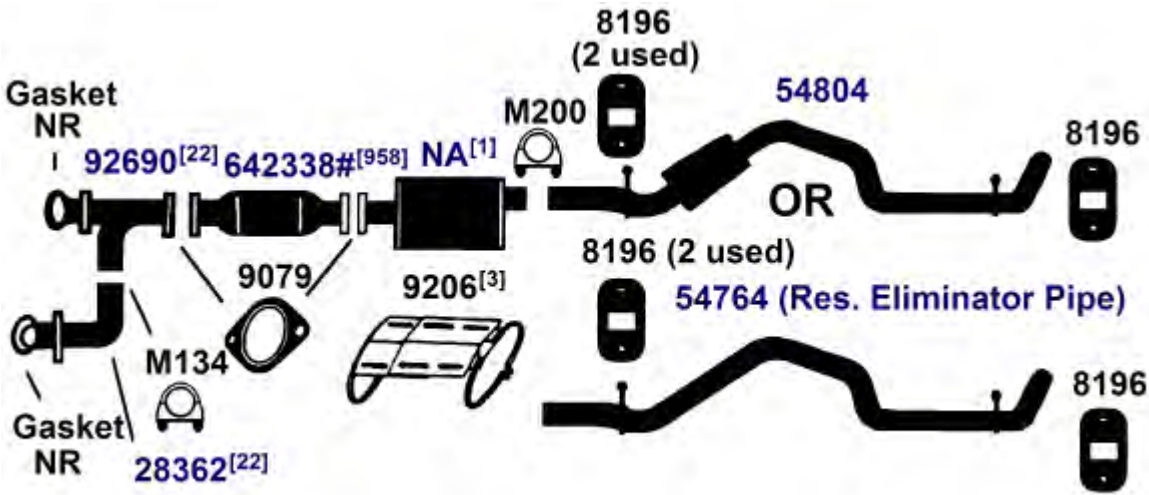

UNIVERSAL FIT MSL/MAXIMUM Muffler... 6536, 709007, 709010

NA-Not Available. NR-Not Required. FL-Remove and Re-Use Old Flange. ● Golden Warehouse. O.E.-Original Equipment.
Airtube Kit [4948] may be required to complete installation. EFI-Electronic Fuel Injection.

[1] OE system was a welded assembly. It is recommended that all parts noted [1] should be replaced.

[3] Required for installation.

[22] O.E. exhaust pipe was one piece. Replacement is two pieces.

[920] Y-Pipe must be cut 1/2" from face of flange

[941] Replaces both front and rear converters. Only failed converters may be replaced.

[958] Federal & California Emission vehicles. Not legal for sale for vehicles licensed in California.

FORD CROWN VICTORIA, LTD (INCL. COUNTRY SQUIRE)

92-94 8 Cyl. Crown Victoria Sedan, 280 (4.6L) Engine; Single Exhaust (5116)

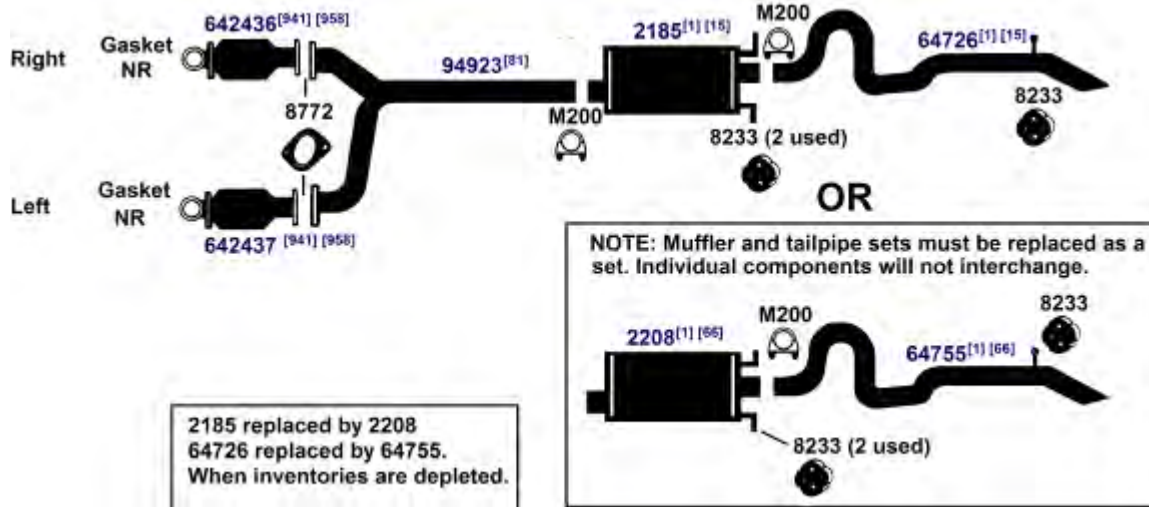

DIRECT FIT MSL/MAXIMUM Muffler... Muffler (option for 2185)- 700042 (Old Design), Muffler (option for 2208)- 700037 (Revised Design), UNIVERSAL FIT MSL/MAXIMUM Muffler... Muffler (option for 2185)- 709012 (Old Design), 709011 (Old Design), Muffler (option for 2208)- 709013 (Revised Design), 709014 (Revised Design)

NA-Not Available. NR-Not Required. FL-Remove and Re-Use Old Flange. ● Golden Warehouse. O.E.-Original Equipment.
Airtube Kit [4948] may be required to complete installation. EFI-Electronic Fuel Injection.

- [1] OE system was a welded assembly. It is recommended that all parts noted [1] should be replaced.
- [15] Discontinued, use until inventory is depleted.
- [66] Muffler and tailpipe sets must be replaced as a set. Individual components will not interchange.
- [81] To align inlets of pipes it may be necessary to reposition converters.
- [941] Replaces both front and rear converters. Only failed converters may be replaced.
- [958] Federal & California Emission vehicles. Not legal for sale for vehicles licensed in California.

FORD CROWN VICTORIA, LTD (INCL. COUNTRY SQUIRE)

(5115)

92-94

8 Cyl.

Crown Victoria Sedan (including Police), 280 (4.6L) Engine; Dual Exhaust

2185 replaced by 2208
64726 replaced by 64755.
64735 replaced by 64758.
When inventories are depleted.

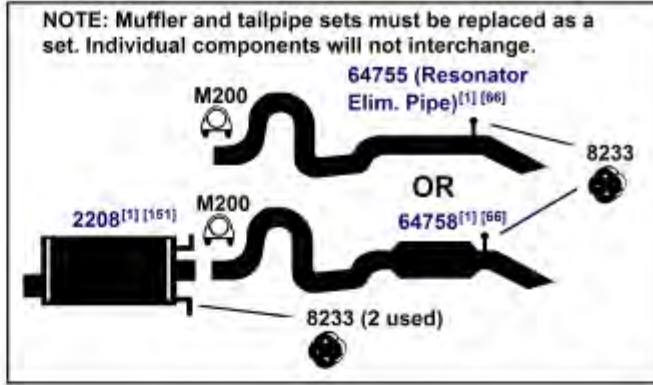

OR

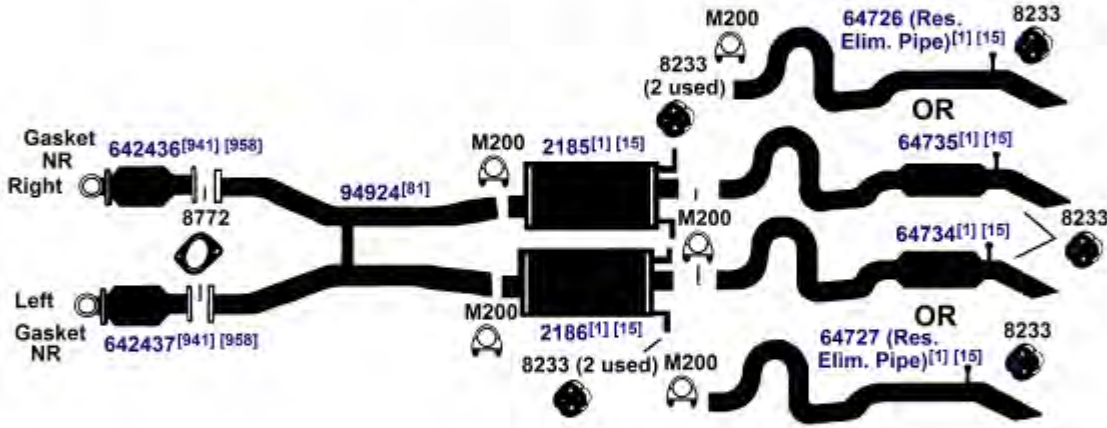

OR

2186 replaced by 2209
64727 replaced by 64756.
64734 replaced by 64757.
When inventories are depleted.

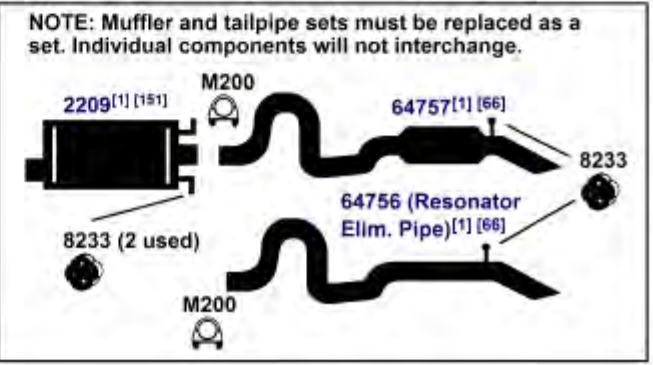

DIRECT FIT MSL/MAXIMUM Muffler... Muffler (option for 2185)-, Right 700042 (Old Design), Muffler (option for 2208)-, Right 700037 (Revised Design), Muffler (option for 2186)-, Left 700043 (Old Design), Muffler (option for 2209)-, Left 700038 (Revised Design), UNIVERSAL FIT MSL/MAXIMUM Muffler... Muffler (option for 2185)-, Right 709012 (Old Design), 709011 (Old Design), Muffler (option for 2208)-, Right 709014 (Revised Design), 709013 (Revised Design), Muffler (option for 2186)-, Left 709012 (Old Design), 709011 (Old Design), Muffler (option for 2209)-, Left 709014 (Revised Design), 709013 (Revised Design)

NA-Not Available. NR-Not Required. FL-Remove and Re-Use Old Flange. ● Golden Warehouse. O.E.-Original Equipment.
Airtube Kit [4948] may be required to complete installation. EFI-Electronic Fuel Injection.

- [1] OE system was a welded assembly. It is recommended that all parts noted [1] should be replaced.
- [15] Discontinued, use until inventory is depleted.
- [66] Muffler and tailpipe sets must be replaced as a set. Individual components will not interchange.
- [81] To align inlets of pipes it may be necessary to reposition converters.
- [151] For Proper sound 2208 and 2209 should be replaced as a pair.
- [941] Replaces both front and rear converters, Only failed converters may be replaced.
- [958] Federal & California Emission vehicles. Not legal for sale for vehicles licensed in California.

FORD CROWN VICTORIA, LTD (INCL. COUNTRY SQUIRE)

90-91 8 Cyl. Crown Victoria Sedan, 302 (5.0L) Engine; Single Exhaust **(5114)**

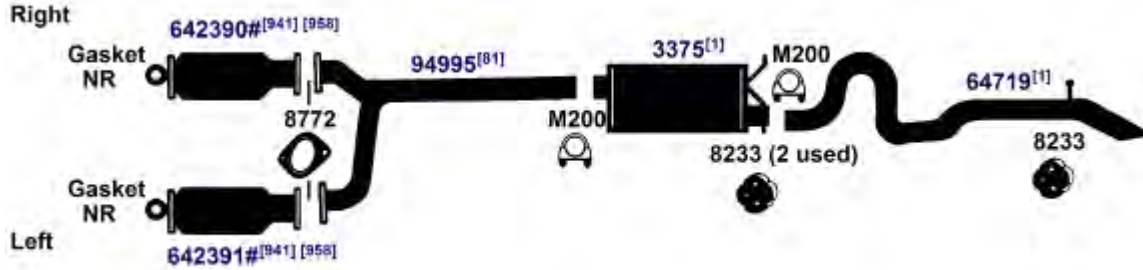

DIRECT FIT MSL/MAXIMUM Muffler... 700013, UNIVERSAL FIT MSL/MAXIMUM Muffler... 6554, 709011, 709012, 709016

90-91 8 Cyl. Crown Victoria Sta. Wagon (Incl. Country Squire), 302 (5.0L) Engine; Single Exhaust **(5112)**

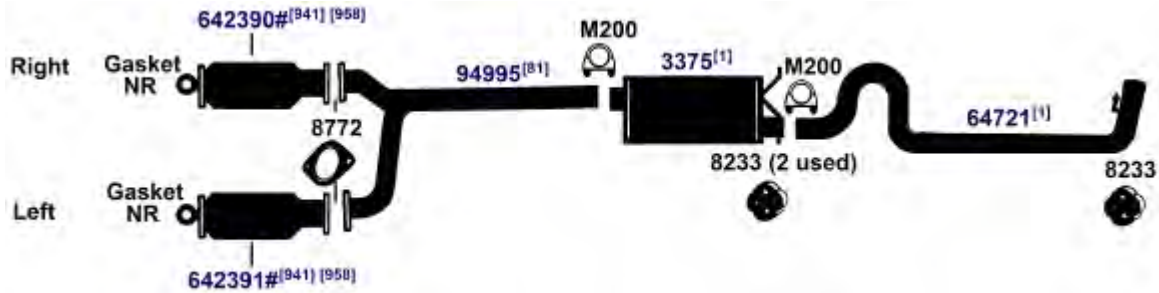

DIRECT FIT MSL/MAXIMUM Muffler... 700013, UNIVERSAL FIT MSL/MAXIMUM Muffler... 6554, 709011, 709012, 709016

90-91 8 Cyl. Crown Victoria Sta. Wagon (Incl. Country Squire); 302 (5.0L), 351 (5.8L) Engine; Dual Exhaust **(5111)**

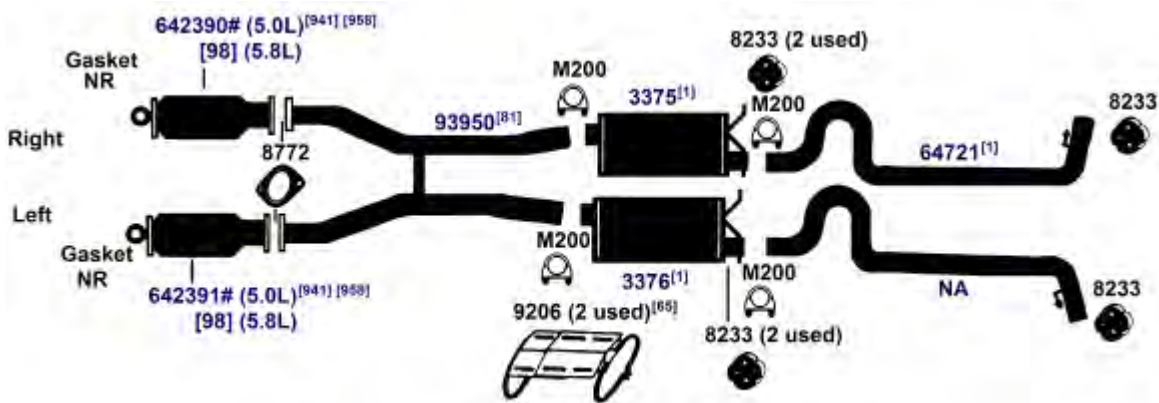

DIRECT FIT MSL/MAXIMUM Muffler... Left 700117, Right 700013, UNIVERSAL FIT MSL/MAXIMUM Muffler... Left 6554, 709011, 709012, 709016, Right 6554, 709011, 709012, 709016

NA-Not Available. NR-Not Required. FL-Remove and Re-Use Old Flange. ● Golden Warehouse. O.E.-Original Equipment.
Airtube Kit [4948] may be required to complete installation. EFI-Electronic Fuel Injection.

[1] OE system was a welded assembly. It is recommended that all parts noted [1] should be replaced.

[65] Heat Shield 9206 is required for installation.

[81] To align inlets of pipes it may be necessary to reposition converters.

[98] Refer to current Catalytic Converter catalog or Website catalog for availability.

[941] Replaces both front and rear converters. Only failed converters may be replaced.

[958] Federal & California Emission vehicles. Not legal for sale for vehicles licensed in California.

FORD CROWN VICTORIA, LTD (INCL. COUNTRY SQUIRE)

(5113) 90-91 8 Cyl. Crown Victoria Sedan; 302 (5.0L), 351 (5.8L) Engine; Dual Exhaust

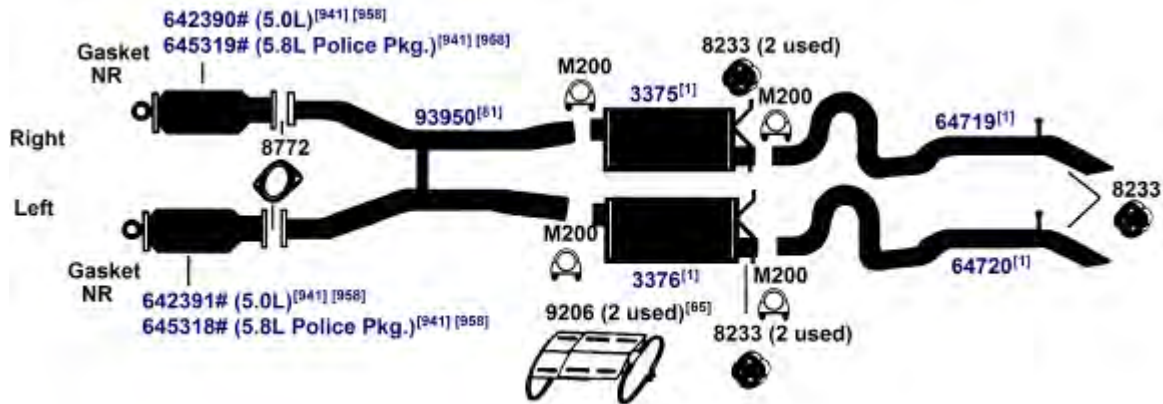

DIRECT FIT MSL/MAXIMUM Muffler... Left 700117, Right 700013, UNIVERSAL FIT MSL/MAXIMUM Muffler... Left 6554, 709011, 709012, 709016, Right 6554, 709011, 709012, 709016

(5103) 85-89 8 Cyl. Crown Victoria Sta. Wagon (Incl. Country Squire), 302 (5.0L) Engine, Single Exhaust

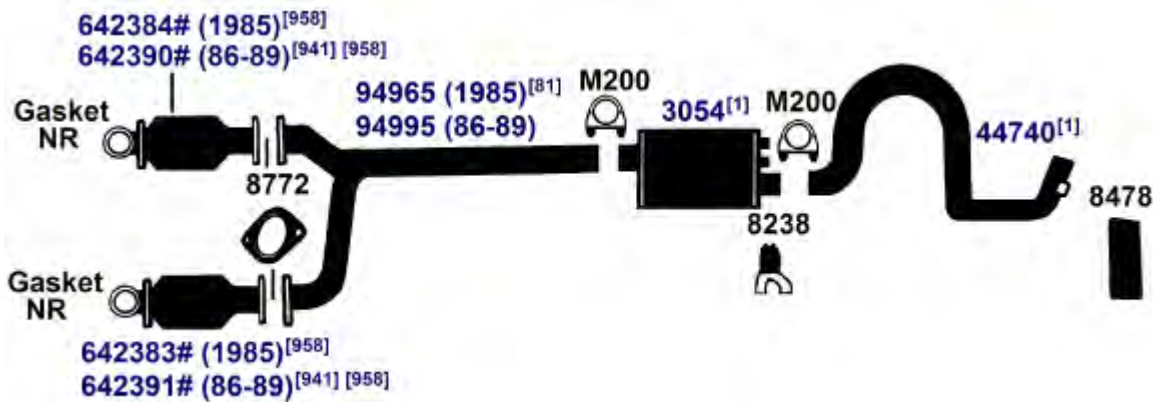

DIRECT FIT MSL/MAXIMUM Muffler... 6554, UNIVERSAL FIT MSL/MAXIMUM Muffler... 6506, 709011, 709012, 709016, Silentone DIY Muffler... 5533

NA-Not Available. NR-Not Required. FL-Remove and Re-Use Old Flange. ● Golden Warehouse. O.E.-Original Equipment.

Airtube Kit [4948] may be required to complete installation. EFI-Electronic Fuel Injection.

[1] OE system was a welded assembly. It is recommended that all parts noted [1] should be replaced.

[65] Heat Shield 9206 is required for installation.

[81] To align inlets of pipes it may be necessary to reposition converters.

[941] Replaces both front and rear converters, Only failed converters may be replaced.

[958] Federal & California Emission vehicles. Not legal for sale for vehicles licensed in California.

FORD CROWN VICTORIA, LTD (INCL. COUNTRY SQUIRE)

85-89 8 Cyl. Crown Victoria Sedan, Sta. Wagon (Incl. Country Squire); 302 (5.0L), 351 (5.8L) **(5110)**
 Engine; Dual Exhaust

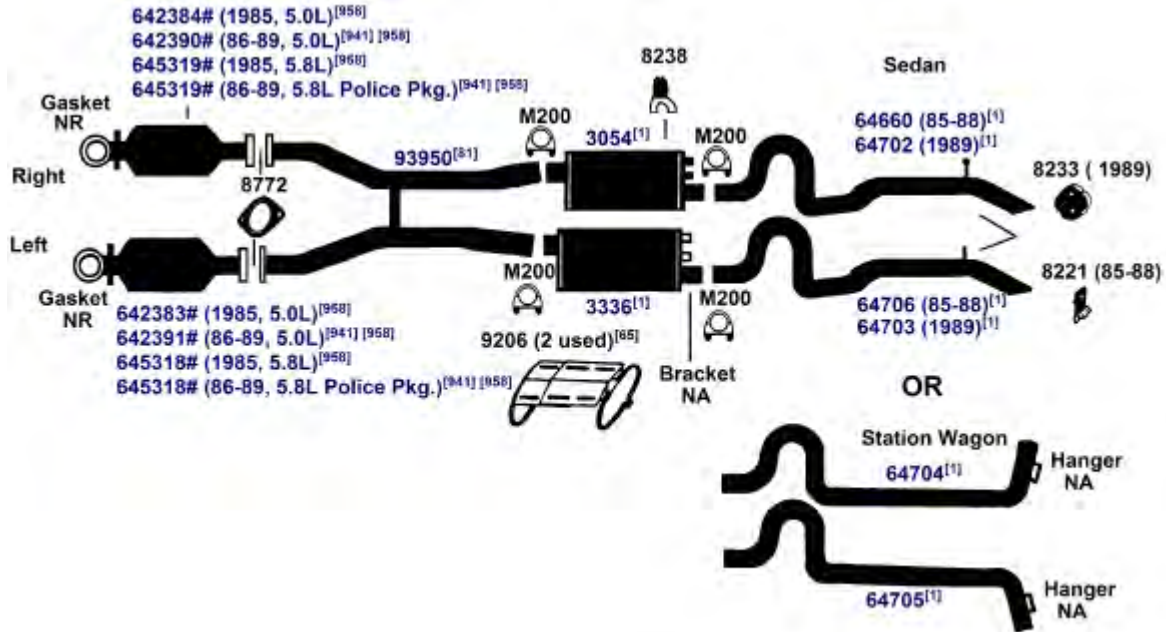

DIRECT FIT MSL/MAXIMUM Muffler... Left 700006, Right 6554, UNIVERSAL FIT MSL/MAXIMUM Muffler... Left 709016, 709011, 709012, Right 709016, 6506, 709011, 709012, Silentone DIY Muffler... Left 5533 and 9206 Heat Shield, Right 5533 and 9206 Heat Shield

85-89 8 Cyl. Crown Victoria Sedan, 302 (5.0L) Engine; Single Exhaust **(5104)**

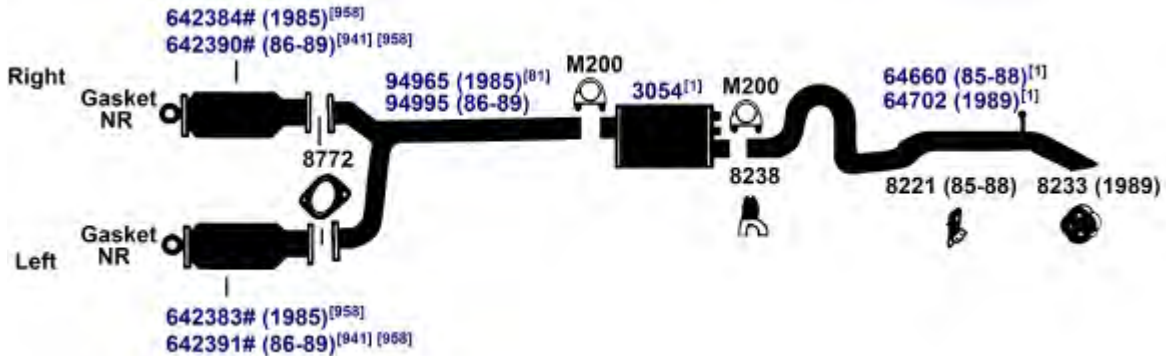

DIRECT FIT MSL/MAXIMUM Muffler... 6554, UNIVERSAL FIT MSL/MAXIMUM Muffler... 6506, 709011, 709012, 709016, Silentone DIY Muffler... 5533

NA-Not Available. NR-Not Required. FL-Remove and Re-Use Old Flange. ● Golden Warehouse. O.E.-Original Equipment.
 # Airtube Kit [4948] may be required to complete installation. EFI-Electronic Fuel Injection.

- [1] OE system was a welded assembly. It is recommended that all parts noted [1] should be replaced.
- [65] Heat Shield 9206 is required for installation.
- [81] To align inlets of pipes it may be necessary to reposition converters.
- [941] Replaces both front and rear converters, Only failed converters may be replaced.
- [958] Federal & California Emission vehicles. Not legal for sale for vehicles licensed in California.

FORD CROWN VICTORIA, LTD (INCL. COUNTRY SQUIRE)

(5106) 85-86 4 Cyl. LTD, 140 (2.3L) Engine

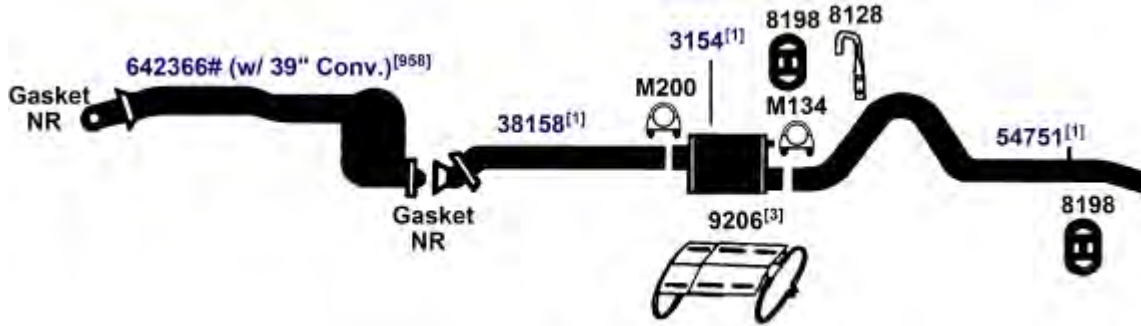

DIRECT FIT MSL/MAXIMUM Muffler... 6556, UNIVERSAL FIT MSL/MAXIMUM Muffler... 709011, Silentone DIY Muffler... 5565 and 8083 Bracket and 9206 Heat Shield

(5105) 85-86 6 Cyl. LTD, 232 (3.8L) Engine, with Electronic Engine Control (Fuel Injection)

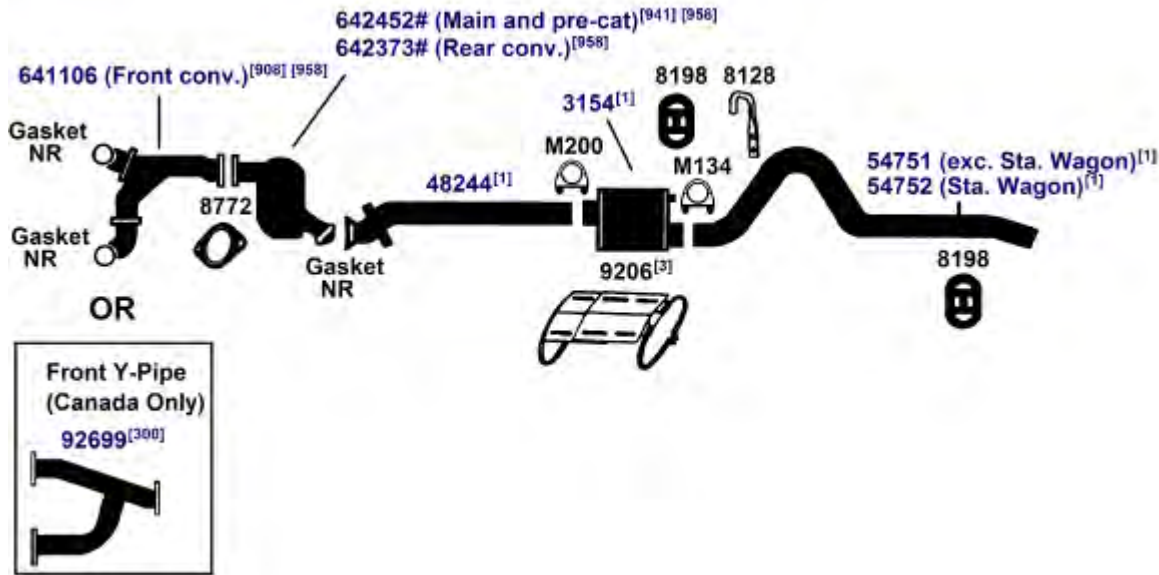

DIRECT FIT MSL/MAXIMUM Muffler... 6556, UNIVERSAL FIT MSL/MAXIMUM Muffler... 709011, Silentone DIY Muffler... 5565 and 8083 Bracket and 9206 Heat Shield

NA-Not Available. NR-Not Required. FL-Remove and Re-Use Old Flange. ● Golden Warehouse. O.E.-Original Equipment.
Airtube Kit [4948] may be required to complete installation. EFI-Electronic Fuel Injection.

[1] OE system was a welded assembly. It is recommended that all parts noted [1] should be replaced.

[3] Required for installation.

[300] For use when resonator originated from O.E. manufacturer.

[908] w/o Airtube on Pre-Cat.

[941] Replaces both front and rear converters, Only failed converters may be replaced.

[958] Federal & California Emission vehicles. Not legal for sale for vehicles licensed in California.

FORD CROWN VICTORIA, LTD (INCL. COUNTRY SQUIRE)

1984 4 Cyl. LTD, 140 (2.3L) Engine

(5106E)

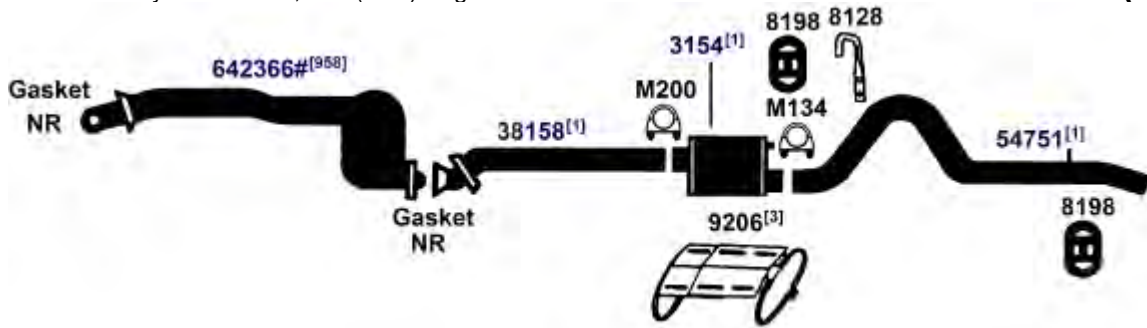

DIRECT FIT MSL/MAXIMUM Muffler... 6556, UNIVERSAL FIT MSL/MAXIMUM Muffler... 709011, Silentone DIY Muffler... 5565 and 8083 Bracket and 9206 Heat Shield

1984 6 Cyl. LTD, 232 (3.8L) Engine, with Electronic Engine Control (Fuel Injection)

(5105E)

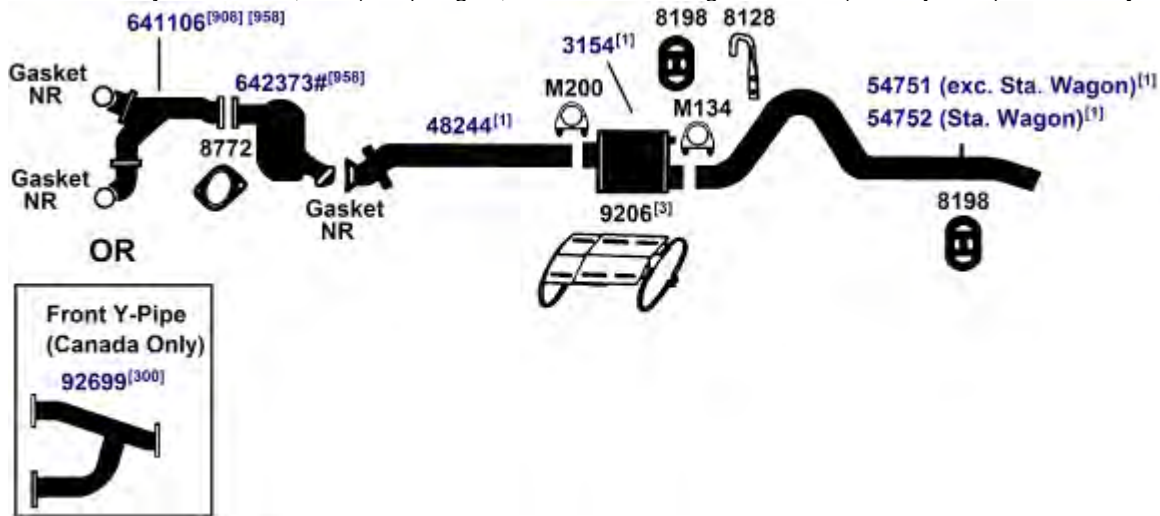

DIRECT FIT MSL/MAXIMUM Muffler... 6556, UNIVERSAL FIT MSL/MAXIMUM Muffler... 709011, Silentone DIY Muffler... 5565 and 8083 Bracket and 9206 Heat Shield

83-84 6 Cyl. LTD, 3.8L, 232 Engine; except Electronic Engine Control (Fuel Injection)

(5102)

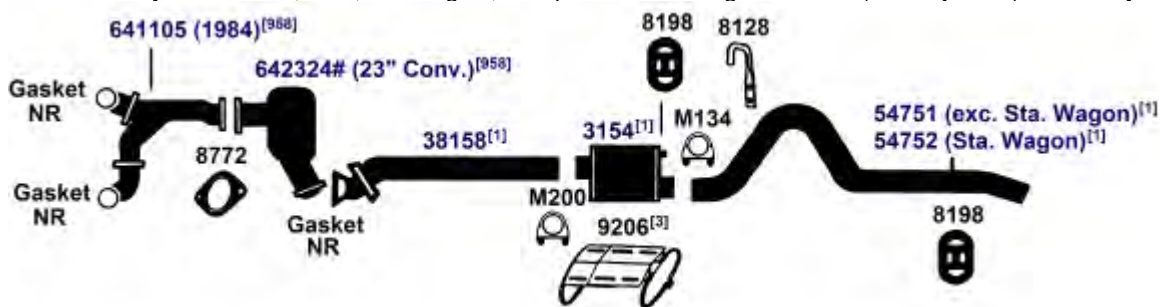

DIRECT FIT MSL/MAXIMUM Muffler... 6556, UNIVERSAL FIT MSL/MAXIMUM Muffler... 709011, Silentone DIY Muffler... 5565 and 8083 Bracket and 9206 Heat Shield

NA-Not Available. NR-Not Required. FL-Remove and Re-Use Old Flange. ● Golden Warehouse. O.E.-Original Equipment.
Airtube Kit [4948] may be required to complete installation. EFI-Electronic Fuel Injection.

- [1] OE system was a welded assembly. It is recommended that all parts noted [1] should be replaced.
- [3] Required for installation.
- [300] For use when resonator originated from O.E. manufacturer.
- [908] w/o Airtube on Pre-Cat.
- [958] Federal & California Emission vehicles. Not legal for sale for vehicles licensed in California.

FORD CROWN VICTORIA, LTD (INCL. COUNTRY SQUIRE)

(5103E) 83-84 8 Cyl. Crown Victoria Sta. Wagon, 302 (5.0L) Engine, Single Exhaust

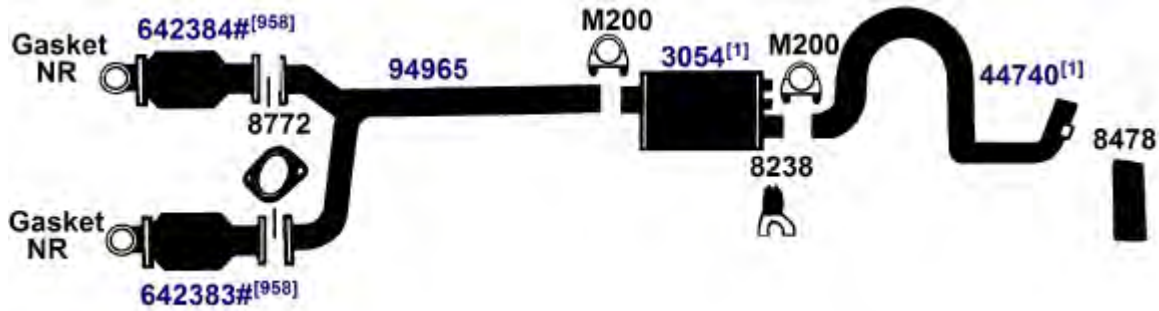

DIRECT FIT MSL/MAXIMUM Muffler... 6554, UNIVERSAL FIT MSL/MAXIMUM Muffler... 6506, 709011, 709012, 709016, Silentone DIY Muffler... 5533

(5104E) 83-84 8 Cyl. Crown Victoria Sedan, 302 (5.0L) Engine; Single Exhaust

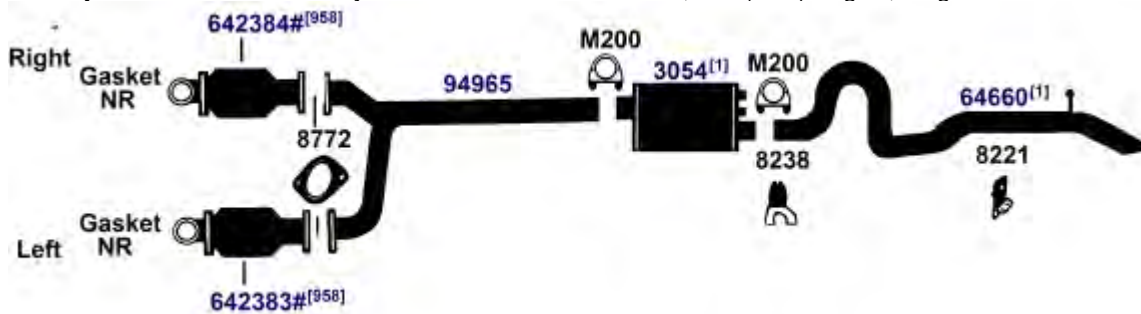

DIRECT FIT MSL/MAXIMUM Muffler... 6554, UNIVERSAL FIT MSL/MAXIMUM Muffler... 6506, 709011, 709012, 709016, Silentone DIY Muffler... 5533

NA-Not Available. NR-Not Required. FL-Remove and Re-Use Old Flange. ● Golden Warehouse. O.E.-Original Equipment.
Airtube Kit [4948] may be required to complete installation. EFI-Electronic Fuel Injection.

[1] OE system was a welded assembly. It is recommended that all parts noted [1] should be replaced. [958] Federal & California Emission vehicles. Not legal for sale for vehicles licensed in California.

FORD CROWN VICTORIA, LTD (INCL. COUNTRY SQUIRE)

83-84 8 Cyl. Crown Victoria Sedan, Sta. Wagon; 302 (5.0L), 351 (5.8L) Engine; Dual Exhaust **(5110E)**

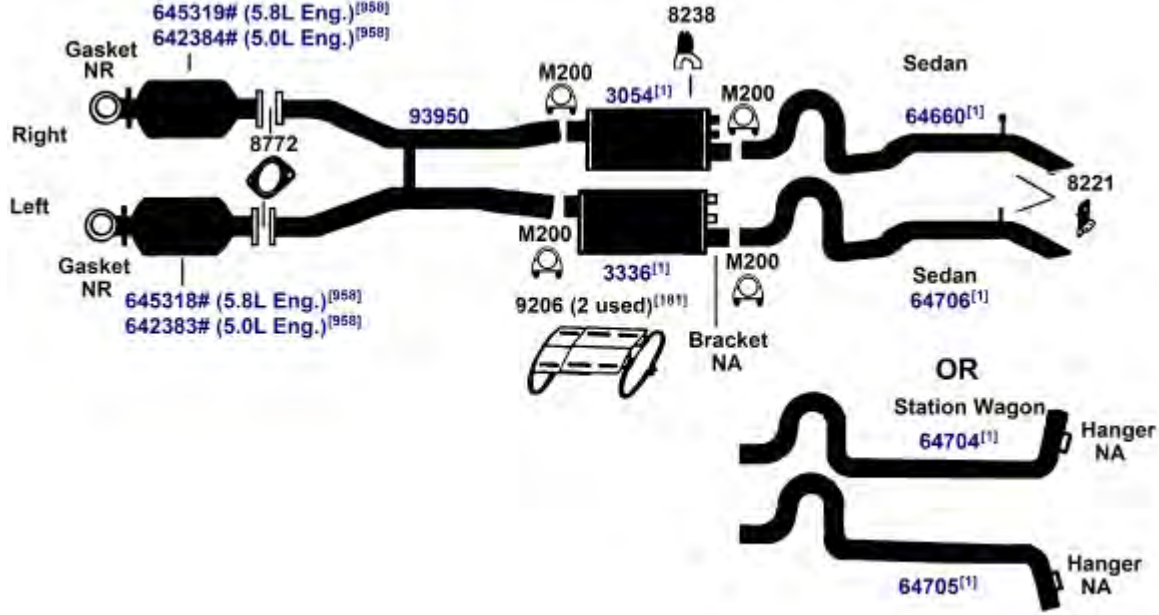

DIRECT FIT MSL/MAXIMUM Muffler... Left 700006, Right 6554, UNIVERSAL FIT MSL/MAXIMUM Muffler... Left 709011, 709012, 709016, Right 6506, 709011, 709012, 709016, Silentone DIY Muffler... Left 5533 and 9206 Heat Shield, Right 5533 and 9206 Heat Shield

1983 4 Cyl. LTD, 2.3L, 140 Engine **(5101)**
1983 6 Cyl. LTD, 3.3L, 200 Engine

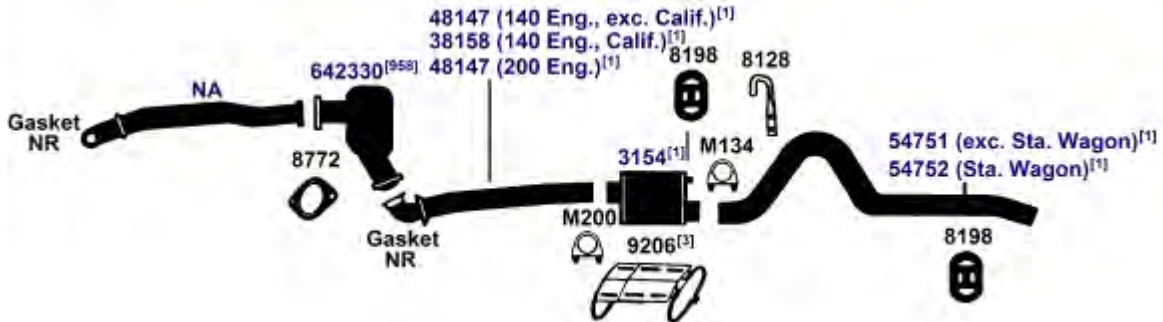

DIRECT FIT MSL/MAXIMUM Muffler... 6556, UNIVERSAL FIT MSL/MAXIMUM Muffler... 709011, Silentone DIY Muffler... 5565 and 8083
 Bracket and 9206 Heat Shield

NA-Not Available. NR-Not Required. FL-Remove and Re-Use Old Flange. ● Golden Warehouse. O.E.-Original Equipment.
 # Airtube Kit [4948] may be required to complete installation. EFI-Electronic Fuel Injection.

- [1] OE system was a welded assembly. It is recommended that all parts noted [1] should be replaced.
- [181] Required for installation on Police models and models with Trailer Towing Package.
- [3] Required for installation.
- [958] Federal & California Emission vehicles. Not legal for sale for vehicles licensed in California.

FORD CROWN VICTORIA, LTD (INCL. COUNTRY SQUIRE)

(5097) 81-82 8 Cyl. LTD, Sedan; 255 (4.2L), 302 (5.0L), 351 (5.8L) Engine

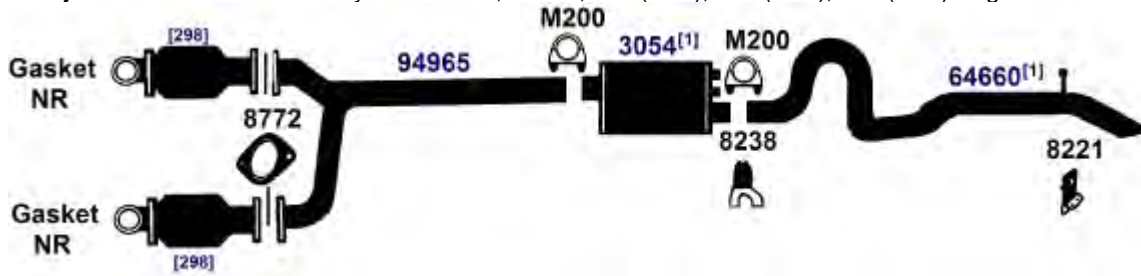

DIRECT FIT MSL/MAXIMUM Muffler... 6554, UNIVERSAL FIT MSL/MAXIMUM Muffler... 6506, 709011, 709012, 709016, Silentone DIY Muffler... 5533

(5096) 81-82 8 Cyl. LTD, Station Wagon; 255 (4.2L), 302 (5.0L) Engine
79-80 8 Cyl. LTD, Station Wagon; 302 (5.0L), 351W (5.8L) Engine

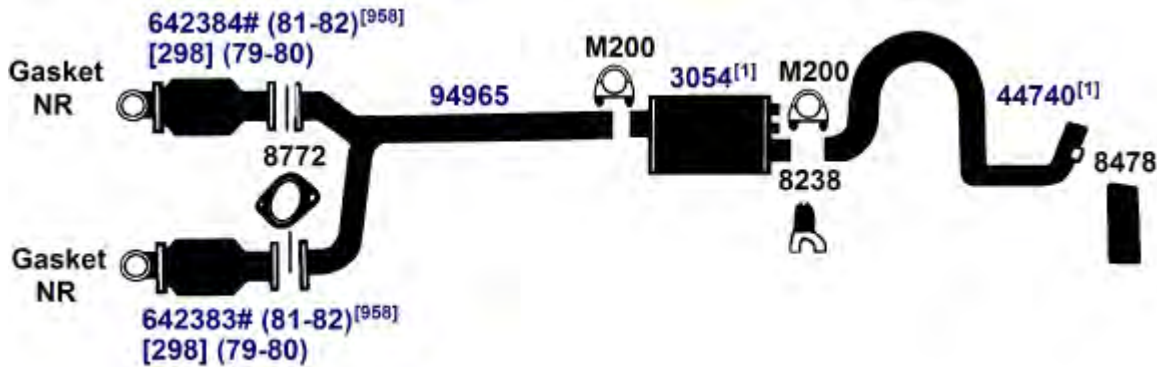

DIRECT FIT MSL/MAXIMUM Muffler... 6554, UNIVERSAL FIT MSL/MAXIMUM Muffler... 6506, 709011, 709012, 709016, Silentone DIY Muffler... 5533

NA-Not Available. NR-Not Required. FL-Remove and Re-Use Old Flange. ● Golden Warehouse. O.E.-Original Equipment.
Airtube Kit [4948] may be required to complete installation. EFI-Electronic Fuel Injection.

[1] OE system was a welded assembly. It is recommended that all parts noted [1] should be replaced.

[98] Refer to current Catalytic Converter catalog or Website catalog for availability.

[298] Coverage available. Due to multiple listings, please refer to Catalytic Converter catalog.

[958] Federal & California Emission vehicles. Not legal for sale for vehicles licensed in California.

FORD CROWN VICTORIA, LTD (INCL. COUNTRY SQUIRE)

80-82 8 Cyl. LTD Sedan, Station Wagon; 5.8L, 351 Engine; Dual Exhaust

(5108)

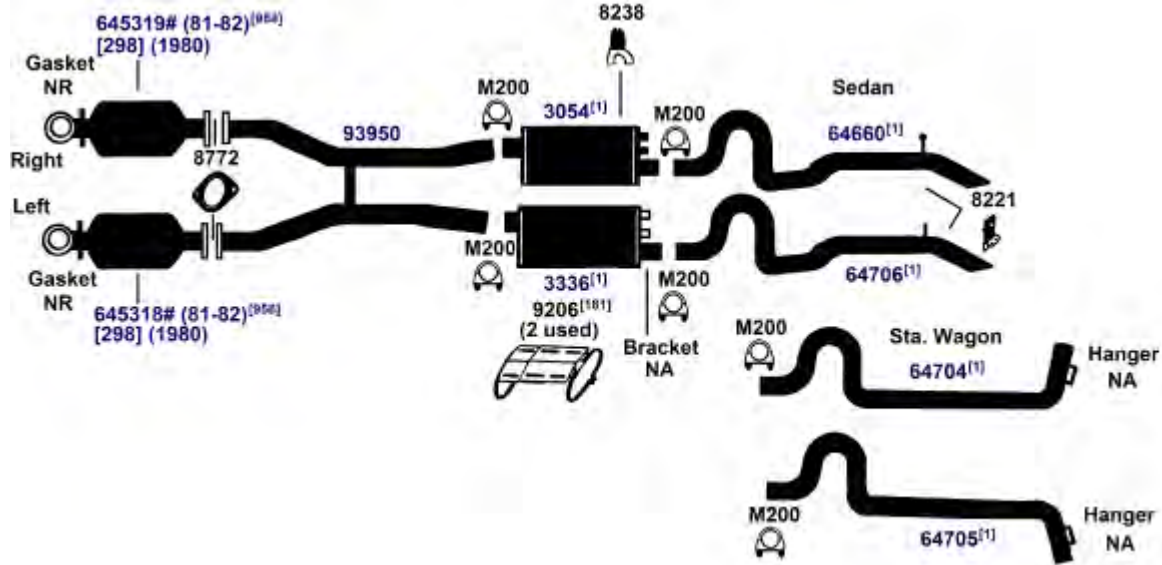

DIRECT FIT MSL/MAXIMUM Muffler... Left 700006, Right 6554, UNIVERSAL FIT MSL/MAXIMUM Muffler... Left 709011, 709012, 709016, Right 6506, 709011, 709012, 709016, Silentone DIY Muffler... Left 5533 and 9206 Heat Shield, Right 5533 and 9206 Heat Shield

1980 8 Cyl. LTD, Sedan; 302, 351W Engine; with Automatic Overdrive

(5095)

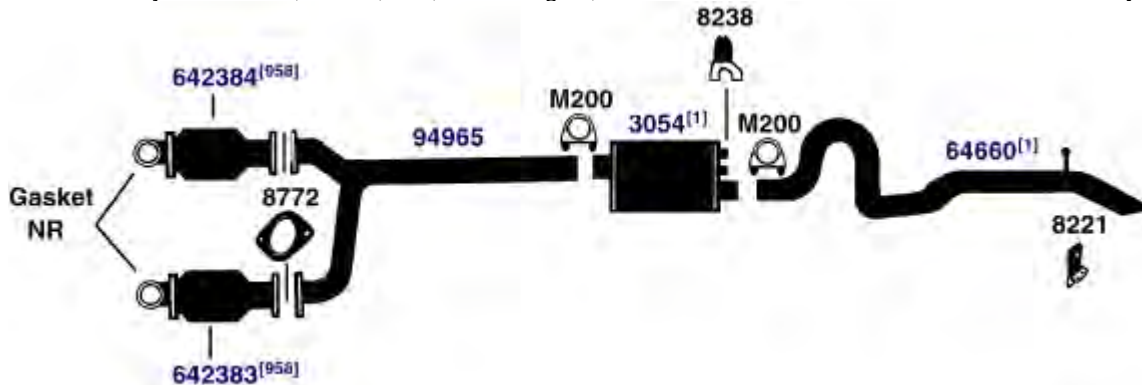

DIRECT FIT MSL/MAXIMUM Muffler... 6554, UNIVERSAL FIT MSL/MAXIMUM Muffler... 6506, 709011, 709012, 709016, Silentone DIY Muffler... 5533

NA-Not Available. NR-Not Required. FL-Remove and Re-Use Old Flange. ● Golden Warehouse. O.E.-Original Equipment.
Airtube Kit [4948] may be required to complete installation. EFI-Electronic Fuel Injection.

- [1] OE system was a welded assembly. It is recommended that all parts noted [1] should be replaced. [958] Federal & California Emission vehicles. Not legal for sale for vehicles licensed in California.
- [181] Required for installation on Police models and models with Trailer Towing Package.

FORD CROWN VICTORIA, LTD (INCL. COUNTRY SQUIRE)

(5094) 79-80 8 Cyl. LTD, Sedan, 302, 351W Engine; without Automatic Overdrive

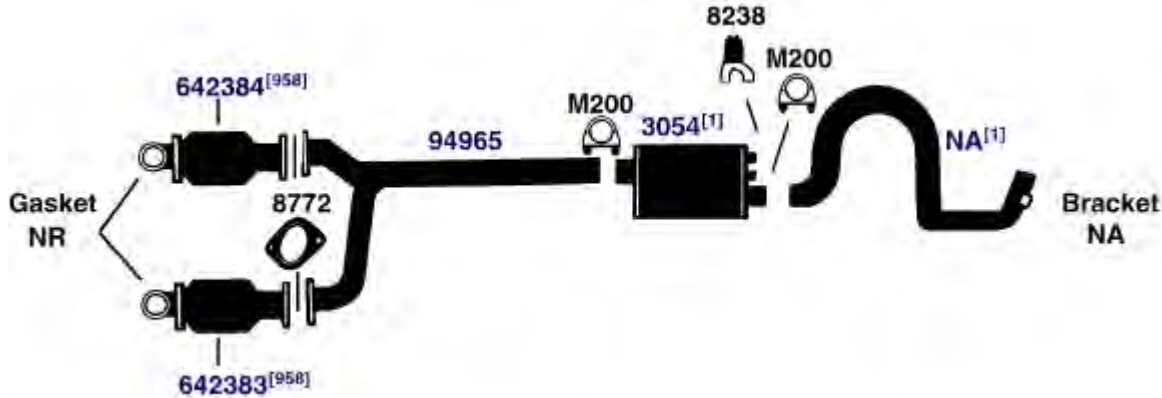

DIRECT FIT MSL/MAXIMUM Muffler... 6554, UNIVERSAL FIT MSL/MAXIMUM Muffler... 6506, 709011, 709012, 709016, Silentone DIY Muffler... 5533

FORD E SERIES - ECONOLINE VANS

(27864) 1994 8 Cyl. E350 Series; Econoline, 138" W.B.; 5.8L Engine; Cutaway Van; with Converter
88-93 8 Cyl. E350 Series; Econoline, 138" W.B.; 5.8L, 7.5L (351, 460) Engine; Cutaway Van; with Converter; except 1993 7.5L with Round Muffler

645343 (90-95 5.8L)^[958]

645343 (88-93 7.5L To 8500 lbs. G.V.W.)^[958]

646303 (88-93 7.5L To 11,620 lbs. G.V.W.)^[958]

645343 (88-89 5.8L To 8500 lbs. G.V.W.)^[958]

646303 (88-89 5.8L To 11,620 lbs. G.V.W.)^[958]

94013 (90-93 5.8L w/ E40D Trans.)

94012 (5.8L w/ C6 Trans.)

94012 (90-93 5.8L w/ AOT Trans.)

95977 (90-93 7.5L w/ E40D Trans.)

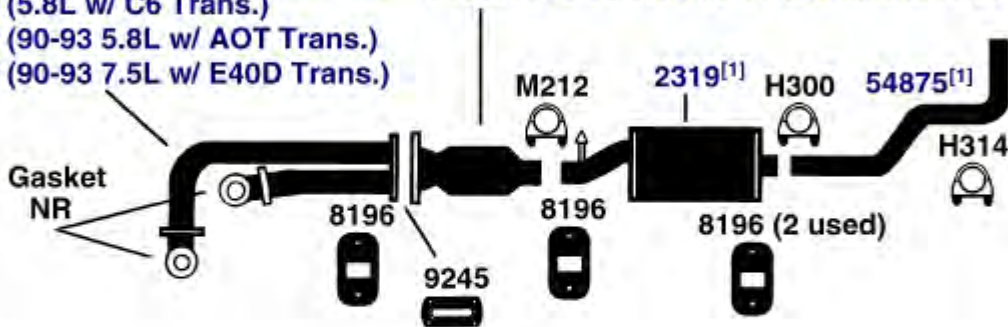

OR

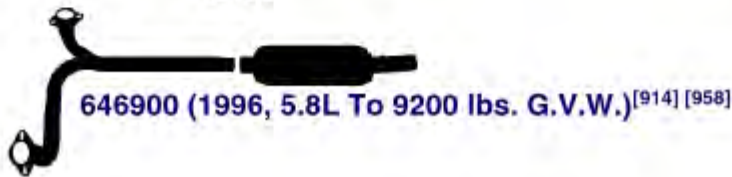

DIRECT FIT MSL/MAXIMUM Muffler... 700435

NA-Not Available. NR-Not Required. FL-Remove and Re-Use Old Flange. ● Golden Warehouse. O.E.-Original Equipment.

Airtube Kit [4948] may be required to complete installation. EFI-Electronic Fuel Injection.

[1] OE system was a welded assembly. It is recommended that all parts noted [1] should be replaced. [958] Federal & California Emission vehicles. Not legal for sale for vehicles licensed in California.

[914] Direct fit converter includes front (Exhaust) pipe, (1) piece assembly.

FORD E SERIES - ECONOLINE VANS

1994 8 Cyl. E350 Series; Econoline, 158" W.B.; 5.8L Engine
88-93 8 Cyl. E350 Series; Econoline, 158" W.B.; 5.8L, 7.5L Engine; 1 Ton; From 2-88

(27861)

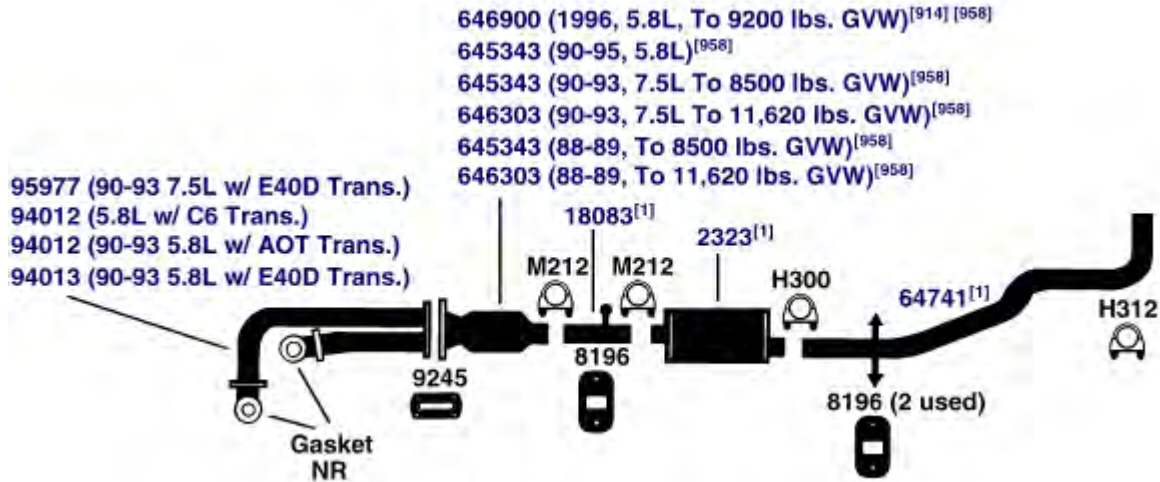

DIRECT FIT MSL/MAXIMUM Muffler... 700434

NA-Not Available. NR-Not Required. FL-Remove and Re-Use Old Flange. ● Golden Warehouse. O.E.-Original Equipment.
 # Airtube Kit [4948] may be required to complete installation. EFI-Electronic Fuel Injection.

^[1] OE system was a welded assembly. It is recommended that all parts noted ^[1] should be replaced. ^[958] Federal & California Emission vehicles. Not legal for sale for vehicles licensed in California.

^[914] Direct fit converter includes front (Exhaust) pipe, (1) piece assembly.

FORD E SERIES - ECONOLINE VANS

(27858)	1994	8 Cyl.	E250, E350 Series; Econoline, 138" W.B.; 5.8L Engine; over 8500 lbs. G.V.W., except Cutaway Van
	88-93	8 Cyl.	E250, E350 Series; Econoline, 138" W.B.; 5.8L, 7.5L (351, 460) Engine; over 8500 lbs. G.V.W. (From 2-88); except Cutaway Van; except 1993 7.5L with Round Muffler

645343 (88-95 E250, 5.8L To 9200 lbs. G.V.W.)^[958]
645343 (88-93 E250, 7.5L To 9200 lbs. G.V.W.)^[958]
645343 (90-95 E350, 5.8L)^[958]

646303 (88-95 E250, 5.8L, To 11620 lbs. G.V.W.)^[958]
646303 (88-93 E250, 7.5L, To 11620 lbs. G.V.W.)^[958]
646303 (88-89 E350, 5.8L, To 11620 lbs. G.V.W.)^[958]
646303 (88-93 E350, 7.5L, To 11620 lbs. G.V.W.)^[958]

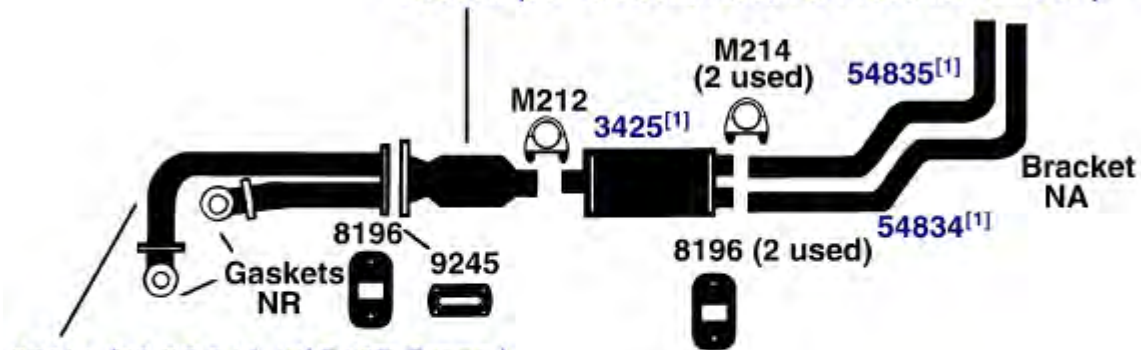

94013 (90-93 5.8L w/ E40D Trans.)
94012 (5.8L w/ C6 Trans.)
94012 (88-91 E250)
94012 (88-93 E350)
94012 (90-93 5.8L w/ AOT Trans.)
95977 (90-93 7.5L w/ E40D Trans.)

OR

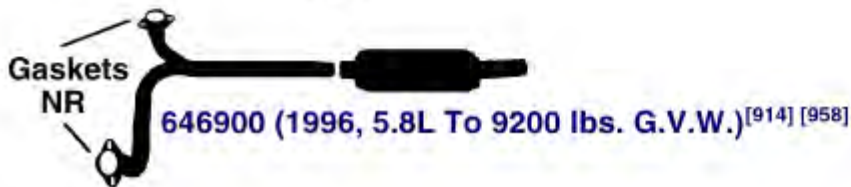

DIRECT FIT MSL/MAXIMUM Muffler... 700274

NA-Not Available. NR-Not Required. FL-Remove and Re-Use Old Flange. ● Golden Warehouse. O.E.-Original Equipment.
 # Airtube Kit [4948] may be required to complete installation. EFI-Electronic Fuel Injection.

[1] OE system was a welded assembly. It is recommended that all parts noted [1] should be replaced. [958] Federal & California Emission vehicles. Not legal for sale for vehicles licensed in California.

[914] Direct fit converter includes front (Exhaust) pipe, (1) piece assembly.

FORD E SERIES - ECONOLINE VANS

93-94 8 Cyl. E350 Super Duty; (138", 158", 176" W.B.); 5.4L Engine, Exc. 2005 CNG; Stripped - Cutaway Chassis; (To 10-16-06) **(100568)**

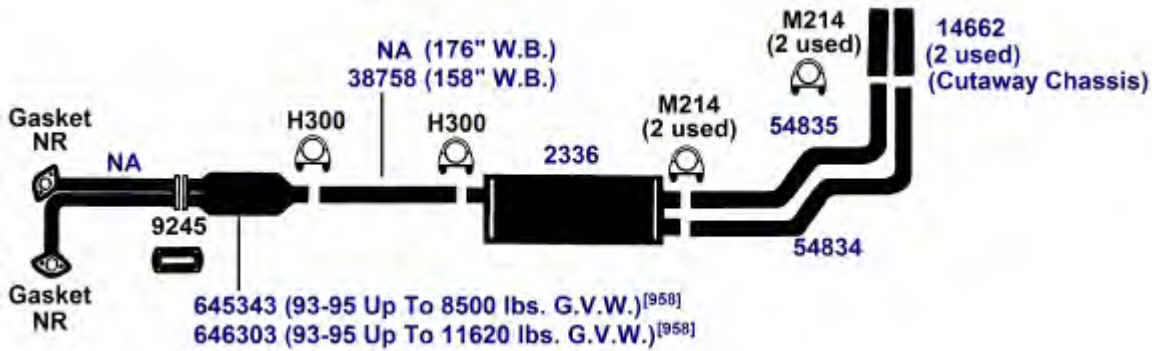

92-94 8 Cyl. E150 Series; Econoline, 138" W.B.; 302 (5.0L) Engine; 1/2-3/4 Ton; with Converter **(27863)**

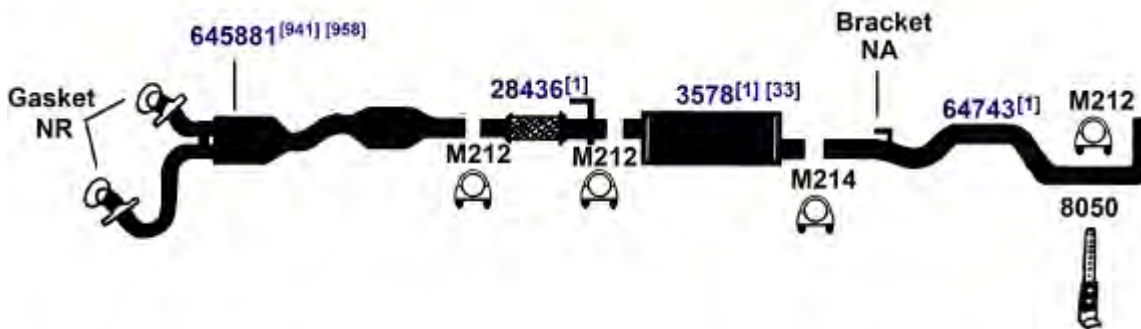

DIRECT FIT MSL/MAXIMUM Muffler... 700194, UNIVERSAL FIT MSL/MAXIMUM Muffler... 709019, Silentone DIY Muffler... 5567

92-94 8 Cyl. E150, E250 Series; Econoline, 138" W.B.; 5.8L Engine; under 8500 lbs. G.V.W. **(27862)**
645962# (92-95, 2 to 1 Conv. replacement) [941] [958]

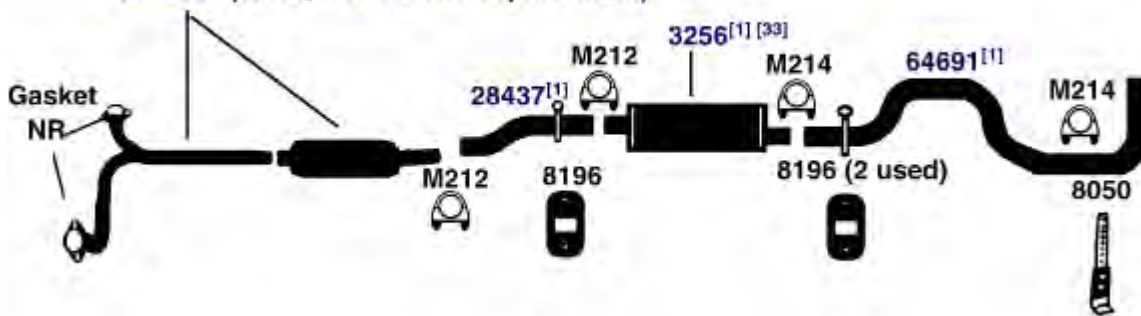

DIRECT FIT MSL/MAXIMUM Muffler... 700000, UNIVERSAL FIT MSL/MAXIMUM Muffler... 6539, 709019, Silentone DIY Muffler... 5567

NA-Not Available. NR-Not Required. FL-Remove and Re-Use Old Flange. ● Golden Warehouse. O.E.-Original Equipment.
 # Airtube Kit [4948] may be required to complete installation. EFI-Electronic Fuel Injection.

- [1] OE system was a welded assembly. It is recommended that all parts noted [1] should be replaced.
- [33] Remove and re-use O.E. heat shield.
- [98] Refer to current Catalytic Converter catalog or Website catalog for availability.
- [941] Replaces both front and rear converters, Only failed converters may be replaced.
- [958] Federal & California Emission vehicles. Not legal for sale for vehicles licensed in California.

FORD E SERIES - ECONOLINE VANS

(26716) 87-94 6 Cyl. E150, E250, E350 Series; Econoline, 138" W.B.; 4.9L Engine

645875 (1996)^[958]
 645917# (90-95 E150, E250)^[921] ^[958]
 645917# (90-95 E350 Up to 8600 lbs. GVW)^[921] ^[958]
 645917# (87-89, Under 8500 lbs. GVW)^[921] ^[958]

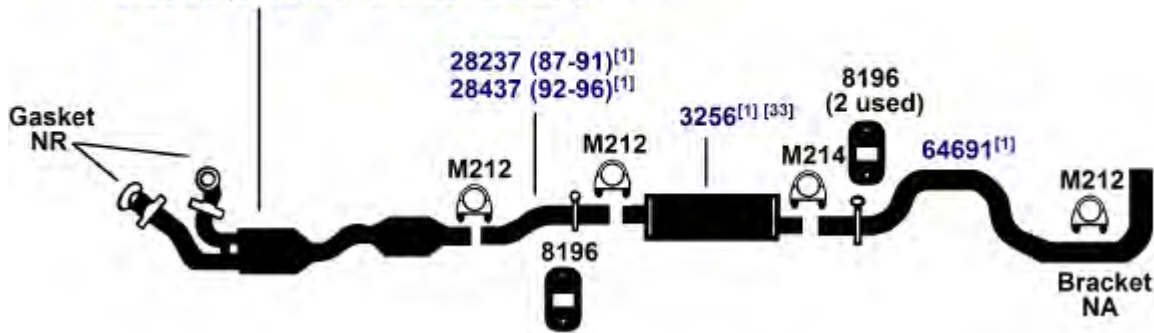

DIRECT FIT MSL/MAXIMUM Muffler... 700000, UNIVERSAL FIT MSL/MAXIMUM Muffler... 6539, 709019, Silentone DIY Muffler... 5567

(27857) 1994 8 Cyl. E350 Series; Econoline, 138" W.B.; 7.3L Diesel Engine; except E350 Cutaway Van
 88-93 8 Cyl. E250, E350 Series; Econoline, 138" W.B.; 7.3L Diesel Engine; except E350 Cutaway Van
 1987 8 Cyl. E250, E350 Series; Econoline, 138" W.B.; 6.9L Diesel Engine; except E350 Cutaway Van

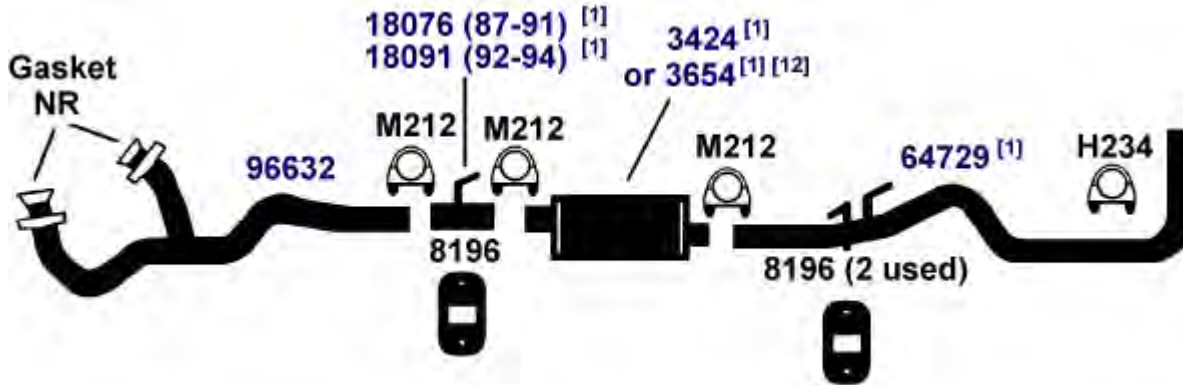

DIRECT FIT MSL/MAXIMUM Muffler... 700164

NA-Not Available. NR-Not Required. FL-Remove and Re-Use Old Flange. ● Golden Warehouse. O.E.-Original Equipment.
 # Airtube Kit [4948] may be required to complete installation. EFI-Electronic Fuel Injection.

[1] OE system was a welded assembly. It is recommended that all parts noted [1] should be replaced.

[12] Optional Heavy Duty Muffler.

[33] Remove and re-use O.E. heat shield.

[98] Refer to current Catalytic Converter catalog or Website catalog for availability.

[921] Combination front & rear converter, 2 to 1 replacement. Only defective converters may legally be replaced.

[958] Federal & California Emission vehicles. Not legal for sale for vehicles licensed in California.

FORD E SERIES - ECONOLINE VANS

88-94 8 Cyl. E350 Series; Econoline, 176" W.B. 7.3L Diesel Engine; Cutaway Van **(27854)**
1987 8 Cyl. E350 Series; Econoline, 176" W.B.; 6.9L Diesel Engine; Cutaway Van

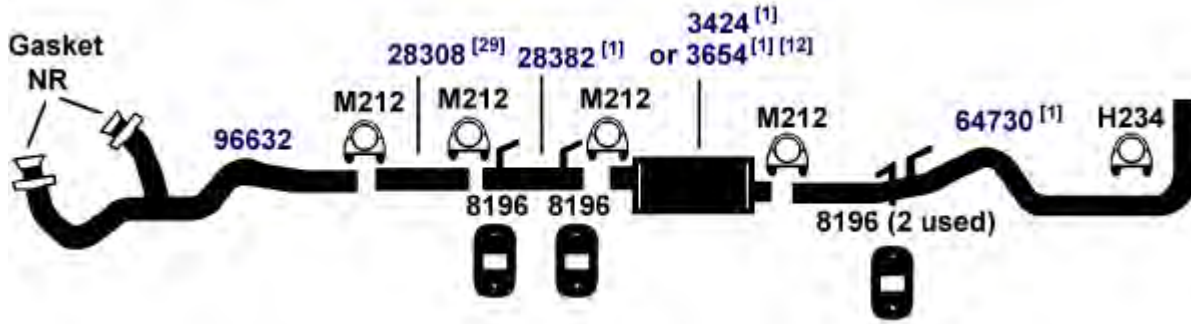

DIRECT FIT MSL/MAXIMUM Muffler... 700164

88-94 8 Cyl. E350 Series; Econoline, 138" W.B.; 7.3L Diesel; Cutaway Van **(27856)**
1987 8 Cyl. E350 Series; Econoline, 138" W.B.; 6.9L Diesel; Cutaway Van

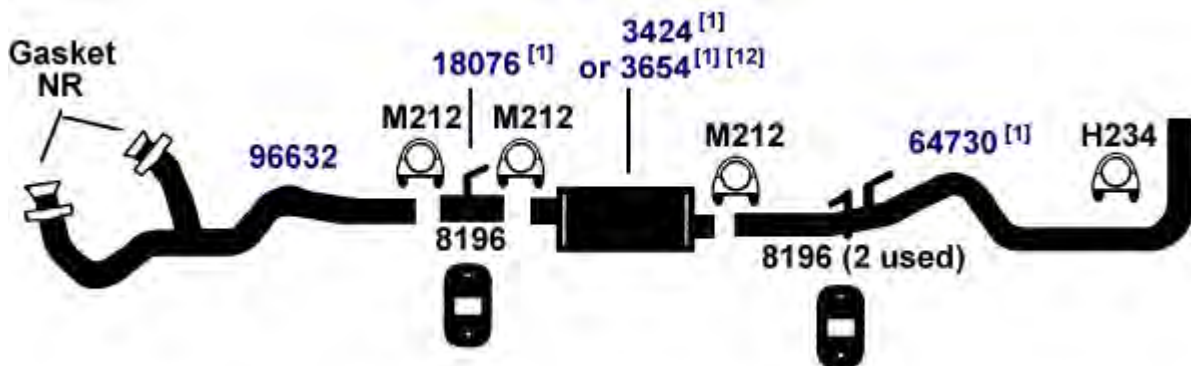

DIRECT FIT MSL/MAXIMUM Muffler... 700164

88-94 8 Cyl. E350 Series; Econoline, 158" W.B.; 7.3L Diesel Engine; Cutaway Van **(27855)**
1987 8 Cyl. E350 Series; Econoline, 158" W.B.; 5.8L, 6.9L Diesel Engine; Cutaway Van

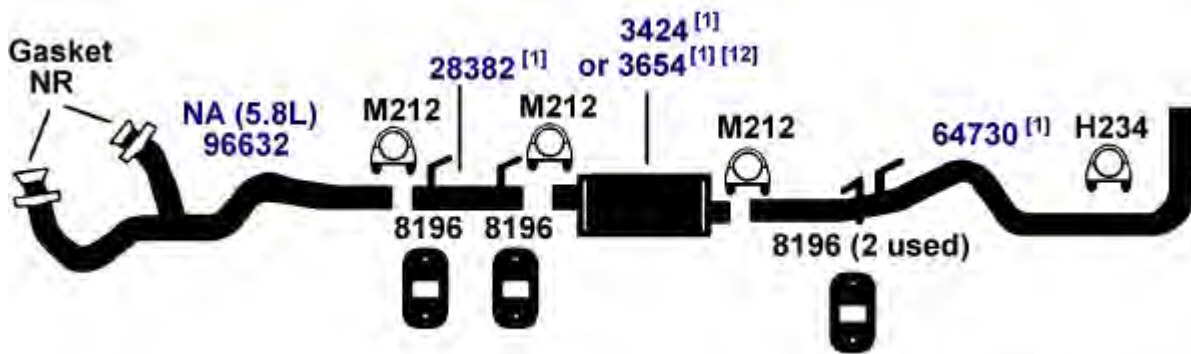

DIRECT FIT MSL/MAXIMUM Muffler... 700164

NA-Not Available. NR-Not Required. FL-Remove and Re-Use Old Flange. • Golden Warehouse. O.E.-Original Equipment.
 # Airtube Kit [4948] may be required to complete installation. EFI-Electronic Fuel Injection.

- [1] OE system was a welded assembly. It is recommended that all parts noted [1] should be replaced.
- [29] Cut as required.
- [12] Optional Heavy Duty Muffler.

FORD E SERIES - ECONOLINE VANS

(27860) 90-93 8 Cyl. E350 Series; Econoline, 176" W.B.; 5.8L, 7.5L Engine; 1 Ton; From 2-88

94012 (5.8L w/ AOT Trans.)
 94012 (5.8L w/ C6 Trans.)
 94013 (5.8L w/ E40D Trans.)
 95977 (7.5L w/ E40D Trans.)

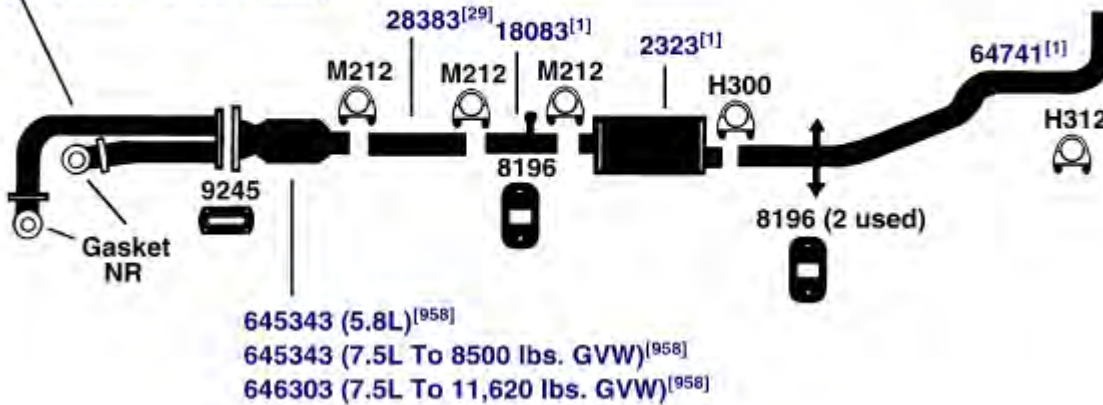

DIRECT FIT MSL/MAXIMUM Muffler... 700434

(27843) 88-91 8 Cyl. E150, E250 Series; Econoline, 138" W.B.; 351 (5.8L) Engine; with Converter; under 8500 G.V.W.
 87-91 8 Cyl. E150, E250 Series; Econoline, 138" W.B.; 302 (5.0L) Engine; with Converter

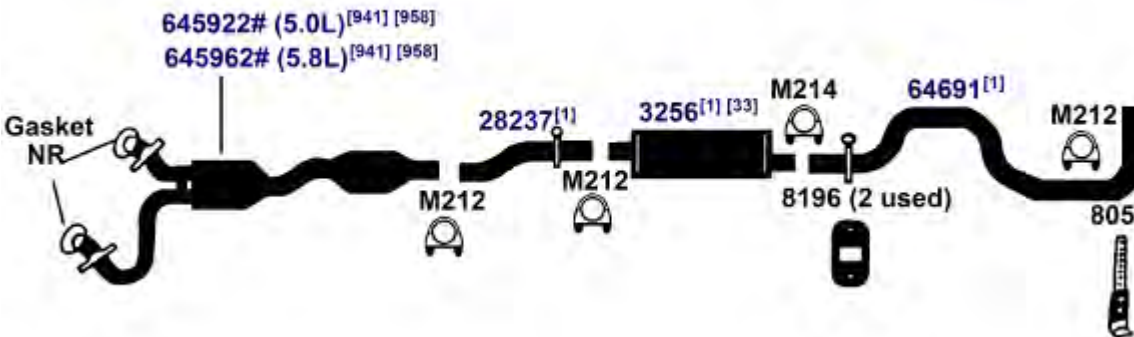

DIRECT FIT MSL/MAXIMUM Muffler... 700000, UNIVERSAL FIT MSL/MAXIMUM Muffler... 6539, 709019, Silentone DIY Muffler... 5567

NA-Not Available. NR-Not Required. FL-Remove and Re-Use Old Flange. ● Golden Warehouse. O.E.-Original Equipment.
 # Airtube Kit [4948] may be required to complete installation. EFI-Electronic Fuel Injection.

- [1] OE system was a welded assembly. It is recommended that all parts noted [1] should be replaced.
 [29] Cut as required.
 [33] Remove and re-use O.E. heat shield.

- [98] Refer to current Catalytic Converter catalog or Website catalog for availability.
 [941] Replaces both front and rear converters. Only failed converters may be replaced.
 [958] Federal & California Emission vehicles. Not legal for sale for vehicles licensed in California.

FORD E SERIES - ECONOLINE VANS

88-91 8 Cyl. E250, E350 Series; Econoline, 158" W.B., 176" W.B.; 7.3L Diesel Engine; (100525)
(Before 6-91)

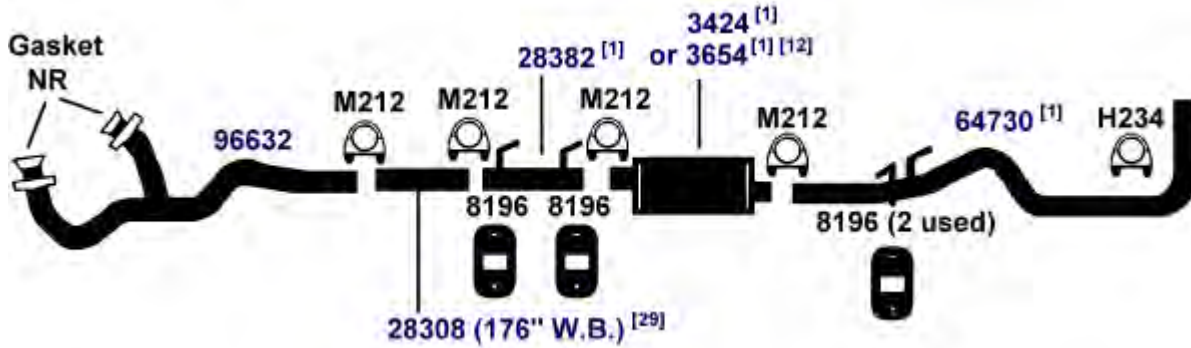

DIRECT FIT MSL/MAXIMUM Muffler... 700164

87-90 6 Cyl. E150 Series; Econoline; 124" W.B.; 300 (4.9L) Engine; with Converter (26718)

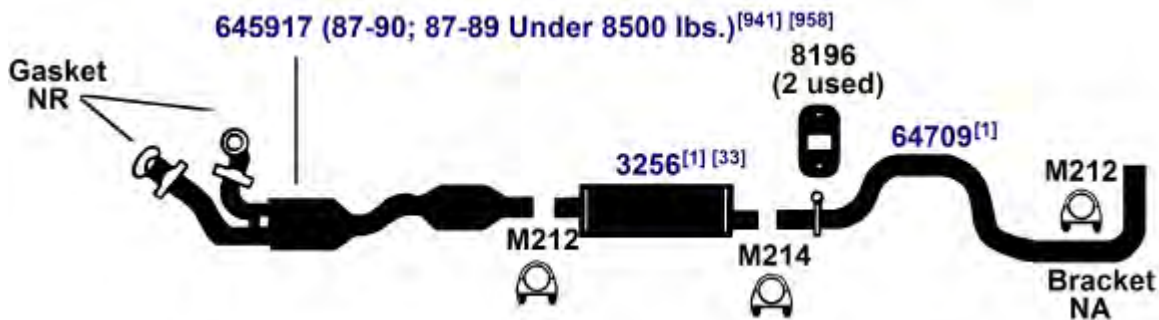

DIRECT FIT MSL/MAXIMUM Muffler... 700000, UNIVERSAL FIT MSL/MAXIMUM Muffler... 6539, 709019, Silentone DIY Muffler... 5567

87-90 8 Cyl. (27844)
88-89 8 Cyl. E150 Series; Econoline, 124" W.B.; 351 (5.8L) Engine; with Converter

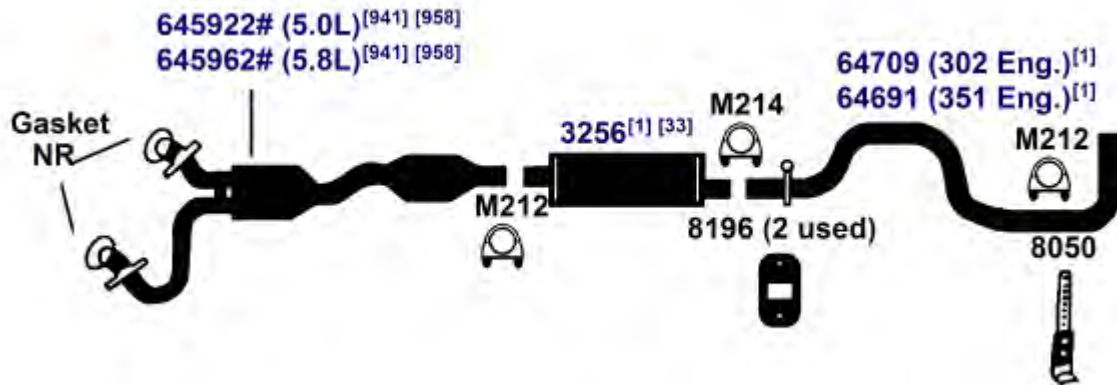

DIRECT FIT MSL/MAXIMUM Muffler... 700000, UNIVERSAL FIT MSL/MAXIMUM Muffler... 6539, 709019, Silentone DIY Muffler... 5567

NA-Not Available. NR-Not Required. FL-Remove and Re-Use Old Flange. ● Golden Warehouse. O.E.-Original Equipment.
Airtube Kit [4948] may be required to complete installation. EFI-Electronic Fuel Injection.

- [1] OE system was a welded assembly. It is recommended that all parts noted [1] should be replaced.
- [12] Optional Heavy Duty Muffler.
- [29] Cut as required.
- [33] Remove and re-use O.E. heat shield.
- [98] Refer to current Catalytic Converter catalog or Website catalog for availability.
- [941] Replaces both front and rear converters, Only failed converters may be replaced.
- [958] Federal & California Emission vehicles. Not legal for sale for vehicles licensed in California.

FORD E SERIES - ECONOLINE VANS

(100524) 87-88 8 Cyl. E250, E350 Series; Econoline, 138" W.B.; 7.5L (460) Engine; (Before 2-88); except Cutaway Van

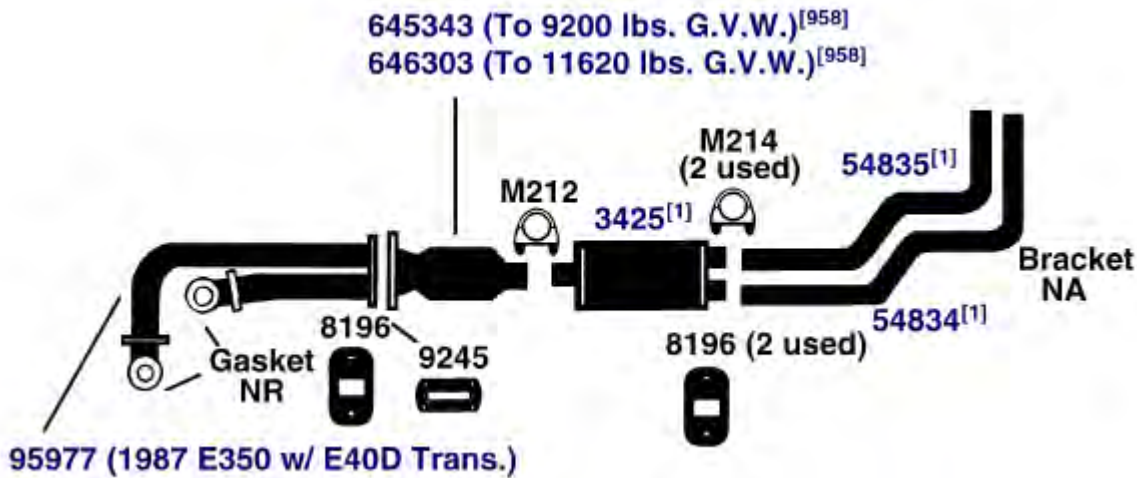

DIRECT FIT MSL/MAXIMUM Muffler... 700274

(26715) 85-86 6 Cyl. E350 Series Econoline; 138" W.B.; 300 (4.9L) Engine; 1 Ton; without Converter

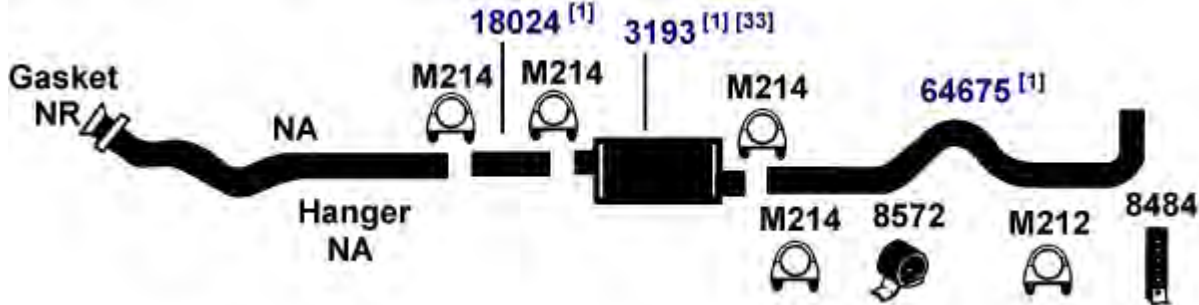

DIRECT FIT MSL/MAXIMUM Muffler... 700079, UNIVERSAL FIT MSL/MAXIMUM Muffler... 6511, 709019, Silentone DIY Muffler... 5567

(26713) 85-86 6 Cyl. E150, E250, E350 Series; Econoline; 138" W.B.; 300 (4.9L) Engine; with Converter

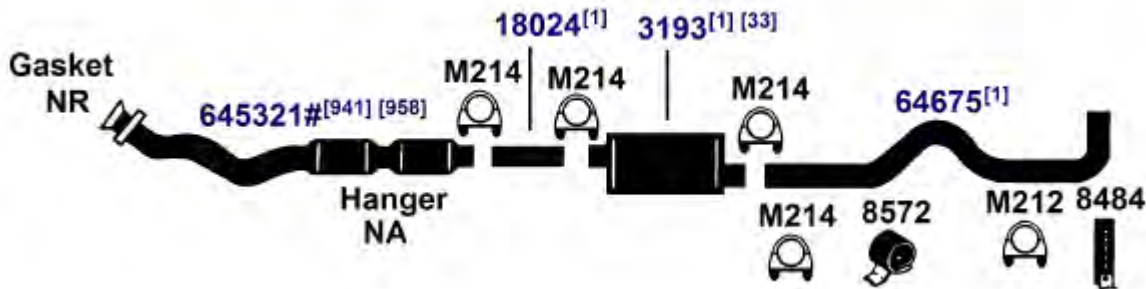

DIRECT FIT MSL/MAXIMUM Muffler... 700079, UNIVERSAL FIT MSL/MAXIMUM Muffler... 6511, 709019, Silentone DIY Muffler... 5567

NA-Not Available. NR-Not Required. FL-Remove and Re-Use Old Flange. ● Golden Warehouse. O.E.-Original Equipment.
Airtube Kit [4948] may be required to complete installation. EFI-Electronic Fuel Injection.

[1] OE system was a welded assembly. It is recommended that all parts noted [1] should be replaced.

[33] Remove and re-use O.E. heat shield.

[941] Replaces both front and rear converters, Only failed converters may be replaced.

[958] Federal & California Emission vehicles. Not legal for sale for vehicles licensed in California.

FORD E SERIES - ECONOLINE VANS

85-86 6 Cyl. E150 Series; Econoline; 124" W.B.; 300 (4.9L) Engine; with Converter **(26714)**

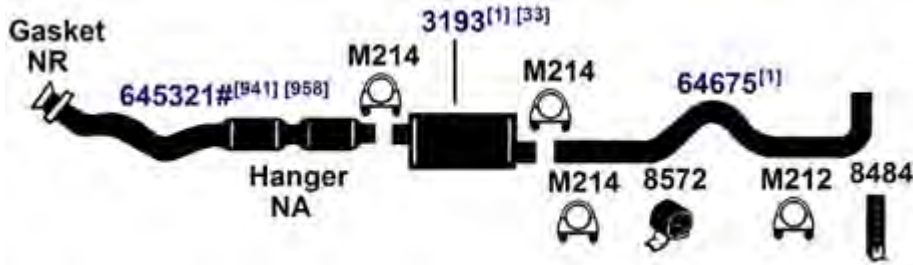

DIRECT FIT MSL/MAXIMUM Muffler... 700079, UNIVERSAL FIT MSL/MAXIMUM Muffler... 6511, 709019, Silentone DIY Muffler... 5567

85-86 8 Cyl. E250, E350 Series; Econoline; 138" W.B.; 420 (6.9L) Diesel Engine **(27851)**

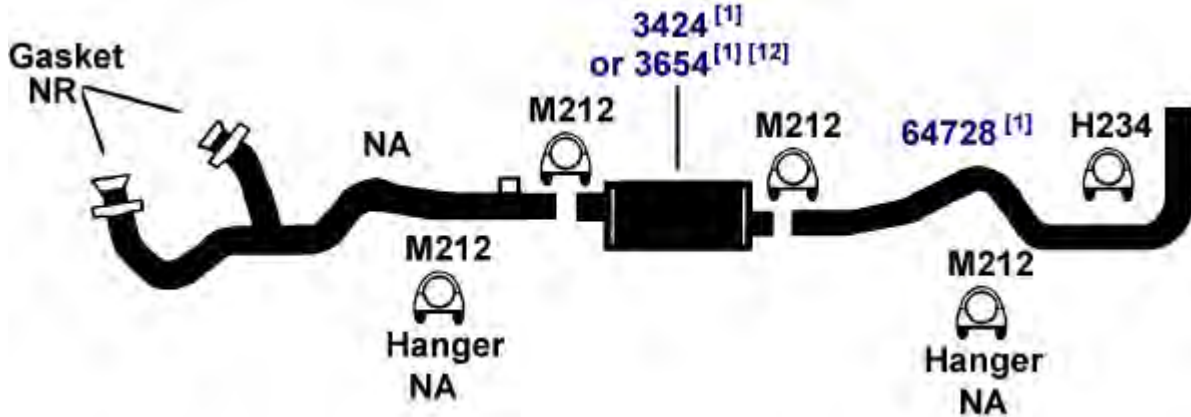

DIRECT FIT MSL/MAXIMUM Muffler... 700164

85-86 8 Cyl. E150, E250, E350 Series; Econoline; 138" W.B.; 302, 351; (1985 Model only for 351) 2-barrel (5.0L, 5.8L) Engine; 1/2-1 Ton; with Converter **(27839)**

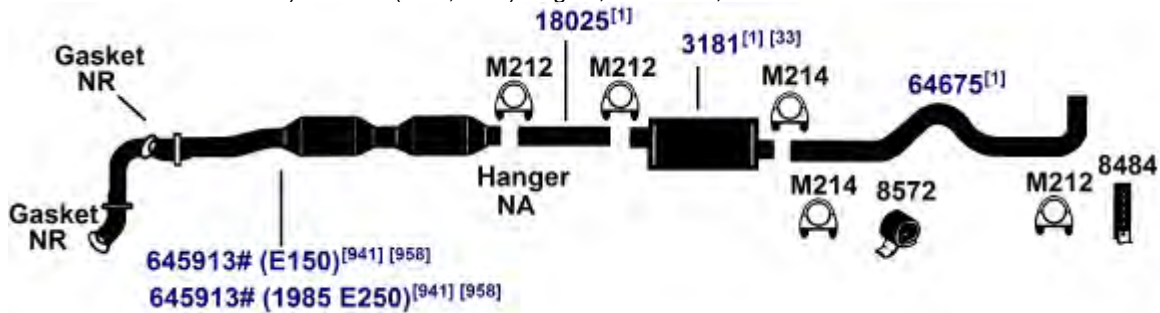

DIRECT FIT MSL/MAXIMUM Muffler... 700076, UNIVERSAL FIT MSL/MAXIMUM Muffler... 6539, 709019, Silentone DIY Muffler... 5567

NA-Not Available. NR-Not Required. FL-Remove and Re-Use Old Flange. ● Golden Warehouse. O.E.-Original Equipment.
Airtube Kit [4948] may be required to complete installation. EFI-Electronic Fuel Injection.

- [1] OE system was a welded assembly. It is recommended that all parts noted [1] should be replaced.
- [12] Optional Heavy Duty Muffler.
- [33] Remove and re-use O.E. heat shield.
- [98] Refer to current Catalytic Converter catalog or Website catalog for availability.
- [941] Replaces both front and rear converters. Only failed converters may be replaced.
- [958] Federal & California Emission vehicles. Not legal for sale for vehicles licensed in California.

FORD E SERIES - ECONOLINE VANS

(27840) 85-86 8 Cyl. E150 Series; Econoline, 124" W.B.; 302, 351; (1985 Model only for 351) 2-barrel (5.0L, 5.8L) Engine; 1/2 Ton; with Converter

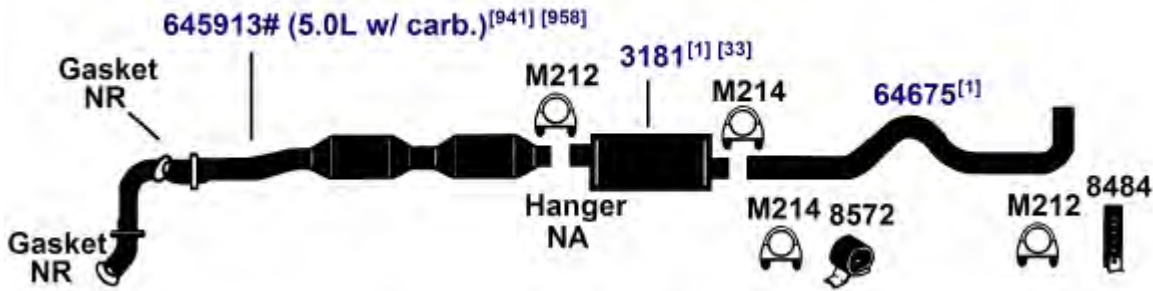

DIRECT FIT MSL/MAXIMUM Muffler... 700076, UNIVERSAL FIT MSL/MAXIMUM Muffler... 6539, 709019, Silentone DIY Muffler... 5567

(27850) 85-86 8 Cyl. E350 Series; Econoline; 158", 176" W.B.; 420 (6.9L) Diesel Engine

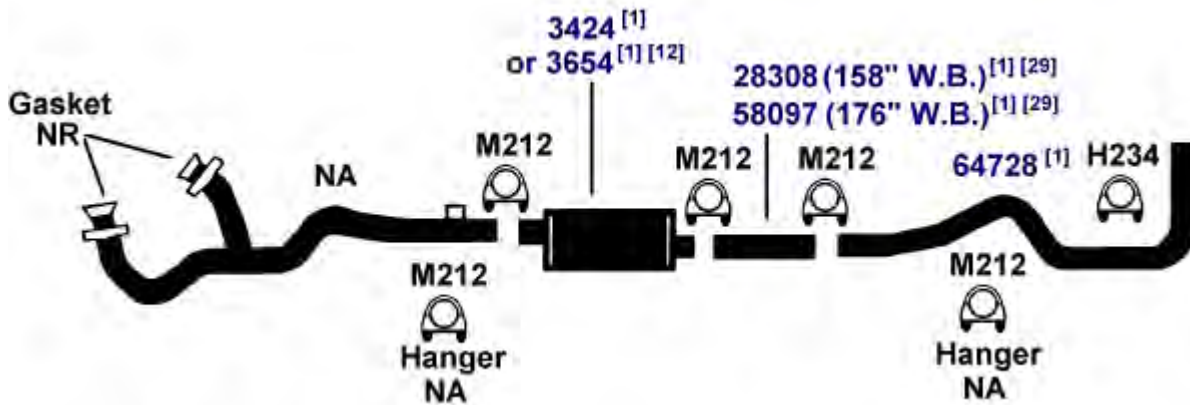

DIRECT FIT MSL/MAXIMUM Muffler... 700164

(27841) 1985 8 Cyl. E350 Series; Econoline; 138" W.B.; 351 2-barrel (5.8L) Engine; 1 Ton; without Converter

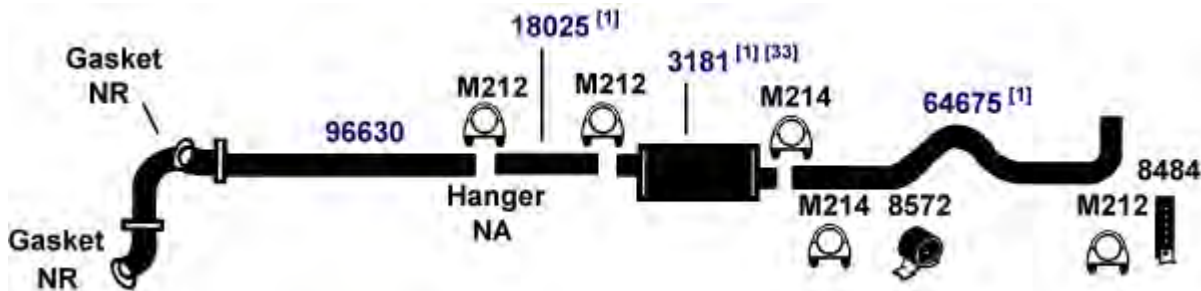

DIRECT FIT MSL/MAXIMUM Muffler... 700076, UNIVERSAL FIT MSL/MAXIMUM Muffler... 6539, 709019, Silentone DIY Muffler... 5567

NA-Not Available. NR-Not Required. FL-Remove and Re-Use Old Flange. ● Golden Warehouse. O.E.-Original Equipment.
Airtube Kit [4948] may be required to complete installation. EFI-Electronic Fuel Injection.

- [1] OE system was a welded assembly. It is recommended that all parts noted [1] should be replaced.
- [12] Optional Heavy Duty Muffler.
- [29] Cut as required.
- [33] Remove and re-use O.E. heat shield.
- [98] Refer to current Catalytic Converter catalog or Website catalog for availability.

- [941] Replaces both front and rear converters, Only failed converters may be replaced.
- [958] Federal & California Emission vehicles. Not legal for sale for vehicles licensed in California.

1985 8 Cyl. E250; 5.4L (From 10-16-06)

(27849)

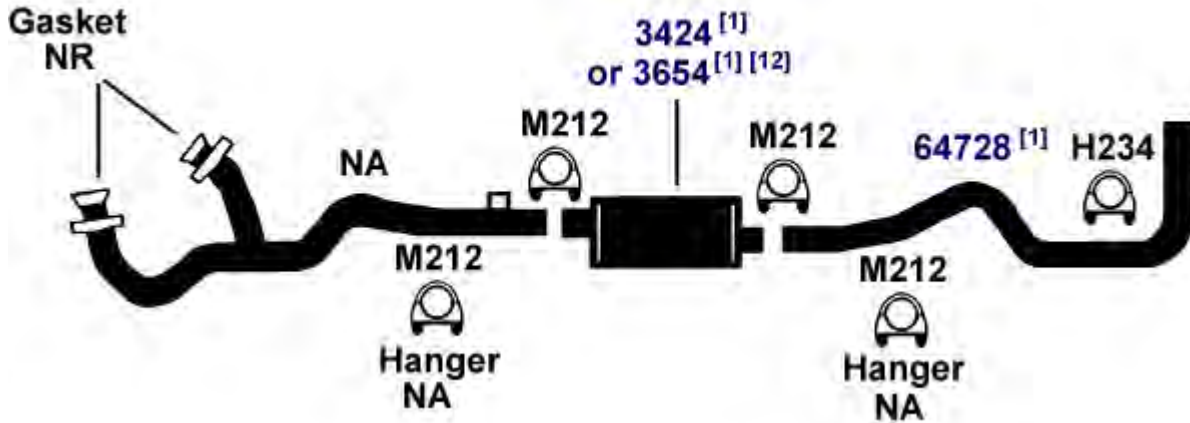

DIRECT FIT MSL/MAXIMUM Muffler... 700164

1985 8 Cyl. E350 Series; Econoline; 158", 176" W.B.; 460 (7.5L) Engine

(27848)

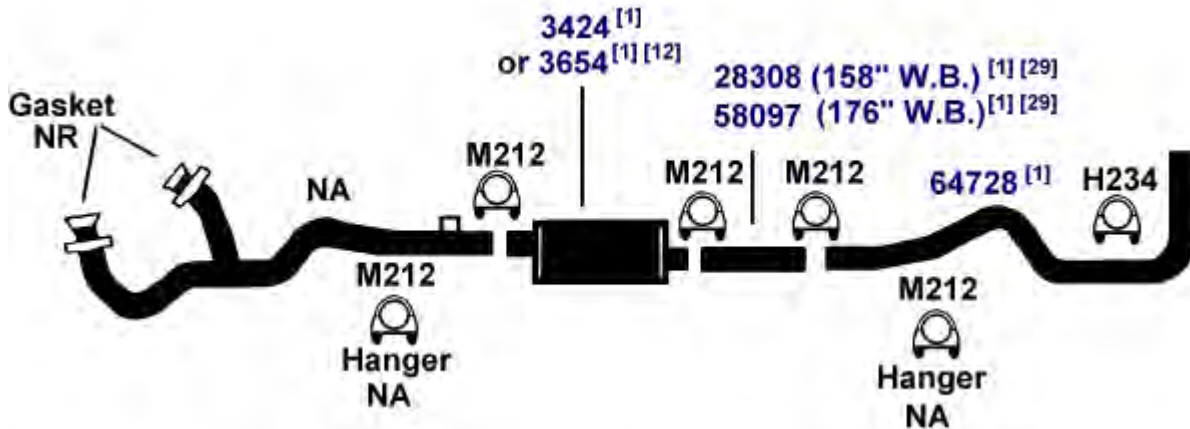

DIRECT FIT MSL/MAXIMUM Muffler... 700164

1984 6 Cyl. E350 Series Econoline; 138" W.B.; 300 (4.9L) Engine; 1 Ton; without Converter (26715E)

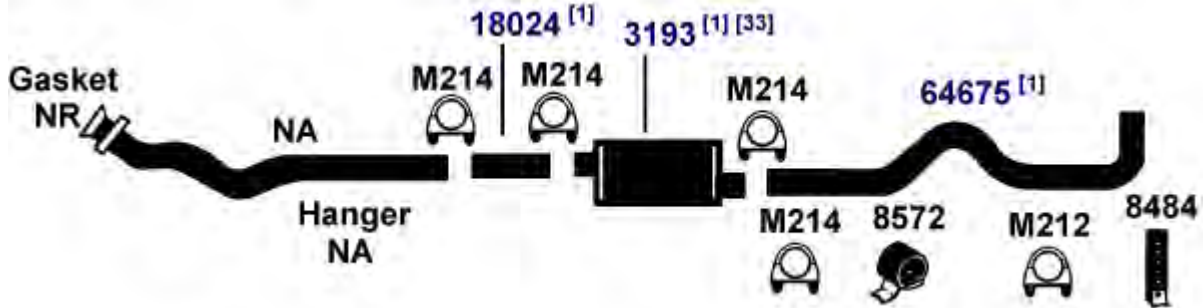

DIRECT FIT MSL/MAXIMUM Muffler... 700079, UNIVERSAL FIT MSL/MAXIMUM Muffler... 6511, 709019, Silentone DIY Muffler... 5567

NA-Not Available. NR-Not Required. FL-Remove and Re-Use Old Flange. • Golden Warehouse. O.E.-Original Equipment.
Airtube Kit [4948] may be required to complete installation. EFI-Electronic Fuel Injection.

[1] OE system was a welded assembly. It is recommended that all parts noted [1] should be replaced.

[29] Cut as required.

[33] Remove and re-use O.E. heat shield.

[12] Optional Heavy Duty Muffler.

FORD E SERIES - ECONOLINE VANS

(26713E) 1984 6 Cyl. E150, E250, E350 Series; Econoline; 138" W.B.; 300 (4.9L) Engine; with Converter

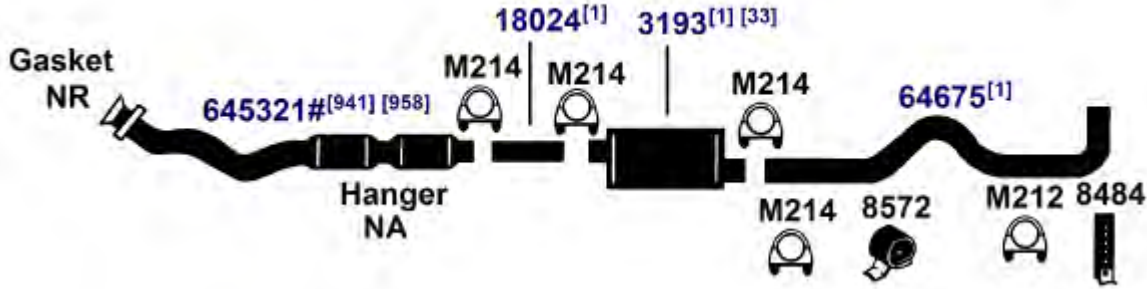

DIRECT FIT MSL/MAXIMUM Muffler... 700079, UNIVERSAL FIT MSL/MAXIMUM Muffler... 6511, 709019, Silentone DIY Muffler... 5567

(26714E) 1984 6 Cyl. E150 Series; Econoline; 124" W.B.; 300 (4.9L) Engine; with Converter

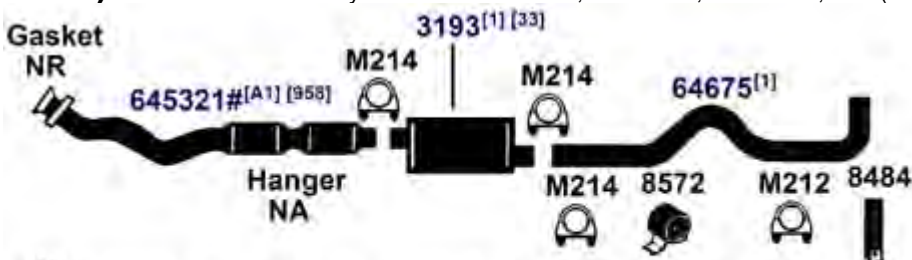

^[A1] Combination Front and Rear Converter, 2 To 1 Replacement
Only Defective Converters May Legally Be Replaced.

DIRECT FIT MSL/MAXIMUM Muffler... 700079, UNIVERSAL FIT MSL/MAXIMUM Muffler... 6511, 709019, Silentone DIY Muffler... 5567

(27841E) 1984 8 Cyl. E350 Series; Econoline; 138" W.B.; 351 2-barrel (5.8L) Engine; 1 Ton; without Converter

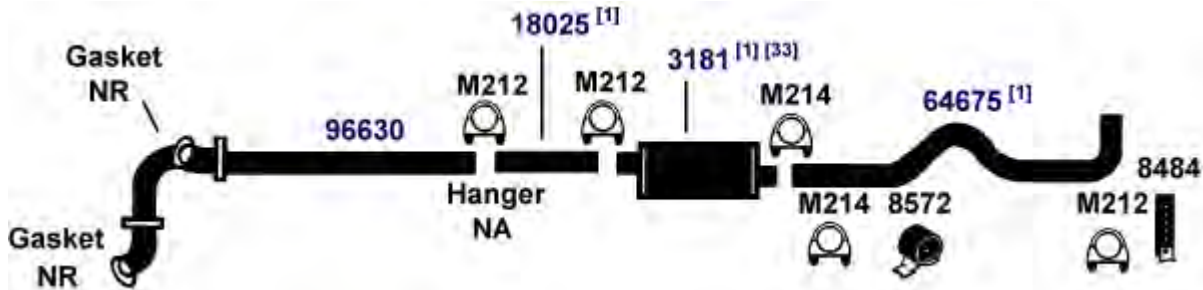

DIRECT FIT MSL/MAXIMUM Muffler... 700076, UNIVERSAL FIT MSL/MAXIMUM Muffler... 709019, 6539, Silentone DIY Muffler... 5567

NA-Not Available. NR-Not Required. FL-Remove and Re-Use Old Flange. ● Golden Warehouse. O.E.-Original Equipment.

Airtube Kit [4948] may be required to complete installation. EFI-Electronic Fuel Injection.

[1] OE system was a welded assembly. It is recommended that all parts noted [1] should be replaced.

[33] Remove and re-use O.E. heat shield.

[98] Refer to current Catalytic Converter catalog or Website catalog for availability.

[941] Replaces both front and rear converters, Only failed converters may be replaced.

[958] Federal & California Emission vehicles. Not legal for sale for vehicles licensed in California.

1984 8 Cyl. E150; 5.4L Engine (27840E)

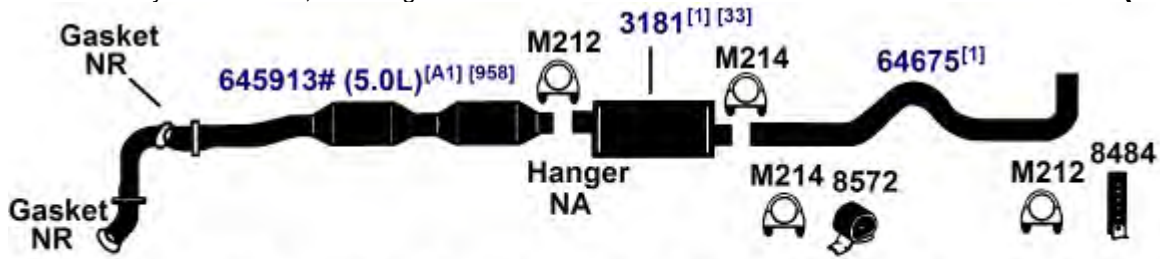

[A1] Combination Front and Rear Converter, 2 To 1 Replacement. Only Defective Converters May Legally Be Replaced.

DIRECT FIT MSL/MAXIMUM Muffler... 700076, UNIVERSAL FIT MSL/MAXIMUM Muffler... 6539, 709019, Silentone DIY Muffler... 5567

1984 8 Cyl. E150, E250, E350 Series; Econoline; 138" W.B.; 302, 351 2-Barrel (5.0L, 5.8L) Engine; 1/2-1 Ton; with Converter (27839E)

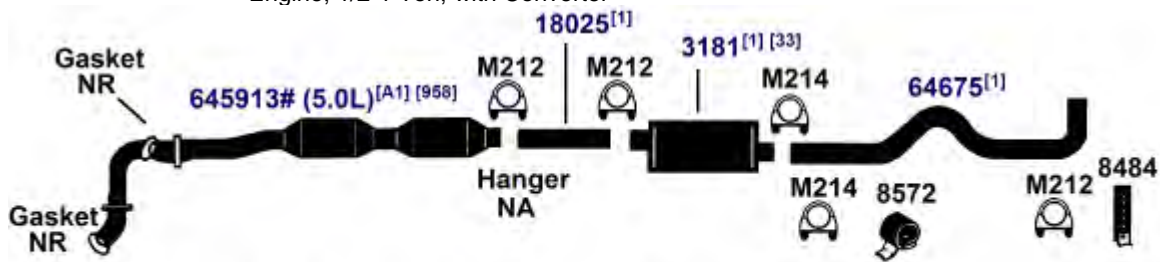

[A1] Combination Front and Rear Converter, 2 To 1 Replacement. Only Defective Converters May Legally Be Replaced.

DIRECT FIT MSL/MAXIMUM Muffler... 700076, UNIVERSAL FIT MSL/MAXIMUM Muffler... 6539, 709019, Silentone DIY Muffler... 5567

83-84 8 Cyl. E350 Series; Econoline; 158", 176" W.B.; 420 (6.9L) Diesel Engine (27850E)

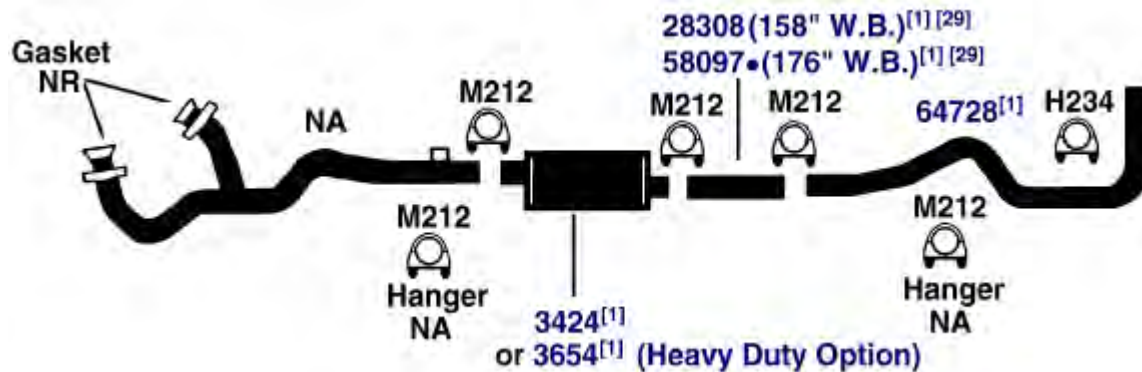

DIRECT FIT MSL/MAXIMUM Muffler... 700164

NA-Not Available. NR-Not Required. FL-Remove and Re-Use Old Flange. ● Golden Warehouse. O.E.-Original Equipment. # Airtube Kit [4948] may be required to complete installation. EFI-Electronic Fuel Injection.

[1] OE system was a welded assembly. It is recommended that all parts noted [1] should be replaced.
 [29] Cut as required.

[33] Remove and re-use O.E. heat shield.
 [958] Federal & California Emission vehicles. Not legal for sale for vehicles licensed in California.

FORD E SERIES - ECONOLINE VANS

(27851E) 83-84 8 Cyl. E250, E350 Series; Econoline; 138" W.B.; 420 (6.9L) Diesel Engine

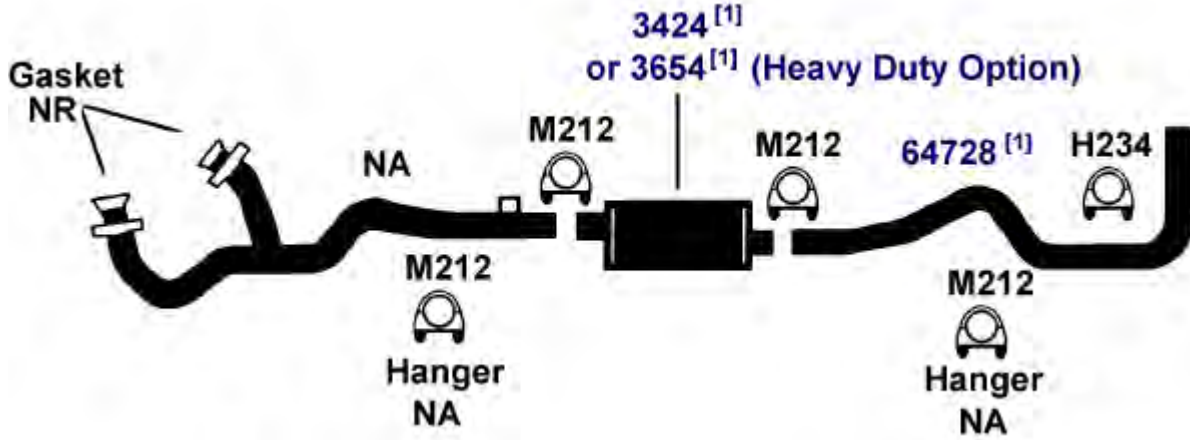

DIRECT FIT MSL/MAXIMUM Muffler... 700164

(27848E) 81-84 8 Cyl. E350 Series; Econoline; 158", 176" W.B.; 460 (7.5L) Engine

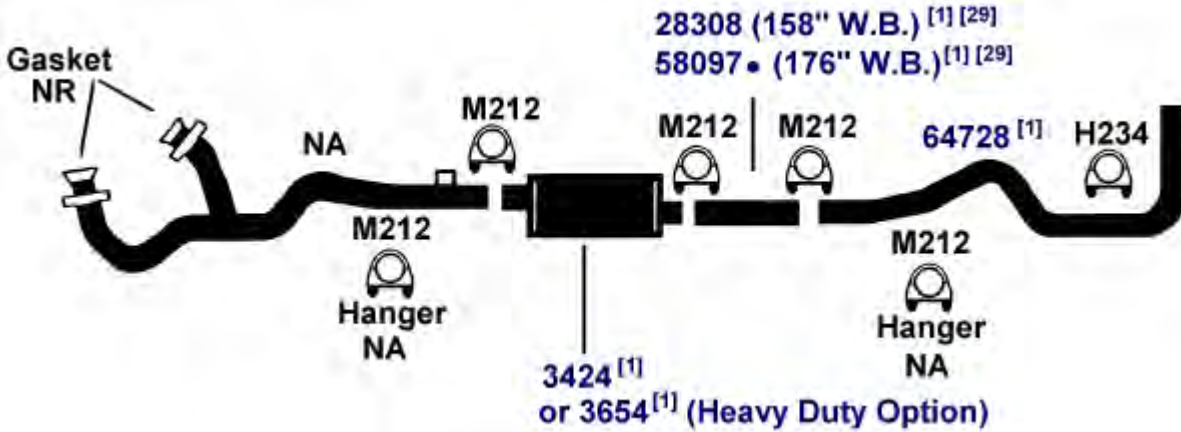

DIRECT FIT MSL/MAXIMUM Muffler... 700164

NA-Not Available. NR-Not Required. FL-Remove and Re-Use Old Flange. • Golden Warehouse. O.E.-Original Equipment.
Airtube Kit [4948] may be required to complete installation. EFI-Electronic Fuel Injection.

[1] OE system was a welded assembly. It is recommended that all parts noted [1] [29] Cut as required. should be replaced.

FORD E SERIES - ECONOLINE VANS

81-84 8 Cyl. E250; 5.4L (From 10-16-06)

(27849E)

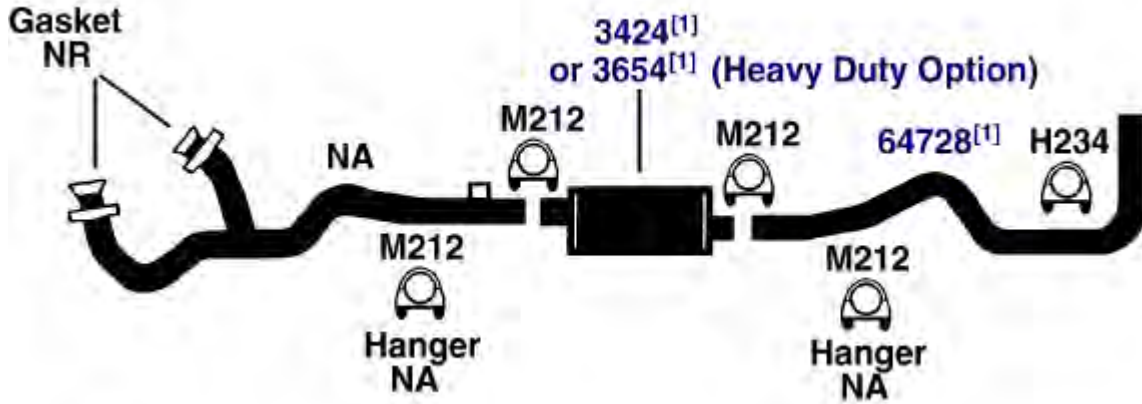

DIRECT FIT MSL/MAXIMUM Muffler... 700164

FORD ESCORT

92-94 4 Cyl. Escort, 1.8L Engine
 1991 4 Cyl. Escort GT, 1.8L Engine

(5288)

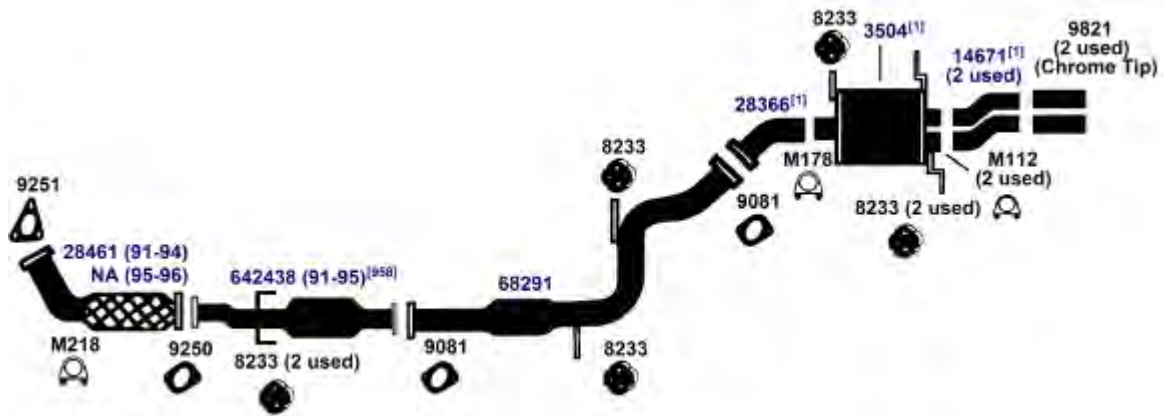

DIRECT FIT MSL/MAXIMUM Muffler... 700165

NA-Not Available. NR-Not Required. FL-Remove and Re-Use Old Flange. ● Golden Warehouse. O.E.-Original Equipment.
 # Airtube Kit [4948] may be required to complete installation. EFI-Electronic Fuel Injection.

[1] OE system was a welded assembly. It is recommended that all parts noted [1] should be replaced. [958] Federal & California Emission vehicles. Not legal for sale for vehicles licensed in California.

FORD ESCORT

(5287) 91-94 4 Cyl. Escort, 116 (1.9L) Engine

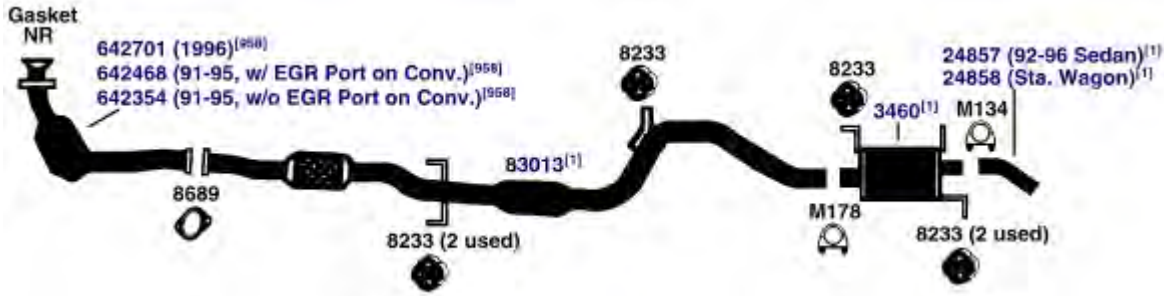

DIRECT FIT MSL/MAXIMUM Muffler... 700159

(5285) 87-90 4 Cyl. Escort, 116 (1.9L) Engine, with Central Fuel Injection (Engine Code 9)



DIRECT FIT MSL/MAXIMUM Muffler... 6567, Silentone DIY Muffler... 5558 and 9206 Heat Shield

(5284) 86-90 4 Cyl. Escort, 116 (1.9L) Engine w/E.F.I. (Engine Code J)
85-86 4 Cyl. Escort, 116 (1.9L) Engine w/2 BBL Carb.



DIRECT FIT MSL/MAXIMUM Muffler... 6567, Silentone DIY Muffler... 5558 and 9206 Heat Shield

NA-Not Available. NR-Not Required. FL-Remove and Re-Use Old Flange. ● Golden Warehouse. O.E.-Original Equipment.
Airtube Kit [4948] may be required to complete installation. EFI-Electronic Fuel Injection.

[1] OE system was a welded assembly. It is recommended that all parts noted [1] should be replaced. [958] Federal & California Emission vehicles. Not legal for sale for vehicles licensed in California.

1985 4 Cyl. Escort, 98 (1.6L) Engine (5281)

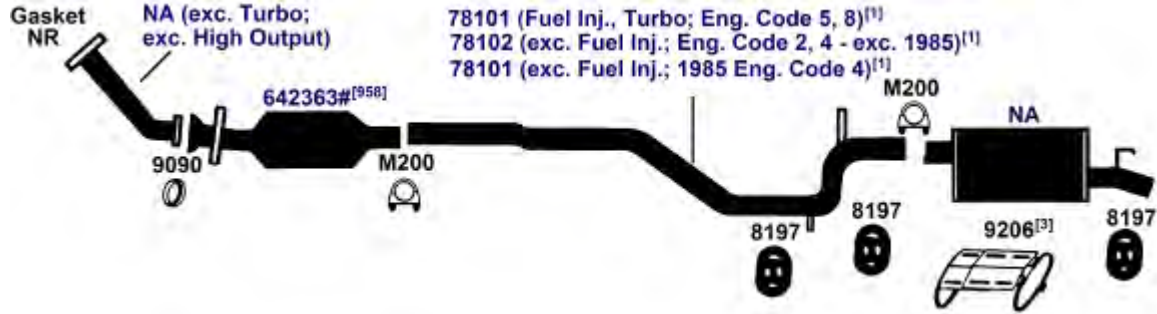

DIRECT FIT MSL/MAXIMUM Muffler... 6549, UNIVERSAL FIT MSL/MAXIMUM Muffler... 709006

1985 4 Cyl. Escort, 122 (2.0L) Diesel Engine (5282)

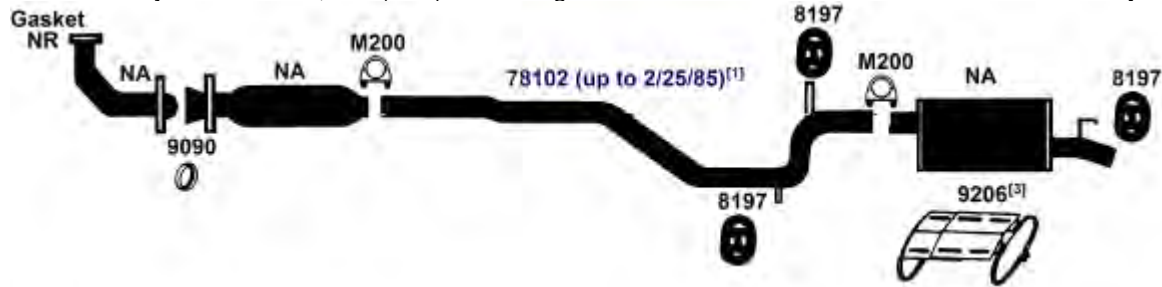

DIRECT FIT MSL/MAXIMUM Muffler... 6549, UNIVERSAL FIT MSL/MAXIMUM Muffler... 709006

1984 4 Cyl. Escort, 122 (2.0L) Diesel Engine (5282E)

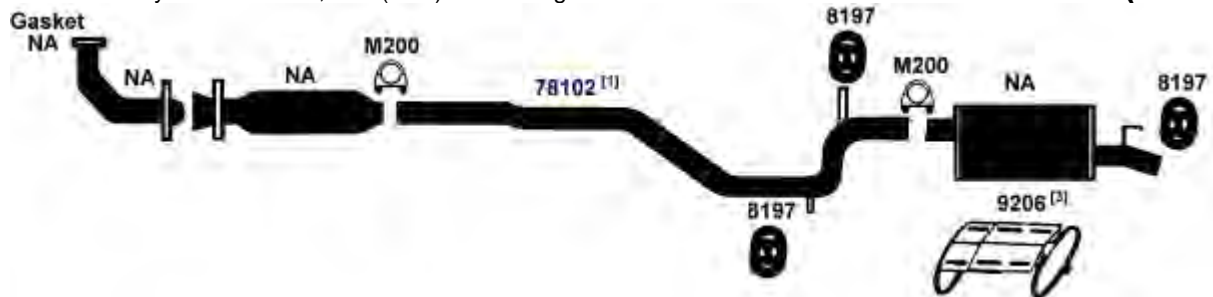

DIRECT FIT MSL/MAXIMUM Muffler... 6549, UNIVERSAL FIT MSL/MAXIMUM Muffler... 709006

NA-Not Available. NR-Not Required. FL-Remove and Re-Use Old Flange. ● Golden Warehouse. O.E.-Original Equipment.
Airtube Kit [4948] may be required to complete installation. EFI-Electronic Fuel Injection.

- [1] OE system was a welded assembly. It is recommended that all parts noted [1] should be replaced.
- [3] Required for installation.
- [958] Federal & California Emission vehicles. Not legal for sale for vehicles licensed in California.

FORD ESCORT

(5281E) 83-84 4 Cyl. Escort, 98 (1.6L) Engine

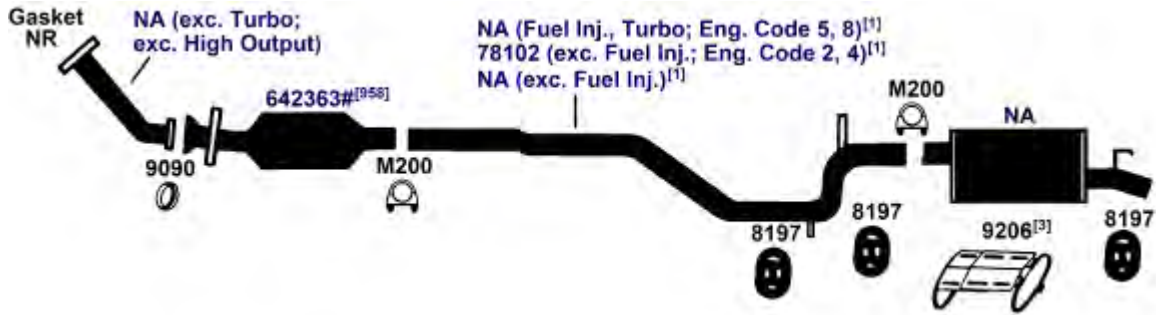

DIRECT FIT MSL/MAXIMUM Muffler... 6549, UNIVERSAL FIT MSL/MAXIMUM Muffler... 709006

FORD EXP

(5335) 87-88 4 Cyl. EXP, 116 (1.9L) Engine, (Engine Code J)
1986 4 Cyl. EXP, 116 (1.9L) Engine



DIRECT FIT MSL/MAXIMUM Muffler... 6567, Silentone DIY Muffler... 5558 and 9206 Heat Shield

(5336) 87-88 4 Cyl. EXP, 116 (1.9L) Engine, with Central Fuel Injection (Engine Code 9)



DIRECT FIT MSL/MAXIMUM Muffler... 6567, Silentone DIY Muffler... 5558 and 9206 Heat Shield

NA-Not Available. NR-Not Required. FL-Remove and Re-Use Old Flange. ● Golden Warehouse. O.E.-Original Equipment.

Airtube Kit [4948] may be required to complete installation. EFI-Electronic Fuel Injection.

[1] OE system was a welded assembly. It is recommended that all parts noted [1] should be replaced.

[3] Required for installation.

[98] Refer to current Catalytic Converter catalog or Website catalog for availability.

[958] Federal & California Emission vehicles. Not legal for sale for vehicles licensed in California.

93-94 6 Cyl. Explorer; 4.0L Engine; 2-Door

(34402)

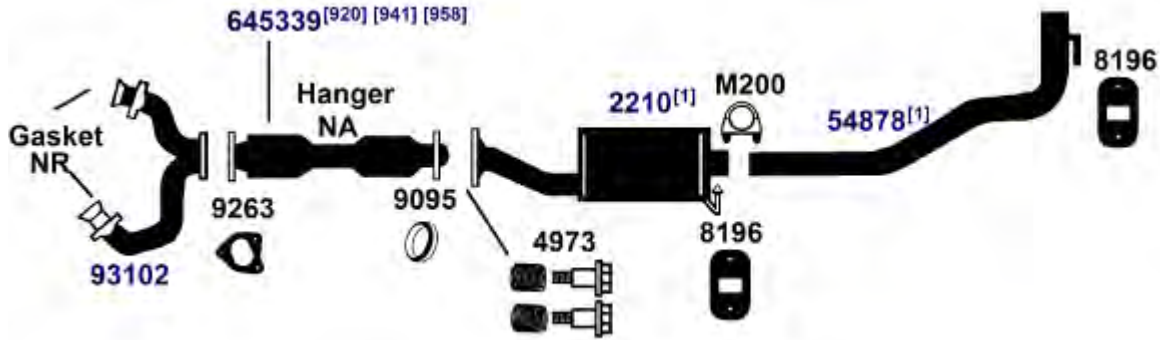

DIRECT FIT MSL/MAXIMUM Muffler... 700035, UNIVERSAL FIT MSL/MAXIMUM Muffler... 709013, 709014

93-94 6 Cyl. Explorer; 4.0L Engine; 4-Door

(34401)

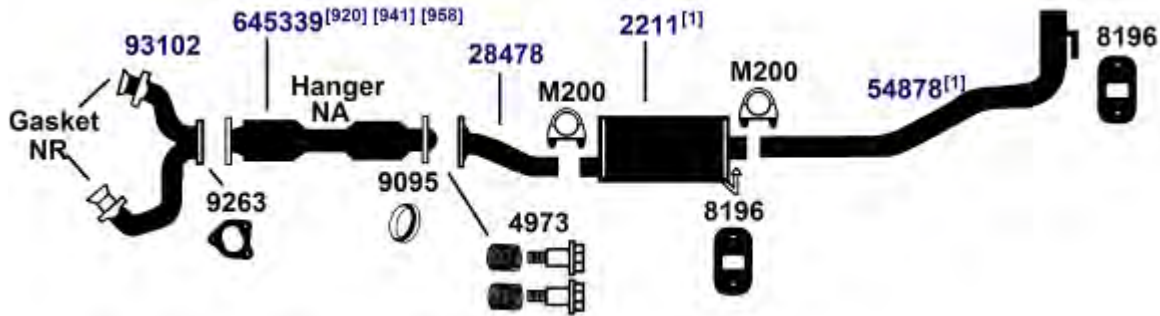

DIRECT FIT MSL/MAXIMUM Muffler... 700036, UNIVERSAL FIT MSL/MAXIMUM Muffler... 709013, 709014

91-92 6 Cyl. Explorer; 4.0L Engine

(34400)

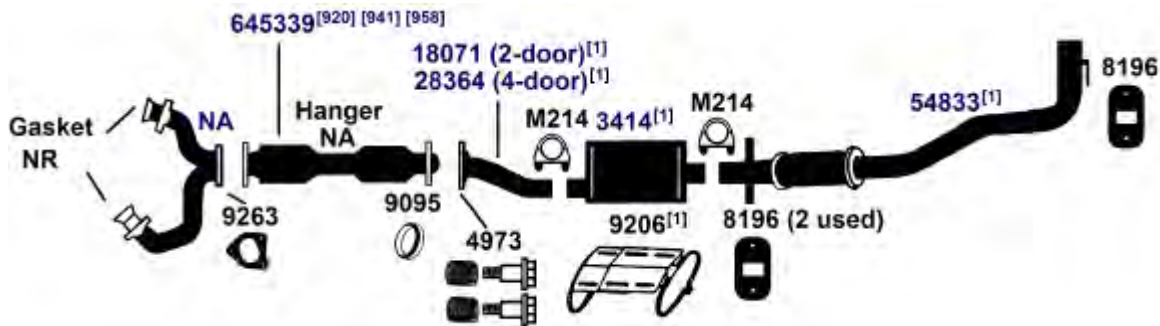

DIRECT FIT MSL/MAXIMUM Muffler... 6597, UNIVERSAL FIT MSL/MAXIMUM Muffler... 709014, 709992, Silentone DIY Muffler... 5549

NA-Not Available. NR-Not Required. FL-Remove and Re-Use Old Flange. ● Golden Warehouse. O.E.-Original Equipment.
Airtube Kit [4948] may be required to complete installation. EFI-Electronic Fuel Injection.

[1] OE system was a welded assembly. It is recommended that all parts noted [1] should be replaced.

[920] Y-Pipe must be cut 1/2" from face of flange

[941] Replaces both front and rear converters, Only failed converters may be replaced.

[958] Federal & California Emission vehicles. Not legal for sale for vehicles licensed in California.

FORD F100/150 SERIES PICKUP

(28029) 1994 8 Cyl. F150 Series 155" W.B.; Super Cab; 5.8L Engine
 87-94 8 Cyl. F150 Series 155" W.B.; Super Cab; 5.0L Engine

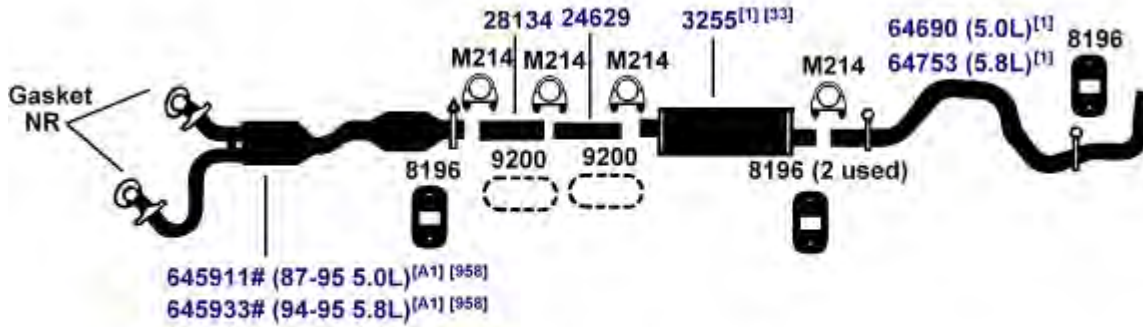

[A1] Combination Front and Rear Converter, 2 To 1 Replacement.
 Only Defective Converters May Be Replaced.

DIRECT FIT MSL/MAXIMUM Muffler... 6592, UNIVERSAL FIT MSL/MAXIMUM Muffler... 6571, 709019, Silentone DIY Muffler... 5557

(28028) 1994 8 Cyl. F150 Series; 116", 133", 138" W.B.; 5.8L Engine; Styleside
 87-94 8 Cyl. F150 Series; 116", 133", 138" W.B.; 5.0L Engine

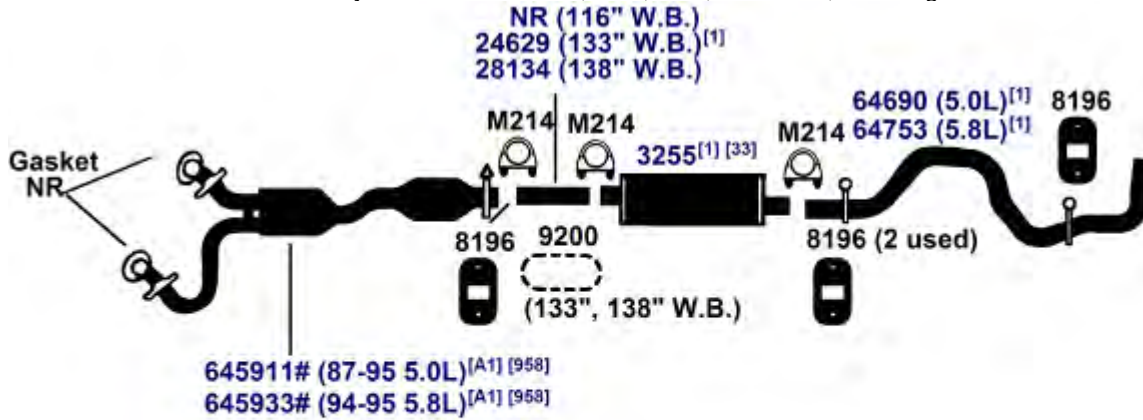

[A1] Combination Front and Rear Converter, 2 To 1 Replacement.
 Only Defective Converters May Legally Be Replaced.

DIRECT FIT MSL/MAXIMUM Muffler... 6592, UNIVERSAL FIT MSL/MAXIMUM Muffler... 6571, 709019, Silentone DIY Muffler... 5557

NA-Not Available. NR-Not Required. FL-Remove and Re-Use Old Flange. ● Golden Warehouse. O.E.-Original Equipment.
 # Airtube Kit [4948] may be required to complete installation. EFI-Electronic Fuel Injection.

[1] OE system was a welded assembly. It is recommended that all parts noted [1] should be replaced.

[33] Remove and re-use O.E. heat shield.

[98] Refer to current Catalytic Converter catalog or Website catalog for availability.
 [958] Federal & California Emission vehicles. Not legal for sale for vehicles licensed in California.

FORD F100/150 SERIES PICKUP

1994 8 Cyl. F150 Series; 116", 138" W.B.; 5.8L Engine, Flareside
 87-93 8 Cyl. F150 Series; 116", 133", 138" W.B.; 5.8L Engine

(28025)

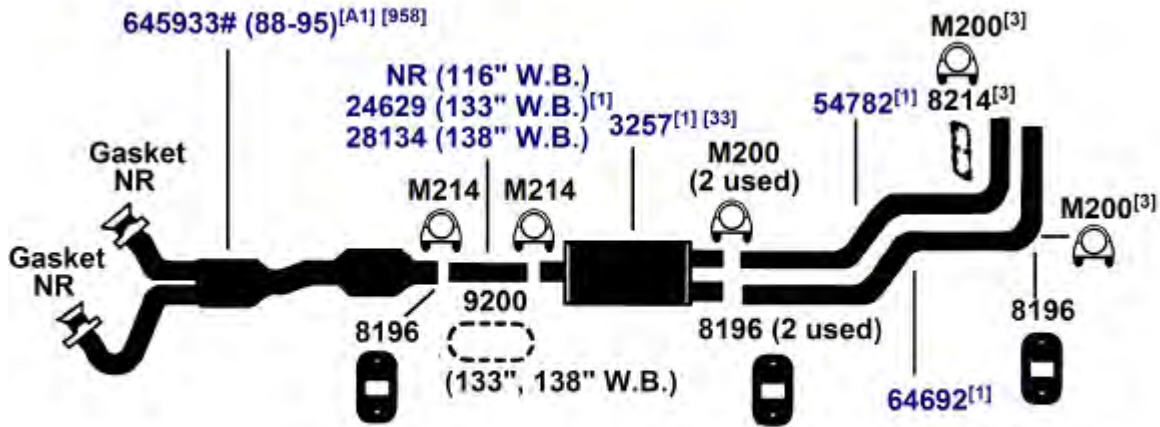

[A1] **Combination Front and Rear Converter, 2 To 1 Replacement. Only Defective Converters May Legally Be Replaced.**

DIRECT FIT MSL/MAXIMUM Muffler... 700099, UNIVERSAL FIT MSL/MAXIMUM Muffler... 6585

87-94 6 Cyl. F150; 155" W.B.; 4.9L Engine

(26872)

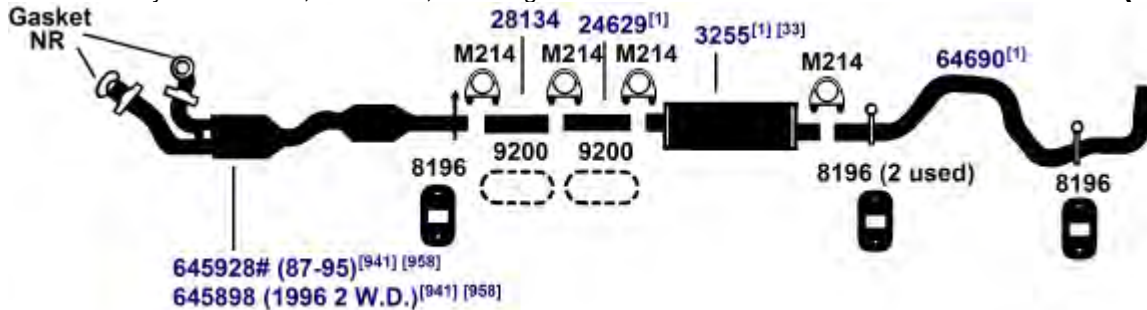

DIRECT FIT MSL/MAXIMUM Muffler... 6592, UNIVERSAL FIT MSL/MAXIMUM Muffler... 6571, 709019, Silentone DIY Muffler... 5557

NA-Not Available. NR-Not Required. FL-Remove and Re-Use Old Flange. ● Golden Warehouse. O.E.-Original Equipment.
 # Airtube Kit [4948] may be required to complete installation. EFI-Electronic Fuel Injection.

- [1] OE system was a welded assembly. It is recommended that all parts noted [1] should be replaced.
- [3] Required for installation.
- [33] Remove and re-use O.E. heat shield.
- [98] Refer to current Catalytic Converter catalog or Website catalog for availability.
- [941] Replaces both front and rear converters, Only failed converters may be replaced.
- [958] Federal & California Emission vehicles. Not legal for sale for vehicles licensed in California.

FORD F100/150 SERIES PICKUP

(26871) 87-94 6 Cyl. F150; 116", 133", 138" W.B.; 4.9L Engine

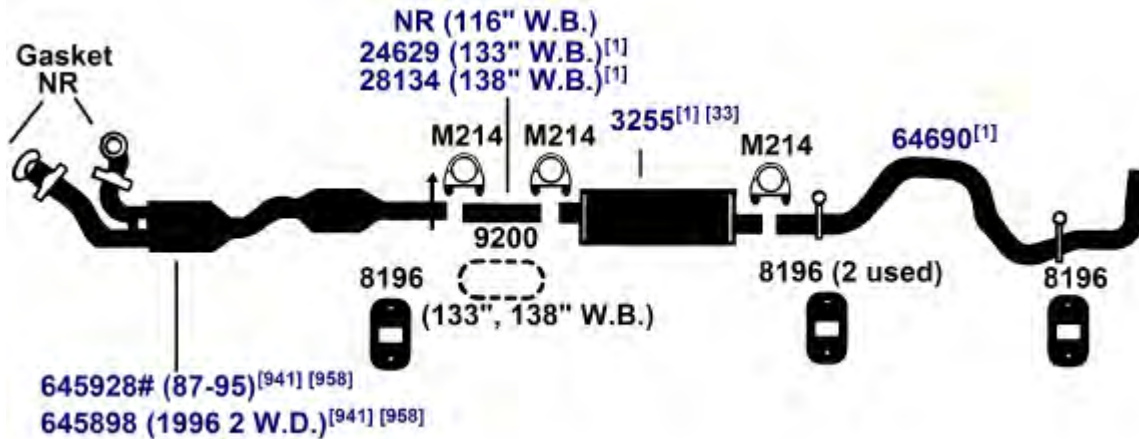

DIRECT FIT MSL/MAXIMUM Muffler... 6592, UNIVERSAL FIT MSL/MAXIMUM Muffler... 6571, 709019, Silentone DIY Muffler... 5557

(28026) 87-93 8 Cyl. F150 Series 155" W.B.; 5.8L Engine

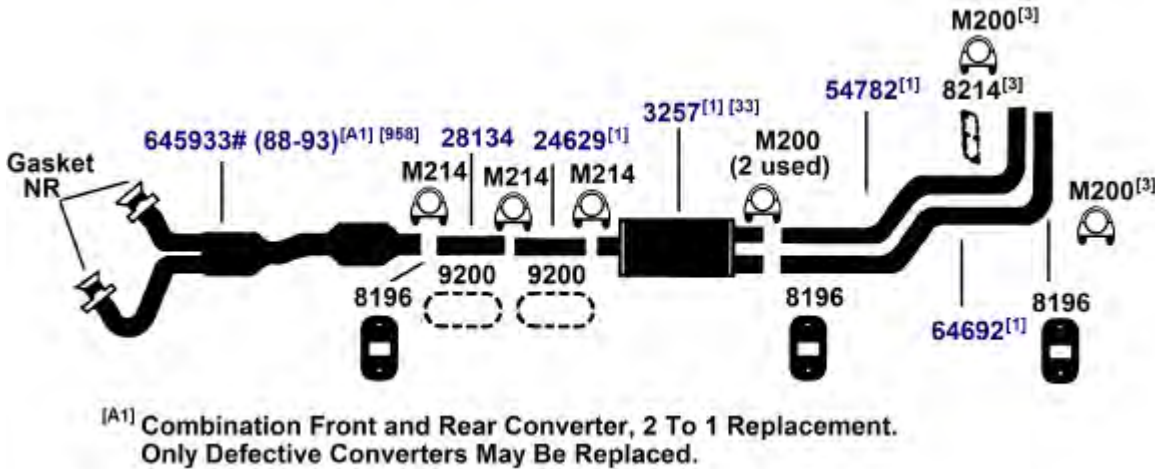

DIRECT FIT MSL/MAXIMUM Muffler... 700099, UNIVERSAL FIT MSL/MAXIMUM Muffler... 6585

(26868) 85-86 6 Cyl. F150 Series; 116" W.B.; 300 (4.9L) Engine; 2 W.D., 4 W.D.; 1/2 Ton; with Converter

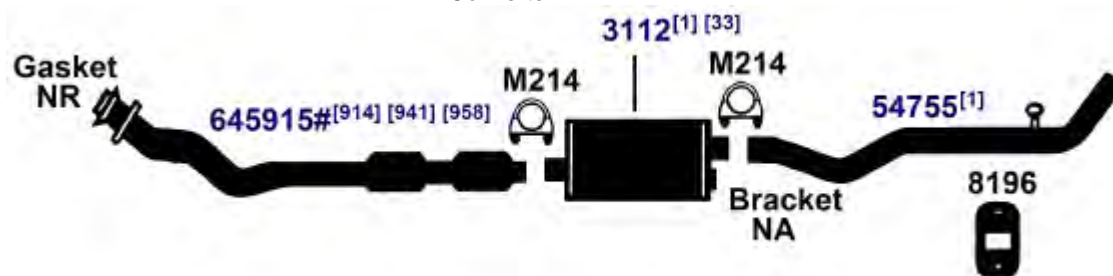

DIRECT FIT MSL/MAXIMUM Muffler... 700001, UNIVERSAL FIT MSL/MAXIMUM Muffler... 6539, 709019, Silentone DIY Muffler... 5534

NA-Not Available. NR-Not Required. FL-Remove and Re-Use Old Flange. ● Golden Warehouse. O.E.-Original Equipment.
Airtube Kit [4948] may be required to complete installation. EFI-Electronic Fuel Injection.

[1] OE system was a welded assembly. It is recommended that all parts noted [1] should be replaced.

[3] Required for installation.

[33] Remove and re-use O.E. heat shield.

[98] Refer to current Catalytic Converter catalog or Website catalog for availability.

[914] Direct fit converter includes front (Exhaust) pipe, (1) piece assembly.

[941] Replaces both front and rear converters, Only failed converters may be replaced.

[958] Federal & California Emission vehicles. Not legal for sale for vehicles licensed in California.

FORD F100/150 SERIES PICKUP

85-86 6 Cyl. F150 Series; 116" W.B.; 300 (4.9L) Engine; 2 W.D., 4 W.D.; 1/2 Ton; without Converter **(26869)**

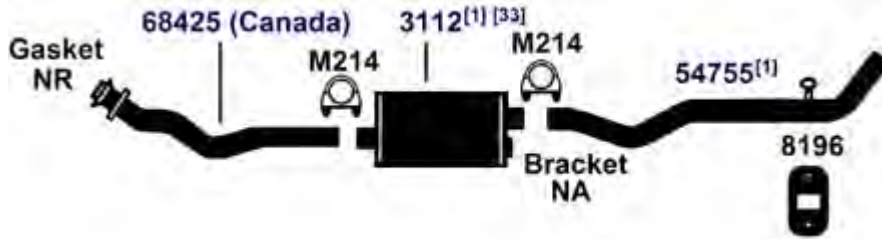

DIRECT FIT MSL/MAXIMUM Muffler... 700001, UNIVERSAL FIT MSL/MAXIMUM Muffler... 6539, 709019, Silentone DIY Muffler... 5534

85-86 6 Cyl. F150 Series; 133", 138" W.B.; Super Cab; 300 (4.9L) Engine; 2 W.D., 4 W.D.; 1/2 Ton; without Converter **(26867)**

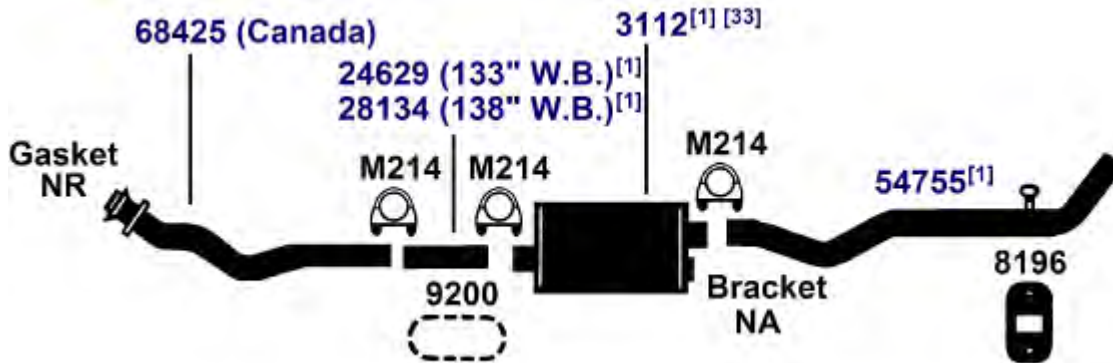

DIRECT FIT MSL/MAXIMUM Muffler... 700001, UNIVERSAL FIT MSL/MAXIMUM Muffler... 6539, 709019, Silentone DIY Muffler... 5534

85-86 6 Cyl. F150 Series; 133" W.B.; 300 (4.9L) Engine; 2 W.D., 4 W.D.; 1/2 Ton; with Converter **(26866)**

85-86 6 Cyl. F150 Series; 138" W.B.; Super Cab; 300 (4.9L) Engine; 2 W.D., 4 W.D.; 1/2 Ton; with Converter

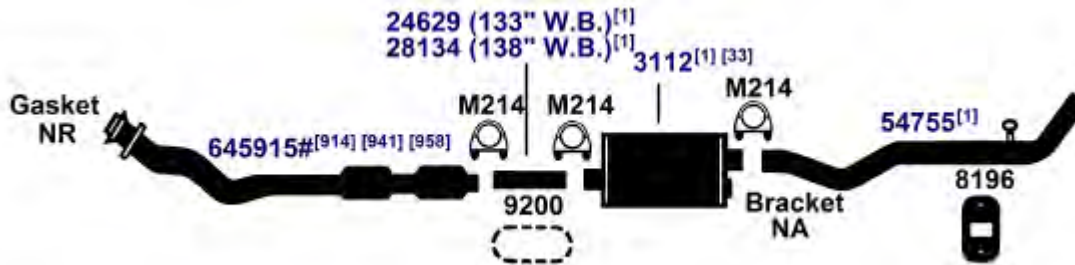

DIRECT FIT MSL/MAXIMUM Muffler... 700001, UNIVERSAL FIT MSL/MAXIMUM Muffler... 6539, 709019, Silentone DIY Muffler... 5534

NA-Not Available. NR-Not Required. FL-Remove and Re-Use Old Flange. ● Golden Warehouse. O.E.-Original Equipment.
Airtube Kit [4948] may be required to complete installation. EFI-Electronic Fuel Injection.

[1] OE system was a welded assembly. It is recommended that all parts noted [1] should be replaced.
[33] Remove and re-use O.E. heat shield.
[914] Direct fit converter includes front (Exhaust) pipe, (1) piece assembly.

[941] Replaces both front and rear converters, Only failed converters may be replaced.
[958] Federal & California Emission vehicles. Not legal for sale for vehicles licensed in California.

FORD F100/150 SERIES PICKUP

(26863) 85-86 6 Cyl. F150 Series; 155" W.B.; Super Cab; 300 (4.9L) Engine; 2 W.D., 4 W.D.; 1/2 Ton; without Converter

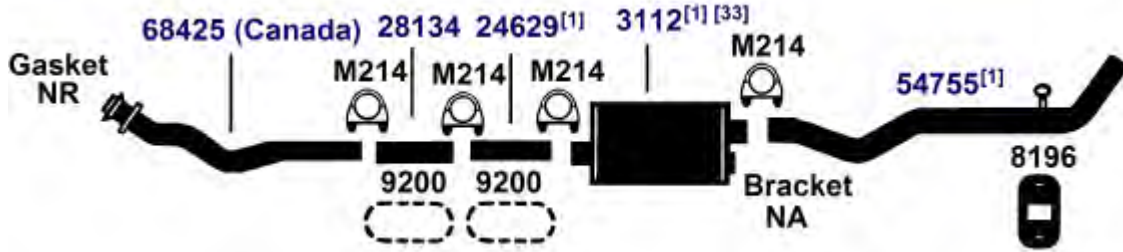

DIRECT FIT MSL/MAXIMUM Muffler... 700001, UNIVERSAL FIT MSL/MAXIMUM Muffler... 6539, 709019, Silentone DIY Muffler... 5534

(26862) 85-86 6 Cyl. F150 Series; 155" W.B.; Super Cab; 300 (4.9L) Engine; 2 W.D., 4 W.D.; 1/2 Ton; with converter



DIRECT FIT MSL/MAXIMUM Muffler... 700001, UNIVERSAL FIT MSL/MAXIMUM Muffler... 6539, 709019, Silentone DIY Muffler... 5534

(28014) 85-86 8 Cyl. F150 Series; 133" W.B.; 302, 351[38] 2-Barrel (5.0L, 5.8L) Engine; 2 W.D., 4 W.D.; 1/2 Ton; without Converter
 85-86 8 Cyl. F150 Series; 138" W.B.; Super Cab; 302, 351[38] 2-barrel (5.0L, 5.8L) Engine; 2 W.D., 4 W.D.; 1/2 Ton; without Converter

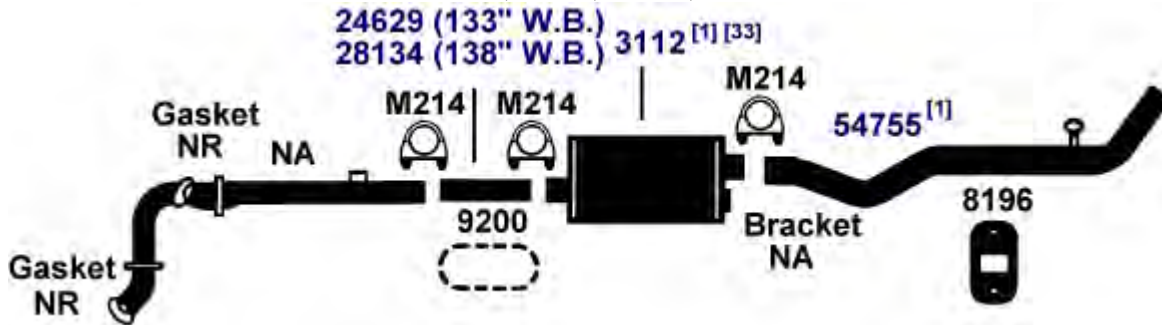

DIRECT FIT MSL/MAXIMUM Muffler... 700001, UNIVERSAL FIT MSL/MAXIMUM Muffler... 6539, 709019, Silentone DIY Muffler... 5534

NA-Not Available. NR-Not Required. FL-Remove and Re-Use Old Flange. ● Golden Warehouse. O.E.-Original Equipment.
 # Airtube Kit [4948] may be required to complete installation. EFI-Electronic Fuel Injection.

[1] OE system was a welded assembly. It is recommended that all parts noted [1] should be replaced.

[33] Remove and re-use O.E. heat shield.

[914] Direct fit converter includes front (Exhaust) pipe, (1) piece assembly.

[941] Replaces both front and rear converters, Only failed converters may be replaced.

[958] Federal & California Emission vehicles. Not legal for sale for vehicles licensed in California.

85-86 8 Cyl. F150 Series; 116" W.B.; 351 4-barrel (5.8L) Engine; 2 W.D., 4 W.D.; 1/2 Ton; (28023)
with Converter

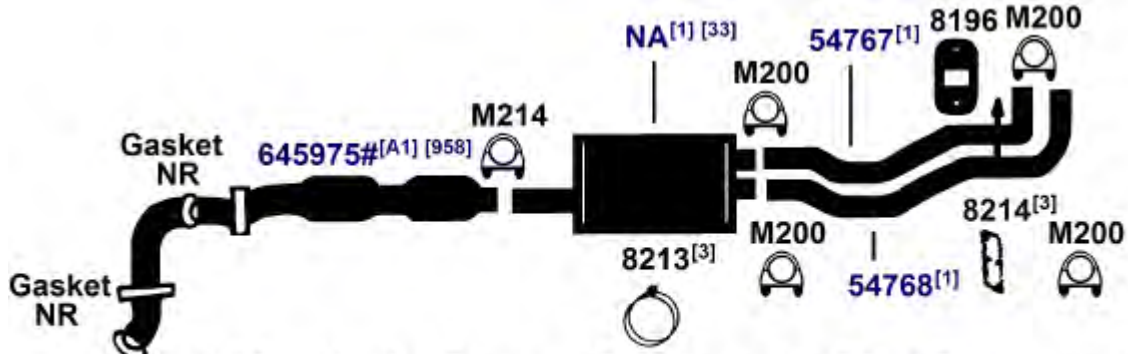

[A1] Combination Front and Rear Converter, 2 To 1 Replacement.
Only Defective Converters May Be Replaced.

DIRECT FIT MSL/MAXIMUM Muffler... 6585

85-86 8 Cyl. F150 Series; 116" W.B.; 302, 351 [38] 2-barrel (5.0L, 5.8L) Engine; 2 W.D., 4 W.D.; 1/2 Ton; with Converter; including EFI (28018)

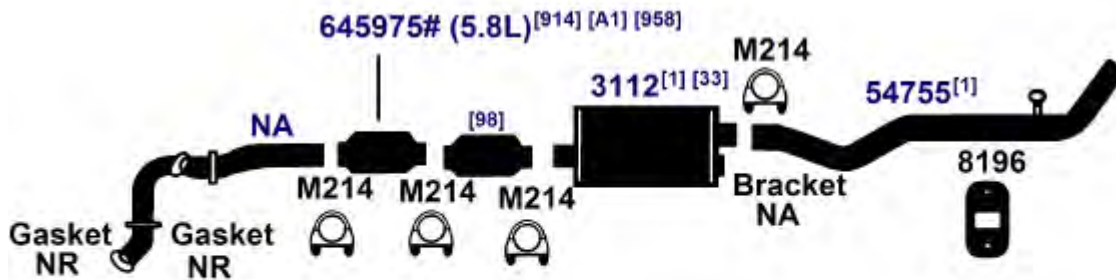

[A1] Combination Front and Rear Converter, 2 To 1 Replacement.
Only Defective Converters May Be Replaced.

DIRECT FIT MSL/MAXIMUM Muffler... 700001, UNIVERSAL FIT MSL/MAXIMUM Muffler... 6539, 709019, Silentone DIY Muffler... 5534

NA-Not Available. NR-Not Required. FL-Remove and Re-Use Old Flange. ● Golden Warehouse. O.E.-Original Equipment.
Airtube Kit [4948] may be required to complete installation. EFI-Electronic Fuel Injection.

- [1] OE system was a welded assembly. It is recommended that all parts noted [1] should be replaced. [914] Direct fit converter includes front (Exhaust) pipe, (1) piece assembly.
- [3] Required for installation. [958] Federal & California Emission vehicles. Not legal for sale for vehicles licensed in California.
- [33] Remove and re-use O.E. heat shield.

FORD F100/150 SERIES PICKUP

(28020) 85-86 8 Cyl. F150 Series; 155" W.B.; Super Cab; 351 4-barrel (5.8L) Engine; 2 W.D., 4 W.D.; 1/2 Ton; with Converter

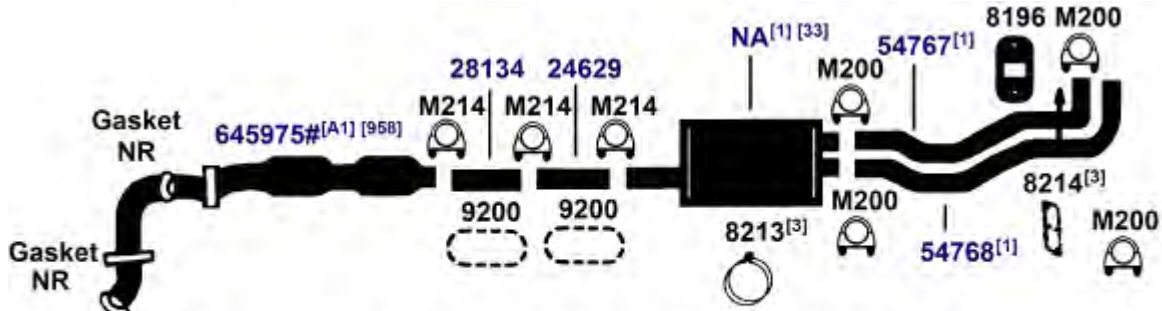

[A1] Combination Front and Rear Converter, 2 To 1 Replacement. Only Defective Converters May Be Replaced.

DIRECT FIT MSL/MAXIMUM Muffler... 6585

(28013) 85-86 8 Cyl. F150 Series; 155" W.B.; Super Cab; 302, 351[38] 2-barrel (5.0L, 5.8L) Engine; 2 W.D., 4 W.D.; 1/2 Ton; without Converter

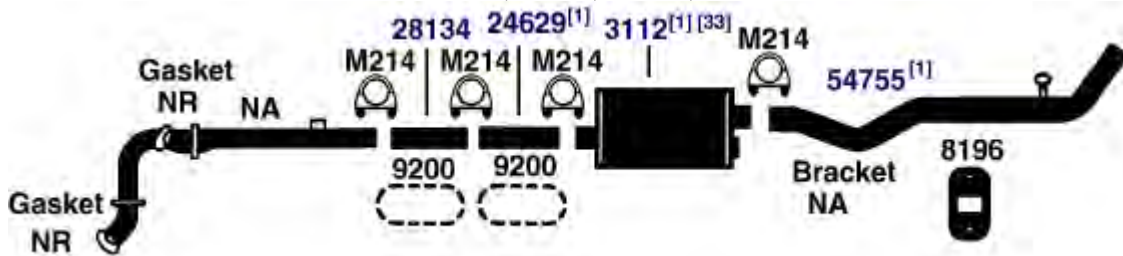

DIRECT FIT MSL/MAXIMUM Muffler... 700001, UNIVERSAL FIT MSL/MAXIMUM Muffler... 6539, 709019, Silentone DIY Muffler... 5534

(28012) 85-86 8 Cyl. F150 Series; 155" W.B.; Super Cab; 302, 351[38] 2-barrel (5.0L, 5.8L) Engine; 2 W.D., 4 W.D.; 1/2 Ton; with Converter; including EFI

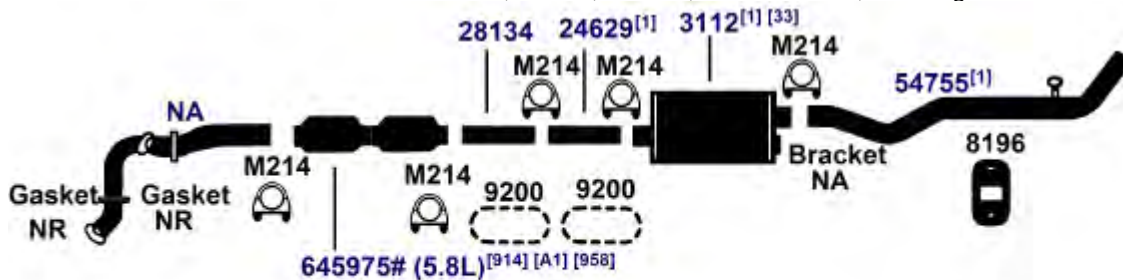

[A1] Combination Front and Rear Converter, 2 To 1 Replacement. Only Defective Converters May Be Replaced.

DIRECT FIT MSL/MAXIMUM Muffler... 700001, UNIVERSAL FIT MSL/MAXIMUM Muffler... 6539, 709019, Silentone DIY Muffler... 5534

NA-Not Available. NR-Not Required. FL-Remove and Re-Use Old Flange. ● Golden Warehouse. O.E.-Original Equipment.
Airtube Kit [4948] may be required to complete installation. EFI-Electronic Fuel Injection.

[1] OE system was a welded assembly. It is recommended that all parts noted [1] should be replaced.

[3] Required for installation.

[33] Remove and re-use O.E. heat shield.

[914] Direct fit converter includes front (Exhaust) pipe, (1) piece assembly.

[921] Combination front & rear converter, 2 to 1 replacement. Only defective converters may legally be replaced.

[958] Federal & California Emission vehicles. Not legal for sale for vehicles licensed in California.

FORD F100/150 SERIES PICKUP

- 85-86** 8 Cyl. F150 Series; 138" W.B.; Super Cab; 302, 351[38] 2-barrel (5.0L, 5.8L) Engine; 2 W.D., 4 W.D.; 1/2 Ton; with Converter; including EFI **(28015)**
- 85-86** 8 Cyl. F150 Series; 133" W.B.; 302, 351 [38] 2-barrel (5.0L, 5.8L) Engine; 2 W.D., 4 W.D.; 1/2 Ton; with Converter, including EFI

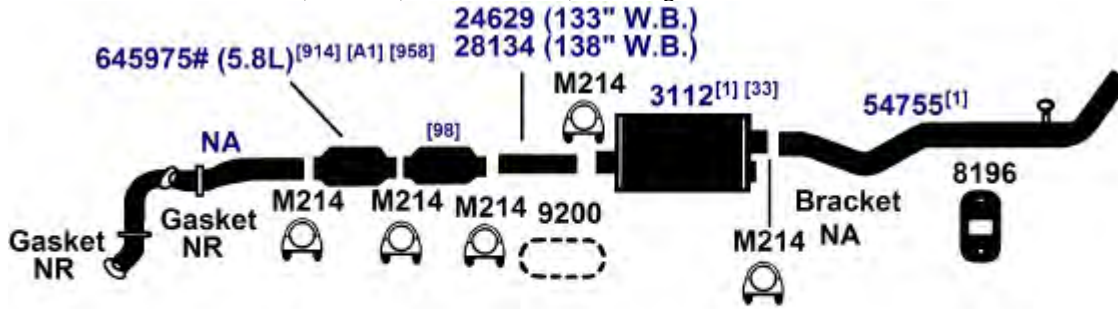

[A1] Combination Front and Rear Converter, 2 To 1 Replacement. Only Defective Converters May Be Replaced.

DIRECT FIT MSL/MAXIMUM Muffler... 700001, UNIVERSAL FIT MSL/MAXIMUM Muffler... 6539, 709019, Silentone DIY Muffler... 5534

- 85-86** 8 Cyl. F150 Series; 116" W.B.; 302, 351 [38] 2-barrel (5.0L, 5.8L) Engine; 2 W.D., 4 W.D.; 1/2 Ton; without Converter, including EFI **(28019)**

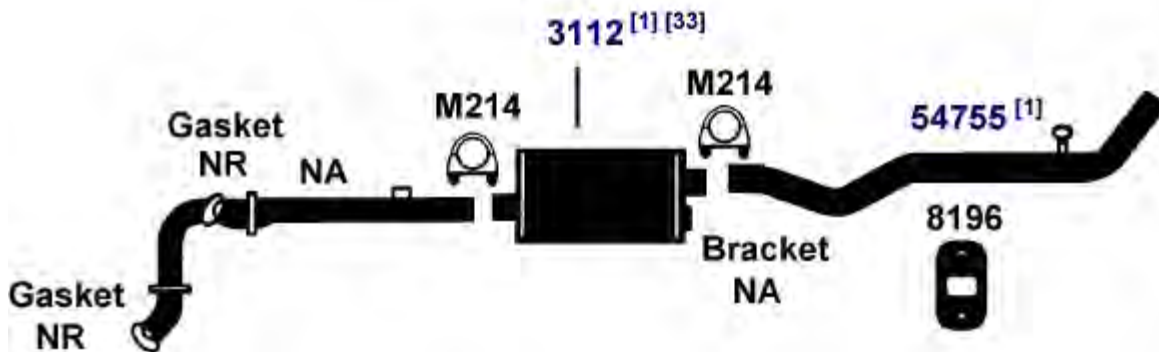

DIRECT FIT MSL/MAXIMUM Muffler... 700001, UNIVERSAL FIT MSL/MAXIMUM Muffler... 6539, 709019, Silentone DIY Muffler... 5534

NA-Not Available. NR-Not Required. FL-Remove and Re-Use Old Flange. ● Golden Warehouse. O.E.-Original Equipment.
Airtube Kit [4948] may be required to complete installation. EFI-Electronic Fuel Injection.

[1] OE system was a welded assembly. It is recommended that all parts noted [1] should be replaced.
[33] Remove and re-use O.E. heat shield.

[914] Direct fit converter includes front (Exhaust) pipe, (1) piece assembly.
[958] Federal & California Emission vehicles. Not legal for sale for vehicles licensed in California.

FORD F100/150 SERIES PICKUP

(28021) 1985 8 Cyl. F150 Series 133", 138" Super Cab W.B.; 351 4-barrel (5.8L) Engine; 2 W.D., 4 W.D., 1/2 Ton with Converter

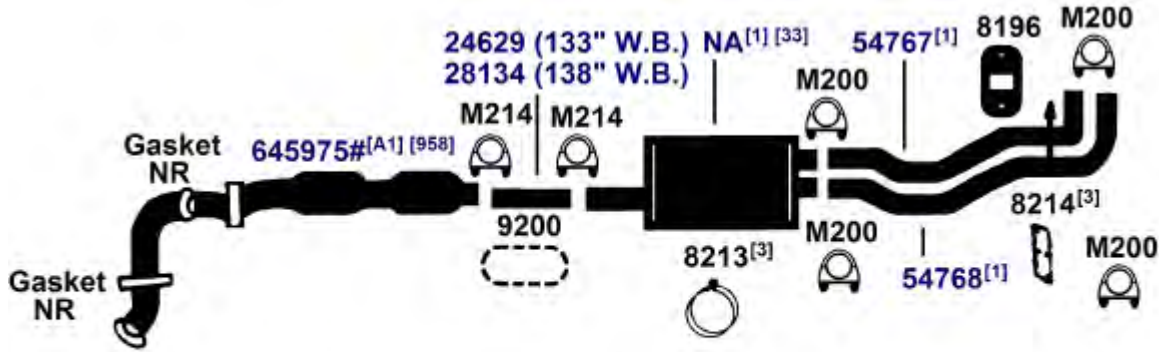

[A1] Combination Front and Rear Converter, 2 To 1 Replacement. Only Defective Converters May Be Replaced.

DIRECT FIT MSL/MAXIMUM Muffler... 6585

(28020E) 1984 8 Cyl. F150 Series; 155" W.B.; Super Cab; 351 4-barrel (5.8L) Engine; 2 W.D., 4 W.D.; 1/2 Ton; with Converter

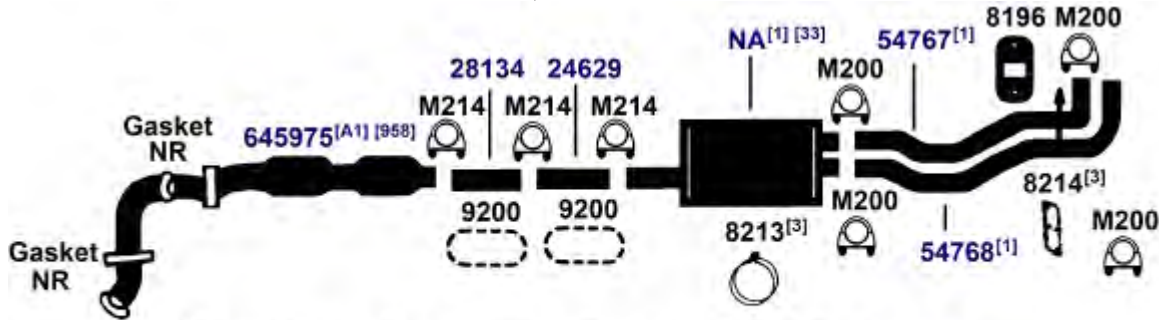

[A1] Combination Front and Rear Converter, 2 To 1 Replacement. Only Defective Converters May Be Replaced.

DIRECT FIT MSL/MAXIMUM Muffler... 6585

NA-Not Available. NR-Not Required. FL-Remove and Re-Use Old Flange. ● Golden Warehouse. O.E.-Original Equipment.
Airtube Kit [4948] may be required to complete installation. EFI-Electronic Fuel Injection.

- [1] OE system was a welded assembly. It is recommended that all parts noted [1] should be replaced.
[3] Required for installation.

- [33] Remove and re-use O.E. heat shield.
[958] Federal & California Emission vehicles. Not legal for sale for vehicles licensed in California.

FORD F100/150 SERIES PICKUP

1984 8 Cyl. F150 Series; 116" W.B.; 351 4-barrel (5.8L) Engine; 2 W.D., 4 W.D.; 1/2 Ton; **(28023E)**
with Converter

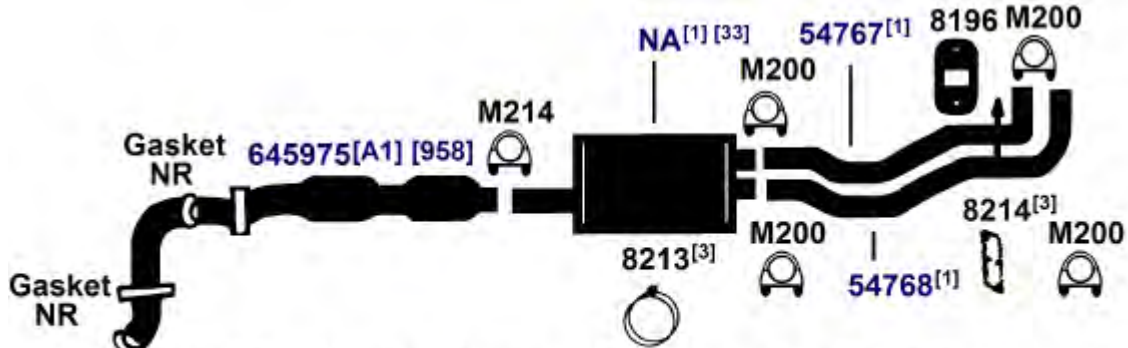

[A1] Combination Front and Rear Converter, 2 To 1 Replacement. Only Defective Converters May Be Replaced.

DIRECT FIT MSL/MAXIMUM Muffler... 6585

1984 8 Cyl. F150 Series 133", 138" Super Cab W.B.; 351 4-barrel (5.8L) Engine; 2 W.D., 4 W.D., 1/2 Ton with Converter **(28021E)**

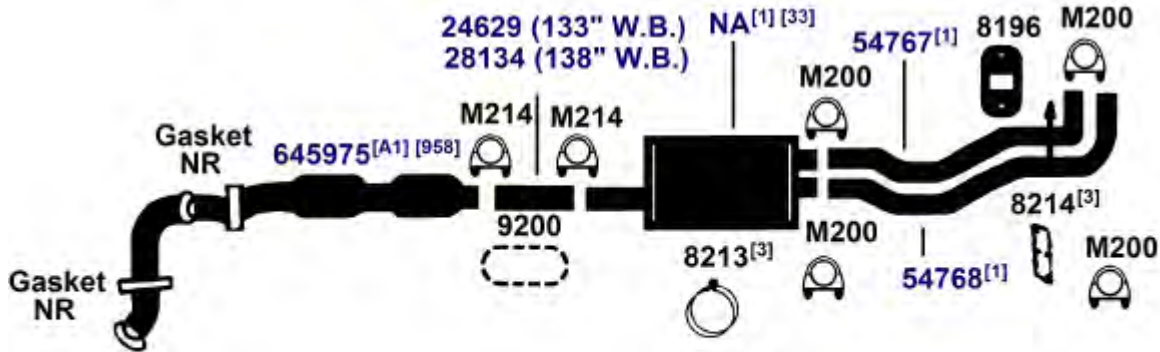

[A1] Combination Front and Rear Converter, 2 To 1 Replacement. Only Defective Converters May Be Replaced.

DIRECT FIT MSL/MAXIMUM Muffler... 6585

NA-Not Available. NR-Not Required. FL-Remove and Re-Use Old Flange. ● Golden Warehouse. O.E.-Original Equipment.
Airtube Kit [4948] may be required to complete installation. EFI-Electronic Fuel Injection.

- [1] OE system was a welded assembly. It is recommended that all parts noted [1] should be replaced.
- [3] Required for installation.
- [33] Remove and re-use O.E. heat shield.
- [958] Federal & California Emission vehicles. Not legal for sale for vehicles licensed in California.

FORD F100/150 SERIES PICKUP

(26863E) 83-84 6 Cyl. F150 Series; 155" W.B.; Super Cab; 300 (4.9L) Engine; 2 W.D., 4 W.D.; 1/2 Ton; without Converter

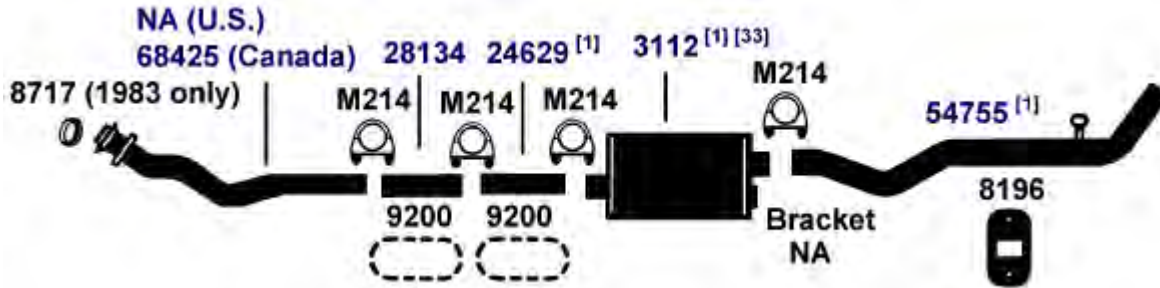

DIRECT FIT MSL/MAXIMUM Muffler... 700001, UNIVERSAL FIT MSL/MAXIMUM Muffler... 6539, 709019, Silentone DIY Muffler... 5534

(26862E) 83-84 6 Cyl. F150 Series; 155" W.B.; Super Cab; 300 (4.9L) Engine; 2 W.D., 4 W.D.; 1/2 Ton; with Converter



^[A1] Combination Front & Rear Converter, 2 to 1 Replacement. Only Defective Converters May Legally Be Replaced.

DIRECT FIT MSL/MAXIMUM Muffler... 700001, UNIVERSAL FIT MSL/MAXIMUM Muffler... 6539, 709019, Silentone DIY Muffler... 5534

(26867E) 83-84 6 Cyl. F150 Series; 133", 138" W.B.; Super Cab; 300 (4.9L) Engine; 2 W.D., 4 W.D.; 1/2 Ton; without Converter

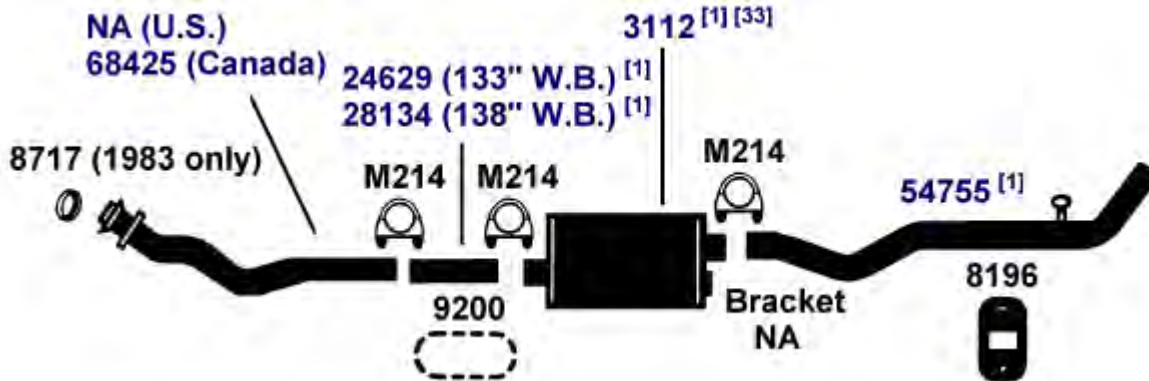

DIRECT FIT MSL/MAXIMUM Muffler... 700001, UNIVERSAL FIT MSL/MAXIMUM Muffler... 6539, 709019, Silentone DIY Muffler... 5534

NA-Not Available. NR-Not Required. FL-Remove and Re-Use Old Flange. ● Golden Warehouse. O.E.-Original Equipment.
Airtube Kit [4948] may be required to complete installation. EFI-Electronic Fuel Injection.

[1] OE system was a welded assembly. It is recommended that all parts noted [1] should be replaced.

[33] Remove and re-use O.E. heat shield.

[98] Refer to current Catalytic Converter catalog or Website catalog for availability.
[958] Federal & California Emission vehicles. Not legal for sale for vehicles licensed in California.

FORD F100/150 SERIES PICKUP

- 83-84** 6 Cyl. F150 Series; 133" W.B.; 300 (4.9L) Engine; 2 W.D., 4 W.D.; 1/2 Ton; with Converter **(26866E)**
- 83-84** 6 Cyl. F150 Series; 138" W.B.; Super Cab; 300 (4.9L) Engine; 2 W.D., 4 W.D.; 1/2 Ton; with Converter

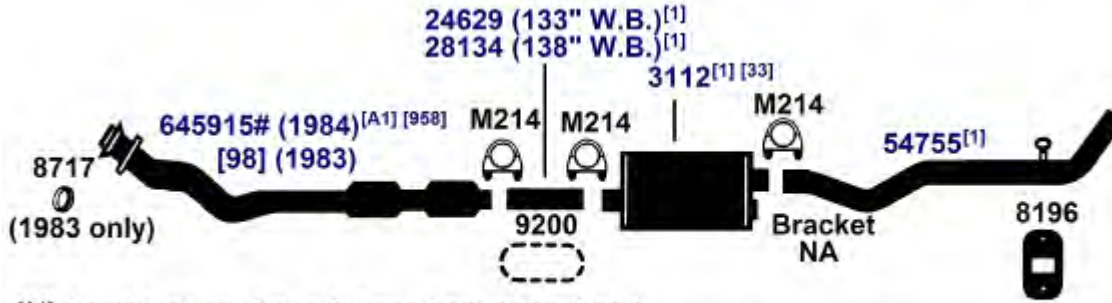

[A1] Combination Front & Rear Converter, 2 to 1 Replacement. Only Defective Converters May Legally Be Replaced.

DIRECT FIT MSL/MAXIMUM Muffler... 700001, UNIVERSAL FIT MSL/MAXIMUM Muffler... 6539, 709019, Silentone DIY Muffler... 5534

- 83-84** 6 Cyl. F150 Series; 116" W.B.; 300 (4.9L) Engine; 2 W.D., 4 W.D.; 1/2 Ton; without Converter **(26869E)**

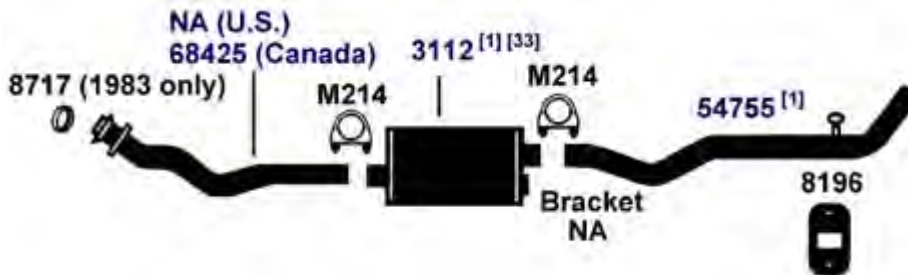

DIRECT FIT MSL/MAXIMUM Muffler... 700001, UNIVERSAL FIT MSL/MAXIMUM Muffler... 6539, 709019, Silentone DIY Muffler... 5534

- 83-84** 6 Cyl. F150 Series; 116" W.B.; 300 (4.9L) Engine; 2 W.D., 4 W.D.; 1/2 Ton; with Converter **(26868E)**

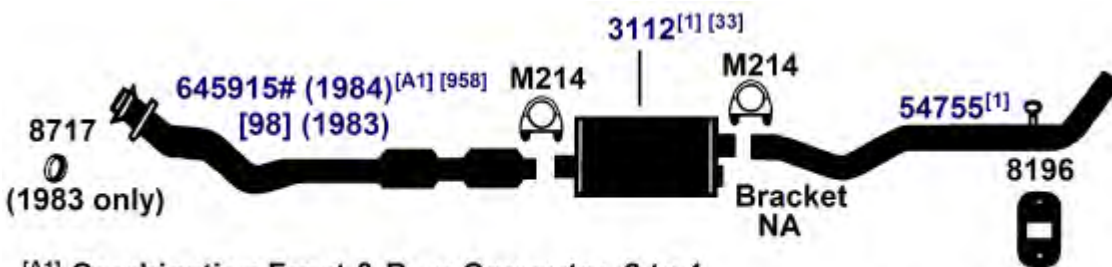

[A1] Combination Front & Rear Converter, 2 to 1 Replacement. Only Defective Converters May Legally Be Replaced.

DIRECT FIT MSL/MAXIMUM Muffler... 700001, UNIVERSAL FIT MSL/MAXIMUM Muffler... 6539, 709019, Silentone DIY Muffler... 5534

NA-Not Available. NR-Not Required. FL-Remove and Re-Use Old Flange. ● Golden Warehouse. O.E.-Original Equipment.
 # Airtube Kit [4948] may be required to complete installation. EFI-Electronic Fuel Injection.

[1] OE system was a welded assembly. It is recommended that all parts noted [1] should be replaced. [98] Refer to current Catalytic Converter catalog or Website catalog for availability.
 [33] Remove and re-use O.E. heat shield. [958] Federal & California Emission vehicles. Not legal for sale for vehicles licensed in California.

FORD F100/150 SERIES PICKUP

83-84 8 Cyl. F100 [41], F150 Series; 116" W.B.; 302, 351 2-barrel (5.0L, 5.8L) Engine; 2 W.D., 4 W.D.; 1/2 Ton; with Converter; including EFI **(28018E)**

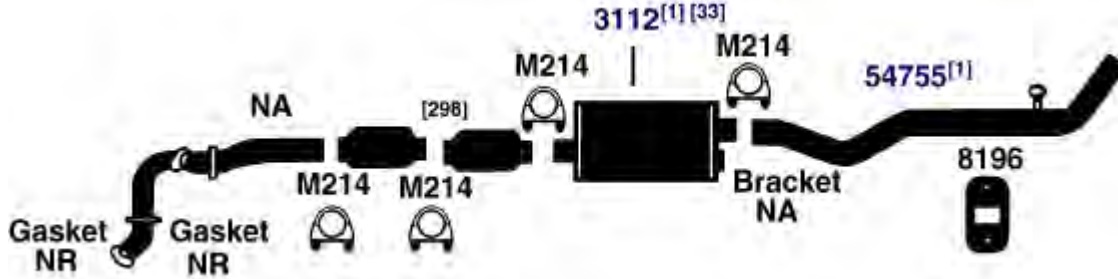

DIRECT FIT MSL/MAXIMUM Muffler... 700001, UNIVERSAL FIT MSL/MAXIMUM Muffler... 6539, 709019, Silentone DIY Muffler... 5534

83-84 8 Cyl. F100 [41], F150 Series; 133" W.B.; 302, 351 2-barrel (5.0L, 5.8L) Engine; 2 W.D., 4 W.D.; 1/2 Ton; with Converter, including EFI **(28015E)**

83-84 8 Cyl. F100 [41], F150 Series; 138" W.B.; Super Cab; 302, 351 2-barrel (5.0L, 5.8L) Engine; 2 W.D., 4 W.D.; 1/2 Ton; with Converter; including EFI

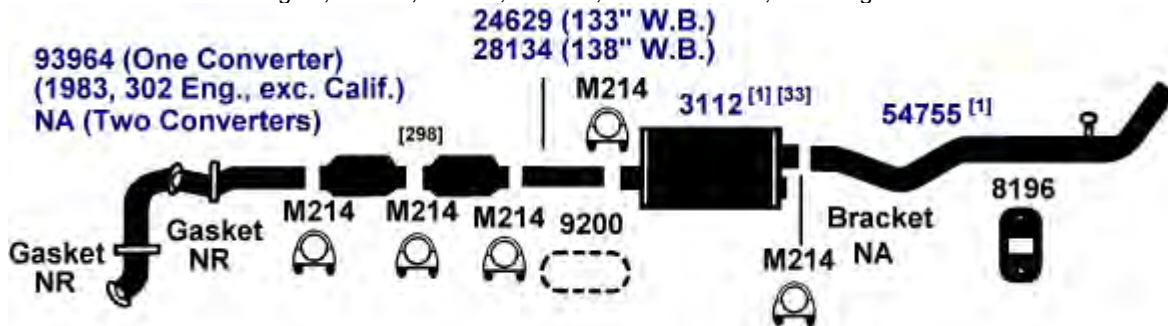

DIRECT FIT MSL/MAXIMUM Muffler... 700001, UNIVERSAL FIT MSL/MAXIMUM Muffler... 6539, 709019, Silentone DIY Muffler... 5534

83-84 8 Cyl. F150 Series; 155" W.B.; Super Cab; 302, 351 2-barrel (5.0L, 5.8L) Engine; 2 W.D., 4 W.D.; 1/2 Ton; with Converter; including EFI **(28012E)**

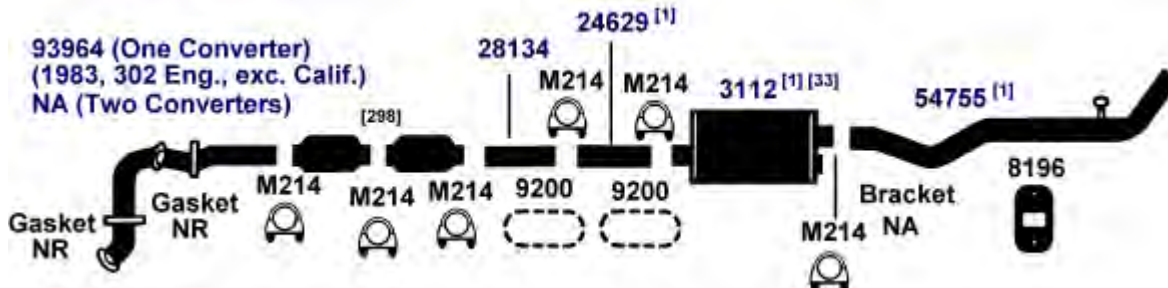

DIRECT FIT MSL/MAXIMUM Muffler... 700001, UNIVERSAL FIT MSL/MAXIMUM Muffler... 6539, 709019, Silentone DIY Muffler... 5534

NA-Not Available. NR-Not Required. FL-Remove and Re-Use Old Flange. ● Golden Warehouse. O.E.-Original Equipment.
Airtube Kit [4948] may be required to complete installation. EFI-Electronic Fuel Injection.

[1] OE system was a welded assembly. It is recommended that all parts noted [1] should be replaced. [298] Coverage available. Due to multiple listings, please refer to Catalytic Converter catalog.
[33] Remove and re-use O.E. heat shield.

FORD F100/150 SERIES PICKUP

(26861) 1983 6 Cyl. F100 Series; 116" W.B.; 232 (3.8L) Engine; 2 W.D.; 1/2 Ton; with Converter

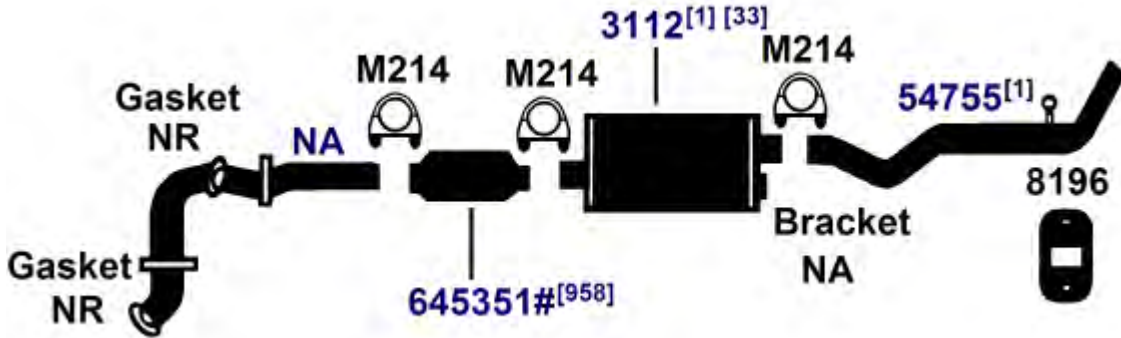

DIRECT FIT MSL/MAXIMUM Muffler... 700001, UNIVERSAL FIT MSL/MAXIMUM Muffler... 6539, 709019, Silentone DIY Muffler... 5534

(26857) 1983 6 Cyl. F100 Series; 133" W.B.; 300 (4.9L) Engine; 2 W.D.; 1/2 Ton; with Converter

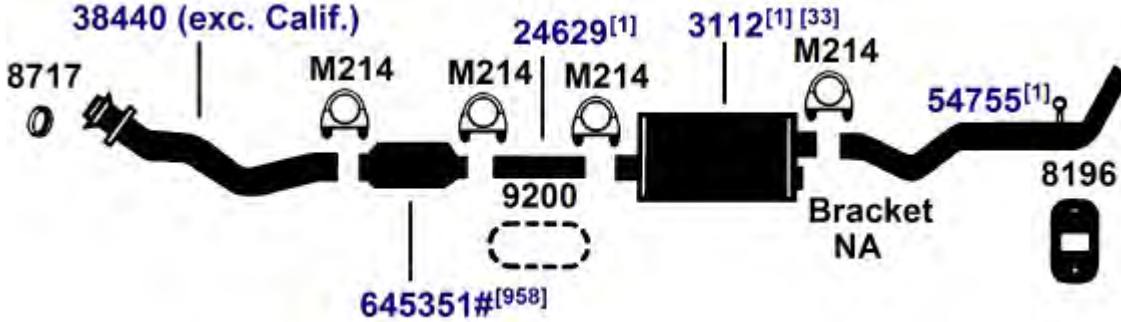

DIRECT FIT MSL/MAXIMUM Muffler... 700001, UNIVERSAL FIT MSL/MAXIMUM Muffler... 6539, 709019, Silentone DIY Muffler... 5534

(26859) 1983 6 Cyl. F100 Series; 116" W.B.; 300 (4.9L) Engine; 2 W.D.; 1/2 Ton; without Converter

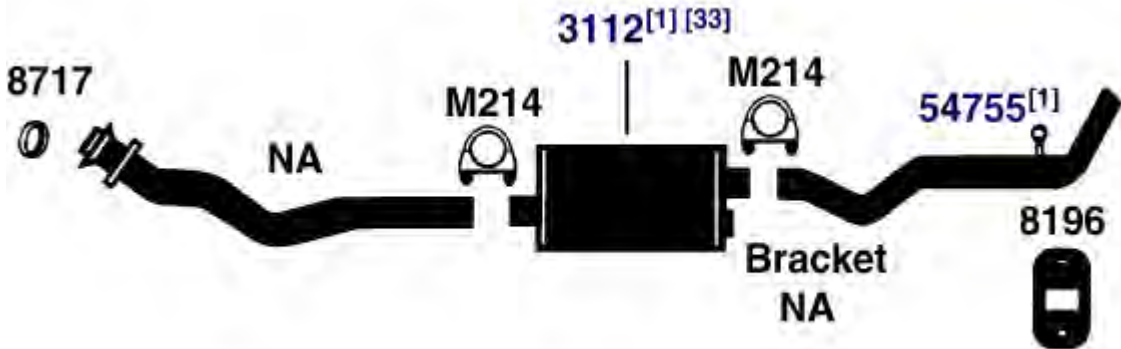

DIRECT FIT MSL/MAXIMUM Muffler... 700001, UNIVERSAL FIT MSL/MAXIMUM Muffler... 6539, 709019, Silentone DIY Muffler... 5534

NA-Not Available. NR-Not Required. FL-Remove and Re-Use Old Flange. ● Golden Warehouse. O.E.-Original Equipment.
Airtube Kit [4948] may be required to complete installation. EFI-Electronic Fuel Injection.

[1] OE system was a welded assembly. It is recommended that all parts noted [1] should be replaced. [958] Federal & California Emission vehicles. Not legal for sale for vehicles licensed in California.

[33] Remove and re-use O.E. heat shield.

FORD F100/150 SERIES PICKUP

1983 6 Cyl. F100 Series; 133" W.B.; 232 (3.8L) Engine; 2 W.D.; 1/2 Ton; with Converter **(26858)**

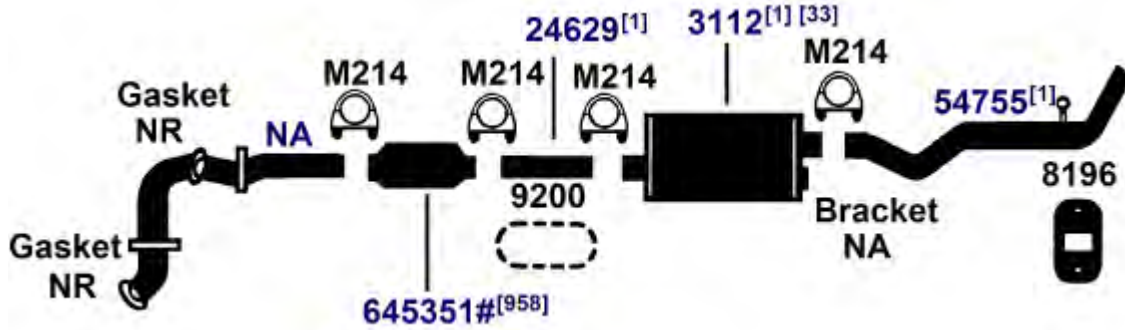

DIRECT FIT MSL/MAXIMUM Muffler... 700001, UNIVERSAL FIT MSL/MAXIMUM Muffler... 6539, 709019, Silentone DIY Muffler... 5534

1983 6 Cyl. F100 Series; 116" W.B.; 300 (4.9L) Engine; 2 W.D.; 1/2 Ton; with Converter **(26860)**

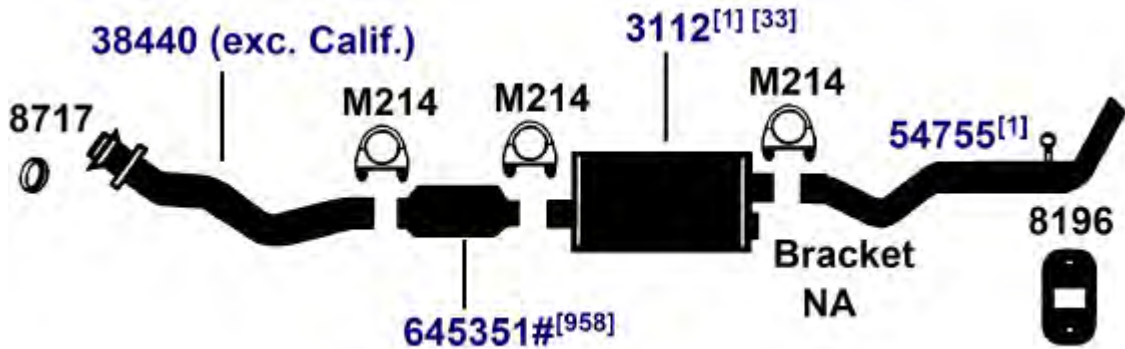

DIRECT FIT MSL/MAXIMUM Muffler... 700001, UNIVERSAL FIT MSL/MAXIMUM Muffler... 6539, 709019, Silentone DIY Muffler... 5534

1983 6 Cyl. F100 Series; 133" W.B.; 300 (4.9L) Engine; 2 W.D.; 1/2 Ton; without Converter **(26856)**

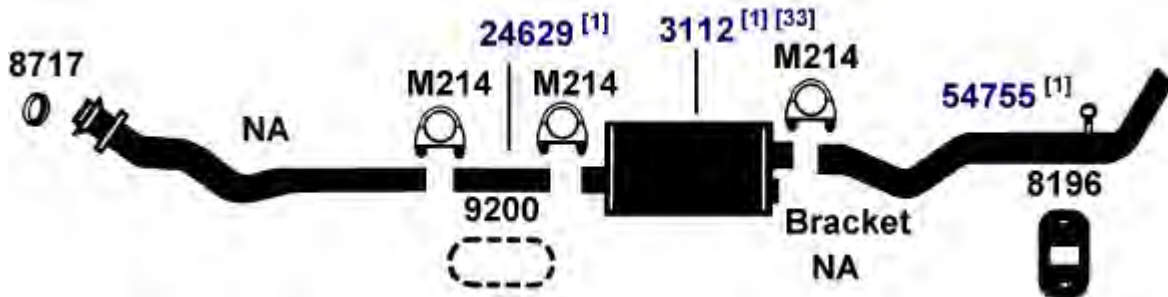

DIRECT FIT MSL/MAXIMUM Muffler... 700001, UNIVERSAL FIT MSL/MAXIMUM Muffler... 6539, 709019, Silentone DIY Muffler... 5534

NA-Not Available. NR-Not Required. FL-Remove and Re-Use Old Flange. • Golden Warehouse. O.E.-Original Equipment.
Airtube Kit [4948] may be required to complete installation. EFI-Electronic Fuel Injection.

- [1] OE system was a welded assembly. It is recommended that all parts noted [1] should be replaced.
- [33] Remove and re-use O.E. heat shield.
- [958] Federal & California Emission vehicles. Not legal for sale for vehicles licensed in California.

FORD F100/150 SERIES PICKUP

(26854) 1982 6 Cyl. F100 Series; 133" W.B.; 232 (3.8L) Engine; 2 W.D.; 1/2 Ton; Regular Cab with Converter

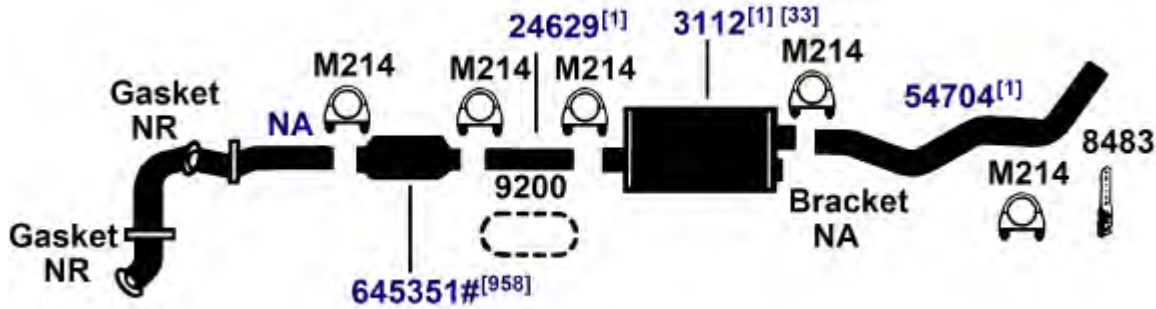

DIRECT FIT MSL/MAXIMUM Muffler... 700001, UNIVERSAL FIT MSL/MAXIMUM Muffler... 6539, 709019, Silentone DIY Muffler... 5534

(26855) 1982 6 Cyl. F100 Series; 116" W.B.; 232 (3.8L) Engine; 2 W.D.; 1/2 Ton; Regular Cab with Converter

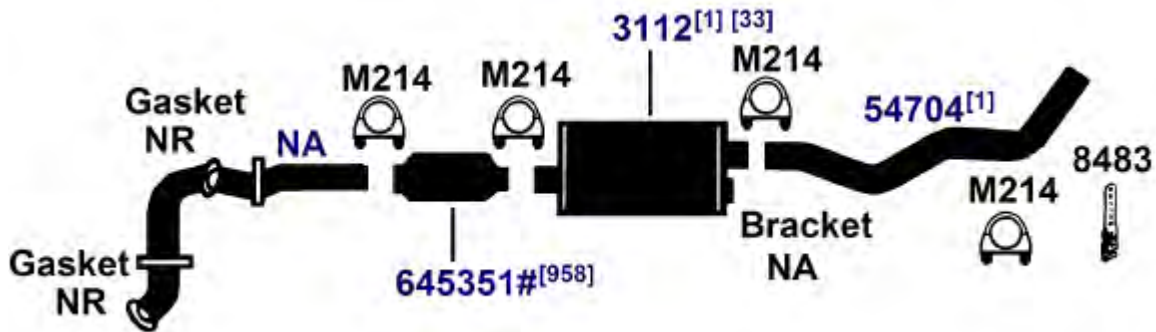

DIRECT FIT MSL/MAXIMUM Muffler... 700001, UNIVERSAL FIT MSL/MAXIMUM Muffler... 6539, 709019, Silentone DIY Muffler... 5534

(28010) 81-82 8 Cyl. F100 Series; 133" W.B.; 255 (4.2L) Engine; 2 W.D., 4 W.D.; 1/2 Ton; Regular Cab with Converter

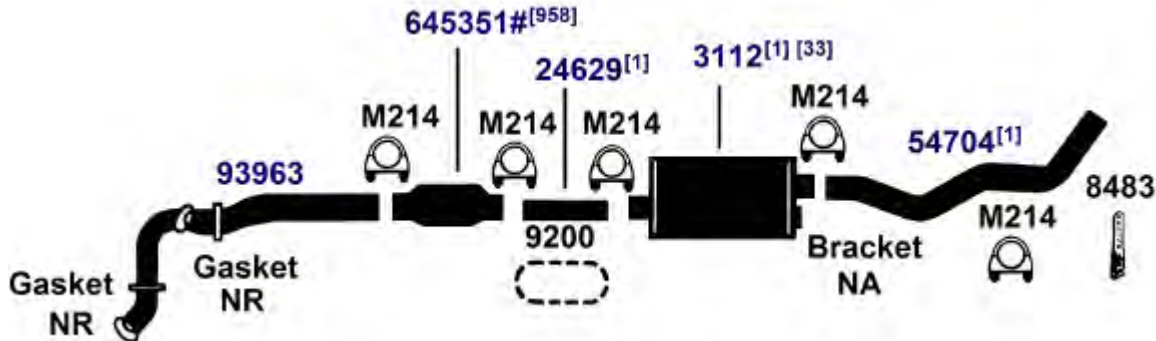

DIRECT FIT MSL/MAXIMUM Muffler... 700001, UNIVERSAL FIT MSL/MAXIMUM Muffler... 6539, 709019, Silentone DIY Muffler... 5534

NA-Not Available. NR-Not Required. FL-Remove and Re-Use Old Flange. ● Golden Warehouse. O.E.-Original Equipment.
Airtube Kit [4948] may be required to complete installation. EFI-Electronic Fuel Injection.

- [1] OE system was a welded assembly. It is recommended that all parts noted [1] should be replaced. [958] Federal & California Emission vehicles. Not legal for sale for vehicles licensed in California.
- [33] Remove and re-use O.E. heat shield.

FORD F100/150 SERIES PICKUP

81-82 8 Cyl. F100 Series; 116" W.B.; 255 (4.2L) Engine; 2 W.D., 4 W.D.; 1/2 Ton; Regular Cab with Converter **(28011)**

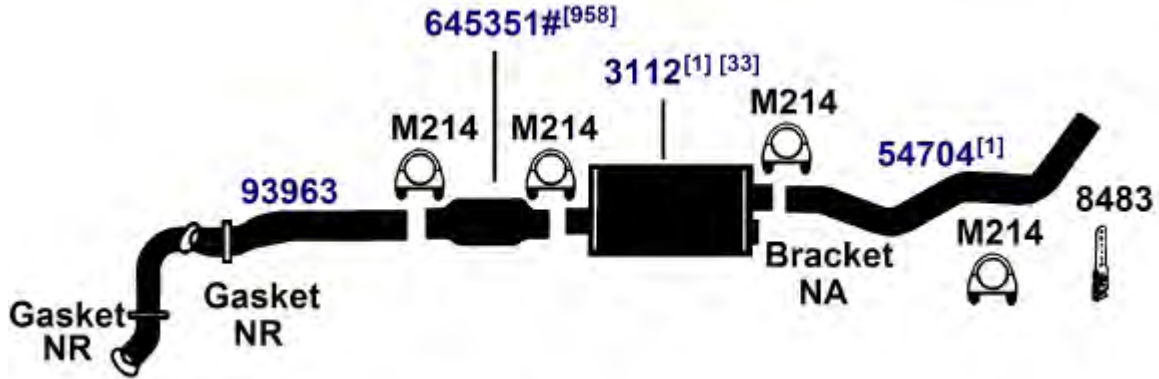

DIRECT FIT MSL/MAXIMUM Muffler... 700001, UNIVERSAL FIT MSL/MAXIMUM Muffler... 6539, 709019, Silentone DIY Muffler... 5534

80-82 6 Cyl. F100, F150 Series; 116" W.B.; 300 (4.9L) Engine; 2 W.D., 4 W.D.; 1/2 Ton; Regular Cab without Converter **(26841)**

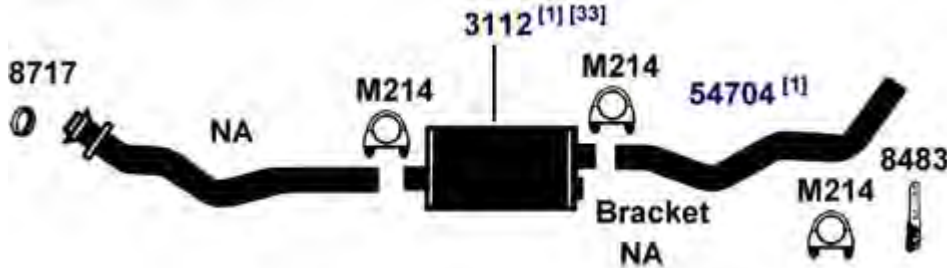

DIRECT FIT MSL/MAXIMUM Muffler... 700001, UNIVERSAL FIT MSL/MAXIMUM Muffler... 6539, 709019, Silentone DIY Muffler... 5534

80-82 6 Cyl. F100, F150 Series; 133" W.B.; 300 (4.9L) Engine; 2 W.D., 4 W.D.; 1/2 Ton; Regular Cab without Converter **(26840)**

80-82 6 Cyl. F100, F150 Series; 138" W.B.; 300 (4.9L) Engine; 2 W.D.; 1/2 Ton; Super Cab without Converter

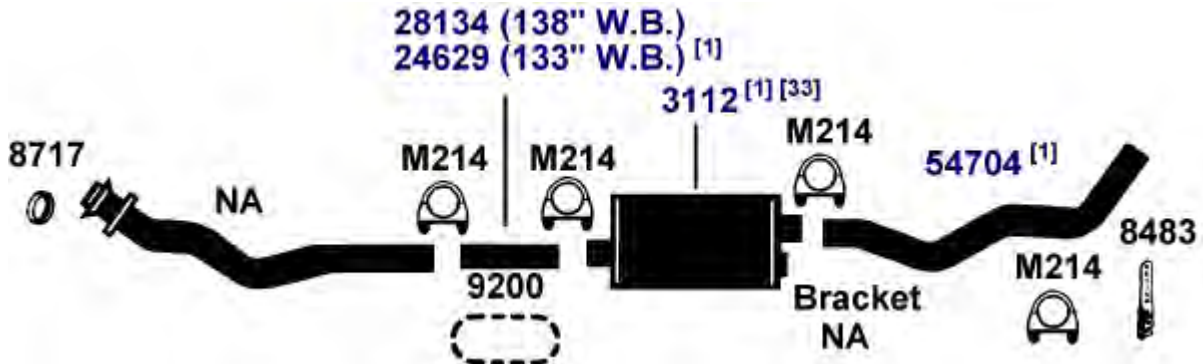

DIRECT FIT MSL/MAXIMUM Muffler... 700001, UNIVERSAL FIT MSL/MAXIMUM Muffler... 6539, 709019, Silentone DIY Muffler... 5534

NA-Not Available. NR-Not Required. FL-Remove and Re-Use Old Flange. • Golden Warehouse. O.E.-Original Equipment.
Airtube Kit [4948] may be required to complete installation. EFI-Electronic Fuel Injection.

[1] OE system was a welded assembly. It is recommended that all parts noted [1] should be replaced. [958] Federal & California Emission vehicles. Not legal for sale for vehicles licensed in California.
[33] Remove and re-use O.E. heat shield.

FORD F100/150 SERIES PICKUP

(26845) 80-82 6 Cyl. F100 Series; 116" W.B.; 300 (4.9L) Engine; 2 W.D., 4 W.D.; 1/2 Ton; Regular Cab with Converter

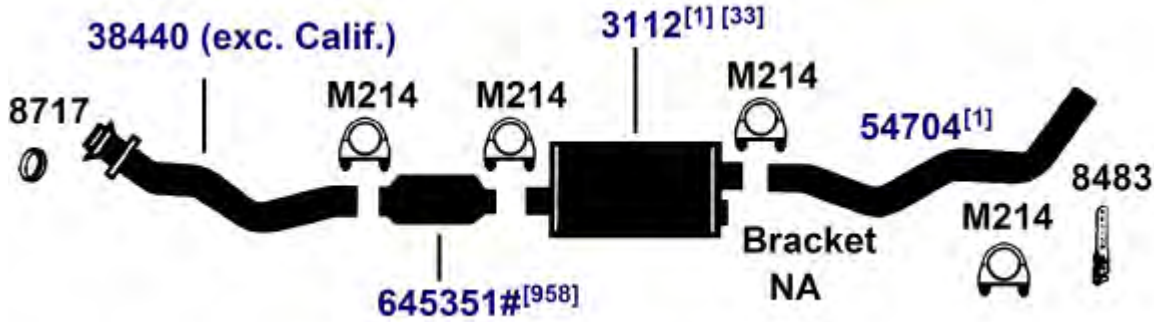

DIRECT FIT MSL/MAXIMUM Muffler... 700001, UNIVERSAL FIT MSL/MAXIMUM Muffler... 6539, 709019, Silentone DIY Muffler... 5534

(26844) 80-82 6 Cyl. F100, F150 Series; 138" W.B.; 300 (4.9L) Engine; 2 W.D.; 1/2 Ton; Super Cab with Converter
 80-82 6 Cyl. F100, F150 Series; 133" W.B.; 300 (4.9L) Engine; 2 W.D., 4 W.D.; 1/2 Ton; Regular Cab with Converter

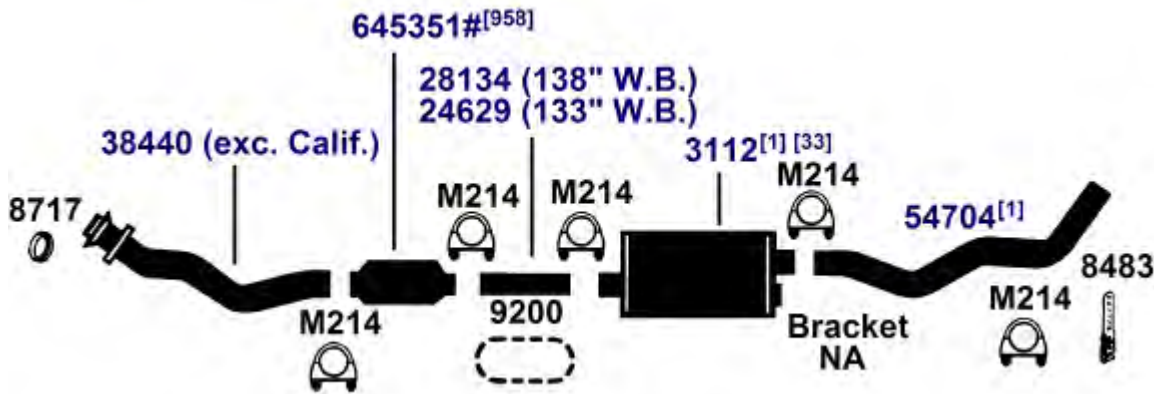

DIRECT FIT MSL/MAXIMUM Muffler... 700001, UNIVERSAL FIT MSL/MAXIMUM Muffler... 6539, 709019, Silentone DIY Muffler... 5534

(26842) 80-82 6 Cyl. F100, F150 Series; 155" W.B.; 300 (4.9L) Engine; 2 W.D., 4 W.D.; 1/2 Ton; Super Cab with Converter

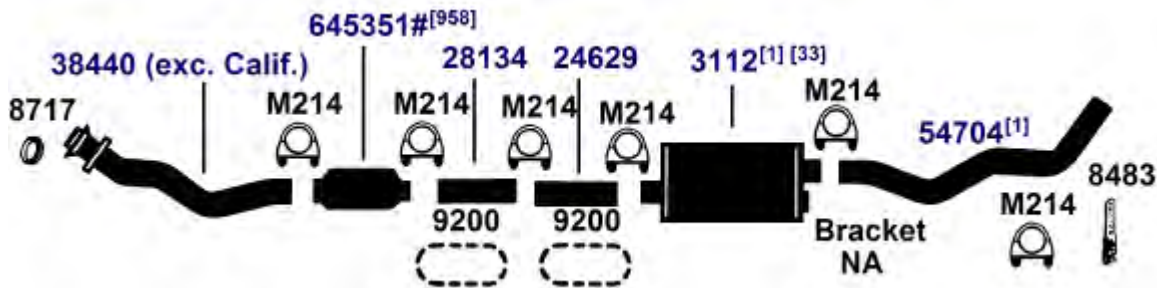

DIRECT FIT MSL/MAXIMUM Muffler... 700001, UNIVERSAL FIT MSL/MAXIMUM Muffler... 6539, 709019, Silentone DIY Muffler... 5534

NA-Not Available. NR-Not Required. FL-Remove and Re-Use Old Flange. ● Golden Warehouse. O.E.-Original Equipment.
 # Airtube Kit [4948] may be required to complete installation. EFI-Electronic Fuel Injection.

- [1] OE system was a welded assembly. It is recommended that all parts noted [1] should be replaced. [958] Federal & California Emission vehicles. Not legal for sale for vehicles licensed in California.
 [33] Remove and re-use O.E. heat shield.

FORD F100/150 SERIES PICKUP

80-82 6 Cyl. F100, F150 Series; 155" W.B.; 300 (4.9L) Engine; 2 W.D., 4 W.D.; 1/2 Ton; **(26838)**
 Super Cab without Converter

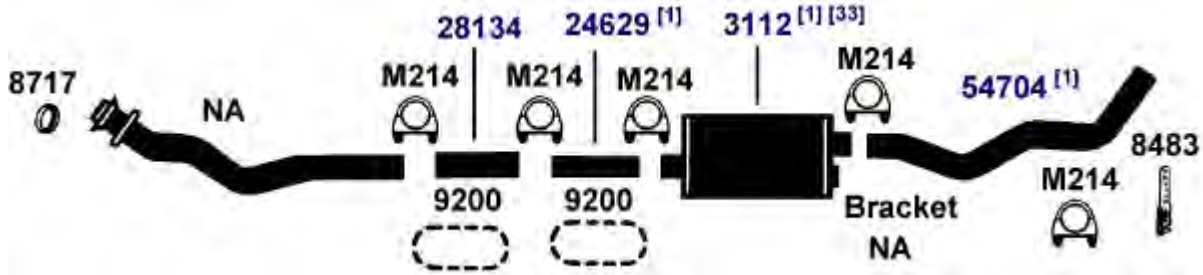

DIRECT FIT MSL/MAXIMUM Muffler... 700001, UNIVERSAL FIT MSL/MAXIMUM Muffler... 6539, 709019, Silentone DIY Muffler... 5534

80-82 8 Cyl. F100, F150 Series; 116" W.B.; 302, 351, 400 (5.0L, 5.8L, 6.6L) Engine; 2 W.D., **(28008)**
 4 W.D.; 1/2 Ton; Regular Cab with Converter

- 645351# (80-82 F100, 5.0L, Federal Emissions)^[959]**
- 645351# (80-82 F150, 5.0L)^[958]**
- 645351# (1981 F100, 5.8L)^[958]**
- 645351# (80-81 F150, 5.8L)^[958]**

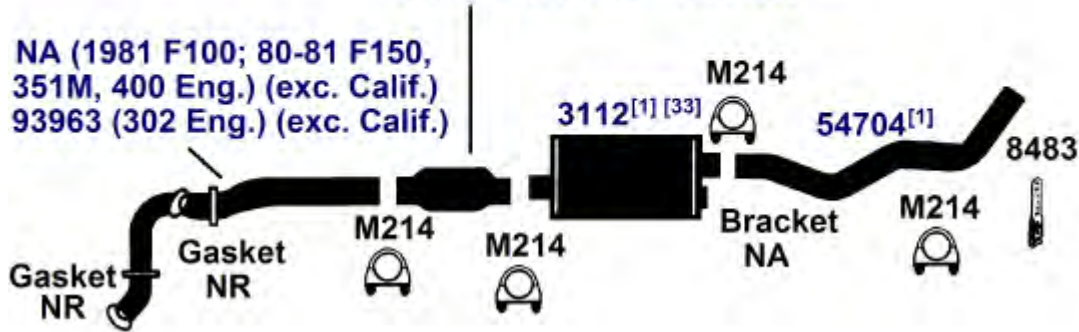

DIRECT FIT MSL/MAXIMUM Muffler... 700001, UNIVERSAL FIT MSL/MAXIMUM Muffler... 6539, 709019, Silentone DIY Muffler... 5534

NA-Not Available. NR-Not Required. FL-Remove and Re-Use Old Flange. ● Golden Warehouse. O.E.-Original Equipment.
 # Airtube Kit [4948] may be required to complete installation. EFI-Electronic Fuel Injection.

[1] OE system was a welded assembly. It is recommended that all parts noted [1] should be replaced. [958] Federal & California Emission vehicles. Not legal for sale for vehicles licensed in California.
 [33] Remove and re-use O.E. heat shield. [959] Federal Emission vehicles. Not legal for sale for vehicles licensed in California.

FORD F100/150 SERIES PICKUP

(28009) 80-82 8 Cyl. F100, F150 Series; 116" W.B.; 302, 351, 400 (5.0L, 5.8L, 6.6L) Engine; 2 W.D., 4 W.D.; 1/2 Ton; Regular Cab without Converter

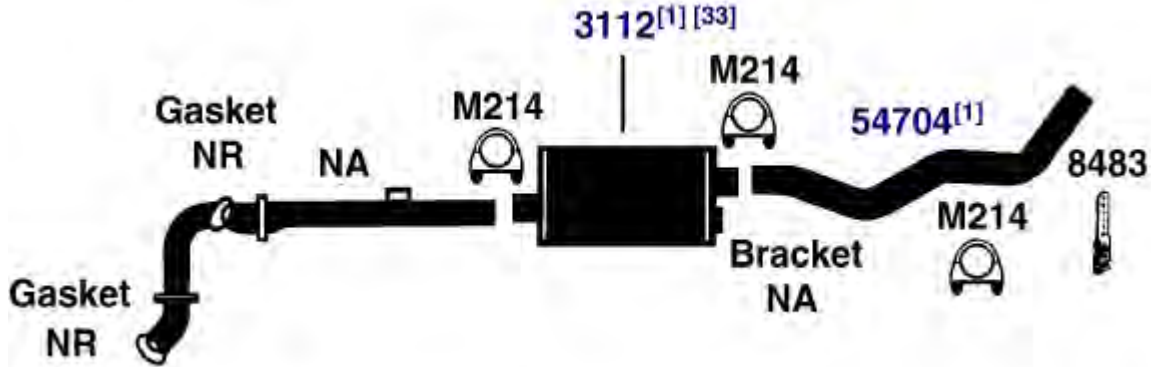

DIRECT FIT MSL/MAXIMUM Muffler... 700001, UNIVERSAL FIT MSL/MAXIMUM Muffler... 6539, 709019, Silentone DIY Muffler... 5534

(28002) 80-82 8 Cyl. F100, F150 Series; 155" W.B.; 302, 351, 400 (5.0L, 5.8L, 6.6L) Engine; 2 W.D., 4 W.D.; 1/2 Ton; Super Cab with Converter

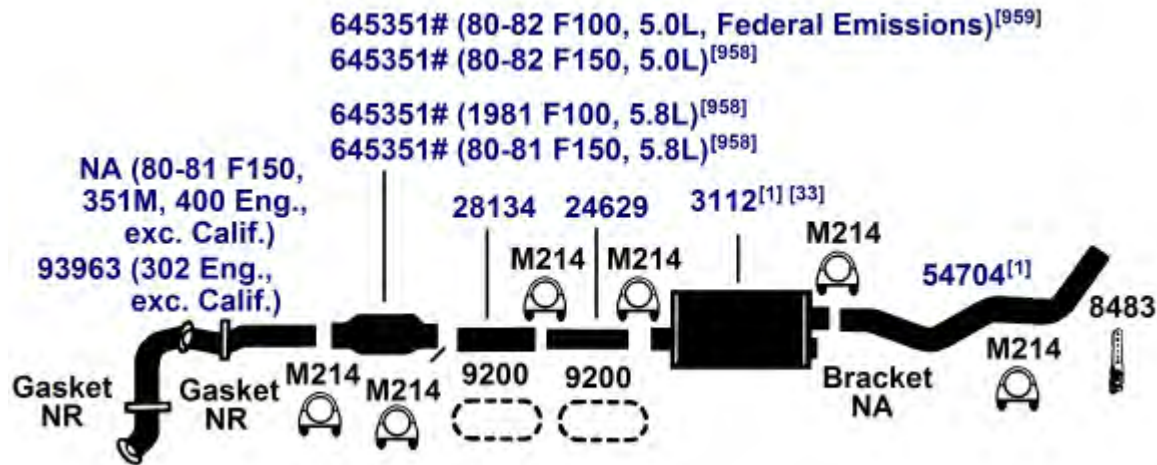

DIRECT FIT MSL/MAXIMUM Muffler... 700001, UNIVERSAL FIT MSL/MAXIMUM Muffler... 6539, 709019, Silentone DIY Muffler... 5534

NA-Not Available. NR-Not Required. FL-Remove and Re-Use Old Flange. ● Golden Warehouse. O.E.-Original Equipment.
Airtube Kit [4948] may be required to complete installation. EFI-Electronic Fuel Injection.

[1] OE system was a welded assembly. It is recommended that all parts noted [1] should be replaced.

[958] Federal & California Emission vehicles. Not legal for sale for vehicles licensed in California.

[33] Remove and re-use O.E. heat shield.

[959] Federal Emission vehicles. Not legal for sale for vehicles licensed in California.

FORD F100/150 SERIES PICKUP

80-82 8 Cyl. F100, F150 Series; 133" W.B.; 302, 351, 400 (5.0L, 5.8L, 6.6L) Engine; 2 W.D., **(28007)**
4 W.D.; 1/2 Ton; Regular Cab without Converter

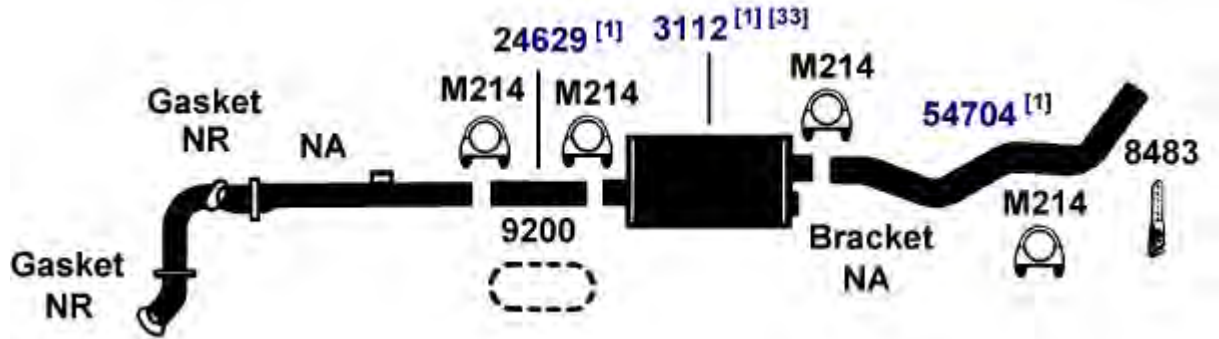

DIRECT FIT MSL/MAXIMUM Muffler... 700001, UNIVERSAL FIT MSL/MAXIMUM Muffler... 6539, 709019, Silentone DIY Muffler... 5534

80-82 8 Cyl. F100, F150 Series; 138" W.B.; 302, 351, 400 (5.0L, 5.8L, 6.6L) Engine; 2 W.D.; **(28004)**
1/2 Ton; Super Cab with Converter

645351# (80-82 F100, 5.0L, Federal Emissions)^[959]
645351# (80-82 F150, 5.0L)^[958]
645351# (1981 F100, 5.8L)^[958]
645351# (80-81 F150, 5.8L)^[958]

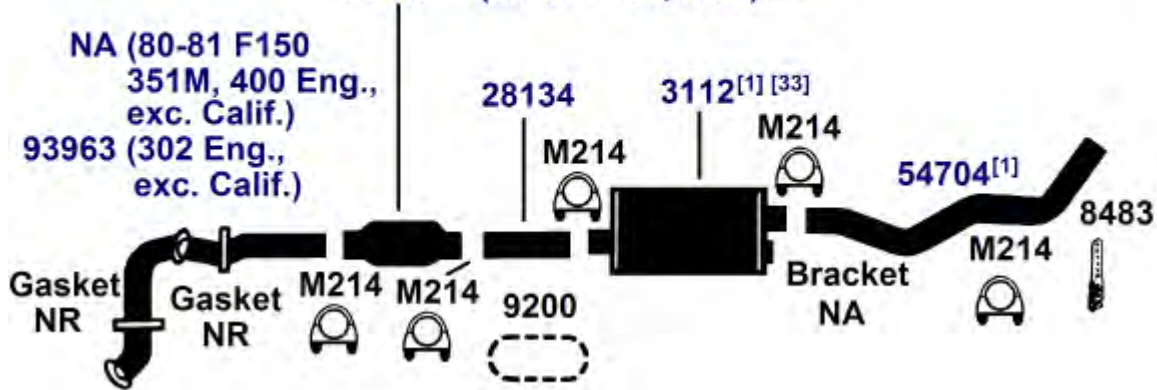

DIRECT FIT MSL/MAXIMUM Muffler... 700001, UNIVERSAL FIT MSL/MAXIMUM Muffler... 6539, 709019, Silentone DIY Muffler... 5534

NA-Not Available. NR-Not Required. FL-Remove and Re-Use Old Flange. ● Golden Warehouse. O.E.-Original Equipment.
Airtube Kit [4948] may be required to complete installation. EFI-Electronic Fuel Injection.

- [1] OE system was a welded assembly. It is recommended that all parts noted [1] should be replaced.
- [33] Remove and re-use O.E. heat shield.
- [958] Federal & California Emission vehicles. Not legal for sale for vehicles licensed in California.
- [959] Federal Emission vehicles. Not legal for sale for vehicles licensed in California.

FORD F100/150 SERIES PICKUP

(28003) 80-82 8 Cyl. F100, F150 Series; 155" W.B.; 302, 351, 400 (5.0L, 5.8L, 6.6L) Engine; 2 W.D., 4 W.D.; 1/2 Ton; Super Cab without Converter

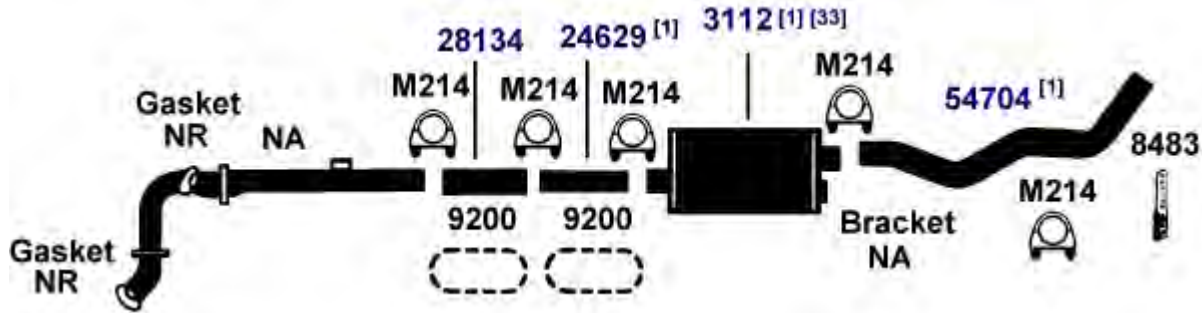

DIRECT FIT MSL/MAXIMUM Muffler... 700001, UNIVERSAL FIT MSL/MAXIMUM Muffler... 6539, 709019, Silentone DIY Muffler... 5534

(28005) 80-82 8 Cyl. F100, F150 Series; 138" W.B.; 302, 351, 400 (5.0L, 5.8L, 6.6L) Engine; 2 W.D.; 1/2 Ton; Super Cab without Converter

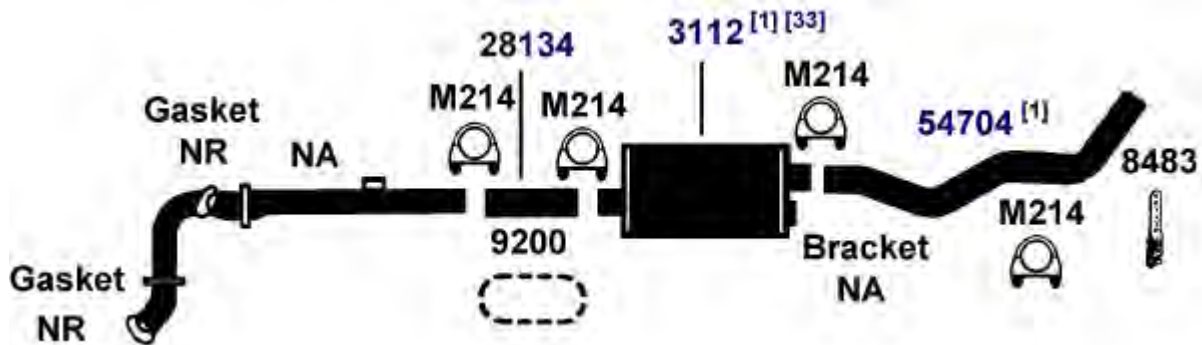

DIRECT FIT MSL/MAXIMUM Muffler... 700001, UNIVERSAL FIT MSL/MAXIMUM Muffler... 6539, 709019, Silentone DIY Muffler... 5534

(28006) 80-82 8 Cyl. F100, F150 Series; 133" W.B.; 302, 351, 400 (5.0L, 5.8L, 6.6L) Engine; 2 W.D., 4 W.D.; 1/2 Ton; Regular Cab with Converter

645351# (80-82 F100, 5.0L, Federal Emissions)^[959]
645351# (80-82 F150, 5.0L)^[958]
645351# (1981 F100, 5.8L)^[958]
645351# (80-81 F150, 5.8L)^[958]

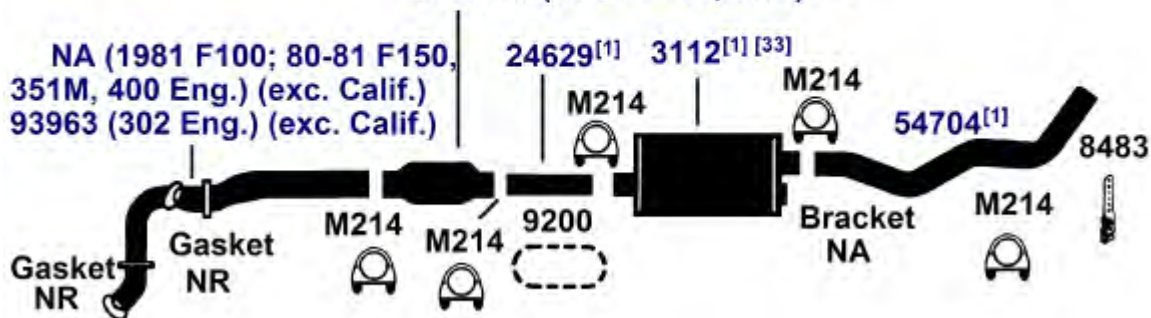

DIRECT FIT MSL/MAXIMUM Muffler... 700001, UNIVERSAL FIT MSL/MAXIMUM Muffler... 6539, 709019, Silentone DIY Muffler... 5534

NA-Not Available. NR-Not Required. FL-Remove and Re-Use Old Flange. ● Golden Warehouse. O.E.-Original Equipment.
 # Airtube Kit [4948] may be required to complete installation. EFI-Electronic Fuel Injection.

[1] OE system was a welded assembly. It is recommended that all parts noted [1] should be replaced.

[958] Federal & California Emission vehicles. Not legal for sale for vehicles licensed in California.

[33] Remove and re-use O.E. heat shield.

[959] Federal Emission vehicles. Not legal for sale for vehicles licensed in California.

FORD F100/150 SERIES PICKUP

1979 6 Cyl. F100, F150 Series; 155" W.B.; 300 (4.9L) Engine; 2 W.D.; 1/2 Ton; Super Cab with Converter **(26831)**

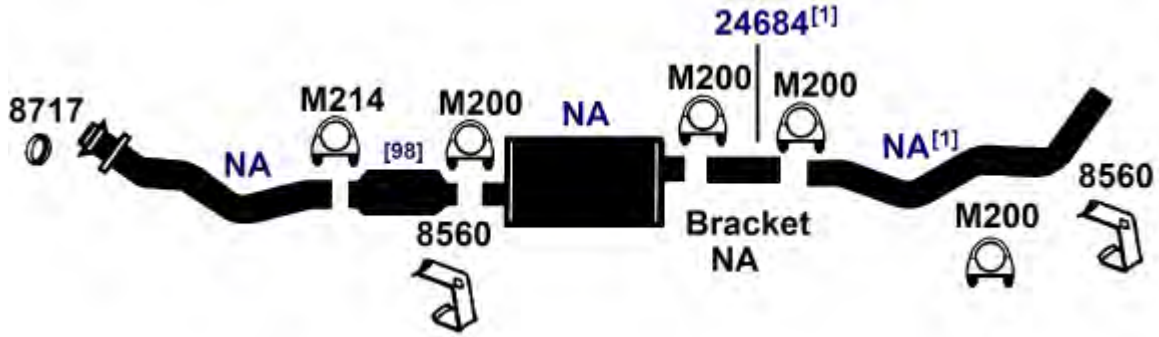

DIRECT FIT MSL/MAXIMUM Muffler... 6511

1979 6 Cyl. F150 Series; 155" W.B.; 300 (4.9L) Engine; 2 W.D.; 1/2 Ton; Super Cab without Converter **(26830)**

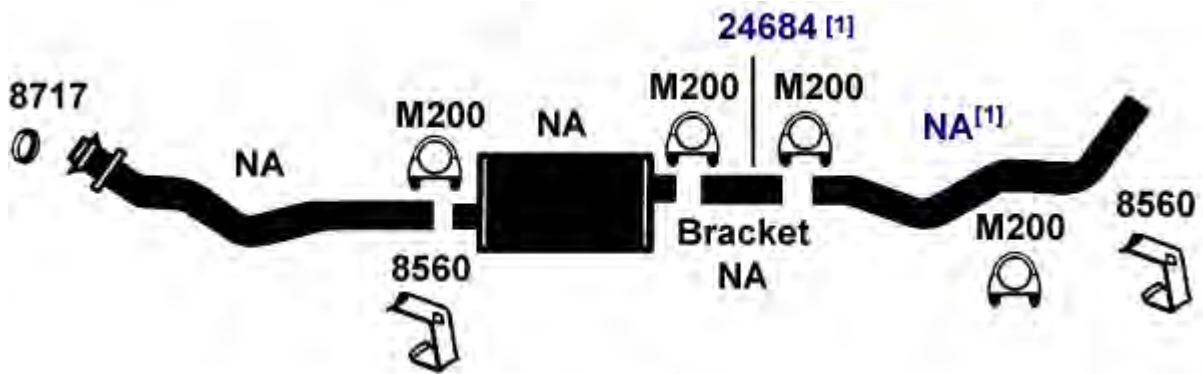

DIRECT FIT MSL/MAXIMUM Muffler... 6511

1979 8 Cyl. F150 Series; 351, 400 Engine; 4 W.D.; 1/2 Ton; Super Cab; with Converter **(27973)**

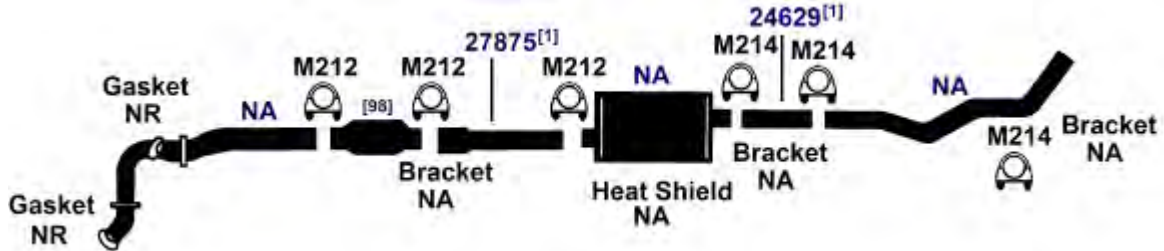

UNIVERSAL FIT MSL/MAXIMUM Muffler... 6539, 709019

NA-Not Available. NR-Not Required. FL-Remove and Re-Use Old Flange. ● Golden Warehouse. O.E.-Original Equipment.
Airtube Kit [4948] may be required to complete installation. EFI-Electronic Fuel Injection.

[1] OE system was a welded assembly. It is recommended that all parts noted [1] [98] Refer to current Catalytic Converter catalog or Website catalog for availability. should be replaced.

FORD F100/150 SERIES PICKUP

(27987) 1979 8 Cyl. F100, F150 Series; 155" W.B.; 351, 400 Engine; 2 W.D.; 1/2 Ton; Super Cab without Converter

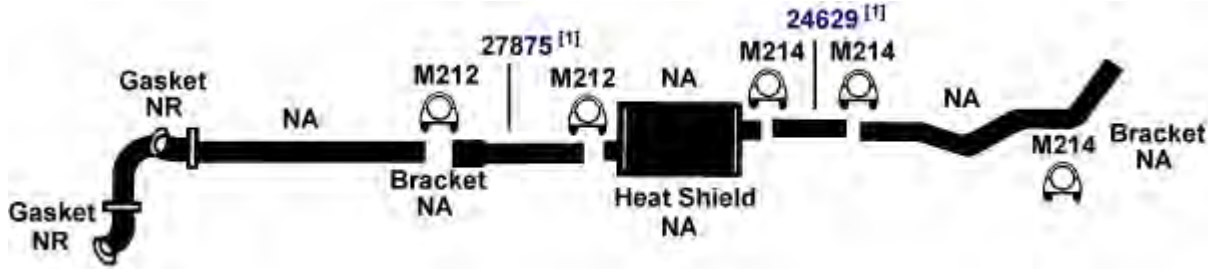

UNIVERSAL FIT MSL/MAXIMUM Muffler... 6539, 709019

(27980) 1979 8 Cyl. F150 Series; 155" W.B.; 302 Engine; 2 W.D.; 1/2 Ton; Super Cab with Converter

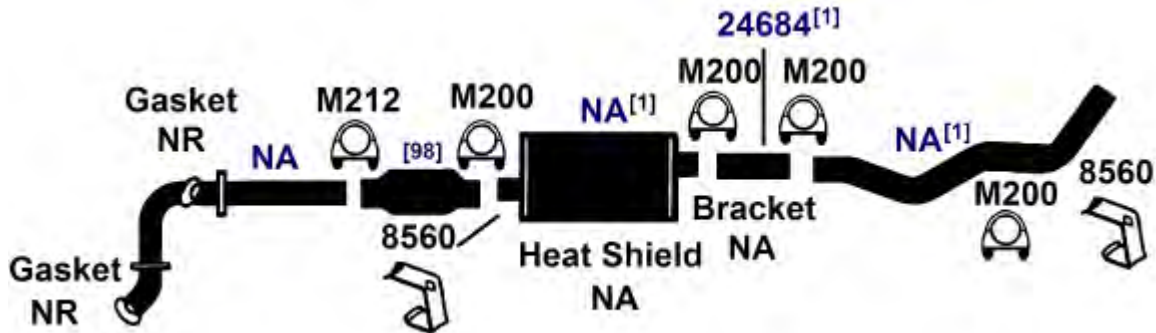

DIRECT FIT MSL/MAXIMUM Muffler... 6511

FORD F250 SERIES PICKUP

(28188) 1994 8 Cyl. F250 Series; 133", 155" W.B. Super Cab; 7.3L Diesel Engine; except Turbo
 88-93 8 Cyl. F250 Series; 133", 155" W.B. Super Cab; 7.3L Diesel Engine
 1987 8 Cyl. F250 Series; 133", 155" W.B. Super Cab; 6.9L Diesel Engine

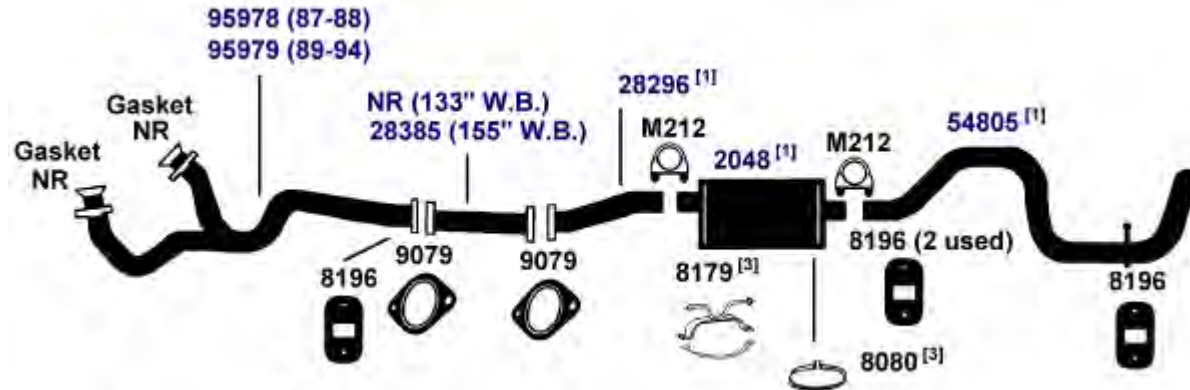

DIRECT FIT MSL/MAXIMUM Muffler... 700046

NA-Not Available. NR-Not Required. FL-Remove and Re-Use Old Flange. ● Golden Warehouse. O.E.-Original Equipment.
 # Airtube Kit [4948] may be required to complete installation. EFI-Electronic Fuel Injection.

- [1] OE system was a welded assembly. It is recommended that all parts noted [1] should be replaced. [98] Refer to current Catalytic Converter catalog or Website catalog for availability.
 [3] Required for installation.

FORD F250 SERIES PICKUP

88-94 8 Cyl. F250 Series; 133", 155" W.B. Super Cab; 5.8L, 7.5L Engine; over 8500 lbs. **(28194)**
 G.V.W.; except 93-97 7.5L with Round Muffler

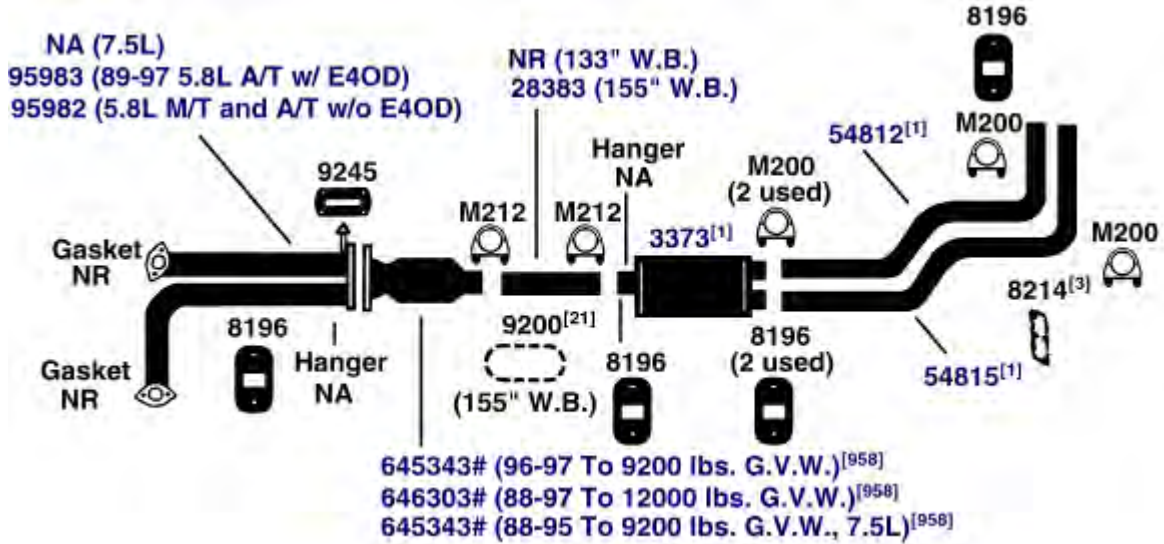

DIRECT FIT MSL/MAXIMUM Muffler... 700270

87-94 6 Cyl. F250; 133" W.B.; 4.9L Engine **(27040)**

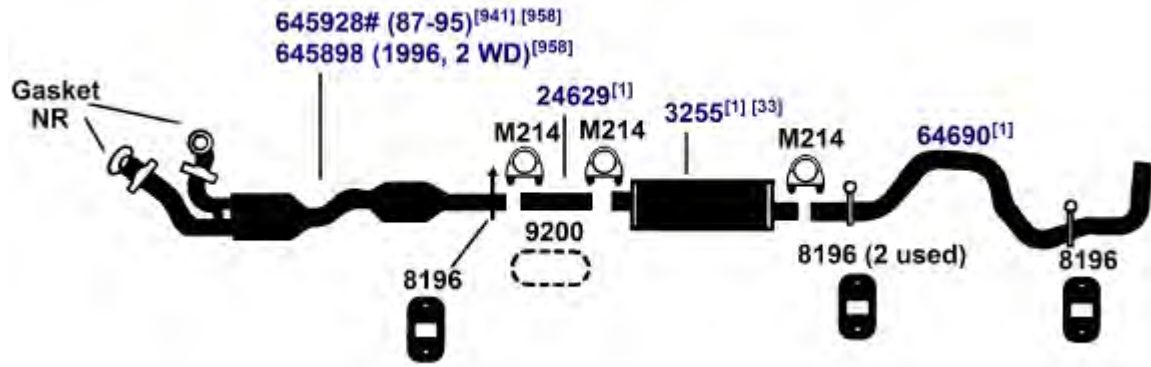

DIRECT FIT MSL/MAXIMUM Muffler... 6592, UNIVERSAL FIT MSL/MAXIMUM Muffler... 6571, 709019, Silentone DIY Muffler... 5557

NA-Not Available. NR-Not Required. FL-Remove and Re-Use Old Flange. ● Golden Warehouse. O.E.-Original Equipment.
 # Airtube Kit [4948] may be required to complete installation. EFI-Electronic Fuel Injection.

- [1] OE system was a welded assembly. It is recommended that all parts noted [1] should be replaced.
- [3] Required for installation.
- [21] Must use modified design (label will read 9200*)
- [33] Remove and re-use O.E. heat shield.
- [98] Refer to current Catalytic Converter catalog or Website catalog for availability.
- [941] Replaces both front and rear converters, Only failed converters may be replaced.
- [958] Federal & California Emission vehicles. Not legal for sale for vehicles licensed in California.

FORD F250 SERIES PICKUP

(27039) 87-94 6 Cyl. F250; 155" W.B.; 4.9L Engine

645928# (87-95)^[941] ^[958]
645898 (1996, 2 WD)^[958]

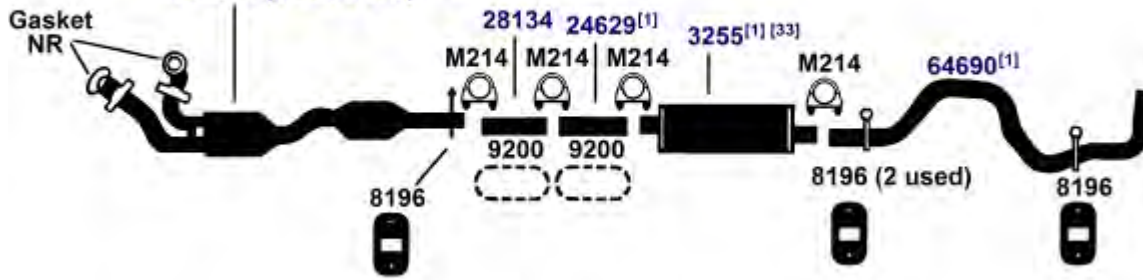

DIRECT FIT MSL/MAXIMUM Muffler... 6592, UNIVERSAL FIT MSL/MAXIMUM Muffler... 6571, 709019, Silentone DIY Muffler... 5557

(28178) 1994 8 Cyl. F250 Series; 133"; 5.8L Engine; (To 8500 lbs. G.V.W.)
87-94 8 Cyl. F250 Series; 133" W.B.; 5.0L Engine

645933# (94-95 5.8L Light Duty Exhaust)^[C1] ^[958]
645911# (87-95 5.0L)^[C1] ^[958]
645923# (1996 5.0L)^[C1] ^[958]

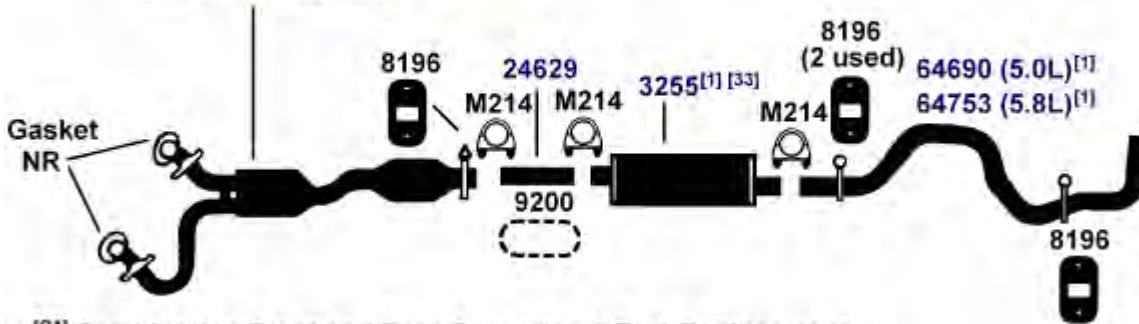

^[C1] Combination Front and Rear Converter, 2 To 1 Replacement.
Only Defective Converters May Legally Be Replaced.

DIRECT FIT MSL/MAXIMUM Muffler... 6592, UNIVERSAL FIT MSL/MAXIMUM Muffler... 6571, 709019, Silentone DIY Muffler... 5557

(100571) 1994 8 Cyl. F250 Series; 133", 155" W.B.; 7.3L Turbo Diesel Engine; 3/4 Ton; (over 8500 lbs. G.V.W.); without Converter

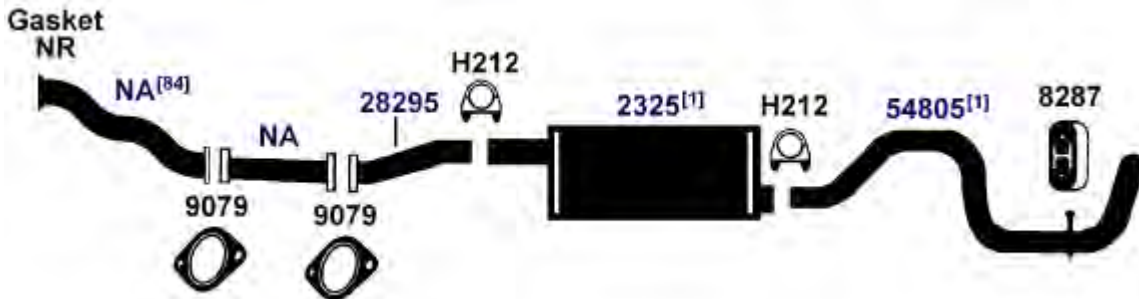

NA-Not Available. NR-Not Required. FL-Remove and Re-Use Old Flange. ● Golden Warehouse. O.E.-Original Equipment.
Airtube Kit [4948] may be required to complete installation. EFI-Electronic Fuel Injection.

[1] OE system was a welded assembly. It is recommended that all parts noted [1] should be replaced.

[33] Remove and re-use O.E. heat shield.

[84] Remove and re-use original clamp.

[98] Refer to current Catalytic Converter catalog or Website catalog for availability.
[941] Replaces both front and rear converters, Only failed converters may be replaced.

[958] Federal & California Emission vehicles. Not legal for sale for vehicles licensed in California.

FORD F250 SERIES PICKUP

87-93 8 Cyl. F250 Series; 133" W.B.; 5.8L Engine

(28191)

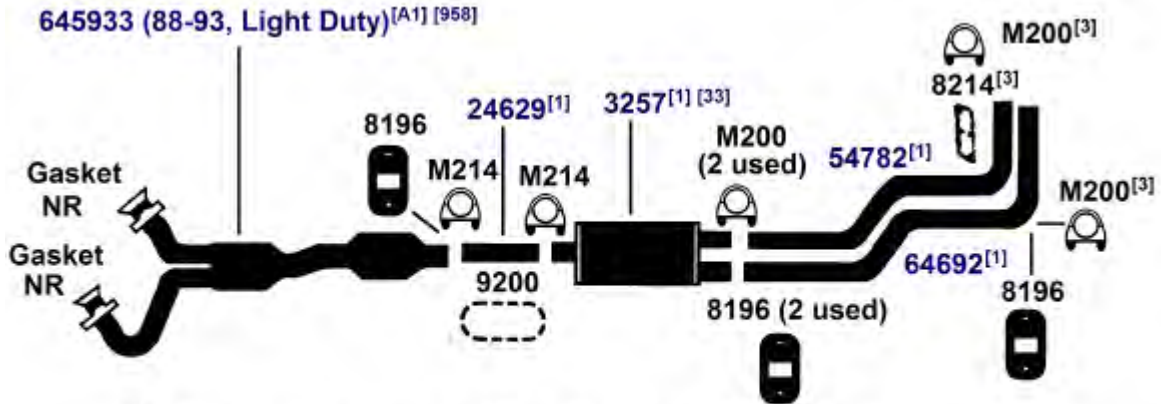

[A1] Combination Front and Rear Converter, 2 To 1 Replacement. Only Defective Converters May Legally Be Replaced.

DIRECT FIT MSL/MAXIMUM Muffler... 700099, UNIVERSAL FIT MSL/MAXIMUM Muffler... 6585

87-93 8 Cyl. F250 Series; 155" W.B.; 5.8L Engine; (To 8500 lbs. G.V.W.)

(28190)

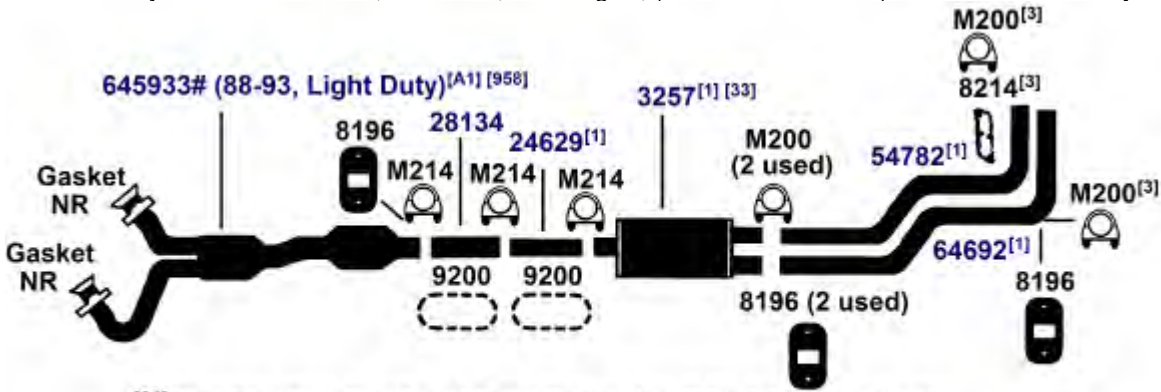

[A1] Combination Front and Rear Converter, 2 To 1 Replacement. Only Defective Converters May Legally Be Replaced.

DIRECT FIT MSL/MAXIMUM Muffler... 700099, UNIVERSAL FIT MSL/MAXIMUM Muffler... 6585

NA-Not Available. NR-Not Required. FL-Remove and Re-Use Old Flange. ● Golden Warehouse. O.E.-Original Equipment.
Airtube Kit [4948] may be required to complete installation. EFI-Electronic Fuel Injection.

- [1] OE system was a welded assembly. It is recommended that all parts noted [1] should be replaced.
- [3] Required for installation.

- [33] Remove and re-use O.E. heat shield.
- [958] Federal & California Emission vehicles. Not legal for sale for vehicles licensed in California.

FORD F250 SERIES PICKUP

(100570) 1992 8 Cyl. F250 Series; 136", 160" W.B. Chassis Cab; 5.8L, 7.5L Engine

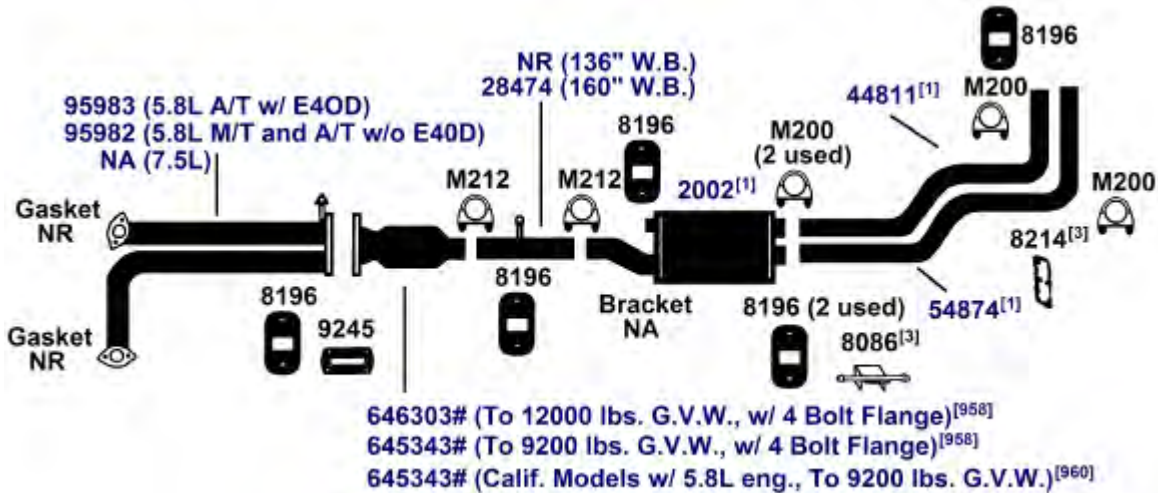

DIRECT FIT MSL/MAXIMUM Muffler... 700433

(28193) 1987 8 Cyl. F250 Series; 133" W.B.; 351 (5.8L) Engine; 2 W.D., 4 W.D.; 3/4 Ton; (over 8500 lbs. G.V.W.); with Converter

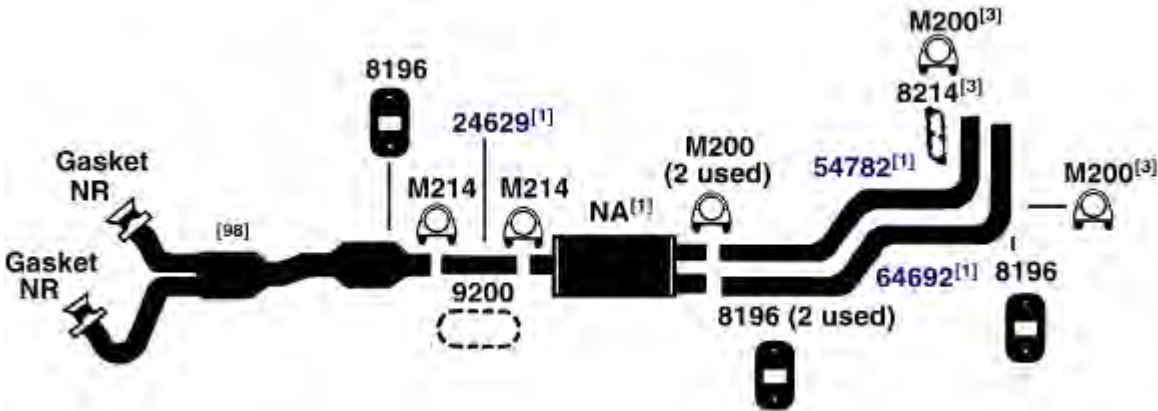

NA-Not Available. NR-Not Required. FL-Remove and Re-Use Old Flange. ● Golden Warehouse. O.E.-Original Equipment.
Airtube Kit [4948] may be required to complete installation. EFI-Electronic Fuel Injection.

- [1] OE system was a welded assembly. It is recommended that all parts noted [1] should be replaced.
[3] Required for installation.
[98] Refer to current Catalytic Converter catalog or Website catalog for availability.

- [958] Federal & California Emission vehicles. Not legal for sale for vehicles licensed in California.
[960] California Emission vehicles licensed in states other than California. Not legal for sale for vehicles licensed in California.

FORD F250 SERIES PICKUP

1987 8 Cyl. F250; 155" W.B.; 351(5.8L) Engine; 2 W.D., 4 W.D.; 3/4 Ton; (over 8500 lbs. G.V.W.); with Converter **(28192)**

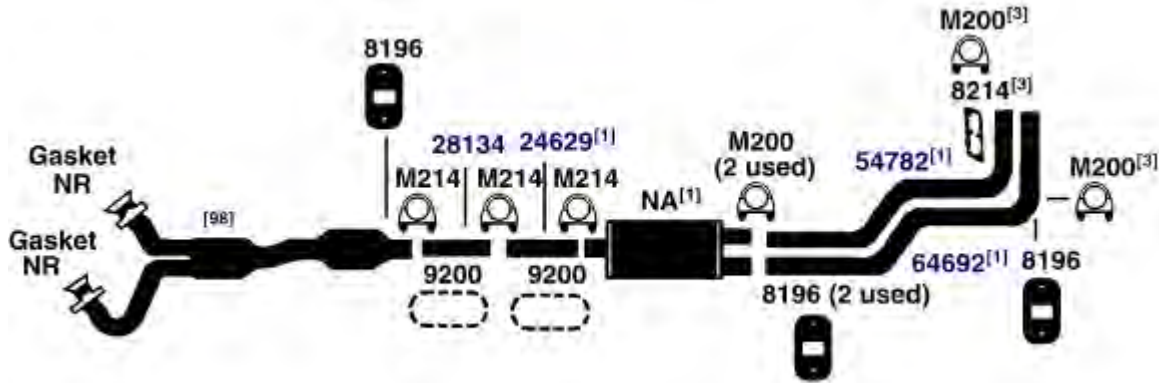

85-87 8 Cyl. F250 Series; 133", 155" W.B. Super Cab; 460 (7.5L) Engine; 2 W.D., 4 W.D.; 3/4 Ton; without Converter; except 1987 with EFI **(28186)**

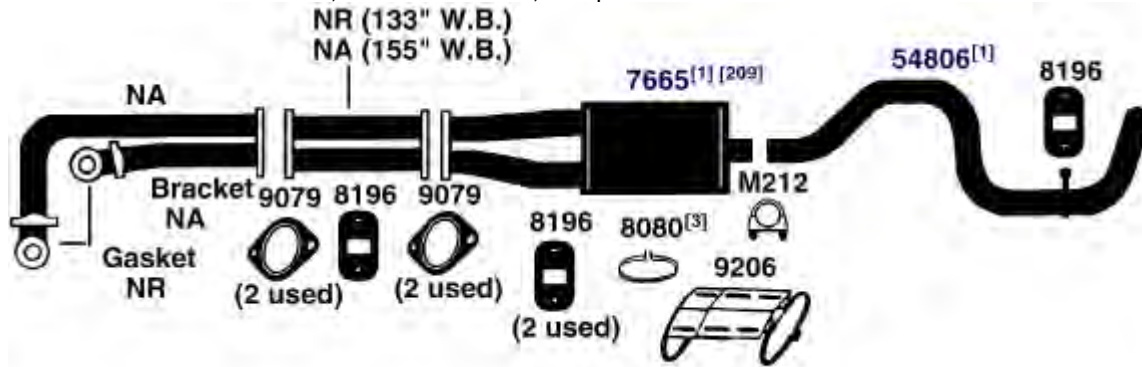

85-86 6 Cyl. F250 Series; 133" W.B.; 300 (4.9L) Engine; 2 W.D., 4 W.D.; 3/4 Ton; without Converter **(27038)**

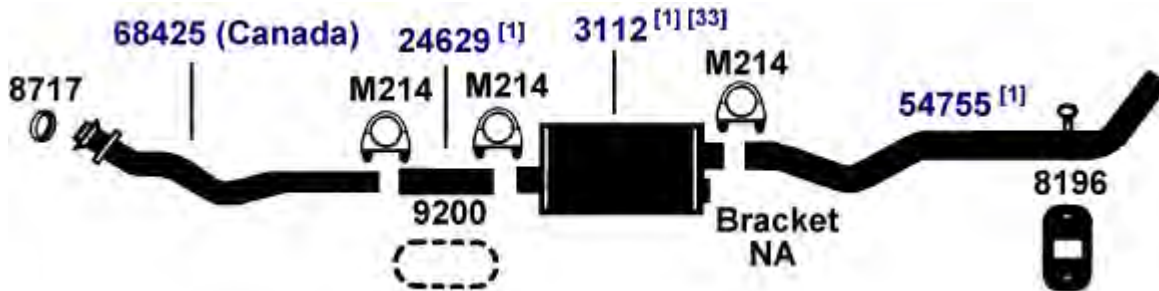

DIRECT FIT MSL/MAXIMUM Muffler... 700001, UNIVERSAL FIT MSL/MAXIMUM Muffler... 6539, 709019, Silentone DIY Muffler... 5534

NA-Not Available. NR-Not Required. FL-Remove and Re-Use Old Flange. ● Golden Warehouse. O.E.-Original Equipment.
Airtube Kit [4948] may be required to complete installation. EFI-Electronic Fuel Injection.

- [1] OE system was a welded assembly. It is recommended that all parts noted [1] should be replaced.
- [2] Refer to current Catalytic Converter catalog or Website catalog for availability.
- [3] Required for installation.
- [33] Remove and re-use O.E. heat shield.
- [98] Refer to current Catalytic Converter catalog or Website catalog for availability.
- [209] If muffler does not include heat shield, universal heat shield 9206 is required for installation.

FORD F250 SERIES PICKUP

(27035) 85-86 6 Cyl. F250 Series; 155" W.B.; Super Cab; 300 (4.9L) Engine; 2 W.D., 4 W.D.; 3/4 Ton; with Converter

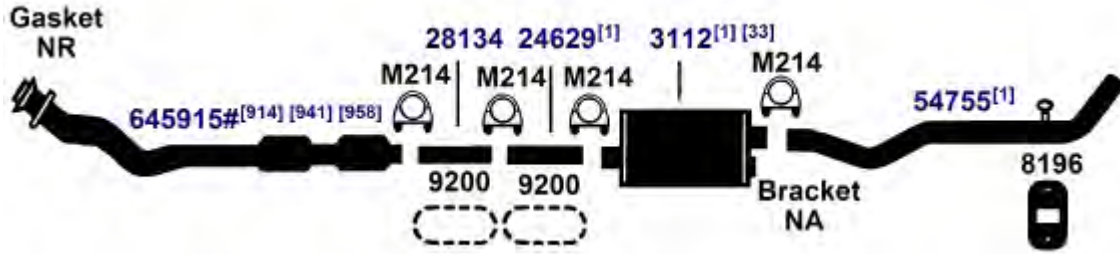

DIRECT FIT MSL/MAXIMUM Muffler... 700001, UNIVERSAL FIT MSL/MAXIMUM Muffler... 6539, 709019, Silentone DIY Muffler... 5534

(27036) 85-86 6 Cyl. F250 Series; 155" W.B.; Super Cab; 300 (4.9L) Engine; 2 W.D., 4 W.D.; 3/4 Ton; without Converter

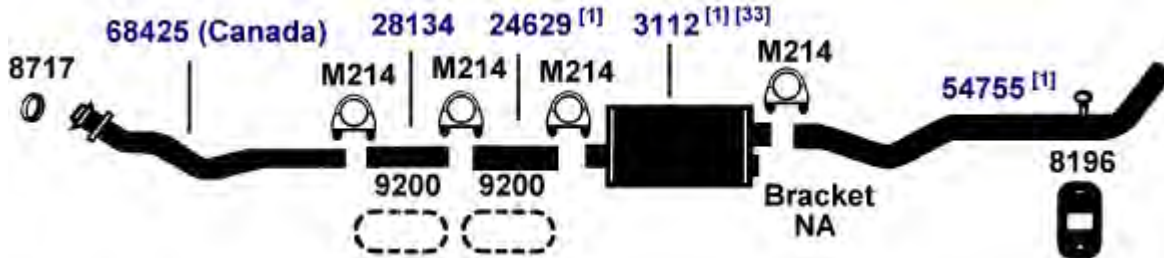

DIRECT FIT MSL/MAXIMUM Muffler... 700001, UNIVERSAL FIT MSL/MAXIMUM Muffler... 6539, 709019, Silentone DIY Muffler... 5534

(27037) 85-86 6 Cyl. F250 Series; 133" W.B.; 300 (4.9L) Engine; 2 W.D., 4 W.D.; 3/4 Ton; with Converter

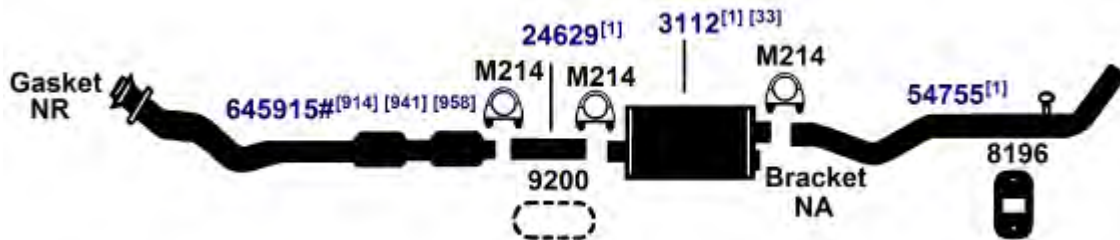

DIRECT FIT MSL/MAXIMUM Muffler... 700001, UNIVERSAL FIT MSL/MAXIMUM Muffler... 6539, 709019, Silentone DIY Muffler... 5534

NA-Not Available. NR-Not Required. FL-Remove and Re-Use Old Flange. ● Golden Warehouse. O.E.-Original Equipment.
Airtube Kit [4948] may be required to complete installation. EFI-Electronic Fuel Injection.

[1] OE system was a welded assembly. It is recommended that all parts noted [1] should be replaced.

[33] Remove and re-use O.E. heat shield.

[98] Refer to current Catalytic Converter catalog or Website catalog for availability.

[914] Direct fit converter includes front (Exhaust) pipe, (1) piece assembly.

[941] Replaces both front and rear converters. Only failed converters may be replaced.

[958] Federal & California Emission vehicles. Not legal for sale for vehicles licensed in California.

FORD F250 SERIES PICKUP

85-86 8 Cyl. F250 Series; 155" W.B.; Super Cab; 302, 351[38] 2-Barrel (5.0L, 5.8L) Engine; 2 (28169) W.D., 4 W.D.; 3/4 Ton; without Converter

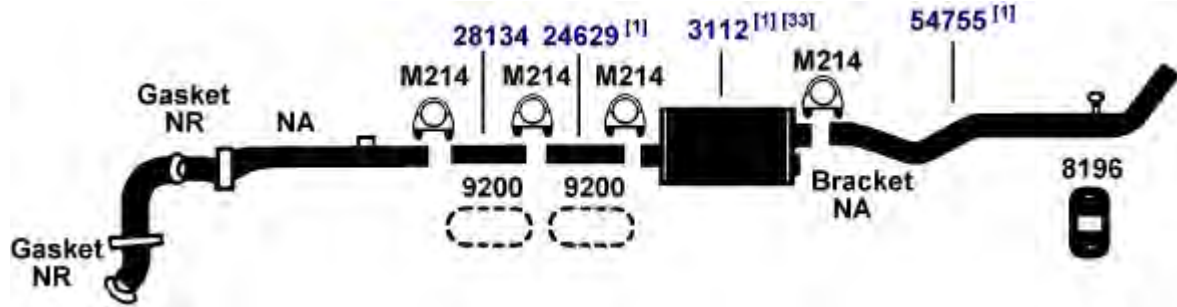

DIRECT FIT MSL/MAXIMUM Muffler... 700001, UNIVERSAL FIT MSL/MAXIMUM Muffler... 6539, 709019, Silentone DIY Muffler... 5534

85-86 8 Cyl. F250 Series; 133", 155" W.B. Super Cab; 6.9L Diesel Engine; From 2-85 (28184)

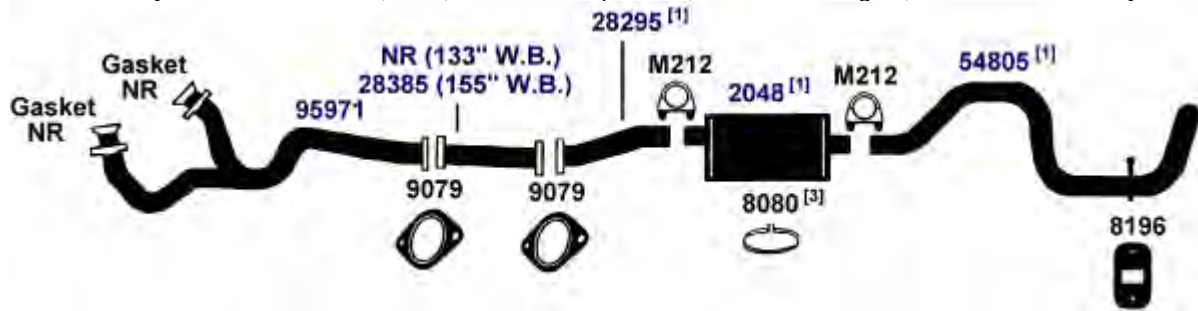

DIRECT FIT MSL/MAXIMUM Muffler... 700046

85-86 8 Cyl. F250 Series; 155" W.B.; Super Cab; 351 4-Barrel (5.8L) Engine; 2 W.D., 4 W.D.; (28174) 3/4 Ton; with Converter

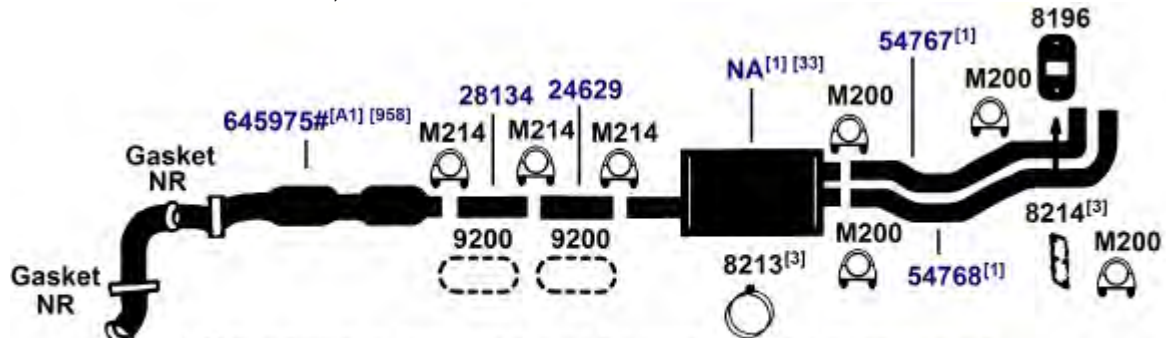

[A1] Combination Front and Rear Converter, 2 To 1 Replacement. Only Defective Converters May Legally Be Replaced.

DIRECT FIT MSL/MAXIMUM Muffler... 6585

NA-Not Available. NR-Not Required. FL-Remove and Re-Use Old Flange. ● Golden Warehouse. O.E.-Original Equipment.

Airtube Kit [4948] may be required to complete installation. EFI-Electronic Fuel Injection.

[1] OE system was a welded assembly. It is recommended that all parts noted [1] should be replaced.

[3] Required for installation.

[33] Remove and re-use O.E. heat shield.

[958] Federal & California Emission vehicles. Not legal for sale for vehicles licensed in California.

FORD F250 SERIES PICKUP

(28172) 85-86 8 Cyl. F250 Series; 155" W.B.; Super Cab; 302, 351[38] 2-Barrel (5.0L, 5.8L) Engine; 2 W.D., 4 W.D.; 3/4 Ton; with Converter; including EFI

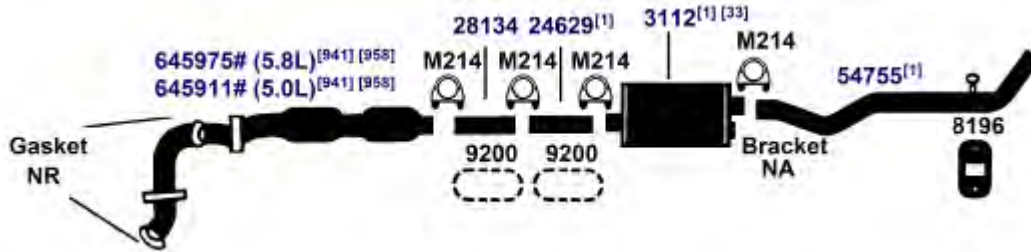

DIRECT FIT MSL/MAXIMUM Muffler... 700001, UNIVERSAL FIT MSL/MAXIMUM Muffler... 6539, 709019, Silentone DIY Muffler... 5534

(28170) 85-86 8 Cyl. F250 Series; 133" W.B.; 302, 351[38] 2-Barrel (5.0L, 5.8L) Engine; 2 W.D., 4 W.D.; 3/4 Ton; without Converter

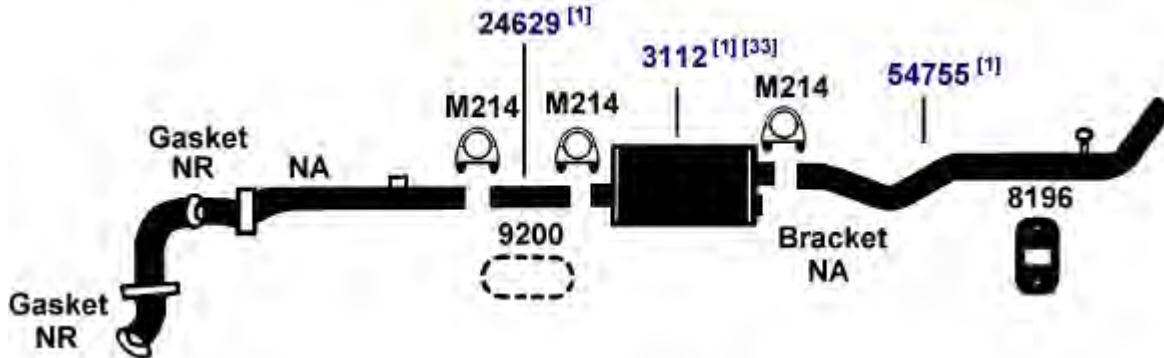

DIRECT FIT MSL/MAXIMUM Muffler... 700001, UNIVERSAL FIT MSL/MAXIMUM Muffler... 6539, 709019, Silentone DIY Muffler... 5534

(28176) 85-86 8 Cyl. F250 Series; 133" W.B.; 351 4-Barrel (5.8L) Engine; 2 W.D., 4 W.D.; 3/4 Ton; with Converter

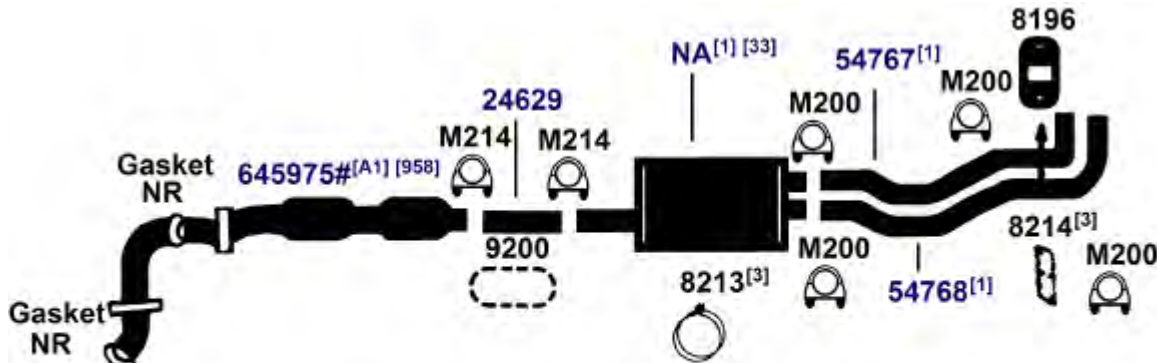

[A1] Combination Front and Rear Converter, 2 To 1 Replacement. Only Defective Converters May Legally Be Replaced.

DIRECT FIT MSL/MAXIMUM Muffler... 6585

NA-Not Available. NR-Not Required. FL-Remove and Re-Use Old Flange. ● Golden Warehouse. O.E.-Original Equipment.
Airtube Kit [4948] may be required to complete installation. EFI-Electronic Fuel Injection.

[1] OE system was a welded assembly. It is recommended that all parts noted [1] should be replaced.

[3] Required for installation.

[33] Remove and re-use O.E. heat shield.

[941] Replaces both front and rear converters, Only failed converters may be replaced.

[958] Federal & California Emission vehicles. Not legal for sale for vehicles licensed in California.

FORD F250 SERIES PICKUP

85-86 8 Cyl. F250 Series; 155" W.B. Super Cab; 351 4-Barrel (5.8L) Engine; 2 W.D., 4 W.D.; (28175)
3/4 Ton; without Converter

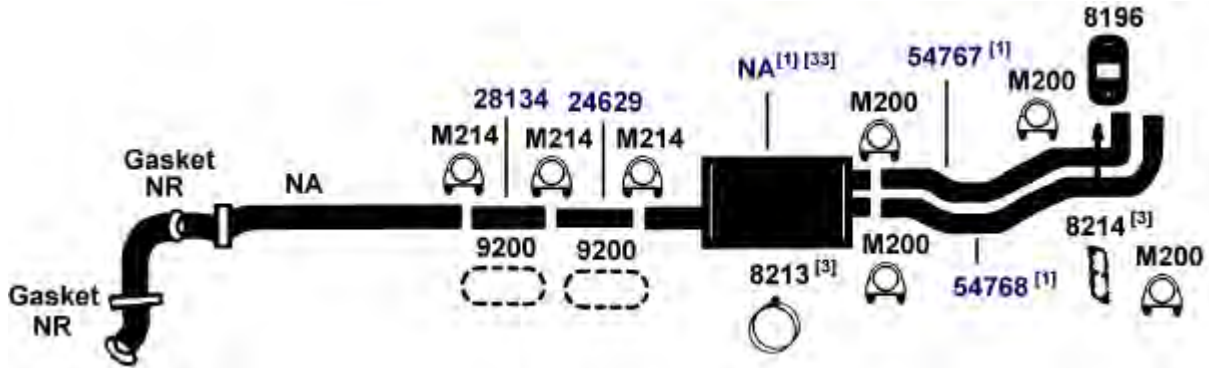

DIRECT FIT MSL/MAXIMUM Muffler... 6585

85-86 8 Cyl. F250 Series; 133" W.B.; 302, 351 [38] 2-Barrel (5.0L, 5.8L) Engine; 2 W.D., 4 W.D.; 3/4 Ton; with Converter; including EFI (28173)

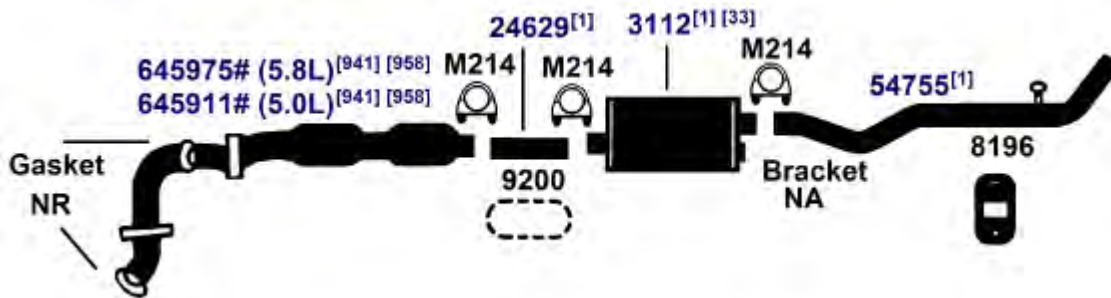

DIRECT FIT MSL/MAXIMUM Muffler... 700001, UNIVERSAL FIT MSL/MAXIMUM Muffler... 6539, 709019, Silentone DIY Muffler... 5534

85-86 8 Cyl. F250 Series; 133" W.B.; 351 4-Barrel (5.8L) Engine; 2 W.D., 4 W.D.; 3/4 Ton; without Converter (28177)

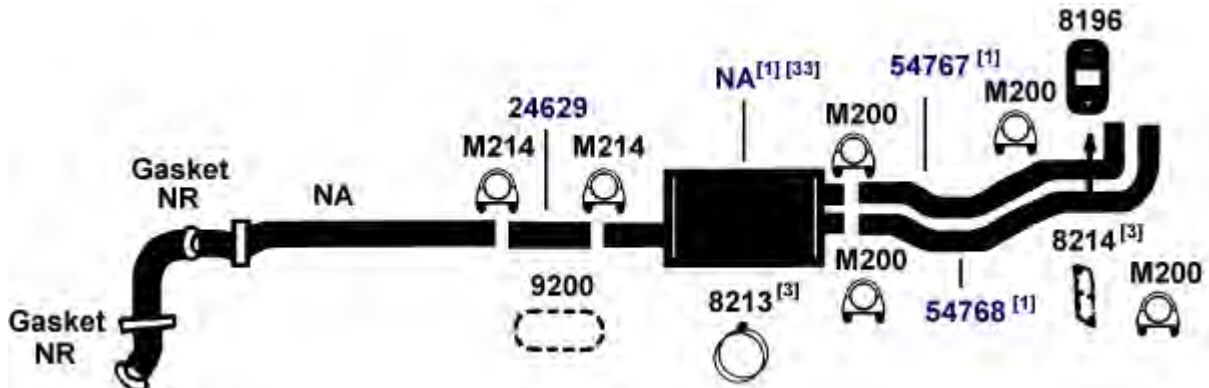

DIRECT FIT MSL/MAXIMUM Muffler... 6585

NA-Not Available. NR-Not Required. FL-Remove and Re-Use Old Flange. ● Golden Warehouse. O.E.-Original Equipment.
Airtube Kit [4948] may be required to complete installation. EFI-Electronic Fuel Injection.

- [1] OE system was a welded assembly. It is recommended that all parts noted [1] should be replaced.
- [3] Required for installation.
- [33] Remove and re-use O.E. heat shield.
- [941] Replaces both front and rear converters, Only failed converters may be replaced.
- [958] Federal & California Emission vehicles. Not legal for sale for vehicles licensed in California.

FORD F250 SERIES PICKUP

(28180) 1985 8 Cyl. F250 Series; 155" W.B.; Super Cab; 460 (7.5L) Engine; 2 W.D., 4 W.D.; 3/4 Ton; without Converter; Before 2-85

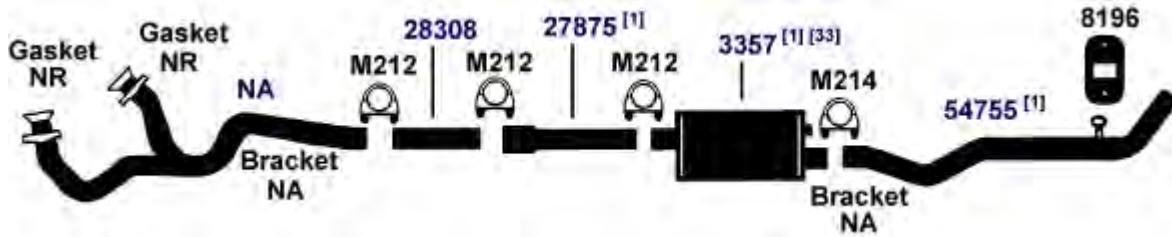

(28183) 1985 8 Cyl. F250 Series; 133" W.B.; 420 (6.9L) Diesel Engine; 2 W.D., 4 W.D.; 3/4 Ton; Before 2-85

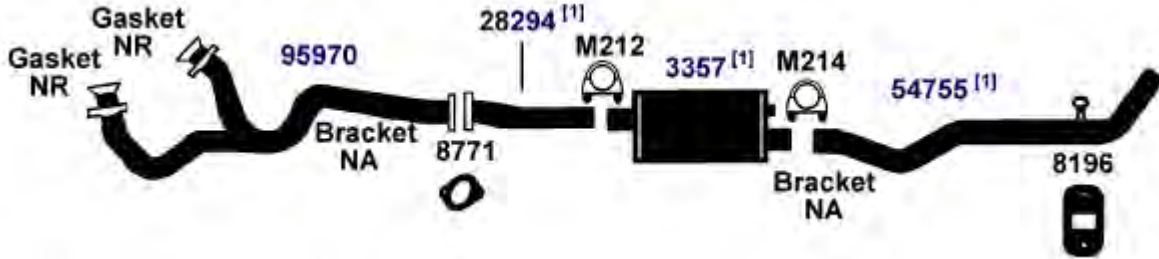

(28182) 1985 8 Cyl. F250 Series; 155" W.B. Super Cab; 420 (6.9L) Diesel Engine; 2 W.D., 4 W.D.; 3/4 Ton; Before 2-85

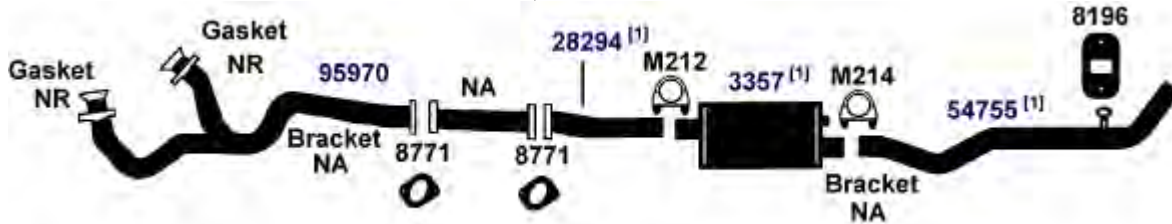

(28171) 1985 8 Cyl. F250 Series; 136" W.B.; Chassis Cab; 351 2-Barrel (5.8L) Engine; 3/4 Ton; without Converter

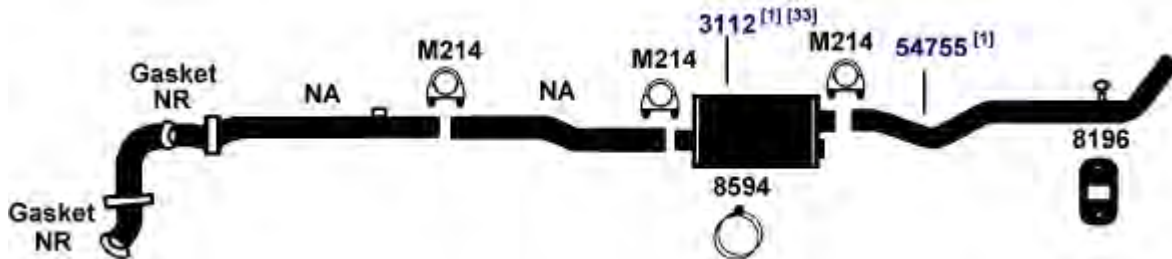

DIRECT FIT MSL/MAXIMUM Muffler... 700001, UNIVERSAL FIT MSL/MAXIMUM Muffler... 6539, 709019, Silentone DIY Muffler... 5534

NA-Not Available. NR-Not Required. FL-Remove and Re-Use Old Flange. ● Golden Warehouse. O.E.-Original Equipment.
Airtube Kit [4948] may be required to complete installation. EFI-Electronic Fuel Injection.

[1] OE system was a welded assembly. It is recommended that all parts noted [1] [33] Remove and re-use O.E. heat shield. should be replaced.

FORD F250 SERIES PICKUP

1985 8 Cyl. F250 Series; 133" W.B.; 460 (7.5L) Engine; 2 W.D., 4 W.D.; 3/4 Ton; without Converter; Before 2- 85 **(28181)**

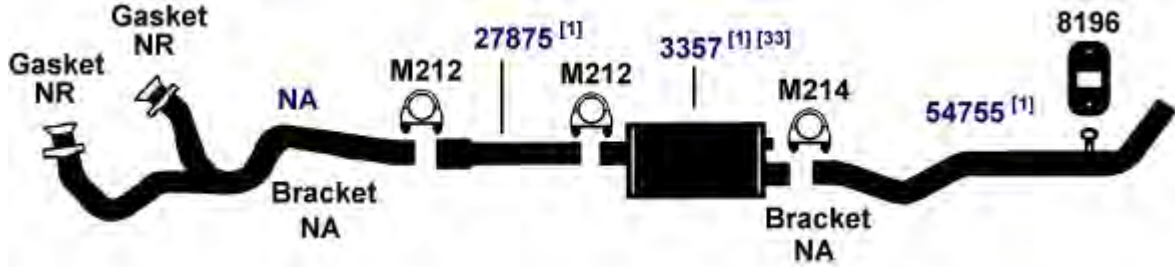

1984 8 Cyl. F250 Series; 133" W.B.; 351 4-Barrel (5.8L) Engine; 2 W.D., 4 W.D.; 3/4 Ton; without Converter **(28177E)**

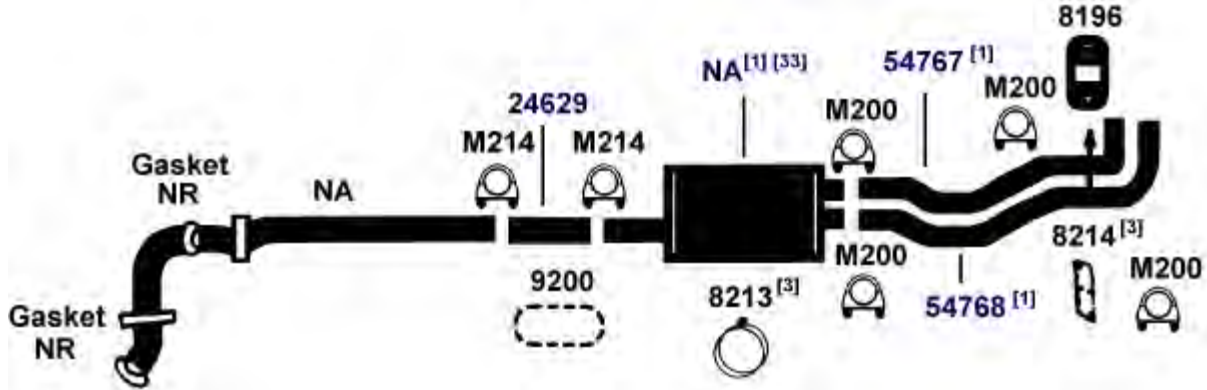

DIRECT FIT MSL/MAXIMUM Muffler... 6585

1984 8 Cyl. F250 Series; 133" W.B.; 351 4-Barrel (5.8L) Engine; 2 W.D., 4 W.D.; 3/4 Ton; with Converter **(28176E)**

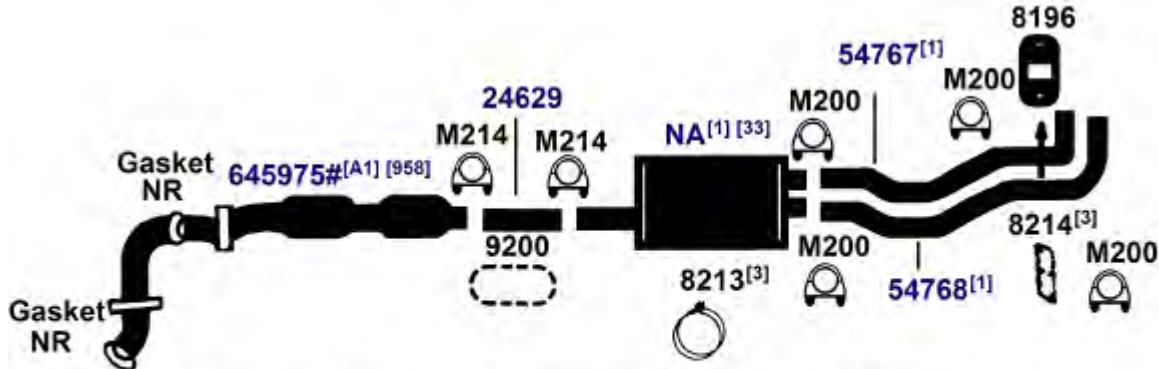

[A1] Combination Front and Rear Converter, 2 To 1 Replacement. Only Defective Converters May Legally Be Replaced.

DIRECT FIT MSL/MAXIMUM Muffler... 6585

NA-Not Available. NR-Not Required. FL-Remove and Re-Use Old Flange. ● Golden Warehouse. O.E.-Original Equipment.
Airtube Kit [4948] may be required to complete installation. EFI-Electronic Fuel Injection.

- [1] OE system was a welded assembly. It is recommended that all parts noted [1] should be replaced.
- [3] Required for installation.
- [33] Remove and re-use O.E. heat shield.
- [958] Federal & California Emission vehicles. Not legal for sale for vehicles licensed in California.

FORD F250 SERIES PICKUP

(28175E) 1984 8 Cyl. F250 Series; 155" W.B. Super Cab; 351 4-Barrel (5.8L) Engine; 2 W.D., 4 W.D.; 3/4 Ton; without Converter

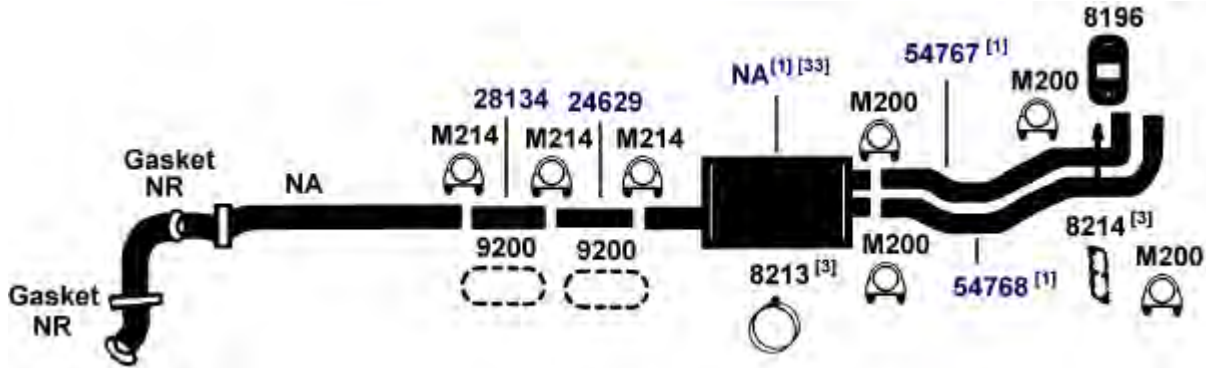

DIRECT FIT MSL/MAXIMUM Muffler... 6585

(28174E) 1984 8 Cyl. F250 Series; 155" W.B.; Super Cab; 351 4-Barrel (5.8L) Engine; 2 W.D., 4 W.D.; 3/4 Ton; with Converter

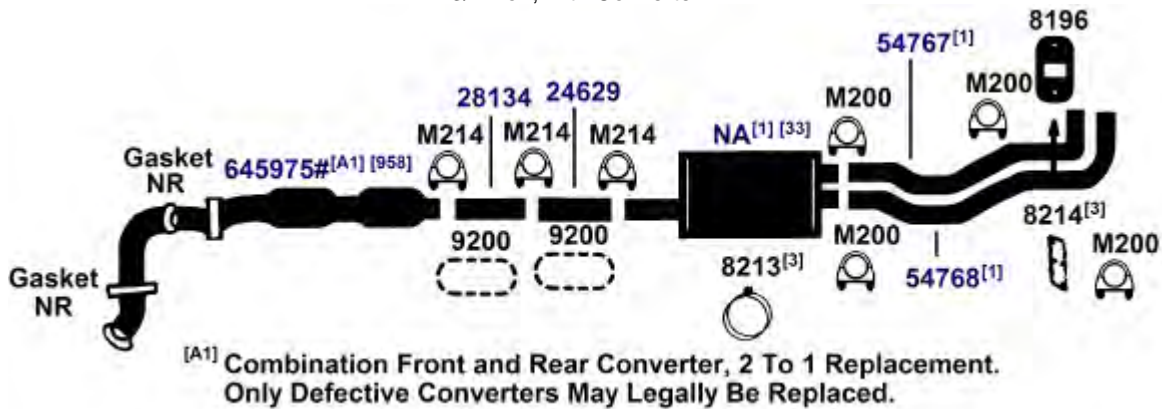

DIRECT FIT MSL/MAXIMUM Muffler... 6585

(28171E) 1984 8 Cyl. F250 Series; 136" W.B.; Chassis Cab; 351 2-Barrel (5.8L) Engine; 3/4 Ton; without Converter

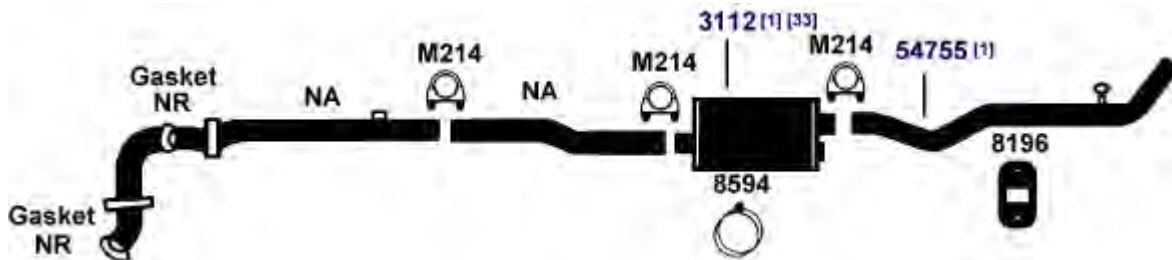

DIRECT FIT MSL/MAXIMUM Muffler... 700001, UNIVERSAL FIT MSL/MAXIMUM Muffler... 6539, 709019, Silentone DIY Muffler... 5534

NA-Not Available. NR-Not Required. FL-Remove and Re-Use Old Flange. ● Golden Warehouse. O.E.-Original Equipment.
Airtube Kit [4948] may be required to complete installation. EFI-Electronic Fuel Injection.

[1] OE system was a welded assembly. It is recommended that all parts noted [1] should be replaced.

[3] Required for installation.

[33] Remove and re-use O.E. heat shield.

[958] Federal & California Emission vehicles. Not legal for sale for vehicles licensed in California.

FORD F250 SERIES PICKUP

83-84 6 Cyl. F250 Series; 133" W.B.; 300 (4.9L) Engine; 2 W.D., 4 W.D.; 3/4 Ton; with Converter **(27037E)**

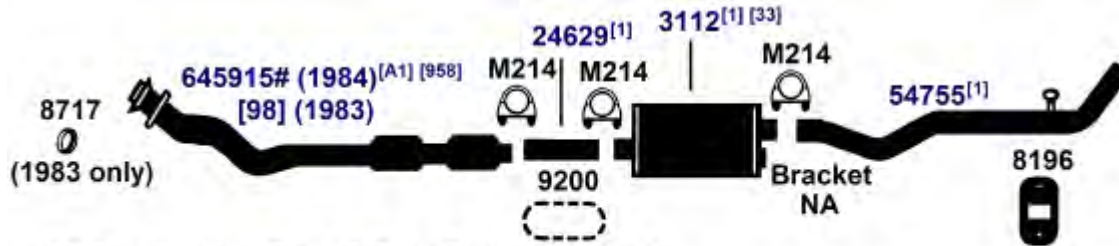

[A1] Combination Front & Rear Converter, 2 to 1 Replacement. Only Defective Converters May Legally Be Replaced.

DIRECT FIT MSL/MAXIMUM Muffler... 700001, UNIVERSAL FIT MSL/MAXIMUM Muffler... 6539, 709019, Silentone DIY Muffler... 5534

83-84 6 Cyl. F250 Series; 155" W.B.; Super Cab; 300 (4.9L) Engine; 2 W.D., 4 W.D.; 3/4 Ton; without Converter **(27036E)**

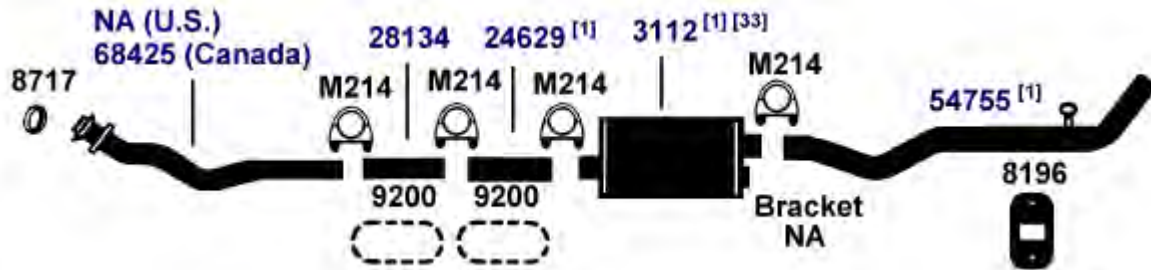

DIRECT FIT MSL/MAXIMUM Muffler... 700001, UNIVERSAL FIT MSL/MAXIMUM Muffler... 6539, 709019, Silentone DIY Muffler... 5534

83-84 6 Cyl. F250 Series; 155" W.B.; Super Cab; 300 (4.9L) Engine; 2 W.D., 4 W.D.; 3/4 Ton; with Converter **(27035E)**

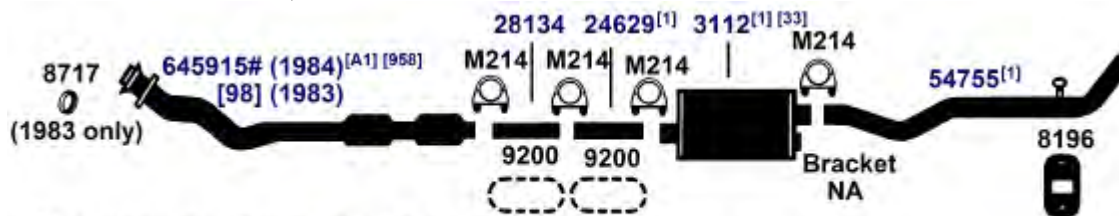

[A1] Combination Front & Rear Converter, 2 to 1 Replacement. Only Defective Converters May Legally Be Replaced.

DIRECT FIT MSL/MAXIMUM Muffler... 700001, UNIVERSAL FIT MSL/MAXIMUM Muffler... 6539, 709019, Silentone DIY Muffler... 5534

NA-Not Available. NR-Not Required. FL-Remove and Re-Use Old Flange. ● Golden Warehouse. O.E.-Original Equipment.
Airtube Kit [4948] may be required to complete installation. EFI-Electronic Fuel Injection.

[1] OE system was a welded assembly. It is recommended that all parts noted [1] should be replaced.
[33] Remove and re-use O.E. heat shield.

[98] Refer to current Catalytic Converter catalog or Website catalog for availability.
[958] Federal & California Emission vehicles. Not legal for sale for vehicles licensed in California.

FORD F250 SERIES PICKUP

(27038E) 83-84 6 Cyl. F250 Series; 133" W.B.; 300 (4.9L) Engine; 2 W.D., 4 W.D.; 3/4 Ton; without Converter

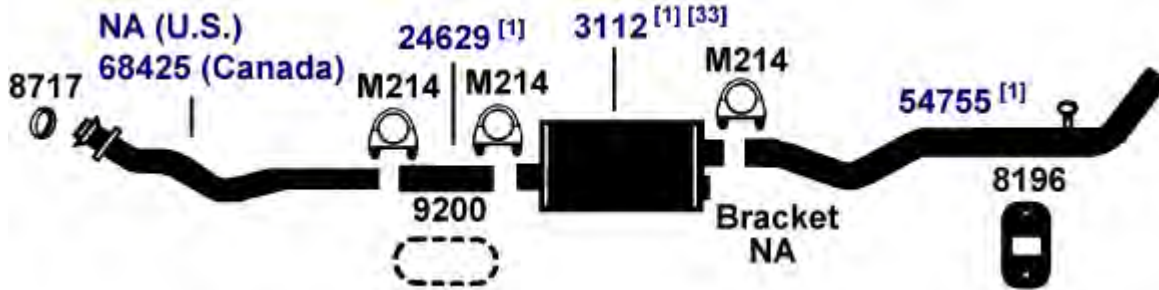

DIRECT FIT MSL/MAXIMUM Muffler... 700001, UNIVERSAL FIT MSL/MAXIMUM Muffler... 6539, 709019, Silentone DIY Muffler... 5534

(28183E) 83-84 8 Cyl. F250 Series; 133" W.B.; 420 (6.9L) Diesel Engine; 2 W.D., 4 W.D.; 3/4 Ton

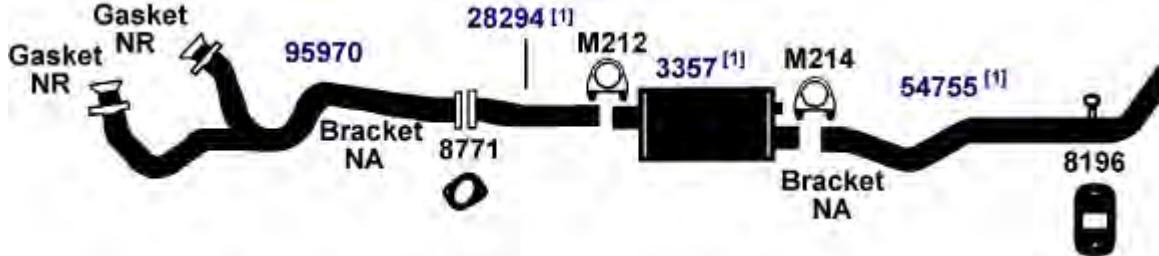

(28182E) 83-84 8 Cyl. F250 Series; 155" W.B. Super Cab; 420 (6.9L) Diesel Engine; 2 W.D., 4 W.D.; 3/4 Ton

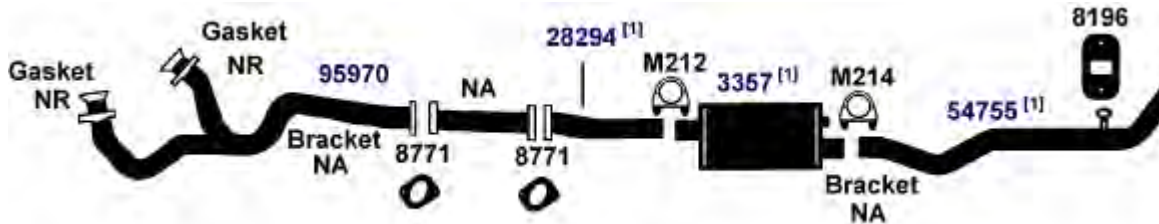

(28170E) 83-84 8 Cyl. F250 Series; 133" W.B.; 302, 351 2-Barrel (5.0L, 5.8L) Engine; 2 W.D., 4 W.D.; 3/4 Ton; without Converter
1983 8 Cyl. F250 Series; 138" W.B.; Super Cab; 302, 351 2-Barrel (5.0L, 5.8L) Engine; 2 W.D., 4 W.D.; 3/4 Ton; without Converter

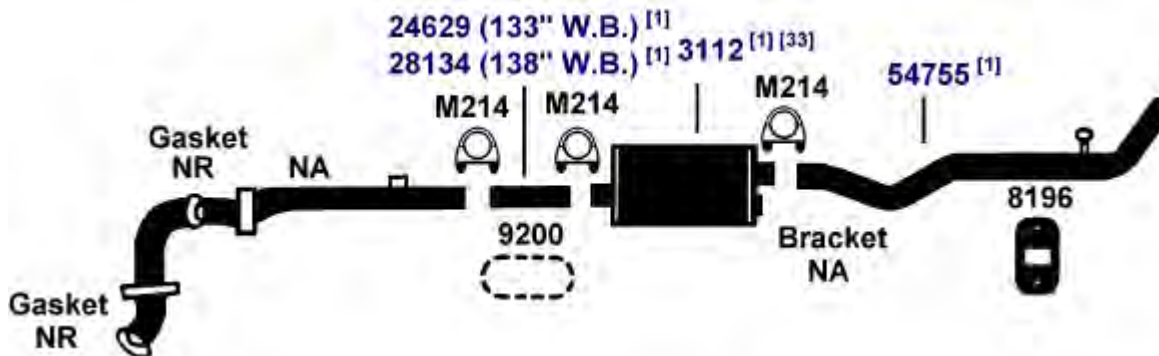

DIRECT FIT MSL/MAXIMUM Muffler... 700001, UNIVERSAL FIT MSL/MAXIMUM Muffler... 6539, 709019, Silentone DIY Muffler... 5534

NA-Not Available. NR-Not Required. FL-Remove and Re-Use Old Flange. ● Golden Warehouse. O.E.-Original Equipment.
Airtube Kit [4948] may be required to complete installation. EFI-Electronic Fuel Injection.

[1] OE system was a welded assembly. It is recommended that all parts noted [1] [33] Remove and re-use O.E. heat shield. should be replaced.

FORD F250 SERIES PICKUP

83-84 8 Cyl. F250 Series; 155" W.B.; Super Cab; 302, 351 2-Barrel (5.0L, 5.8L) Engine; 2 W.D., 4 W.D.; 3/4 Ton; without Converter **(28169E)**

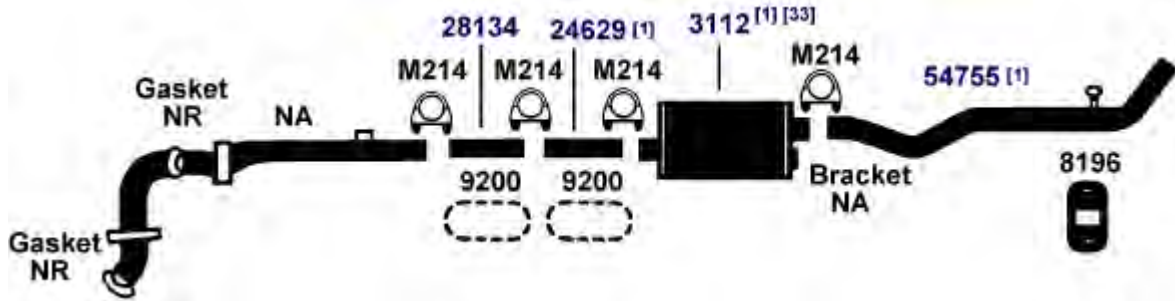

DIRECT FIT MSL/MAXIMUM Muffler... 700001, UNIVERSAL FIT MSL/MAXIMUM Muffler... 6539, 709019, Silentone DIY Muffler... 5534

83-84 8 Cyl. F250 Series; 133" W.B.; 460 (7.5L) Engine; 2 W.D., 4 W.D.; 3/4 Ton; without Converter **(28181E)**

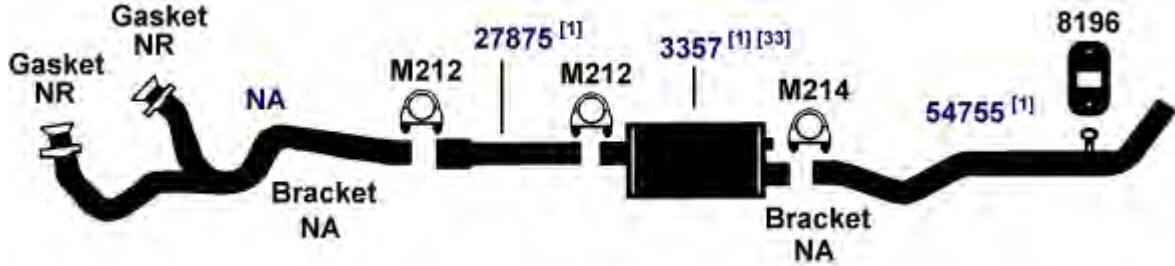

83-84 8 Cyl. F250 Series; 155" W.B.; Super Cab; 460 (7.5L) Engine; 2 W.D., 4 W.D.; 3/4 Ton; without Converter **(28180E)**

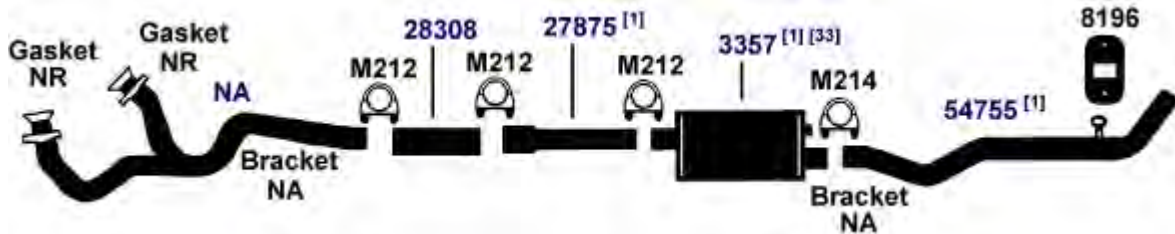

83-84 8 Cyl. F250 Series; 155" W.B.; Super Cab; 302, 351 2-Barrel (5.0L, 5.8L) Engine; 2 W.D., 4 W.D.; 3/4 Ton; with Converter; including EFI **(28172E)**

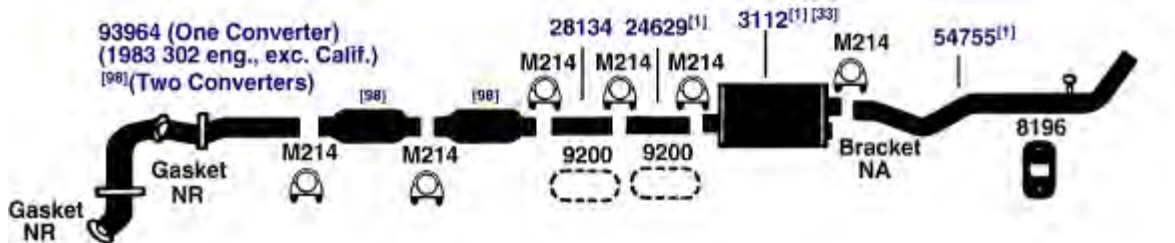

DIRECT FIT MSL/MAXIMUM Muffler... 700001, UNIVERSAL FIT MSL/MAXIMUM Muffler... 6539, 709019, Silentone DIY Muffler... 5534

NA-Not Available. NR-Not Required. FL-Remove and Re-Use Old Flange. ● Golden Warehouse. O.E.-Original Equipment.
Airtube Kit [4948] may be required to complete installation. EFI-Electronic Fuel Injection.

- [1] OE system was a welded assembly. It is recommended that all parts noted [1] should be replaced.
- [98] Refer to current Catalytic Converter catalog or Website catalog for availability.
- [33] Remove and re-use O.E. heat shield.

FORD F250 SERIES PICKUP

(28173E) 83-84 8 Cyl. F250 Series; 133" W.B.; 302, 351 2-Barrel (5.0L, 5.8L) Engine; 2 W.D., 4 W.D.; 3/4 Ton; with Converter; including EFI

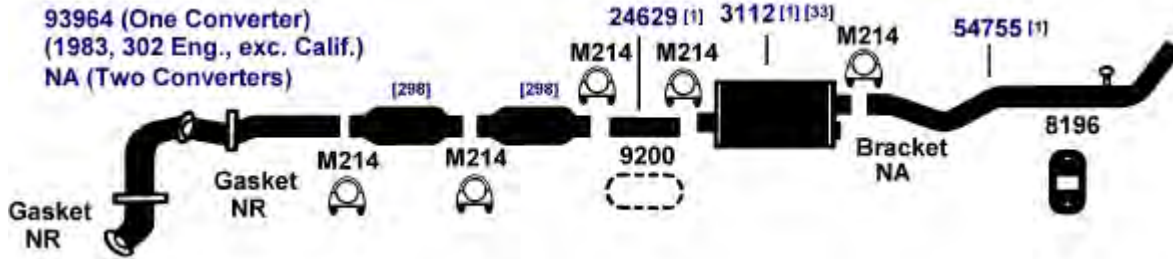

DIRECT FIT MSL/MAXIMUM Muffler... 700001, UNIVERSAL FIT MSL/MAXIMUM Muffler... 6539, 709019, Silentone DIY Muffler... 5534

(27034) 1983 6 Cyl. F250 Series; 138" W.B.; Super Cab; 300 (4.9L) Engine; 2 W.D., 4 W.D.; 3/4 Ton; without Converter

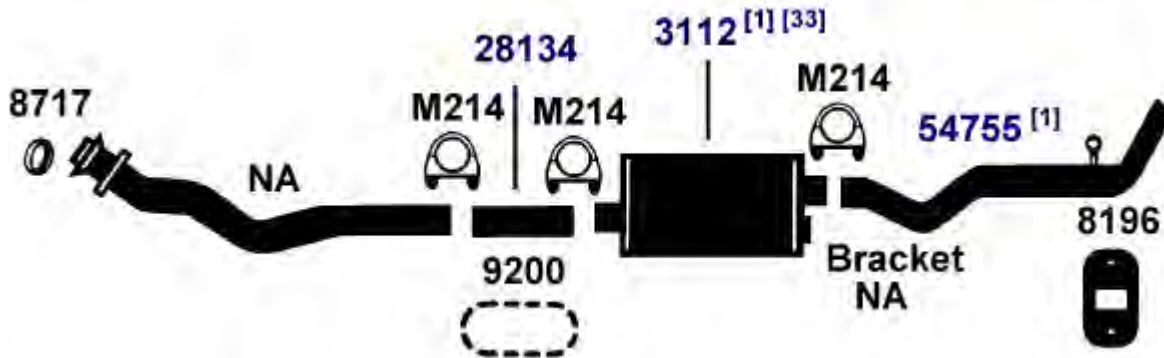

DIRECT FIT MSL/MAXIMUM Muffler... 700001, UNIVERSAL FIT MSL/MAXIMUM Muffler... 6539, 709019, Silentone DIY Muffler... 5534

(27033) 1983 6 Cyl. F250 Series; 138" W.B.; Super Cab; 300 (4.9L) Engine; 2 W.D., 4 W.D.; 3/4 Ton; with Converter

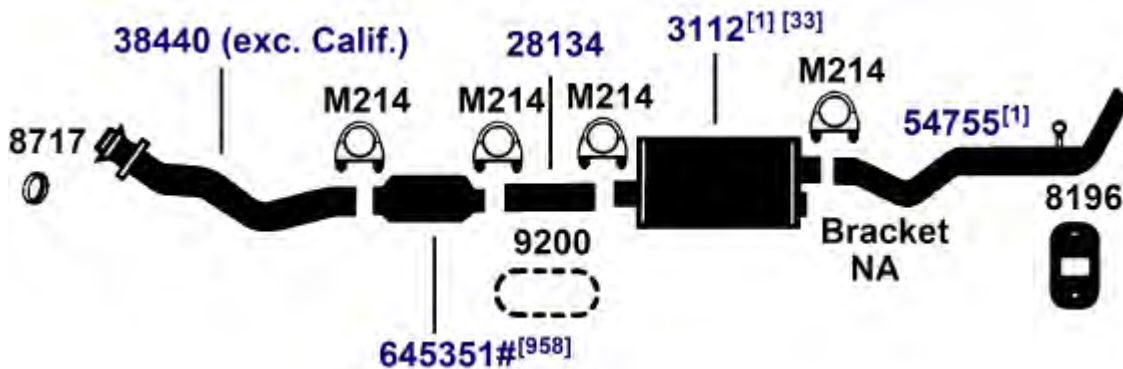

DIRECT FIT MSL/MAXIMUM Muffler... 700001, UNIVERSAL FIT MSL/MAXIMUM Muffler... 6539, 709019, Silentone DIY Muffler... 5534

NA-Not Available. NR-Not Required. FL-Remove and Re-Use Old Flange. ● Golden Warehouse. O.E.-Original Equipment.

Airtube Kit [4948] may be required to complete installation. EFI-Electronic Fuel Injection.

[1] OE system was a welded assembly. It is recommended that all parts noted [1] should be replaced.

[33] Remove and re-use O.E. heat shield.

[298] Coverage available. Due to multiple listings, please refer to Catalytic Converter catalog.

[958] Federal & California Emission vehicles. Not legal for sale for vehicles licensed in California.

FORD F250 SERIES PICKUP

1983 8 Cyl. F250 Series; 138" W.B.; Super Cab; 302, 351 2-Barrel (5.0L, 5.8L) Engine; 2 W.D., 4 W.D.; 3/4 Ton; with Converter **(28167)**

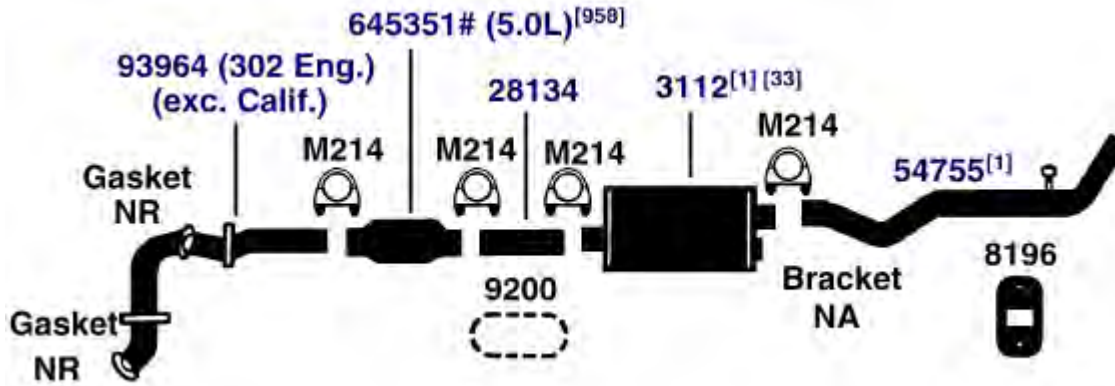

DIRECT FIT MSL/MAXIMUM Muffler... 700001, UNIVERSAL FIT MSL/MAXIMUM Muffler... 6539, 709019, Silentone DIY Muffler... 5534

81-82 8 Cyl. F250 Series; 138" W.B.; 302, 351, 400 (5.0L, 5.8L, 6.6L) Engine; 2 W.D.; 3/4 Ton; Super Cab; without Converter **(28166)**

81-82 8 Cyl. F250 Series; 133" W.B.; 302, 351, 400 (5.0L, 5.8L, 6.6L) Engine; 2 W.D., 4 W.D.; 3/4 Ton; Regular Cab; without Converter

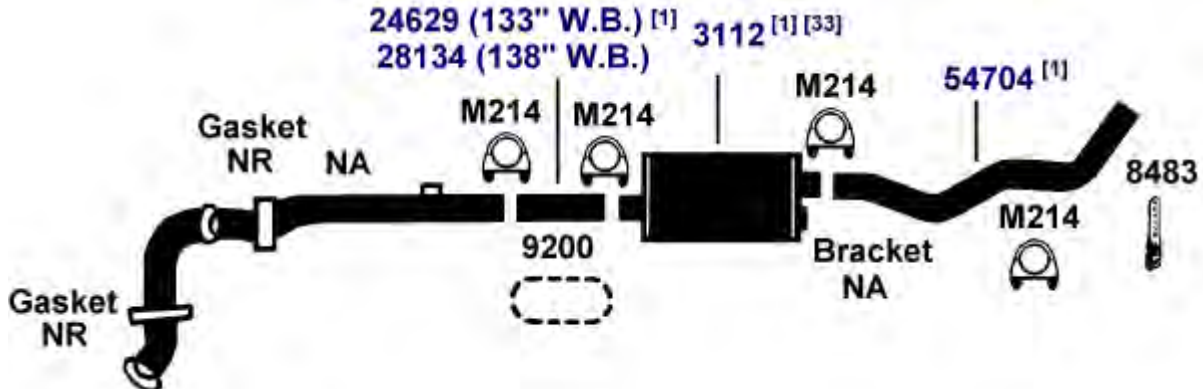

DIRECT FIT MSL/MAXIMUM Muffler... 700001, UNIVERSAL FIT MSL/MAXIMUM Muffler... 6539, 709019, Silentone DIY Muffler... 5534

NA-Not Available. NR-Not Required. FL-Remove and Re-Use Old Flange. ● Golden Warehouse. O.E.-Original Equipment.
Airtube Kit [4948] may be required to complete installation. EFI-Electronic Fuel Injection.

[1] OE system was a welded assembly. It is recommended that all parts noted [1] should be replaced. [958] Federal & California Emission vehicles. Not legal for sale for vehicles licensed in California.
[33] Remove and re-use O.E. heat shield.

FORD F250 SERIES PICKUP

(28163) 81-82 8 Cyl. F250 Series; 138" W.B.; 302, 351, 400 (5.0L, 5.8L, 6.6L) Engine; 2 W.D.; 3/4 Ton; Super Cab; with Converter

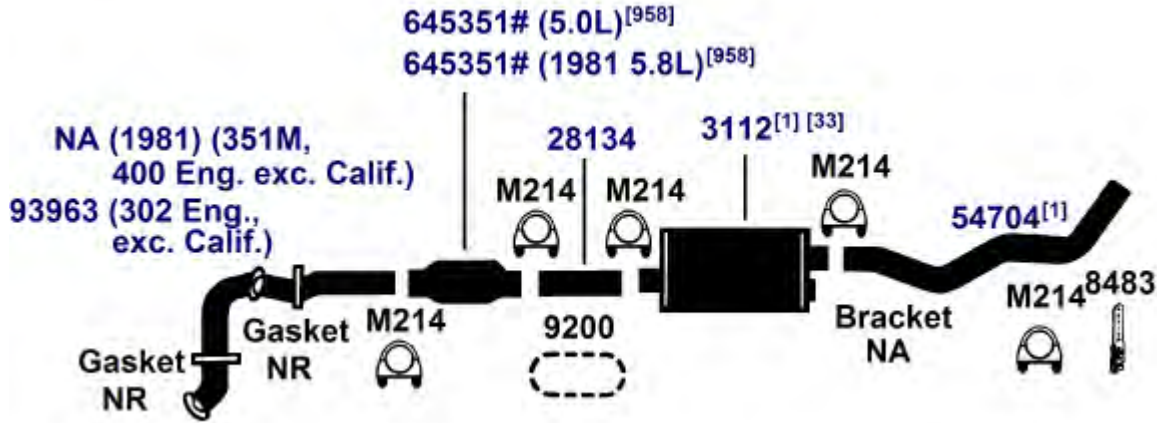

DIRECT FIT MSL/MAXIMUM Muffler... 700001, UNIVERSAL FIT MSL/MAXIMUM Muffler... 6539, 709019, Silentone DIY Muffler... 5534

(27031) 80-82 6 Cyl. F250 Series; 133" W.B.; 300 (4.9L) Engine; 2 W.D., 4 W.D.; 3/4 Ton; Regular Cab with Converter
 80-82 6 Cyl. F250 Series; 138" W.B.; 300 (4.9L) Engine; 2 W.D.; 3/4 Ton; Super Cab with Converter

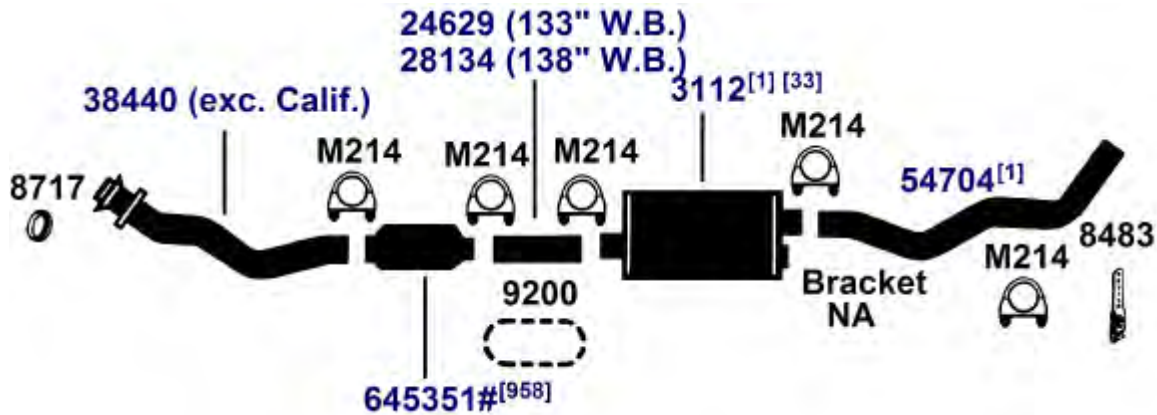

DIRECT FIT MSL/MAXIMUM Muffler... 700001, UNIVERSAL FIT MSL/MAXIMUM Muffler... 6539, 709019, Silentone DIY Muffler... 5534

NA-Not Available. NR-Not Required. FL-Remove and Re-Use Old Flange. ● Golden Warehouse. O.E.-Original Equipment.
 # Airtube Kit [4948] may be required to complete installation. EFI-Electronic Fuel Injection.

[1] OE system was a welded assembly. It is recommended that all parts noted [1] should be replaced. [958] Federal & California Emission vehicles. Not legal for sale for vehicles licensed in California.

[33] Remove and re-use O.E. heat shield.

FORD F250 SERIES PICKUP

80-82 6 Cyl. F250 Series; 155" W.B.; 300 (4.9L) Engine; 2 W.D., 4 W.D.; 3/4 Ton; Super Cab; with Converter **(27027)**

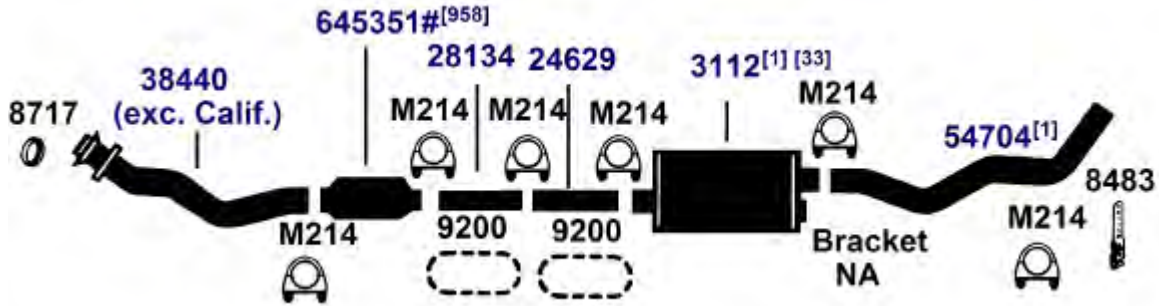

DIRECT FIT MSL/MAXIMUM Muffler... 700001, UNIVERSAL FIT MSL/MAXIMUM Muffler... 6539, 709019, Silentone DIY Muffler... 5534

80-82 6 Cyl. F250 Series; 155" W.B.; 300 (4.9L) Engine; 2 W.D., 4 W.D.; 3/4 Ton; Super Cab; without Converter **(27028)**

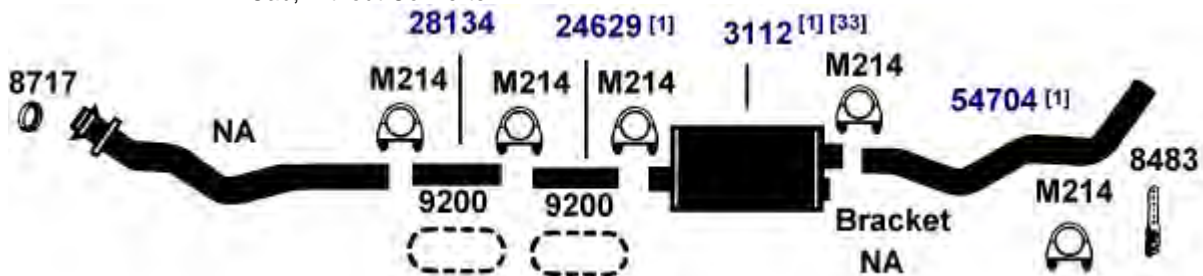

DIRECT FIT MSL/MAXIMUM Muffler... 700001, UNIVERSAL FIT MSL/MAXIMUM Muffler... 6539, 709019, Silentone DIY Muffler... 5534

80-82 6 Cyl. F250 Series; 133" W.B.; 300 (4.9L) Engine; 2 W.D.; 3/4 Ton; Regular Cab; without Converter **(27032)**

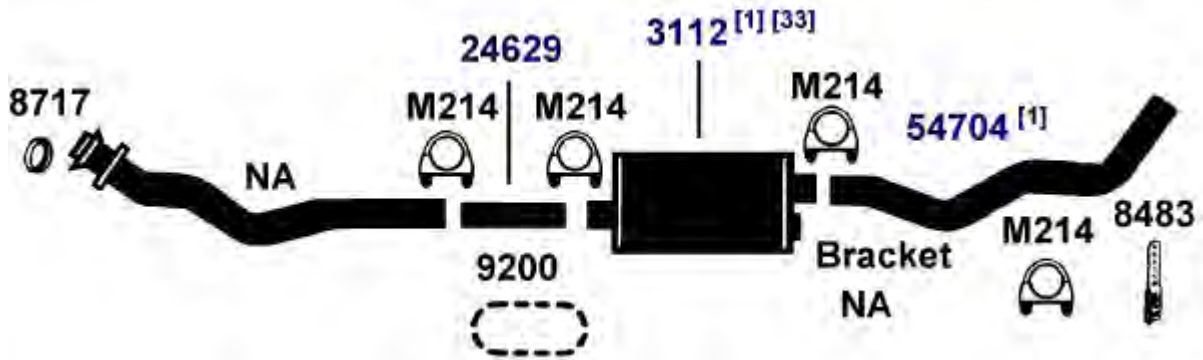

DIRECT FIT MSL/MAXIMUM Muffler... 700001, UNIVERSAL FIT MSL/MAXIMUM Muffler... 6539, 709019, Silentone DIY Muffler... 5534

NA-Not Available. NR-Not Required. FL-Remove and Re-Use Old Flange. • Golden Warehouse. O.E.-Original Equipment.
Airtube Kit [4948] may be required to complete installation. EFI-Electronic Fuel Injection.

- [1] OE system was a welded assembly. It is recommended that all parts noted [1] should be replaced.
- [33] Remove and re-use O.E. heat shield.
- [958] Federal & California Emission vehicles. Not legal for sale for vehicles licensed in California.

FORD F250 SERIES PICKUP

(27030) 80-82 6 Cyl. F250 Series; 138" W.B.; 300 (4.9L) Engine; 2 W.D.; 3/4 Ton; Super Cab without Converter

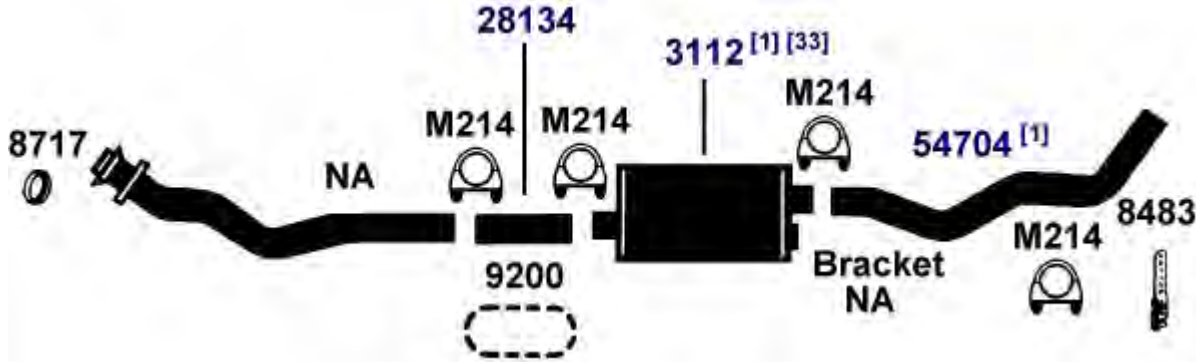

DIRECT FIT MSL/MAXIMUM Muffler... 700001, UNIVERSAL FIT MSL/MAXIMUM Muffler... 6539, 709019, Silentone DIY Muffler... 5534

(28165) 80-82 8 Cyl. F250 Series; 133" W.B.; 302, 351, 400 (5.0L, 5.8L, 6.6L) Engine; 2 W.D., 4 W.D.; 3/4 Ton; Regular Cab; with Converter

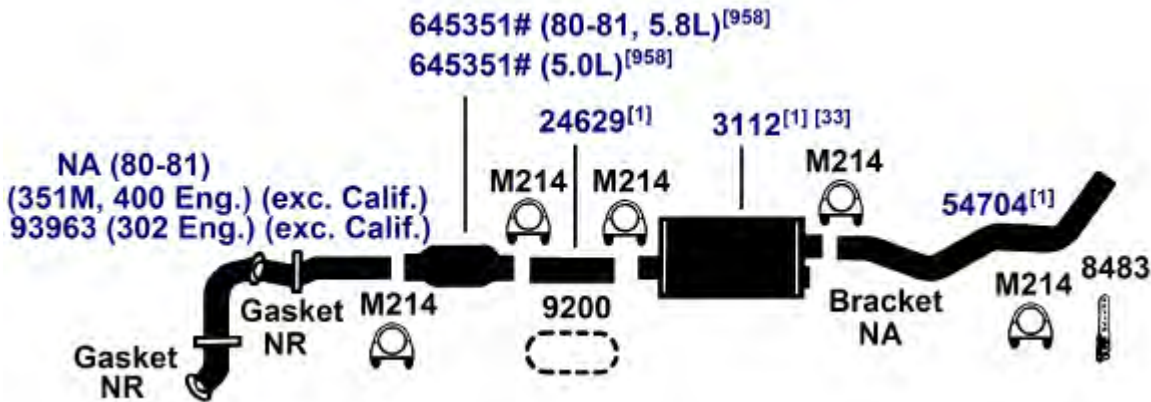

DIRECT FIT MSL/MAXIMUM Muffler... 700001, UNIVERSAL FIT MSL/MAXIMUM Muffler... 6539, 709019, Silentone DIY Muffler... 5534

NA-Not Available. NR-Not Required. FL-Remove and Re-Use Old Flange. ● Golden Warehouse. O.E.-Original Equipment.
Airtube Kit [4948] may be required to complete installation. EFI-Electronic Fuel Injection.

[1] OE system was a welded assembly. It is recommended that all parts noted [1] should be replaced. [958] Federal & California Emission vehicles. Not legal for sale for vehicles licensed in California.

[33] Remove and re-use O.E. heat shield.

FORD F250 SERIES PICKUP

80-82 8 Cyl. F250 Series; 155" W.B.; 302, 351, 400 (5.0L, 5.8L, 6.6L) Engine; 2 W.D., 4 W.D.; 3/4 Ton; Super Cab; with Converter **(28161)**

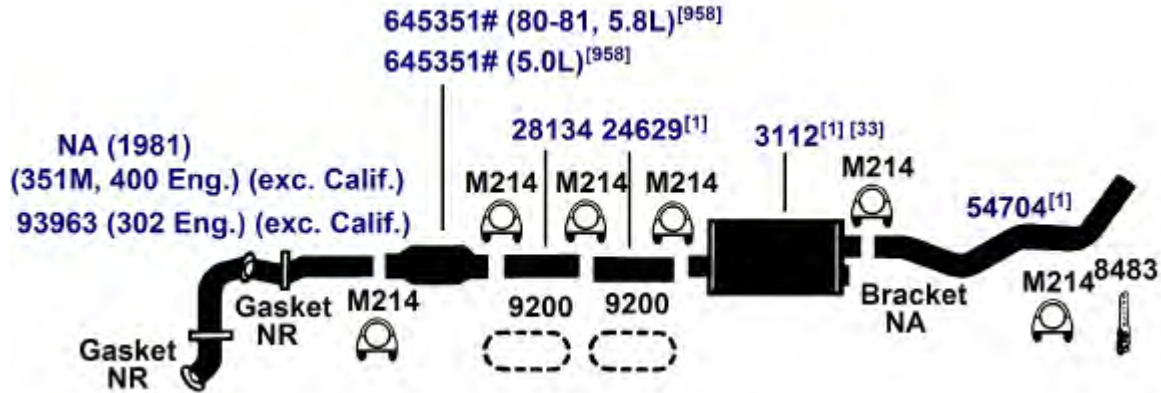

DIRECT FIT MSL/MAXIMUM Muffler... 700001, UNIVERSAL FIT MSL/MAXIMUM Muffler... 6539, 709019, Silentone DIY Muffler... 5534

80-82 8 Cyl. F250 Series; 155" W.B.; 302, 351, 400 (5.0L, 5.8L, 6.6L) Engine; 2 W.D., 4 W.D.; 3/4 Ton; Super Cab; without Converter **(28162)**

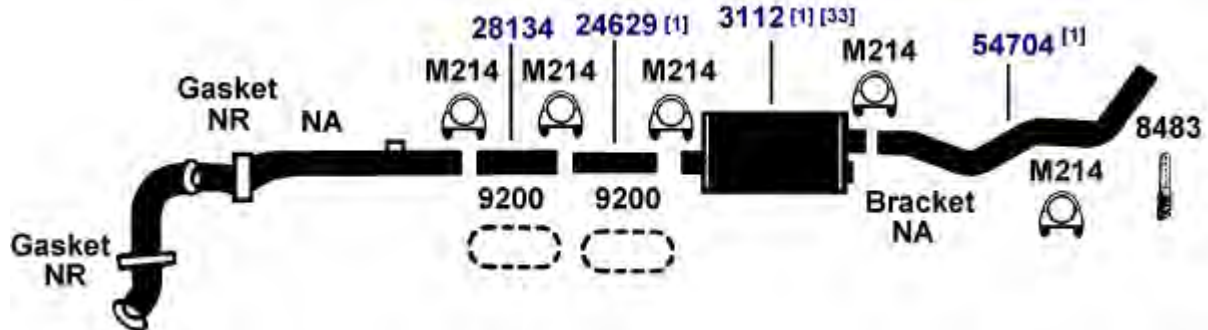

DIRECT FIT MSL/MAXIMUM Muffler... 700001, UNIVERSAL FIT MSL/MAXIMUM Muffler... 6539, 709019, Silentone DIY Muffler... 5534

1980 8 Cyl. F250 Series; 116" W.B.; 302, 351, 400 (5.0L, 5.8L, 6.6L) Engine; 2 W.D., 4 W.D.; 3/4 Ton; Regular Cab; without Converter **(28160)**

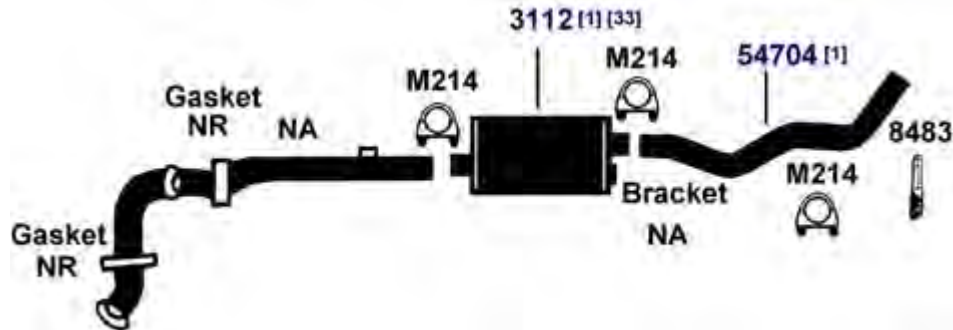

DIRECT FIT MSL/MAXIMUM Muffler... 700001, UNIVERSAL FIT MSL/MAXIMUM Muffler... 6539, 709019, Silentone DIY Muffler... 5534

NA-Not Available. NR-Not Required. FL-Remove and Re-Use Old Flange. ● Golden Warehouse. O.E.-Original Equipment.
Airtube Kit [4948] may be required to complete installation. EFI-Electronic Fuel Injection.

- [1] OE system was a welded assembly. It is recommended that all parts noted [1] should be replaced.
- [33] Remove and re-use O.E. heat shield.
- [958] Federal & California Emission vehicles. Not legal for sale for vehicles licensed in California.

FORD F250 SERIES PICKUP

(28158) 1980 8 Cyl. F250 Series; 138" W.B.; 302, 351, 400 (5.0L, 5.8L, 6.6L) Engine; 2 W.D.; 3/4 Ton; Super Cab; without Converter

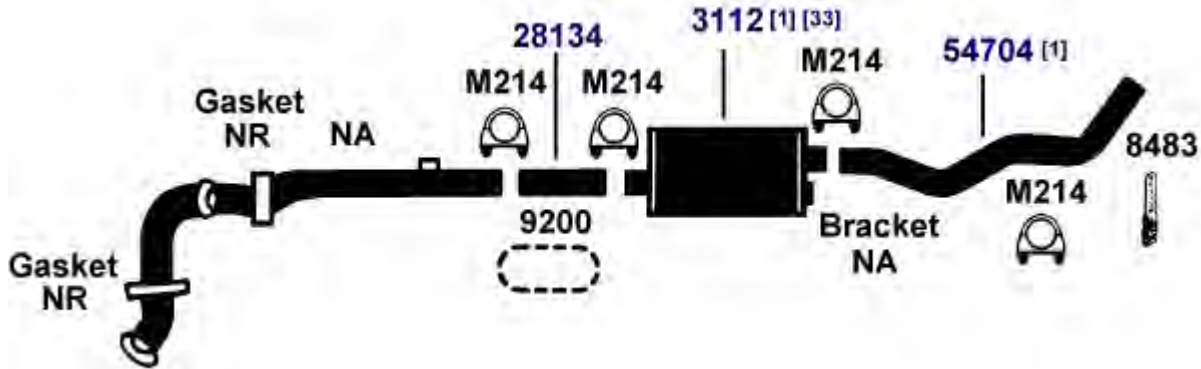

DIRECT FIT MSL/MAXIMUM Muffler... 700001, UNIVERSAL FIT MSL/MAXIMUM Muffler... 6539, 709019, Silentone DIY Muffler... 5534

(28159) 1980 8 Cyl. F250 Series; 116" W.B.; 302, 351, 400 (5.0L, 5.8L, 6.6L) Engine; 2 W.D., 4 W.D.; 3/4 Ton; Regular Cab; with Converter

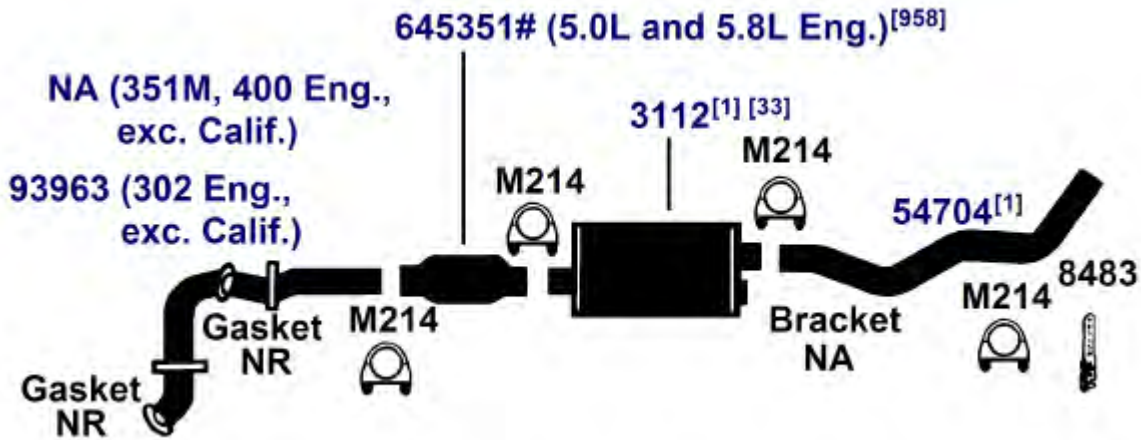

DIRECT FIT MSL/MAXIMUM Muffler... 700001, UNIVERSAL FIT MSL/MAXIMUM Muffler... 6539, 709019, Silentone DIY Muffler... 5534

NA-Not Available. NR-Not Required. FL-Remove and Re-Use Old Flange. ● Golden Warehouse. O.E.-Original Equipment.
Airtube Kit [4948] may be required to complete installation. EFI-Electronic Fuel Injection.

- [1] OE system was a welded assembly. It is recommended that all parts noted [1] should be replaced. [958] Federal & California Emission vehicles. Not legal for sale for vehicles licensed in California.
- [33] Remove and re-use O.E. heat shield.

FORD F250 SERIES PICKUP

1980 8 Cyl. F250 Series; 138" W.B.; 302, 351, 400 (5.0L, 5.8L, 6.6L) Engine; 2 W.D.; 3/4 Ton; Super Cab; with Converter **(28157)**

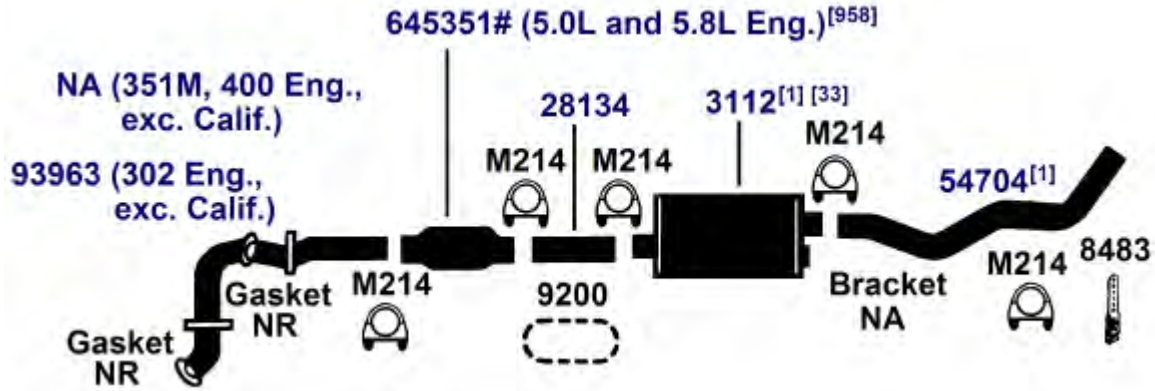

DIRECT FIT MSL/MAXIMUM Muffler... 700001, UNIVERSAL FIT MSL/MAXIMUM Muffler... 6539, 709019, Silentone DIY Muffler... 5534

1979 8 Cyl. F250 Series; 155" W.B.; 351, 400 Engine; 2 W.D., 4 W.D.; 3/4 Ton; Super Cab; with Converter **(28149)**

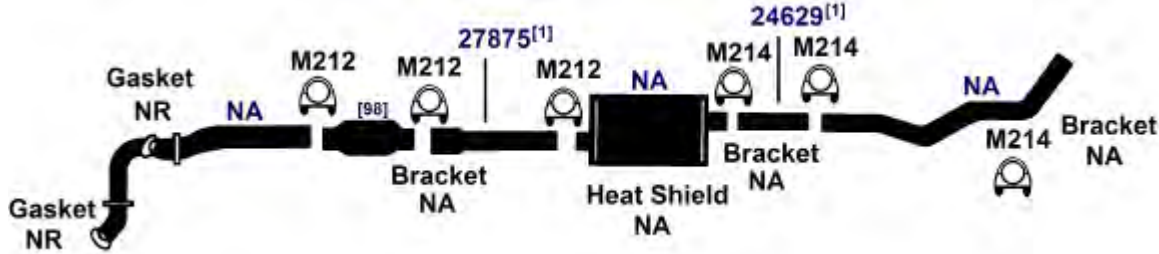

UNIVERSAL FIT MSL/MAXIMUM Muffler... 6539, 709019

1979 8 Cyl. F250 Series; 155" W.B.; 351, 400 Engine; 2 W.D., 4 W.D.; 3/4 Ton; Super Cab; without Converter **(28150)**

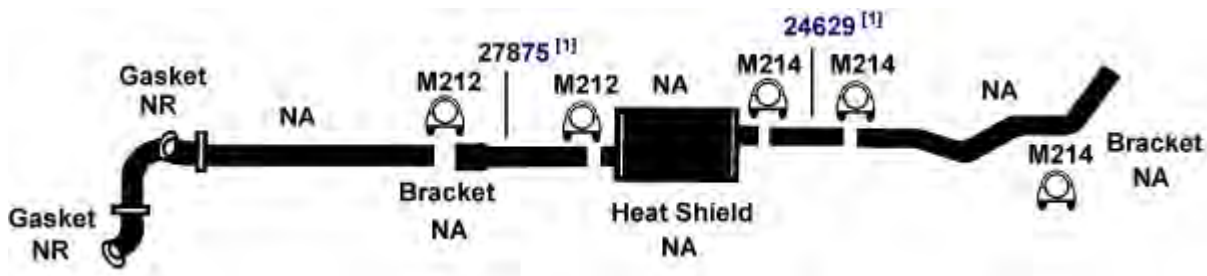

UNIVERSAL FIT MSL/MAXIMUM Muffler... 6539, 709019

NA-Not Available. NR-Not Required. FL-Remove and Re-Use Old Flange. • Golden Warehouse. O.E.-Original Equipment.
Airtube Kit [4948] may be required to complete installation. EFI-Electronic Fuel Injection.

[1] OE system was a welded assembly. It is recommended that all parts noted [1] should be replaced.
[33] Remove and re-use O.E. heat shield.

[98] Refer to current Catalytic Converter catalog or Website catalog for availability.
[958] Federal & California Emission vehicles. Not legal for sale for vehicles licensed in California.

FORD F350 SERIES PICKUP

(28371) 1994 8 Cyl. F350 Series; 133", 155" W.B. Super Cab; 168" W.B. Crew Cab; 5.8L Engine
 88-93 8 Cyl. F350 Series; 133", 155" W.B. Super Cab; 168" W.B. Crew Cab; 5.8L, 7.5L Engine; except 1993 7.5L with Round Muffler

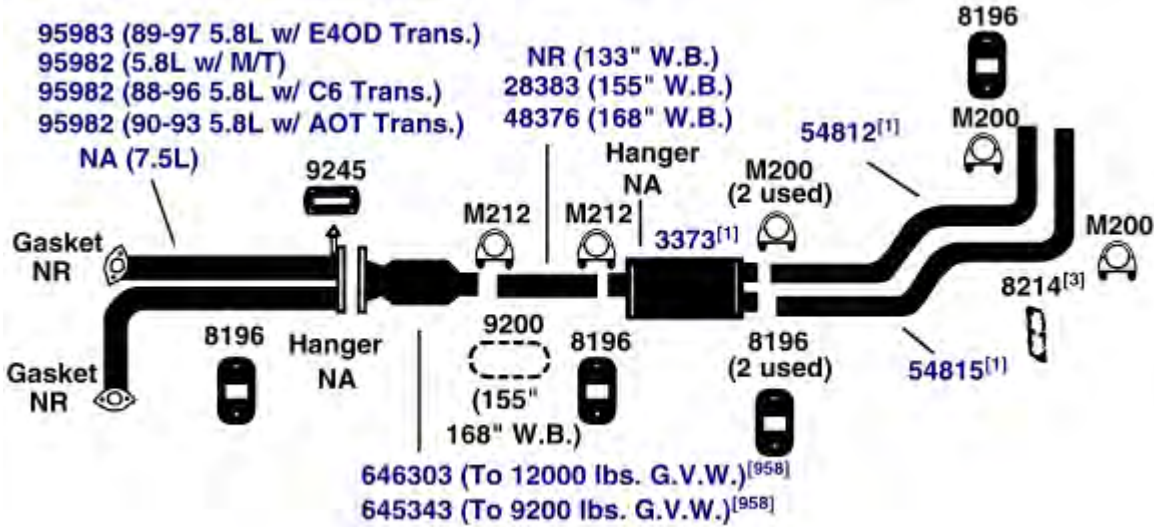

DIRECT FIT MSL/MAXIMUM Muffler... 700270

(28382) 1994 8 Cyl. F350 Series; 136", 160" W.B. Chassis Cab; 5.8L Engine
 88-93 8 Cyl. F350 Series; 136", 160" W.B. Chassis Cab; 5.8L, 7.5L Engine; From 2-88; except 1993 7.5L with Round Muffler

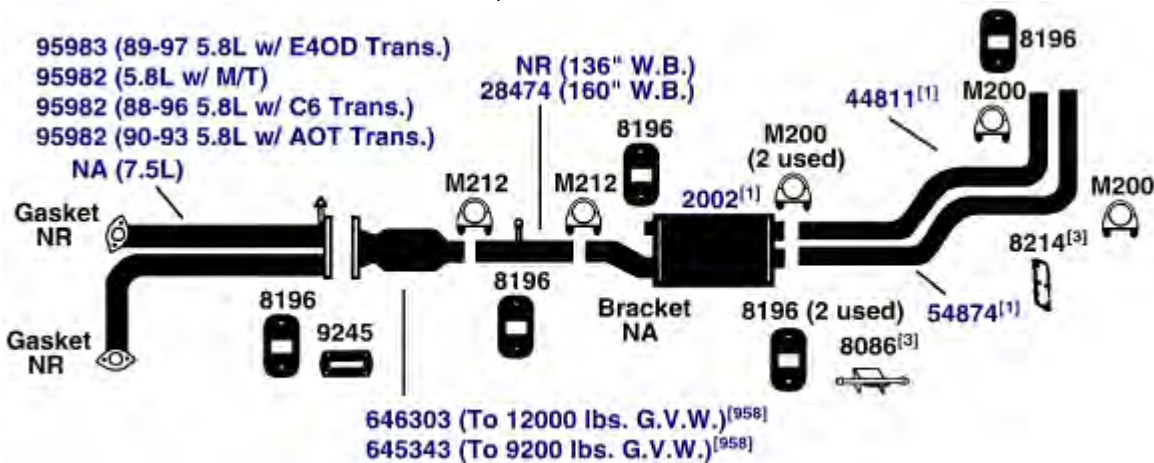

DIRECT FIT MSL/MAXIMUM Muffler... 700433

NA-Not Available. NR-Not Required. FL-Remove and Re-Use Old Flange. ● Golden Warehouse. O.E.-Original Equipment.
 # Airtube Kit [4948] may be required to complete installation. EFI-Electronic Fuel Injection.

- [1] OE system was a welded assembly. It is recommended that all parts noted [1] should be replaced. [958] Federal & California Emission vehicles. Not legal for sale for vehicles licensed in California.
- [3] Required for installation.

FORD F350 SERIES PICKUP

1994	8 Cyl.	F350 Series; 136", 160" W.B. Chassis Cab; 5.8L Engine (Non OEM Single Outlet Option)	(100705)
88-93	8 Cyl.	F350 Series; 136", 160" W.B. Chassis Cab; 5.8L, 7.5L Engine; From 2-88; except 1993 7.5L with Round Muffler (Non OEM Single Outlet Option)	

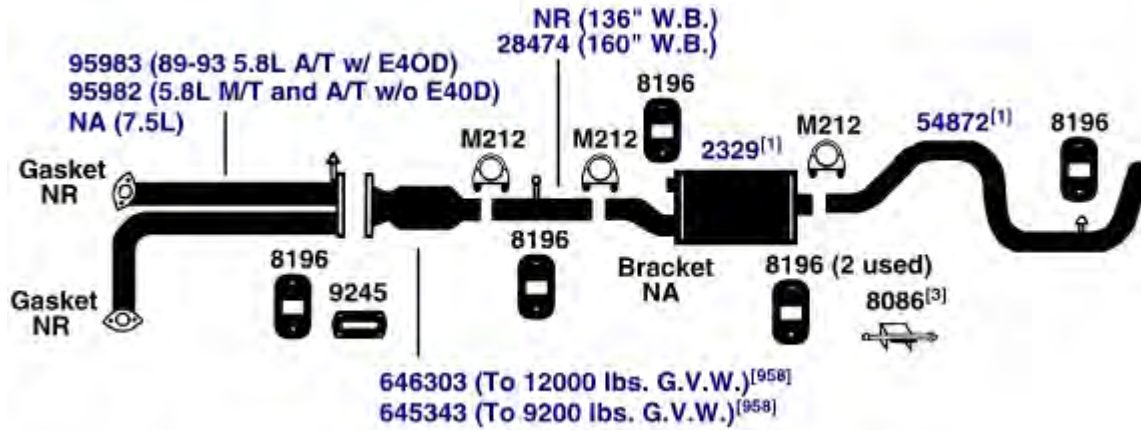

87-94	6 Cyl.	F350 Series; 136", 160" W.B.; Chassis Cabs; 4.9L Engine	(27130)
--------------	--------	---	----------------

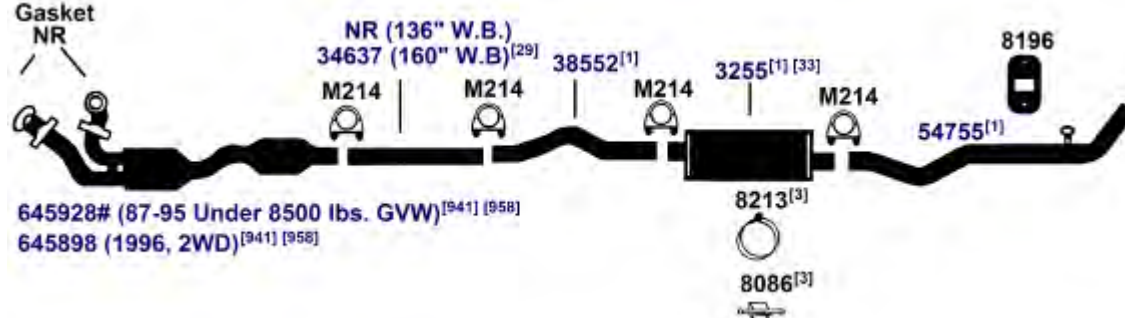

DIRECT FIT MSL/MAXIMUM Muffler... 6592, UNIVERSAL FIT MSL/MAXIMUM Muffler... 6571, 709019, Silentone DIY Muffler... 5557

93-94	8 Cyl.	F350 Series; 136", 160" W.B.; 460 Engine (7.5L); with Round Muffler	(100441)
--------------	--------	---	-----------------

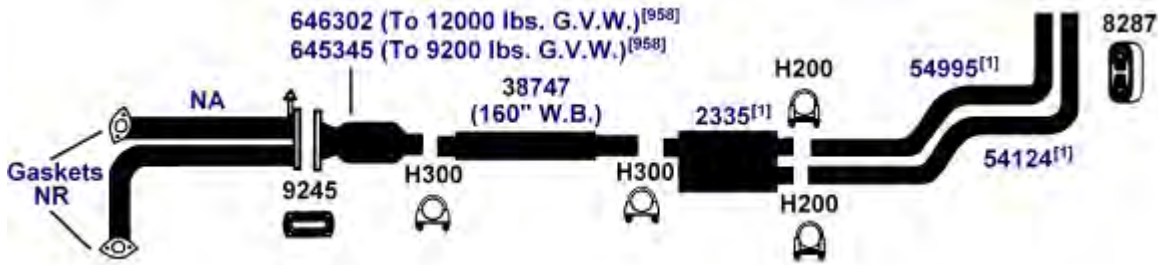

DIRECT FIT MSL/MAXIMUM Muffler... 700436

NA-Not Available. NR-Not Required. FL-Remove and Re-Use Old Flange. ● Golden Warehouse. O.E.-Original Equipment.
 # Airtube Kit [4948] may be required to complete installation. EFI-Electronic Fuel Injection.

- [1] OE system was a welded assembly. It is recommended that all parts noted [1] should be replaced.
- [29] Cut as required.
- [33] Remove and re-use O.E. heat shield.
- [941] Replaces both front and rear converters, Only failed converters may be replaced.
- [958] Federal & California Emission vehicles. Not legal for sale for vehicles licensed in California.

FORD F350 SERIES PICKUP

(100439) 88-94 6 Cyl. F350 Series; 133" W.B.; 300 (4.9L) Engine; 2 W.D., 4 W.D.; 1 Ton

645928# (Under 8500 lbs. GVW)^{[941] [958]}

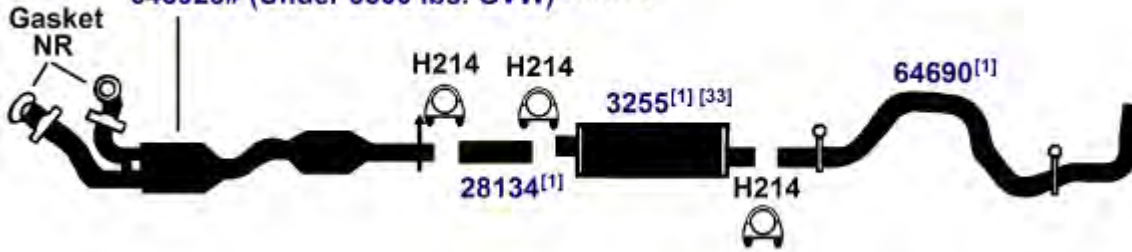

DIRECT FIT MSL/MAXIMUM Muffler... 6592, UNIVERSAL FIT MSL/MAXIMUM Muffler... 6571, 709019, Silentone DIY Muffler... 5557

(100572) 1994 8 Cyl. F350 Series; 133", 155", 168" W.B.; 7.3L Turbo Diesel Engine; 1 Ton; (over 8500 lbs. G.V.W.); without Converter

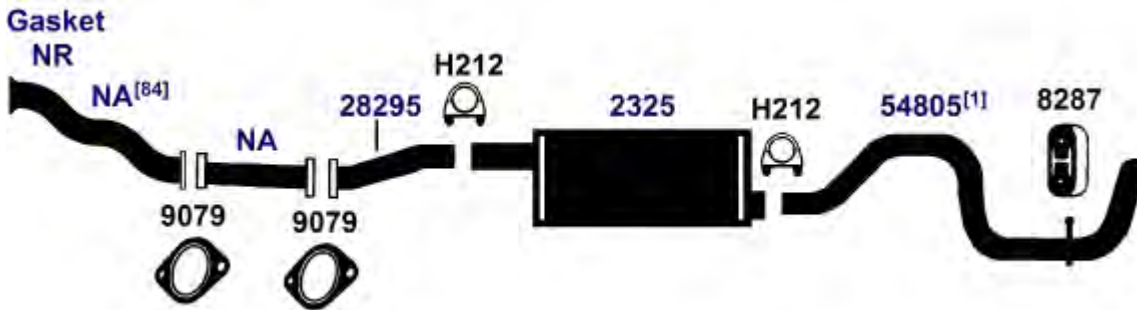

(28366) 88-94 8 Cyl. F350 Series; 133", 155" W.B. Super Cab; 168" W.B. Crew Cab; 7.3L Diesel Engine; except 93-94 Turbo Models
1987 8 Cyl. F350 Series; 133", 155" W.B. Super Cab; 168" W.B. Crew Cab; 6.9L Diesel Engine

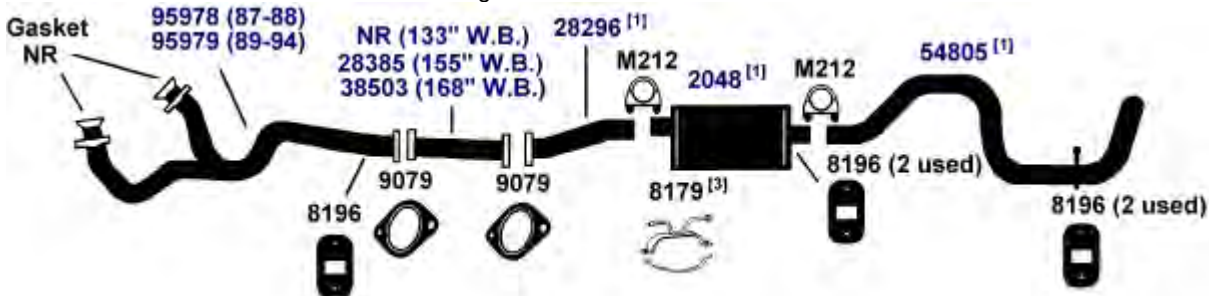

DIRECT FIT MSL/MAXIMUM Muffler... 700046

NA-Not Available. NR-Not Required. FL-Remove and Re-Use Old Flange. ● Golden Warehouse. O.E.-Original Equipment.
Airtube Kit [4948] may be required to complete installation. EFI-Electronic Fuel Injection.

[1] OE system was a welded assembly. It is recommended that all parts noted [1] should be replaced.

[3] Required for installation.

[33] Remove and re-use O.E. heat shield.

[84] Remove and re-use original clamp.

[941] Replaces both front and rear converters, Only failed converters may be replaced.

[958] Federal & California Emission vehicles. Not legal for sale for vehicles licensed in California.

FORD F350 SERIES PICKUP

88-94 8 Cyl. F350 Series; 136", 160" W.B. Chassis Cab; 7.3L Diesel Engine; except 93-94 Turbo Models **(28380)**

85-87 8 Cyl. F350 Series; 136", 160" W.B. Chassis Cab; 6.9L Diesel Engine; From 2-85

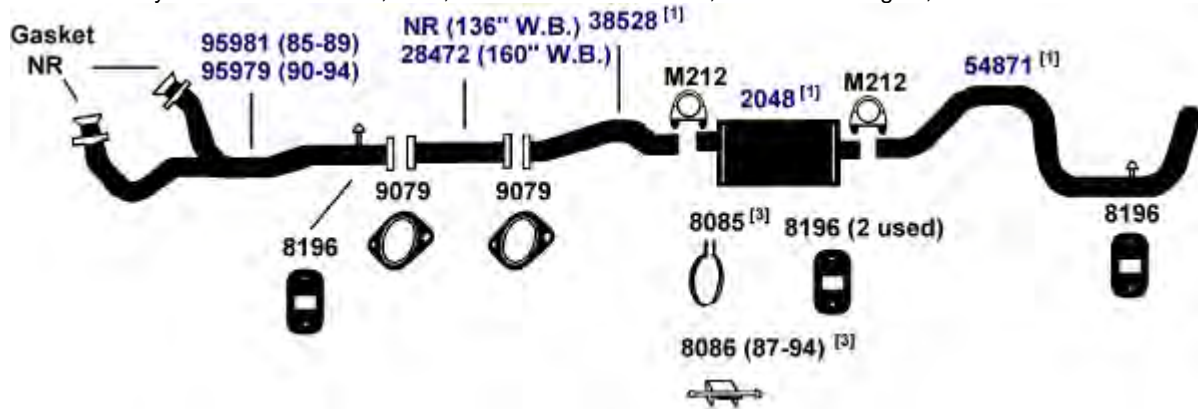

DIRECT FIT MSL/MAXIMUM Muffler... 700046

87-88 8 Cyl. F350 Series; 136", 160" W.B. Chassis Cab; 5.8L, 7.5L Engine; Before 2-88; except 1987 Carb. Models **(28378)**

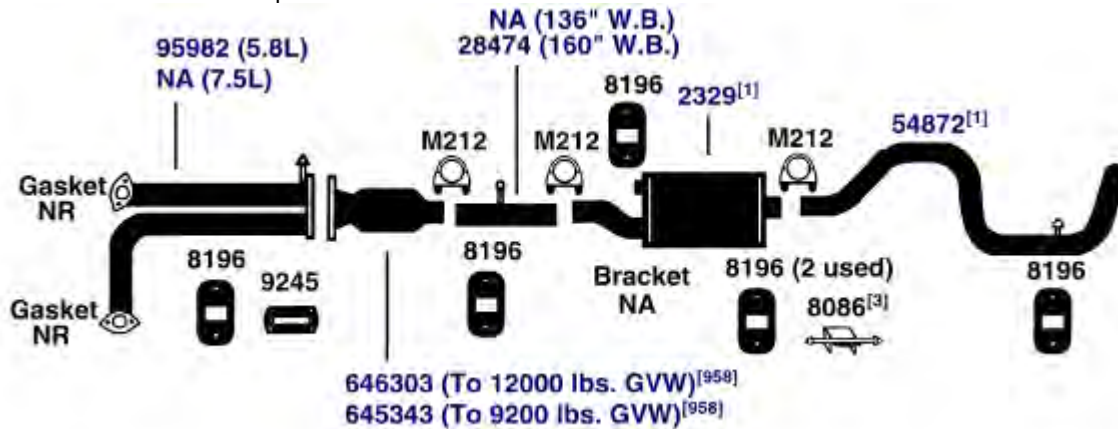

NA-Not Available. NR-Not Required. FL-Remove and Re-Use Old Flange. ● Golden Warehouse. O.E.-Original Equipment.
 # Airtube Kit [4948] may be required to complete installation. EFI-Electronic Fuel Injection.

- [1] OE system was a welded assembly. It is recommended that all parts noted [1] should be replaced. [958] Federal & California Emission vehicles. Not legal for sale for vehicles licensed in California.
- [3] Required for installation.

FORD F350 SERIES PICKUP

(28368) 1987 8 Cyl. F350; 155" W.B. 351 (5.8L) Engine; 2 W.D., 4 W.D.; 1 Ton; (over 8500 lbs. G.V.W.); with Converter

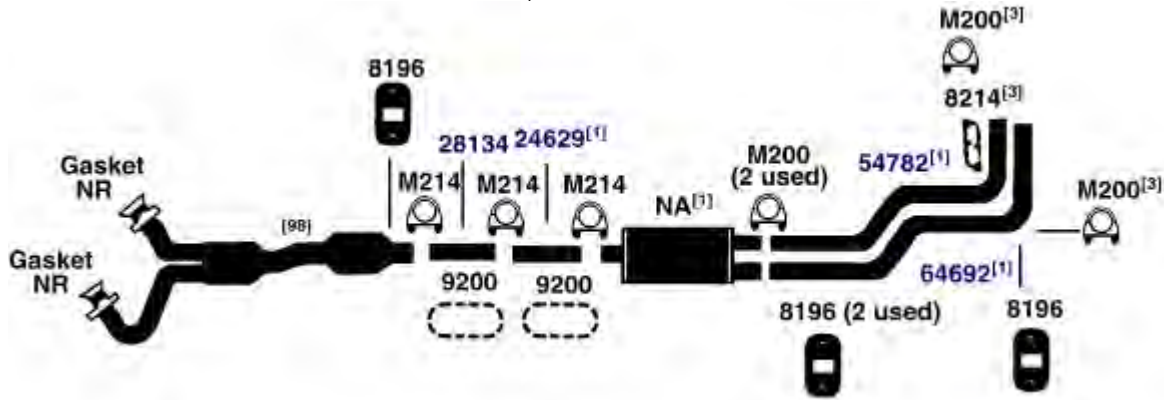

(28369) 1987 8 Cyl. F350; 133" W.B. 351 (5.8L) Engine; 2 W.D., 4 W.D.; 1 Ton; (over 8500 lbs. G.V.W.); with Converter

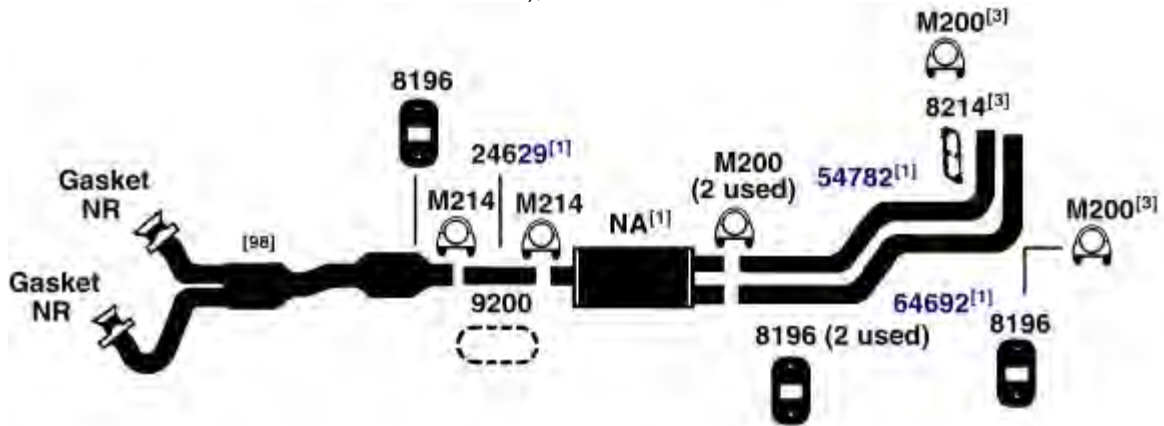

NA-Not Available. NR-Not Required. FL-Remove and Re-Use Old Flange. ● Golden Warehouse. O.E.-Original Equipment.
Airtube Kit [4948] may be required to complete installation. EFI-Electronic Fuel Injection.

- [1] OE system was a welded assembly. It is recommended that all parts noted [1] should be replaced. [98] Refer to current Catalytic Converter catalog or Website catalog for availability.
[3] Required for installation.

FORD F350 SERIES PICKUP

85-87 8 Cyl. F350 Series; 136", 160" W.B. Chassis Cab; 5.8L, 7.5L Engine; From 2-85; **(28365)**
except 1987 with EFI

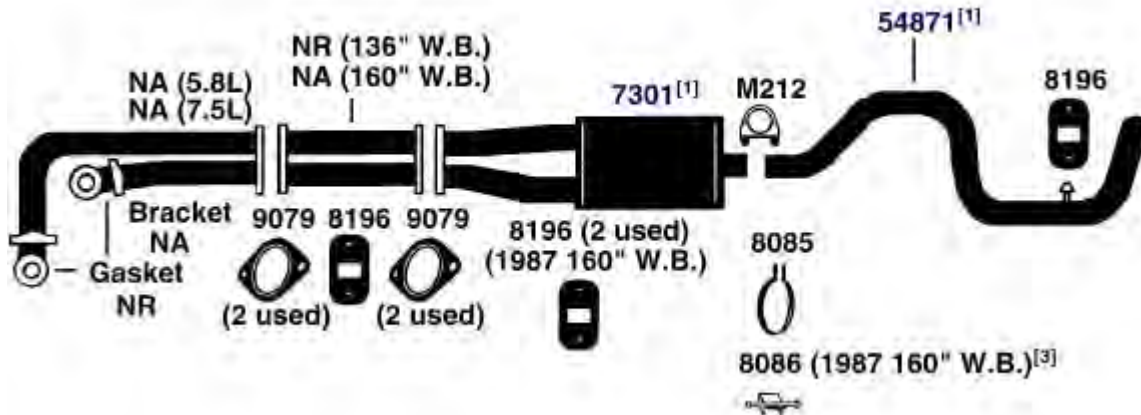

85-87 8 Cyl. F350 Series; 155" W.B. Super Cab; 168" W.B. Crew Cab; 7.5L Engine; 2 W.D., **(28364)**
4 W.D.; 1 Ton; without Converter; From 2-85; except EFI

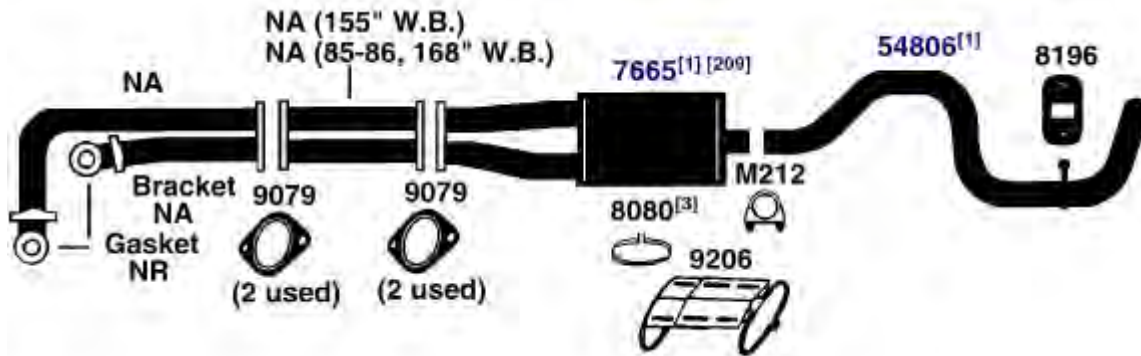

85-87 8 Cyl. F350 Series; 133", 155" W.B. Super Cab; 168" W.B. Crew Cab; 7.5L Engine; **(28373)**
except 1987 with EFI

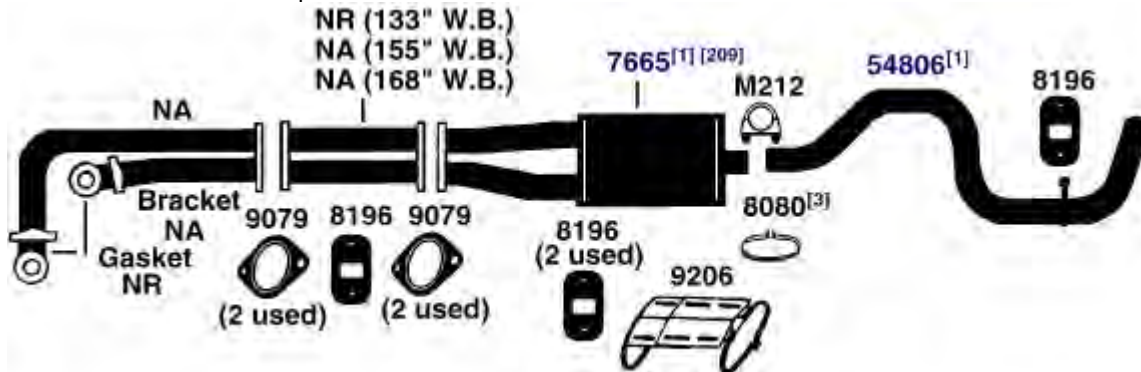

NA-Not Available. NR-Not Required. FL-Remove and Re-Use Old Flange. ● Golden Warehouse. O.E.-Original Equipment.
Airtube Kit [4948] may be required to complete installation. EFI-Electronic Fuel Injection.

- [1] OE system was a welded assembly. It is recommended that all parts noted [1] should be replaced. [209] If muffler does not include heat shield, universal heat shield 9206 is required for installation.
- [3] Required for installation.

FORD F350 SERIES PICKUP

(27124) 85-86 6 Cyl. F350 Series; 160" W.B.; 300 (4.9L) Engine; 2 W.D., 4 W.D.; 1 Ton; Chassis Cab without Converter

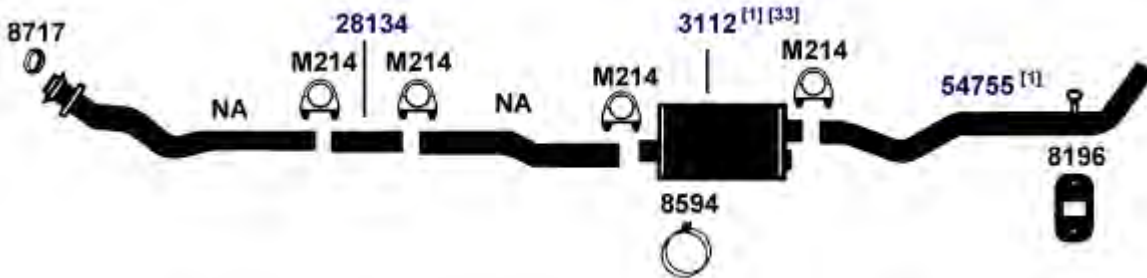

DIRECT FIT MSL/MAXIMUM Muffler... 700001, UNIVERSAL FIT MSL/MAXIMUM Muffler... 6539, 709019, Silentone DIY Muffler... 5534

(27128) 85-86 6 Cyl. F350 Series; 133" W.B.; 300 (4.9L) Engine; 2 W.D., 4 W.D.; 1 Ton; with Converter

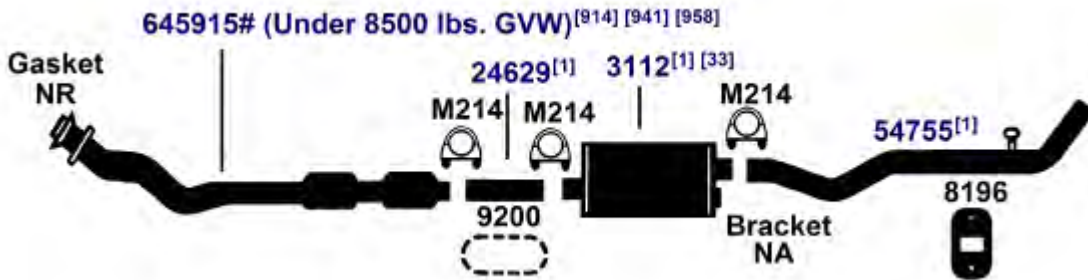

DIRECT FIT MSL/MAXIMUM Muffler... 700001, UNIVERSAL FIT MSL/MAXIMUM Muffler... 6539, 709019, Silentone DIY Muffler... 5534

(27125) 85-86 6 Cyl. F350 Series; 155" W.B.; 300 (4.9L) Engine; 2 W.D., 4 W.D.; 1 Ton; Super Cab with Converter

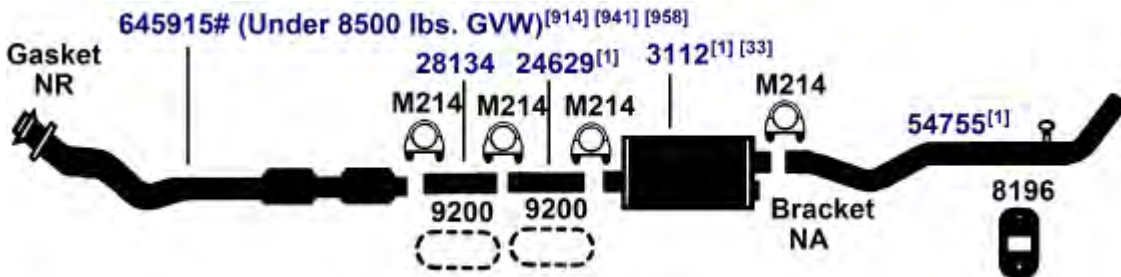

DIRECT FIT MSL/MAXIMUM Muffler... 700001, UNIVERSAL FIT MSL/MAXIMUM Muffler... 6539, 709019, Silentone DIY Muffler... 5534

NA-Not Available. NR-Not Required. FL-Remove and Re-Use Old Flange. ● Golden Warehouse. O.E.-Original Equipment.
Airtube Kit [4948] may be required to complete installation. EFI-Electronic Fuel Injection.

[1] OE system was a welded assembly. It is recommended that all parts noted [1] should be replaced.

[33] Remove and re-use O.E. heat shield.

[914] Direct fit converter includes front (Exhaust) pipe, (1) piece assembly.

[941] Replaces both front and rear converters, Only failed converters may be replaced.

[958] Federal & California Emission vehicles. Not legal for sale for vehicles licensed in California.

FORD F350 SERIES PICKUP

85-86 6 Cyl. F350 Series; 136" W.B.; Chassis Cab; 300 (4.9L) Engine; 2 W.D., 4 W.D.; 1 Ton; without Converter **(27127)**

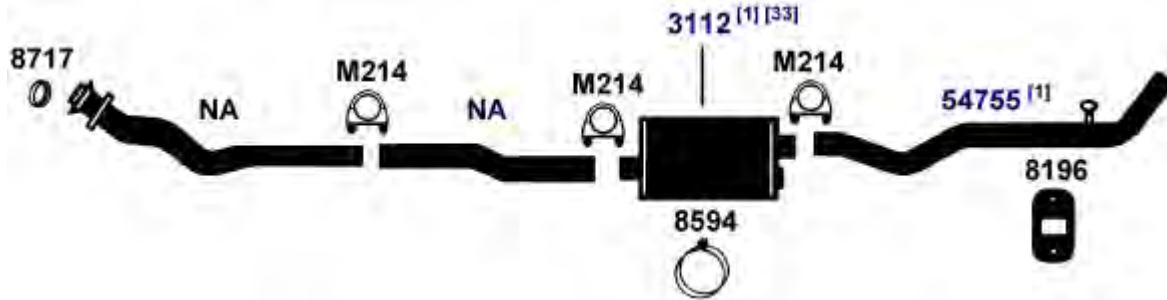

DIRECT FIT MSL/MAXIMUM Muffler... 700001, UNIVERSAL FIT MSL/MAXIMUM Muffler... 6539, 709019, Silentone DIY Muffler... 5534

85-86 6 Cyl. F350 Series; 133" W.B.; 300 (4.9L) Engine; 2 W.D., 4 W.D.; 1 Ton; without Converter **(27129)**

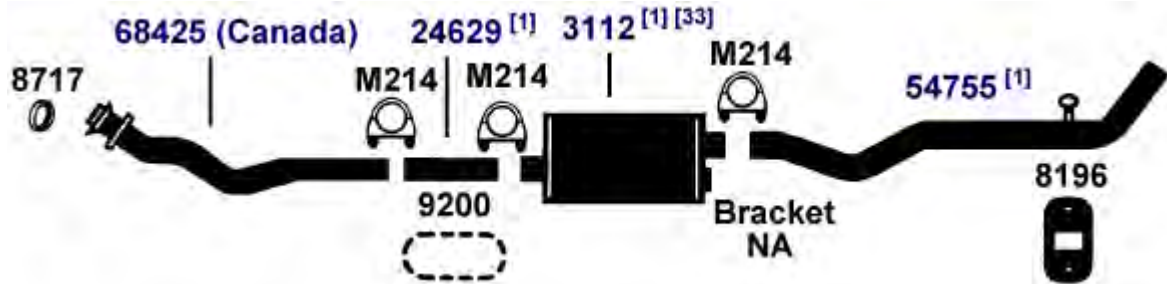

DIRECT FIT MSL/MAXIMUM Muffler... 700001, UNIVERSAL FIT MSL/MAXIMUM Muffler... 6539, 709019, Silentone DIY Muffler... 5534

85-86 6 Cyl. F350 Series; 155" W.B.; 300 (4.9L) Engine; 2 W.D., 4 W.D.; 1 Ton; Super Cab without Converter **(27126)**

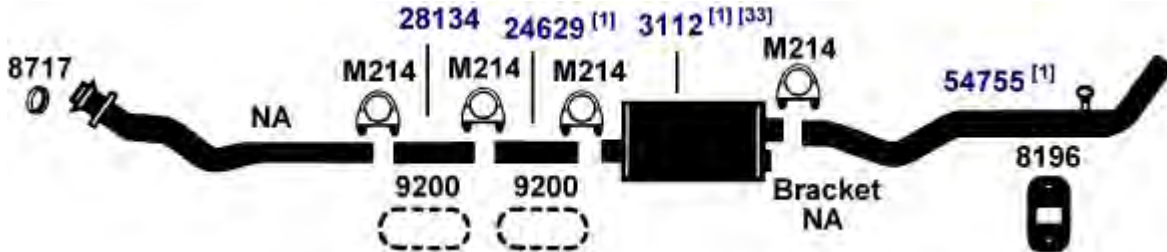

DIRECT FIT MSL/MAXIMUM Muffler... 700001, UNIVERSAL FIT MSL/MAXIMUM Muffler... 6539, 709019, Silentone DIY Muffler... 5534

NA-Not Available. NR-Not Required. FL-Remove and Re-Use Old Flange. ● Golden Warehouse. O.E.-Original Equipment.
Airtube Kit [4948] may be required to complete installation. EFI-Electronic Fuel Injection.

[1] OE system was a welded assembly. It is recommended that all parts noted [1] should be replaced. [33] Remove and re-use O.E. heat shield.

FORD F350 SERIES PICKUP

(28354) 85-86 8 Cyl. F350 Series; 155" W.B.; Super Cab; 351 4-Barrel (5.8L) Engine; 2 W.D., 4 W.D.; 1 Ton; with Converter

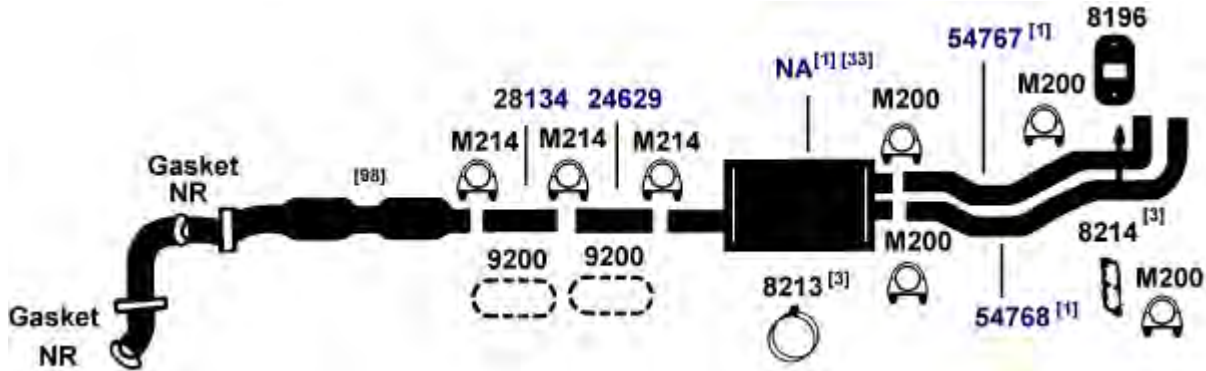

DIRECT FIT MSL/MAXIMUM Muffler... 6585

(28356) 85-86 8 Cyl. F350 Series; 133" W.B.; 351 4-Barrel (5.8L) Engine; 2 W.D., 4 W.D.; 1 Ton; with Converter

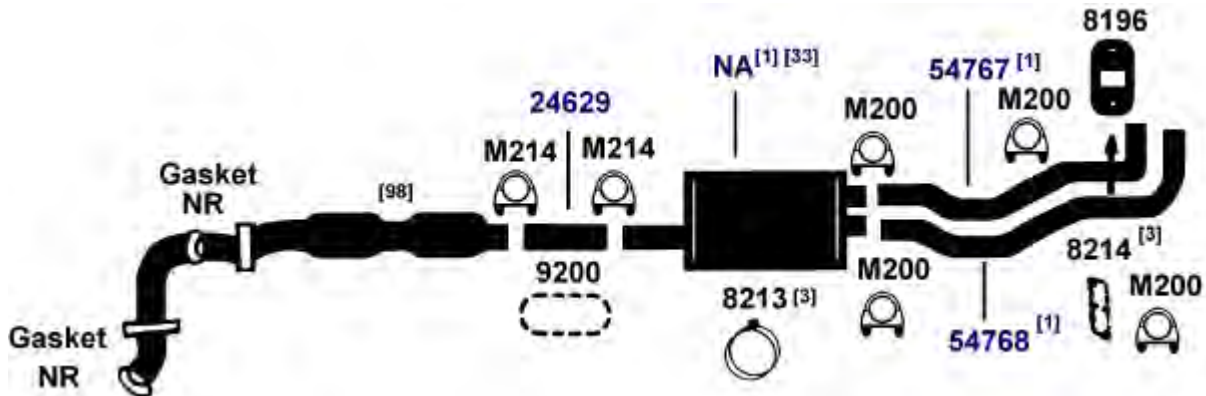

DIRECT FIT MSL/MAXIMUM Muffler... 6585

(28355) 85-86 8 Cyl. F350 Series; 155" W.B.; Super Cab; 351 4-Barrel (5.8L) Engine; 2 W.D., 4 W.D.; 1 Ton; without Converter

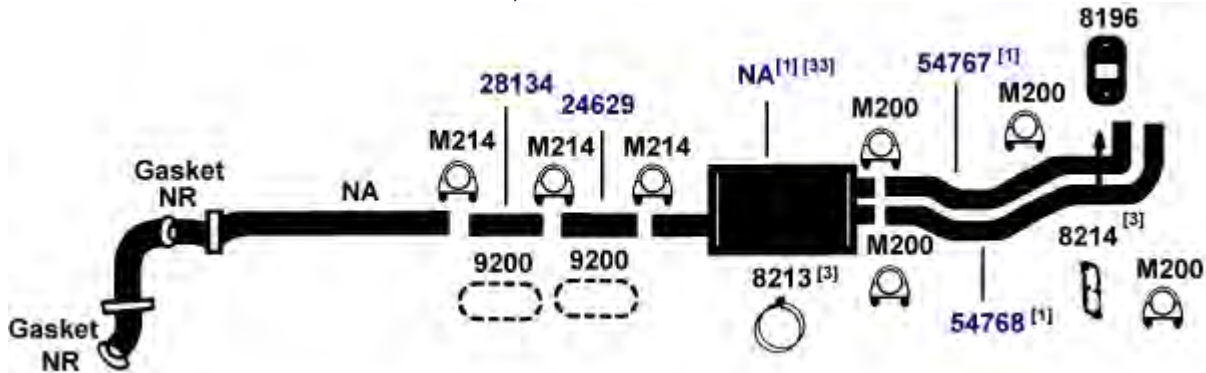

DIRECT FIT MSL/MAXIMUM Muffler... 6585

NA-Not Available. NR-Not Required. FL-Remove and Re-Use Old Flange. ● Golden Warehouse. O.E.-Original Equipment.
Airtube Kit [4948] may be required to complete installation. EFI-Electronic Fuel Injection.

- [1] OE system was a welded assembly. It is recommended that all parts noted [1] should be replaced.
 [3] Required for installation.
 [33] Remove and re-use O.E. heat shield.
 [98] Refer to current Catalytic Converter catalog or Website catalog for availability.

FORD F350 SERIES PICKUP

85-86 8 Cyl. F350 Series; 133" W.B.; 351 4-Barrel (5.8L) Engine; 2 W.D., 4 W.D.; 1 Ton; **(28357)**
without Converter

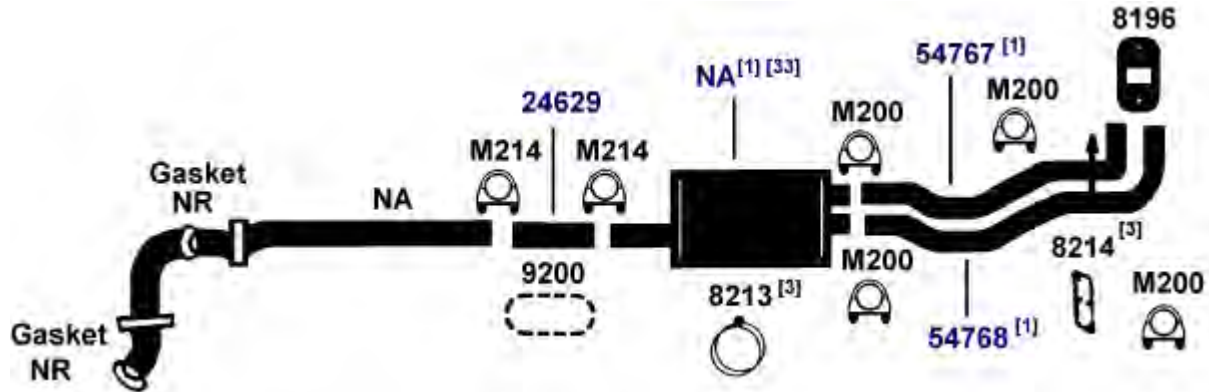

DIRECT FIT MSL/MAXIMUM Muffler... 6585

85-86 8 Cyl. F350 Series; 133", 155" W.B. Super Cab; 168" W.B. Crew Cab; 6.9L Diesel Engine; From 2-85 **(28362)**

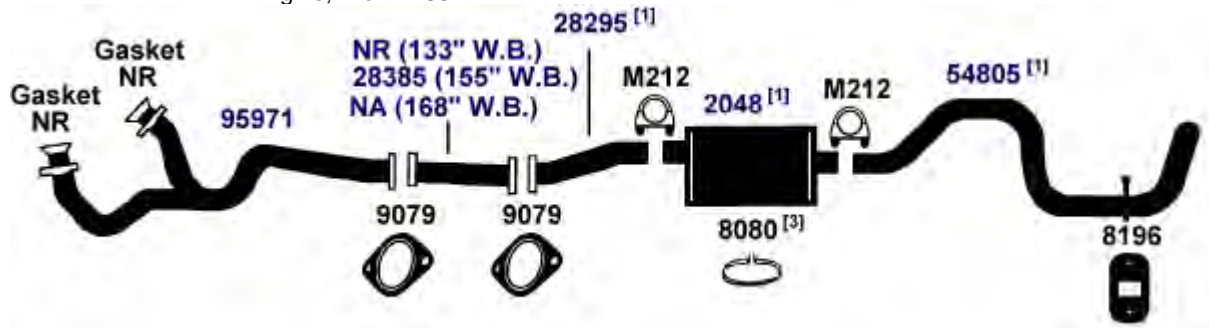

DIRECT FIT MSL/MAXIMUM Muffler... 700046

1985 8 Cyl. F350 Series; 155" W.B.; Super Cab; 351 2-Barrel (5.8L) Engine; 2 W.D., 4 W.D.; 1-Ton; with Converter **(28352)**



DIRECT FIT MSL/MAXIMUM Muffler... 700001, UNIVERSAL FIT MSL/MAXIMUM Muffler... 6539, 709019, Silentone DIY Muffler... 5534

NA-Not Available. NR-Not Required. FL-Remove and Re-Use Old Flange. ● Golden Warehouse. O.E.-Original Equipment.
Airtube Kit [4948] may be required to complete installation. EFI-Electronic Fuel Injection.

- [1] OE system was a welded assembly. It is recommended that all parts noted [1] should be replaced.
- [3] Required for installation.
- [33] Remove and re-use O.E. heat shield.
- [98] Refer to current Catalytic Converter catalog or Website catalog for availability.

FORD F350 SERIES PICKUP

(28353) 1985 8 Cyl. F350 Series; 133" W.B.; 351 2-Barrel (5.8L) Engine; 2 W.D., 4 W.D.; 1 Ton; with Converter

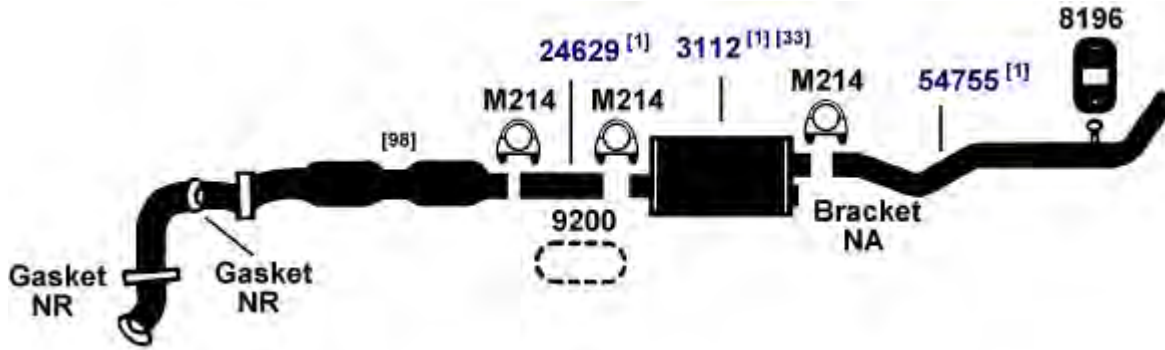

DIRECT FIT MSL/MAXIMUM Muffler... 700001, UNIVERSAL FIT MSL/MAXIMUM Muffler... 6539, 709019, Silentone DIY Muffler... 5534

(28348) 1985 8 Cyl. F350 Series; 136" W.B.; Chassis Cab; 351 2-Barrel (5.8L) Engine; 2 W.D., 4 W.D.; 1 Ton; without Converter

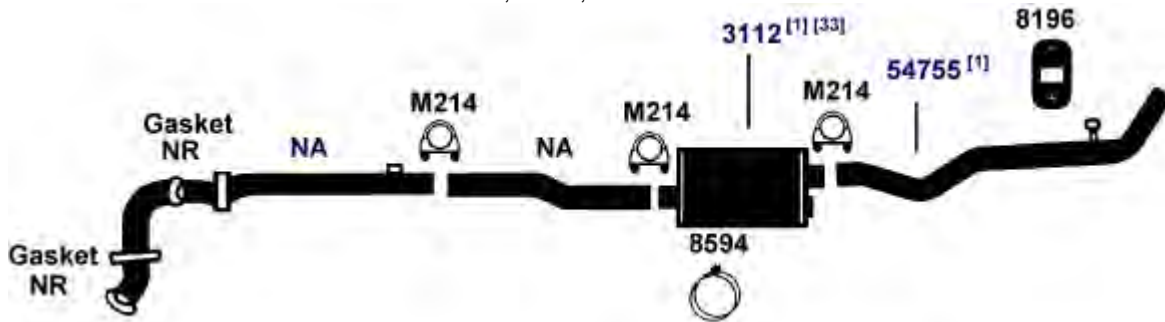

DIRECT FIT MSL/MAXIMUM Muffler... 700001, UNIVERSAL FIT MSL/MAXIMUM Muffler... 6539, 709019, Silentone DIY Muffler... 5534

(28359) 1985 8 Cyl. F350 Series; 133" W.B.; 460 (7.5L) Engine; 2 W.D., 4 W.D.; 1 Ton; without Converter; Before 2-85

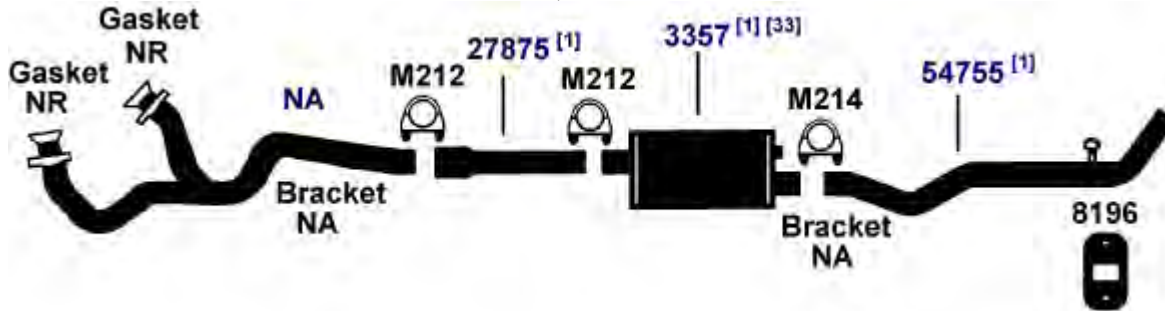

NA-Not Available. NR-Not Required. FL-Remove and Re-Use Old Flange. ● Golden Warehouse. O.E.-Original Equipment.
Airtube Kit [4948] may be required to complete installation. EFI-Electronic Fuel Injection.

[1] OE system was a welded assembly. It is recommended that all parts noted [1] [98] Refer to current Catalytic Converter catalog or Website catalog for availability. should be replaced.

[33] Remove and re-use O.E. heat shield.

FORD F350 SERIES PICKUP

1985 8 Cyl. F350 Series; 155" W.B.; Super Cab; 168" W.B.; Crew Cab; 460 (7.5L) Engine; 2 W.D., 4 W.D.; 1 Ton; without Converter; Before 2-85 **(28358)**

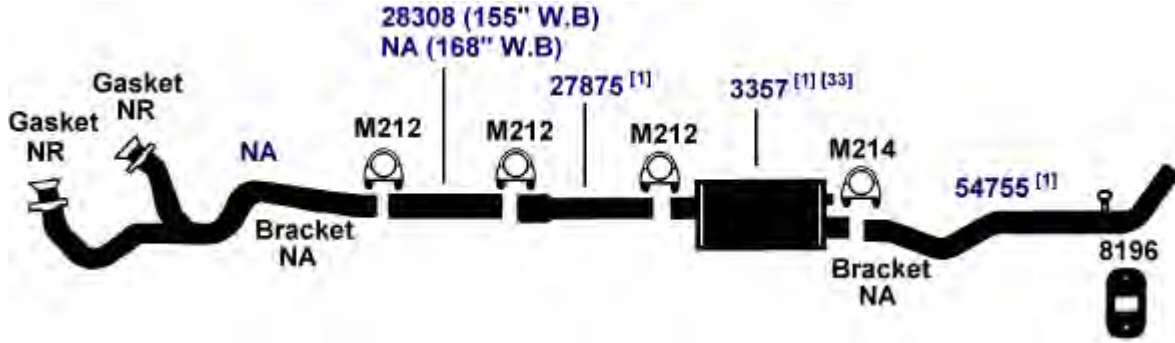

1985 8 Cyl. F350 Series; 133" W.B.; 420 (6.9L) Diesel Engine; 2 W.D., 4 W.D.; 1 Ton; Before 2-85 **(28361)**

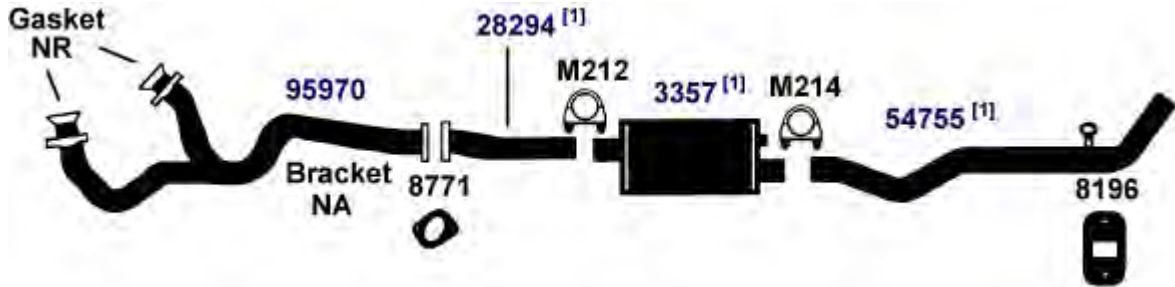

1985 8 Cyl. F350 Series; 155" W.B.; Super Cab; 168" W.B.; Crew Cab; 420 (6.9L) Diesel Engine; 2 W.D., 4 W.D.; 1 Ton; Before 2-85 **(28360)**

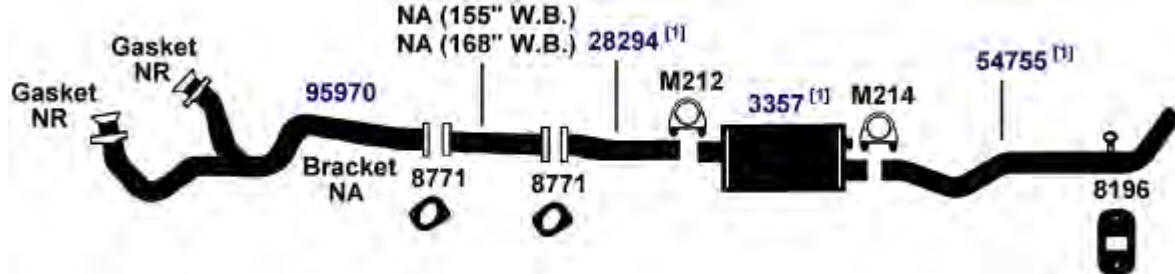

1985 8 Cyl. F350 Series; 160" W.B.; Chassis Cab; 351 2-Barrel (5.8L) Engine; 2 W.D., 4 W.D.; 1 Ton; without Converter **(28349)**

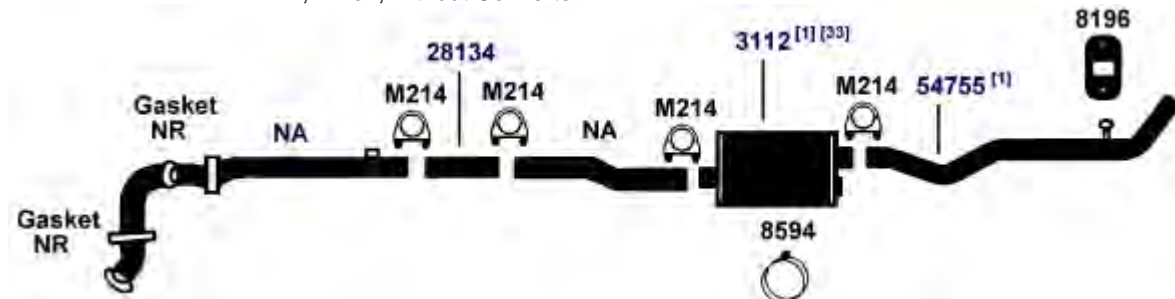

DIRECT FIT MSL/MAXIMUM Muffler... 700001, UNIVERSAL FIT MSL/MAXIMUM Muffler... 6539, 709019, Silentone DIY Muffler... 5534

NA-Not Available. NR-Not Required. FL-Remove and Re-Use Old Flange. • Golden Warehouse. O.E.-Original Equipment. # Airtube Kit [4948] may be required to complete installation. EFI-Electronic Fuel Injection.

[1] OE system was a welded assembly. It is recommended that all parts noted [1] [33] Remove and re-use O.E. heat shield. should be replaced.

FORD F350 SERIES PICKUP

(28350) 1985 8 Cyl. F350 Series; 155" W.B.; Super Cab; 351 2-Barrel (5.8L) Engine; 2 W.D., 4 W.D.; 1-Ton; without Converter

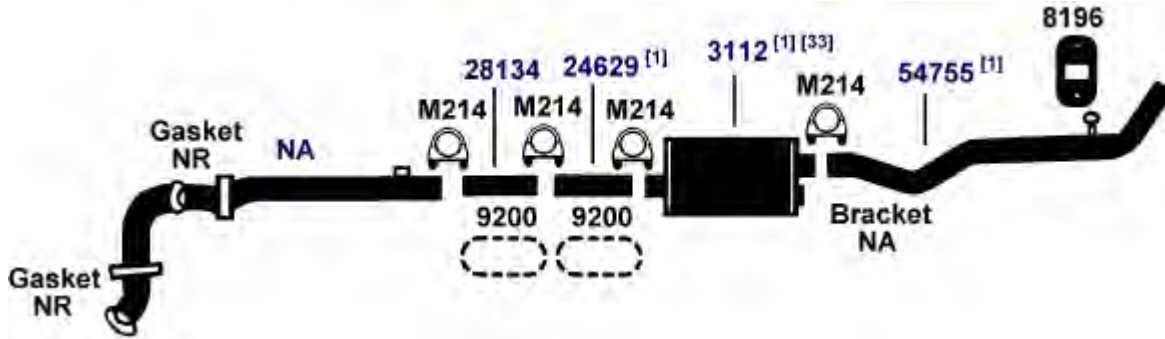

DIRECT FIT MSL/MAXIMUM Muffler... 700001, UNIVERSAL FIT MSL/MAXIMUM Muffler... 6539, 709019, Silentone DIY Muffler... 5534

(28351) 1985 8 Cyl. F350 Series; 133" W.B.; 351 2-Barrel (5.8L) Engine; 2 W.D., 4 W.D.; 1 Ton; without Converter

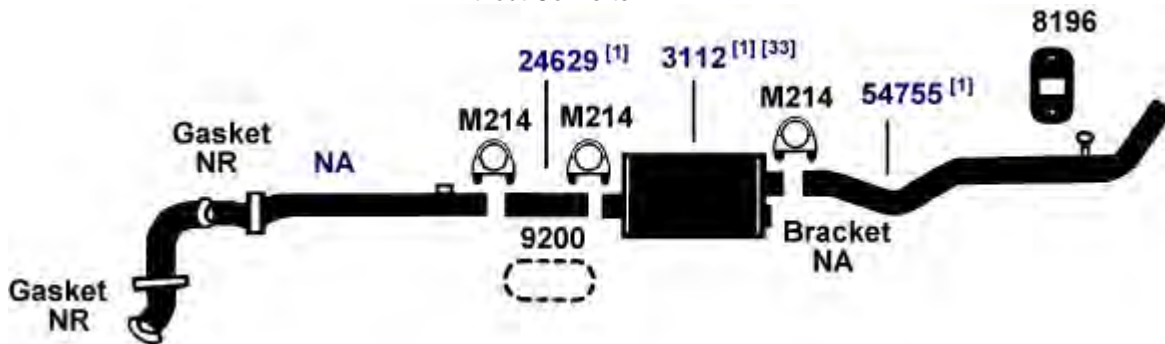

DIRECT FIT MSL/MAXIMUM Muffler... 700001, UNIVERSAL FIT MSL/MAXIMUM Muffler... 6539, 709019, Silentone DIY Muffler... 5534

(28357E) 1984 8 Cyl. F350 Series; 133" W.B.; 351 4-Barrel (5.8L) Engine; 2 W.D., 4 W.D.; 1 Ton; without Converter

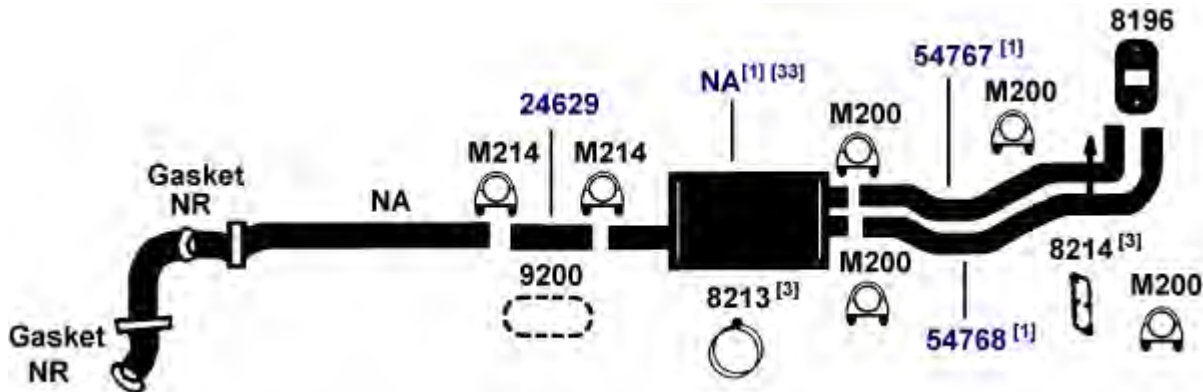

DIRECT FIT MSL/MAXIMUM Muffler... 6585

NA-Not Available. NR-Not Required. FL-Remove and Re-Use Old Flange. ● Golden Warehouse. O.E.-Original Equipment.
Airtube Kit [4948] may be required to complete installation. EFI-Electronic Fuel Injection.

- [1] OE system was a welded assembly. It is recommended that all parts noted [1] should be replaced.
[3] Required for installation.

FORD F350 SERIES PICKUP

1984 8 Cyl. F350 Series; 155" W.B.; Super Cab; 351 4-Barrel (5.8L) Engine; 2 W.D., 4 W.D.; (28355E)
1 Ton; without Converter

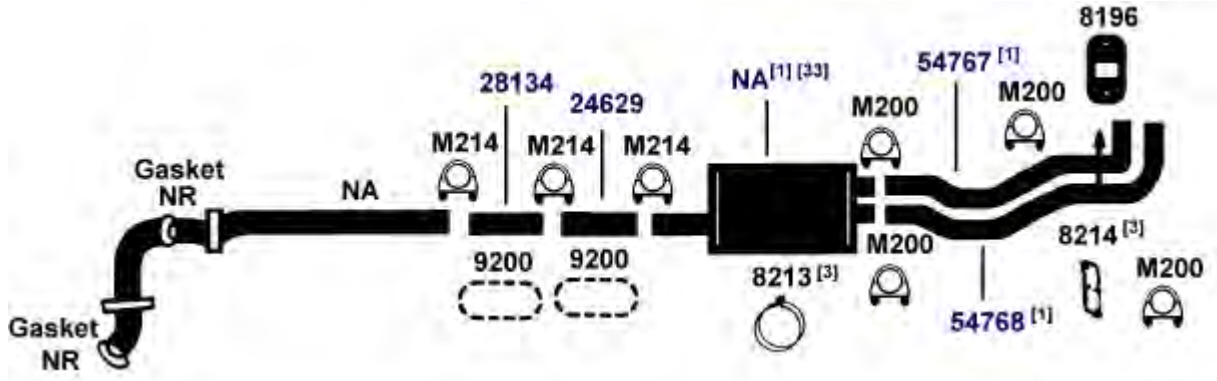

DIRECT FIT MSL/MAXIMUM Muffler... 6585

1984 8 Cyl. F350 Series; 133" W.B.; 351 4-Barrel (5.8L) Engine; 2 W.D., 4 W.D.; 1 Ton; with (28356E)
Converter

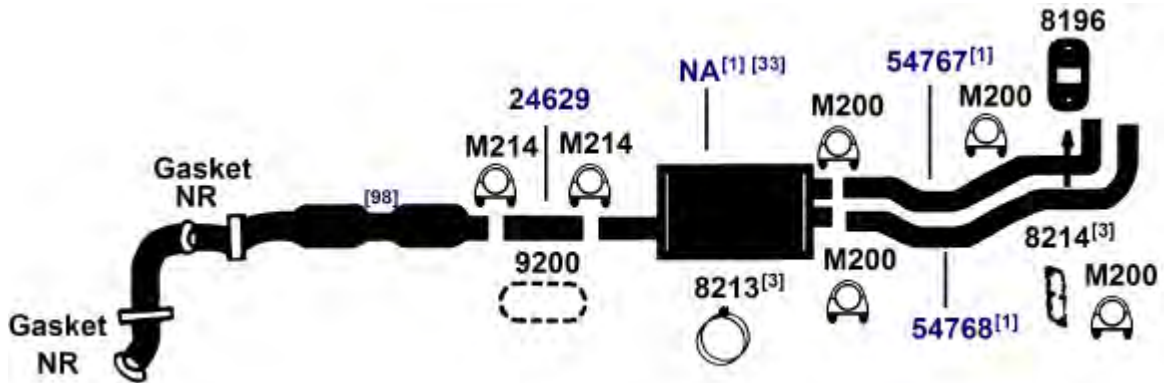

DIRECT FIT MSL/MAXIMUM Muffler... 6585

1984 8 Cyl. F350 Series; 155" W.B.; Super Cab; 351 4-Barrel (5.8L) Engine; 2 W.D., 4 W.D.; (28354E)
1 Ton; with Converter

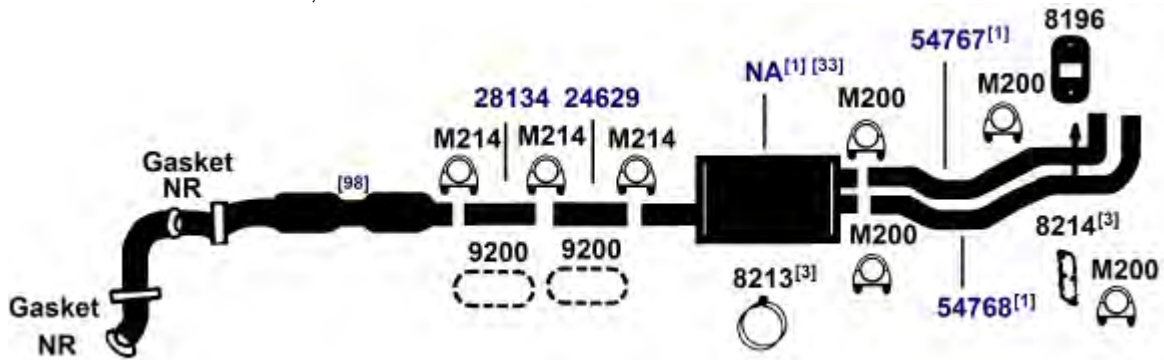

DIRECT FIT MSL/MAXIMUM Muffler... 6585

NA-Not Available. NR-Not Required. FL-Remove and Re-Use Old Flange. ● Golden Warehouse. O.E.-Original Equipment.
Airtube Kit [4948] may be required to complete installation. EFI-Electronic Fuel Injection.

- [1] OE system was a welded assembly. It is recommended that all parts noted [1] should be replaced.
- [33] Remove and re-use O.E. heat shield.
- [98] Refer to current Catalytic Converter catalog or Website catalog for availability.
- [3] Required for installation.

FORD F350 SERIES PICKUP

(27129E) 83-84 6 Cyl. F350 Series; 133" W.B.; 300 (4.9L) Engine; 2 W.D., 4 W.D.; 1 Ton; without Converter

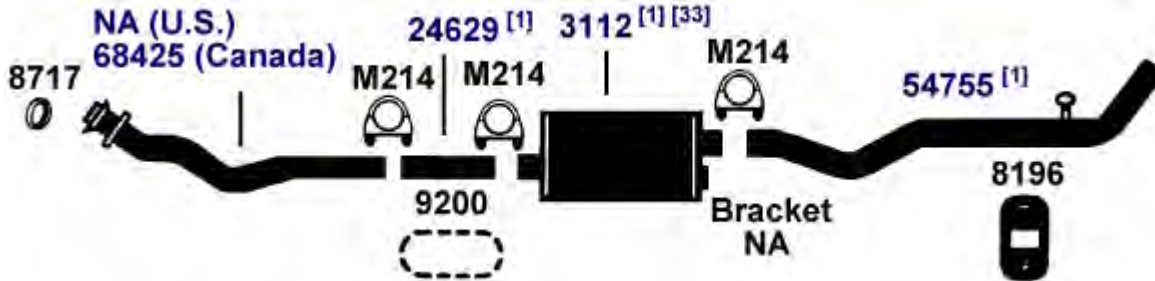

DIRECT FIT MSL/MAXIMUM Muffler... 700001, UNIVERSAL FIT MSL/MAXIMUM Muffler... 6539, 709019, Silentone DIY Muffler... 5534

(27128E) 83-84 6 Cyl. F350 Series; 133" W.B.; 300 (4.9L) Engine; 2 W.D., 4 W.D.; 1 Ton; with Converter

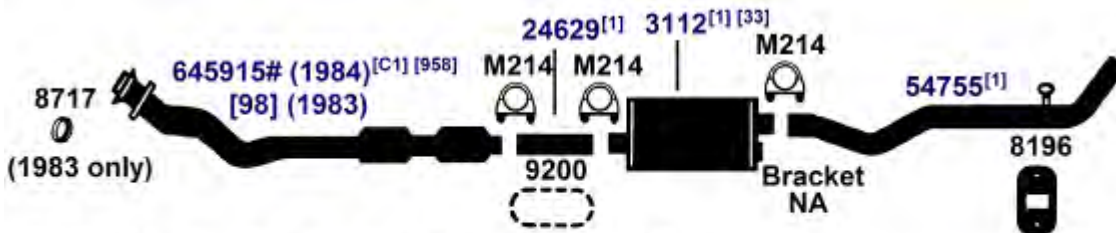

**[C1] Combination Front & Rear Converter, 2 to 1 Replacement.
Only Defective Converters May Legally Be Replaced.**

DIRECT FIT MSL/MAXIMUM Muffler... 700001, UNIVERSAL FIT MSL/MAXIMUM Muffler... 6539, 709019, Silentone DIY Muffler... 5534

(27127E) 83-84 6 Cyl. F350 Series; 136" W.B.; Chassis Cab; 300 (4.9L) Engine; 2 W.D., 4 W.D.; 1 Ton; without Converter

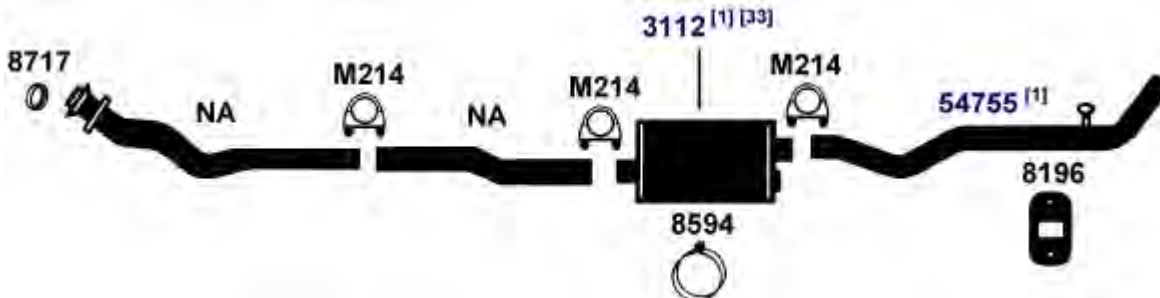

DIRECT FIT MSL/MAXIMUM Muffler... 700001, UNIVERSAL FIT MSL/MAXIMUM Muffler... 6539, 709019, Silentone DIY Muffler... 5534

NA-Not Available. NR-Not Required. FL-Remove and Re-Use Old Flange. ● Golden Warehouse. O.E.-Original Equipment.
Airtube Kit [4948] may be required to complete installation. EFI-Electronic Fuel Injection.

[1] OE system was a welded assembly. It is recommended that all parts noted [1] should be replaced. [958] Federal & California Emission vehicles. Not legal for sale for vehicles licensed in California.

[33] Remove and re-use O.E. heat shield.

FORD F350 SERIES PICKUP

83-84 6 Cyl. F350 Series; 155" W.B.; 300 (4.9L) Engine; 2 W.D., 4 W.D.; 1 Ton; Super Cab **(27125E)**
with Converter



**[C1] Combination Front & Rear Converter, 2 to 1 Replacement.
Only Defective Converters May Legally Be Replaced.**

DIRECT FIT MSL/MAXIMUM Muffler... 700001, UNIVERSAL FIT MSL/MAXIMUM Muffler... 6539, 709019, Silentone DIY Muffler... 5534

83-84 6 Cyl. F350 Series; 155" W.B.; 300 (4.9L) Engine; 2 W.D., 4 W.D.; 1 Ton; Super Cab **(27126E)**
without Converter

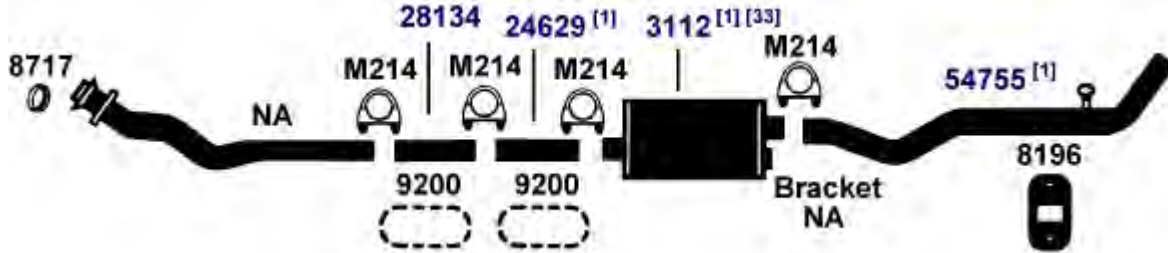

DIRECT FIT MSL/MAXIMUM Muffler... 700001, UNIVERSAL FIT MSL/MAXIMUM Muffler... 6539, 709019, Silentone DIY Muffler... 5534

83-84 6 Cyl. F350 Series; 160" W.B.; 300 (4.9L) Engine; 2 W.D., 4 W.D.; 1 Ton; Chassis Cab **(27124E)**
without Converter

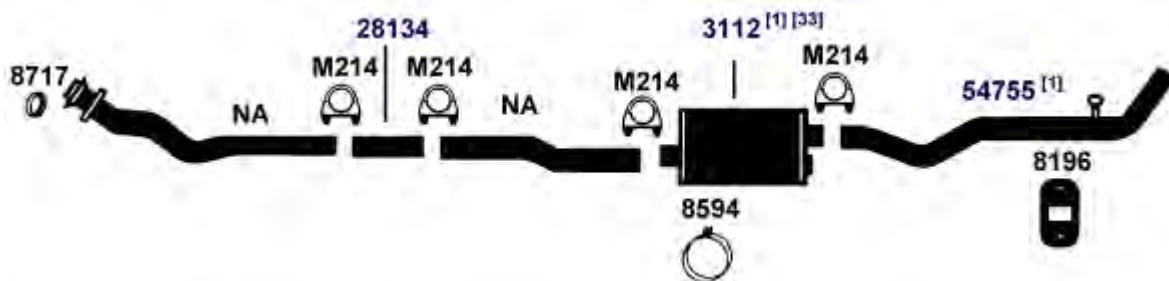

DIRECT FIT MSL/MAXIMUM Muffler... 700001, UNIVERSAL FIT MSL/MAXIMUM Muffler... 6539, 709019, Silentone DIY Muffler... 5534

NA-Not Available. NR-Not Required. FL-Remove and Re-Use Old Flange. ● Golden Warehouse. O.E.-Original Equipment.
Airtube Kit [4948] may be required to complete installation. EFI-Electronic Fuel Injection.

[1] OE system was a welded assembly. It is recommended that all parts noted [1] should be replaced.
[33] Remove and re-use O.E. heat shield.

[98] Refer to current Catalytic Converter catalog or Website catalog for availability.
[958] Federal & California Emission vehicles. Not legal for sale for vehicles licensed in California.

FORD F350 SERIES PICKUP

(28349E) 83-84 8 Cyl. F350 Series; 160" W.B.; Chassis Cab; 351 2-Barrel (5.8L) Engine; 2 W.D., 4 W.D.; 1 Ton; without Converter

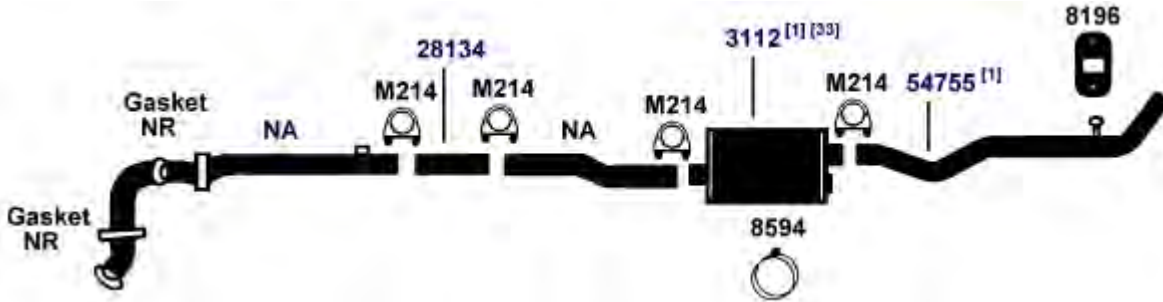

DIRECT FIT MSL/MAXIMUM Muffler... 700001, UNIVERSAL FIT MSL/MAXIMUM Muffler... 6539, 709019, Silentone DIY Muffler... 5534

(28352E) 83-84 8 Cyl. F350 Series; 155" W.B.; Super Cab; 351 2-Barrel (5.8L) Engine; 2 W.D., 4 W.D.; 1-Ton; with Converter

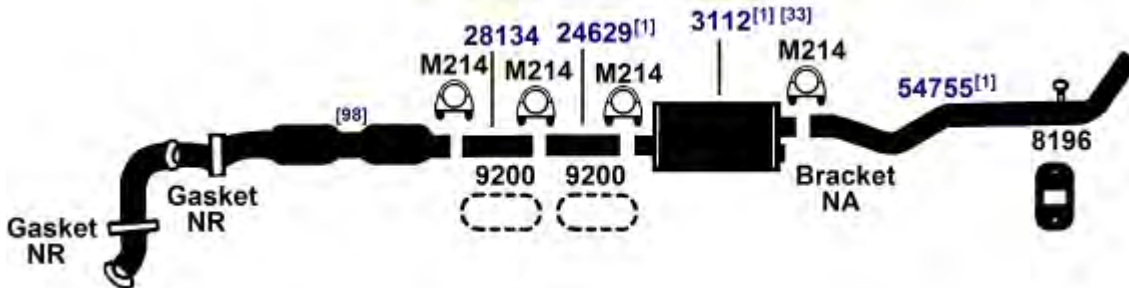

DIRECT FIT MSL/MAXIMUM Muffler... 700001, UNIVERSAL FIT MSL/MAXIMUM Muffler... 6539, 709019, Silentone DIY Muffler... 5534

(28350E) 83-84 8 Cyl. F350 Series; 155" W.B.; Super Cab; 351 2-Barrel (5.8L) Engine; 2 W.D., 4 W.D.; 1-Ton; without Converter
80-82 8 Cyl. F350 Series; 155" W.B.; Super Cab; 351 2-Barrel (5.8L) (1982); 351, 400 (80-81) Engine; 2 W.D.; 4 W.D.; 1 Ton; without Converter

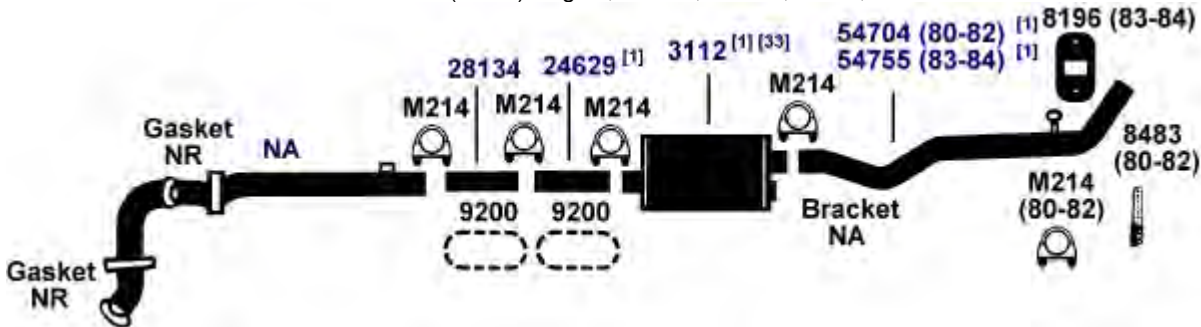

DIRECT FIT MSL/MAXIMUM Muffler... 700001, UNIVERSAL FIT MSL/MAXIMUM Muffler... 6539, 709019, Silentone DIY Muffler... 5534

NA-Not Available. NR-Not Required. FL-Remove and Re-Use Old Flange. ● Golden Warehouse. O.E.-Original Equipment.
Airtube Kit [4948] may be required to complete installation. EFI-Electronic Fuel Injection.

[1] OE system was a welded assembly. It is recommended that all parts noted [1] should be replaced. [98] Refer to current Catalytic Converter catalog or Website catalog for availability.

[33] Remove and re-use O.E. heat shield.

FORD F350 SERIES PICKUP

83-84 8 Cyl. F350 Series; 133" W.B.; 460 (7.5L) Engine; 2 W.D., 4 W.D.; 1 Ton; without Converter **(28359E)**

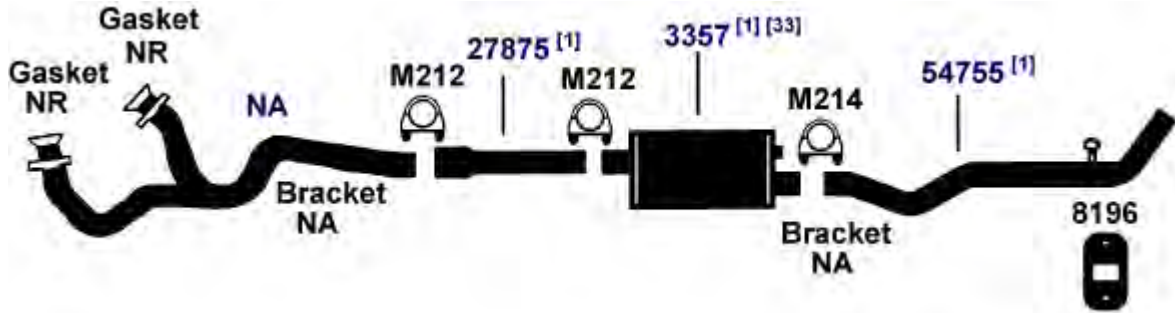

83-84 8 Cyl. F350 Series; 155" W.B.; Super Cab; 168" W.B.; Crew Cab; 460 (7.5L) Engine; 2 W.D., 4 W.D.; 1 Ton; without Converter **(28358E)**

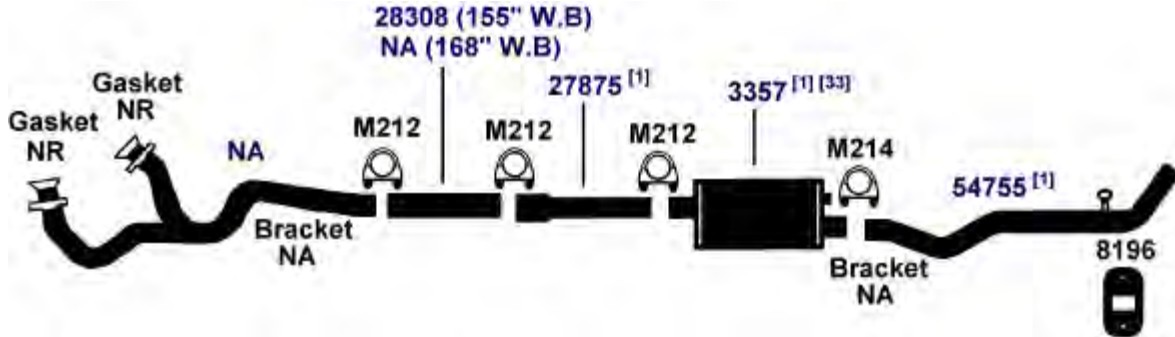

83-84 8 Cyl. F350 Series; 133" W.B.; 351 2-Barrel (5.8L) Engine; 2 W.D., 4 W.D.; 1 Ton; with Converter **(28353E)**

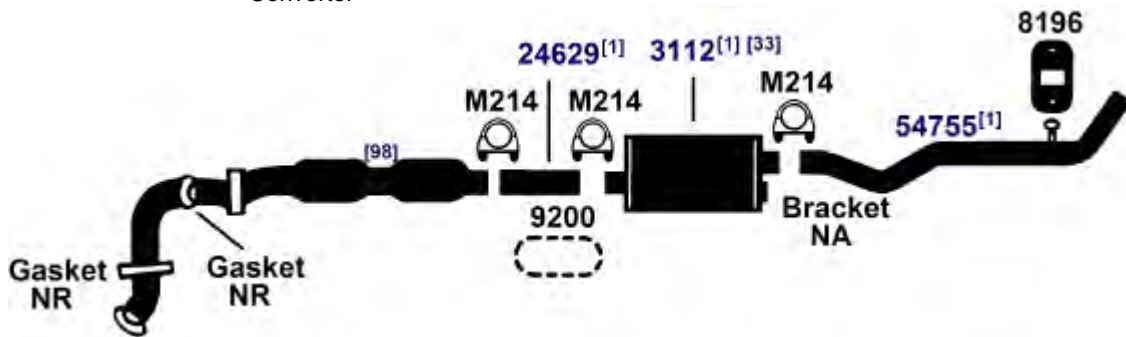

DIRECT FIT MSL/MAXIMUM Muffler... 700001, UNIVERSAL FIT MSL/MAXIMUM Muffler... 6539, 709019, Silentone DIY Muffler... 5534

NA-Not Available. NR-Not Required. FL-Remove and Re-Use Old Flange. ● Golden Warehouse. O.E.-Original Equipment.
Airtube Kit [4948] may be required to complete installation. EFI-Electronic Fuel Injection.

- [1] OE system was a welded assembly. It is recommended that all parts noted [1] should be replaced.
- [33] Remove and re-use O.E. heat shield.
- [98] Refer to current Catalytic Converter catalog or Website catalog for availability.

FORD F350 SERIES PICKUP

(28360E) 83-84 8 Cyl. F350 Series; 155" W.B.; Super Cab; 168" W.B.; Crew Cab; 420 (6.9L) Diesel Engine; 2 W.D., 4 W.D.; 1 Ton

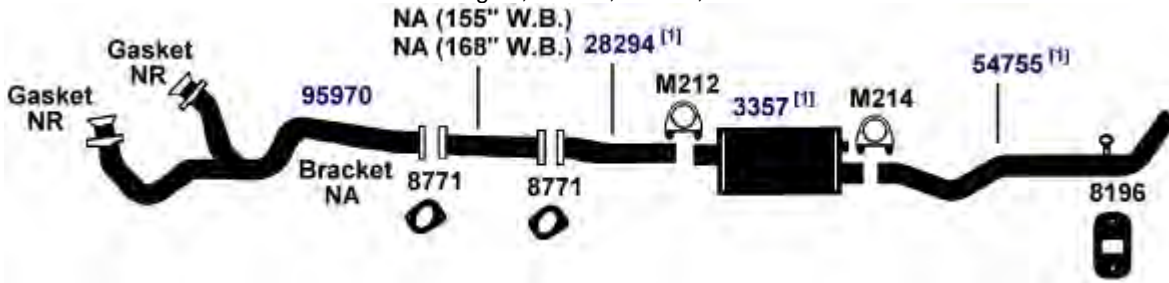

(28348E) 83-84 8 Cyl. F350 Series; 136" W.B.; Chassis Cab; 351 2-Barrel (5.8L) Engine; 2 W.D., 4 W.D.; 1 Ton; without Converter
 80-82 8 Cyl. F350 Series; 136" W.B.; Chassis Cab; 351 2-Barrel (5.8L) (1982); 351, 400 (80-81) Engine; 2 W.D., 4 W.D.; 1 Ton; without Converter

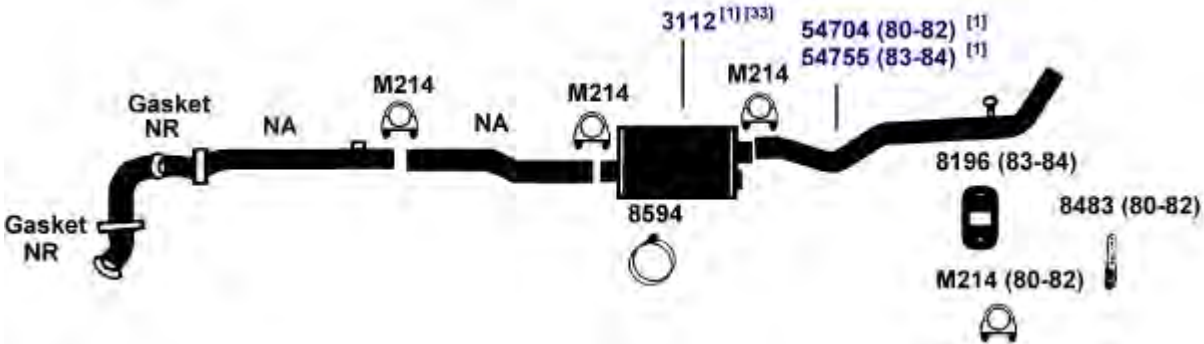

DIRECT FIT MSL/MAXIMUM Muffler... 700001, UNIVERSAL FIT MSL/MAXIMUM Muffler... 6539, 709019, Silentone DIY Muffler... 5534

(28361E) 83-84 8 Cyl. F350 Series; 133" W.B.; 420 (6.9L) Diesel Engine; 2 W.D., 4 W.D.; 1 Ton

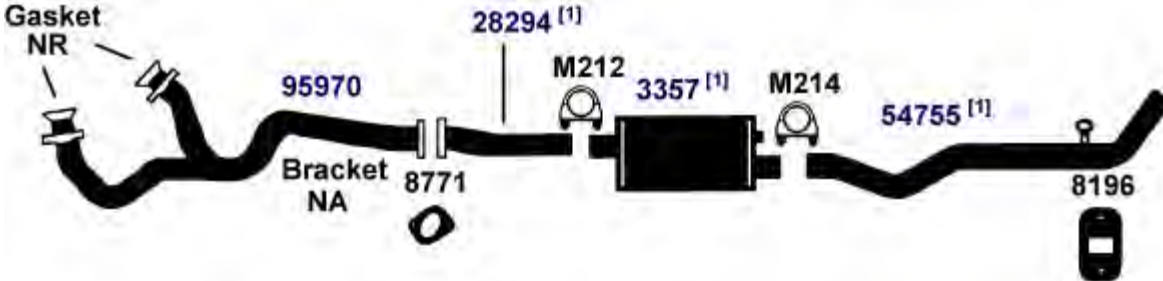

NA-Not Available. NR-Not Required. FL-Remove and Re-Use Old Flange. ● Golden Warehouse. O.E.-Original Equipment.
 # Airtube Kit [4948] may be required to complete installation. EFI-Electronic Fuel Injection.

[1] OE system was a welded assembly. It is recommended that all parts noted [1] should be replaced. [33] Remove and re-use O.E. heat shield.

FORD F350 SERIES PICKUP

82-84 8 Cyl. F350 Series; 133" W.B.; 351 2-Barrel (5.8L) Engine; 2 W.D., 4 W.D.; 1 Ton; without Converter **(28351E)**

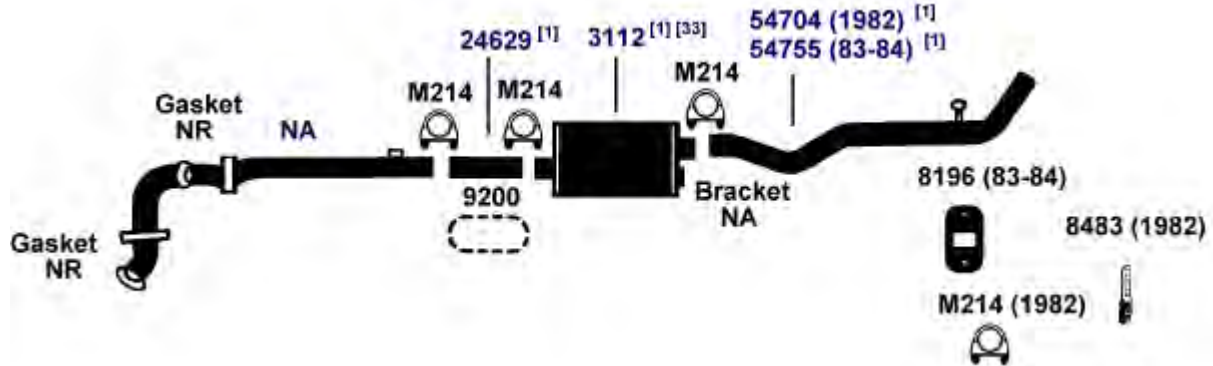

DIRECT FIT MSL/MAXIMUM Muffler... 700001, UNIVERSAL FIT MSL/MAXIMUM Muffler... 6539, 709019, Silentone DIY Muffler... 5534

1982 8 Cyl. F350 Series; 133" W.B.; 351 2-Barrel, 400 (5.8L, 6.5L) Engine; 2 W.D., 4 W.D.; 1 Ton; with Converter **(28346)**

1981 8 Cyl. F350 Series; 133" W.B.; 351, 400 Engine; 2 W.D., 4 W.D.; 1 Ton; Regular Cab; with Converter

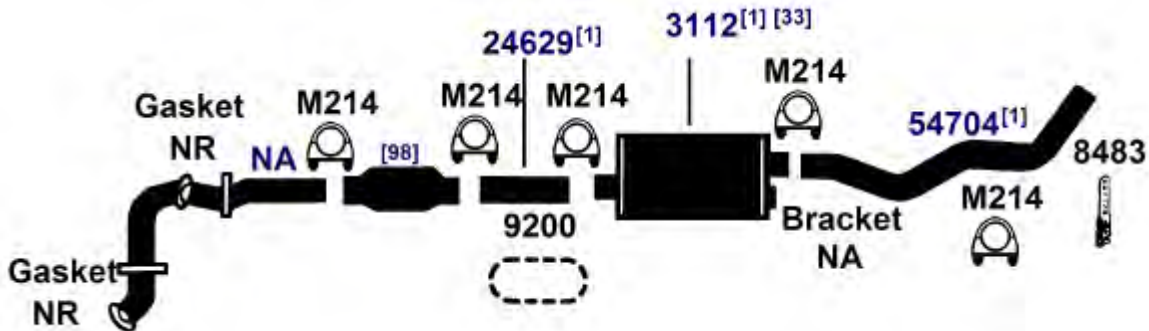

DIRECT FIT MSL/MAXIMUM Muffler... 700001, UNIVERSAL FIT MSL/MAXIMUM Muffler... 6539, 709019, Silentone DIY Muffler... 5534

81-82 6 Cyl. F350 Series; 133" W.B.; 300 (4.9L) Engine; 2 W.D., 4 W.D.; 1 Ton; Regular Cab; with Converter **(27123)**

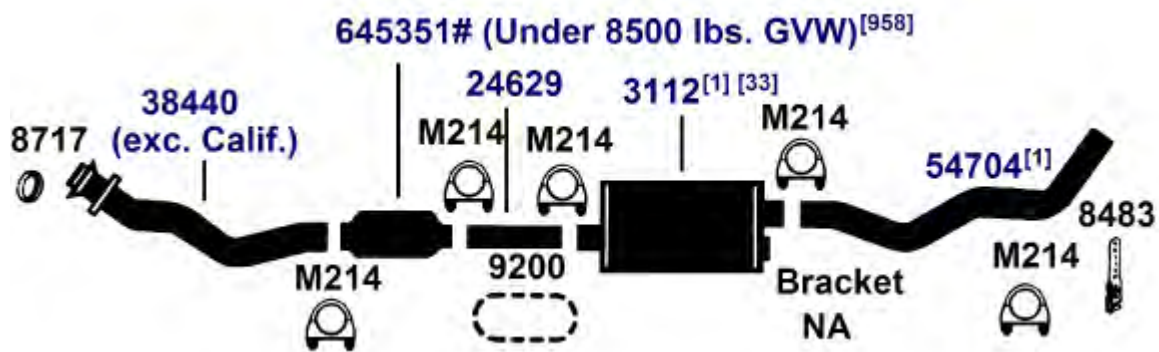

DIRECT FIT MSL/MAXIMUM Muffler... 700001, UNIVERSAL FIT MSL/MAXIMUM Muffler... 6539, 709019, Silentone DIY Muffler... 5534

NA-Not Available. NR-Not Required. FL-Remove and Re-Use Old Flange. ● Golden Warehouse. O.E.-Original Equipment.
Airtube Kit [4948] may be required to complete installation. EFI-Electronic Fuel Injection.

[1] OE system was a welded assembly. It is recommended that all parts noted [1] should be replaced.
[33] Remove and re-use O.E. heat shield.
[98] Refer to current Catalytic Converter catalog or Website catalog for availability.
[958] Federal & California Emission vehicles. Not legal for sale for vehicles licensed in California.

FORD F350 SERIES PICKUP

(27122) 81-82 6 Cyl. F350 Series; 133" W.B.; 300 (4.9L) Engine; 2 W.D.; 1 Ton; Regular Cab; without Converter

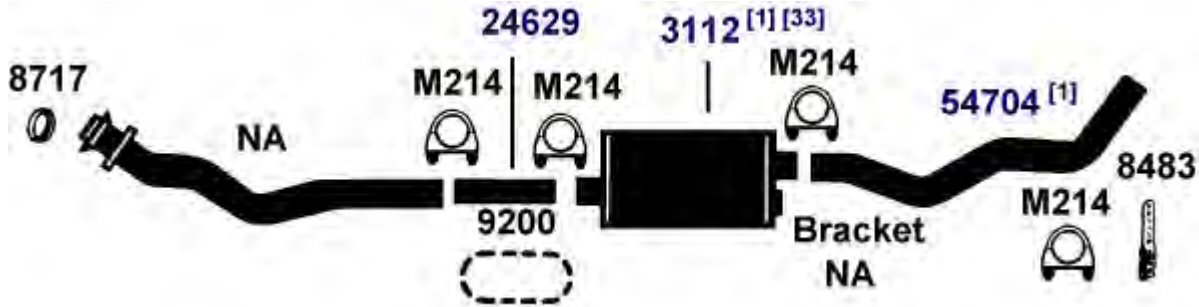

DIRECT FIT MSL/MAXIMUM Muffler... 700001, UNIVERSAL FIT MSL/MAXIMUM Muffler... 6539, 709019, Silentone DIY Muffler... 5534

(27120) 81-82 6 Cyl. F350 Series; 155" W.B.; 300 (4.9L) Engine; 2 W.D., 4 W.D.; 1 Ton; Super Cab; with Converter

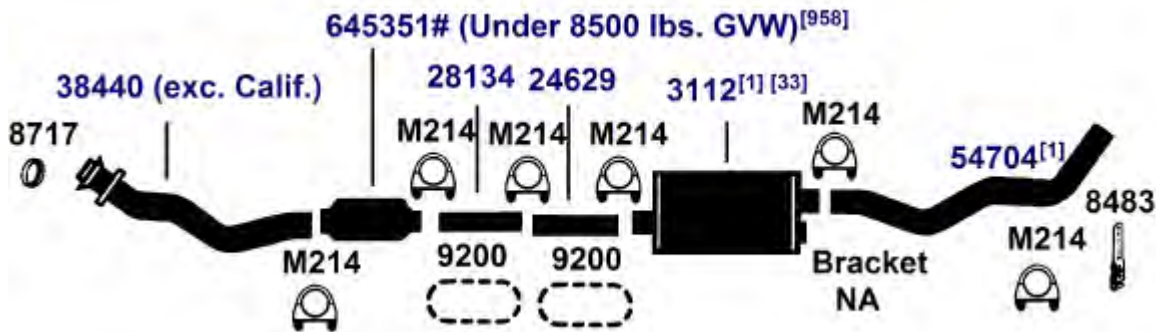

DIRECT FIT MSL/MAXIMUM Muffler... 700001, UNIVERSAL FIT MSL/MAXIMUM Muffler... 6539, 709019, Silentone DIY Muffler... 5534

(27118) 81-82 6 Cyl. F350 Series; 160" W.B.; 300 (4.9L) Engine; 2 W.D., 4 W.D.; 1 Ton; without Converter

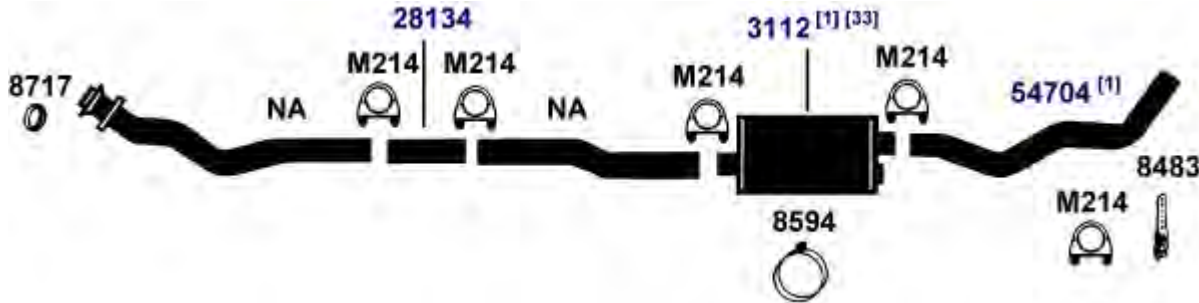

DIRECT FIT MSL/MAXIMUM Muffler... 700001, UNIVERSAL FIT MSL/MAXIMUM Muffler... 6539, 709019, Silentone DIY Muffler... 5534

NA-Not Available. NR-Not Required. FL-Remove and Re-Use Old Flange. ● Golden Warehouse. O.E.-Original Equipment.
Airtube Kit [4948] may be required to complete installation. EFI-Electronic Fuel Injection.

[1] OE system was a welded assembly. It is recommended that all parts noted [1] should be replaced. [958] Federal & California Emission vehicles. Not legal for sale for vehicles licensed in California.

[33] Remove and re-use O.E. heat shield.

FORD F350 SERIES PICKUP

81-82 8 Cyl. F350 Series; 155" W.B.; 351 2-Barrel (5.8L) (1982); 351, 400 (1981) Engine; 2 W.D., 4 W.D.; 1 Ton; Super Cab; with Converter **(28343)**

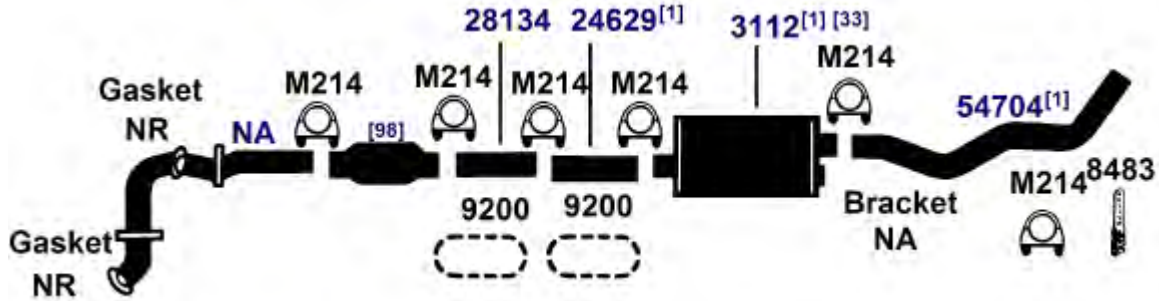

DIRECT FIT MSL/MAXIMUM Muffler... 700001, UNIVERSAL FIT MSL/MAXIMUM Muffler... 6539, 709019, Silentone DIY Muffler... 5534

80-82 6 Cyl. F350 Series; 155" W.B.; 300 (4.9L) Engine; 2 W.D., 4 W.D.; 1 Ton; Super Cab; without Converter **(27119)**

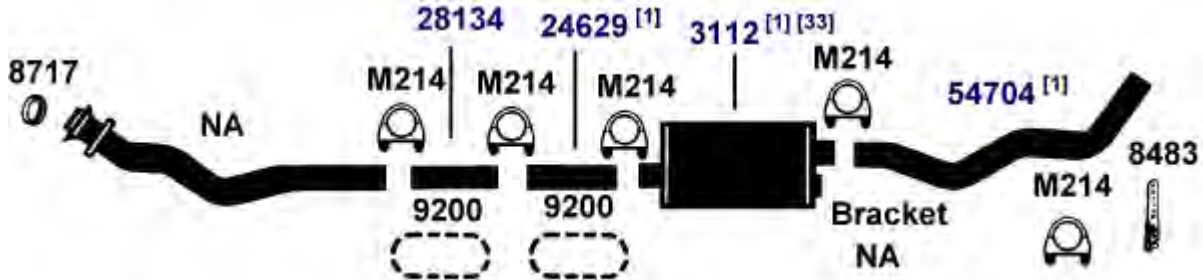

DIRECT FIT MSL/MAXIMUM Muffler... 700001, UNIVERSAL FIT MSL/MAXIMUM Muffler... 6539, 709019, Silentone DIY Muffler... 5534

80-82 6 Cyl. F350 Series; 136" W.B.; 300 (4.9L) Engine; 2 W.D., 4 W.D.; 1 Ton; without Converter **(27121)**

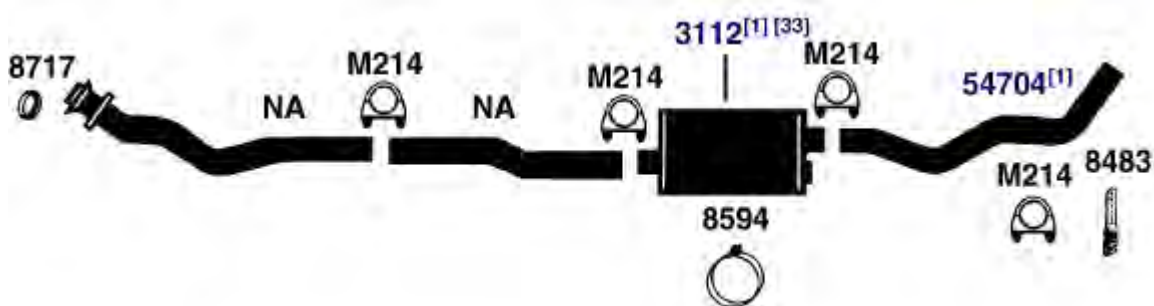

DIRECT FIT MSL/MAXIMUM Muffler... 700001, UNIVERSAL FIT MSL/MAXIMUM Muffler... 6539, 709019, Silentone DIY Muffler... 5534

NA-Not Available. NR-Not Required. FL-Remove and Re-Use Old Flange. ● Golden Warehouse. O.E.-Original Equipment.
Airtube Kit [4948] may be required to complete installation. EFI-Electronic Fuel Injection.

- [1] OE system was a welded assembly. It is recommended that all parts noted [1] should be replaced.
- [98] Refer to current Catalytic Converter catalog or Website catalog for availability.
- [33] Remove and re-use O.E. heat shield.

FORD F350 SERIES PICKUP

(28342) 80-82 8 Cyl. F350 Series; 160" W.B.; 351 2-Barrel (5.8L) (1982); 351, 400 (80-81) Engine; 2 W.D., 4 W.D.; 1 Ton; Chassis Cab; without Converter

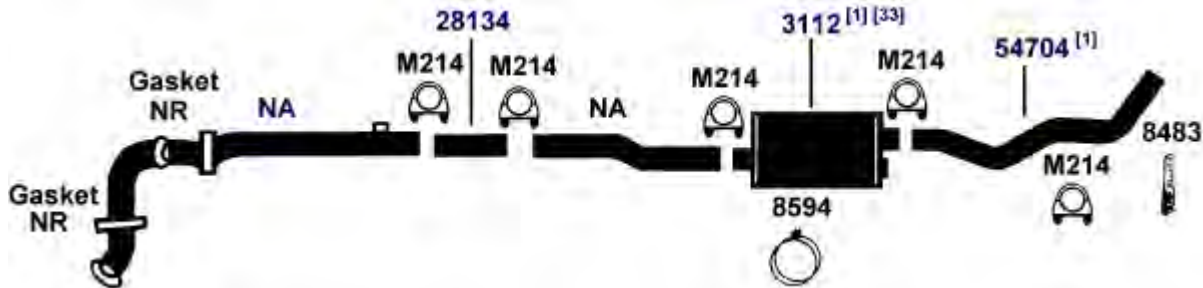

DIRECT FIT MSL/MAXIMUM Muffler... 700001, UNIVERSAL FIT MSL/MAXIMUM Muffler... 6539, 709019, Silentone DIY Muffler... 5534

(28340) 80-81 8 Cyl. F350 Series; 133" W.B.; 351, 400 Engine; 2 W.D., 4 W.D.; 1 Ton; Regular Cab; without Converter

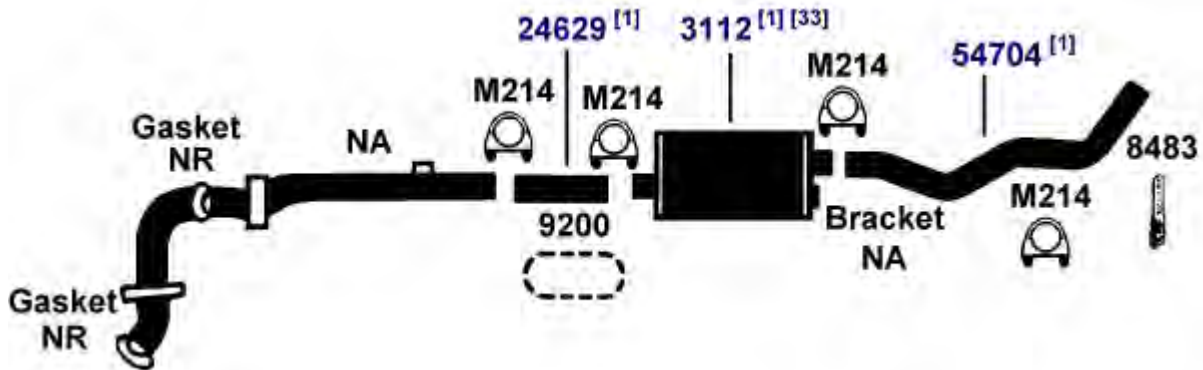

DIRECT FIT MSL/MAXIMUM Muffler... 700001, UNIVERSAL FIT MSL/MAXIMUM Muffler... 6539, 709019, Silentone DIY Muffler... 5534

(28327) 1979 8 Cyl. F350 Series; 133" W.B.; 351, 400 Engine; 4 W.D.; 1 Ton; Regular Cab; without Converter

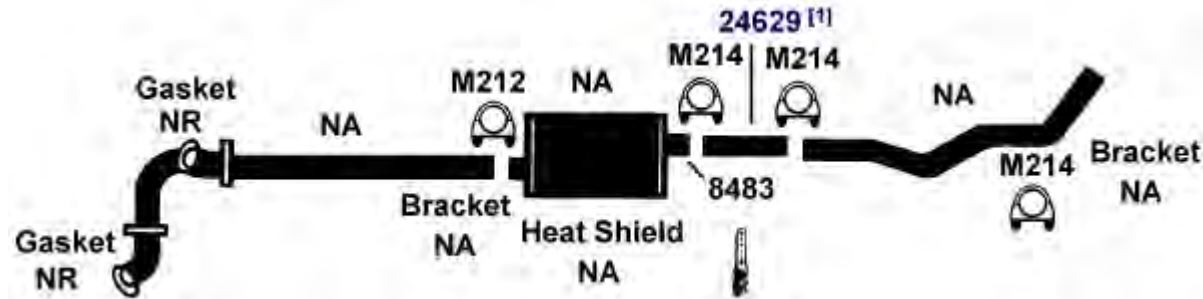

UNIVERSAL FIT MSL/MAXIMUM Muffler... 6539, 709019

NA-Not Available. NR-Not Required. FL-Remove and Re-Use Old Flange. • Golden Warehouse. O.E.-Original Equipment.
Airtube Kit [4948] may be required to complete installation. EFI-Electronic Fuel Injection.

[1] OE system was a welded assembly. It is recommended that all parts noted [1] [33] Remove and re-use O.E. heat shield. should be replaced.

FORD F350 SERIES PICKUP

1979 8 Cyl. F350 Series; 351, 400 Engine; 4 W.D.; 1 Ton; Super Cab; without Converter **(28326)**

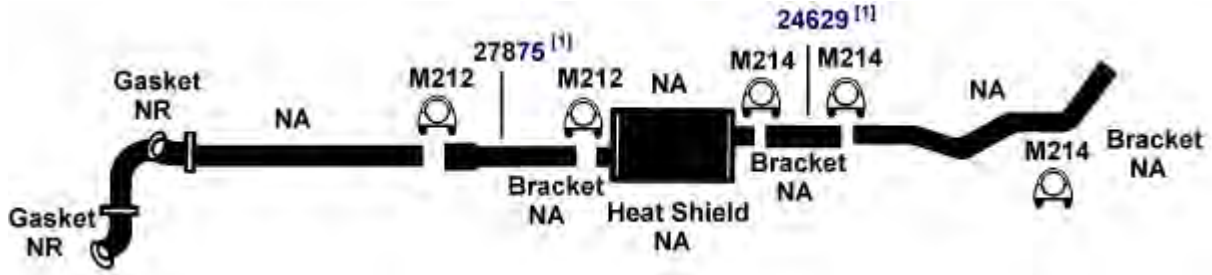

UNIVERSAL FIT MSL/MAXIMUM Muffler... 6539, 709019

FORD F450 SERIES PICKUP

93-94 8 Cyl. F450 Series; 136", 160" W.B.; Super Duty; 460 Engine (7.5L); without Converter **(100445)**

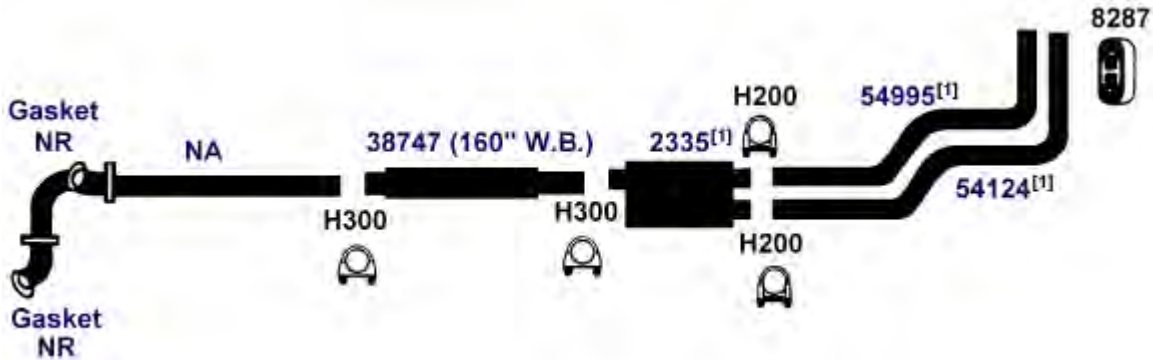

DIRECT FIT MSL/MAXIMUM Muffler... 700436

93-94 8 Cyl. F450 Series; 136", 160", 185" W.B.; Super Duty; 460 Engine (7.5L); with Converter **(100444)**

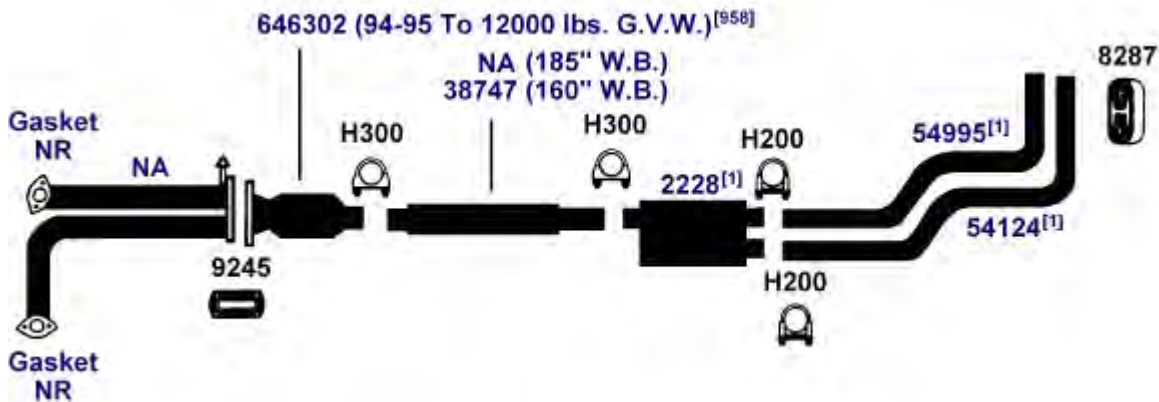

DIRECT FIT MSL/MAXIMUM Muffler... 700436

NA-Not Available. NR-Not Required. FL-Remove and Re-Use Old Flange. • Golden Warehouse. O.E.-Original Equipment.
Airtube Kit [4948] may be required to complete installation. EFI-Electronic Fuel Injection.

[1] OE system was a welded assembly. It is recommended that all parts noted [1] should be replaced. [958] Federal & California Emission vehicles. Not legal for sale for vehicles licensed in California.

FORD F450 SERIES PICKUP

(28455) 92-94 8 Cyl. F450 Series; 185" W.B.; Super Duty; Chassis Cab; 7.3L Diesel Engine; without Converter; except 93-94 Turbo Models

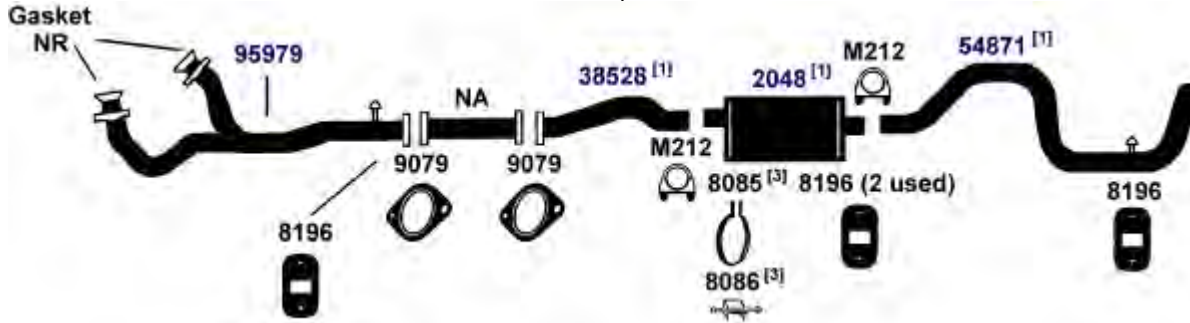

DIRECT FIT MSL/MAXIMUM Muffler... 700046

(28452) 88-94 8 Cyl. F450 Super Duty; 136", 160" W.B.; Chassis Cab; 7.3L Diesel Engine; except 93-94 Turbo Models

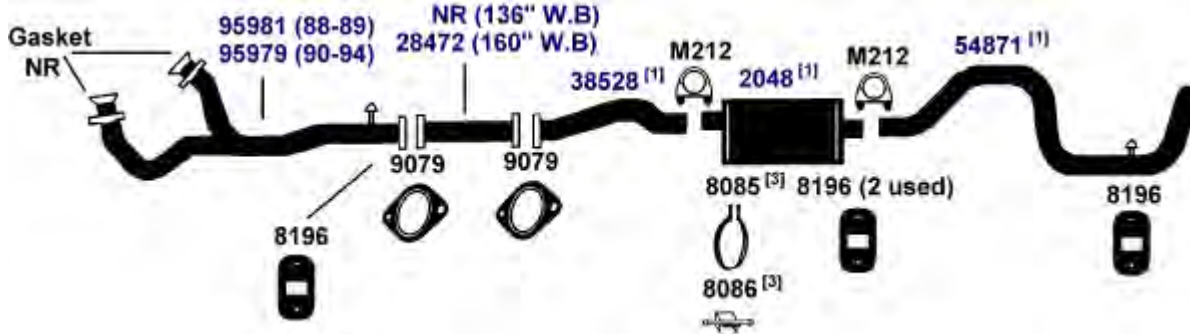

DIRECT FIT MSL/MAXIMUM Muffler... 700046

(28454) 92-93 8 Cyl. F450 Series; 185" W.B.; Super Duty; Chassis Cab; 7.5L Engine; with Converter; except 1993 with Round Muffler

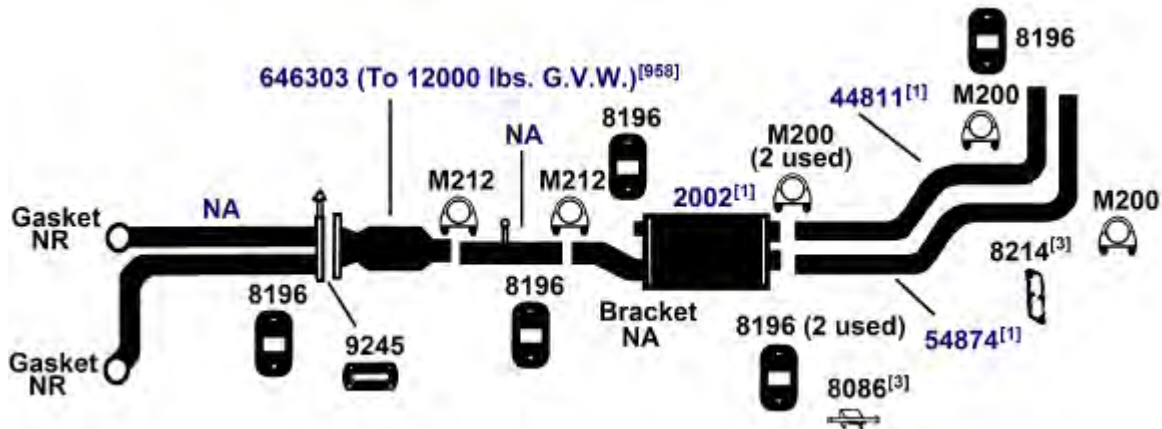

DIRECT FIT MSL/MAXIMUM Muffler... 700433

NA-Not Available. NR-Not Required. FL-Remove and Re-Use Old Flange. ● Golden Warehouse. O.E.-Original Equipment.
Airtube Kit [4948] may be required to complete installation. EFI-Electronic Fuel Injection.

- [1] OE system was a welded assembly. It is recommended that all parts noted [1] should be replaced. [958] Federal & California Emission vehicles. Not legal for sale for vehicles licensed in California.
- [3] Required for installation.

FORD F450 SERIES PICKUP

88-93 8 Cyl. F450 Super Duty; 136", 160" W.B.; Chassis Cab; 7.5L Engine; except 1993 with **(28450)**
Round Muffler

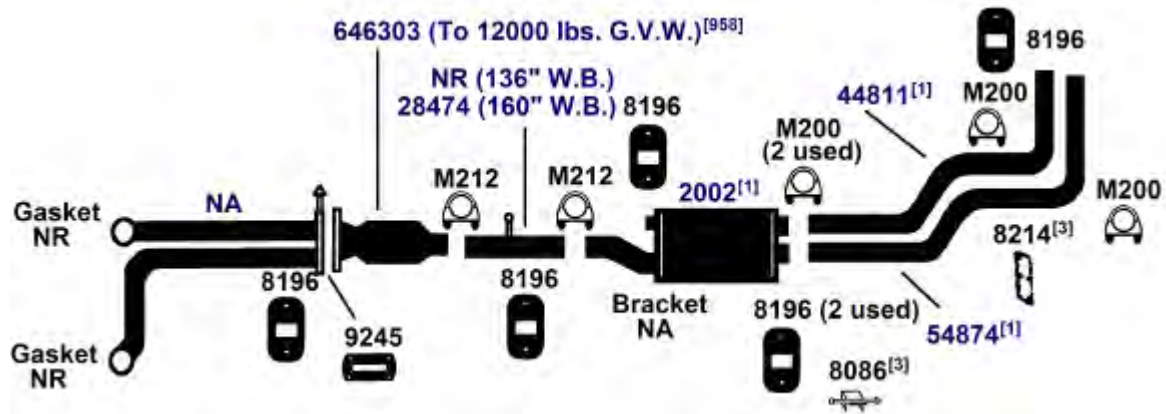

DIRECT FIT MSL/MAXIMUM Muffler... 700433

FORD F53/F59 COMMERCIAL CHASSIS, MOTOR HOME

88-94 8 Cyl. Commercial Stripped Chassis, F59 Motor Home; 448 (7.3L) Diesel Engine; 158", **(29351)**
178" W.B.

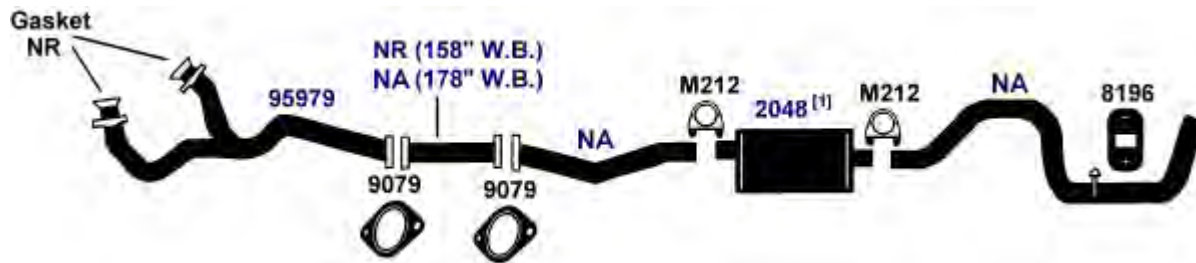

DIRECT FIT MSL/MAXIMUM Muffler... 700046

NA-Not Available. NR-Not Required. FL-Remove and Re-Use Old Flange. ● Golden Warehouse. O.E.-Original Equipment.
Airtube Kit [4948] may be required to complete installation. EFI-Electronic Fuel Injection.

- [1] OE system was a welded assembly. It is recommended that all parts noted [1] should be replaced. [958] Federal & California Emission vehicles. Not legal for sale for vehicles licensed in California.
- [3] Required for installation.

FORD FAIRMONT

(5396)	1983	4 Cyl.	Fairmont, All Models with 2.3L, 140 Engine
	1983	6 Cyl.	Fairmont, All Models with 3.3L, 200 Engine

642366# (2.3L w/ 39" Long Converter)^[958]
 642324# (2.3L w/ 22" Long Converter)^[958]
 642330 (3.3L Eng.)^[958]
 48147 (140 Eng., exc. Calif.)^[1]
 38158 (140 Eng., Calif.)^[1]
 48147 (200 Eng.)^[1]

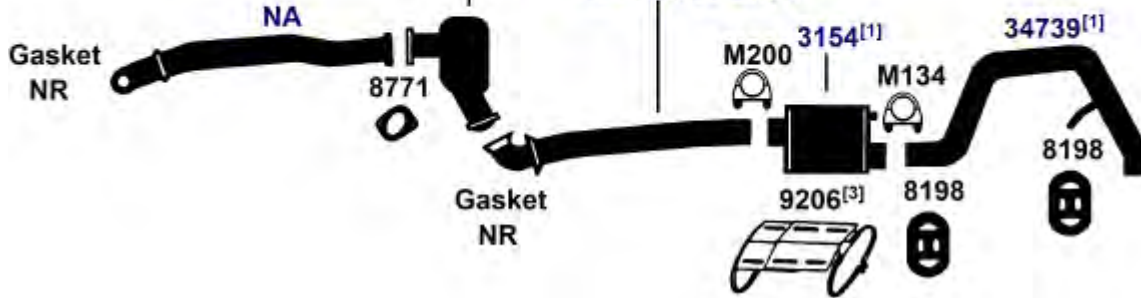

DIRECT FIT MSL/MAXIMUM Muffler... 6556, UNIVERSAL FIT MSL/MAXIMUM Muffler... 709011, Silentone DIY Muffler... 5565 and 8083 Bracket and 9206 Heat Shield

(5395)	81-82	4 Cyl.	Fairmont, All Models with 2.3L, 140 Engine
	81-82	6 Cyl.	Fairmont, All Models with 3.3L, 200 Engine; except Police, Taxi

642324# (2.3L Eng.)^[958]
 642330 (3.3L Eng.)^[958]
 48147 (140 Eng., exc. Calif.)^[1]
 38158 (140 Eng., Calif.)^[1]
 48147 (200 Eng.)^[1]

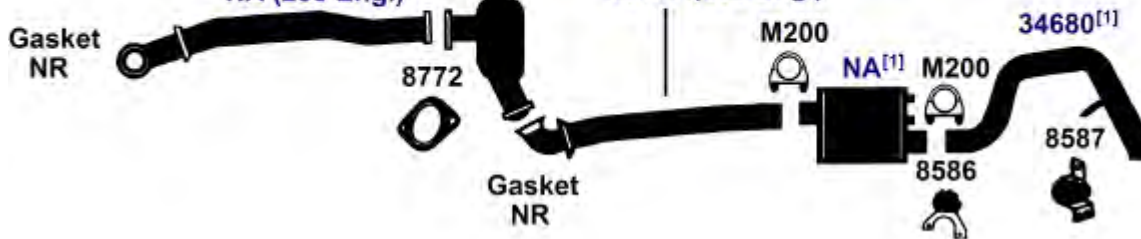

DIRECT FIT MSL/MAXIMUM Muffler... 6553, UNIVERSAL FIT MSL/MAXIMUM Muffler... 6538, 709011, 709012, Silentone DIY Muffler... 5531 and 9206 Heat Shield

NA-Not Available. NR-Not Required. FL-Remove and Re-Use Old Flange. ● Golden Warehouse. O.E.-Original Equipment.
 # Airtube Kit [4948] may be required to complete installation. EFI-Electronic Fuel Injection.

- [1] OE system was a welded assembly. It is recommended that all parts noted [1] should be replaced. [958] Federal & California Emission vehicles. Not legal for sale for vehicles licensed in California.
- [3] Required for installation.

81-82 8 Cyl. Fairmont Sedan, 4.2L, 255 Engine, except Canada, Police, Taxi **(5393)**
1981 8 Cyl. Fairmont Station Wagon, 4.2L, 255 Engine, except Canada, Police, Taxi
642324# (1981; 1982 w/ 23" Long Converter)^[958]
642457 (1982 w/ 25" Long Converter)^[958]



DIRECT FIT MSL/MAXIMUM Muffler... 6553, UNIVERSAL FIT MSL/MAXIMUM Muffler... 6538, 709011, 709012, Silentone DIY Muffler... 5531 and 9206 Heat Shield

1980 4 Cyl. Fairmont, All Models with 2.3L, 140 Engine; with Turbo and Catalytic Converter **(5391)**

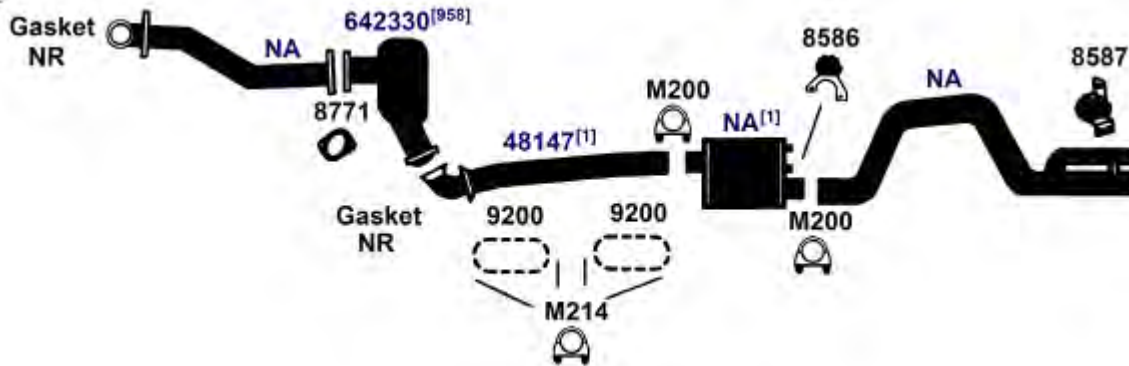

DIRECT FIT MSL/MAXIMUM Muffler... 6553, UNIVERSAL FIT MSL/MAXIMUM Muffler... 6538, 709011, 709012, Silentone DIY Muffler... 5531 and 9206 Heat Shield

NA-Not Available. NR-Not Required. FL-Remove and Re-Use Old Flange. ● Golden Warehouse. O.E.-Original Equipment.
 # Airtube Kit [4948] may be required to complete installation. EFI-Electronic Fuel Injection.

[1] OE system was a welded assembly. It is recommended that all parts noted [1] should be replaced. [958] Federal & California Emission vehicles. Not legal for sale for vehicles licensed in California.

FORD FAIRMONT

(5390) 1980 4 Cyl. Fairmont, All Models with 2.3L, 140 Engine; without Turbo, with Catalytic Converter

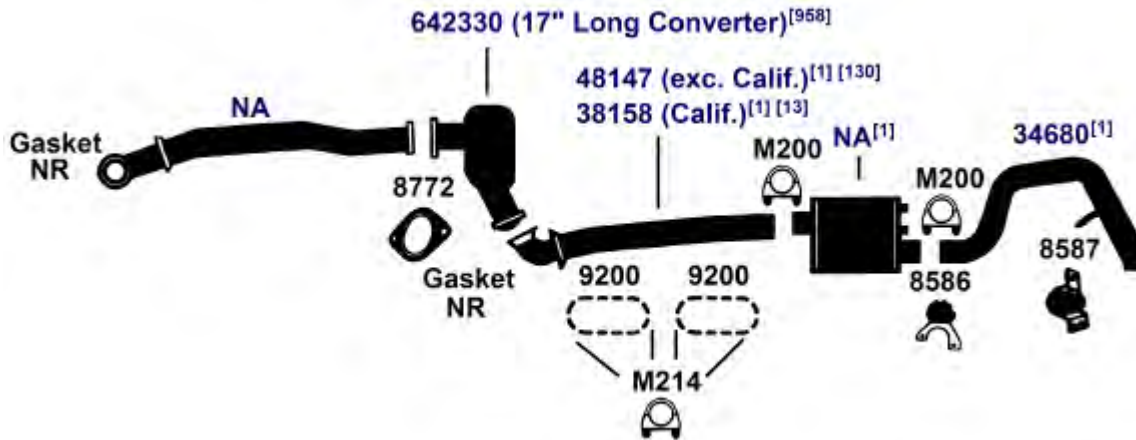

DIRECT FIT MSL/MAXIMUM Muffler... 6553, UNIVERSAL FIT MSL/MAXIMUM Muffler... 6538, 709011, 709012, Silentone DIY Muffler... 5531 and 9206 Heat Shield

(5389) 1980 6 Cyl. Fairmont, All Models with 3.3L, 200 Engine; with Catalytic Converter

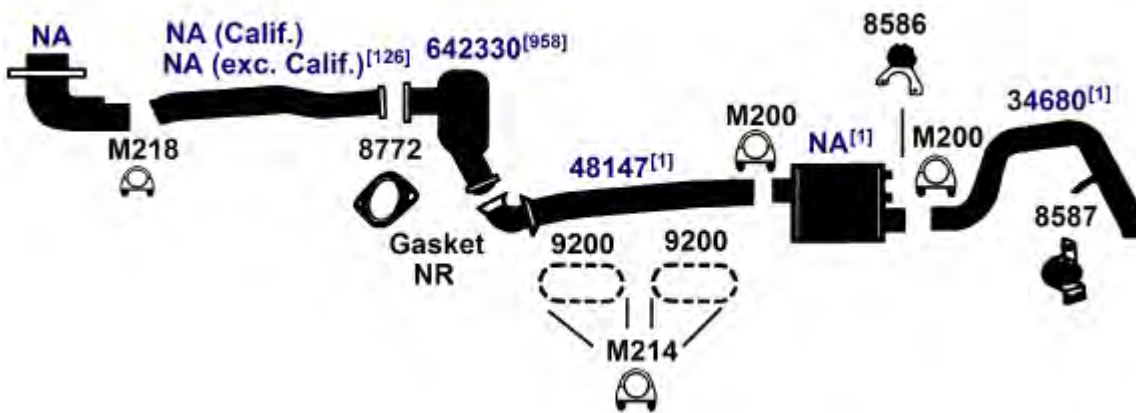

DIRECT FIT MSL/MAXIMUM Muffler... 6553, UNIVERSAL FIT MSL/MAXIMUM Muffler... 6538, 709011, 709012, Silentone DIY Muffler... 5531 and 9206 Heat Shield

NA-Not Available. NR-Not Required. FL-Remove and Re-Use Old Flange. ● Golden Warehouse. O.E.-Original Equipment.
Airtube Kit [4948] may be required to complete installation. EFI-Electronic Fuel Injection.

[1] OE system was a welded assembly. It is recommended that all parts noted [1] should be replaced.

[13] Catalytic converter body length measures 18".

[126] On some vehicles it may be required to remove locating tabs on front converter.

[130] Catalytic converter body length measures 12".

[958] Federal & California Emission vehicles. Not legal for sale for vehicles licensed in California.

1980 8 Cyl. Fairmont, All Models with 4.2L, 255 Engine, with Catalytic Converter, except California **(5388)**

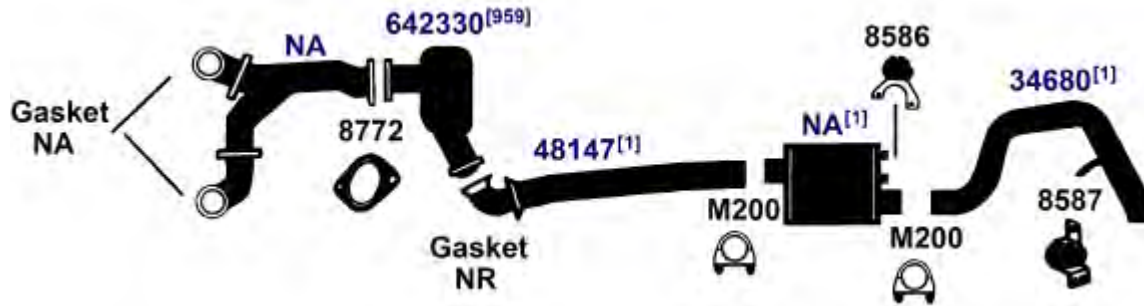

DIRECT FIT MSL/MAXIMUM Muffler... 6553, UNIVERSAL FIT MSL/MAXIMUM Muffler... 6538, 709011, 709012, Silentone DIY Muffler... 5531 and 9206 Heat Shield

1979 4,6 Cyl. Fairmont, All Models with 140 (2.3L), 200 (3.3) Engine, with Catalytic Converter **(5387)**

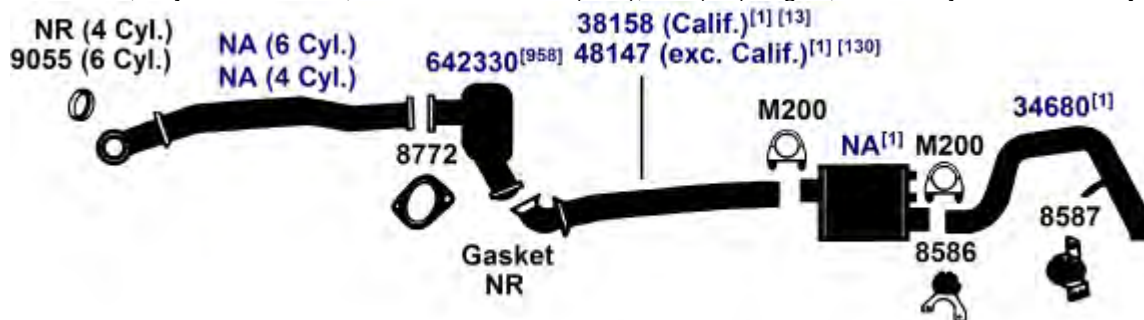

DIRECT FIT MSL/MAXIMUM Muffler... 6553, UNIVERSAL FIT MSL/MAXIMUM Muffler... 6538, 709011, 709012, Silentone DIY Muffler... 5531 and 9206 Heat Shield

1979 8 Cyl. Fairmont, All Models with 5.0L, 302 Engine; with Catalytic Converter **(5386)**

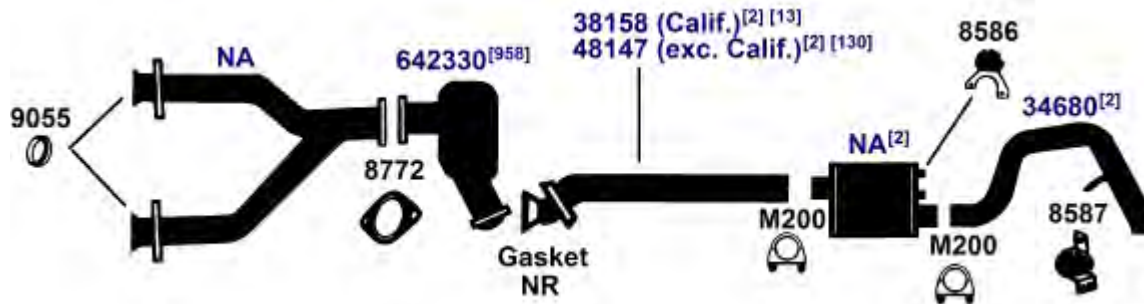

DIRECT FIT MSL/MAXIMUM Muffler... 6553, UNIVERSAL FIT MSL/MAXIMUM Muffler... 6538, 709011, 709012, Silentone DIY Muffler... 5531 and 9206 Heat Shield

NA-Not Available. NR-Not Required. FL-Remove and Re-Use Old Flange. ● Golden Warehouse. O.E.-Original Equipment.
Airtube Kit [4948] may be required to complete installation. EFI-Electronic Fuel Injection.

- [1] OE system was a welded assembly. It is recommended that all parts noted [1] should be replaced. [130] Catalytic converter body length measures 12".
- [2] May be necessary to replace all noted [2] parts. [958] Federal & California Emission vehicles. Not legal for sale for vehicles licensed in California.
- [13] Catalytic converter body length measures 18". [959] Federal Emission vehicles. Not legal for sale for vehicles licensed in California.

FORD FESTIVA

(11250) 88-93 4 Cyl. Festiva, 1.3L Engine

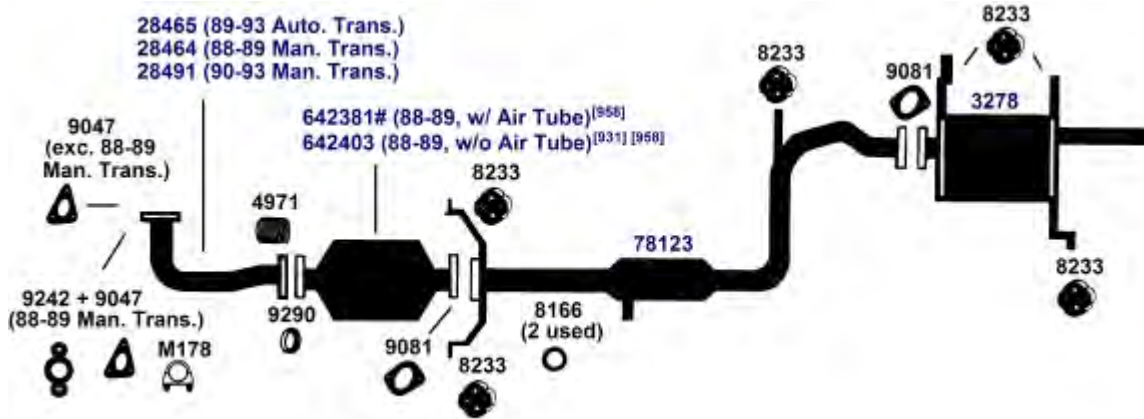

DIRECT FIT MSL/MAXIMUM Muffler... 700012

FORD GRANADA

(5479) 1982 6 Cyl. Granada, All Models with 3.8L, 232 Engine

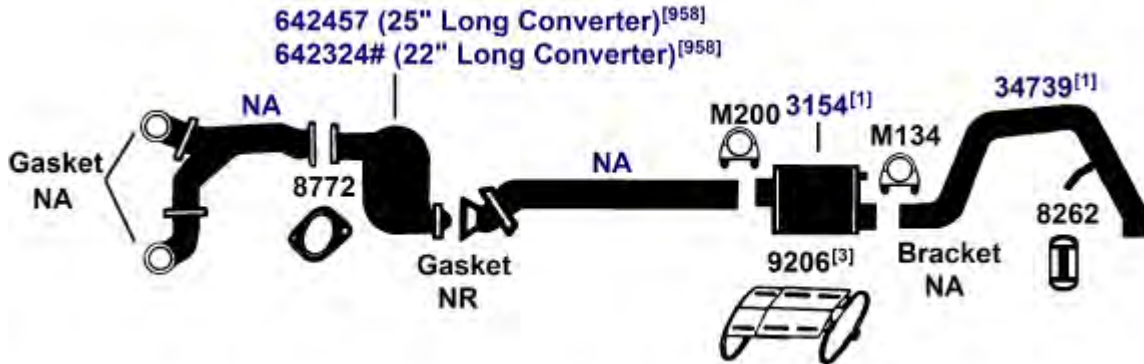

DIRECT FIT MSL/MAXIMUM Muffler... 6556, UNIVERSAL FIT MSL/MAXIMUM Muffler... 709011, Silentone DIY Muffler... 5565 and 8083 Bracket and 9206 Heat Shield

(5480) 1982 6 Cyl. Granada Station Wagon, 3.3L, 200 Engine

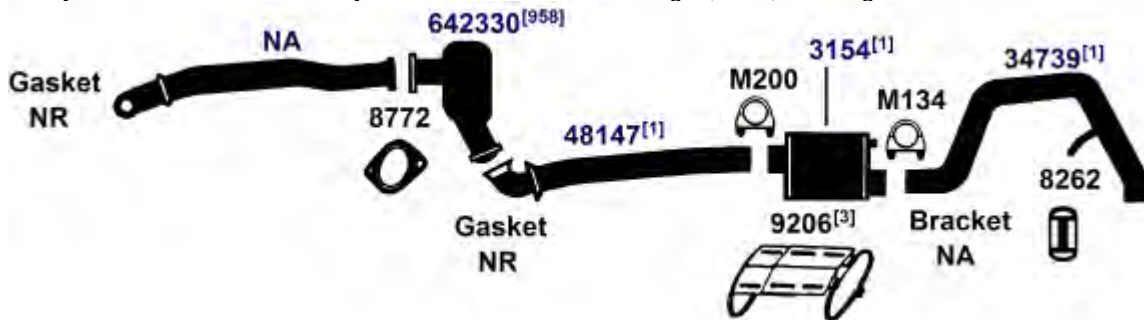

DIRECT FIT MSL/MAXIMUM Muffler... 6556, UNIVERSAL FIT MSL/MAXIMUM Muffler... 709011, Silentone DIY Muffler... 5565 and 8083 Bracket and 9206 Heat Shield

NA-Not Available. NR-Not Required. FL-Remove and Re-Use Old Flange. • Golden Warehouse. O.E.-Original Equipment.
Airtube Kit [4948] may be required to complete installation. EFI-Electronic Fuel Injection.

- [1] OE system was a welded assembly. It is recommended that all parts noted [1] should be replaced.
[3] Required for installation.

- [931] This unit was designed to fit many applications. Measurement of the old unit and cutting of new unit is required.
[958] Federal & California Emission vehicles. Not legal for sale for vehicles licensed in California.

81-82 4 Cyl. Granada, All Models with 2.3L, 140 Engine
81-82 6 Cyl. Granada, All Models with 3.3, 200 Engine; except 1982 Station Wagon

(5478)

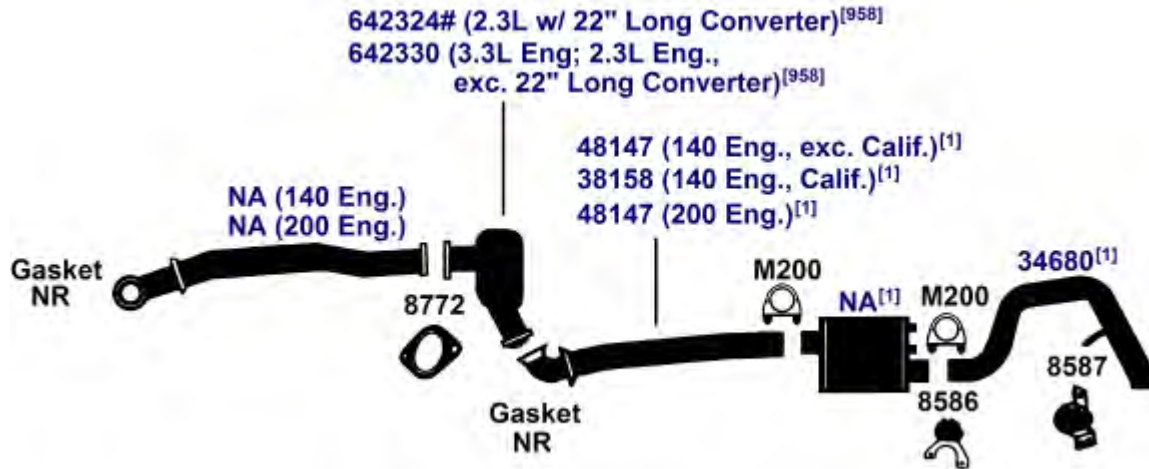

DIRECT FIT MSL/MAXIMUM Muffler... 6538, 6553, UNIVERSAL FIT MSL/MAXIMUM Muffler... 6538, 6553, 709011, 709012, Silentone DIY Muffler... 5531 and 9206 Heat Shield

1981 8 Cyl. Granada Sedan, 4.2L, 255 Engine; except Canada, Police, Taxi

(5476)

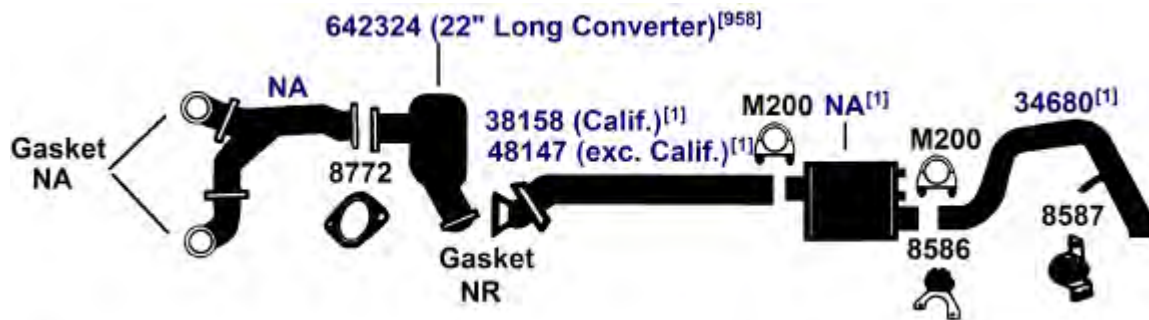

DIRECT FIT MSL/MAXIMUM Muffler... 6553, UNIVERSAL FIT MSL/MAXIMUM Muffler... 6538, 709011, 709012, Silentone DIY Muffler... 5531 and 9206 Heat Shield

NA-Not Available. NR-Not Required. FL-Remove and Re-Use Old Flange. ● Golden Warehouse. O.E.-Original Equipment.
 # Airtube Kit [4948] may be required to complete installation. EFI-Electronic Fuel Injection.

[1] OE system was a welded assembly. It is recommended that all parts noted [1] should be replaced. [958] Federal & California Emission vehicles. Not legal for sale for vehicles licensed in California.

FORD MUSTANG

(5611) 1994 6 Cyl. Mustang, 3.8L Engine

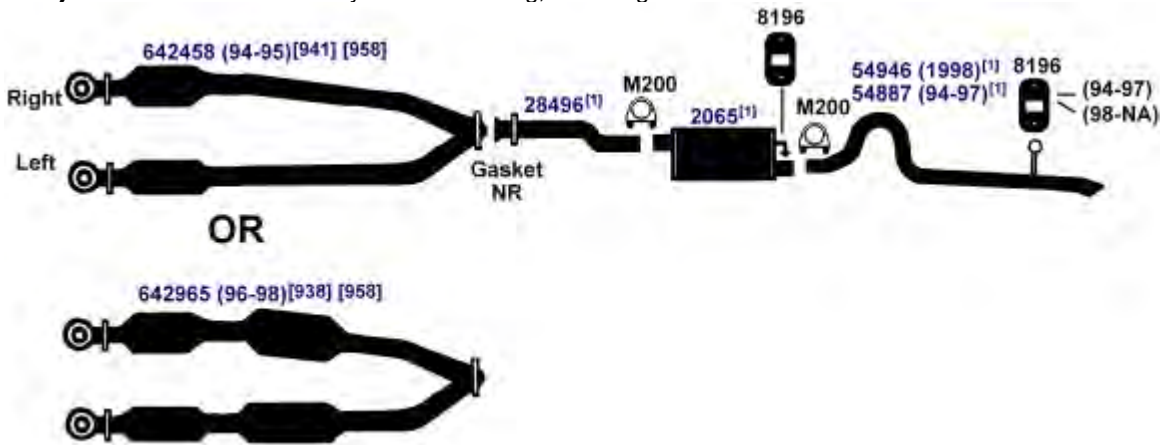

DIRECT FIT MSL/MAXIMUM Muffler... 700310, UNIVERSAL FIT MSL/MAXIMUM Muffler... 709011

(5610) 1994 8 Cyl. Mustang GT, Cobra, 5.0L Engine

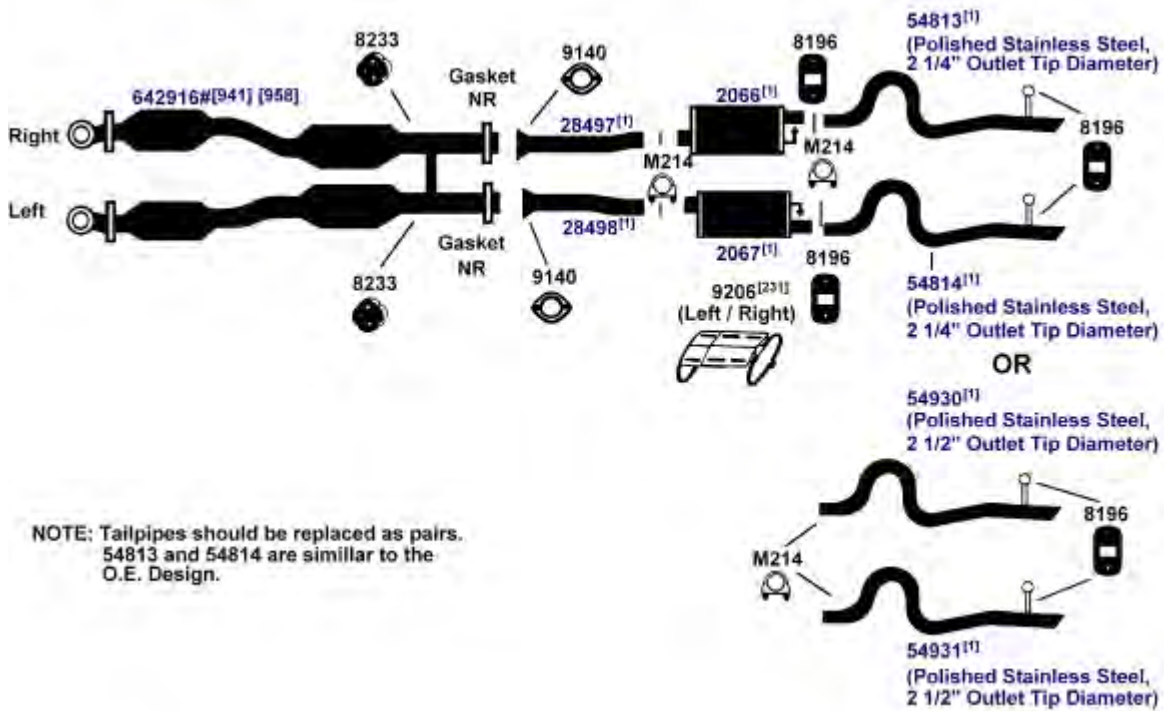

DIRECT FIT MSL/MAXIMUM Muffler... Left 700330, Right 700331, UNIVERSAL FIT MSL/MAXIMUM Muffler... Left 6497, 6498

NA-Not Available. NR-Not Required. FL-Remove and Re-Use Old Flange. ● Golden Warehouse. O.E.-Original Equipment.
Airtube Kit [4948] may be required to complete installation. EFI-Electronic Fuel Injection.

[1] OE system was a welded assembly. It is recommended that all parts noted [1] should be replaced.

[65] Heat Shield 9206 is required for installation.

[231] If muffler is equipped with a heat shield (does not have a black triangle on the carton label), purchase of 9206 is not required.

[938] Direct fit unit contains front and rear converter body. Only failed converters may be replaced.

[941] Replaces both front and rear converters, Only failed converters may be replaced.

[958] Federal & California Emission vehicles. Not legal for sale for vehicles licensed in California.

90-93 4 Cyl. Mustang, 140 (2.3L) Engine

(5608)

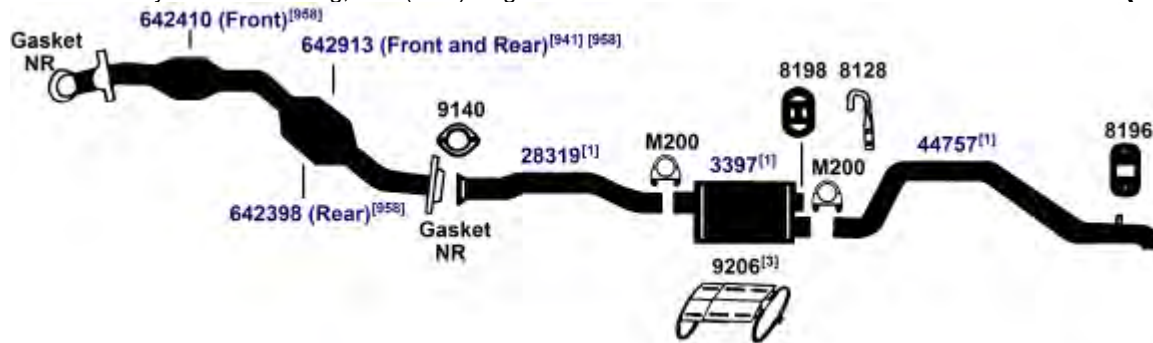

DIRECT FIT MSL/MAXIMUM Muffler... 700272, UNIVERSAL FIT MSL/MAXIMUM Muffler... 6497, Silentone DIY Muffler... 5554 and 8083 Bracket and 9206 Heat Shield

87-93 8 Cyl. Mustang LX, 302 (5.0L) Engine, Dual Exhaust
 1986 8 Cyl. Mustang, 302 (5.0L) Engine, Dual Exhaust

(5606)

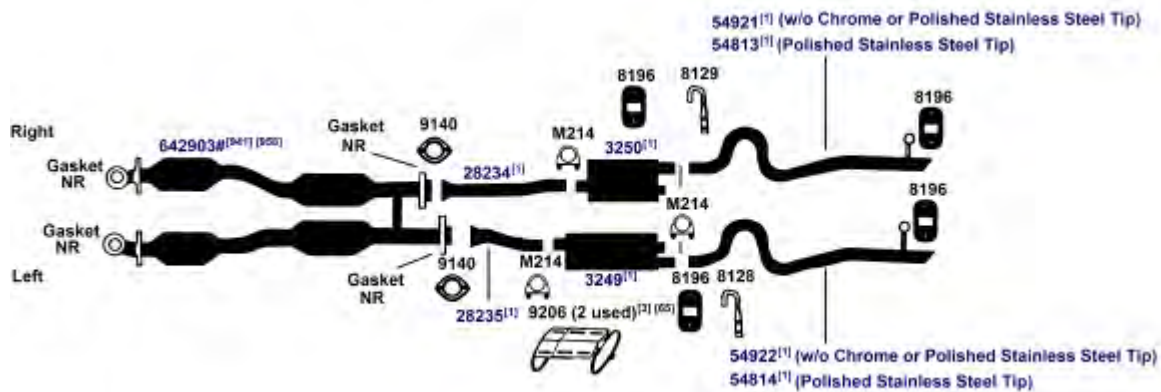

DIRECT FIT MSL/MAXIMUM Muffler... Left 700096, Right 700097, UNIVERSAL FIT MSL/MAXIMUM Muffler... Left 6563, Right 6580, Silentone DIY Muffler... Left 5554 and 8083 Bracket and 9206 Heat Shield, Right 5554 and 8083 Bracket and 9206 Heat Shield

NA-Not Available. NR-Not Required. FL-Remove and Re-Use Old Flange. ● Golden Warehouse. O.E.-Original Equipment.
 # Airtube Kit [4948] may be required to complete installation. EFI-Electronic Fuel Injection.

- [1] OE system was a welded assembly. It is recommended that all parts noted [1] should be replaced.
- [3] Required for installation.
- [65] Heat Shield 9206 is required for installation.
- [941] Replaces both front and rear converters, Only failed converters may be replaced.
- [958] Federal & California Emission vehicles. Not legal for sale for vehicles licensed in California.

FORD MUSTANG

(5605) 87-93 8 Cyl. Mustang GT, 302 (5.0L) Engine, Dual Exhaust

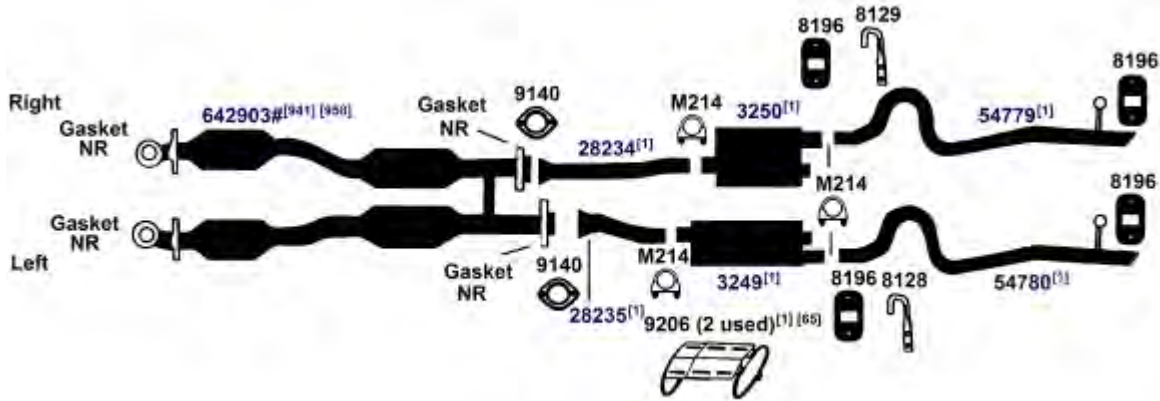

DIRECT FIT MSL/MAXIMUM Muffler... Left 700096, Right 700097, UNIVERSAL FIT MSL/MAXIMUM Muffler... Left 6563, Right 6580, Silentone DIY Muffler... Left 5554 and 8083 Bracket and 9206 Heat Shield, Right 5554 and 8083 Bracket and 9206 Heat Shield

(5604) 87-89 4 Cyl. Mustang, 140 (2.3L) Engine

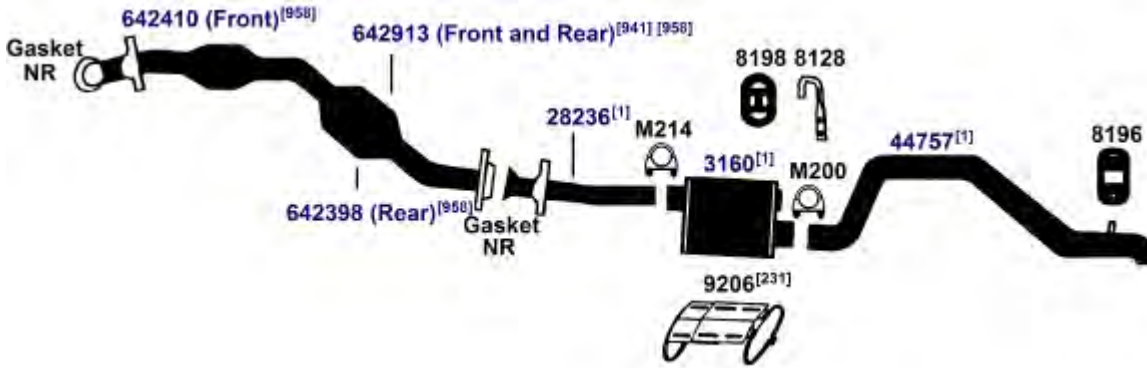

DIRECT FIT MSL/MAXIMUM Muffler... 6563, UNIVERSAL FIT MSL/MAXIMUM Muffler... 6548, 709012

NA-Not Available. NR-Not Required. FL-Remove and Re-Use Old Flange. ● Golden Warehouse. O.E.-Original Equipment.
Airtube Kit [4948] may be required to complete installation. EFI-Electronic Fuel Injection.

[1] OE system was a welded assembly. It is recommended that all parts noted [1] should be replaced.

[65] Heat Shield 9206 is required for installation.

[231] If muffler is equipped with a heat shield (does not have a black triangle on the carton label), purchase of 9206 is not required.

[941] Replaces both front and rear converters, Only failed converters may be replaced.

[958] Federal & California Emission vehicles. Not legal for sale for vehicles licensed in California.

1986 4 Cyl. Mustang, 140 (2.3L) Turbo Engine

(5607)

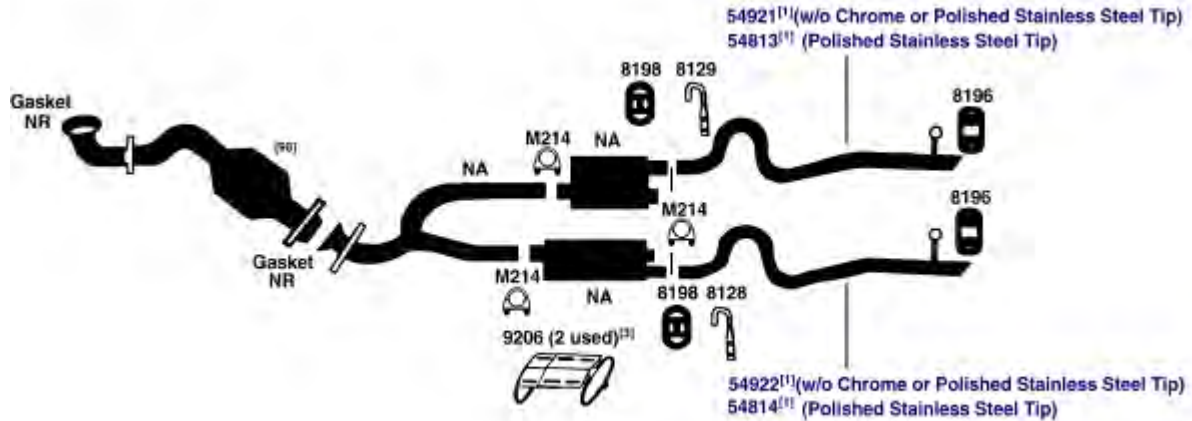

DIRECT FIT MSL/MAXIMUM Muffler... Right 6580

85-86 4 Cyl. Mustang, 140 (2.3L) Engine

(5599)

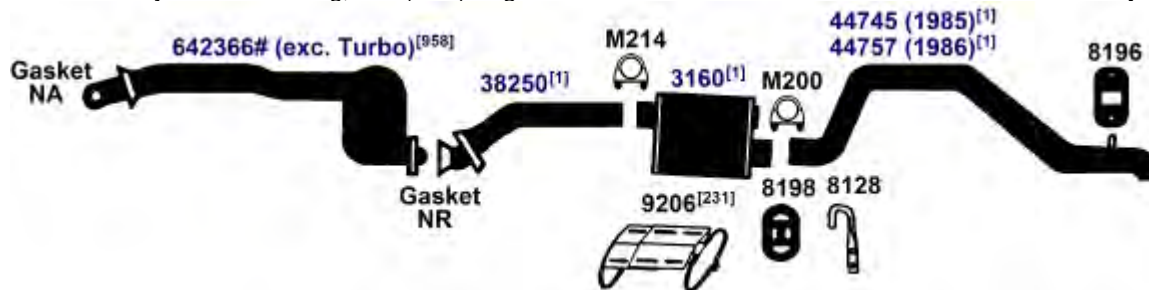

DIRECT FIT MSL/MAXIMUM Muffler... 6563, UNIVERSAL FIT MSL/MAXIMUM Muffler... 6548, 709012

85-86 6 Cyl. Mustang, 232 (3.8L) Engine

(5598)

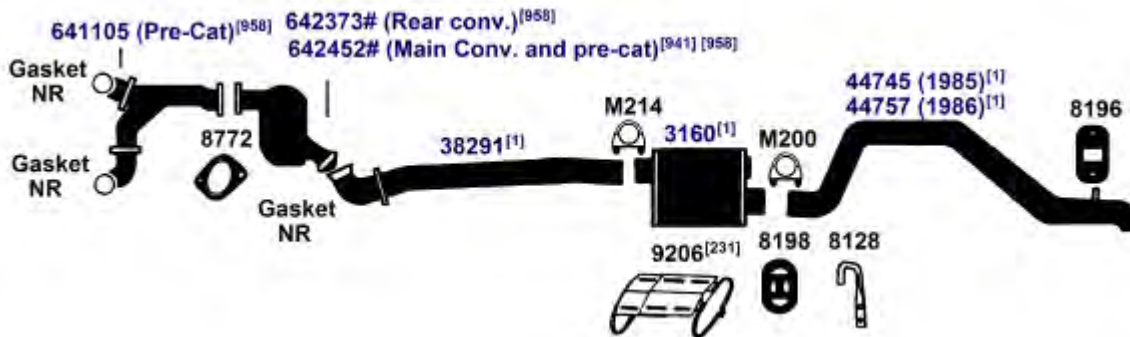

DIRECT FIT MSL/MAXIMUM Muffler... 6563, UNIVERSAL FIT MSL/MAXIMUM Muffler... 6548, 709012

NA-Not Available. NR-Not Required. FL-Remove and Re-Use Old Flange. ● Golden Warehouse. O.E.-Original Equipment.
Airtube Kit [4948] may be required to complete installation. EFI-Electronic Fuel Injection.

- [1] OE system was a welded assembly. It is recommended that all parts noted [1] should be replaced.
- [3] Required for installation.
- [98] Refer to current Catalytic Converter catalog or Website catalog for availability.

- [231] If muffler is equipped with a heat shield (does not have a black triangle on the carton label), purchase of 9206 is not required.
- [941] Replaces both front and rear converters, Only failed converters may be replaced.
- [958] Federal & California Emission vehicles. Not legal for sale for vehicles licensed in California.

FORD MUSTANG

(5602) 1985 8 Cyl. Mustang, 302 (5.0L) Engine; except Auto. Trans.; Dual Exhaust

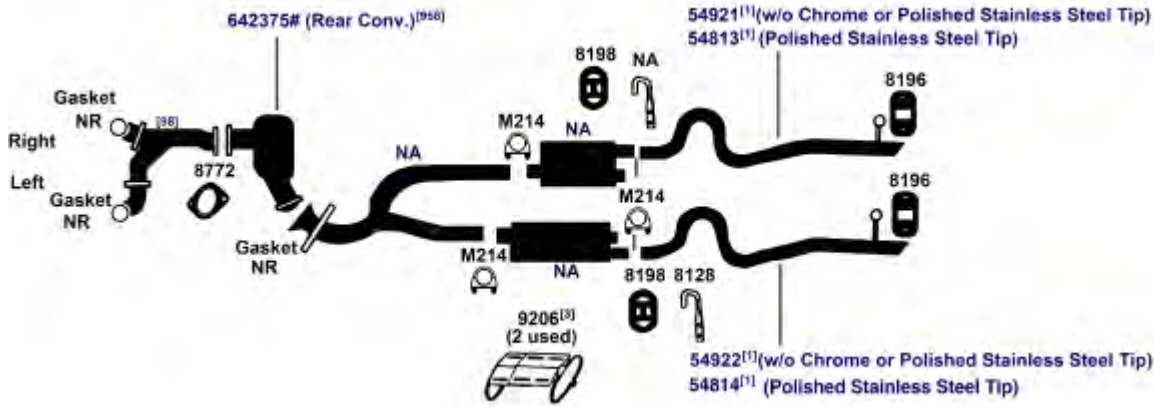

UNIVERSAL FIT MSL/MAXIMUM Muffler... Right 6580

(5603) 1985 8 Cyl. Mustang, 302 (5.0L) Engine, Auto, Trans., Dual Exhaust

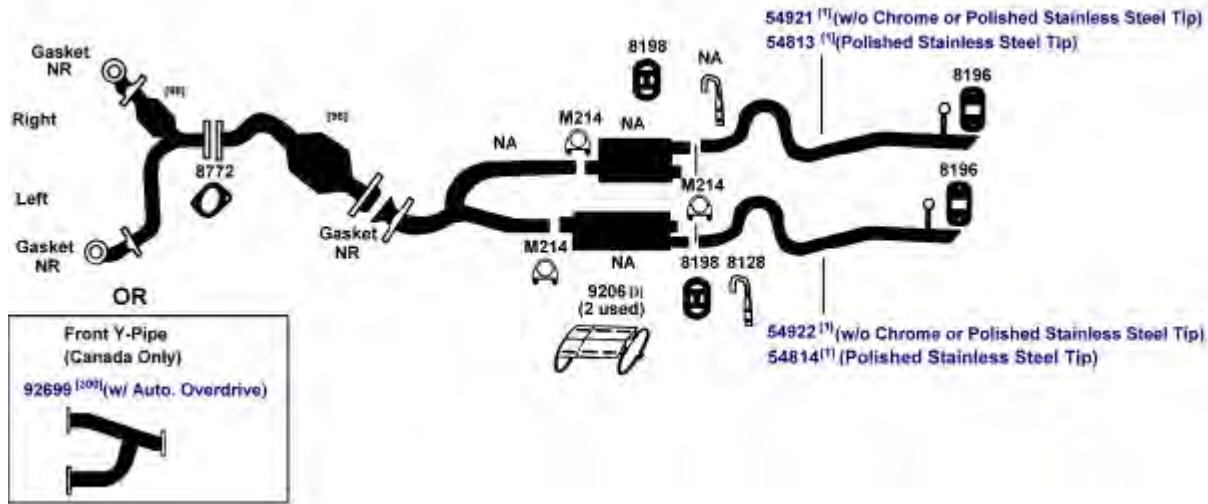

UNIVERSAL FIT MSL/MAXIMUM Muffler... Right 6580

NA-Not Available. NR-Not Required. FL-Remove and Re-Use Old Flange. ● Golden Warehouse. O.E.-Original Equipment.
 # Airtube Kit [4948] may be required to complete installation. EFI-Electronic Fuel Injection.

[1] OE system was a welded assembly. It is recommended that all parts noted [1] should be replaced.

[3] Required for installation.

[98] Refer to current Catalytic Converter catalog or Website catalog for availability.

[300] For use when resonator originated from O.E. manufacturer.

[958] Federal & California Emission vehicles. Not legal for sale for vehicles licensed in California.

1984 8 Cyl. Mustang, 302 (5.0L) Engine; except 1985 Auto. Trans.; Dual Exhaust

(5602E)

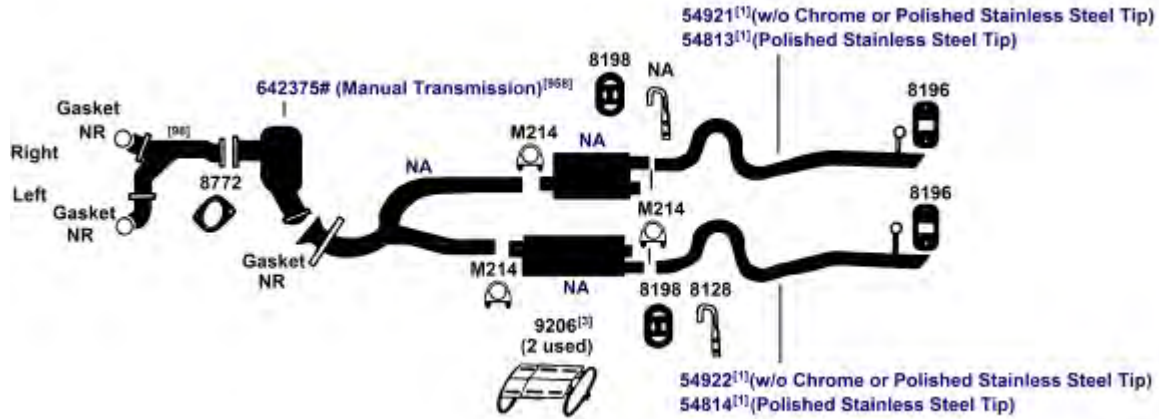

UNIVERSAL FIT MSL/MAXIMUM Muffler... Right 6580

83-84 4 Cyl. Mustang, 140 (2.3L) Engine

(5599E)

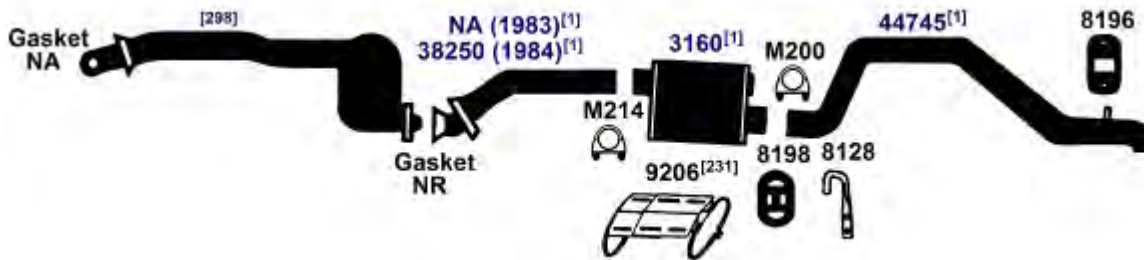

DIRECT FIT MSL/MAXIMUM Muffler... 6563, UNIVERSAL FIT MSL/MAXIMUM Muffler... 6548, 709012

83-84 6 Cyl. Mustang, 232 (3.8L) Engine

(5598E)

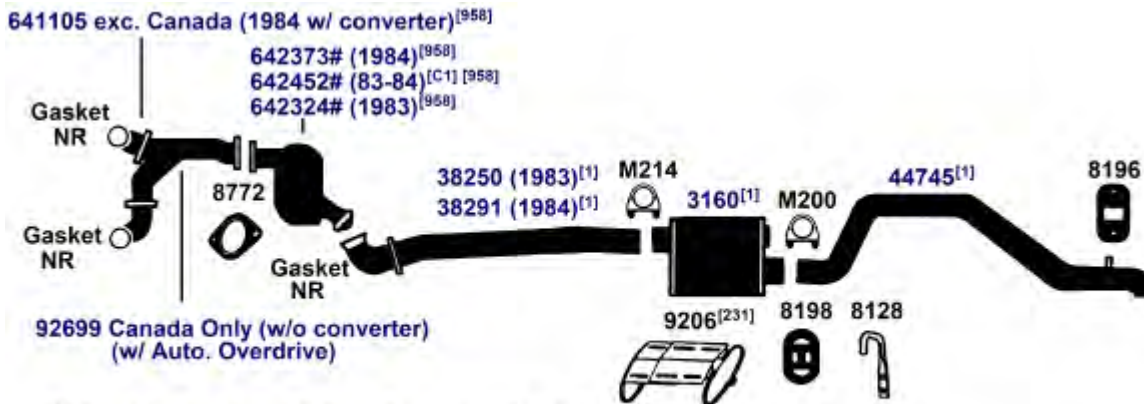

92699 Canada Only (w/o converter) (w/ Auto. Overdrive)

[C1] Combination Front & Rear Converter, 2 to 1 Replacement. Only Defective Converters May Legally Be Replaced.

DIRECT FIT MSL/MAXIMUM Muffler... 6563, UNIVERSAL FIT MSL/MAXIMUM Muffler... 6548, 709012

NA-Not Available. NR-Not Required. FL-Remove and Re-Use Old Flange. ● Golden Warehouse. O.E.-Original Equipment. # Airtube Kit [4948] may be required to complete installation. EFI-Electronic Fuel Injection.

- [1] OE system was a welded assembly. It is recommended that all parts noted [1] should be replaced.
- [231] If muffler is equipped with a heat shield (does not have a black triangle on the carton label), purchase of 9206 is not required.
- [3] Required for installation.
- [958] Federal & California Emission vehicles. Not legal for sale for vehicles licensed in California.

FORD PROBE

(12404) 93-94 4 Cyl. Probe, 2.0L (122) Engine

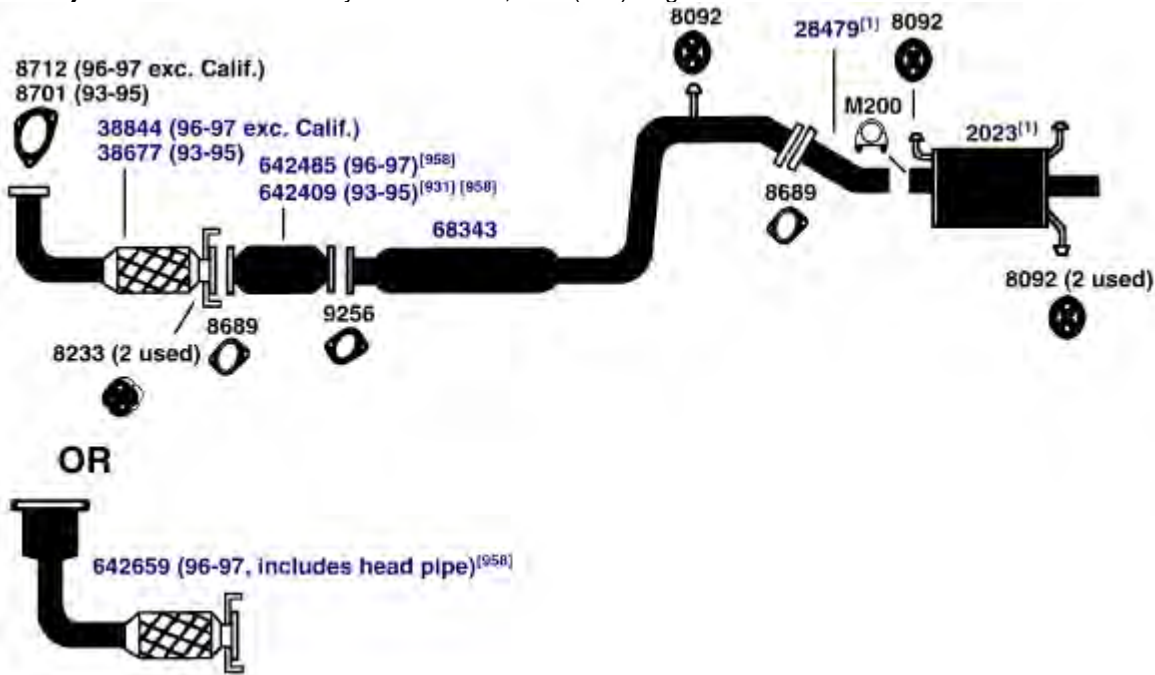

DIRECT FIT MSL/MAXIMUM Muffler... 700151

(12403) 93-94 6 Cyl. Probe GT, 2.5L (153) Engine

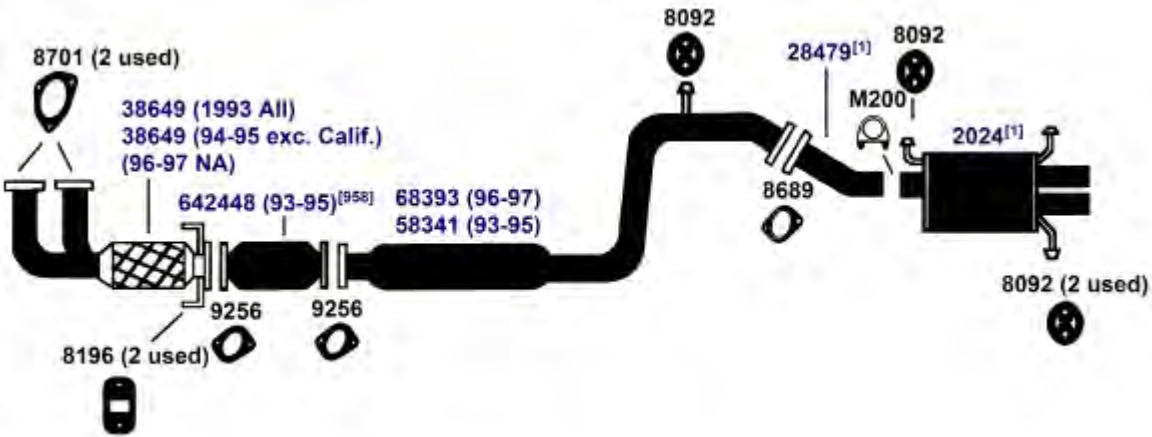

DIRECT FIT MSL/MAXIMUM Muffler... 700168

NA-Not Available. NR-Not Required. FL-Remove and Re-Use Old Flange. ● Golden Warehouse. O.E.-Original Equipment.

Airtube Kit [4948] may be required to complete installation. EFI-Electronic Fuel Injection.

[1] OE system was a welded assembly. It is recommended that all parts noted [1] should be replaced.

[931] This unit was designed to fit many applications. Measurement of the old unit and cutting of new unit is required.

[958] Federal & California Emission vehicles. Not legal for sale for vehicles licensed in California.

90-92 6 Cyl. Probe, 3.0L (182) Engine (12402)

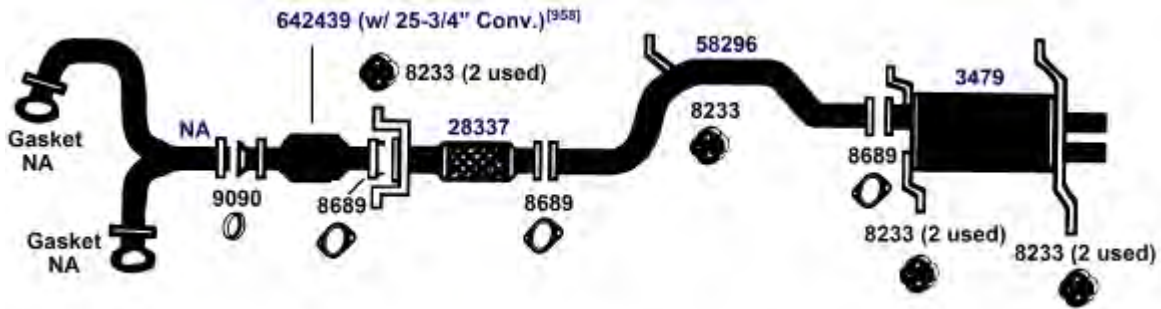

89-92 4 Cyl. Probe, 2.2L (133) Engine; except Turbo (12401)

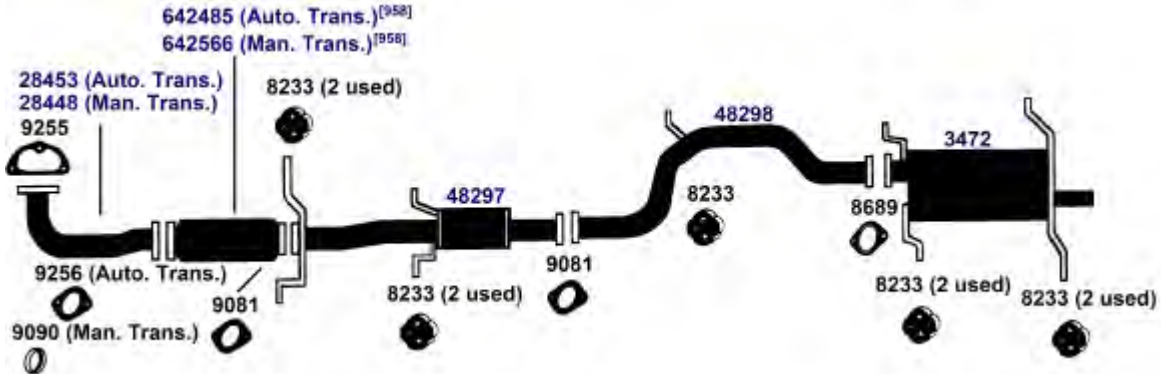

DIRECT FIT MSL/MAXIMUM Muffler... 6593, UNIVERSAL FIT MSL/MAXIMUM Muffler... 6529

89-92 4 Cyl. Probe, 2.2L (133) Turbo Engine (12400)

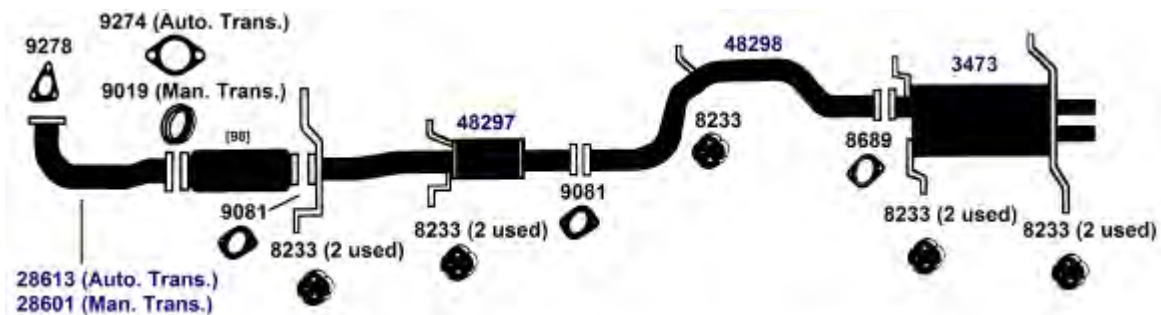

DIRECT FIT MSL/MAXIMUM Muffler... 700007

NA-Not Available. NR-Not Required. FL-Remove and Re-Use Old Flange. ● Golden Warehouse. O.E.-Original Equipment.
 # Airtube Kit [4948] may be required to complete installation. EFI-Electronic Fuel Injection.

[98] Refer to current Catalytic Converter catalog or Website catalog for availability.

[958] Federal & California Emission vehicles. Not legal for sale for vehicles licensed in California.

FORD RANGER

(26528) 93-94 4 Cyl. Ranger; 2.3L Engine; 108", 114" W.B.

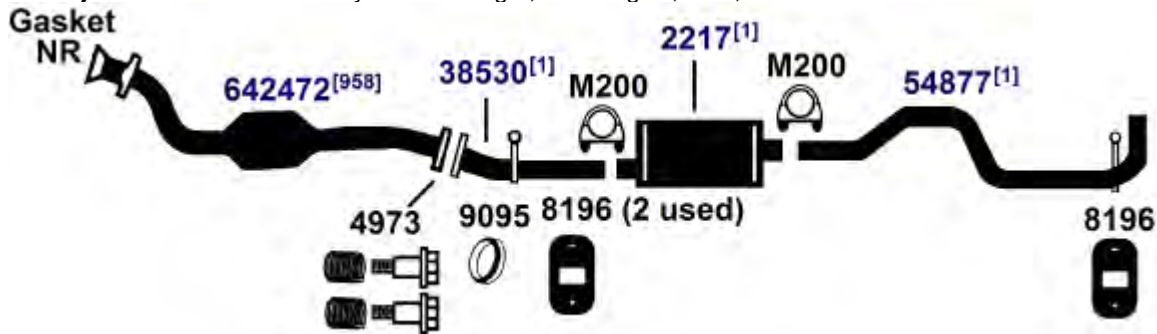

DIRECT FIT MSL/MAXIMUM Muffler... 700034, UNIVERSAL FIT MSL/MAXIMUM Muffler... 709013, Silentone DIY Muffler... 5555

(26527) 93-94 4 Cyl. Ranger; 2.3L Engine; 125" W.B. Super Cab

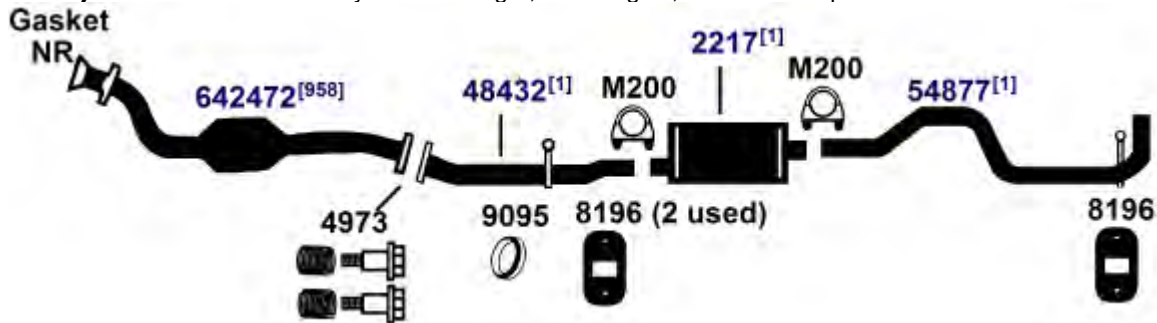

DIRECT FIT MSL/MAXIMUM Muffler... 700034, UNIVERSAL FIT MSL/MAXIMUM Muffler... 709013, Silentone DIY Muffler... 5555

(26526) 93-94 6 Cyl. Ranger; 3.0L, 4.0L Engine; 108", 114" W.B.



DIRECT FIT MSL/MAXIMUM Muffler... 700034, UNIVERSAL FIT MSL/MAXIMUM Muffler... 709013, Silentone DIY Muffler... 5555

NA-Not Available. NR-Not Required. FL-Remove and Re-Use Old Flange. ● Golden Warehouse. O.E.-Original Equipment.
Airtube Kit [4948] may be required to complete installation. EFI-Electronic Fuel Injection.

[1] OE system was a welded assembly. It is recommended that all parts noted [1] should be replaced.

[236] Not Required with aftermarket Converter

[920] Y-Pipe must be cut 1/2" from face of flange

[941] Replaces both front and rear converters, Only failed converters may be replaced.

[958] Federal & California Emission vehicles. Not legal for sale for vehicles licensed in California.

93-94 6 Cyl. Ranger; 3.0L, 4.0L Engine; 125" W.B. Super Cab

(26525)

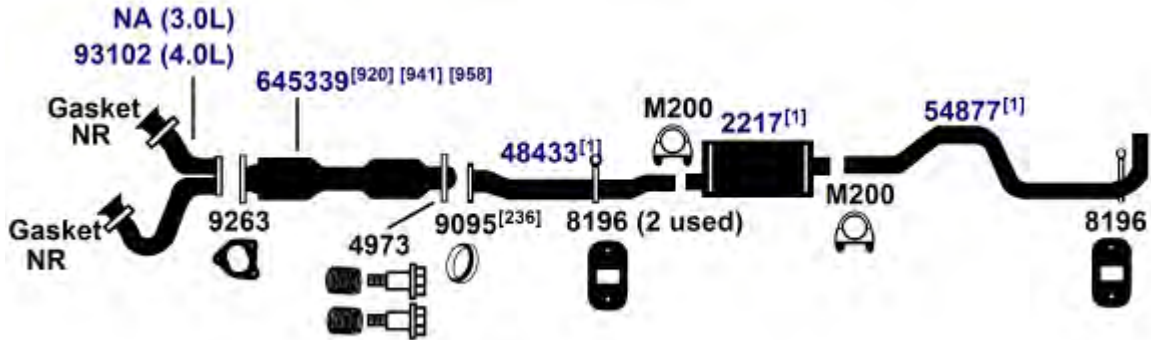

DIRECT FIT MSL/MAXIMUM Muffler... 700034, UNIVERSAL FIT MSL/MAXIMUM Muffler... 709013, Silentone DIY Muffler... 5555

1992 4 Cyl. Ranger; 140 (2.3L) Engine; 108", 114" W.B.

(26524)

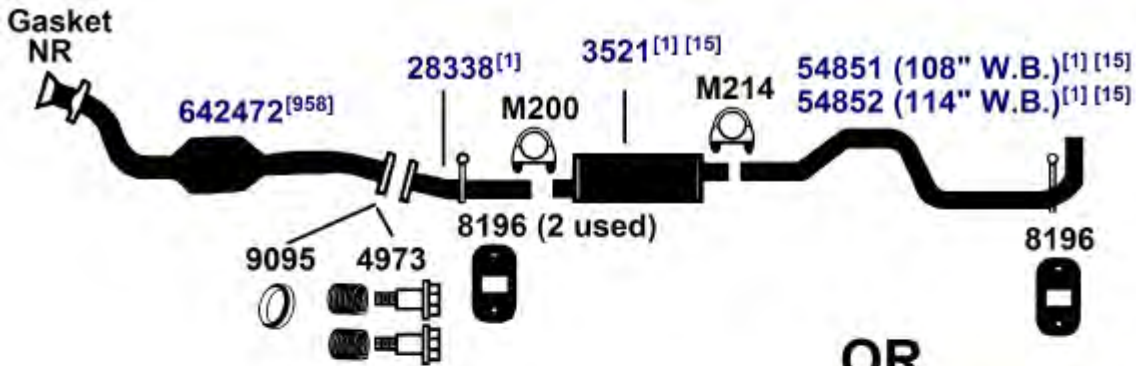

OR

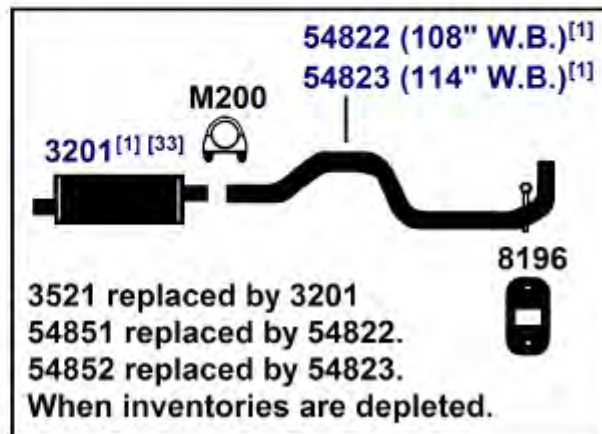

DIRECT FIT MSL/MAXIMUM Muffler... 700163 (Old Design), 6571 (Revised Design), UNIVERSAL FIT MSL/MAXIMUM Muffler... 6512 (Old Design), 709993 (Old Design), 709993 (Revised Design), Silentone DIY Muffler... 5552 (Revised Design)

NA-Not Available. NR-Not Required. FL-Remove and Re-Use Old Flange. ● Golden Warehouse. O.E.-Original Equipment.
Airtube Kit [4948] may be required to complete installation. EFI-Electronic Fuel Injection.

[1] OE system was a welded assembly. It is recommended that all parts noted [1] should be replaced.

[15] Discontinued, use until inventory is depleted.

[33] Remove and re-use O.E. heat shield.

[236] Not Required with aftermarket Converter

[920] Y-Pipe must be cut 1/2" from face of flange

[941] Replaces both front and rear converters, Only failed converters may be replaced.

[958] Federal & California Emission vehicles. Not legal for sale for vehicles licensed in California.

FORD RANGER

(26521) 1992 6 Cyl. Ranger; 2.9L Engine; 108", 114" W.B.
 91-92 6 Cyl. Ranger; 3.0L, 4.0L Engine; 108", 114" W.B.

28339 (2.9L Eng.)^{[1] [15]}
 28419 (3.0L Eng.)^[1]
 28420 (4.0L Eng.)^{[1] [15]}

NOTE: All pipes to be replaced by 28419 when inventories are depleted.

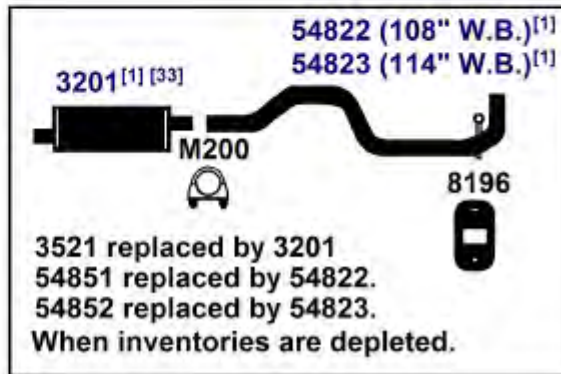
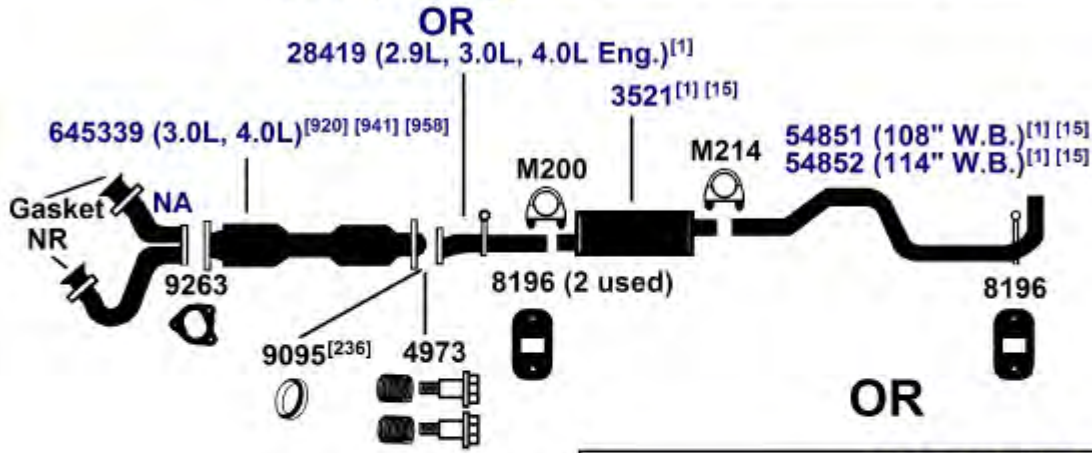

DIRECT FIT MSL/MAXIMUM Muffler... 700163 (Old Design), 6571 (Revised Design), UNIVERSAL FIT MSL/MAXIMUM Muffler... 6512 (Old Design), 709993 (Old Design), 709993 (Revised Design), Silentone DIY Muffler... 5552 (Revised Design)

NA-Not Available. NR-Not Required. FL-Remove and Re-Use Old Flange. ● Golden Warehouse. O.E.-Original Equipment.
 # Airtube Kit [4948] may be required to complete installation. EFI-Electronic Fuel Injection.

[1] OE system was a welded assembly. It is recommended that all parts noted [1] should be replaced.

[15] Discontinued, use until inventory is depleted.

[33] Remove and re-use O.E. heat shield.

[236] Not Required with aftermarket Converter

[920] Y-Pipe must be cut 1/2" from face of flange

[941] Replaces both front and rear converters, Only failed converters may be replaced.

[958] Federal & California Emission vehicles. Not legal for sale for vehicles licensed in California.

1992 6 Cyl. Ranger; 2.9L Engine; 125" W.B. Super Cab
 91-92 6 Cyl. Ranger; 3.0L, 4.0L Engine; 125" W.B. Super Cab

(26520)

48336 (2.9L Eng.)^{[1] [15]}
 48400 (3.0L Eng.)^{[1] [15]}
 48401 (4.0L Eng.)^[1]

NOTE: All pipes to be replaced by 48401 when inventories are depleted.

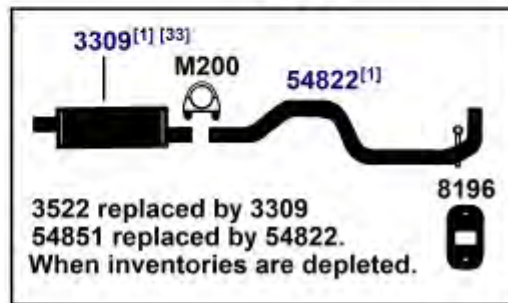
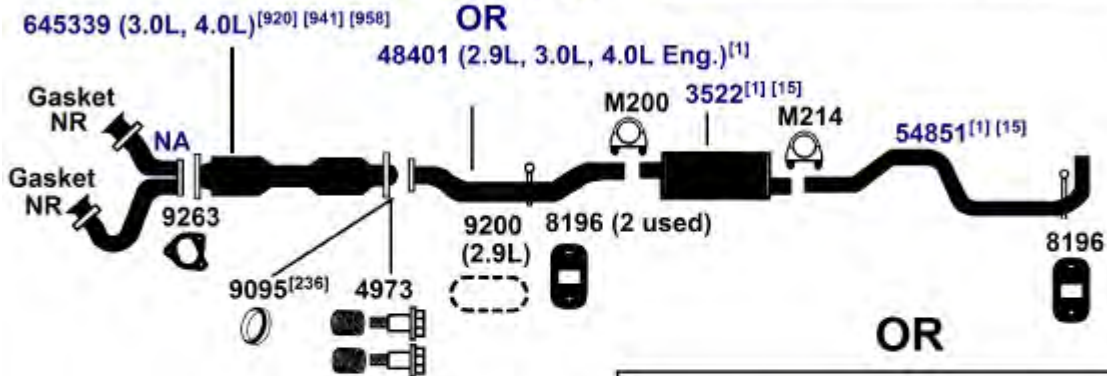

DIRECT FIT MSL/MAXIMUM Muffler... 700283 (Old Design), 700108 (Revised Design), UNIVERSAL FIT MSL/MAXIMUM Muffler... 6512 (Old Design), 709993 (Old Design), 6571 (Revised Design), Silentone DIY Muffler... 5552 (Revised Design)

NA-Not Available. NR-Not Required. FL-Remove and Re-Use Old Flange. ● Golden Warehouse. O.E.-Original Equipment.
 # Airtube Kit [4948] may be required to complete installation. EFI-Electronic Fuel Injection.

- [1] OE system was a welded assembly. It is recommended that all parts noted [1] should be replaced.
- [15] Discontinued, use until inventory is depleted.
- [33] Remove and re-use O.E. heat shield.
- [236] Not Required with aftermarket Converter
- [920] Y-Pipe must be cut 1/2" from face of flange
- [941] Replaces both front and rear converters, Only failed converters may be replaced.
- [958] Federal & California Emission vehicles. Not legal for sale for vehicles licensed in California.

FORD RANGER

(26516) 90-92 4 Cyl. Ranger; 140 (2.3L) Engine; 125" W.B.

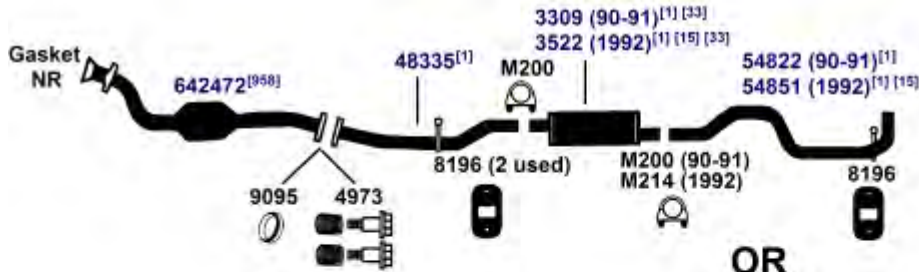

OR
1990-92

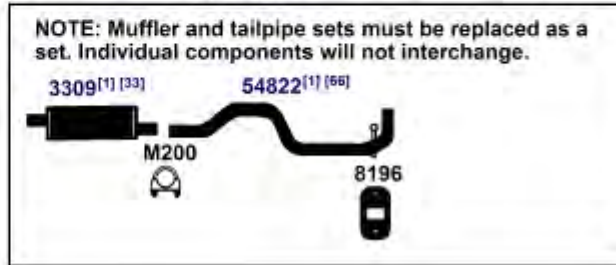

DIRECT FIT MSL/MAXIMUM Muffler... 90-91- 700108, 700283 (1992 Old Design), 700108 (1992 Revised Design), UNIVERSAL FIT MSL/MAXIMUM Muffler... 90-91- 6571, 709993 (1992 Old Design), 6512 (1992 Old Design), 6571 (1992 Revised Design), Silentone DIY Muffler... 90-91- 5552, 5552 (1992 Revised Design)

(26518) 1991 6 Cyl. Ranger; 2.9L Engine; 125" W.B. Super Cab
1990 6 Cyl. Ranger; 2.9L, 4.0L Engine; 125" W.B.; Super Cab

48336 (2.9L Eng.)^{[1] [15]}
48337 (4.0L Eng.)^{[1] [15]}

NOTE: Both pipes to be replaced by 48401 when inventories are depleted.

OR

48401 (2.9L, 4.0L Eng.)^[1]

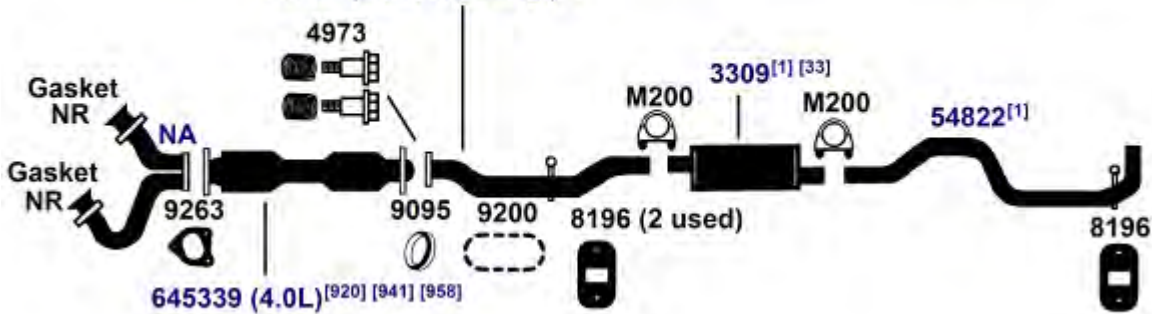

DIRECT FIT MSL/MAXIMUM Muffler... 700108, UNIVERSAL FIT MSL/MAXIMUM Muffler... 6571, Silentone DIY Muffler... 5552

NA-Not Available. NR-Not Required. FL-Remove and Re-Use Old Flange. ● Golden Warehouse. O.E.-Original Equipment.
Airtube Kit [4948] may be required to complete installation. EFI-Electronic Fuel Injection.

[1] OE system was a welded assembly. It is recommended that all parts noted [1] should be replaced.

[15] Discontinued, use until inventory is depleted.

[33] Remove and re-use O.E. heat shield.

[66] Muffler and tailpipe sets must be replaced as a set. Individual components will not interchange.

[920] Y-Pipe must be cut 1/2" from face of flange

[941] Replaces both front and rear converters, Only failed converters may be replaced.

[958] Federal & California Emission vehicles. Not legal for sale for vehicles licensed in California.

1991 6 Cyl. Ranger; 2.9L Engine; 108", 114" W.B.
 1990 6 Cyl. Ranger; 2.9L, 4.0L Engine; 108", 114" W.B.

(26519)

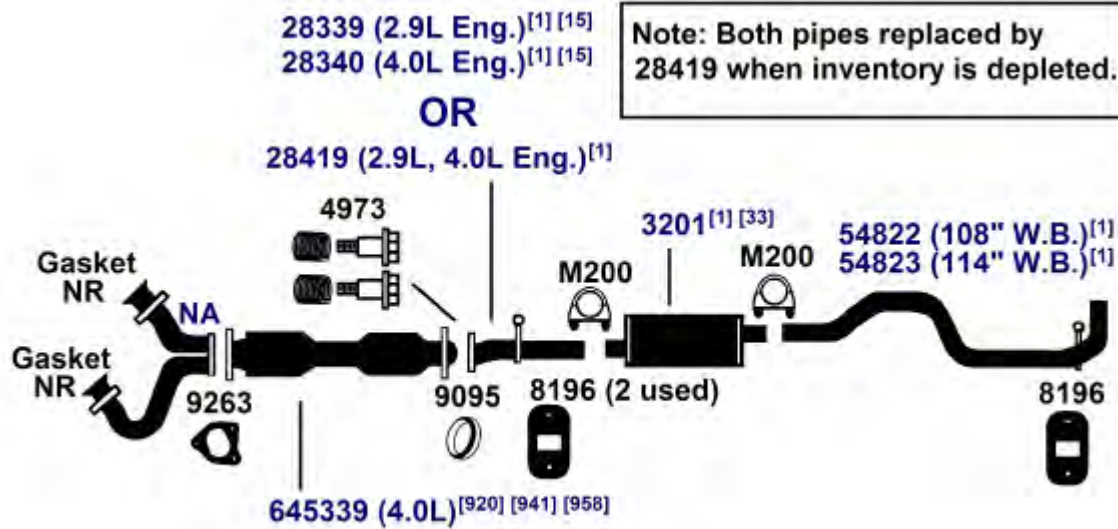

DIRECT FIT MSL/MAXIMUM Muffler... 6571, UNIVERSAL FIT MSL/MAXIMUM Muffler... 709993, Silentone DIY Muffler... 5552

90-91 4 Cyl. Ranger; 140 (2.3L) Engine; 108", 114" W.B.

(26517)

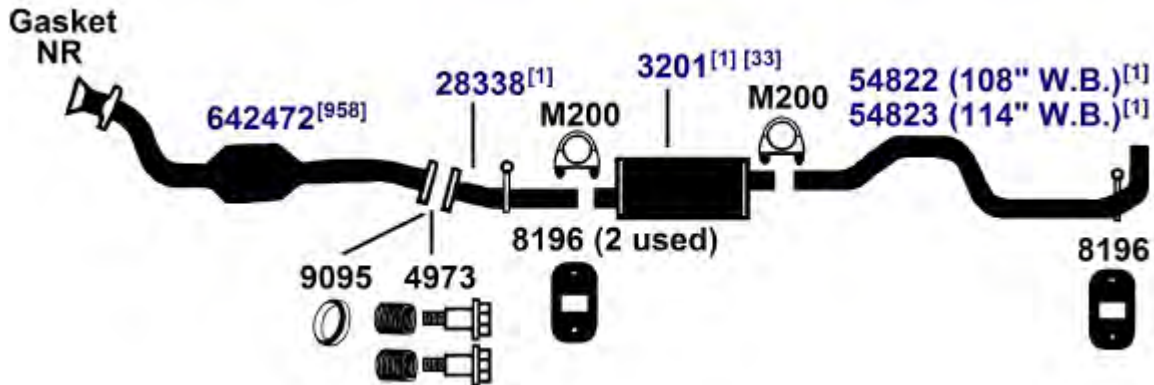

DIRECT FIT MSL/MAXIMUM Muffler... 6571, UNIVERSAL FIT MSL/MAXIMUM Muffler... 709993, Silentone DIY Muffler... 5552

NA-Not Available. NR-Not Required. FL-Remove and Re-Use Old Flange. ● Golden Warehouse. O.E.-Original Equipment.
 # Airtube Kit [4948] may be required to complete installation. EFI-Electronic Fuel Injection.

- [1] OE system was a welded assembly. It is recommended that all parts noted [1] should be replaced.
- [15] Discontinued, use until inventory is depleted.
- [33] Remove and re-use O.E. heat shield.
- [920] Y-Pipe must be cut 1/2" from face of flange
- [941] Replaces both front and rear converters. Only failed converters may be replaced.
- [958] Federal & California Emission vehicles. Not legal for sale for vehicles licensed in California.

FORD RANGER

(26515) 1989 4 Cyl. Ranger; 140 (2.3L) Engine; 125" W.B.; Super Cab

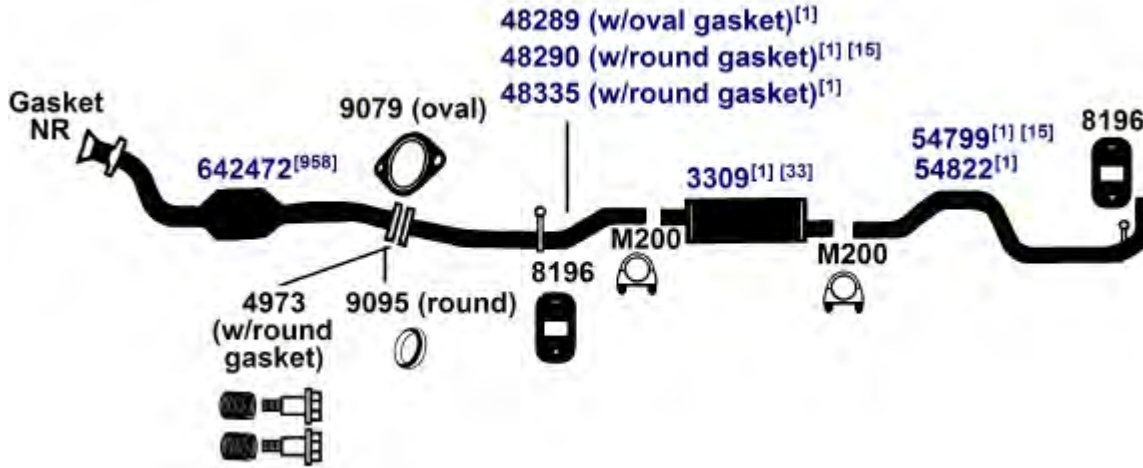

DIRECT FIT MSL/MAXIMUM Muffler... 700108, UNIVERSAL FIT MSL/MAXIMUM Muffler... 6571, Silentone DIY Muffler... 5552

(26514) 1989 6 Cyl. Ranger; 2.9L Engine; 125" W.B.; Super Cab

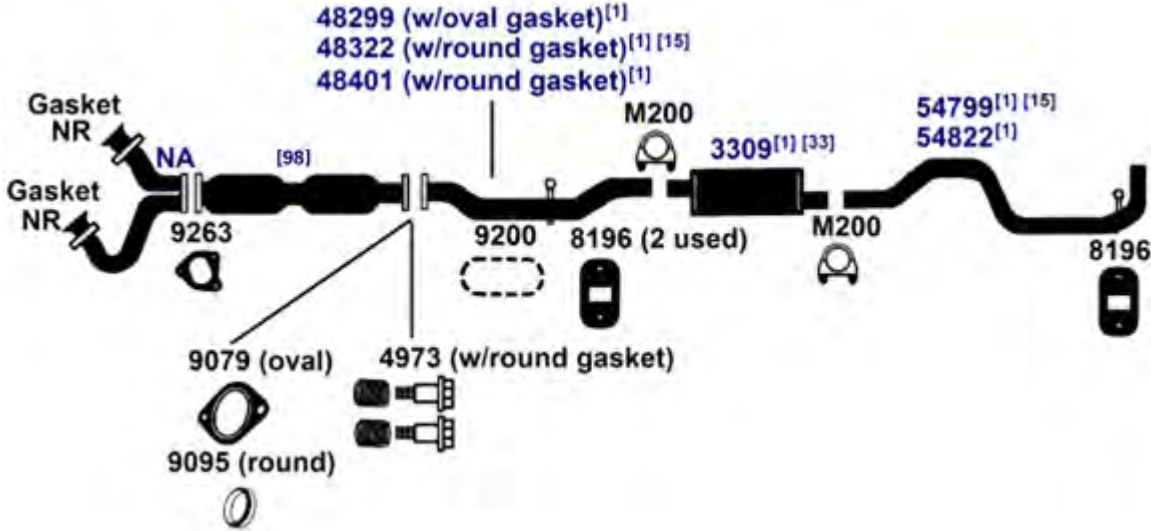

DIRECT FIT MSL/MAXIMUM Muffler... 700108, UNIVERSAL FIT MSL/MAXIMUM Muffler... 6571, Silentone DIY Muffler... 5552

NA-Not Available. NR-Not Required. FL-Remove and Re-Use Old Flange. ● Golden Warehouse. O.E.-Original Equipment.
Airtube Kit [4948] may be required to complete installation. EFI-Electronic Fuel Injection.

[1] OE system was a welded assembly. It is recommended that all parts noted [1] should be replaced.

[15] Discontinued, use until inventory is depleted.

[33] Remove and re-use O.E. heat shield.

[98] Refer to current Catalytic Converter catalog or Website catalog for availability.
[958] Federal & California Emission vehicles. Not legal for sale for vehicles licensed in California.

86-89 4 Cyl. Ranger; 122, 140 (2.0L, 2.3L) Engine; 108", 114" W.B.; except California for 1986 Models (26507)

642343 (87-88 2.0L w/o Air Tube)^[958]
 642337 (1/86-89 2.3L; 86-88 2.0L w/ Air Tube)^[958]
 642339 (To 1/86)^[958]

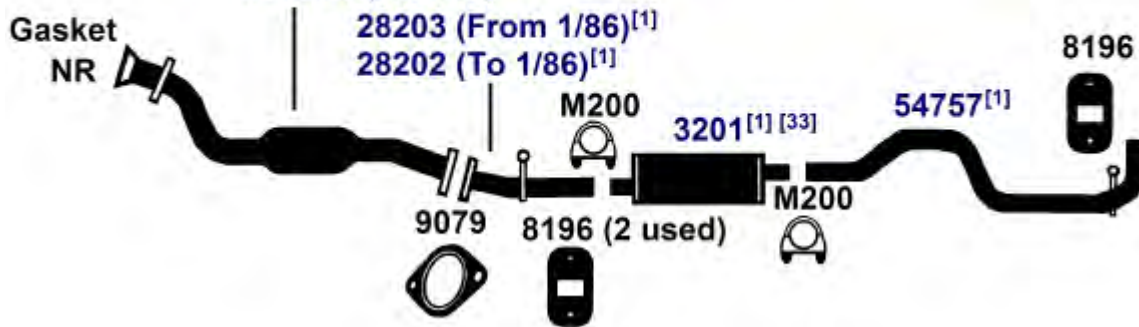

DIRECT FIT MSL/MAXIMUM Muffler... 6571, UNIVERSAL FIT MSL/MAXIMUM Muffler... 709993, Silentone DIY Muffler... 5552

86-89 6 Cyl. Ranger; 2.9L Engine; 108", 114" W.B. (26510)

645338 (86-87)^{[941] [958]}
 645340 (1988)^{[920] [941] [958]}

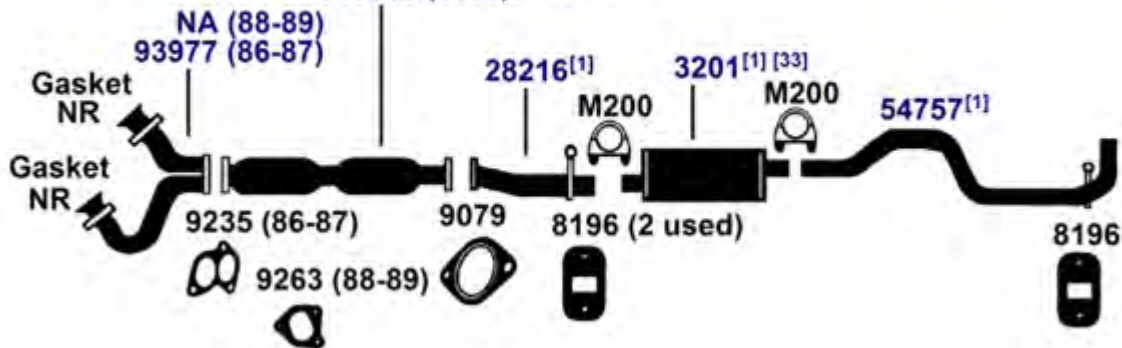

DIRECT FIT MSL/MAXIMUM Muffler... 6571, UNIVERSAL FIT MSL/MAXIMUM Muffler... 709993, Silentone DIY Muffler... 5552

1988 6 Cyl. Ranger; 2.9L Engine; 125" W.B.; Super Cab (26512)

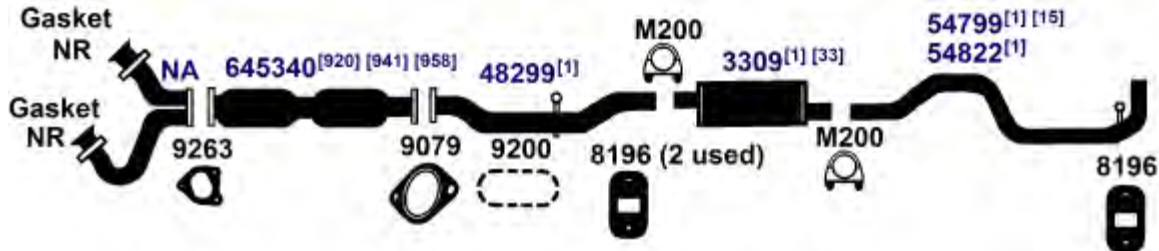

DIRECT FIT MSL/MAXIMUM Muffler... 700108, UNIVERSAL FIT MSL/MAXIMUM Muffler... 6571, Silentone DIY Muffler... 5552

NA-Not Available. NR-Not Required. FL-Remove and Re-Use Old Flange. ● Golden Warehouse. O.E.-Original Equipment.
 # Airtube Kit [4948] may be required to complete installation. EFI-Electronic Fuel Injection.

- [1] OE system was a welded assembly. It is recommended that all parts noted [1] should be replaced.
- [15] Discontinued, use until inventory is depleted.
- [33] Remove and re-use O.E. heat shield.
- [920] Y-Pipe must be cut 1/2" from face of flange
- [941] Replaces both front and rear converters, Only failed converters may be replaced.
- [958] Federal & California Emission vehicles. Not legal for sale for vehicles licensed in California.

FORD RANGER

(26511) 87-88 4 Cyl. Ranger; 2.3L Engine; 125" W.B.; Super Cab; From 11-86

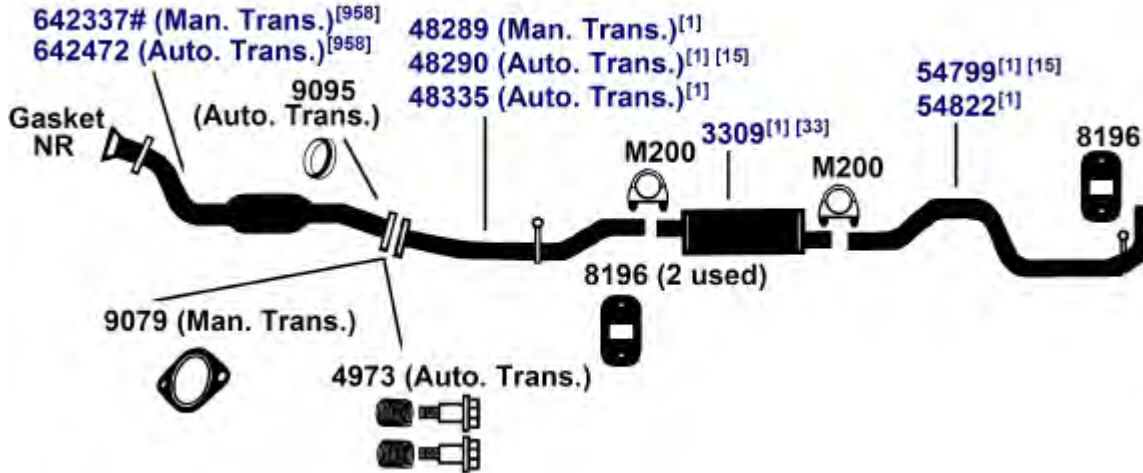

DIRECT FIT MSL/MAXIMUM Muffler... 700108, UNIVERSAL FIT MSL/MAXIMUM Muffler... 6571, Silentone DIY Muffler... 5552

(26506) 86-87 4 Cyl. Ranger; 122, 140 (2.0L, 2.3L) Engine; 125" W.B.; Super Cab; Before 11-86

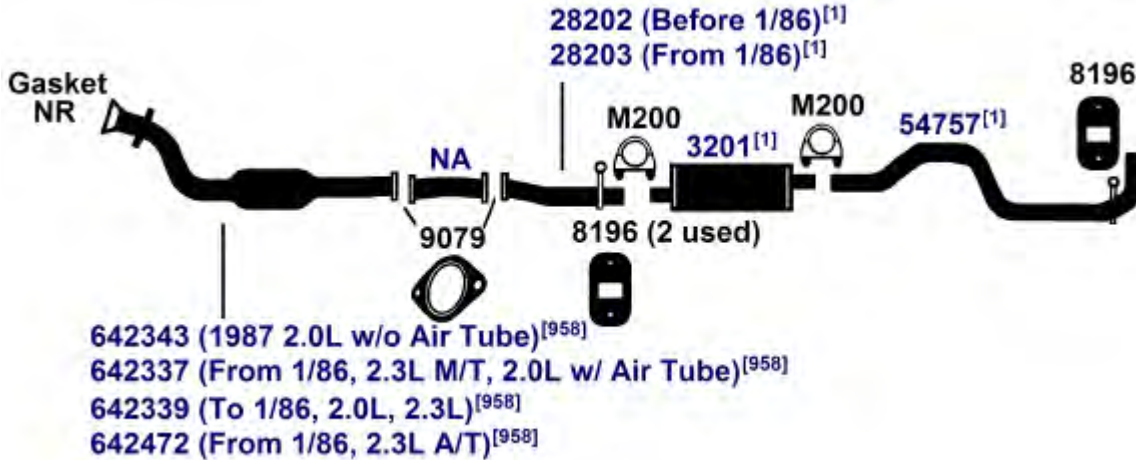

DIRECT FIT MSL/MAXIMUM Muffler... 6571, UNIVERSAL FIT MSL/MAXIMUM Muffler... 709993, Silentone DIY Muffler... 5552

NA-Not Available. NR-Not Required. FL-Remove and Re-Use Old Flange. ● Golden Warehouse. O.E.-Original Equipment.
Airtube Kit [4948] may be required to complete installation. EFI-Electronic Fuel Injection.

[1] OE system was a welded assembly. It is recommended that all parts noted [1] should be replaced.

[33] Remove and re-use O.E. heat shield.

[958] Federal & California Emission vehicles. Not legal for sale for vehicles licensed in California.

[15] Discontinued, use until inventory is depleted.

FORD RANGER

86-87 6 Cyl. Ranger; 177 (2.9L) Engine; 125" W.B.; Super Cab **(26508)**

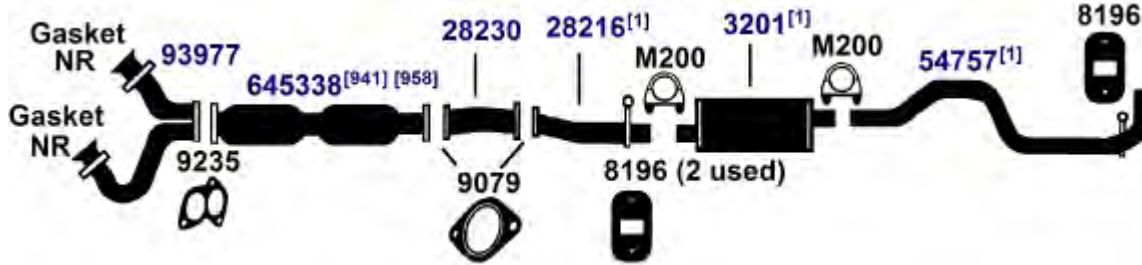

DIRECT FIT MSL/MAXIMUM Muffler... 6571, UNIVERSAL FIT MSL/MAXIMUM Muffler... 709993, Silentone DIY Muffler... 5552

1986 4 Cyl. Ranger; 122, 140 (2.0L, 2.3L) Engine; 108", 114" W.B.; California **(26509)**

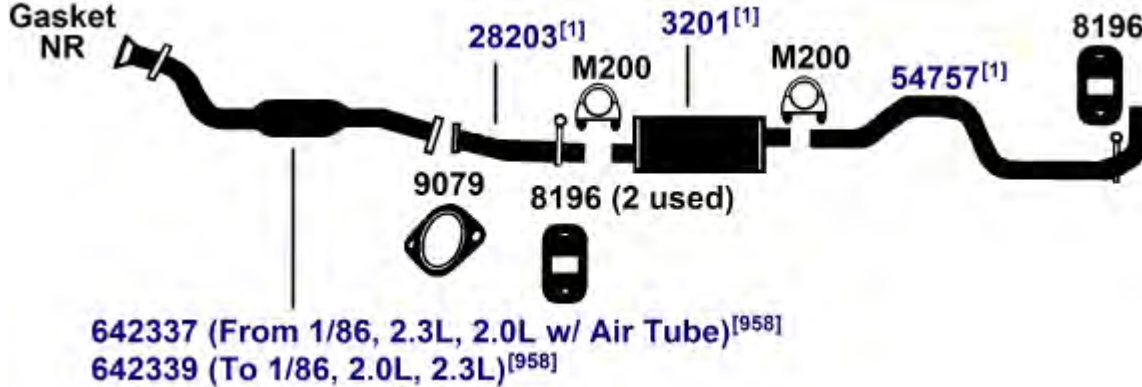

DIRECT FIT MSL/MAXIMUM Muffler... 6571, UNIVERSAL FIT MSL/MAXIMUM Muffler... 709993, Silentone DIY Muffler... 5552

85-86 4 Cyl. Ranger; 140 Diesel (2.3L) Engine; 108", 114" W.B.; except Turbo, without Converter **(26504)**

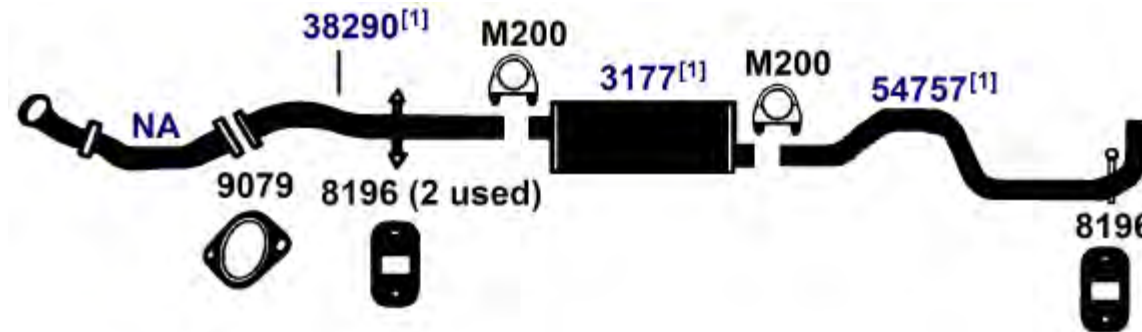

DIRECT FIT MSL/MAXIMUM Muffler... 700074, UNIVERSAL FIT MSL/MAXIMUM Muffler... 6558

NA-Not Available. NR-Not Required. FL-Remove and Re-Use Old Flange. ● Golden Warehouse. O.E.-Original Equipment.
 # Airtube Kit [4948] may be required to complete installation. EFI-Electronic Fuel Injection.

[1] OE system was a welded assembly. It is recommended that all parts noted [1] should be replaced. [958] Federal & California Emission vehicles. Not legal for sale for vehicles licensed in California.
 [941] Replaces both front and rear converters, Only failed converters may be replaced.

FORD RANGER

(26505) 1985 4 Cyl. Ranger; 2.0L, 2.3L Engine; 108", 114" W.B.

28202 (exc. Calif.)^[1]
28203 (Calif.)^[1]

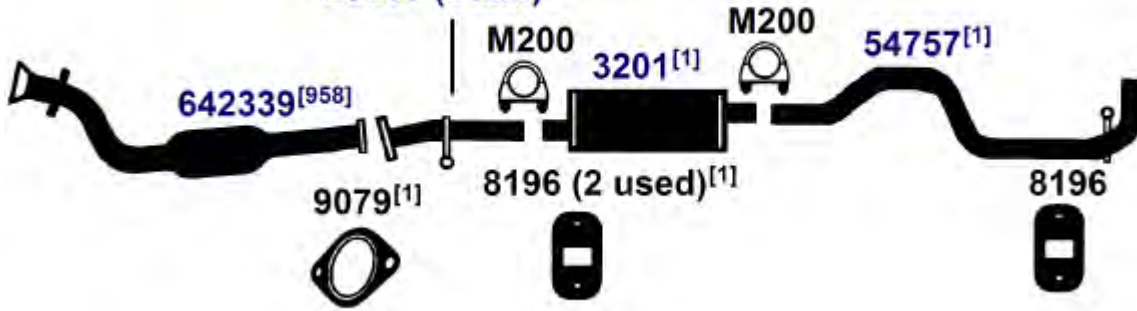

DIRECT FIT MSL/MAXIMUM Muffler... 6571, UNIVERSAL FIT MSL/MAXIMUM Muffler... 709993, Silentone DIY Muffler... 5552

(26503) 1985 6 Cyl. Ranger; 170 (2.8L) Engine; 108", 114" W.B.; with Converter

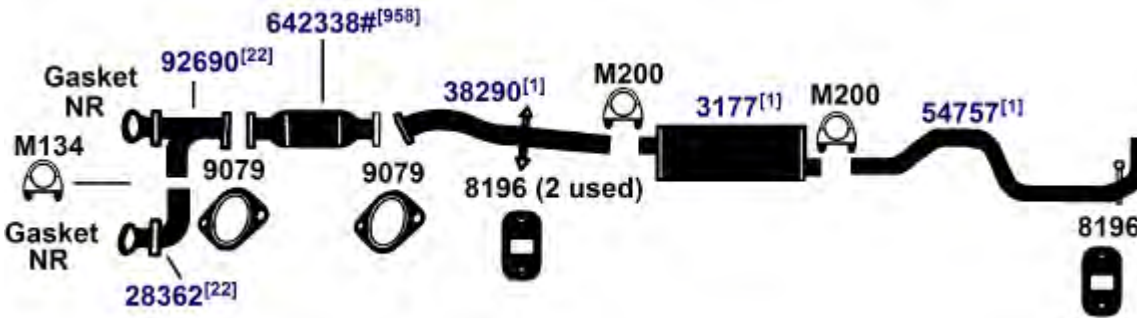

DIRECT FIT MSL/MAXIMUM Muffler... 700074, UNIVERSAL FIT MSL/MAXIMUM Muffler... 6558

(26502) 1984 4 Cyl. Ranger; 122, 140 (2.0L, 2.3L) Engine; 108", 114" W.B.; with Converter

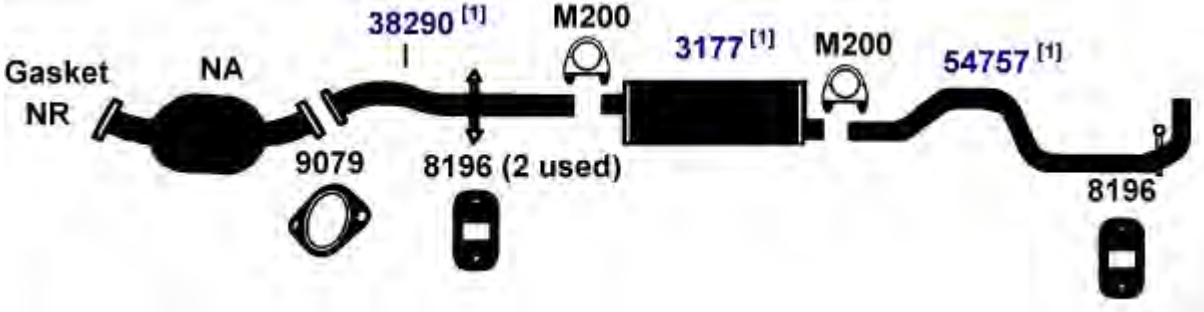

DIRECT FIT MSL/MAXIMUM Muffler... 700074, UNIVERSAL FIT MSL/MAXIMUM Muffler... 6558

NA-Not Available. NR-Not Required. FL-Remove and Re-Use Old Flange. ● Golden Warehouse. O.E.-Original Equipment.
Airtube Kit [4948] may be required to complete installation. EFI-Electronic Fuel Injection.

[1] OE system was a welded assembly. It is recommended that all parts noted [1] should be replaced.

[22] O.E. exhaust pipe was one piece. Replacement is two pieces.

[98] Refer to current Catalytic Converter catalog or Website catalog for availability.
[958] Federal & California Emission vehicles. Not legal for sale for vehicles licensed in California.

83-84 4 Cyl. Ranger; 134 Diesel (2.2L) Engine; 108", 114" W.B.

(26500)

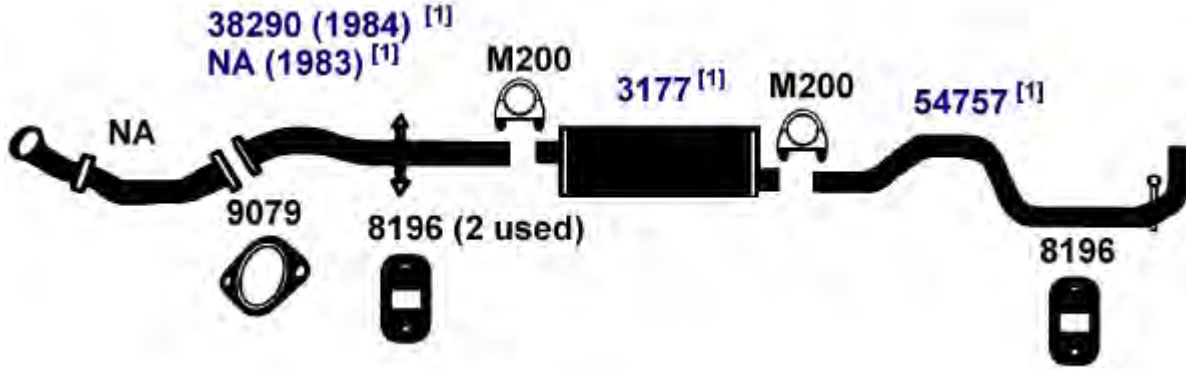

DIRECT FIT MSL/MAXIMUM Muffler... 700074, UNIVERSAL FIT MSL/MAXIMUM Muffler... 6558

83-84 6 Cyl. Ranger; 170 (2.8L) Engine; 108", 114" W.B.; with Converter

(26503E)

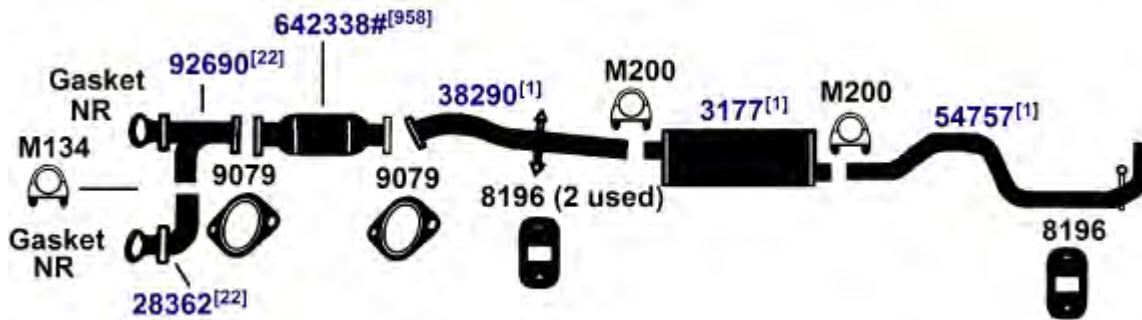

DIRECT FIT MSL/MAXIMUM Muffler... 700074, UNIVERSAL FIT MSL/MAXIMUM Muffler... 6558

1983 4 Cyl. Ranger; 122, 140 (2.0L, 2.3L) Engine; 108", 114" W.B.; with Converter

(26501)

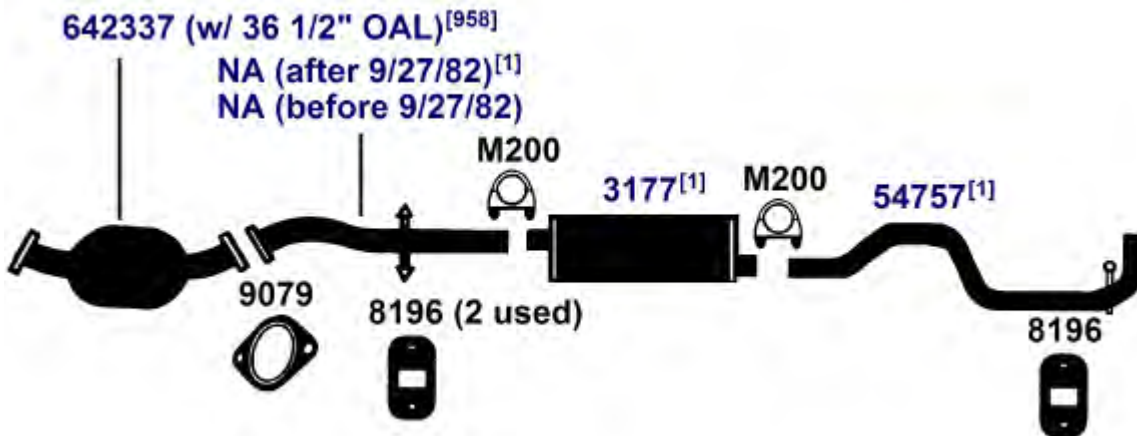

DIRECT FIT MSL/MAXIMUM Muffler... 700074, UNIVERSAL FIT MSL/MAXIMUM Muffler... 6558

NA-Not Available. NR-Not Required. FL-Remove and Re-Use Old Flange. ● Golden Warehouse. O.E.-Original Equipment.
Airtube Kit [4948] may be required to complete installation. EFI-Electronic Fuel Injection.

- [1] OE system was a welded assembly. It is recommended that all parts noted [1] should be replaced. [958] Federal & California Emission vehicles. Not legal for sale for vehicles licensed in California.
- [22] O.E. exhaust pipe was one piece. Replacement is two pieces.

FORD TAURUS

(11309) 93-94 6 Cyl. Taurus SHO, 3.0L (182) Engine, Dual Exhaust

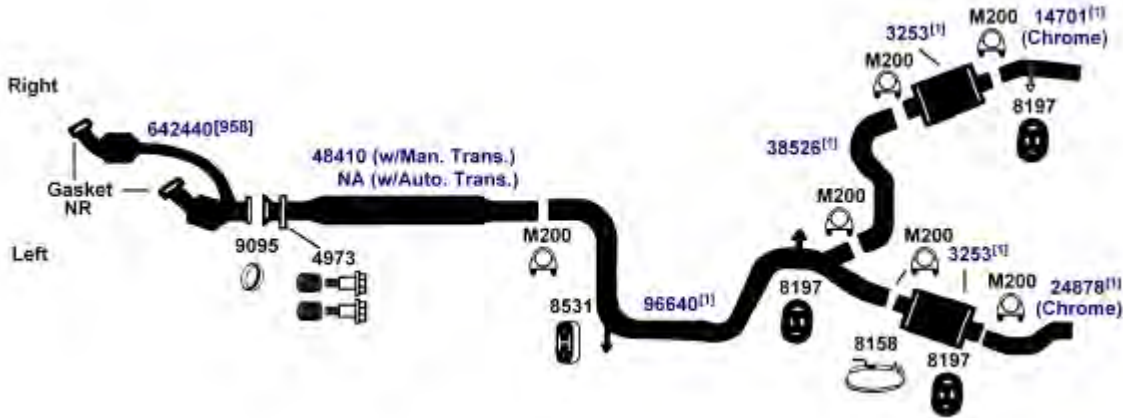

DIRECT FIT MSL/MAXIMUM Muffler... Left 700098, Right 700098, UNIVERSAL FIT MSL/MAXIMUM Muffler... Left 6516, 6538, 709011, 709012, Right 6516, 6538, 709011, 709012, Silentone DIY Muffler... Left 5533, Right 5533

(11307) 1994 6 Cyl. Taurus, 3.0L (182) Engine, Single Exhaust
 91-94 6 Cyl. Taurus, 3.8L (232) Engine, Single Exhaust



DIRECT FIT MSL/MAXIMUM Muffler... 700098, UNIVERSAL FIT MSL/MAXIMUM Muffler... 6516, 6538, 709011, 709012, Silentone DIY Muffler... 5533

(11304) 1993 6 Cyl. Taurus, 3.0L (182) Engine, Single Exhaust; except California
 89-92 6 Cyl. Taurus, 3.0L (182) Engine, Single Exhaust

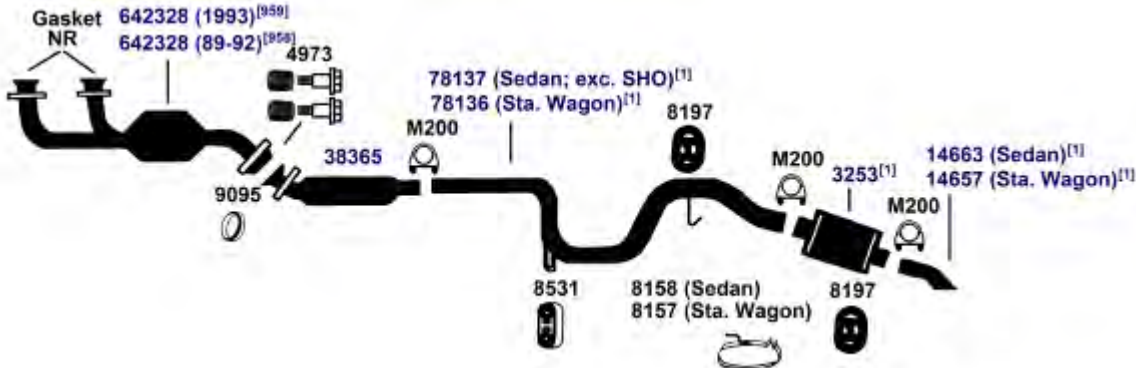

DIRECT FIT MSL/MAXIMUM Muffler... 700098, UNIVERSAL FIT MSL/MAXIMUM Muffler... 6516, 6538, 709011, 709012, Silentone DIY Muffler... 5533

NA-Not Available. NR-Not Required. FL-Remove and Re-Use Old Flange. ● Golden Warehouse. O.E.-Original Equipment.
 # Airtube Kit [4948] may be required to complete installation. EFI-Electronic Fuel Injection.

[1] OE system was a welded assembly. It is recommended that all parts noted [1] [959] Federal Emission vehicles. Not legal for sale for vehicles licensed in California. should be replaced.
 [958] Federal & California Emission vehicles. Not legal for sale for vehicles licensed in California.

91-92 6 Cyl. Taurus SHO, 3.0L (182) Engine, Dual Exhaust (from May, 1991) (11308)

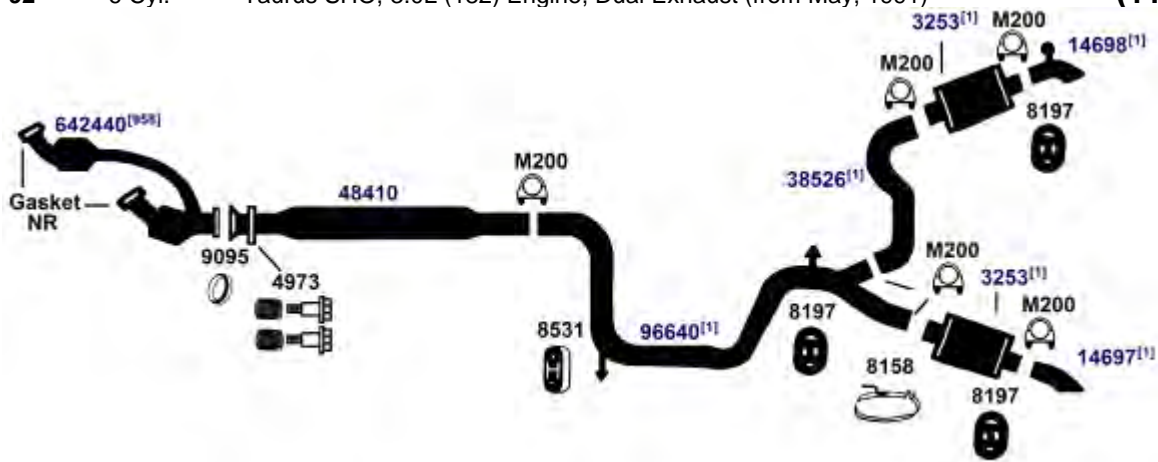

DIRECT FIT MSL/MAXIMUM Muffler... Left 700098, Right 700098, UNIVERSAL FIT MSL/MAXIMUM Muffler... Left 6516, 6538, 709011, 709012, Right 6516, 6538, 709011, 709012, Silentone DIY Muffler... Left 5533, Right 5533

91-92 6 Cyl. Taurus Police Car, 3.8L (232) Engine, Dual Exhaust (11306)

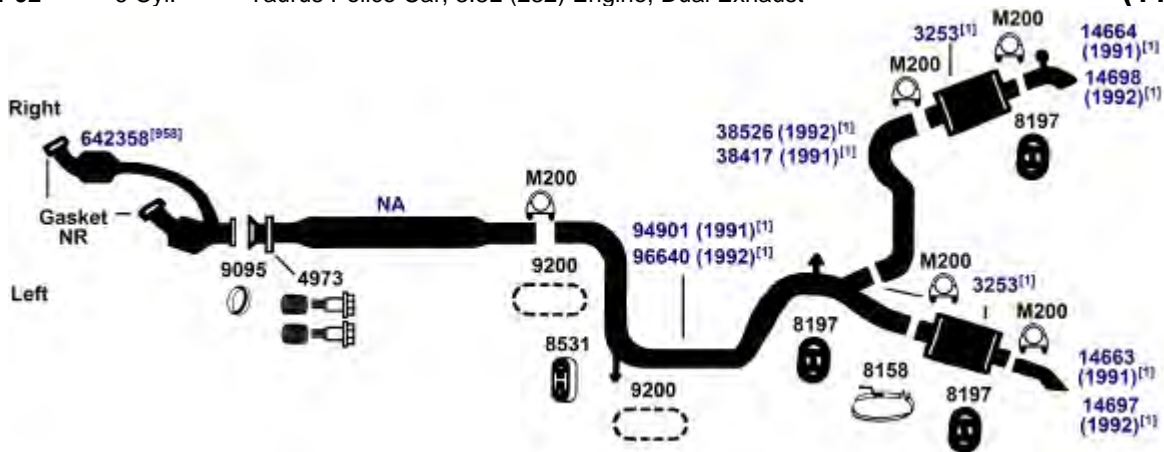

DIRECT FIT MSL/MAXIMUM Muffler... Left 700098, Right 700098, UNIVERSAL FIT MSL/MAXIMUM Muffler... Left 6516, 6538, 709011, 709012, Right 6516, 6538, 709011, 709012, Silentone DIY Muffler... Left 5533, Right 5533

NA-Not Available. NR-Not Required. FL-Remove and Re-Use Old Flange. ● Golden Warehouse. O.E.-Original Equipment.
Airtube Kit [4948] may be required to complete installation. EFI-Electronic Fuel Injection.

[1] OE system was a welded assembly. It is recommended that all parts noted [1] should be replaced. [958] Federal & California Emission vehicles. Not legal for sale for vehicles licensed in California.

FORD TAURUS

(11305) 89-91 6 Cyl. Taurus SHO, 3.0L (182) Engine, Dual Exhaust (before May, 1991)

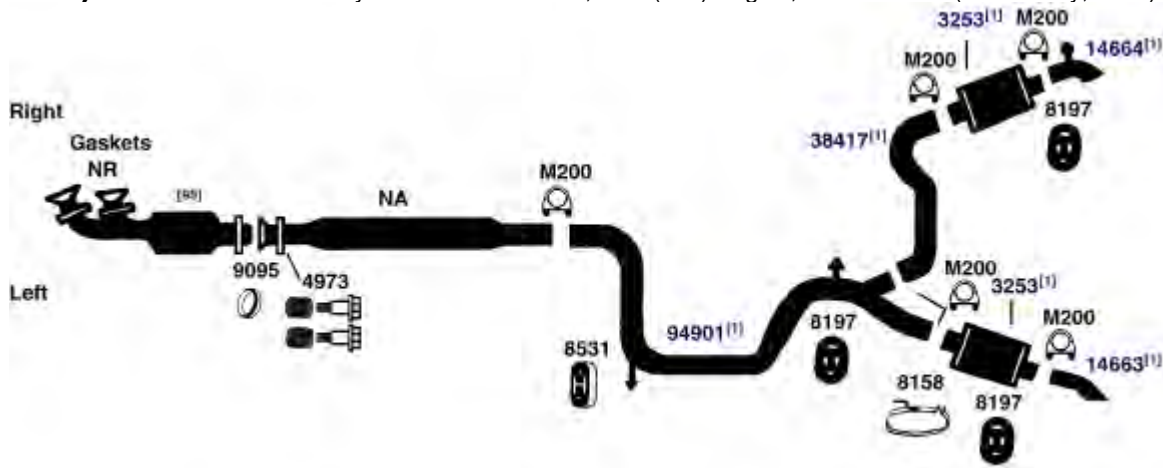

DIRECT FIT MSL/MAXIMUM Muffler... Left 700098, Right 700098, UNIVERSAL FIT MSL/MAXIMUM Muffler... Left 6516, 6538, 709011, 709012, Right 6516, 6538, 709011, 709012, Silentone DIY Muffler... Left 5533, Right 5533

(11302) 88-90 4 Cyl. Taurus Sedan, 2.5L (153) Engine

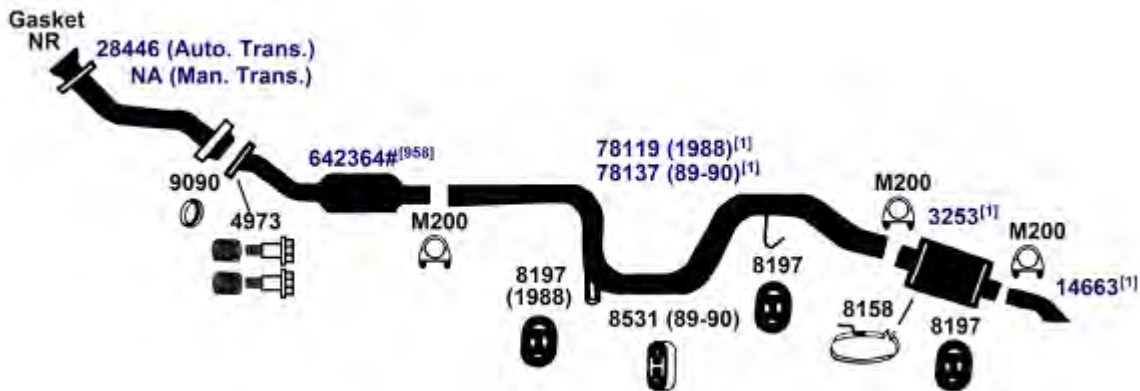

DIRECT FIT MSL/MAXIMUM Muffler... 700098, UNIVERSAL FIT MSL/MAXIMUM Muffler... 6516, 6538, 709011, 709012, Silentone DIY Muffler... 5533

NA-Not Available. NR-Not Required. FL-Remove and Re-Use Old Flange. ● Golden Warehouse. O.E.-Original Equipment.
Airtube Kit [4948] may be required to complete installation. EFI-Electronic Fuel Injection.

[1] OE system was a welded assembly. It is recommended that all parts noted [1] should be replaced.

[958] Federal & California Emission vehicles. Not legal for sale for vehicles licensed in California.

[98] Refer to current Catalytic Converter catalog or Website catalog for availability.

88-90 6 Cyl. Taurus, 3.8L (232) Engine

(11303)



DIRECT FIT MSL/MAXIMUM Muffler... 700098, UNIVERSAL FIT MSL/MAXIMUM Muffler... 6516, 6538, 709011, 709012, Silentone DIY Muffler... 5533

86-88 6 Cyl. Taurus, 3.0L (182) Engine

(11300)



DIRECT FIT MSL/MAXIMUM Muffler... 700098, UNIVERSAL FIT MSL/MAXIMUM Muffler... 6516, 6538, 709011, 709012, Silentone DIY Muffler... 5533

86-87 4 Cyl. Taurus, 2.5L Engine

(11301)



DIRECT FIT MSL/MAXIMUM Muffler... 700098, UNIVERSAL FIT MSL/MAXIMUM Muffler... 6516, 6538, 709011, 709012, Silentone DIY Muffler... 5533

NA-Not Available. NR-Not Required. FL-Remove and Re-Use Old Flange. ● Golden Warehouse. O.E.-Original Equipment.
Airtube Kit [4948] may be required to complete installation. EFI-Electronic Fuel Injection.

[1] OE system was a welded assembly. It is recommended that all parts noted [1] should be replaced.
[904] w/O2 Sensor ports in Converter.

[941] Replaces both front and rear converters, Only failed converters may be replaced.
[958] Federal & California Emission vehicles. Not legal for sale for vehicles licensed in California.

FORD TEMPO

(5706) 92-94 6 Cyl. Tempo, 182 (3.0L) Engine; except GLS
 1992 6 Cyl. Tempo GLS, 182 (3.0L) Engine

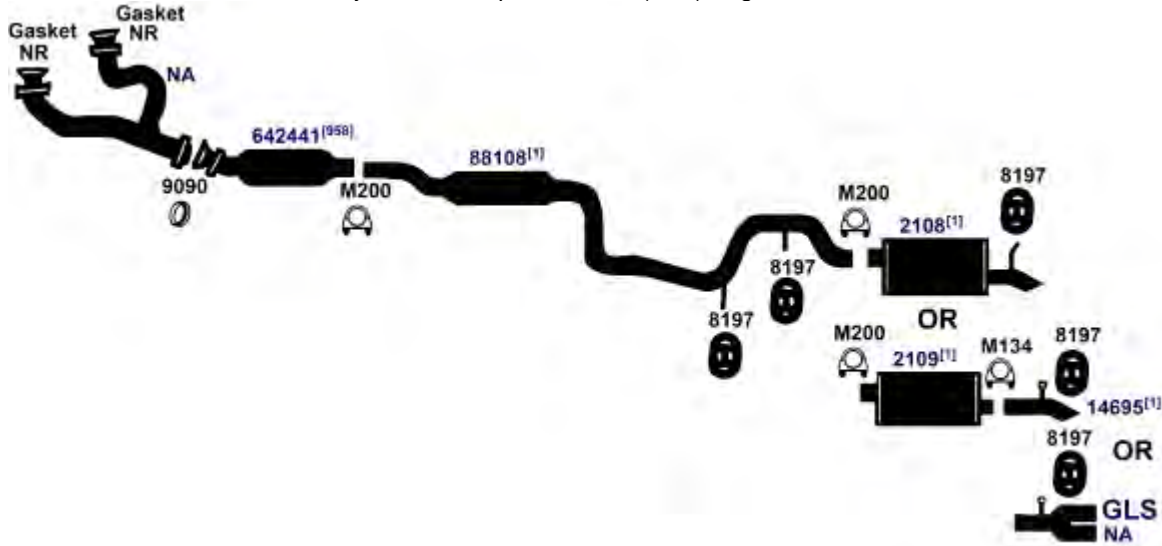

DIRECT FIT MSL/MAXIMUM Muffler... Welded Assembly- 700016, Split System- 6558, UNIVERSAL FIT MSL/MAXIMUM Muffler... Welded Assembly- 6558, 709018, Split System- 709018, Silentone DIY Muffler... Welded Assembly- 5544 and 14695 Spout, Split System- 5544

(5705) 88-94 4 Cyl. Tempo, 140 (2.3L) Engine; except All Wheel Drive

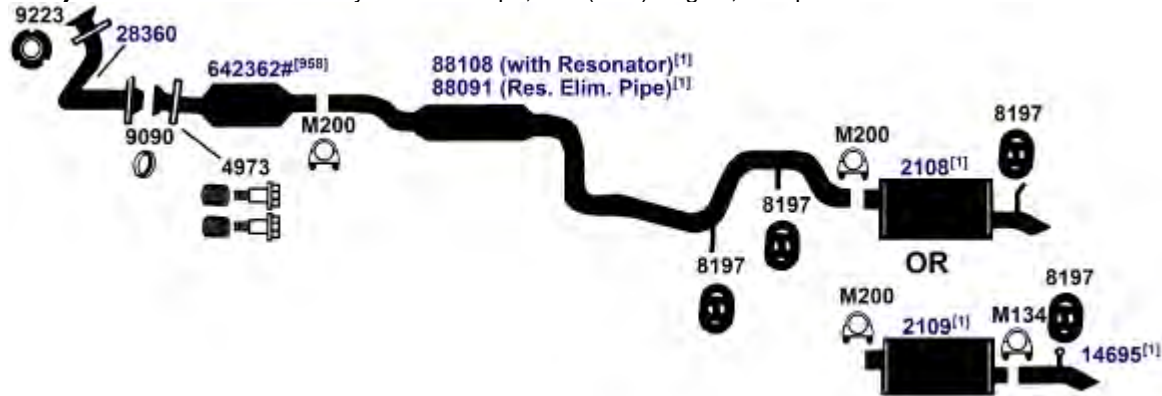

DIRECT FIT MSL/MAXIMUM Muffler... Welded Assembly- 700016, Split System- 6558, UNIVERSAL FIT MSL/MAXIMUM Muffler... Welded Assembly- 6558, 709018, Split System- 709018, Silentone DIY Muffler... Welded Assembly- 5544 and 14695 Spout, Split System- 5544

NA-Not Available. NR-Not Required. FL-Remove and Re-Use Old Flange. ● Golden Warehouse. O.E.-Original Equipment.
 # Airtube Kit [4948] may be required to complete installation. EFI-Electronic Fuel Injection.

[1] OE system was a welded assembly. It is recommended that all parts noted [1] should be replaced. [958] Federal & California Emission vehicles. Not legal for sale for vehicles licensed in California.

87-91 4 Cyl. Tempo, 140 (2.3L) Engine; All Wheel Drive

(5704)

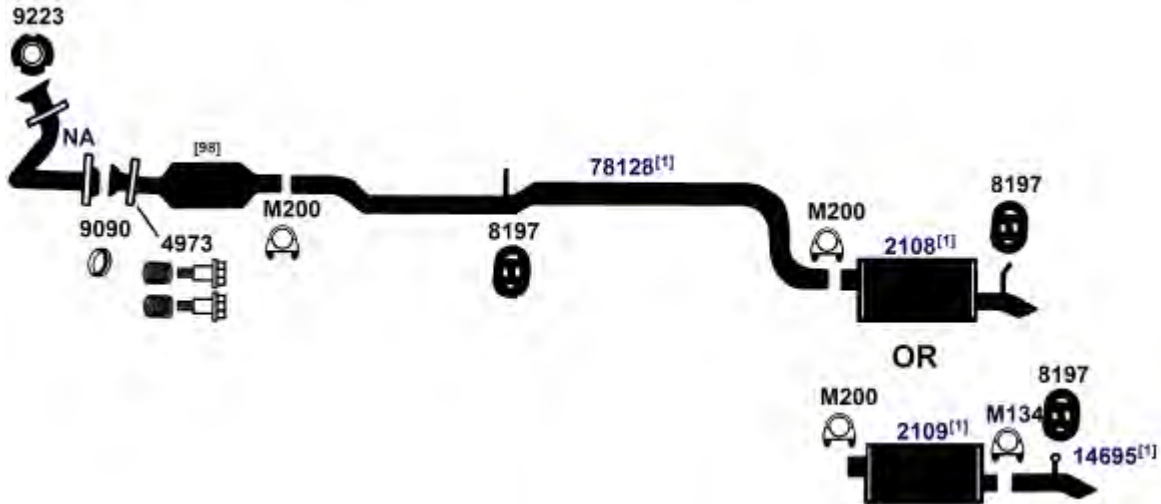

DIRECT FIT MSL/MAXIMUM Muffler... Welded Assembly- 700016, Split System- 6558, UNIVERSAL FIT MSL/MAXIMUM Muffler... Welded Assembly- 6558, 709018, Split System- 709018, Silentone DIY Muffler... Welded Assembly- 5544 and 14695 Spout, Split System- 5544

85-87 4 Cyl. Tempo, 140 (2.3L) Engine; except 1987 All Wheel Drive

(5703)

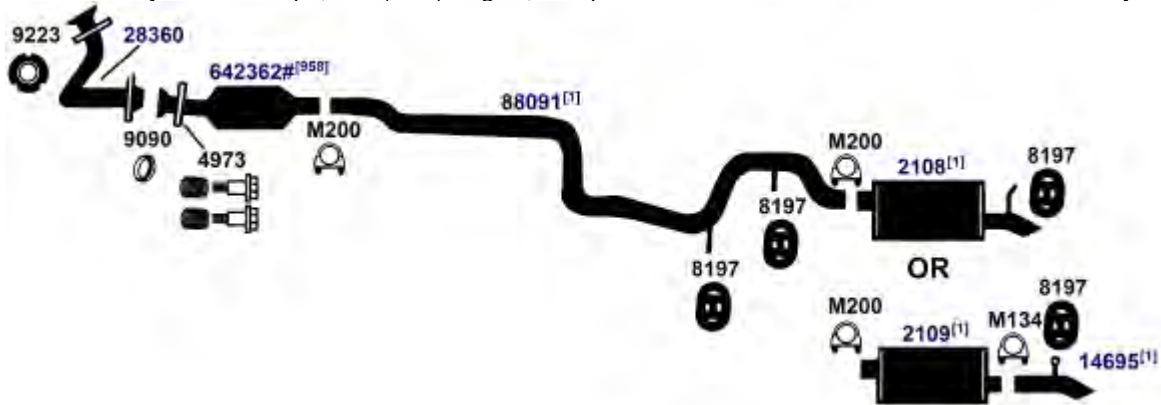

DIRECT FIT MSL/MAXIMUM Muffler... Welded Assembly- 700016, Split System- 6558, UNIVERSAL FIT MSL/MAXIMUM Muffler... Welded Assembly- 6558, 709018, Split System- 709018, Silentone DIY Muffler... Welded Assembly- 5544 and 14695 Spout, Split System- 5544

NA-Not Available. NR-Not Required. FL-Remove and Re-Use Old Flange. ● Golden Warehouse. O.E.-Original Equipment.
Airtube Kit [4948] may be required to complete installation. EFI-Electronic Fuel Injection.

[1] OE system was a welded assembly. It is recommended that all parts noted [1] should be replaced.
[98] Refer to current Catalytic Converter catalog or Website catalog for availability.

[958] Federal & California Emission vehicles. Not legal for sale for vehicles licensed in California.

FORD TEMPO

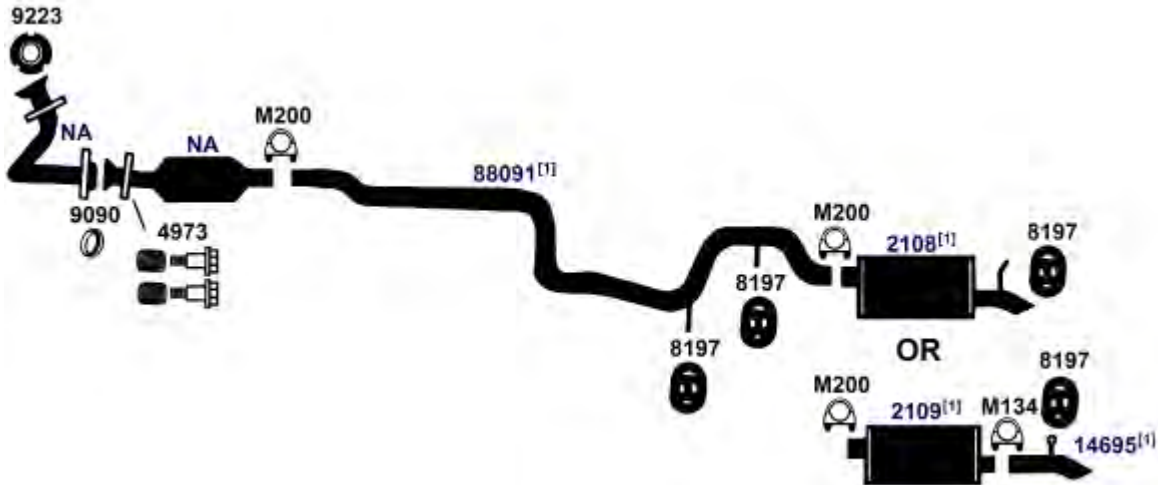
(5702) 85-86 4 Cyl. Tempo, 122 (2.0L) Diesel Engine

DIRECT FIT MSL/MAXIMUM Muffler... Welded Assembly- 700016, Split System- 6558, UNIVERSAL FIT MSL/MAXIMUM Muffler... Welded Assembly- 6558, 709018, Split System- 709018, Silentone DIY Muffler... Welded Assembly- 5544 and 14695 Spout, Split System- 5544

(5703E) 1984 4 Cyl. Tempo, 140 (2.3L) Engine

DIRECT FIT MSL/MAXIMUM Muffler... Welded Assembly- 700016, Split System- 6558, UNIVERSAL FIT MSL/MAXIMUM Muffler... Welded Assembly- 709018, 6558, Split System- 709018, Silentone DIY Muffler... Welded Assembly- 5544 and 14695 Spout, Split System- 5544

NA-Not Available. NR-Not Required. FL-Remove and Re-Use Old Flange. ● Golden Warehouse. O.E.-Original Equipment.
Airtube Kit [4948] may be required to complete installation. EFI-Electronic Fuel Injection.

[1] OE system was a welded assembly. It is recommended that all parts noted [1] should be replaced. [958] Federal & California Emission vehicles. Not legal for sale for vehicles licensed in California.

FORD TEMPO

1984 4 Cyl. Tempo, 122 (2.0L) Diesel Engine

(5702E)



DIRECT FIT MSL/MAXIMUM Muffler... Welded Assembly- 700016, Split System- 6558, UNIVERSAL FIT MSL/MAXIMUM Muffler... Welded Assembly- 6558, 709018, Split System- 709018, Silentone DIY Muffler... Welded Assembly- 5544 and 14695 Spout, Split System- 5544

FORD THUNDERBIRD

1994 8 Cyl. Thunderbird, 280 (4.6L) Engine, Dual Exhaust
 92-93 8 Cyl. Thunderbird, 302 (5.0L) Engine, Dual Exhaust

(5791)

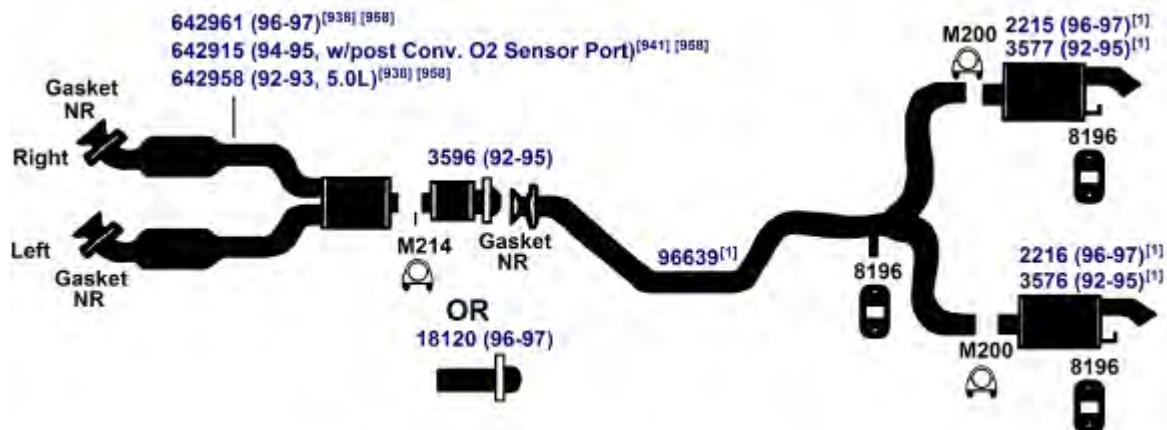

DIRECT FIT MSL/MAXIMUM Muffler... Left Muffler (3576) (92-95)- 700200 (Left), 700200

NA-Not Available. NR-Not Required. FL-Remove and Re-Use Old Flange. ● Golden Warehouse. O.E.-Original Equipment.
 # Airtube Kit [4948] may be required to complete installation. EFI-Electronic Fuel Injection.

[1] OE system was a welded assembly. It is recommended that all parts noted [1] should be replaced.

[938] Direct fit unit contains front and rear converter body. Only failed converters may be replaced.

[941] Replaces both front and rear converters, Only failed converters may be replaced.

[958] Federal & California Emission vehicles. Not legal for sale for vehicles licensed in California.

FORD THUNDERBIRD

(5794) 1994 6 Cyl. Thunderbird Super Coupe, 232 (3.8L) Engine, Dual Exhaust; Manual Trans. only

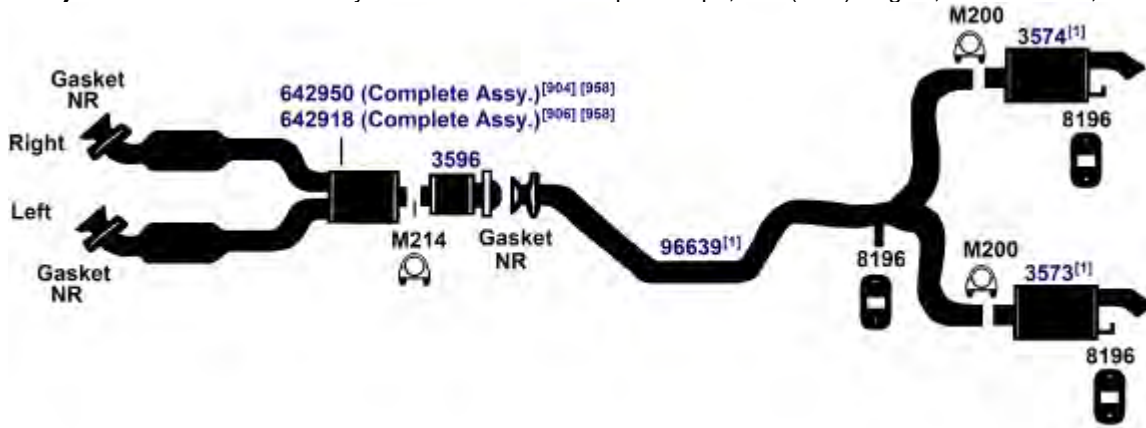

(5793) 92-94 6 Cyl. Thunderbird, 232 (3.8L) Engine, Single Exhaust

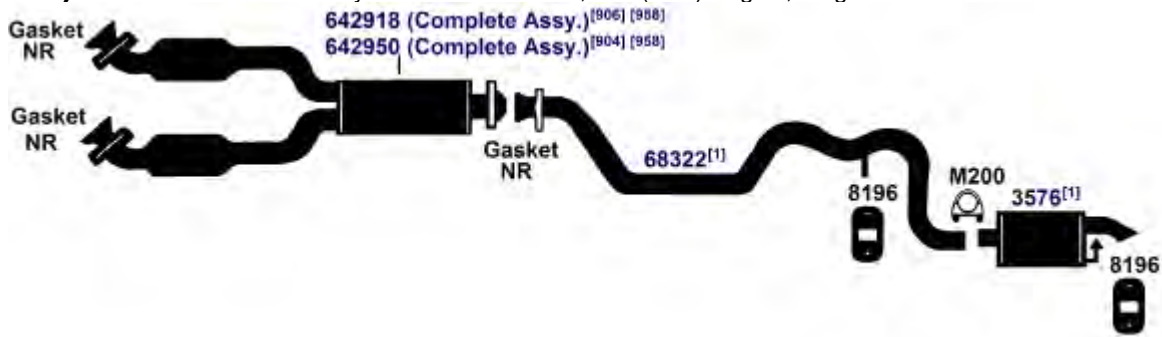

DIRECT FIT MSL/MAXIMUM Muffler... 700200

(5792) 92-94 6 Cyl. Thunderbird Super Coupe, 232 (3.8L) Engine, Dual Exhaust; Auto. Trans.

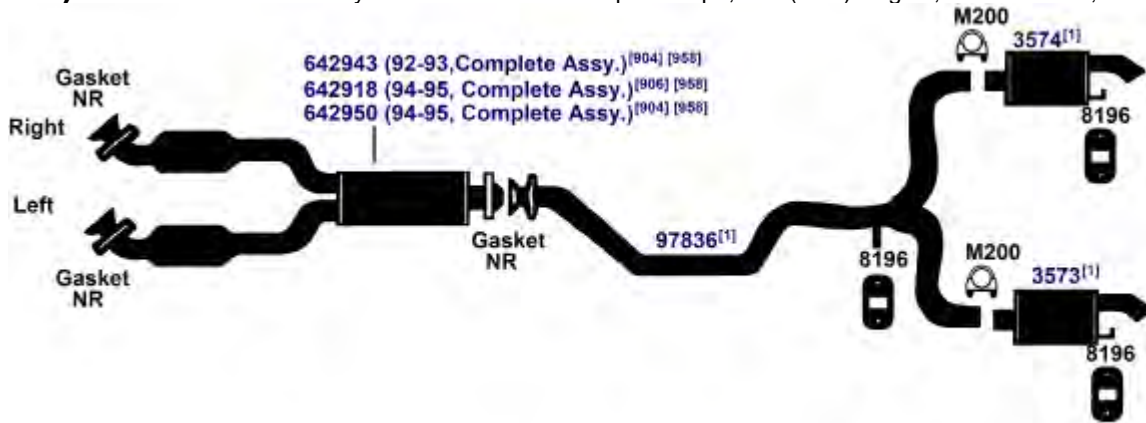

NA-Not Available. NR-Not Required. FL-Remove and Re-Use Old Flange. ● Golden Warehouse. O.E.-Original Equipment.
Airtube Kit [4948] may be required to complete installation. EFI-Electronic Fuel Injection.

[1] OE system was a welded assembly. It is recommended that all parts noted [1] should be replaced.

[904] w/O2 Sensor ports in Converter.

[906] w/o O2 Sensor ports in Converter.

[958] Federal & California Emission vehicles. Not legal for sale for vehicles licensed in California.

1991 8 Cyl. Thunderbird, 302 (5.0L) Engine, Dual Exhaust

(5790)

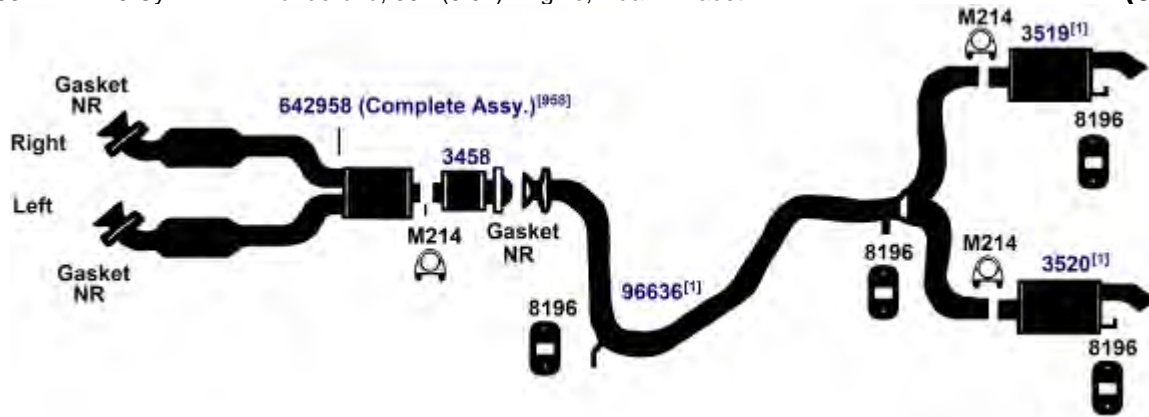

89-91 6 Cyl. Thunderbird, 232 (3.8L) Engine, Single Exhaust

(5788)

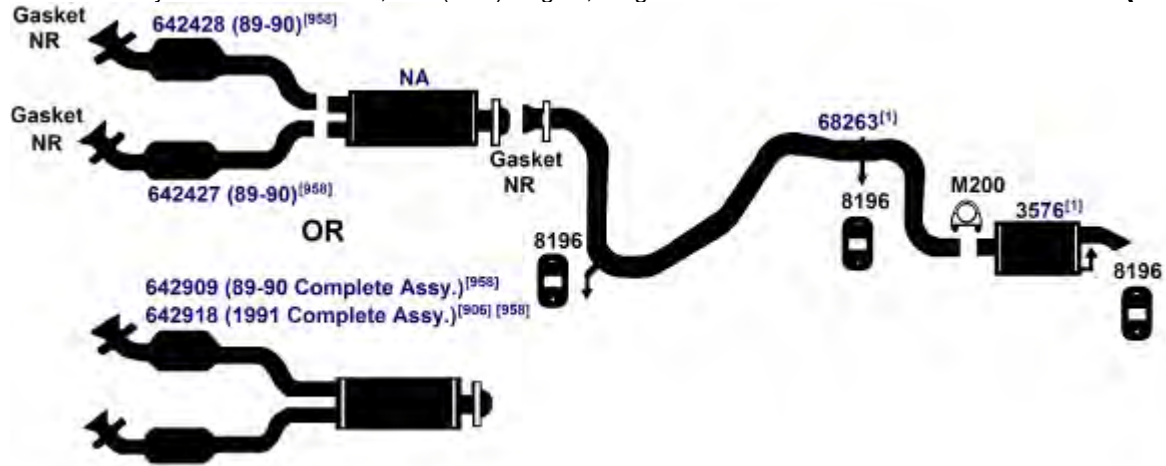

DIRECT FIT MSL/MAXIMUM Muffler... 700200

NA-Not Available. NR-Not Required. FL-Remove and Re-Use Old Flange. ● Golden Warehouse. O.E.-Original Equipment.
 # Airtube Kit [4948] may be required to complete installation. EFI-Electronic Fuel Injection.

[1] OE system was a welded assembly. It is recommended that all parts noted [1] should be replaced.
 [904] w/O2 Sensor ports in Converter.

[906] w/o O2 Sensor ports in Converter.
 [958] Federal & California Emission vehicles. Not legal for sale for vehicles licensed in California.

FORD THUNDERBIRD

(5789) 89-91 6 Cyl. Thunderbird Super Coupe, 232 (3.8L) Supercharged Engine, Dual Exhaust

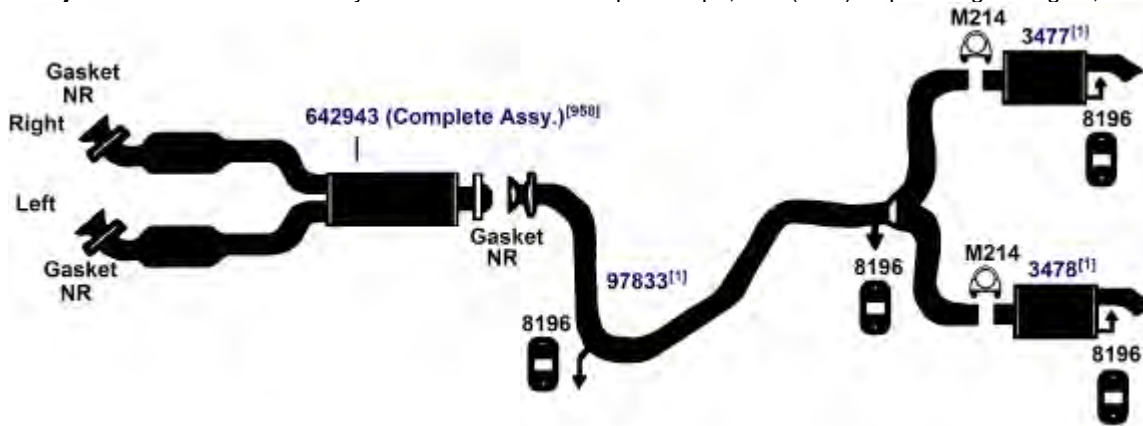

(5787) 1988 8 Cyl. Thunderbird, 302 (5.0L) Engine, Dual Exhaust

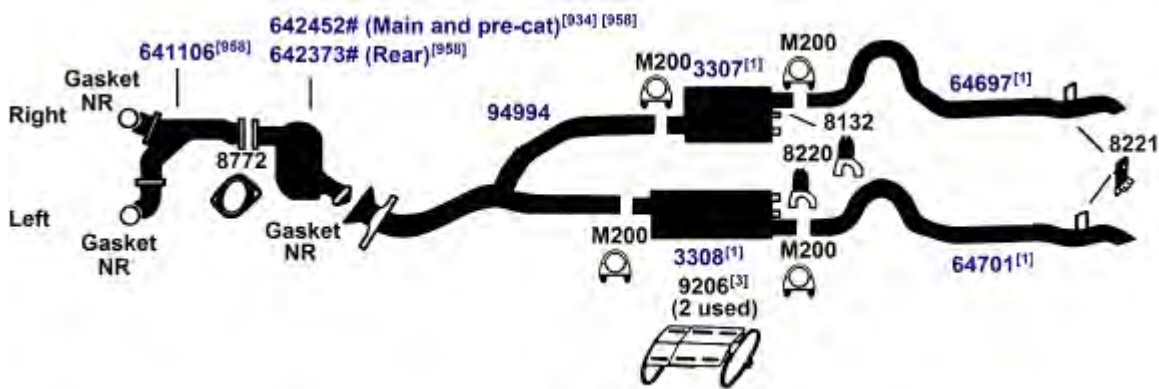

DIRECT FIT MSL/MAXIMUM Muffler... Left 700015, Right 700014, UNIVERSAL FIT MSL/MAXIMUM Muffler... Left 6516, 709011, 709012, Right 709003, 709006, Silentone DIY Muffler... Left 5552 and 8248 Bracket and 9206 Heat Shield, Right 5565 and 8248 Bracket and 9206 Heat Shield

(5786) 87-88 4 Cyl. Thunderbird, 140 (2.3L) Turbo Engine, Auto. Trans., Single Exhaust

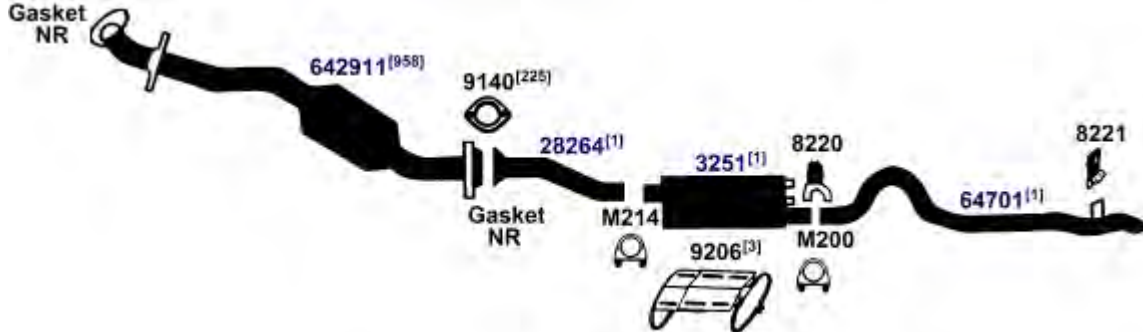

DIRECT FIT MSL/MAXIMUM Muffler... 6587, UNIVERSAL FIT MSL/MAXIMUM Muffler... 709012

NA-Not Available. NR-Not Required. FL-Remove and Re-Use Old Flange. ● Golden Warehouse. O.E.-Original Equipment.
Airtube Kit [4948] may be required to complete installation. EFI-Electronic Fuel Injection.

[1] OE system was a welded assembly. It is recommended that all parts noted [1] should be replaced.

[3] Required for installation.

[225] If pipe includes flange, 9140 not required.

[934] Replaces multiple OE Converters. Only failed converters may be replaced.

[958] Federal & California Emission vehicles. Not legal for sale for vehicles licensed in California.

87-88 4 Cyl. Thunderbird, 140 (2.3L) Turbo Engine, Manual. Trans., Dual Exhaust (5785)

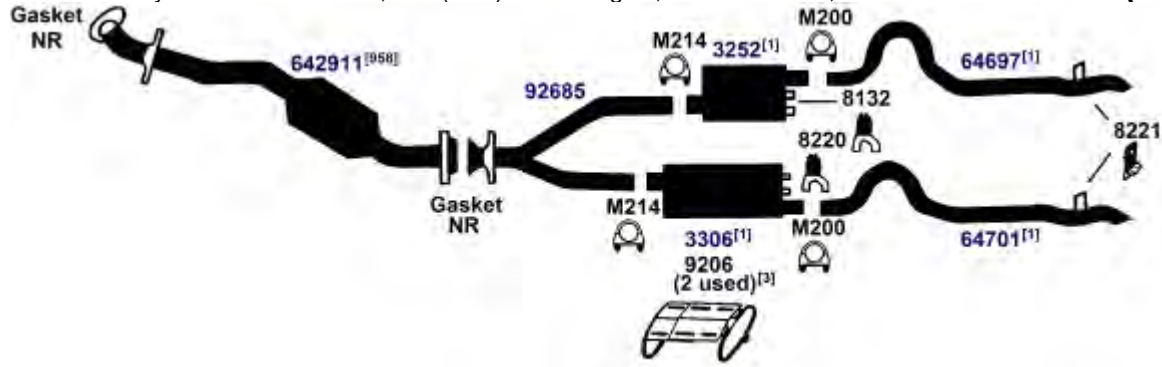

UNIVERSAL FIT MSL/MAXIMUM Muffler... Left 6543, 709012, Silentone DIY Muffler... Right 5554 and 8083 Bracket and 9206 Heat Shield

87-88 6 Cyl. Thunderbird, 232 (3.8L) Engine, Single Exhaust (5784)
 1987 8 Cyl. Thunderbird, 302 (5.0L) Engine, Single Exhaust

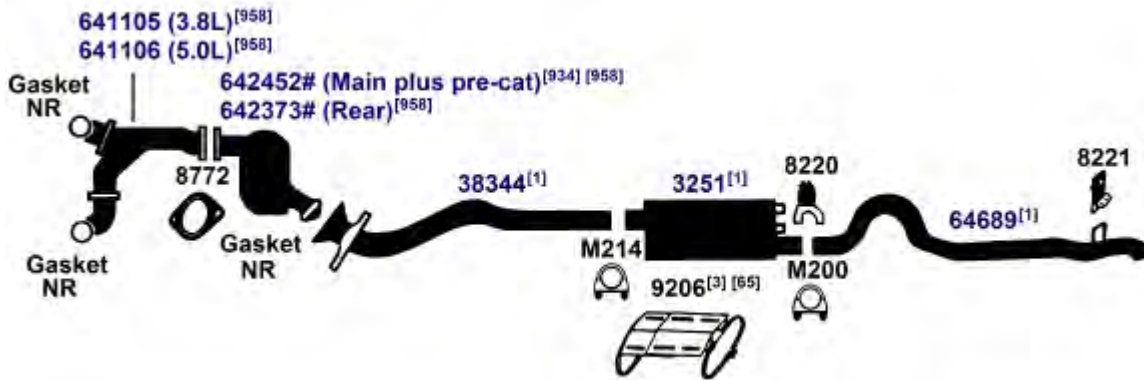

DIRECT FIT MSL/MAXIMUM Muffler... 6587, UNIVERSAL FIT MSL/MAXIMUM Muffler... 709012

NA-Not Available. NR-Not Required. FL-Remove and Re-Use Old Flange. ● Golden Warehouse. O.E.-Original Equipment.
 # Airtube Kit [4948] may be required to complete installation. EFI-Electronic Fuel Injection.

- [1] OE system was a welded assembly. It is recommended that all parts noted [1] should be replaced. [934] Replaces multiple OE Converters. Only failed converters may be replaced.
- [2] Required for installation. [958] Federal & California Emission vehicles. Not legal for sale for vehicles licensed in California.
- [3] Required for installation.

FORD THUNDERBIRD

(5782) 1986 8 Cyl. Thunderbird, 302 (5.0L) Engine
 85-86 6 Cyl. Thunderbird, 232 (3.8L) Engine

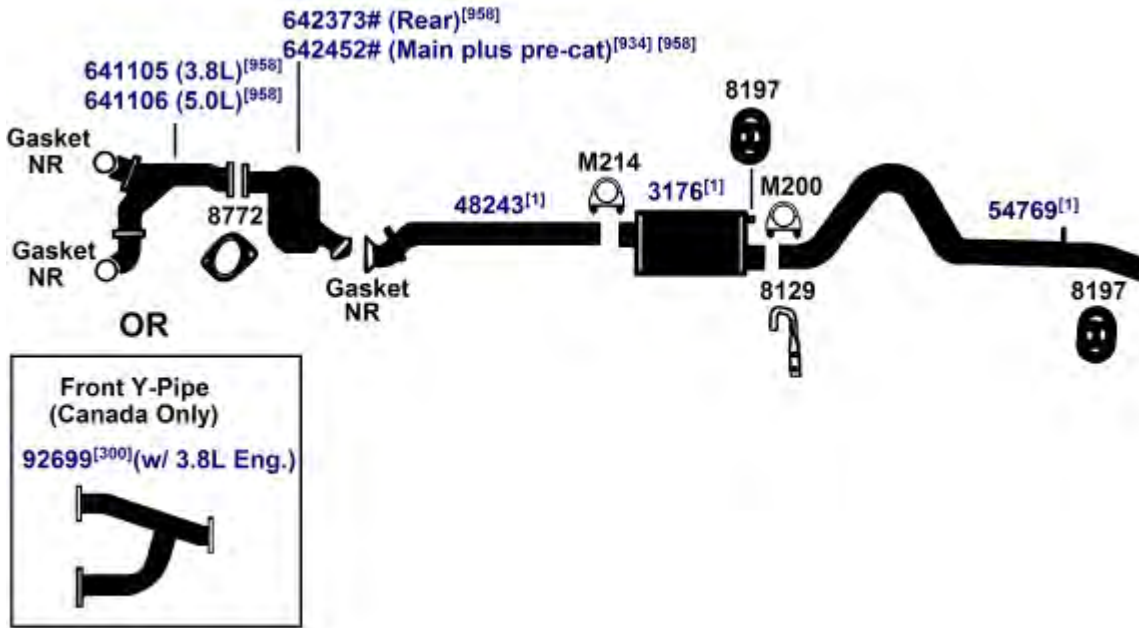

DIRECT FIT MSL/MAXIMUM Muffler... 700073, UNIVERSAL FIT MSL/MAXIMUM Muffler... 6563, Silentone DIY Muffler... 5554 and 8083 Bracket and 9206 Heat Shield

(5783) 85-86 4 Cyl. Thunderbird, 140 (2.3L) Turbo Engine

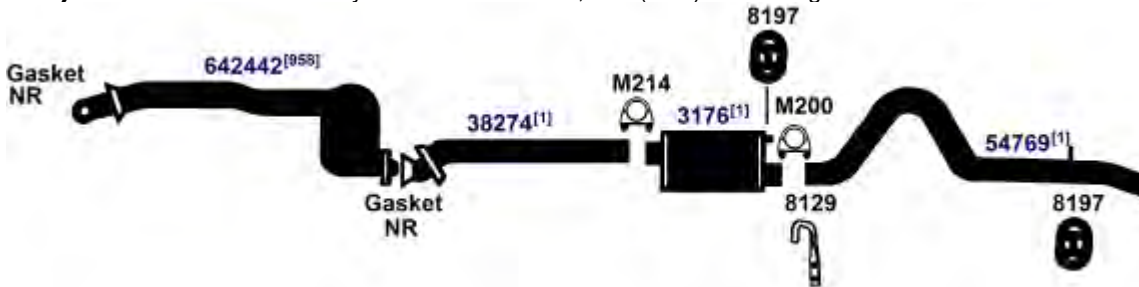

DIRECT FIT MSL/MAXIMUM Muffler... 700073, UNIVERSAL FIT MSL/MAXIMUM Muffler... 6563, Silentone DIY Muffler... 5554 and 8083 Bracket and 9206 Heat Shield

NA-Not Available. NR-Not Required. FL-Remove and Re-Use Old Flange. ● Golden Warehouse. O.E.-Original Equipment.
 # Airtube Kit [4948] may be required to complete installation. EFI-Electronic Fuel Injection.

[1] OE system was a welded assembly. It is recommended that all parts noted [1] should be replaced.

[300] For use when resonator originated from O.E. manufacturer.

[934] Replaces multiple OE Converters. Only failed converters may be replaced.

[958] Federal & California Emission vehicles. Not legal for sale for vehicles licensed in California.

1985 8 Cyl. Thunderbird, 302 (5.0L) Engine

(5781)

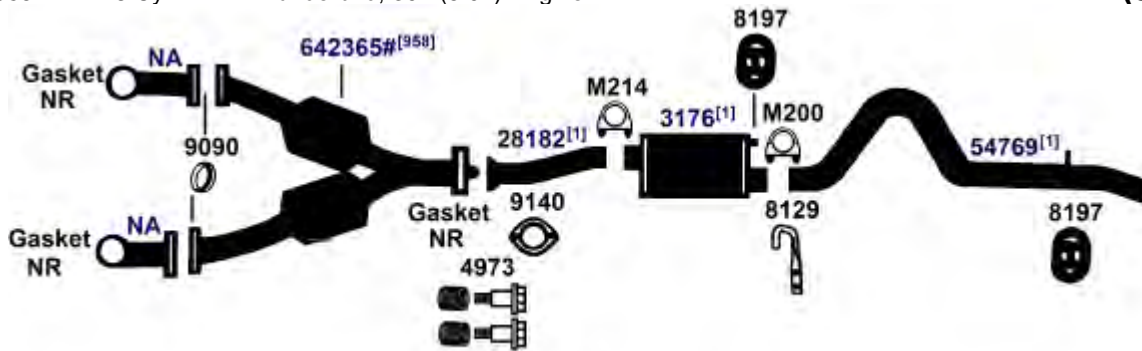

DIRECT FIT MSL/MAXIMUM Muffler... 700073, UNIVERSAL FIT MSL/MAXIMUM Muffler... 6563, Silentone DIY Muffler... 5554 and 8083 Bracket and 9206 Heat Shield

83-84 4 Cyl. Thunderbird, 140 (2.3L) Turbo Engine

(5783E)

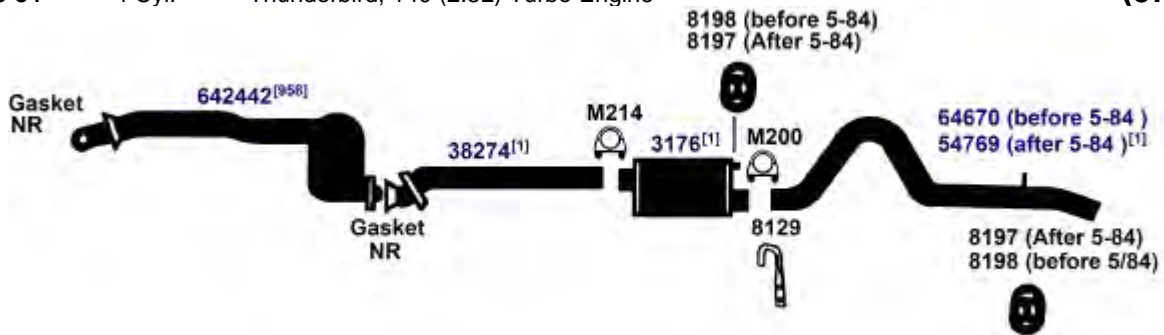

DIRECT FIT MSL/MAXIMUM Muffler... 700073, UNIVERSAL FIT MSL/MAXIMUM Muffler... 6563, Silentone DIY Muffler... 5554 and 8083 Bracket and 9206 Heat Shield

83-84 6 Cyl. Thunderbird, 232 (3.8L) Engine

(5782E)

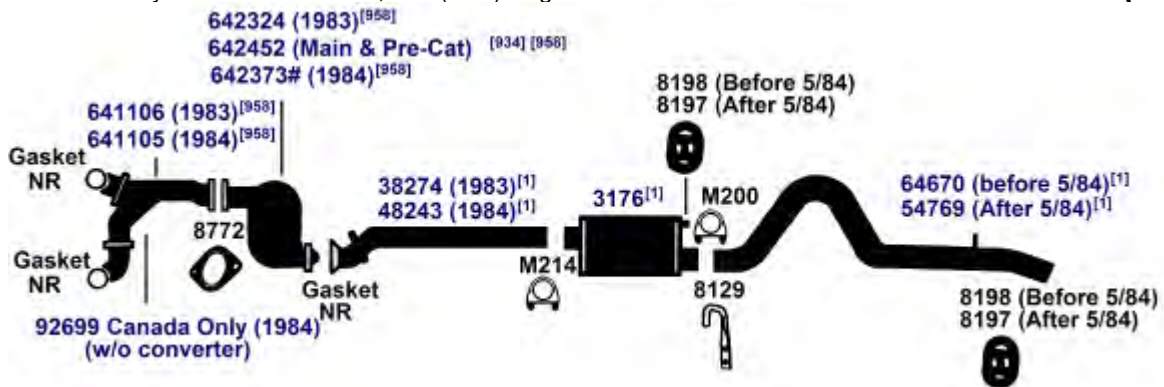

DIRECT FIT MSL/MAXIMUM Muffler... 700073, UNIVERSAL FIT MSL/MAXIMUM Muffler... 6563, Silentone DIY Muffler... 5554 and 8083 Bracket and 9206 Heat Shield

NA-Not Available. NR-Not Required. FL-Remove and Re-Use Old Flange. ● Golden Warehouse. O.E.-Original Equipment.
Airtube Kit [4948] may be required to complete installation. EFI-Electronic Fuel Injection.

- [1] OE system was a welded assembly. It is recommended that all parts noted [1] should be replaced.
- [958] Federal & California Emission vehicles. Not legal for sale for vehicles licensed in California.
- [934] Replaces multiple OE Converters. Only failed converters may be replaced.

FORD THUNDERBIRD

(5781E) 83-84 8 Cyl. Thunderbird, 302 (5.0L) Engine

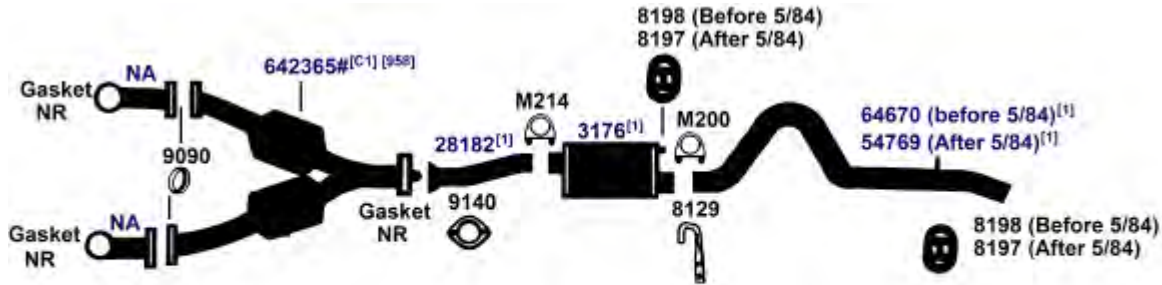

[C1] Combination Front & Rear Converter, 2 to 1 Replacement. Only Defective Converters May Legally Be Replaced.

DIRECT FIT MSL/MAXIMUM Muffler... 700073, UNIVERSAL FIT MSL/MAXIMUM Muffler... 6563, Silentone DIY Muffler... 5554 and 8083 Bracket and 9206 Heat Shield

GEO

GEO METRO (see CHEVROLET METRO for 1998 & later)

(100288) 92-94 4 Cyl. Metro 4-Door Sedan, 1.3L Engine, except Turbo (CANADA ONLY)

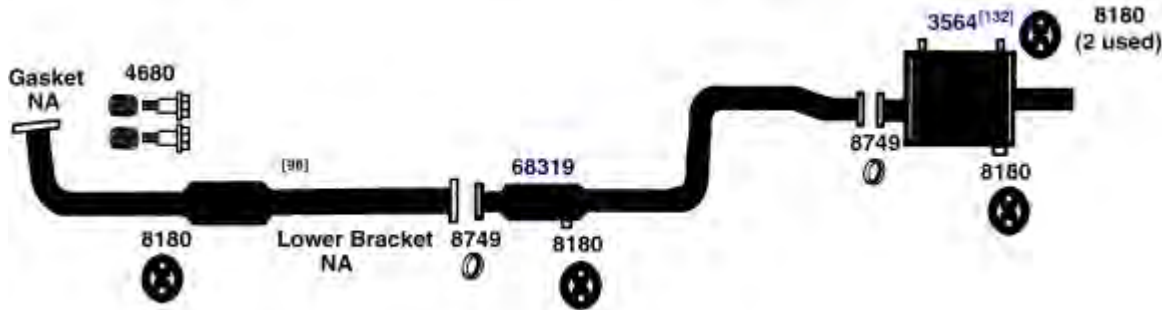

(12650) 89-94 3 Cyl. Metro, 1.0L Engine

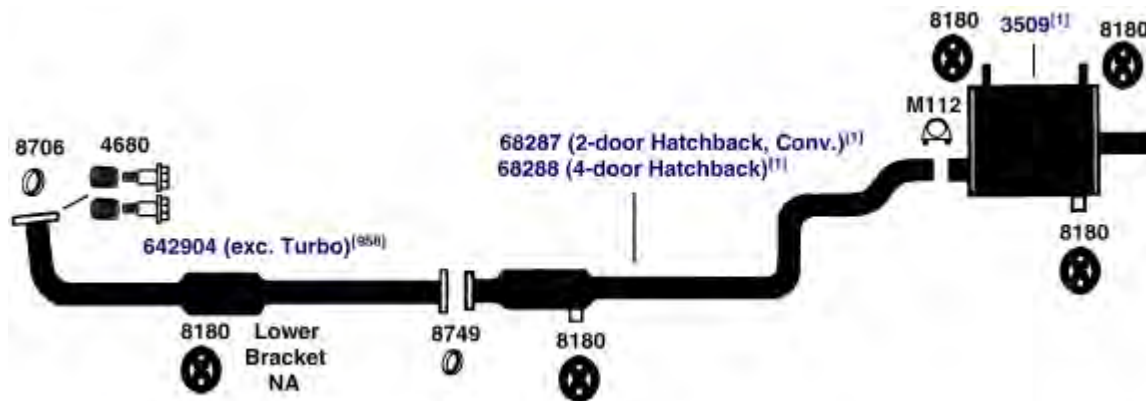

DIRECT FIT MSL/MAXIMUM Muffler... 700003, UNIVERSAL FIT MSL/MAXIMUM Muffler... 6653

NA-Not Available. NR-Not Required. FL-Remove and Re-Use Old Flange. ● Golden Warehouse. O.E.-Original Equipment.
Airtube Kit [4948] may be required to complete installation. EFI-Electronic Fuel Injection.

[1] OE system was a welded assembly. It is recommended that all parts noted [1] should be replaced.

[98] Refer to current Catalytic Converter catalog or Website catalog for availability.

[132] If black triangle appears on muffler label, remove and re-use O.E. heat shield or fabricate heat shield.

[958] Federal & California Emission vehicles. Not legal for sale for vehicles licensed in California.

GEO PRIZM (see CHEVROLET PRIZM for 1998 & later)

93-94 4 Cyl. Prizm, 1.6L Engine; Prizm LSI, 1.8L Engine

(12702)

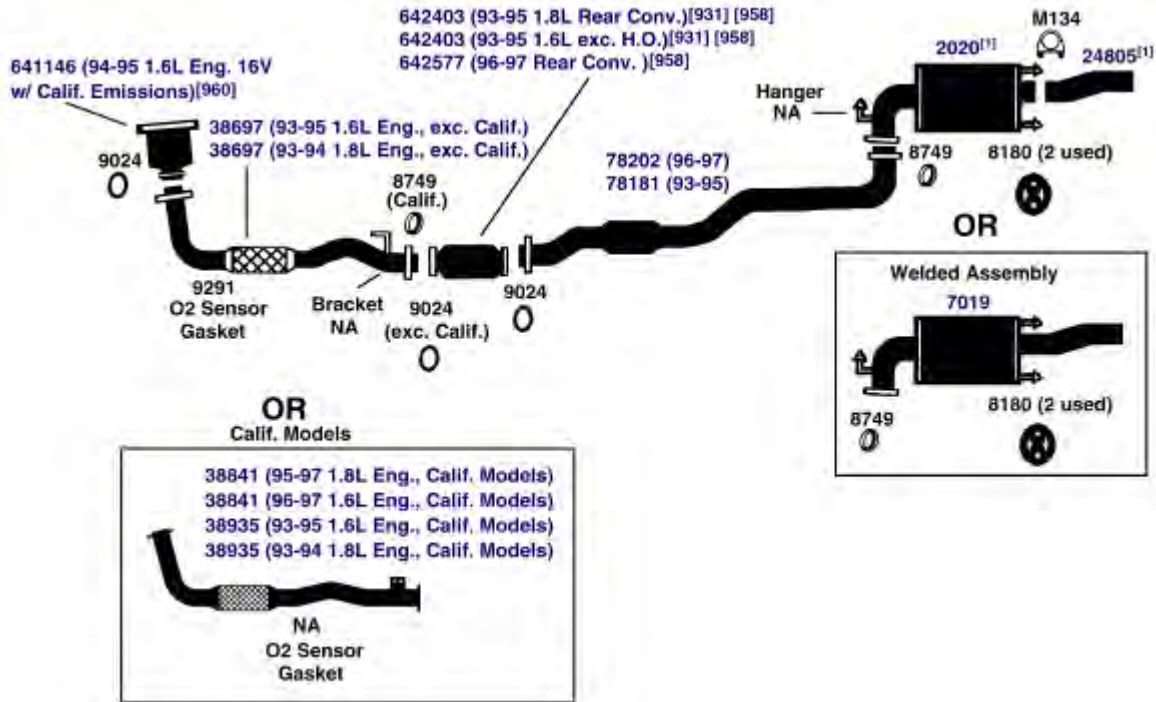

DIRECT FIT MSL/MAXIMUM Muffler... Split System- 700211

90-92 4 Cyl. Prizm, 1.6L Twin Cam Engine; except GSI

(12701)

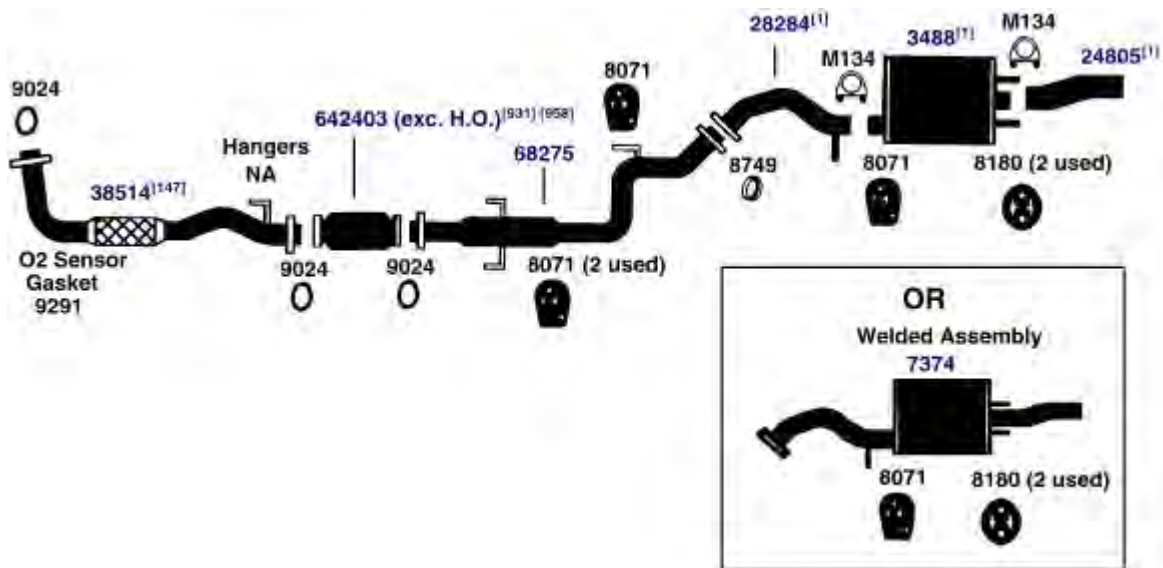

DIRECT FIT MSL/MAXIMUM Muffler... Split System- 6694, UNIVERSAL FIT MSL/MAXIMUM Muffler... Split System- 6677, Silentone DIY Muffler... Split System- 5595 and 24906 Spout

NA-Not Available. NR-Not Required. FL-Remove and Re-Use Old Flange. ● Golden Warehouse. O.E.-Original Equipment.
Airtube Kit [4948] may be required to complete installation. EFI-Electronic Fuel Injection.

[1] OE system was a welded assembly. It is recommended that all parts noted [1] should be replaced.
[147] For vehicles where oxygen sensor is attached to flange in exhaust pipe, drill 5/8" diameter hole through center hole of flange into exhaust pipe.
[931] This unit was designed to fit many applications. Measurement of the old unit and cutting of new unit is required.

[958] Federal & California Emission vehicles. Not legal for sale for vehicles licensed in California.
[960] California Emission vehicles licensed in states other than California. Not legal for sale for vehicles licensed in California.

GEO SPECTRUM (see CHEVROLET SPECTRUM for 1985-88)

(12050) 1989 4 Cyl. Spectrum, 1.5L Turbo Engine



UNIVERSAL FIT MSL/MAXIMUM Muffler... 6519, 709005

(12051) 1989 4 Cyl. Spectrum, 1.5L Engine, except Turbo

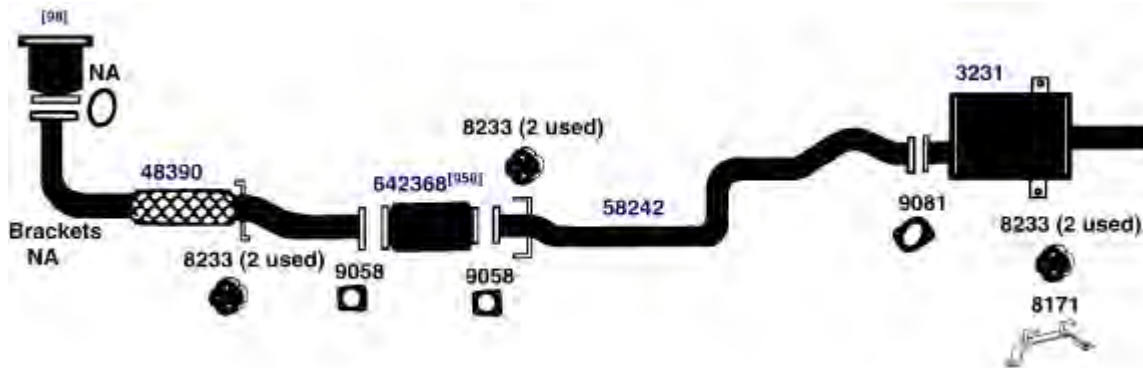

DIRECT FIT MSL/MAXIMUM Muffler... 6683, UNIVERSAL FIT MSL/MAXIMUM Muffler... 6653

GEO STORM

(13050) 92-93 4 Cyl. Storm GSi, 1.8L DOHC Engine
90-91 4 Cyl. Storm GSi, 1.6L DOHC Engine

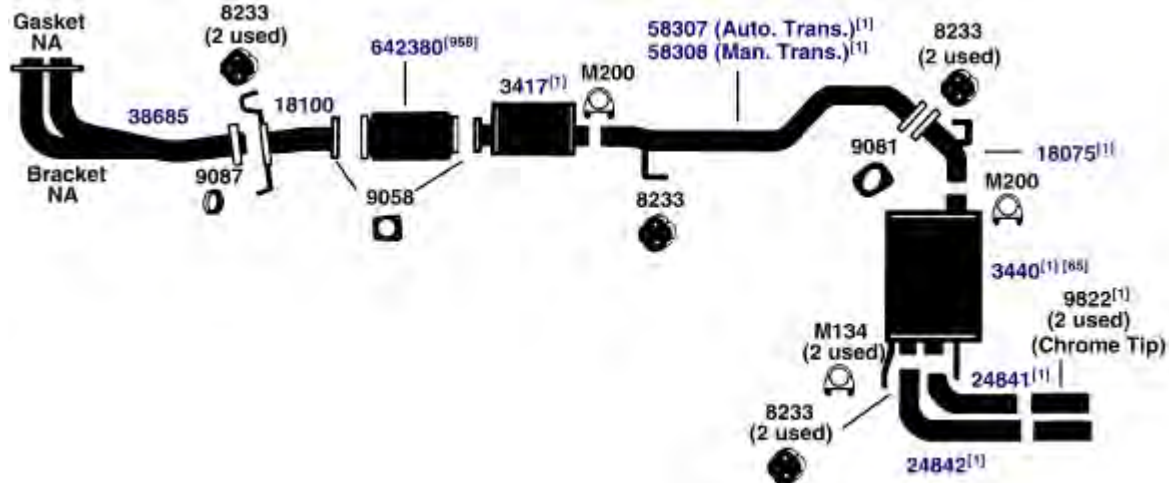

DIRECT FIT MSL/MAXIMUM Muffler... Front Muffler- 700273, Rear Muffler- 700128, UNIVERSAL FIT MSL/MAXIMUM Muffler... Rear Muffler- 709015

NA-Not Available. NR-Not Required. FL-Remove and Re-Use Old Flange. ● Golden Warehouse. O.E.-Original Equipment.
Airtube Kit [4948] may be required to complete installation. EFI-Electronic Fuel Injection.

[1] OE system was a welded assembly. It is recommended that all parts noted [1] should be replaced.

[65] Heat Shield 9206 is required for installation.

[98] Refer to current Catalytic Converter catalog or Website catalog for availability.
[958] Federal & California Emission vehicles. Not legal for sale for vehicles licensed in California.

90-93 4 Cyl. Storm, 1.6L Engine; SOHC

(13051)

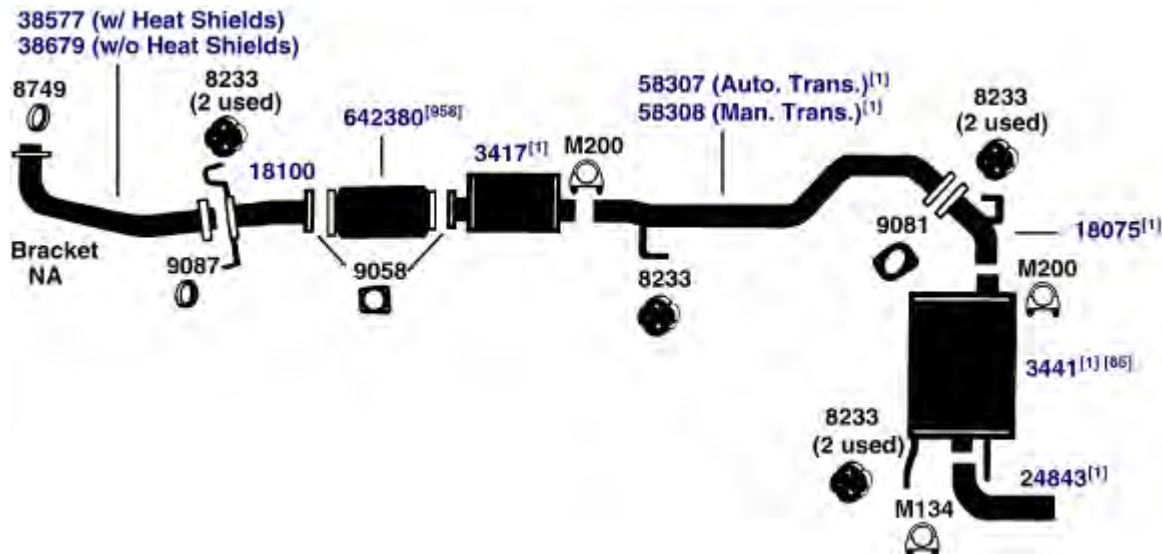

DIRECT FIT MSL/MAXIMUM Muffler... Front Muffler- 700273, Rear Muffler- 700025, UNIVERSAL FIT MSL/MAXIMUM Muffler... Rear Muffler- 6573

GEO TRACKER (Also see Chev./GMC Tracker)

1994 4 Cyl. Tracker, 2-Door & Convertibles; 1.6L (16 Valve Engine)

(33801)

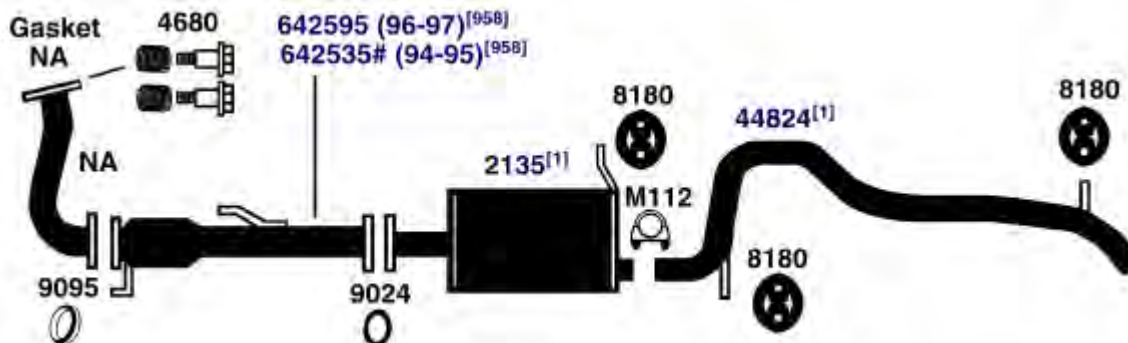

DIRECT FIT MSL/MAXIMUM Muffler... 700242, UNIVERSAL FIT MSL/MAXIMUM Muffler... 6651

NA-Not Available. NR-Not Required. FL-Remove and Re-Use Old Flange. ● Golden Warehouse. O.E.-Original Equipment.
Airtube Kit [4948] may be required to complete installation. EFI-Electronic Fuel Injection.

- [1] OE system was a welded assembly. It is recommended that all parts noted [1] should be replaced.
- [958] Federal & California Emission vehicles. Not legal for sale for vehicles licensed in California.
- [65] Heat Shield 9206 is required for installation.

GEO TRACKER (Also see Chev./GMC Tracker)

(33800) 1994 4 Cyl. Tracker; 1.6L Engine (except 16 Valve Engine)
 89-93 4 Cyl. Tracker; 1.6L Engine

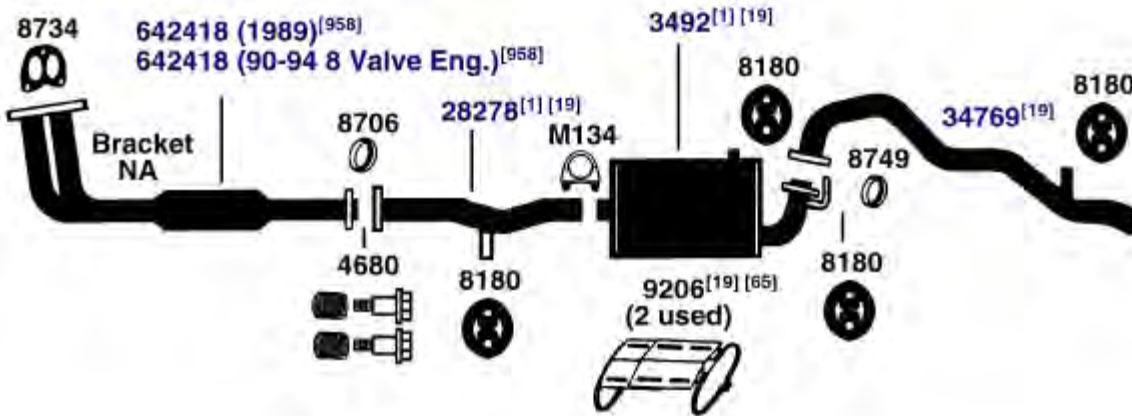

DIRECT FIT MSL/MAXIMUM Muffler... 700024, UNIVERSAL FIT MSL/MAXIMUM Muffler... 709008

HONDA ACCORD

(5848) 1994 4 Cyl. Accord LX; Sta. Wagon, 2.2L Engine

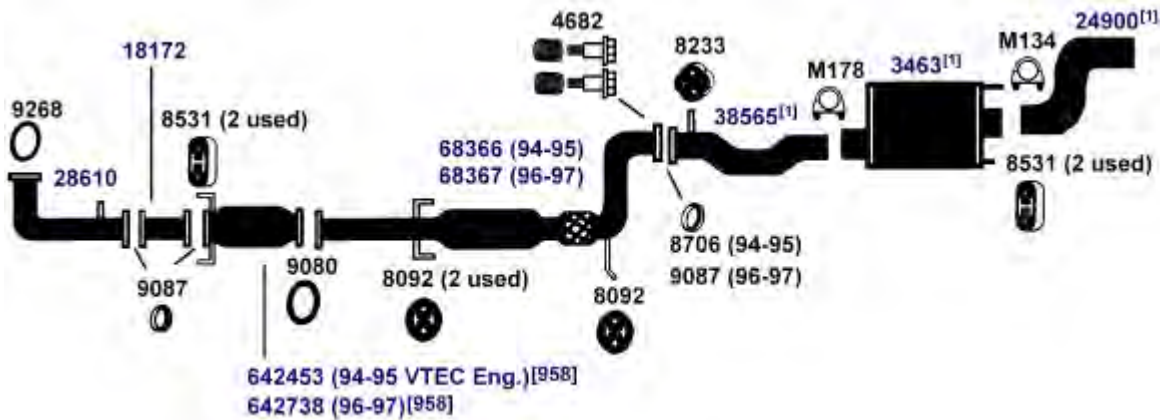

DIRECT FIT MSL/MAXIMUM Muffler... 700280, UNIVERSAL FIT MSL/MAXIMUM Muffler... 700018

NA-Not Available. NR-Not Required. FL-Remove and Re-Use Old Flange. ● Golden Warehouse. O.E.-Original Equipment.
 # Airtube Kit [4948] may be required to complete installation. EFI-Electronic Fuel Injection.

[1] OE system was a welded assembly. It is recommended that all parts noted [1] should be replaced.

[19] On vehicles that have an O.E. one piece exhaust pipe-muffler-tail pipe assembly, all parts noted [19] must be used in combination to replace the O.E. assembly.

[65] Heat Shield 9206 is required for installation.

[958] Federal & California Emission vehicles. Not legal for sale for vehicles licensed in California.

1994 4 Cyl. Accord EX; 2-Door Coupe, 4-Door Sedan; 2.2L Engine

(5849)

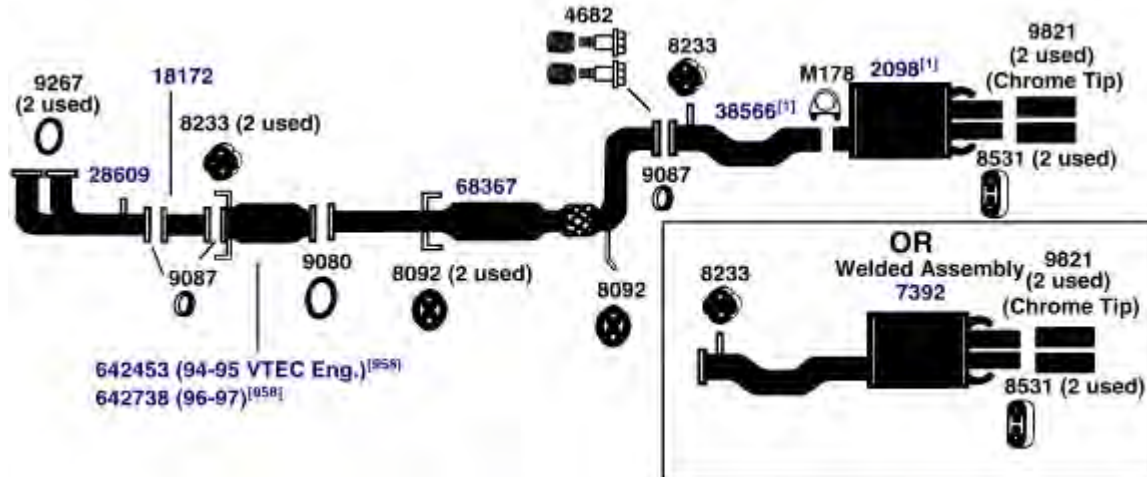

DIRECT FIT MSL/MAXIMUM Muffler... Split System- 700188

1994 4 Cyl. Accord DX, LX, SE; 2.2L Engine; (except 1995-97 LX, SE 4-Door California models), (except Sta. Wagon)

(5850)

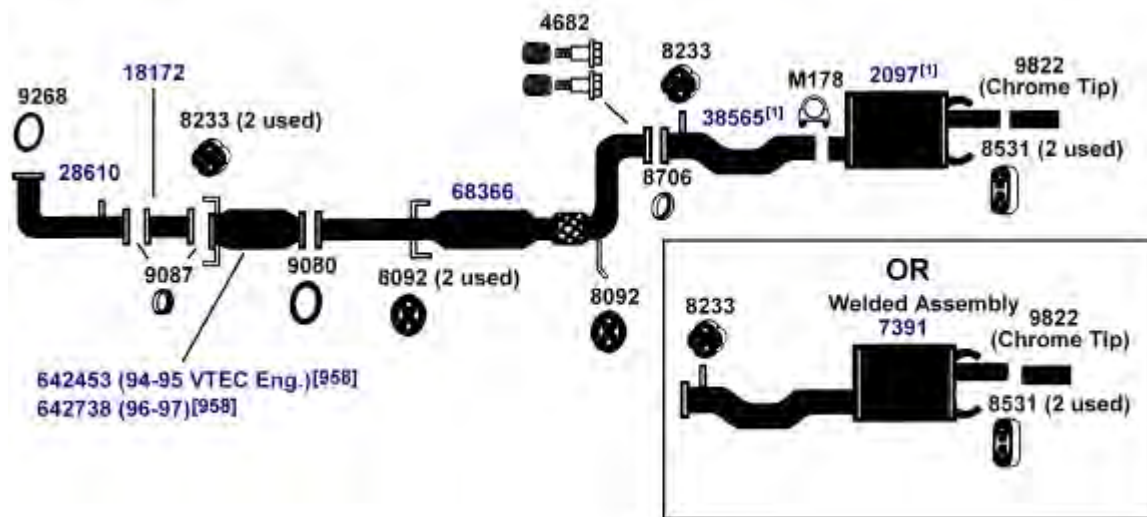

DIRECT FIT MSL/MAXIMUM Muffler... Split System- 700181, UNIVERSAL FIT MSL/MAXIMUM Muffler... Split System- 6503, 6544, Silentone DIY Muffler... Split System- 5572 and 14762 Pipe

NA-Not Available. NR-Not Required. FL-Remove and Re-Use Old Flange. ● Golden Warehouse. O.E.-Original Equipment.
Airtube Kit [4948] may be required to complete installation. EFI-Electronic Fuel Injection.

[1] OE system was a welded assembly. It is recommended that all parts noted [1] should be replaced.

[958] Federal & California Emission vehicles. Not legal for sale for vehicles licensed in California.

HONDA ACCORD

(5847) 1994 4 Cyl. Accord EX Sta. Wagon, 2.2L Engine

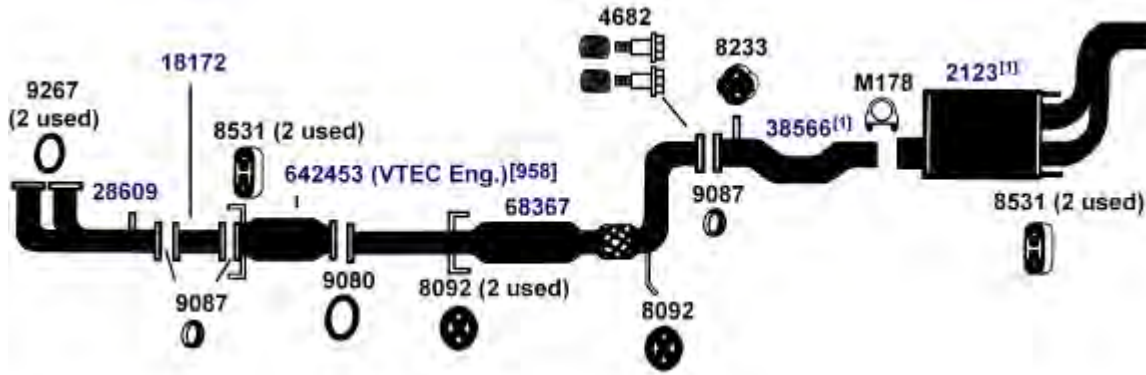

DIRECT FIT MSL/MAXIMUM Muffler... 700400

(5839) 1993 4 Cyl. Accord SE, 2-Door Coupe, 2.2L Engine
 91-93 4 Cyl. Accord SE, 4-Door Sedan, 2.2L Engine
 90-93 4 Cyl. Accord EX, 2-Door Coupe, 4-Door Sedan; 2.2L Engine

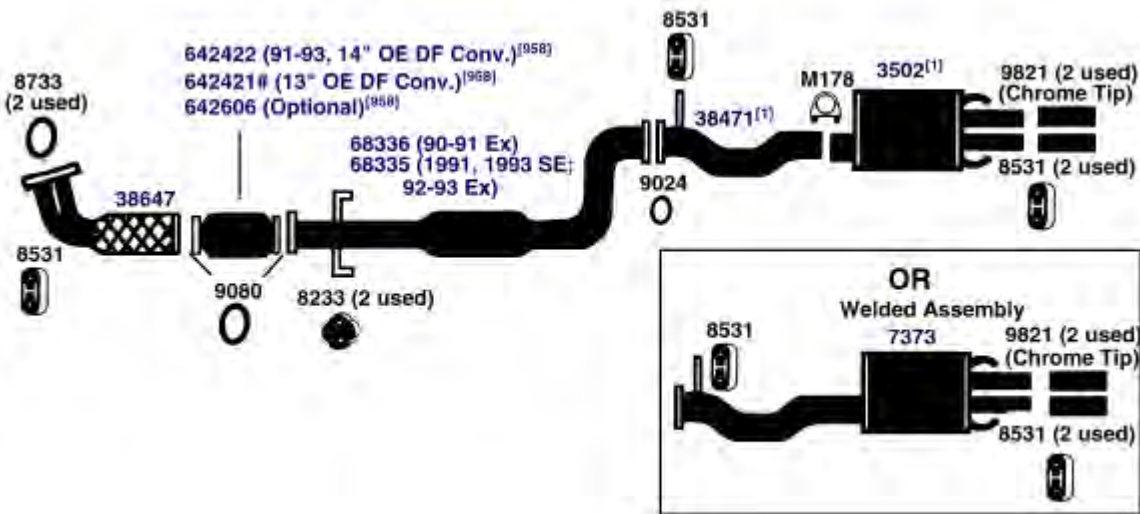

DIRECT FIT MSL/MAXIMUM Muffler... Split System- 700019

NA-Not Available. NR-Not Required. FL-Remove and Re-Use Old Flange. ● Golden Warehouse. O.E.-Original Equipment.
 # Airtube Kit [4948] may be required to complete installation. EFI-Electronic Fuel Injection.

[1] OE system was a welded assembly. It is recommended that all parts noted [1] should be replaced. [958] Federal & California Emission vehicles. Not legal for sale for vehicles licensed in California.

91-93 4 Cyl. Accord EX Sta. Wagon, 2.2L Engine

(5841)

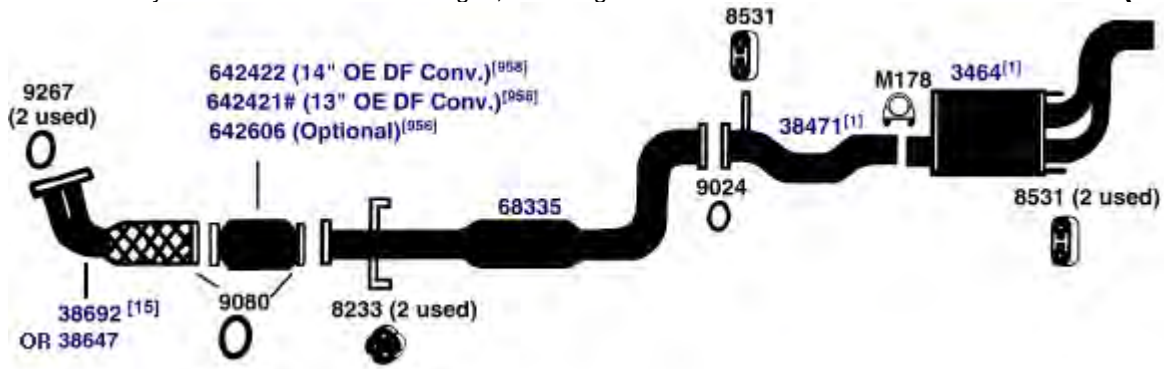

DIRECT FIT MSL/MAXIMUM Muffler... 700410

91-93 4 Cyl. Accord LX Sta. Wagon, 2.2L Engine

(5842)

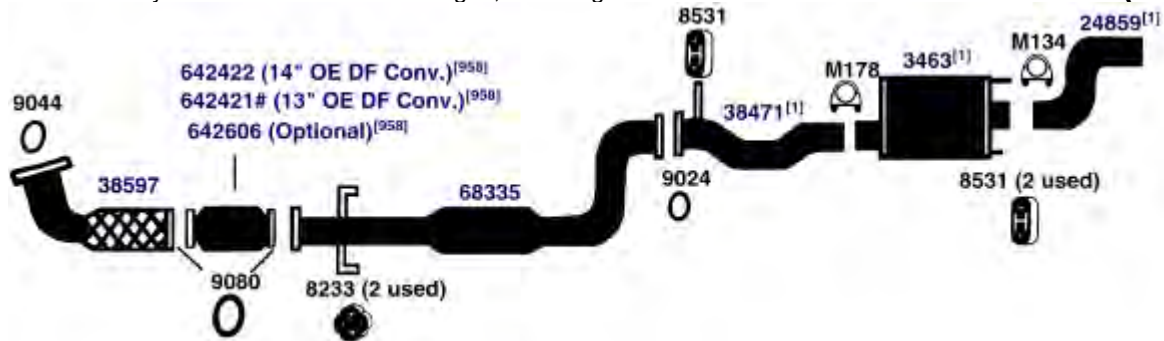

DIRECT FIT MSL/MAXIMUM Muffler... 700280, UNIVERSAL FIT MSL/MAXIMUM Muffler... 700018

90-93 4 Cyl. Accord DX, LX; 2-Door Coupe, 4-Door Sedan; 2.2L Engine

(5840)

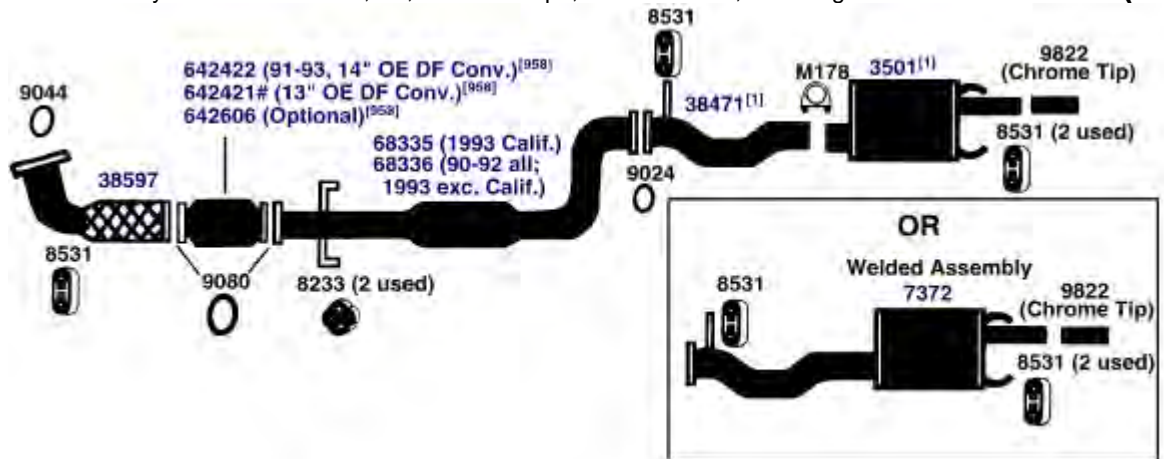

DIRECT FIT MSL/MAXIMUM Muffler... Split System- 700018, UNIVERSAL FIT MSL/MAXIMUM Muffler... Split System- 6503, Silentone DIY Muffler... Split System- 5572 and 14762 Pipe

NA-Not Available. NR-Not Required. FL-Remove and Re-Use Old Flange. ● Golden Warehouse. O.E.-Original Equipment.
Airtube Kit [4948] may be required to complete installation. EFI-Electronic Fuel Injection.

- [1] OE system was a welded assembly. It is recommended that all parts noted [1] should be replaced.
- [15] Discontinued, use until inventory is depleted.
- [958] Federal & California Emission vehicles. Not legal for sale for vehicles licensed in California.

HONDA ACCORD

(5846) 1989 4 Cyl. Accord Coupe, Hatchback, Sedan; 2.0L Engine and 2.0L Fuel Injection Engine; Auto. Trans., except SE-i

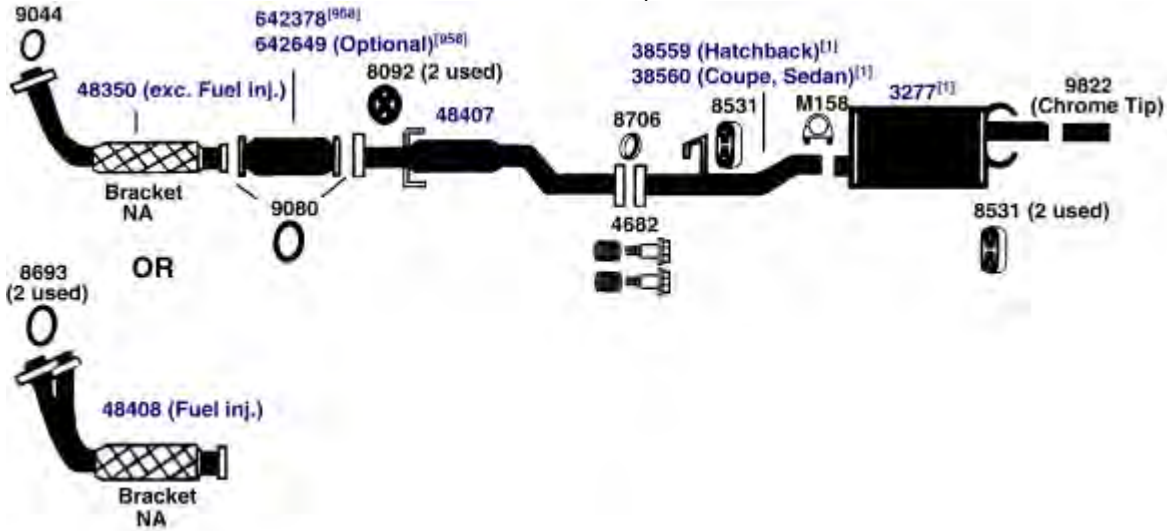

DIRECT FIT MSL/MAXIMUM Muffler... 700017, UNIVERSAL FIT MSL/MAXIMUM Muffler... 6676, 709006, 709011, Silentone DIY Muffler... 5593 and 14642 Pipe

(5844) 1989 4 Cyl. Accord SE-i, 2.0L Engine, Auto. Trans. (US Only)
 1989 4 Cyl. Accord EX-i, SE-i, 2.0L Engine, Auto. Trans. (Canada Only)

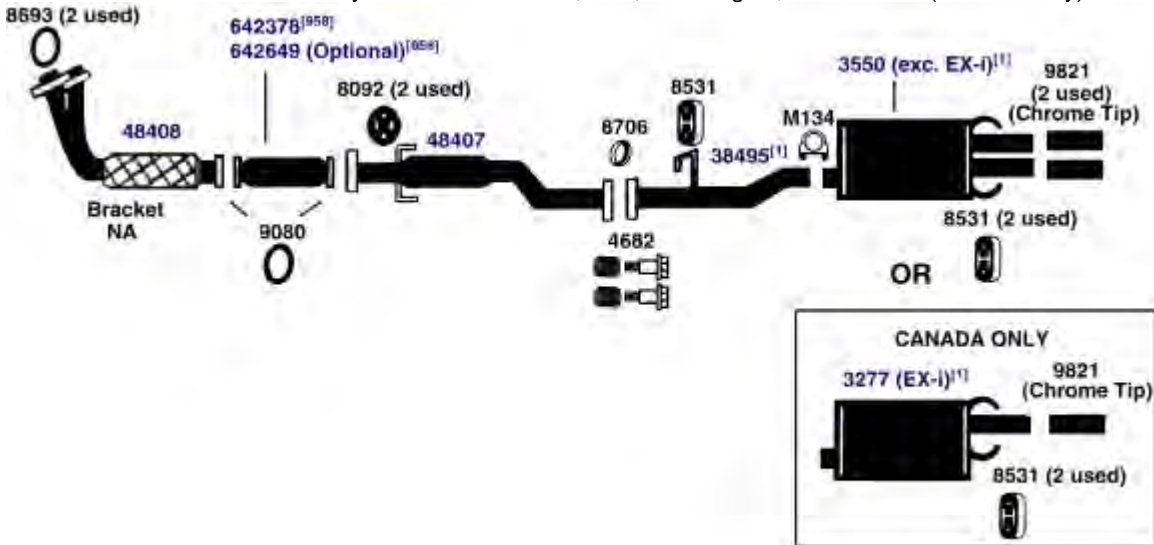

DIRECT FIT MSL/MAXIMUM Muffler... Muffler (3277)- 700017, UNIVERSAL FIT MSL/MAXIMUM Muffler... Muffler (3277)- 6676, 709006, 709011, Silentone DIY Muffler... Muffler (3277)- 5593 and 14642 Pipe

NA-Not Available. NR-Not Required. FL-Remove and Re-Use Old Flange. ● Golden Warehouse. O.E.-Original Equipment.
 # Airtube Kit [4948] may be required to complete installation. EFI-Electronic Fuel Injection.

[1] OE system was a welded assembly. It is recommended that all parts noted [1] should be replaced. [958] Federal & California Emission vehicles. Not legal for sale for vehicles licensed in California.

1989 4 Cyl. Accord SE-i, 2.0L Engine, Manual Trans.

(5843)

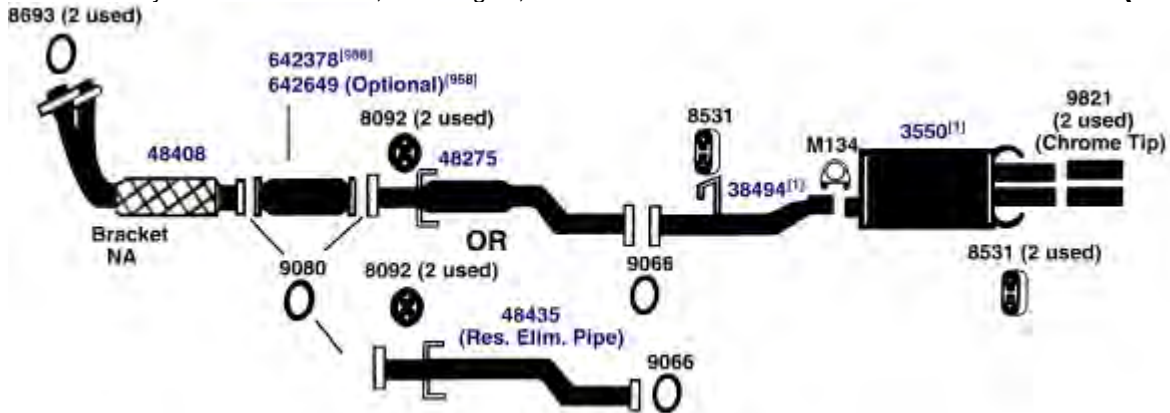

1989 4 Cyl. Accord Coupe, Hatchback, Sedan; 2.0L Engine and 2.0L Fuel Injection Engine; Manual Trans., except SE-i (5845)

86-88 4 Cyl. Accord 2-Door Hatchback, 2-Door Coupe, 4-Door Sedan; 2.0L Engine and 2.0L Fuel Injection Engine

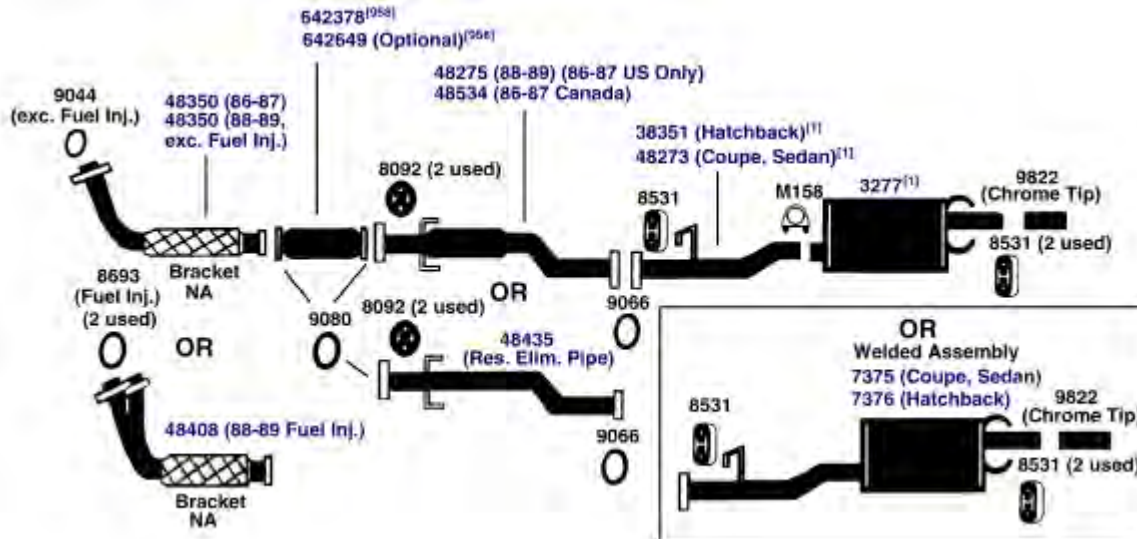

DIRECT FIT MSL/MAXIMUM Muffler... Split System- 700017, UNIVERSAL FIT MSL/MAXIMUM Muffler... Split System- 6676, 709006, 709011, Welded Assembly (7375)- 709006, 709011, Welded Assembly (7376)- 709006, 709011, Silentone DIY Muffler... Split System- 5593 and 14642 Pipe

NA-Not Available. NR-Not Required. FL-Remove and Re-Use Old Flange. ● Golden Warehouse. O.E.-Original Equipment.
Airtube Kit [4948] may be required to complete installation. EFI-Electronic Fuel Injection.

[1] OE system was a welded assembly. It is recommended that all parts noted [1] should be replaced. [958] Federal & California Emission vehicles. Not legal for sale for vehicles licensed in California.

HONDA ACCORD

(100289) 1985 4 Cyl. Accord, Accord SE-i, 4-Door, Fuel Injection Engine (CANADA ONLY)

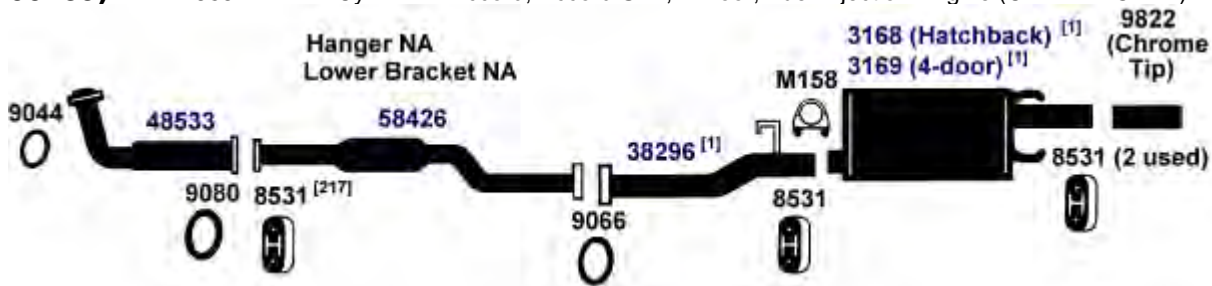

DIRECT FIT MSL/MAXIMUM Muffler... 6681 (4-Door), 700071 (Hatchback), UNIVERSAL FIT MSL/MAXIMUM Muffler... 6652 (4-Door), 709011 (4-Door), 709009 (4-Door), 6676 (Hatchback), 709006 (Hatchback), Silentone DIY Muffler... 5593 and 14642 Pipe

(5837) 1985 4 Cyl. Accord, Accord SE-I, 4-Door, Fuel Injection Engine (US Only)

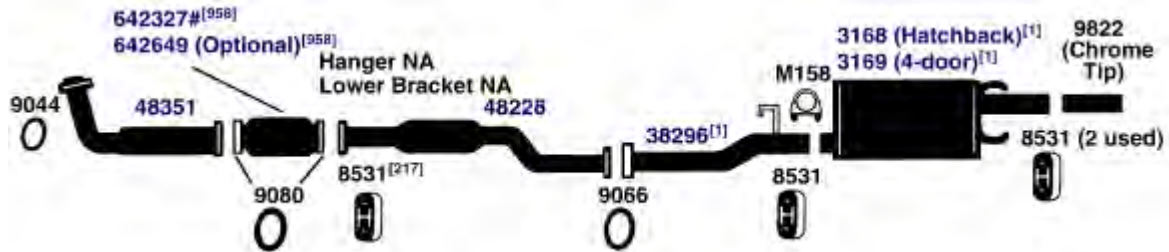

DIRECT FIT MSL/MAXIMUM Muffler... Hatchback- 700071, 4-Door- 6681, UNIVERSAL FIT MSL/MAXIMUM Muffler... Hatchback- 6676, 709006, 4-Door- 6652, 709009, 709011, Silentone DIY Muffler... Hatchback- 5593 and 14642 Pipe

(5837E) 82-84 4 Cyl. Accord (U.S. Only)

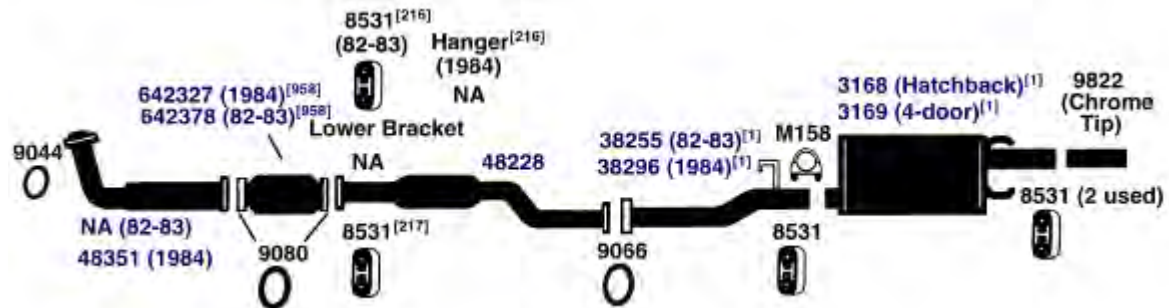

DIRECT FIT MSL/MAXIMUM Muffler... Hatchback- 700071, 4-Door- 6681, UNIVERSAL FIT MSL/MAXIMUM Muffler... Hatchback- 6676, 709006, 4-Door- 6652, 709009, 709011, Silentone DIY Muffler... Hatchback- 5593 and 14642 Pipe

NA-Not Available. NR-Not Required. FL-Remove and Re-Use Old Flange. ● Golden Warehouse. O.E.-Original Equipment.

Airtube Kit [4948] may be required to complete installation. EFI-Electronic Fuel Injection.

[1] OE system was a welded assembly. It is recommended that all parts noted [1] should be replaced.

[216] Right Hand.

[217] Left Hand.

[958] Federal & California Emission vehicles. Not legal for sale for vehicles licensed in California.

82-84 4 Cyl. Accord, Accord SE-i, 4-Door, Fuel Injection Engine (CANADA ONLY) (100289E)

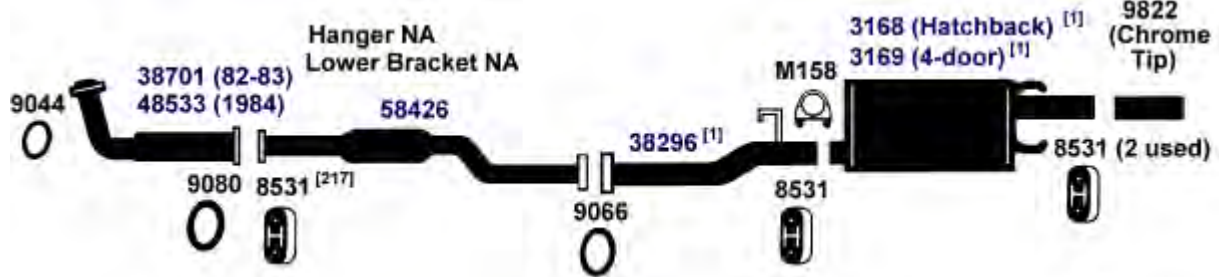

DIRECT FIT MSL/MAXIMUM Muffler... 700071 (Hatchback), 6681 (4-Door), UNIVERSAL FIT MSL/MAXIMUM Muffler... 6676 (Hatchback), 709006 (Hatchback), 6652 (4-Door), 709011 (4-Door), 709009 (4-Door), Silentone DIY Muffler... 5593 and 14642 Pipe

80-81 4 Cyl. Accord CVCC, Hatchback, 4-Door; with Converter (5835)

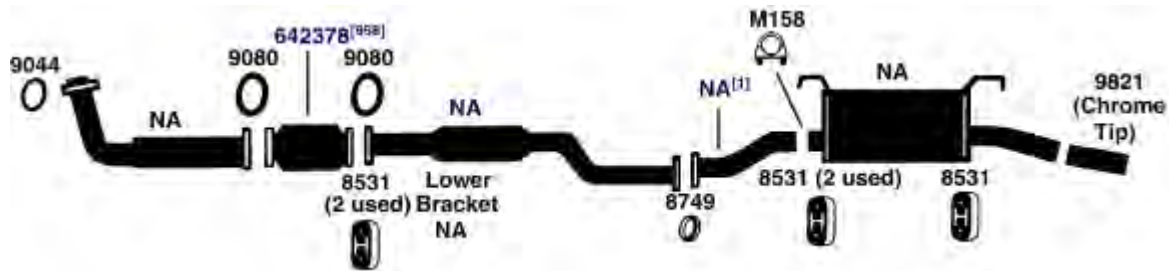

NA-Not Available. NR-Not Required. FL-Remove and Re-Use Old Flange. ● Golden Warehouse. O.E.-Original Equipment.
Airtube Kit [4948] may be required to complete installation. EFI-Electronic Fuel Injection.

[1] OE system was a welded assembly. It is recommended that all parts noted [1] should be replaced. [958] Federal & California Emission vehicles. Not legal for sale for vehicles licensed in California.
[217] Left Hand.

HONDA CIVIC

(5917)

92-94

4 Cyl.

Civic, CX, VX Hatchback; 1.5L Engine (US Built)

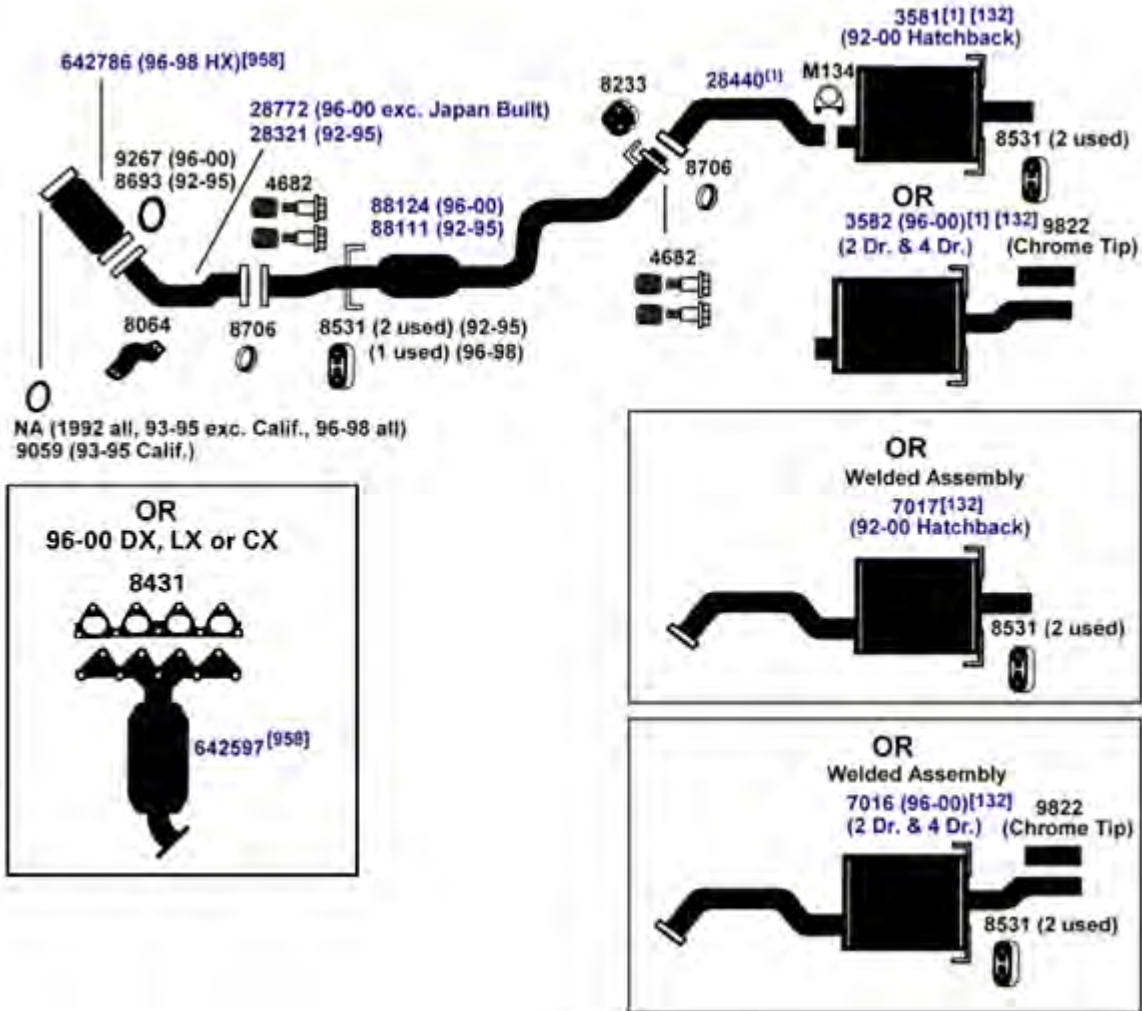

DIRECT FIT MSL/MAXIMUM Muffler... Split System- 700169 (3-Door Hatchback)

NA-Not Available. NR-Not Required. FL-Remove and Re-Use Old Flange. ● Golden Warehouse. O.E.-Original Equipment.
Airtube Kit [4948] may be required to complete installation. EFI-Electronic Fuel Injection.

[1] OE system was a welded assembly. It is recommended that all parts noted [1] should be replaced.
[98] Refer to current Catalytic Converter catalog or Website catalog for availability.

[132] If black triangle appears on muffler label, remove and re-use O.E. heat shield or fabricate heat shield.
[958] Federal & California Emission vehicles. Not legal for sale for vehicles licensed in California.

93-94 4 Cyl. Civic, EX 2-Door Coupe; 1.6L Engine
 92-94 4 Cyl. Civic, EX Sedan; 1.6L Engine

(5913)

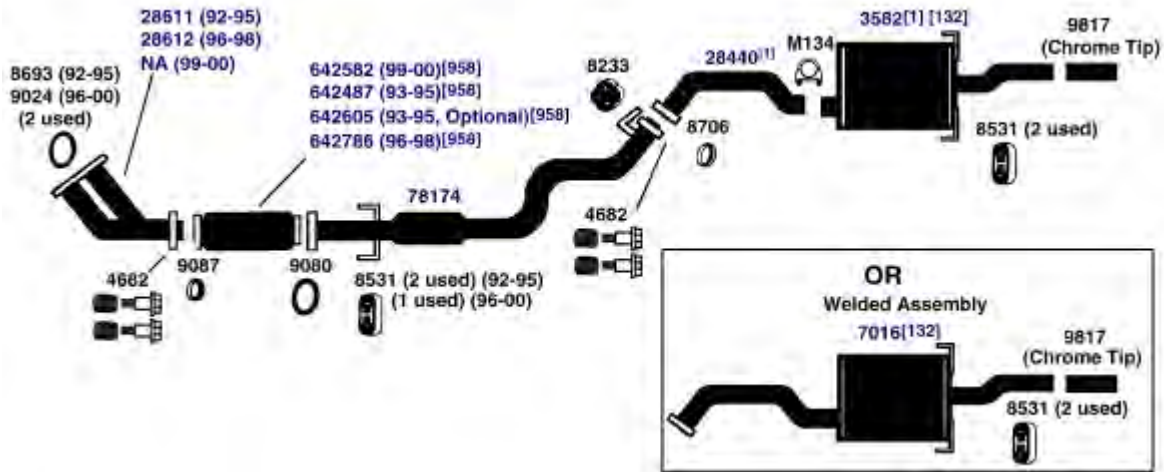

DIRECT FIT MSL/MAXIMUM Muffler... Split System- 700147

93-94 4 Cyl. Civic DX 2-Door Coupe; 1.5L Engine
 92-94 4 Cyl. Civic EX Sedan, 1.5L Engine (Canada Only)
 92-94 4 Cyl. Civic DX, LX Sedan; 1.5L Engine

(5915)

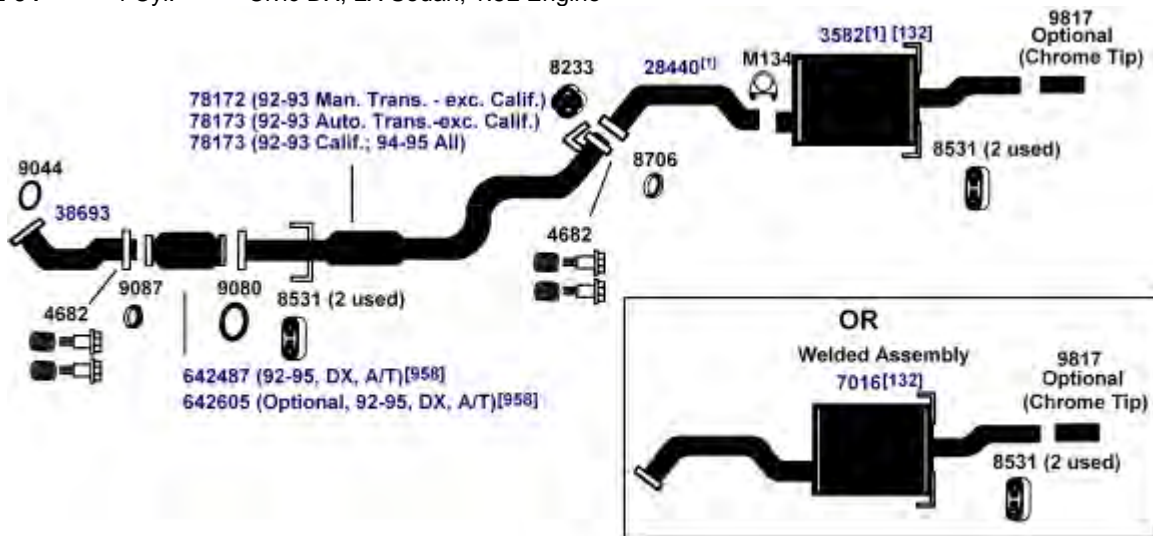

DIRECT FIT MSL/MAXIMUM Muffler... Split System- 700147

NA-Not Available. NR-Not Required. FL-Remove and Re-Use Old Flange. ● Golden Warehouse. O.E.-Original Equipment.
 # Airtube Kit [4948] may be required to complete installation. EFI-Electronic Fuel Injection.

[1] OE system was a welded assembly. It is recommended that all parts noted [1] should be replaced.
 [98] Refer to current Catalytic Converter catalog or Website catalog for availability.

[132] If black triangle appears on muffler label, remove and re-use O.E. heat shield or fabricate heat shield.
 [958] Federal & California Emission vehicles. Not legal for sale for vehicles licensed in California.

HONDA CIVIC

(5919) 93-94 4 Cyl. Civic del Sol S, 1.5L Engine

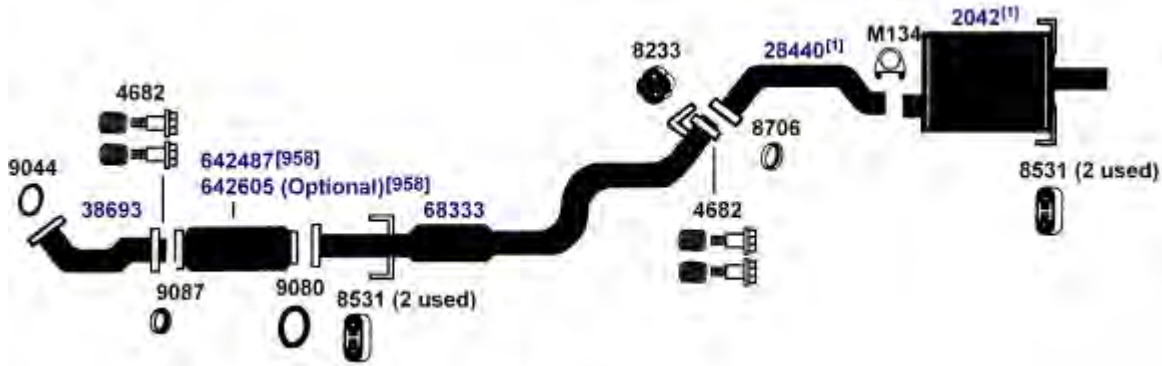

DIRECT FIT MSL/MAXIMUM Muffler... 700217

(5918) 93-94 4 Cyl. Civic del Sol Si, 1.6L SOHC V-TEC Engine

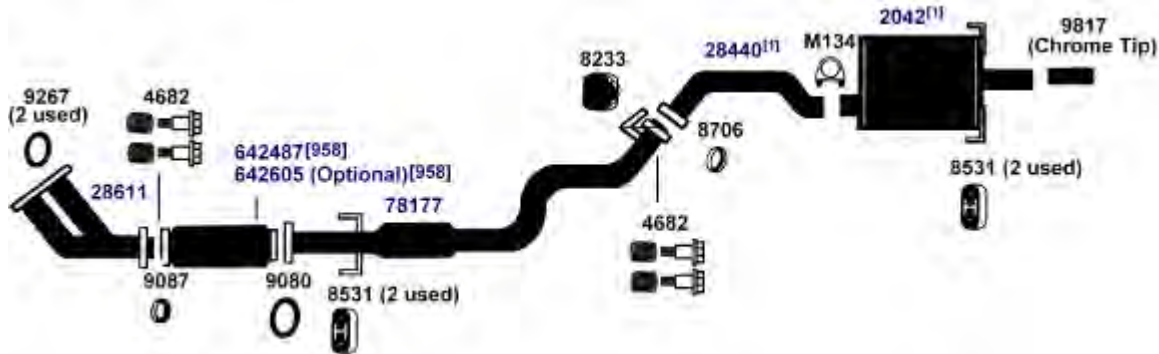

DIRECT FIT MSL/MAXIMUM Muffler... 700217

NA-Not Available. NR-Not Required. FL-Remove and Re-Use Old Flange. ● Golden Warehouse. O.E.-Original Equipment.
Airtube Kit [4948] may be required to complete installation. EFI-Electronic Fuel Injection.

[1] OE system was a welded assembly. It is recommended that all parts noted [1] should be replaced. [958] Federal & California Emission vehicles. Not legal for sale for vehicles licensed in California.

92-94 4 Cyl. Civic Si Hatchback; 1.6L Engine
 92-93 4 Cyl. Civic EXV 4-Door Sedan, 1.6L Engine (Canada Only)

(5914)

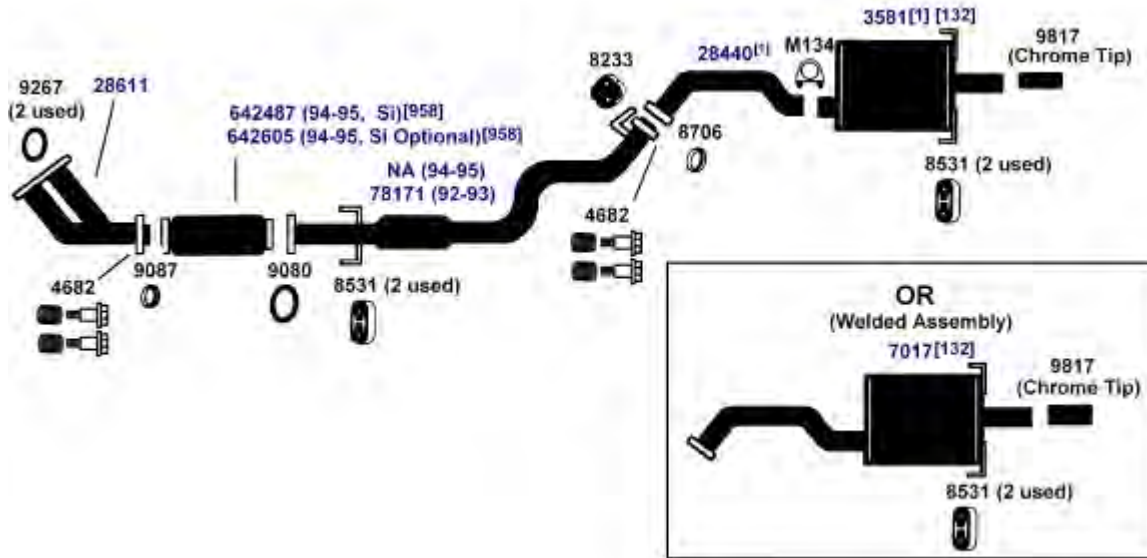

DIRECT FIT MSL/MAXIMUM Muffler... Split System- 700169

92-94 4 Cyl. Civic DX Hatchback; 1.5L Engine
 92-94 4 Cyl. Civic CX, 1.5L Engine (Canada only)

(5916)

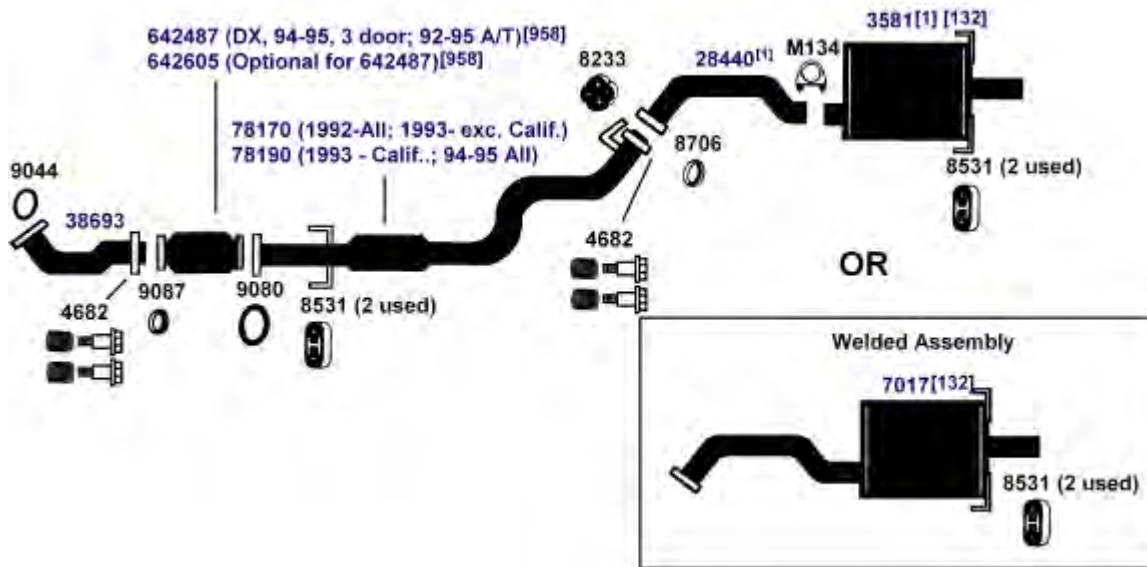

DIRECT FIT MSL/MAXIMUM Muffler... Split System- 700169

NA-Not Available. NR-Not Required. FL-Remove and Re-Use Old Flange. ● Golden Warehouse. O.E.-Original Equipment.
 # Airtube Kit [4948] may be required to complete installation. EFI-Electronic Fuel Injection.

[1] OE system was a welded assembly. It is recommended that all parts noted [1] should be replaced.
 [98] Refer to current Catalytic Converter catalog or Website catalog for availability.

[132] If black triangle appears on muffler label, remove and re-use O.E. heat shield or fabricate heat shield.
 [958] Federal & California Emission vehicles. Not legal for sale for vehicles licensed in California.

HONDA CIVIC

(5912) 90-91 4 Cyl. Civic STD Hatchback; 1.5L Engine

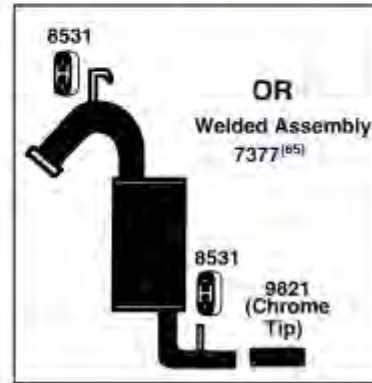
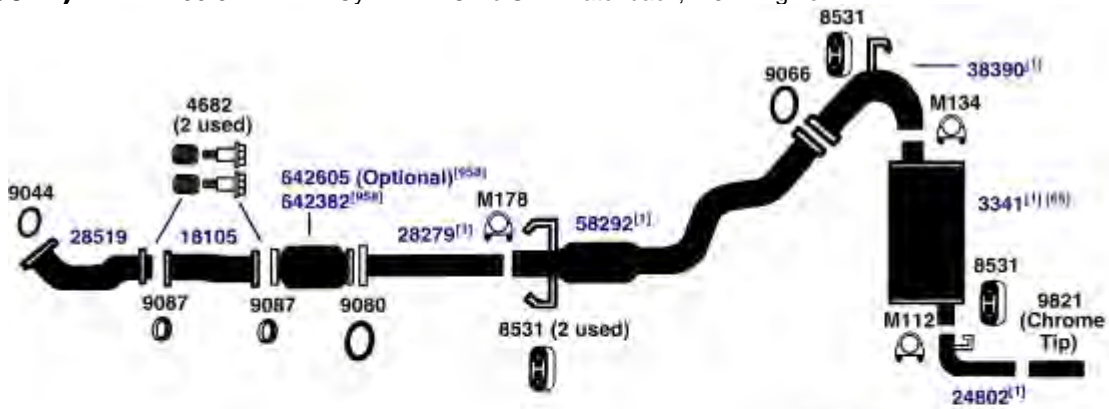

DIRECT FIT MSL/MAXIMUM Muffler... Split System- 700110, UNIVERSAL FIT MSL/MAXIMUM Muffler... Split System- 6652, Silentone DIY Muffler... Split System- 5599 and 34770 Pipe

(5911) 90-91 4 Cyl. Civic EX Sedan, 1.6L Engine

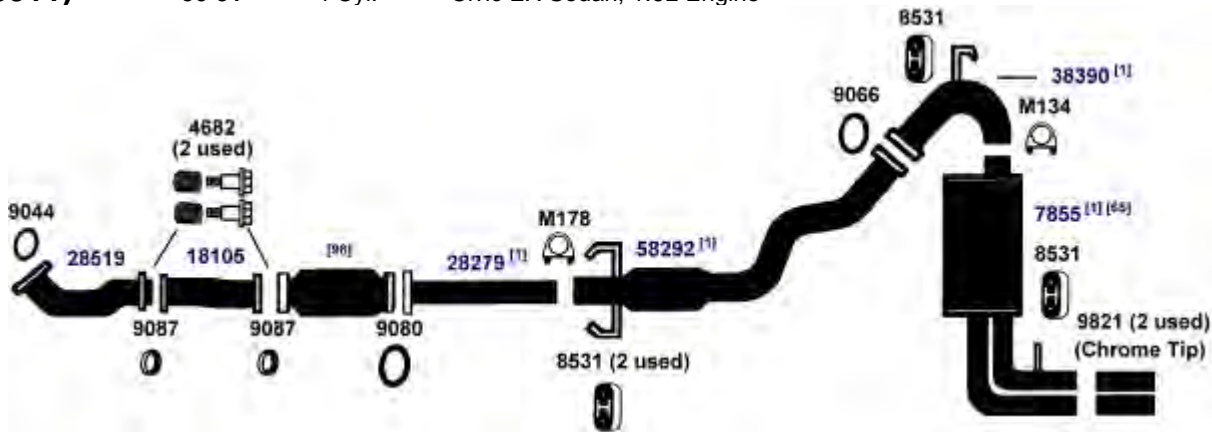

Silentone DIY Muffler... 5599 and 34770 Pipe

NA-Not Available. NR-Not Required. FL-Remove and Re-Use Old Flange. ● Golden Warehouse. O.E.-Original Equipment.
Airtube Kit [4948] may be required to complete installation. EFI-Electronic Fuel Injection.

[1] OE system was a welded assembly. It is recommended that all parts noted [1] should be replaced.

[65] Heat Shield 9206 is required for installation.

[98] Refer to current Catalytic Converter catalog or Website catalog for availability.
[958] Federal & California Emission vehicles. Not legal for sale for vehicles licensed in California.

89-91 4 Cyl. Civic DX Hatchback; DX, LX Sedan; 1.5L Engine

(5910)

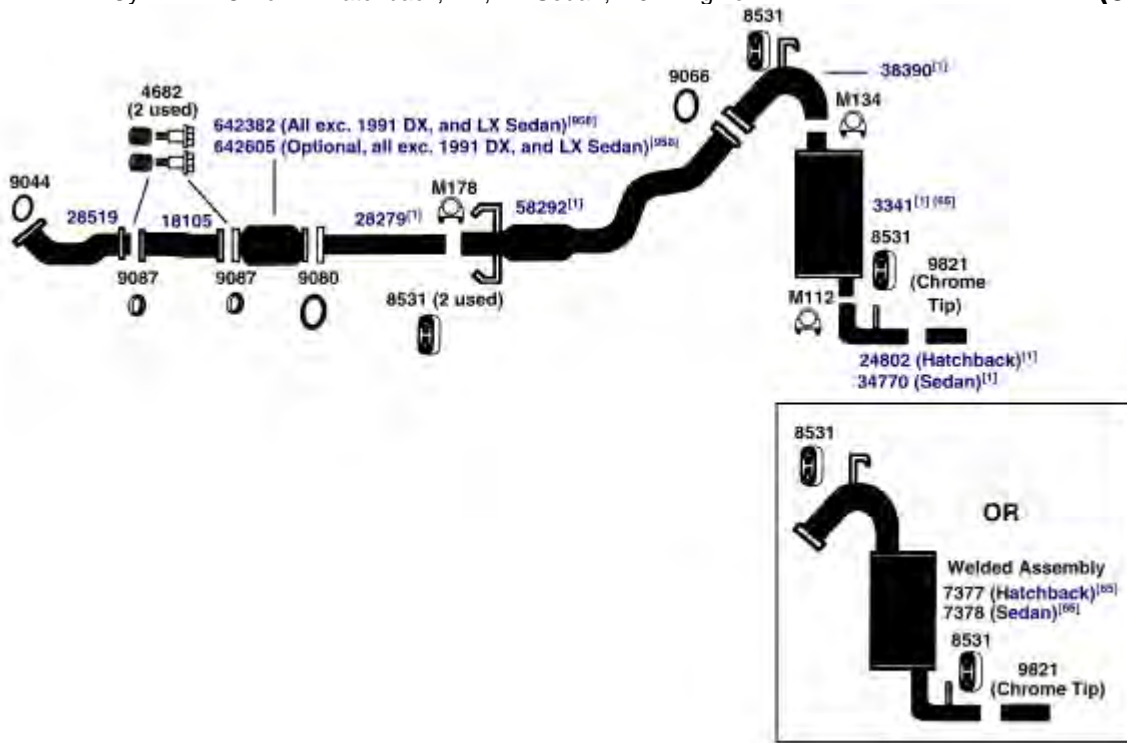

DIRECT FIT MSL/MAXIMUM Muffler... Split System- 700110, UNIVERSAL FIT MSL/MAXIMUM Muffler... Split System- 6652, Silentone
 DIY Muffler... Split System- 5599 and 34770 Pipe

NA-Not Available. NR-Not Required. FL-Remove and Re-Use Old Flange. ● Golden Warehouse. O.E.-Original Equipment.
 # Airtube Kit [4948] may be required to complete installation. EFI-Electronic Fuel Injection.

[1] OE system was a welded assembly. It is recommended that all parts noted [1] should be replaced. [958] Federal & California Emission vehicles. Not legal for sale for vehicles licensed in California.
 [65] Heat Shield 9206 is required for installation.

HONDA CIVIC

(5909) 89-91 4 Cyl. Civic Si Hatchback; 1.6L Engine

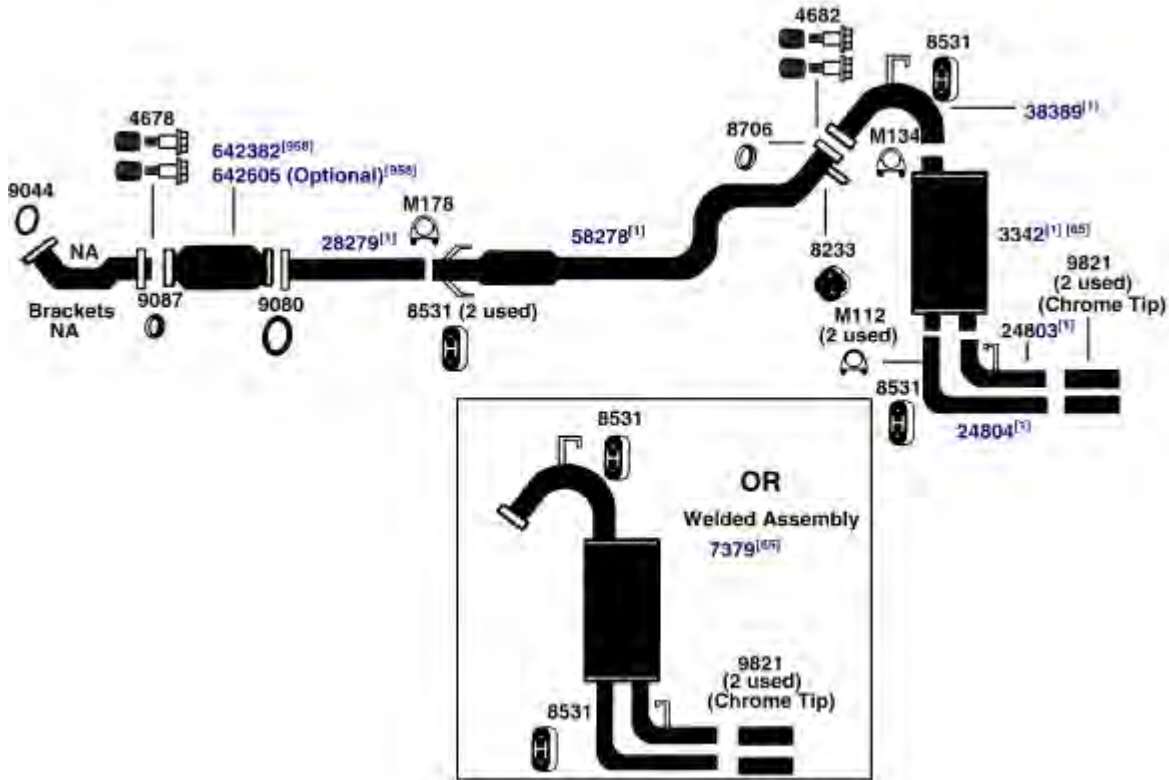

DIRECT FIT MSL/MAXIMUM Muffler... Split System- 700111, UNIVERSAL FIT MSL/MAXIMUM Muffler... Split System- 6686, Silentone DIY Muffler... Split System- 5599 and 34770 Pipe

(5906) 89-91 4 Cyl. Civic Sta. Wagon, Wagon; 1.6L Engine, 4WD

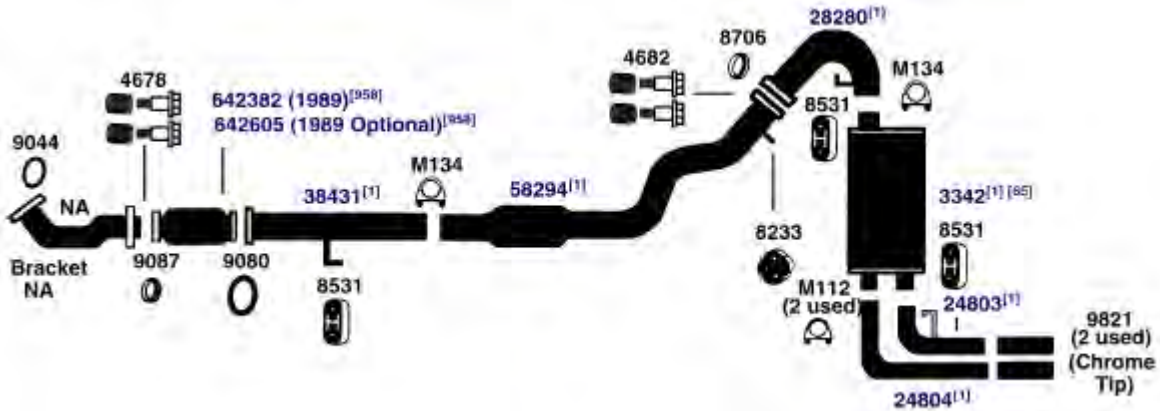

DIRECT FIT MSL/MAXIMUM Muffler... 700111, UNIVERSAL FIT MSL/MAXIMUM Muffler... 6686, Silentone DIY Muffler... 5599 and 34770 Pipe

NA-Not Available. NR-Not Required. FL-Remove and Re-Use Old Flange. ● Golden Warehouse. O.E.-Original Equipment.
Airtube Kit [4948] may be required to complete installation. EFI-Electronic Fuel Injection.

- [1] OE system was a welded assembly. It is recommended that all parts noted [1] should be replaced. [958] Federal & California Emission vehicles. Not legal for sale for vehicles licensed in California.
[65] Heat Shield 9206 is required for installation.

88-91 4 Cyl. Civic Sta. Wagon, Wagovan; 1.5L Engine, 2WD

(5907)

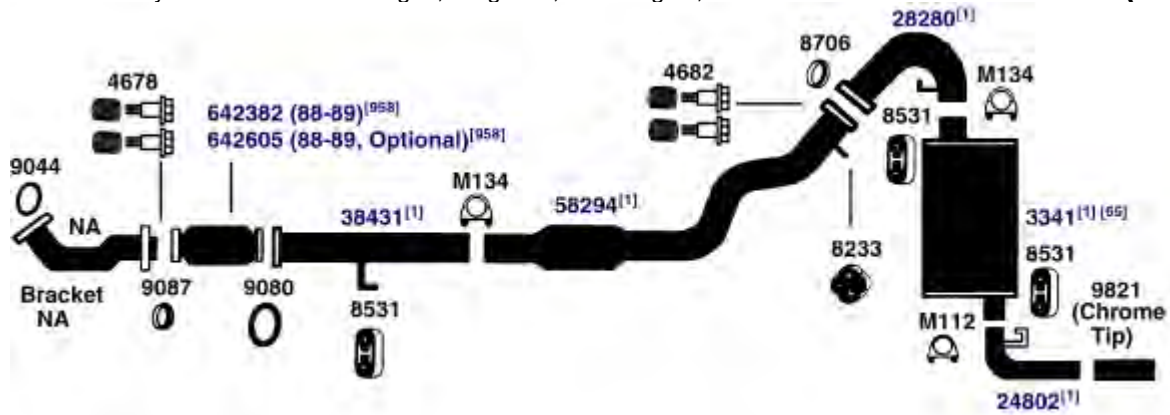

DIRECT FIT MSL/MAXIMUM Muffler... 700110, UNIVERSAL FIT MSL/MAXIMUM Muffler... 6652, Silentone DIY Muffler... 5599 and 34770 Pipe

88-89 4 Cyl. Civic STD Hatchback, 1.5L Engine

(5908)

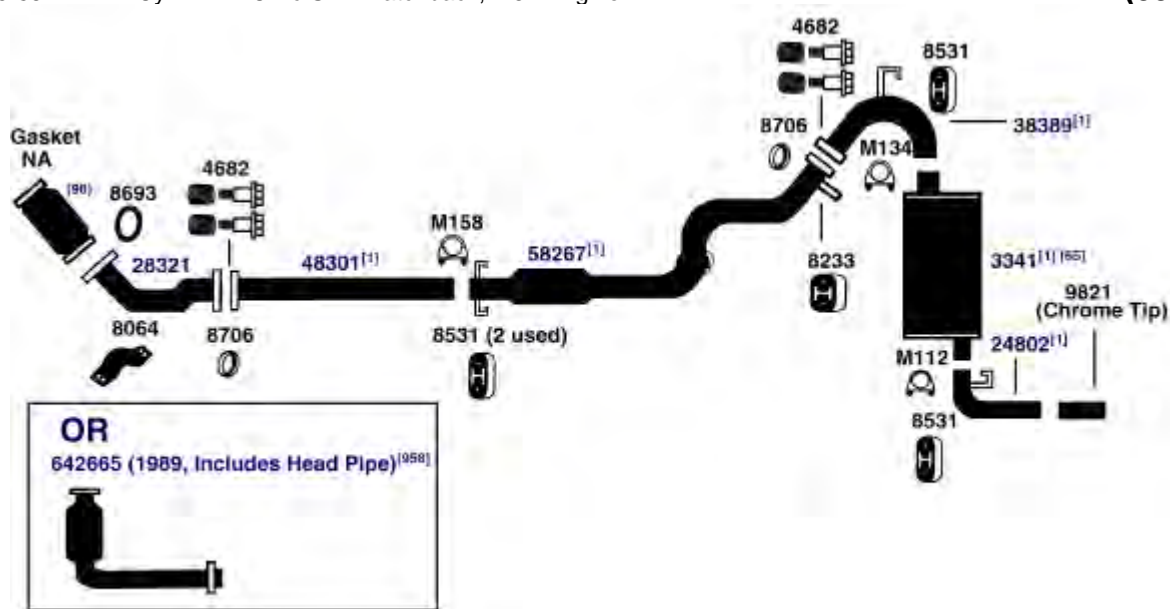

DIRECT FIT MSL/MAXIMUM Muffler... 700110, UNIVERSAL FIT MSL/MAXIMUM Muffler... 6652, Silentone DIY Muffler... 5599 and 34770 Pipe

NA-Not Available. NR-Not Required. FL-Remove and Re-Use Old Flange. ● Golden Warehouse. O.E.-Original Equipment.
Airtube Kit [4948] may be required to complete installation. EFI-Electronic Fuel Injection.

- [1] OE system was a welded assembly. It is recommended that all parts noted [1] should be replaced.
- [65] Heat Shield 9206 is required for installation.
- [958] Federal & California Emission vehicles. Not legal for sale for vehicles licensed in California.

HONDA CIVIC

(5905)	1988	4 Cyl.	Civic DX Hatchback, 1.5L Engine
	1988	4 Cyl.	Civic DX, LX Sedan, 1.5L Engine

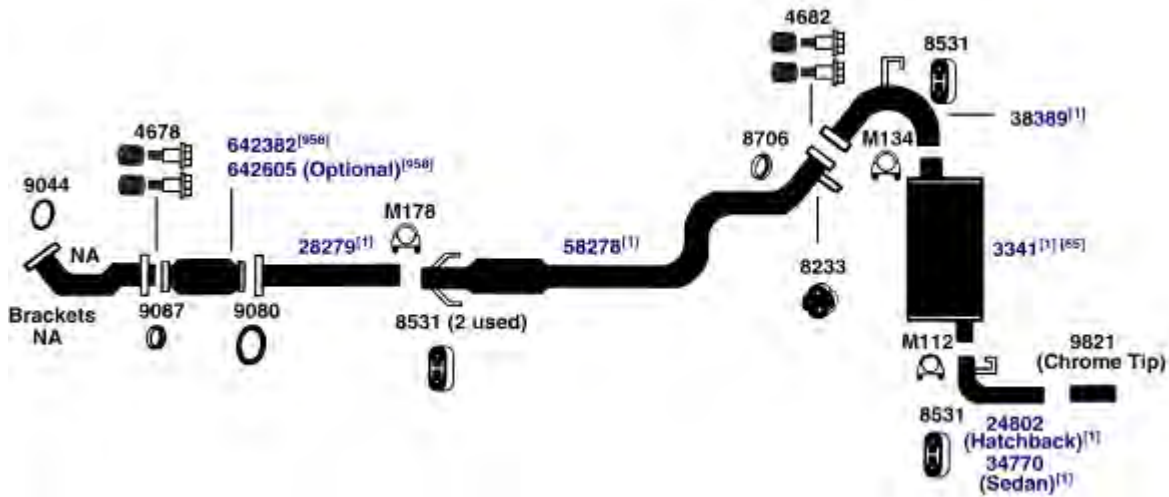

DIRECT FIT MSL/MAXIMUM Muffler... 700110, UNIVERSAL FIT MSL/MAXIMUM Muffler... 6652, Silentone DIY Muffler... 5599 and 34770 Pipe

(5902)	86-87	4 Cyl.	Civic Si Hatchback; Fuel Injection Engine
---------------	-------	--------	---

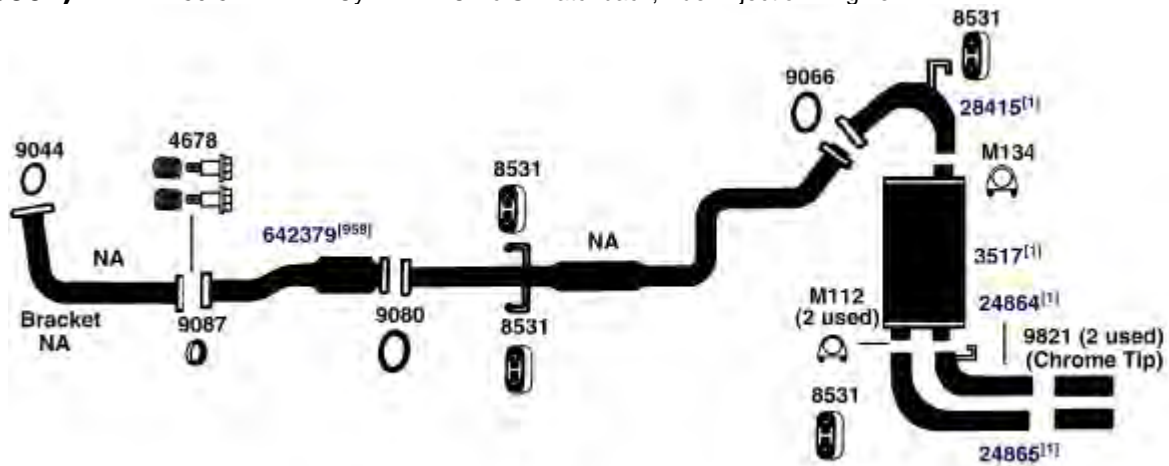

DIRECT FIT MSL/MAXIMUM Muffler... 6685

NA-Not Available. NR-Not Required. FL-Remove and Re-Use Old Flange. ● Golden Warehouse. O.E.-Original Equipment.
 # Airtube Kit [4948] may be required to complete installation. EFI-Electronic Fuel Injection.

[1] OE system was a welded assembly. It is recommended that all parts noted [1] should be replaced. [958] Federal & California Emission vehicles. Not legal for sale for vehicles licensed in California.
 [65] Heat Shield 9206 is required for installation.

85-87 4 Cyl. Civic 2-Door Hatchback, 1300cc, 1500cc; except Fuel Injection (US Only)

(5901)

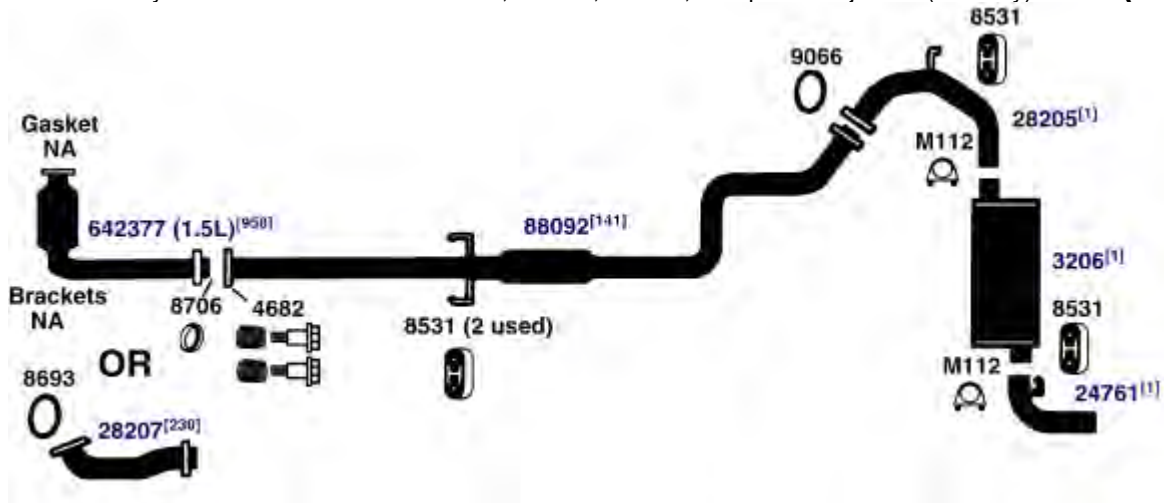

DIRECT FIT MSL/MAXIMUM Muffler... 700082, UNIVERSAL FIT MSL/MAXIMUM Muffler... 6655

85-87 4 Cyl. Civic 4-Door Sedan (US Only)

(5900)

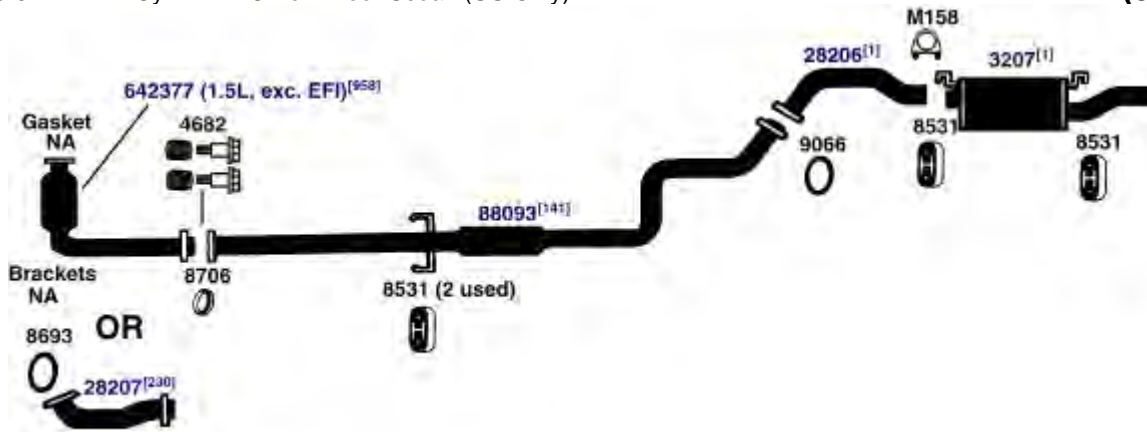

DIRECT FIT MSL/MAXIMUM Muffler... 700083, UNIVERSAL FIT MSL/MAXIMUM Muffler... 6651, 6654

NA-Not Available. NR-Not Required. FL-Remove and Re-Use Old Flange. ● Golden Warehouse. O.E.-Original Equipment.
 # Airtube Kit [4948] may be required to complete installation. EFI-Electronic Fuel Injection.

[1] OE system was a welded assembly. It is recommended that all parts noted [1] should be replaced.

[141] Remove and re-use O.E. heat shield, if required.

[230] Use with O.E.M. Converter
 [958] Federal & California Emission vehicles. Not legal for sale for vehicles licensed in California.

HONDA CIVIC

(100291) 85-87 4 Cyl. Civic, 4-Door Sedan; 1.5L Engine (CANADA ONLY)

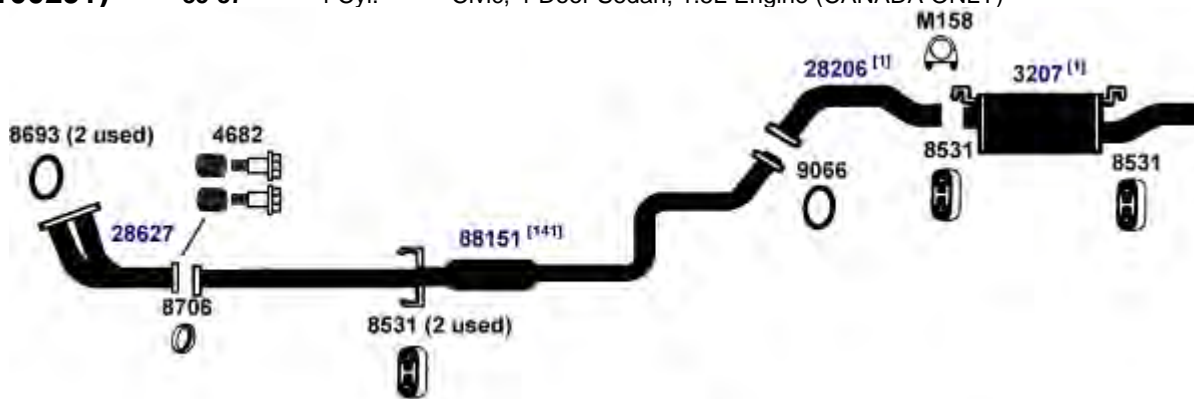

DIRECT FIT MSL/MAXIMUM Muffler... 700083, UNIVERSAL FIT MSL/MAXIMUM Muffler... 6651, 6654

(100290) 85-87 4 Cyl. Civic, 2-Door Hatchback; 1300cc, 1500cc Engine; except Fuel Injection (CANADA ONLY)

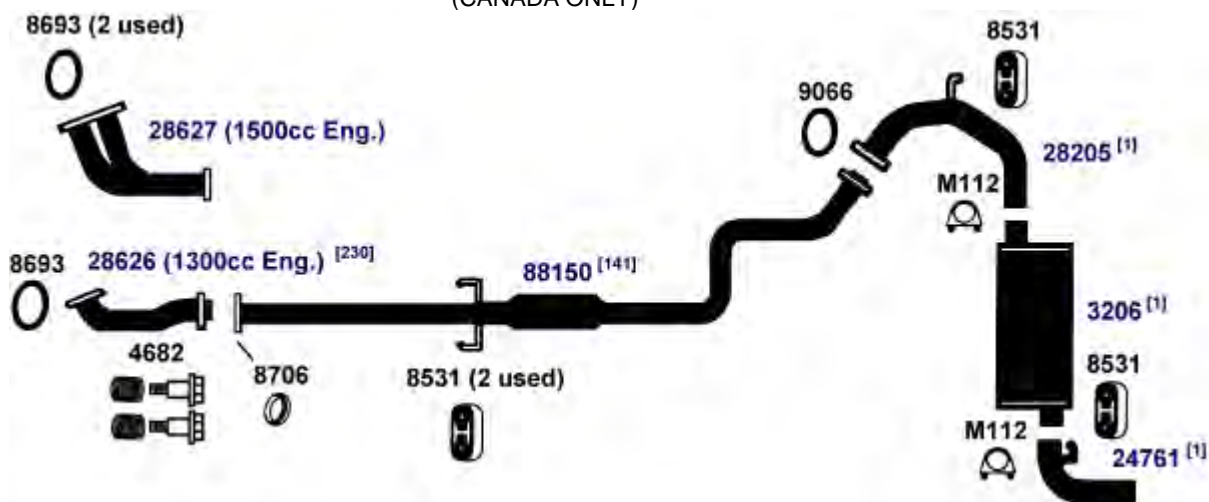

DIRECT FIT MSL/MAXIMUM Muffler... 700082, UNIVERSAL FIT MSL/MAXIMUM Muffler... 6655

NA-Not Available. NR-Not Required. FL-Remove and Re-Use Old Flange. ● Golden Warehouse. O.E.-Original Equipment.
Airtube Kit [4948] may be required to complete installation. EFI-Electronic Fuel Injection.

[1] OE system was a welded assembly. It is recommended that all parts noted [1] should be replaced. [230] Use with O.E.M. Converter

[141] Remove and re-use O.E. heat shield, if required.

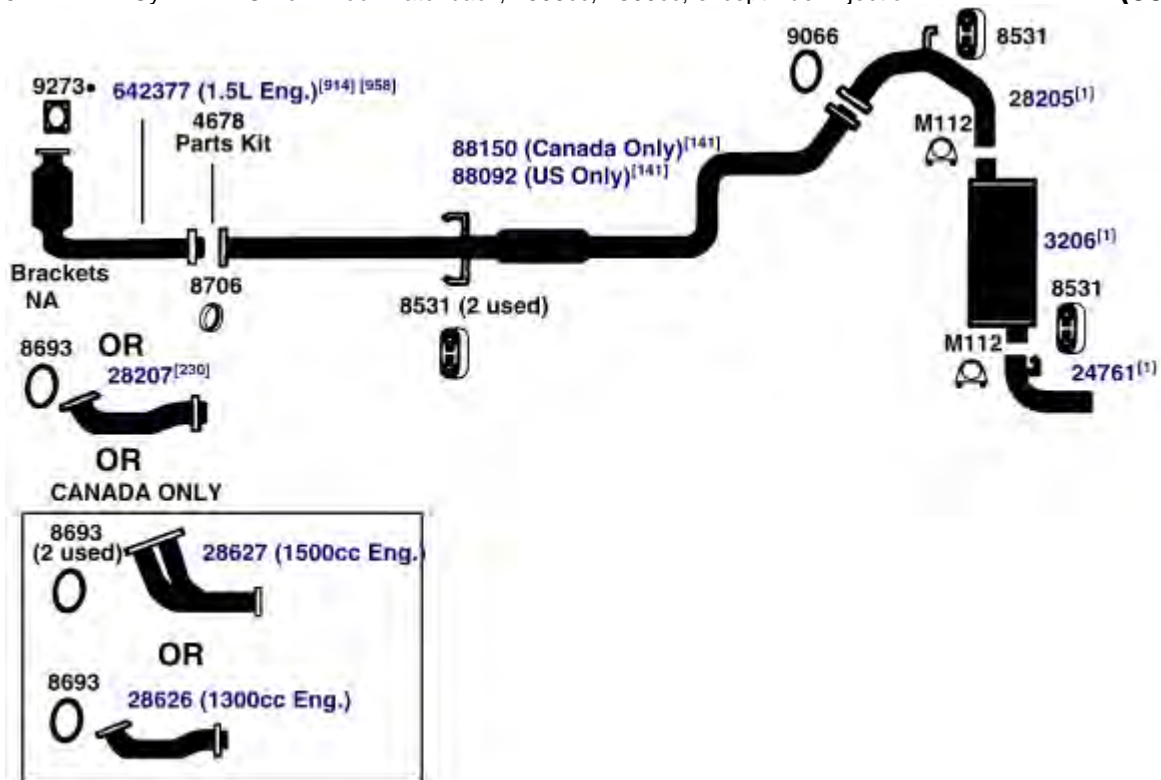

DIRECT FIT MSL/MAXIMUM Muffler... 700082, UNIVERSAL FIT MSL/MAXIMUM Muffler... 6655

NA-Not Available. NR-Not Required. FL-Remove and Re-Use Old Flange. ● Golden Warehouse. O.E.-Original Equipment.
Airtube Kit [4948] may be required to complete installation. EFI-Electronic Fuel Injection.

[1] OE system was a welded assembly. It is recommended that all parts noted [1] should be replaced.

[141] Remove and re-use O.E. heat shield, if required.

[230] Use with O.E.M. Converter

[914] Direct fit converter includes front (Exhaust) pipe, (1) piece assembly.

[958] Federal & California Emission vehicles. Not legal for sale for vehicles licensed in California.

HONDA CIVIC

(5900E)

1984

4 Cyl.

Civic 4-Door Sedan

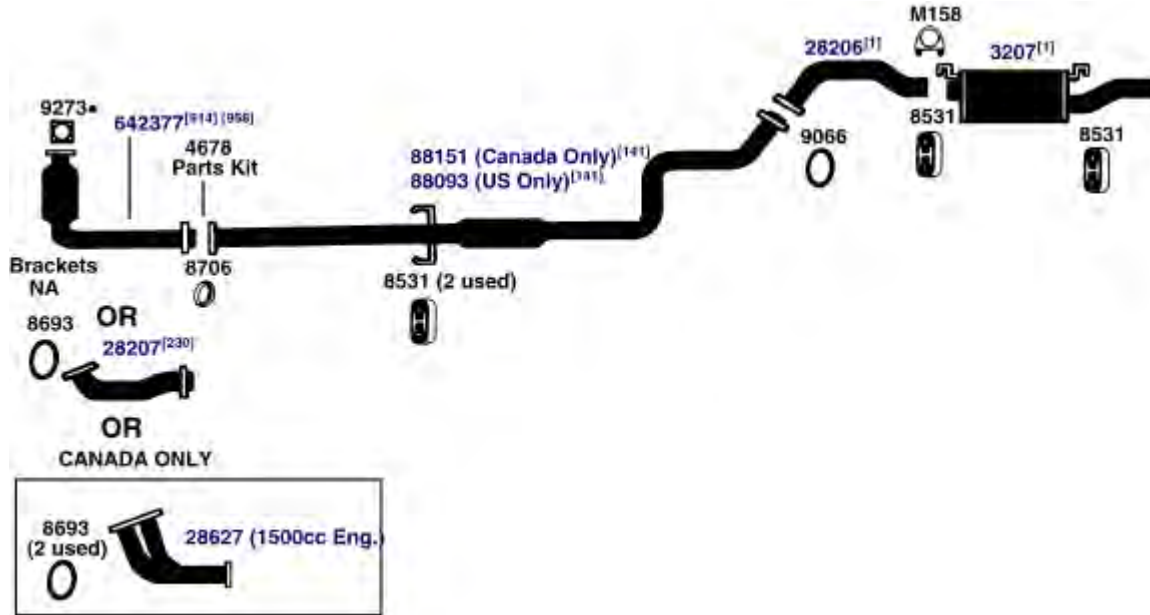

DIRECT FIT MSL/MAXIMUM Muffler... 700083, UNIVERSAL FIT MSL/MAXIMUM Muffler... 6651, 6654

NA-Not Available. NR-Not Required. FL-Remove and Re-Use Old Flange. ● Golden Warehouse. O.E.-Original Equipment.
Airtube Kit [4948] may be required to complete installation. EFI-Electronic Fuel Injection.

[1] OE system was a welded assembly. It is recommended that all parts noted [1] should be replaced.

[141] Remove and re-use O.E. heat shield, if required.

[230] Use with O.E.M. Converter

[914] Direct fit converter includes front (Exhaust) pipe, (1) piece assembly.

[958] Federal & California Emission vehicles. Not legal for sale for vehicles licensed in California.

89-91 4 Cyl. CRX DX, 1.5L Engine

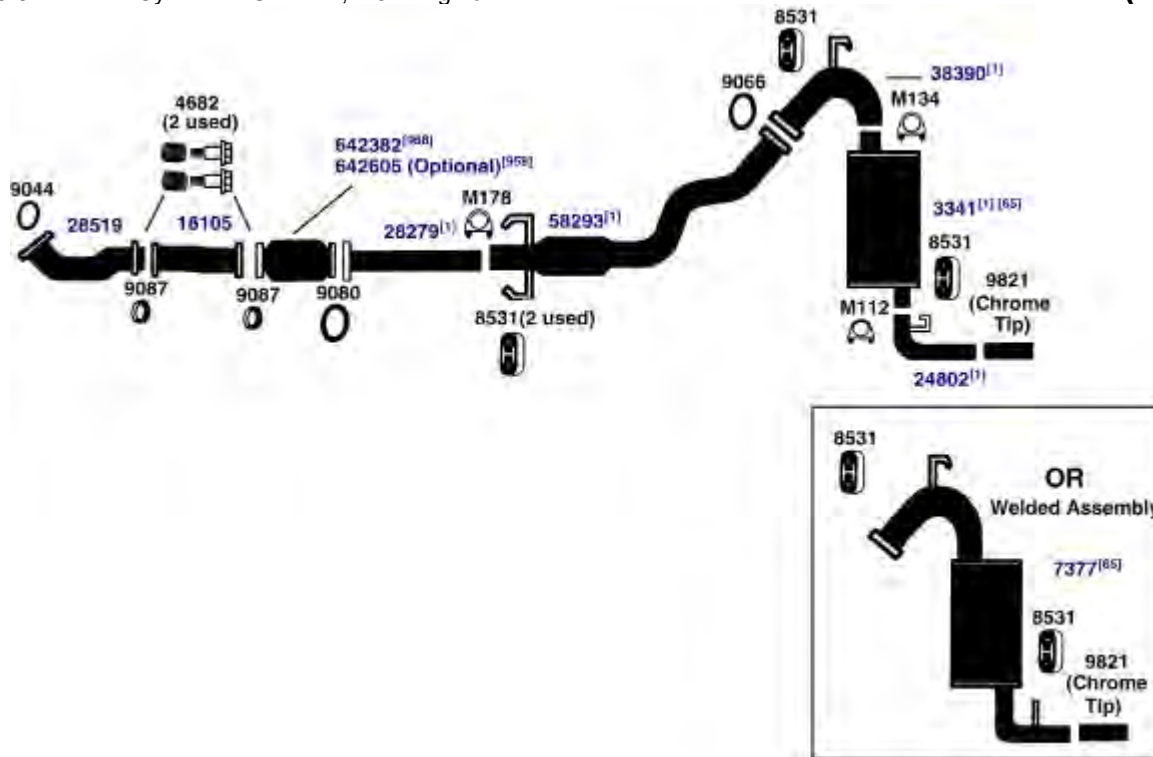

DIRECT FIT MSL/MAXIMUM Muffler... Split System- 700110, UNIVERSAL FIT MSL/MAXIMUM Muffler... Split System- 6652, Silentone
DIY Muffler... Split System- 5599 and 34770 Pipe

NA-Not Available. NR-Not Required. FL-Remove and Re-Use Old Flange. ● Golden Warehouse. O.E.-Original Equipment.
Airtube Kit [4948] may be required to complete installation. EFI-Electronic Fuel Injection.

[1] OE system was a welded assembly. It is recommended that all parts noted [1] should be replaced. [958] Federal & California Emission vehicles. Not legal for sale for vehicles licensed in California.
[65] Heat Shield 9206 is required for installation.

HONDA CRX

(12452) 88-91 4 Cyl. CRX HF, 1.5L Engine

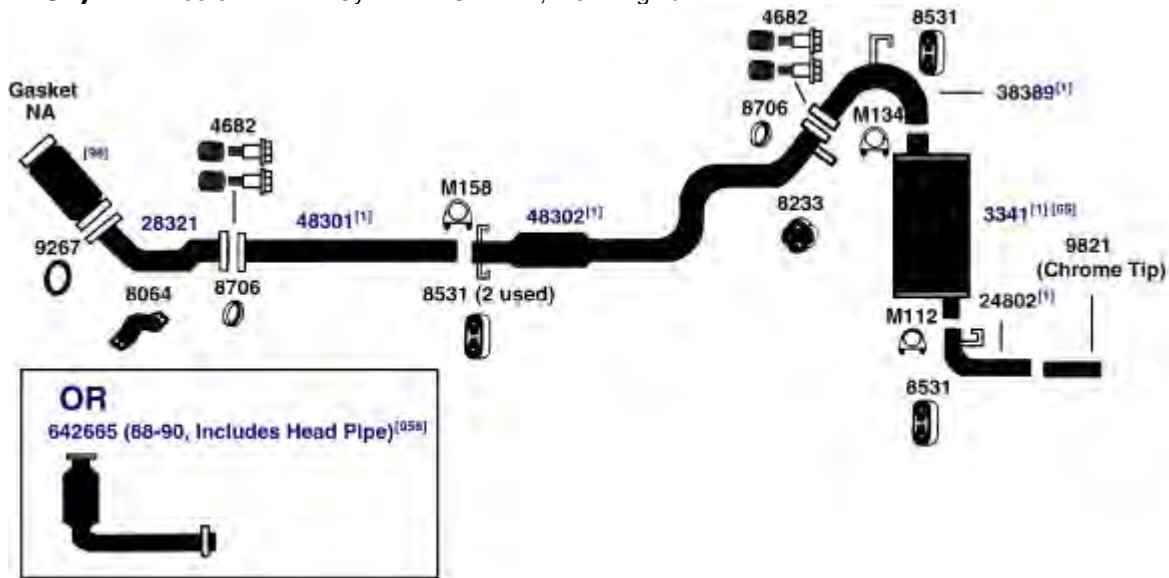

DIRECT FIT MSL/MAXIMUM Muffler... 700110, UNIVERSAL FIT MSL/MAXIMUM Muffler... 6652, Silentone DIY Muffler... 5599 and 34770 Pipe

NA-Not Available. NR-Not Required. FL-Remove and Re-Use Old Flange. ● Golden Warehouse. O.E.-Original Equipment.
Airtube Kit [4948] may be required to complete installation. EFI-Electronic Fuel Injection.

- [1] OE system was a welded assembly. It is recommended that all parts noted [1] [958] Federal & California Emission vehicles. Not legal for sale for vehicles licensed in California.
[65] Heat Shield 9206 is required for installation.

88-91 4 Cyl. CRX Si, 1.6L Engine

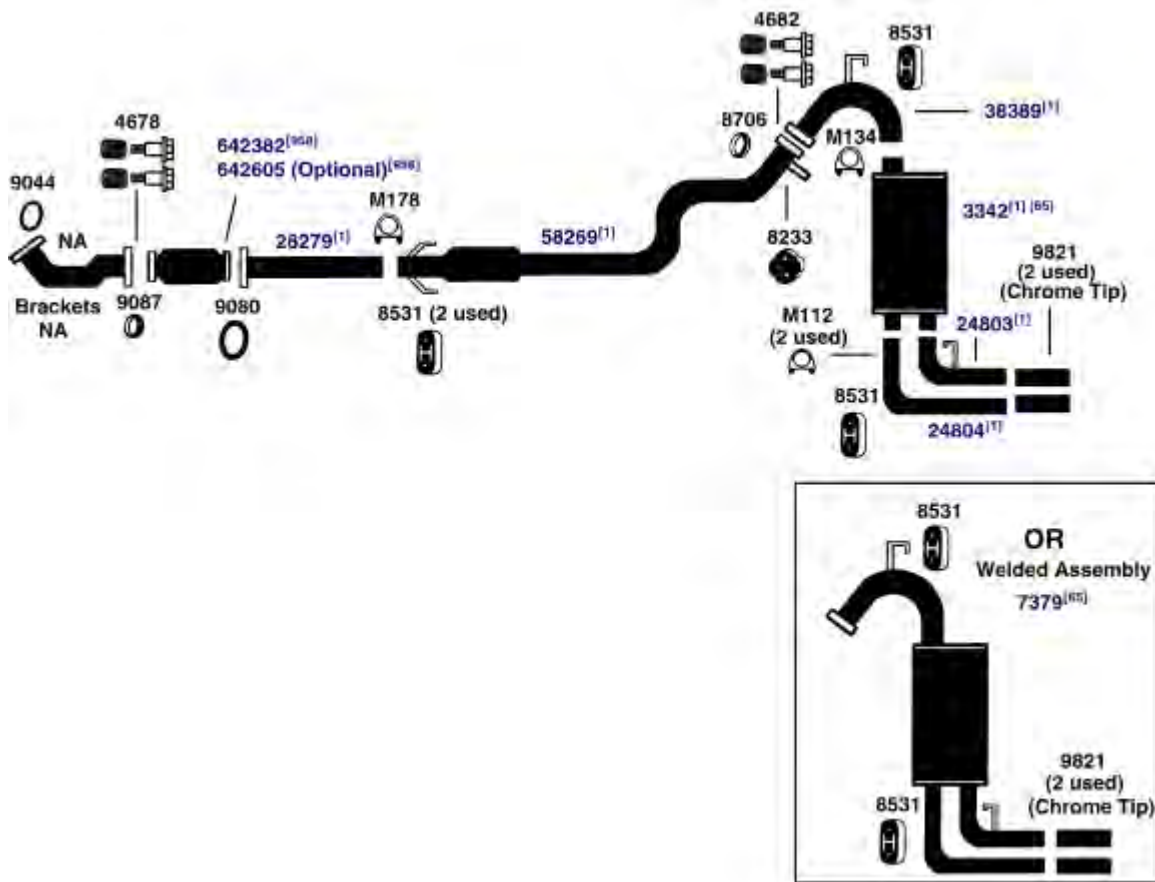

DIRECT FIT MSL/MAXIMUM Muffler... Split System- 700111, UNIVERSAL FIT MSL/MAXIMUM Muffler... Split System- 6686, Silentone
 DIY Muffler... Split System- 5599 and 34770 Pipe

NA-Not Available. NR-Not Required. FL-Remove and Re-Use Old Flange. ● Golden Warehouse. O.E.-Original Equipment.
 # Airtube Kit [4948] may be required to complete installation. EFI-Electronic Fuel Injection.

- [1] OE system was a welded assembly. It is recommended that all parts noted [1] should be replaced.
- [65] Heat Shield 9206 is required for installation.
- [958] Federal & California Emission vehicles. Not legal for sale for vehicles licensed in California.

HONDA CRX

(12450) 1988 4 Cyl. CRX DX, 1.5L Engine

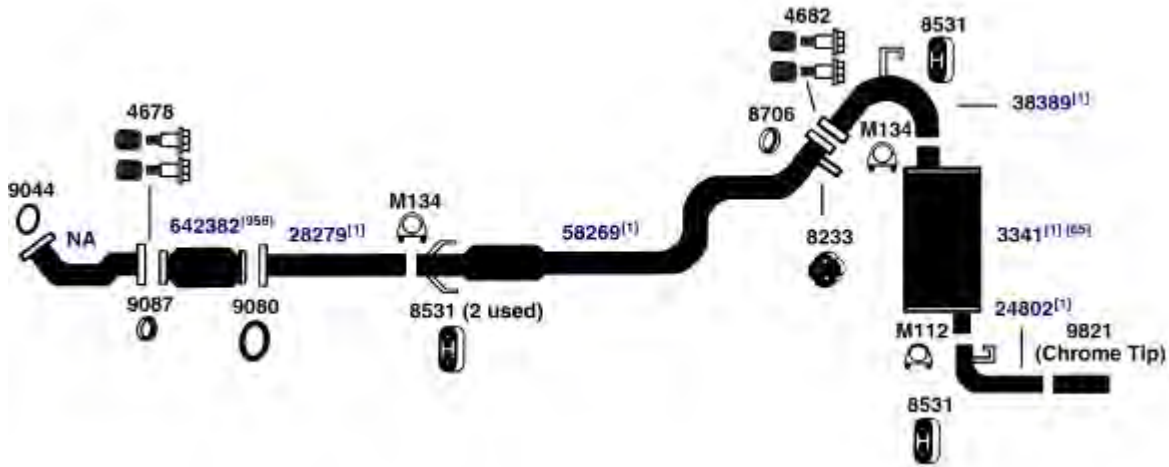

DIRECT FIT MSL/MAXIMUM Muffler... 700110, UNIVERSAL FIT MSL/MAXIMUM Muffler... 6652, Silentone DIY Muffler... 5599 and 34770 Pipe

(12454) 85-87 4 Cyl. CRX; 1300cc, 1500cc Engine, except Fuel Injection (US Only)

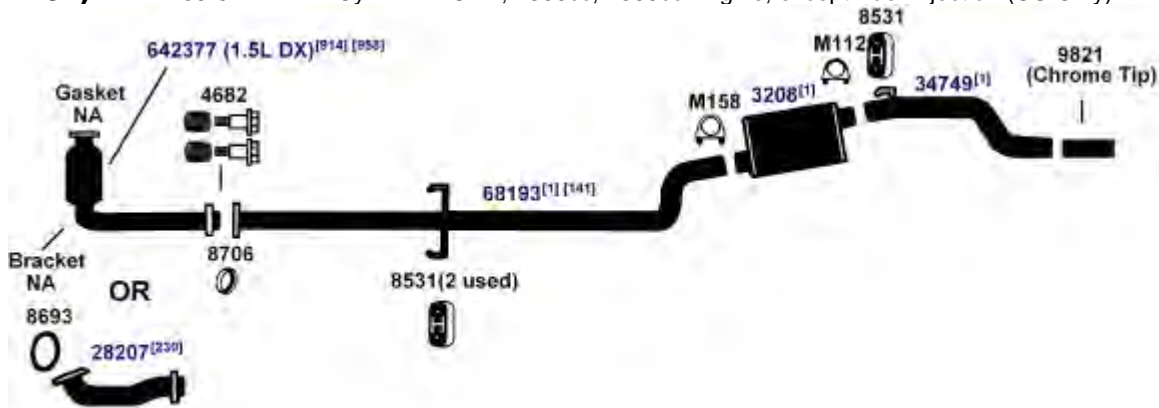

DIRECT FIT MSL/MAXIMUM Muffler... 700084, UNIVERSAL FIT MSL/MAXIMUM Muffler... 6654

NA-Not Available. NR-Not Required. FL-Remove and Re-Use Old Flange. ● Golden Warehouse. O.E.-Original Equipment.
Airtube Kit [4948] may be required to complete installation. EFI-Electronic Fuel Injection.

[1] OE system was a welded assembly. It is recommended that all parts noted [1] should be replaced.

[65] Heat Shield 9206 is required for installation.

[141] Remove and re-use O.E. heat shield, if required.

[230] Use with O.E.M. Converter

[914] Direct fit converter includes front (Exhaust) pipe, (1) piece assembly.

[958] Federal & California Emission vehicles. Not legal for sale for vehicles licensed in California.

85-87 4 Cyl. CRX Si, 1.5L Fuel Injection Engine

(12453)

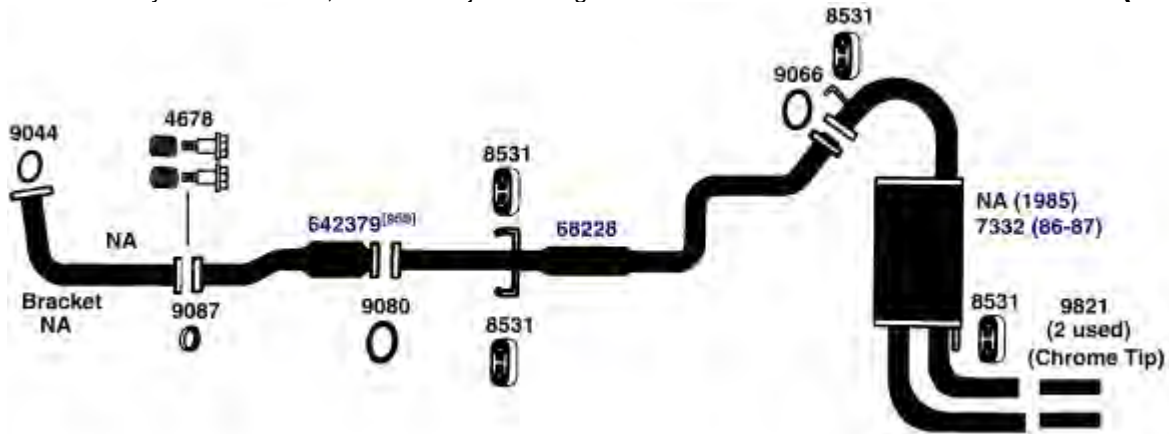

UNIVERSAL FIT MSL/MAXIMUM Muffler... Welded Assembly (7332)- 6685 (86-87)

85-87 4 Cyl. CRX, 1.5L Engine (except CRX-Si) (CANADA ONLY)

(100293)

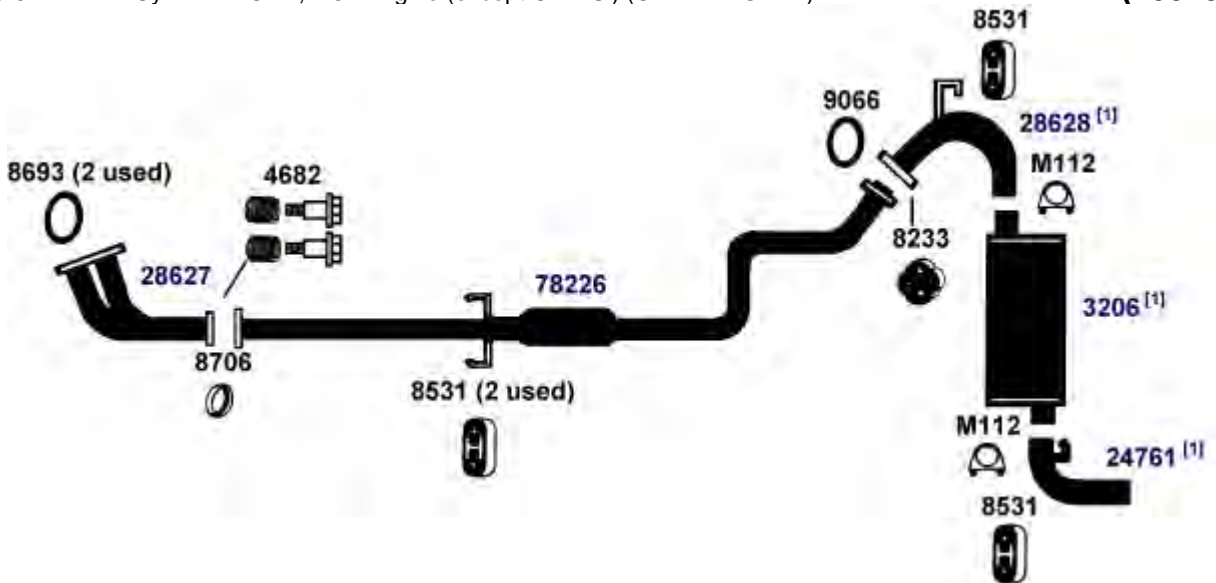

DIRECT FIT MSL/MAXIMUM Muffler... 700082, UNIVERSAL FIT MSL/MAXIMUM Muffler... 6655

NA-Not Available. NR-Not Required. FL-Remove and Re-Use Old Flange. ● Golden Warehouse. O.E.-Original Equipment.
Airtube Kit [4948] may be required to complete installation. EFI-Electronic Fuel Injection.

[1] OE system was a welded assembly. It is recommended that all parts noted [1] should be replaced. [958] Federal & California Emission vehicles. Not legal for sale for vehicles licensed in California.

HONDA CRX

(12454E) 1984 4 Cyl. CRX; 1300cc, 1500cc Engine, except Fuel Injection (Si model in Canada)

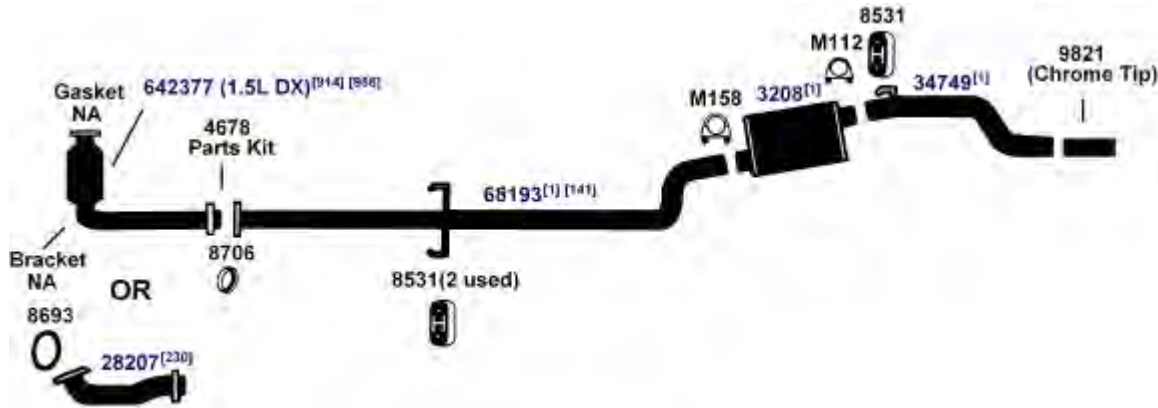

DIRECT FIT MSL/MAXIMUM Muffler... 700084, UNIVERSAL FIT MSL/MAXIMUM Muffler... 6654

HONDA PASSPORT

(24201) 1994 6 Cyl. Passport, 3.2L Engine

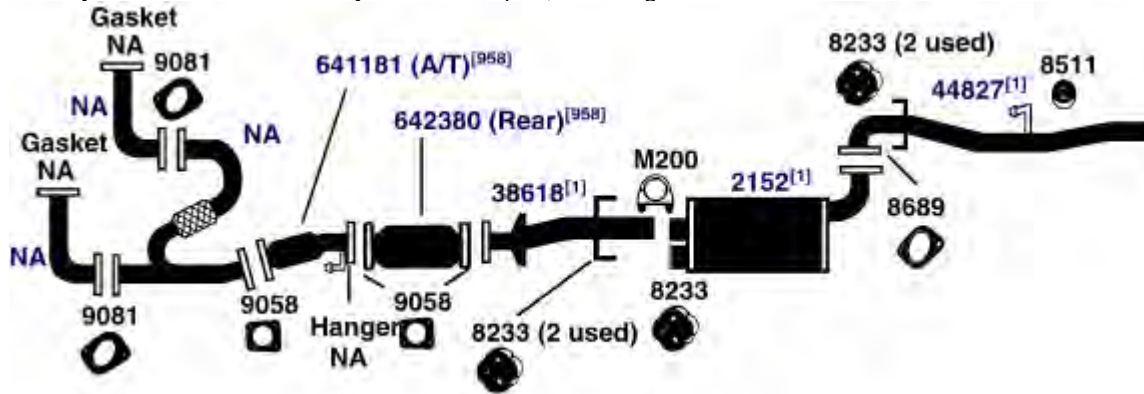

DIRECT FIT MSL/MAXIMUM Muffler... 700248

(24200) 1994 4 Cyl. Passport, 2.6L Engine

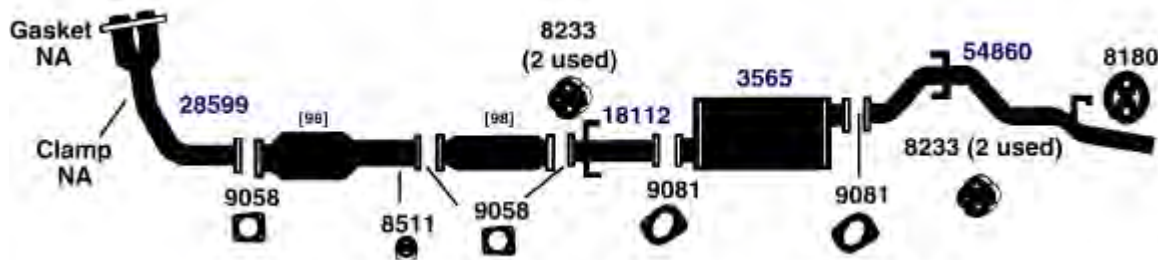

DIRECT FIT MSL/MAXIMUM Muffler... 700170, UNIVERSAL FIT MSL/MAXIMUM Muffler... 709993

NA-Not Available. NR-Not Required. FL-Remove and Re-Use Old Flange. ● Golden Warehouse. O.E.-Original Equipment.
Airtube Kit [4948] may be required to complete installation. EFI-Electronic Fuel Injection.

[1] OE system was a welded assembly. It is recommended that all parts noted [1] should be replaced.

[98] Refer to current Catalytic Converter catalog or Website catalog for availability.

[141] Remove and re-use O.E. heat shield, if required.

[230] Use with O.E.M. Converter

[914] Direct fit converter includes front (Exhaust) pipe, (1) piece assembly.

[958] Federal & California Emission vehicles. Not legal for sale for vehicles licensed in California.

92-94 4 Cyl. Prelude, All Models

(5954)

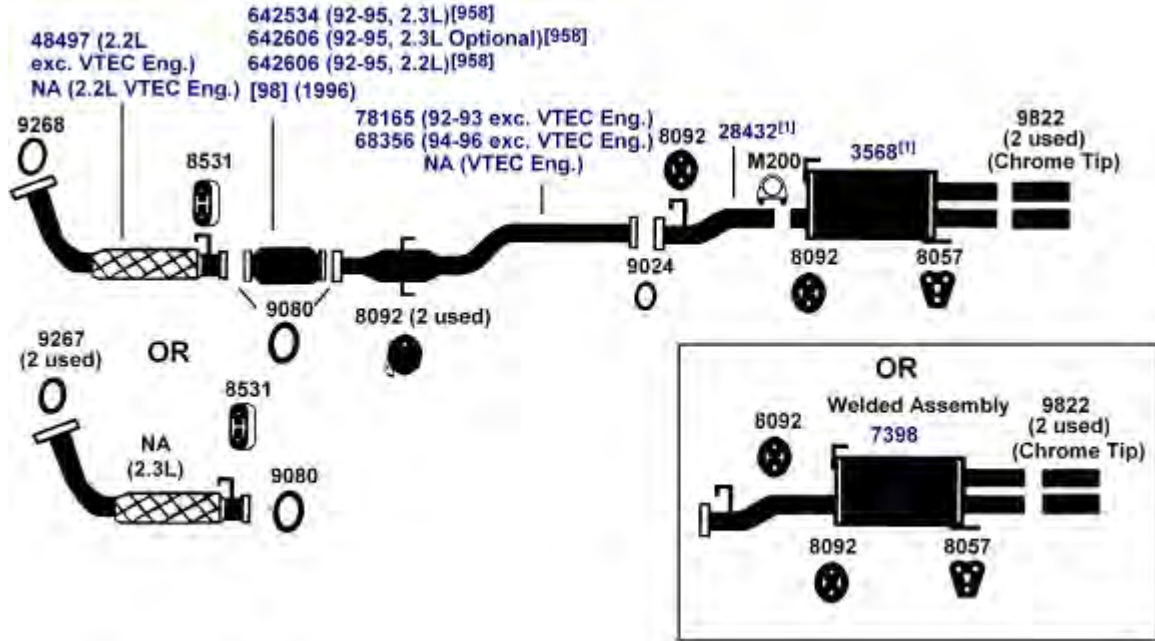

DIRECT FIT MSL/MAXIMUM Muffler... Split System- 700289

90-91 4 Cyl. Prelude Si; 2.0L Fuel Injection Engine

(5953)

90-91 4 Cyl. Prelude Si, SR; 2.0L, 2.1L Fuel Injection Engine (Canada Only)

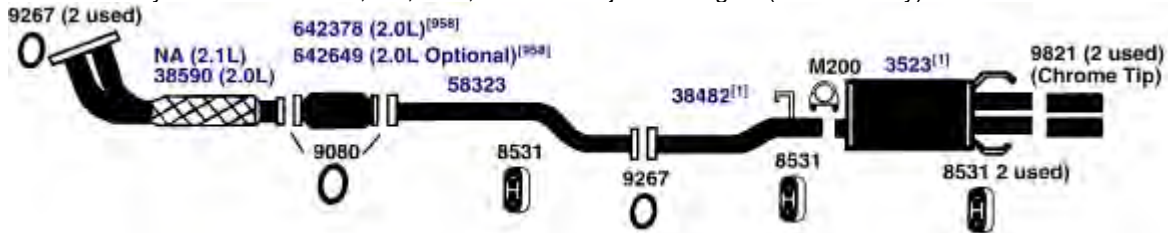

DIRECT FIT MSL/MAXIMUM Muffler... 700140

88-90 4 Cyl. Prelude, 2.0L Engine; except Fuel Injection

(5952)

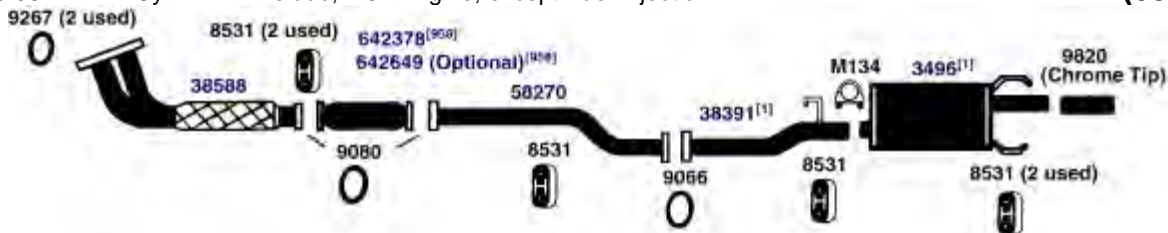

DIRECT FIT MSL/MAXIMUM Muffler... 700008, UNIVERSAL FIT MSL/MAXIMUM Muffler... 709007, 709010

NA-Not Available. NR-Not Required. FL-Remove and Re-Use Old Flange. ● Golden Warehouse. O.E.-Original Equipment.

Airtube Kit [4948] may be required to complete installation. EFI-Electronic Fuel Injection.

[1] OE system was a welded assembly. It is recommended that all parts noted [1] should be replaced.

[98] Refer to current Catalytic Converter catalog or Website catalog for availability.

[958] Federal & California Emission vehicles. Not legal for sale for vehicles licensed in California.

HONDA PRELUDE

(5951) 88-89 4 Cyl. Prelude, 2.0L Fuel Injection Engine, including 4-Wheel Steering

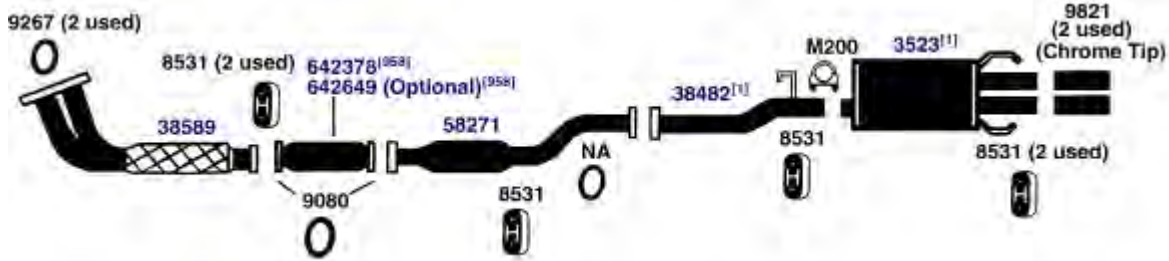

DIRECT FIT MSL/MAXIMUM Muffler... 700140

(5950) 86-87 4 Cyl. Prelude Si, 2.0L Fuel Injection Engine (Canada Only)
85-87 4 Cyl. Prelude, 2.0L Fuel Injection Engine (US Only)

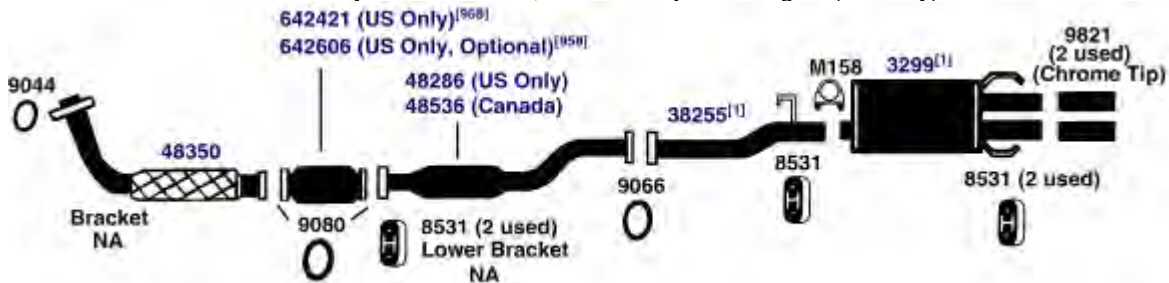

(5949) 85-87 4 Cyl. Prelude, except Fuel Injection Engine (except Canada)

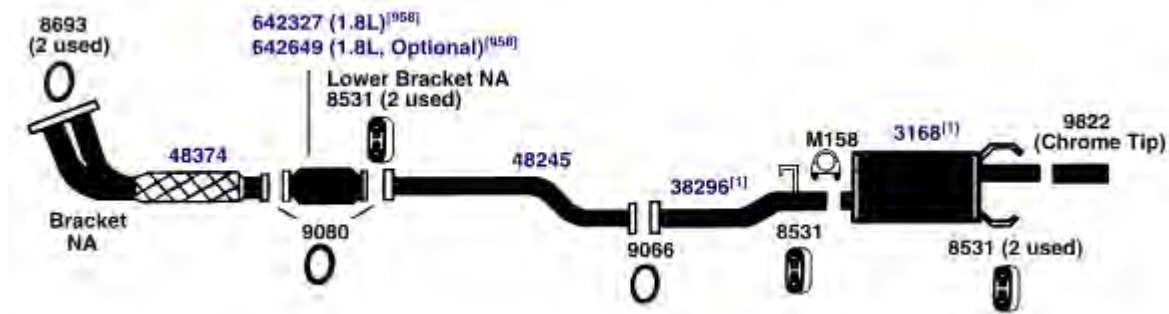

DIRECT FIT MSL/MAXIMUM Muffler... 700071, UNIVERSAL FIT MSL/MAXIMUM Muffler... 6676, 709006, Silentone DIY Muffler... 5593 and 14642 Pipe

NA-Not Available. NR-Not Required. FL-Remove and Re-Use Old Flange. ● Golden Warehouse. O.E.-Original Equipment.
Airtube Kit [4948] may be required to complete installation. EFI-Electronic Fuel Injection.

[1] OE system was a welded assembly. It is recommended that all parts noted [1] should be replaced. [958] Federal & California Emission vehicles. Not legal for sale for vehicles licensed in California.

85-87 4 Cyl. Prelude, 1.8L except Fuel Injected Engine (CANADA ONLY)

(100294)

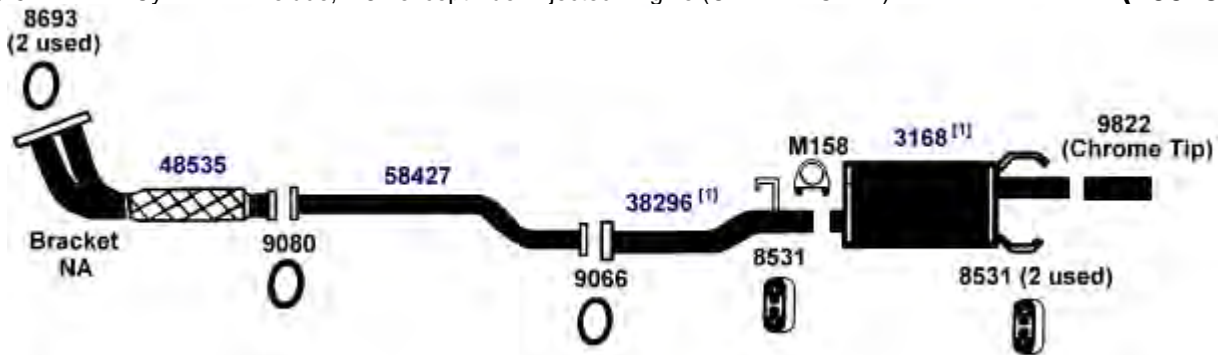

DIRECT FIT MSL/MAXIMUM Muffler... 700071, UNIVERSAL FIT MSL/MAXIMUM Muffler... 6676, 709006, Silentone DIY Muffler... 5593 and 14642 Pipe

83-84 4 Cyl. Prelude, except Fuel Injection Engine

(5949E)

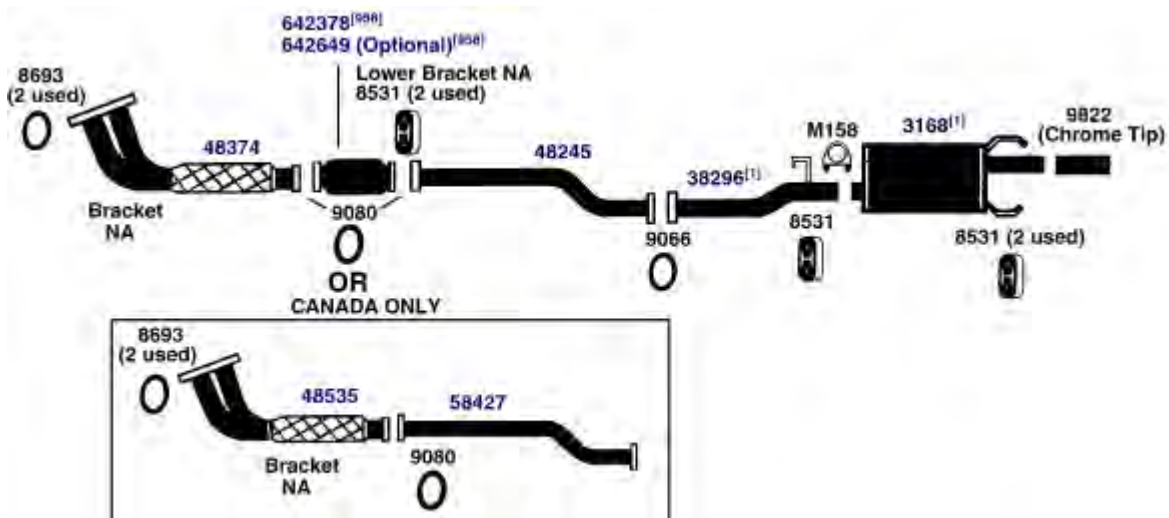

DIRECT FIT MSL/MAXIMUM Muffler... 700071, UNIVERSAL FIT MSL/MAXIMUM Muffler... 6676, 709006, Silentone DIY Muffler... 5593 and 14642 Pipe

NA-Not Available. NR-Not Required. FL-Remove and Re-Use Old Flange. ● Golden Warehouse. O.E.-Original Equipment.

Airtube Kit [4948] may be required to complete installation. EFI-Electronic Fuel Injection.

[1] OE system was a welded assembly. It is recommended that all parts noted [1] should be replaced.

[958] Federal & California Emission vehicles. Not legal for sale for vehicles licensed in California.

HYUNDAI

HYUNDAI ELANTRA

(13825) 93-94 4 Cyl. Elantra, 1.8L DOHC Engine

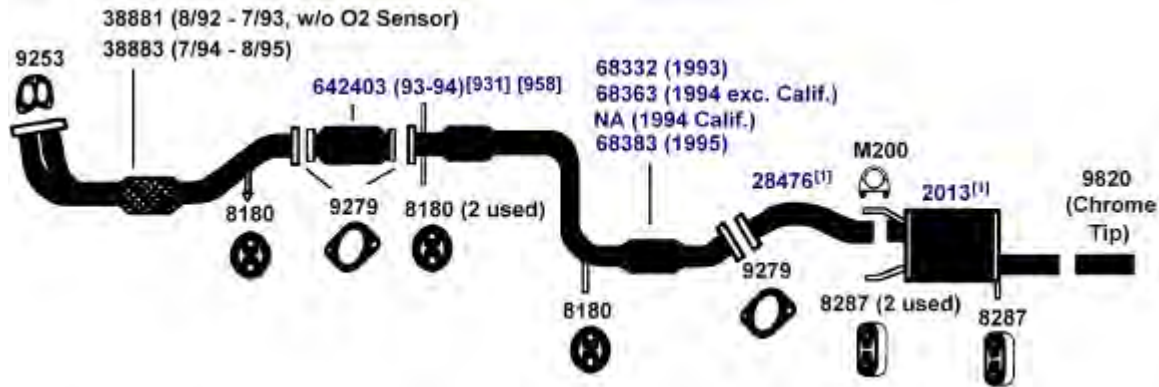

DIRECT FIT MSL/MAXIMUM Muffler... 700210

(13826) 92-94 4 Cyl. Elantra, 1.6L DOHC Engine

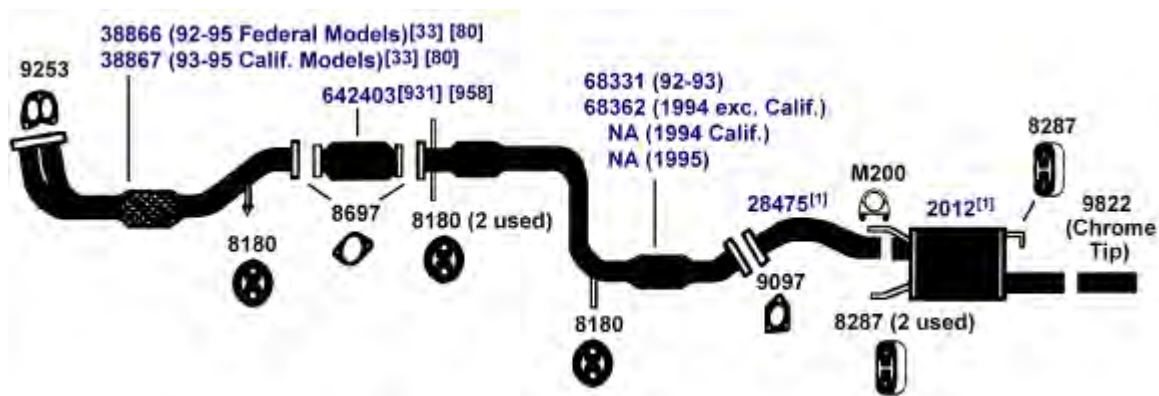

DIRECT FIT MSL/MAXIMUM Muffler... 700209

NA-Not Available. NR-Not Required. FL-Remove and Re-Use Old Flange. ● Golden Warehouse. O.E.-Original Equipment.
Airtube Kit [4948] may be required to complete installation. EFI-Electronic Fuel Injection.

[1] OE system was a welded assembly. It is recommended that all parts noted [1] should be replaced.

[33] Remove and re-use O.E. heat shield.

[80] Remove and re-use original bracket.

[931] This unit was designed to fit many applications. Measurement of the old unit and cutting of new unit is required.

[958] Federal & California Emission vehicles. Not legal for sale for vehicles licensed in California.

90-94 4 Cyl. Excel, 1.5L Engine

(11352)

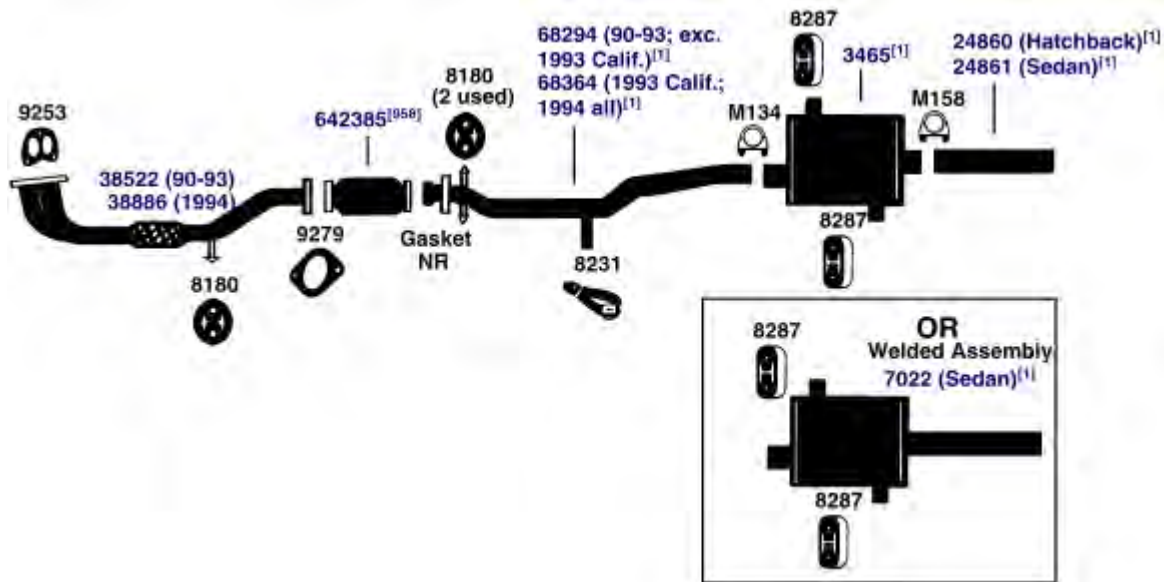

DIRECT FIT MSL/MAXIMUM Muffler... Split System- 700009

86-89 4 Cyl. Excel, 1.5L Engine

(11351)

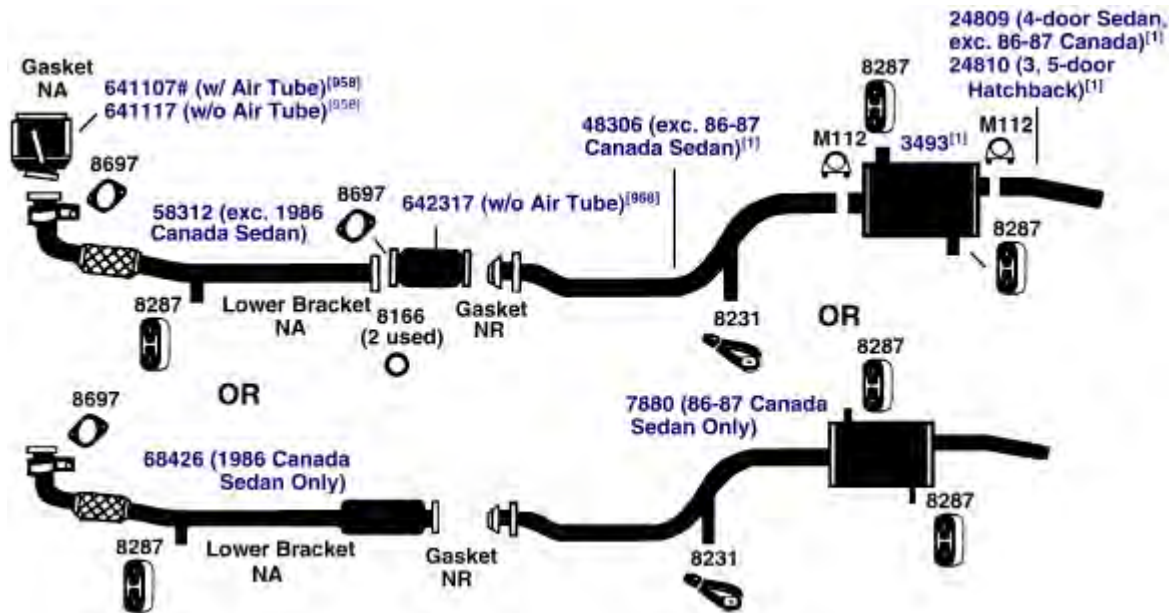

DIRECT FIT MSL/MAXIMUM Muffler... Muffler 3493- 6690, UNIVERSAL FIT MSL/MAXIMUM Muffler... Muffler 3493- 6658

NA-Not Available. NR-Not Required. FL-Remove and Re-Use Old Flange. ● Golden Warehouse. O.E.-Original Equipment.
 # Airtube Kit [4948] may be required to complete installation. EFI-Electronic Fuel Injection.

[1] OE system was a welded assembly. It is recommended that all parts noted [1] should be replaced. [958] Federal & California Emission vehicles. Not legal for sale for vehicles licensed in California.

HYUNDAI SCOUPE

(13101) 93-94 4 Cyl. Scoupe, 1.5L Engine; except Turbo

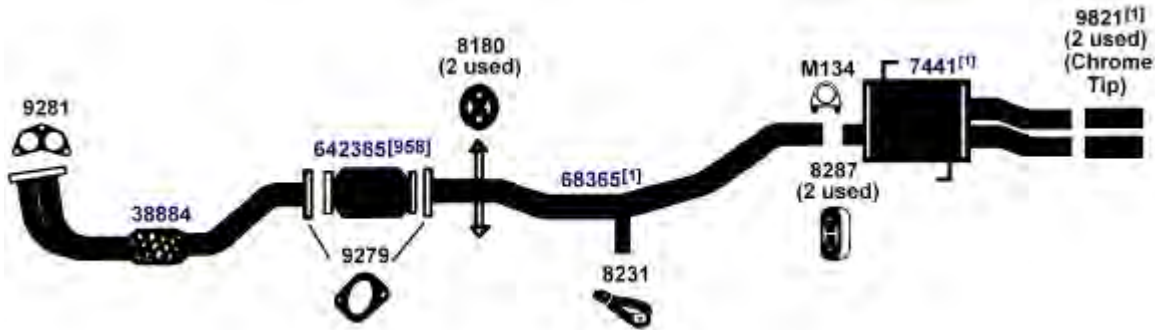

(13100) 91-92 4 Cyl. Scoupe, 1.5L Engine

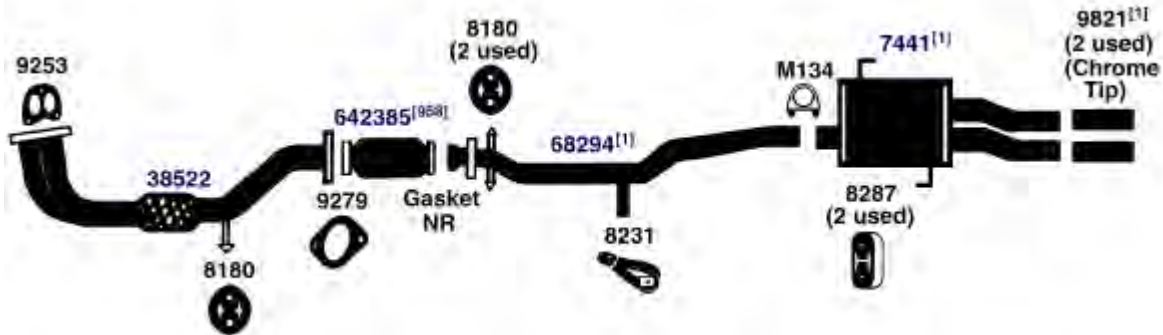

HYUNDAI SONATA

(13152) 92-94 4 Cyl. Sonata, 2.0L DOHC Engine

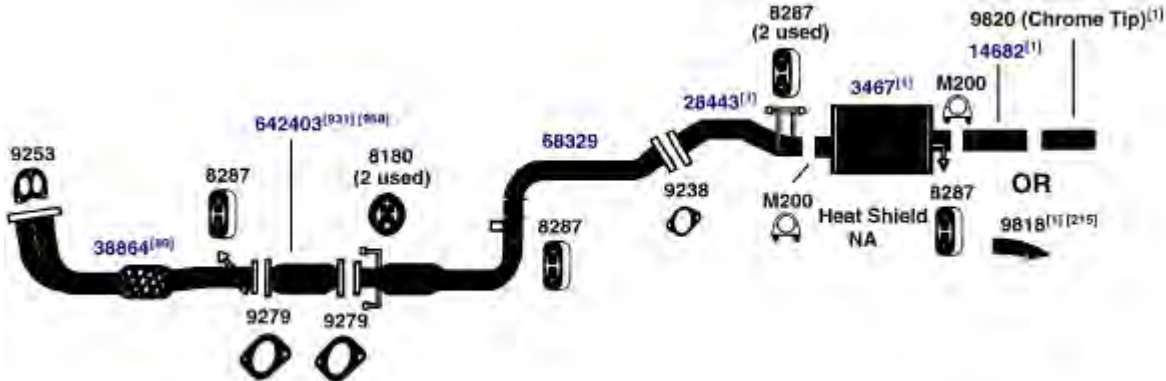

DIRECT FIT MSL/MAXIMUM Muffler... 700131, UNIVERSAL FIT MSL/MAXIMUM Muffler... 6536, 6544, 709010

NA-Not Available. NR-Not Required. FL-Remove and Re-Use Old Flange. ● Golden Warehouse. O.E.-Original Equipment.
Airtube Kit [4948] may be required to complete installation. EFI-Electronic Fuel Injection.

[1] OE system was a welded assembly. It is recommended that all parts noted [1] should be replaced.

[80] Remove and re-use original bracket.

[215] Polished stainless steel spout.

[931] This unit was designed to fit many applications. Measurement of the old unit and cutting of new unit is required.

[958] Federal & California Emission vehicles. Not legal for sale for vehicles licensed in California.

90-94 6 Cyl. Sonata, 3.0L Engine

(13151)

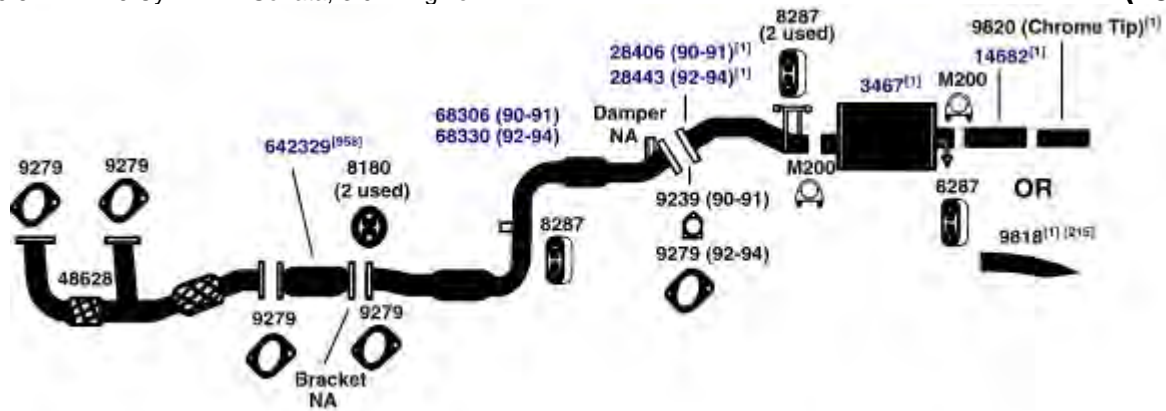

DIRECT FIT MSL/MAXIMUM Muffler... 700131, UNIVERSAL FIT MSL/MAXIMUM Muffler... 6536, 6544, 709010

89-91 4 Cyl. Sonata, 2.4L Engine

(13150)

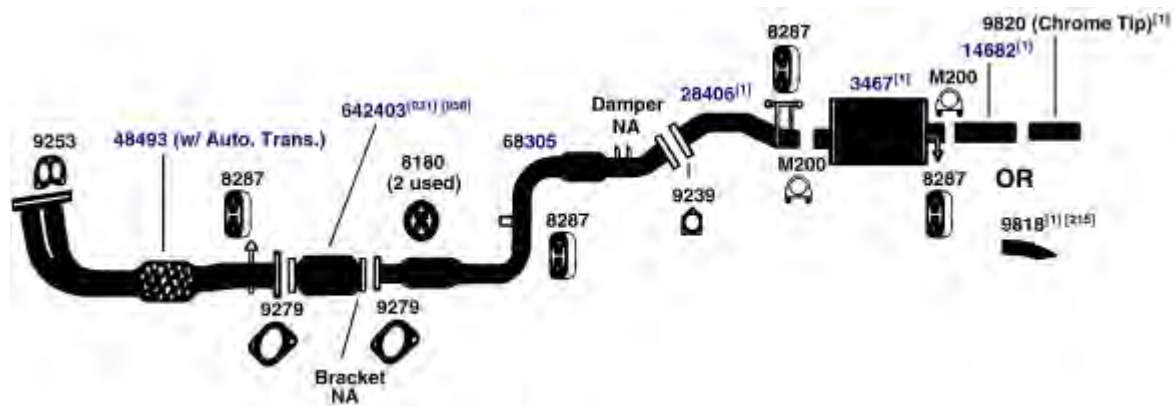

DIRECT FIT MSL/MAXIMUM Muffler... 700131, UNIVERSAL FIT MSL/MAXIMUM Muffler... 6536, 6544, 709010

NA-Not Available. NR-Not Required. FL-Remove and Re-Use Old Flange. ● Golden Warehouse. O.E.-Original Equipment.
Airtube Kit [4948] may be required to complete installation. EFI-Electronic Fuel Injection.

[1] OE system was a welded assembly. It is recommended that all parts noted [1] should be replaced.

[215] Polished stainless steel spout.

[931] This unit was designed to fit many applications. Measurement of the old unit and cutting of new unit is required.

[958] Federal & California Emission vehicles. Not legal for sale for vehicles licensed in California.

INFINITI

INFINITI G20

(14125) 91-94 4 Cyl. G20, 2.0L Engine

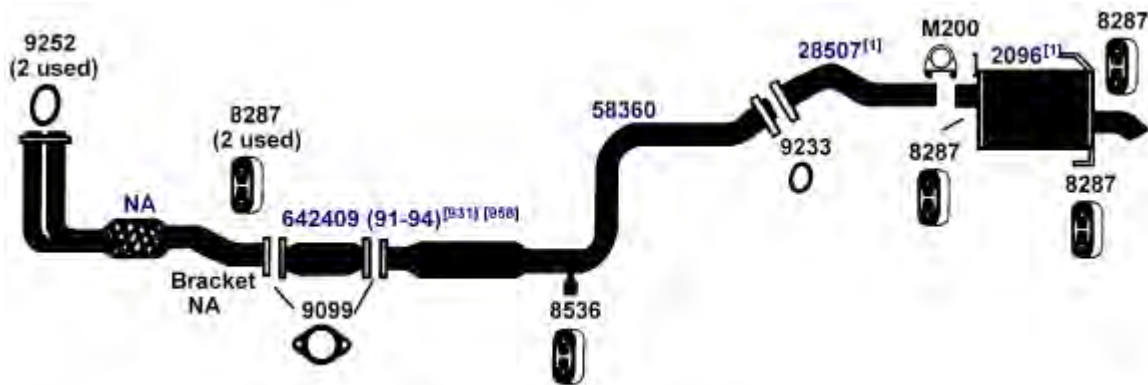

DIRECT FIT MSL/MAXIMUM Muffler... 700233

ISUZU

ISUZU AMIGO

(34500) 89-94 4 Cyl. Amigo; 2.3L Engine; 2 W.D.
89-94 4 Cyl. Amigo; 2.6L Engine; 2 W.D., 4 W.D.; Including California

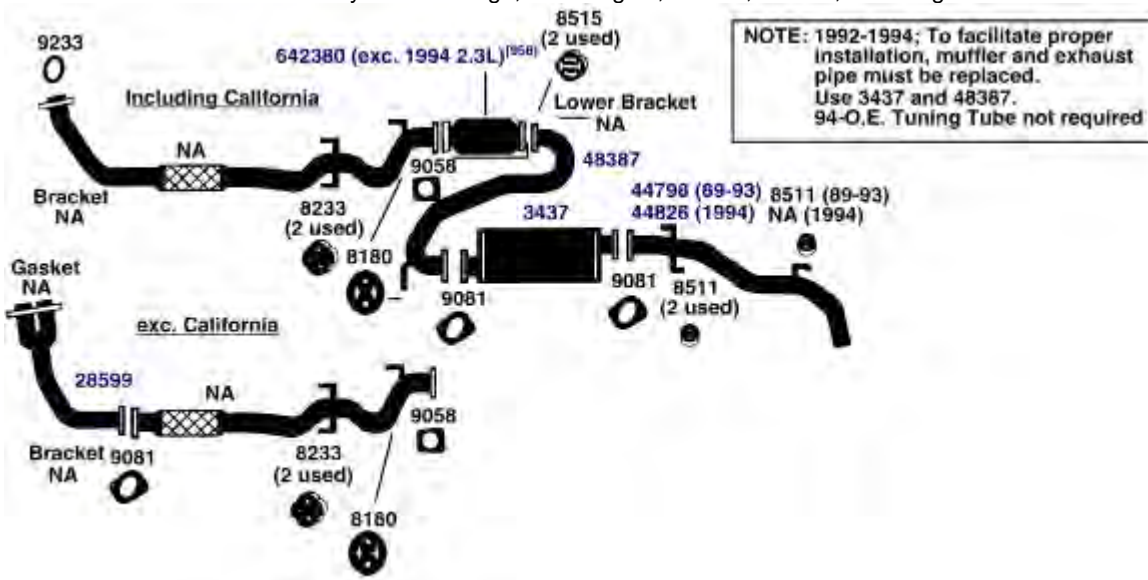

NA-Not Available. NR-Not Required. FL-Remove and Re-Use Old Flange. ● Golden Warehouse. O.E.-Original Equipment.
Airtube Kit [4948] may be required to complete installation. EFI-Electronic Fuel Injection.

[1] OE system was a welded assembly. It is recommended that all parts noted [1] should be replaced.

[958] Federal & California Emission vehicles. Not legal for sale for vehicles licensed in California.

[931] This unit was designed to fit many applications. Measurement of the old unit and cutting of new unit is required.

ISUZU AMIGO

89-91 4 Cyl. Amigo; 2.6L Engine; 2 W.D., 4 W.D.; except California

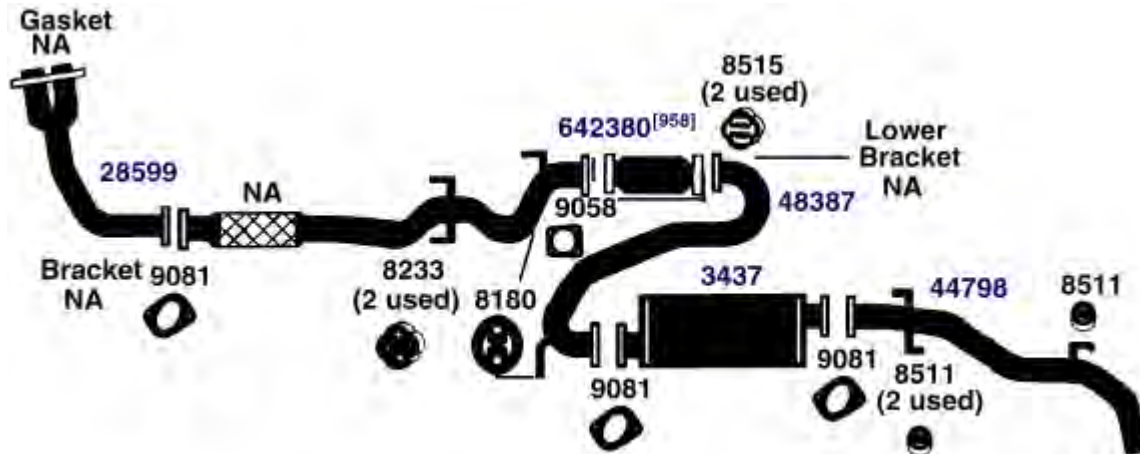
(34501)

ISUZU I-MARK

85-89 4 Cyl. I-Mark, 1.5L Engine (from Feb., 1985), except Turbo

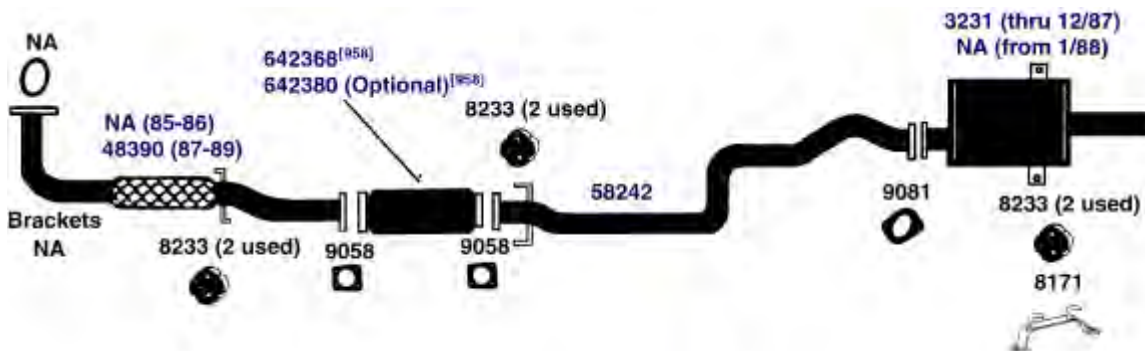
(5975)

DIRECT FIT MSL/MAXIMUM Muffler... 6683, UNIVERSAL FIT MSL/MAXIMUM Muffler... 6653

NA-Not Available. NR-Not Required. FL-Remove and Re-Use Old Flange. ● Golden Warehouse. O.E.-Original Equipment.

Airtube Kit [4948] may be required to complete installation. EFI-Electronic Fuel Injection.

[958] Federal & California Emission vehicles. Not legal for sale for vehicles licensed in California.

ISUZU IMPULSE

(5978) 90-92 4 Cyl. Impulse Hatchback; 1.6L, 1.8L Engine; except Sport Coupe and Turbo Models

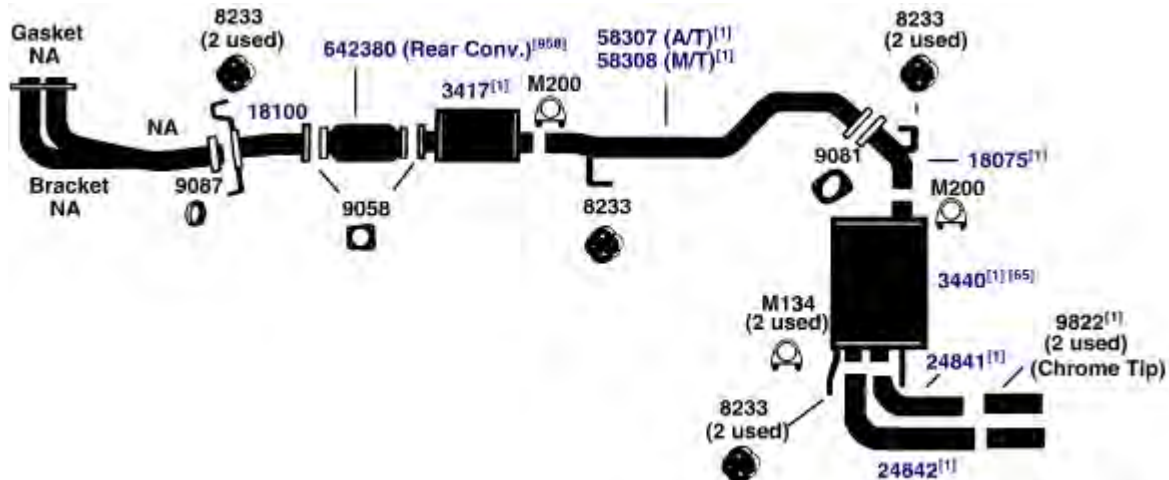

DIRECT FIT MSL/MAXIMUM Muffler... Front Muffler- 700273, Rear Muffler- 700128, UNIVERSAL FIT MSL/MAXIMUM Muffler... Rear Muffler- 709015

ISUZU PICKUP

(30028) 93-94 4 Cyl. Pickup; 2.3L Engine; California
 93-94 4 Cyl. Pickup; 2.3L Engine; 2 W.D.; California

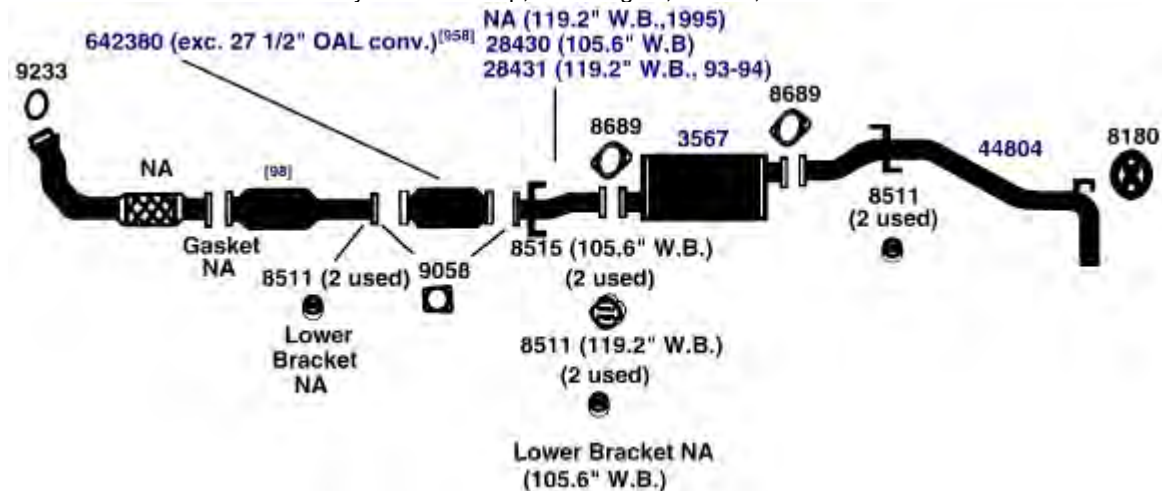

DIRECT FIT MSL/MAXIMUM Muffler... 700288, UNIVERSAL FIT MSL/MAXIMUM Muffler... 6571, 709993, 709994

NA-Not Available. NR-Not Required. FL-Remove and Re-Use Old Flange. ● Golden Warehouse. O.E.-Original Equipment.

Airtube Kit [4948] may be required to complete installation. EFI-Electronic Fuel Injection.

[1] OE system was a welded assembly. It is recommended that all parts noted [1] should be replaced. [958] Federal & California Emission vehicles. Not legal for sale for vehicles licensed in California.

[65] Heat Shield 9206 is required for installation.

93-94 4 Cyl. Pickup; 2.6L Engine; 4 W.D.; California (30026)

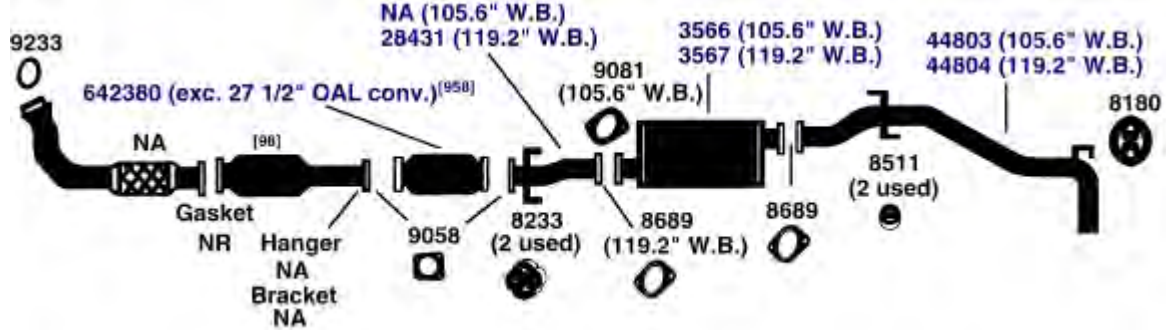

DIRECT FIT MSL/MAXIMUM Muffler... 119.2\"/>

91-94 6 Cyl. Pickup; 3.1L Engine; 4 W.D. (30020)

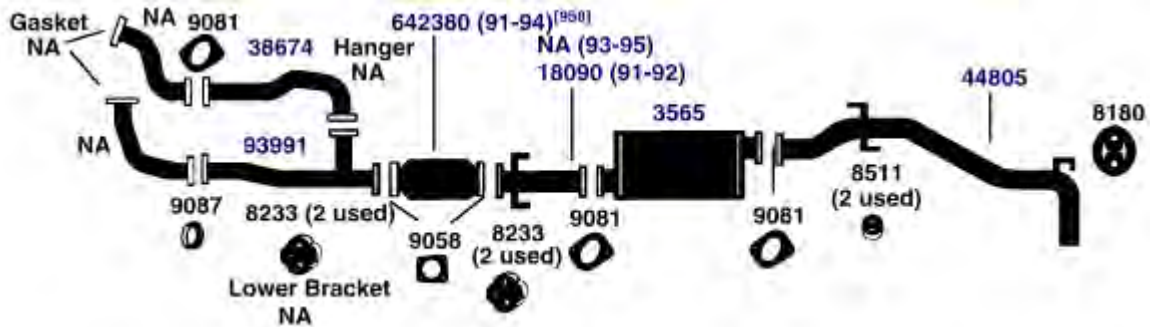

DIRECT FIT MSL/MAXIMUM Muffler... 700170, UNIVERSAL FIT MSL/MAXIMUM Muffler... 709993

91-94 4 Cyl. Pickup; 2.3L Engine; except 1993 California (30025)

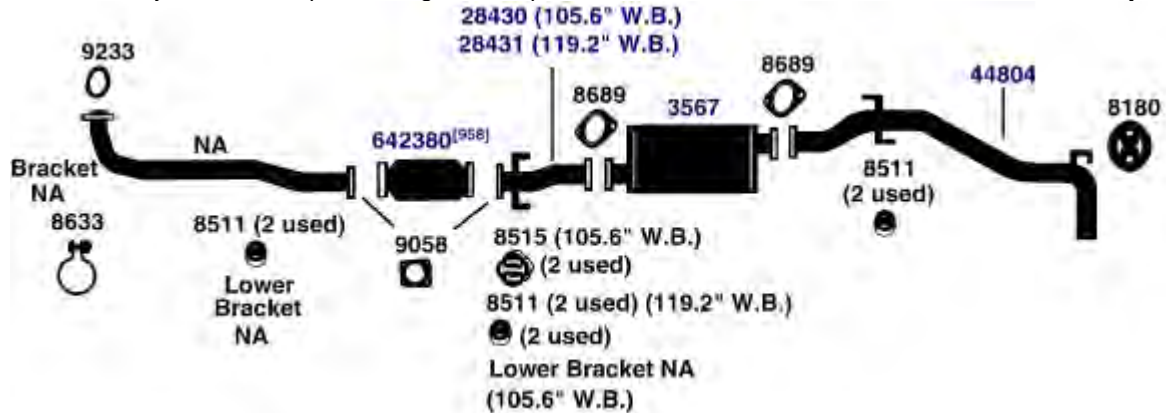

DIRECT FIT MSL/MAXIMUM Muffler... 700288, UNIVERSAL FIT MSL/MAXIMUM Muffler... 6571, 709993, 709994

NA-Not Available. NR-Not Required. FL-Remove and Re-Use Old Flange. ● Golden Warehouse. O.E.-Original Equipment.
 # Airtube Kit [4948] may be required to complete installation. EFI-Electronic Fuel Injection.

[958] Federal & California Emission vehicles. Not legal for sale for vehicles licensed in California.

ISUZU PICKUP

(30024) 91-94 4 Cyl. Pickup; 2.6L Engine; 2 W.D.; except California

642380 (exc. 27-1/2" Conv.)^[958]

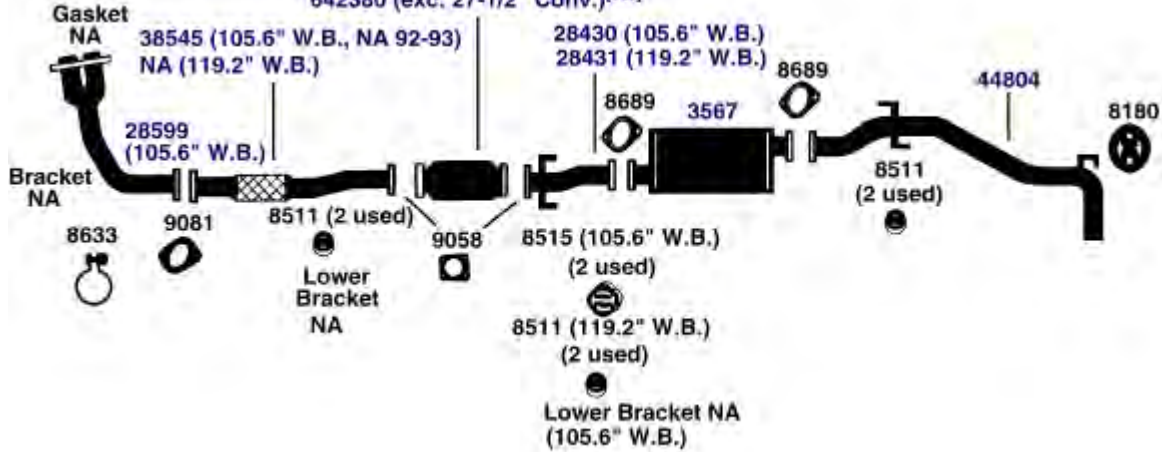

DIRECT FIT MSL/MAXIMUM Muffler... 700288, UNIVERSAL FIT MSL/MAXIMUM Muffler... 6571, 709993, 709994

(30022) 91-94 4 Cyl. Pickup; 2.6L Engine; 4 W.D.; except California

NA (105.6" W.B., 93-94)

18089 (105.6" W.B., 91-92)

28431 (119.2" W.B.)

3566 (105.6" W.B.)

3567 (119.2" W.B.)

44803 (105.6" W.B.)

44804 (119.2" W.B.)

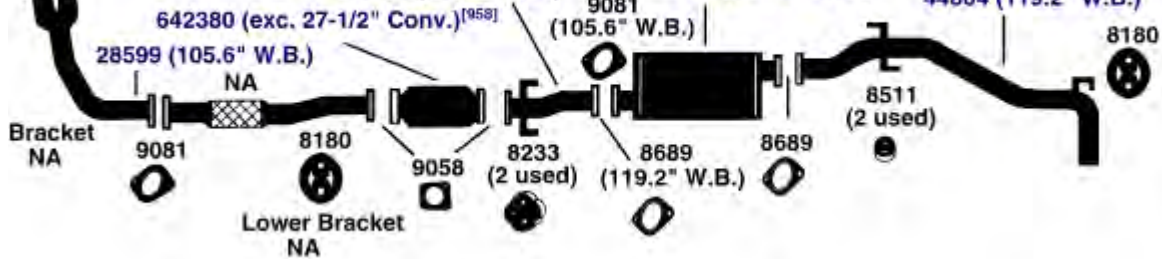

DIRECT FIT MSL/MAXIMUM Muffler... 119.2" W.B.- 700288, UNIVERSAL FIT MSL/MAXIMUM Muffler... 119.2" W.B.- 6571, 709993, 709994

NA-Not Available. NR-Not Required. FL-Remove and Re-Use Old Flange. ● Golden Warehouse. O.E.-Original Equipment.

Airtube Kit [4948] may be required to complete installation. EFI-Electronic Fuel Injection.

^[958] Federal & California Emission vehicles. Not legal for sale for vehicles licensed in California.

91-92 4 Cyl. Pickup; 2.6L Engine; 2 W.D.; California

(30023)

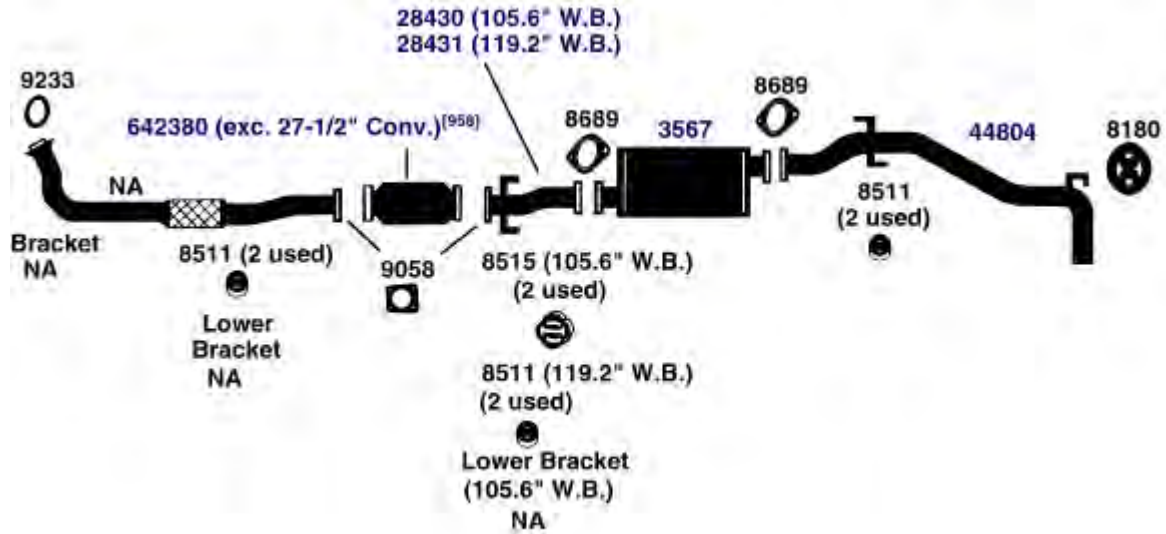

DIRECT FIT MSL/MAXIMUM Muffler... 700288, UNIVERSAL FIT MSL/MAXIMUM Muffler... 6571, 709993, 709994

91-92 4 Cyl. Pickup; 2.6L Engine; 4 W.D.; California

(30021)

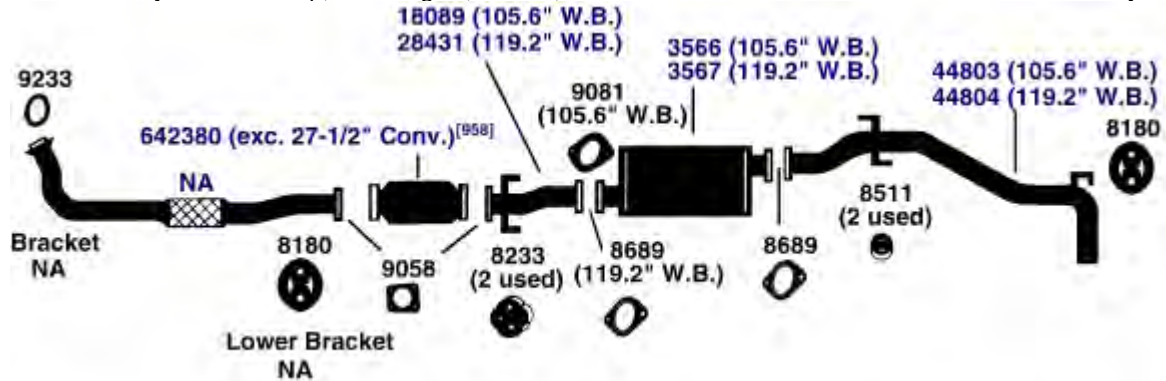

DIRECT FIT MSL/MAXIMUM Muffler... 119.2" W.B.- 700288, UNIVERSAL FIT MSL/MAXIMUM Muffler... 119.2" W.B.- 6571, 709993, 709994

NA-Not Available. NR-Not Required. FL-Remove and Re-Use Old Flange. ● Golden Warehouse. O.E.-Original Equipment.
Airtube Kit [4948] may be required to complete installation. EFI-Electronic Fuel Injection.

[958] Federal & California Emission vehicles. Not legal for sale for vehicles licensed in California.

ISUZU PICKUP

(30019) 89-90 4 Cyl. Pickup; 2.6L Engine; 4 W.D.; California

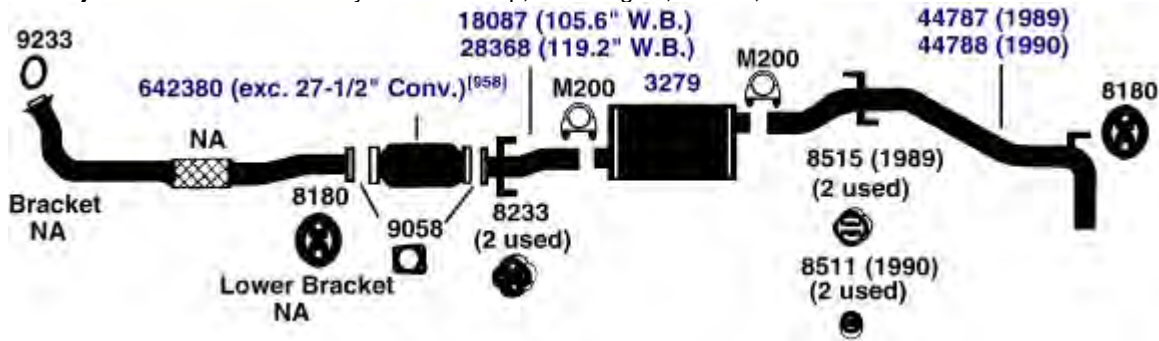

DIRECT FIT MSL/MAXIMUM Muffler... 6530, UNIVERSAL FIT MSL/MAXIMUM Muffler... 709993, 709994, Silentone DIY Muffler... 5524

(30018) 89-90 4 Cyl. Pickup; 2.6L Engine; 2 W.D.; California
88-90 4 Cyl. Pickup; 2.3L Engine

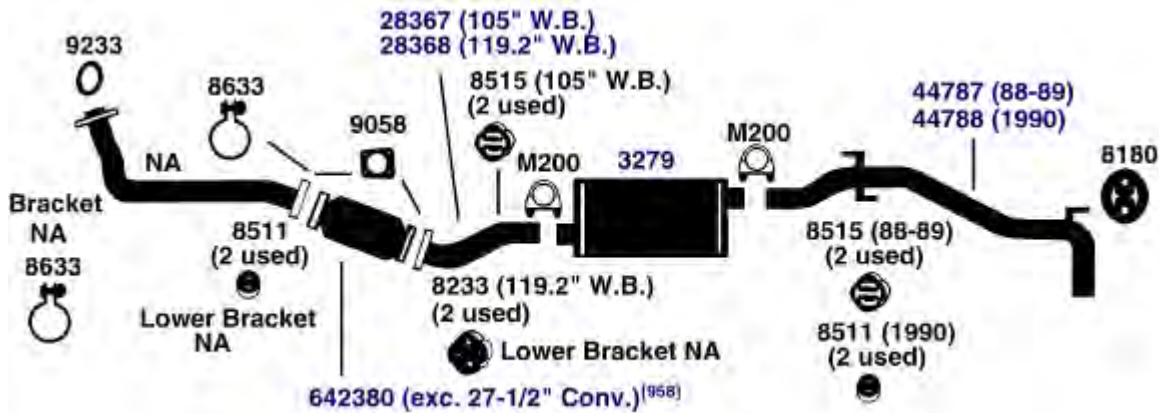

DIRECT FIT MSL/MAXIMUM Muffler... 6530, UNIVERSAL FIT MSL/MAXIMUM Muffler... 709993, 709994, Silentone DIY Muffler... 5524

(30017) 88-90 4 Cyl. Pickup; 2.6L Engine; 2 W.D.; except 89-90 California

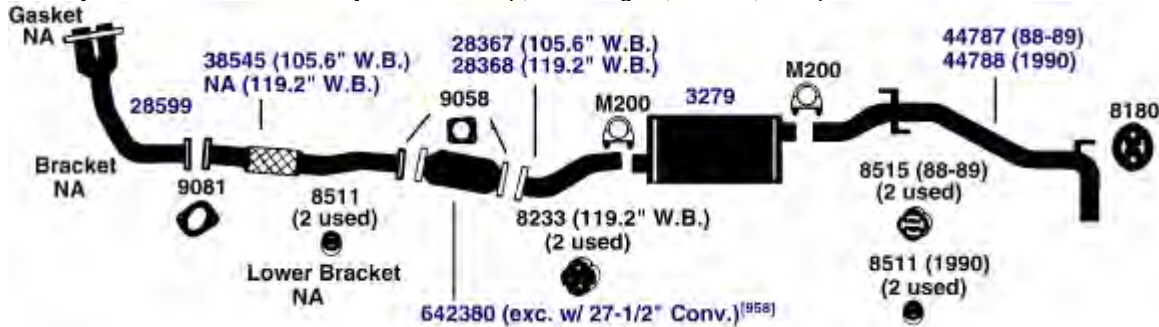

DIRECT FIT MSL/MAXIMUM Muffler... 6530, UNIVERSAL FIT MSL/MAXIMUM Muffler... 709993, 709994, Silentone DIY Muffler... 5524

NA-Not Available. NR-Not Required. FL-Remove and Re-Use Old Flange. ● Golden Warehouse. O.E.-Original Equipment.
Airtube Kit [4948] may be required to complete installation. EFI-Electronic Fuel Injection.

[958] Federal & California Emission vehicles. Not legal for sale for vehicles licensed in California.

88-90 4 Cyl. Pickup; 2.6L Engine; 4 W.D.; except 89-90 California (30016)

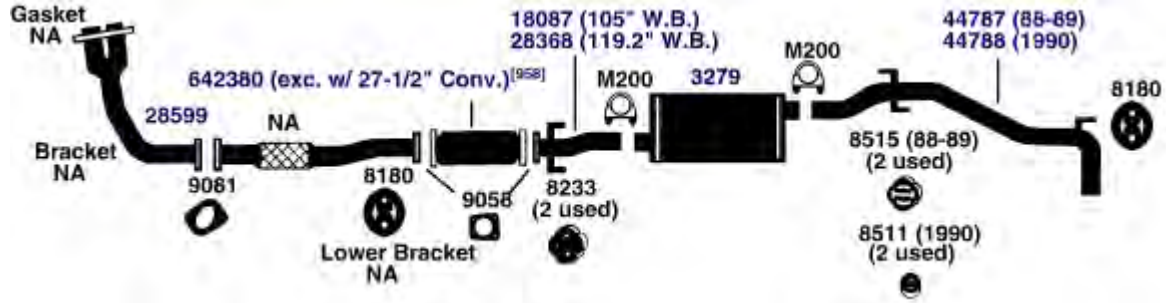

DIRECT FIT MSL/MAXIMUM Muffler... 6530, UNIVERSAL FIT MSL/MAXIMUM Muffler... 709993, 709994, Silentone DIY Muffler... 5524

86-87 4 Cyl. Pickup; 2.2L Diesel Engine; with Extended Cargo Box; without Turbo (30007)



DIRECT FIT MSL/MAXIMUM Muffler... 6672, UNIVERSAL FIT MSL/MAXIMUM Muffler... 709994, Silentone DIY Muffler... 5580

86-87 4 Cyl. Pickup; 2.2L Diesel Engine; with Extended Cargo Box; with Turbo; 2 W.D., 4 W.D. (30008)

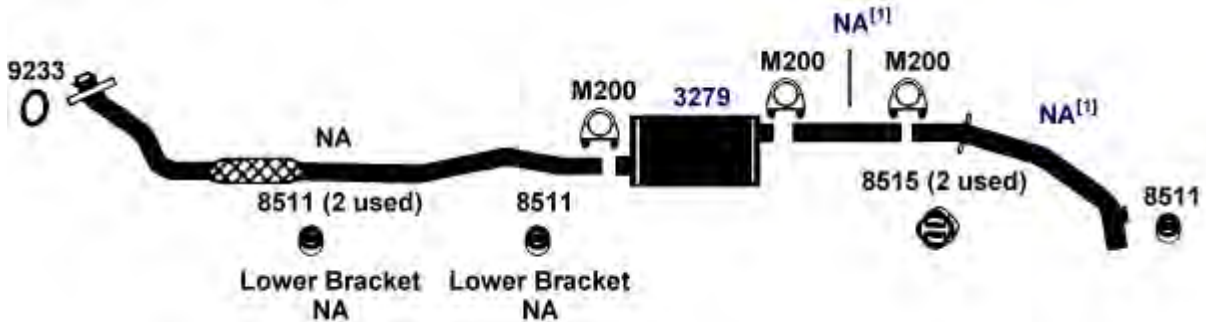

DIRECT FIT MSL/MAXIMUM Muffler... 6530, UNIVERSAL FIT MSL/MAXIMUM Muffler... 709993, 709994, Silentone DIY Muffler... 5524

NA-Not Available. NR-Not Required. FL-Remove and Re-Use Old Flange. ● Golden Warehouse. O.E.-Original Equipment.
 # Airtube Kit [4948] may be required to complete installation. EFI-Electronic Fuel Injection.

[1] OE system was a welded assembly. It is recommended that all parts noted [1] should be replaced. [958] Federal & California Emission vehicles. Not legal for sale for vehicles licensed in California.

ISUZU PICKUP

(30009) 86-87 4 Cyl. Pickup; 2.2L Diesel Engine; with Std. Cargo Box; without Turbo

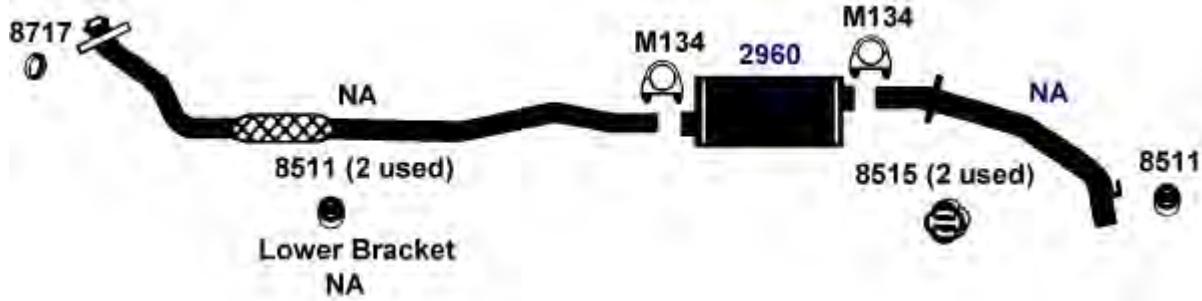

DIRECT FIT MSL/MAXIMUM Muffler... 6672, UNIVERSAL FIT MSL/MAXIMUM Muffler... 709994, Silentone DIY Muffler... 5580

(30010) 86-87 4 Cyl. Pickup; 2.2L Diesel Engine; with Std. Cargo Box; with Turbo; 2 W.D., 4 W.D.

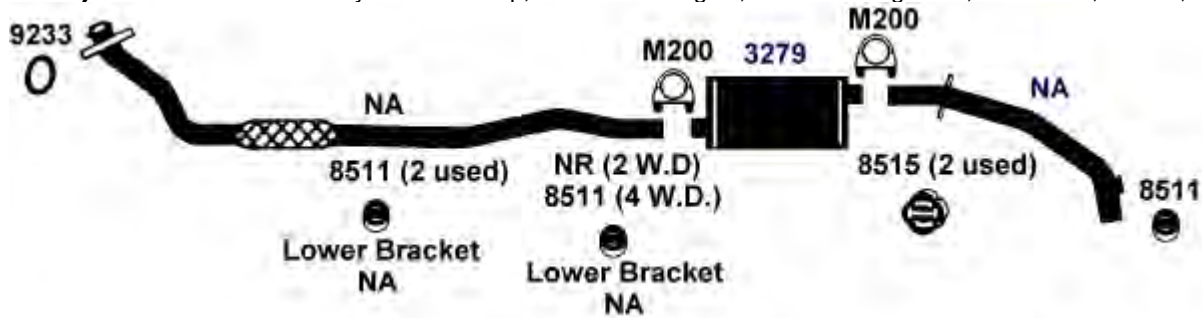

DIRECT FIT MSL/MAXIMUM Muffler... 6530, UNIVERSAL FIT MSL/MAXIMUM Muffler... 709993, 709994, Silentone DIY Muffler... 5524

(30011) 86-87 4 Cyl. Pickup; 2.3L Engine; Regular Cab with Std. Cargo Box; 4 W.D.

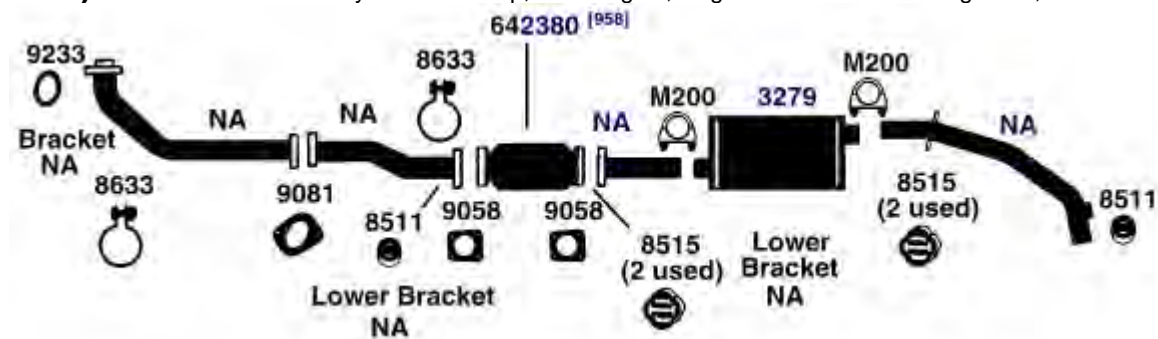

DIRECT FIT MSL/MAXIMUM Muffler... 6530, UNIVERSAL FIT MSL/MAXIMUM Muffler... 709993, 709994, Silentone DIY Muffler... 5524

NA-Not Available. NR-Not Required. FL-Remove and Re-Use Old Flange. ● Golden Warehouse. O.E.-Original Equipment.
Airtube Kit [4948] may be required to complete installation. EFI-Electronic Fuel Injection.

[958] Federal & California Emission vehicles. Not legal for sale for vehicles licensed in California.

86-87 4 Cyl. Pickup; 2.3L Engine; with Std. Cargo Box; 2 W.D.

(30012)

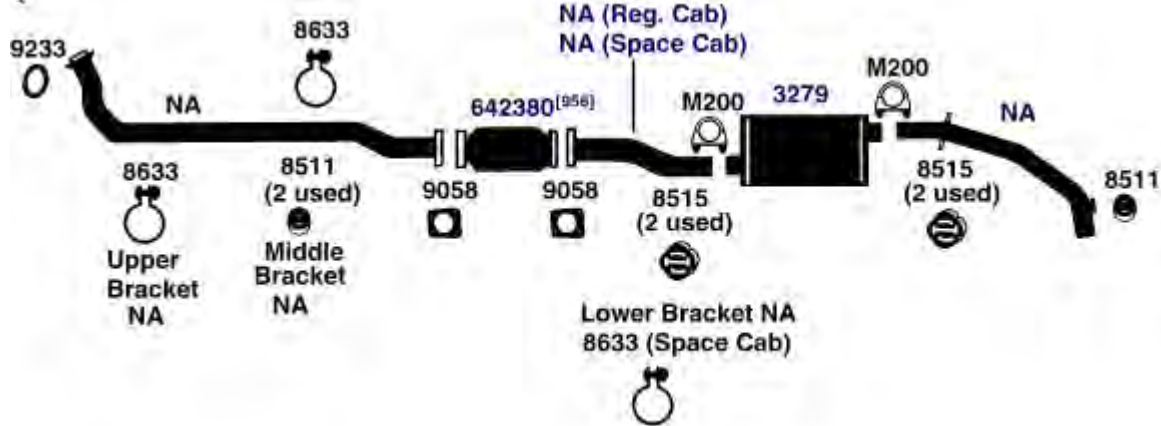

DIRECT FIT MSL/MAXIMUM Muffler... 6530, UNIVERSAL FIT MSL/MAXIMUM Muffler... 709993, 709994, Silentone DIY Muffler... 5524

86-87 4 Cyl. Pickup; 2.3L Engine; Space Cab with Std. Cargo Box; 4 W.D.

(30013)

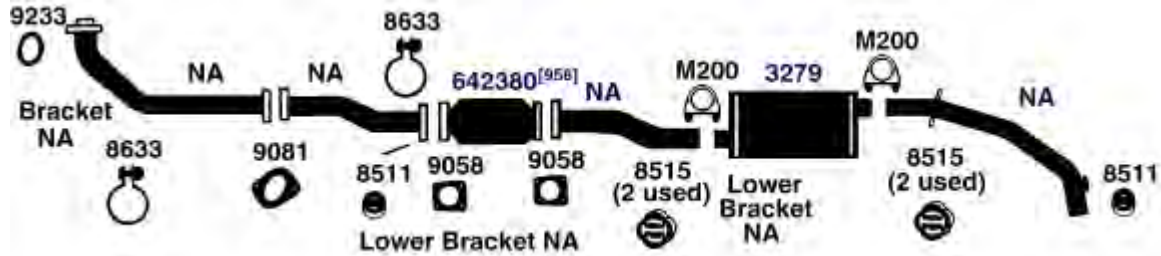

DIRECT FIT MSL/MAXIMUM Muffler... 6530, UNIVERSAL FIT MSL/MAXIMUM Muffler... 709993, 709994, Silentone DIY Muffler... 5524

86-87 4 Cyl. Pickup; 2.3L Engine; Regular Cab with Extended Cargo Box; 4 W.D.

(30014)

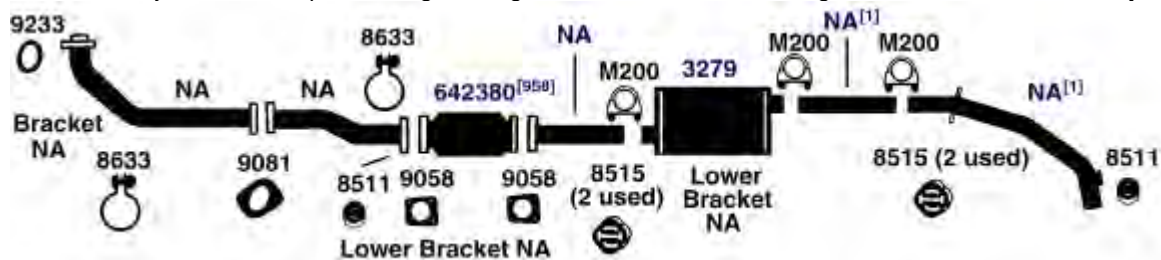

DIRECT FIT MSL/MAXIMUM Muffler... 6530, UNIVERSAL FIT MSL/MAXIMUM Muffler... 709993, 709994, Silentone DIY Muffler... 5524

NA-Not Available. NR-Not Required. FL-Remove and Re-Use Old Flange. ● Golden Warehouse. O.E.-Original Equipment.
Airtube Kit [4948] may be required to complete installation. EFI-Electronic Fuel Injection.

[1] OE system was a welded assembly. It is recommended that all parts noted [1] should be replaced. [958] Federal & California Emission vehicles. Not legal for sale for vehicles licensed in California.

ISUZU PICKUP

(30015) 86-87 4 Cyl. Pickup; 2.3L Engine; Regular Cab with Extended Cargo Box; 2 W.D.

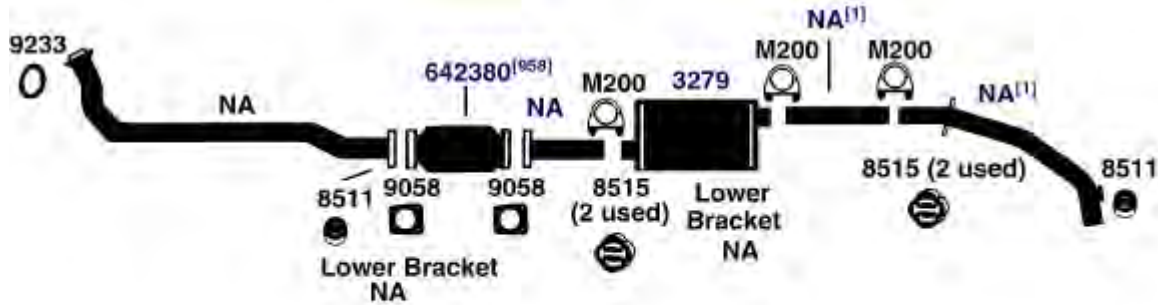

DIRECT FIT MSL/MAXIMUM Muffler... 6530, UNIVERSAL FIT MSL/MAXIMUM Muffler... 709993, 709994, Silentone DIY Muffler... 5524

(30006) 85-87 4 Cyl. Pickup; with Std. Cargo Box; 1.8L, 1.9L Engine; with Converter; 2 W.D.

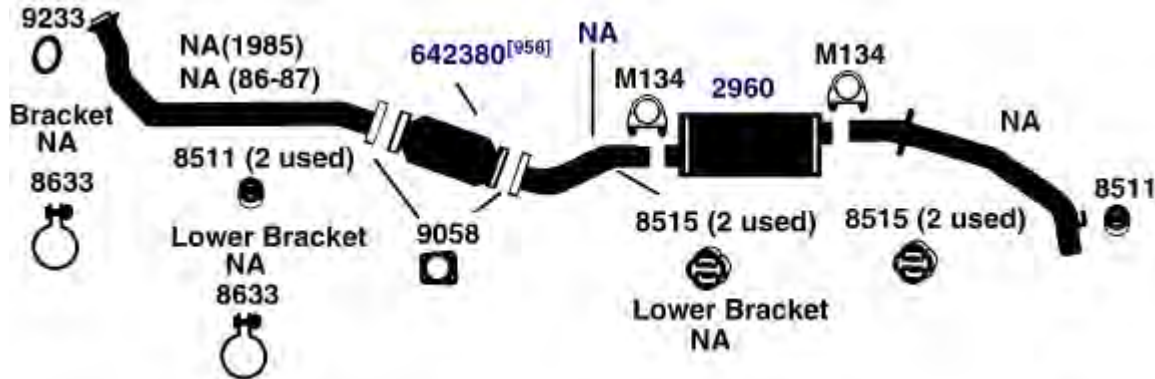

DIRECT FIT MSL/MAXIMUM Muffler... 6672, UNIVERSAL FIT MSL/MAXIMUM Muffler... 709994, Silentone DIY Muffler... 5580

(30005) 1985 4 Cyl. Pickup; with Extended Cargo Box; with Converter; 2 W.D., 4 W.D.

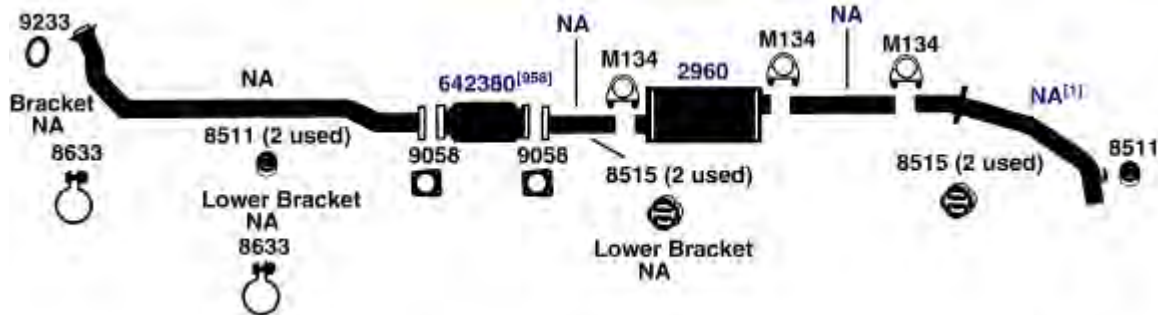

DIRECT FIT MSL/MAXIMUM Muffler... 6672, UNIVERSAL FIT MSL/MAXIMUM Muffler... 709994, Silentone DIY Muffler... 5580

NA-Not Available. NR-Not Required. FL-Remove and Re-Use Old Flange. ● Golden Warehouse. O.E.-Original Equipment.
Airtube Kit [4948] may be required to complete installation. EFI-Electronic Fuel Injection.

[1] OE system was a welded assembly. It is recommended that all parts noted [1] should be replaced. [958] Federal & California Emission vehicles. Not legal for sale for vehicles licensed in California.

1985 4 Cyl. Pickup; with Std. Cargo Box; with Converter; 4 W.D.

(30004)

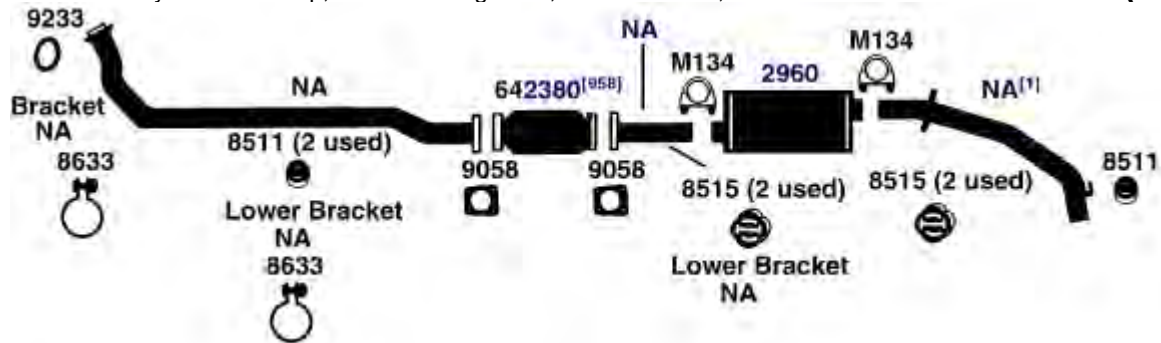

DIRECT FIT MSL/MAXIMUM Muffler... 6672, UNIVERSAL FIT MSL/MAXIMUM Muffler... 709994, Silentone DIY Muffler... 5580

1985 4 Cyl. Pickup; 2 W.D., with Std. Cargo Box; 4 W.D.; Diesel Engine

(30003)

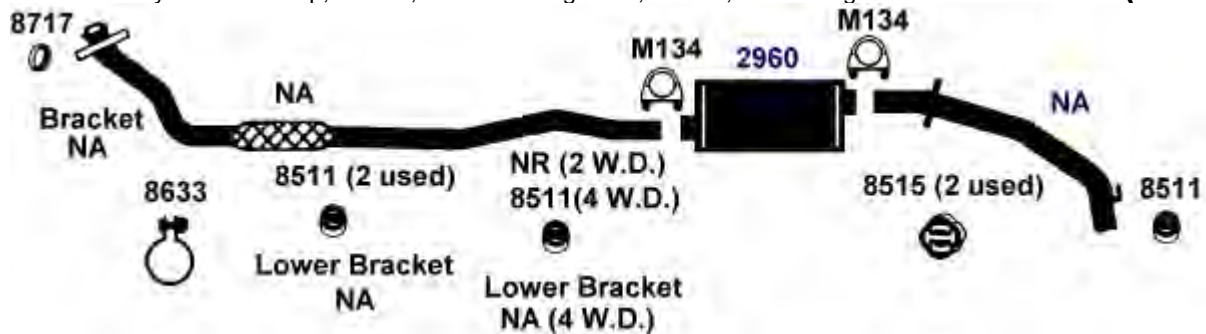

DIRECT FIT MSL/MAXIMUM Muffler... 6672, UNIVERSAL FIT MSL/MAXIMUM Muffler... 709994, Silentone DIY Muffler... 5580

1985 4 Cyl. Pickup; with Extended Cargo Box; Diesel Engine

(30002)

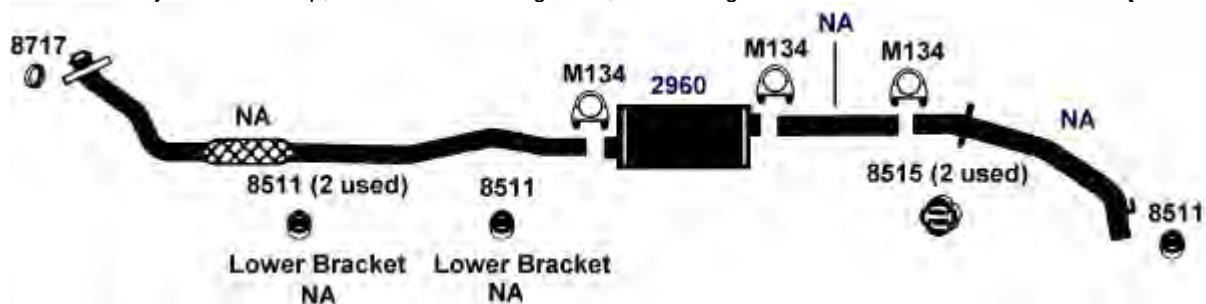

DIRECT FIT MSL/MAXIMUM Muffler... 6672, UNIVERSAL FIT MSL/MAXIMUM Muffler... 709994, Silentone DIY Muffler... 5580

NA-Not Available. NR-Not Required. FL-Remove and Re-Use Old Flange. ● Golden Warehouse. O.E.-Original Equipment.
Airtube Kit [4948] may be required to complete installation. EFI-Electronic Fuel Injection.

[1] OE system was a welded assembly. It is recommended that all parts noted [1] should be replaced. [958] Federal & California Emission vehicles. Not legal for sale for vehicles licensed in California.

ISUZU PICKUP

(30005E) 81-84 4 Cyl. Pickup; with Extended Cargo Box; with Converter; 2 W.D., 4 W.D.

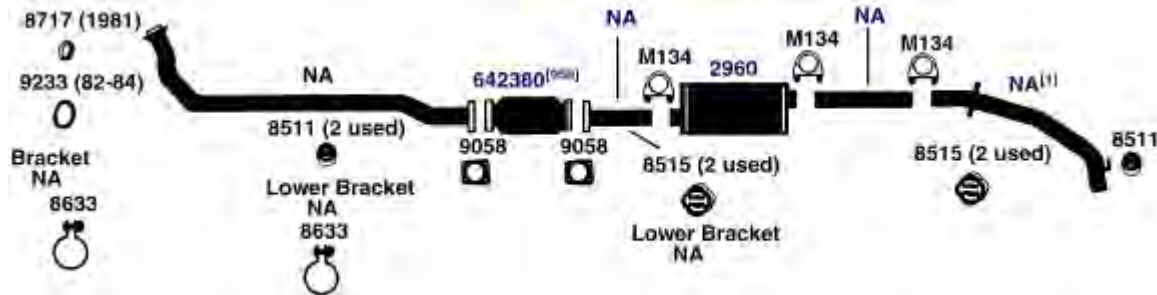

DIRECT FIT MSL/MAXIMUM Muffler... 6672, UNIVERSAL FIT MSL/MAXIMUM Muffler... 709994, Silentone DIY Muffler... 5580

(30006E) 81-84 4 Cyl. Pickup; with Std. Cargo Box; 1.8L, 1.9L Engine; with Converter; 2 W.D.

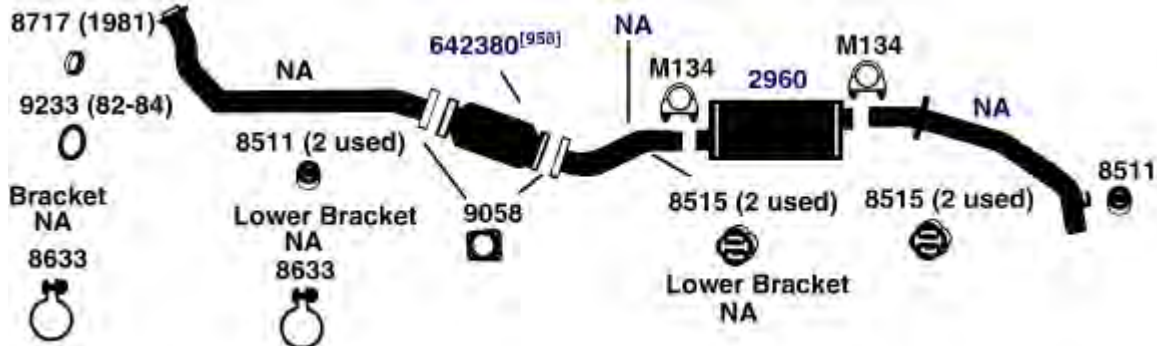

DIRECT FIT MSL/MAXIMUM Muffler... 6672, UNIVERSAL FIT MSL/MAXIMUM Muffler... 709994, Silentone DIY Muffler... 5580

(30002E) 81-84 4 Cyl. Pickup; with Extended Cargo Box; Diesel Engine

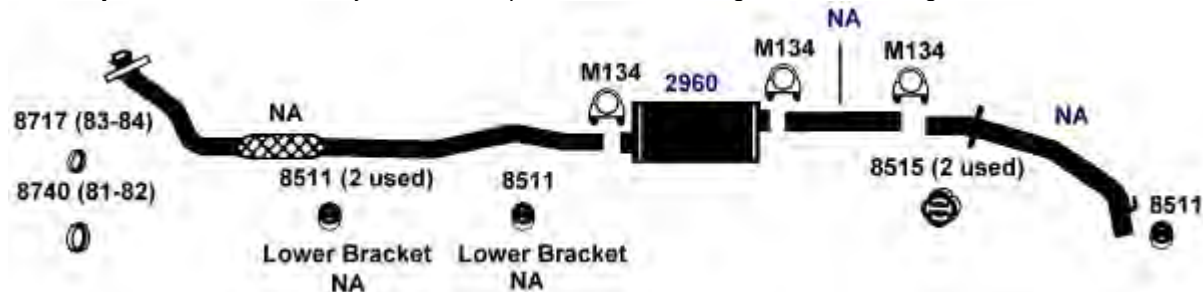

DIRECT FIT MSL/MAXIMUM Muffler... 6672, UNIVERSAL FIT MSL/MAXIMUM Muffler... 709994, Silentone DIY Muffler... 5580

NA-Not Available. NR-Not Required. FL-Remove and Re-Use Old Flange. ● Golden Warehouse. O.E.-Original Equipment.

Airtube Kit [4948] may be required to complete installation. EFI-Electronic Fuel Injection.

[1] OE system was a welded assembly. It is recommended that all parts noted [1] should be replaced.

[958] Federal & California Emission vehicles. Not legal for sale for vehicles licensed in California.

81-84 4 Cyl. Pickup; 2 W.D., with Std. Cargo Box; 4 W.D.; Diesel Engine

(30003E)

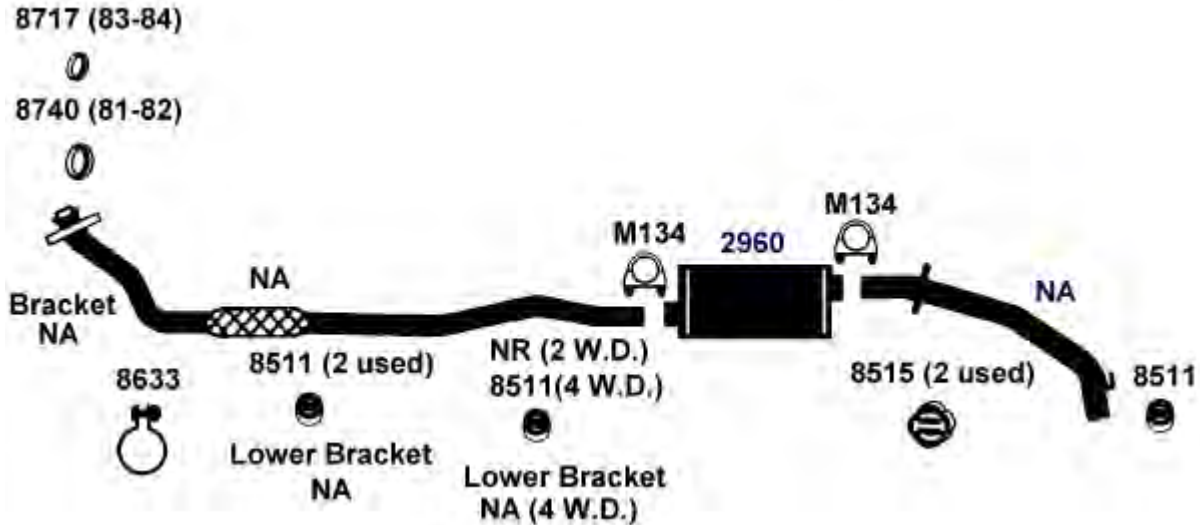

DIRECT FIT MSL/MAXIMUM Muffler... 6672, UNIVERSAL FIT MSL/MAXIMUM Muffler... 709994, Silentone DIY Muffler... 5580

81-84 4 Cyl. Pickup; with Std. Cargo Box; with Converter; 4 W.D.

(30004E)

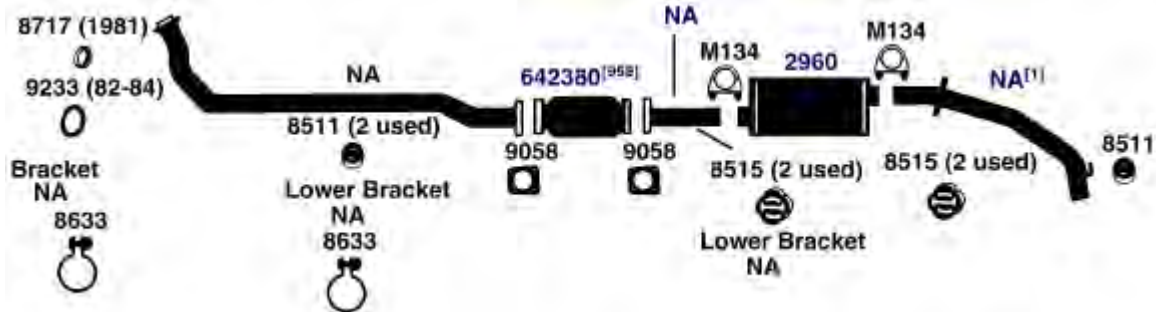

DIRECT FIT MSL/MAXIMUM Muffler... 6672, UNIVERSAL FIT MSL/MAXIMUM Muffler... 709994, Silentone DIY Muffler... 5580

1981 4 Cyl. Pickup, with Extended Cargo Box; without Converter, except Diesel

(30000)

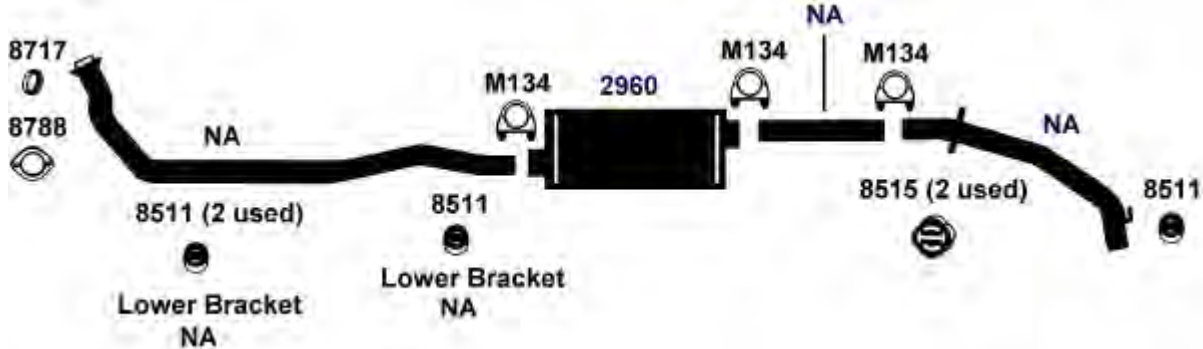

DIRECT FIT MSL/MAXIMUM Muffler... 6672, UNIVERSAL FIT MSL/MAXIMUM Muffler... 709994, Silentone DIY Muffler... 5580

NA-Not Available. NR-Not Required. FL-Remove and Re-Use Old Flange. ● Golden Warehouse. O.E.-Original Equipment.
Airtube Kit [4948] may be required to complete installation. EFI-Electronic Fuel Injection.

[1] OE system was a welded assembly. It is recommended that all parts noted [1] should be replaced. [958] Federal & California Emission vehicles. Not legal for sale for vehicles licensed in California.

ISUZU PICKUP

(30001) 1981 4 Cyl. Pickup; 2 W.D. with Std. Cargo Box; 4 W.D.; without Converter, except Diesel

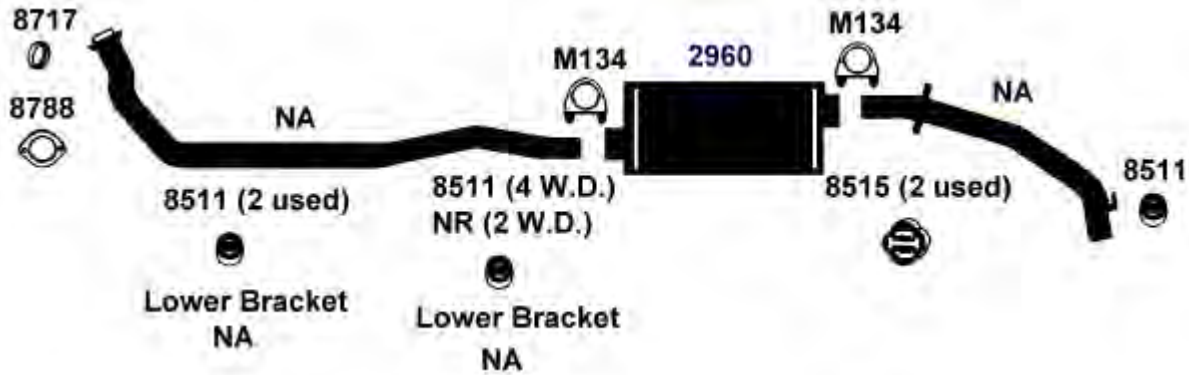

DIRECT FIT MSL/MAXIMUM Muffler... 6672, UNIVERSAL FIT MSL/MAXIMUM Muffler... 709994, Silentone DIY Muffler... 5580

ISUZU RODEO

(34802) 1993 4 Cyl. Rodeo; 2.6L Engine; California
1994 4 Cyl. Rodeo; 2.6L Engine

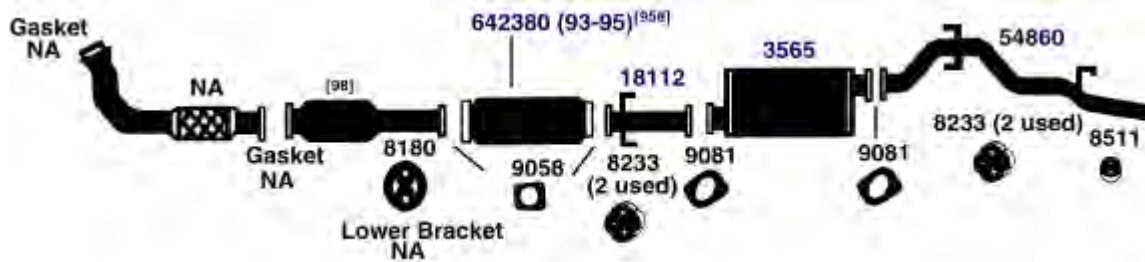

DIRECT FIT MSL/MAXIMUM Muffler... 700170, UNIVERSAL FIT MSL/MAXIMUM Muffler... 709993

(34804) 1994 6 Cyl. Rodeo, 3.2L

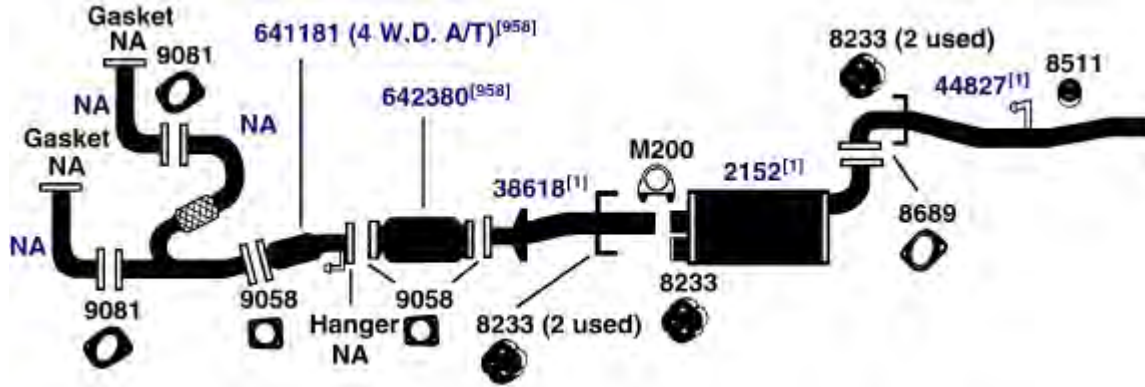

DIRECT FIT MSL/MAXIMUM Muffler... 700248

NA-Not Available. NR-Not Required. FL-Remove and Re-Use Old Flange. ● Golden Warehouse. O.E.-Original Equipment.

Airtube Kit [4948] may be required to complete installation. EFI-Electronic Fuel Injection.

[1] OE system was a welded assembly. It is recommended that all parts noted [1] should be replaced.

[98] Refer to current Catalytic Converter catalog or Website catalog for availability.

[95E] Federal & California Emission vehicles. Not legal for sale for vehicles licensed in California.

91-93 4 Cyl. Rodeo; 2.6L Engine; except 1993 California

(34801)

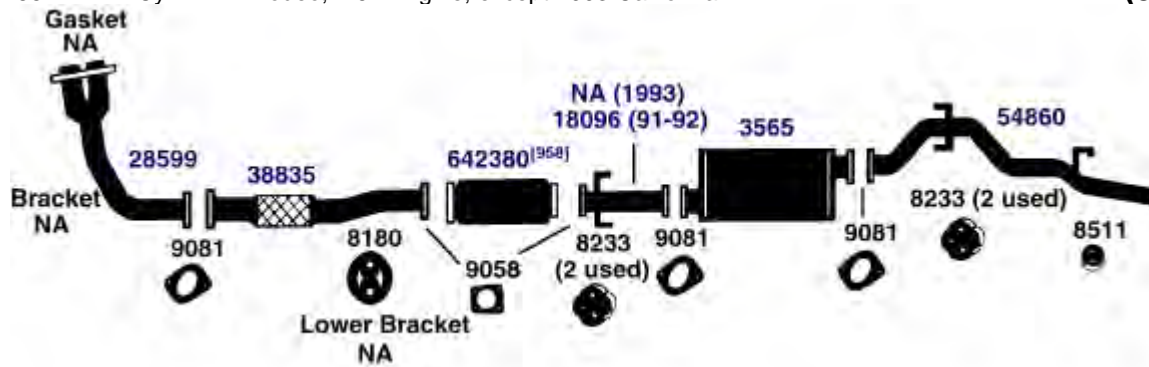

DIRECT FIT MSL/MAXIMUM Muffler... 700170, UNIVERSAL FIT MSL/MAXIMUM Muffler... 709993

1993 6 Cyl. Rodeo, 3.2L Engine; except California

(34803)

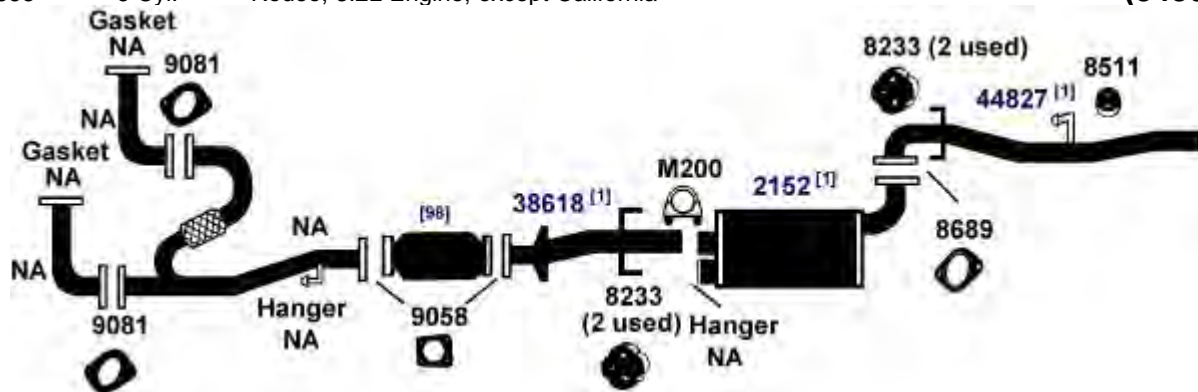

DIRECT FIT MSL/MAXIMUM Muffler... 700248

91-92 6 Cyl. Rodeo; 3.1L Engine

(34800)

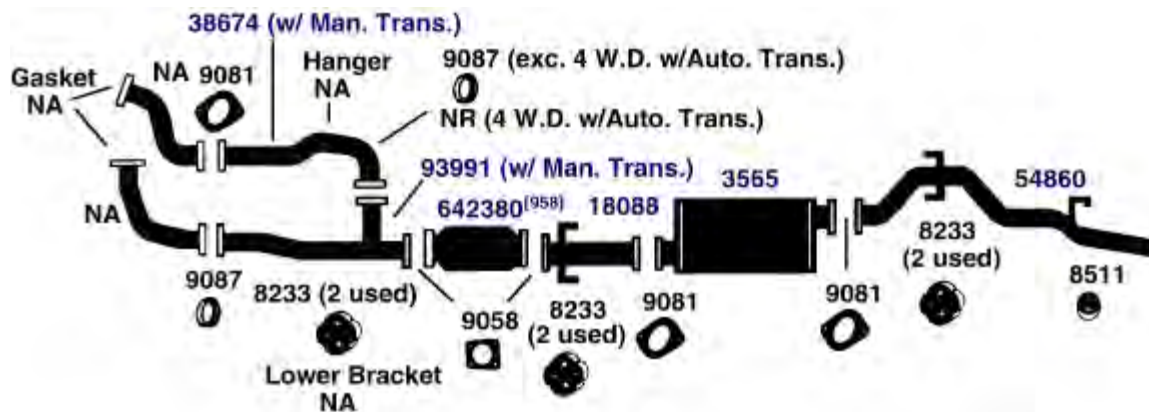

DIRECT FIT MSL/MAXIMUM Muffler... 700170, UNIVERSAL FIT MSL/MAXIMUM Muffler... 709993

NA-Not Available. NR-Not Required. FL-Remove and Re-Use Old Flange. ● Golden Warehouse. O.E.-Original Equipment.
Airtube Kit [4948] may be required to complete installation. EFI-Electronic Fuel Injection.

- [1] OE system was a welded assembly. It is recommended that all parts noted [1] should be replaced.
- [958] Federal & California Emission vehicles. Not legal for sale for vehicles licensed in California.
- [98] Refer to current Catalytic Converter catalog or Website catalog for availability.

ISUZU STYLUS

(13975) 91-93 4 Cyl. Stylus, 1.6L SOHC Engine

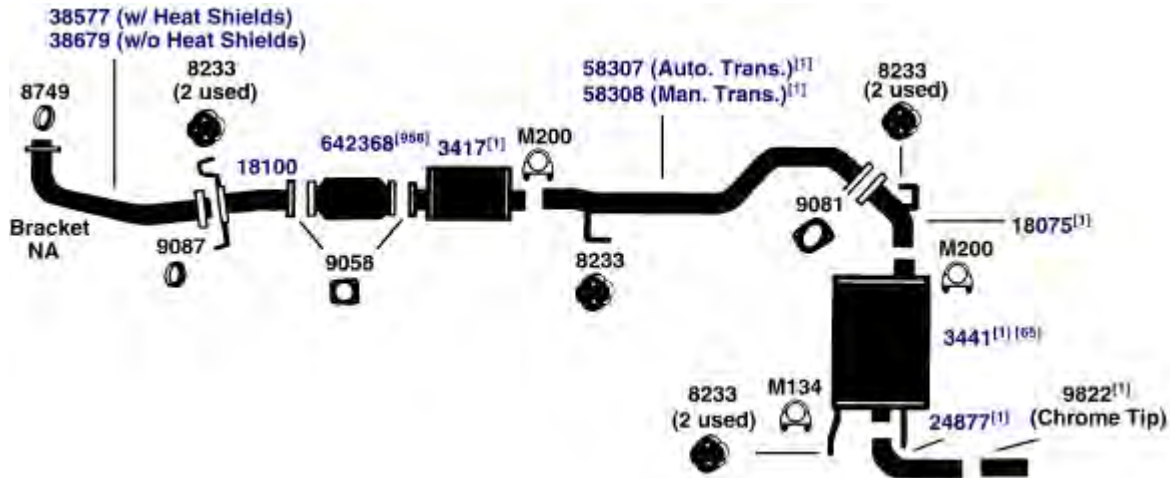

DIRECT FIT MSL/MAXIMUM Muffler... Front Muffler- 700273, Rear Muffler- 700025, UNIVERSAL FIT MSL/MAXIMUM Muffler... Rear Muffler- 6573

ISUZU TROOPER, TROOPER II

(31207) 1994 6 Cyl. Trooper, 4-Door; 3.2L Engine, Calif. (up to 10/94)

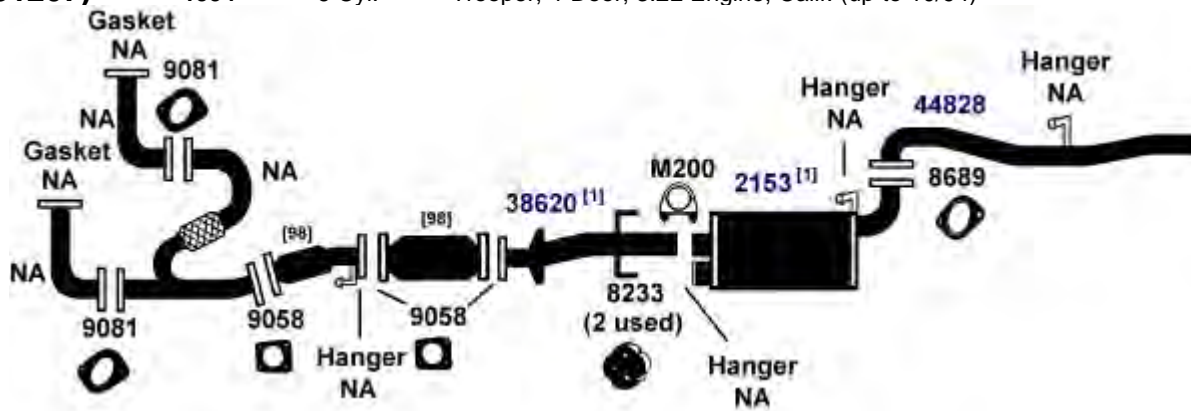

DIRECT FIT MSL/MAXIMUM Muffler... 700249

NA-Not Available. NR-Not Required. FL-Remove and Re-Use Old Flange. ● Golden Warehouse. O.E.-Original Equipment.
Airtube Kit [4948] may be required to complete installation. EFI-Electronic Fuel Injection.

[1] OE system was a welded assembly. It is recommended that all parts noted [1] should be replaced.

[65] Heat Shield 9206 is required for installation.

[98] Refer to current Catalytic Converter catalog or Website catalog for availability.
[958] Federal & California Emission vehicles. Not legal for sale for vehicles licensed in California.

ISUZU TROOPER, TROOPER II

1994 6 Cyl. Trooper, 4-Door; 3.2L Engine, except Calif. (up to 10/94)
 92-93 6 Cyl. Trooper, 4-Door; 3.2L Engine, All Models

(31206)

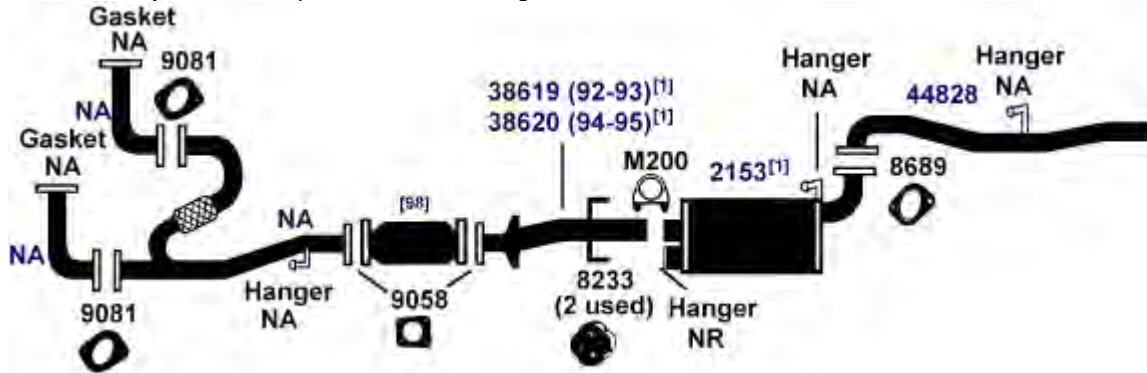

DIRECT FIT MSL/MAXIMUM Muffler... 700249

89-91 6 Cyl. Trooper, Trooper II; 2.8L Engine

(31205)

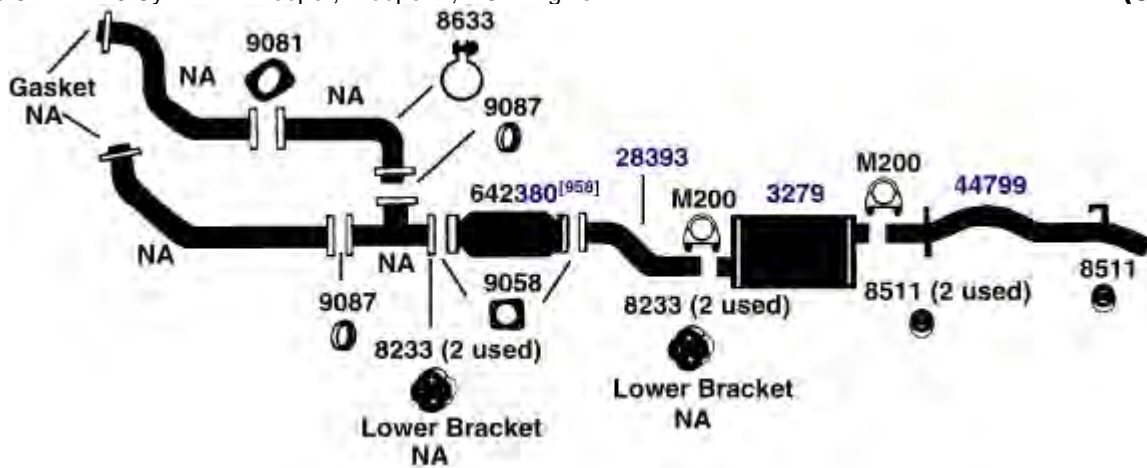

DIRECT FIT MSL/MAXIMUM Muffler... 6530, UNIVERSAL FIT MSL/MAXIMUM Muffler... 709993, 709994, Silentone DIY Muffler... 5524

NA-Not Available. NR-Not Required. FL-Remove and Re-Use Old Flange. ● Golden Warehouse. O.E.-Original Equipment.
 # Airtube Kit [4948] may be required to complete installation. EFI-Electronic Fuel Injection.

[1] OE system was a welded assembly. It is recommended that all parts noted [1] should be replaced.
 [98] Refer to current Catalytic Converter catalog or Website catalog for availability.

[958] Federal & California Emission vehicles. Not legal for sale for vehicles licensed in California.

ISUZU TROOPER, TROOPER II

(31204) 88-91 4 Cyl. Trooper, Trooper II 2.6L Engine

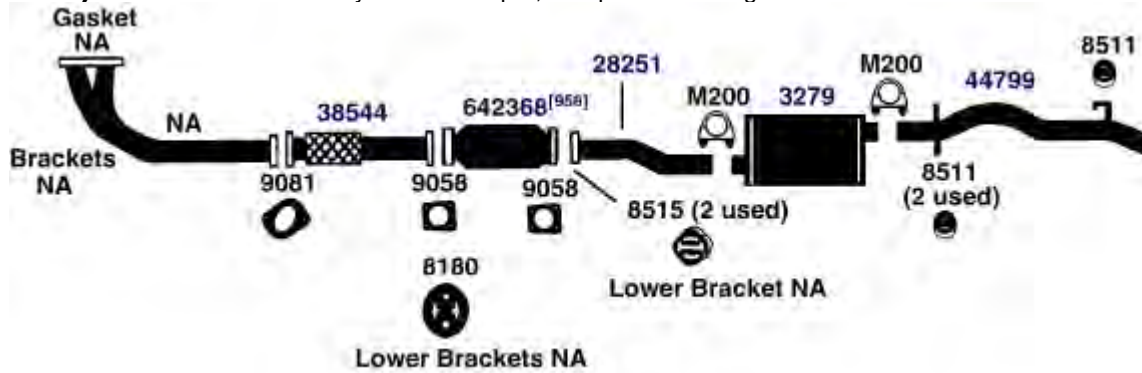

DIRECT FIT MSL/MAXIMUM Muffler... 6530, UNIVERSAL FIT MSL/MAXIMUM Muffler... 709993, 709994, Silentone DIY Muffler... 5524

(31200) 1987 4 Cyl. Trooper II, 2.3L Engine except Diesel; (from 11/86)

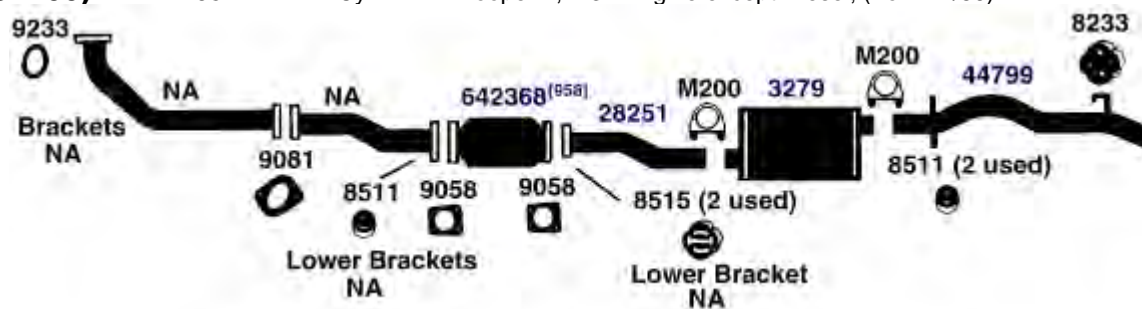

DIRECT FIT MSL/MAXIMUM Muffler... 6530, UNIVERSAL FIT MSL/MAXIMUM Muffler... 709993, 709994, Silentone DIY Muffler... 5524

(31201) 86-87 4 Cyl. Trooper II, 2.2L Diesel Engine

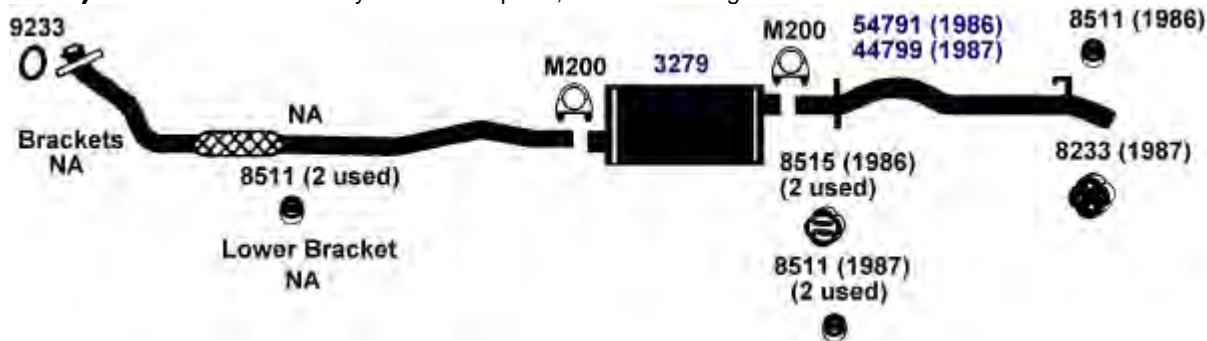

DIRECT FIT MSL/MAXIMUM Muffler... 6530, UNIVERSAL FIT MSL/MAXIMUM Muffler... 709993, 709994, Silentone DIY Muffler... 5524

NA-Not Available. NR-Not Required. FL-Remove and Re-Use Old Flange. ● Golden Warehouse. O.E.-Original Equipment.
Airtube Kit [4948] may be required to complete installation. EFI-Electronic Fuel Injection.

[958] Federal & California Emission vehicles. Not legal for sale for vehicles licensed in California.

ISUZU TROOPER, TROOPER II

1986 4 Cyl. Trooper II, 2.3L Engine; except Diesel; thru 10/86 (31202)

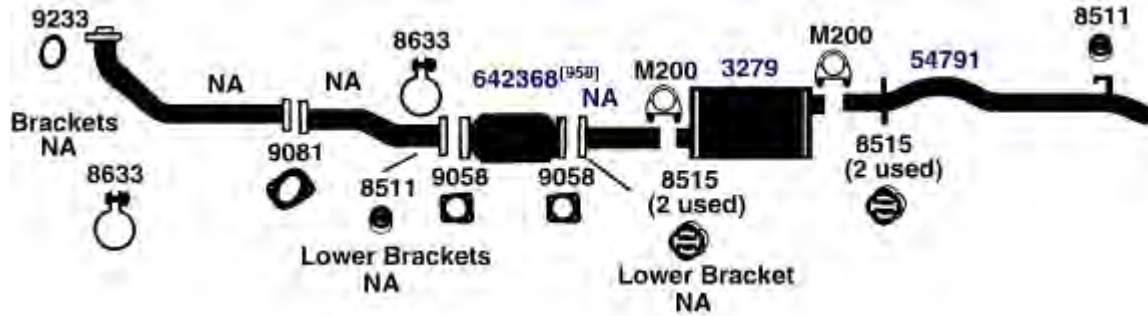

DIRECT FIT MSL/MAXIMUM Muffler... 6530, UNIVERSAL FIT MSL/MAXIMUM Muffler... 709993, 709994, Silentone DIY Muffler... 5524

1985 4 Cyl. Trooper II, 1.9L Engine (31203)

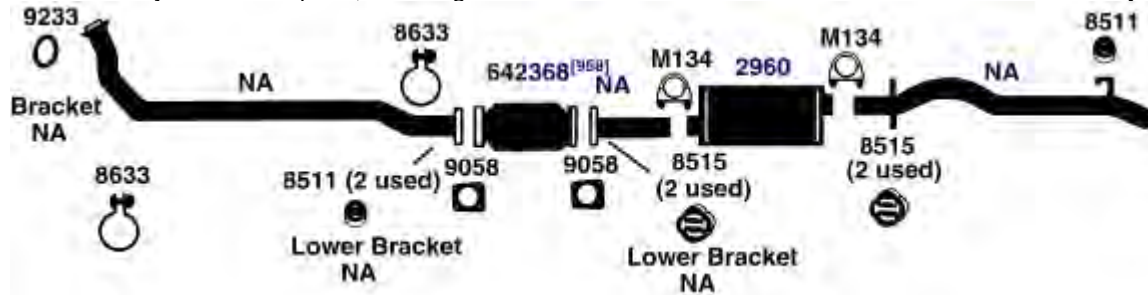

DIRECT FIT MSL/MAXIMUM Muffler... 6672, UNIVERSAL FIT MSL/MAXIMUM Muffler... 709994, Silentone DIY Muffler... 5580

1984 4 Cyl. Trooper II, 1.9L Engine (31203E)

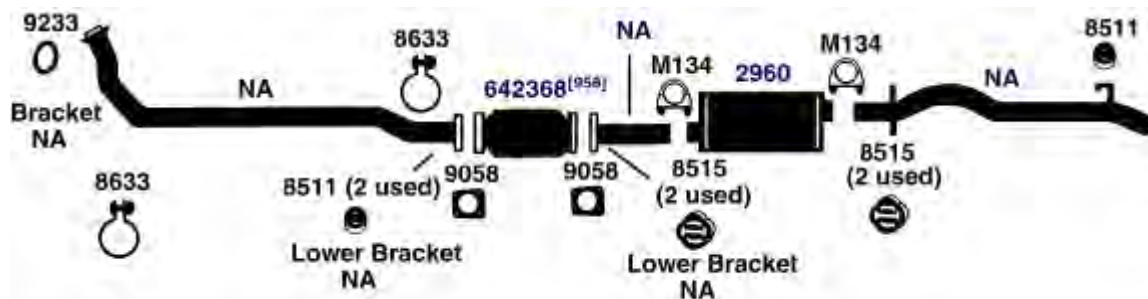

DIRECT FIT MSL/MAXIMUM Muffler... 6672, UNIVERSAL FIT MSL/MAXIMUM Muffler... 709994, Silentone DIY Muffler... 5580

NA-Not Available. NR-Not Required. FL-Remove and Re-Use Old Flange. ● Golden Warehouse. O.E.-Original Equipment.
Airtube Kit [4948] may be required to complete installation. EFI-Electronic Fuel Injection.

[958] Federal & California Emission vehicles. Not legal for sale for vehicles licensed in California.

JEEP

JEEP CHEROKEE, WAGONEER, SERIES 10

(6127) 93-94 6 Cyl. Grand Cherokee, 242 (4.0L) Engine; 2 W.D., 4 W.D.

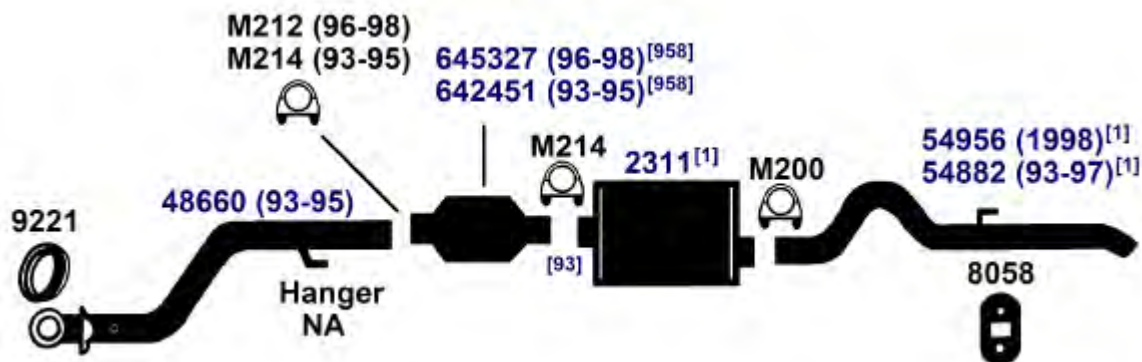

DIRECT FIT MSL/MAXIMUM Muffler... 700206

(6126) 93-94 8 Cyl. Grand Wagoneer, Grand Cherokee, 5.2L Engine; 2 W.D., 4 W.D.

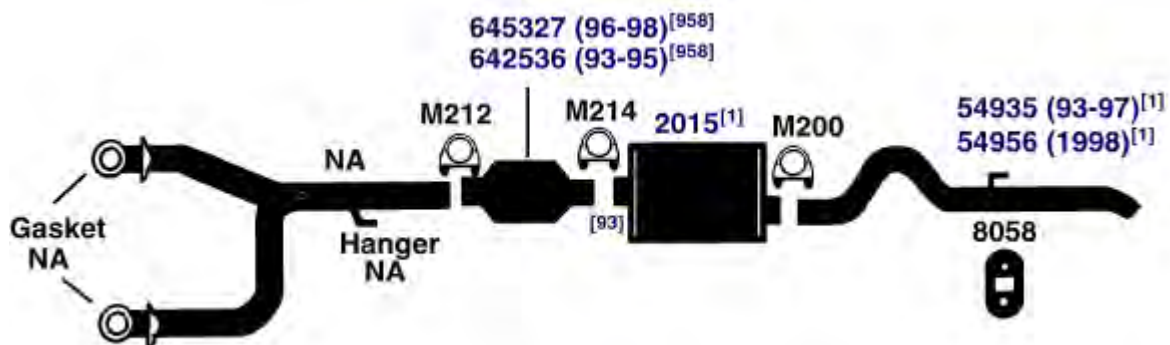

DIRECT FIT MSL/MAXIMUM Muffler... 700153, UNIVERSAL FIT MSL/MAXIMUM Muffler... 709992

(6128) 93-94 4 Cyl. Cherokee, 150 (2.5L) Engine; 2 W.D., 4 W.D.
93-94 6 Cyl. Cherokee, 242 (4.0L) Engine; 2 W.D., 4 W.D.

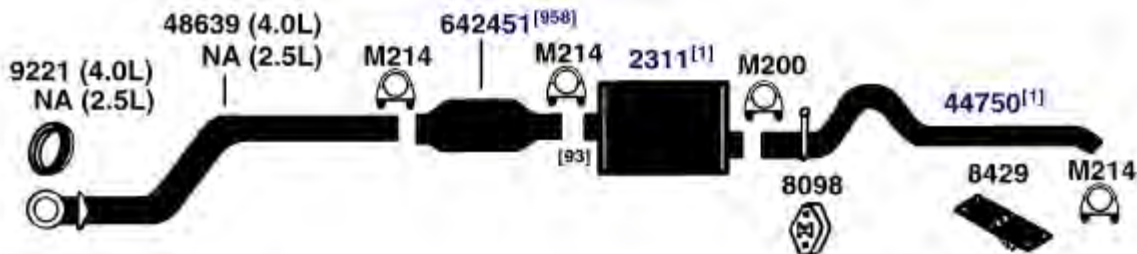

DIRECT FIT MSL/MAXIMUM Muffler... 700206

NA-Not Available. NR-Not Required. FL-Remove and Re-Use Old Flange. ● Golden Warehouse. O.E.-Original Equipment.

Airtube Kit [4948] may be required to complete installation. EFI-Electronic Fuel Injection.

[1] OE system was a welded assembly. It is recommended that all parts noted [1] should be replaced. [958] Federal & California Emission vehicles. Not legal for sale for vehicles licensed in California.

[93] Locating clip must be knocked off OEM converter for proper installation.

JEEP CHEROKEE, WAGONEER, SERIES 10

86-87 4 Cyl. Wagoneer, Cherokee; 126 (2.1L) Turbocharged Diesel Engine; with Resonator **(6121)**

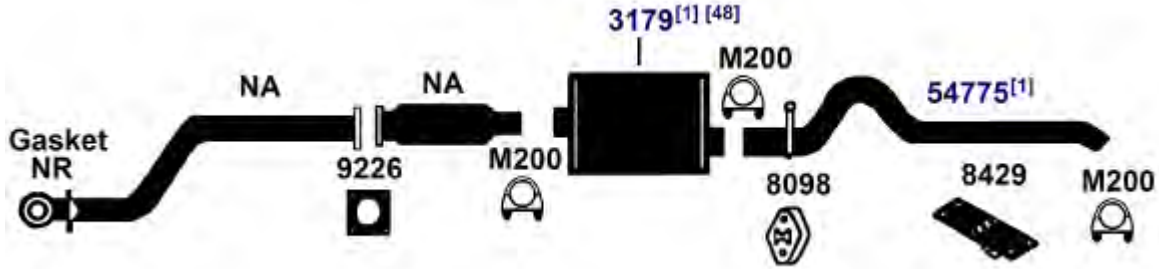

DIRECT FIT MSL/MAXIMUM Muffler... 700075, UNIVERSAL FIT MSL/MAXIMUM Muffler... 6503, Silentone DIY Muffler... 5555

90-92 4 Cyl. Wagoneer, Cherokee; 150 (2.5L) Engine with Converter; 2 W.D., 4 W.D. **(6125)**
90-92 6 Cyl. Wagoneer, Cherokee; 242 (4.0L) Engine with Converter; 2 W.D., 4 W.D.

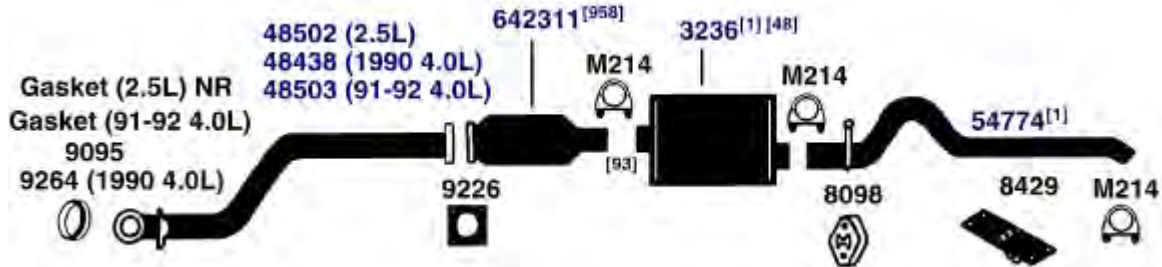

DIRECT FIT MSL/MAXIMUM Muffler... 700045, UNIVERSAL FIT MSL/MAXIMUM Muffler... 6541, 709992, Silentone DIY Muffler... 5543

85-91 8 Cyl. Grand Wagoneer, 360 (5.9L) Engine; with Converter **(6118)**

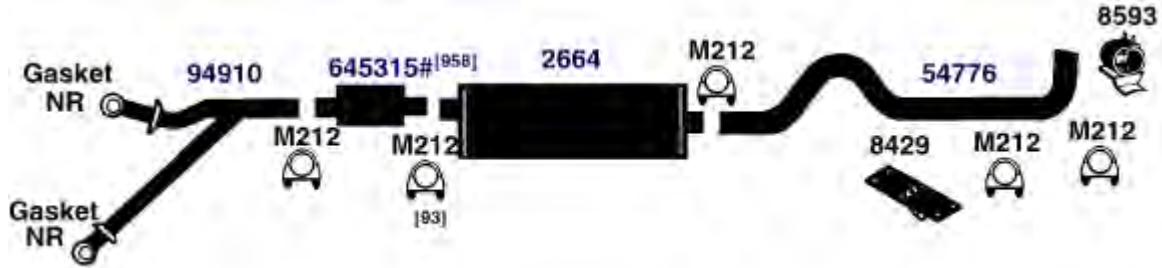

DIRECT FIT MSL/MAXIMUM Muffler... 700264, UNIVERSAL FIT MSL/MAXIMUM Muffler... 6510

NA-Not Available. NR-Not Required. FL-Remove and Re-Use Old Flange. ● Golden Warehouse. O.E.-Original Equipment.
 # Airtube Kit [4948] may be required to complete installation. EFI-Electronic Fuel Injection.

[1] OE system was a welded assembly. It is recommended that all parts noted [1] should be replaced.
 [48] Use end with center nipple as inlet.

[93] Locating clip must be knocked off OEM converter for proper installation.
 [958] Federal & California Emission vehicles. Not legal for sale for vehicles licensed in California.

JEEP CHEROKEE, WAGONEER, SERIES 10

(6120) 87-89 6 Cyl. Wagoneer, Cherokee; 4.0L Engine; with Converter
 86-89 4 Cyl. Wagoneer, Cherokee; 2.5L Engine; with Converter

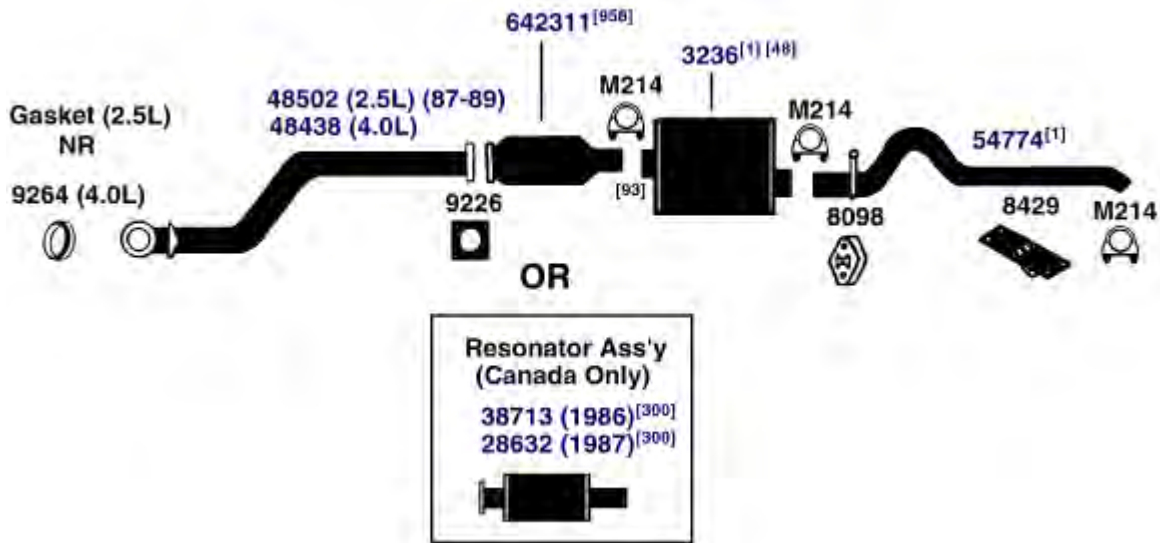

DIRECT FIT MSL/MAXIMUM Muffler... 700045, UNIVERSAL FIT MSL/MAXIMUM Muffler... 6541, 709992, Silentone DIY Muffler... 5543

(6119) 1986 6 Cyl. Wagoneer, Cherokee; 2.8L Engine; with Converter
 NA (Calif.)
 94908 (exc. Calif.)

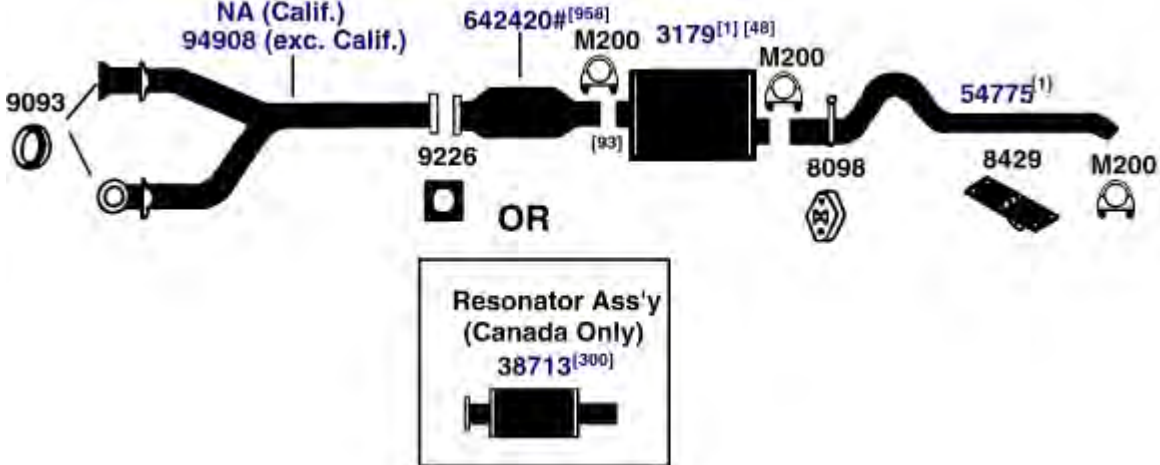

DIRECT FIT MSL/MAXIMUM Muffler... 700075, UNIVERSAL FIT MSL/MAXIMUM Muffler... 6503, Silentone DIY Muffler... 5555

NA-Not Available. NR-Not Required. FL-Remove and Re-Use Old Flange. ● Golden Warehouse. O.E.-Original Equipment.
 # Airtube Kit [4948] may be required to complete installation. EFI-Electronic Fuel Injection.

[1] OE system was a welded assembly. It is recommended that all parts noted [1] should be replaced.

[48] Use end with center nipple as inlet.

[93] Locating clip must be knocked off OEM converter for proper installation.

[300] For use when resonator originated from O.E. manufacturer.

[958] Federal & California Emission vehicles. Not legal for sale for vehicles licensed in California.

JEEP CHEROKEE, WAGONEER, SERIES 10

1985 4 Cyl. Wagoneer, Cherokee, 2.5L Engine; with Converter (6117)

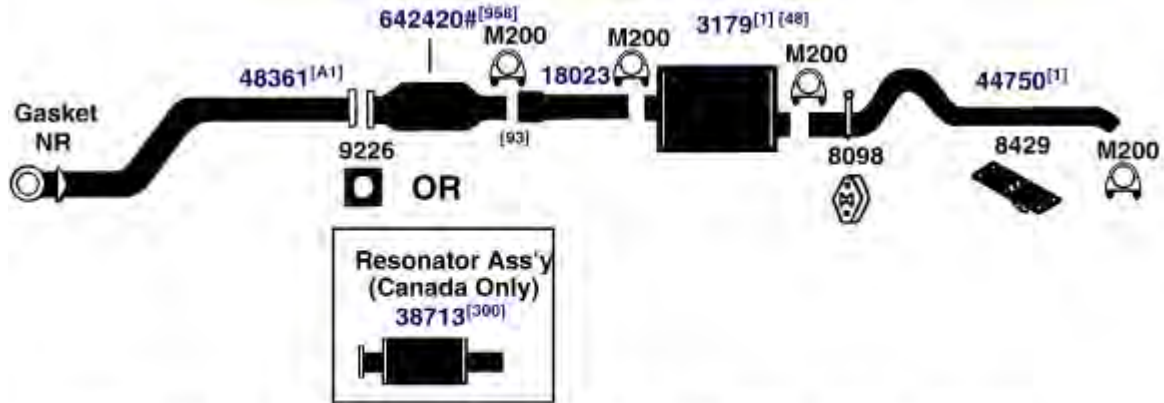

(A1) For Vehicle where air pump line is attached to emission fitting in exhaust pipe, drill 1/2" hole through fitting into exhaust pipe.

DIRECT FIT MSL/MAXIMUM Muffler... 700075, UNIVERSAL FIT MSL/MAXIMUM Muffler... 6503, Silentone DIY Muffler... 5555

1985 6 Cyl. Wagoneer, Cherokee, 2.8L Engine; with Converter (6116)

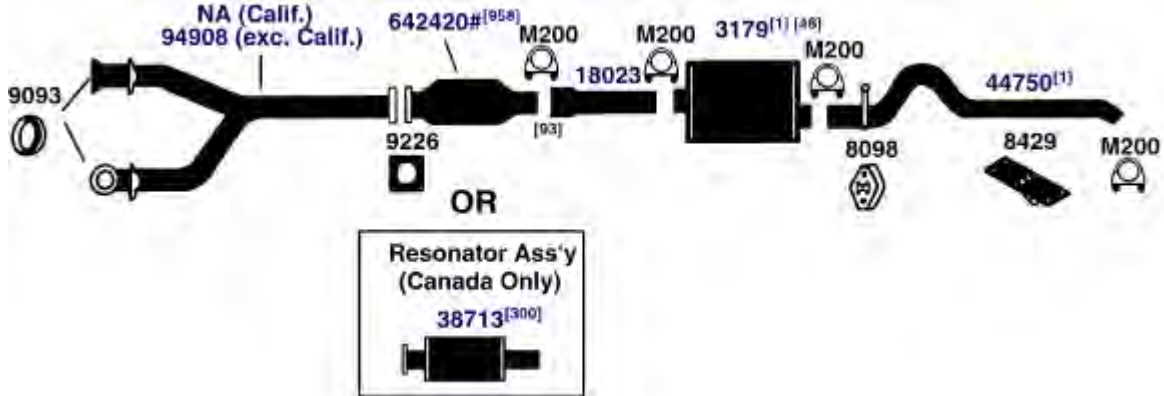

DIRECT FIT MSL/MAXIMUM Muffler... 700075, UNIVERSAL FIT MSL/MAXIMUM Muffler... 6503, Silentone DIY Muffler... 5555

NA-Not Available. NR-Not Required. FL-Remove and Re-Use Old Flange. ● Golden Warehouse. O.E.-Original Equipment.
Airtube Kit [4948] may be required to complete installation. EFI-Electronic Fuel Injection.

- [1] OE system was a welded assembly. It is recommended that all parts noted [1] should be replaced.
- [48] Use end with center nipple as inlet.
- [93] Locating clip must be knocked off OEM converter for proper installation.

- [300] For use when resonator originated from O.E. manufacturer.
- [958] Federal & California Emission vehicles. Not legal for sale for vehicles licensed in California.

JEEP CHEROKEE, WAGONEER, SERIES 10

(6117E) 1984 4 Cyl. Wagoneer, Cherokee, 2.5L Engine; with Converter

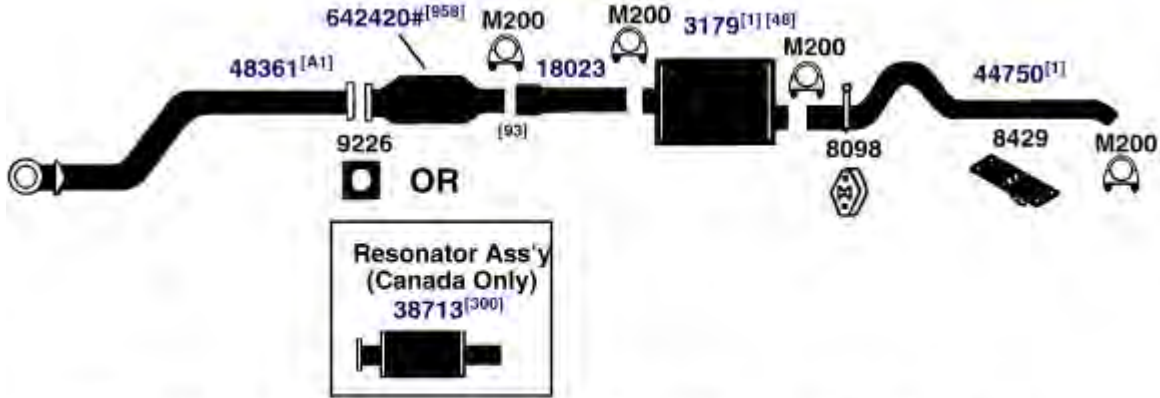

DIRECT FIT MSL/MAXIMUM Muffler... 700075, UNIVERSAL FIT MSL/MAXIMUM Muffler... 6503, Silentone DIY Muffler... 5555

(6116E) 1984 6 Cyl. Wagoneer, Cherokee, 2.8L Engine; with Converter

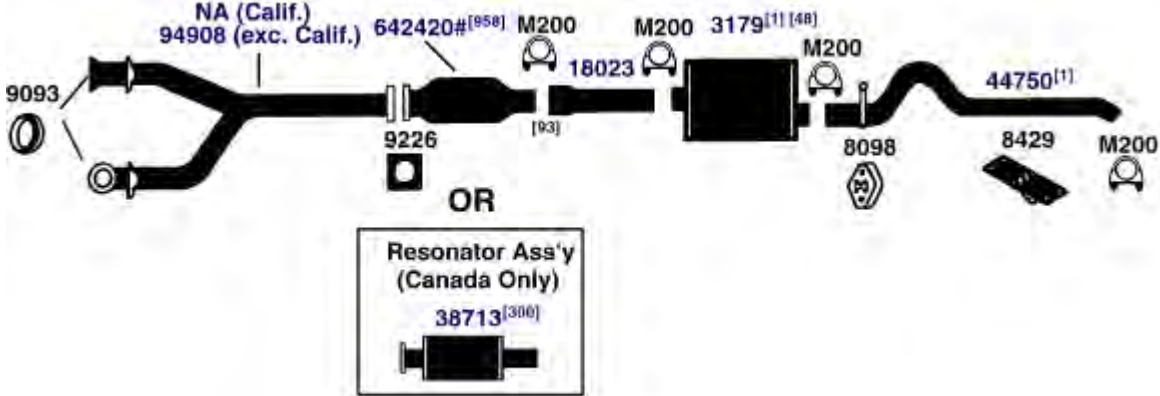

DIRECT FIT MSL/MAXIMUM Muffler... 700075, UNIVERSAL FIT MSL/MAXIMUM Muffler... 6503, Silentone DIY Muffler... 5555

(6118E) 1984 8 Cyl. Grand Wagoneer, 360 (5.9L) Engine; with Converter

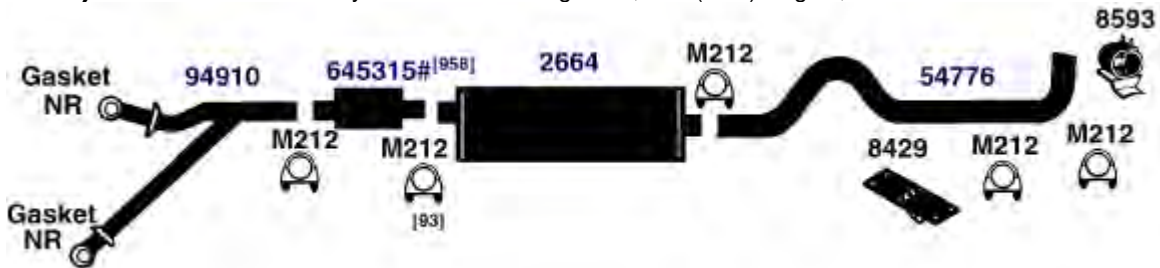

DIRECT FIT MSL/MAXIMUM Muffler... 700264, UNIVERSAL FIT MSL/MAXIMUM Muffler... 6510

NA-Not Available. NR-Not Required. FL-Remove and Re-Use Old Flange. ● Golden Warehouse. O.E.-Original Equipment.
 # Airtube Kit [4948] may be required to complete installation. EFI-Electronic Fuel Injection.

[1] OE system was a welded assembly. It is recommended that all parts noted [1] should be replaced.
 [48] Use end with center nipple as inlet.
 [93] Locating clip must be knocked off OEM converter for proper installation.

[300] For use when resonator originated from O.E. manufacturer.
 [958] Federal & California Emission vehicles. Not legal for sale for vehicles licensed in California.

JEEP CHEROKEE, WAGONEER, SERIES 10

1983 8 Cyl. Wagoneer, Cherokee; 360 Engine; with Converter **(6115)**
80-82 8 Cyl. Series 10, Wagoneer, Cherokee, with Converter



DIRECT FIT MSL/MAXIMUM Muffler... 700264, UNIVERSAL FIT MSL/MAXIMUM Muffler... 6510

80-81 6 Cyl. Series 10, Wagoneer, Cherokee, with Catalytic Converter; except 1981 California Models **(6113)**



DIRECT FIT MSL/MAXIMUM Muffler... 700264, UNIVERSAL FIT MSL/MAXIMUM Muffler... 6510

JEEP CJ/DJ SERIES

85-86 4 Cyl. CJ7, (CJ8 Scrambler); 2.5L Engine; with Catalytic Converter **(6041)**
85-86 6 Cyl. CJ7, (CJ8 Scrambler); 4.2L Engine; with Catalytic Converter; except California

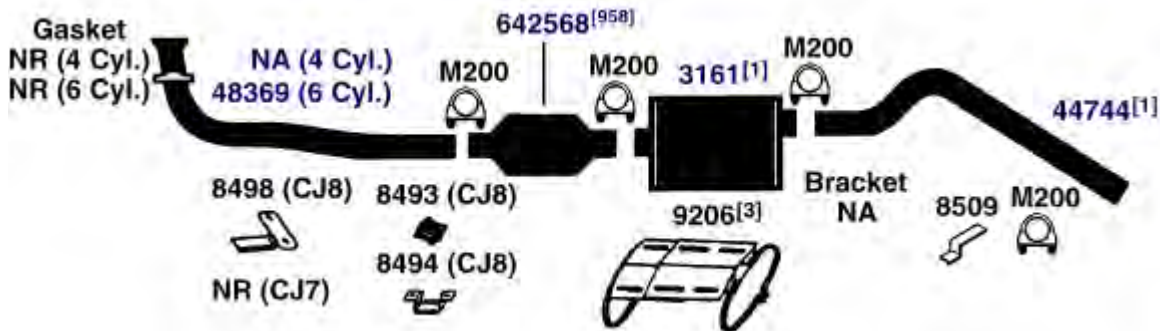

DIRECT FIT MSL/MAXIMUM Muffler... 700068, UNIVERSAL FIT MSL/MAXIMUM Muffler... 709005

NA-Not Available. NR-Not Required. FL-Remove and Re-Use Old Flange. ● Golden Warehouse. O.E.-Original Equipment.
 # Airtube Kit [4948] may be required to complete installation. EFI-Electronic Fuel Injection.

- [1] OE system was a welded assembly. It is recommended that all parts noted [1] should be replaced. [98] Refer to current Catalytic Converter catalog or Website catalog for availability.
 [3] Required for installation. [958] Federal & California Emission vehicles. Not legal for sale for vehicles licensed in California.
 [49] Replaces 2" system. Muffler and tail pipe must be replaced together.

JEEP CJ/DJ SERIES

(6041E) 1984 4 Cyl. CJ7, (CJ8 Scrambler); 2.5L Engine; with Catalytic Converter
 1984 6 Cyl. CJ7, (CJ8 Scrambler); 4.2L Engine; with Catalytic Converter; except California

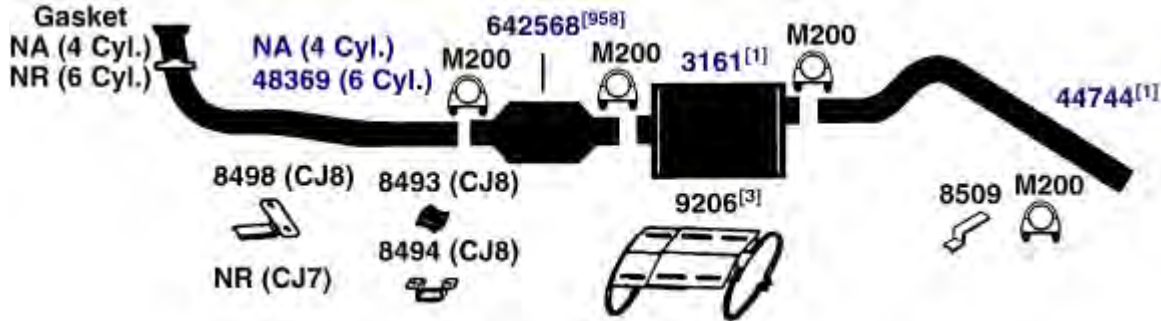

DIRECT FIT MSL/MAXIMUM Muffler... 700068, UNIVERSAL FIT MSL/MAXIMUM Muffler... 709005

(6040) 82-83 4 Cyl. CJ5, CJ7 (CJ8 Scrambler); with Catalytic Converter

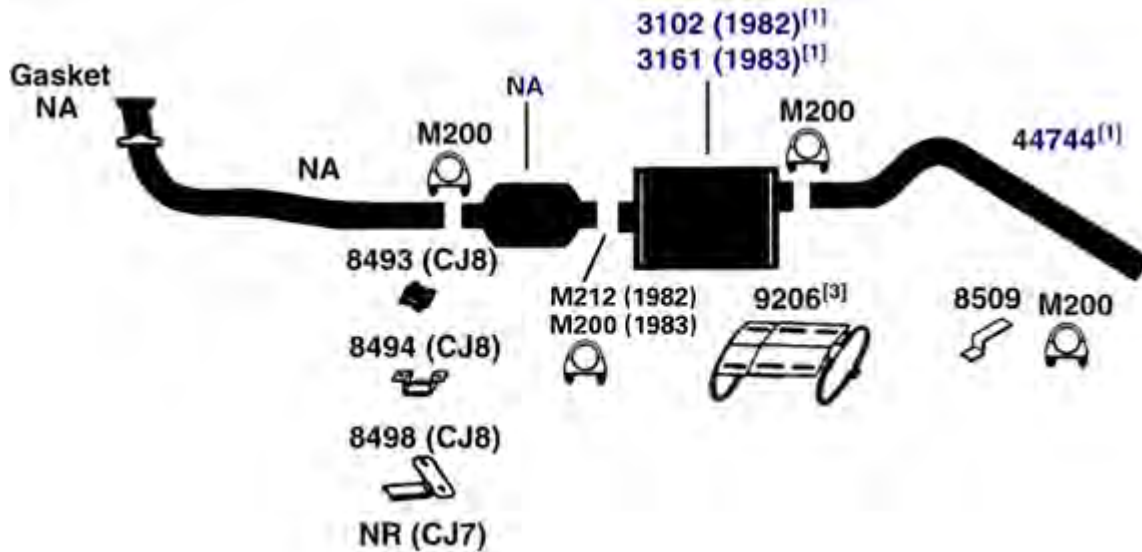

DIRECT FIT MSL/MAXIMUM Muffler... Muffler (3161)- 700068, UNIVERSAL FIT MSL/MAXIMUM Muffler... Muffler (3161)- 709005

NA-Not Available. NR-Not Required. FL-Remove and Re-Use Old Flange. ● Golden Warehouse. O.E.-Original Equipment.
 # Airtube Kit [4948] may be required to complete installation. EFI-Electronic Fuel Injection.

- [1] OE system was a welded assembly. It is recommended that all parts noted [1] should be replaced. [958] Federal & California Emission vehicles. Not legal for sale for vehicles licensed in California.
 [3] Required for installation.

82-83 6 Cyl. CJ5, CJ7 (CJ8 Scrambler); with Catalytic Converter; except California (6039)

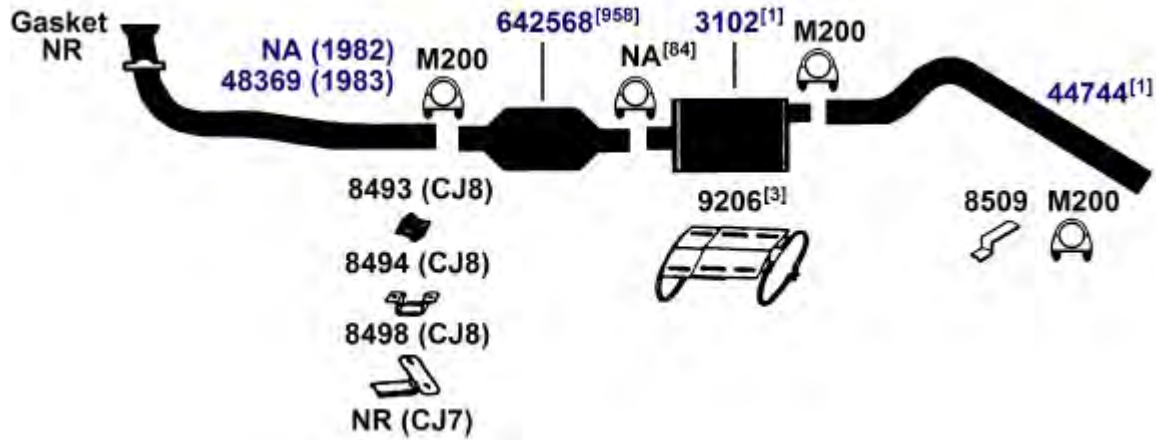

1982 6 Cyl. CJ5, CJ7, CJ8 Scrambler; with Catalytic Converter; California models (6038)

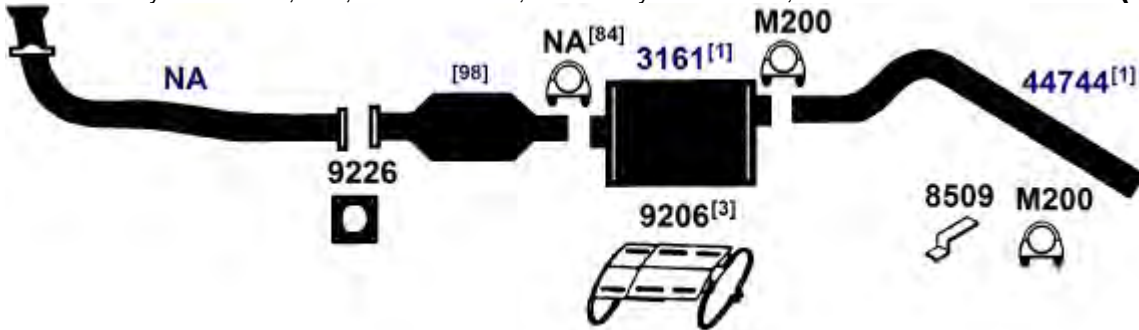

DIRECT FIT MSL/MAXIMUM Muffler... 700068, UNIVERSAL FIT MSL/MAXIMUM Muffler... 709005

81-82 4 Cyl. CJ8, Scrambler; with Catalytic Converter (6035)

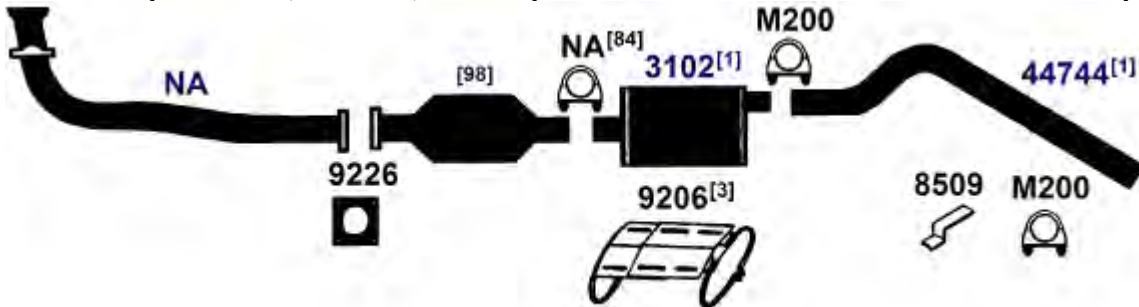

NA-Not Available. NR-Not Required. FL-Remove and Re-Use Old Flange. ● Golden Warehouse. O.E.-Original Equipment.
Airtube Kit [4948] may be required to complete installation. EFI-Electronic Fuel Injection.

- [1] OE system was a welded assembly. It is recommended that all parts noted [1] should be replaced.
- [2] Refer to current Catalytic Converter catalog or Website catalog for availability.
- [3] Required for installation.
- [4] Federal & California Emission vehicles. Not legal for sale for vehicles licensed in California.
- [5] Remove and re-use original clamp.

JEEP CJ/DJ SERIES

(6032) 1981 6 Cyl. CJ8, Scrambler; with Catalytic Converter

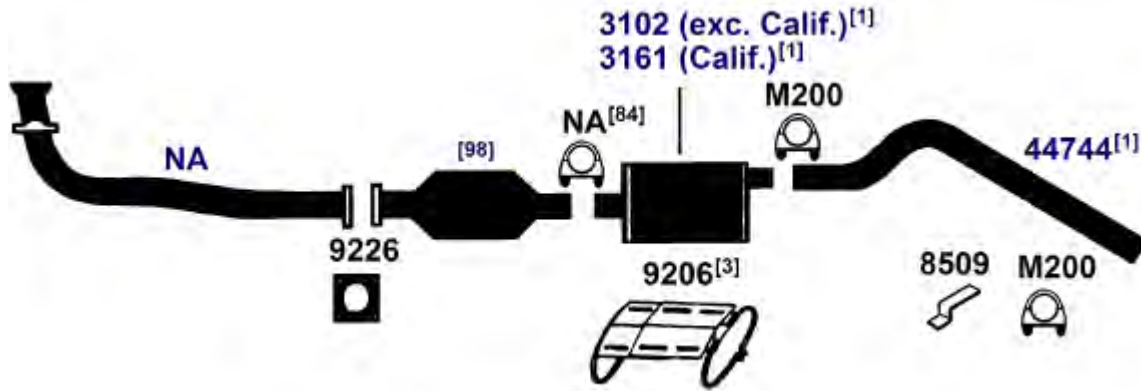

DIRECT FIT MSL/MAXIMUM Muffler... Calif.- 700068, UNIVERSAL FIT MSL/MAXIMUM Muffler... Calif.- 709005

(6034) 1981 6 Cyl. CJ5, CJ7; with Catalytic Converter; California models

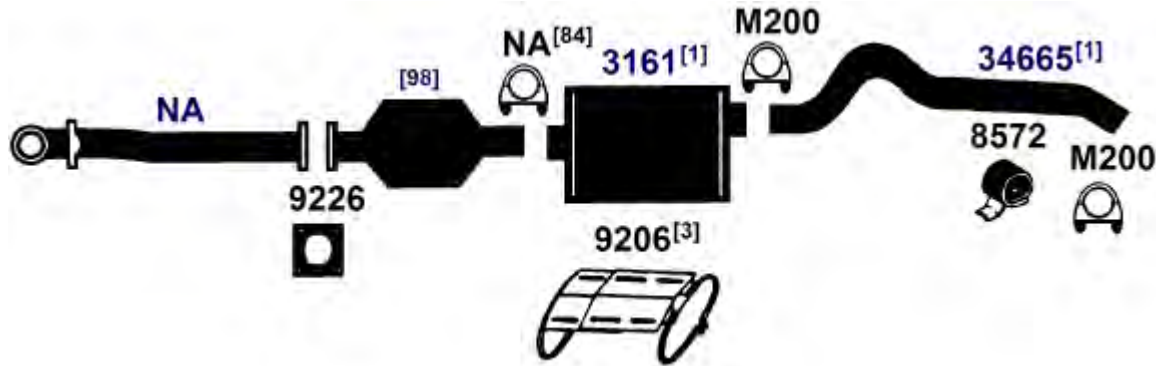

DIRECT FIT MSL/MAXIMUM Muffler... 700068, UNIVERSAL FIT MSL/MAXIMUM Muffler... 709005

JEEP COMANCHE

(30255) 90-92 4,6 Cyl. Comanche; 150, 242 (2.5L, 4.0L) Engine; 2 W.D., 4 W.D.; with Converter; with 6', 7' Bed

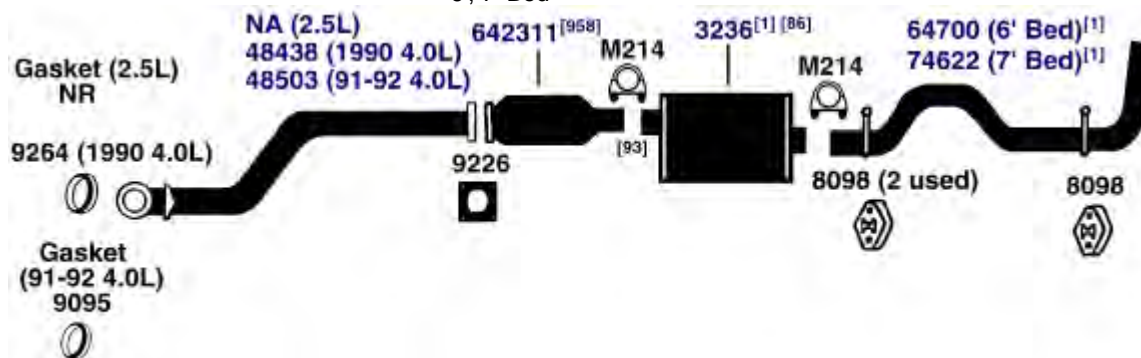

DIRECT FIT MSL/MAXIMUM Muffler... 700045, UNIVERSAL FIT MSL/MAXIMUM Muffler... 6541, 709992, Silentone DIY Muffler... 5543

NA-Not Available. NR-Not Required. FL-Remove and Re-Use Old Flange. ● Golden Warehouse. O.E.-Original Equipment.
Airtube Kit [4948] may be required to complete installation. EFI-Electronic Fuel Injection.

- [1] OE system was a welded assembly. It is recommended that all parts noted [1] should be replaced.
- [3] Required for installation.
- [84] Remove and re-use original clamp.
- [86] Use end with offset nipple as inlet.
- [93] Locating clip must be knocked off OEM converter for proper installation.

- [98] Refer to current Catalytic Converter catalog or Website catalog for availability.
- [958] Federal & California Emission vehicles. Not legal for sale for vehicles licensed in California.

JEEP COMANCHE

88-89 4,6 Cyl. Comanche; 150, 242 (2.5L, 4.0L) Engine; with Converter; with 6', 7' Bed **(30254)**
1987 6 Cyl. Comanche; 242 (4.0L) Engine; with Converter; with 6', 7' Bed

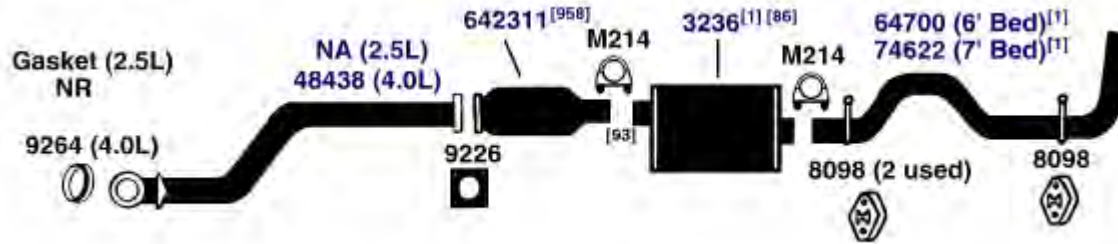

DIRECT FIT MSL/MAXIMUM Muffler... 700045, UNIVERSAL FIT MSL/MAXIMUM Muffler... 6541, 709992, Silentone DIY Muffler... 5543

86-87 4 Cyl. Comanche; 150 (2.5L) Engine; with Converter; with 6', 7' Bed **(30252)**

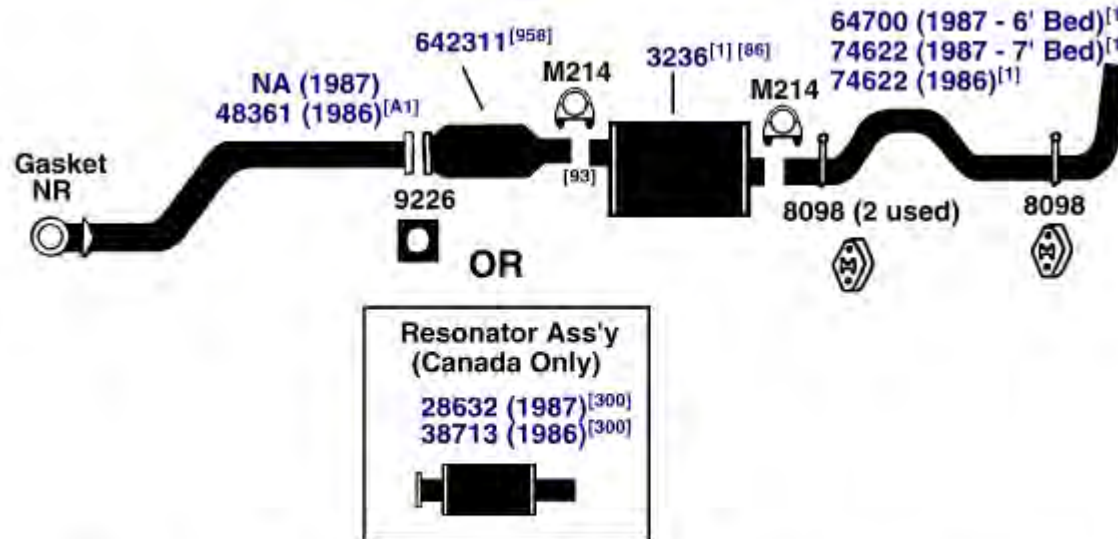

(A1) For Vehicle where air pump line is attached to emission fitting in exhaust pipe, drill 1/2" hole through fitting into exhaust pipe.

DIRECT FIT MSL/MAXIMUM Muffler... 700045, UNIVERSAL FIT MSL/MAXIMUM Muffler... 6541, 709992, Silentone DIY Muffler... 5543

1986 4 Cyl. Comanche; 126 (2.1L) Turbo Diesel Engine; with Resonator; with 6', 7' Bed **(30251)**

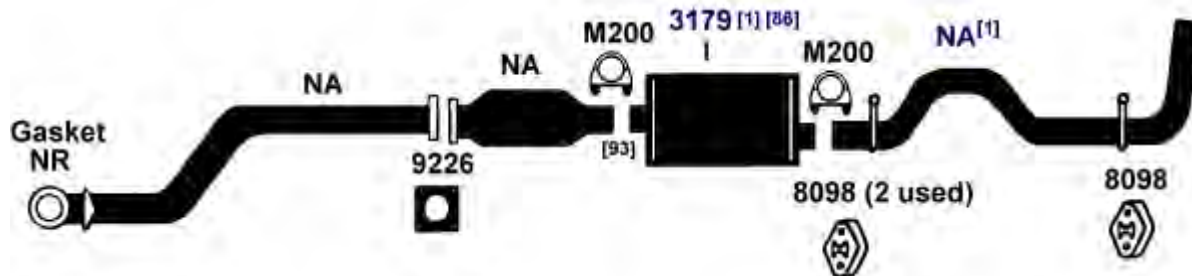

DIRECT FIT MSL/MAXIMUM Muffler... 700075, UNIVERSAL FIT MSL/MAXIMUM Muffler... 6503, Silentone DIY Muffler... 5555

NA-Not Available. NR-Not Required. FL-Remove and Re-Use Old Flange. • Golden Warehouse. O.E.-Original Equipment.
 # Airtube Kit [4948] may be required to complete installation. EFI-Electronic Fuel Injection.

- [1] OE system was a welded assembly. It is recommended that all parts noted [1] should be replaced.
- [86] Use end with offset nipple as inlet.
- [93] Locating clip must be knocked off OEM converter for proper installation.
- [300] For use when resonator originated from O.E. manufacturer.
- [958] Federal & California Emission vehicles. Not legal for sale for vehicles licensed in California.

JEEP COMANCHE

(30250) 1986 6 Cyl. Comanche; 173 (2.8L) Engine; with Converter

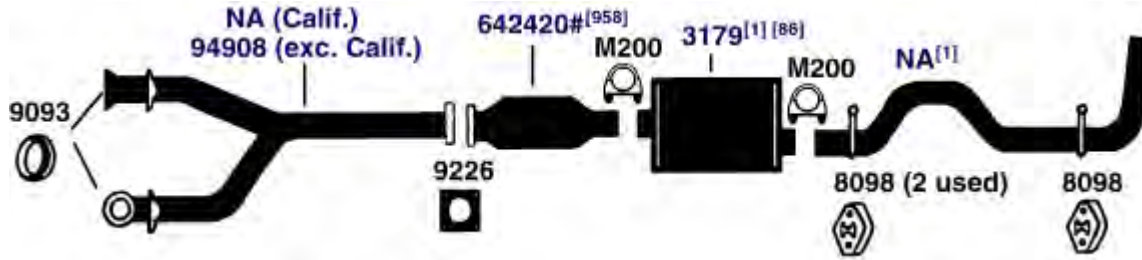

DIRECT FIT MSL/MAXIMUM Muffler... 700075, UNIVERSAL FIT MSL/MAXIMUM Muffler... 6503, Silentone DIY Muffler... 5555

JEEP WRANGLER

(11902) 93-94 4 Cyl. Wrangler; 150 (2.5L) Engine
93-94 6 Cyl. Wrangler; 242 (4.0L) Engine

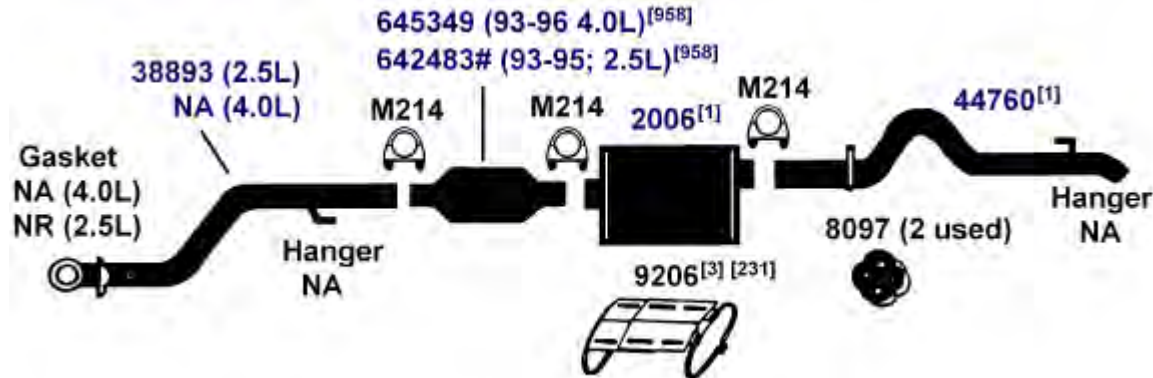

DIRECT FIT MSL/MAXIMUM Muffler... 700190, UNIVERSAL FIT MSL/MAXIMUM Muffler... 6536

NA-Not Available. NR-Not Required. FL-Remove and Re-Use Old Flange. ● Golden Warehouse. O.E.-Original Equipment.
Airtube Kit [4948] may be required to complete installation. EFI-Electronic Fuel Injection.

[1] OE system was a welded assembly. It is recommended that all parts noted [1] should be replaced.

[3] Required for installation.

[86] Use end with offset nipple as inlet.

[231] If muffler is equipped with a heat shield (does not have a black triangle on the carton label), purchase of 9206 is not required.

[958] Federal & California Emission vehicles. Not legal for sale for vehicles licensed in California.

87-92 4 Cyl. Wrangler, 150 (2.5L) Engine, with Catalytic Converter **(11901)**

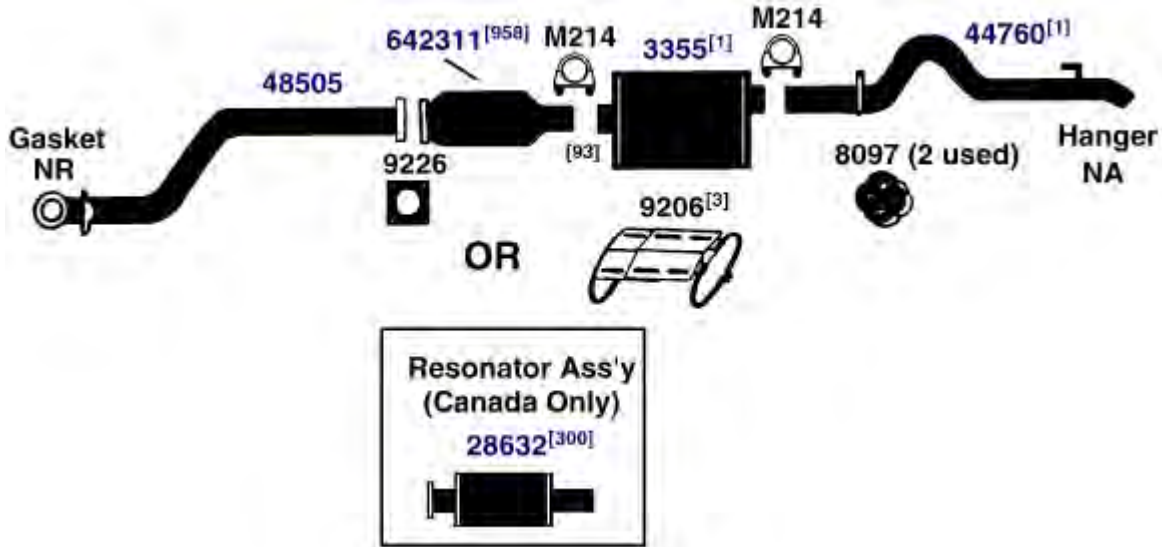

DIRECT FIT MSL/MAXIMUM Muffler... 700114, UNIVERSAL FIT MSL/MAXIMUM Muffler... 6536, 6590

91-92 6 Cyl. Wrangler, 242 (4.0L) High Output Engine, with Catalytic Converter **(11900)**
87-90 6 Cyl. Wrangler, 258 (4.2L) Engine, with Catalytic Converter

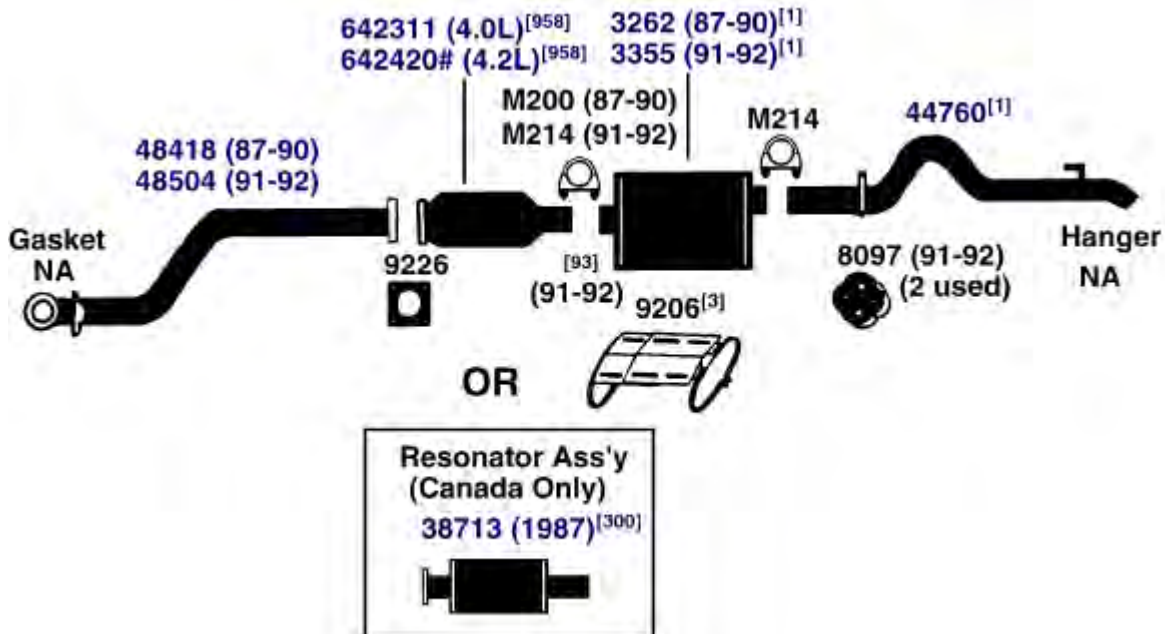

DIRECT FIT MSL/MAXIMUM Muffler... 87-90- 700100, 91-92- 700114, UNIVERSAL FIT MSL/MAXIMUM Muffler... 91-92- 6536, 6590

NA-Not Available. NR-Not Required. FL-Remove and Re-Use Old Flange. ● Golden Warehouse. O.E.-Original Equipment.
 # Airtube Kit [4948] may be required to complete installation. EFI-Electronic Fuel Injection.

- [1] OE system was a welded assembly. It is recommended that all parts noted [1] should be replaced.
- [3] Required for installation.
- [93] Locating clip must be knocked off OEM converter for proper installation.
- [300] For use when resonator originated from O.E. manufacturer.
- [958] Federal & California Emission vehicles. Not legal for sale for vehicles licensed in California.

LAND ROVER

LAND ROVER DISCOVERY

(100604) 1994 8 Cyl. Discovery; 3.9L, 4.0L Engine

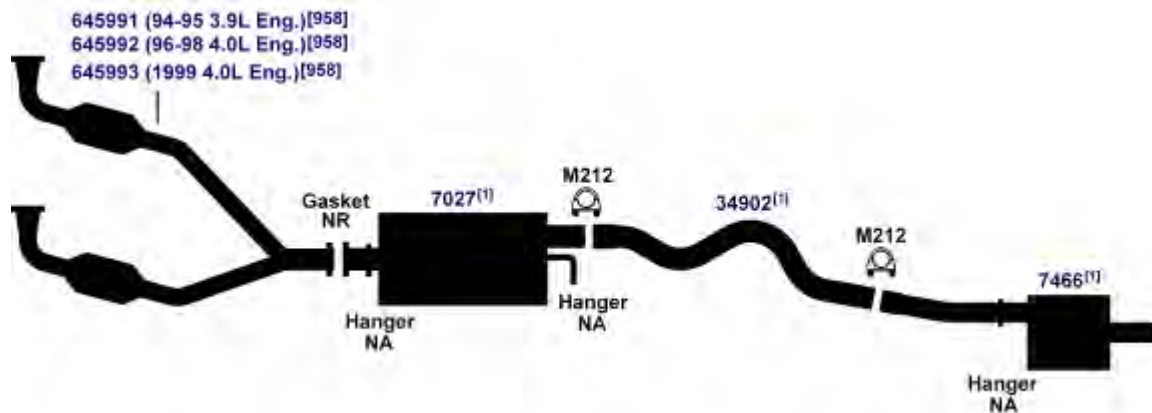

LEXUS

LEXUS ES SERIES

(14526) 1994 6 Cyl. ES300, 3.0L EFI Engine

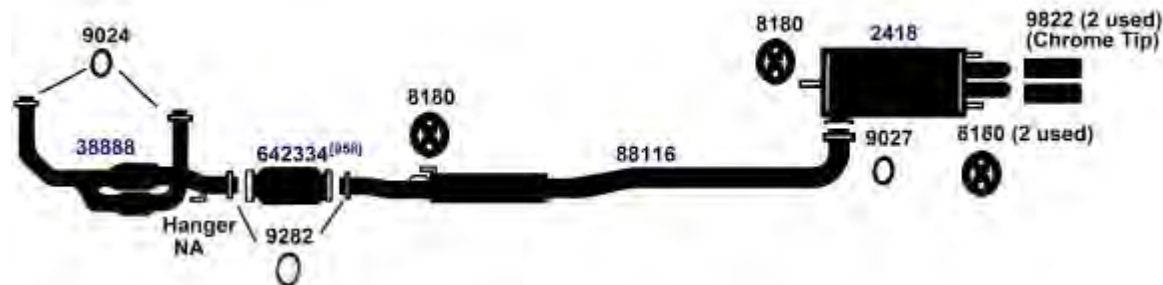

DIRECT FIT MSL/MAXIMUM Muffler... 700447

(14525) 92-93 6 Cyl. ES300, 3.0L EFI Engine

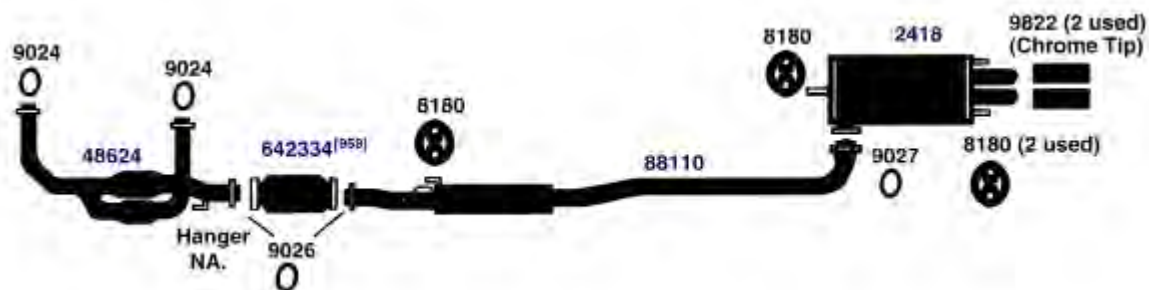

DIRECT FIT MSL/MAXIMUM Muffler... 700447

NA-Not Available. NR-Not Required. FL-Remove and Re-Use Old Flange. ● Golden Warehouse. O.E.-Original Equipment.
Airtube Kit [4948] may be required to complete installation. EFI-Electronic Fuel Injection.

[1] OE system was a welded assembly. It is recommended that all parts noted [1] should be replaced. [958] Federal & California Emission vehicles. Not legal for sale for vehicles licensed in California.

LEXUS ES SERIES

90-91 6 Cyl. ES250, 2.5L EFI Engine

(14475)

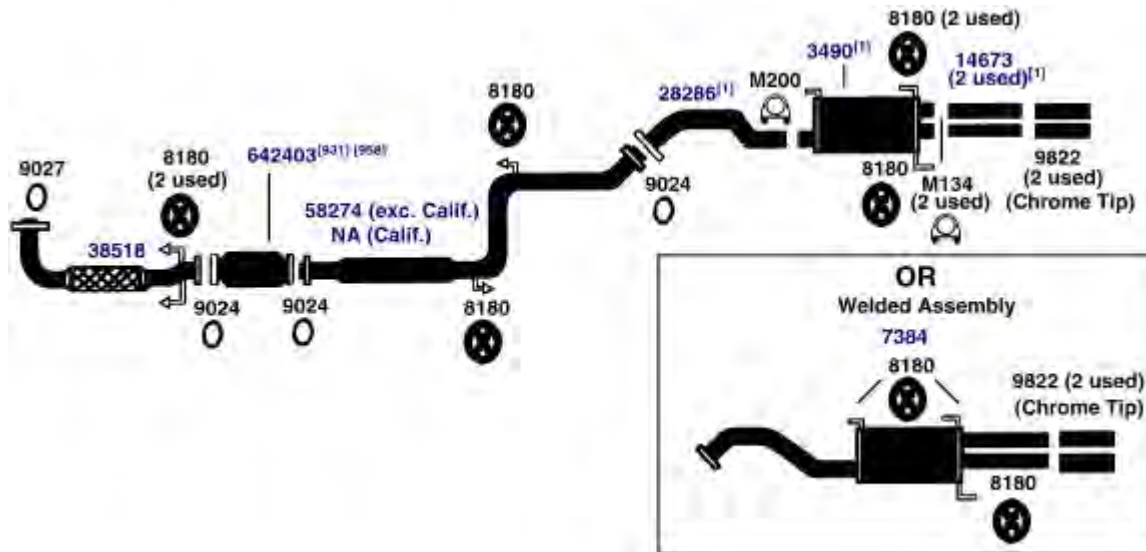

DIRECT FIT MSL/MAXIMUM Muffler... Split System- 700135, UNIVERSAL FIT MSL/MAXIMUM Muffler... Split System- 709015, Welded Assembly- 700015, 709015

LEXUS LS SERIES

90-94 8 Cyl. LS400, 4.0L Engine

(100631)

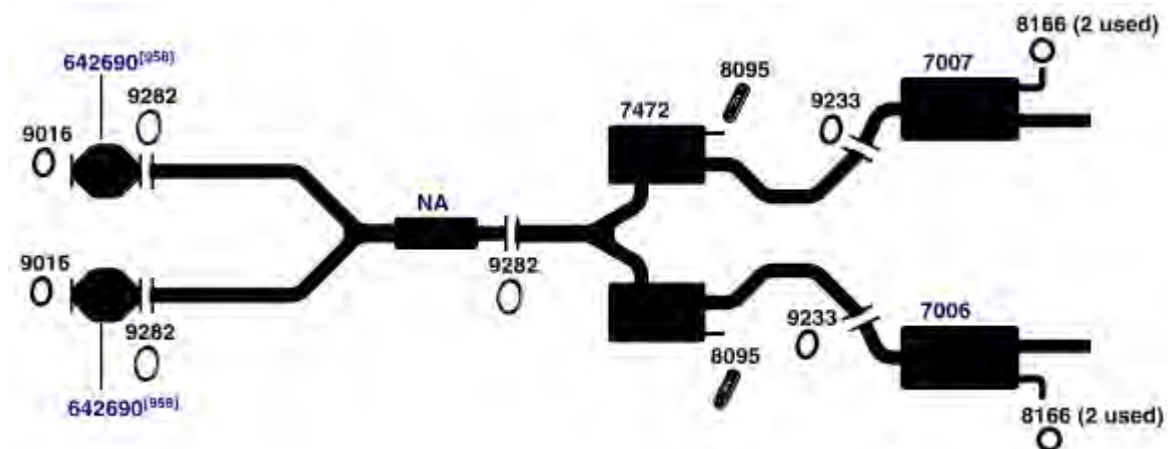

NA-Not Available. NR-Not Required. FL-Remove and Re-Use Old Flange. ● Golden Warehouse. O.E.-Original Equipment.
Airtube Kit [4948] may be required to complete installation. EFI-Electronic Fuel Injection.

[1] OE system was a welded assembly. It is recommended that all parts noted [1] should be replaced.

[931] This unit was designed to fit many applications. Measurement of the old unit and cutting of new unit is required.

[958] Federal & California Emission vehicles. Not legal for sale for vehicles licensed in California.

LINCOLN

LINCOLN CONTINENTAL, TOWN CAR

(6220) 92-94 6 Cyl. Continental, 3.8L (232) Engine; Dual Exhaust (from 2/92)

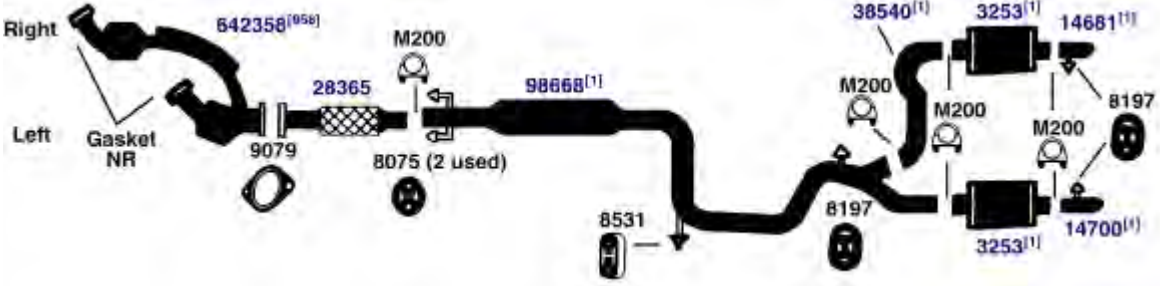

DIRECT FIT MSL/MAXIMUM Muffler... Left Muffler- 700098, Right Muffler- 700098, UNIVERSAL FIT MSL/MAXIMUM Muffler... Left Muffler- 6516, 6538, 709011, 709012, Right Muffler- 6516, 6538, 709011, 709012, Silentone DIY Muffler... Left Muffler- 5533, Right Muffler- 5533

(6217) 91-94 8 Cyl. Town Car, 280 (4.6L) Engine; Single Exhaust
1990 8 Cyl. Town Car, 302 (5.0L) Engine; Single Exhaust

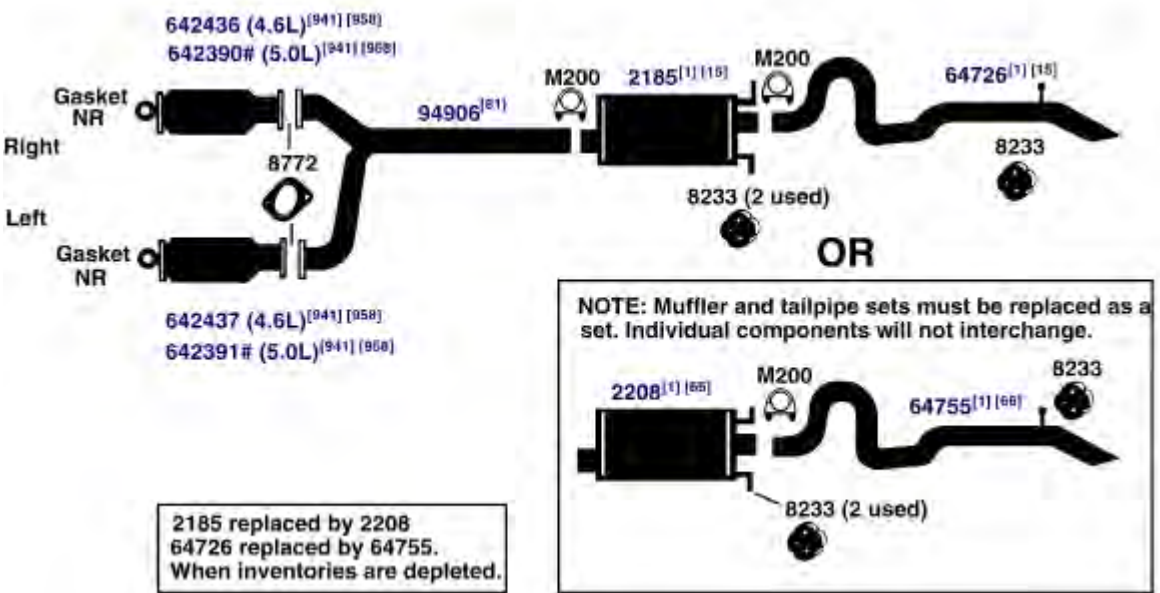

DIRECT FIT MSL/MAXIMUM Muffler... Muffler (option for 2185)- 700042 (Old Design), Muffler (option for 2208)- 700037 (Revised Design), 700037 (Revised Design), UNIVERSAL FIT MSL/MAXIMUM Muffler... Muffler (option for 2185)- 709012 (Old Design), 709011 (Old Design), Muffler (option for 2208)- 709013 (Revised Design), 709014 (Revised Design), 709013 (Revised Design), 709014 (Revised Design)

NA-Not Available. NR-Not Required. FL-Remove and Re-Use Old Flange. ● Golden Warehouse. O.E.-Original Equipment.
Airtube Kit [4948] may be required to complete installation. EFI-Electronic Fuel Injection.

[1] OE system was a welded assembly. It is recommended that all parts noted [1] should be replaced.
[15] Discontinued, use until inventory is depleted.
[66] Muffler and tailpipe sets must be replaced as a set. Individual components will not interchange.
[81] To align inlets of pipes it may be necessary to reposition converters.
[941] Replaces both front and rear converters. Only failed converters may be replaced.
[958] Federal & California Emission vehicles. Not legal for sale for vehicles licensed in California.

91-94 8 Cyl. Town Car, 280 (4.6L) Engine; Dual Exhaust
 1990 8 Cyl. Town Car, 302 (5.0L) Engine; Dual Exhaust

(6216)

2185 replaced by 2208
 64726 replaced by 64755.
 64735 replaced by 64758.
 When inventories are depleted.

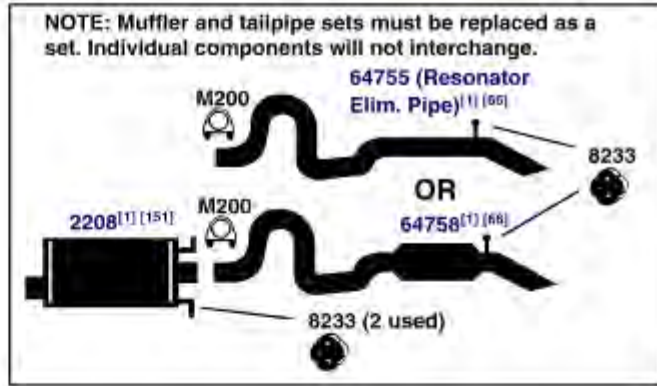

OR

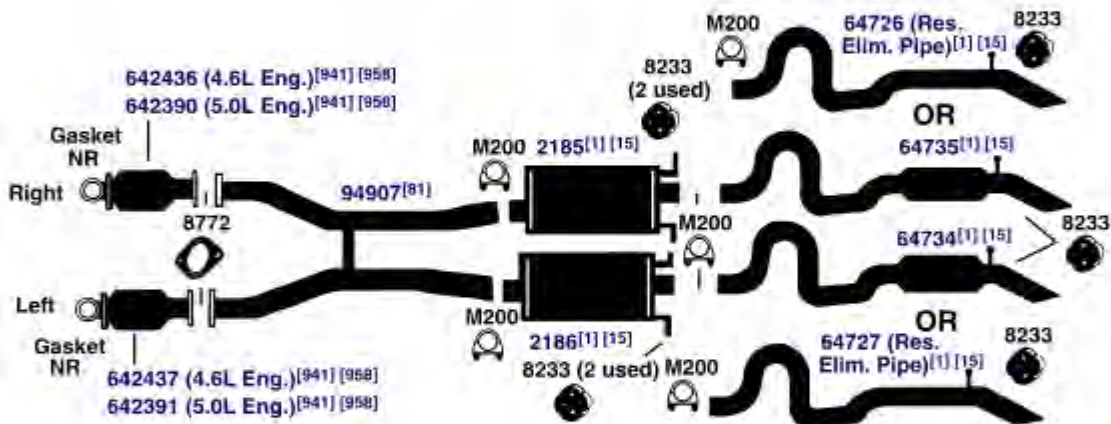

OR

2186 replaced by 2209
 64727 replaced by 64756.
 64734 replaced by 64757.
 When inventories are depleted.

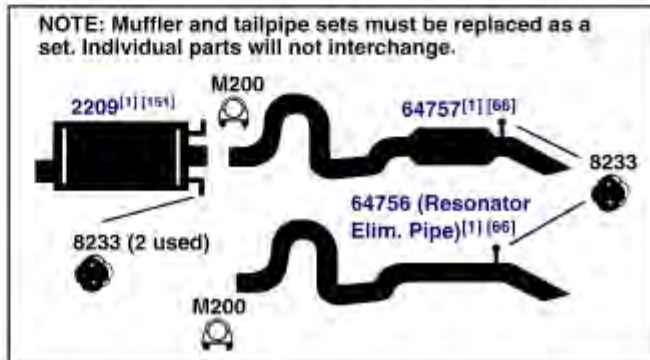

DIRECT FIT MSL/MAXIMUM Muffler... Muffler (option for 2185)-, Right 700042 (Old Design), Muffler (option for 2208)-, Right 700037 (Revised Design), Muffler (option for 2186)-, Left 700043 (Old Design), Muffler (option for 2209)-, Left 700038 (Revised Design), UNIVERSAL FIT MSL/MAXIMUM Muffler... Muffler (option for 2185)-, Right 709012 (Old Design), 709011 (Old Design), Muffler (option for 2208)-, Right 709014 (Revised Design), 709013 (Revised Design), Muffler (option for 2186)-, Left 709012 (Old Design), 709011 (Old Design), Muffler (option for 2209)-, Left 709014 (Revised Design), 709013 (Revised Design)

NA-Not Available. NR-Not Required. FL-Remove and Re-Use Old Flange. ● Golden Warehouse. O.E.-Original Equipment.
 # Airtube Kit [4948] may be required to complete installation. EFI-Electronic Fuel Injection.

[1] OE system was a welded assembly. It is recommended that all parts noted [1] should be replaced.
 [15] Discontinued, use until inventory is depleted.
 [66] Muffler and tailpipe sets must be replaced as a set. Individual components will not interchange.
 [81] To align inlets of pipes it may be necessary to reposition converters.

[151] For Proper sound 2208 and 2209 should be replaced as a pair.
 [938] Direct fit unit contains front and rear converter body. Only failed converters may be replaced.
 [941] Replaces both front and rear converters, Only failed converters may be replaced.
 [958] Federal & California Emission vehicles. Not legal for sale for vehicles licensed in California.

LINCOLN CONTINENTAL, TOWN CAR

(6219) 91-92 6 Cyl. Continental, 3.8L (232) Engine, Dual Exhaust (before 2/92)

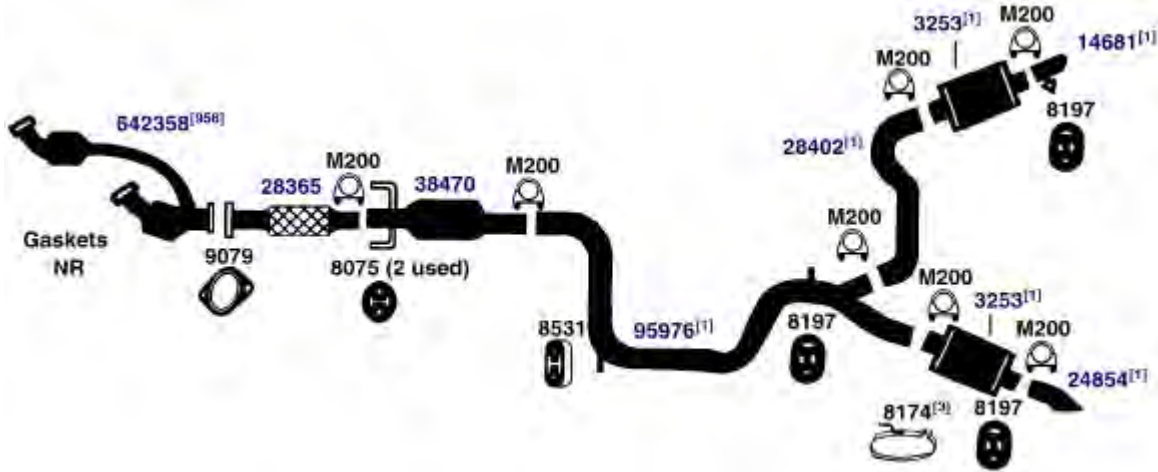

DIRECT FIT MSL/MAXIMUM Muffler... Left Muffler- 700098, Right Muffler- 700098, UNIVERSAL FIT MSL/MAXIMUM Muffler... Left Muffler- 6516, 6538, 709011, 709012, Right Muffler- 6516, 6538, 709011, 709012, Silentone DIY Muffler... Left Muffler- 5533, Right Muffler- 5533

(6218) 1990 6 Cyl. Continental, 3.8L (232) Engine (from 12/89)

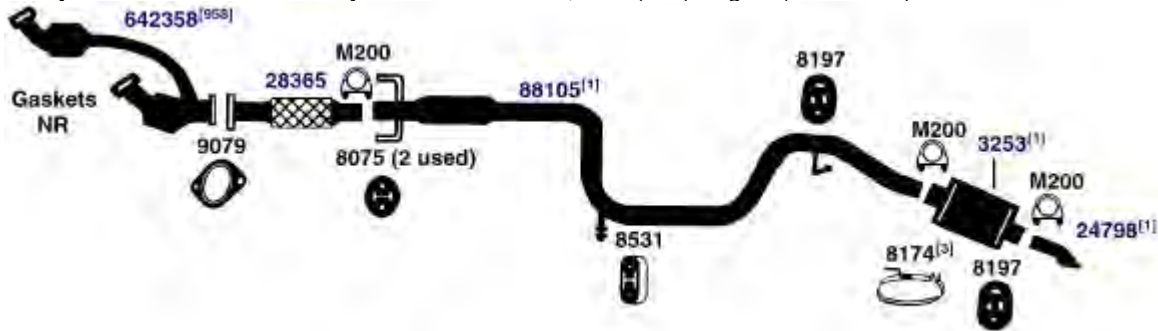

DIRECT FIT MSL/MAXIMUM Muffler... 700098, UNIVERSAL FIT MSL/MAXIMUM Muffler... 6516, 6538, 709011, 709012, Silentone DIY Muffler... 5533

NA-Not Available. NR-Not Required. FL-Remove and Re-Use Old Flange. ● Golden Warehouse. O.E.-Original Equipment.
Airtube Kit [4948] may be required to complete installation. EFI-Electronic Fuel Injection.

- [1] OE system was a welded assembly. It is recommended that all parts noted [1] should be replaced.
- [3] Required for installation.
- [958] Federal & California Emission vehicles. Not legal for sale for vehicles licensed in California.

LINCOLN CONTINENTAL, TOWN CAR

88-90 6 Cyl. Continental, 3.8L (232) Engine (before 12/89)

(6215)

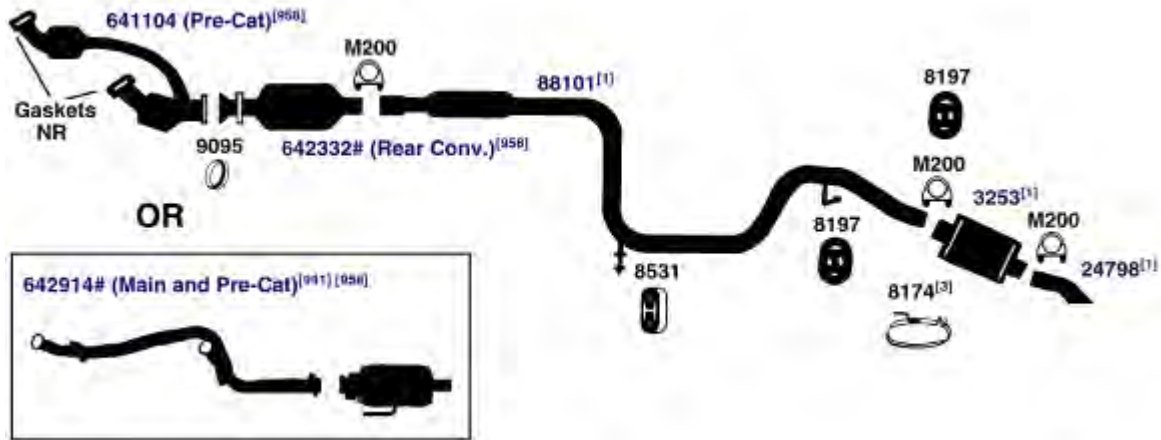

DIRECT FIT MSL/MAXIMUM Muffler... 700098, UNIVERSAL FIT MSL/MAXIMUM Muffler... 6516, 6538, 709011, 709012, Silentone DIY Muffler... 5533

88-89 8 Cyl. Town Car, 302 (5.0L) Engine; Single Exhaust; Models built from 1/88

(6214)

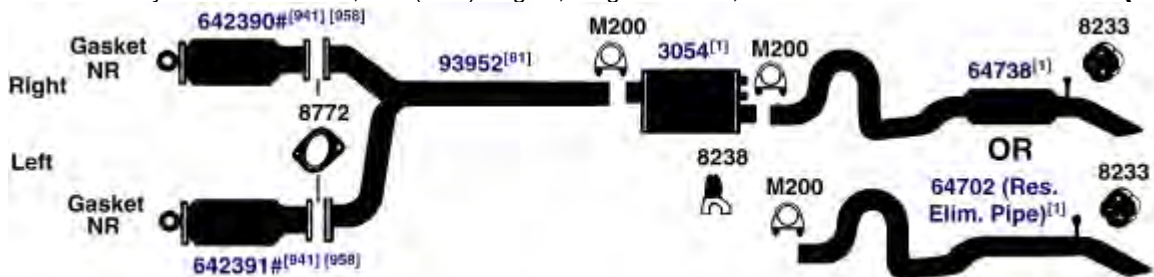

DIRECT FIT MSL/MAXIMUM Muffler... 6554, UNIVERSAL FIT MSL/MAXIMUM Muffler... 6506, 709011, 709012, 709016, Silentone DIY Muffler... 5533

NA-Not Available. NR-Not Required. FL-Remove and Re-Use Old Flange. ● Golden Warehouse. O.E.-Original Equipment.
Airtube Kit [4948] may be required to complete installation. EFI-Electronic Fuel Injection.

- [1] OE system was a welded assembly. It is recommended that all parts noted [1] should be replaced.
- [3] Required for installation.
- [81] To align inlets of pipes it may be necessary to reposition converters.
- [941] Replaces both front and rear converters, Only failed converters may be replaced.
- [958] Federal & California Emission vehicles. Not legal for sale for vehicles licensed in California.

LINCOLN CONTINENTAL, TOWN CAR

(6213) 88-89 8 Cyl. Town Car, 302 (5.0L) Engine; Dual Exhaust; Models built from 1/88

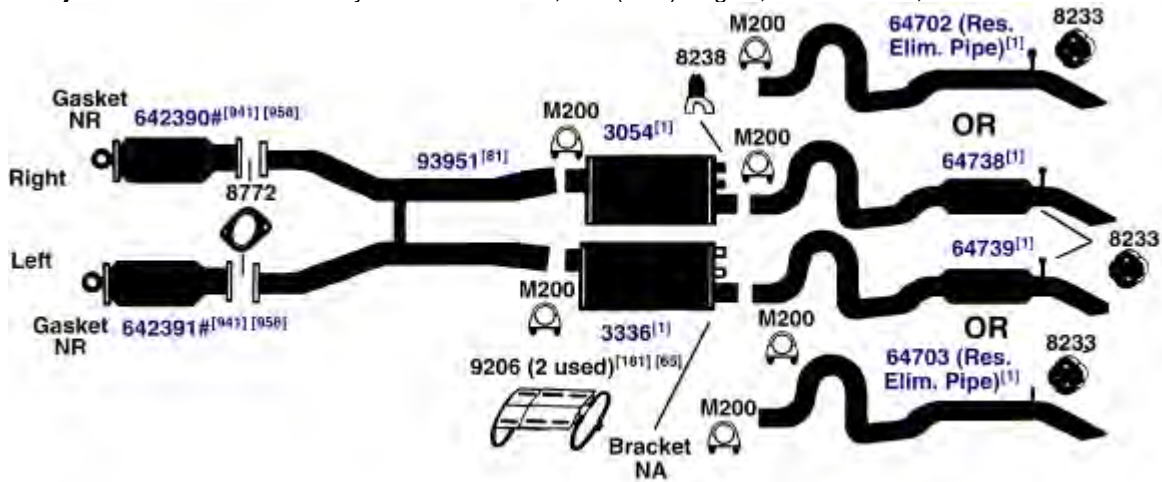

DIRECT FIT MSL/MAXIMUM Muffler... Left- 700006, Right- 6554, UNIVERSAL FIT MSL/MAXIMUM Muffler... Left- 709011, 709012, 709016, Right- 6506, 709011, 709012, 709016, Silentone DIY Muffler... Left- 5533 and 9206 Heat Shield, Right- 5533 and 9206 Heat Shield

(6208) 85-88 8 Cyl. Town Car, 302 (5.0L) Engine; Models built before 1/88

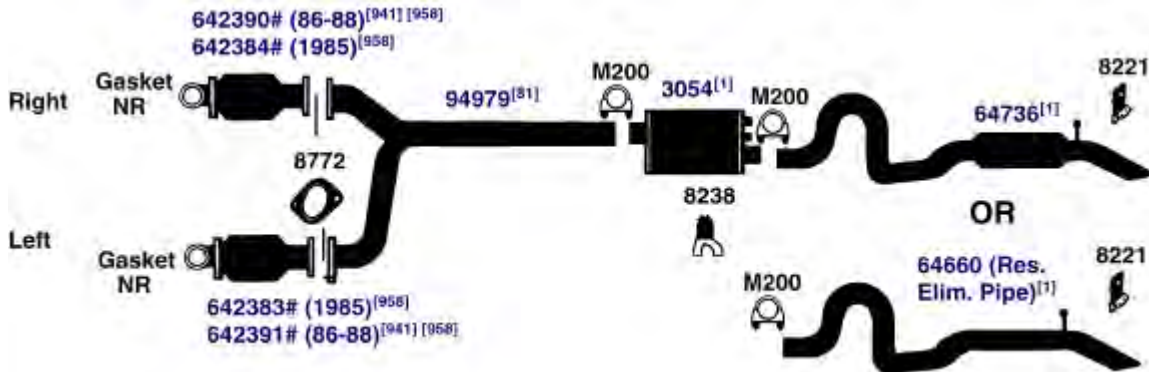

DIRECT FIT MSL/MAXIMUM Muffler... 6554, UNIVERSAL FIT MSL/MAXIMUM Muffler... 6506, 709011, 709012, 709016, Silentone DIY Muffler... 5533

NA-Not Available. NR-Not Required. FL-Remove and Re-Use Old Flange. ● Golden Warehouse. O.E.-Original Equipment.
Airtube Kit [4948] may be required to complete installation. EFI-Electronic Fuel Injection.

[1] OE system was a welded assembly. It is recommended that all parts noted [1] should be replaced.
[65] Heat Shield 9206 is required for installation.
[81] To align inlets of pipes it may be necessary to reposition converters.

[181] Required for installation on Police models and models with Trailer Towing Package.
[941] Replaces both front and rear converters, Only failed converters may be replaced.
[958] Federal & California Emission vehicles. Not legal for sale for vehicles licensed in California.

LINCOLN CONTINENTAL, TOWN CAR

85-88 8 Cyl. Town Car, 302 (5.0L) Engine; Dual Exhaust; Models built before 1/88 **(6212)**

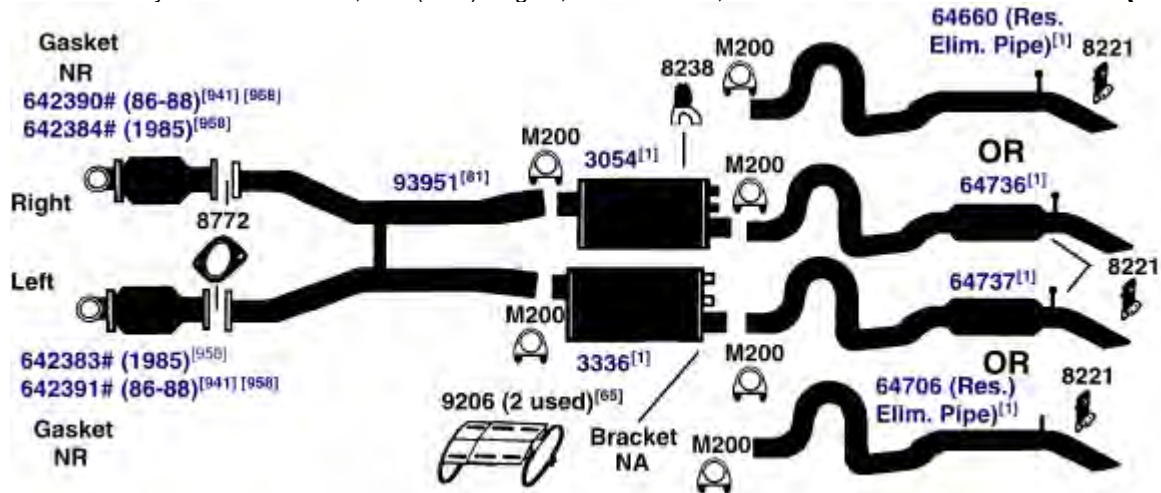

DIRECT FIT MSL/MAXIMUM Muffler... Left- 700006, Right- 6554, UNIVERSAL FIT MSL/MAXIMUM Muffler... Left- 709011, 709012, 709016, Right- 6506, 709011, 709012, 709016, Silentone DIY Muffler... Left- 5533 and 9206 Heat Shield, Right- 5533 and 9206 Heat Shield

86-87 8 Cyl. Continental, 302 (5.0L) Engine; Single Exhaust **(6210)**

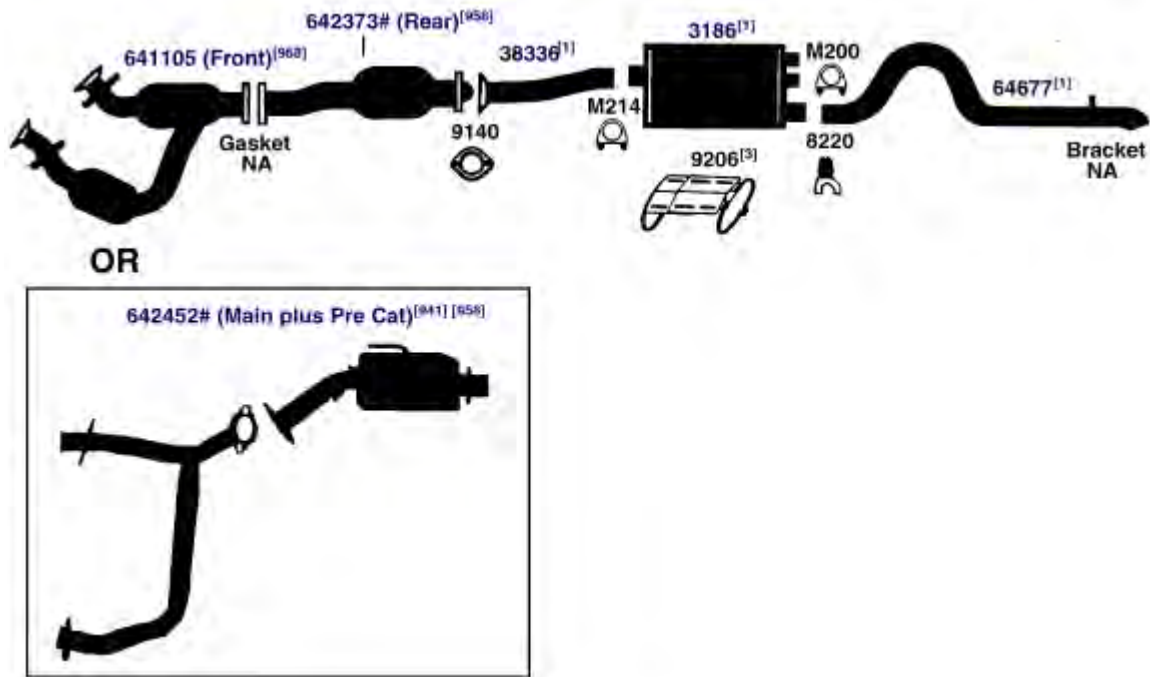

UNIVERSAL FIT MSL/MAXIMUM Muffler... 6543, 709012, Silentone DIY Muffler... 5533 and 9206 Heat Shield

NA-Not Available. NR-Not Required. FL-Remove and Re-Use Old Flange. ● Golden Warehouse. O.E.-Original Equipment.
Airtube Kit [4948] may be required to complete installation. EFI-Electronic Fuel Injection.

- [1] OE system was a welded assembly. It is recommended that all parts noted [1] should be replaced.
- [3] Required for installation.
- [65] Heat Shield 9206 is required for installation.
- [81] To align inlets of pipes it may be necessary to reposition converters.
- [941] Replaces both front and rear converters, Only failed converters may be replaced.
- [958] Federal & California Emission vehicles. Not legal for sale for vehicles licensed in California.

LINCOLN CONTINENTAL, TOWN CAR

(6211) 86-87 8 Cyl. Continental, 302 (5.0L) Engine; Dual Exhaust

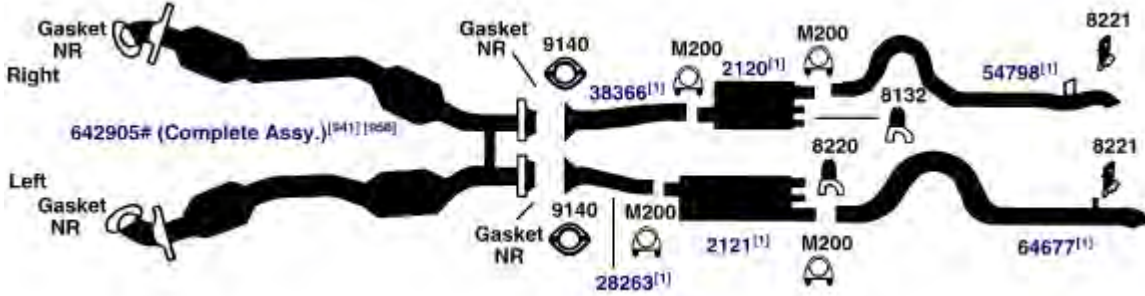

DIRECT FIT MSL/MAXIMUM Muffler... Left- 700237, Right- 700236, UNIVERSAL FIT MSL/MAXIMUM Muffler... Left- 6516, 709011, 709012, Right- 709003, 709006, Silentone DIY Muffler... Left- 5565 and 8248 Bracket and 9206 Heat Shield, Right- 5565 and 8248 Bracket and 9206 Heat Shield

(6207) 1985 8 Cyl. Continental, 302 (5.0L) Engine

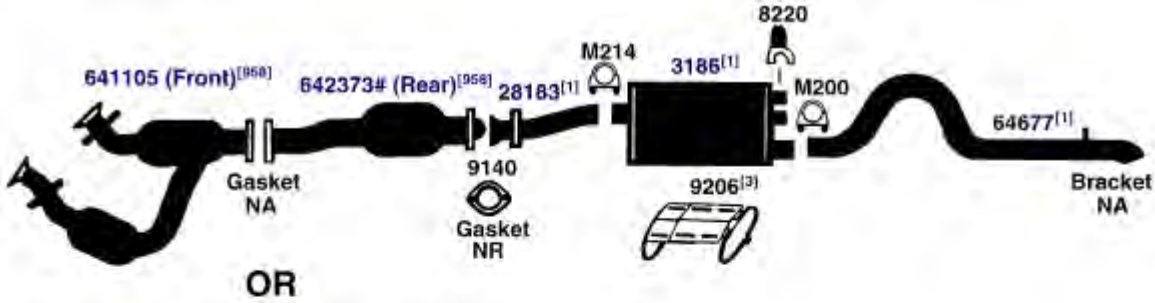

UNIVERSAL FIT MSL/MAXIMUM Muffler... 6543, 709012, Silentone DIY Muffler... 5533 and 9206 Heat Shield

NA-Not Available. NR-Not Required. FL-Remove and Re-Use Old Flange. ● Golden Warehouse. O.E.-Original Equipment.
Airtube Kit [4948] may be required to complete installation. EFI-Electronic Fuel Injection.

[1] OE system was a welded assembly. It is recommended that all parts noted [1] should be replaced.
[3] Required for installation.

[941] Replaces both front and rear converters, Only failed converters may be replaced.
[958] Federal & California Emission vehicles. Not legal for sale for vehicles licensed in California.

LINCOLN CONTINENTAL, TOWN CAR

83-84 8 Cyl. Town Car, 302 (5.0L) Engine

(6208E)

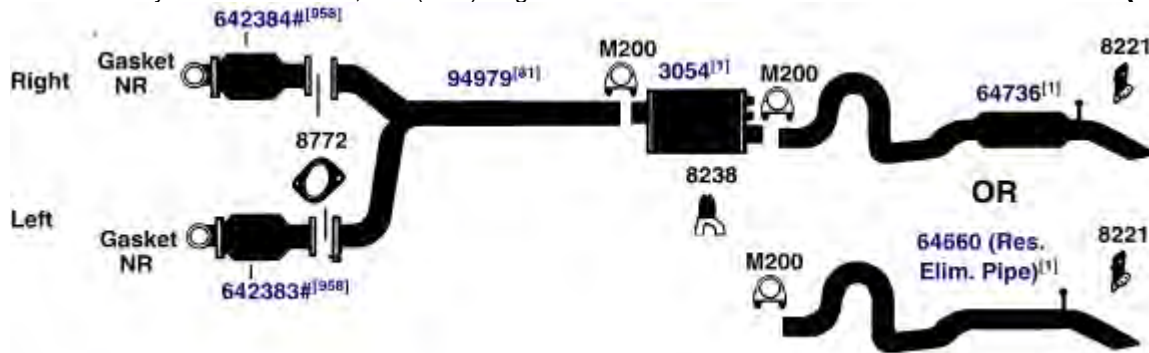

DIRECT FIT MSL/MAXIMUM Muffler... 6554, UNIVERSAL FIT MSL/MAXIMUM Muffler... 6506, 709011, 709012, 709016, Silentone DIY Muffler... 5533

83-84 8 Cyl. Continental, 302 (5.0L) Engine

(6207E)

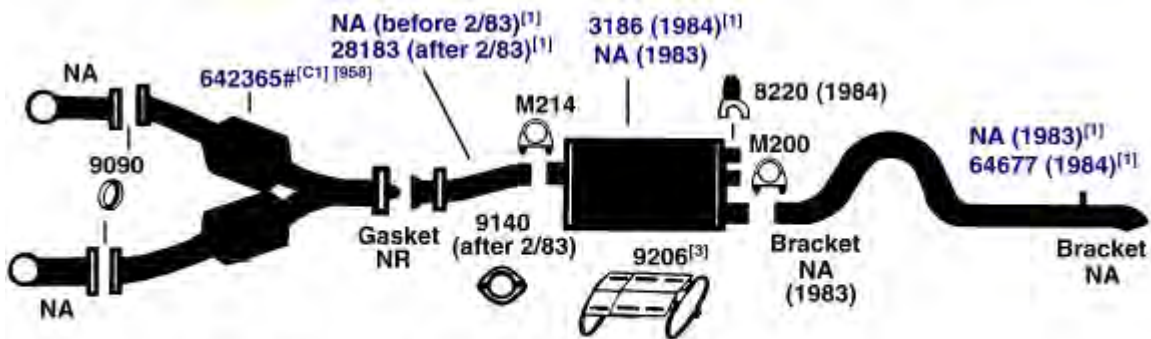

^[C1] Exc. Calif. Combination Front & Rear Converter, 2 to 1 Replacement Only Defective Converters May Legally Be Replaced.

UNIVERSAL FIT MSL/MAXIMUM Muffler... 6543, 709012, Silentone DIY Muffler... 5533 and 9206 Heat Shield

NA-Not Available. NR-Not Required. FL-Remove and Re-Use Old Flange. ● Golden Warehouse. O.E.-Original Equipment.
Airtube Kit [4948] may be required to complete installation. EFI-Electronic Fuel Injection.

- [1] OE system was a welded assembly. It is recommended that all parts noted [1] should be replaced.
- [3] Required for installation.

- [81] To align inlets of pipes it may be necessary to reposition converters.
- [958] Federal & California Emission vehicles. Not legal for sale for vehicles licensed in California.

LINCOLN CONTINENTAL, TOWN CAR

(6212E) 82-84 8 Cyl. Town Car, 5.0L, 302 Engine; Dual Exhaust

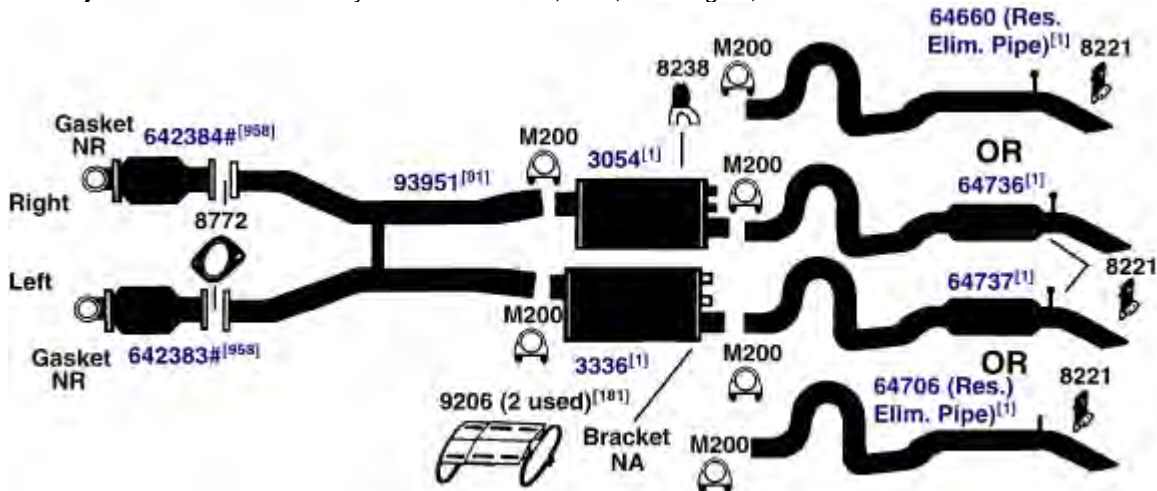

DIRECT FIT MSL/MAXIMUM Muffler... Left- 700006, Right- 6554, UNIVERSAL FIT MSL/MAXIMUM Muffler... Left- 709011, 709012, 709016, Right- 6506, 709011, 709012, 709016, Silentone DIY Muffler... Left- 5533 and 9206 Heat Shield, Right- 5533 and 9206 Heat Shield

(6204) 81-82 8 Cyl. Town Car, 5.0L, 302 Engine
1981 8 Cyl. Continental, 5.0L, 302 Engine

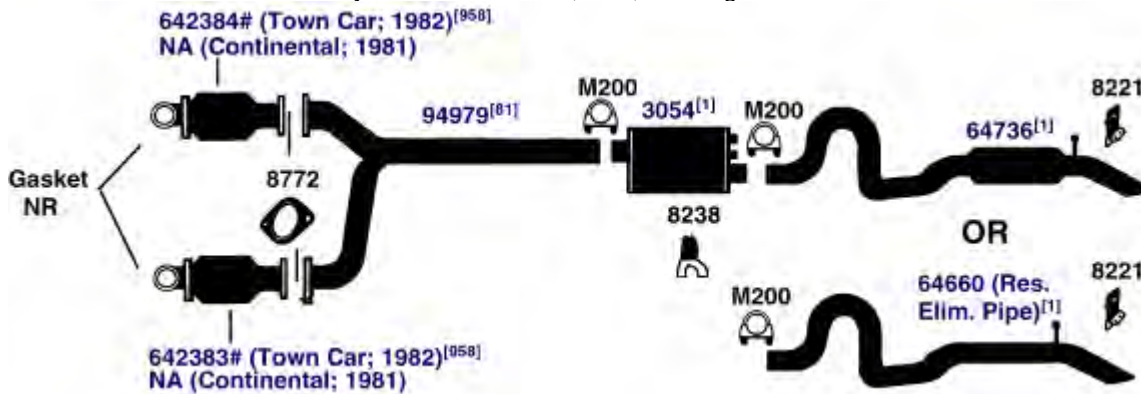

DIRECT FIT MSL/MAXIMUM Muffler... 6554, UNIVERSAL FIT MSL/MAXIMUM Muffler... 6506, 709011, 709012, 709016, Silentone DIY Muffler... 5533

(6203) 1980 8 Cyl. Continental, 302, 351 Engine

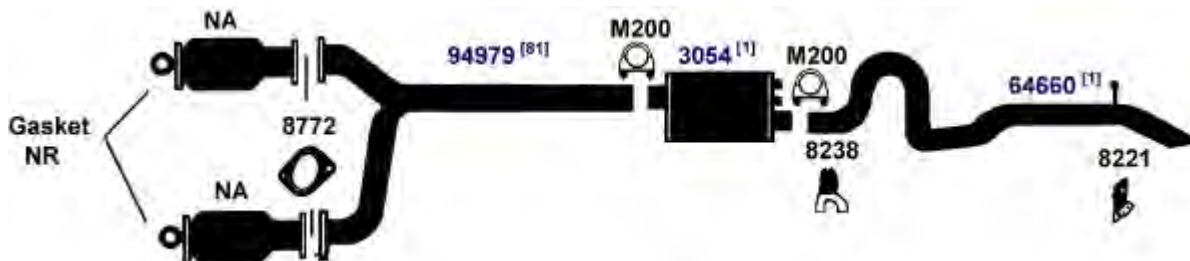

DIRECT FIT MSL/MAXIMUM Muffler... 6554, UNIVERSAL FIT MSL/MAXIMUM Muffler... 6506, 709011, 709012, 709016, Silentone DIY Muffler... 5533

NA-Not Available. NR-Not Required. FL-Remove and Re-Use Old Flange. ● Golden Warehouse. O.E.-Original Equipment.

Airtube Kit [4948] may be required to complete installation. EFI-Electronic Fuel Injection.

[1] OE system was a welded assembly. It is recommended that all parts noted [1] should be replaced.

[81] To align inlets of pipes it may be necessary to reposition converters.

[98] Refer to current Catalytic Converter catalog or Website catalog for availability.

[181] Required for installation on Police models and models with Trailer Towing Package.

[958] Federal & California Emission vehicles. Not legal for sale for vehicles licensed in California.

93-94 8 Cyl. Mark VIII, 280 (4.6L) Engine

(6277)

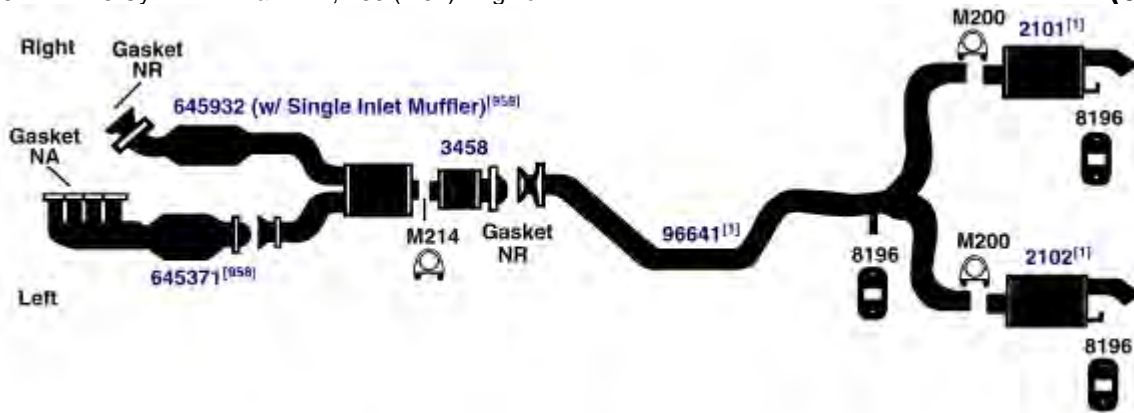

86-92 8 Cyl. Mark VII, 302 (5.0L) Engine, Dual Exhaust

(6276)

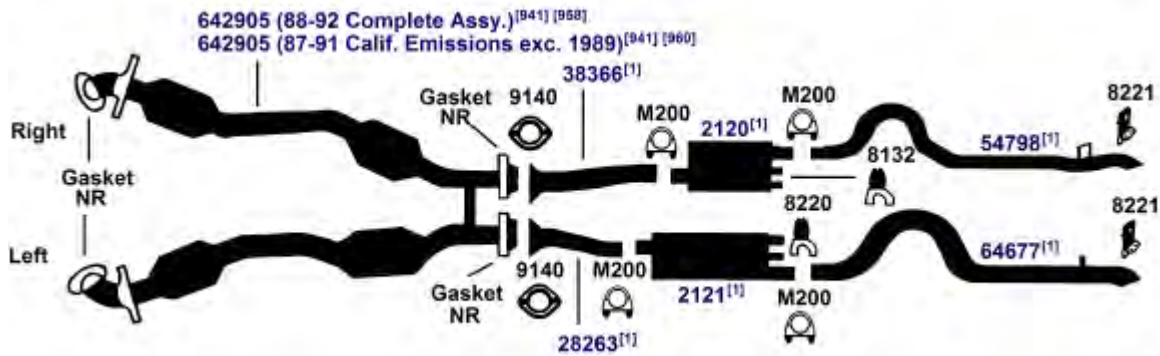

DIRECT FIT MSL/MAXIMUM Muffler... Left- 700237, Right- 700236, UNIVERSAL FIT MSL/MAXIMUM Muffler... Left- 6516, 709011, 709012, Right- 709003, 709006, Silentone DIY Muffler... Left- 5565 and 8248 Bracket and 9206 Heat Shield, Right- 5565 and 8248 Bracket and 9206 Heat Shield

86-87 8 Cyl. Mark VII, 302 (5.0L) Engine

(6275)

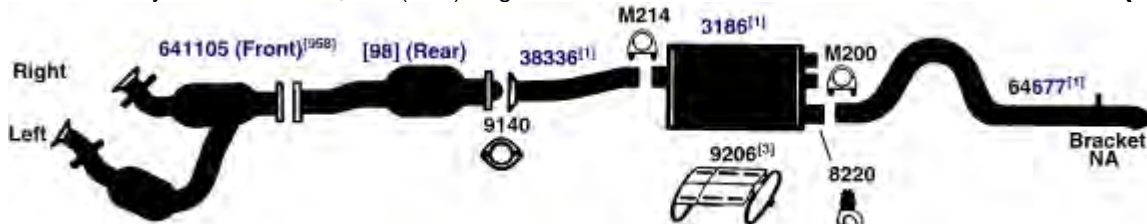

UNIVERSAL FIT MSL/MAXIMUM Muffler... 6543, 709012, Silentone DIY Muffler... 5533 and 9206 Heat Shield

NA-Not Available. NR-Not Required. FL-Remove and Re-Use Old Flange. ● Golden Warehouse. O.E.-Original Equipment.
Airtube Kit [4948] may be required to complete installation. EFI-Electronic Fuel Injection.

- [1] OE system was a welded assembly. It is recommended that all parts noted [1] should be replaced.
- [3] Required for installation.
- [98] Refer to current Catalytic Converter catalog or Website catalog for availability.

- [941] Replaces both front and rear converters, Only failed converters may be replaced.
- [958] Federal & California Emission vehicles. Not legal for sale for vehicles licensed in California.
- [960] California Emission vehicles licensed in states other than California. Not legal for sale for vehicles licensed in California.

LINCOLN MARK VI,VII,VIII

(6274) 1985 8 Cyl. Mark VII, 302 (5.0L) Engine

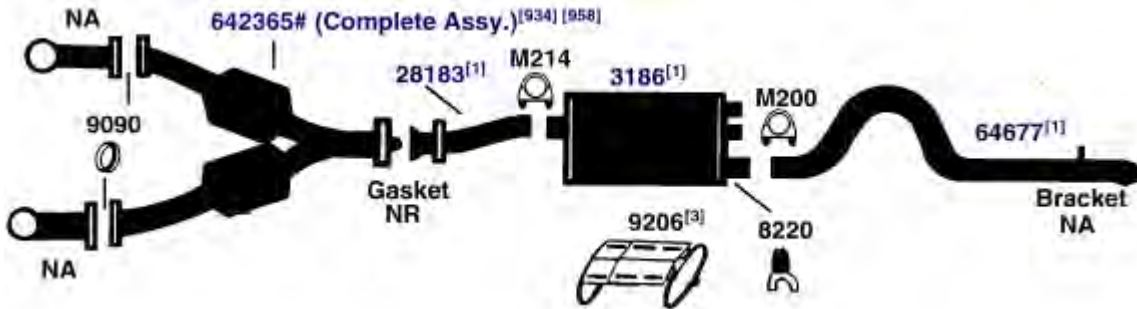

UNIVERSAL FIT MSL/MAXIMUM Muffler... 6543, 709012, Silentone DIY Muffler... 5533 and 9206 Heat Shield

(6274E) 1984 8 Cyl. Mark VII, 302 (5.0L) Engine

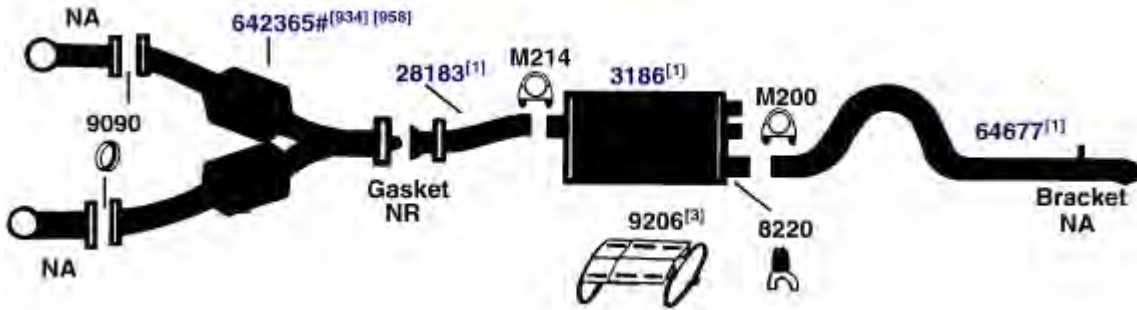

UNIVERSAL FIT MSL/MAXIMUM Muffler... 6543, 709012, Silentone DIY Muffler... 5533 and 9206 Heat Shield

(6272) 80-83 8 Cyl. Mark VI, All Models with 302 (5.0L), 351 (5.8L) Engine

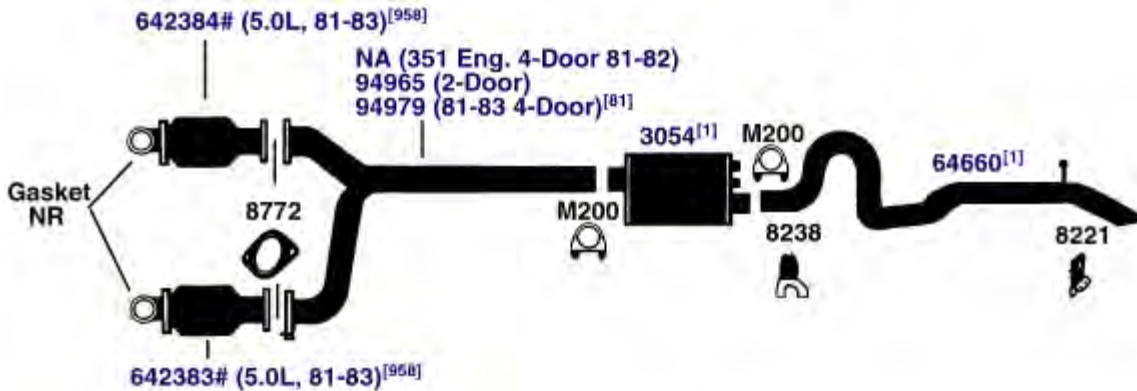

DIRECT FIT MSL/MAXIMUM Muffler... 6554, UNIVERSAL FIT MSL/MAXIMUM Muffler... 6506, 709011, 709012, 709016, Silentone DIY Muffler... 5533

NA-Not Available. NR-Not Required. FL-Remove and Re-Use Old Flange. ● Golden Warehouse. O.E.-Original Equipment.
Airtube Kit [4948] may be required to complete installation. EFI-Electronic Fuel Injection.

[1] OE system was a welded assembly. It is recommended that all parts noted [1] should be replaced.

[3] Required for installation.

[81] To align inlets of pipes it may be necessary to reposition converters.

[934] Replaces multiple OE Converters. Only failed converters may be replaced.

[958] Federal & California Emission vehicles. Not legal for sale for vehicles licensed in California.

90-94 4 Cyl. 323, 1.6L Engine

(11403)

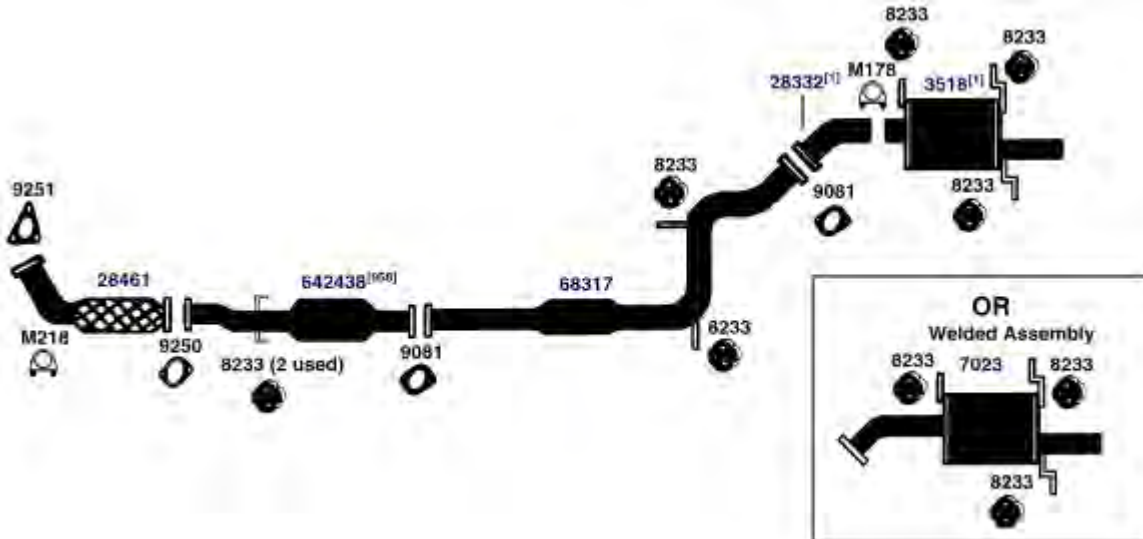

DIRECT FIT MSL/MAXIMUM Muffler... Split System- 700139

90-94 4 Cyl. 323 Protege, 1.8L Engine, DOHC, 2WD

(11402)

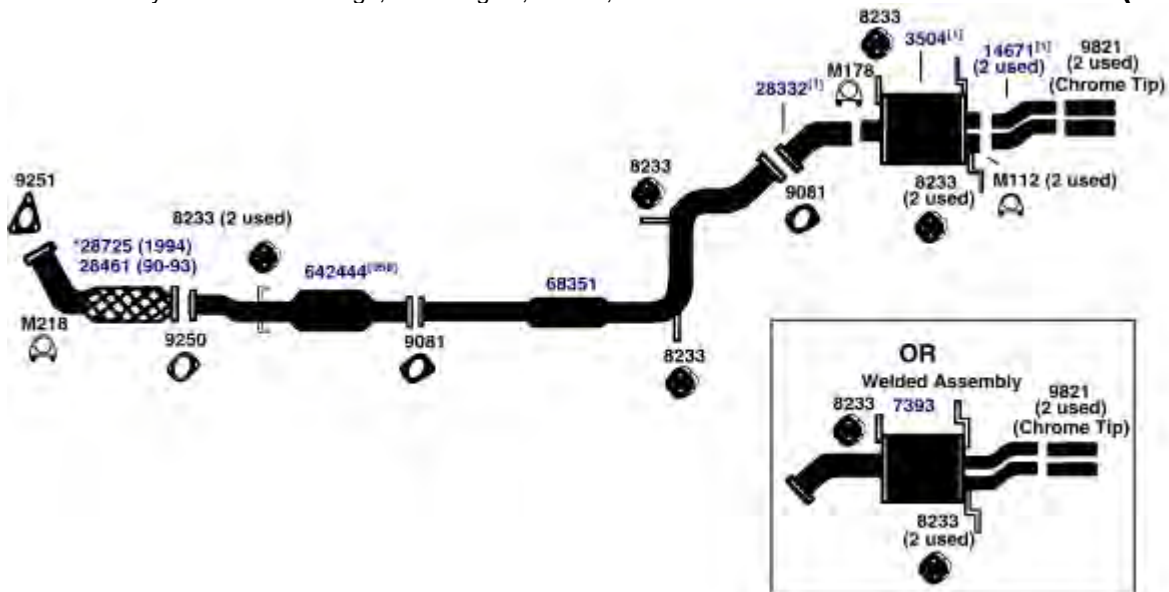

DIRECT FIT MSL/MAXIMUM Muffler... Split System- 700165

NA-Not Available. NR-Not Required. FL-Remove and Re-Use Old Flange. ● Golden Warehouse. O.E.-Original Equipment.
Airtube Kit [4948] may be required to complete installation. EFI-Electronic Fuel Injection.

[1] OE system was a welded assembly. It is recommended that all parts noted [1] should be replaced. [958] Federal & California Emission vehicles. Not legal for sale for vehicles licensed in California.

MAZDA 323, PROTEGE

(11401) 90-94 4 Cyl. 323 Protege, 1.8L Engine, SOHC, 2WD.

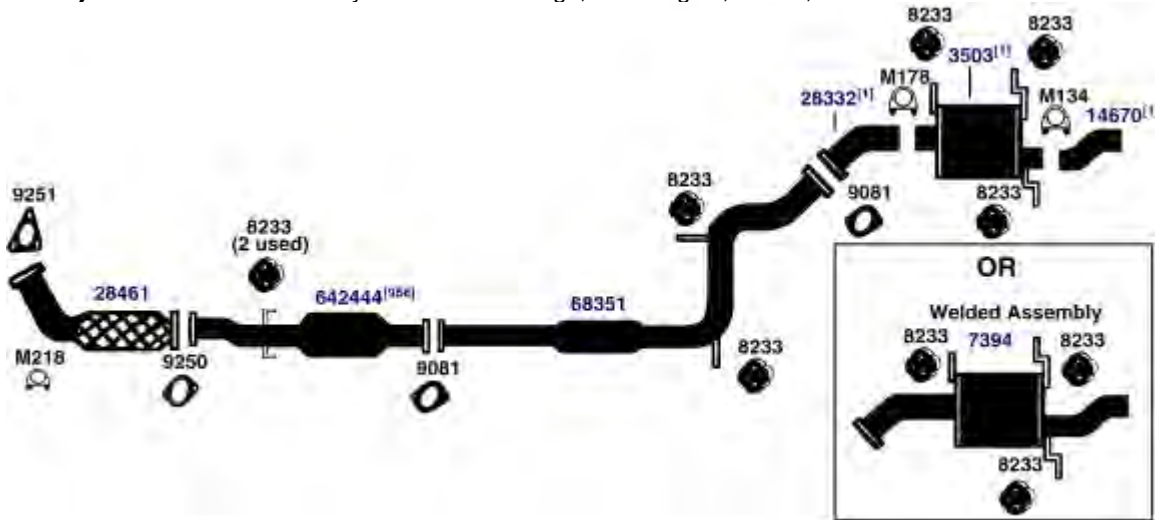

DIRECT FIT MSL/MAXIMUM Muffler... Split System- 700137

(11400) 86-89 4 Cyl. 323 Sedan, Hatchback, 1.6L Fuel Injection Engine; except Turbo
87-88 4 Cyl. 323 Sta. Wagon, 1.6L Fuel Injection Engine; except Turbo

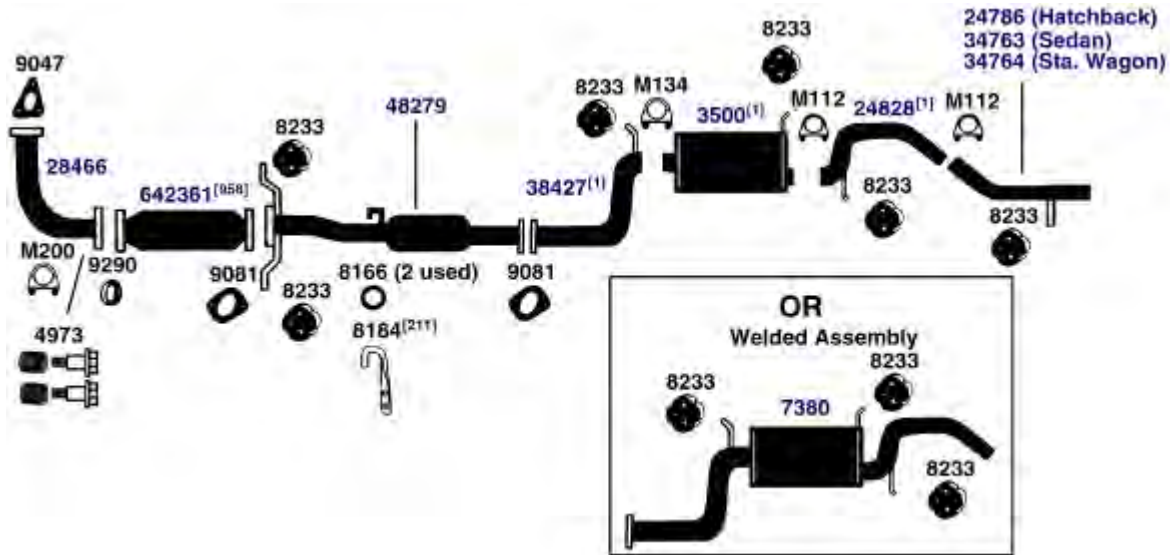

DIRECT FIT MSL/MAXIMUM Muffler... Split System- 700136, UNIVERSAL FIT MSL/MAXIMUM Muffler... Split System- 6653

NA-Not Available. NR-Not Required. FL-Remove and Re-Use Old Flange. ● Golden Warehouse. O.E.-Original Equipment.
Airtube Kit [4948] may be required to complete installation. EFI-Electronic Fuel Injection.

[1] OE system was a welded assembly. It is recommended that all parts noted [1] should be replaced. [958] Federal & California Emission vehicles. Not legal for sale for vehicles licensed in California.

[211] Not required if label on pipe 48279 has black triangle.

93-94 4 Cyl. 626, 2.0L Engine

(6515)

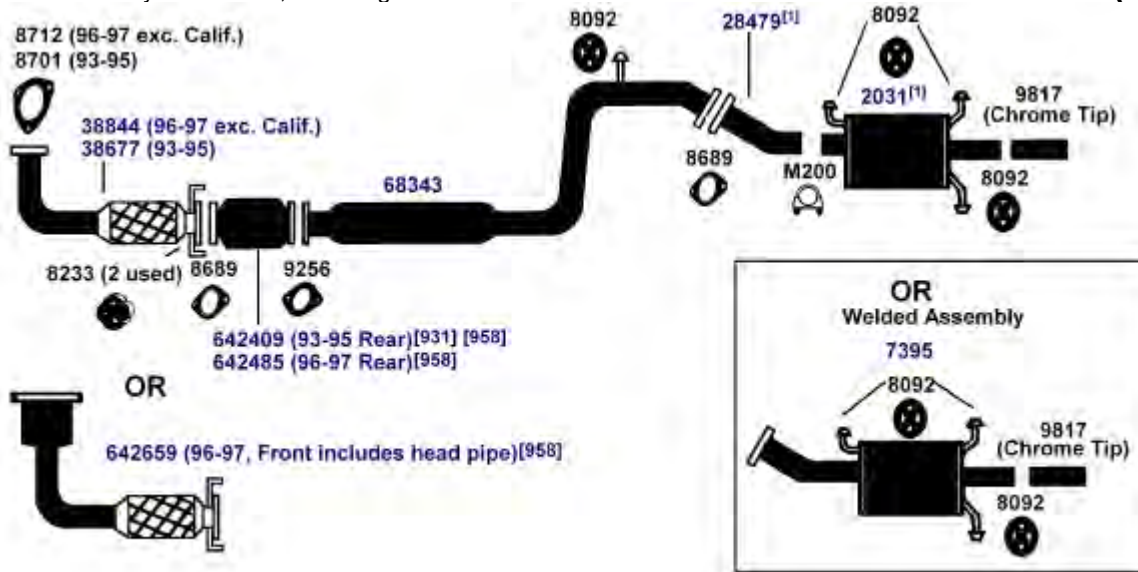

DIRECT FIT MSL/MAXIMUM Muffler... Split System- 700155

93-94 6 Cyl. 626, 2.5L Engine

(6514)

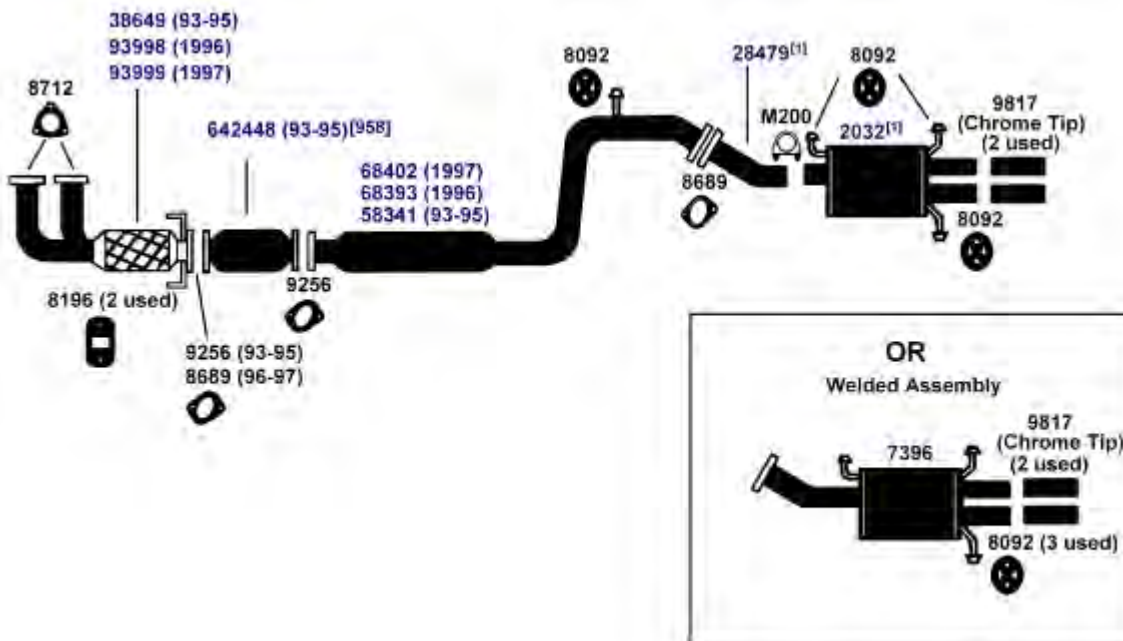

DIRECT FIT MSL/MAXIMUM Muffler... Split System- 700212

NA-Not Available. NR-Not Required. FL-Remove and Re-Use Old Flange. ● Golden Warehouse. O.E.-Original Equipment.
Airtube Kit [4948] may be required to complete installation. EFI-Electronic Fuel Injection.

[1] OE system was a welded assembly. It is recommended that all parts noted [1] should be replaced.

[931] This unit was designed to fit many applications. Measurement of the old unit and cutting of new unit is required.

[958] Federal & California Emission vehicles. Not legal for sale for vehicles licensed in California.

MAZDA 626

(6513)	88-92	4 Cyl.	626, 2.2L Engine; except Turbo
	88-91	4 Cyl.	626, 2.2L Turbo Engine; except 4-Wheel Steering

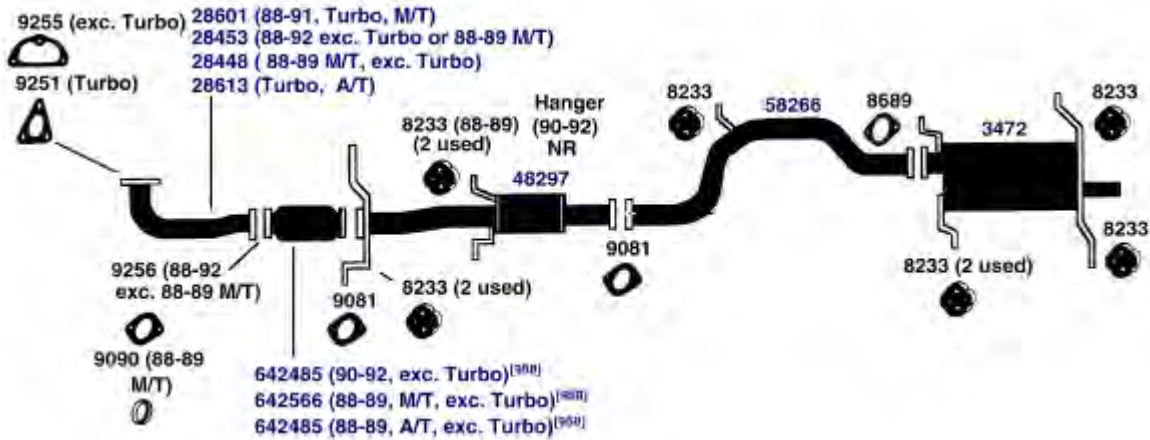

DIRECT FIT MSL/MAXIMUM Muffler... 6593, UNIVERSAL FIT MSL/MAXIMUM Muffler... 6529

MAZDA 929

(12301)	92-94	6 Cyl.	929, 3.0L Engine, DOHC
----------------	--------------	--------	------------------------

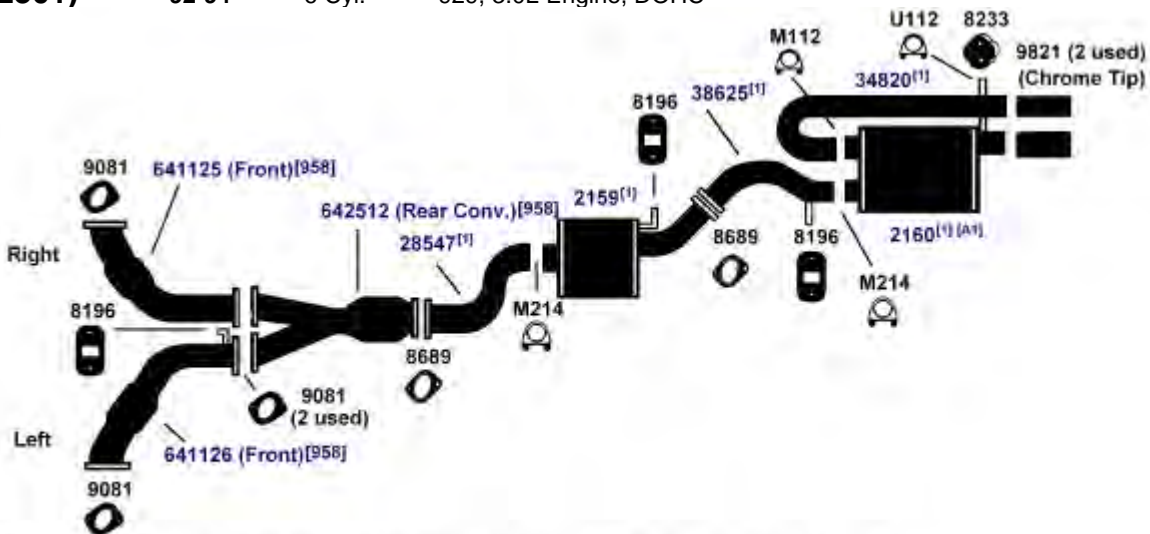

[A1] 92-93 Models do not have valve. Leave rubber boot from O.E. muffler inserted in trunk.

DIRECT FIT MSL/MAXIMUM Muffler... Front Muffler- 700251, Rear Muffler- 700412 [A1]

NA-Not Available. NR-Not Required. FL-Remove and Re-Use Old Flange. • Golden Warehouse. O.E.-Original Equipment.
Airtube Kit [4948] may be required to complete installation. EFI-Electronic Fuel Injection.

- [1] OE system was a welded assembly. It is recommended that all parts noted [1] should be replaced. [958] Federal & California Emission vehicles. Not legal for sale for vehicles licensed in California.

MAZDA 929

88-91 6 Cyl. 929 Sedan, 3.0L Engine, SOHC (exc. 929S w/double overhead cam)

(12300)

UNIVERSAL FIT MSL/MAXIMUM Muffler... 6571, 709993

MAZDA MPV

1994 6 Cyl. MPV; 3.0L Engine, 2 W.D. (From 8-1-94)

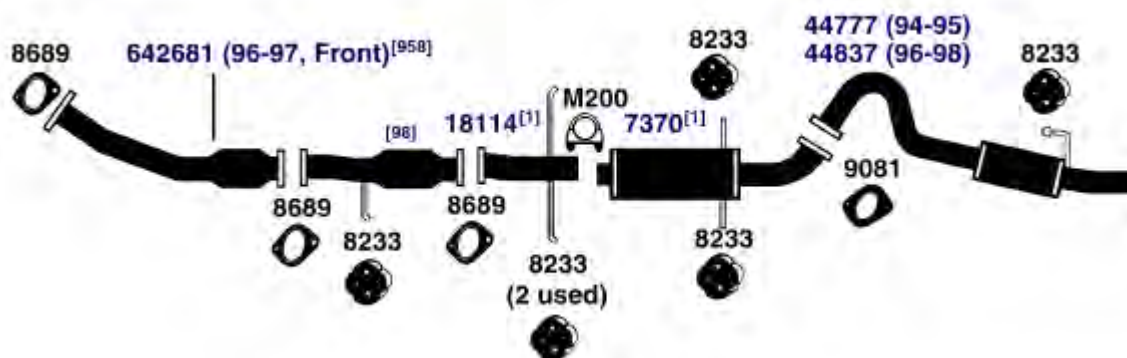
(30413)

89-94 4 Cyl. MPV; 2.6L Engine

(30412)

89-94 6 Cyl. MPV; 3.0L Engine, 2 W.D. (To 8-1-94)

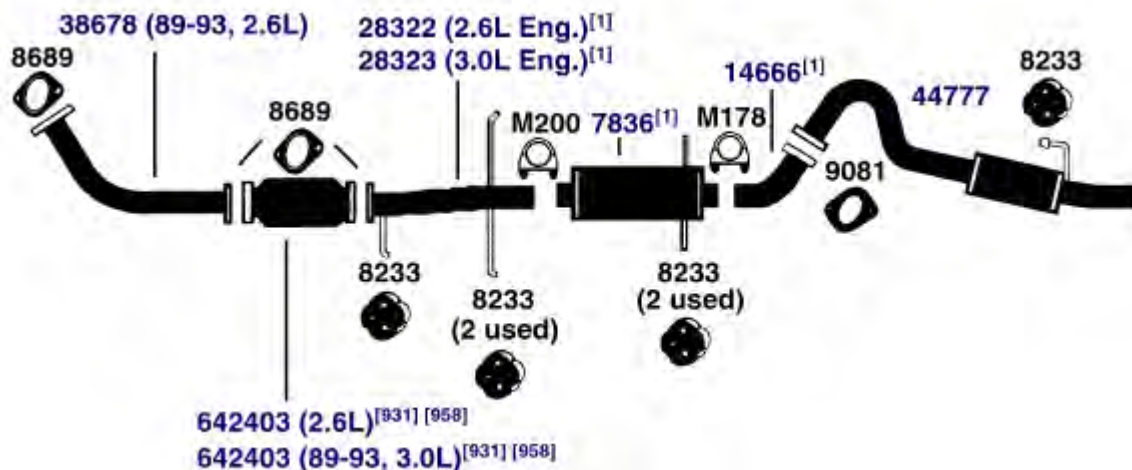

UNIVERSAL FIT MSL/MAXIMUM Muffler... Front Muffler- 6512, 709994

NA-Not Available. NR-Not Required. FL-Remove and Re-Use Old Flange. ● Golden Warehouse. O.E.-Original Equipment.
 # Airtube Kit [4948] may be required to complete installation. EFI-Electronic Fuel Injection.

[1] OE system was a welded assembly. It is recommended that all parts noted [1] should be replaced.

[98] Refer to current Catalytic Converter catalog or Website catalog for availability.

[931] This unit was designed to fit many applications. Measurement of the old unit and cutting of new unit is required.

[958] Federal & California Emission vehicles. Not legal for sale for vehicles licensed in California.

MAZDA MPV

(30411) 89-94 6 Cyl. MPV; 3.0L Engine, 4 W.D.

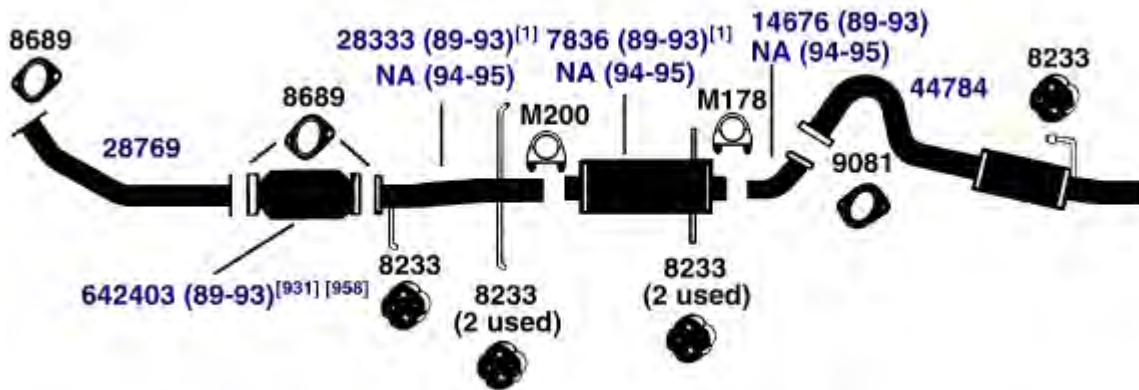

UNIVERSAL FIT MSL/MAXIMUM Muffler... Front Muffler- 6512, 709994

MAZDA MX-3

(13777) 1994 4 Cyl. MX-3, 1.6L Engine

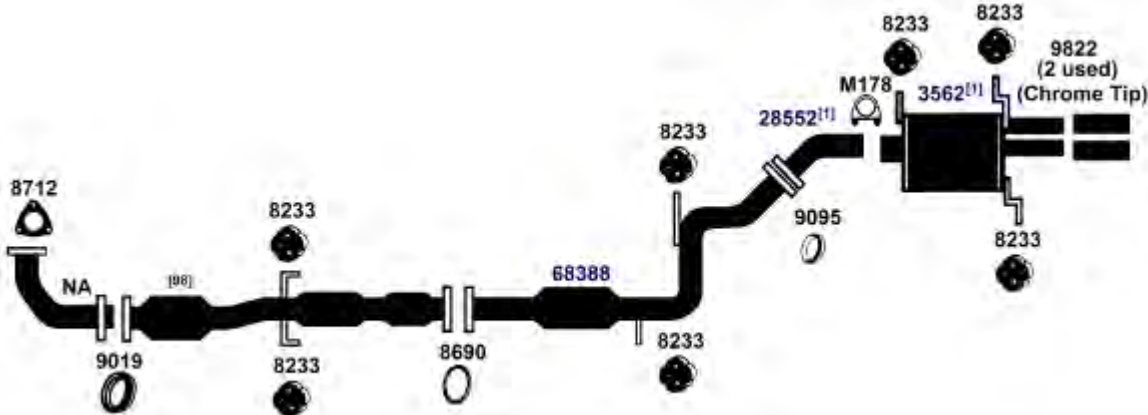

DIRECT FIT MSL/MAXIMUM Muffler... 700287

NA-Not Available. NR-Not Required. FL-Remove and Re-Use Old Flange. ● Golden Warehouse. O.E.-Original Equipment.
Airtube Kit [4948] may be required to complete installation. EFI-Electronic Fuel Injection.

- [1] OE system was a welded assembly. It is recommended that all parts noted [1] should be replaced.
[98] Refer to current Catalytic Converter catalog or Website catalog for availability.

- [931] This unit was designed to fit many applications. Measurement of the old unit and cutting of new unit is required.
[958] Federal & California Emission vehicles. Not legal for sale for vehicles licensed in California.

92-94 6 Cyl. MX-3, 1.8L Engine

(13775)

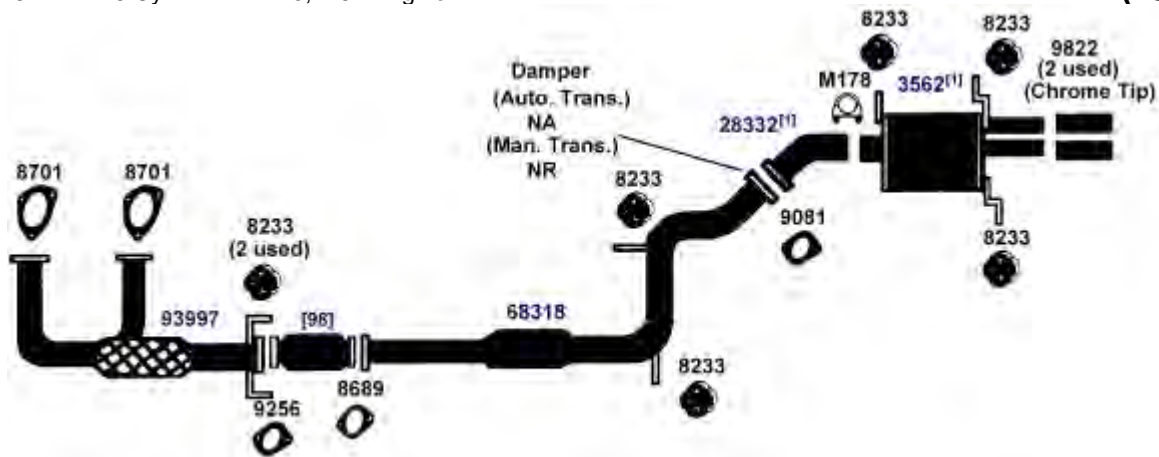

DIRECT FIT MSL/MAXIMUM Muffler... 700287

92-93 4 Cyl. MX-3, 1.6L Engine

(13776)

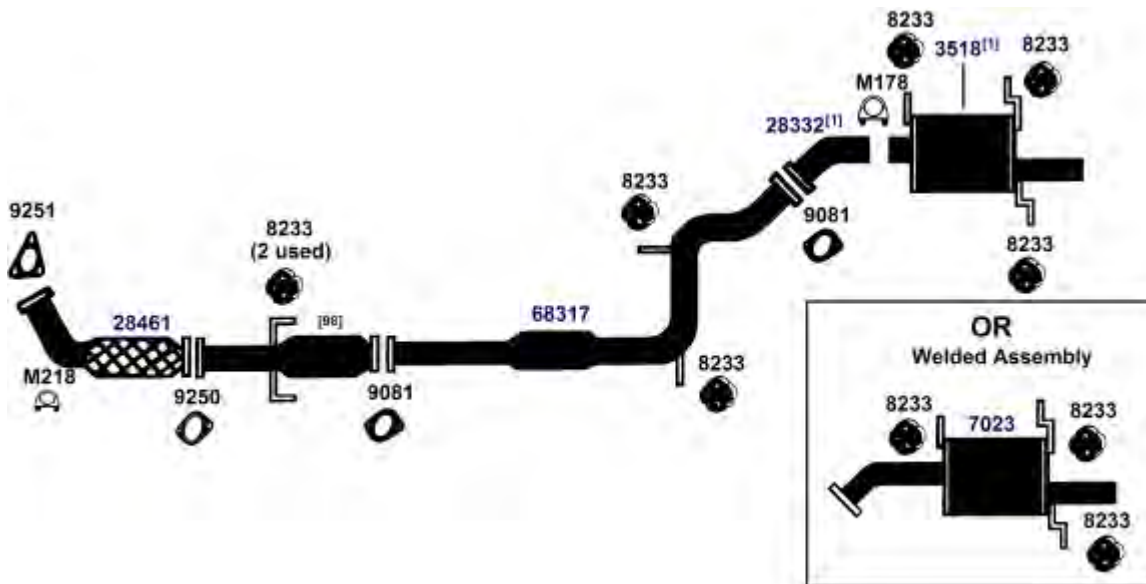

DIRECT FIT MSL/MAXIMUM Muffler... Split System- 700139

NA-Not Available. NR-Not Required. FL-Remove and Re-Use Old Flange. ● Golden Warehouse. O.E.-Original Equipment.
Airtube Kit [4948] may be required to complete installation. EFI-Electronic Fuel Injection.

[1] OE system was a welded assembly. It is recommended that all parts noted [1] should be replaced. [98] Refer to current Catalytic Converter catalog or Website catalog for availability.

MAZDA MX-5 MIATA

(12750) 90-94 4 Cyl. MX-5 Miata, 1.6L and 1.8L Engine

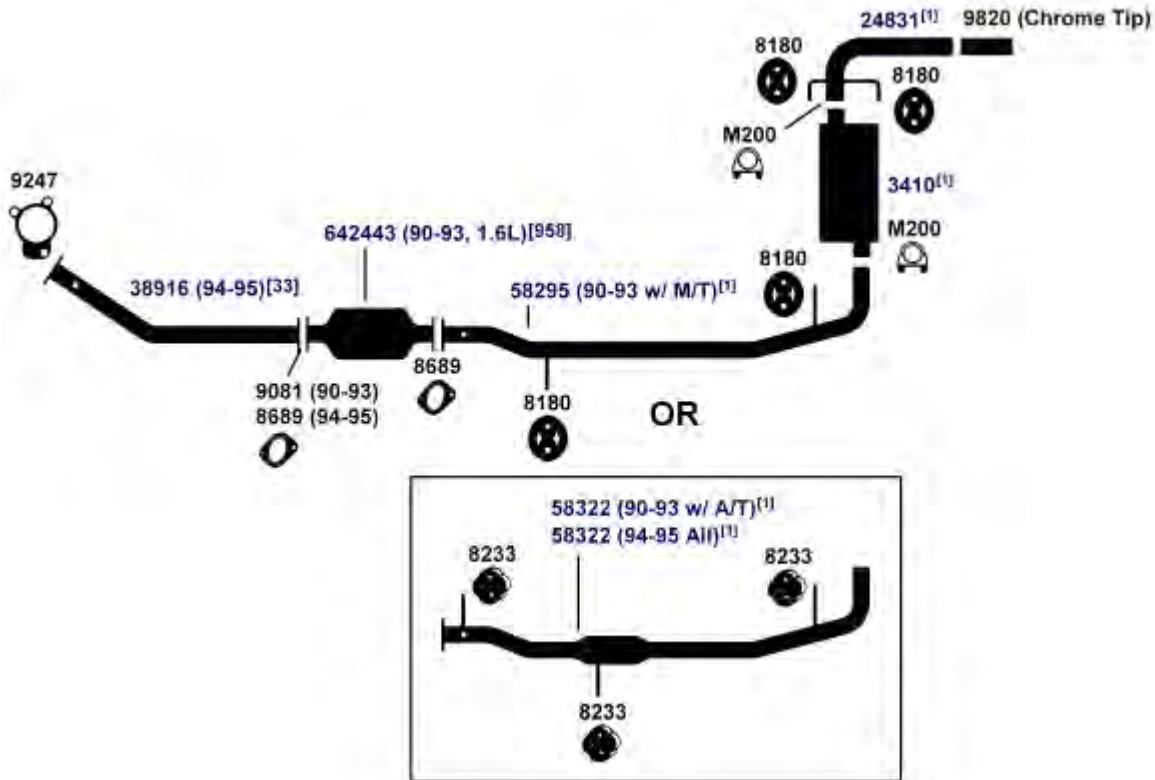

DIRECT FIT MSL/MAXIMUM Muffler... 700320, UNIVERSAL FIT MSL/MAXIMUM Muffler... 709017

NA-Not Available. NR-Not Required. FL-Remove and Re-Use Old Flange. ● Golden Warehouse. O.E.-Original Equipment.
Airtube Kit [4948] may be required to complete installation. EFI-Electronic Fuel Injection.

[1] OE system was a welded assembly. It is recommended that all parts noted [1] should be replaced.

[33] Remove and re-use O.E. heat shield.

[98] Refer to current Catalytic Converter catalog or Website catalog for availability.
[958] Federal & California Emission vehicles. Not legal for sale for vehicles licensed in California.

93-94 4 Cyl. MX-6, 2.0L Engine

(12353)

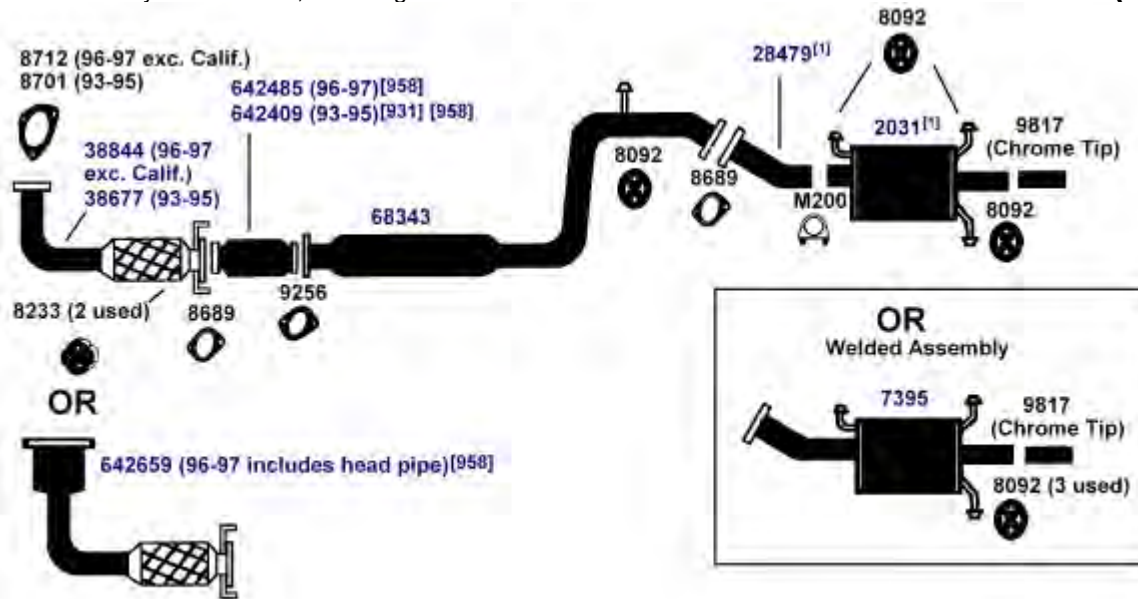

DIRECT FIT MSL/MAXIMUM Muffler... Split System- 700155

93-94 6 Cyl. MX-6, 2.5L Engine

(12352)

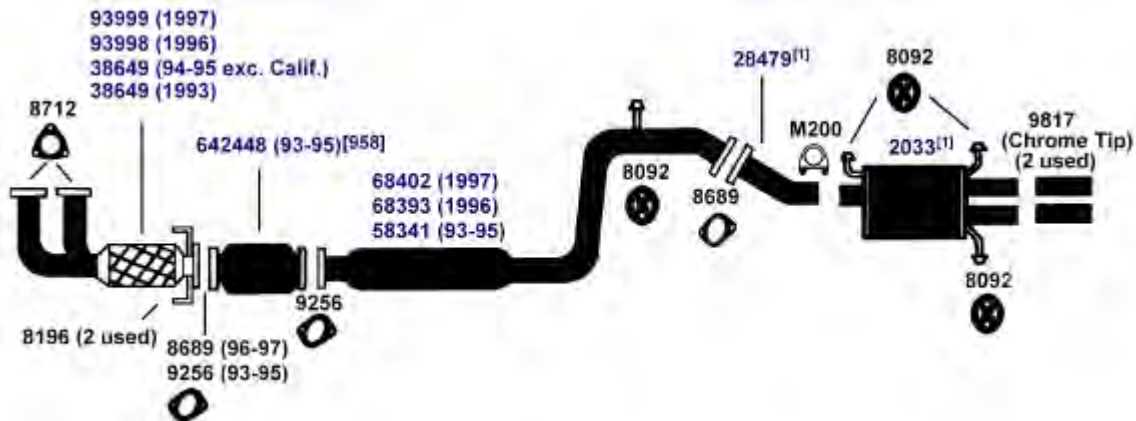

DIRECT FIT MSL/MAXIMUM Muffler... 700213

NA-Not Available. NR-Not Required. FL-Remove and Re-Use Old Flange. ● Golden Warehouse. O.E.-Original Equipment.
Airtube Kit [4948] may be required to complete installation. EFI-Electronic Fuel Injection.

[1] OE system was a welded assembly. It is recommended that all parts noted [1] should be replaced.
[98] Refer to current Catalytic Converter catalog or Website catalog for availability.

[931] This unit was designed to fit many applications. Measurement of the old unit and cutting of new unit is required.
[958] Federal & California Emission vehicles. Not legal for sale for vehicles licensed in California.

MAZDA MX-6

(12351) 88-92 4 Cyl. MX-6, 2.2L Engine; except Turbo

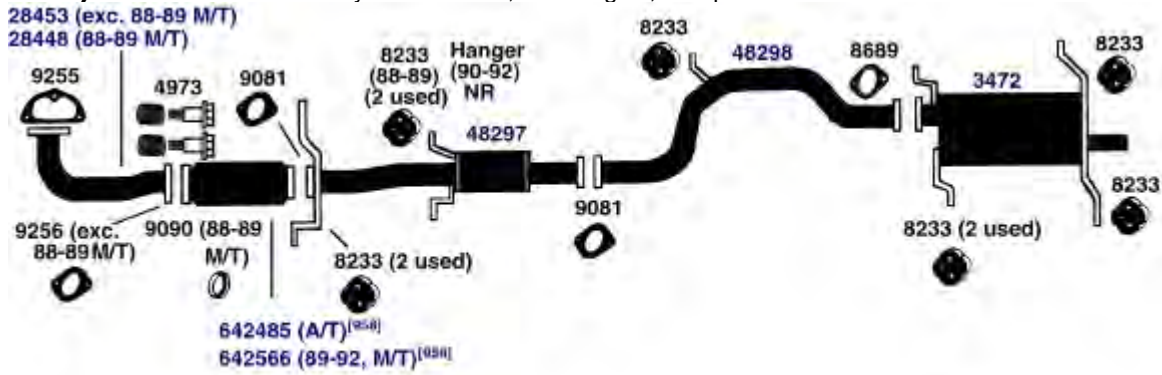

DIRECT FIT MSL/MAXIMUM Muffler... 6593, UNIVERSAL FIT MSL/MAXIMUM Muffler... 6529

(12350) 88-92 4 Cyl. MX-6, 2.2L Turbo Engine; except 4-Wheel Steering

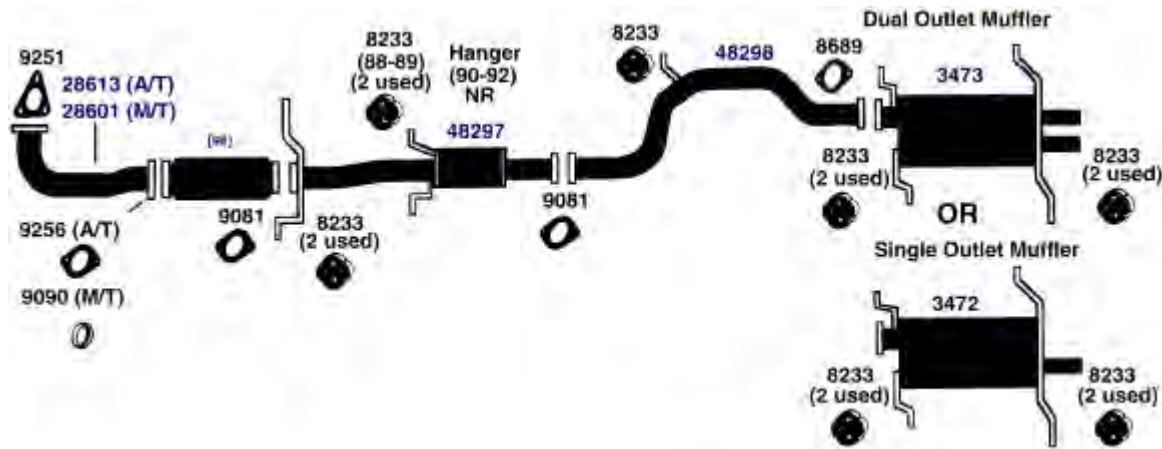

DIRECT FIT MSL/MAXIMUM Muffler... 70007 (Dual Outlet), 6593 (Single Outlet), UNIVERSAL FIT MSL/MAXIMUM Muffler... 6529 (Single Outlet)

NA-Not Available. NR-Not Required. FL-Remove and Re-Use Old Flange. ● Golden Warehouse. O.E.-Original Equipment.
Airtube Kit [4948] may be required to complete installation. EFI-Electronic Fuel Injection.

[98] Refer to current Catalytic Converter catalog or Website catalog for availability.

[958] Federal & California Emission vehicles. Not legal for sale for vehicles licensed in California.

MAZDA NAVAJO

93-94 6 Cyl. Navajo; 4.0L Engine

(30451)

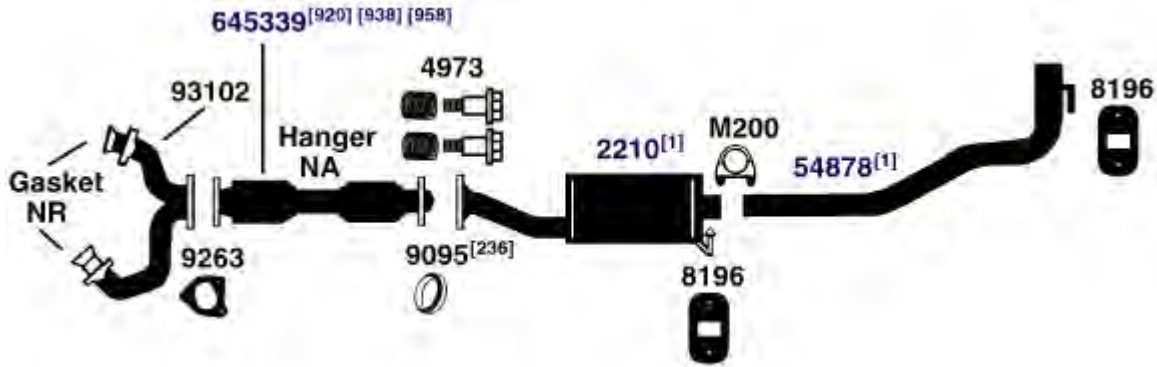

DIRECT FIT MSL/MAXIMUM Muffler... 700035, UNIVERSAL FIT MSL/MAXIMUM Muffler... 709013, 709014

91-92 6 Cyl. Navajo; 4.0L Engine

(30450)

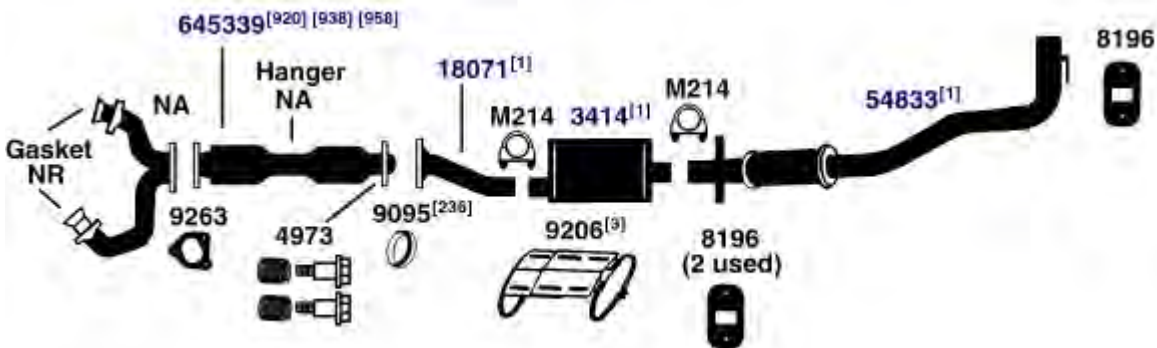

DIRECT FIT MSL/MAXIMUM Muffler... 6597, UNIVERSAL FIT MSL/MAXIMUM Muffler... 709014, 709992, Silentone DIY Muffler... 5549

MAZDA PICKUP

1994 4 Cyl. B2300; 2.3L Engines; 108" W.B. Short Bed; 114" W.B. Long Bed

(30427)



DIRECT FIT MSL/MAXIMUM Muffler... 700034, UNIVERSAL FIT MSL/MAXIMUM Muffler... 709013, Silentone DIY Muffler... 5555

NA-Not Available. NR-Not Required. FL-Remove and Re-Use Old Flange. ● Golden Warehouse. O.E.-Original Equipment.
Airtube Kit [4948] may be required to complete installation. EFI-Electronic Fuel Injection.

- [1] OE system was a welded assembly. It is recommended that all parts noted [1] should be replaced.
- [3] Required for installation.
- [236] Not Required with aftermarket Converter

- [920] Y-Pipe must be cut 1/2" from face of flange
- [938] Direct fit unit contains front and rear converter body. Only failed converters may be replaced.
- [958] Federal & California Emission vehicles. Not legal for sale for vehicles licensed in California.

MAZDA PICKUP

(30426) 1994 4 Cyl. B2300; 2.3L Engine; 125" W.B. Cab Plus

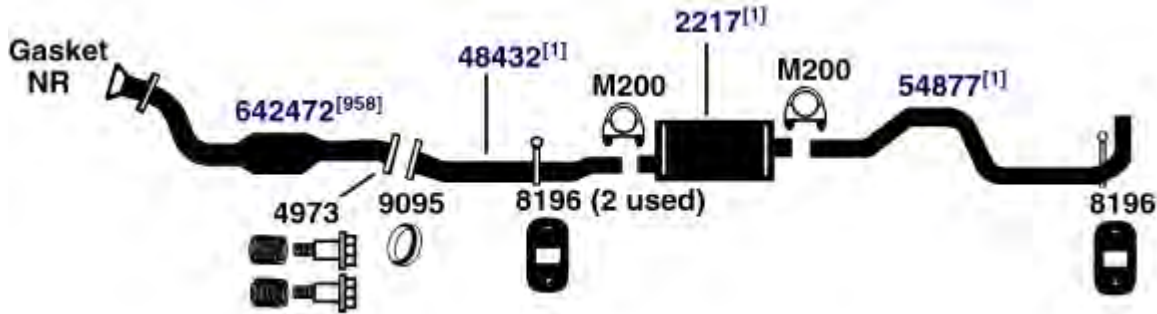

DIRECT FIT MSL/MAXIMUM Muffler... 700034, UNIVERSAL FIT MSL/MAXIMUM Muffler... 709013, Silentone DIY Muffler... 5555

(30425) 1994 6 Cyl. B3000, B4000; 3.0L, 4.0L Engines; 108" W.B. Short Bed; 114" W.B. Long Bed

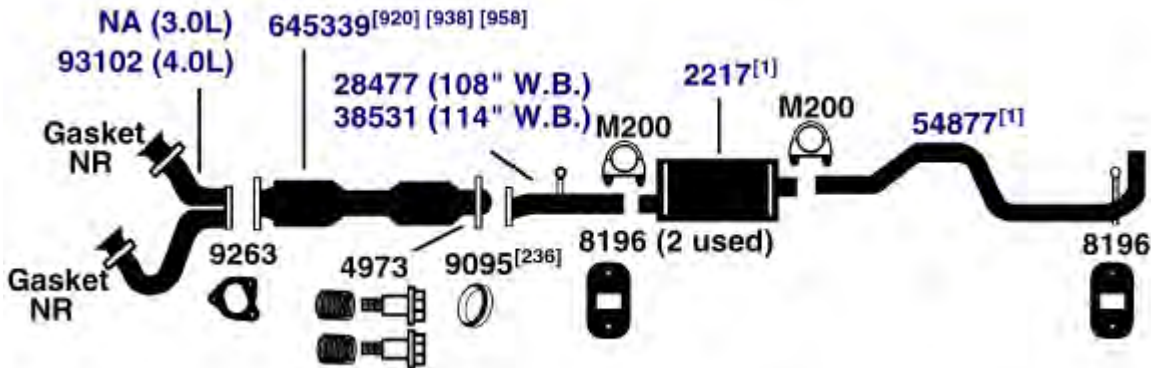

DIRECT FIT MSL/MAXIMUM Muffler... 700034, UNIVERSAL FIT MSL/MAXIMUM Muffler... 709013, Silentone DIY Muffler... 5555

(30424) 1994 6 Cyl. B3000, B4000; 3.0L, 4.0L Engines; 125" W.B. Cab Plus

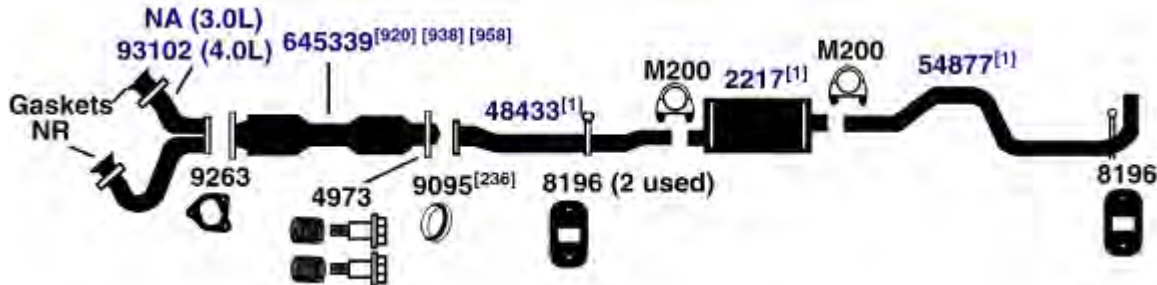

DIRECT FIT MSL/MAXIMUM Muffler... 700034, UNIVERSAL FIT MSL/MAXIMUM Muffler... 709013, Silentone DIY Muffler... 5555

NA-Not Available. NR-Not Required. FL-Remove and Re-Use Old Flange. ● Golden Warehouse. O.E.-Original Equipment.

Airtube Kit [4948] may be required to complete installation. EFI-Electronic Fuel Injection.

[1] OE system was a welded assembly. It is recommended that all parts noted [1] should be replaced.

[236] Not Required with aftermarket Converter

[920] Y-Pipe must be cut 1/2" from face of flange

[938] Direct fit unit contains front and rear converter body. Only failed converters may be replaced.

[958] Federal & California Emission vehicles. Not legal for sale for vehicles licensed in California.

90-93 4 Cyl. B2200 Pickup, 2.2L Engine; F.I.

(30423)

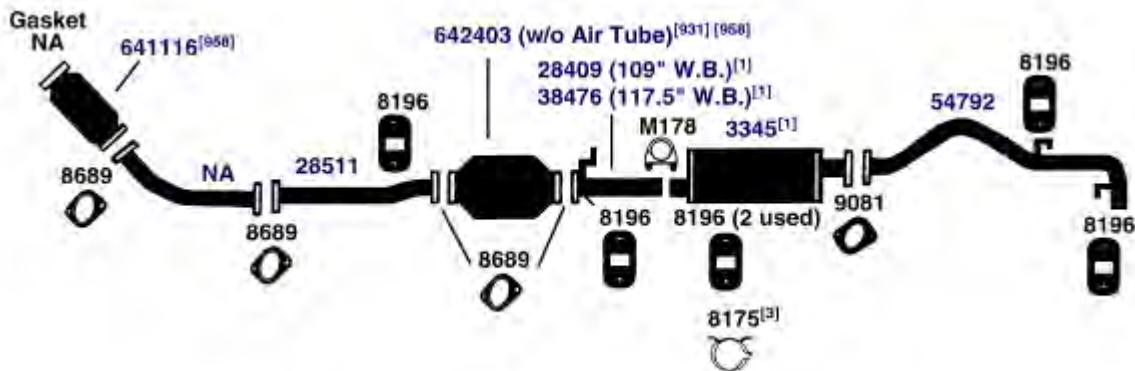

DIRECT FIT MSL/MAXIMUM Muffler... 700010, UNIVERSAL FIT MSL/MAXIMUM Muffler... 6568, 6569, 709018, 709993

90-93 4 Cyl. B2200 Pickup, 2.2L Carb. Eng.
 87-89 4 Cyl. B2200 Pickup, 2.2L Engine
 86-87 4 Cyl. B2000 Pickup, 2.0L Engine

(30407)

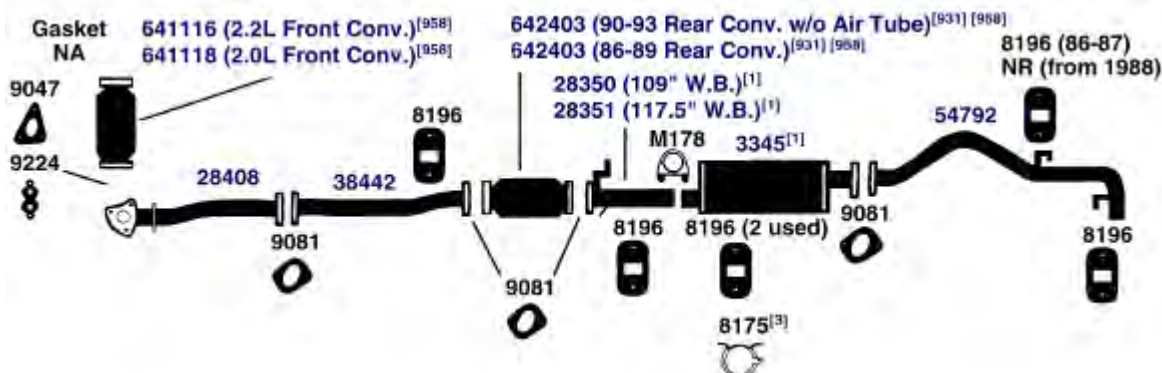

DIRECT FIT MSL/MAXIMUM Muffler... 700010, UNIVERSAL FIT MSL/MAXIMUM Muffler... 6568, 6569, 709018, 709993

NA-Not Available. NR-Not Required. FL-Remove and Re-Use Old Flange. ● Golden Warehouse. O.E.-Original Equipment.
 # Airtube Kit [4948] may be required to complete installation. EFI-Electronic Fuel Injection.

- [1] OE system was a welded assembly. It is recommended that all parts noted [1] should be replaced.
- [2] This unit was designed to fit many applications. Measurement of the old unit and cutting of new unit is required.
- [3] Required for installation.
- [958] Federal & California Emission vehicles. Not legal for sale for vehicles licensed in California.

MAZDA PICKUP

(30422) 90-93 4 Cyl. B2600 Pickup, 2.6L Engine; 2 W.D.

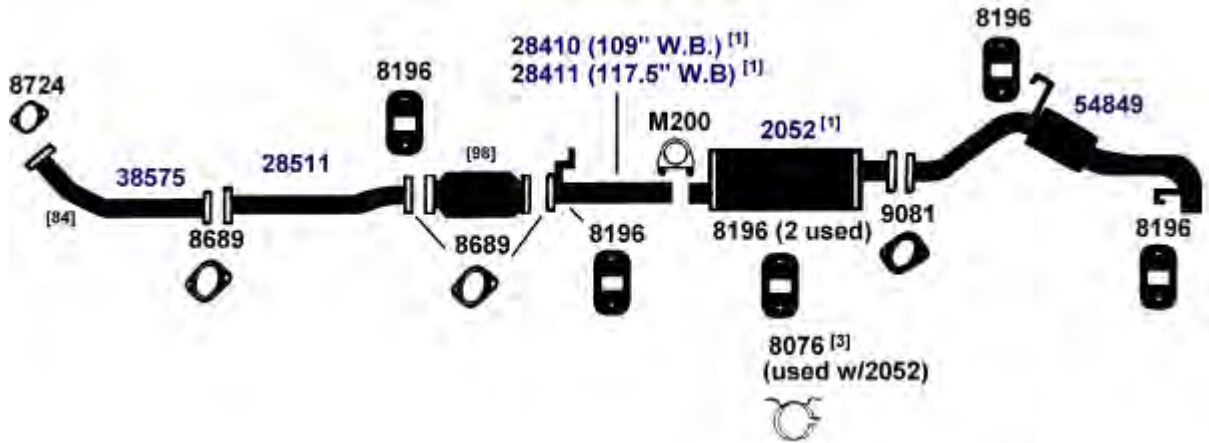

DIRECT FIT MSL/MAXIMUM Muffler... 700220

(30421) 90-93 4 Cyl. B2600 Pickup, 2.6L Engine; 4 W.D.

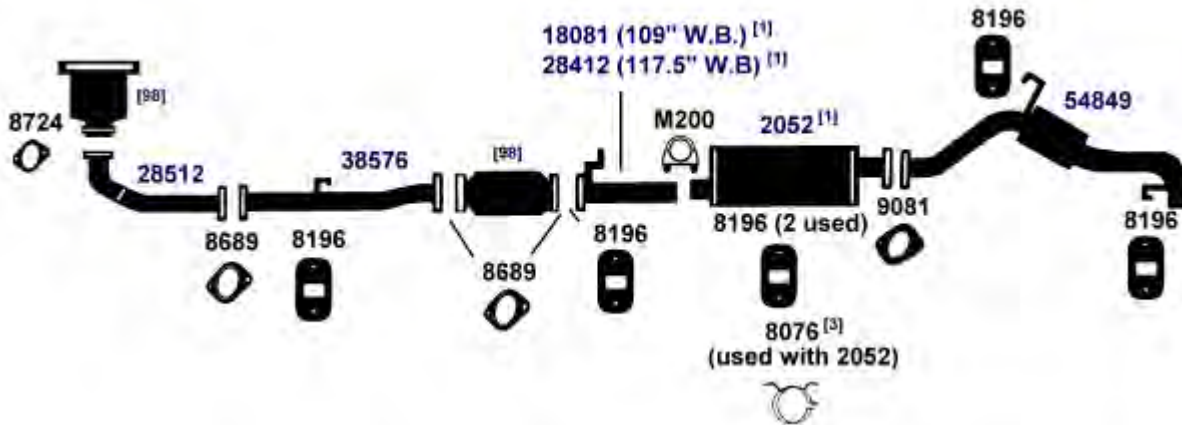

DIRECT FIT MSL/MAXIMUM Muffler... 700220

NA-Not Available. NR-Not Required. FL-Remove and Re-Use Old Flange. ● Golden Warehouse. O.E.-Original Equipment.
Airtube Kit [4948] may be required to complete installation. EFI-Electronic Fuel Injection.

[1] OE system was a welded assembly. It is recommended that all parts noted [1] should be replaced.

[3] Required for installation.

[84] Remove and re-use original clamp.

[98] Refer to current Catalytic Converter catalog or Website catalog for availability.
[958] Federal & California Emission vehicles. Not legal for sale for vehicles licensed in California.

1989 4 Cyl. B2600 Pickup, 2.6L Engine; 4 W.D.

(100414)

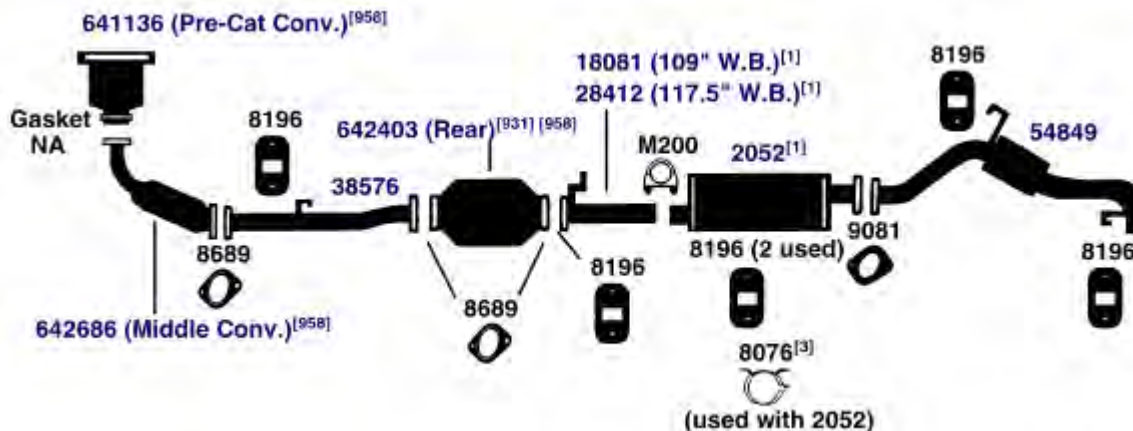

DIRECT FIT MSL/MAXIMUM Muffler... 700220

87-88 4 Cyl. B2600 Pickup, 2.6L Engine; 4 W.D.; 109" W.B.

(30410)

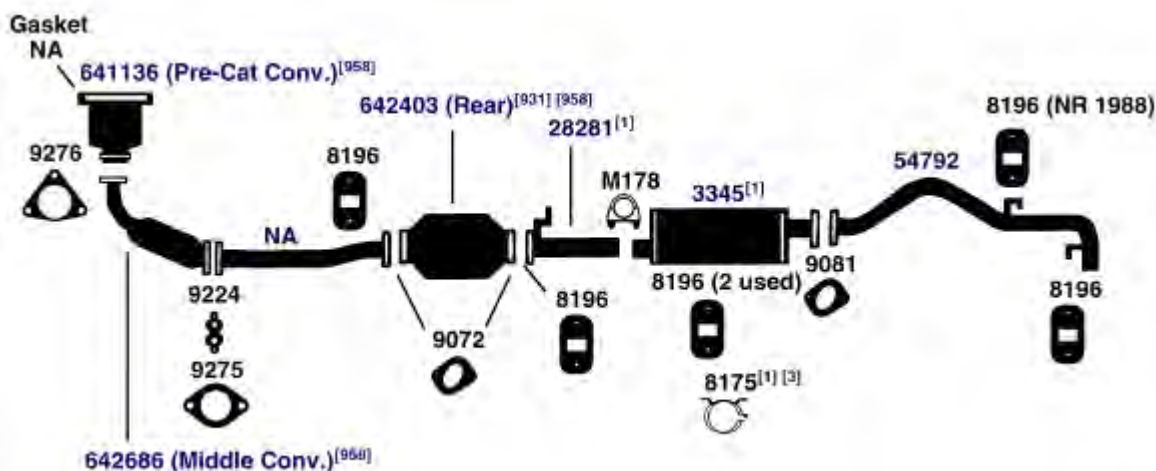

DIRECT FIT MSL/MAXIMUM Muffler... 700010, UNIVERSAL FIT MSL/MAXIMUM Muffler... 6568, 6569, 709018, 709993

NA-Not Available. NR-Not Required. FL-Remove and Re-Use Old Flange. ● Golden Warehouse. O.E.-Original Equipment.
 # Airtube Kit [4948] may be required to complete installation. EFI-Electronic Fuel Injection.

- [1] OE system was a welded assembly. It is recommended that all parts noted [1] should be replaced.
- [3] Required for installation.

- [931] This unit was designed to fit many applications. Measurement of the old unit and cutting of new unit is required.
- [958] Federal & California Emission vehicles. Not legal for sale for vehicles licensed in California.

MAZDA PICKUP

(30408) 87-88 4 Cyl. B2600 Pickup, 2.6L Engine; 2 W.D.

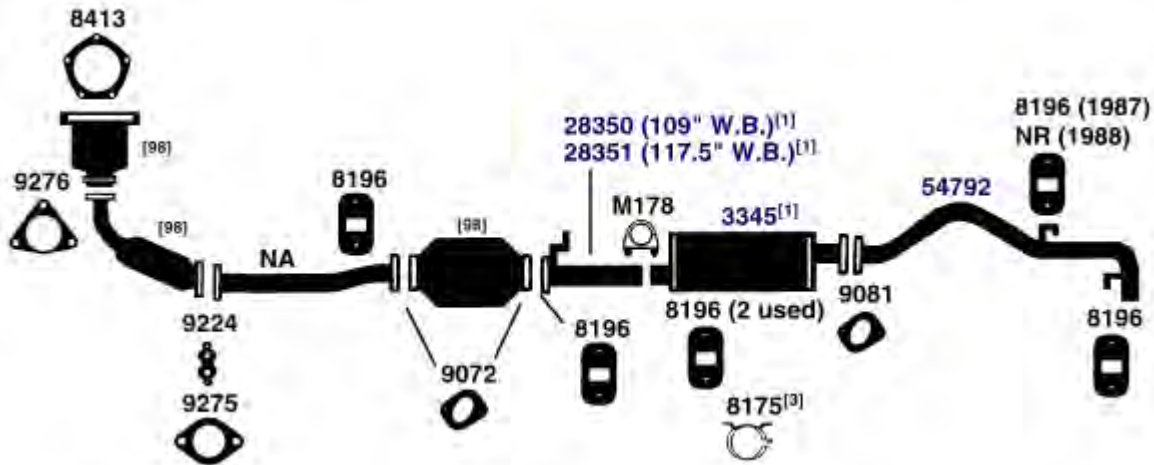

DIRECT FIT MSL/MAXIMUM Muffler... 700010, UNIVERSAL FIT MSL/MAXIMUM Muffler... 6568, 6569, 709018, 709993

NA-Not Available. NR-Not Required. FL-Remove and Re-Use Old Flange. ● Golden Warehouse. O.E.-Original Equipment.
Airtube Kit [4948] may be required to complete installation. EFI-Electronic Fuel Injection.

- [1] OE system was a welded assembly. It is recommended that all parts noted [1] [98] Refer to current Catalytic Converter catalog or Website catalog for availability. should be replaced.
[3] Required for installation.

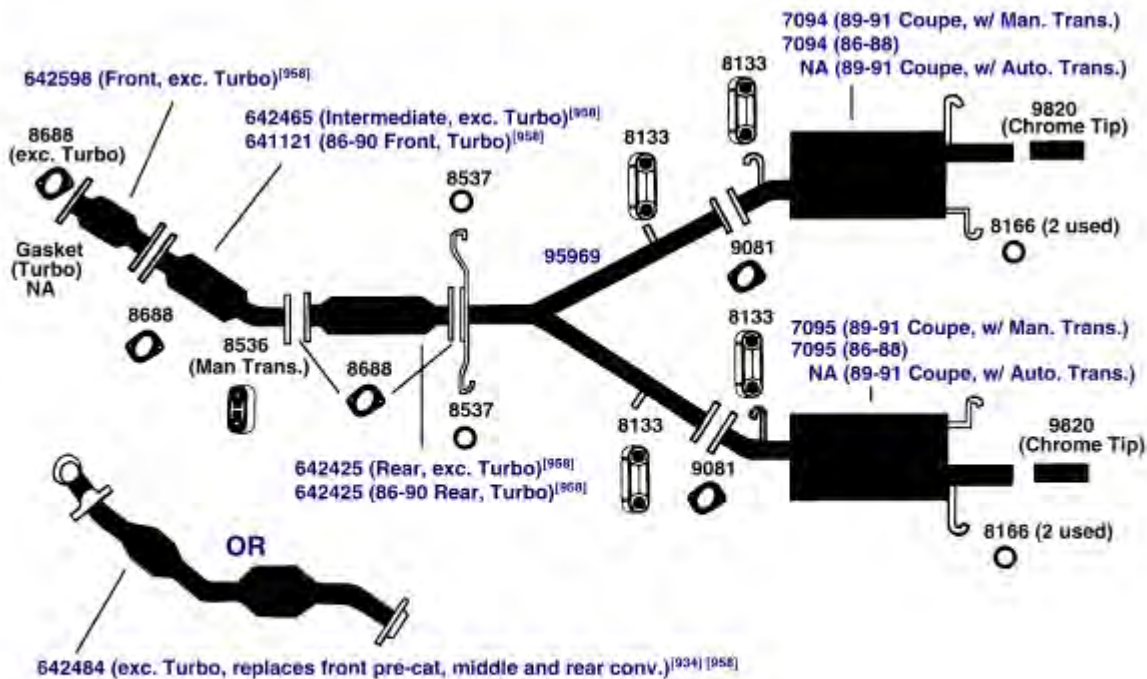

MERCEDES-BENZ

MERCEDES-BENZ 190 SERIES

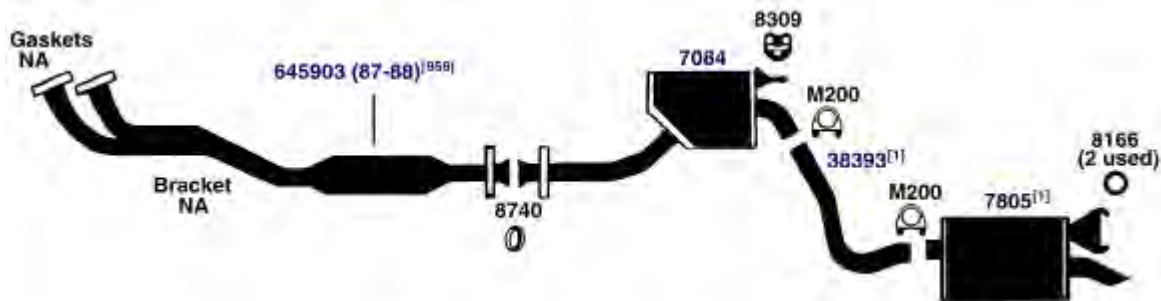

NA-Not Available. NR-Not Required. FL-Remove and Re-Use Old Flange. ● Golden Warehouse. O.E.-Original Equipment.
 # Airtube Kit [4948] may be required to complete installation. EFI-Electronic Fuel Injection.

[1] OE system was a welded assembly. It is recommended that all parts noted [1] should be replaced. [958] Federal & California Emission vehicles. Not legal for sale for vehicles licensed in California.
 [934] Replaces multiple OE Converters. Only failed converters may be replaced.

MERCEDES-BENZ 190 SERIES

(100247) 87-93 6 Cyl. 190E, 2.6L Engine (Model Code: 201.029)

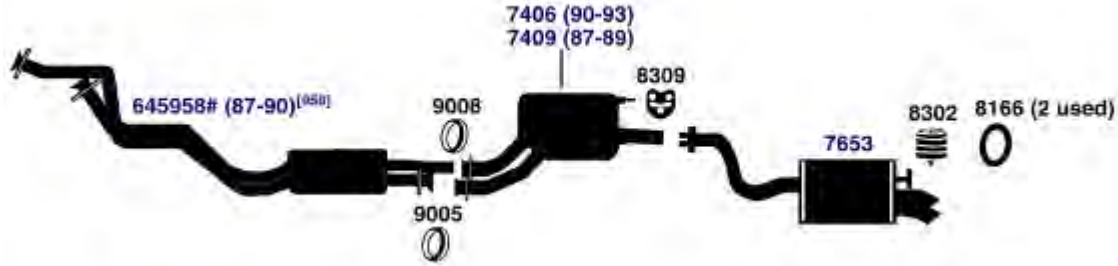

(6575) 85-86 4 Cyl. 190E, 2.3L Engine (Model 201.024), except 16 Valve Engine

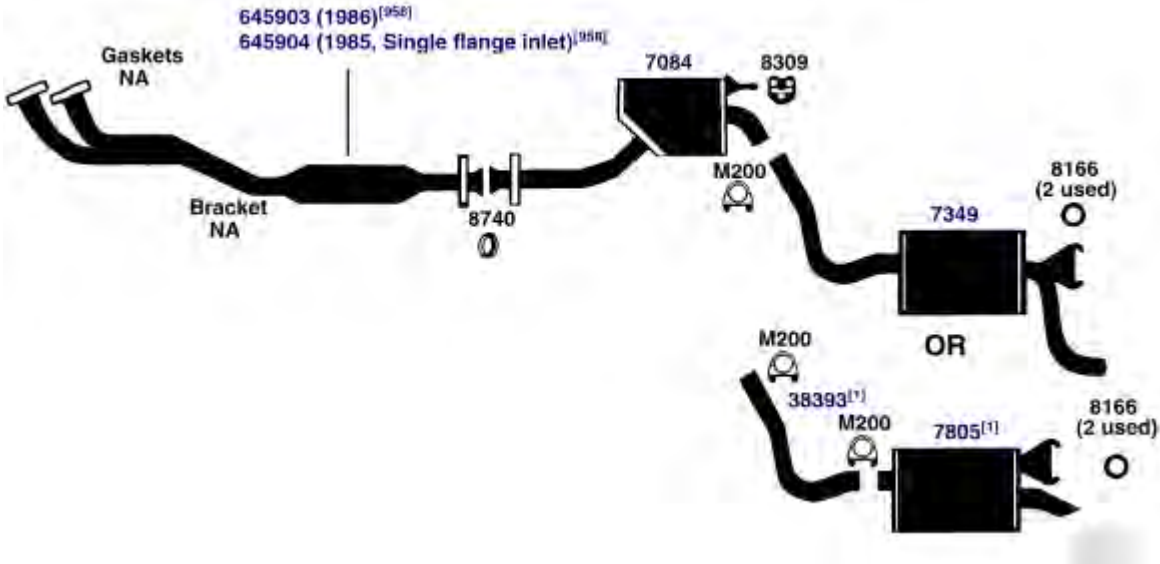

NA-Not Available. NR-Not Required. FL-Remove and Re-Use Old Flange. ● Golden Warehouse. O.E.-Original Equipment.
Airtube Kit [4948] may be required to complete installation. EFI-Electronic Fuel Injection.

[1] OE system was a welded assembly. It is recommended that all parts noted [1] should be replaced.

[958] Federal & California Emission vehicles. Not legal for sale for vehicles licensed in California.

[98] Refer to current Catalytic Converter catalog or Website catalog for availability.

MERCEDES-BENZ 190 SERIES

1984 4 Cyl. 190E, 2.3L Engine (Model 201.024), except 16 Valve Engine

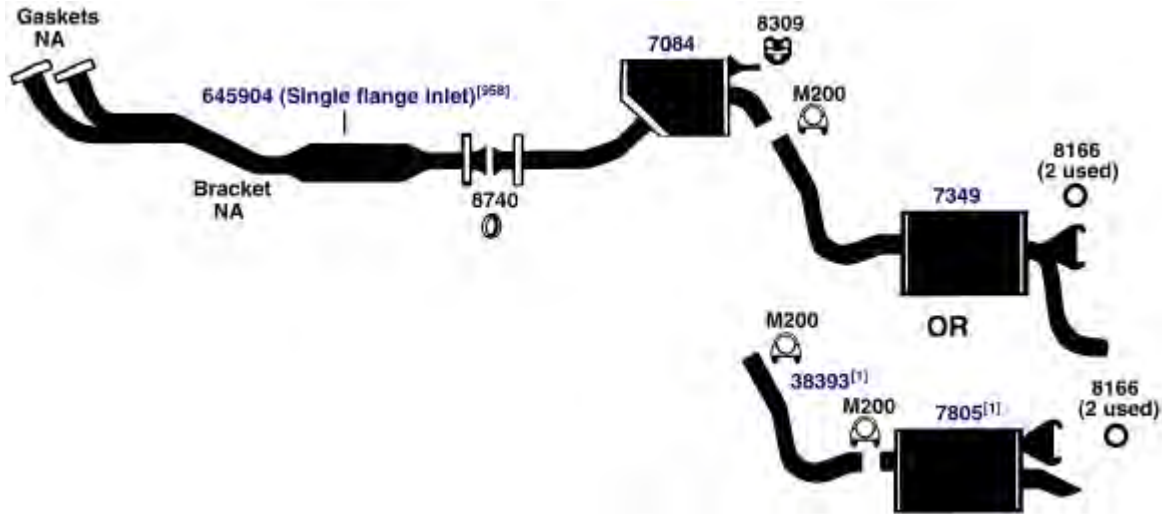
(6575E)

MERCEDES-BENZ 220, 260, 280 SERIES

1994 6 Cyl. C280, 2.8L Engine (To Vin: HA28)

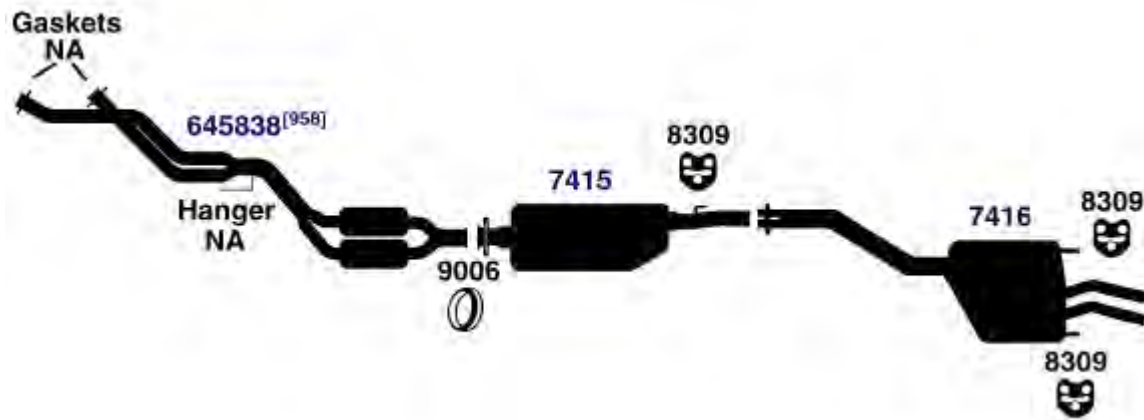
(100248)

NA-Not Available. NR-Not Required. FL-Remove and Re-Use Old Flange. ● Golden Warehouse. O.E.-Original Equipment.
Airtube Kit [4948] may be required to complete installation. EFI-Electronic Fuel Injection.

- [1] OE system was a welded assembly. It is recommended that all parts noted [1] should be replaced. [958] Federal & California Emission vehicles. Not legal for sale for vehicles licensed in California.

MERCEDES-BENZ 220, 260, 280 SERIES

(100249) 1994 4 Cyl. C220 Sedan, 2.2L Engine (To Vin: HA22)

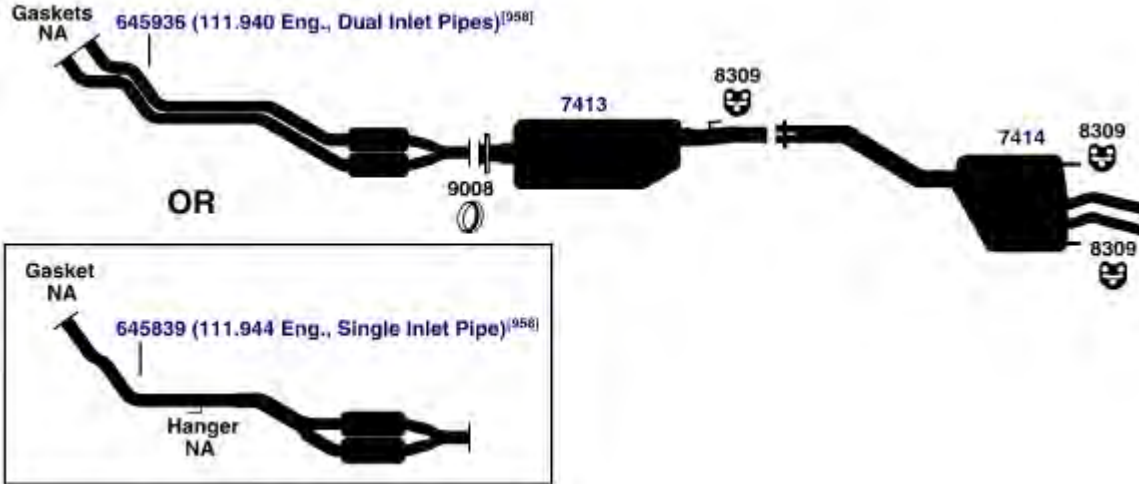

(100250) 87-89 6 Cyl. 260E, 2.6L Engine, 190 HP (Model Code: 124.026)

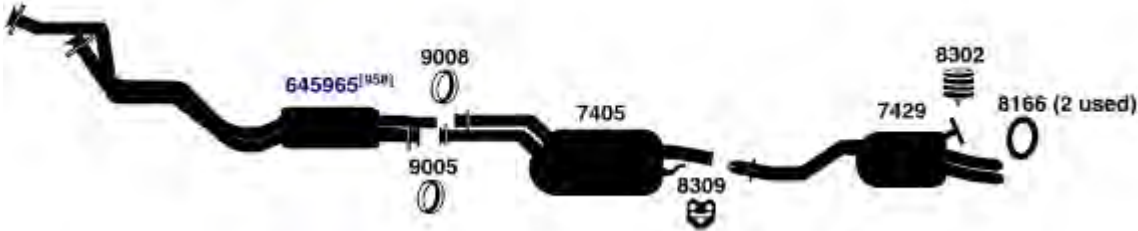

MERCEDES-BENZ 300, 320, 380 SERIES

(100251) 1994 6 Cyl. E320 Sedan, 3.2L Engine (To Vin: EA32, JF55)
 1993 6 Cyl. 300E Sedan (To Vin: EA28, EA32)

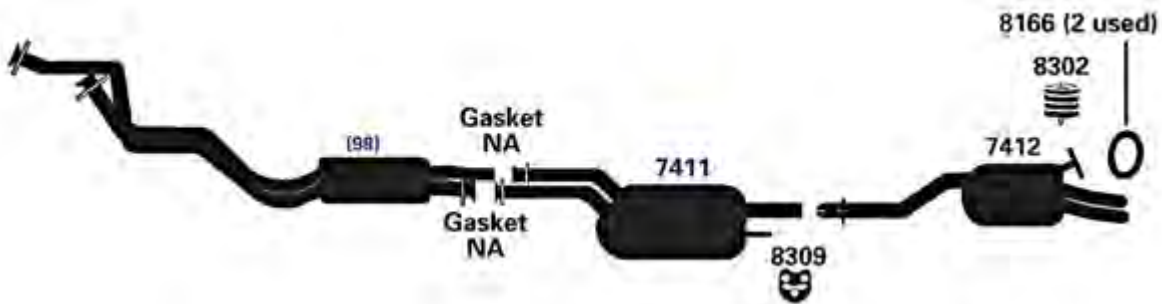

NA-Not Available. NR-Not Required. FL-Remove and Re-Use Old Flange. ● Golden Warehouse. O.E.-Original Equipment.
 # Airtube Kit [4948] may be required to complete installation. EFI-Electronic Fuel Injection.

[98] Refer to current Catalytic Converter catalog or Website catalog for availability.

[958] Federal & California Emission vehicles. Not legal for sale for vehicles licensed in California.

MERCEDES-BENZ 300, 320, 380 SERIES

1994 6 Cyl. E320 Coupe, 3.2L Engine (To Vin: EA52)

(100252)

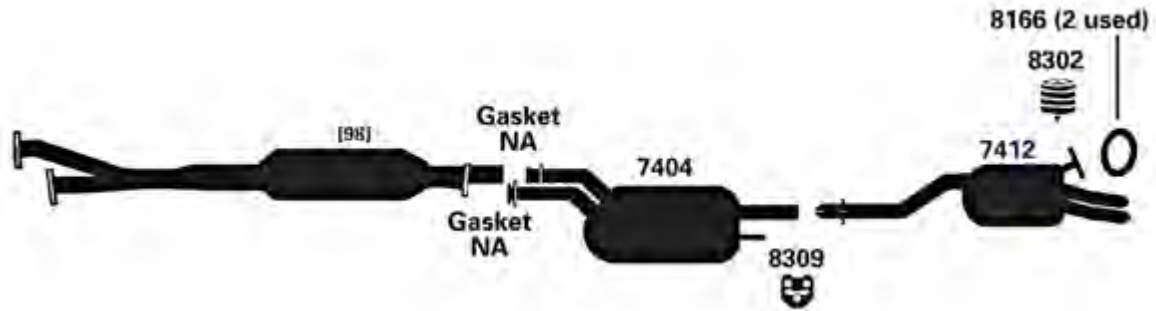

90-93 6 Cyl. 300E, 4 Matic, 3.0L Engine (To Vin: ED30)
86-92 6 Cyl. 300E, 2.6L, 3.0L Engine (To Vin: EA26, EA30)

(100253)

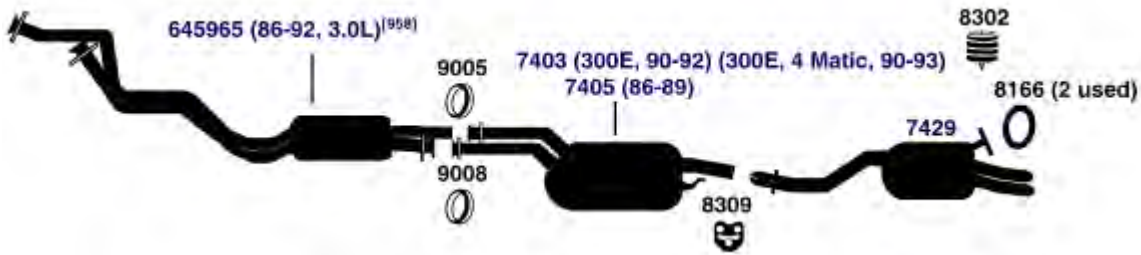

88-93 6 Cyl. 300TE, Incl. 4 Matic, 3.0L, 3.2L Engine (Model Code 124.090)

(100254)

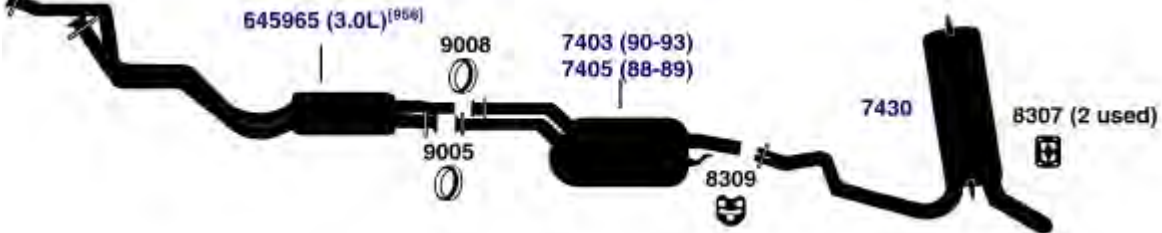

88-91 6 Cyl. 300 SEL, 3.0L Engine (Model Code: 126.025)

(100255)

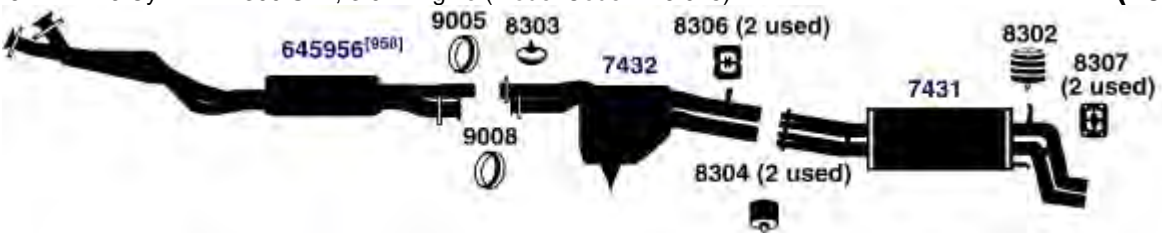

NA-Not Available. NR-Not Required. FL-Remove and Re-Use Old Flange. ● Golden Warehouse. O.E.-Original Equipment.
Airtube Kit [4948] may be required to complete installation. EFI-Electronic Fuel Injection.

[98] Refer to current Catalytic Converter catalog or Website catalog for availability. [958] Federal & California Emission vehicles. Not legal for sale for vehicles licensed in California.

MERCEDES-BENZ 300, 320, 380 SERIES

(100256) 85-91 6 Cyl. 300SE, 3.0L Engine (Model Code: 126.024)

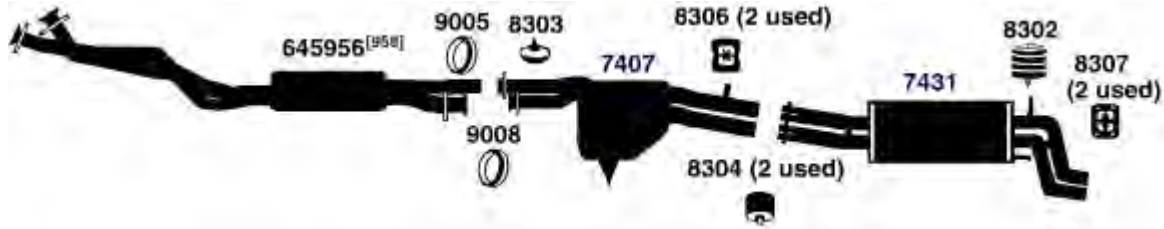

MERCEDES-BENZ 420 SERIES

(100257) 86-91 8 Cyl. 420SEL, 4.2L Engine (Model Code: 126.035)

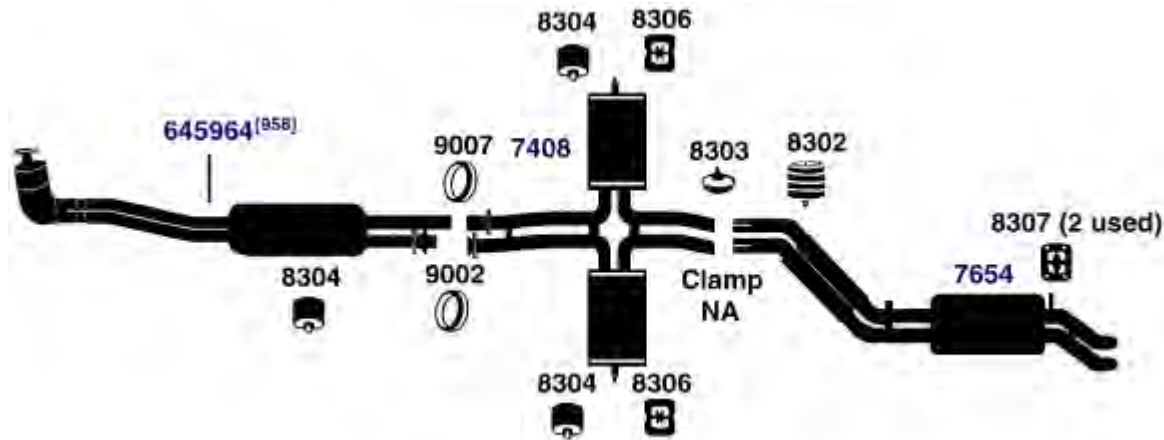

MERCEDES-BENZ 500, 560 SERIES

(100258) 86-91 8 Cyl. 560SEL, 560 SEC, 5.6L Engine (Model code: 126.039, 126.045)

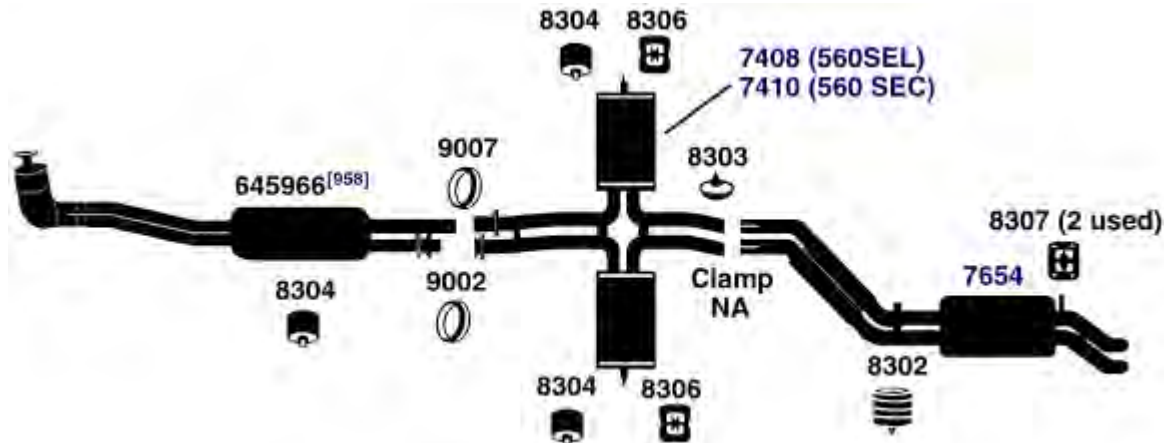

NA-Not Available. NR-Not Required. FL-Remove and Re-Use Old Flange. ● Golden Warehouse. O.E.-Original Equipment.
Airtube Kit [4948] may be required to complete installation. EFI-Electronic Fuel Injection.

[958] Federal & California Emission vehicles. Not legal for sale for vehicles licensed in California.

91-94 4 Cyl. Capri, 98 (1.6L) Turbo Engine (1356)

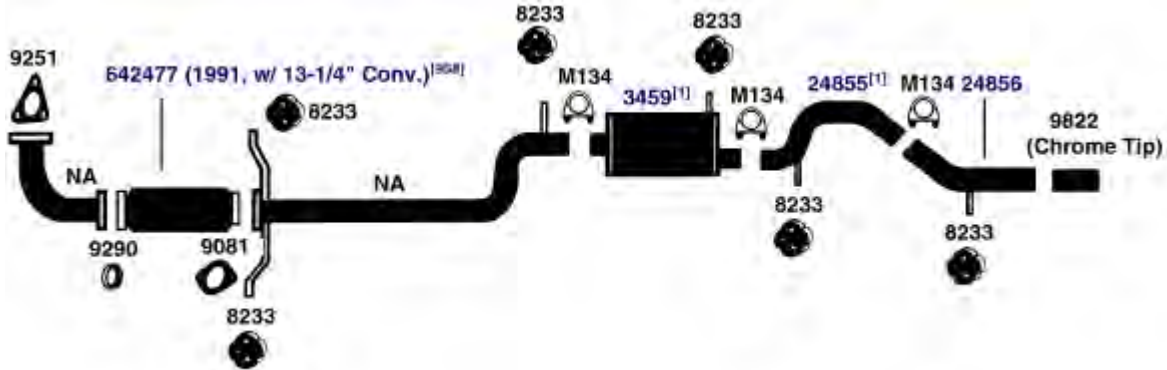

UNIVERSAL FIT MSL/MAXIMUM Muffler... 6653

91-94 4 Cyl. Capri, 98 (1.6L) Engine; except Turbo (1357)

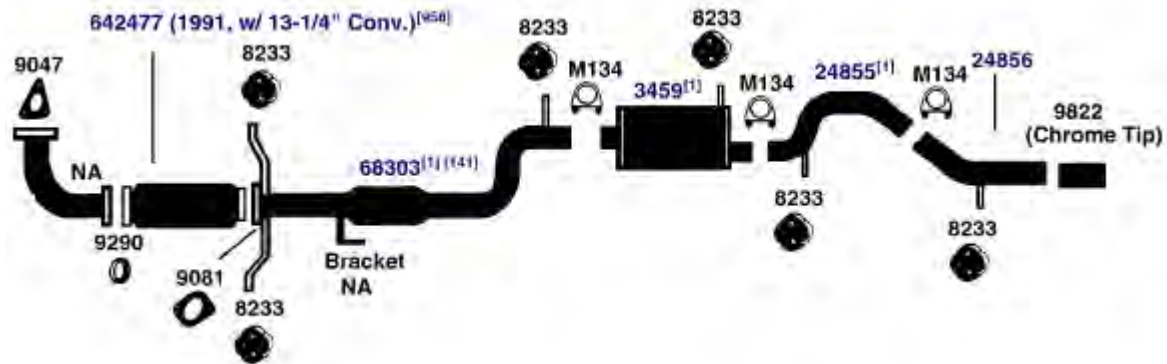

UNIVERSAL FIT MSL/MAXIMUM Muffler... 6653

1986 8 Cyl. Capri, 302 (5.0L) Engine, Dual Exhaust (1355)

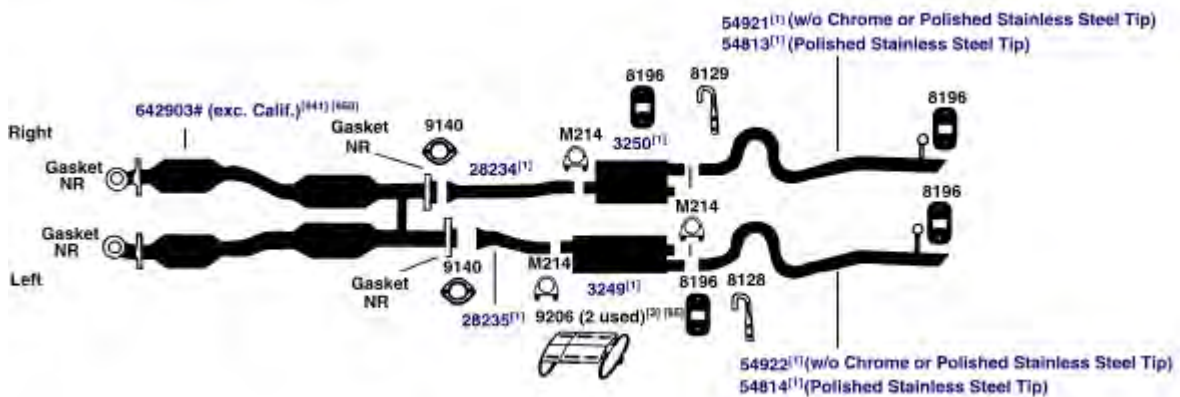

DIRECT FIT MSL/MAXIMUM Muffler... Left- 700096, Right- 700097, UNIVERSAL FIT MSL/MAXIMUM Muffler... Left- 6653, Right- 6580, Silentone DIY Muffler... Left- 5554 and 8083 Bracket and 9206 Heat Shield, Right- 5554 and 8083 Bracket and 9206 Heat Shield

NA-Not Available. NR-Not Required. FL-Remove and Re-Use Old Flange. ● Golden Warehouse. O.E.-Original Equipment.
Airtube Kit [4948] may be required to complete installation. EFI-Electronic Fuel Injection.

- [1] OE system was a welded assembly. It is recommended that all parts noted [1] should be replaced.
- [3] Required for installation.
- [65] Heat Shield 9206 is required for installation.
- [141] Remove and re-use O.E. heat shield, if required.
- [941] Replaces both front and rear converters. Only failed converters may be replaced.
- [958] Federal & California Emission vehicles. Not legal for sale for vehicles licensed in California.

MERCURY CAPRI

(1350) 85-86 4 Cyl. Capri, 140 (2.3L) Engine, except Turbo

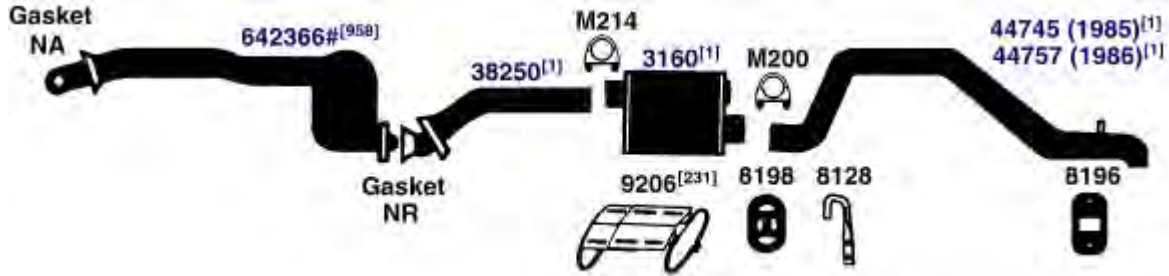

DIRECT FIT MSL/MAXIMUM Muffler... 6563, UNIVERSAL FIT MSL/MAXIMUM Muffler... 6548, 709012

(1349) 85-86 6 Cyl. Capri, 232 (3.8L) Engine

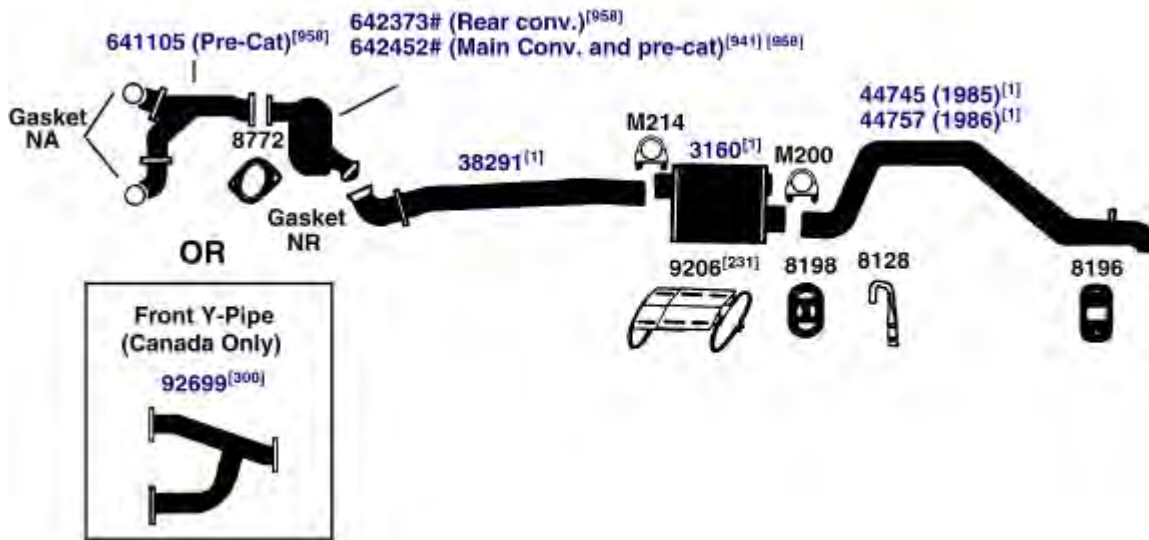

DIRECT FIT MSL/MAXIMUM Muffler... 6563, UNIVERSAL FIT MSL/MAXIMUM Muffler... 6548, 709012

NA-Not Available. NR-Not Required. FL-Remove and Re-Use Old Flange. ● Golden Warehouse. O.E.-Original Equipment.
Airtube Kit [4948] may be required to complete installation. EFI-Electronic Fuel Injection.

[1] OE system was a welded assembly. It is recommended that all parts noted [1] should be replaced.

[231] If muffler is equipped with a heat shield (does not have a black triangle on the carton label), purchase of 9206 is not required.

[300] For use when resonator originated from O.E. manufacturer.

[941] Replaces both front and rear converters, Only failed converters may be replaced.

[958] Federal & California Emission vehicles. Not legal for sale for vehicles licensed in California.

1985 8 Cyl. Capri, 302 (5.0L) Engine, Dual Exhaust

(1354)

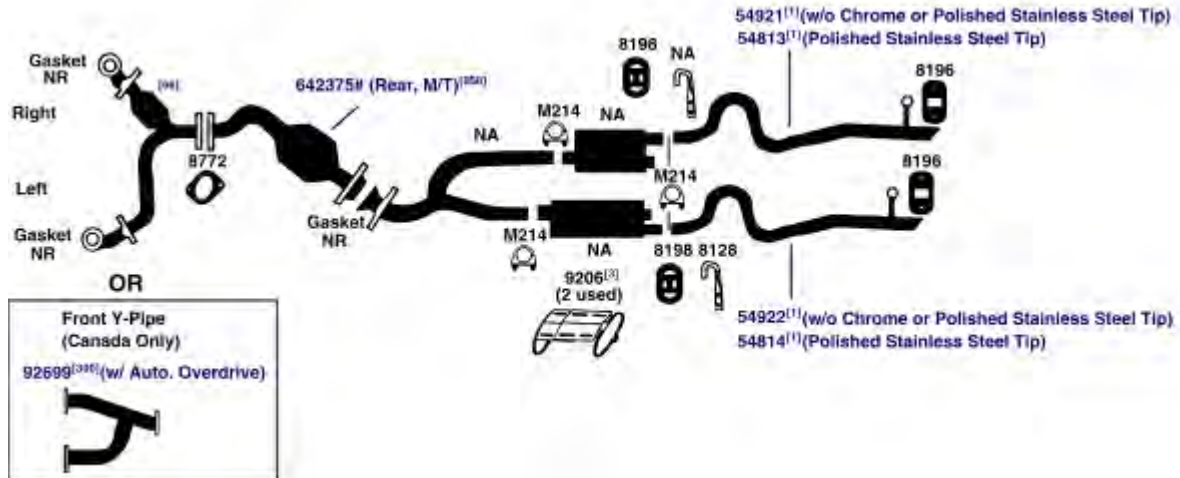

UNIVERSAL FIT MSL/MAXIMUM Muffler... Right- 6580

1984 4 Cyl. Capri, 140 (2.3L) Engine, except Turbo

(1350E)

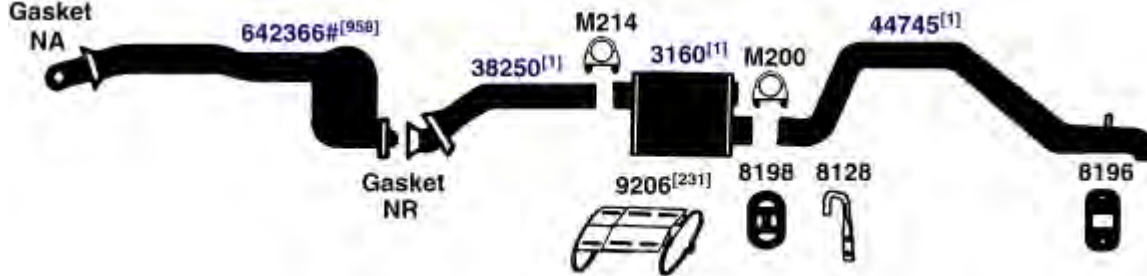

DIRECT FIT MSL/MAXIMUM Muffler... 6563, UNIVERSAL FIT MSL/MAXIMUM Muffler... 6548, 709012

NA-Not Available. NR-Not Required. FL-Remove and Re-Use Old Flange. ● Golden Warehouse. O.E.-Original Equipment.
Airtube Kit [4948] may be required to complete installation. EFI-Electronic Fuel Injection.

- [1] OE system was a welded assembly. It is recommended that all parts noted [1] should be replaced.
- [3] Required for installation.
- [98] Refer to current Catalytic Converter catalog or Website catalog for availability.

- [231] If muffler is equipped with a heat shield (does not have a black triangle on the carton label), purchase of 9206 is not required.
- [300] For use when resonator originated from O.E. manufacturer.
- [958] Federal & California Emission vehicles. Not legal for sale for vehicles licensed in California.

MERCURY CAPRI

(1349E) 1984 6 Cyl. Capri, 232 (3.8L) Engine

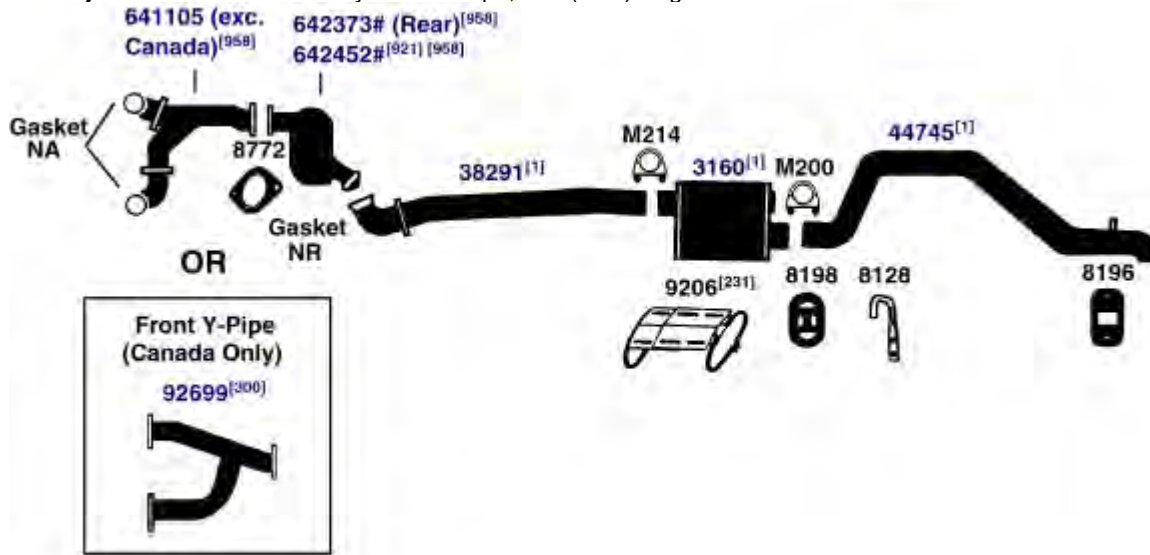

DIRECT FIT MSL/MAXIMUM Muffler... 6563, UNIVERSAL FIT MSL/MAXIMUM Muffler... 6548, 709012

(1353) 1984 8 Cyl. Capri, 5.0L, 302 Engine; Dual Exhaust

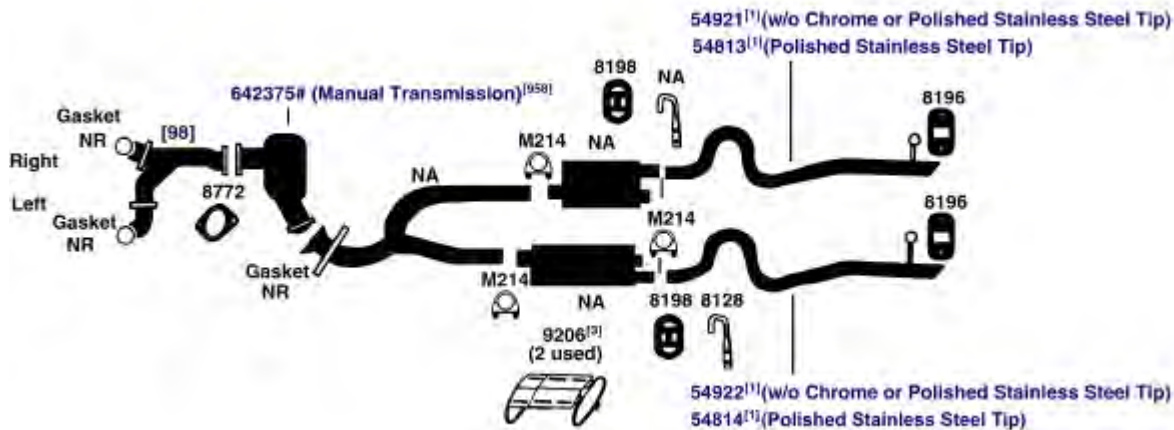

UNIVERSAL FIT MSL/MAXIMUM Muffler... Right- 6580

NA-Not Available. NR-Not Required. FL-Remove and Re-Use Old Flange. ● Golden Warehouse. O.E.-Original Equipment.
Airtube Kit [4948] may be required to complete installation. EFI-Electronic Fuel Injection.

[1] OE system was a welded assembly. It is recommended that all parts noted [1] should be replaced.

[3] Required for installation.

[98] Refer to current Catalytic Converter catalog or Website catalog for availability.

[231] If muffler is equipped with a heat shield (does not have a black triangle on the carton label), purchase of 9206 is not required.

[300] For use when resonator originated from O.E. manufacturer.

[921] Combination front & rear converter, 2 to 1 replacement. Only defective converters may legally be replaced.

[958] Federal & California Emission vehicles. Not legal for sale for vehicles licensed in California.

MERCURY CAPRI

1983 4 Cyl. Capri, 2.3L, 140 Engine; except Turbo

(1348)

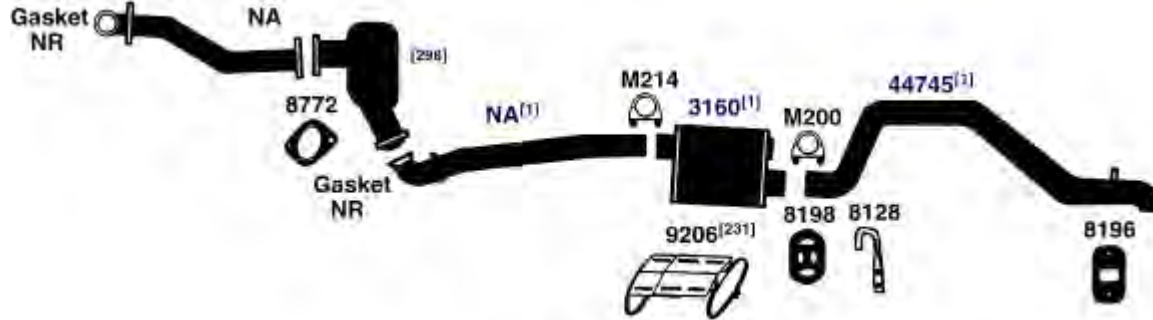

DIRECT FIT MSL/MAXIMUM Muffler... 6563, UNIVERSAL FIT MSL/MAXIMUM Muffler... 6548, 709012

1983 6 Cyl. Capri, 3.8L, 232 Engine

(1347)

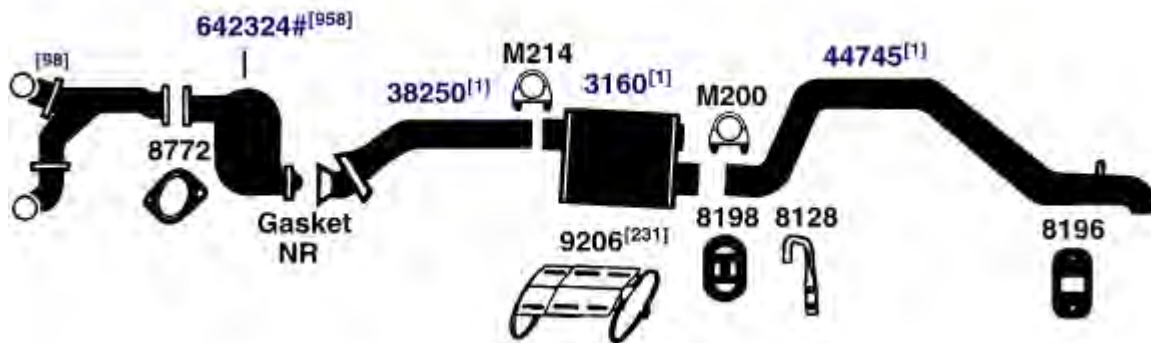

DIRECT FIT MSL/MAXIMUM Muffler... 6563, UNIVERSAL FIT MSL/MAXIMUM Muffler... 6548, 709012

MERCURY COUGAR

1994 8 Cyl. Cougar, 280 (4.6L) Engine, Dual Exhaust
 92-93 8 Cyl. Cougar, 302 (5.0L) Engine, Dual Exhaust

(7142)

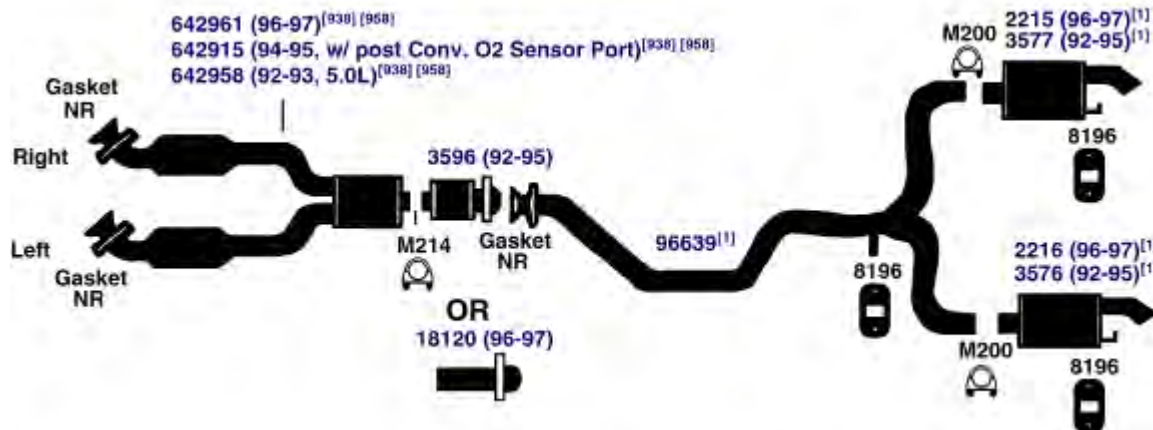

DIRECT FIT MSL/MAXIMUM Muffler... Left Muffler (3576) (92-95)- 700200

NA-Not Available. NR-Not Required. FL-Remove and Re-Use Old Flange. ● Golden Warehouse. O.E.-Original Equipment.
 # Airtube Kit [4948] may be required to complete installation. EFI-Electronic Fuel Injection.

[1] OE system was a welded assembly. It is recommended that all parts noted [1] should be replaced.

[98] Refer to current Catalytic Converter catalog or Website catalog for availability.

[231] If muffler is equipped with a heat shield (does not have a black triangle on the carton label), purchase of 9206 is not required.

[298] Coverage available. Due to multiple listings, please refer to Catalytic Converter catalog.

[938] Direct fit unit contains front and rear converter body. Only failed converters may be replaced.

[958] Federal & California Emission vehicles. Not legal for sale for vehicles licensed in California.

MERCURY COUGAR

(7143) 92-94 6 Cyl. Cougar, 232 (3.8L) Engine, Single Exhaust



DIRECT FIT MSL/MAXIMUM Muffler... 700200

(7141) 1991 8 Cyl. Cougar, 302 (5.0L) Engine, Dual Exhaust

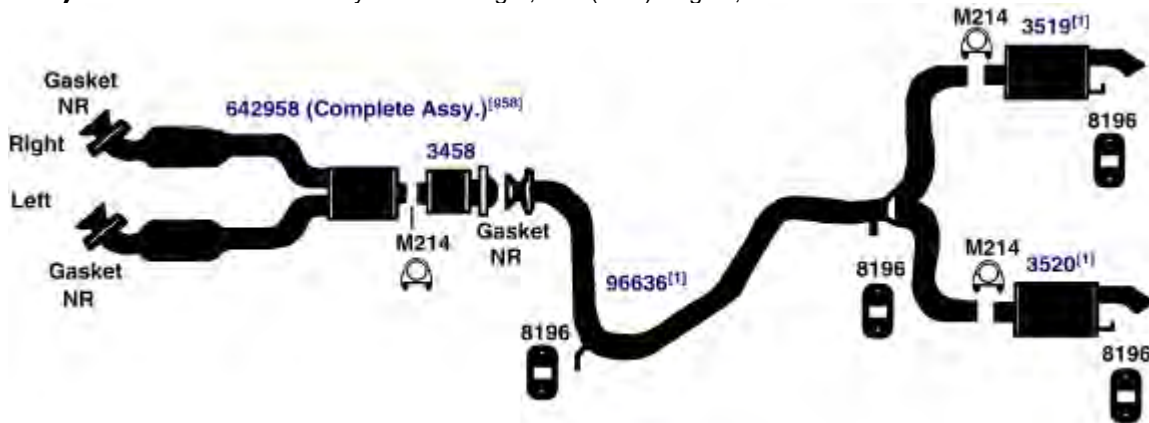

NA-Not Available. NR-Not Required. FL-Remove and Re-Use Old Flange. ● Golden Warehouse. O.E.-Original Equipment.
 # Airtube Kit [4948] may be required to complete installation. EFI-Electronic Fuel Injection.

[1] OE system was a welded assembly. It is recommended that all parts noted [1] should be replaced.
 [904] w/O2 Sensor ports in Converter.

[906] w/o O2 Sensor ports in Converter.
 [958] Federal & California Emission vehicles. Not legal for sale for vehicles licensed in California.

89-91 6 Cyl. Cougar, 232 (3.8L) Engine, Single Exhaust (exc. XR7)

(7139)

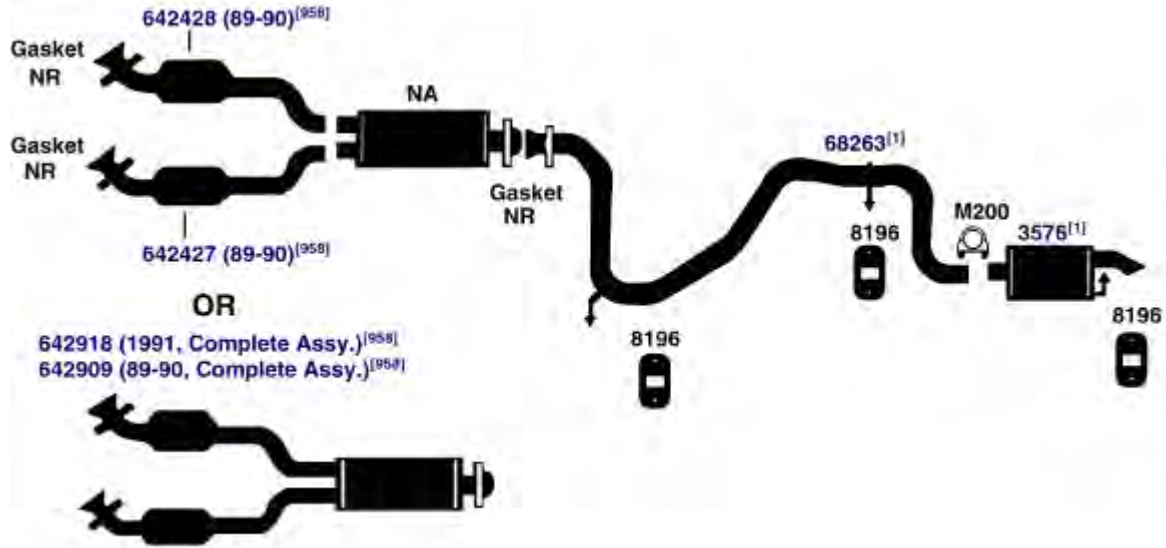

DIRECT FIT MSL/MAXIMUM Muffler... Rear Muffler (3576)- 700200

1988 8 Cyl. Cougar, 302 (5.0L) Engine, Dual Exhaust

(7138)

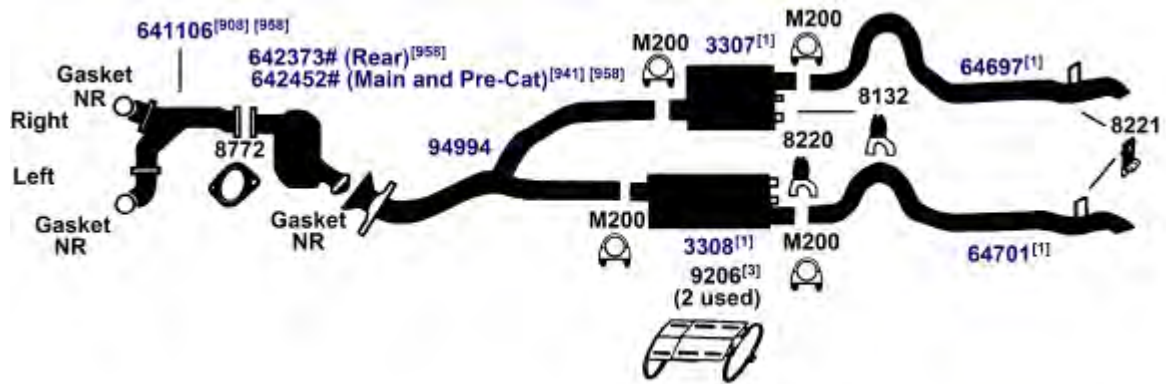

DIRECT FIT MSL/MAXIMUM Muffler... Left- 700015, Right- 700014, UNIVERSAL FIT MSL/MAXIMUM Muffler... Left- 6516, 709011, 709012, Right- 709003, 709006, Silentone DIY Muffler... Left- 5552 and 8248 Bracket and 9206 Heat Shield, Right- 5565 and 8248 Bracket and 9206 Heat Shield

NA-Not Available. NR-Not Required. FL-Remove and Re-Use Old Flange. ● Golden Warehouse. O.E.-Original Equipment.
Airtube Kit [4948] may be required to complete installation. EFI-Electronic Fuel Injection.

[1] OE system was a welded assembly. It is recommended that all parts noted [1] should be replaced.
[3] Required for installation.
[908] w/o Airtube on Pre-Cat.

[941] Replaces both front and rear converters, Only failed converters may be replaced.
[958] Federal & California Emission vehicles. Not legal for sale for vehicles licensed in California.

MERCURY COUGAR

(7137) 87-88 6 Cyl. Cougar, 232 (3.8L) Engine
 1987 8 Cyl. Cougar, 302 (5.0L) Engine

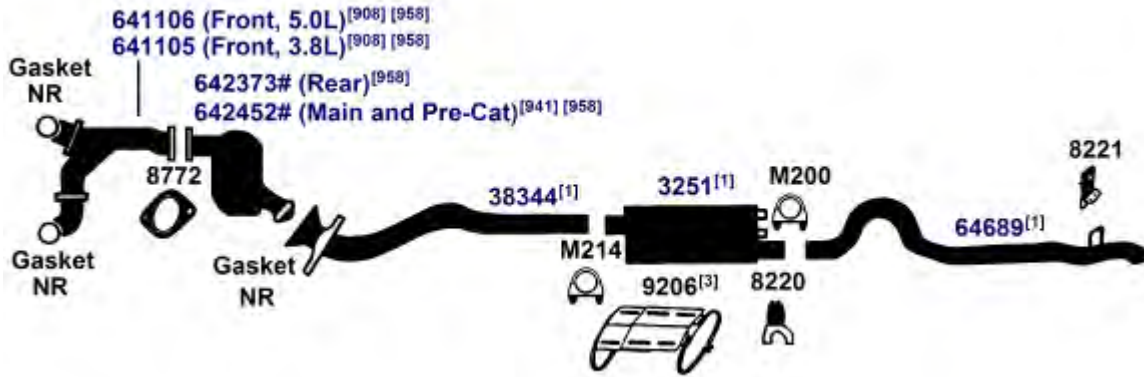

DIRECT FIT MSL/MAXIMUM Muffler... 6587, UNIVERSAL FIT MSL/MAXIMUM Muffler... 709012

(7135) 1986 8 Cyl. Cougar, 302 (5.0L) Engine
 85-86 6 Cyl. Cougar, 232 (3.8L) Engine

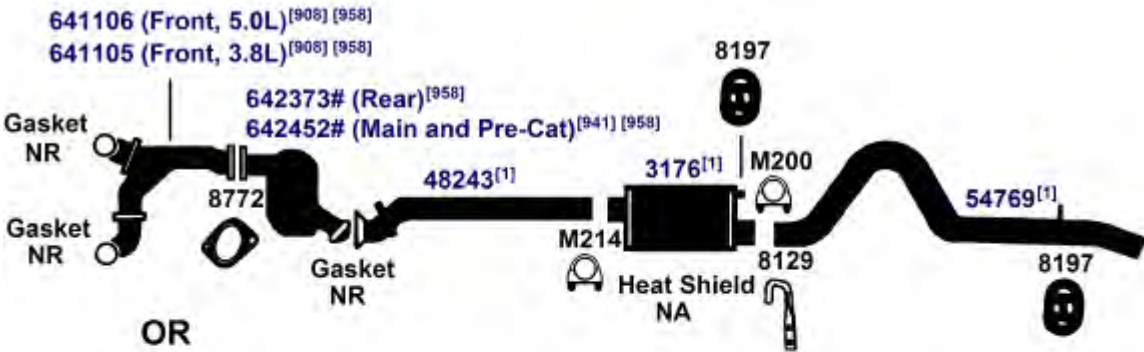

OR



DIRECT FIT MSL/MAXIMUM Muffler... 700073, UNIVERSAL FIT MSL/MAXIMUM Muffler... 6563, Silentone DIY Muffler... 5554 and 8083 Bracket and 9206 Heat Shield

NA-Not Available. NR-Not Required. FL-Remove and Re-Use Old Flange. ● Golden Warehouse. O.E.-Original Equipment.
 # Airtube Kit [4948] may be required to complete installation. EFI-Electronic Fuel Injection.

[1] OE system was a welded assembly. It is recommended that all parts noted [1] should be replaced.
 [3] Required for installation.
 [908] w/o Airtube on Pre-Cat.

[941] Replaces both front and rear converters, Only failed converters may be replaced.
 [958] Federal & California Emission vehicles. Not legal for sale for vehicles licensed in California.

85-86 4 Cyl. Cougar, 140 (2.3L) Turbo Engine

(7136)

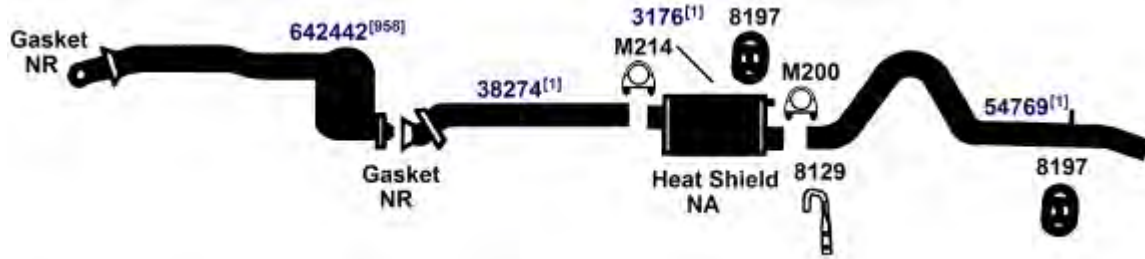

DIRECT FIT MSL/MAXIMUM Muffler... 700073, UNIVERSAL FIT MSL/MAXIMUM Muffler... 6563, Silentone DIY Muffler... 5554 and 8083 Bracket and 9206 Heat Shield

1985 8 Cyl. Cougar, 302 (5.0L) Engine

(7134)

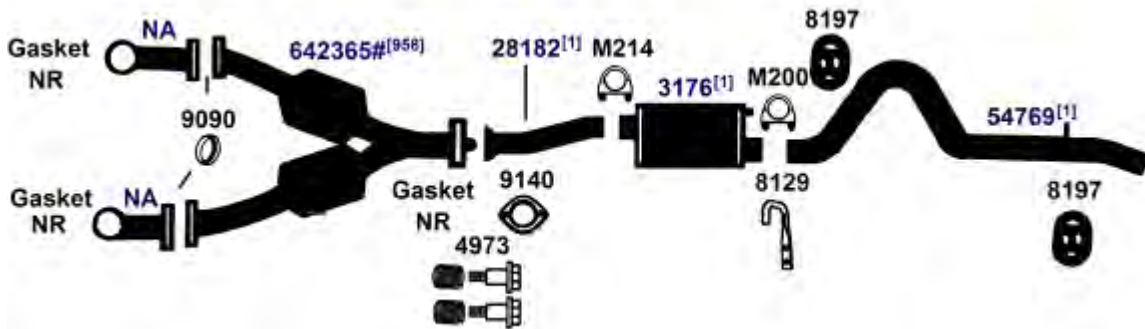

DIRECT FIT MSL/MAXIMUM Muffler... 700073, UNIVERSAL FIT MSL/MAXIMUM Muffler... 6563, Silentone DIY Muffler... 5554 and 8083 Bracket and 9206 Heat Shield

83-84 4 Cyl. Cougar, 140 (2.3L) Turbo Engine

(7136E)

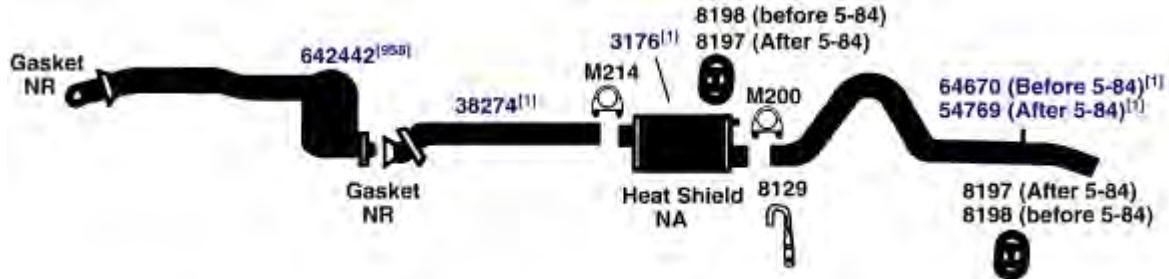

DIRECT FIT MSL/MAXIMUM Muffler... 700073, UNIVERSAL FIT MSL/MAXIMUM Muffler... 6563, Silentone DIY Muffler... 5554 and 8083 Bracket and 9206 Heat Shield

NA-Not Available. NR-Not Required. FL-Remove and Re-Use Old Flange. ● Golden Warehouse. O.E.-Original Equipment.

Airtube Kit [4948] may be required to complete installation. EFI-Electronic Fuel Injection.

[1] OE system was a welded assembly. It is recommended that all parts noted [1] should be replaced. [958] Federal & California Emission vehicles. Not legal for sale for vehicles licensed in California.

MERCURY COUGAR

(7135E) 83-84 6 Cyl. Cougar, 232 (3.8L) Engine

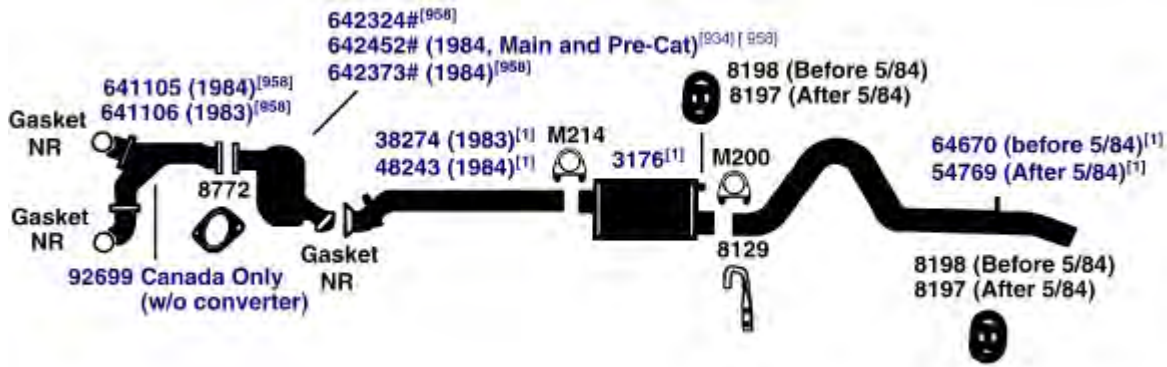

DIRECT FIT MSL/MAXIMUM Muffler... 700073, UNIVERSAL FIT MSL/MAXIMUM Muffler... 6563, Silentone DIY Muffler... 5554 and 8083 Bracket and 9206 Heat Shield

(7134E) 83-84 8 Cyl. Cougar, 302 (5.0L) Engine

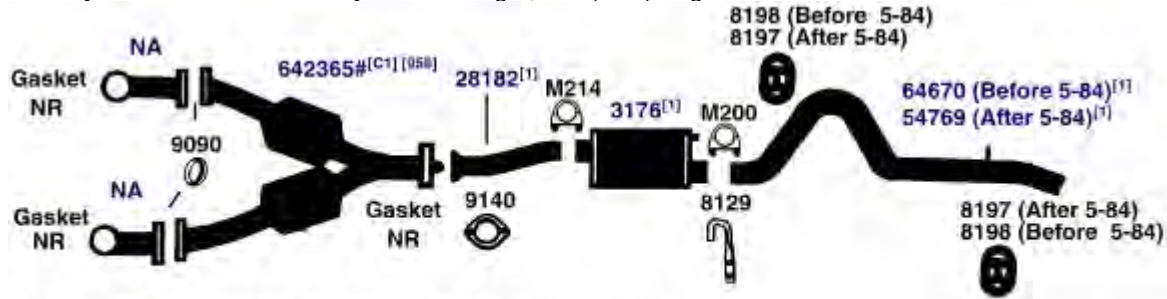

[C1] Combination Front & Rear Converter, 2 to 1 Replacement Only Defective Converters May Legally Be Replaced.

DIRECT FIT MSL/MAXIMUM Muffler... 700073, UNIVERSAL FIT MSL/MAXIMUM Muffler... 6563, Silentone DIY Muffler... 5554 and 8083 Bracket and 9206 Heat Shield

(7132) 1982 6 Cyl. Cougar, Station Wagon, 3.3L, 200 Engine

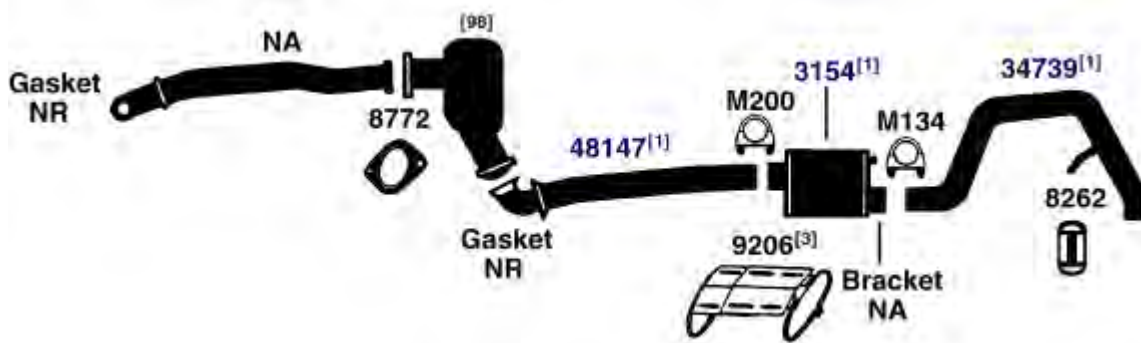

DIRECT FIT MSL/MAXIMUM Muffler... 6556, UNIVERSAL FIT MSL/MAXIMUM Muffler... 709011, Silentone DIY Muffler... 5565 and 8083 Bracket and 9206 Heat Shield

NA-Not Available. NR-Not Required. FL-Remove and Re-Use Old Flange. ● Golden Warehouse. O.E.-Original Equipment.
Airtube Kit [4948] may be required to complete installation. EFI-Electronic Fuel Injection.

- [1] OE system was a welded assembly. It is recommended that all parts noted [1] should be replaced.
- [3] Required for installation.

- [98] Refer to current Catalytic Converter catalog or Website catalog for availability.
- [958] Federal & California Emission vehicles. Not legal for sale for vehicles licensed in California.

1982 6 Cyl. Cougar, All Models with 3.8L, 232 Engine; except XR7

(7131)

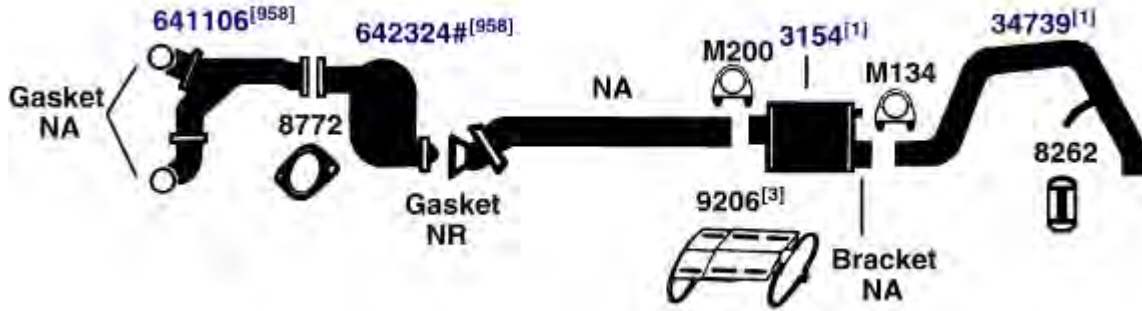

DIRECT FIT MSL/MAXIMUM Muffler... 6556, UNIVERSAL FIT MSL/MAXIMUM Muffler... 709011, Silentone DIY Muffler... 5565 and 8083
Bracket and 9206 Heat Shield

81-82 4 Cyl. Cougar, All Models with 2.3L, 140 Engine; except XR7

(7128)

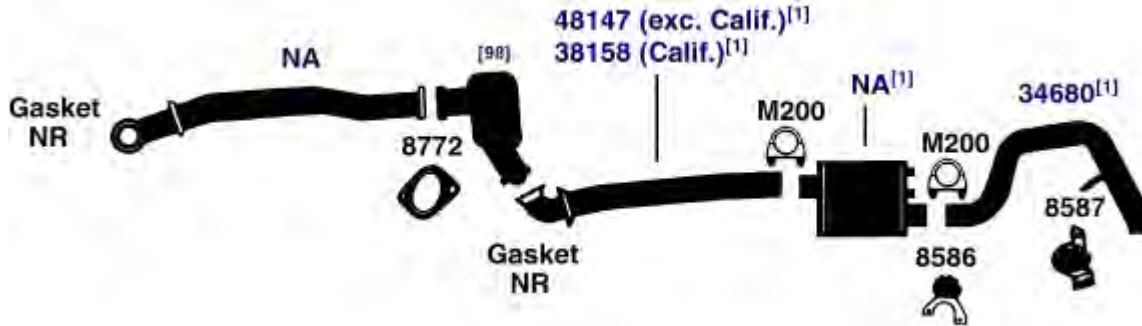

DIRECT FIT MSL/MAXIMUM Muffler... 6553, UNIVERSAL FIT MSL/MAXIMUM Muffler... 6538, 709011, 709012, Silentone DIY Muffler...
5531 and 9206 Heat Shield

81-82 6 Cyl. Cougar, All Models with 3.3L, 200 Engine; except XR7 and 1982 Station Wagon (7127)

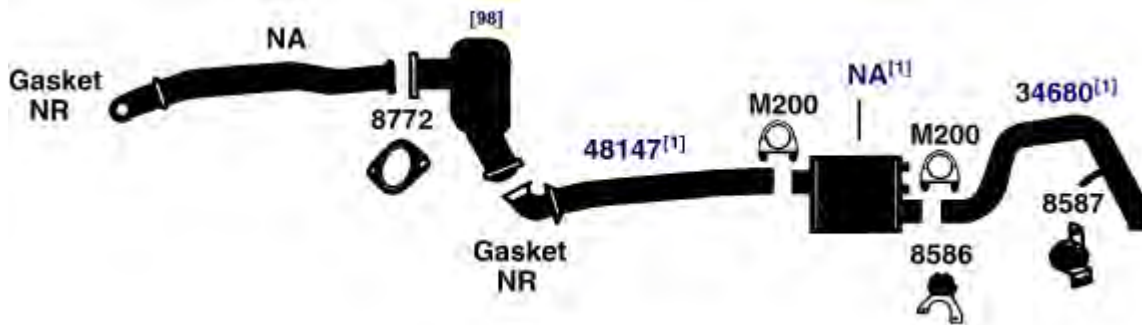

DIRECT FIT MSL/MAXIMUM Muffler... 6553, UNIVERSAL FIT MSL/MAXIMUM Muffler... 6538, 709011, 709012, Silentone DIY Muffler...
5531 and 9206 Heat Shield

NA-Not Available. NR-Not Required. FL-Remove and Re-Use Old Flange. ● Golden Warehouse. O.E.-Original Equipment.
Airtube Kit [4948] may be required to complete installation. EFI-Electronic Fuel Injection.

- [1] OE system was a welded assembly. It is recommended that all parts noted [1] should be replaced.
- [3] Required for installation.

- [98] Refer to current Catalytic Converter catalog or Website catalog for availability.
- [958] Federal & California Emission vehicles. Not legal for sale for vehicles licensed in California.

MERCURY COUGAR

(7125)

1981

8 Cyl.

Cougar Sedan, 4.2L, 255 Engine; except Canada, Police, Taxi, XR7



DIRECT FIT MSL/MAXIMUM Muffler... 6553, UNIVERSAL FIT MSL/MAXIMUM Muffler... 6538, 709011, 709012, Silentone DIY Muffler... 5531 and 9206 Heat Shield

NA-Not Available. NR-Not Required. FL-Remove and Re-Use Old Flange. ● Golden Warehouse. O.E.-Original Equipment.
Airtube Kit [4948] may be required to complete installation. EFI-Electronic Fuel Injection.

[1] OE system was a welded assembly. It is recommended that all parts noted [1] should be replaced. [958] Federal & California Emission vehicles. Not legal for sale for vehicles licensed in California.

[934] Replaces multiple OE Converters. Only failed converters may be replaced.

92-94

8 Cyl.

Grand Marquis Sedan (including Police), 280 (4.6L) Engine; Dual Exhaust

(6883)

2185 replaced by 2208
64726 replaced by 64755.
64735 replaced by 64758.
When inventories are depleted.

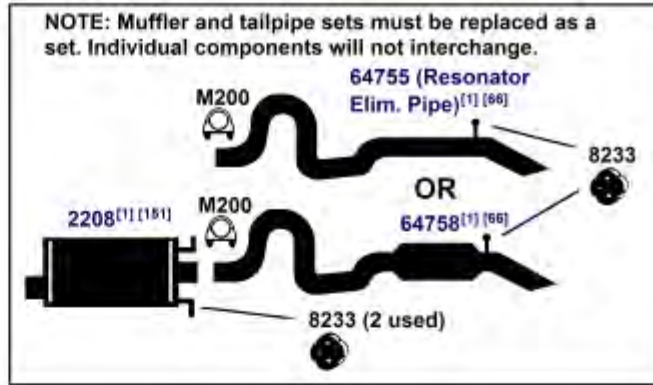

OR

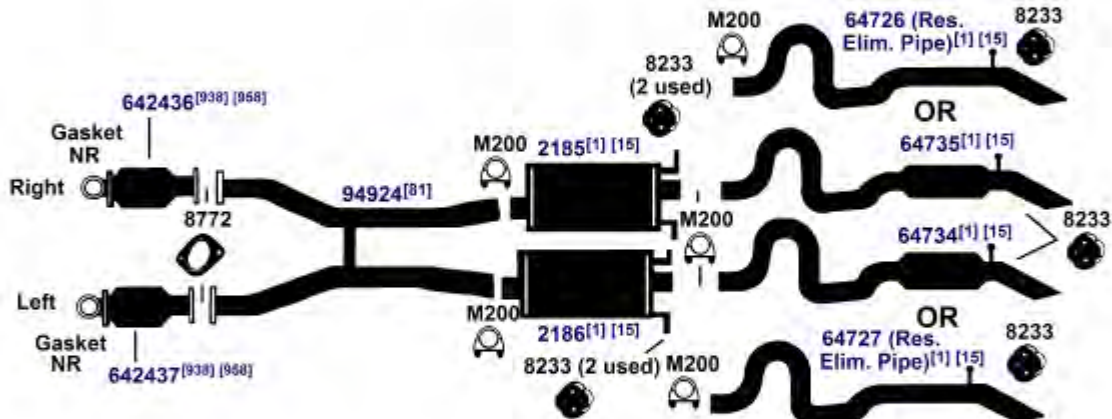

OR

2186 replaced by 2209
64727 replaced by 64756.
64734 replaced by 64757.
When inventories are depleted.

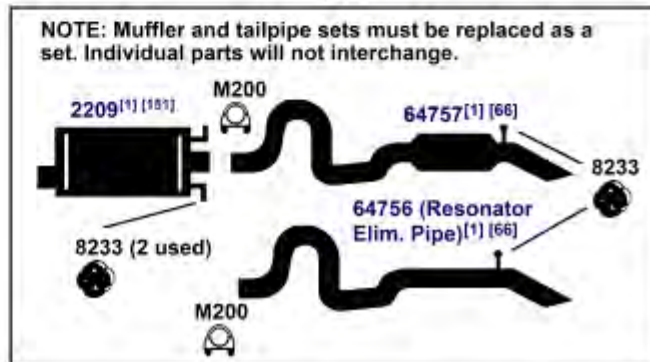

DIRECT FIT MSL/MAXIMUM Muffler... Muffler (option for 2185)-, Right 700042 (Old Design), Muffler (option for 2208)-, Right 700037 (Revised Design), Muffler (option for 2186)-, Left 700043 (Old Design), Muffler (option for 2209)-, Left 700038 (Revised Design), UNIVERSAL FIT MSL/MAXIMUM Muffler... Muffler (option for 2185)-, Right 709012 (Old Design), 709011 (Old Design), Muffler (option for 2208)-, Right 709014 (Revised Design), 709013 (Revised Design), Muffler (option for 2186)-, Left 709012 (Old Design), 709011 (Old Design), Muffler (option for 2209)-, Left 709014 (Revised Design), 709013 (Revised Design)

NA-Not Available. NR-Not Required. FL-Remove and Re-Use Old Flange. ● Golden Warehouse. O.E.-Original Equipment.
Airtube Kit [4948] may be required to complete installation. EFI-Electronic Fuel Injection.

- [1] OE system was a welded assembly. It is recommended that all parts noted [1] should be replaced.
- [15] Discontinued, use until inventory is depleted.
- [66] Muffler and tailpipe sets must be replaced as a set. Individual components will not interchange.
- [81] To align inlets of pipes it may be necessary to reposition converters.
- [151] For Proper sound 2208 and 2209 should be replaced as a pair.

- [938] Direct fit unit contains front and rear converter body. Only failed converters may be replaced.
- [958] Federal & California Emission vehicles. Not legal for sale for vehicles licensed in California.

MERCURY GRAND MARQUIS, MARQUIS

(6884) 92-94 8 Cyl. Grand Marquis Sedan, 280 (4.6L) Engine; Single Exhaust

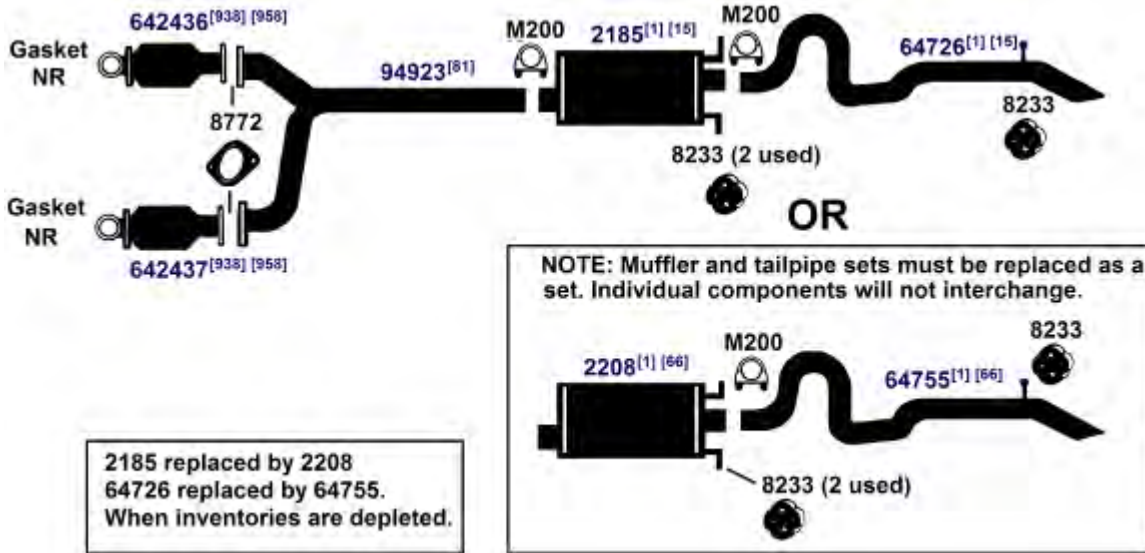

DIRECT FIT MSL/MAXIMUM Muffler... Muffler (option for 2185)- 700042 (Old Design), Muffler (option for 2208)- 700037 (Revised Design), UNIVERSAL FIT MSL/MAXIMUM Muffler... Muffler (option for 2185)- 709012 (Old Design), 709011 (Old Design), Muffler (option for 2208)- 709013 (Revised Design), 709014 (Revised Design)

(6881) 90-91 8 Cyl. Grand Marquis Sedan, 302 (5.0L) Engine; Dual Exhaust

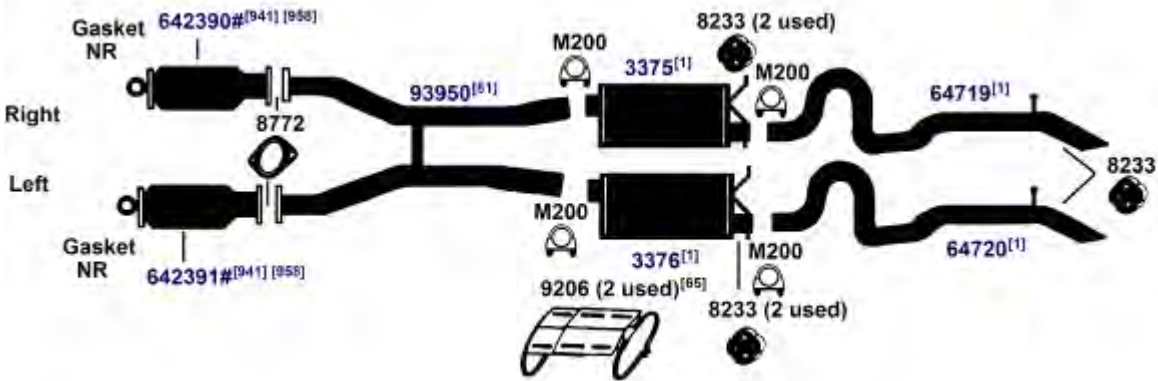

DIRECT FIT MSL/MAXIMUM Muffler... Left- 700117, Right- 700013, UNIVERSAL FIT MSL/MAXIMUM Muffler... Left- 6554, 709011, 709012, 709016, Right- 6554, 709011, 709012, 709016

NA-Not Available. NR-Not Required. FL-Remove and Re-Use Old Flange. ● Golden Warehouse. O.E.-Original Equipment.
Airtube Kit [4948] may be required to complete installation. EFI-Electronic Fuel Injection.

[1] OE system was a welded assembly. It is recommended that all parts noted [1] should be replaced.
[15] Discontinued, use until inventory is depleted.
[65] Heat Shield 9206 is required for installation.
[66] Muffler and tailpipe sets must be replaced as a set. Individual components will not interchange.

[81] To align inlets of pipes it may be necessary to reposition converters.
[938] Direct fit unit contains front and rear converter body. Only failed converters may be replaced.
[941] Replaces both front and rear converters, Only failed converters may be replaced.
[958] Federal & California Emission vehicles. Not legal for sale for vehicles licensed in California.

MERCURY GRAND MARQUIS, MARQUIS

90-91 8 Cyl. Grand Marquis Sta. Wagon (Incl. Colony Park), 302 (5.0L) Engine; Single Exhaust **(6880)**

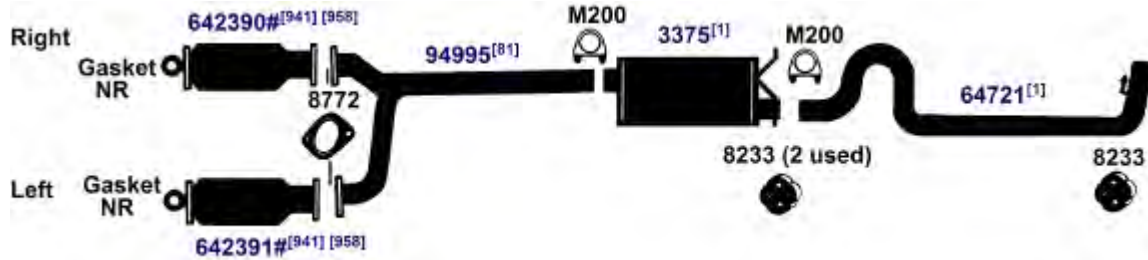

DIRECT FIT MSL/MAXIMUM Muffler... 700013, UNIVERSAL FIT MSL/MAXIMUM Muffler... 6554, 709011, 709012, 709016

90-91 8 Cyl. Grand Marquis Sedan, 302 (5.0L) Engine; Single Exhaust **(6882)**



DIRECT FIT MSL/MAXIMUM Muffler... 700013, UNIVERSAL FIT MSL/MAXIMUM Muffler... 6554, 709011, 709012, 709016

90-91 8 Cyl. Grand Marquis Sta. Wagon (Incl. Colony Park), 302 (5.0L) Engine; Dual Exhaust **(6879)**

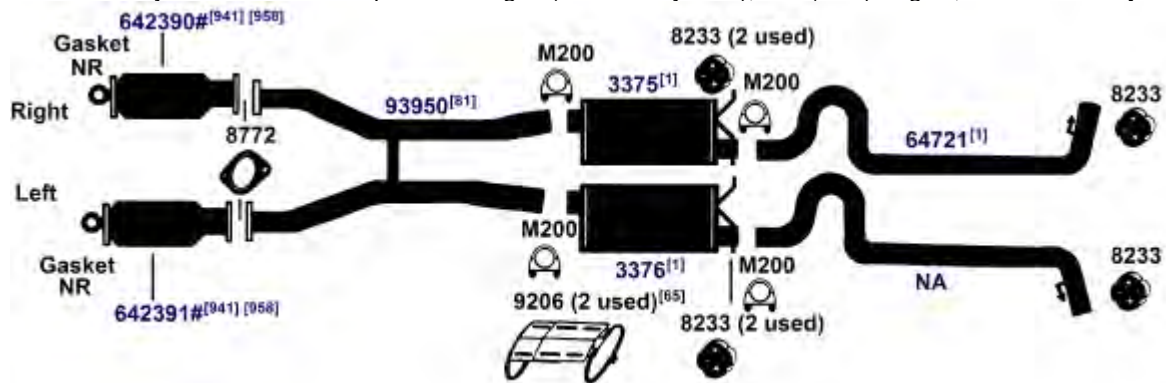

DIRECT FIT MSL/MAXIMUM Muffler... Left- 700117, Right- 700013, UNIVERSAL FIT MSL/MAXIMUM Muffler... Left- 6554, 709011, 709012, 709016, Right- 6554, 709011, 709012, 709016

NA-Not Available. NR-Not Required. FL-Remove and Re-Use Old Flange. ● Golden Warehouse. O.E.-Original Equipment.
Airtube Kit [4948] may be required to complete installation. EFI-Electronic Fuel Injection.

[1] OE system was a welded assembly. It is recommended that all parts noted [1] should be replaced.
[65] Heat Shield 9206 is required for installation.
[81] To align inlets of pipes it may be necessary to reposition converters.

[941] Replaces both front and rear converters, Only failed converters may be replaced.
[958] Federal & California Emission vehicles. Not legal for sale for vehicles licensed in California.

MERCURY GRAND MARQUIS, MARQUIS

(6878) 85-89 8 Cyl. Grand Marquis Sedan, Sta. Wagon (Incl. Colony Park); 302 (5.0L), 351 (5.8L) Engine; Dual Exhaust

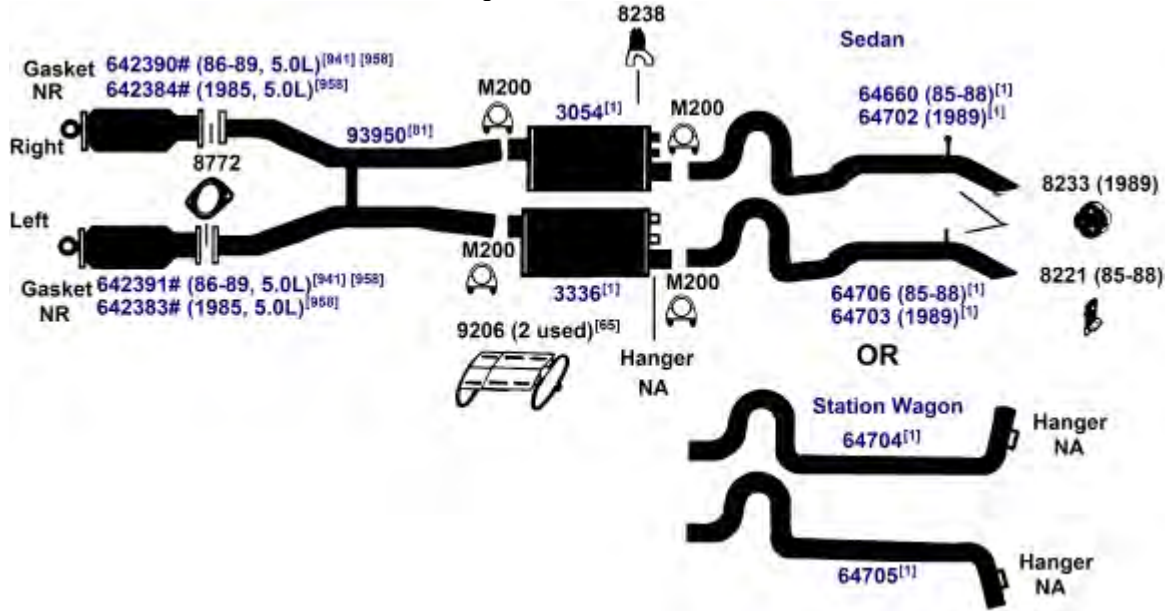

DIRECT FIT MSL/MAXIMUM Muffler... Left- 700006, Right- 6554, UNIVERSAL FIT MSL/MAXIMUM Muffler... Left- 709011, 709012, 709016, Right- 6506, 709011, 709012, 709016, Silentone DIY Muffler... Left- 5533 and 9206 Heat Shield, Right- 5533 and 9206 Heat Shield

(6872) 85-89 8 Cyl. Grand Marquis Sedan, 302 (5.0L) Engine; Single Exhaust

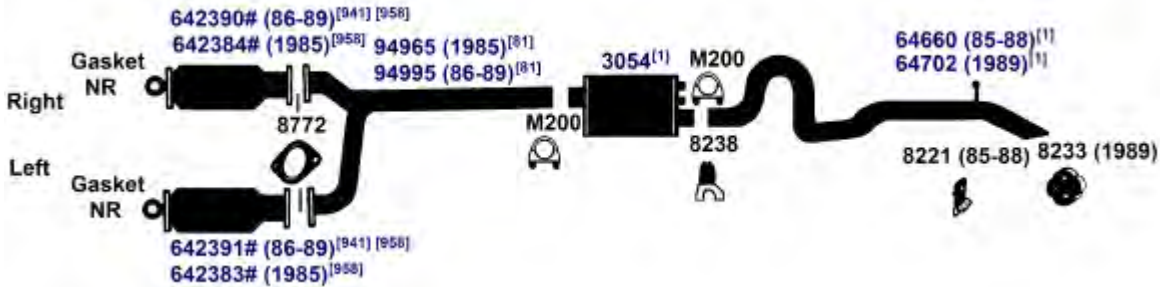

DIRECT FIT MSL/MAXIMUM Muffler... 6554, UNIVERSAL FIT MSL/MAXIMUM Muffler... 6506, 709011, 709012, 709016, Silentone DIY Muffler... 5533

NA-Not Available. NR-Not Required. FL-Remove and Re-Use Old Flange. ● Golden Warehouse. O.E.-Original Equipment.
Airtube Kit [4948] may be required to complete installation. EFI-Electronic Fuel Injection.

[1] OE system was a welded assembly. It is recommended that all parts noted [1] should be replaced.
[65] Heat Shield 9206 is required for installation.
[81] To align inlets of pipes it may be necessary to reposition converters.

[941] Replaces both front and rear converters, Only failed converters may be replaced.
[958] Federal & California Emission vehicles. Not legal for sale for vehicles licensed in California.

MERCURY GRAND MARQUIS, MARQUIS

85-89 8 Cyl. Grand Marquis Sta. Wagon (Incl. Colony Park), 302 (5.0L) Engine; Single Exhaust **(6871)**

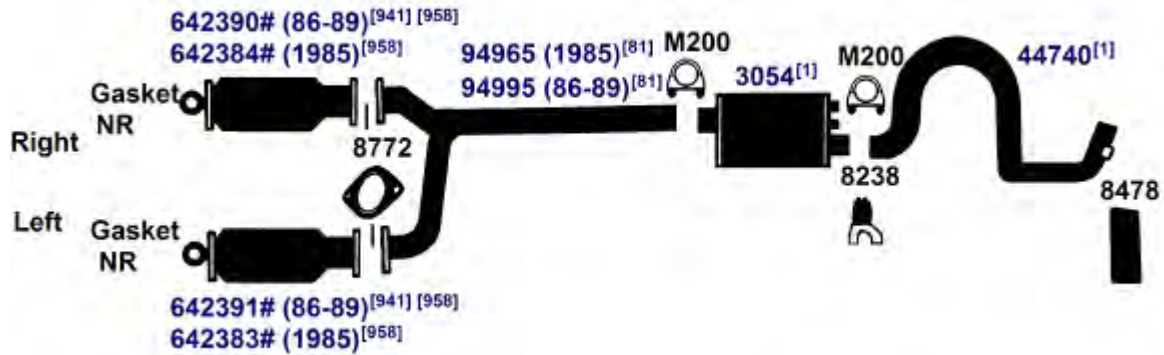

DIRECT FIT MSL/MAXIMUM Muffler... 6554, UNIVERSAL FIT MSL/MAXIMUM Muffler... 6506, 709011, 709012, 709016, Silentone DIY Muffler... 5533

85-86 4 Cyl. Marquis Sedan, 140 (2.3L) Engine **(6874)**

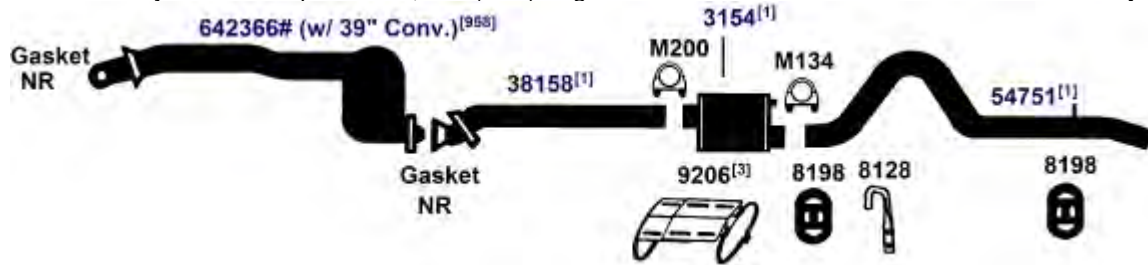

DIRECT FIT MSL/MAXIMUM Muffler... 6556, UNIVERSAL FIT MSL/MAXIMUM Muffler... 709011, Silentone DIY Muffler... 5565 and 8083 Bracket and 9206 Heat Shield

NA-Not Available. NR-Not Required. FL-Remove and Re-Use Old Flange. ● Golden Warehouse. O.E.-Original Equipment.
Airtube Kit [4948] may be required to complete installation. EFI-Electronic Fuel Injection.

- [1] OE system was a welded assembly. It is recommended that all parts noted [1] should be replaced. [941] Replaces both front and rear converters, Only failed converters may be replaced.
- [3] Required for installation. [958] Federal & California Emission vehicles. Not legal for sale for vehicles licensed in California.
- [81] To align inlets of pipes it may be necessary to reposition converters.

MERCURY GRAND MARQUIS, MARQUIS

(6873) 85-86 6 Cyl. Marquis, 232 (3.8L) Engine with Electronic Engine Control

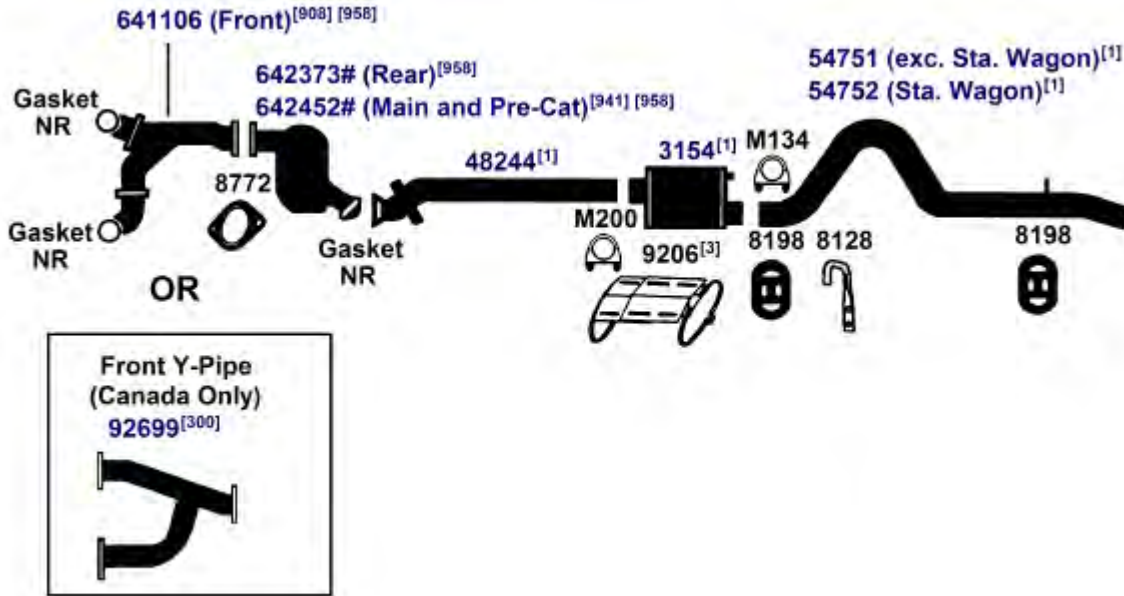

DIRECT FIT MSL/MAXIMUM Muffler... 6556, UNIVERSAL FIT MSL/MAXIMUM Muffler... 709011, Silentone DIY Muffler... 5565 and 8083 Bracket and 9206 Heat Shield

(6874E) 1984 4 Cyl. Marquis Sedan, 140 (2.3L) Engine

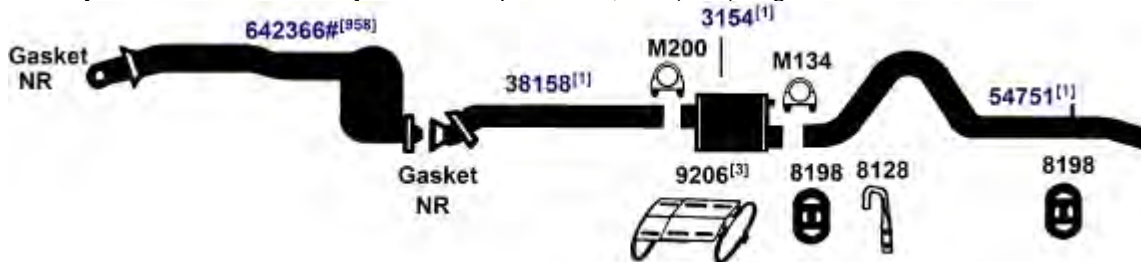

DIRECT FIT MSL/MAXIMUM Muffler... 6556, UNIVERSAL FIT MSL/MAXIMUM Muffler... 709011, Silentone DIY Muffler... 5565 and 8083 Bracket and 9206 Heat Shield

(6870) 1984 6 Cyl. Marquis, 3.8L, 232 Engine; without Electronic Engine Control
 1983 6 Cyl. Marquis, 3.8L, 232 Engine; with Electronic Engine Control

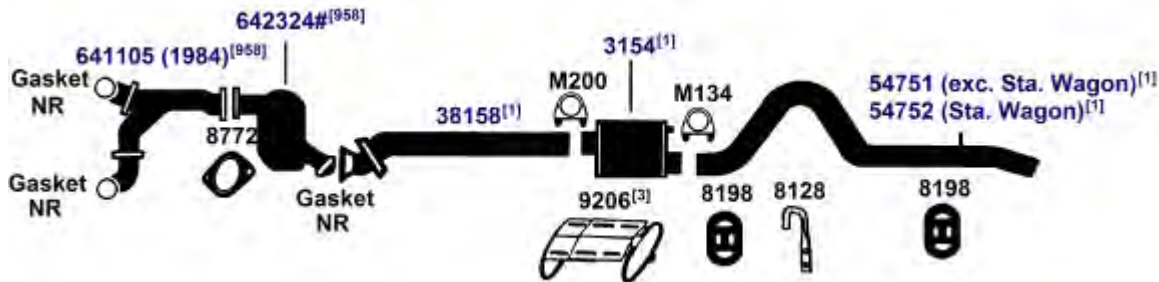

DIRECT FIT MSL/MAXIMUM Muffler... 6556, UNIVERSAL FIT MSL/MAXIMUM Muffler... 709011, Silentone DIY Muffler... 5565 and 8083 Bracket and 9206 Heat Shield

NA-Not Available. NR-Not Required. FL-Remove and Re-Use Old Flange. ● Golden Warehouse. O.E.-Original Equipment.
 # Airtube Kit [4948] may be required to complete installation. EFI-Electronic Fuel Injection.

- [1] OE system was a welded assembly. It is recommended that all parts noted [1] should be replaced.
- [3] Required for installation.
- [300] For use when resonator originated from O.E. manufacturer.

- [908] w/o Airtube on Pre-Cat.
- [941] Replaces both front and rear converters, Only failed converters may be replaced.
- [958] Federal & California Emission vehicles. Not legal for sale for vehicles licensed in California.

MERCURY GRAND MARQUIS, MARQUIS

1984 6 Cyl. Marquis, 232 (3.8L) Engine with Electronic Engine Control

(6873E)

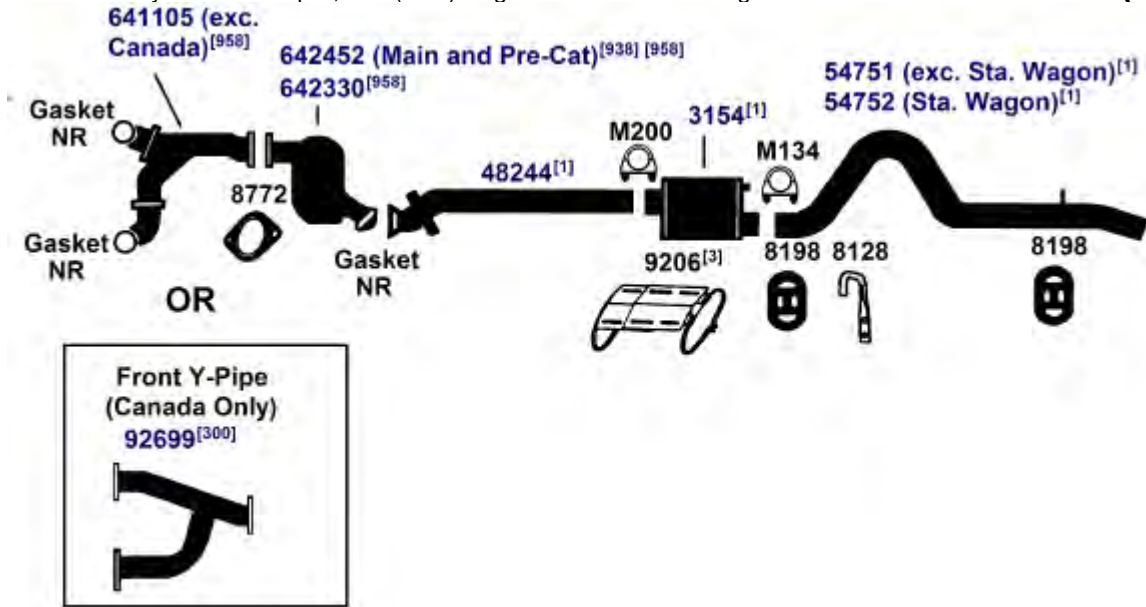

DIRECT FIT MSL/MAXIMUM Muffler... 6556, UNIVERSAL FIT MSL/MAXIMUM Muffler... 709011, Silentone DIY Muffler... 5565 and 8083 Bracket and 9206 Heat Shield

83-84 8 Cyl. Grand Marquis Sta. Wagon, 302 (5.0L) Engine; Single Exhaust

(6871E)

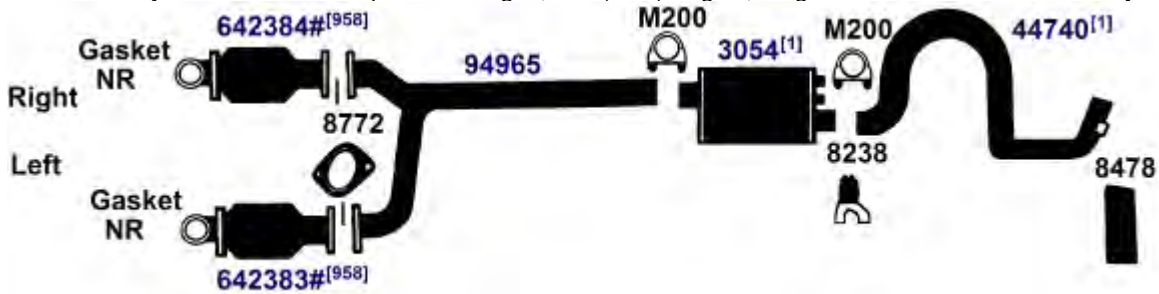

DIRECT FIT MSL/MAXIMUM Muffler... 6554, UNIVERSAL FIT MSL/MAXIMUM Muffler... 6506, 709011, 709012, 709016, Silentone DIY Muffler... 5533

NA-Not Available. NR-Not Required. FL-Remove and Re-Use Old Flange. ● Golden Warehouse. O.E.-Original Equipment.
Airtube Kit [4948] may be required to complete installation. EFI-Electronic Fuel Injection.

[1] OE system was a welded assembly. It is recommended that all parts noted [1] should be replaced.
[3] Required for installation.
[300] For use when resonator originated from O.E. manufacturer.

[938] Direct fit unit contains front and rear converter body. Only failed converters may be replaced.
[958] Federal & California Emission vehicles. Not legal for sale for vehicles licensed in California.

MERCURY GRAND MARQUIS, MARQUIS

(6872E) 83-84 8 Cyl. Grand Marquis Sedan, 302 (5.0L) Engine; Single Exhaust

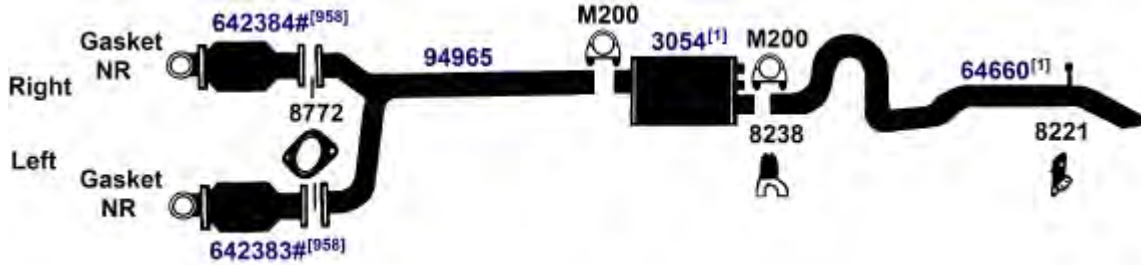

DIRECT FIT MSL/MAXIMUM Muffler... 6554, UNIVERSAL FIT MSL/MAXIMUM Muffler... 6506, 709011, 709012, 709016, Silentone DIY Muffler... 5533

(6878E) 83-84 8 Cyl. Grand Marquis Sedan, Sta. Wagon; 302 (5.0L), 351 (5.8L) Engine; Dual Exhaust

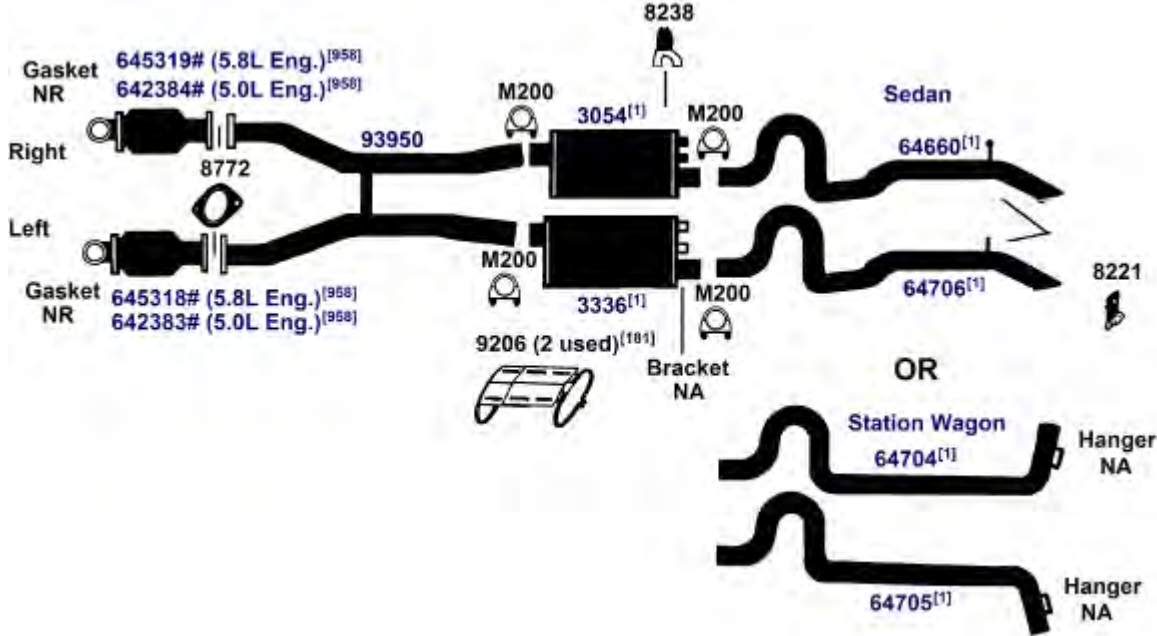

DIRECT FIT MSL/MAXIMUM Muffler... Left- 700006, Right- 6554, UNIVERSAL FIT MSL/MAXIMUM Muffler... Left- 709011, 709012, 709016, Right- 6506, 709011, 709012, 709016, Silentone DIY Muffler... Left- 5533 and 9206 Heat Shield, Right- 5533 and 9206 Heat Shield

NA-Not Available. NR-Not Required. FL-Remove and Re-Use Old Flange. ● Golden Warehouse. O.E.-Original Equipment.
Airtube Kit [4948] may be required to complete installation. EFI-Electronic Fuel Injection.

[1] OE system was a welded assembly. It is recommended that all parts noted [1] should be replaced. [958] Federal & California Emission vehicles. Not legal for sale for vehicles licensed in California.

[181] Required for installation on Police models and models with Trailer Towing Package.

MERCURY GRAND MARQUIS, MARQUIS

1983 4 Cyl. Marquis, 2.3L, 140 Engine (6869)
 1983 6 Cyl. Marquis, 3.3L, 200 Engine

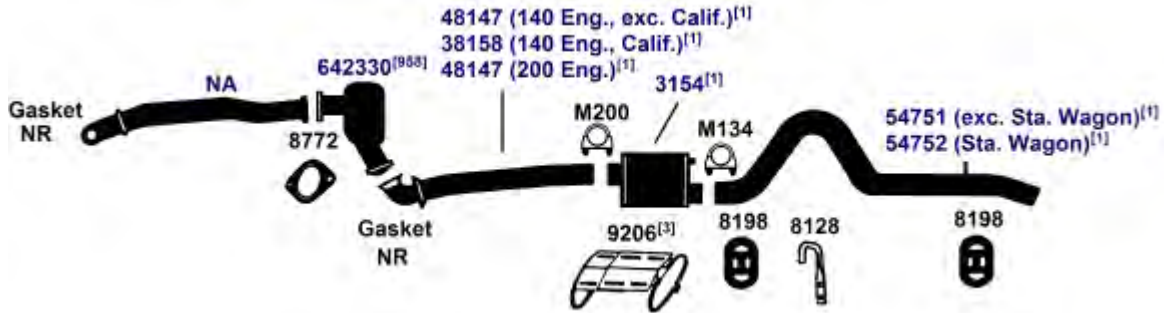

DIRECT FIT MSL/MAXIMUM Muffler... 6556, UNIVERSAL FIT MSL/MAXIMUM Muffler... 709011, Silentone DIY Muffler... 5565 and 8083
 Bracket and 9206 Heat Shield

81-82 8 Cyl. Marquis Sedan, 255 (4.2L), 302 (5.0L), 351 (5.8L) Engine (6865)
 1980 8 Cyl. Marquis Sedan, 302, 351W Engine; with Automatic Overdrive

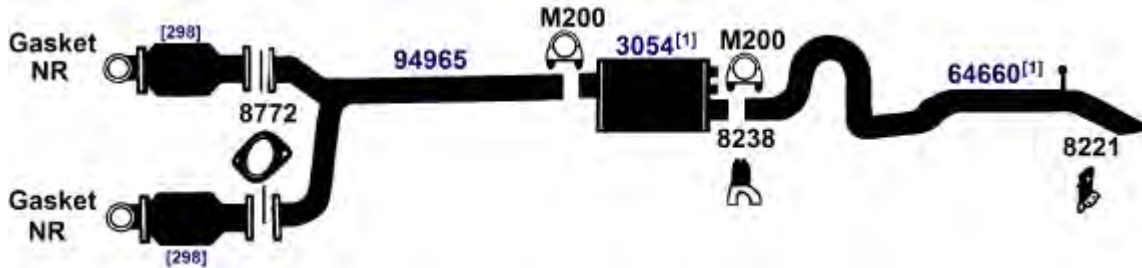

DIRECT FIT MSL/MAXIMUM Muffler... 6554, UNIVERSAL FIT MSL/MAXIMUM Muffler... 6506, 709011, 709012, 709016, Silentone DIY Muffler... 5533

81-82 8 Cyl. Mercury Station Wagon, 255 (4.2L), 302 (5.0L) Engine (6864)

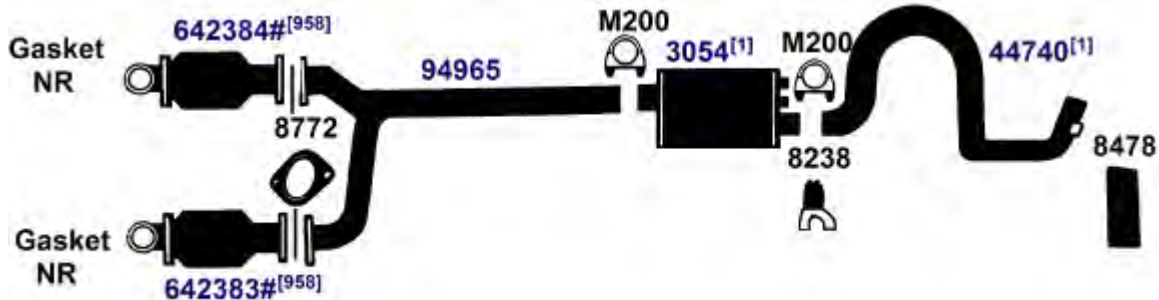

DIRECT FIT MSL/MAXIMUM Muffler... 6554, UNIVERSAL FIT MSL/MAXIMUM Muffler... 6506, 709011, 709012, 709016, Silentone DIY Muffler... 5533

NA-Not Available. NR-Not Required. FL-Remove and Re-Use Old Flange. ● Golden Warehouse. O.E.-Original Equipment.
 # Airtube Kit [4948] may be required to complete installation. EFI-Electronic Fuel Injection.

- [1] OE system was a welded assembly. It is recommended that all parts noted [1] should be replaced. [298] Coverage available. Due to multiple listings, please refer to Catalytic Converter catalog.
 [3] Required for installation. [958] Federal & California Emission vehicles. Not legal for sale for vehicles licensed in California.

MERCURY GRAND MARQUIS, MARQUIS

(6876) 80-82 8 Cyl. Mercury Marquis Sedan, Station Wagon; 5.8L, 351 Engine; Dual Exhaust

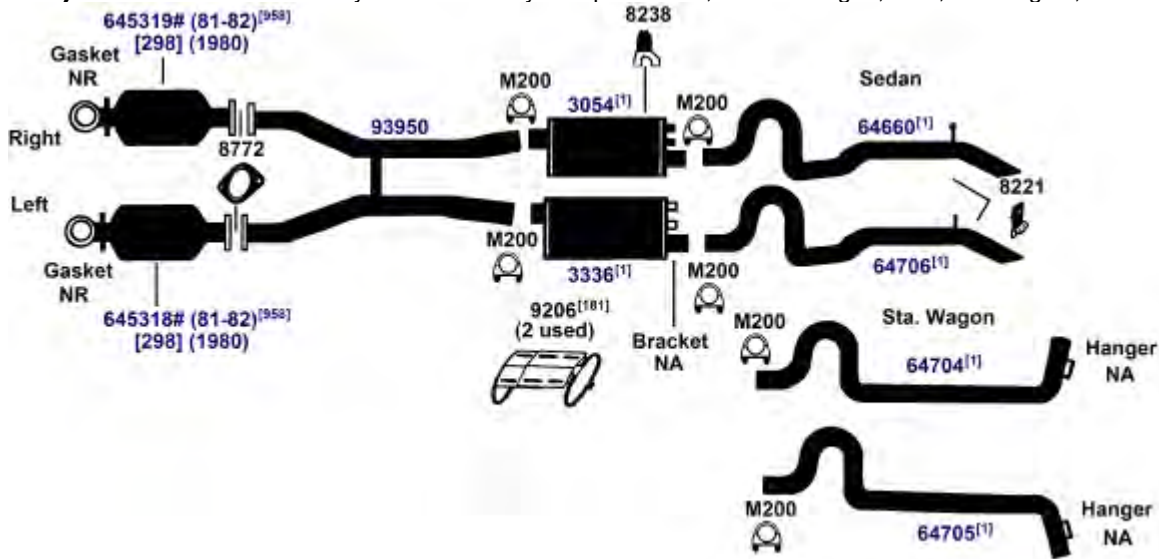

DIRECT FIT MSL/MAXIMUM Muffler... Left- 700006, Right- 6554, UNIVERSAL FIT MSL/MAXIMUM Muffler... Left- 709011, 709012, 709016, Right- 6506, 709011, 709012, 709016, Silentone DIY Muffler... Left- 5533 and 9206 Heat Shield, Right- 5533 and 9206 Heat Shield

(6861) 79-80 8 Cyl. Mercury Marquis Station Wagon, 302, 351W Engine

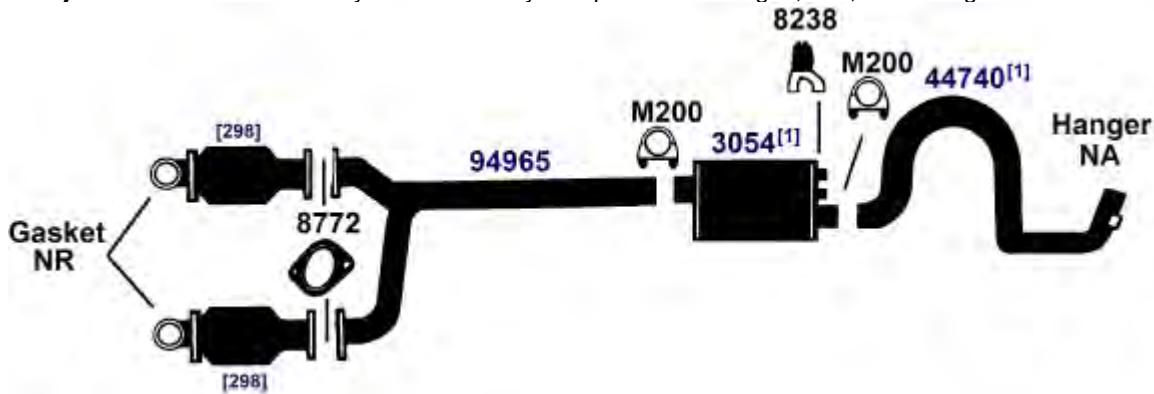

DIRECT FIT MSL/MAXIMUM Muffler... 6554, UNIVERSAL FIT MSL/MAXIMUM Muffler... 6506, 709011, 709012, 709016, Silentone DIY Muffler... 5533

NA-Not Available. NR-Not Required. FL-Remove and Re-Use Old Flange. ● Golden Warehouse. O.E.-Original Equipment.
Airtube Kit [4948] may be required to complete installation. EFI-Electronic Fuel Injection.

[1] OE system was a welded assembly. It is recommended that all parts noted [1] should be replaced.

[181] Required for installation on Police models and models with Trailer Towing Package.

[298] Coverage available. Due to multiple listings, please refer to Catalytic Converter catalog.

[958] Federal & California Emission vehicles. Not legal for sale for vehicles licensed in California.

MERCURY GRAND MARQUIS, MARQUIS

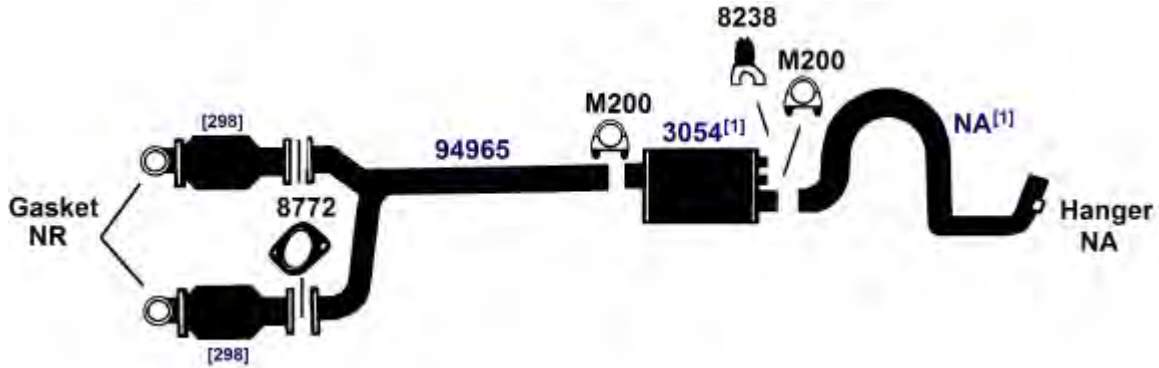
79-80 8 Cyl. Mercury Marquis Sedan, 302, 351W Engine; without Automatic Overdrive **(6862)**

DIRECT FIT MSL/MAXIMUM Muffler... 6554, UNIVERSAL FIT MSL/MAXIMUM Muffler... 6506, 709011, 709012, 709016, Silentone DIY Muffler... 5533

MERCURY LYNX

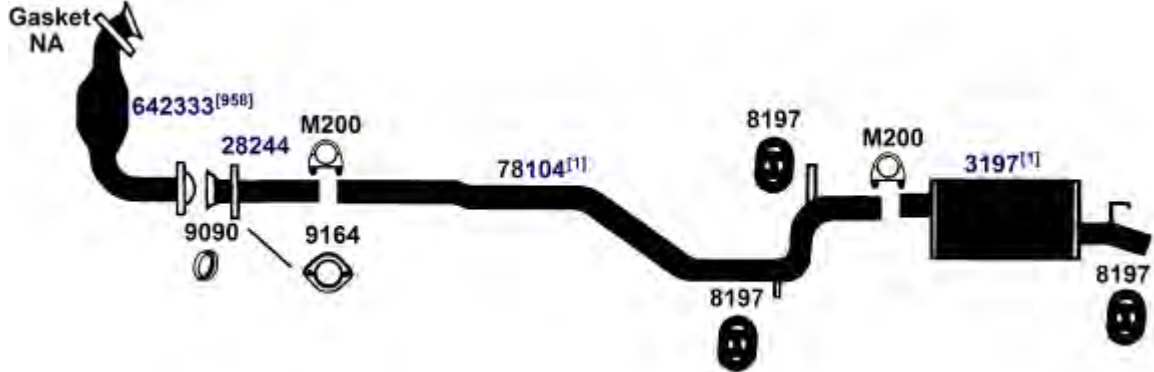
1987 4 Cyl. Lynx, 116 (1.9L) Engine (Engine Code 9); Central Fuel Injection **(7218)**

DIRECT FIT MSL/MAXIMUM Muffler... 6567, Silentone DIY Muffler... 5558 and 9206 Heat Shield

1987 4 Cyl. Lynx, 116 (1.9L) Engine (Engine Code J) **(7217)**
85-86 4 Cyl. Lynx, 116 (1.9L) Engine

DIRECT FIT MSL/MAXIMUM Muffler... 6567, Silentone DIY Muffler... 5558 and 9206 Heat Shield

NA-Not Available. NR-Not Required. FL-Remove and Re-Use Old Flange. ● Golden Warehouse. O.E.-Original Equipment.
Airtube Kit [4948] may be required to complete installation. EFI-Electronic Fuel Injection.

[1] OE system was a welded assembly. It is recommended that all parts noted [1] should be replaced.

[298] Coverage available. Due to multiple listings, please refer to Catalytic Converter catalog.

[958] Federal & California Emission vehicles. Not legal for sale for vehicles licensed in California.

MERCURY LYNX

(7215) 1985 4 Cyl. Lynx, 122 (2.0L) Diesel Engine

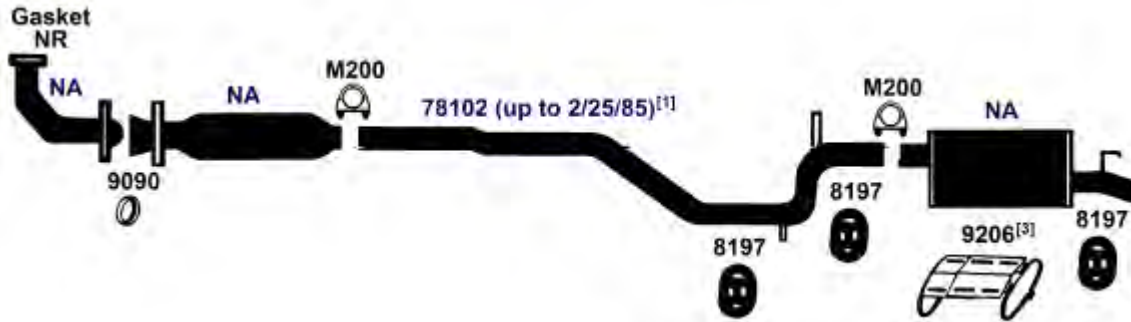

DIRECT FIT MSL/MAXIMUM Muffler... 6549, UNIVERSAL FIT MSL/MAXIMUM Muffler... 709006

(7214) 1985 4 Cyl. Lynx, 98 (1.6L) Engine

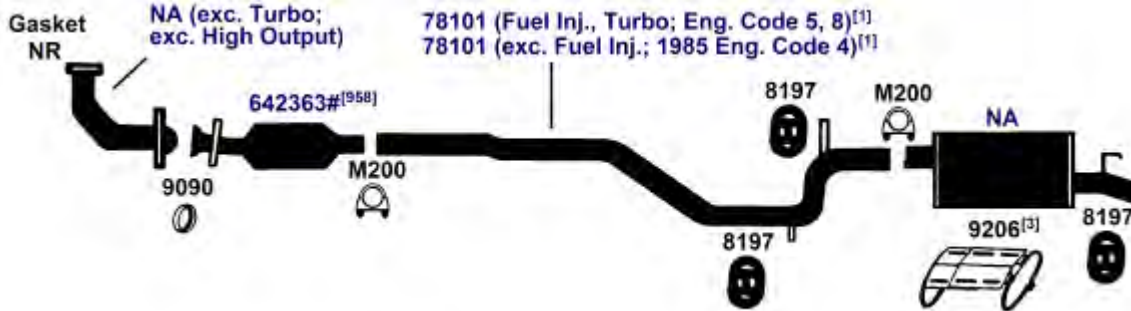

DIRECT FIT MSL/MAXIMUM Muffler... 6549, UNIVERSAL FIT MSL/MAXIMUM Muffler... 709006

(7215E) 1984 4 Cyl. Lynx, 122 (2.0L) Diesel Engine

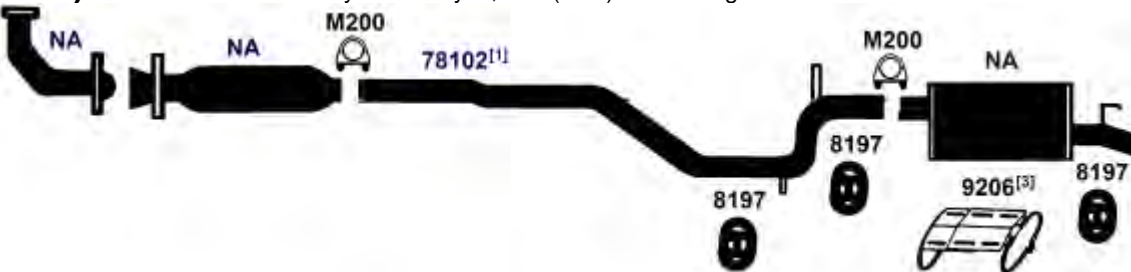

DIRECT FIT MSL/MAXIMUM Muffler... 6549, UNIVERSAL FIT MSL/MAXIMUM Muffler... 709006

NA-Not Available. NR-Not Required. FL-Remove and Re-Use Old Flange. ● Golden Warehouse. O.E.-Original Equipment.
 # Airtube Kit [4948] may be required to complete installation. EFI-Electronic Fuel Injection.

- [1] OE system was a welded assembly. It is recommended that all parts noted [1] should be replaced. [958] Federal & California Emission vehicles. Not legal for sale for vehicles licensed in California.
- [3] Required for installation.

MERCURY LYNX

83-84 4 Cyl. Lynx, 98 (1.6L) Engine

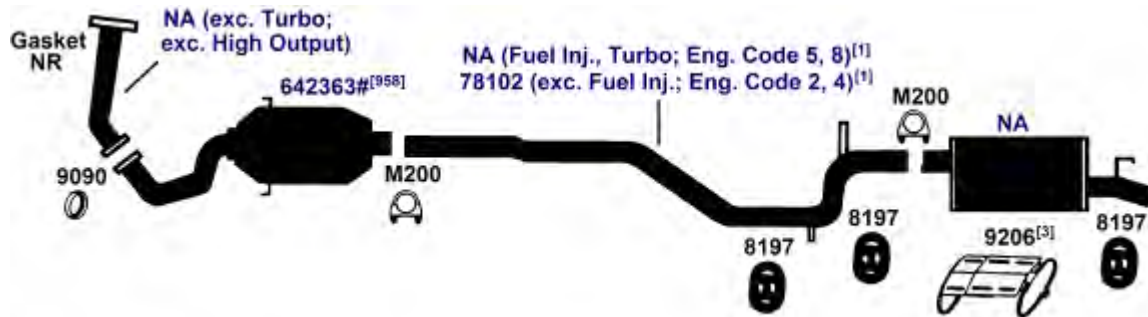
(7214E)

DIRECT FIT MSL/MAXIMUM Muffler... 6549, UNIVERSAL FIT MSL/MAXIMUM Muffler... 709006

MERCURY SABLE1994 6 Cyl. Sable, 3.0L (182) Engine
91-94 6 Cyl. Sable, 3.8L (232) Engine**(11454)**

DIRECT FIT MSL/MAXIMUM Muffler... 700098, UNIVERSAL FIT MSL/MAXIMUM Muffler... 6516, 6538, 709011, 709012, Silentone DIY Muffler... 5533

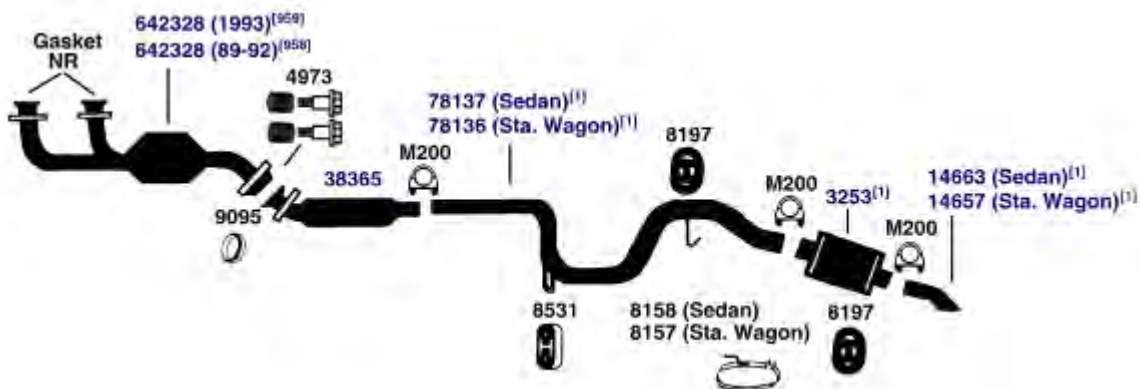
1993 6 Cyl. Sable, 3.0L (182) Engine; except California
89-92 6 Cyl. Sable, 3.0L (182) Engine**(11453)**

DIRECT FIT MSL/MAXIMUM Muffler... 700098, UNIVERSAL FIT MSL/MAXIMUM Muffler... 6516, 6538, 709011, 709012, Silentone DIY Muffler... 5533

NA-Not Available. NR-Not Required. FL-Remove and Re-Use Old Flange. ● Golden Warehouse. O.E.-Original Equipment.
Airtube Kit [4948] may be required to complete installation. EFI-Electronic Fuel Injection.

- [1] OE system was a welded assembly. It is recommended that all parts noted [1] should be replaced.
[3] Required for installation.

- [958] Federal & California Emission vehicles. Not legal for sale for vehicles licensed in California.
[959] Federal Emission vehicles. Not legal for sale for vehicles licensed in California.

MERCURY SABLE

(11452) 88-90 6 Cyl. Sable, 3.8L (232) Engine



DIRECT FIT MSL/MAXIMUM Muffler... 700098, UNIVERSAL FIT MSL/MAXIMUM Muffler... 6516, 6538, 709011, 709012, Silentone DIY Muffler... 5533

(11451) 86-88 6 Cyl. Sable, 3.0L (182) Engine



DIRECT FIT MSL/MAXIMUM Muffler... 700098, UNIVERSAL FIT MSL/MAXIMUM Muffler... 6516, 6538, 709011, 709012, Silentone DIY Muffler... 5533

(11450) 1986 4 Cyl. Sable, 2.5L Engine



DIRECT FIT MSL/MAXIMUM Muffler... 700098, UNIVERSAL FIT MSL/MAXIMUM Muffler... 6516, 6538, 709011, 709012, Silentone DIY Muffler... 5533

NA-Not Available. NR-Not Required. FL-Remove and Re-Use Old Flange. ● Golden Warehouse. O.E.-Original Equipment.
Airtube Kit [4948] may be required to complete installation. EFI-Electronic Fuel Injection.

[1] OE system was a welded assembly. It is recommended that all parts noted [1] should be replaced. [958] Federal & California Emission vehicles. Not legal for sale for vehicles licensed in California.

[941] Replaces both front and rear converters, Only failed converters may be replaced.

92-94 6 Cyl. Topaz, 182 (3.0L) Engine, except LTS

(7333)



DIRECT FIT MSL/MAXIMUM Muffler... Welded Assembly- 700016, Split Assembly- 6558, UNIVERSAL FIT MSL/MAXIMUM Muffler... Welded Assembly- 6558, 709018, Split Assembly- 709018, Silentone DIY Muffler... Welded Assembly- 5544 and 14695 Spout, Split Assembly- 5544

88-94 4 Cyl. Topaz, 140 (2.3L) Engine; except All Wheel Drive

(7332)



DIRECT FIT MSL/MAXIMUM Muffler... Welded Assembly- 700016, Split Assembly- 6558, UNIVERSAL FIT MSL/MAXIMUM Muffler... Welded Assembly- 6558, 709018, Split Assembly- 709018, Silentone DIY Muffler... Welded Assembly- 5544 and 14695 Spout, Split Assembly- 5544

NA-Not Available. NR-Not Required. FL-Remove and Re-Use Old Flange. ● Golden Warehouse. O.E.-Original Equipment.
Airtube Kit [4948] may be required to complete installation. EFI-Electronic Fuel Injection.

[1] OE system was a welded assembly. It is recommended that all parts noted [1] should be replaced. [958] Federal & California Emission vehicles. Not legal for sale for vehicles licensed in California.

MERCURY TOPAZ

(7334) 1992 6 Cyl. Topaz LTS, 182 (3.0L) Engine

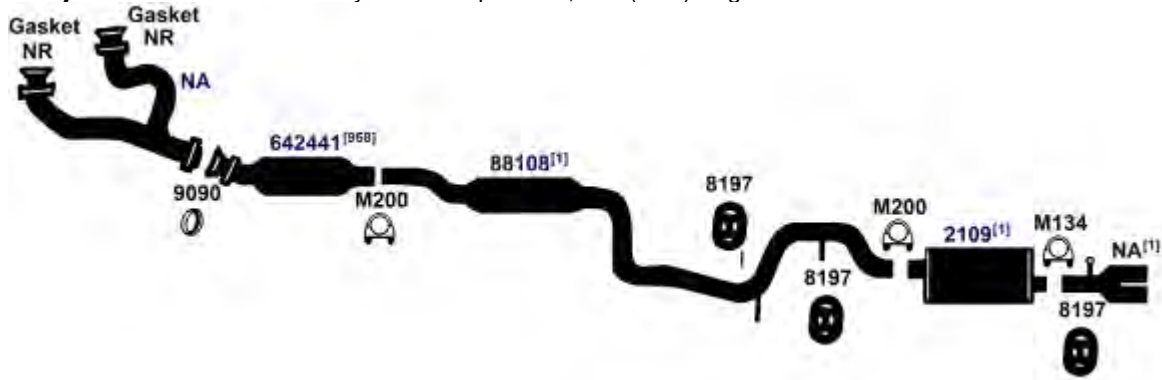

DIRECT FIT MSL/MAXIMUM Muffler... 6558, UNIVERSAL FIT MSL/MAXIMUM Muffler... 709018, Silentone DIY Muffler... 5544

(7331) 87-91 4 Cyl. Topaz, 140 (2.3L) Engine, All Wheel Drive

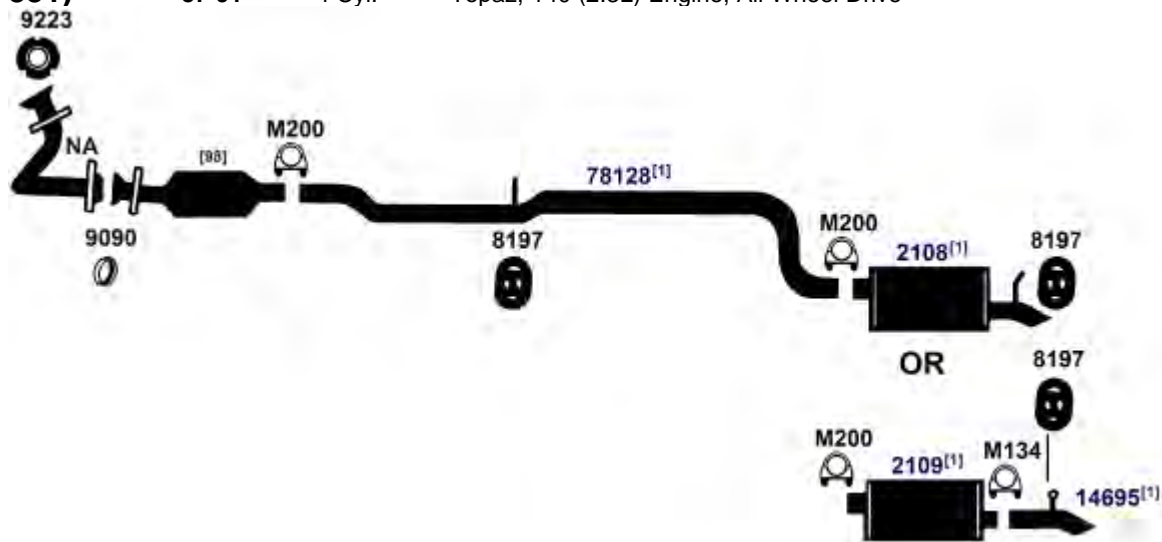

DIRECT FIT MSL/MAXIMUM Muffler... Welded Assembly- 700016, Split Assembly- 6558, UNIVERSAL FIT MSL/MAXIMUM Muffler... Welded Assembly- 6558, 709018, Split Assembly- 709018, Silentone DIY Muffler... Welded Assembly- 5544 and 14695 Spout, Split Assembly- 5544

NA-Not Available. NR-Not Required. FL-Remove and Re-Use Old Flange. ● Golden Warehouse. O.E.-Original Equipment.
Airtube Kit [4948] may be required to complete installation. EFI-Electronic Fuel Injection.

[1] OE system was a welded assembly. It is recommended that all parts noted [1] should be replaced.

[958] Federal & California Emission vehicles. Not legal for sale for vehicles licensed in California.

[98] Refer to current Catalytic Converter catalog or Website catalog for availability.

85-87 4 Cyl. Topaz, 140 (2.3L) Engine, except 1987 All Wheel Drive

(7330)

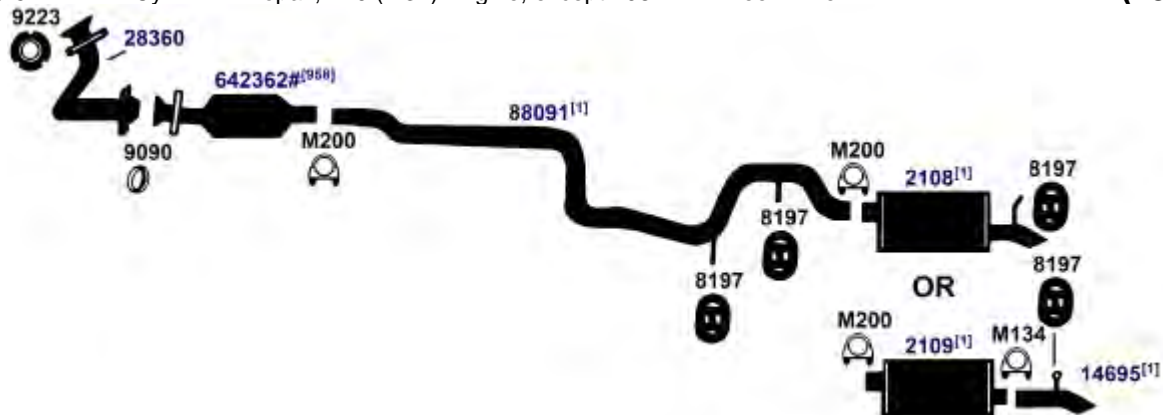

DIRECT FIT MSL/MAXIMUM Muffler... Welded Assembly- 700016, Split Assembly- 6558, UNIVERSAL FIT MSL/MAXIMUM Muffler... Welded Assembly- 6558, 709018, Split Assembly- 709018, Silentone DIY Muffler... Welded Assembly- 5544 and 14695 Spout, Split Assembly- 5544

85-86 4 Cyl. Topaz, 122 Diesel Engine (2.0L)

(7329)

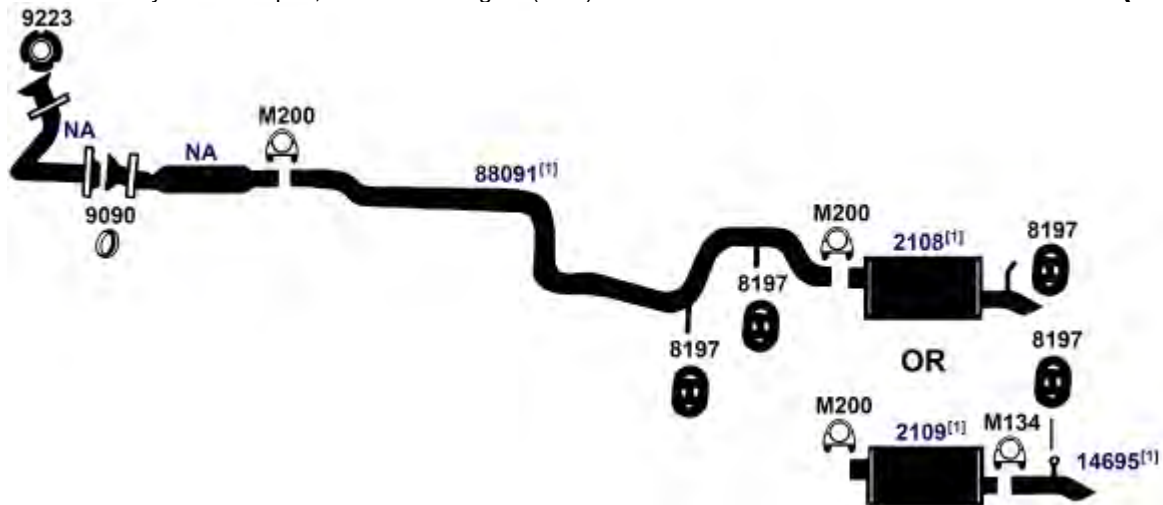

DIRECT FIT MSL/MAXIMUM Muffler... Welded Assembly- 700016, Split Assembly- 6558, UNIVERSAL FIT MSL/MAXIMUM Muffler... Welded Assembly- 6558, 709018, Split Assembly- 709018, Silentone DIY Muffler... Welded Assembly- 5544 and 14695 Spout, Split Assembly- 5544

NA-Not Available. NR-Not Required. FL-Remove and Re-Use Old Flange. ● Golden Warehouse. O.E.-Original Equipment.
Airtube Kit [4948] may be required to complete installation. EFI-Electronic Fuel Injection.

[1] OE system was a welded assembly. It is recommended that all parts noted [1] should be replaced. [958] Federal & California Emission vehicles. Not legal for sale for vehicles licensed in California.

MERCURY TOPAZ

(7330E) 1984 4 Cyl. Topaz, 140 (2.3L) Engine

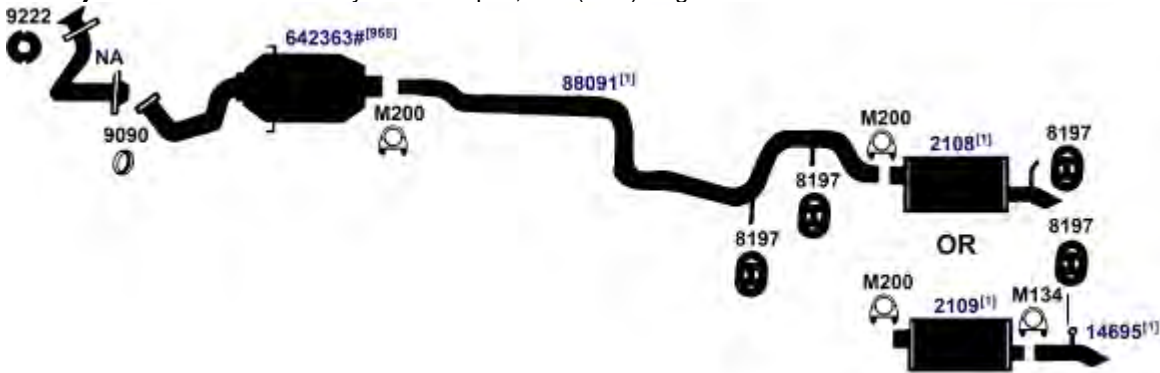

DIRECT FIT MSL/MAXIMUM Muffler... Welded Assembly- 700016, Split Assembly- 6558, UNIVERSAL FIT MSL/MAXIMUM Muffler... Welded Assembly- 6558, 709018, Split Assembly- 709018, Silentone DIY Muffler... Welded Assembly- 5544 and 14695 Spout, Split Assembly- 5544

(7329E) 1984 4 Cyl. Topaz, 122 (2.0L) Diesel Engine



DIRECT FIT MSL/MAXIMUM Muffler... Welded Assembly- 700016, Split Assembly- 6558, UNIVERSAL FIT MSL/MAXIMUM Muffler... Welded Assembly- 6558, 709018, Split Assembly- 709018, Silentone DIY Muffler... Welded Assembly- 5544 and 14695 Spout, Split Assembly- 5544

NA-Not Available. NR-Not Required. FL-Remove and Re-Use Old Flange. ● Golden Warehouse. O.E.-Original Equipment.
Airtube Kit [4948] may be required to complete installation. EFI-Electronic Fuel Injection.

[1] OE system was a welded assembly. It is recommended that all parts noted [1] should be replaced. [958] Federal & California Emission vehicles. Not legal for sale for vehicles licensed in California.

92-94 4 Cyl. Tracer, 1.8L Engine
 1991 4 Cyl. Tracer LTS, 1.8L Engine

(11502)

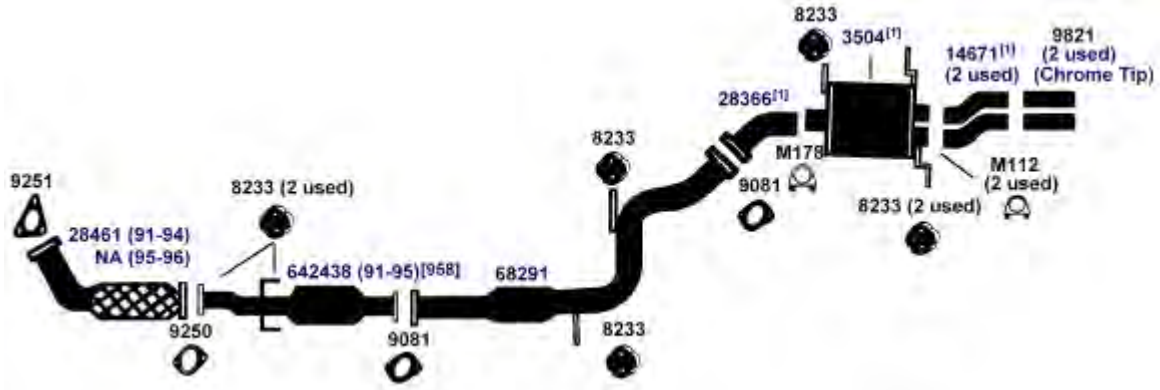

DIRECT FIT MSL/MAXIMUM Muffler... 700165

91-94 4 Cyl. Tracer, 1.9L (116) Engine

(11501)

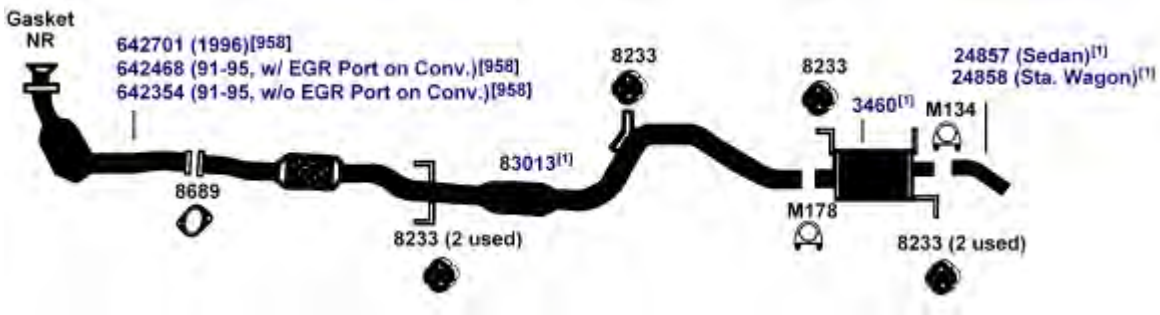

DIRECT FIT MSL/MAXIMUM Muffler... 700159

NA-Not Available. NR-Not Required. FL-Remove and Re-Use Old Flange. ● Golden Warehouse. O.E.-Original Equipment.
 # Airtube Kit [4948] may be required to complete installation. EFI-Electronic Fuel Injection.

[1] OE system was a welded assembly. It is recommended that all parts noted [1] should be replaced. [958] Federal & California Emission vehicles. Not legal for sale for vehicles licensed in California.

MERCURY TRACER

(11500) 88-89 4 Cyl. Tracer, 1.6L Engine

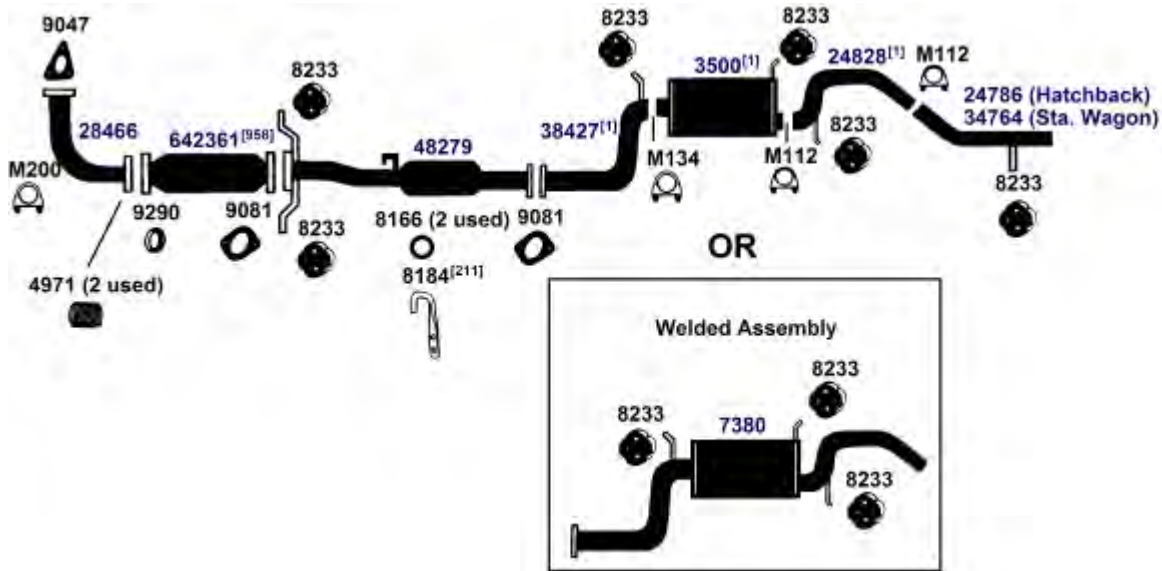

DIRECT FIT MSL/MAXIMUM Muffler... Split System- 700136, UNIVERSAL FIT MSL/MAXIMUM Muffler... Split System- 6653

MERCURY VILLAGER

(34901) 1994 6 Cyl. Villager; 3.0L Engine

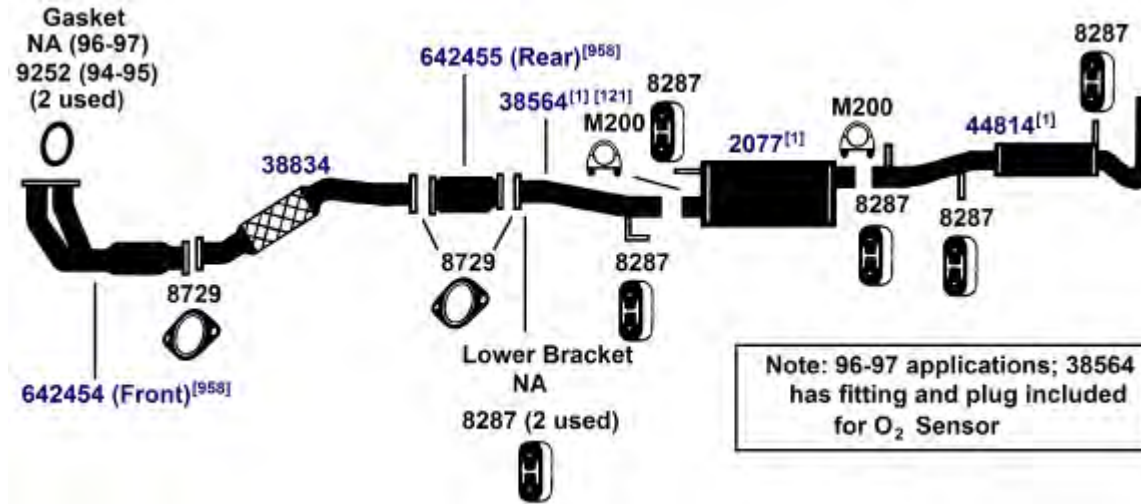

DIRECT FIT MSL/MAXIMUM Muffler... 700225

NA-Not Available. NR-Not Required. FL-Remove and Re-Use Old Flange. ● Golden Warehouse. O.E.-Original Equipment.
Airtube Kit [4948] may be required to complete installation. EFI-Electronic Fuel Injection.

[1] OE system was a welded assembly. It is recommended that all parts noted [1] should be replaced.

[121] Sensor plug supplied, should be used on 94-95 models.

[211] Not required if label on pipe 48279 has black triangle.

[958] Federal & California Emission vehicles. Not legal for sale for vehicles licensed in California.

MERCURY VILLAGER

1993 6 Cyl. Villager; 3.0L Engine

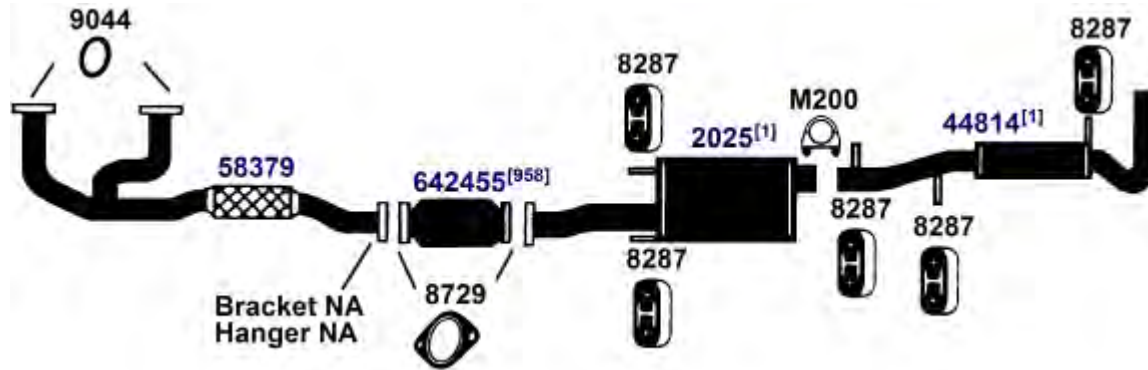
(34900)

DIRECT FIT MSL/MAXIMUM Muffler... 700148

MERCURY ZEPHYR

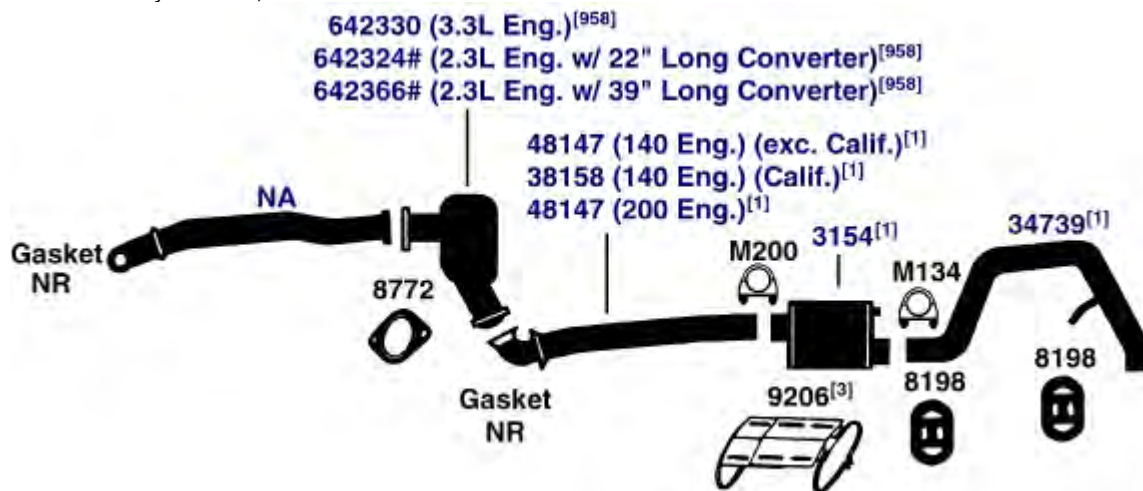
1983 4 Cyl. Zephyr, All Models with 2.3L, 140 Engine
1983 6 Cyl. i, iL**(7394)**DIRECT FIT MSL/MAXIMUM Muffler... 6556, UNIVERSAL FIT MSL/MAXIMUM Muffler... 709011, Silentone DIY Muffler... 5565 and 8083
Bracket and 9206 Heat Shield

NA-Not Available. NR-Not Required. FL-Remove and Re-Use Old Flange. ● Golden Warehouse. O.E.-Original Equipment.
Airtube Kit [4948] may be required to complete installation. EFI-Electronic Fuel Injection.

- [1] OE system was a welded assembly. It is recommended that all parts noted [1] should be replaced. [958] Federal & California Emission vehicles. Not legal for sale for vehicles licensed in California.
- [3] Required for installation.

MERCURY ZEPHYR

(7393) 81-82 4 Cyl. Zephyr, All Models with 2.3L, 140 Engine
 81-82 6 Cyl. Zephyr, All Models with 3.3L, 200 Engine; except Police, Taxi

642330 (3.3L Eng.)^[958]
 642324# (2.3L Eng. w/ 22" Long Converter)^[958]

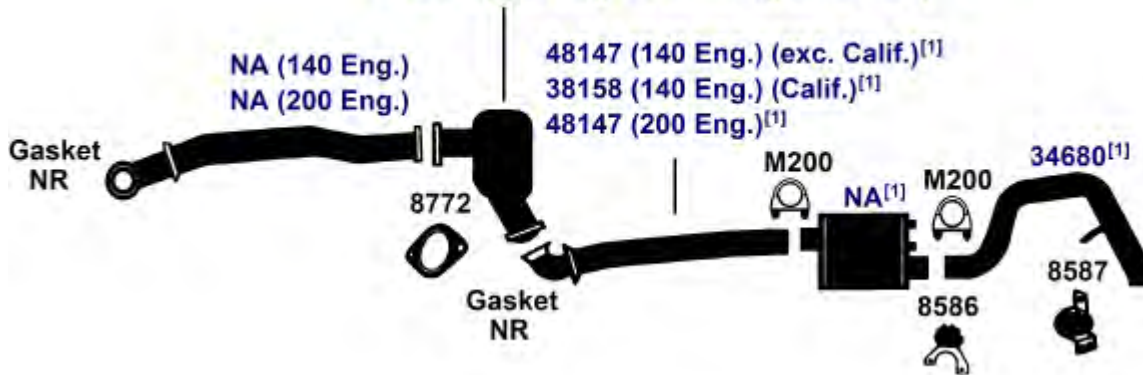

DIRECT FIT MSL/MAXIMUM Muffler... 6553, UNIVERSAL FIT MSL/MAXIMUM Muffler... 6538, 709011, 709012, Silentone DIY Muffler... 5531 and 9206 Heat Shield

(7391) 81-82 8 Cyl. Zephyr Sedan, 4.2L, 255 Engine; except Canada, Police, Taxi
 1981 8 Cyl. Zephyr Station Wagon, 4.2L, 255 Engine; except Canada, Police, Taxi

642457# (1982, with 25" Long Conv.)^[958]
 642324# (1982, with 23" Long Conv.)^[958]
 642324# (1981)^[958]

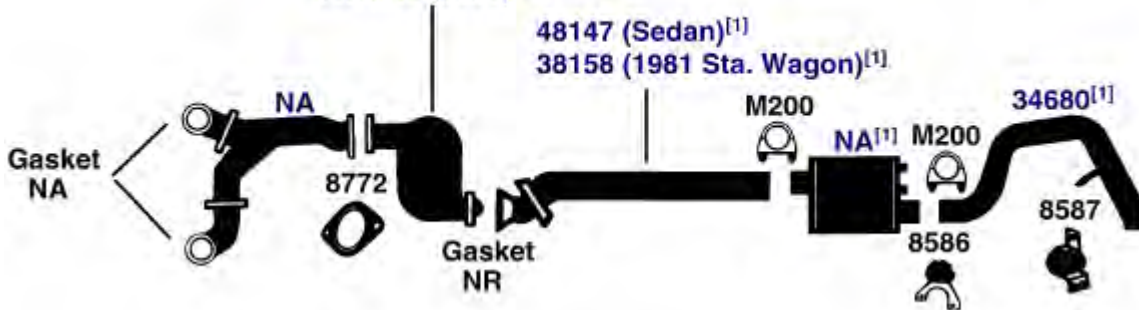

DIRECT FIT MSL/MAXIMUM Muffler... 6553, UNIVERSAL FIT MSL/MAXIMUM Muffler... 6538, 709011, 709012, Silentone DIY Muffler... 5531 and 9206 Heat Shield

NA-Not Available. NR-Not Required. FL-Remove and Re-Use Old Flange. ● Golden Warehouse. O.E.-Original Equipment.
 # Airtube Kit [4948] may be required to complete installation. EFI-Electronic Fuel Injection.

[1] OE system was a welded assembly. It is recommended that all parts noted [1] should be replaced. [958] Federal & California Emission vehicles. Not legal for sale for vehicles licensed in California.

1980 4 Cyl. Zephyr, All Models with 2.3L, 140 Engine; without Turbo, with Catalytic Converter (7390)

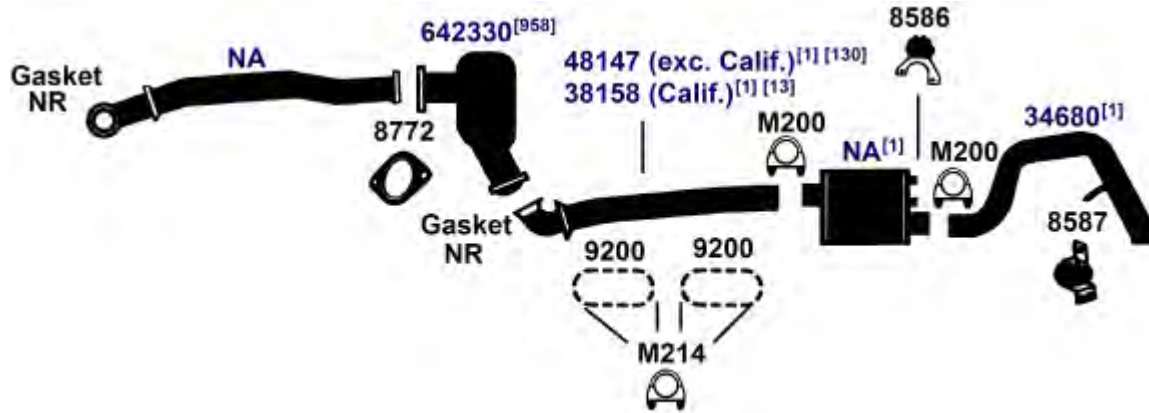

DIRECT FIT MSL/MAXIMUM Muffler... 6553, UNIVERSAL FIT MSL/MAXIMUM Muffler... 6538, 709011, 709012, Silentone DIY Muffler... 5531 and 9206 Heat Shield

1980 4 Cyl. Zephyr, All Models with 2.3L, 140 Engine; with Turbo and Catalytic Converter (7389)

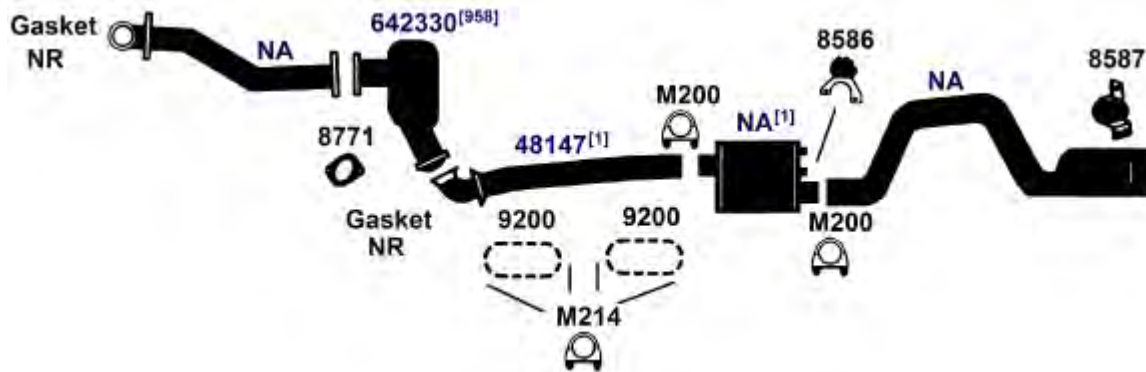

DIRECT FIT MSL/MAXIMUM Muffler... 6553, UNIVERSAL FIT MSL/MAXIMUM Muffler... 6538, 709011, 709012, Silentone DIY Muffler... 5531 and 9206 Heat Shield

NA-Not Available. NR-Not Required. FL-Remove and Re-Use Old Flange. ● Golden Warehouse. O.E.-Original Equipment.
Airtube Kit [4948] may be required to complete installation. EFI-Electronic Fuel Injection.

[1] OE system was a welded assembly. It is recommended that all parts noted [1] should be replaced.
[13] Catalytic converter body length measures 18".

[130] Catalytic converter body length measures 12".
[958] Federal & California Emission vehicles. Not legal for sale for vehicles licensed in California.

MERCURY ZEPHYR

(7388) 1980 6 Cyl. Zephyr, All Models with 3.3L, 200 Engine; with Catalytic Converter

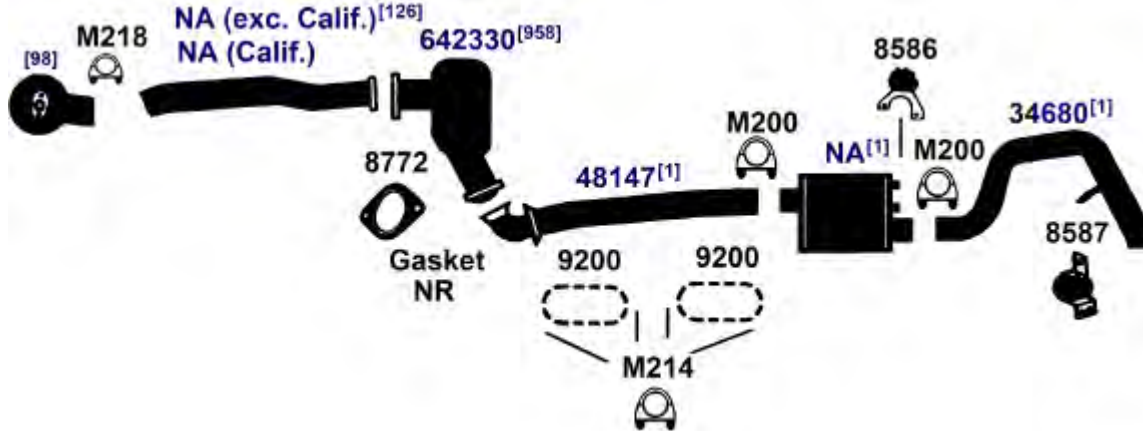

DIRECT FIT MSL/MAXIMUM Muffler... 6553, UNIVERSAL FIT MSL/MAXIMUM Muffler... 6538, 709011, 709012, Silentone DIY Muffler... 5531 and 9206 Heat Shield

(7387) 1980 8 Cyl. Zephyr, All Models with 4.2L, 255 Engine; with Catalytic Converter

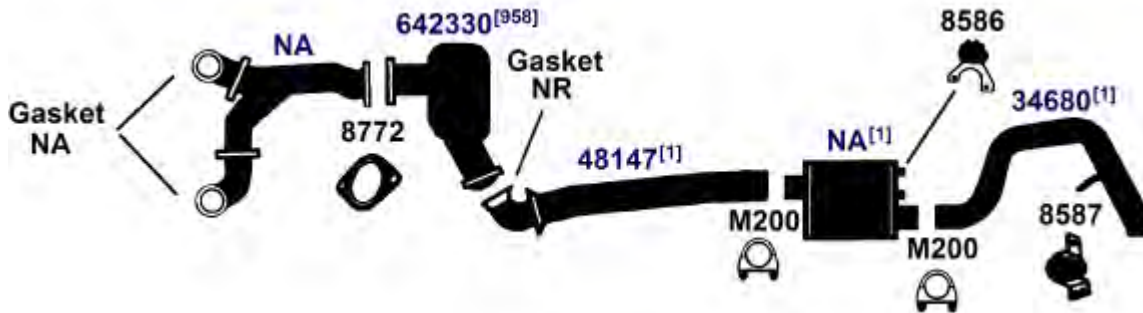

DIRECT FIT MSL/MAXIMUM Muffler... 6553, UNIVERSAL FIT MSL/MAXIMUM Muffler... 6538, 709011, 709012, Silentone DIY Muffler... 5531 and 9206 Heat Shield

(7386) 1979 4,6 Cyl. Zephyr, All Models with 140 (2.3L), 200 (3.3L) Engine; with Catalytic Converter

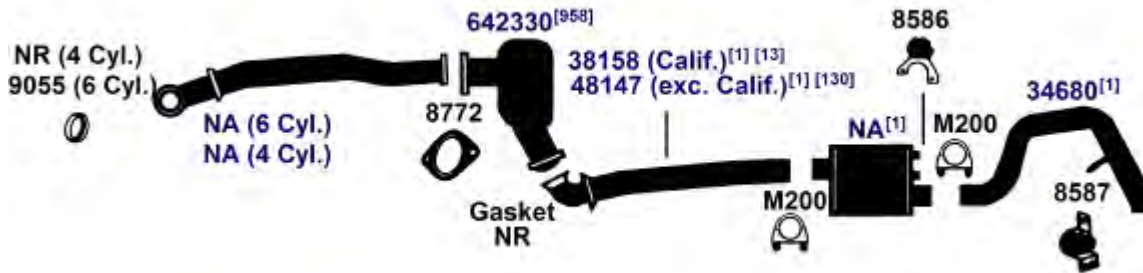

DIRECT FIT MSL/MAXIMUM Muffler... 6553, UNIVERSAL FIT MSL/MAXIMUM Muffler... 6538, 709011, 709012, Silentone DIY Muffler... 5531 and 9206 Heat Shield

NA-Not Available. NR-Not Required. FL-Remove and Re-Use Old Flange. ● Golden Warehouse. O.E.-Original Equipment.
Airtube Kit [4948] may be required to complete installation. EFI-Electronic Fuel Injection.

[1] OE system was a welded assembly. It is recommended that all parts noted [1] should be replaced.
[13] Catalytic converter body length measures 18".
[98] Refer to current Catalytic Converter catalog or Website catalog for availability.

[126] On some vehicles it may be required to remove locating tabs on front converter.
[130] Catalytic converter body length measures 12".
[958] Federal & California Emission vehicles. Not legal for sale for vehicles licensed in California.

1979 8 Cyl. Zephyr, All Models with 5.0L, 302 Engine; with Catalytic Converter

(7384)

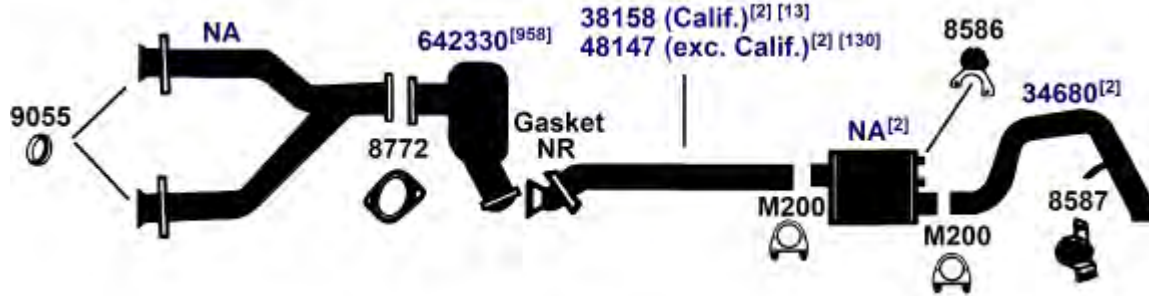

DIRECT FIT MSL/MAXIMUM Muffler... 6553, UNIVERSAL FIT MSL/MAXIMUM Muffler... 6538, 709011, 709012, Silentone DIY Muffler... 5531 and 9206 Heat Shield

MERKUR
MERKUR SCORPIO

88-89 6 Cyl. Merkur Scorpio, 177 (2.9L) Engine

(11551)

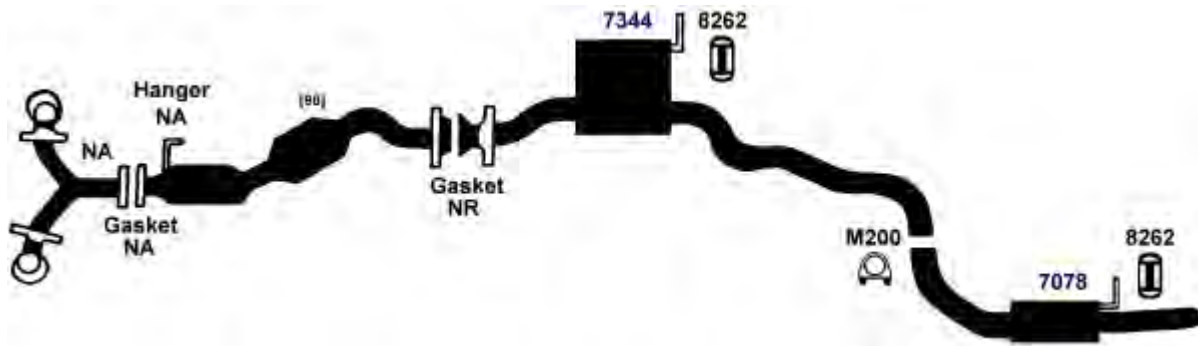

NA-Not Available. NR-Not Required. FL-Remove and Re-Use Old Flange. ● Golden Warehouse. O.E.-Original Equipment.
Airtube Kit [4948] may be required to complete installation. EFI-Electronic Fuel Injection.

[2] May be necessary to replace all noted [2] parts.

[13] Catalytic converter body length measures 18".

[98] Refer to current Catalytic Converter catalog or Website catalog for availability.

[130] Catalytic converter body length measures 12".

[958] Federal & California Emission vehicles. Not legal for sale for vehicles licensed in California.

MITSUBISHI

MITSUBISHI 3000GT

(14725) 91-94 6 Cyl. 3000GT, 3.0L Engine; except Turbo and All Wheel Drive

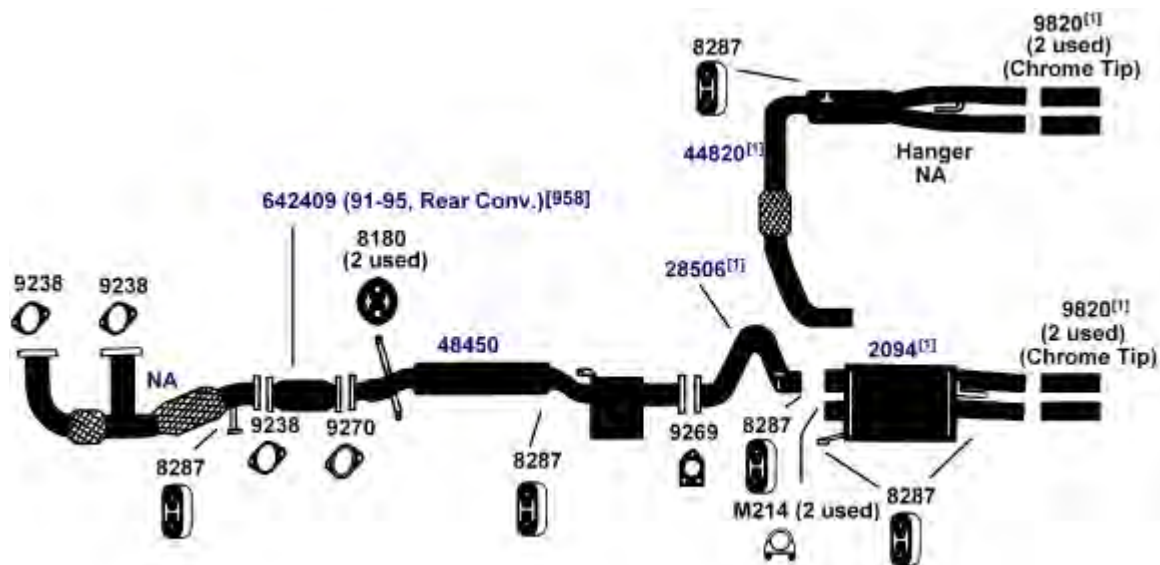

MITSUBISHI DIAMANTE

(13875) 92-94 6 Cyl. Diamante Sedan, 3.0L Engine

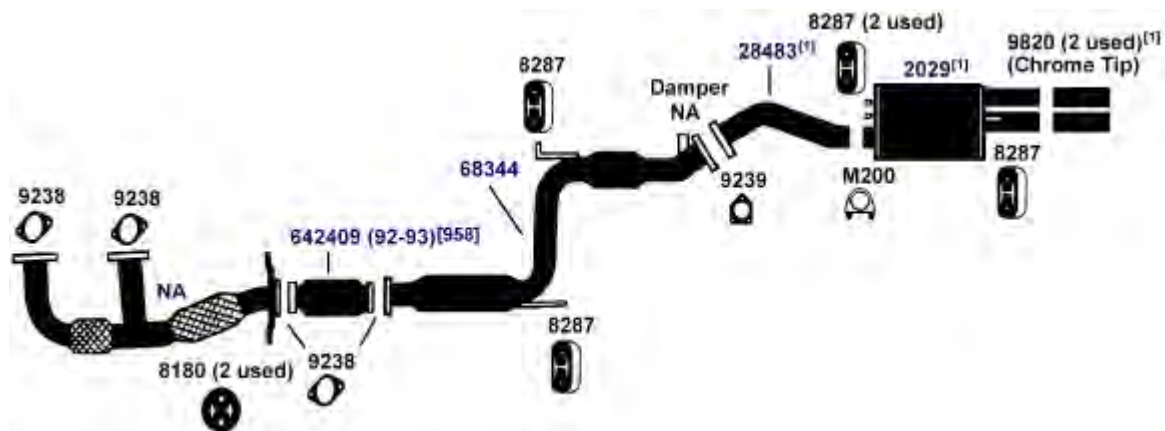

DIRECT FIT MSL/MAXIMUM Muffler... 700383

NA-Not Available. NR-Not Required. FL-Remove and Re-Use Old Flange. ● Golden Warehouse. O.E.-Original Equipment.
 # Airtube Kit [4948] may be required to complete installation. EFI-Electronic Fuel Injection.

[1] OE system was a welded assembly. It is recommended that all parts noted [1] should be replaced. [958] Federal & California Emission vehicles. Not legal for sale for vehicles licensed in California.

92-94 4 Cyl. Eclipse, 1.8L SOHC Engine

(13206)

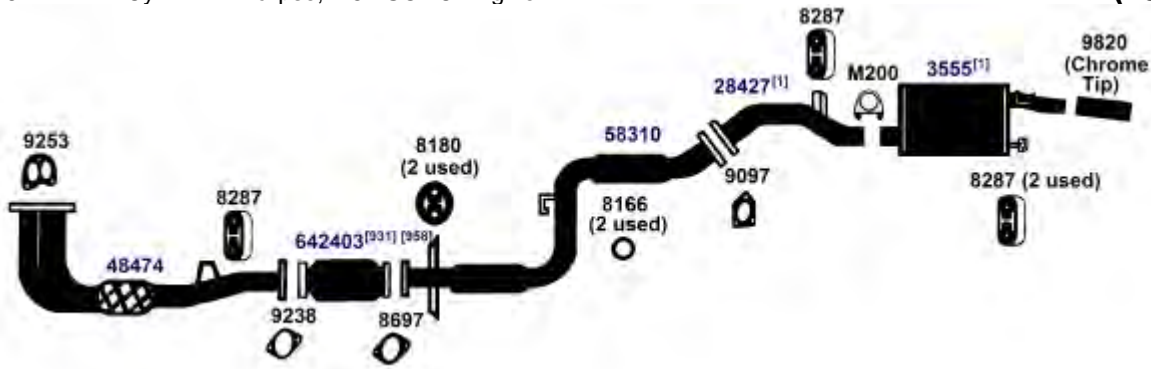

UNIVERSAL FIT MSL/MAXIMUM Muffler... 6563

92-94 4 Cyl. Eclipse, 2.0L DOHC Engine; except Turbo and 4WD

(13205)

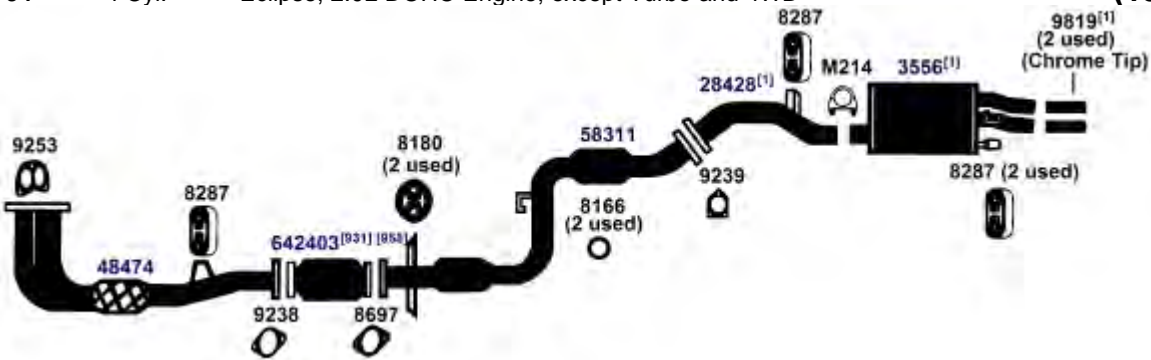

92-94 4 Cyl. Eclipse, 2.0L DOHC Turbo Engine; except 4WD

(13204)

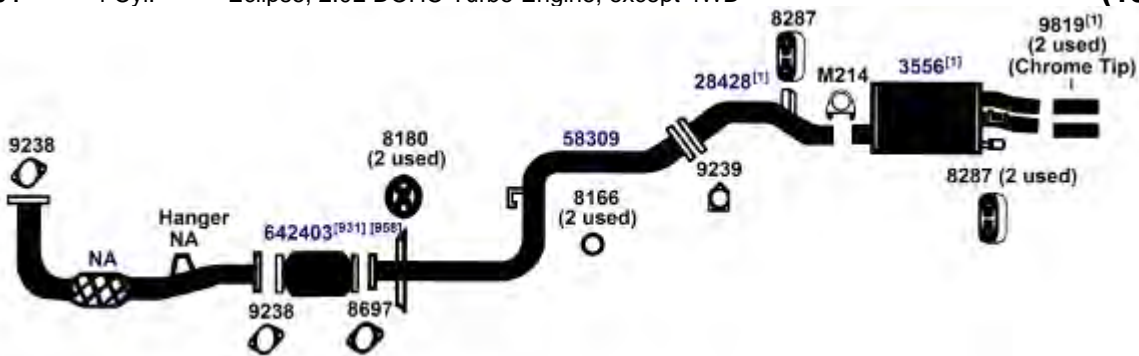

NA-Not Available. NR-Not Required. FL-Remove and Re-Use Old Flange. ● Golden Warehouse. O.E.-Original Equipment.
Airtube Kit [4948] may be required to complete installation. EFI-Electronic Fuel Injection.

[1] OE system was a welded assembly. It is recommended that all parts noted [1] should be replaced.

[958] Federal & California Emission vehicles. Not legal for sale for vehicles licensed in California.

[931] This unit was designed to fit many applications. Measurement of the old unit and cutting of new unit is required.

MITSUBISHI ECLIPSE

(13203) 90-94 4 Cyl. Eclipse, 2.0L DOHC Turbo Engine; 4WD

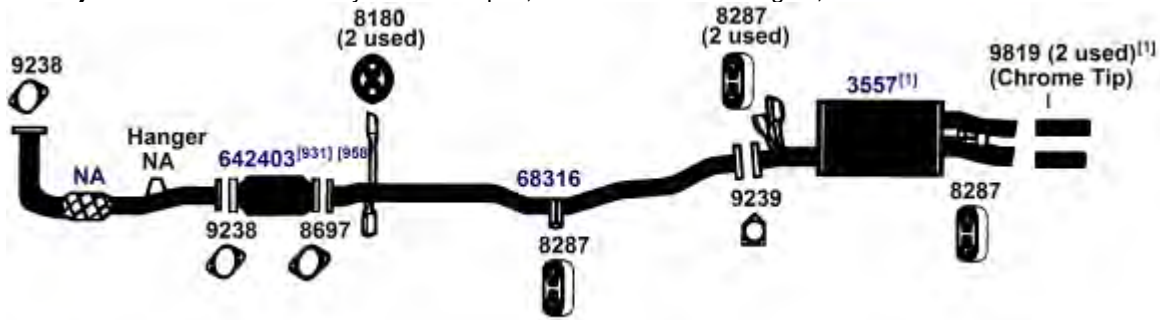

(13202) 90-91 4 Cyl. Eclipse, 1.8L SOHC Engine

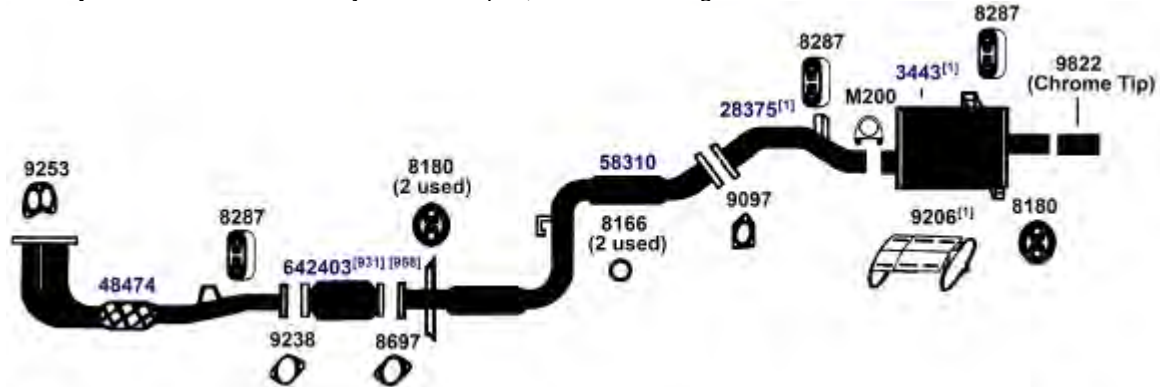

UNIVERSAL FIT MSL/MAXIMUM Muffler... 6549, 6676, 709011

(13201) 90-91 4 Cyl. Eclipse, 2.0L DOHC Engine; except Turbo and 4WD

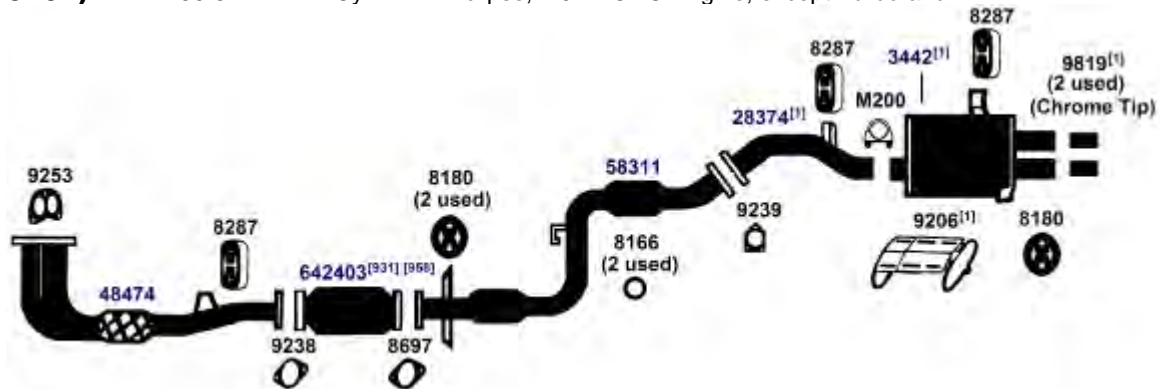

NA-Not Available. NR-Not Required. FL-Remove and Re-Use Old Flange. ● Golden Warehouse. O.E.-Original Equipment.
Airtube Kit [4948] may be required to complete installation. EFI-Electronic Fuel Injection.

[1] OE system was a welded assembly. It is recommended that all parts noted [1] should be replaced.

[958] Federal & California Emission vehicles. Not legal for sale for vehicles licensed in California.

[931] This unit was designed to fit many applications. Measurement of the old unit and cutting of new unit is required.

90-91 4 Cyl. Eclipse, 2.0L DOHC Turbo Engine; except 4WD

(13200)

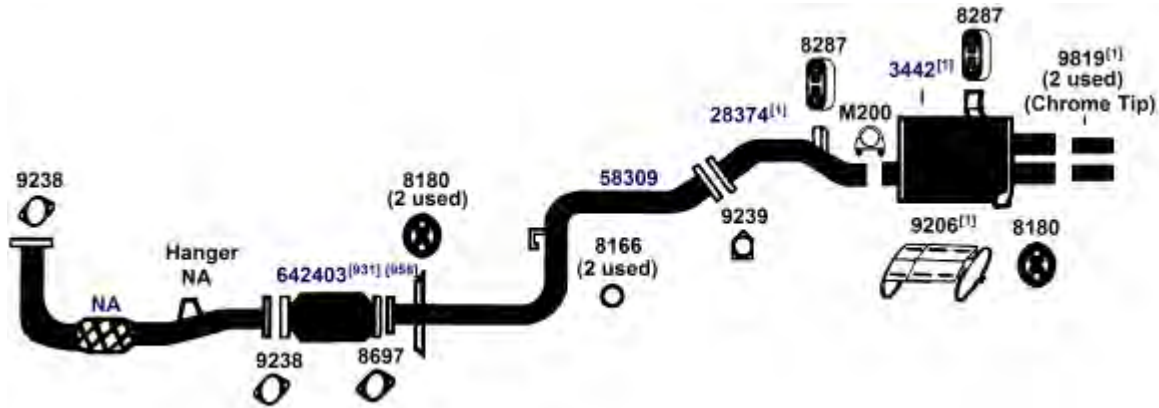

MITSUBISHI EXPO-LRV

92-94 4 Cyl. Expo-LRV, 1.8L Engine; 2WD
 1992 4 Cyl. Expo-LRV, 2.4L Engine; 2WD

(14675)

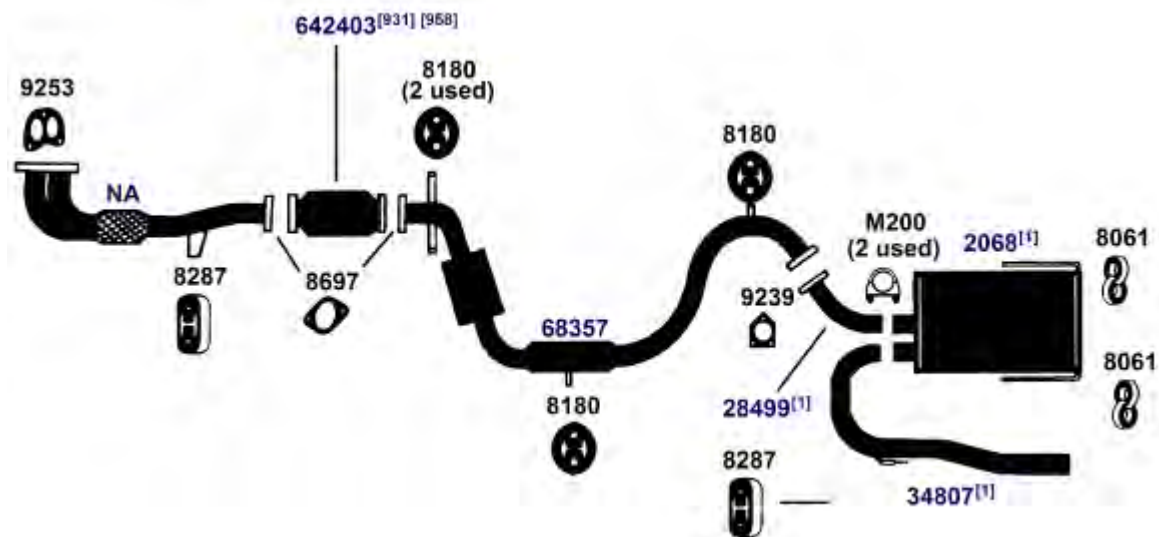

NA-Not Available. NR-Not Required. FL-Remove and Re-Use Old Flange. ● Golden Warehouse. O.E.-Original Equipment.
 # Airtube Kit [4948] may be required to complete installation. EFI-Electronic Fuel Injection.

[1] OE system was a welded assembly. It is recommended that all parts noted [1] should be replaced.

[958] Federal & California Emission vehicles. Not legal for sale for vehicles licensed in California.

[931] This unit was designed to fit many applications. Measurement of the old unit and cutting of new unit is required.

MITSUBISHI GALANT

(12204) 1994 4 Cyl. Galant, 2.4L SOHC Engine; except 6/94-98 Calif. Models

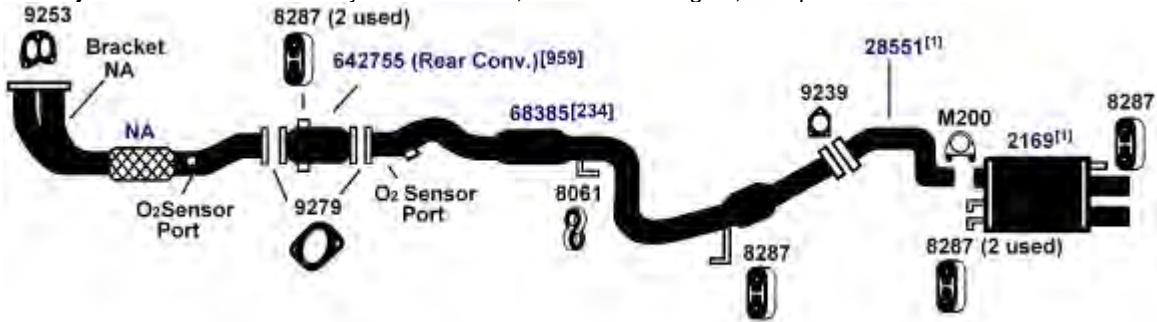

DIRECT FIT MSL/MAXIMUM Muffler... 700390, UNIVERSAL FIT MSL/MAXIMUM Muffler... 709015

(12202) 89-93 4 Cyl. Galant, 2.0L SOHC Engine; except 4WD

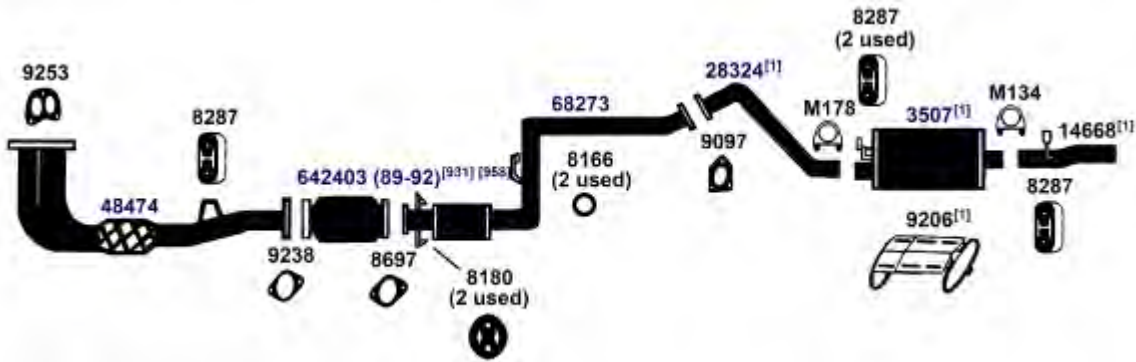

DIRECT FIT MSL/MAXIMUM Muffler... 6544

NA-Not Available. NR-Not Required. FL-Remove and Re-Use Old Flange. ● Golden Warehouse. O.E.-Original Equipment.
Airtube Kit [4948] may be required to complete installation. EFI-Electronic Fuel Injection.

[1] OE system was a welded assembly. It is recommended that all parts noted [1] should be replaced.

[234] For models equipped with O2 sensor, plug must be removed from adapter.

[931] This unit was designed to fit many applications. Measurement of the old unit and cutting of new unit is required.

[958] Federal & California Emission vehicles. Not legal for sale for vehicles licensed in California.

[959] Federal Emission vehicles. Not legal for sale for vehicles licensed in California.

93-94 4 Cyl. Mirage Notchback; 1.5L, 1.8L SOHC Engine

(11605)

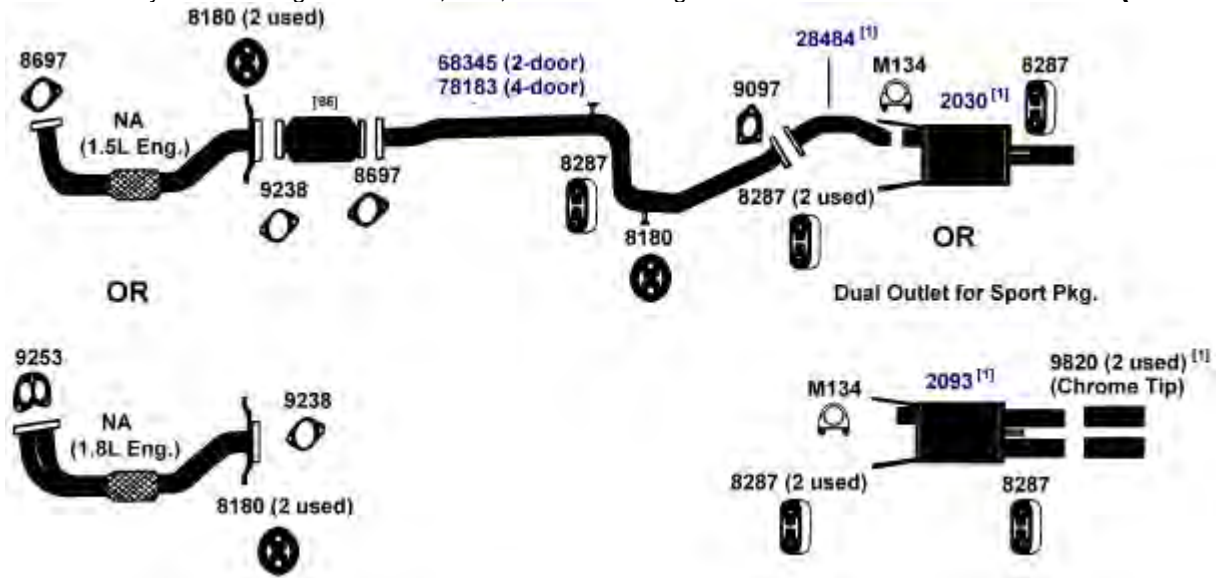

UNIVERSAL FIT MSL/MAXIMUM Muffler... Single Outlet Muffler- 6676

91-92 4 Cyl. Mirage Sedan, 1.6L DOHC Engine

(11604)

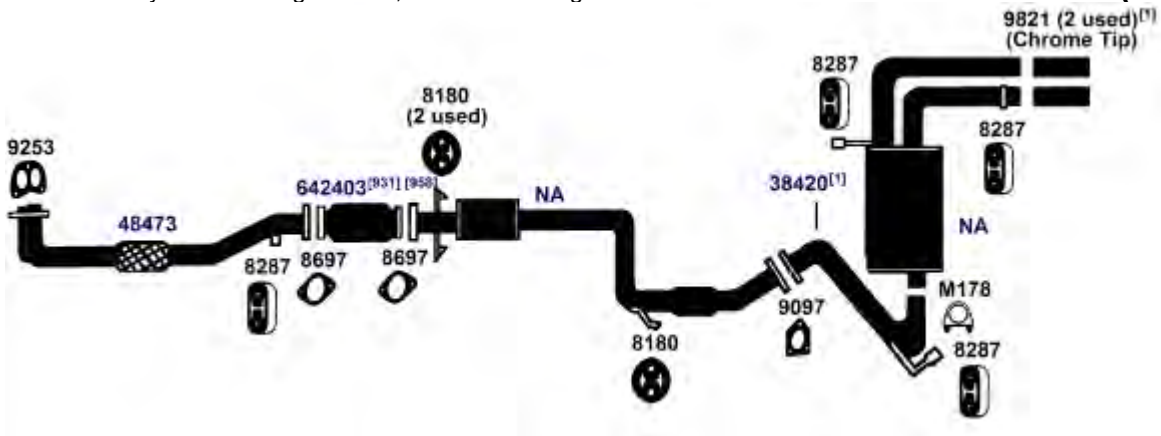

NA-Not Available. NR-Not Required. FL-Remove and Re-Use Old Flange. ● Golden Warehouse. O.E.-Original Equipment.
Airtube Kit [4948] may be required to complete installation. EFI-Electronic Fuel Injection.

[1] OE system was a welded assembly. It is recommended that all parts noted [1] should be replaced.

[98] Refer to current Catalytic Converter catalog or Website catalog for availability.

[931] This unit was designed to fit many applications. Measurement of the old unit and cutting of new unit is required.

[958] Federal & California Emission vehicles. Not legal for sale for vehicles licensed in California.

MITSUBISHI MIRAGE

(11603) 89-92 4 Cyl. Mirage Hatchback, Sedan, 1.5L Engine

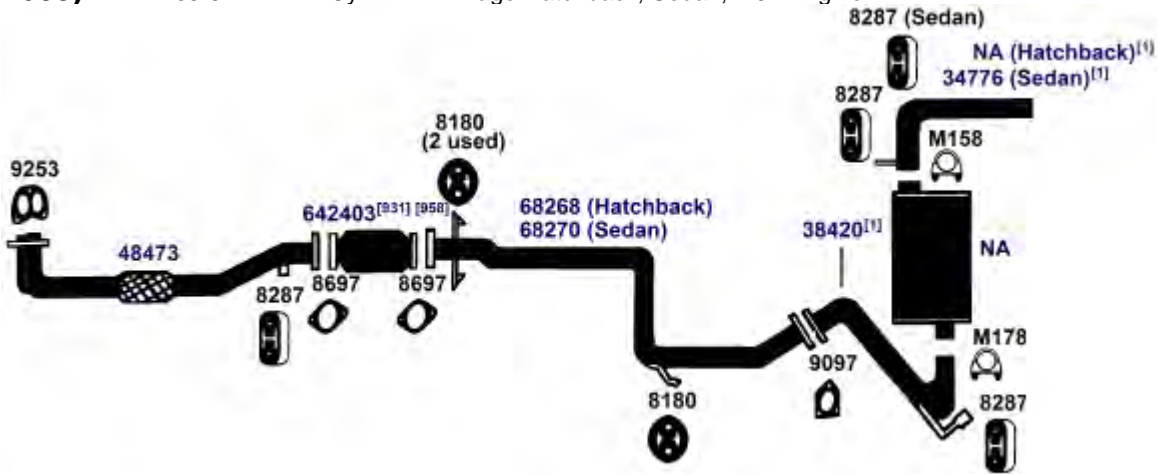

(11601) 87-88 4 Cyl. Mirage 2-Door Hatchback, 4-Door Sedan; 1.5L Engine, 1.6L Fuel Injection Turbo Engine

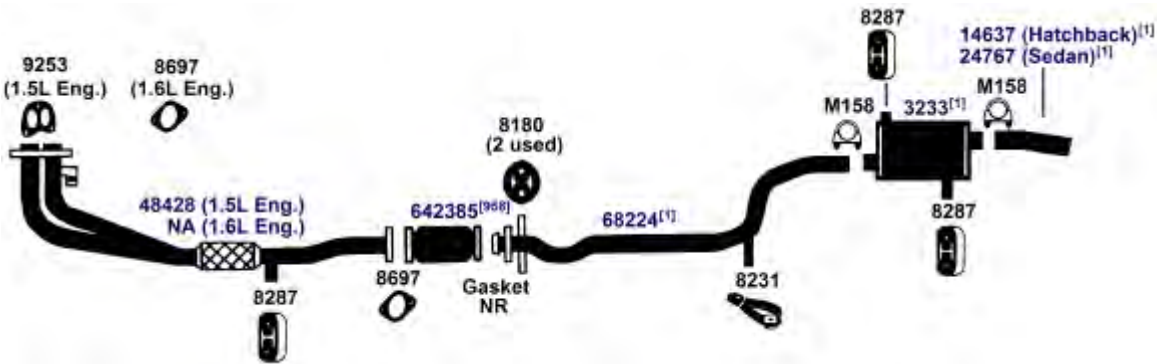

DIRECT FIT MSL/MAXIMUM Muffler... 6684, UNIVERSAL FIT MSL/MAXIMUM Muffler... 6658

MITSUBISHI MONTERO, PICKUP

(31011) 90-94 4 Cyl. Pickup; 2.4L Engine; 2 W.D.; except 93-94 California

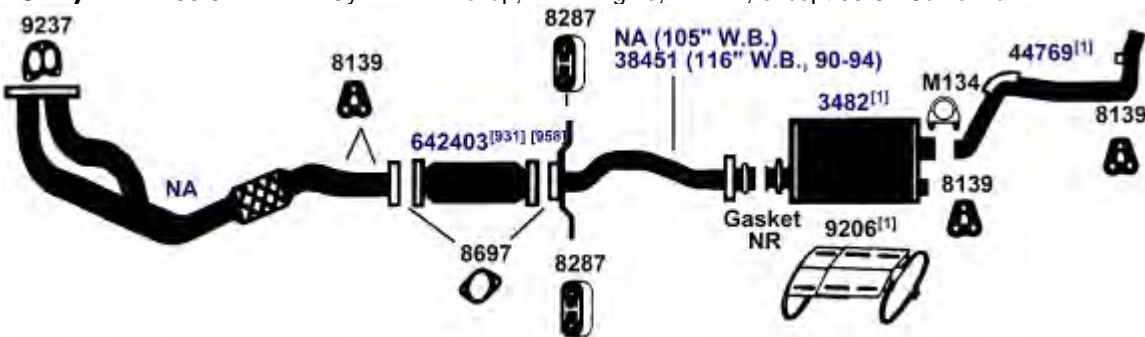

DIRECT FIT MSL/MAXIMUM Muffler... 700134, UNIVERSAL FIT MSL/MAXIMUM Muffler... 709011

NA-Not Available. NR-Not Required. FL-Remove and Re-Use Old Flange. ● Golden Warehouse. O.E.-Original Equipment.
Airtube Kit [4948] may be required to complete installation. EFI-Electronic Fuel Injection.

[1] OE system was a welded assembly. It is recommended that all parts noted [1] should be replaced. [958] Federal & California Emission vehicles. Not legal for sale for vehicles licensed in California.

[931] This unit was designed to fit many applications. Measurement of the old unit and cutting of new unit is required.

90-91 6 Cyl. Montero; 3.0L Engine

(31009)

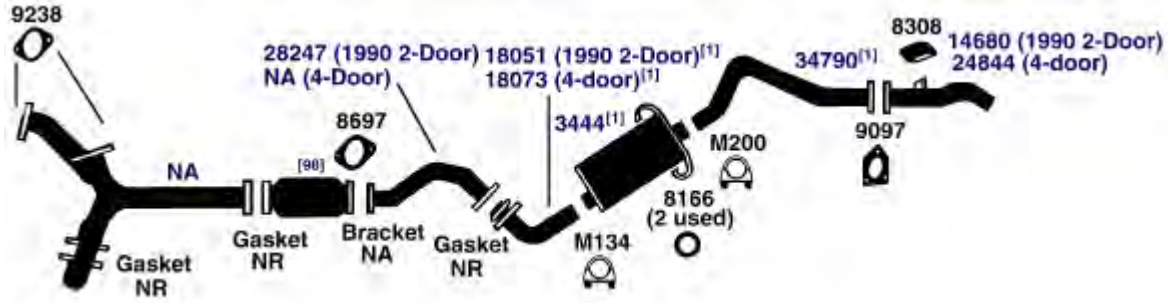

1990 4 Cyl. Pickup; 2.4L Engine; 4 W.D.

(100564)

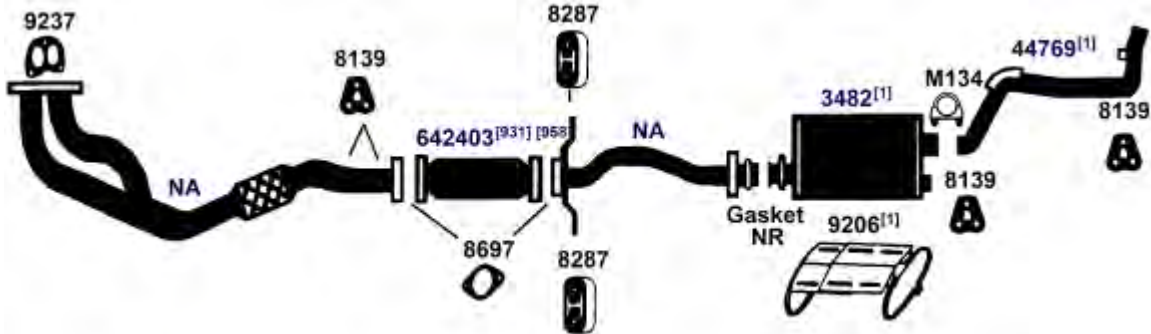

DIRECT FIT MSL/MAXIMUM Muffler... 700134, UNIVERSAL FIT MSL/MAXIMUM Muffler... 709011

87-89 4 Cyl. Montero; 2.6L Engine

(31005)

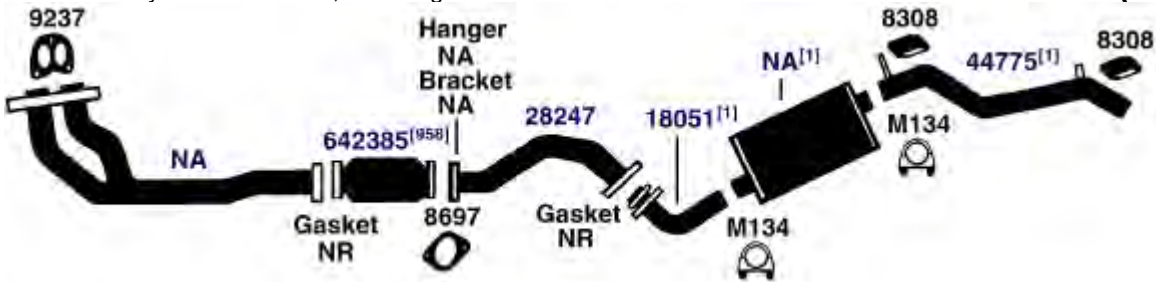

UNIVERSAL FIT MSL/MAXIMUM Muffler... 6655, 709018

NA-Not Available. NR-Not Required. FL-Remove and Re-Use Old Flange. ● Golden Warehouse. O.E.-Original Equipment.
Airtube Kit [4948] may be required to complete installation. EFI-Electronic Fuel Injection.

[1] OE system was a welded assembly. It is recommended that all parts noted [1] should be replaced.
[98] Refer to current Catalytic Converter catalog or Website catalog for availability.

[931] This unit was designed to fit many applications. Measurement of the old unit and cutting of new unit is required.
[958] Federal & California Emission vehicles. Not legal for sale for vehicles licensed in California.

MITSUBISHI MONTERO, PICKUP

(31008) 87-89 4 Cyl. Pickup; 2.0L, 2.6L Engine; 2 W.D.

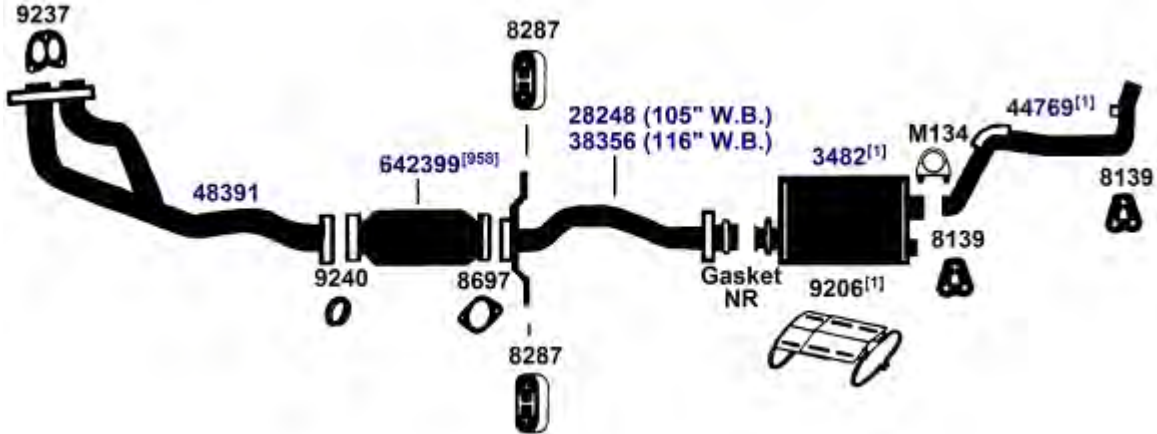

DIRECT FIT MSL/MAXIMUM Muffler... 700134, UNIVERSAL FIT MSL/MAXIMUM Muffler... 709011

(31007) 87-89 4 Cyl. Pickup; 2.6L Engine; 4 W.D.

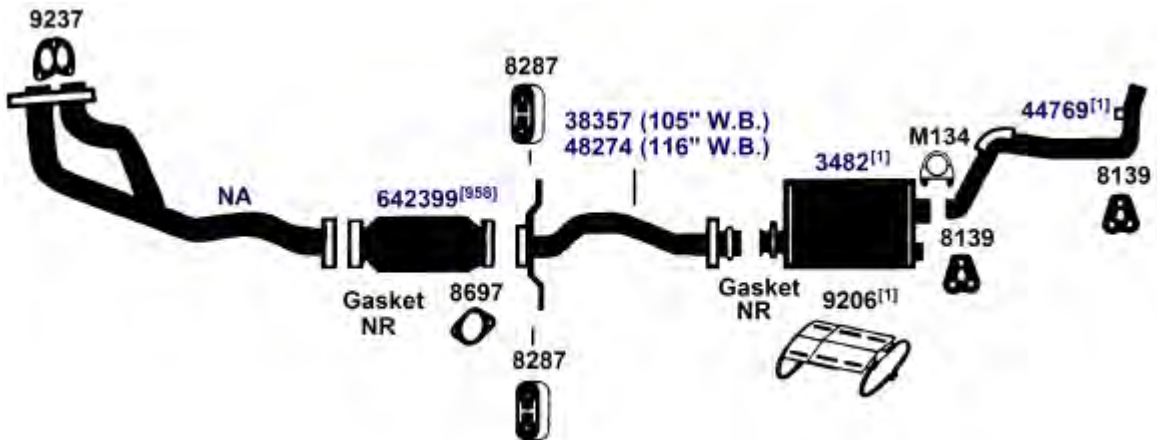

DIRECT FIT MSL/MAXIMUM Muffler... 700134, UNIVERSAL FIT MSL/MAXIMUM Muffler... 709011

NA-Not Available. NR-Not Required. FL-Remove and Re-Use Old Flange. ● Golden Warehouse. O.E.-Original Equipment.
 # Airtube Kit [4948] may be required to complete installation. EFI-Electronic Fuel Injection.

[1] OE system was a welded assembly. It is recommended that all parts noted [1] should be replaced. [958] Federal & California Emission vehicles. Not legal for sale for vehicles licensed in California.

MITSUBISHI PRECIS

90-92 4 Cyl. Precis, 1.5L Engine

(11626)

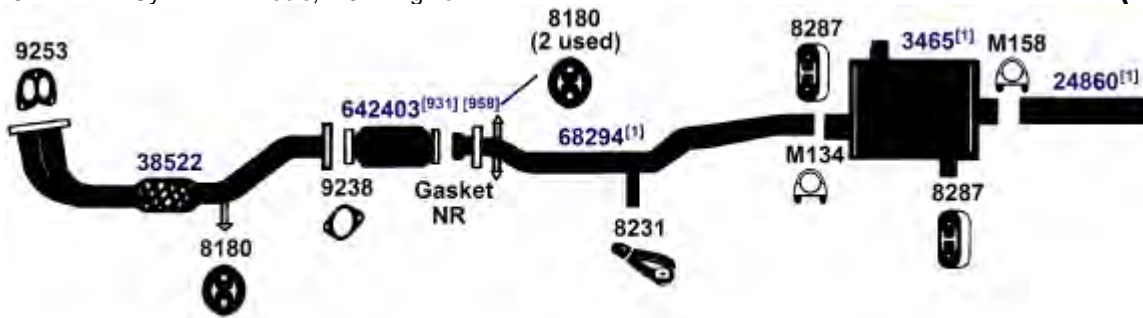

DIRECT FIT MSL/MAXIMUM Muffler... 700009

87-89 4 Cyl. Precis, 1.5L Engine

(11625)

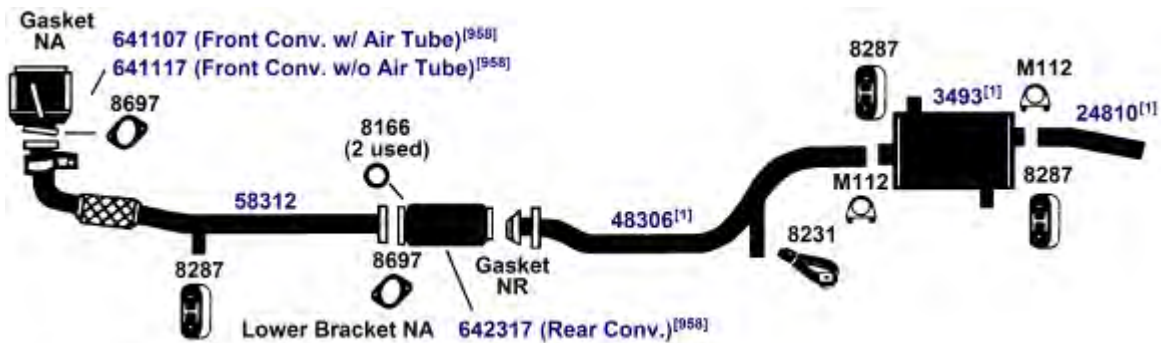

DIRECT FIT MSL/MAXIMUM Muffler... 6690, UNIVERSAL FIT MSL/MAXIMUM Muffler... 6658

MITSUBISHI VAN/WAGON

87-90 4 Cyl. Van/Wagon; 2.4L Engine

(31100)

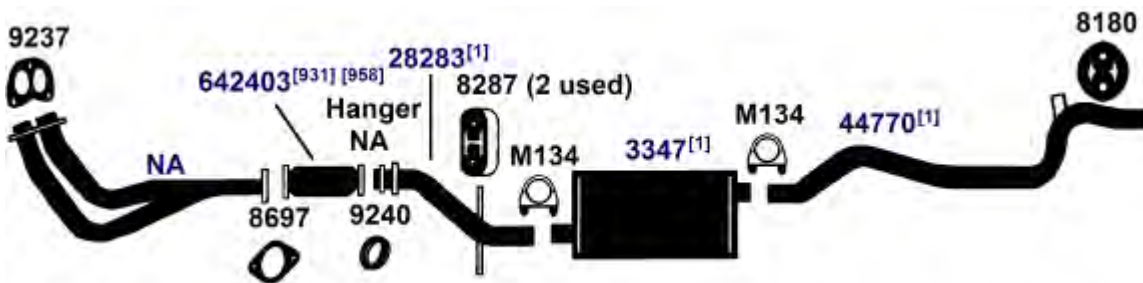

UNIVERSAL FIT MSL/MAXIMUM Muffler... 6655, 709018

NA-Not Available. NR-Not Required. FL-Remove and Re-Use Old Flange. ● Golden Warehouse. O.E.-Original Equipment.
Airtube Kit [4948] may be required to complete installation. EFI-Electronic Fuel Injection.

[1] OE system was a welded assembly. It is recommended that all parts noted [1] should be replaced.

[931] This unit was designed to fit many applications. Measurement of the old unit and cutting of new unit is required.

[958] Federal & California Emission vehicles. Not legal for sale for vehicles licensed in California.

NISSAN

NISSAN 200SX

(3625) 87-88 4 Cyl. 200SX; 2.0L Engine
 85-86 4 Cyl. 200SX, except Turbo (from Nov., 1984)

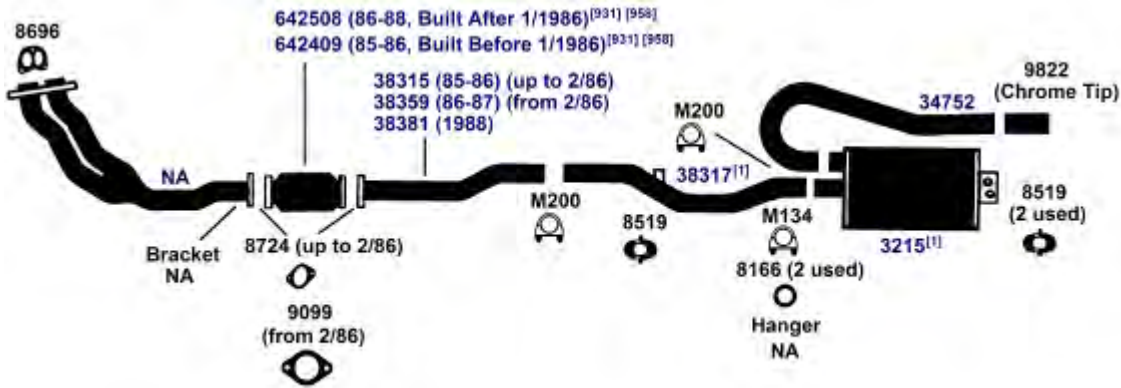

DIRECT FIT MSL/MAXIMUM Muffler... 700086

(3624) 85-86 4 Cyl. 200SX, Turbo

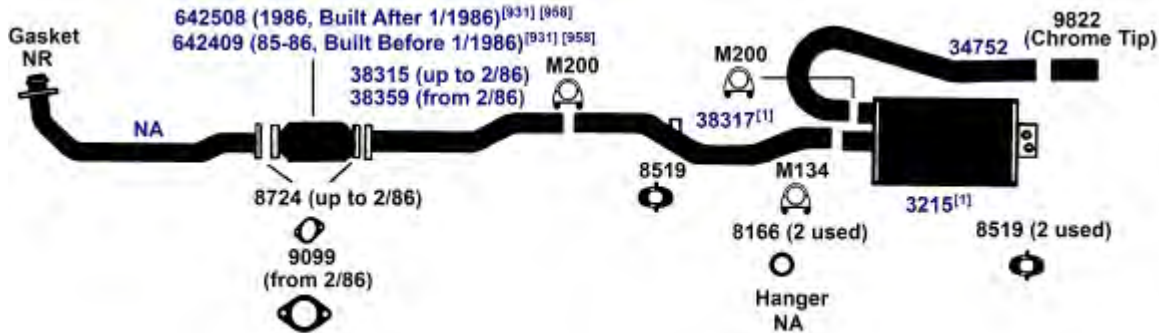

DIRECT FIT MSL/MAXIMUM Muffler... 700086

NA-Not Available. NR-Not Required. FL-Remove and Re-Use Old Flange. ● Golden Warehouse. O.E.-Original Equipment.
 # Airtube Kit [4948] may be required to complete installation. EFI-Electronic Fuel Injection.

[1] OE system was a welded assembly. It is recommended that all parts noted [1] should be replaced.

[931] This unit was designed to fit many applications. Measurement of the old unit and cutting of new unit is required.

[958] Federal & California Emission vehicles. Not legal for sale for vehicles licensed in California.

NISSAN 200SX

1984 4 Cyl. 200SX, Turbo

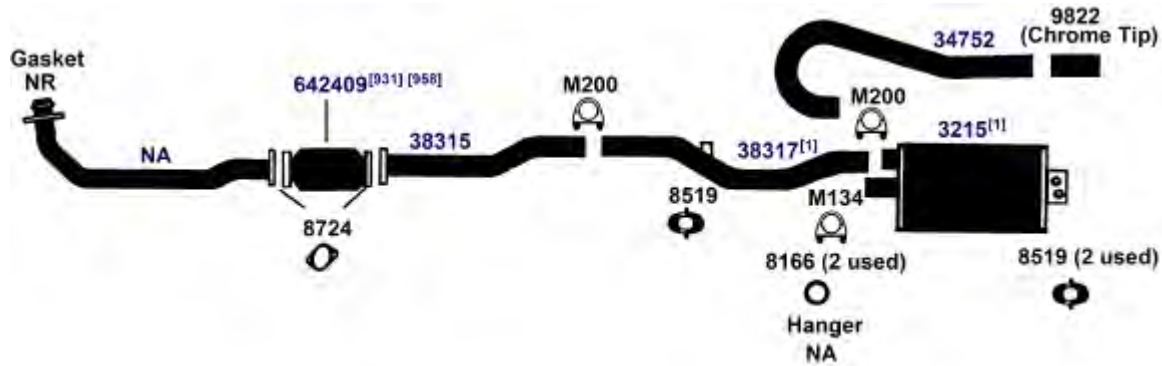
(3624E)

DIRECT FIT MSL/MAXIMUM Muffler... 700086

NISSAN 240SX

93-94 4 Cyl. 240SX, 2.4L Engine

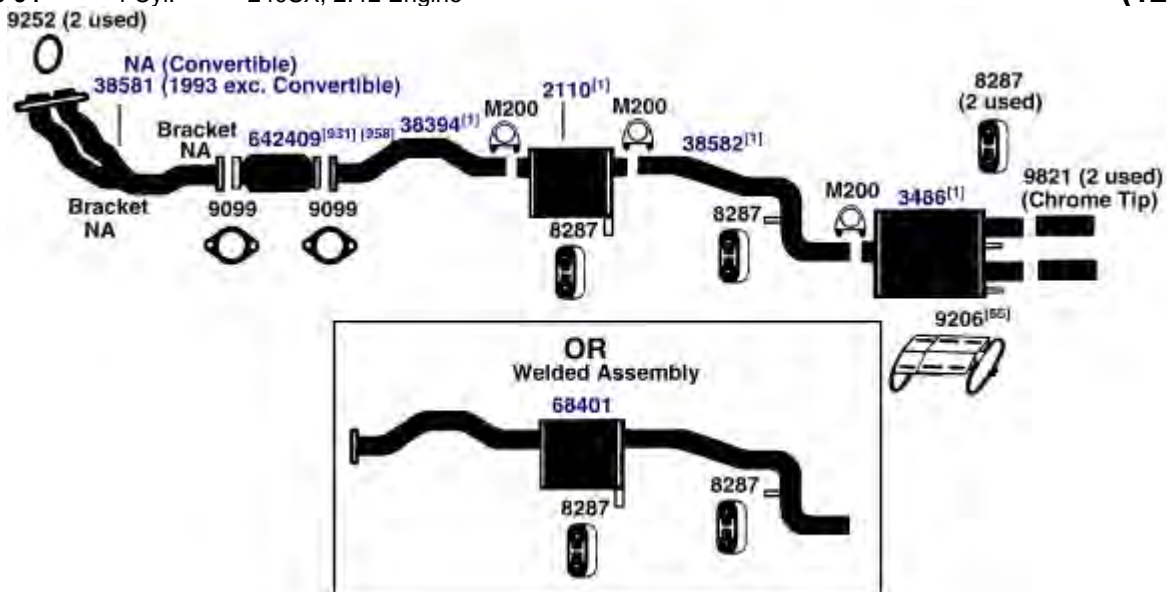
(12851)

DIRECT FIT MSL/MAXIMUM Muffler... Rear Muffler- 700030

NA-Not Available. NR-Not Required. FL-Remove and Re-Use Old Flange. ● Golden Warehouse. O.E.-Original Equipment.
 # Airtube Kit [4948] may be required to complete installation. EFI-Electronic Fuel Injection.

[1] OE system was a welded assembly. It is recommended that all parts noted [1] should be replaced.

[65] Heat Shield 9206 is required for installation.

[931] This unit was designed to fit many applications. Measurement of the old unit and cutting of new unit is required.

[958] Federal & California Emission vehicles. Not legal for sale for vehicles licensed in California.

NISSAN 240SX

(12850) 89-92 4 Cyl. 240SX, 2.4L Engine

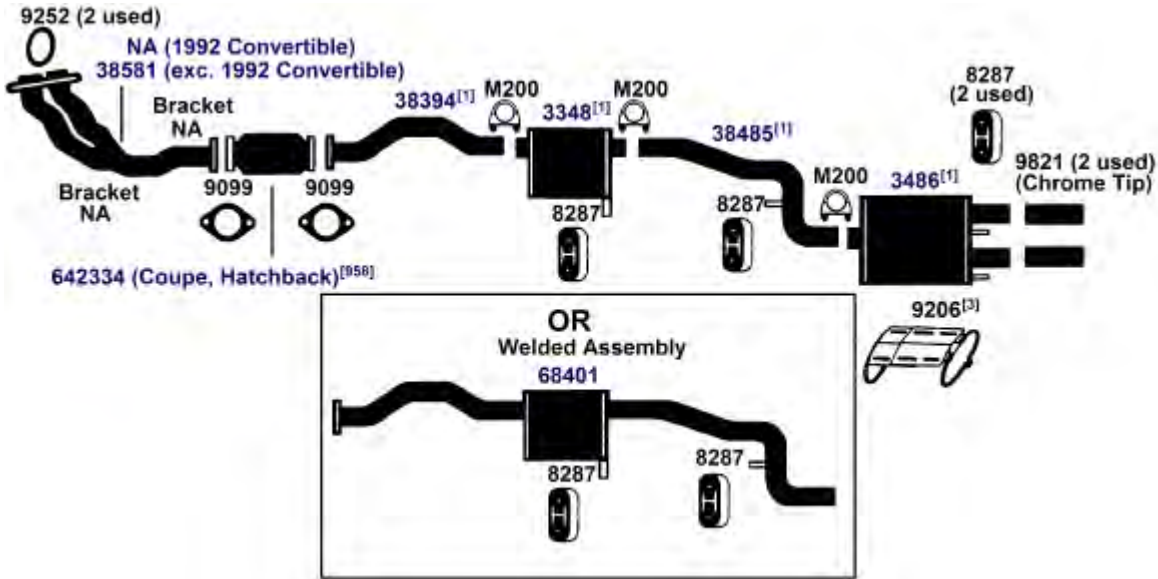

DIRECT FIT MSL/MAXIMUM Muffler... Split System - Front Muffler- 700112, Rear Muffler- 700030

NISSAN 280ZX, 300ZX

(3919) 90-94 6 Cyl. 300ZX, 2 Seat Coupe, 3.0L Engine; except Turbo

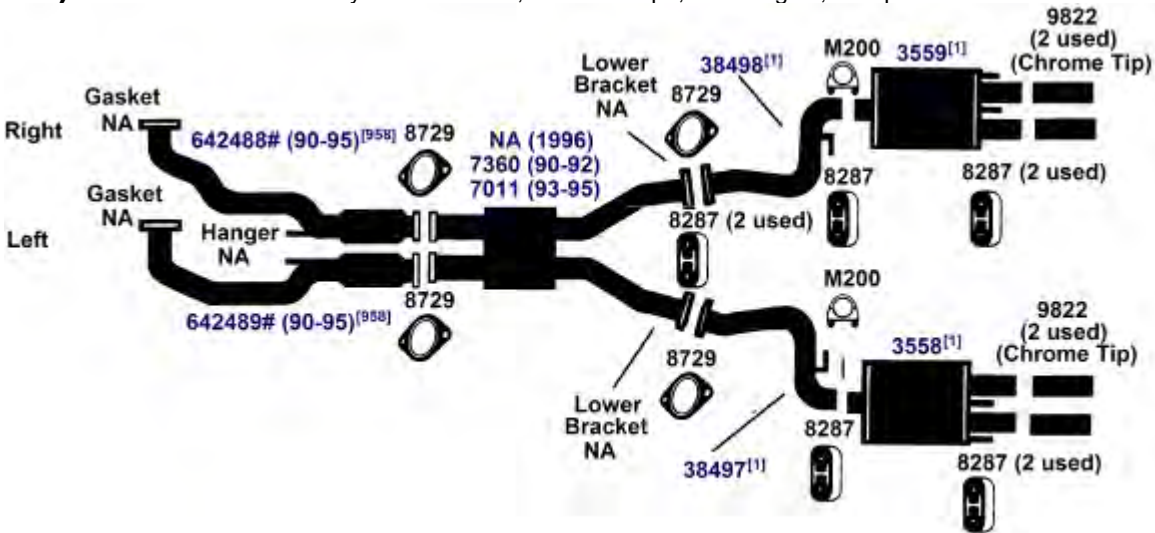

NA-Not Available. NR-Not Required. FL-Remove and Re-Use Old Flange. ● Golden Warehouse. O.E.-Original Equipment.
 # Airtube Kit [4948] may be required to complete installation. EFI-Electronic Fuel Injection.

- [1] OE system was a welded assembly. It is recommended that all parts noted [1] should be replaced. [958] Federal & California Emission vehicles. Not legal for sale for vehicles licensed in California.
 [3] Required for installation.

90-94 6 Cyl. 300ZX, 2 + 2 Seater, 3.0L Engine; except Turbo (3918)

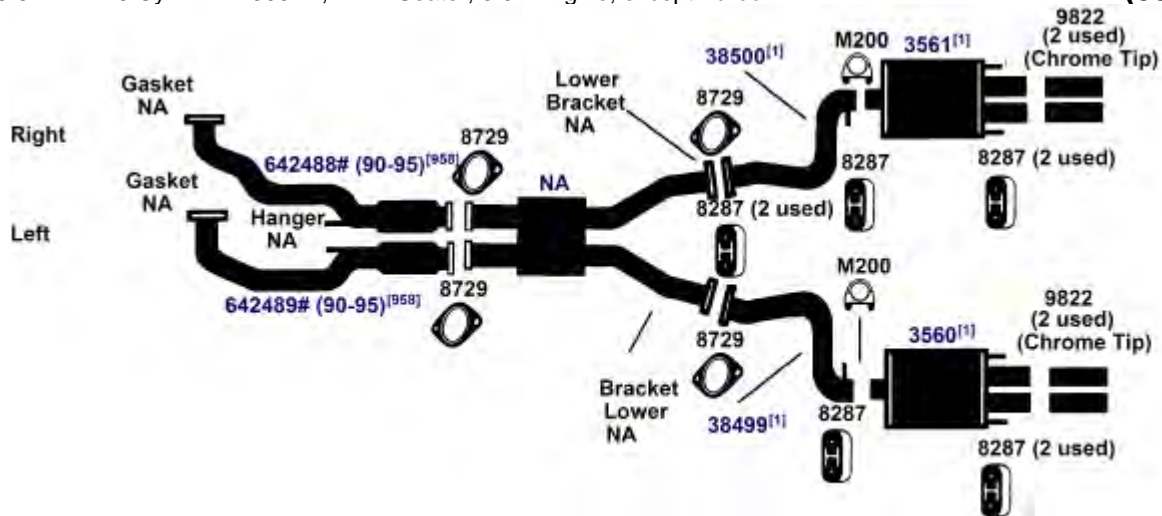

90-94 6 Cyl. 300ZX, 3.0L Turbo Engine (3917)

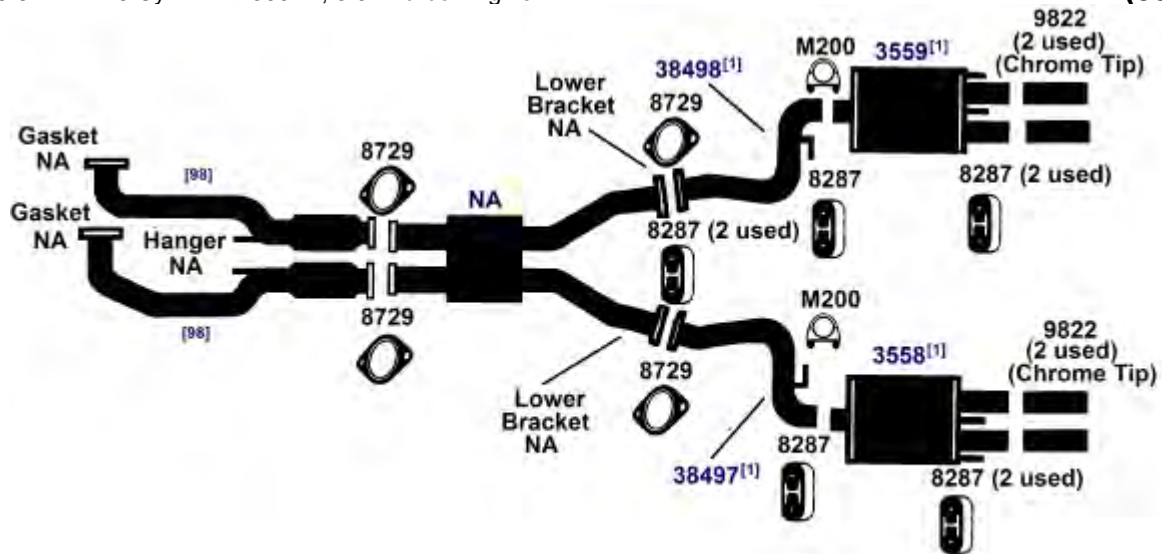

NA-Not Available. NR-Not Required. FL-Remove and Re-Use Old Flange. ● Golden Warehouse. O.E.-Original Equipment.
 # Airtube Kit [4948] may be required to complete installation. EFI-Electronic Fuel Injection.

[1] OE system was a welded assembly. It is recommended that all parts noted [1] should be replaced.

[958] Federal & California Emission vehicles. Not legal for sale for vehicles licensed in California.

[98] Refer to current Catalytic Converter catalog or Website catalog for availability.

NISSAN 280ZX, 300ZX

(3914) 85-89 6 Cyl. 300ZX, except Turbo



DIRECT FIT MSL/MAXIMUM Muffler... 700031

(3913) 85-89 6 Cyl. 300ZX, Turbo

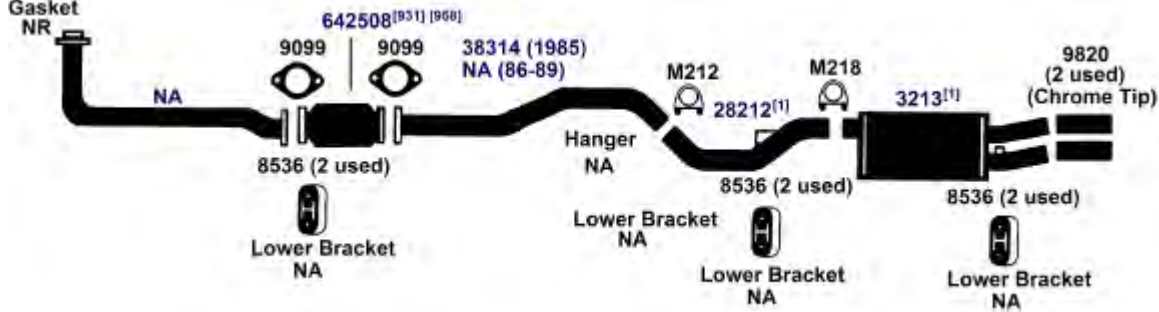

DIRECT FIT MSL/MAXIMUM Muffler... 700031

(3914E) 1984 6 Cyl. 300ZX, except Turbo



DIRECT FIT MSL/MAXIMUM Muffler... 700031

NA-Not Available. NR-Not Required. FL-Remove and Re-Use Old Flange. ● Golden Warehouse. O.E.-Original Equipment.
Airtube Kit [4948] may be required to complete installation. EFI-Electronic Fuel Injection.

[1] OE system was a welded assembly. It is recommended that all parts noted [1] should be replaced.

[141] Remove and re-use O.E. heat shield, if required.

[931] This unit was designed to fit many applications. Measurement of the old unit and cutting of new unit is required.

[958] Federal & California Emission vehicles. Not legal for sale for vehicles licensed in California.

1984 6 Cyl. 300ZX, Turbo

(3913E)

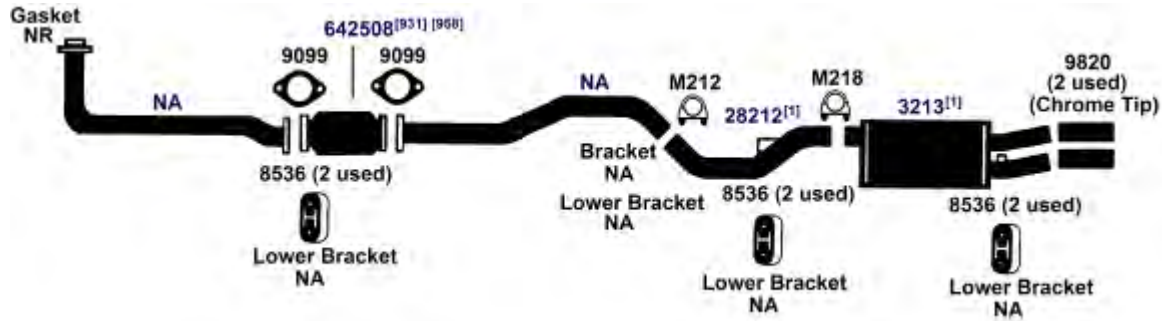

DIRECT FIT MSL/MAXIMUM Muffler... 700031

NISSAN 720 SERIES PICKUP

85-86 4 Cyl. 720 Pickup; 2.4L Engine; 2 W.D.; (Vehicles built from Nov. 1982 thru Oct. 1985); (23106) except Heavy Duty Long Bed, Cab and Chassis, and Diesel

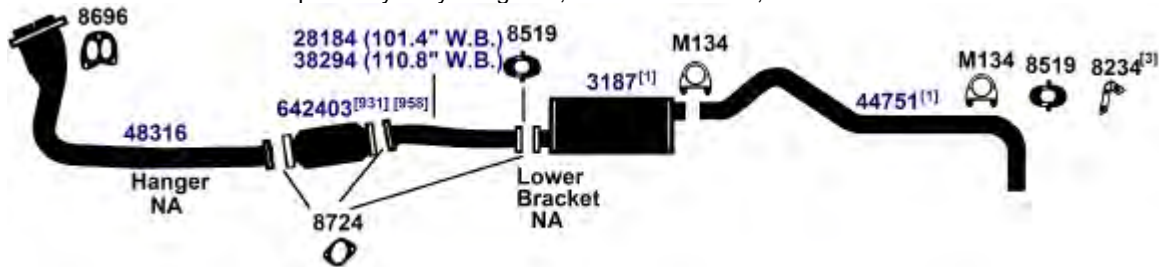

DIRECT FIT MSL/MAXIMUM Muffler... 700077, UNIVERSAL FIT MSL/MAXIMUM Muffler... 6569, 6656, 709018

85-86 4 Cyl. 720 Pickup; 4 W.D. (Vehicles built from Jan. 1983 thru Oct. 1985) (23105)

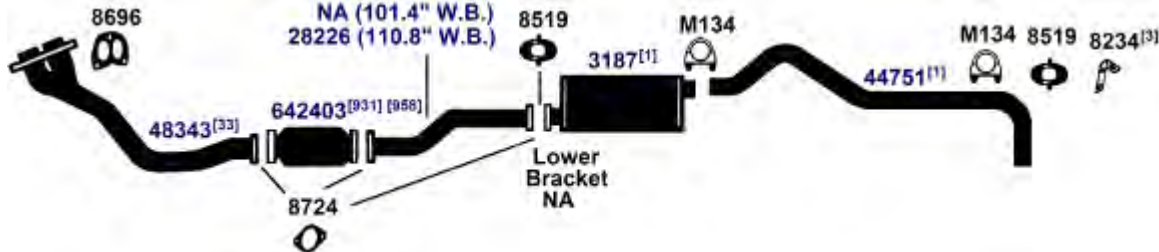

DIRECT FIT MSL/MAXIMUM Muffler... 700077, UNIVERSAL FIT MSL/MAXIMUM Muffler... 6569, 6656, 709018

NA-Not Available. NR-Not Required. FL-Remove and Re-Use Old Flange. ● Golden Warehouse. O.E.-Original Equipment.
Airtube Kit [4948] may be required to complete installation. EFI-Electronic Fuel Injection.

- [1] OE system was a welded assembly. It is recommended that all parts noted [1] should be replaced.
- [3] Required for installation.
- [33] Remove and re-use O.E. heat shield.
- [931] This unit was designed to fit many applications. Measurement of the old unit and cutting of new unit is required.
- [958] Federal & California Emission vehicles. Not legal for sale for vehicles licensed in California.

NISSAN 720 SERIES PICKUP

(23105E) 83-84 4 Cyl. 720 Pickup; 4 W.D. (Vehicles built from Jan. 1983 thru Oct. 1985)

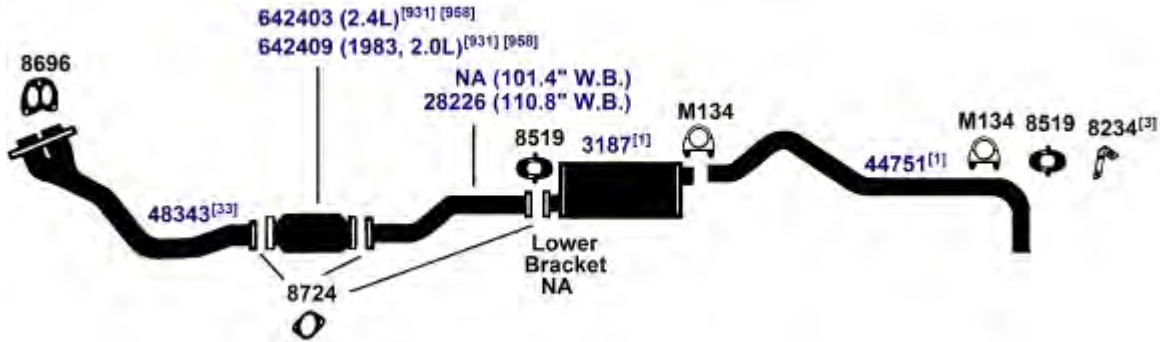

DIRECT FIT MSL/MAXIMUM Muffler... 700077, UNIVERSAL FIT MSL/MAXIMUM Muffler... 6569, 6656, 709018

(23104) 83-84 4 Cyl. 720 Pickup; Diesel (from Jan. 1983)

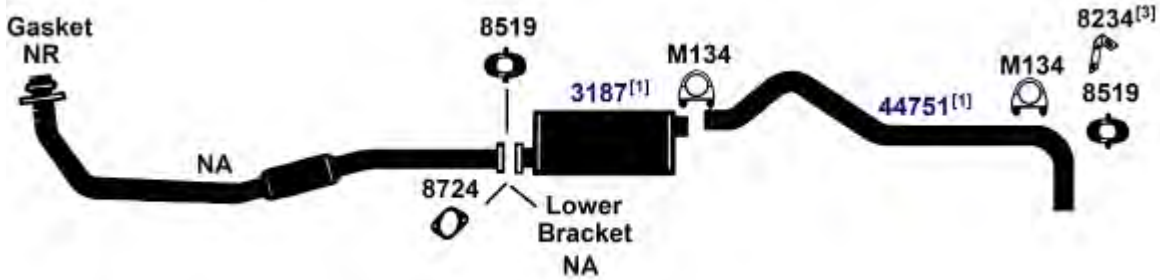

DIRECT FIT MSL/MAXIMUM Muffler... 700077, UNIVERSAL FIT MSL/MAXIMUM Muffler... 6569, 6656, 709018

(23106E) 83-84 4 Cyl. 720 Pickup; 2.0L, 2.4L Engine; 2 W.D.; (Vehicles built from Nov. 1982 thru Oct. 1985); except Heavy Duty Long Bed, Cab and Chassis, and Diesel

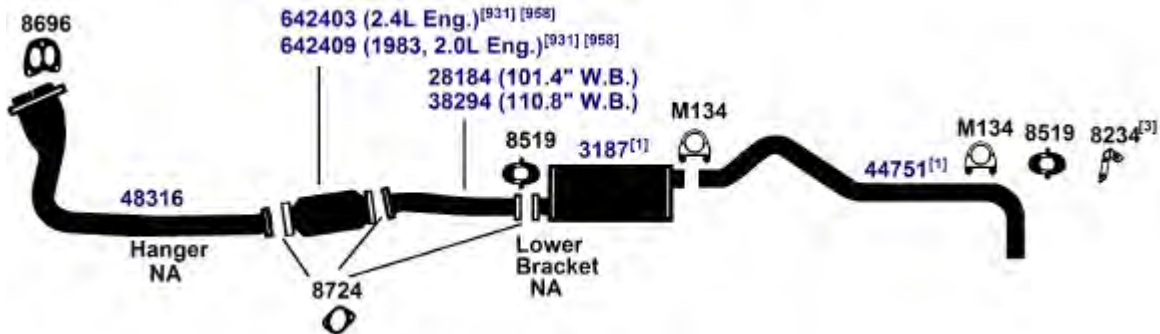

DIRECT FIT MSL/MAXIMUM Muffler... 700077, UNIVERSAL FIT MSL/MAXIMUM Muffler... 6569, 6656, 709018

NA-Not Available. NR-Not Required. FL-Remove and Re-Use Old Flange. ● Golden Warehouse. O.E.-Original Equipment.
Airtube Kit [4948] may be required to complete installation. EFI-Electronic Fuel Injection.

[1] OE system was a welded assembly. It is recommended that all parts noted [1] should be replaced.

[3] Required for installation.

[33] Remove and re-use O.E. heat shield.

[931] This unit was designed to fit many applications. Measurement of the old unit and cutting of new unit is required.

[958] Federal & California Emission vehicles. Not legal for sale for vehicles licensed in California.

NISSAN 720 SERIES PICKUP

81-83 4 Cyl. 720 Pickup; 2.2L Engine; 2 W.D.; except Heavy Duty Long Bed, Cab and Chassis, and Diesel Models (through Oct. 1982) **(23103)**

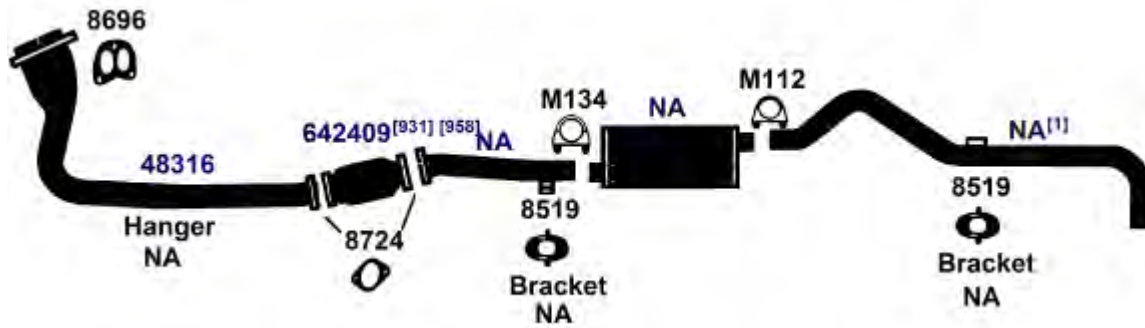

NISSAN ALTIMA

1994 4 Cyl. Altima, 2.4L Engine; with Auto Trans. (Calif.) **(14026)**
 1994 4 Cyl. Altima, 2.4L Engine; with Manual Trans.

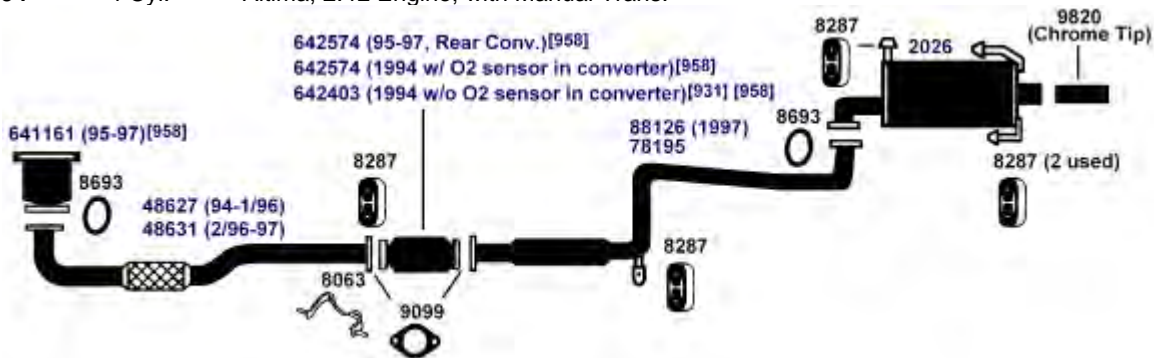

DIRECT FIT MSL/MAXIMUM Muffler... 700167

NA-Not Available. NR-Not Required. FL-Remove and Re-Use Old Flange. ● Golden Warehouse. O.E.-Original Equipment.
 # Airtube Kit [4948] may be required to complete installation. EFI-Electronic Fuel Injection.

[1] OE system was a welded assembly. It is recommended that all parts noted [1] should be replaced.

[931] This unit was designed to fit many applications. Measurement of the old unit and cutting of new unit is required.

[958] Federal & California Emission vehicles. Not legal for sale for vehicles licensed in California.

NISSAN ALTIMA

(14025)	1994	4 Cyl.	Altima, 2.4L DOHC Engine with Auto Trans. (exc. Calif.)
	1993	4 Cyl.	Altima, 2.4L DOHC Engine; All Models

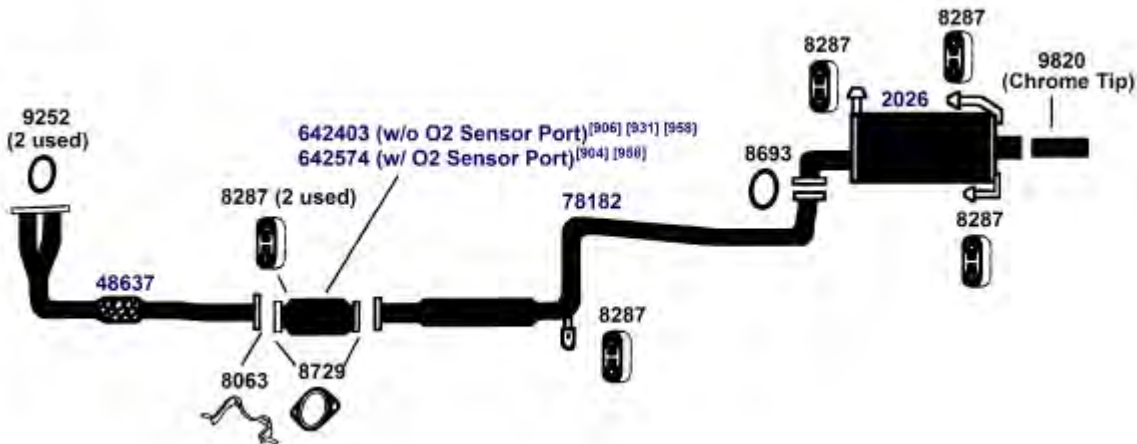

DIRECT FIT MSL/MAXIMUM Muffler... 700167

NISSAN AXXESS

(100314)	91-94	4 Cyl.	Axxess, 2.4L Engine; 2 W.D. (Canada Only)
	1990	4 Cyl.	Axxess, 2.4L Engine; 2 W.D.

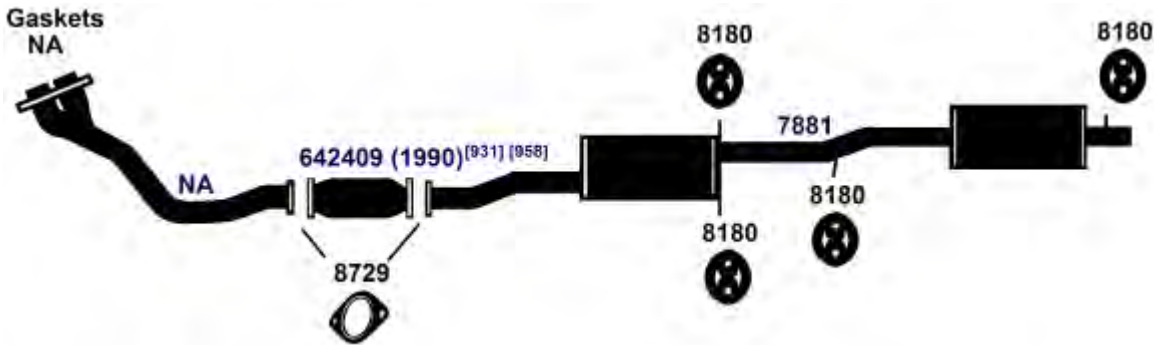

NA-Not Available. NR-Not Required. FL-Remove and Re-Use Old Flange. ● Golden Warehouse. O.E.-Original Equipment.

Airtube Kit [4948] may be required to complete installation. EFI-Electronic Fuel Injection.

[904] w/O2 Sensor ports in Converter.
[906] w/o O2 Sensor ports in Converter.

[931] This unit was designed to fit many applications. Measurement of the old unit and cutting of new unit is required.

[958] Federal & California Emission vehicles. Not legal for sale for vehicles licensed in California.

NISSAN D21 (HARDBODY) PICKUP

90-94 4 Cyl. D21 (Hardbody) Pickup; 2.4L Engine; 2 W.D. (116" W.B.)

(32510)

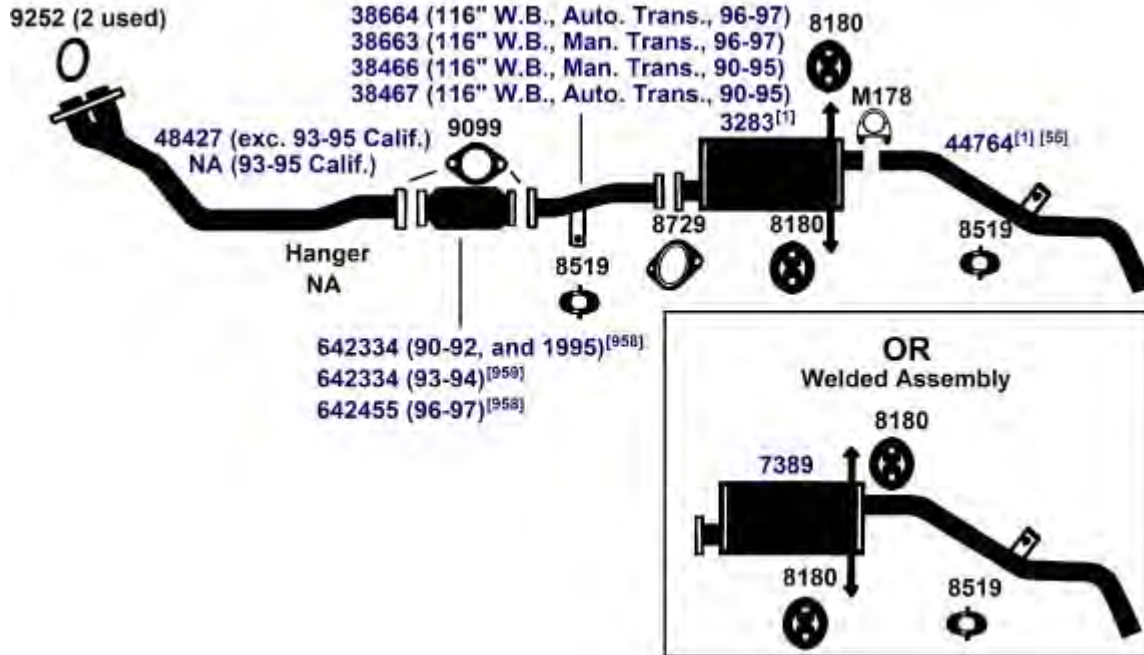

DIRECT FIT MSL/MAXIMUM Muffler... Split System- 6695, UNIVERSAL FIT MSL/MAXIMUM Muffler... Split System- 6558, Silentone DIY Muffler... Split System- 5597

NA-Not Available. NR-Not Required. FL-Remove and Re-Use Old Flange. ● Golden Warehouse. O.E.-Original Equipment.
 # Airtube Kit [4948] may be required to complete installation. EFI-Electronic Fuel Injection.

[1] OE system was a welded assembly. It is recommended that all parts noted [1] should be replaced.
 [55] Resonator Eliminator on 90-93 models.

[958] Federal & California Emission vehicles. Not legal for sale for vehicles licensed in California.
 [959] Federal Emission vehicles. Not legal for sale for vehicles licensed in California.

NISSAN D21 (HARDBODY) PICKUP

(32507) 90-94 4 Cyl. D21 (Hardbody) Pickup; 2.4L Engine; 2 W.D. (104" W.B.)

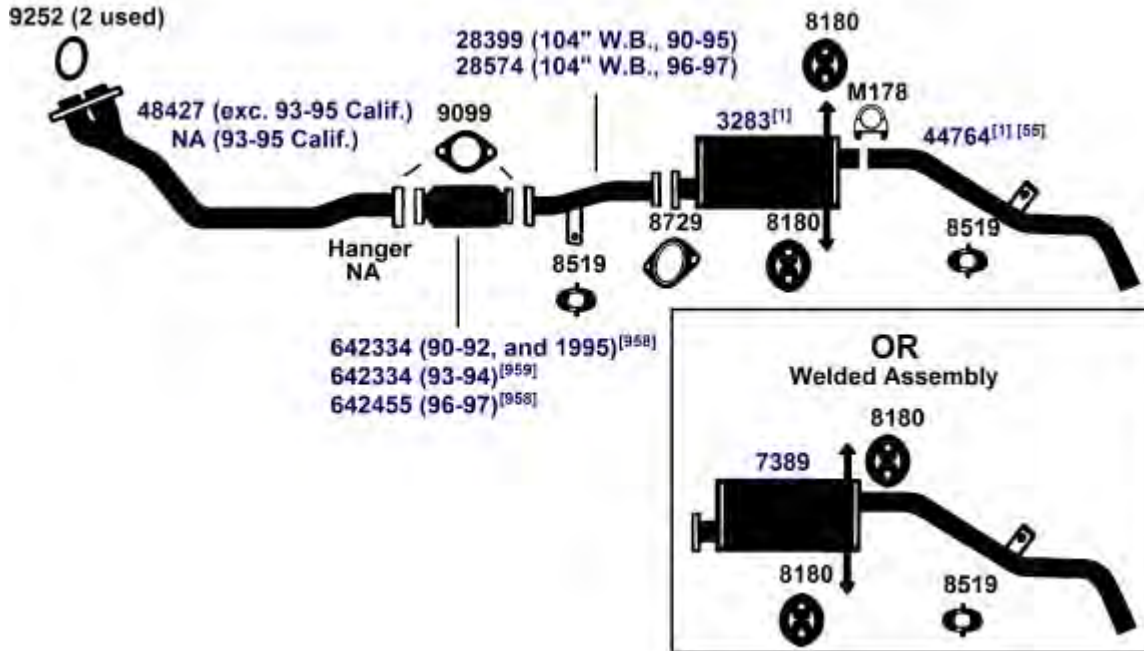

DIRECT FIT MSL/MAXIMUM Muffler... Split System- 6695, UNIVERSAL FIT MSL/MAXIMUM Muffler... Split System- 6558, Silentone DIY Muffler... Split System- 5597

NA-Not Available. NR-Not Required. FL-Remove and Re-Use Old Flange. ● Golden Warehouse. O.E.-Original Equipment.
 # Airtube Kit [4948] may be required to complete installation. EFI-Electronic Fuel Injection.

[1] OE system was a welded assembly. It is recommended that all parts noted [1] should be replaced.

[55] Resonator Eliminator on 90-93 models.

[958] Federal & California Emission vehicles. Not legal for sale for vehicles licensed in California.

[959] Federal Emission vehicles. Not legal for sale for vehicles licensed in California.

86-94

4 Cyl.

D21 (Hardbody) Pickup; 2.4L Engine; 4 W.D. (from Nov., 1985)

(32501)

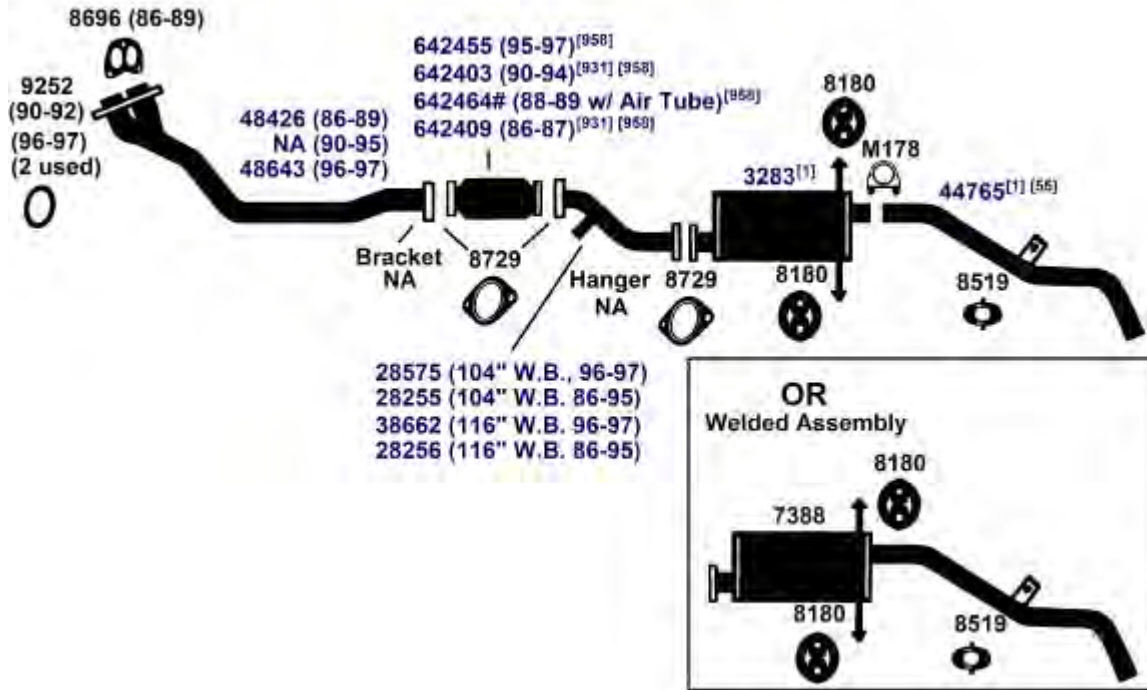

DIRECT FIT MSL/MAXIMUM Muffler... Split System- 6695, UNIVERSAL FIT MSL/MAXIMUM Muffler... Split System- 6558, Silentone DIY Muffler... Split System- 5597

NA-Not Available. NR-Not Required. FL-Remove and Re-Use Old Flange. ● Golden Warehouse. O.E.-Original Equipment.
Airtube Kit [4948] may be required to complete installation. EFI-Electronic Fuel Injection.

[1] OE system was a welded assembly. It is recommended that all parts noted [1] should be replaced.

[55] Resonator Eliminator on 90-93 models.

[931] This unit was designed to fit many applications. Measurement of the old unit and cutting of new unit is required.

[958] Federal & California Emission vehicles. Not legal for sale for vehicles licensed in California.

NISSAN D21 (HARDBODY) PICKUP

(32508) 1994 6 Cyl. D21 (Hardbody) Pickup; 3.0L Engine; 4 W.D.; California

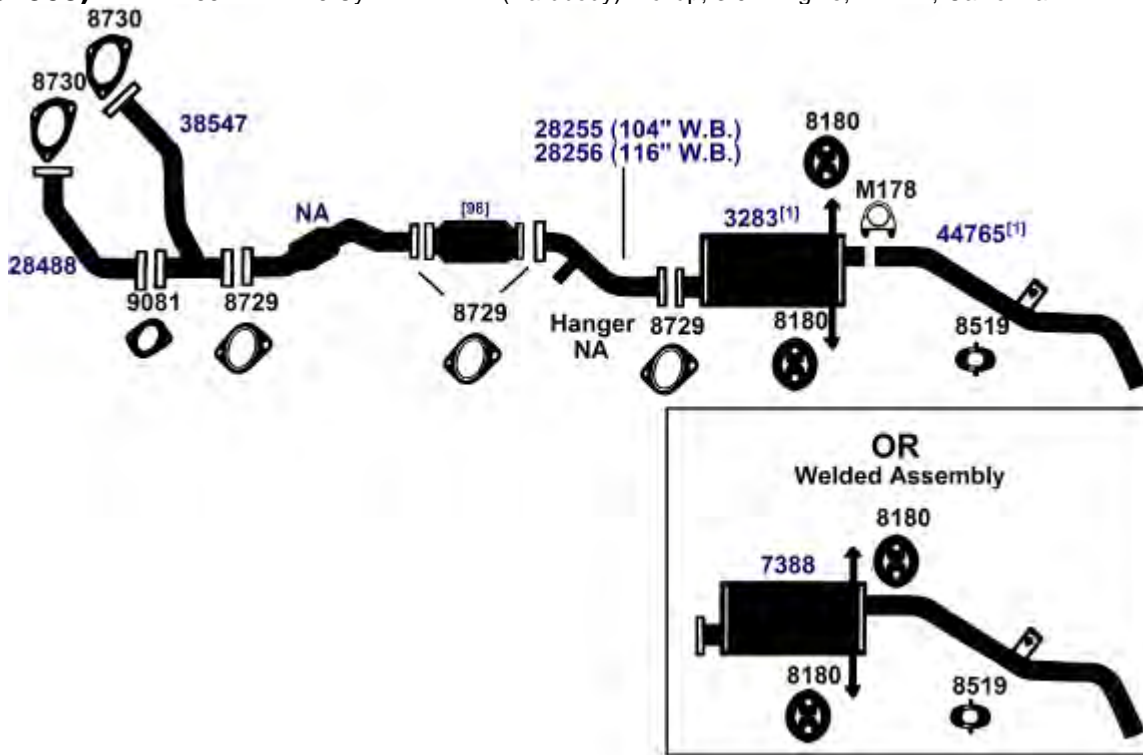

DIRECT FIT MSL/MAXIMUM Muffler... Split System- 6695, UNIVERSAL FIT MSL/MAXIMUM Muffler... Split System- 6558, Silentone DIY Muffler... Split System- 5597

NA-Not Available. NR-Not Required. FL-Remove and Re-Use Old Flange. ● Golden Warehouse. O.E.-Original Equipment.
 # Airtube Kit [4948] may be required to complete installation. EFI-Electronic Fuel Injection.

[1] OE system was a welded assembly. It is recommended that all parts noted [1] [98] Refer to current Catalytic Converter catalog or Website catalog for availability. should be replaced.

86-94 6 Cyl. D21 (Hardbody) Pickup; 3.0L Engine; 2 W.D.; except 1994 California

(32502)

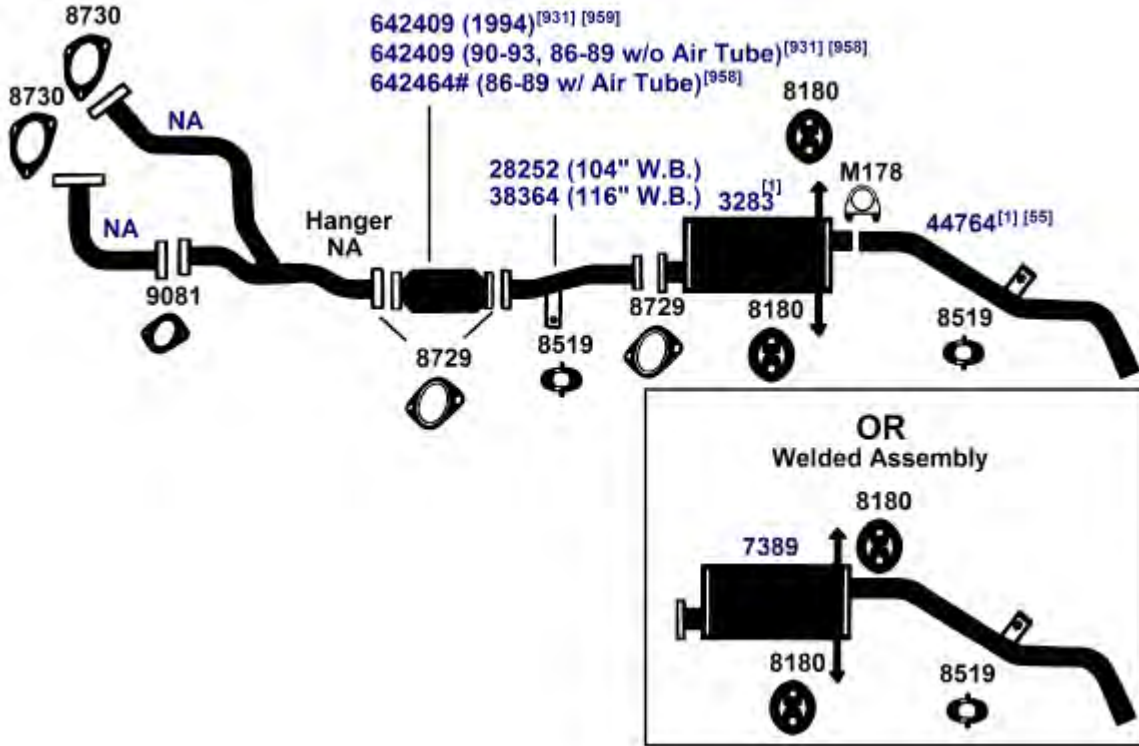

DIRECT FIT MSL/MAXIMUM Muffler... Split System- 6695, UNIVERSAL FIT MSL/MAXIMUM Muffler... Split System- 6558, Silentone DIY Muffler... Split System- 5597

NA-Not Available. NR-Not Required. FL-Remove and Re-Use Old Flange. ● Golden Warehouse. O.E.-Original Equipment.
Airtube Kit [4948] may be required to complete installation. EFI-Electronic Fuel Injection.

[1] OE system was a welded assembly. It is recommended that all parts noted [1] should be replaced.
[55] Resonator Eliminator on 90-93 models.
[931] This unit was designed to fit many applications. Measurement of the old unit and cutting of new unit is required.

[958] Federal & California Emission vehicles. Not legal for sale for vehicles licensed in California.
[959] Federal Emission vehicles. Not legal for sale for vehicles licensed in California.

NISSAN D21 (HARDBODY) PICKUP

(32503) 86-94 6 Cyl. D21 (Hardbody) Pickup; 3.0L Engine; 4 W.D.; except 1994 California

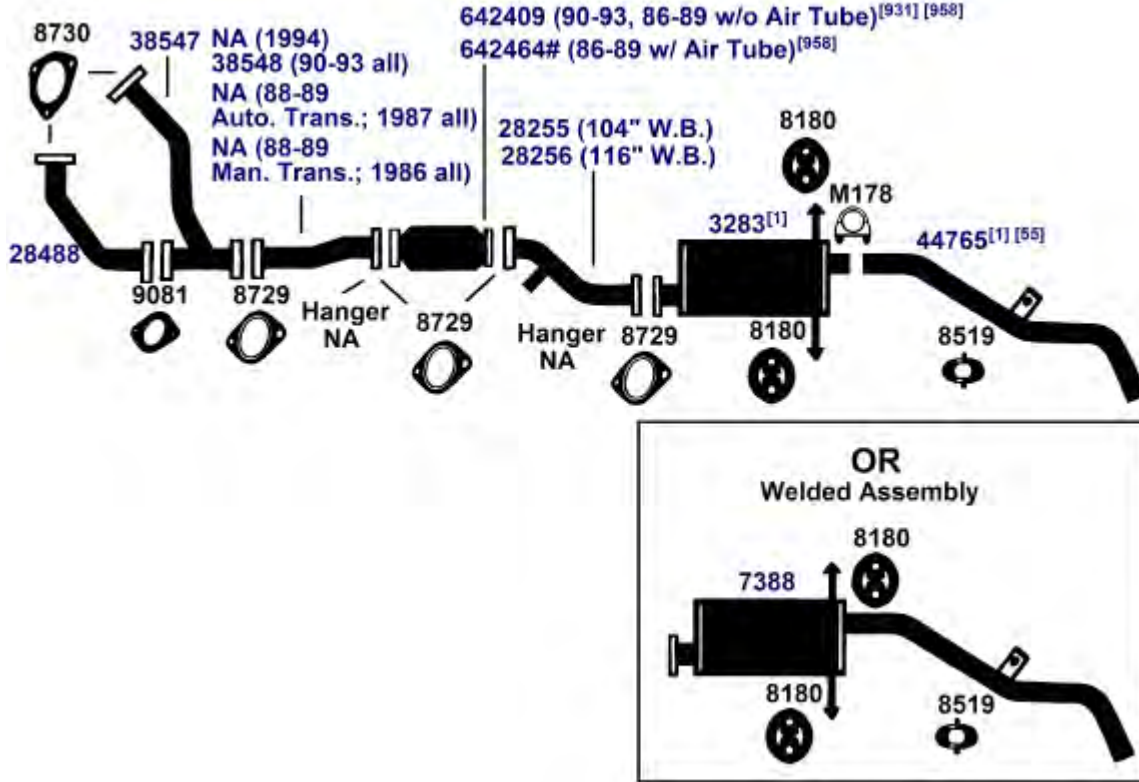

DIRECT FIT MSL/MAXIMUM Muffler... Split System- 6695, UNIVERSAL FIT MSL/MAXIMUM Muffler... Split System- 6558, Silentone DIY Muffler... Split System- 5597

NA-Not Available. NR-Not Required. FL-Remove and Re-Use Old Flange. ● Golden Warehouse. O.E.-Original Equipment.
 # Airtube Kit [4948] may be required to complete installation. EFI-Electronic Fuel Injection.

[1] OE system was a welded assembly. It is recommended that all parts noted [1] should be replaced.

[55] Resonator Eliminator on 90-93 models.

[931] This unit was designed to fit many applications. Measurement of the old unit and cutting of new unit is required.

[958] Federal & California Emission vehicles. Not legal for sale for vehicles licensed in California.

1994

6 Cyl.

D21 (Hardbody) Pickup; 3.0L Engine; 2 W.D.; California

(32509)

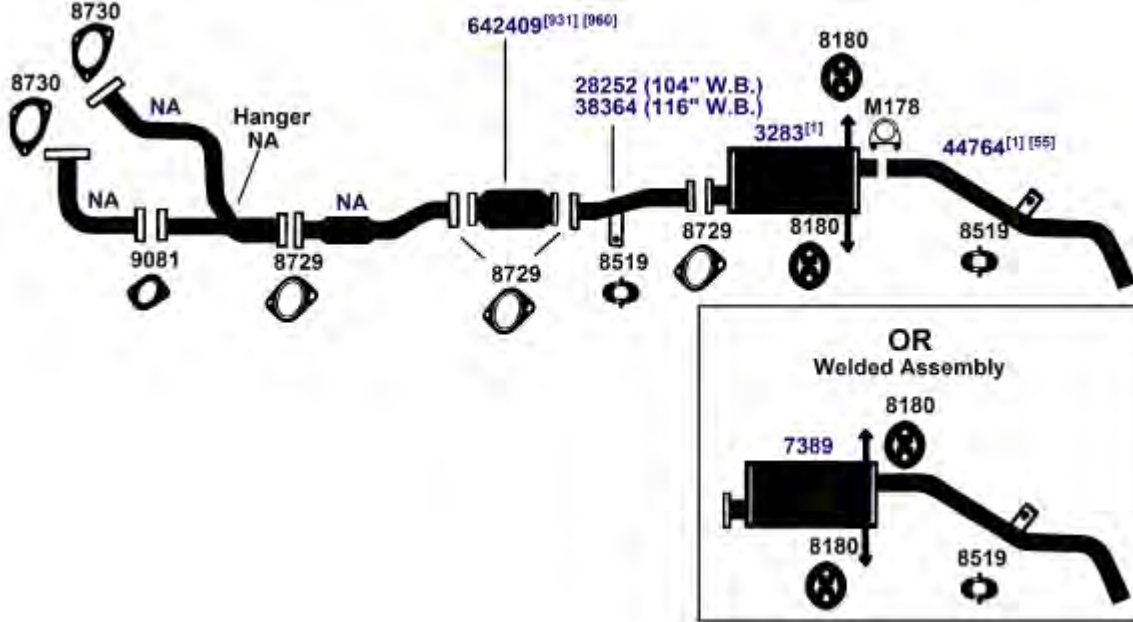

DIRECT FIT MSL/MAXIMUM Muffler... Split System- 6695, UNIVERSAL FIT MSL/MAXIMUM Muffler... Split System- 6558, Silentone DIY Muffler... Split System- 5597

NA-Not Available. NR-Not Required. FL-Remove and Re-Use Old Flange. ● Golden Warehouse. O.E.-Original Equipment.
 # Airtube Kit [4948] may be required to complete installation. EFI-Electronic Fuel Injection.

- [1] OE system was a welded assembly. It is recommended that all parts noted [1] should be replaced.
- [55] Resonator Eliminator on 90-93 models.
- [98] Refer to current Catalytic Converter catalog or Website catalog for availability.

- [931] This unit was designed to fit many applications. Measurement of the old unit and cutting of new unit is required.
- [960] California Emission vehicles licensed in states other than California. Not legal for sale for vehicles licensed in California.

NISSAN D21 (HARDBODY) PICKUP

(32506) 88-89 4 Cyl. D21 (Hardbody) Pickup; 2.4L Engine; 2 W.D.; Manual Trans

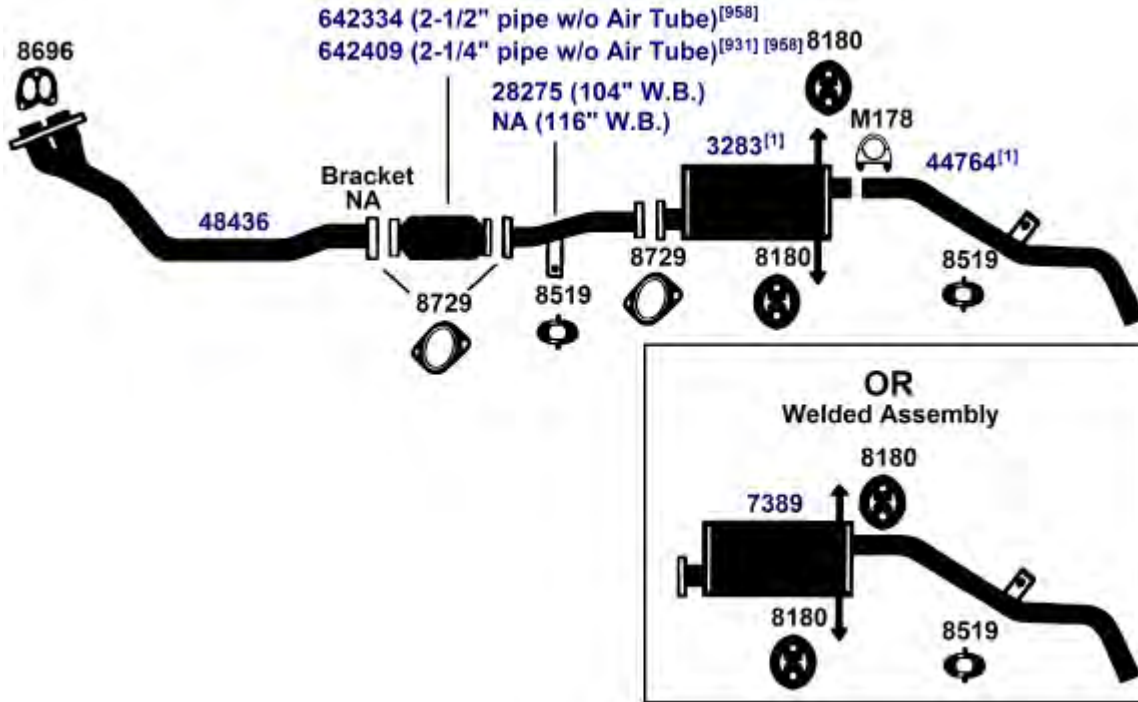

DIRECT FIT MSL/MAXIMUM Muffler... Split System- 6695, UNIVERSAL FIT MSL/MAXIMUM Muffler... Split System- 6558, Silentone DIY Muffler... Split System- 5597

NA-Not Available. NR-Not Required. FL-Remove and Re-Use Old Flange. ● Golden Warehouse. O.E.-Original Equipment.
 # Airtube Kit [4948] may be required to complete installation. EFI-Electronic Fuel Injection.

[1] OE system was a welded assembly. It is recommended that all parts noted [1] should be replaced.

[958] Federal & California Emission vehicles. Not legal for sale for vehicles licensed in California.

[931] This unit was designed to fit many applications. Measurement of the old unit and cutting of new unit is required.

88-89 4 Cyl. D21 (Hardbody) Pickup; 2.4L Engine; 2 W.D.; Auto Trans

(32505)

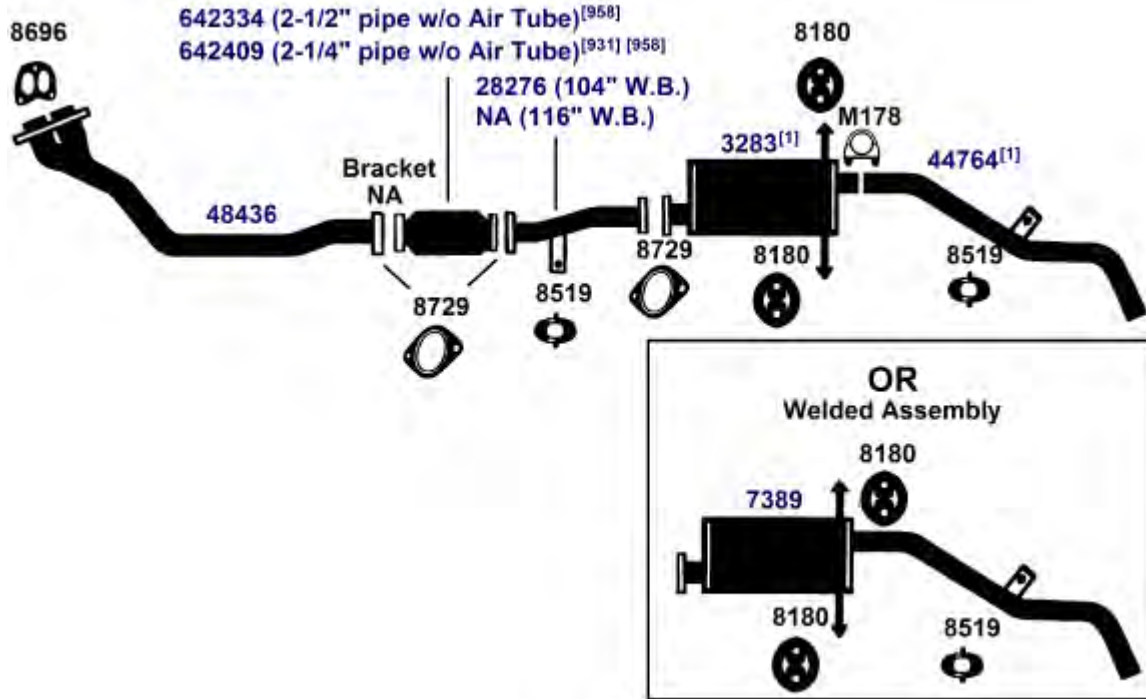

DIRECT FIT MSL/MAXIMUM Muffler... Split System- 6695, UNIVERSAL FIT MSL/MAXIMUM Muffler... Split System- 6558, Silentone DIY Muffler... Split System- 5597

NA-Not Available. NR-Not Required. FL-Remove and Re-Use Old Flange. ● Golden Warehouse. O.E.-Original Equipment.
 # Airtube Kit [4948] may be required to complete installation. EFI-Electronic Fuel Injection.

[1] OE system was a welded assembly. It is recommended that all parts noted [1] should be replaced.

[931] This unit was designed to fit many applications. Measurement of the old unit and cutting of new unit is required.

[958] Federal & California Emission vehicles. Not legal for sale for vehicles licensed in California.

NISSAN D21 (HARDBODY) PICKUP

(32504) 86-87 4 Cyl. D21 (Hardbody) Pickup; 2.4L Engine; 2 W.D.; (from Nov., 1985)

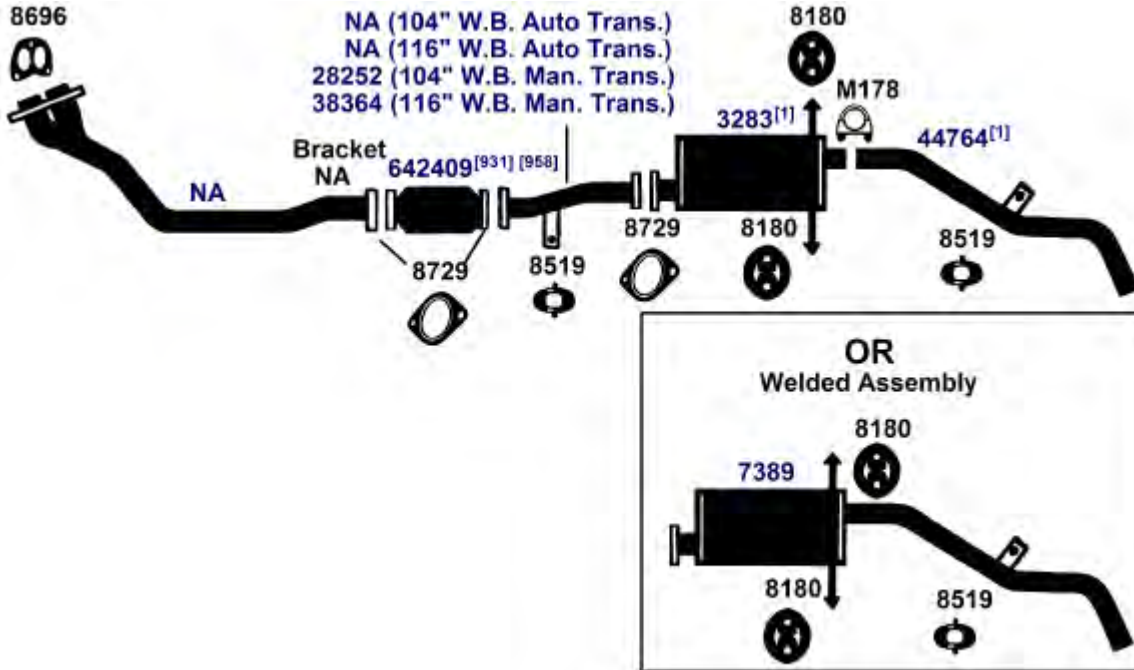

DIRECT FIT MSL/MAXIMUM Muffler... Split System- 6695, UNIVERSAL FIT MSL/MAXIMUM Muffler... Split System- 6558, Silentone DIY Muffler... Split System- 5597

NISSAN MAXIMA

(3850) 92-94 6 Cyl. Maxima GXE Sedan, 3.0L SOHC Engine
89-91 6 Cyl. Maxima GXE Sedan, 3.0L Engine; Auto. Trans.

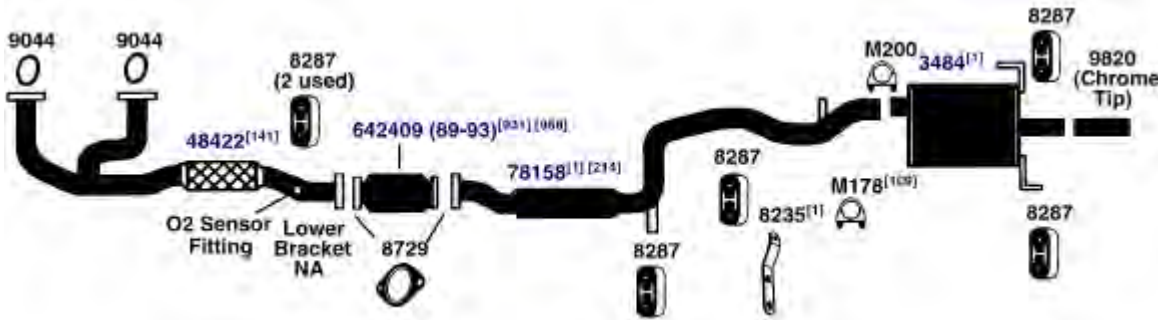

DIRECT FIT MSL/MAXIMUM Muffler... 700157, UNIVERSAL FIT MSL/MAXIMUM Muffler... 6560

NA-Not Available. NR-Not Required. FL-Remove and Re-Use Old Flange. ● Golden Warehouse. O.E.-Original Equipment.
Airtube Kit [4948] may be required to complete installation. EFI-Electronic Fuel Injection.

[1] OE system was a welded assembly. It is recommended that all parts noted [1] should be replaced.

[98] Refer to current Catalytic Converter catalog or Website catalog for availability.

[109] Required for proper installation of 8235 hanger.

[141] Remove and re-use O.E. heat shield, if required.

[214] If a welded bracket is located near the outlet end of pipe, 8235 hanger and M178 clamp is not needed for installation.

[931] This unit was designed to fit many applications. Measurement of the old unit and cutting of new unit is required.

[958] Federal & California Emission vehicles. Not legal for sale for vehicles licensed in California.

92-94	6 Cyl.	Maxima SE Sedan, 3.0L DOHC Engine	(3849)
89-91	6 Cyl.	Maxima Sedan, 3.0L Engine; All Models with Manual Trans.	
89-91	6 Cyl.	Maxima SE Sedan, 3.0L Engine; Auto. Trans.	

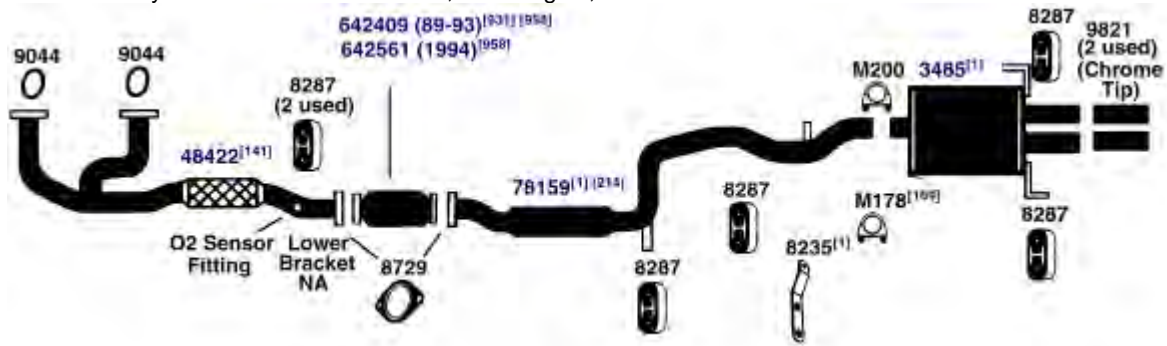

DIRECT FIT MSL/MAXIMUM Muffler... 700174, UNIVERSAL FIT MSL/MAXIMUM Muffler... 6688

87-88	6 Cyl.	Maxima Sedan, Sta. Wagon; 3.0L Engine	(3848)
--------------	--------	---------------------------------------	---------------

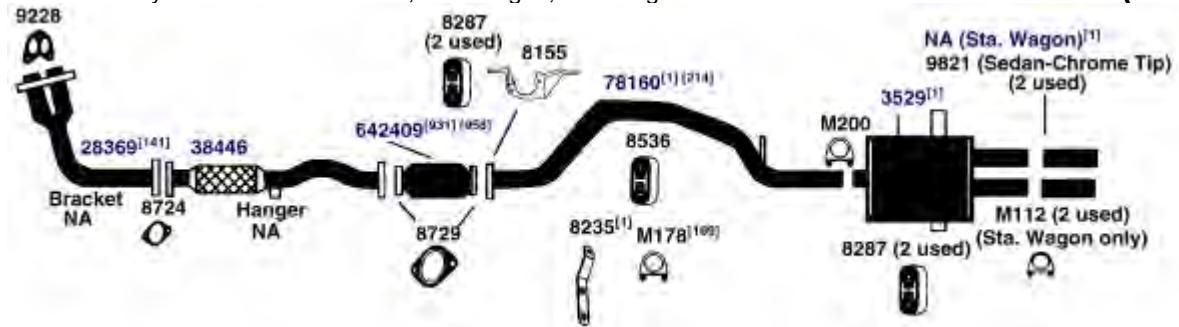

DIRECT FIT MSL/MAXIMUM Muffler... 700029, UNIVERSAL FIT MSL/MAXIMUM Muffler... 6688

85-86	6 Cyl.	Maxima Sedan, Sta. Wagon	(3847)
--------------	--------	--------------------------	---------------

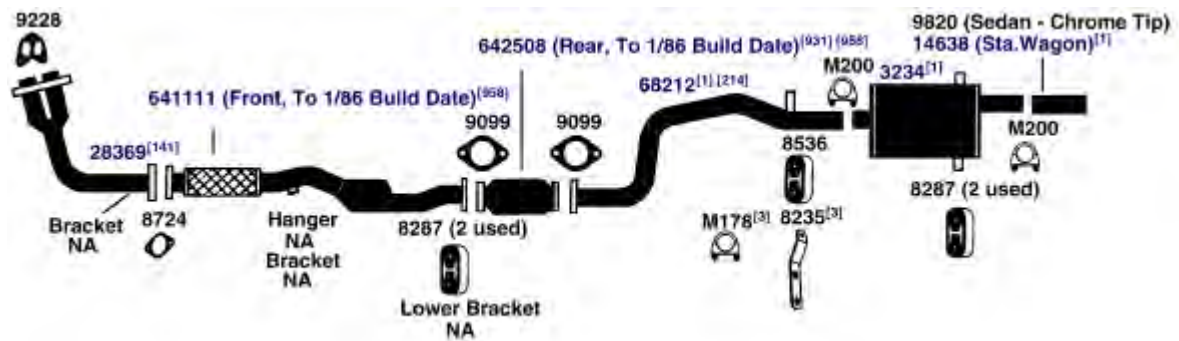

DIRECT FIT MSL/MAXIMUM Muffler... 700092, UNIVERSAL FIT MSL/MAXIMUM Muffler... 6504

NA-Not Available. NR-Not Required. FL-Remove and Re-Use Old Flange. ● Golden Warehouse. O.E.-Original Equipment.
 # Airtube Kit [4948] may be required to complete installation. EFI-Electronic Fuel Injection.

- [1] OE system was a welded assembly. It is recommended that all parts noted [1] should be replaced.
- [3] Required for installation.
- [109] Required for proper installation of 8235 hanger.
- [141] Remove and re-use O.E. heat shield, if required.
- [214] If a welded bracket is located near the outlet end of pipe, 8235 hanger and M178 clamp is not needed for installation.
- [931] This unit was designed to fit many applications. Measurement of the old unit and cutting of new unit is required.
- [958] Federal & California Emission vehicles. Not legal for sale for vehicles licensed in California.

NISSAN MICRA

(100299) 88-92 4 Cyl. Micra (CANADA ONLY)

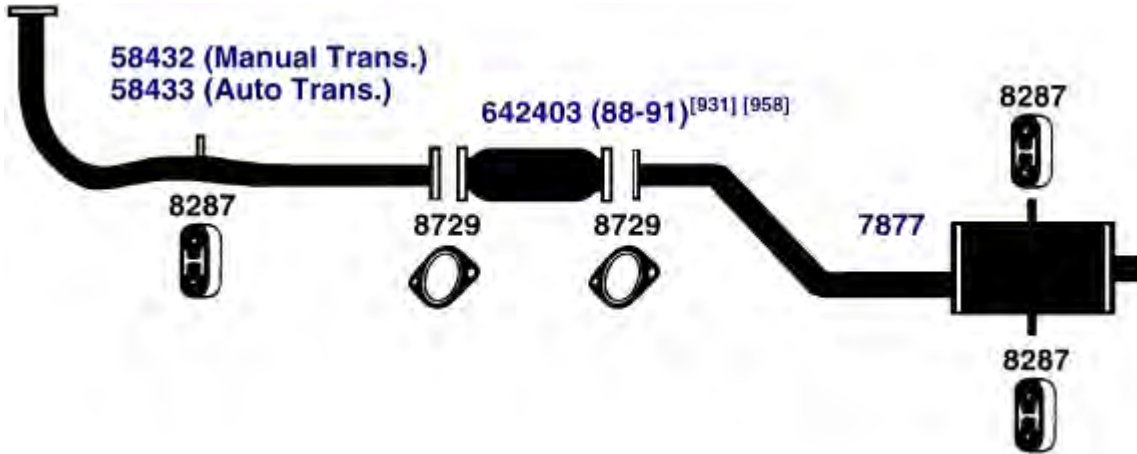

NISSAN MULTI

(100301) 86-89 4 Cyl. Multi Sta. Wagon, 2 W.D., 2.0L Engine (CANADA ONLY)

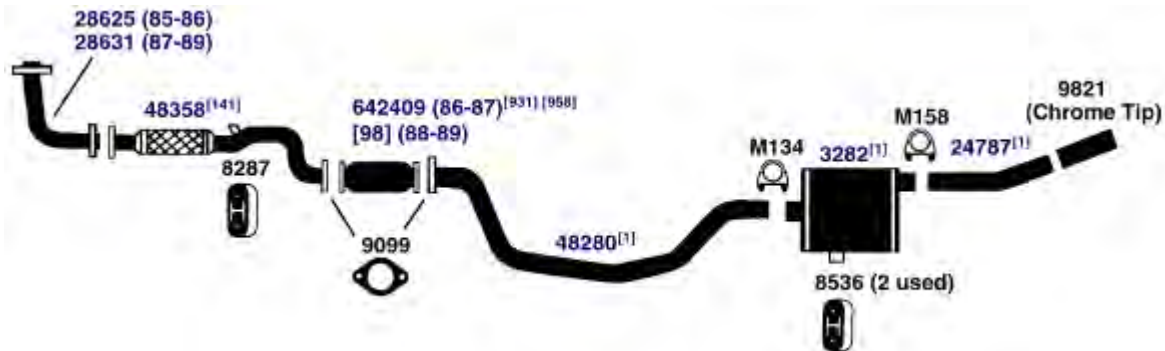

UNIVERSAL FIT MSL/MAXIMUM Muffler... 6651, 6674, 709008

NA-Not Available. NR-Not Required. FL-Remove and Re-Use Old Flange. ● Golden Warehouse. O.E.-Original Equipment.
Airtube Kit [4948] may be required to complete installation. EFI-Electronic Fuel Injection.

[1] OE system was a welded assembly. It is recommended that all parts noted [1] should be replaced.

[141] Remove and re-use O.E. heat shield, if required.

[931] This unit was designed to fit many applications. Measurement of the old unit and cutting of new unit is required.

[958] Federal & California Emission vehicles. Not legal for sale for vehicles licensed in California.

91-93 4 Cyl. NX1600, 1.6L DOHC Engine

(14076)

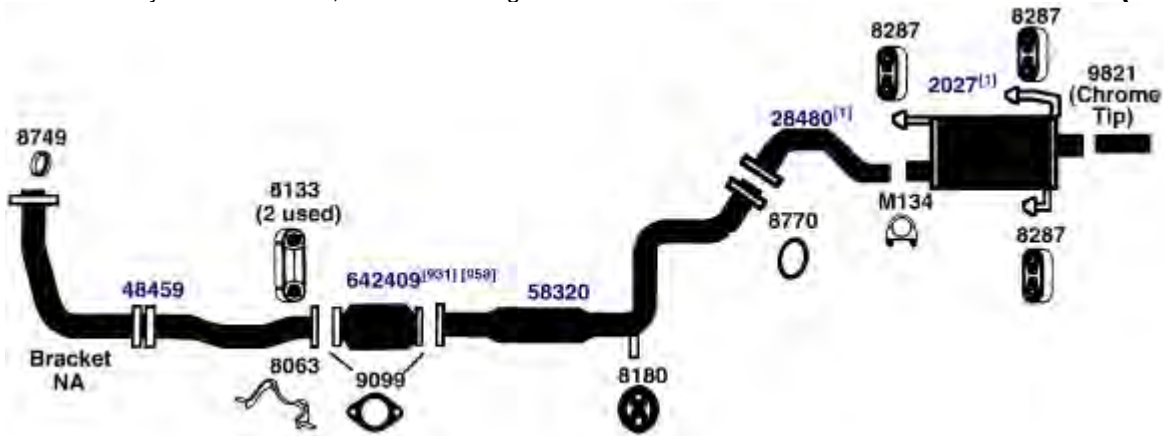

UNIVERSAL FIT MSL/MAXIMUM Muffler... 6692, 6693, 709010

91-93 4 Cyl. NX2000, 2.0L DOHC Engine

(14075)

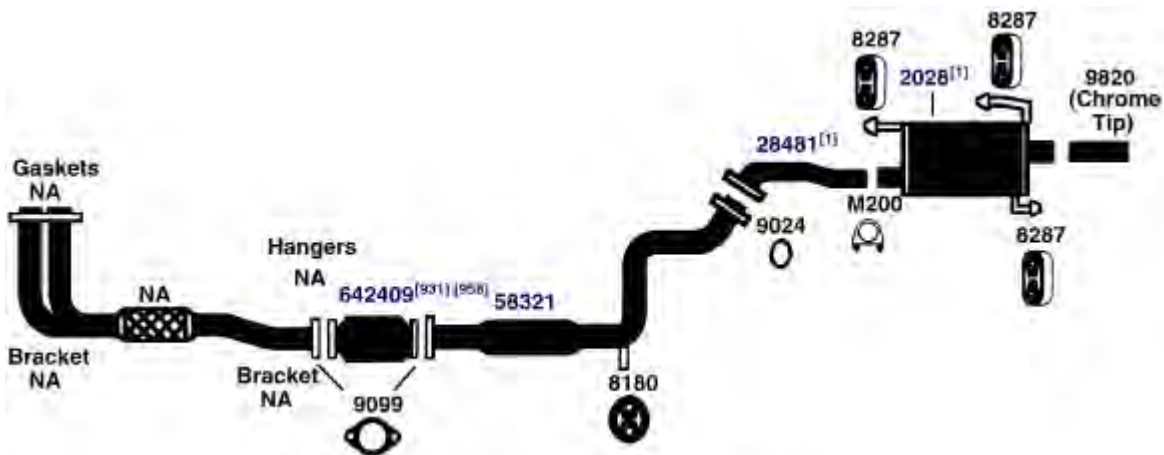

NA-Not Available. NR-Not Required. FL-Remove and Re-Use Old Flange. ● Golden Warehouse. O.E.-Original Equipment.
Airtube Kit [4948] may be required to complete installation. EFI-Electronic Fuel Injection.

[1] OE system was a welded assembly. It is recommended that all parts noted [1] should be replaced.

[958] Federal & California Emission vehicles. Not legal for sale for vehicles licensed in California.

[931] This unit was designed to fit many applications. Measurement of the old unit and cutting of new unit is required.

NISSAN PATHFINDER

(32003) 1994 6 Cyl. Pathfinder; 3.0L Engine; 2 W.D. 4 W.D.; California

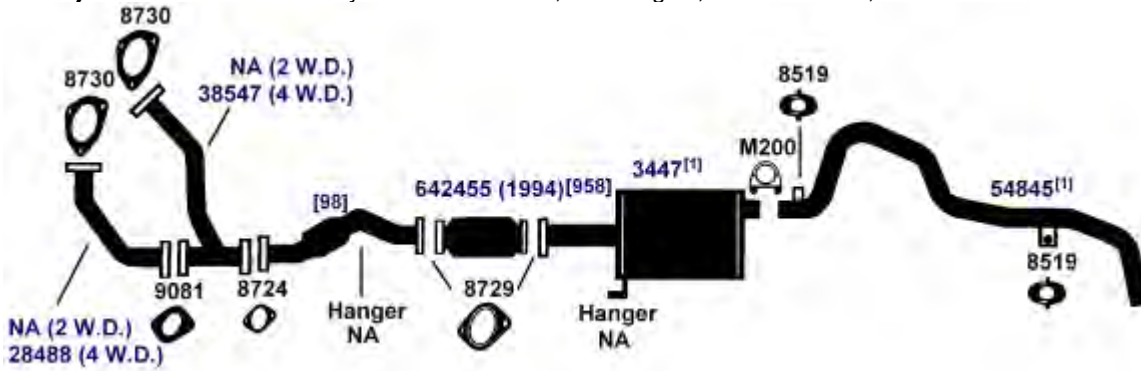

DIRECT FIT MSL/MAXIMUM Muffler... 700279, UNIVERSAL FIT MSL/MAXIMUM Muffler... 6503, 6536, 6544, 709010

(32002) 90-94 6 Cyl. Pathfinder; 3.0L Engine; 2 W.D. and 4 W.D.; except 1994 California

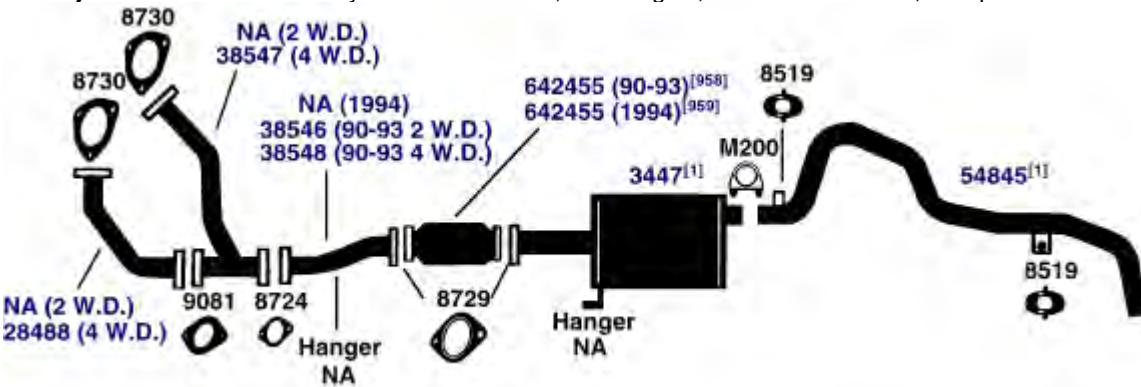

DIRECT FIT MSL/MAXIMUM Muffler... 700279, UNIVERSAL FIT MSL/MAXIMUM Muffler... 6503, 6536, 6544, 709010

(32001) 1989 6 Cyl. Pathfinder; 3.0L Engine; 2 W.D.
87-89 6 Cyl. Pathfinder; 3.0L Engine; 4 W.D.

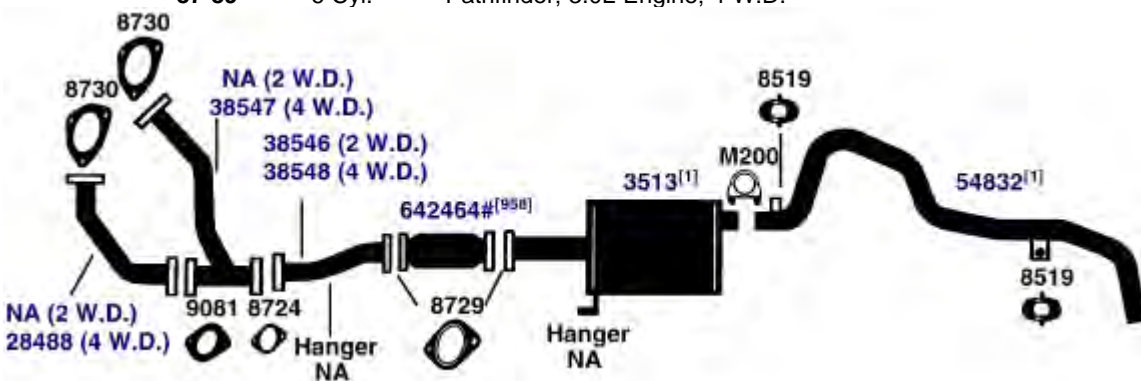

DIRECT FIT MSL/MAXIMUM Muffler... 700138, UNIVERSAL FIT MSL/MAXIMUM Muffler... 6503, 6544, 6536, 709010

NA-Not Available. NR-Not Required. FL-Remove and Re-Use Old Flange. ● Golden Warehouse. O.E.-Original Equipment.
Airtube Kit [4948] may be required to complete installation. EFI-Electronic Fuel Injection.

[1] OE system was a welded assembly. It is recommended that all parts noted [1] should be replaced.

[98] Refer to current Catalytic Converter catalog or Website catalog for availability.

[958] Federal & California Emission vehicles. Not legal for sale for vehicles licensed in California.

[959] Federal Emission vehicles. Not legal for sale for vehicles licensed in California.

[960] California Emission vehicles licensed in states other than California. Not legal for sale for vehicles licensed in California.

NISSAN PATHFINDER

87-89 4 Cyl. Pathfinder; 2.4L Engine

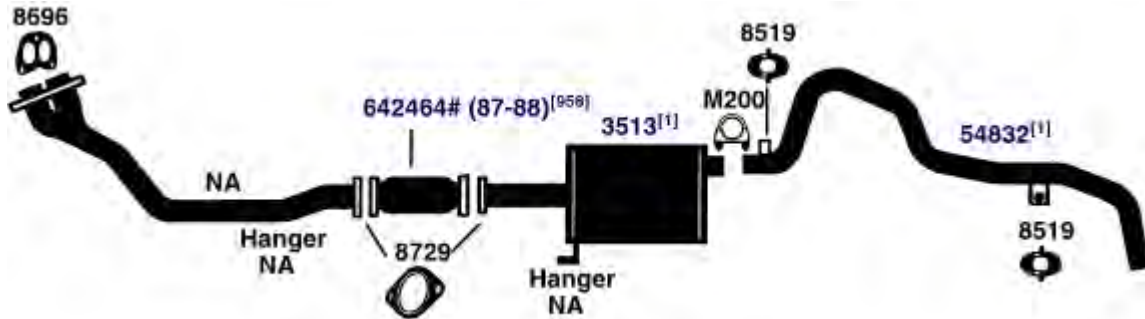
(32000)

DIRECT FIT MSL/MAXIMUM Muffler... 700138, UNIVERSAL FIT MSL/MAXIMUM Muffler... 6503, 6536, 6544, 709010

NISSAN PULSAR

89-90 4 Cyl. Pulsar, 1.6L Engine

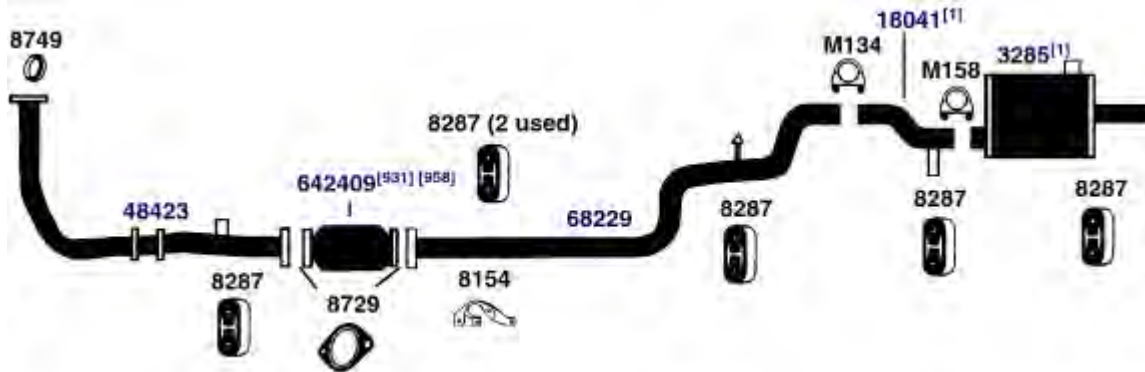
(3474)

DIRECT FIT MSL/MAXIMUM Muffler... 6693, UNIVERSAL FIT MSL/MAXIMUM Muffler... 6677, Silentone DIY Muffler... 5594 and 14643 Pipe

88-89 4 Cyl. Pulsar, 1.8L Twin Cam 16 Valve Engine

(3473)

NA-Not Available. NR-Not Required. FL-Remove and Re-Use Old Flange. ● Golden Warehouse. O.E.-Original Equipment.

Airtube Kit [4948] may be required to complete installation. EFI-Electronic Fuel Injection.

[1] OE system was a welded assembly. It is recommended that all parts noted [1] should be replaced.

[931] This unit was designed to fit many applications. Measurement of the old unit and cutting of new unit is required.

[958] Federal & California Emission vehicles. Not legal for sale for vehicles licensed in California.

NISSAN PULSAR

(3472) 87-88 4 Cyl. Pulsar, 1.6L Engine; except Twin Cam 16 Valve Engine

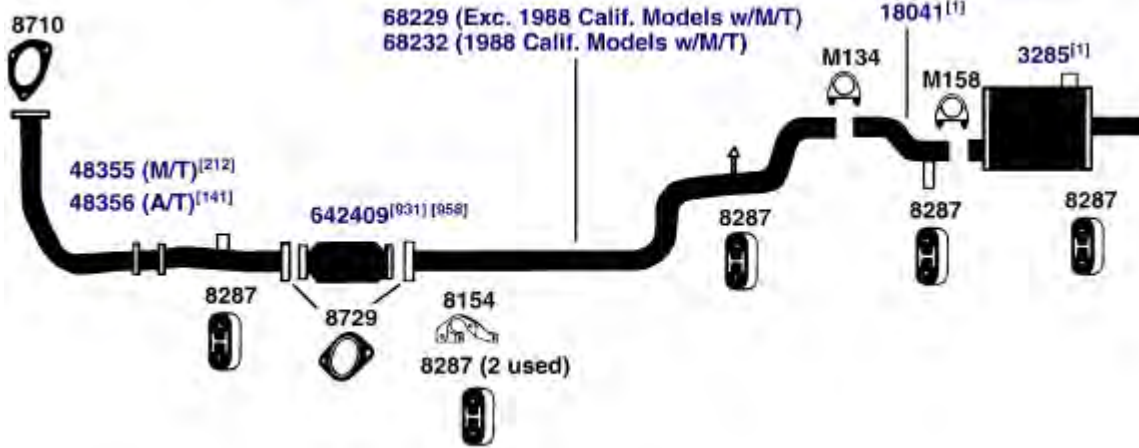

DIRECT FIT MSL/MAXIMUM Muffler... 6693, UNIVERSAL FIT MSL/MAXIMUM Muffler... 6677, Silentone DIY Muffler... 5594 and 14643 Pipe

(3470) 85-86 4 Cyl. Pulsar, 1.6L Engine; except Turbo, (US Only)

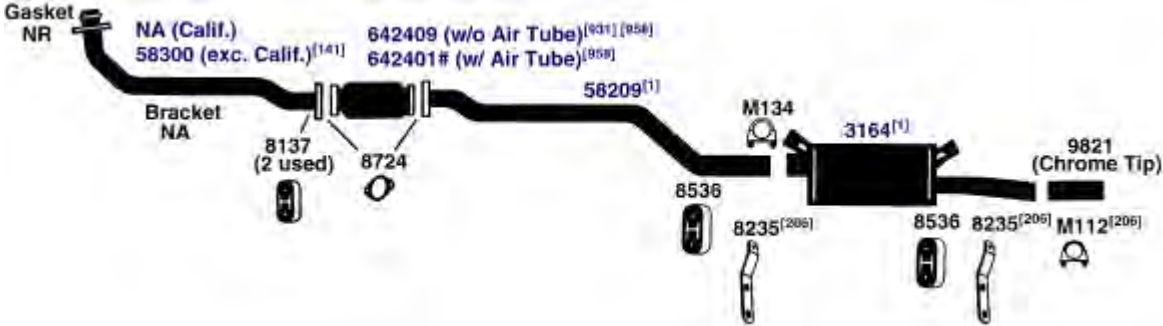

DIRECT FIT MSL/MAXIMUM Muffler... 6680, UNIVERSAL FIT MSL/MAXIMUM Muffler... 6655

(3470E) 83-84 4 Cyl. Pulsar, 1.6L Engine; except Turbo, (US Only)



DIRECT FIT MSL/MAXIMUM Muffler... 6680, UNIVERSAL FIT MSL/MAXIMUM Muffler... 6655

NA-Not Available. NR-Not Required. FL-Remove and Re-Use Old Flange. ● Golden Warehouse. O.E.-Original Equipment.
Airtube Kit [4948] may be required to complete installation. EFI-Electronic Fuel Injection.

[1] OE system was a welded assembly. It is recommended that all parts noted [1] should be replaced.

[141] Remove and re-use O.E. heat shield, if required.

[206] Required for mufflers without brackets on heads of muffler (no triangle on label).

[212] Remove and re-use O.E. heat shield if 48355 purchased does not include shields.

[931] This unit was designed to fit many applications. Measurement of the old unit and cutting of new unit is required.

[958] Federal & California Emission vehicles. Not legal for sale for vehicles licensed in California.

1994 6 Cyl. Quest; 3.0L Engine

(33402)

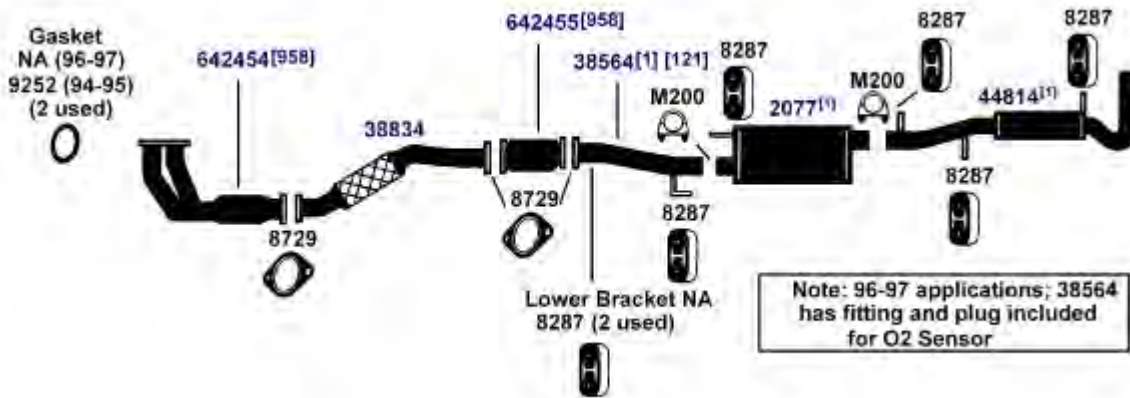

DIRECT FIT MSL/MAXIMUM Muffler... 700225

1993 6 Cyl. Quest; 3.0L Engine

(33401)

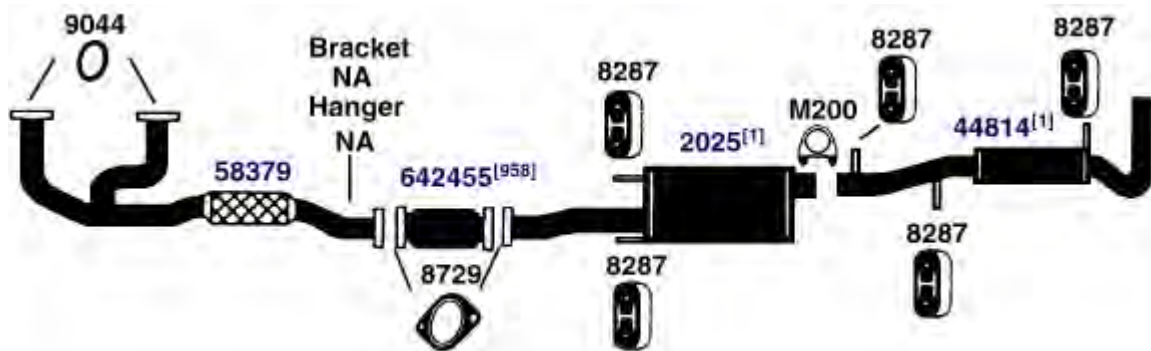

DIRECT FIT MSL/MAXIMUM Muffler... 700148

NA-Not Available. NR-Not Required. FL-Remove and Re-Use Old Flange. ● Golden Warehouse. O.E.-Original Equipment.
 # Airtube Kit [4948] may be required to complete installation. EFI-Electronic Fuel Injection.

- [1] OE system was a welded assembly. It is recommended that all parts noted [1] should be replaced.
- [958] Federal & California Emission vehicles. Not legal for sale for vehicles licensed in California.
- [121] Sensor plug supplied, should be used on 94-95 models.

NISSAN SENTRA

(3528) 91-94 4 Cyl. Sentra, 1.6L Engine (US Only)
 91-94 4 Cyl. Sentra, 1.6L Engine; 16-Valve; exc. Sentra Classic; exc. Japan Production
 7/90-9/90 (Canada Only)

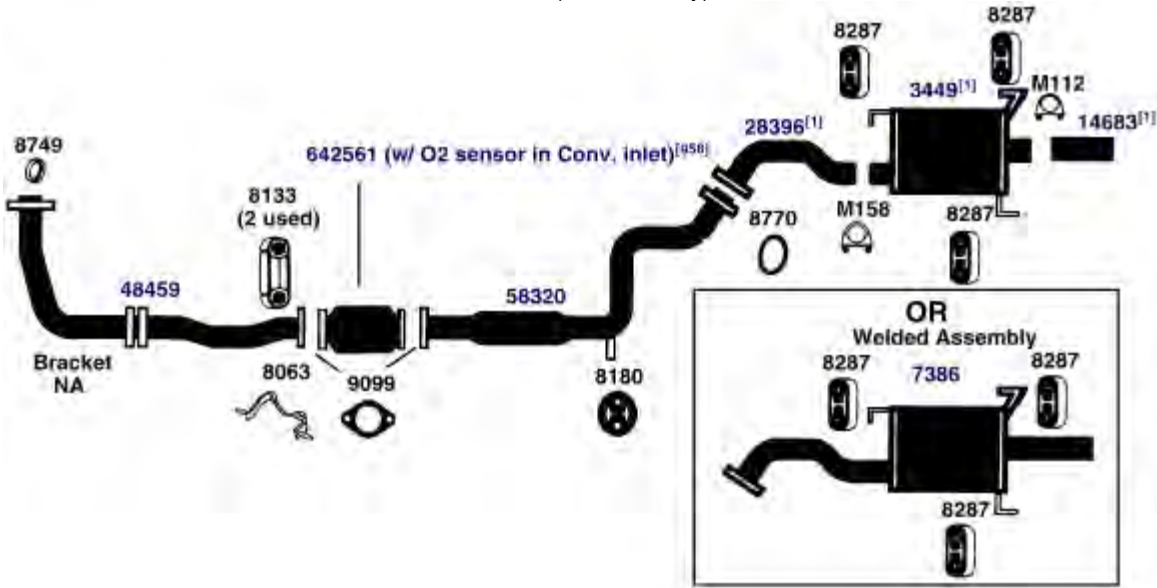

DIRECT FIT MSL/MAXIMUM Muffler... Split System- 700129, UNIVERSAL FIT MSL/MAXIMUM Muffler... Split System- 6653, 6677, Welded Assembly- 6653, 6677, 700129

(3527) 91-94 4 Cyl. Sentra, 2.0L Engine

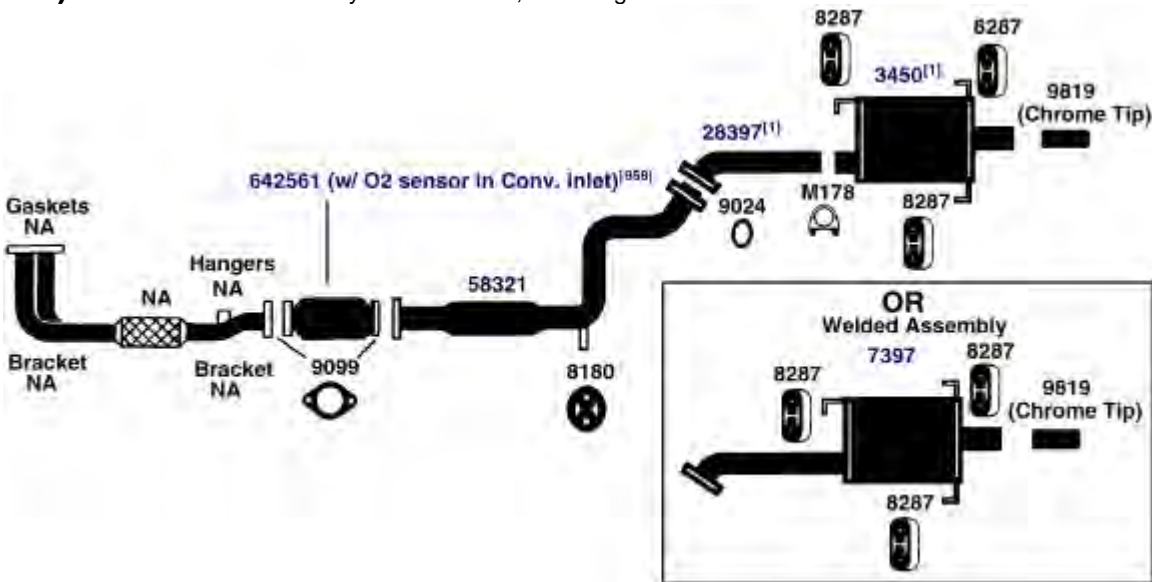

UNIVERSAL FIT MSL/MAXIMUM Muffler... Split System- 6565

NA-Not Available. NR-Not Required. FL-Remove and Re-Use Old Flange. ● Golden Warehouse. O.E.-Original Equipment.
 # Airtube Kit [4948] may be required to complete installation. EFI-Electronic Fuel Injection.

[1] OE system was a welded assembly. It is recommended that all parts noted [1] should be replaced.

[958] Federal & California Emission vehicles. Not legal for sale for vehicles licensed in California.

91-93 4 Cyl. Sentra Classic, 2 WD; 1.6L Engine (exc. 16-Valve) (Canada Only)
88-90 4 Cyl. Sentra Sedan, 2 WD Wagon; 1.6L Engine (US Only)

(3526)

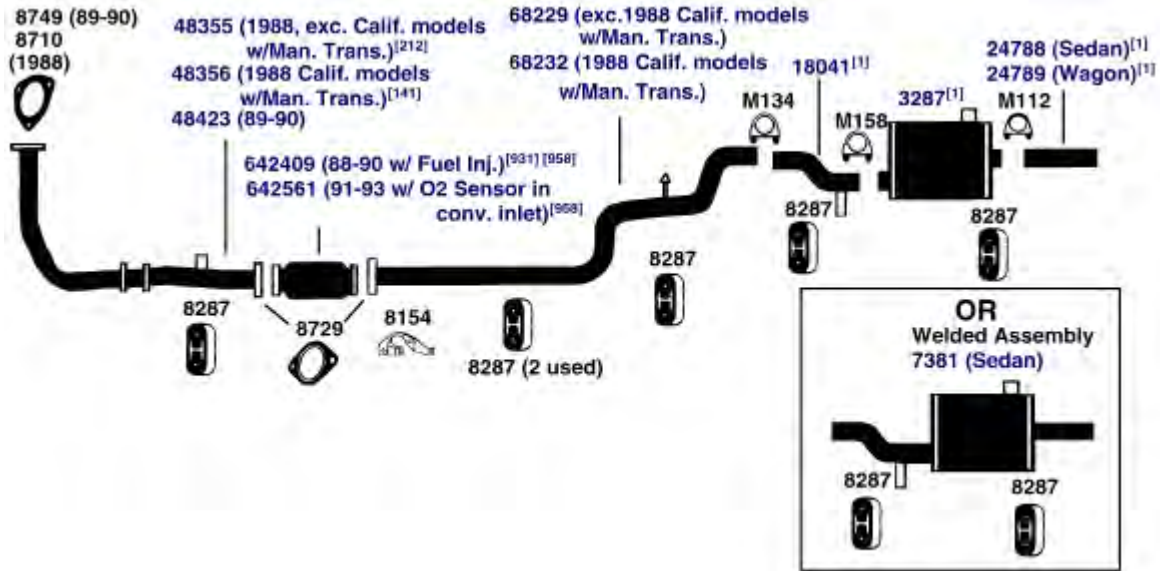

DIRECT FIT MSL/MAXIMUM Muffler... Split System- 6692, Welded Assembly- 6692, UNIVERSAL FIT MSL/MAXIMUM Muffler... Split System- 6677, Welded Assembly- 6677, 6692, Silentone DIY Muffler... Split System- 5594

1991 4 Cyl. Sentra, 1.6L DOHC Engine; (Japan Production 7/90 to 9/90 Only)

(100590)

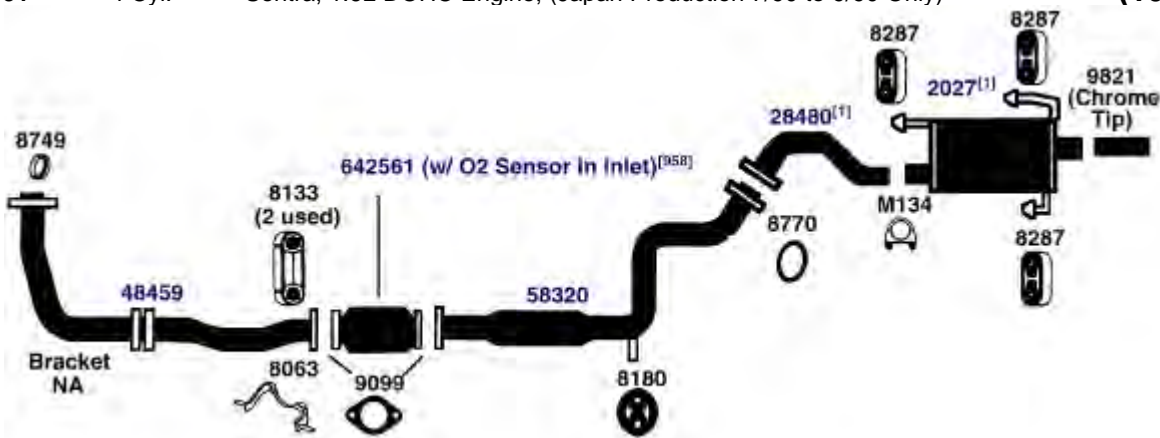

UNIVERSAL FIT MSL/MAXIMUM Muffler... 6692, 6693, 709010

NA-Not Available. NR-Not Required. FL-Remove and Re-Use Old Flange. ● Golden Warehouse. O.E.-Original Equipment.
 # Airtube Kit [4948] may be required to complete installation. EFI-Electronic Fuel Injection.

[1] OE system was a welded assembly. It is recommended that all parts noted [1] should be replaced.
 [141] Remove and re-use O.E. heat shield, if required.
 [212] Remove and re-use O.E. heat shield if 48355 purchased does not include shields.

[931] This unit was designed to fit many applications. Measurement of the old unit and cutting of new unit is required.
 [958] Federal & California Emission vehicles. Not legal for sale for vehicles licensed in California.

NISSAN SENTRA

(3525)	89-90	4 Cyl.	Sentra Sport Coupe, 1.6L Engine
	1988	4 Cyl.	Sentra Hatchback, Sport Coupe; 1.6L Engine
	1987	4 Cyl.	Sentra Sport Coupe; 1.6L Fuel Injected Engine

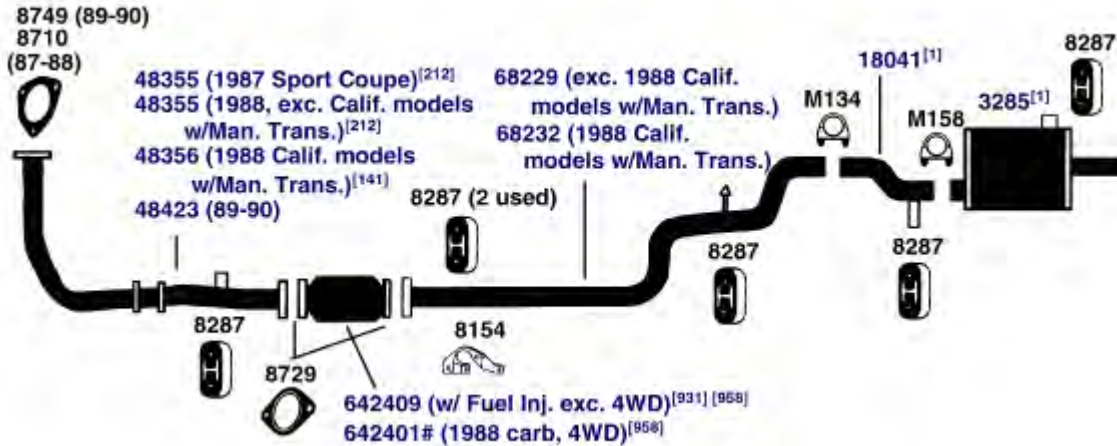

DIRECT FIT MSL/MAXIMUM Muffler... 6693, UNIVERSAL FIT MSL/MAXIMUM Muffler... 6677, Silentone DIY Muffler... 5594 and 14643 Pipe

(3524)	1987	4 Cyl.	Sentra Hatchback, 1.6L Engine; except Sport Coupe; California (from Jan., 1986)
---------------	------	--------	---

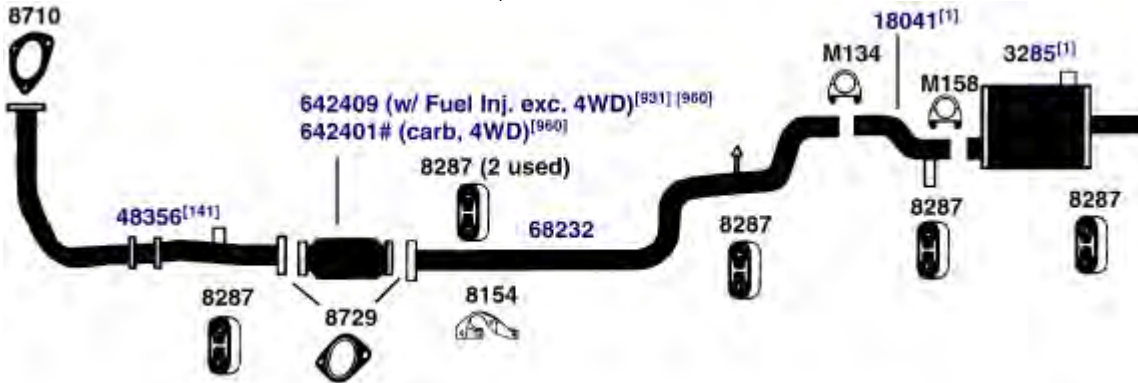

DIRECT FIT MSL/MAXIMUM Muffler... 6693, UNIVERSAL FIT MSL/MAXIMUM Muffler... 6677, Silentone DIY Muffler... 5594 and 14643 Pipe

NA-Not Available. NR-Not Required. FL-Remove and Re-Use Old Flange. ● Golden Warehouse. O.E.-Original Equipment.
Airtube Kit [4948] may be required to complete installation. EFI-Electronic Fuel Injection.

[1] OE system was a welded assembly. It is recommended that all parts noted [1] should be replaced.

[141] Remove and re-use O.E. heat shield, if required.

[212] Remove and re-use O.E. heat shield if 48355 purchased does not include shields.

[931] This unit was designed to fit many applications. Measurement of the old unit and cutting of new unit is required.

[958] Federal & California Emission vehicles. Not legal for sale for vehicles licensed in California.

[960] California Emission vehicles licensed in states other than California. Not legal for sale for vehicles licensed in California.

1987	4 Cyl.	Sentra Hatchback, 1.6L Engine; exc. Sport Coupe; exc. California (from Jan.1986)	(3523)
1986	4 Cyl.	Sentra Hatchback, 1.6L Engine; exc. Sport Coupe (Canada Only)	

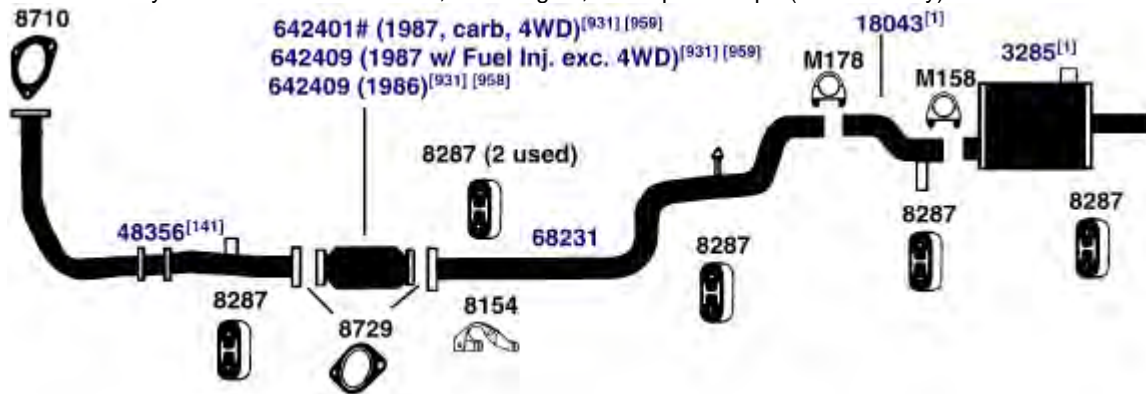

DIRECT FIT MSL/MAXIMUM Muffler... 6693, UNIVERSAL FIT MSL/MAXIMUM Muffler... 6677, Silentone DIY Muffler... 5594 and 14643 Pipe

1987	4 Cyl.	Sentra Sedan, 2 WD Wagon; 1.6L Engine	(3522)
1986	4 Cyl.	Sentra Sedan, 2 WD Wagon; 1.6L Engine (Canada Only)	

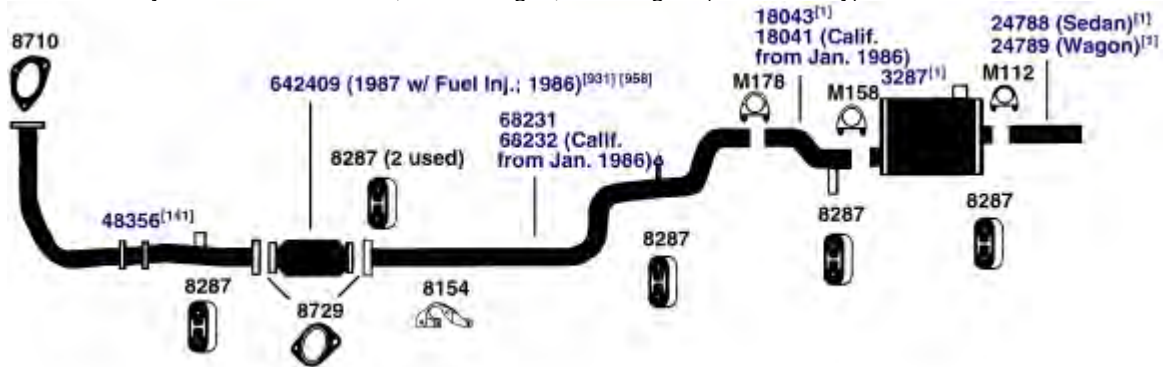

DIRECT FIT MSL/MAXIMUM Muffler... 6692, UNIVERSAL FIT MSL/MAXIMUM Muffler... 6677, Silentone DIY Muffler... 5594

NA-Not Available. NR-Not Required. FL-Remove and Re-Use Old Flange. ● Golden Warehouse. O.E.-Original Equipment.
Airtube Kit [4948] may be required to complete installation. EFI-Electronic Fuel Injection.

[1] OE system was a welded assembly. It is recommended that all parts noted [1] should be replaced.
[141] Remove and re-use O.E. heat shield, if required.
[931] This unit was designed to fit many applications. Measurement of the old unit and cutting of new unit is required.

[958] Federal & California Emission vehicles. Not legal for sale for vehicles licensed in California.
[959] Federal Emission vehicles. Not legal for sale for vehicles licensed in California.

NISSAN SENTRA

(3520) 85-86 4 Cyl. Sentra Sedan, Hatchback Coupe, Sta. Wagon; 1.5L, 1.6L Engine; except Diesel, except Canada (through Dec., 1985)

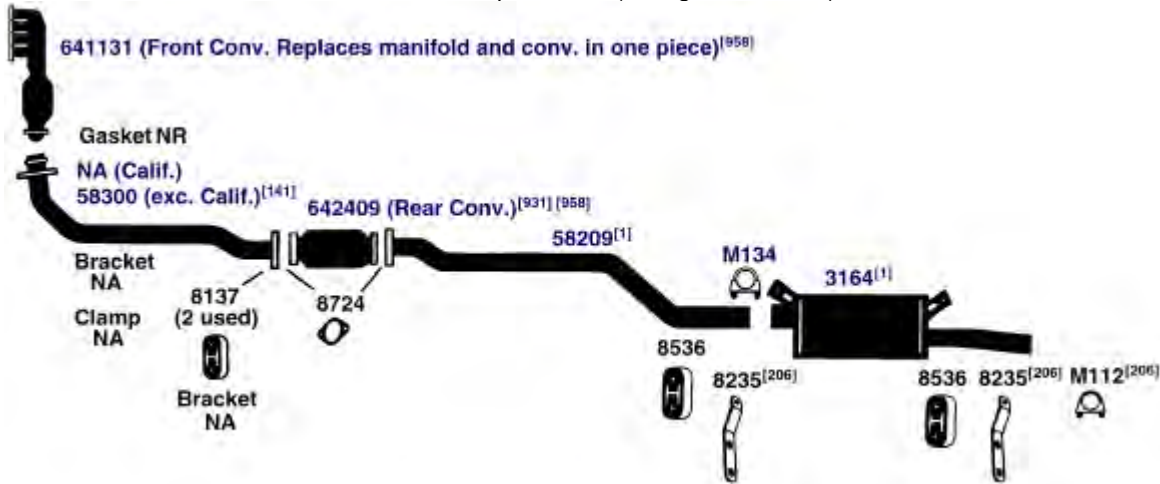

DIRECT FIT MSL/MAXIMUM Muffler... 6680, UNIVERSAL FIT MSL/MAXIMUM Muffler... 6655

(3520E) 82-84 4 Cyl. Sentra Sedan, Hatchback Coupe, Sta. Wagon; 1.5L, 1.6L Engine; except Diesel, except Canada

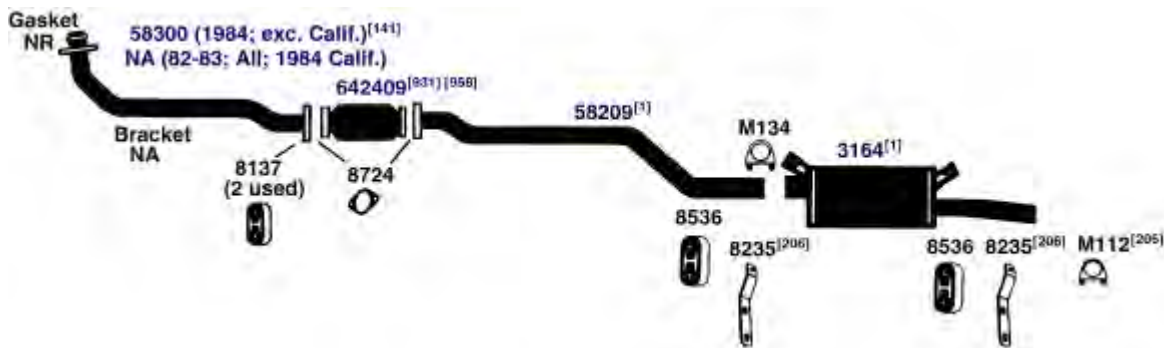

DIRECT FIT MSL/MAXIMUM Muffler... 6680, UNIVERSAL FIT MSL/MAXIMUM Muffler... 6655

NA-Not Available. NR-Not Required. FL-Remove and Re-Use Old Flange. ● Golden Warehouse. O.E.-Original Equipment.
 # Airtube Kit [4948] may be required to complete installation. EFI-Electronic Fuel Injection.

[1] OE system was a welded assembly. It is recommended that all parts noted [1] should be replaced.

[141] Remove and re-use O.E. heat shield, if required.

[206] Required for mufflers without brackets on heads of muffler (no triangle on label).

[931] This unit was designed to fit many applications. Measurement of the old unit and cutting of new unit is required.

[958] Federal & California Emission vehicles. Not legal for sale for vehicles licensed in California.

90-92 4 Cyl. Stanza, 2.4L Engine

(3574)

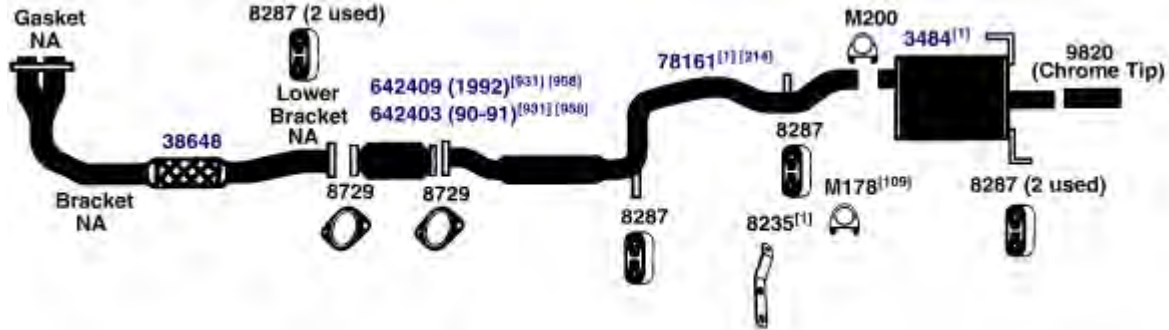

DIRECT FIT MSL/MAXIMUM Muffler... 700157, UNIVERSAL FIT MSL/MAXIMUM Muffler... 6560

87-89 4 Cyl. Stanza Sedan, Hatchback; 2.0L Engine

(3572)

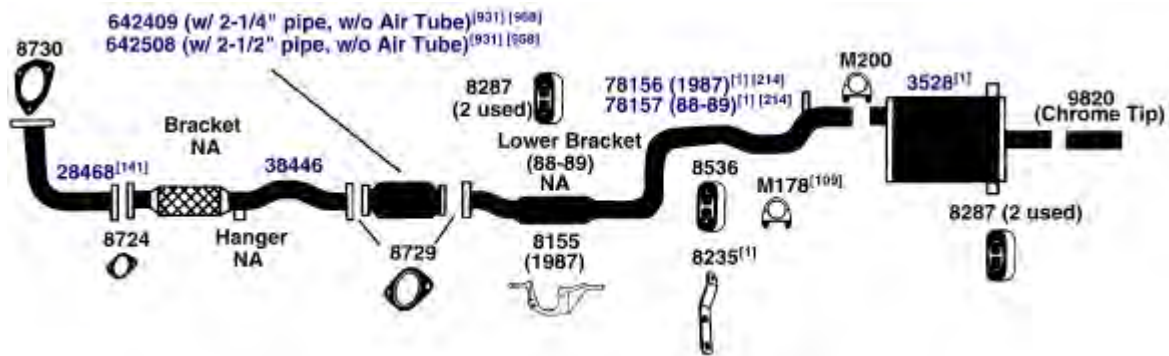

DIRECT FIT MSL/MAXIMUM Muffler... 700005

NA-Not Available. NR-Not Required. FL-Remove and Re-Use Old Flange. ● Golden Warehouse. O.E.-Original Equipment.
Airtube Kit [4948] may be required to complete installation. EFI-Electronic Fuel Injection.

[1] OE system was a welded assembly. It is recommended that all parts noted [1] should be replaced.

[109] Required for proper installation of 8235 hanger.

[141] Remove and re-use O.E. heat shield, if required.

[214] If a welded bracket is located near the outlet end of pipe, 8235 hanger and M178 clamp is not needed for installation.

[931] This unit was designed to fit many applications. Measurement of the old unit and cutting of new unit is required.

[958] Federal & California Emission vehicles. Not legal for sale for vehicles licensed in California.

OLDSMOBILE

OLDSMOBILE 88, 98, DELTA 88, LSS, REGENCY (INCL. CUSTOM CRUISER)

(7574)

1994

6 Cyl.

88, 3.8L Engine

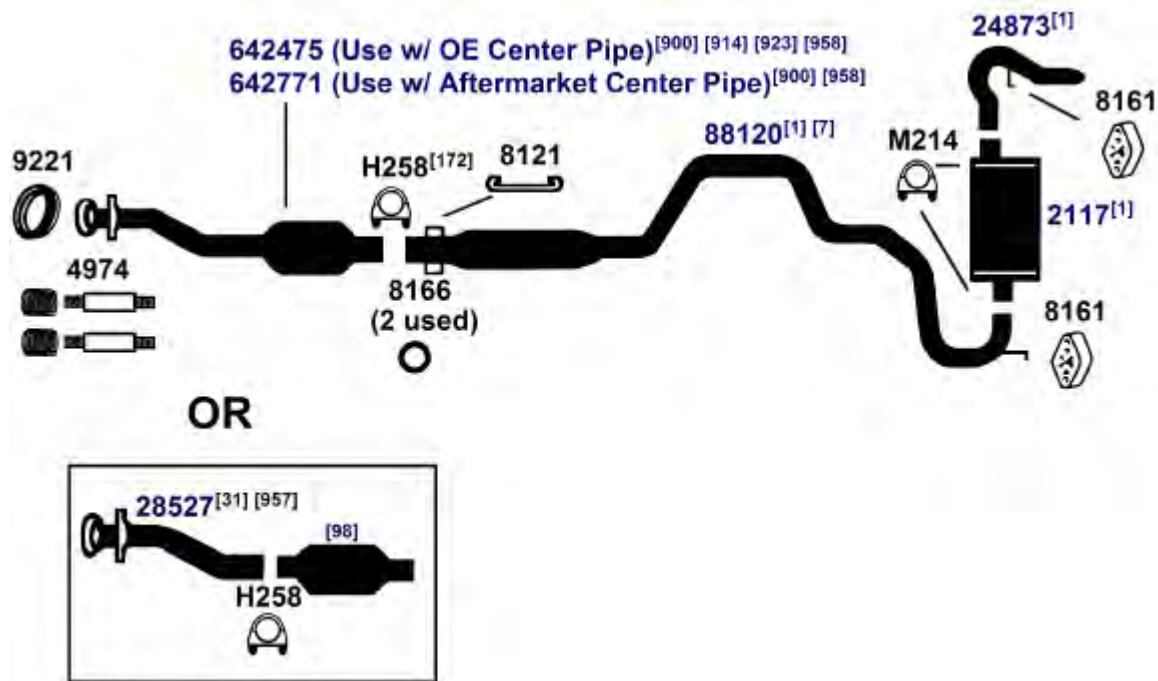

DIRECT FIT MSL/MAXIMUM Muffler... 700234, UNIVERSAL FIT MSL/MAXIMUM Muffler... 709014

NA-Not Available. NR-Not Required. FL-Remove and Re-Use Old Flange. ● Golden Warehouse. O.E.-Original Equipment.

Airtube Kit [4948] may be required to complete installation. EFI-Electronic Fuel Injection.

[1] OE system was a welded assembly. It is recommended that all parts noted [1] should be replaced.

[7] The O.E. extension pipe must be cut off 1 3/8" behind the pipe to converter weld.

[31] The O.E. front exhaust pipe must be cut off 1 1/4" in front of the pipe to converter weld.

[172] Special O.E. style clamp designed for this application.

[900] Direct fit converter may require resizing, cutting or bushing.

[914] Direct fit converter includes front (Exhaust) pipe, (1) piece assembly.

[923] #3 bushing may be required

[957] Front pipe is not required when ordering converter.

[958] Federal & California Emission vehicles. Not legal for sale for vehicles licensed in California.

OLDSMOBILE 88, 98, DELTA 88, LSS, REGENCY (INCL. CUSTOM CRUISER)

1994 6 Cyl. 98, 3.8L Engine
 1994 6 Cyl. 98, 3.8L Supercharged Engine

(7573)

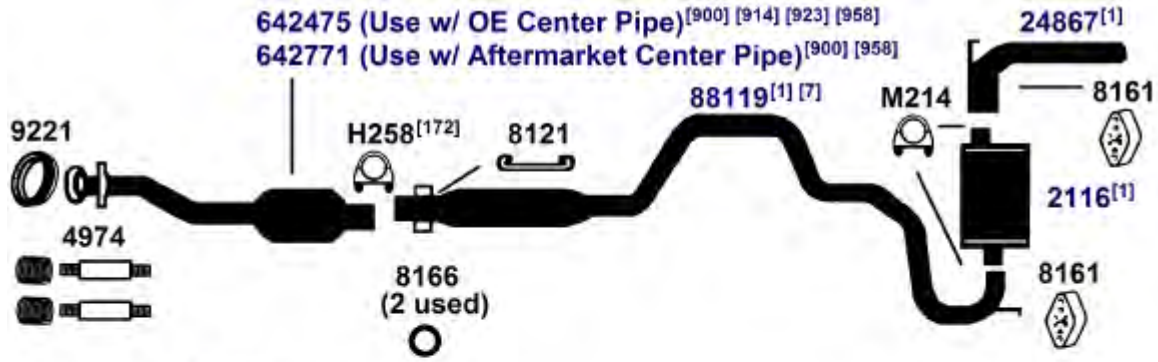

OR

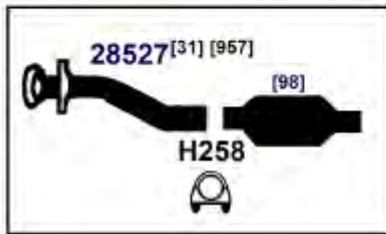

DIRECT FIT MSL/MAXIMUM Muffler... 6597, UNIVERSAL FIT MSL/MAXIMUM Muffler... 6533, 6596, 709014, Silentone DIY Muffler... 5505

NA-Not Available. NR-Not Required. FL-Remove and Re-Use Old Flange. ● Golden Warehouse. O.E.-Original Equipment.
 # Airtube Kit [4948] may be required to complete installation. EFI-Electronic Fuel Injection.

- [1] OE system was a welded assembly. It is recommended that all parts noted [1] should be replaced.
- [7] The O.E. extension pipe must be cut off 1 3/8" behind the pipe to converter weld.
- [31] The O.E. front exhaust pipe must be cut off 1 1/4" in front of the pipe to converter weld.
- [172] Special O.E. style clamp designed for this application.
- [900] Direct fit converter may require resizing, cutting or bushing.
- [914] Direct fit converter includes front (Exhaust) pipe, (1) piece assembly.
- [923] #3 bushing may be required
- [957] Front pipe is not required when ordering converter.
- [958] Federal & California Emission vehicles. Not legal for sale for vehicles licensed in California.

OLDSMOBILE 88, 98, DELTA 88, LSS, REGENCY (INCL. CUSTOM CRUISER)

(7572) 92-93 6 Cyl. 88, 231 Engine (3.8L)

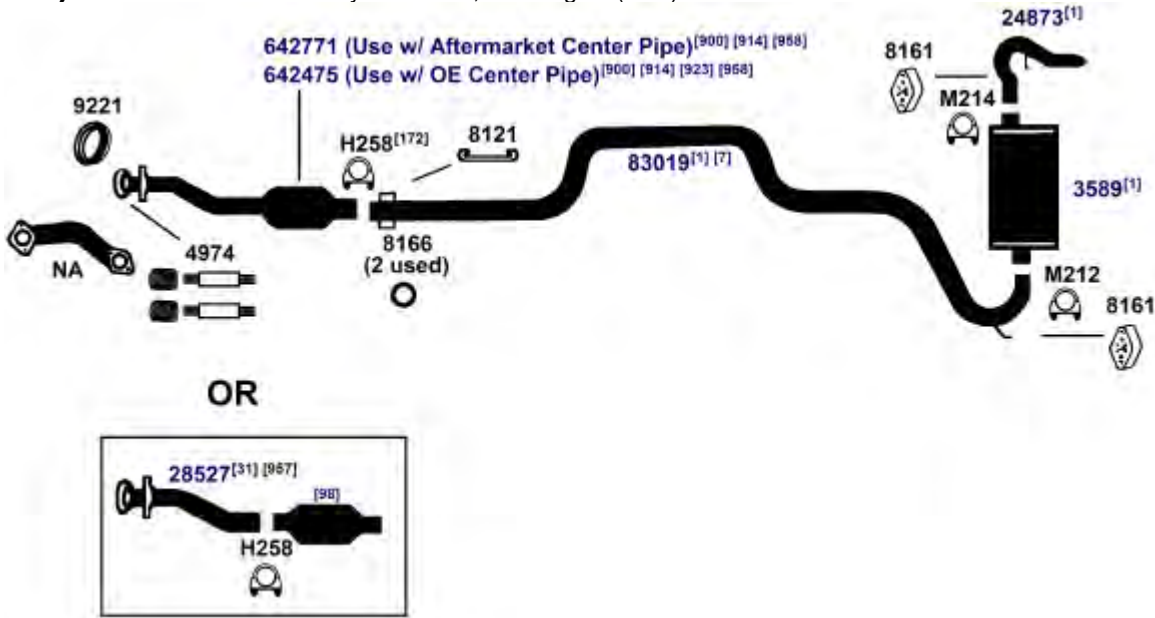

DIRECT FIT MSL/MAXIMUM Muffler... 700197

(7571) 92-93 6 Cyl. 98, 231 Engine (3.8L); except Supercharged Engine

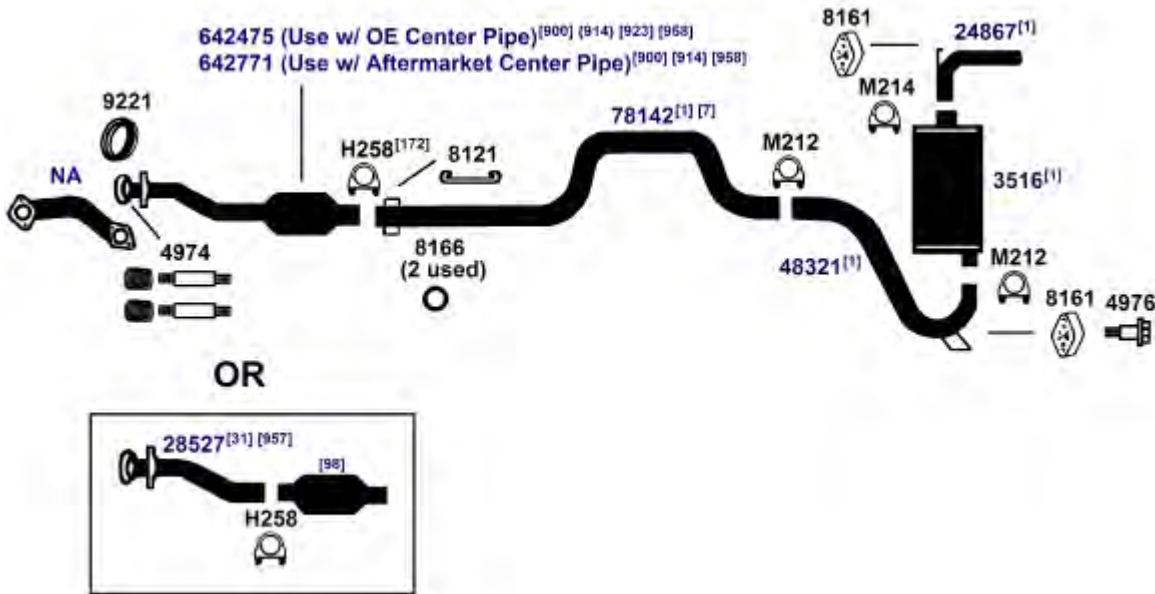

DIRECT FIT MSL/MAXIMUM Muffler... 700282, Silentone DIY Muffler... 5549

NA-Not Available. NR-Not Required. FL-Remove and Re-Use Old Flange. ● Golden Warehouse. O.E.-Original Equipment.
Airtube Kit [4948] may be required to complete installation. EFI-Electronic Fuel Injection.

- [1] OE system was a welded assembly. It is recommended that all parts noted [1] should be replaced.
- [7] The O.E. extension pipe must be cut off 1 3/8" behind the pipe to converter weld.
- [31] The O.E. front exhaust pipe must be cut off 1 1/4" in front of the pipe to converter weld.
- [172] Special O.E. style clamp designed for this application.
- [900] Direct fit converter may require resizing, cutting or bushing.

- [914] Direct fit converter includes front (Exhaust) pipe, (1) piece assembly.
- [923] #3 bushing may be required
- [957] Front pipe is not required when ordering converter.
- [958] Federal & California Emission vehicles. Not legal for sale for vehicles licensed in California.

OLDSMOBILE 88, 98, DELTA 88, LSS, REGENCY (INCL. CUSTOM CRUISER)

1992 8 Cyl. Custom Cruiser, 350 Engine (5.7L) (7569)
 91-92 8 Cyl. Custom Cruiser, 305E Engine (5.0L)

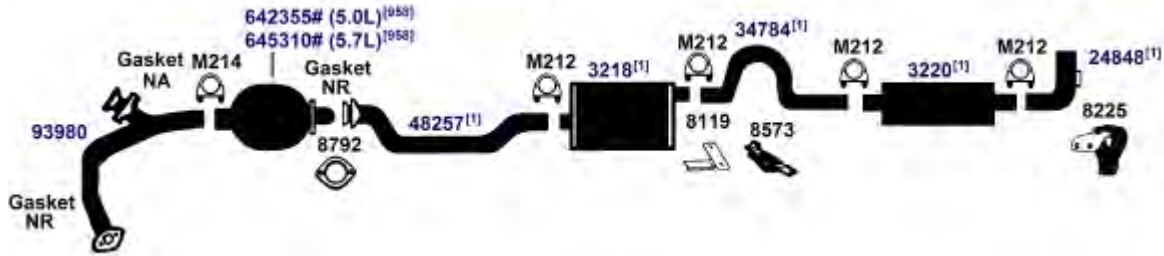

DIRECT FIT MSL/MAXIMUM Muffler... Front Muffler- 700087, Rear Muffler- 700196, UNIVERSAL FIT MSL/MAXIMUM Muffler... Front Muffler- 6543, Rear Muffler- 6527, Silentone DIY Muffler... Front Muffler- 5508 and 8913 Adapter and M212 Clamp

88-91 6 Cyl. 88, 98; 231 Engine (3.8L), except Sport Exhaust (100413)

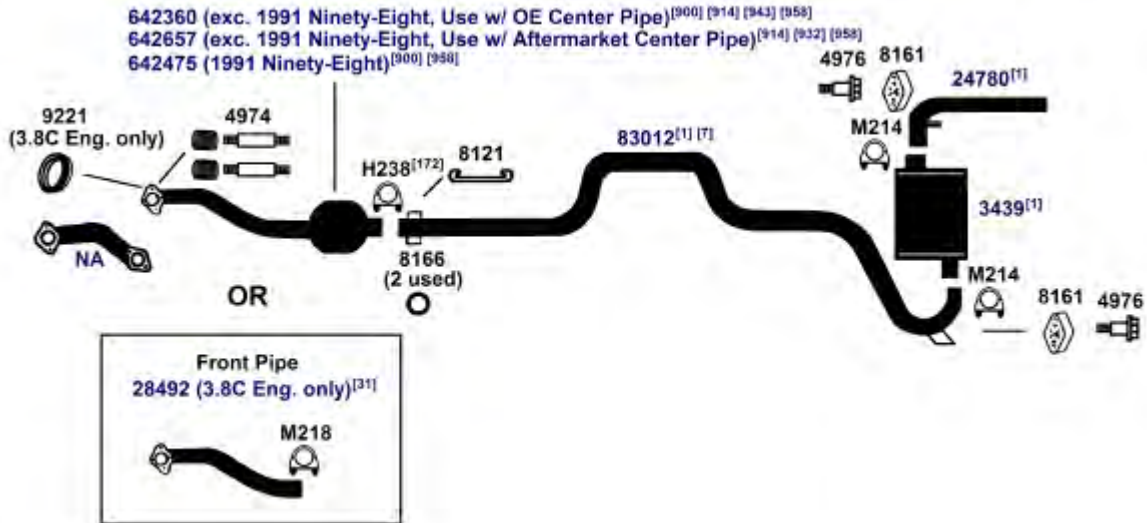

DIRECT FIT MSL/MAXIMUM Muffler... 6578, UNIVERSAL FIT MSL/MAXIMUM Muffler... 709012, Silentone DIY Muffler... 5528

NA-Not Available. NR-Not Required. FL-Remove and Re-Use Old Flange. ● Golden Warehouse. O.E.-Original Equipment.
 # Airtube Kit [4948] may be required to complete installation. EFI-Electronic Fuel Injection.

- [1] OE system was a welded assembly. It is recommended that all parts noted [1] should be replaced.
- [7] The O.E. extension pipe must be cut off 1 3/8" behind the pipe to converter weld.
- [31] The O.E. front exhaust pipe must be cut off 1 1/4" in front of the pipe to converter weld.
- [172] Special O.E. style clamp designed for this application.
- [900] Direct fit converter may require resizing, cutting or bushing.
- [914] Direct fit converter includes front (Exhaust) pipe, (1) piece assembly.
- [932] For use with 2 3/8" I.D. intermediate pipe.
- [943] #6 bushing may be required w/aftermarket pipe.
- [958] Federal & California Emission vehicles. Not legal for sale for vehicles licensed in California.

OLDSMOBILE 88, 98, DELTA 88, LSS, REGENCY (INCL. CUSTOM CRUISER)

(7559) 85-90 8 Cyl. Custom Cruiser, 307 Engine (5.0L)

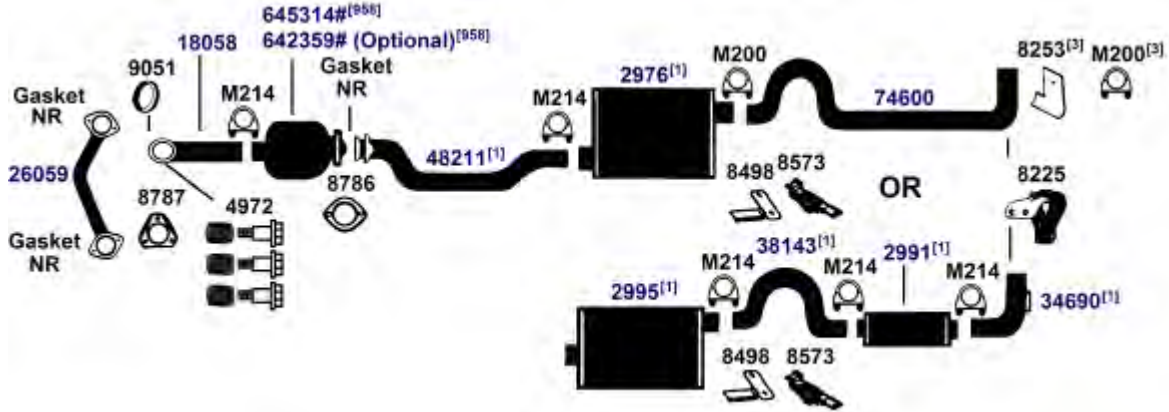

DIRECT FIT MSL/MAXIMUM Muffler... Front Muffler-#2976- 6543, Front 700056 (System With Rear Resonator), Rear Muffler- 700054, UNIVERSAL FIT MSL/MAXIMUM Muffler... Front Muffler-#2976- 709012, Front 6543 (System With Rear Resonator), 709012 (System With Rear Resonator), Rear Muffler- 6526, Silentone DIY Muffler... Front Muffler-#2976- 5528, Front 5528 (System With Rear Resonator), Rear Muffler- 5559

(7566) 86-87 6 Cyl. 88, 98; 231 Engine (3.8L), except Sport Exhaust
1986 6 Cyl. 88, 181 Engine (3.0L)

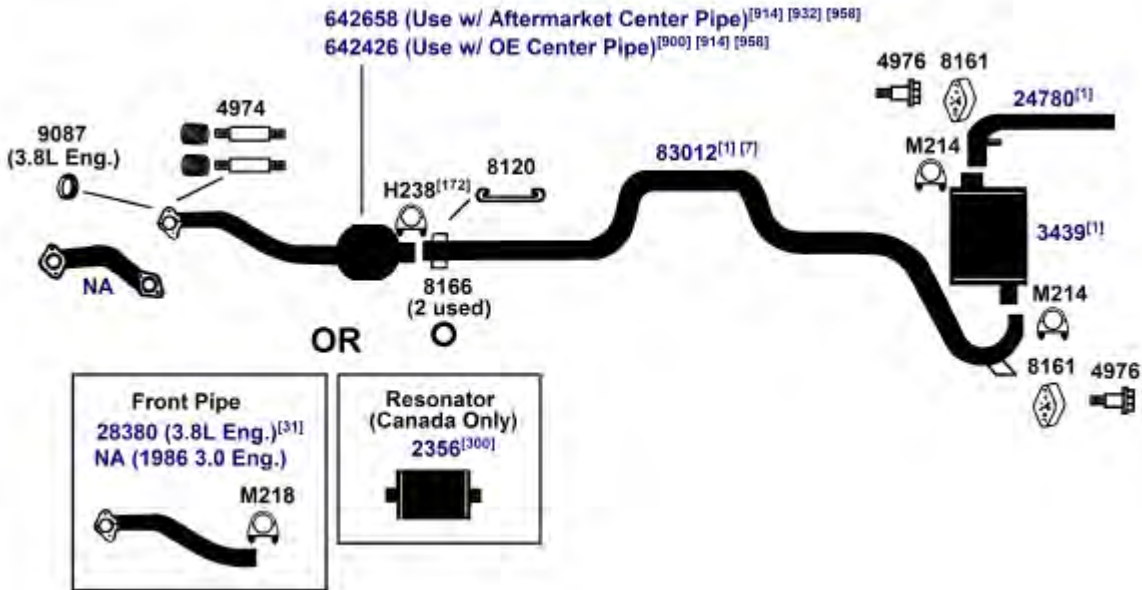

DIRECT FIT MSL/MAXIMUM Muffler... Rear Muffler- 6578, UNIVERSAL FIT MSL/MAXIMUM Muffler... Rear Muffler- 709012, Silentone DIY Muffler... Rear Muffler- 5528

NA-Not Available. NR-Not Required. FL-Remove and Re-Use Old Flange. ● Golden Warehouse. O.E.-Original Equipment.
Airtube Kit [4948] may be required to complete installation. EFI-Electronic Fuel Injection.

- [1] OE system was a welded assembly. It is recommended that all parts noted [1] should be replaced.
- [3] Required for installation.
- [7] The O.E. extension pipe must be cut off 1 3/8" behind the pipe to converter weld.
- [31] The O.E. front exhaust pipe must be cut off 1 1/4" in front of the pipe to converter weld.
- [172] Special O.E. style clamp designed for this application.

- [300] For use when resonator originated from O.E. manufacturer.
- [900] Direct fit converter may require resizing, cutting or bushing.
- [914] Direct fit converter includes front (Exhaust) pipe, (1) piece assembly.
- [932] For use with 2 3/8" I.D. intermediate pipe.
- [958] Federal & California Emission vehicles. Not legal for sale for vehicles licensed in California.

OLDSMOBILE 88, 98, DELTA 88, LSS, REGENCY (INCL. CUSTOM CRUISER)

1985 6 Cyl. 98 (Front Wheel Drive); 260 Diesel Engine (4.3L); without Converter **(7562)**

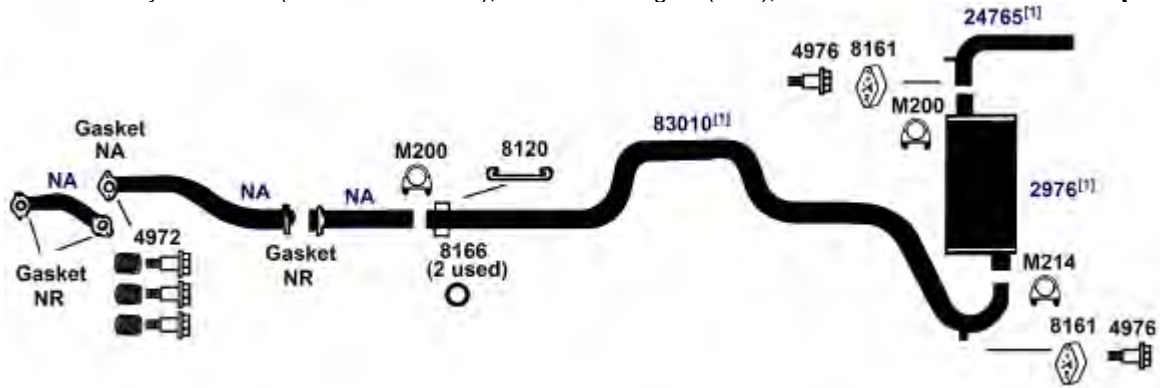

DIRECT FIT MSL/MAXIMUM Muffler... 6543, UNIVERSAL FIT MSL/MAXIMUM Muffler... 709012, Silentone DIY Muffler... 5528

1985 6 Cyl. 98 (Front Wheel Drive); 181, 231 Engine (3.0L, 3.8L); with Converter **(7563)**

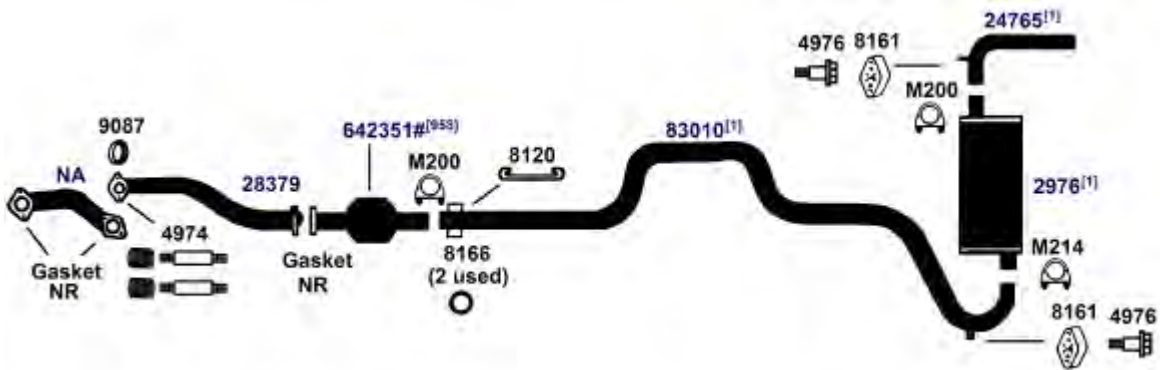

DIRECT FIT MSL/MAXIMUM Muffler... 6543, UNIVERSAL FIT MSL/MAXIMUM Muffler... 709012, Silentone DIY Muffler... 5528

1985 6 Cyl. Delta 88, 231 Engine (3.8L) **(7561)**

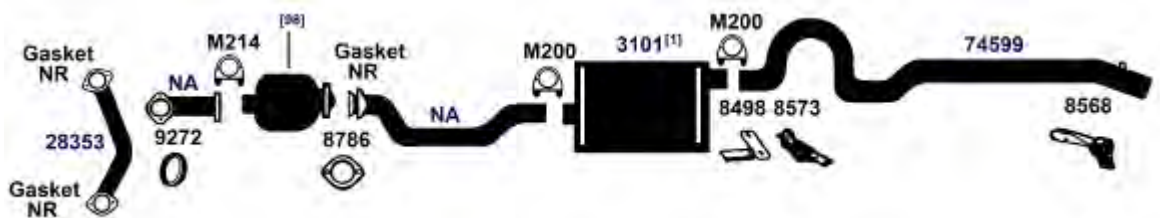

DIRECT FIT MSL/MAXIMUM Muffler... 6538, UNIVERSAL FIT MSL/MAXIMUM Muffler... 709011, Silentone DIY Muffler... 5528

NA-Not Available. NR-Not Required. FL-Remove and Re-Use Old Flange. ● Golden Warehouse. O.E.-Original Equipment.
Airtube Kit [4948] may be required to complete installation. EFI-Electronic Fuel Injection.

[1] OE system was a welded assembly. It is recommended that all parts noted [1] should be replaced.

[98] Refer to current Catalytic Converter catalog or Website catalog for availability.

[958] Federal & California Emission vehicles. Not legal for sale for vehicles licensed in California.

OLDSMOBILE 88, 98, DELTA 88, LSS, REGENCY (INCL. CUSTOM CRUISER)

(7560) 1985 8 Cyl. Delta 88, 307 Engine (5.0L), except Custom Cruiser

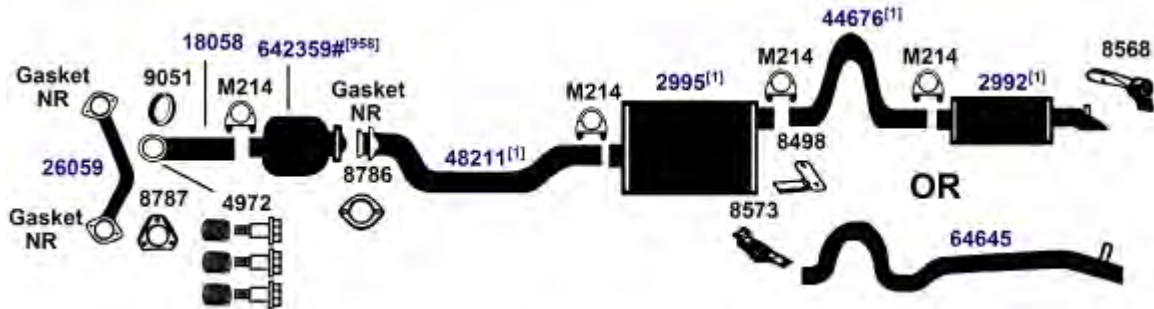

DIRECT FIT MSL/MAXIMUM Muffler... Front Muffler- 700056, Rear Muffler- 700055, UNIVERSAL FIT MSL/MAXIMUM Muffler... Front Muffler- 6543, 709012, Rear Muffler- 6526, Silentone DIY Muffler... Front Muffler- 5528, Rear Muffler- 5559 and 14677 Spout

(7557) 1985 8 Cyl. Custom Cruiser, 350N Diesel Engine (5.7L)

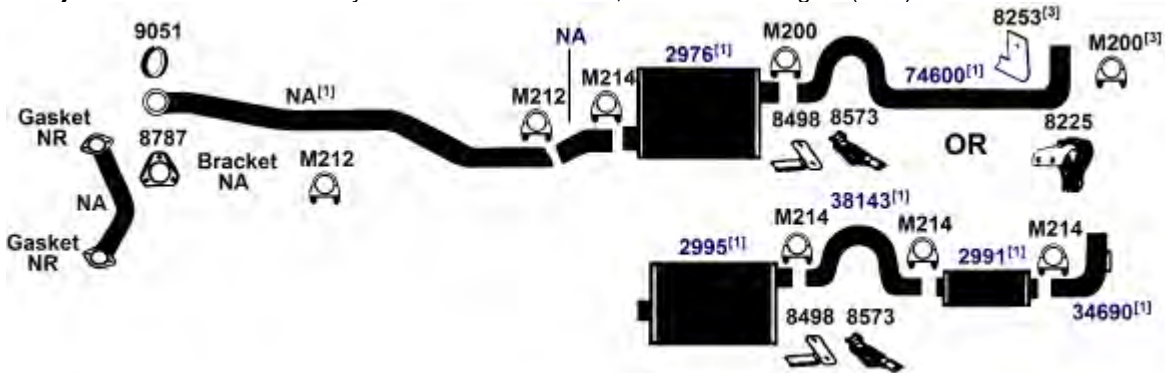

DIRECT FIT MSL/MAXIMUM Muffler... Front Muffler-#2976- 6543, Front 700056 (System With Rear Resonator), Rear Muffler- 700054, UNIVERSAL FIT MSL/MAXIMUM Muffler... Front Muffler-#2976- 709012, Front 6543 (System With Rear Resonator), 709012 (System With Rear Resonator), Rear Muffler- 6526, Silentone DIY Muffler... Front Muffler-#2976- 5528, Front 5528 (System With Rear Resonator), Rear Muffler- 5559

(7558) 1985 8 Cyl. Delta 88, 350N Diesel Engine (5.7L), except Custom Cruiser

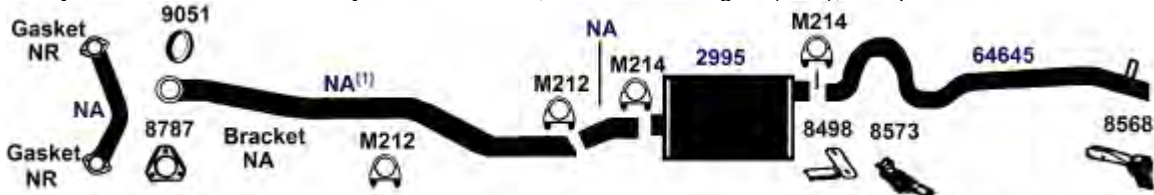

DIRECT FIT MSL/MAXIMUM Muffler... 700056, UNIVERSAL FIT MSL/MAXIMUM Muffler... 6543, 709012, Silentone DIY Muffler... 5528

NA-Not Available. NR-Not Required. FL-Remove and Re-Use Old Flange. ● Golden Warehouse. O.E.-Original Equipment.
Airtube Kit [4948] may be required to complete installation. EFI-Electronic Fuel Injection.

- [1] OE system was a welded assembly. It is recommended that all parts noted [1] should be replaced. [958] Federal & California Emission vehicles. Not legal for sale for vehicles licensed in California.
- [3] Required for installation.

OLDSMOBILE 88, 98, DELTA 88, LSS, REGENCY (INCL. CUSTOM CRUISER)

1984 6 Cyl. Delta 88, 231 (3.8L) Engine (7561E)

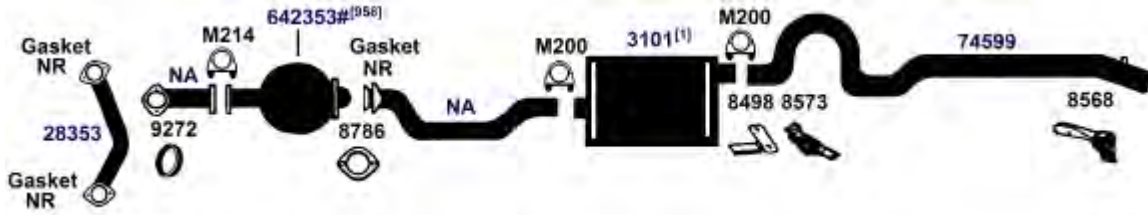

DIRECT FIT MSL/MAXIMUM Muffler... 6538, UNIVERSAL FIT MSL/MAXIMUM Muffler... 709011, Silentone DIY Muffler... 5528

1984 8 Cyl. 98, 5.0L, 307 Engine; except Custom Cruiser (7560E)
 1984 8 Cyl. Delta 88, 307 Engine (5.0L), except Custom Cruiser

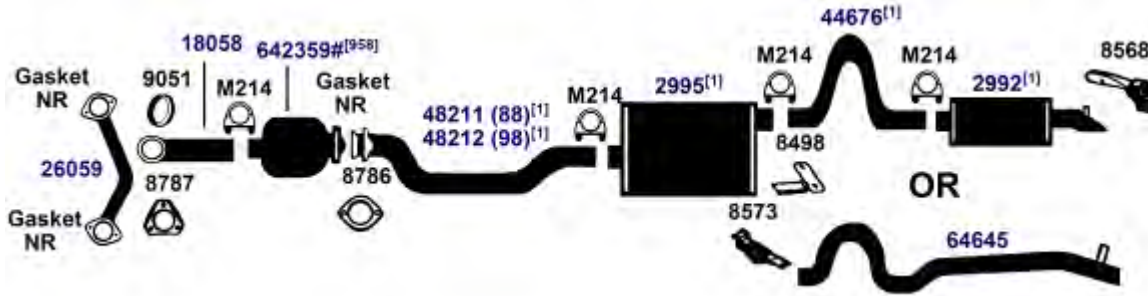

DIRECT FIT MSL/MAXIMUM Muffler... Front Muffler- 700056, Rear Muffler- 700055, UNIVERSAL FIT MSL/MAXIMUM Muffler... Front Muffler- 6543, 709012, Rear Muffler- 6526, Silentone DIY Muffler... Front Muffler- 5528, Rear Muffler- 5559 and 14677 Spout

1984 8 Cyl. Custom Cruiser, 307 (5.0L) Engine (7559E)

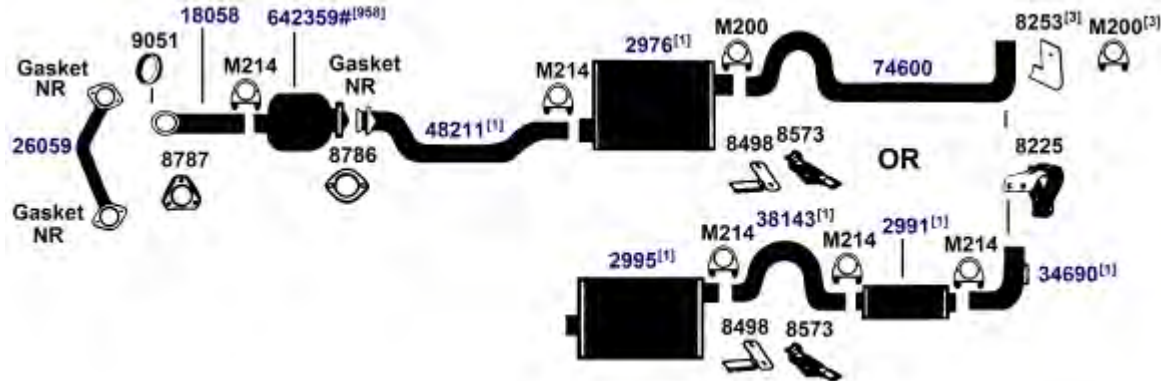

DIRECT FIT MSL/MAXIMUM Muffler... Front Muffler-#2976- 6543, Front 700056 (System With Rear Resonator), Rear Muffler- 700054, UNIVERSAL FIT MSL/MAXIMUM Muffler... Front Muffler-#2976- 709012, Front 6543 (System With Rear Resonator), 709012 (System With Rear Resonator), Rear Muffler- 6526, Silentone DIY Muffler... Front Muffler-#2976- 5528, Front 5528 (System With Rear Resonator), Rear Muffler- 5559

NA-Not Available. NR-Not Required. FL-Remove and Re-Use Old Flange. ● Golden Warehouse. O.E.-Original Equipment.
 # Airtube Kit [4948] may be required to complete installation. EFI-Electronic Fuel Injection.

- [1] OE system was a welded assembly. It is recommended that all parts noted [1] should be replaced.
- [2] Federal & California Emission vehicles. Not legal for sale for vehicles licensed in California.
- [3] Required for installation.

OLDSMOBILE 88, 98, DELTA 88, LSS, REGENCY (INCL. CUSTOM CRUISER)

(7557E) 83-84 8 Cyl. Custom Cruiser, 350N (5.7L) Diesel Engine

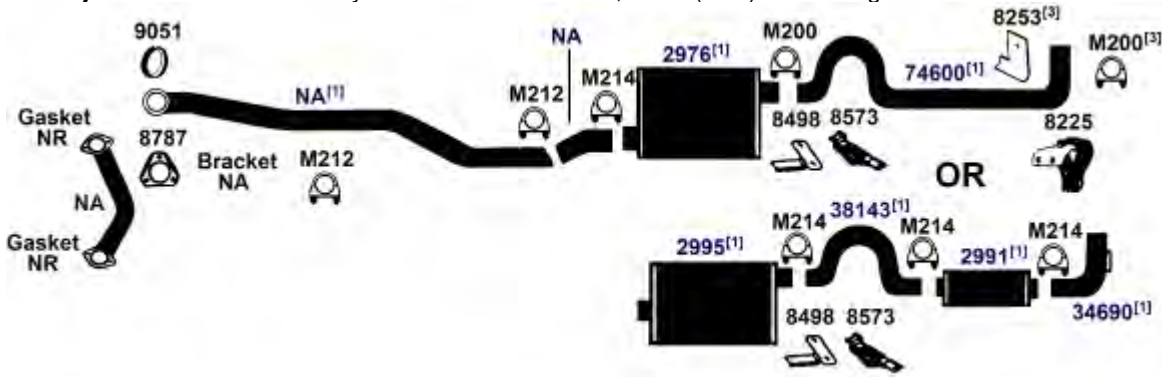

DIRECT FIT MSL/MAXIMUM Muffler... Front Muffler-#2976- 6543, Front 700056 (System With Rear Resonator), Rear Muffler- 700054, UNIVERSAL FIT MSL/MAXIMUM Muffler... Front Muffler-#2976- 709012, Front 6543 (System With Rear Resonator), 709012 (System With Rear Resonator), Rear Muffler- 6526, Silentone DIY Muffler... Front Muffler-#2976- 5528, Front 5528 (System With Rear Resonator), Rear Muffler- 5559

(7558E) 83-84 8 Cyl. Delta 88, 350N Diesel Engine (5.7L), except Custom Cruiser
83-84 8 Cyl. 98, 5.7L, 350N Diesel Engine; except Custom Cruiser



DIRECT FIT MSL/MAXIMUM Muffler... 700056, UNIVERSAL FIT MSL/MAXIMUM Muffler... 6543, 709012, Silentone DIY Muffler... 5528

(7554) 1983 6 Cyl. Delta 88, 3.8L, 231 Engine; California, Export, Canada

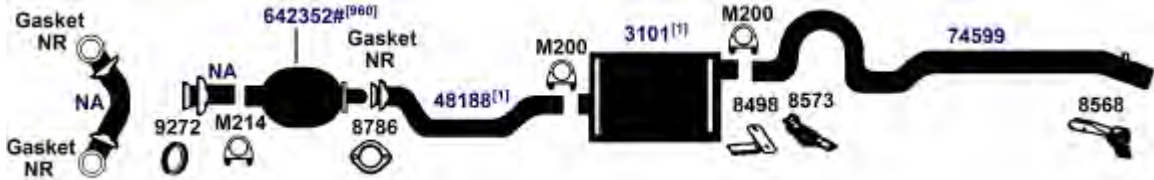

DIRECT FIT MSL/MAXIMUM Muffler... 6538, UNIVERSAL FIT MSL/MAXIMUM Muffler... 709011, Silentone DIY Muffler... 5528

NA-Not Available. NR-Not Required. FL-Remove and Re-Use Old Flange. ● Golden Warehouse. O.E.-Original Equipment.
Airtube Kit [4948] may be required to complete installation. EFI-Electronic Fuel Injection.

- [1] OE system was a welded assembly. It is recommended that all parts noted [1] should be replaced. [960] California Emission vehicles licensed in states other than California. Not legal for sale for vehicles licensed in California.
- [3] Required for installation.

OLDSMOBILE 88, 98, DELTA 88, LSS, REGENCY (INCL. CUSTOM CRUISER)

1983 6 Cyl. Delta 88, 98; 4.1L, 252 Engine

(7552)

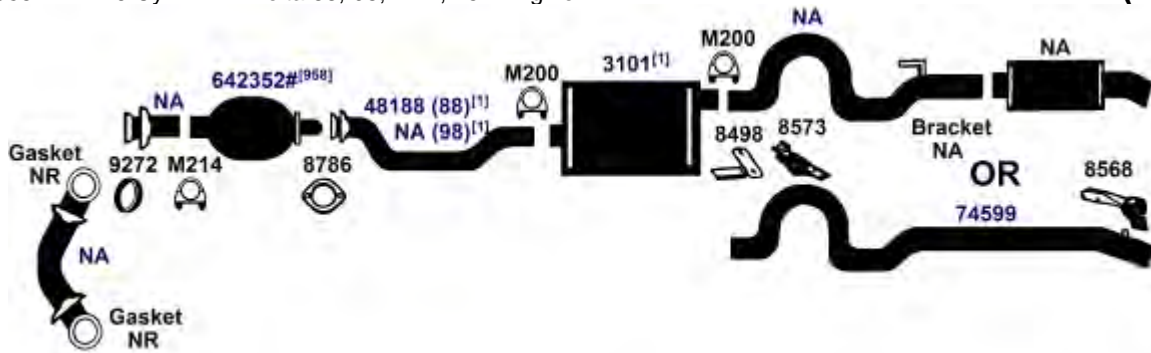

DIRECT FIT MSL/MAXIMUM Muffler... Front Muffler- 6538, UNIVERSAL FIT MSL/MAXIMUM Muffler... Front Muffler- 709011, Silentone DIY Muffler... Front Muffler- 5528

1983 6 Cyl. Delta 88, 3.8L, 231 Engine; except California, Export Canada

(7553)

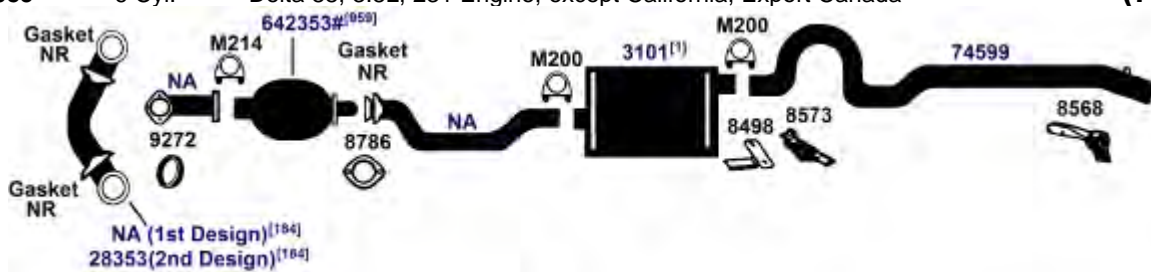

DIRECT FIT MSL/MAXIMUM Muffler... 6538, UNIVERSAL FIT MSL/MAXIMUM Muffler... 709011, Silentone DIY Muffler... 5528

1983 8 Cyl. Delta 88, 98; 5.0L, 307 Engine; except Custom Cruiser

(7551)

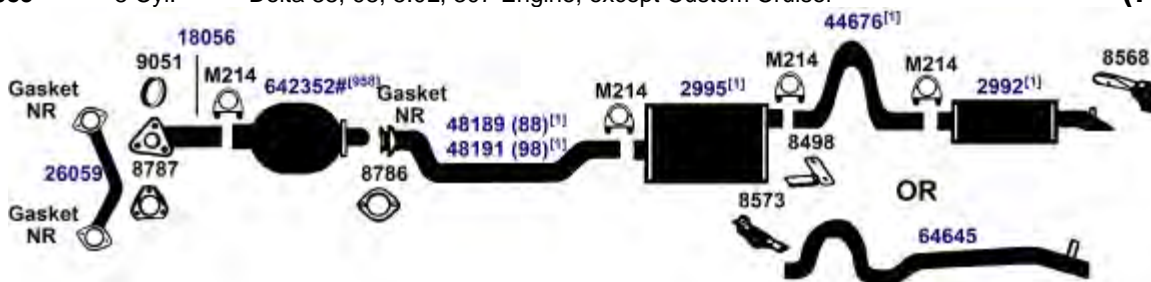

DIRECT FIT MSL/MAXIMUM Muffler... Front Muffler- 700056, Rear Muffler- 700055, UNIVERSAL FIT MSL/MAXIMUM Muffler... Front Muffler- 6543, 709012, Rear Muffler- 6526, Silentone DIY Muffler... Front Muffler- 5528, Rear Muffler- 5559 and 14677 Spout

NA-Not Available. NR-Not Required. FL-Remove and Re-Use Old Flange. ● Golden Warehouse. O.E.-Original Equipment.
Airtube Kit [4948] may be required to complete installation. EFI-Electronic Fuel Injection.

[1] OE system was a welded assembly. It is recommended that all parts noted [1] should be replaced.
[184] 1st Design has EFE actuator on left hand manifold. 2nd Design does not.

[958] Federal & California Emission vehicles. Not legal for sale for vehicles licensed in California.
[959] Federal Emission vehicles. Not legal for sale for vehicles licensed in California.

OLDSMOBILE 88, 98, DELTA 88, LSS, REGENCY (INCL. CUSTOM CRUISER)

(7550) 1983 8 Cyl. Custom Cruiser, 5.0L, 307 Engine

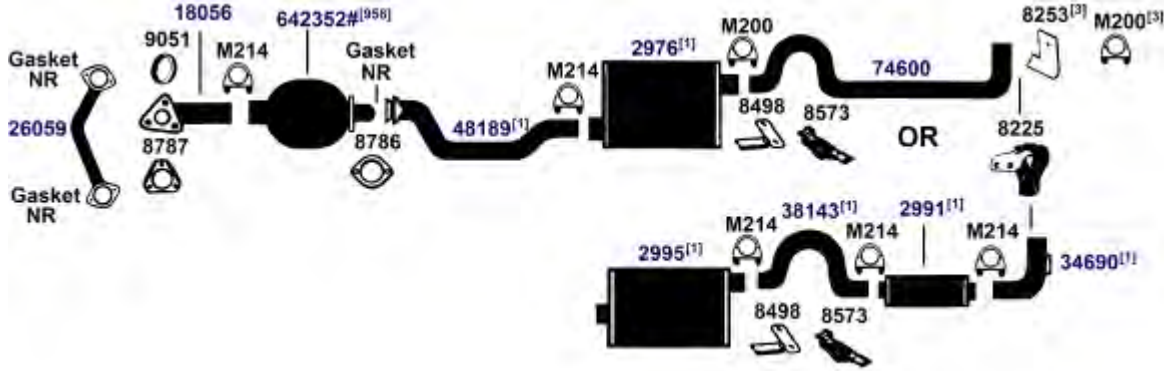

DIRECT FIT MSL/MAXIMUM Muffler... Front Muffler-#2976- 6543, Front 700056 (System With Rear Resonator), Rear Muffler- 700054, UNIVERSAL FIT MSL/MAXIMUM Muffler... Front Muffler-#2976- 709012, Front 6543 (System With Rear Resonator), 709012 (System With Rear Resonator), Rear Muffler- 6526, Silentone DIY Muffler... Front Muffler-#2976- 5528, Front 5528 (System With Rear Resonator), Rear Muffler- 5559

(7543) 81-82 6 Cyl. Delta 88, 98; 4.1L, 252 Engine

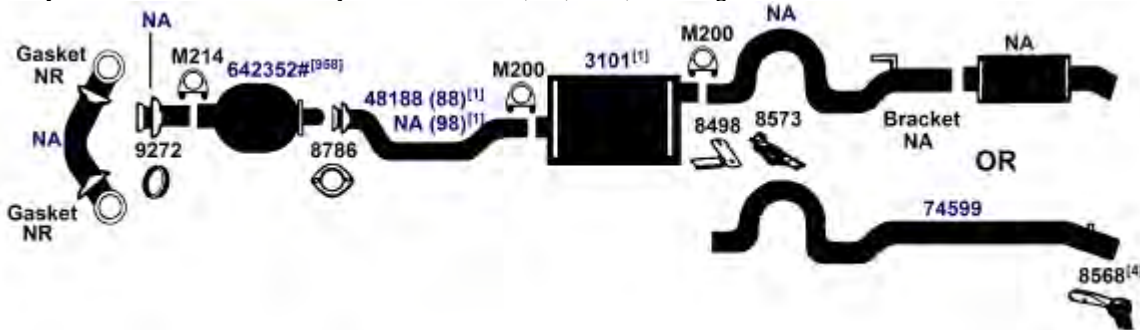

DIRECT FIT MSL/MAXIMUM Muffler... Front Muffler- 6538, UNIVERSAL FIT MSL/MAXIMUM Muffler... Front Muffler- 709011, Silentone DIY Muffler... Front Muffler- 5528

(7536) 81-82 8 Cyl. Delta 88, 98; 307, 350R Engine; except Custom Cruiser

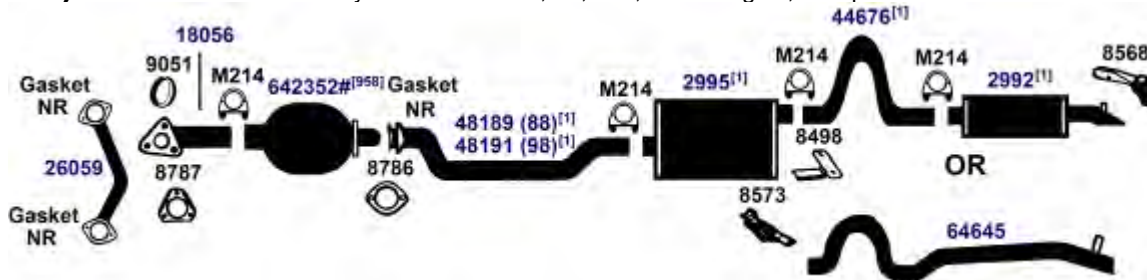

DIRECT FIT MSL/MAXIMUM Muffler... Front Muffler- 700056, Rear Muffler- 700055, UNIVERSAL FIT MSL/MAXIMUM Muffler... Front Muffler- 6543, 709012, Rear Muffler- 6526, Silentone DIY Muffler... Front Muffler- 5528, Rear Muffler- 5559 and 14677 Spout

NA-Not Available. NR-Not Required. FL-Remove and Re-Use Old Flange. ● Golden Warehouse. O.E.-Original Equipment.
Airtube Kit [4948] may be required to complete installation. EFI-Electronic Fuel Injection.

- [1] OE system was a welded assembly. It is recommended that all parts noted [1] should be replaced.
- [3] Required for installation.

- [4] Required for installation with 74599 tail pipe.
- [958] Federal & California Emission vehicles. Not legal for sale for vehicles licensed in California.

OLDSMOBILE 88, 98, DELTA 88, LSS, REGENCY (INCL. CUSTOM CRUISER)

81-82 8 Cyl. Delta 88, 4.4L, 267 Engine **(7542)**

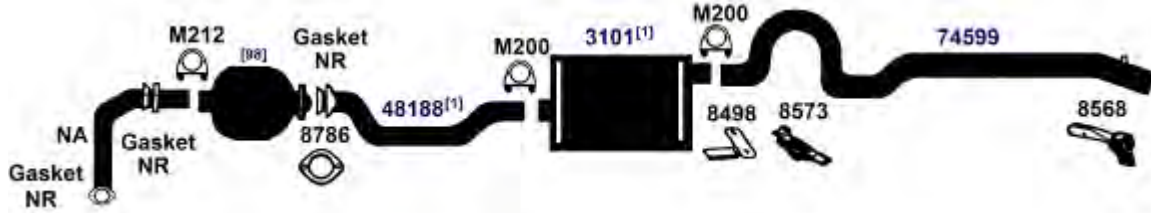

DIRECT FIT MSL/MAXIMUM Muffler... 6538, UNIVERSAL FIT MSL/MAXIMUM Muffler... 709011, Silentone DIY Muffler... 5528

81-82 8 Cyl. Delta 88, 98; 5.7L, 350N Diesel Engine; except Custom Cruiser **(7541)**

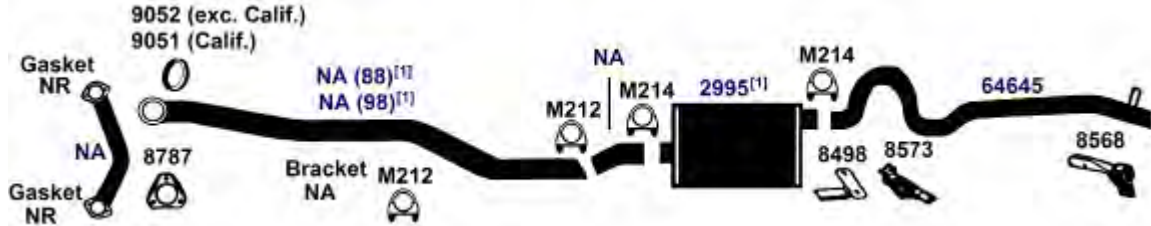

DIRECT FIT MSL/MAXIMUM Muffler... 700056, UNIVERSAL FIT MSL/MAXIMUM Muffler... 6543, 709012, Silentone DIY Muffler... 5528

81-82 8 Cyl. Delta 88, 4.3L, 260F Engine **(7538)**



DIRECT FIT MSL/MAXIMUM Muffler... 6538, UNIVERSAL FIT MSL/MAXIMUM Muffler... 709011, Silentone DIY Muffler... 5528

81-82 8 Cyl. Custom Cruiser, 307, 350R Engine **(7534)**

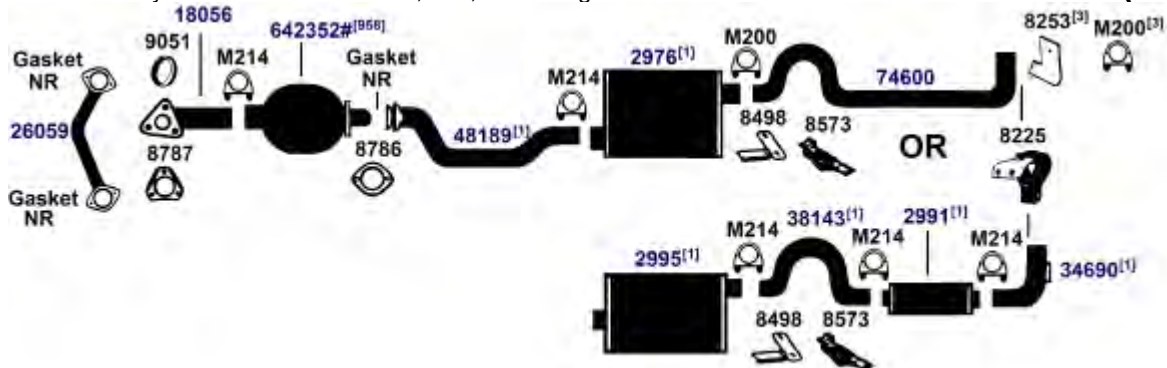

DIRECT FIT MSL/MAXIMUM Muffler... Front Muffler-#2976- 6543, Front 700056 (System With Rear Resonator), Rear Muffler- 700054, UNIVERSAL FIT MSL/MAXIMUM Muffler... Front Muffler-#2976- 709012, Front 6543 (System With Rear Resonator), 709012 (System With Rear Resonator), Rear Muffler- 6526, Silentone DIY Muffler... Front Muffler-#2976- 5528, Front 5528 (System With Rear Resonator), Rear Muffler- 5559

NA-Not Available. NR-Not Required. FL-Remove and Re-Use Old Flange. ● Golden Warehouse. O.E.-Original Equipment.
Airtube Kit [4948] may be required to complete installation. EFI-Electronic Fuel Injection.

- [1] OE system was a welded assembly. It is recommended that all parts noted [1] should be replaced. [98] Refer to current Catalytic Converter catalog or Website catalog for availability.
[3] Required for installation. [958] Federal & California Emission vehicles. Not legal for sale for vehicles licensed in California.

OLDSMOBILE 88, 98, DELTA 88, LSS, REGENCY (INCL. CUSTOM CRUISER)

(7539) 79-82 6 Cyl. Delta 88, 3.8L, 231 Engine

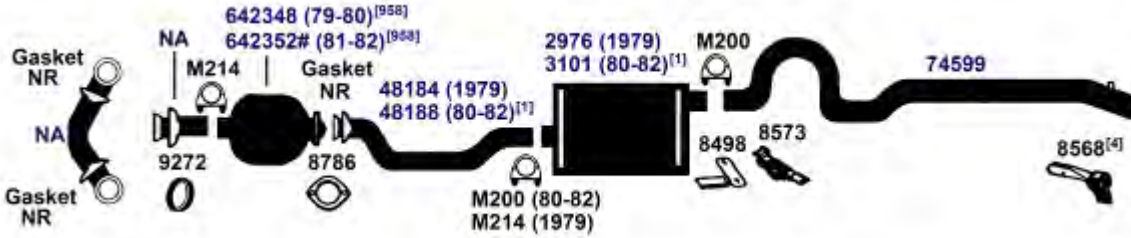

DIRECT FIT MSL/MAXIMUM Muffler... 3101- 6538 (80-82), 2976- 6543 (1979), UNIVERSAL FIT MSL/MAXIMUM Muffler... 3101- 709011 (80-82), 2976- 709012 (1979), Silentone DIY Muffler... 3101- 5528 (80-82), 2976- 5528 (1979)

(7540) 79-82 8 Cyl. Custom Cruiser, 5.7L, 350N Diesel Engine

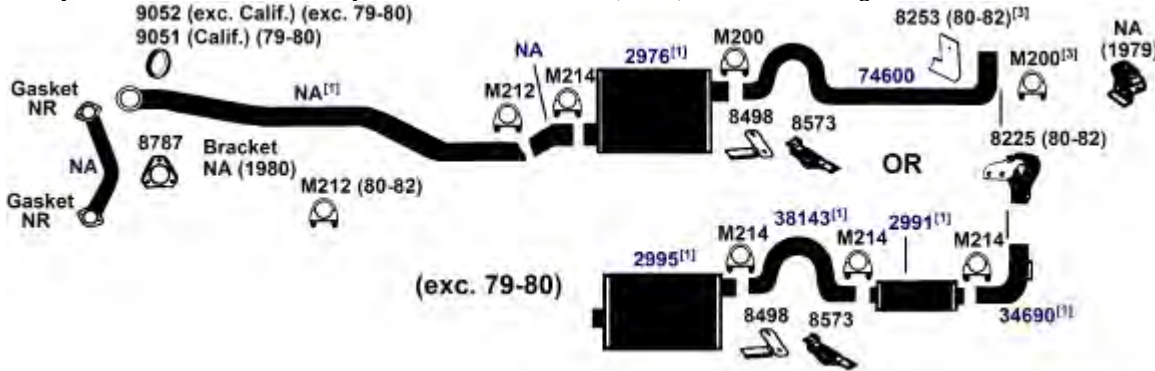

DIRECT FIT MSL/MAXIMUM Muffler... Front Muffler-#2976- 6543, Front 700056 (System With Rear Resonator), Rear Muffler- 700054, UNIVERSAL FIT MSL/MAXIMUM Muffler... Front Muffler-#2976- 709012, Front 6543 (System With Rear Resonator), 709012 (System With Rear Resonator), Rear Muffler- 6526, Silentone DIY Muffler... Front Muffler-#2976- 5528, Front 5528 (System With Rear Resonator), Rear Muffler- 5559

(7567) 1980 8 Cyl. Custom Cruiser, 307, 350R Engine

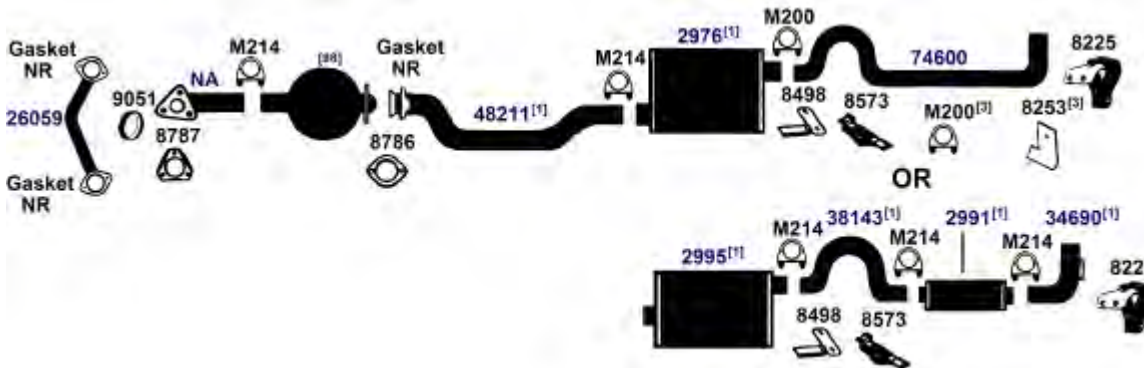

DIRECT FIT MSL/MAXIMUM Muffler... Front Muffler-#2976- 6543, Front 700056 (System With Rear Resonator), Rear Muffler- 700054, UNIVERSAL FIT MSL/MAXIMUM Muffler... Front Muffler-#2976- 709012, Front 6543 (System With Rear Resonator), 709012 (System With Rear Resonator), Rear Muffler- 6526, Silentone DIY Muffler... Front Muffler-#2976- 5528, Front 5528 (System With Rear Resonator), Rear Muffler- 5559

NA-Not Available. NR-Not Required. FL-Remove and Re-Use Old Flange. ● Golden Warehouse. O.E.-Original Equipment.
Airtube Kit [4948] may be required to complete installation. EFI-Electronic Fuel Injection.

- [1] OE system was a welded assembly. It is recommended that all parts noted [1] should be replaced.
- [3] Required for installation.
- [4] Required for installation with 74599 tail pipe.
- [98] Refer to current Catalytic Converter catalog or Website catalog for availability.
- [958] Federal & California Emission vehicles. Not legal for sale for vehicles licensed in California.

OLDSMOBILE 88, 98, DELTA 88, LSS, REGENCY (INCL. CUSTOM CRUISER)

1980 8 Cyl. Delta 88, 98; 307, 350R Engine; except Custom Cruiser (7535)

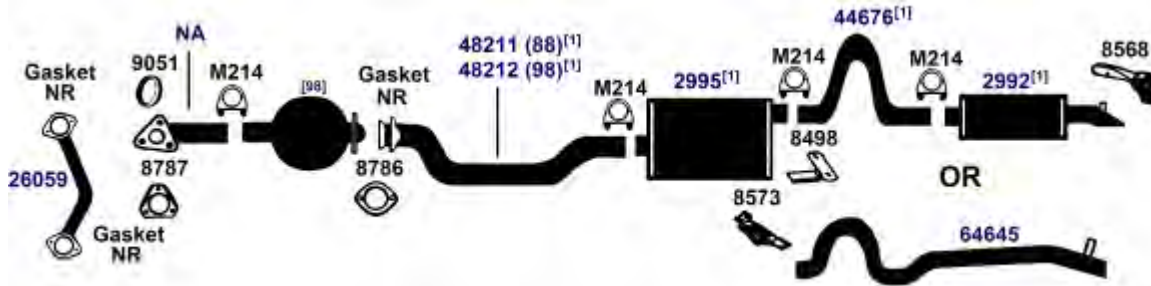

DIRECT FIT MSL/MAXIMUM Muffler... Front Muffler- 700056, Rear Muffler- 700055, UNIVERSAL FIT MSL/MAXIMUM Muffler... Front Muffler- 6543, 709012, Rear Muffler- 6526, Silentone DIY Muffler... Front Muffler- 5528, Rear Muffler- 5559 and 14677 Spout

1980 8 Cyl. Delta 88, 4.3L, 260F Engine (7568)



DIRECT FIT MSL/MAXIMUM Muffler... 6538, UNIVERSAL FIT MSL/MAXIMUM Muffler... 709011, Silentone DIY Muffler... 5528

79-80 8 Cyl. Delta 88, 98; 350N Diesel Engine, except Custom Cruiser (7523)

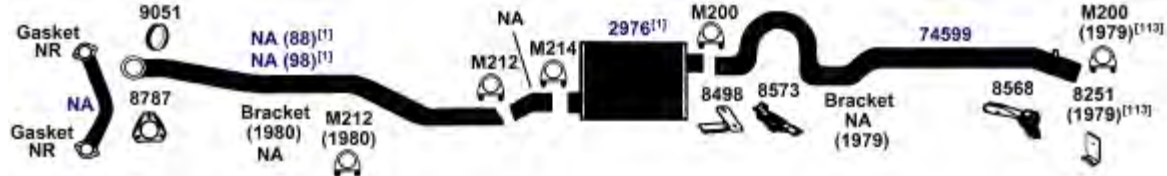

DIRECT FIT MSL/MAXIMUM Muffler... 6543, UNIVERSAL FIT MSL/MAXIMUM Muffler... 709012, Silentone DIY Muffler... 5528

1979 8 Cyl. Delta 88, 301 Engine (7529)

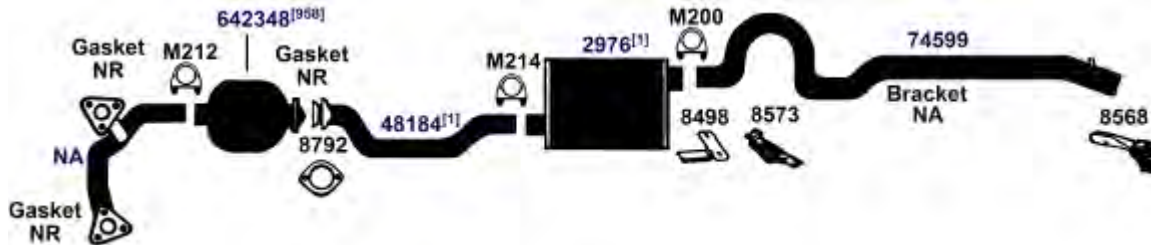

DIRECT FIT MSL/MAXIMUM Muffler... 6543, UNIVERSAL FIT MSL/MAXIMUM Muffler... 709012, Silentone DIY Muffler... 5528

NA-Not Available. NR-Not Required. FL-Remove and Re-Use Old Flange. ● Golden Warehouse. O.E.-Original Equipment.
Airtube Kit [4948] may be required to complete installation. EFI-Electronic Fuel Injection.

[1] OE system was a welded assembly. It is recommended that all parts noted [1] should be replaced.
[98] Refer to current Catalytic Converter catalog or Website catalog for availability.

[113] Required for installation on 1979 models.
[958] Federal & California Emission vehicles. Not legal for sale for vehicles licensed in California.

OLDSMOBILE 88, 98, DELTA 88, LSS, REGENCY (INCL. CUSTOM CRUISER)

(7526) 1979 8 Cyl. Delta 88, 98; 350R, 403 Engine; except Custom Cruiser

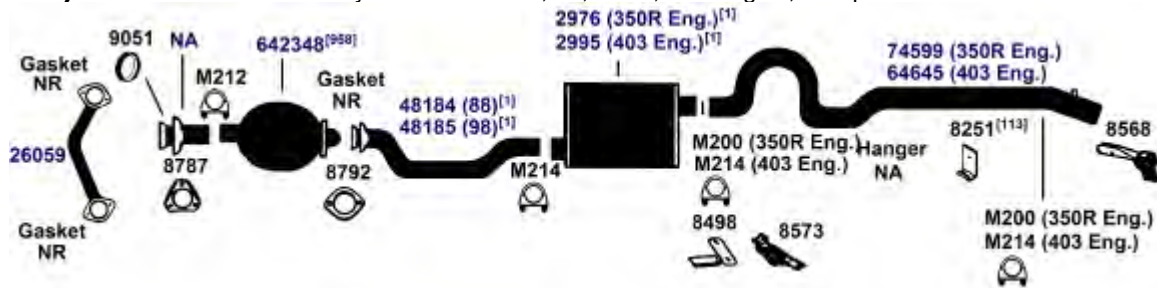

DIRECT FIT MSL/MAXIMUM Muffler... 350R Engine- 6543, 403 Engine- 700056, UNIVERSAL FIT MSL/MAXIMUM Muffler... 350R Engine- 709012, 403 Engine- 6543, Silentone DIY Muffler... 350R Engine- 5528

(7524) 1979 8 Cyl. Custom Cruiser, 403 Engine

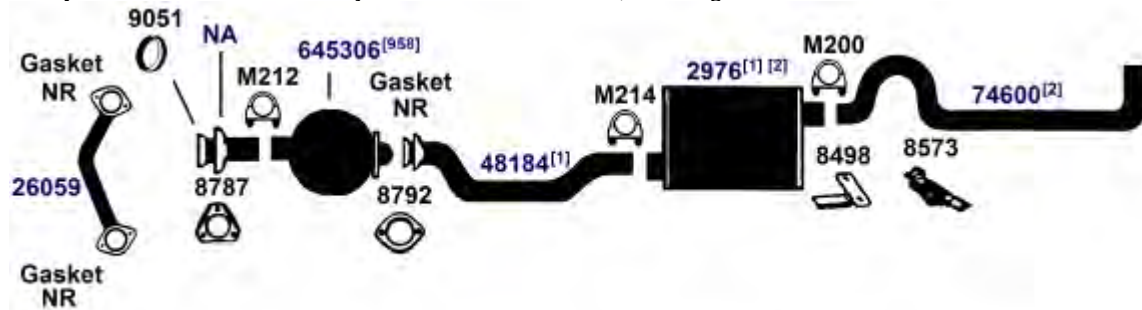

DIRECT FIT MSL/MAXIMUM Muffler... 6543, UNIVERSAL FIT MSL/MAXIMUM Muffler... 709012, Silentone DIY Muffler... 5528

(7528) 1979 8 Cyl. Delta 88, 260 Engine

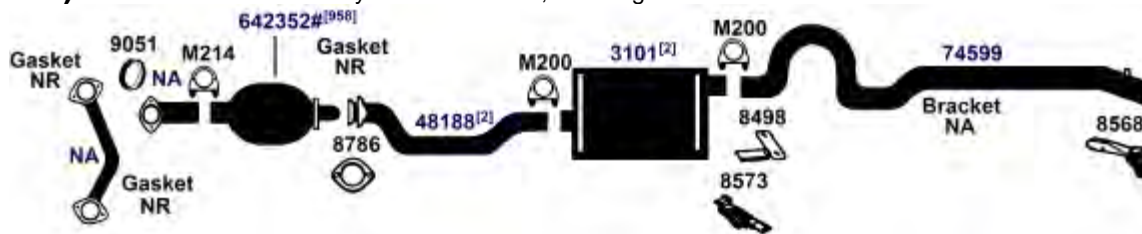

DIRECT FIT MSL/MAXIMUM Muffler... 6538, UNIVERSAL FIT MSL/MAXIMUM Muffler... 709011, Silentone DIY Muffler... 5528

NA-Not Available. NR-Not Required. FL-Remove and Re-Use Old Flange. ● Golden Warehouse. O.E.-Original Equipment.
Airtube Kit [4948] may be required to complete installation. EFI-Electronic Fuel Injection.

[1] OE system was a welded assembly. It is recommended that all parts noted [1] should be replaced.

[113] Required for installation on 1979 models.

[958] Federal & California Emission vehicles. Not legal for sale for vehicles licensed in California.

[2] May be necessary to replace all noted [2] parts.

OLDSMOBILE 88, 98, DELTA 88, LSS, REGENCY (INCL. CUSTOM CRUISER)

1979 8 Cyl. Custom Cruiser, 350R Engine

(7525)

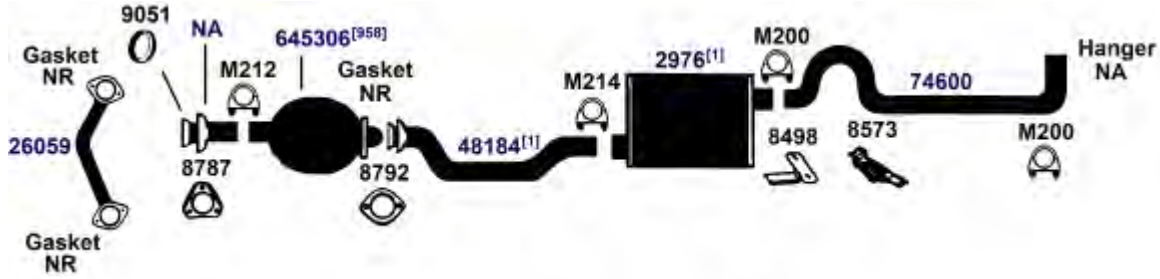

DIRECT FIT MSL/MAXIMUM Muffler... 6543, UNIVERSAL FIT MSL/MAXIMUM Muffler... 709012, Silentone DIY Muffler... 5528

OLDSMOBILE ACHIEVA

93-94 4 Cyl. Achieva, 138 Engine (2.3-3) (Quad OHC)

(13682)

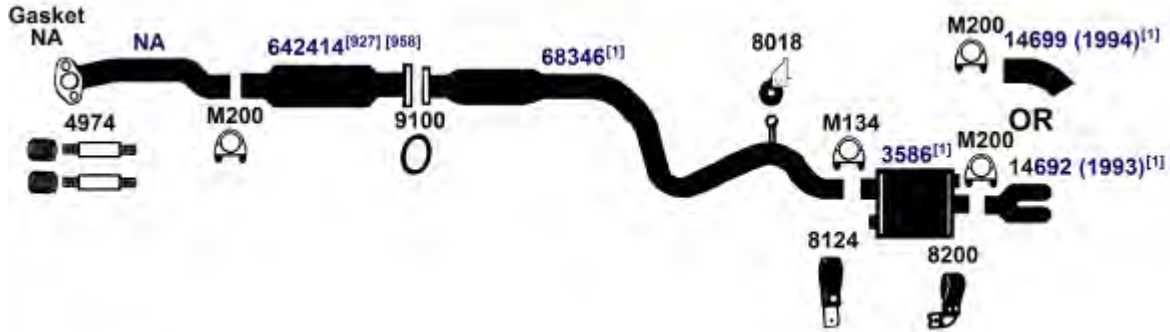

DIRECT FIT MSL/MAXIMUM Muffler... 700180, UNIVERSAL FIT MSL/MAXIMUM Muffler... 709001, 709013

1994 6 Cyl. Achieva, 3.1L Engine, Single Exhaust
 93-94 4 Cyl. Achieva, 138 Engine (2.3L-D) (Quad 4) Single Exhaust

(13681)

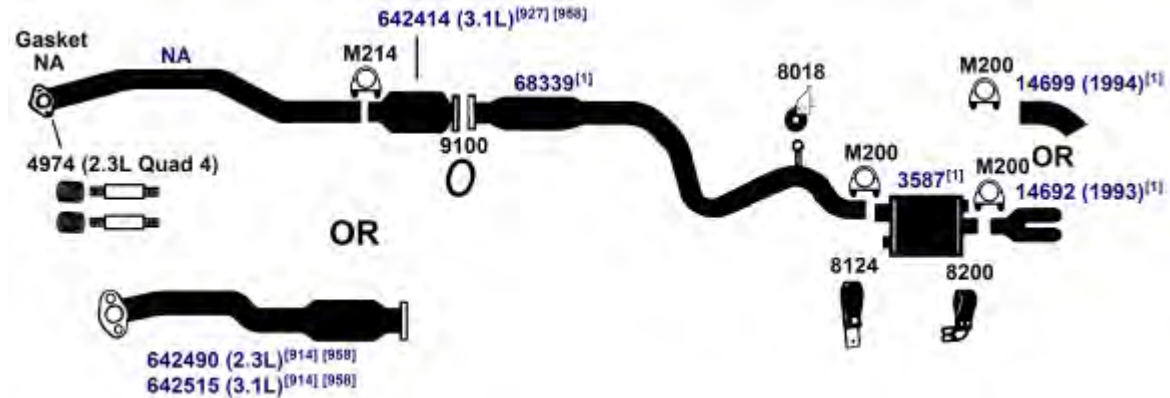

DIRECT FIT MSL/MAXIMUM Muffler... 700162, UNIVERSAL FIT MSL/MAXIMUM Muffler... 709001, 709013, 709014

NA-Not Available. NR-Not Required. FL-Remove and Re-Use Old Flange. ● Golden Warehouse. O.E.-Original Equipment.
 # Airtube Kit [4948] may be required to complete installation. EFI-Electronic Fuel Injection.

[1] OE system was a welded assembly. It is recommended that all parts noted [1] should be replaced.
 [914] Direct fit converter includes front (Exhaust) pipe, (1) piece assembly.

[927] Semi-direct fit conv. Must reuse front pipe.
 [958] Federal & California Emission vehicles. Not legal for sale for vehicles licensed in California.

OLDSMOBILE ACHIEVA

(13680) 1994 6 Cyl. Achieva, 3.1L Engine, Dual Exhaust
 93-94 4 Cyl. Achieva, 138 Engine (2.3L-D) (Quad 4), Dual Exhaust

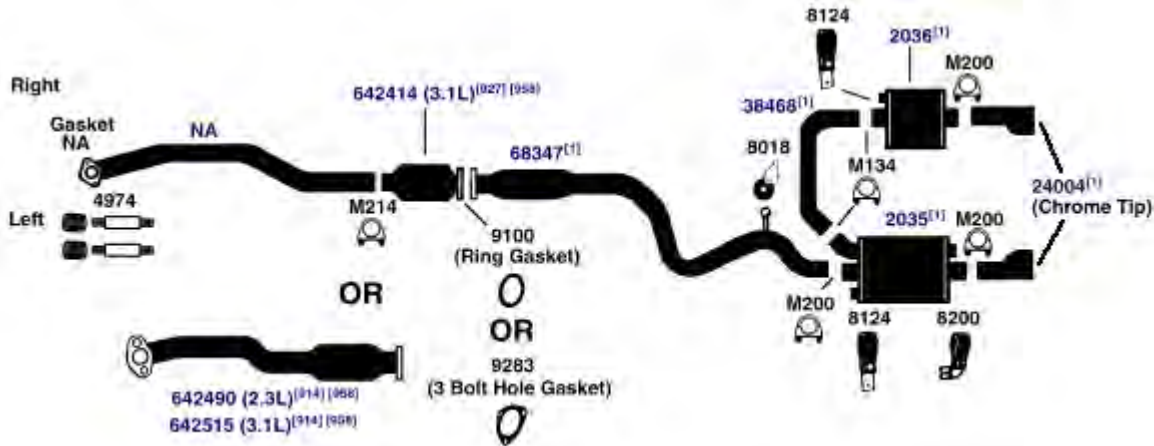

DIRECT FIT MSL/MAXIMUM Muffler... Left Muffler (2035)- 700198, Right Muffler (2036)- 700199, UNIVERSAL FIT MSL/MAXIMUM Muffler... Right Muffler (2036)- 709004

(13679) 1993 6 Cyl. Achieva, 204 Engine (3.3L), Dual Exhaust

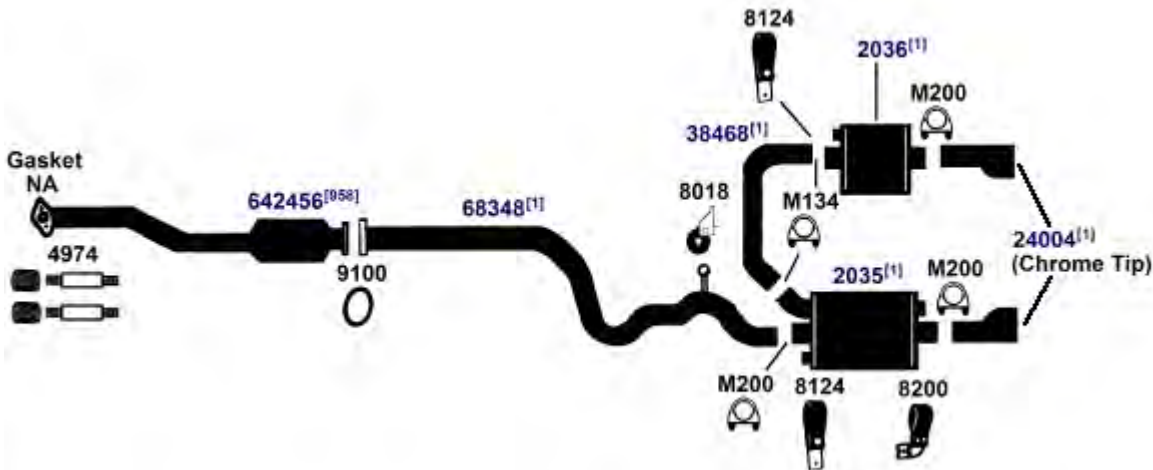

DIRECT FIT MSL/MAXIMUM Muffler... Left Muffler (2035)- 700198, Right Muffler (2036)- 700199, UNIVERSAL FIT MSL/MAXIMUM Muffler... Right Muffler (2036)- 709004

NA-Not Available. NR-Not Required. FL-Remove and Re-Use Old Flange. ● Golden Warehouse. O.E.-Original Equipment.
 # Airtube Kit [4948] may be required to complete installation. EFI-Electronic Fuel Injection.

[1] OE system was a welded assembly. It is recommended that all parts noted [1] should be replaced.

[914] Direct fit converter includes front (Exhaust) pipe, (1) piece assembly.

[927] Semi-direct fit conv. Must reuse front pipe.

[958] Federal & California Emission vehicles. Not legal for sale for vehicles licensed in California.

92-93 6 Cyl. Achieva, 204 Engine (3.3L), Single Exhaust

(13675)

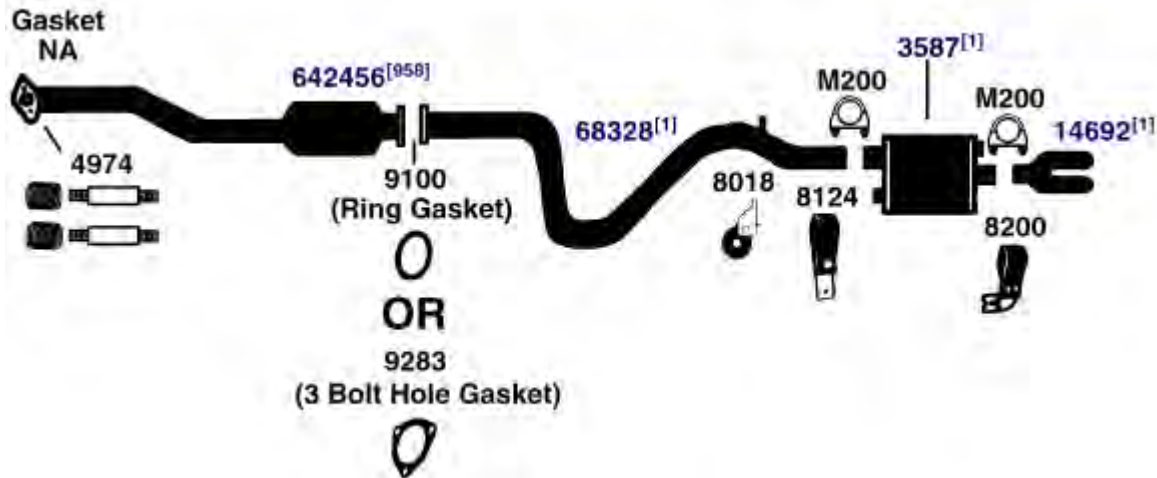

DIRECT FIT MSL/MAXIMUM Muffler... 700162, UNIVERSAL FIT MSL/MAXIMUM Muffler... 709001, 709013, 709014

1992 4 Cyl. Achieva, 138 Engine (2.3-3) (Quad OHC)

(13677)



DIRECT FIT MSL/MAXIMUM Muffler... 700180, UNIVERSAL FIT MSL/MAXIMUM Muffler... 709001, 709013

1992 4 Cyl. Achieva, 138 Engine (2.3D) (Quad 4), Single Exhaust

(13676)

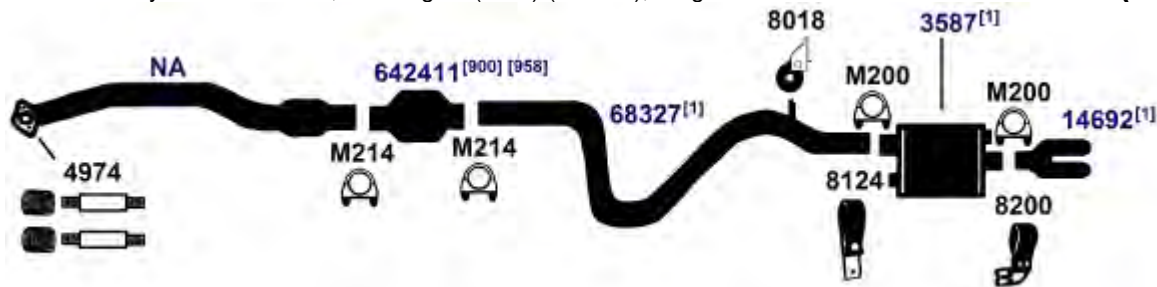

DIRECT FIT MSL/MAXIMUM Muffler... 700162, UNIVERSAL FIT MSL/MAXIMUM Muffler... 709001, 709013, 709014

NA-Not Available. NR-Not Required. FL-Remove and Re-Use Old Flange. ● Golden Warehouse. O.E.-Original Equipment.
 # Airtube Kit [4948] may be required to complete installation. EFI-Electronic Fuel Injection.

[1] OE system was a welded assembly. It is recommended that all parts noted [1] should be replaced. [958] Federal & California Emission vehicles. Not legal for sale for vehicles licensed in California.
 [900] Direct fit converter may require resizing, cutting or bushing.

OLDSMOBILE ACHIEVA

(13678) 1992 4 Cyl. Achieva, 138 Engine (2.3-A) (Quad 4), Dual Exhaust

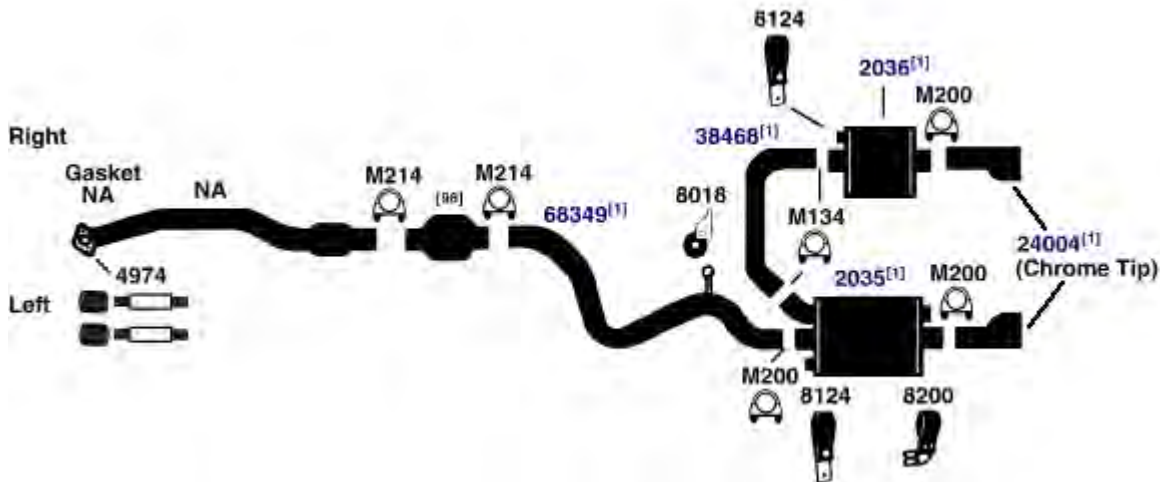

DIRECT FIT MSL/MAXIMUM Muffler... Left Muffler (2035)- 700198, Right Muffler (2036)- 700199, UNIVERSAL FIT MSL/MAXIMUM Muffler... Right Muffler (2036)- 709004

OLDSMOBILE BRAVADA

(34601) 92-94 6 Cyl. Bravada; 262W (4.3L) Engine

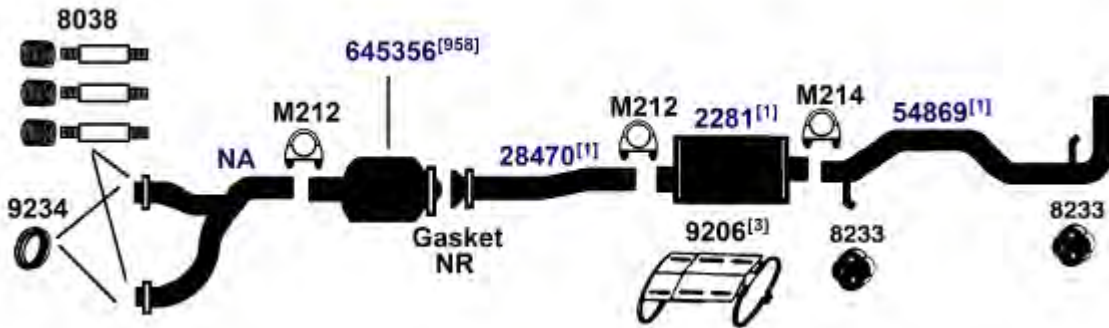

DIRECT FIT MSL/MAXIMUM Muffler... 700178, Silentone DIY Muffler... 5561

NA-Not Available. NR-Not Required. FL-Remove and Re-Use Old Flange. ● Golden Warehouse. O.E.-Original Equipment.
Airtube Kit [4948] may be required to complete installation. EFI-Electronic Fuel Injection.

- [1] OE system was a welded assembly. It is recommended that all parts noted [1] should be replaced.
[3] Required for installation.

- [98] Refer to current Catalytic Converter catalog or Website catalog for availability.
[958] Federal & California Emission vehicles. Not legal for sale for vehicles licensed in California.

OLDSMOBILE BRAVADA

1991 6 Cyl. Bravada; 262 (4.3L) Engine

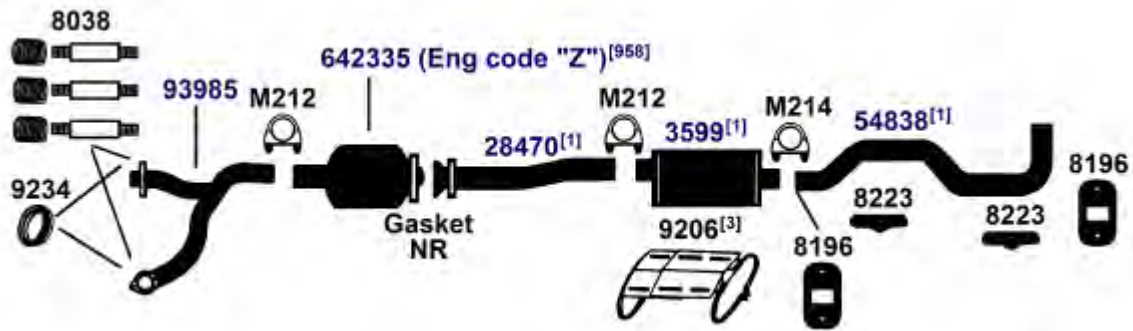
(34600)

DIRECT FIT MSL/MAXIMUM Muffler... 700020, Silentone DIY Muffler... 5561

OLDSMOBILE CALAIS

1991 4 Cyl. Calais, 138 Engine (2.3L) (Quad 4); Single Exhaust

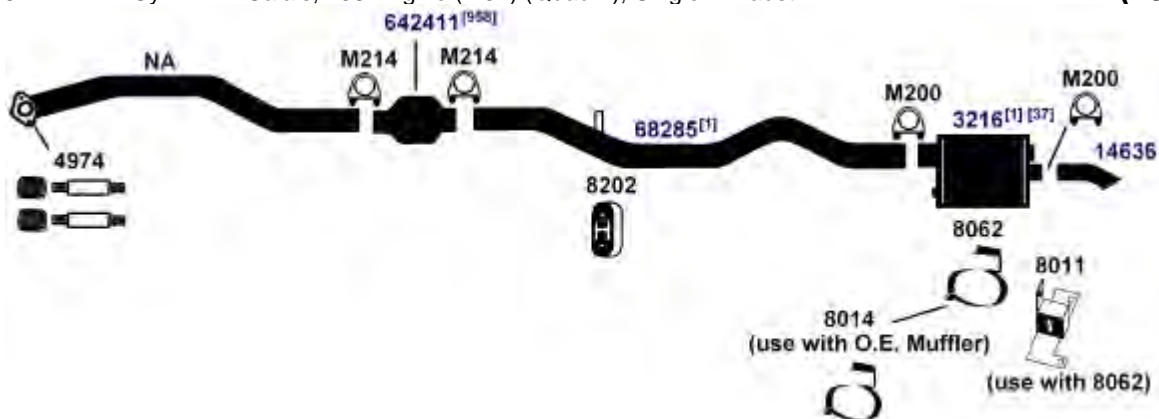
(7589)

DIRECT FIT MSL/MAXIMUM Muffler... 6560, 700060 with spout on muffler (rear exit only)., UNIVERSAL FIT MSL/MAXIMUM Muffler... 6536, Silentone DIY Muffler... 5555

NA-Not Available. NR-Not Required. FL-Remove and Re-Use Old Flange. ● Golden Warehouse. O.E.-Original Equipment.
Airtube Kit [4948] may be required to complete installation. EFI-Electronic Fuel Injection.

- [1] OE system was a welded assembly. It is recommended that all parts noted [1] should be replaced.
[3] Required for installation.

- [37] Brackets on heads of muffler are not used on this application.
[958] Federal & California Emission vehicles. Not legal for sale for vehicles licensed in California.

OLDSMOBILE CALAIS

(7588) 90-91 4 Cyl. Calais, 138 Engine (2.3L) (Quad 4); Dual Exhaust

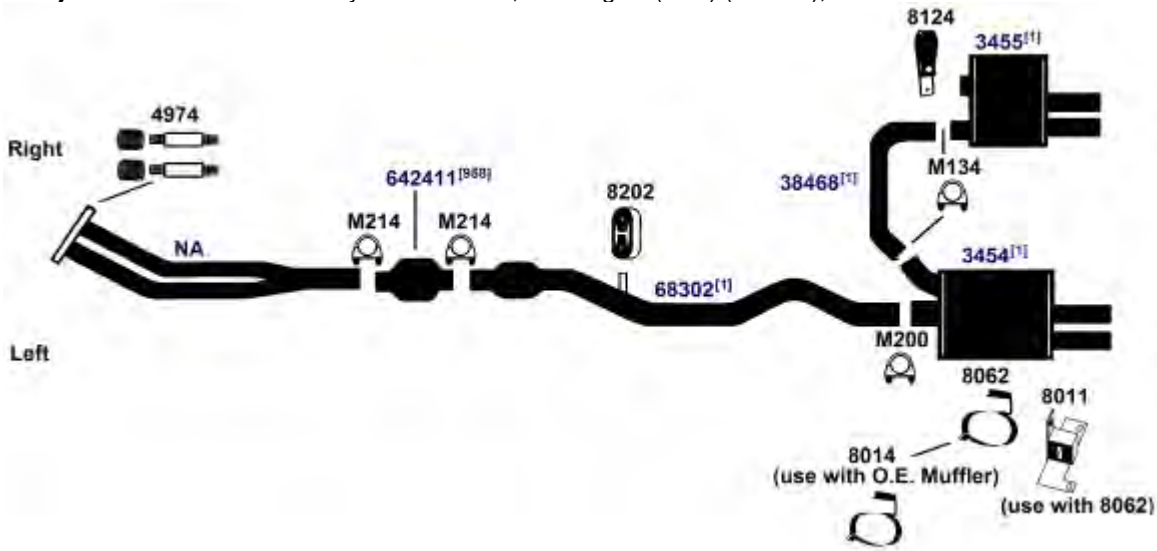

(7585) 90-91 4 Cyl. Calais, 151 Engine (2.5L)



DIRECT FIT MSL/MAXIMUM Muffler... 6560, 700060 with spout on muffler (rear exit only)., UNIVERSAL FIT MSL/MAXIMUM Muffler... 6536, Silentone DIY Muffler... 5555

NA-Not Available. NR-Not Required. FL-Remove and Re-Use Old Flange. ● Golden Warehouse. O.E.-Original Equipment.
Airtube Kit [4948] may be required to complete installation. EFI-Electronic Fuel Injection.

- [1] OE system was a welded assembly. It is recommended that all parts noted [1] should be replaced. [958] Federal & California Emission vehicles. Not legal for sale for vehicles licensed in California.
- [37] Brackets on heads of muffler are not used on this application.

90-91 6 Cyl. Calais, 204 Engine (3.3L); 1990 2nd Design with Welded Connection between Front Exhaust Pipe and Converter **(7583)**

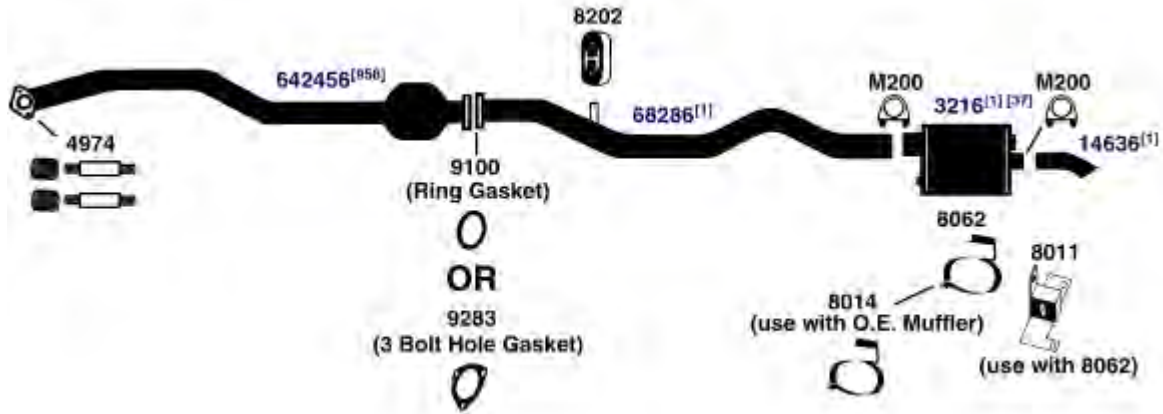

DIRECT FIT MSL/MAXIMUM Muffler... 6560, 700060 with spout on muffler (rear exit only)., UNIVERSAL FIT MSL/MAXIMUM Muffler... 6536, Silentone DIY Muffler... 5555

1990 4 Cyl. Calais, 138 Engine (2.3L) (Quad 4), Single Exhaust **(7586)**

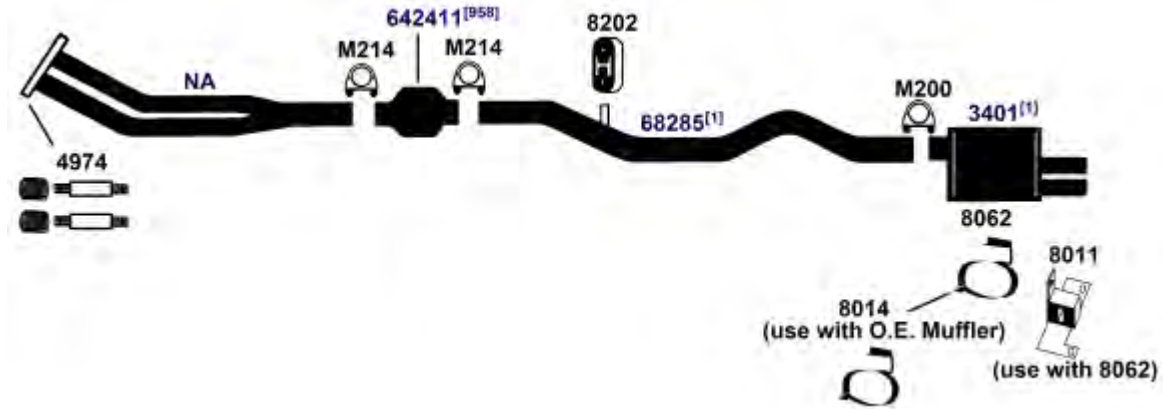

DIRECT FIT MSL/MAXIMUM Muffler... 700122, UNIVERSAL FIT MSL/MAXIMUM Muffler... 6561, 709015, Silentone DIY Muffler... 5545 two 14636 Spouts and 8062 Hanger

NA-Not Available. NR-Not Required. FL-Remove and Re-Use Old Flange. ● Golden Warehouse. O.E.-Original Equipment.
Airtube Kit [4948] may be required to complete installation. EFI-Electronic Fuel Injection.

[1] OE system was a welded assembly. It is recommended that all parts noted [1] should be replaced. [958] Federal & California Emission vehicles. Not legal for sale for vehicles licensed in California.
[37] Brackets on heads of muffler are not used on this application.

OLDSMOBILE CALAIS

(7584) 1990 6 Cyl. Calais, 204 Engine (3.3L); 1st Design with Flanged Connection between Front Exhaust Pipe and Converter

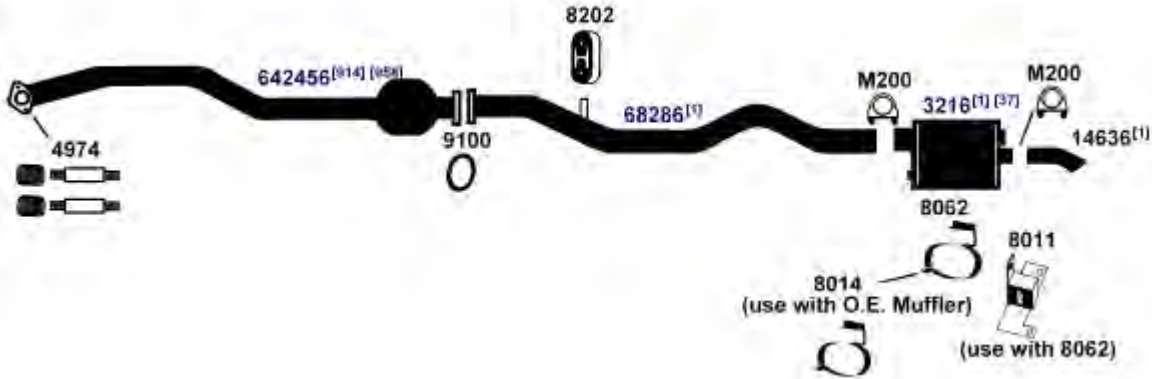

DIRECT FIT MSL/MAXIMUM Muffler... 6560, 700060 with spout on muffler (rear exit only)., UNIVERSAL FIT MSL/MAXIMUM Muffler... 6536, Silentone DIY Muffler... 5555

(7587) 1989 4 Cyl. Calais, 138 Engine (2.3L) (Quad 4), Dual Exhaust

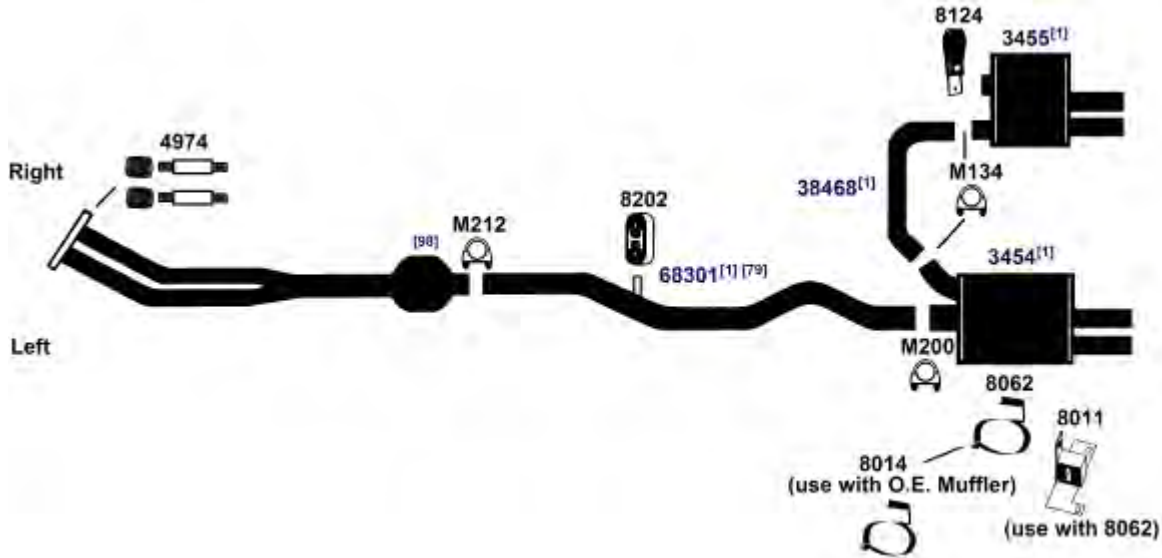

NA-Not Available. NR-Not Required. FL-Remove and Re-Use Old Flange. ● Golden Warehouse. O.E.-Original Equipment.
Airtube Kit [4948] may be required to complete installation. EFI-Electronic Fuel Injection.

- [1] OE system was a welded assembly. It is recommended that all parts noted [1] should be replaced.
- [37] Brackets on heads of muffler are not used on this application.
- [79] The O.E. extension pipe must be cut off 1 3/4" behind the pipe to converter weld.

- [98] Refer to current Catalytic Converter catalog or Website catalog for availability.
- [914] Direct fit converter includes front (Exhaust) pipe, (1) piece assembly.
- [958] Federal & California Emission vehicles. Not legal for sale for vehicles licensed in California.

OLDSMOBILE CALAIS

1989 6 Cyl. Calais, 204 Engine (3.3L); Single Outlet
 85-89 4 Cyl. Calais, 151 Engine (2.5L)

(7581)

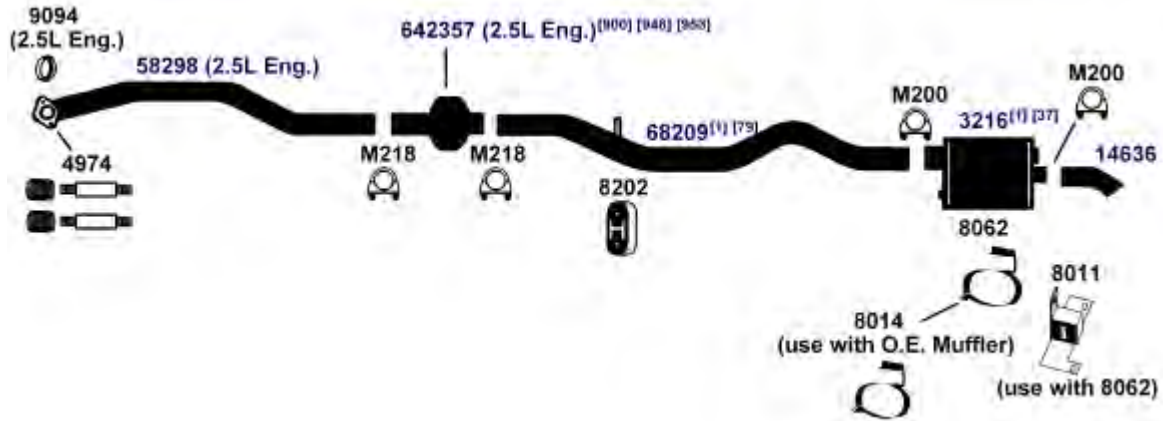

DIRECT FIT MSL/MAXIMUM Muffler... 6560, 700060 with spout on muffler (rear exit only)., UNIVERSAL FIT MSL/MAXIMUM Muffler... 6536, 700060 with spout on muffler (rear exit only)., Silentone DIY Muffler... 5555

1989 6 Cyl. Calais, 204 Engine (3.3L); Dual Outlet
 85-88 6 Cyl. Calais, 181 Engine (3.0L) (1988 2nd Design)

(7580)

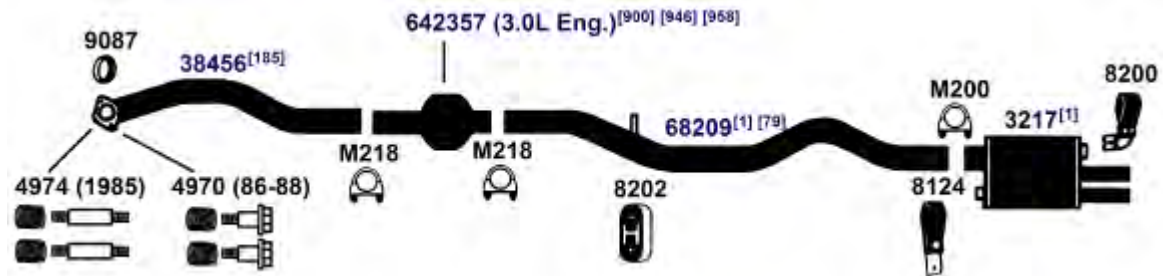

DIRECT FIT MSL/MAXIMUM Muffler... 6575, UNIVERSAL FIT MSL/MAXIMUM Muffler... 6561, 709015, Silentone DIY Muffler... 5545 two 14636 Spouts and 8062 Hanger

NA-Not Available. NR-Not Required. FL-Remove and Re-Use Old Flange. ● Golden Warehouse. O.E.-Original Equipment.
 # Airtube Kit [4948] may be required to complete installation. EFI-Electronic Fuel Injection.

- [1] OE system was a welded assembly. It is recommended that all parts noted [1] should be replaced.
- [37] Brackets on heads of muffler are not used on this application.
- [79] The O.E. extension pipe must be cut off 1 3/4" behind the pipe to converter weld.
- [185] The O.E. front exhaust pipe must be cut off 1 3/4" in front of the pipe to converter weld.
- [900] Direct fit converter may require resizing, cutting or bushing.
- [946] Two #8 bushings may be required.
- [958] Federal & California Emission vehicles. Not legal for sale for vehicles licensed in California.

OLDSMOBILE CALAIS

(7582) 88-89 4 Cyl. Calais, 138 Engine (2.3L) (Quad 4); Single Exhaust

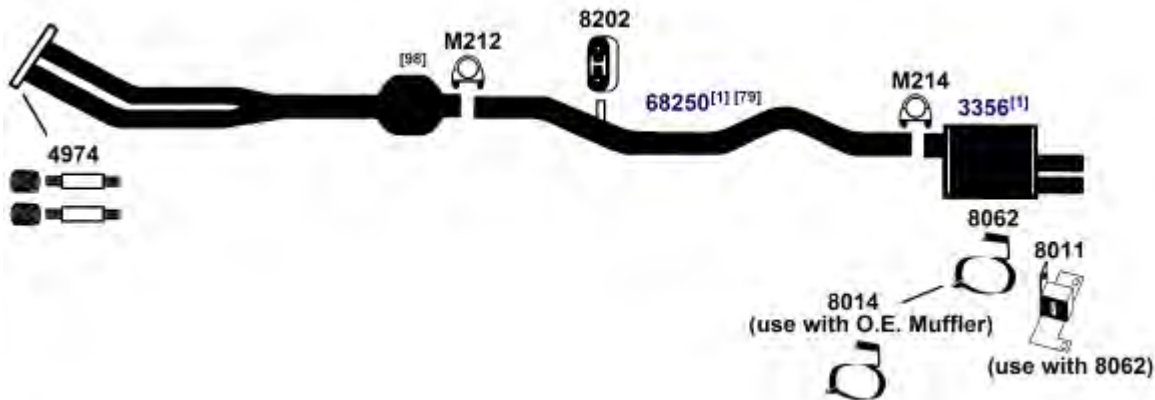

DIRECT FIT MSL/MAXIMUM Muffler... 700115, UNIVERSAL FIT MSL/MAXIMUM Muffler... 6570, 709015

OLDSMOBILE CUTLASS, CIERA

(7738) 1994 6 Cyl. Cutlass Supreme, 3.1L Engine

642474 (94-95 w/o post Conv. O2 Sensor)^[958]
 642569 (95-96 w/ post Conv. O2 Sensor)^[958]
 642949 (1997)^[958]

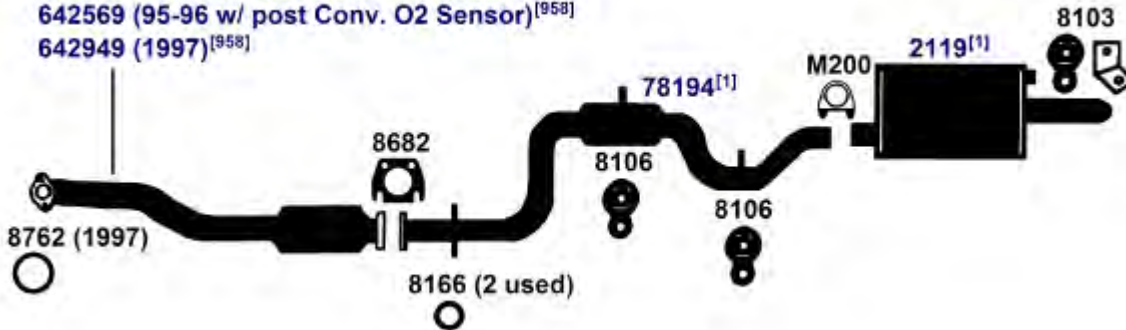

DIRECT FIT MSL/MAXIMUM Muffler... 700235

(7740) 1994 4 Cyl. Cutlass Ciera, 2.2L Engine; except Sta. Wagon

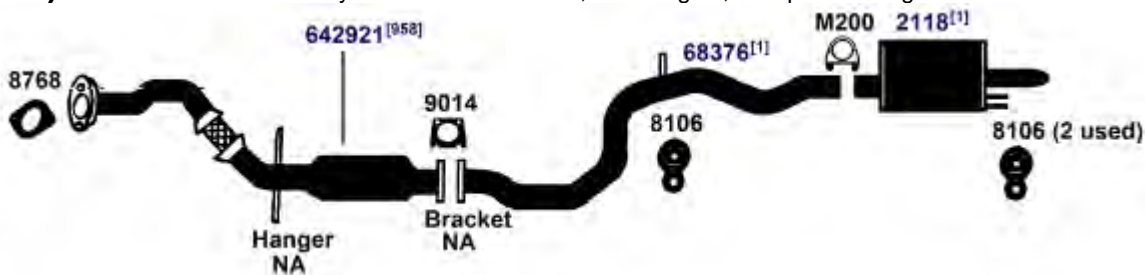

DIRECT FIT MSL/MAXIMUM Muffler... 700143, Silentone DIY Muffler... 5572 and 14761 Pipe

NA-Not Available. NR-Not Required. FL-Remove and Re-Use Old Flange. ● Golden Warehouse. O.E.-Original Equipment.
 # Airtube Kit [4948] may be required to complete installation. EFI-Electronic Fuel Injection.

[1] OE system was a welded assembly. It is recommended that all parts noted [1] should be replaced.

[79] The O.E. extension pipe must be cut off 1 3/4" behind the pipe to converter weld.

[98] Refer to current Catalytic Converter catalog or Website catalog for availability.
 [958] Federal & California Emission vehicles. Not legal for sale for vehicles licensed in California.

OLDSMOBILE CUTLASS, CIERA

1994 6 Cyl. Cutlass Ciera Sta. Wagon, 3.1L Engine
 1993 6 Cyl. Cutlass Ciera Sta. Wagon, 204 Engine (3.3L)

(7732)

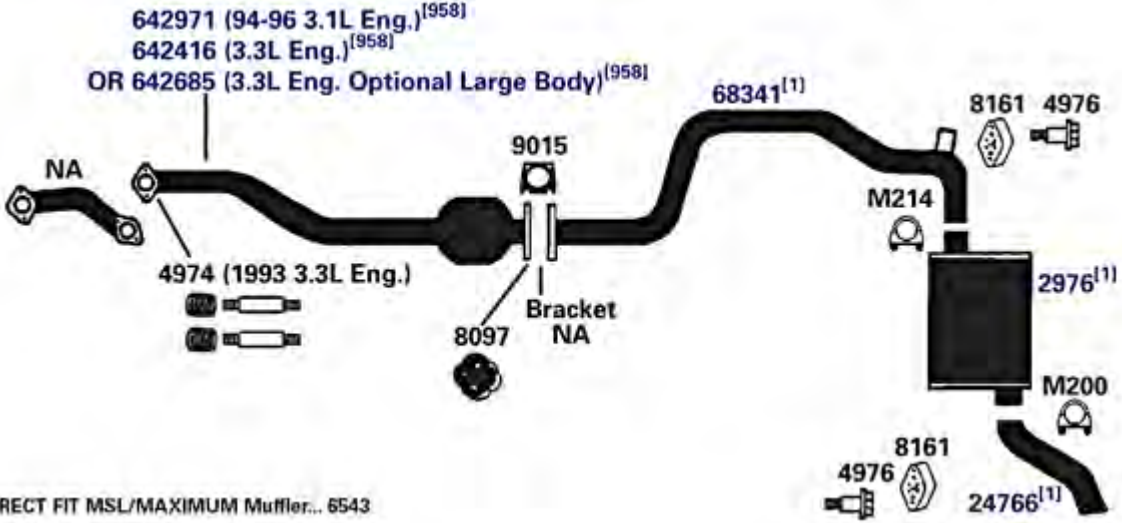

DIRECT FIT MSL/MAXIMUM Muffler... 6543
 DIRECT FIT MSL/MAXIMUM Muffler... 6543, UNIVERSAL FIT MSL/MAXIMUM Muffler... 709012, Silentone DIY Muffler... 5528

1994 6 Cyl. Cutlass Ciera, 3.1L Engine; except Sta. Wagon

(7739)

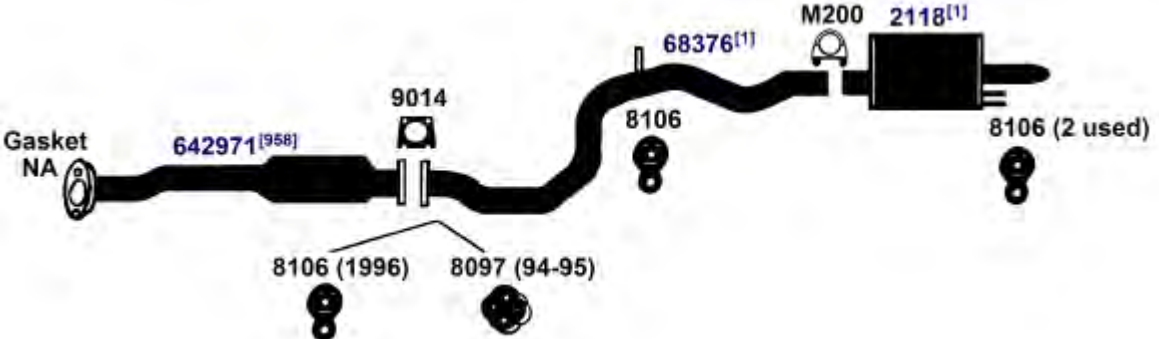

DIRECT FIT MSL/MAXIMUM Muffler... 700143, Silentone DIY Muffler... 5572 and 14761 Pipe

NA-Not Available. NR-Not Required. FL-Remove and Re-Use Old Flange. ● Golden Warehouse. O.E.-Original Equipment.
 # Airtube Kit [4948] may be required to complete installation. EFI-Electronic Fuel Injection.

[1] OE system was a welded assembly. It is recommended that all parts noted [1] should be replaced. [958] Federal & California Emission vehicles. Not legal for sale for vehicles licensed in California.

OLDSMOBILE CUTLASS, CIERA

(7731) 93-94 6 Cyl. Cutlass Supreme, 207 Engine (3.4L); Dual Exhaust

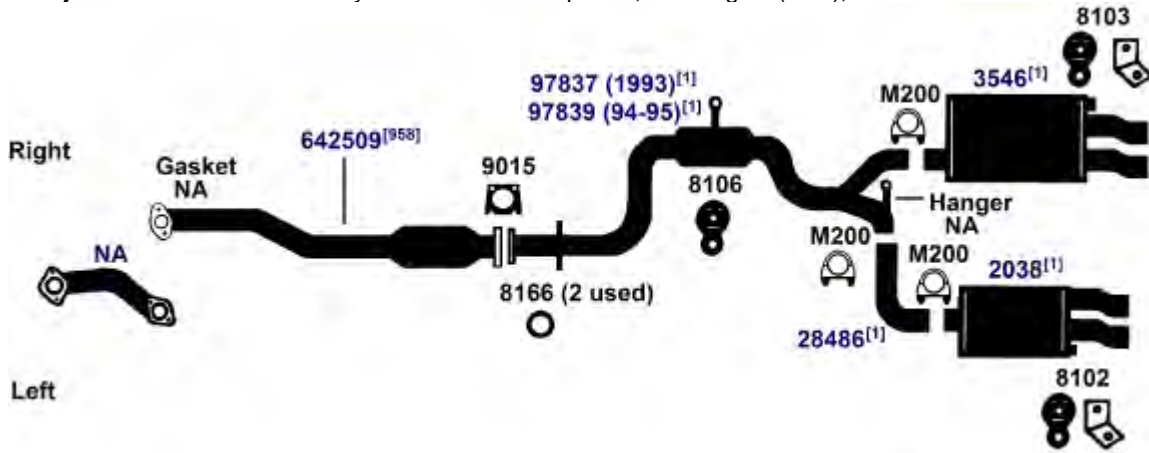

DIRECT FIT MSL/MAXIMUM Muffler... Right Muffler- 700444, Left Muffler- 700355

(7736) 1993 4 Cyl. Cutlass Ciera Sta. Wagon, 2.2L Engine

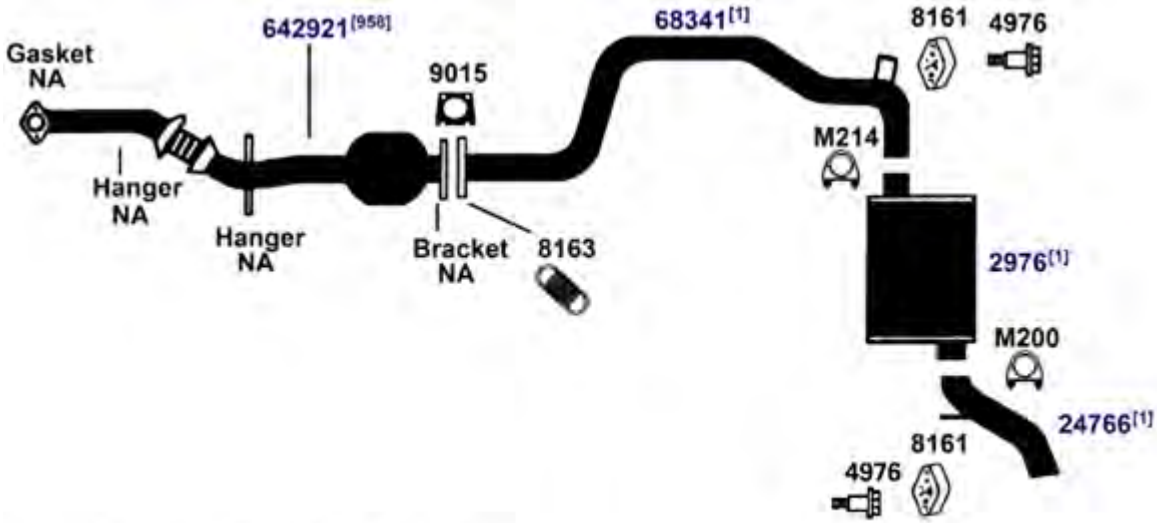

DIRECT FIT MSL/MAXIMUM Muffler... 6543

DIRECT FIT MSL/MAXIMUM Muffler... 6543, UNIVERSAL FIT MSL/MAXIMUM Muffler... 709012, Silentone DIY Muffler... 5528

NA-Not Available. NR-Not Required. FL-Remove and Re-Use Old Flange. ● Golden Warehouse. O.E.-Original Equipment.
Airtube Kit [4948] may be required to complete installation. EFI-Electronic Fuel Injection.

[1] OE system was a welded assembly. It is recommended that all parts noted [1] should be replaced. [958] Federal & California Emission vehicles. Not legal for sale for vehicles licensed in California.

1993 4 Cyl. Cutlass Ciera, 2.2L Engine; except Sta. Wagon (7737)

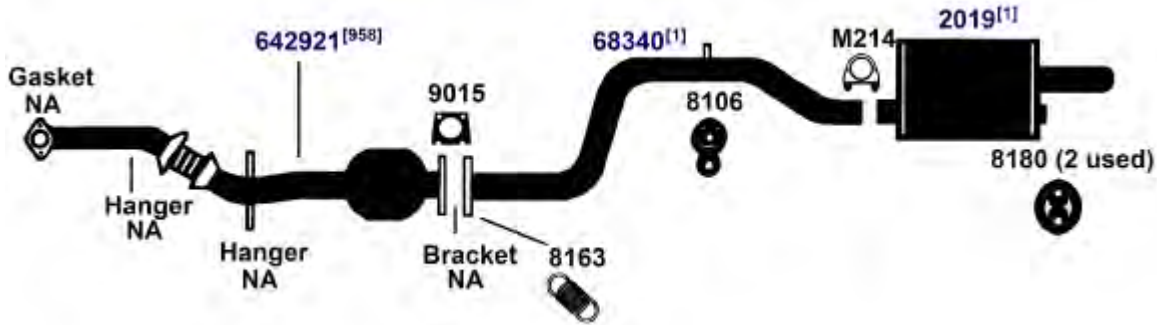

DIRECT FIT MSL/MAXIMUM Muffler... 700145, UNIVERSAL FIT MSL/MAXIMUM Muffler... 6538, 6543, 6553, 6556, 709012

1993 6 Cyl. Cutlass Ciera, 204 Engine (3.3L); except Sta. Wagon (7733)

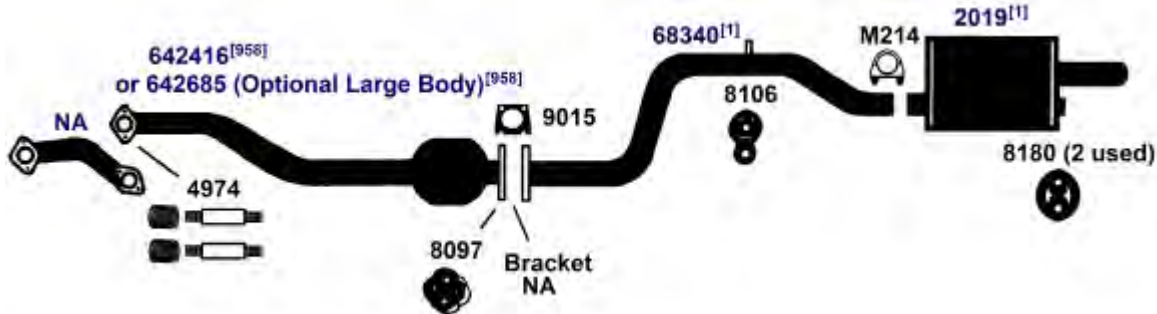

DIRECT FIT MSL/MAXIMUM Muffler... 700145, UNIVERSAL FIT MSL/MAXIMUM Muffler... 6538, 6543, 6553, 6556, 709012

1993 6 Cyl. Cutlass Supreme, 189 Engine (3.1L); Single Exhaust; except California (7735)

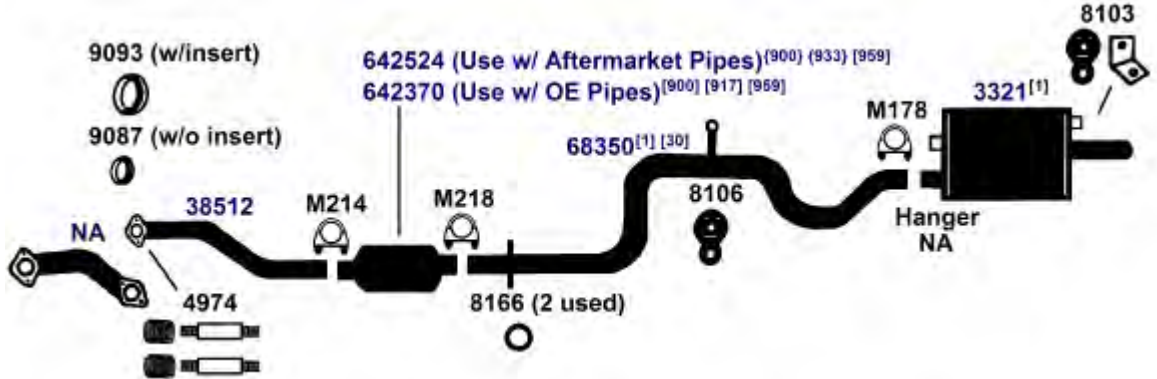

DIRECT FIT MSL/MAXIMUM Muffler... 6579, UNIVERSAL FIT MSL/MAXIMUM Muffler... 709010, Silentone DIY Muffler... 5569 and 14663 Spout

NA-Not Available. NR-Not Required. FL-Remove and Re-Use Old Flange. ● Golden Warehouse. O.E.-Original Equipment.
Airtube Kit [4948] may be required to complete installation. EFI-Electronic Fuel Injection.

[1] OE system was a welded assembly. It is recommended that all parts noted [1] should be replaced.

[958] Federal & California Emission vehicles. Not legal for sale for vehicles licensed in California.

[30] The O.E. extension pipe must be cut off 1 1/2" behind the pipe to convert weld.

[959] Federal Emission vehicles. Not legal for sale for vehicles licensed in California.

[900] Direct fit converter may require resizing, cutting or bushing.

[917] # 6 bushing may be required at inlet & # 8 bushing may be required at outlet for use w/aftermarket pipe.

[933] For use with 2 1/8" I.D. intermediate pipe.

OLDSMOBILE CUTLASS, CIERA

(7734) 1993 6 Cyl. Cutlass Supreme, 189 Engine (3.1L); Dual Exhaust

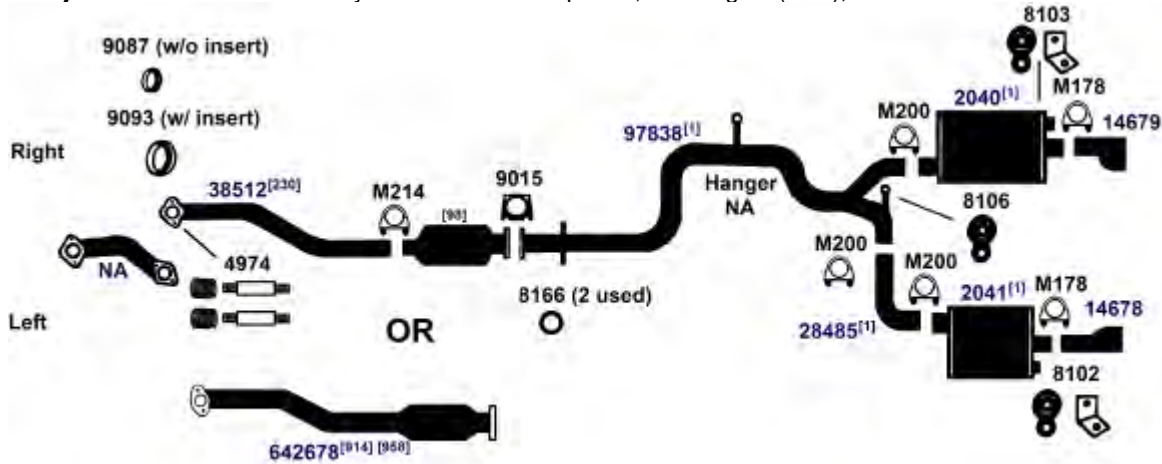

DIRECT FIT MSL/MAXIMUM Muffler... Right Muffler (2040)- 700215, Left Muffler (2041)- 700216, UNIVERSAL FIT MSL/MAXIMUM Muffler... Right Muffler (2040)- 709007, 709010, Left Muffler (2041)- 709005, 709010

(100528) 1993 6 Cyl. Cutlass Supreme, 189 Engine (3.1L); Single Exhaust; California Models

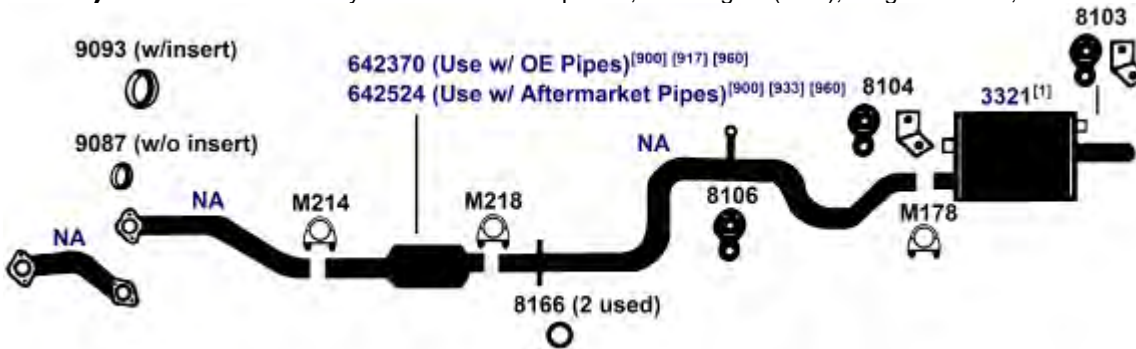

DIRECT FIT MSL/MAXIMUM Muffler... 6579, UNIVERSAL FIT MSL/MAXIMUM Muffler... 709010, Silentone DIY Muffler... 5569 and 14663 Spout

NA-Not Available. NR-Not Required. FL-Remove and Re-Use Old Flange. ● Golden Warehouse. O.E.-Original Equipment.
Airtube Kit [4948] may be required to complete installation. EFI-Electronic Fuel Injection.

[1] OE system was a welded assembly. It is recommended that all parts noted [1] should be replaced.

[230] Use with O.E.M. Converter

[900] Direct fit converter may require resizing, cutting or bushing.

[914] Direct fit converter includes front (Exhaust) pipe, (1) piece assembly.

[917] # 6 bushing may be required at inlet & # 8 bushing may be required at outlet for use w/aftermarket pipe.

[933] For use with 2 1/8" I.D. intermediate pipe.

[958] Federal & California Emission vehicles. Not legal for sale for vehicles licensed in California.

[960] California Emission vehicles licensed in states other than California. Not legal for sale for vehicles licensed in California.

OLDSMOBILE CUTLASS, CIERA

91-92 6 Cyl. Cutlass Supreme, 207 Engine (3.4L); Dual Exhaust

(7730)

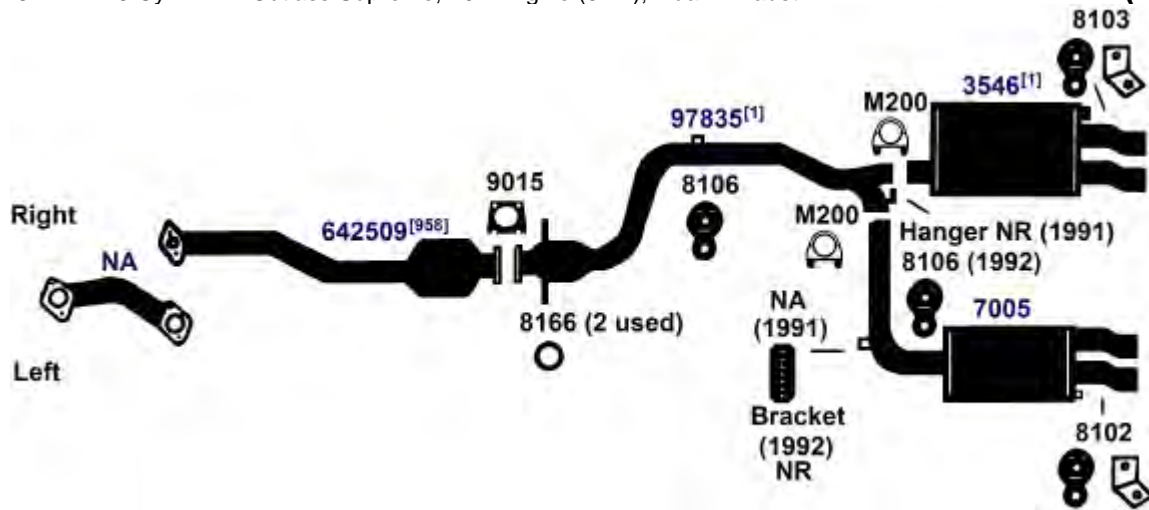

DIRECT FIT MSL/MAXIMUM Muffler... Right Muffler- 700444

91-92 6 Cyl. Cutlass Supreme, 189 Engine (3.1L); Single Exhaust
 89-90 6 Cyl. Cutlass Supreme, 189 Engine (3.1L); except Sport Exhaust

(7717)



DIRECT FIT MSL/MAXIMUM Muffler... 6579, UNIVERSAL FIT MSL/MAXIMUM Muffler... 709010, Silentone DIY Muffler... 5569 and 14663 Spout

NA-Not Available. NR-Not Required. FL-Remove and Re-Use Old Flange. ● Golden Warehouse. O.E.-Original Equipment.
 # Airtube Kit [4948] may be required to complete installation. EFI-Electronic Fuel Injection.

- [1] OE system was a welded assembly. It is recommended that all parts noted [1] should be replaced.
- [30] The O.E. extension pipe must be cut off 1 1/2" behind the pipe to converter weld.
- [900] Direct fit converter may require resizing, cutting or bushing.

- [917] # 6 bushing may be required at inlet & # 8 bushing may be required at outlet for use w/aftermarket pipe.
- [933] For use with 2 1/8" I.D. intermediate pipe.
- [958] Federal & California Emission vehicles. Not legal for sale for vehicles licensed in California.

OLDSMOBILE CUTLASS, CIERA

(7729) 90-92 6 Cyl. Cutlass Supreme, 189 Engine (3.1L); Dual Exhaust

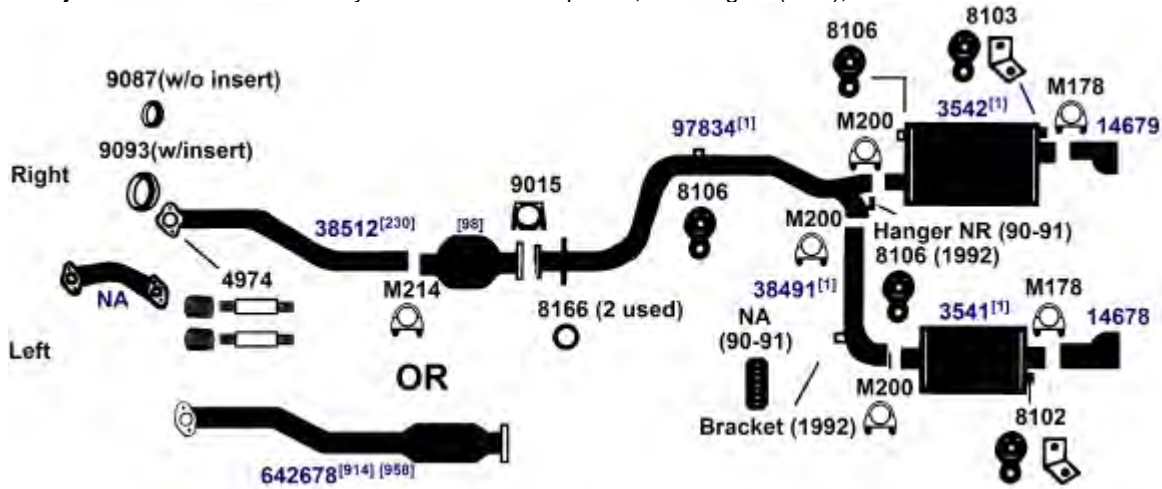

DIRECT FIT MSL/MAXIMUM Muffler... Right Muffler (3542)- 700192, Left Muffler (3541)- 700193, UNIVERSAL FIT MSL/MAXIMUM Muffler... Right Muffler (3542)- 709007, 709010

(7720) 89-92 6 Cyl. Cutlass Ciera, 173 Engine (2.8L, 1989 only), 204 Engine (3.3L); except Sta. Wagon (models with Single outlet muffler)

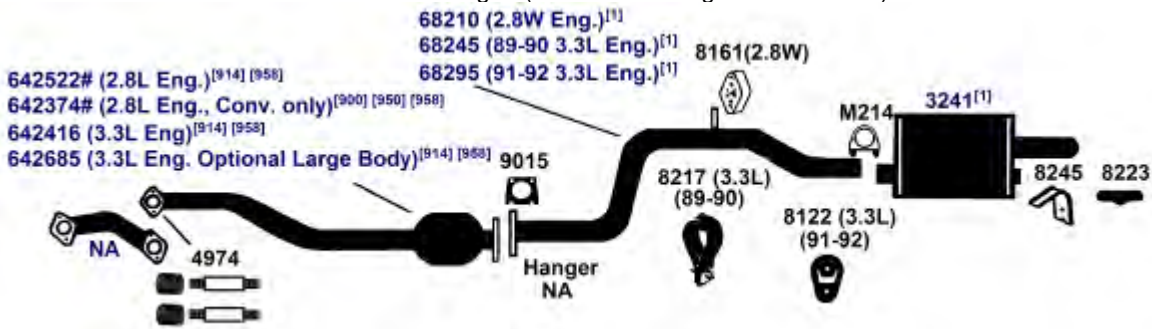

DIRECT FIT MSL/MAXIMUM Muffler... 6591, UNIVERSAL FIT MSL/MAXIMUM Muffler... 6562, 709014, Silentone DIY Muffler... 5556 and 14636 Spout and 8506 Bracket, 8245 hanger

NA-Not Available. NR-Not Required. FL-Remove and Re-Use Old Flange. ● Golden Warehouse. O.E.-Original Equipment.
Airtube Kit [4948] may be required to complete installation. EFI-Electronic Fuel Injection.

[1] OE system was a welded assembly. It is recommended that all parts noted [1] should be replaced.

[98] Refer to current Catalytic Converter catalog or Website catalog for availability.

[230] Use with O.E.M. Converter

[900] Direct fit converter may require resizing, cutting or bushing.

[914] Direct fit converter includes front (Exhaust) pipe, (1) piece assembly.

[950] Conv. only, w/o front pipe.

[958] Federal & California Emission vehicles. Not legal for sale for vehicles licensed in California.

OLDSMOBILE CUTLASS, CIERA

89-92 6 Cyl. Cutlass Ciera Sta. Wagon, 173 Engine (2.8L, 1989 only), 204 Engine (3.3L) **(7718)**

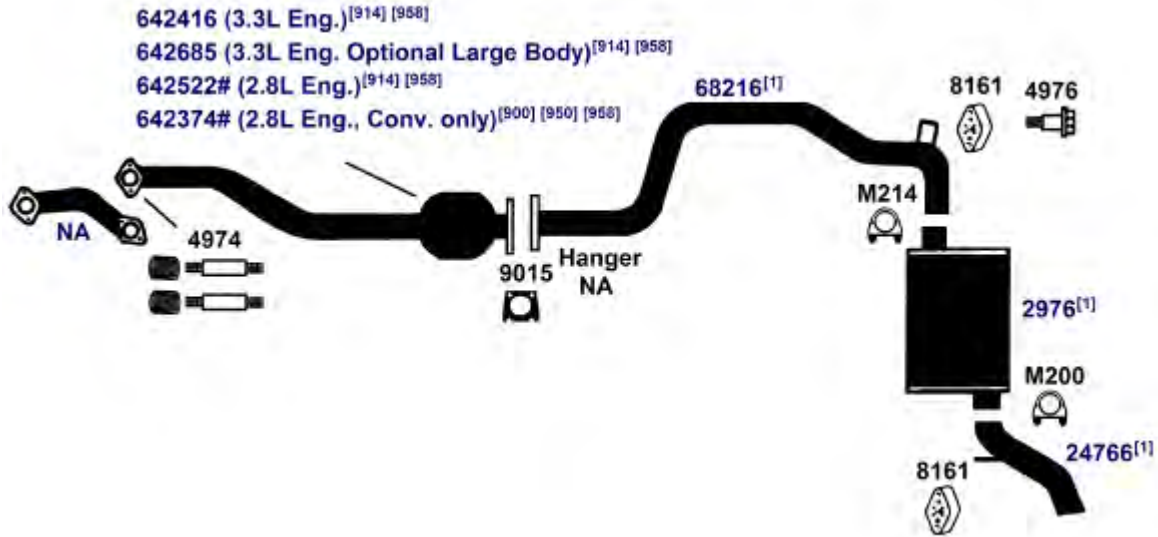

DIRECT FIT MSL/MAXIMUM Muffler... 6543, UNIVERSAL FIT MSL/MAXIMUM Muffler... 709012, Silentone DIY Muffler... 5528

88-92 4 Cyl. Cutlass Ciera Sta. Wagon, 151 Engine (2.5L) **(7714)**

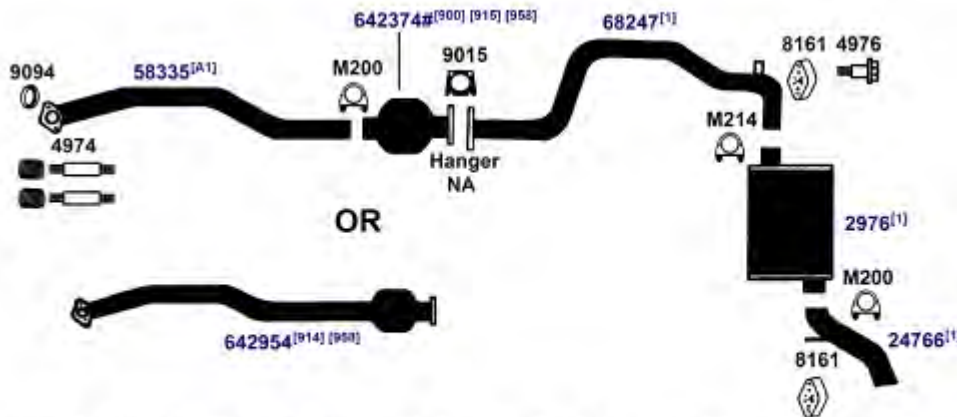

^[A1] Cut O.E. Manifold Pipe directly behind pipe to converter weld. Remove any portion of original Manifold Pipe that is in converter inlet. 58335 is then installed inside O.E.M. converter inlet. Use with O.E.M. converter only.

DIRECT FIT MSL/MAXIMUM Muffler... 6543, UNIVERSAL FIT MSL/MAXIMUM Muffler... 709012, Silentone DIY Muffler... 5528

NA-Not Available. NR-Not Required. FL-Remove and Re-Use Old Flange. ● Golden Warehouse. O.E.-Original Equipment.
Airtube Kit [4948] may be required to complete installation. EFI-Electronic Fuel Injection.

[1] OE system was a welded assembly. It is recommended that all parts noted [1] should be replaced.

[900] Direct fit converter may require resizing, cutting or bushing.

[914] Direct fit converter includes front (Exhaust) pipe, (1) piece assembly.

[915] Does not include complete front pipe.

[950] Conv. only, w/o front pipe.

[958] Federal & California Emission vehicles. Not legal for sale for vehicles licensed in California.

OLDSMOBILE CUTLASS, CIERA

(7715) 88-92 4 Cyl. Cutlass Ciera, 151 Engine (2.5L); except Sta. Wagon

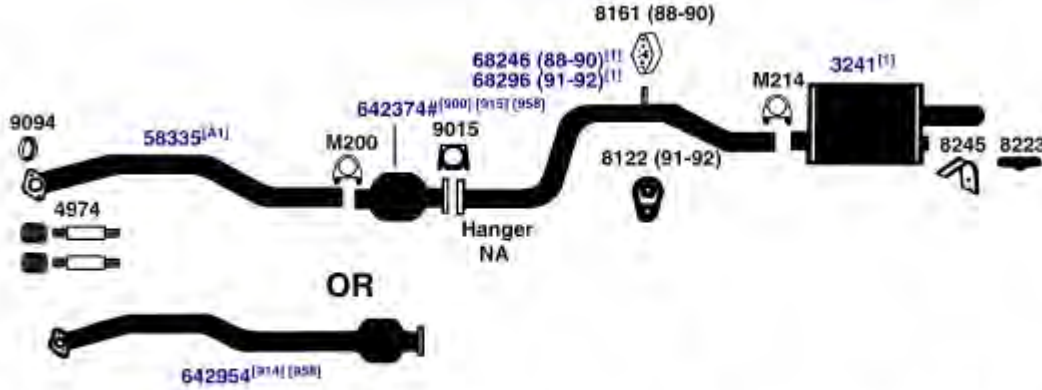

[A1] Cut O.E. Manifold Pipe directly behind pipe to converter weld. Remove any portion of original Manifold Pipe that is in converter inlet. 58335 is then installed inside O.E.M. converter inlet. Use with O.E.M. converter only.

DIRECT FIT MSL/MAXIMUM Muffler... 6591, UNIVERSAL FIT MSL/MAXIMUM Muffler... 6562, 709014, Silentone DIY Muffler... 5556 and 14636 Spout and 8506 Bracket, 8245 hanger

(7727) 90-91 4 Cyl. Cutlass Supreme, 138 Engine (2.3L), Quad 4

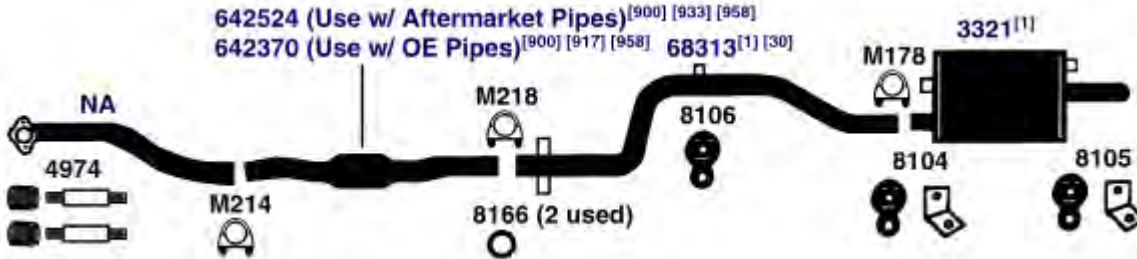

DIRECT FIT MSL/MAXIMUM Muffler... 6579, UNIVERSAL FIT MSL/MAXIMUM Muffler... 709010, Silentone DIY Muffler... 5569 and 14663 Spout

(7716) 89-90 6 Cyl. Cutlass Supreme, 189 Engine, (3.1L); with Sport Exhaust
88-89 6 Cyl. Cutlass Supreme, 173 Engine, (2.8L); with Sport Exhaust

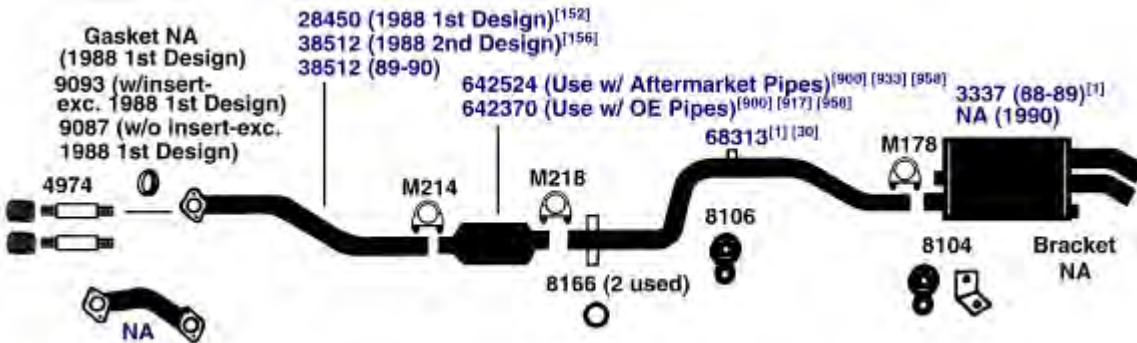

DIRECT FIT MSL/MAXIMUM Muffler... 700189, Silentone DIY Muffler... 5569 and 14663 Spout

NA-Not Available. NR-Not Required. FL-Remove and Re-Use Old Flange. ● Golden Warehouse. O.E.-Original Equipment.
Airtube Kit [4948] may be required to complete installation. EFI-Electronic Fuel Injection.

[1] OE system was a welded assembly. It is recommended that all parts noted [1] should be replaced.

[30] The O.E. extension pipe must be cut off 1 1/2" behind the pipe to converter weld.

[152] With Tubular Manifold.

[156] With Cast Manifold.

[900] Direct fit converter may require resizing, cutting or bushing.

[914] Direct fit converter includes front (Exhaust) pipe, (1) piece assembly.

[915] Does not include complete front pipe.

[917] # 6 bushing may be required at inlet & # 8 bushing may be required at outlet for use w/aftermarket pipe.

[933] For use with 2 1/8" I.D. intermediate pipe.

[958] Federal & California Emission vehicles. Not legal for sale for vehicles licensed in California.

OLDSMOBILE CUTLASS, CIERA

89-90 6 Cyl. Cutlass Ciera, 173 Engine (2.8L) (1989 only), 204 Engine (3.3L), except Sta. Wagon (models with dual outlet muffler) **(7719)**

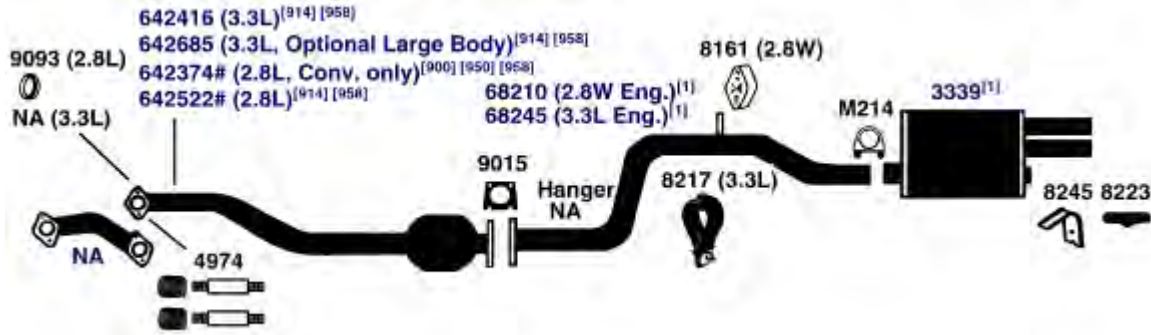

UNIVERSAL FIT MSL/MAXIMUM Muffler... 6570, 709015

88-89 6 Cyl. Cutlass Supreme, 173 Engine, (2.8L); except Sport Exhaust **(7713)**

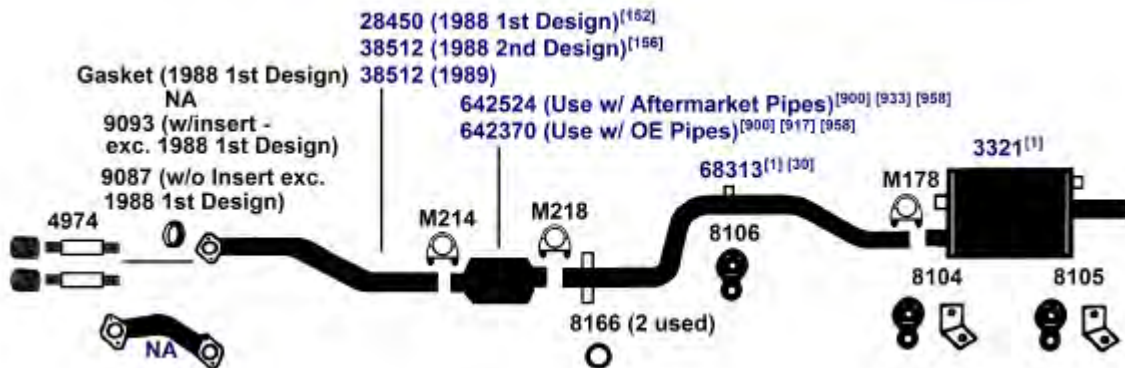

DIRECT FIT MSL/MAXIMUM Muffler... 6579, UNIVERSAL FIT MSL/MAXIMUM Muffler... 709010, Silentone DIY Muffler... 5569 and 14663 Spout

1988 8 Cyl. Cutlass Supreme Classic, 307 Engine, (5.0L) (Rear Wheel Drive) **(7712)**



DIRECT FIT MSL/MAXIMUM Muffler... 700057, UNIVERSAL FIT MSL/MAXIMUM Muffler... 6540, Silentone DIY Muffler... 5522

NA-Not Available. NR-Not Required. FL-Remove and Re-Use Old Flange. ● Golden Warehouse. O.E.-Original Equipment.
Airtube Kit [4948] may be required to complete installation. EFI-Electronic Fuel Injection.

- [1] OE system was a welded assembly. It is recommended that all parts noted [1] should be replaced.
- [30] The O.E. extension pipe must be cut off 1 1/2" behind the pipe to converter weld.
- [152] With Tubular Manifold.
- [156] With Cast Manifold.
- [900] Direct fit converter may require resizing, cutting or bushing.

- [914] Direct fit converter includes front (Exhaust) pipe, (1) piece assembly.
- [917] # 6 bushing may be required at inlet & # 8 bushing may be required at outlet for use w/aftermarket pipe.
- [933] For use with 2 1/8" I.D. intermediate pipe.
- [950] Conv. only, w/o front pipe.
- [958] Federal & California Emission vehicles. Not legal for sale for vehicles licensed in California.

OLDSMOBILE CUTLASS, CIERA

(7707) 87-88 6 Cyl. Cutlass Ciera Sta. Wagon; 173, 231 Engine, (2.8W, 3.8L)

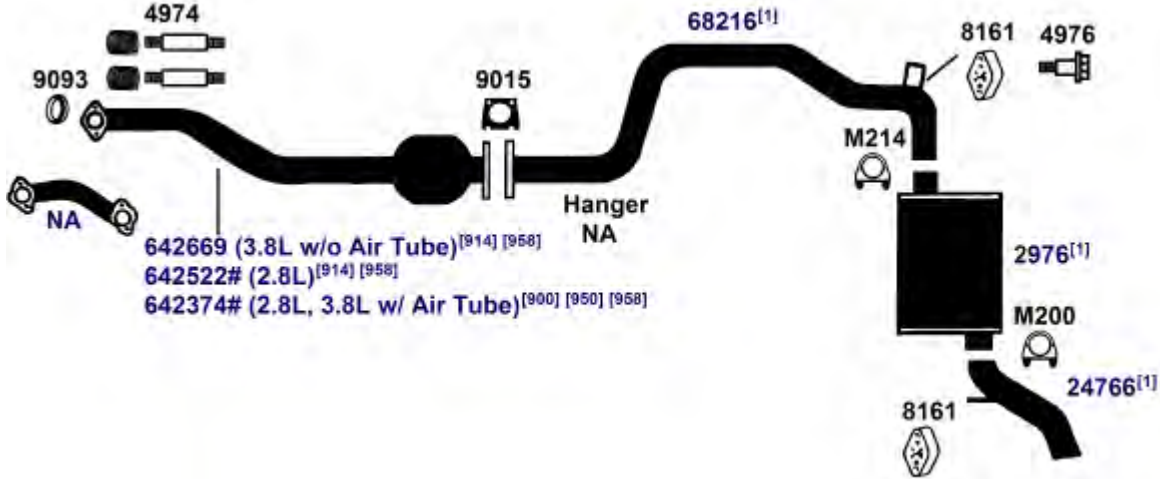

DIRECT FIT MSL/MAXIMUM Muffler... 6543, UNIVERSAL FIT MSL/MAXIMUM Muffler... 709012, Silentone DIY Muffler... 5528

(7709) 87-88 6 Cyl. Cutlass Ciera; 173, 231 Engine (2.8W, 3.8L); except Sta. Wagon (models with Single outlet muffler)
 1986 6 Cyl. Cutlass Ciera; 231 Engine (3.8L); except Sta. Wagon (models with Single outlet muffler)

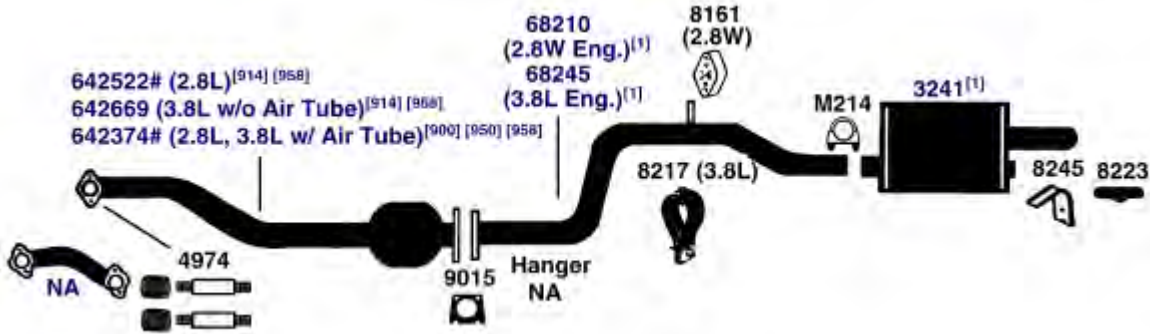

DIRECT FIT MSL/MAXIMUM Muffler... 6591, UNIVERSAL FIT MSL/MAXIMUM Muffler... 6562, 709014, Silentone DIY Muffler... 5556 and 14636 Spout and 8506 Bracket, 8245 hanger

NA-Not Available. NR-Not Required. FL-Remove and Re-Use Old Flange. ● Golden Warehouse. O.E.-Original Equipment.
 # Airtube Kit [4948] may be required to complete installation. EFI-Electronic Fuel Injection.

[1] OE system was a welded assembly. It is recommended that all parts noted [1] should be replaced.

[900] Direct fit converter may require resizing, cutting or bushing.

[914] Direct fit converter includes front (Exhaust) pipe, (1) piece assembly.

[950] Conv. only, w/o front pipe.

[958] Federal & California Emission vehicles. Not legal for sale for vehicles licensed in California.

86-88 6 Cyl. Cutlass Ciera; 173, 231 Engine, (2.8W, 3.8L); except Sta. Wagon (models with **(7708)** dual outlet muffler)

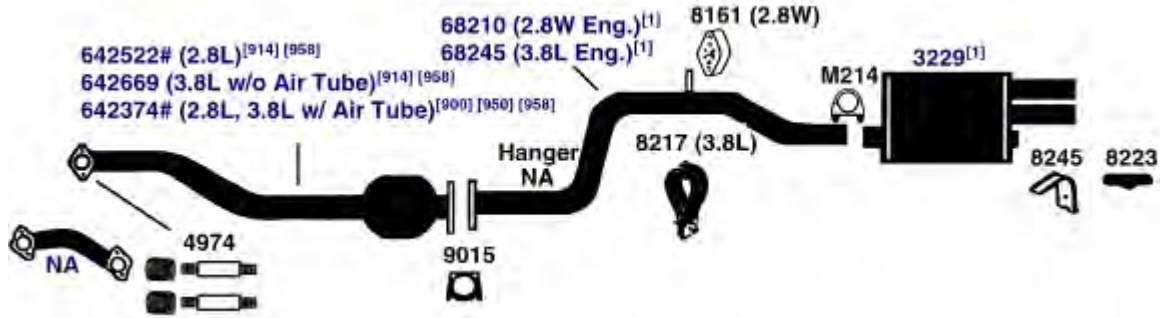

DIRECT FIT MSL/MAXIMUM Muffler... 700091, UNIVERSAL FIT MSL/MAXIMUM Muffler... 6570, 709015

1987 4 Cyl. Cutlass Ciera Sta. Wagon, 151 Engine, (2.5L) **(7710)**

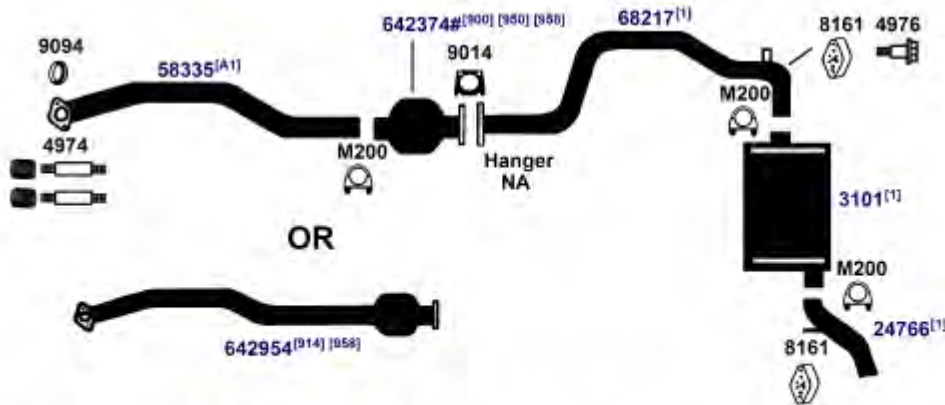

^[A1] Cut O.E. Manifold Pipe directly behind pipe to converter weld. Remove any portion of original Manifold Pipe that is in converter inlet. 58335 is then installed inside O.E.M. converter inlet. Use with O.E.M. converter only.

DIRECT FIT MSL/MAXIMUM Muffler... 6538, UNIVERSAL FIT MSL/MAXIMUM Muffler... 709011, Silentone DIY Muffler... 5528

NA-Not Available. NR-Not Required. FL-Remove and Re-Use Old Flange. ● Golden Warehouse. O.E.-Original Equipment.
Airtube Kit [4948] may be required to complete installation. EFI-Electronic Fuel Injection.

[1] OE system was a welded assembly. It is recommended that all parts noted [1] should be replaced.

[900] Direct fit converter may require resizing, cutting or bushing.

[914] Direct fit converter includes front (Exhaust) pipe, (1) piece assembly.

[950] Conv. only, w/o front pipe.

[958] Federal & California Emission vehicles. Not legal for sale for vehicles licensed in California.

OLDSMOBILE CUTLASS, CIERA

(7704) 86-87 4 Cyl. Cutlass Ciera, 151 Engine (2.5L); except Sta. Wagon

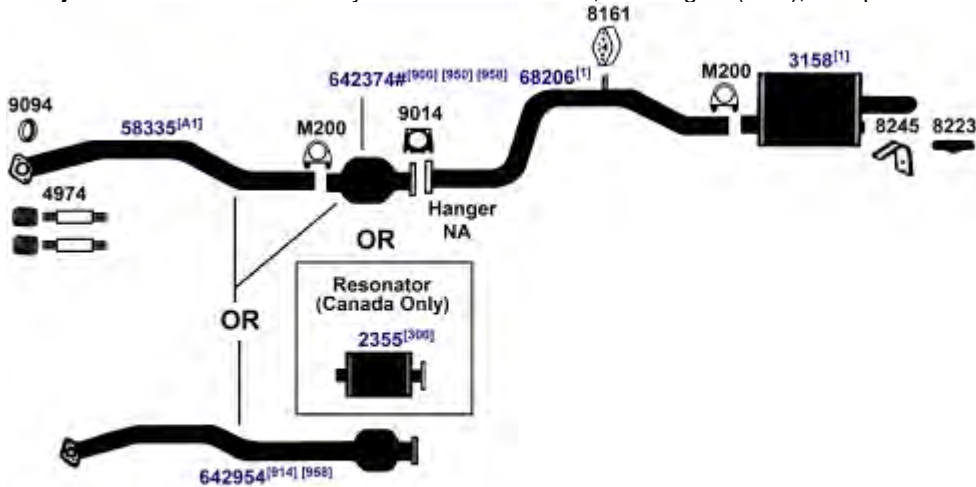

[A1] Cut O.E. Manifold Pipe directly behind pipe to converter weld. Remove any portion of original Manifold Pipe that is in converter inlet. 58335 is then installed inside O.E.M. converter inlet. Use with O.E.M. converter only.

DIRECT FIT MSL/MAXIMUM Muffler... Rear Muffler- 6573, UNIVERSAL FIT MSL/MAXIMUM Muffler... Rear Muffler- 6544, 6562, 709014, Silentone DIY Muffler... Rear Muffler- 5535

(7697) 86-87 8 Cyl. Cutlass, 307 Engine (5.0L); except models with High Performance (W40)(W42)

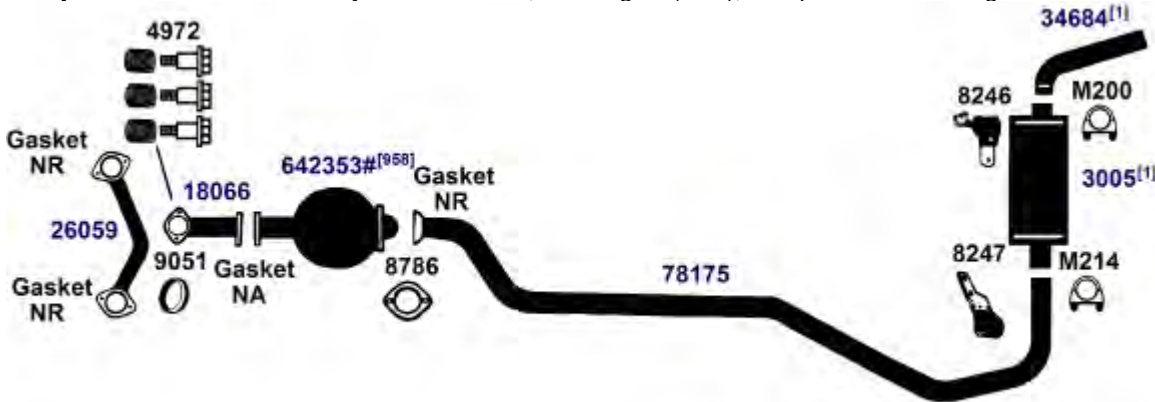

DIRECT FIT MSL/MAXIMUM Muffler... 700057, UNIVERSAL FIT MSL/MAXIMUM Muffler... 6540, Silentone DIY Muffler... 5522

NA-Not Available. NR-Not Required. FL-Remove and Re-Use Old Flange. ● Golden Warehouse. O.E.-Original Equipment.
Airtube Kit [4948] may be required to complete installation. EFI-Electronic Fuel Injection.

[1] OE system was a welded assembly. It is recommended that all parts noted [1] should be replaced.

[300] For use when resonator originated from O.E. manufacturer.

[900] Direct fit converter may require resizing, cutting or bushing.

[914] Direct fit converter includes front (Exhaust) pipe, (1) piece assembly.

[950] Conv. only, w/o front pipe.

[958] Federal & California Emission vehicles. Not legal for sale for vehicles licensed in California.

85-87 6 Cyl. Cutlass, 231 Engine (3.8L)

(7694)



DIRECT FIT MSL/MAXIMUM Muffler... 6540, Silentone DIY Muffler... 5503

1986 4 Cyl. Cutlass Ciera Sta. Wagon, 151 Engine (2.5L)

(7703)

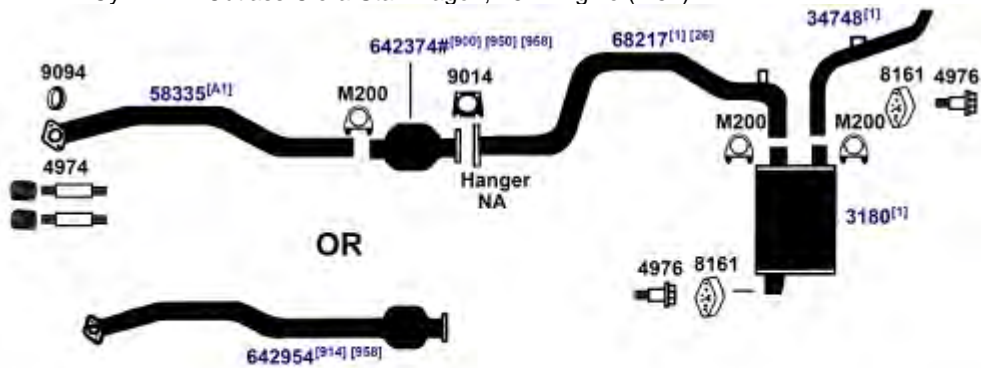

[A1] Cut O.E. Manifold Pipe directly behind pipe to converter weld. Remove any portion of original Manifold Pipe that is in converter inlet. 58335 is then installed inside O.E.M. converter inlet. Use with O.E.M. converter only.

DIRECT FIT MSL/MAXIMUM Muffler... 6564

NA-Not Available. NR-Not Required. FL-Remove and Re-Use Old Flange. ● Golden Warehouse. O.E.-Original Equipment.
Airtube Kit [4948] may be required to complete installation. EFI-Electronic Fuel Injection.

- [1] OE system was a welded assembly. It is recommended that all parts noted [1] should be replaced.
- [26] Bracket on pipe is not required on all applications.
- [900] Direct fit converter may require resizing, cutting or bushing.
- [914] Direct fit converter includes front (Exhaust) pipe, (1) piece assembly.
- [950] Conv. only, w/o front pipe.
- [958] Federal & California Emission vehicles. Not legal for sale for vehicles licensed in California.

OLDSMOBILE CUTLASS, CIERA

(7701) 1986 6 Cyl. Cutlass Ciera; 173 Engine (2.8X, 2.8W); except Sta. Wagon (models with Single outlet muffler)

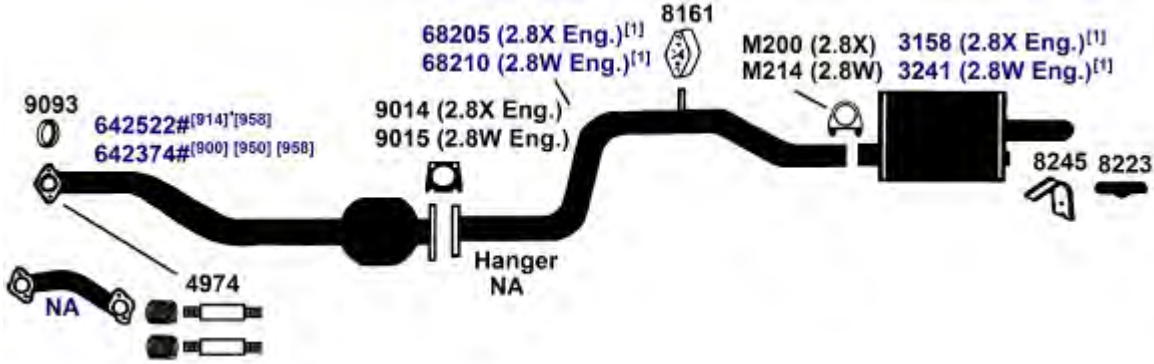

DIRECT FIT MSL/MAXIMUM Muffler... 2.8X Engine- 6573 (2.8X Eng.), 2.8W Engine- 6591 (2.8W Eng.), UNIVERSAL FIT MSL/MAXIMUM Muffler... 2.8X Engine- 6544 (2.8X Eng.), 6562 (2.8X Eng.), 709014 (2.8X Eng.), 2.8W Engine- 6562 (2.8W Eng.), 709014 (2.8W Eng.), Silentone DIY Muffler... 2.8X Engine- 5535 (2.8X Eng.), 2.8W Engine- 5556 and 14636 Spout and 8506 Bracket, 8245 hanger

(7700) 1986 6 Cyl. Cutlass Ciera Sta. Wagon; 173 Engine (2.8X, 2.8W)

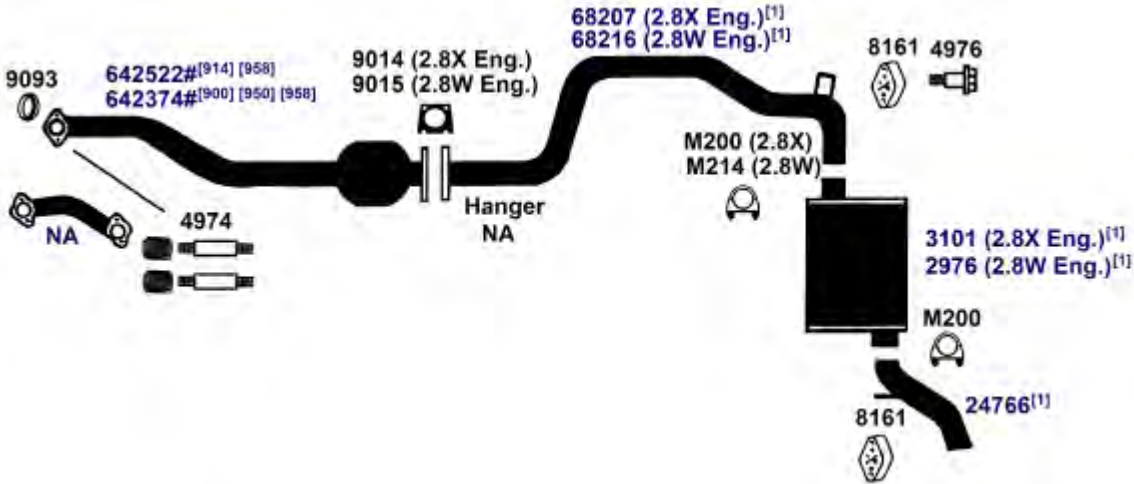

DIRECT FIT MSL/MAXIMUM Muffler... 2.8X Engine- 6538 (2.8X Eng.), 2.8W Engine- 6543 (2.8W Eng.), UNIVERSAL FIT MSL/MAXIMUM Muffler... 2.8X Engine- 709011 (2.8X Eng.), 2.8W Engine- 709012, Silentone DIY Muffler... 2.8X Engine- 5528 (2.8X Eng.), 2.8W Engine- 5528 (2.8W Eng.)

NA-Not Available. NR-Not Required. FL-Remove and Re-Use Old Flange. ● Golden Warehouse. O.E.-Original Equipment.
Airtube Kit [4948] may be required to complete installation. EFI-Electronic Fuel Injection.

[1] OE system was a welded assembly. It is recommended that all parts noted [1] should be replaced.

[900] Direct fit converter may require resizing, cutting or bushing.

[914] Direct fit converter includes front (Exhaust) pipe, (1) piece assembly.

[950] Conv. only, w/o front pipe.

[958] Federal & California Emission vehicles. Not legal for sale for vehicles licensed in California.

OLDSMOBILE CUTLASS, CIERA

1985 4 Cyl. Cutlass Ciera Sta. Wagon, Cutlass Cruiser; 151 Engine (2.5L) **(7689)**

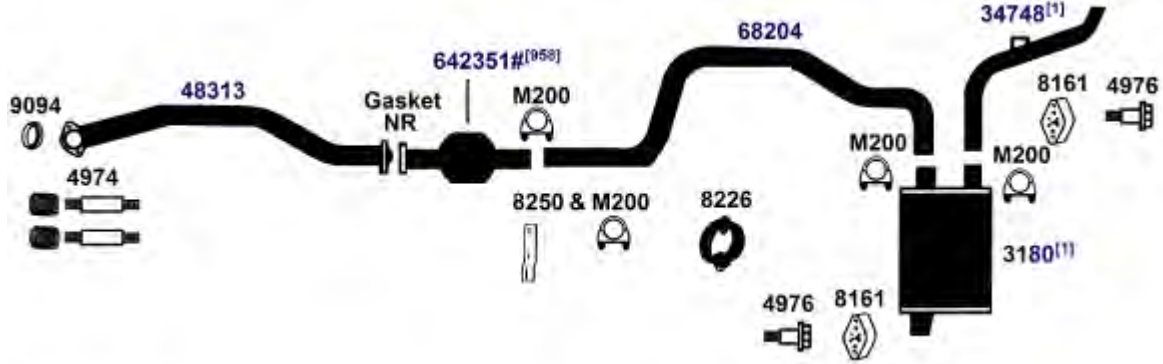

DIRECT FIT MSL/MAXIMUM Muffler... 6564

1985 4 Cyl. Cutlass Ciera; 151 Engine (2.5L); except Sta. Wagon, Cutlass Cruiser **(7690)**

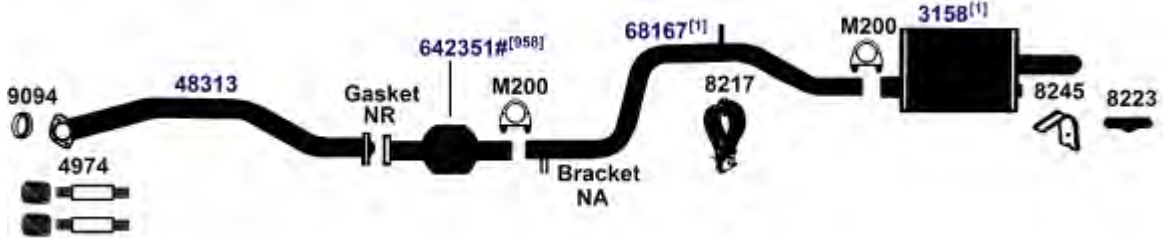

DIRECT FIT MSL/MAXIMUM Muffler... 6573, UNIVERSAL FIT MSL/MAXIMUM Muffler... 6544, 6562, 709014, Silentone DIY Muffler... 5535

1985 6 Cyl. Cutlass Ciera, 260 Diesel Engine (4.3L); except Sta. Wagon **(7721)**



DIRECT FIT MSL/MAXIMUM Muffler... 6573, UNIVERSAL FIT MSL/MAXIMUM Muffler... 6544, 6562, 709014, Silentone DIY Muffler... 5535

NA-Not Available. NR-Not Required. FL-Remove and Re-Use Old Flange. ● Golden Warehouse. O.E.-Original Equipment.
Airtube Kit [4948] may be required to complete installation. EFI-Electronic Fuel Injection.

[1] OE system was a welded assembly. It is recommended that all parts noted [1] should be replaced. [958] Federal & California Emission vehicles. Not legal for sale for vehicles licensed in California.

OLDSMOBILE CUTLASS, CIERA

(7695) 1985 6 Cyl. Cutlass Ciera, 181 Engine (3.0L) (1st Design for 1985 models)[111]

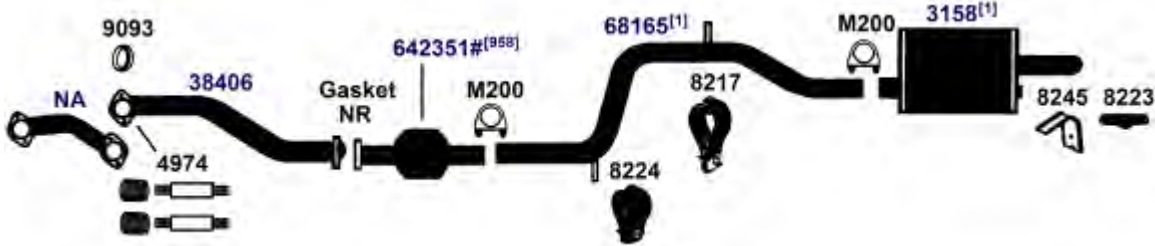

DIRECT FIT MSL/MAXIMUM Muffler... 6573, UNIVERSAL FIT MSL/MAXIMUM Muffler... 6544, 6562, 709014, Silentone DIY Muffler... 5535

(7728) 1985 6 Cyl. Cutlass Ciera Sta. Wagon, Cutlass Cruiser; 181 Engine (3.0L)

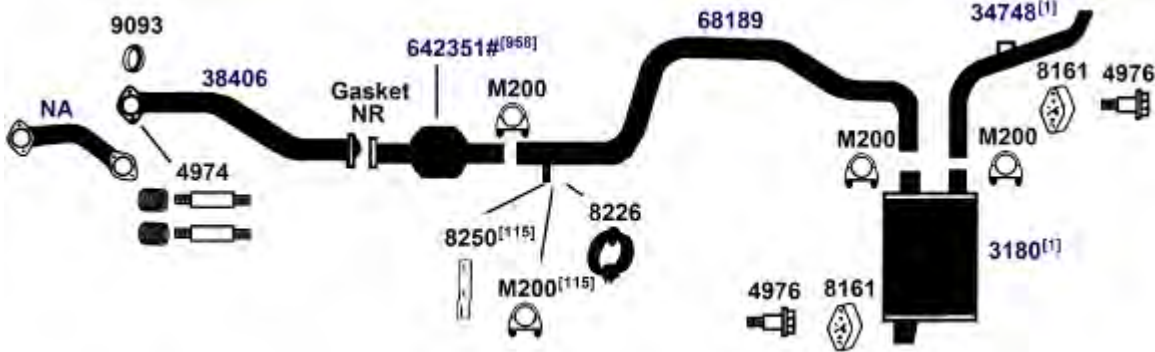

DIRECT FIT MSL/MAXIMUM Muffler... 6564

(7711) 1985 6 Cyl. Cutlass Ciera; 181 Engine (3.0L) (2nd Design)

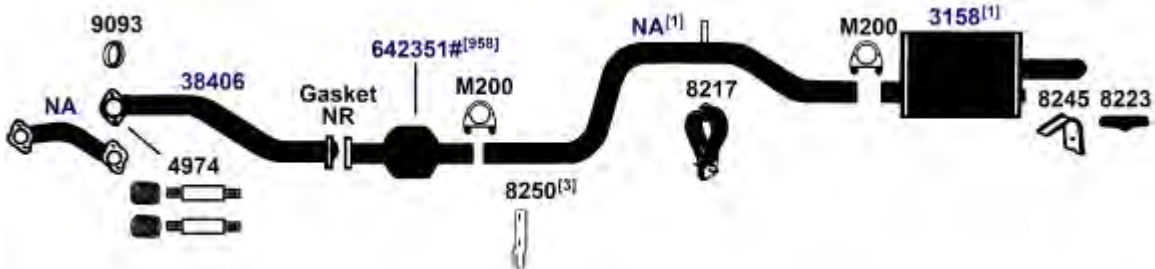

DIRECT FIT MSL/MAXIMUM Muffler... 6573, UNIVERSAL FIT MSL/MAXIMUM Muffler... 6544, 6562, 709014, Silentone DIY Muffler... 5535

NA-Not Available. NR-Not Required. FL-Remove and Re-Use Old Flange. ● Golden Warehouse. O.E.-Original Equipment.
Airtube Kit [4948] may be required to complete installation. EFI-Electronic Fuel Injection.

[1] OE system was a welded assembly. It is recommended that all parts noted [1] should be replaced.
[3] Required for installation.

[115] Not required for installation if bracket is welded on exhaust pipe.
[958] Federal & California Emission vehicles. Not legal for sale for vehicles licensed in California.

OLDSMOBILE CUTLASS, CIERA

1985 6 Cyl. Cutlass Ciera, 231 Engine (3.8L), except Sta. Wagon

(7699)

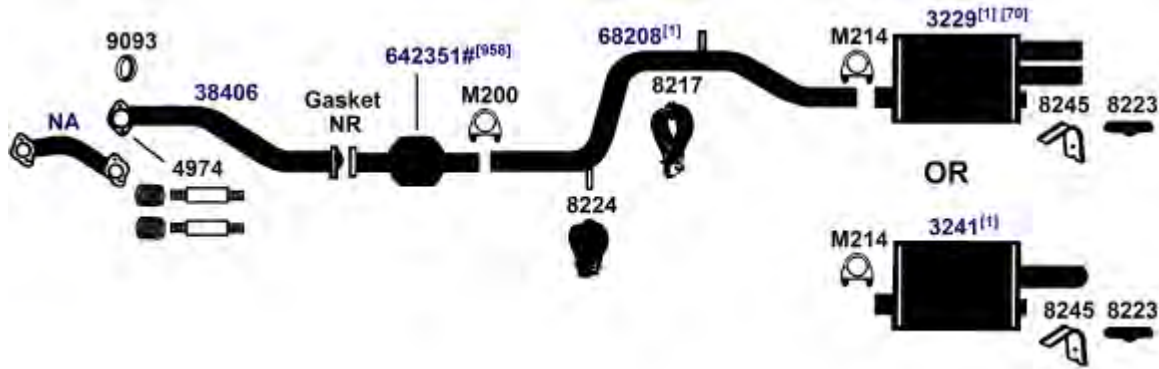

DIRECT FIT MSL/MAXIMUM Muffler... Dual Outlet (3229)- 700091, Single Outlet (3241)- 6591, UNIVERSAL FIT MSL/MAXIMUM Muffler... Dual Outlet (3229)- 6570, 709015, Single Outlet (3241)- 6562, 709014, Silentone DIY Muffler... Single Outlet (3241)- 5556 and 14636 Spout and 8506 Bracket, 8245 hanger

1985 6 Cyl. Cutlass, 260 Diesel Engine (4.3L)

(7693)

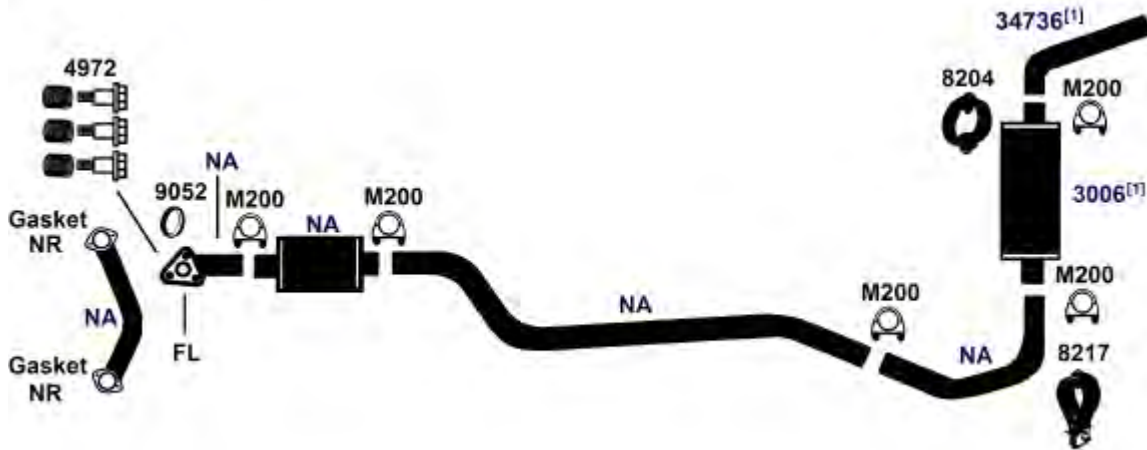

DIRECT FIT MSL/MAXIMUM Muffler... 6540, Silentone DIY Muffler... 5503

NA-Not Available. NR-Not Required. FL-Remove and Re-Use Old Flange. ● Golden Warehouse. O.E.-Original Equipment.
Airtube Kit [4948] may be required to complete installation. EFI-Electronic Fuel Injection.

- [1] OE system was a welded assembly. It is recommended that all parts noted [1] should be replaced.
- [70] On some models the plastic panel below the rear bumper may have to be trimmed for dual spouts on muffler 3229.
- [958] Federal & California Emission vehicles. Not legal for sale for vehicles licensed in California.

OLDSMOBILE CUTLASS, CIERA

(7722) 1985 6 Cyl. Cutlass Ciera Sta. Wagon, 231 Engine (3.8L)

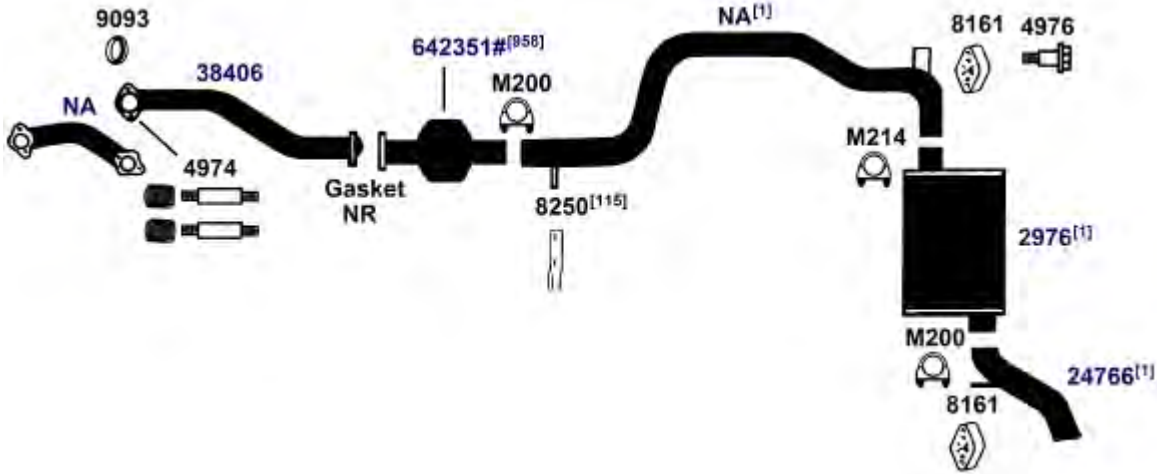

DIRECT FIT MSL/MAXIMUM Muffler... 6543, UNIVERSAL FIT MSL/MAXIMUM Muffler... 709012, Silentone DIY Muffler... 5528

(7687) 1985 6 Cyl. Cutlass Ciera Sta. Wagon, Cutlass Cruiser; 260 Diesel Engine (4.3L)

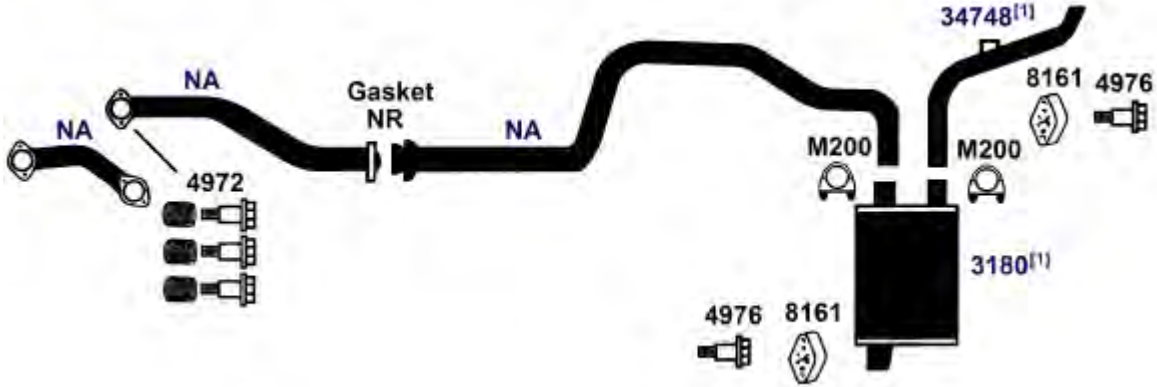

DIRECT FIT MSL/MAXIMUM Muffler... 6564

NA-Not Available. NR-Not Required. FL-Remove and Re-Use Old Flange. ● Golden Warehouse. O.E.-Original Equipment.
Airtube Kit [4948] may be required to complete installation. EFI-Electronic Fuel Injection.

[1] OE system was a welded assembly. It is recommended that all parts noted [1] should be replaced.

[958] Federal & California Emission vehicles. Not legal for sale for vehicles licensed in California.

[115] Not required for installation if bracket is welded on exhaust pipe.

OLDSMOBILE CUTLASS, CIERA

1985 8 Cyl. Cutlass, 350N Diesel Engine (5.7L)

(7691)

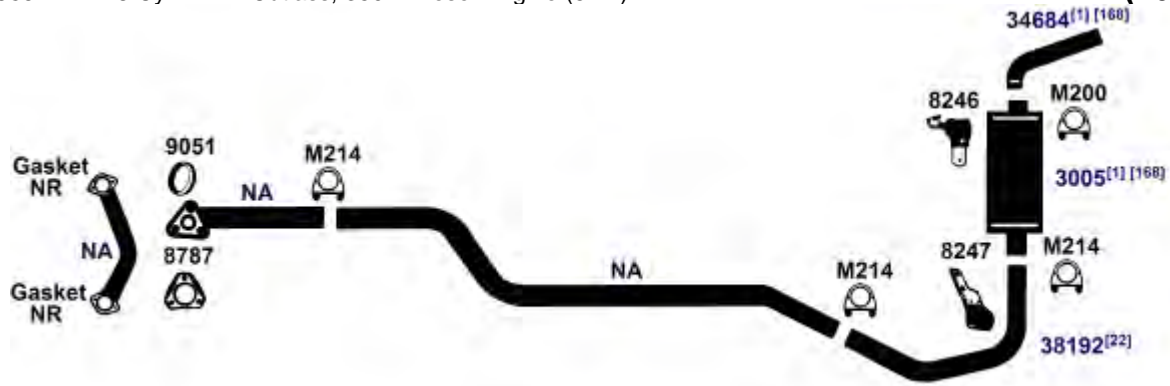

DIRECT FIT MSL/MAXIMUM Muffler... 700057, UNIVERSAL FIT MSL/MAXIMUM Muffler... 6540, Silentone DIY Muffler... 5522

1985 8 Cyl. Cutlass, 307 Engine (5.0L), except models with High Performance (W40)

(7692)

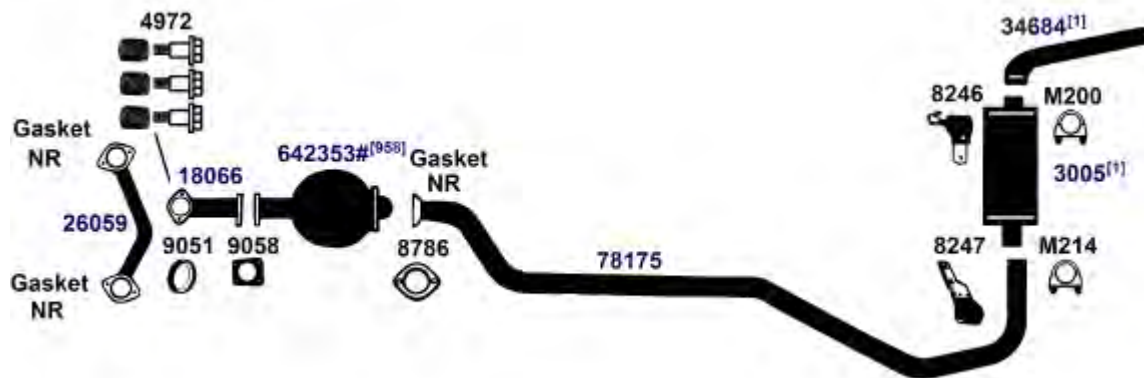

DIRECT FIT MSL/MAXIMUM Muffler... 700057, UNIVERSAL FIT MSL/MAXIMUM Muffler... 6540, Silentone DIY Muffler... 5522

1984 4 Cyl. Cutlass Ciera; 151 Engine (2.5L); except Sta. Wagon, Cutlass Cruiser

(7690E)

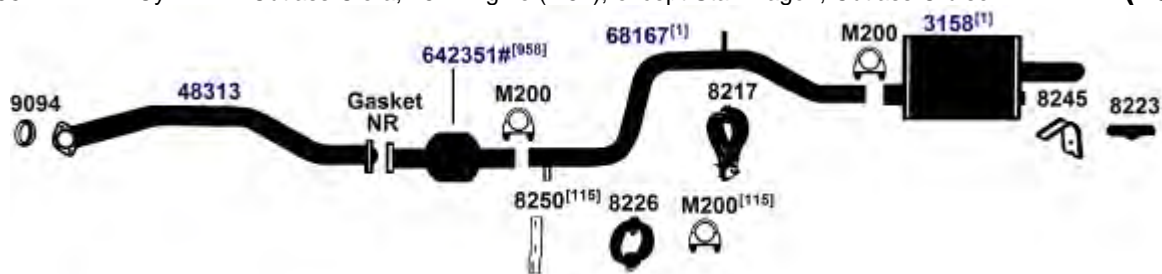

DIRECT FIT MSL/MAXIMUM Muffler... 6573, UNIVERSAL FIT MSL/MAXIMUM Muffler... 6544, 6562, 709014, Silentone DIY Muffler... 5535

NA-Not Available. NR-Not Required. FL-Remove and Re-Use Old Flange. ● Golden Warehouse. O.E.-Original Equipment.
Airtube Kit [4948] may be required to complete installation. EFI-Electronic Fuel Injection.

[1] OE system was a welded assembly. It is recommended that all parts noted [1] should be replaced.

[22] O.E. exhaust pipe was one piece. Replacement is two pieces.

[115] Not required for installation if bracket is welded on exhaust pipe.

[168] Functionally approved Single Outlet System replaces Dual Outlet.

[958] Federal & California Emission vehicles. Not legal for sale for vehicles licensed in California.

OLDSMOBILE CUTLASS, CIERA

(7689E) 1984 4 Cyl. Cutlass Ciera Sta. Wagon, Cutlass Cruiser; 151 (2.5L) Engine

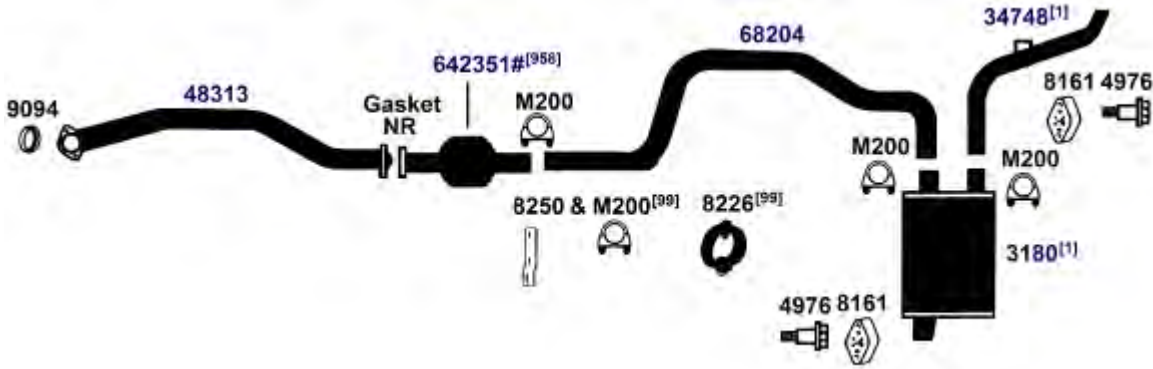

DIRECT FIT MSL/MAXIMUM Muffler... 6564

(7728E) 1984 6 Cyl. Cutlass Ciera Sta. Wagon, Cutlass Cruiser; 181 (3.0L) Engine; 2nd Design [111]

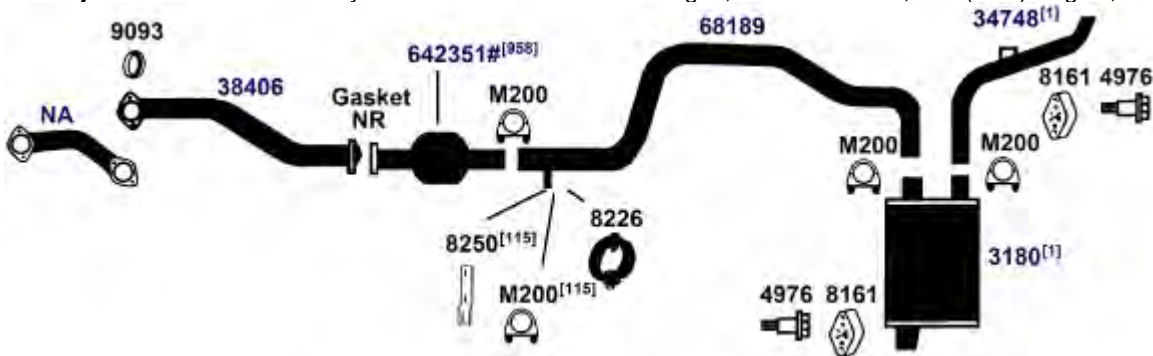

DIRECT FIT MSL/MAXIMUM Muffler... 6564

(7722E) 1984 6 Cyl. Cutlass Ciera Sta. Wagon, 231 (3.8L) Engine

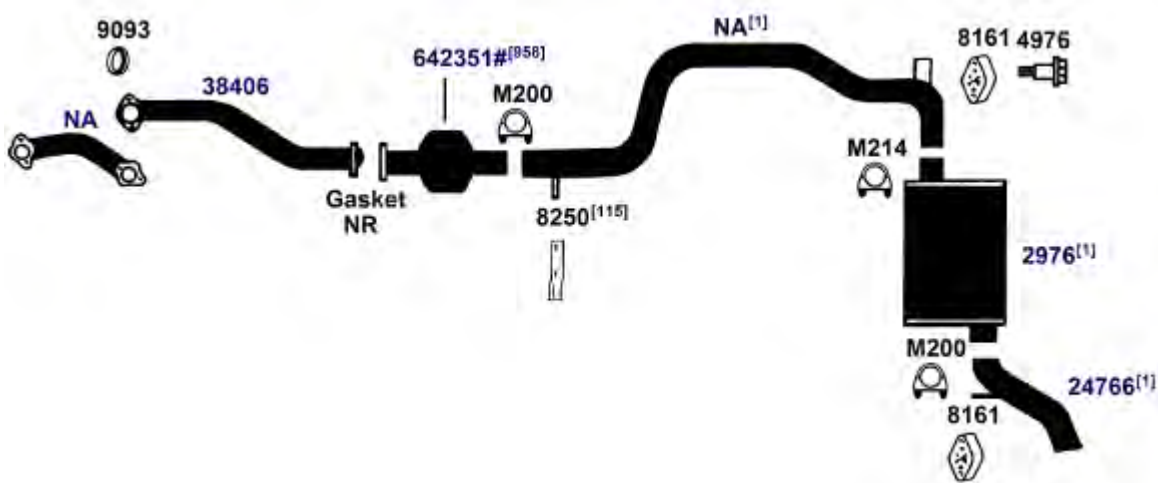

DIRECT FIT MSL/MAXIMUM Muffler... 6543, UNIVERSAL FIT MSL/MAXIMUM Muffler... 709012, Silentone DIY Muffler... 5528

NA-Not Available. NR-Not Required. FL-Remove and Re-Use Old Flange. ● Golden Warehouse. O.E.-Original Equipment.
Airtube Kit [4948] may be required to complete installation. EFI-Electronic Fuel Injection.

[1] OE system was a welded assembly. It is recommended that all parts noted [1] should be replaced.

[99] Required for installation on 1984 models only.

[115] Not required for installation if bracket is welded on exhaust pipe.

[958] Federal & California Emission vehicles. Not legal for sale for vehicles licensed in California.

1984 6 Cyl. Cutlass, 231 (3.8L) Engine

(7694E)



DIRECT FIT MSL/MAXIMUM Muffler... 6540, Silentone DIY Muffler... 5503

1984 6 Cyl. Cutlass Ciera, 231 (3.8-3L) Engine, except Sta. Wagon

(7699E)

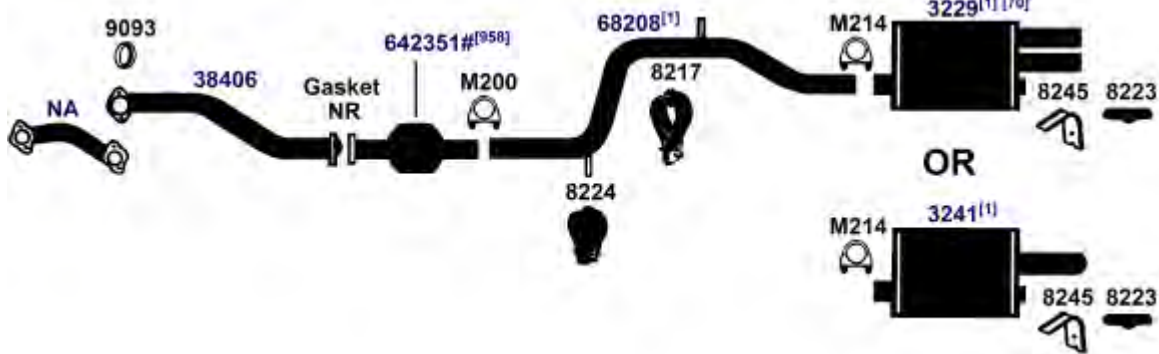

DIRECT FIT MSL/MAXIMUM Muffler... Dual Outlet (3229)- 700091, Single Outlet (3241)- 6591, UNIVERSAL FIT MSL/MAXIMUM Muffler... Dual Outlet (3229)- 6570, 709015, Single Outlet (3241)- 6562, 709014, Silentone DIY Muffler... Single Outlet (3241)- 5556 and 14636 Spout and 8506 Bracket, 8245 hanger

1984 6 Cyl. Cutlass Ciera, 181 Engine (3.0L)

(7695E)

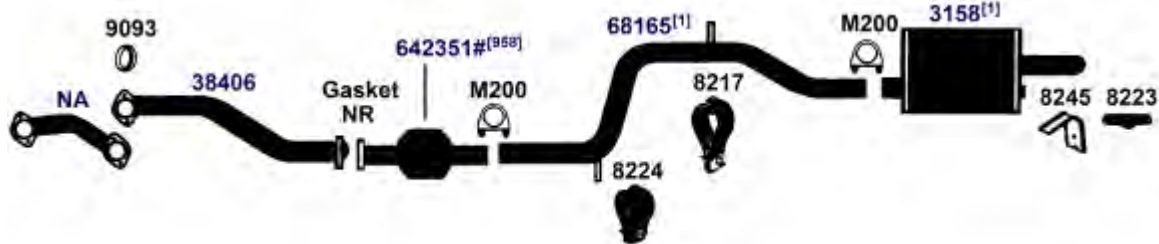

DIRECT FIT MSL/MAXIMUM Muffler... 6573, UNIVERSAL FIT MSL/MAXIMUM Muffler... 6544, 6562, 709014, Silentone DIY Muffler... 5535

NA-Not Available. NR-Not Required. FL-Remove and Re-Use Old Flange. ● Golden Warehouse. O.E.-Original Equipment.
Airtube Kit [4948] may be required to complete installation. EFI-Electronic Fuel Injection.

- [1] OE system was a welded assembly. It is recommended that all parts noted [1] should be replaced.
- [70] On some models the plastic panel below the rear bumper may have to be trimmed for dual spouts on muffler 3229.
- [958] Federal & California Emission vehicles. Not legal for sale for vehicles licensed in California.

OLDSMOBILE CUTLASS, CIERA

(7688) 1984 6 Cyl. Cutlass Ciera Station Wagon, Cutlass Cruiser; 3.0L, 181 Engine; 1st Design[111]

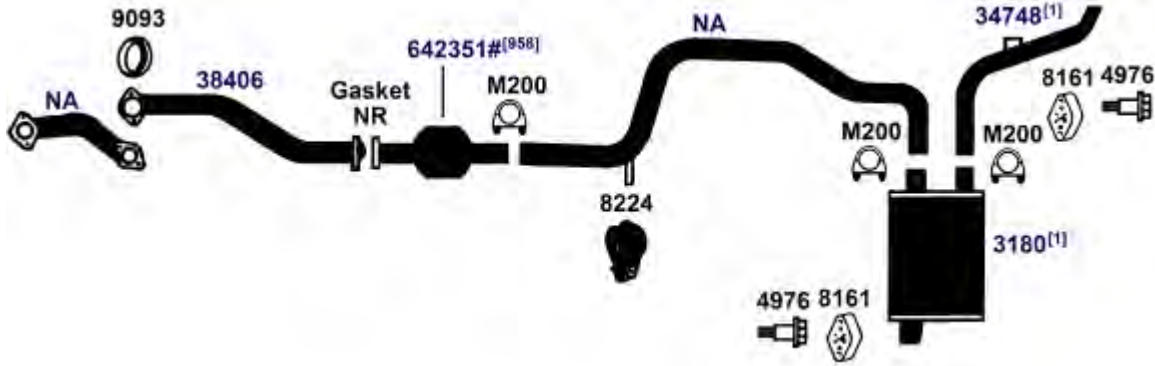

DIRECT FIT MSL/MAXIMUM Muffler... 6564

(7687E) 1984 6 Cyl. Cutlass Ciera Sta. Wagon, Cutlass Cruiser; 260 (4.3L) Diesel Engine

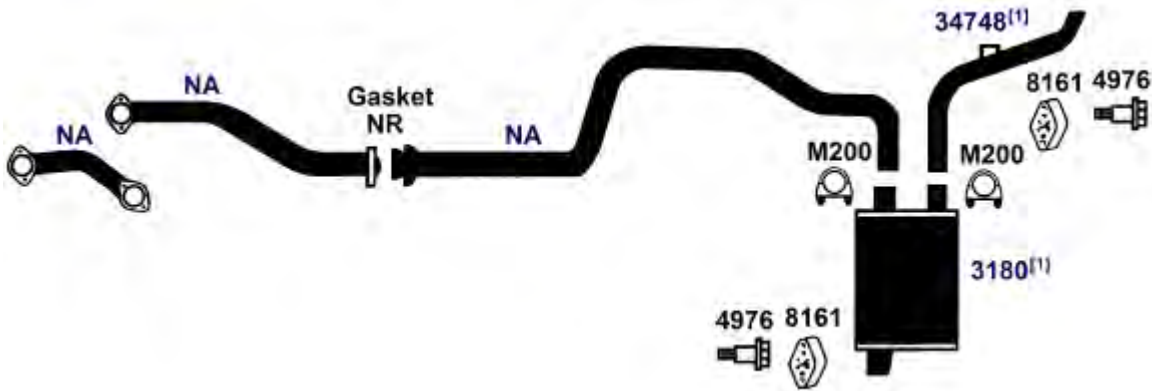

DIRECT FIT MSL/MAXIMUM Muffler... 6564

(7692E) 1984 8 Cyl. Cutlass, 307 Engine (5.0L), except models with High Performance (W40)

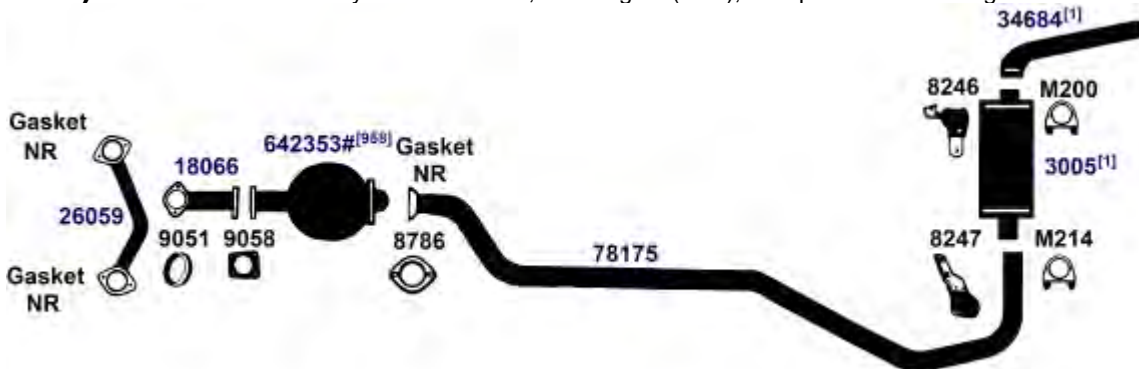

DIRECT FIT MSL/MAXIMUM Muffler... 700057, UNIVERSAL FIT MSL/MAXIMUM Muffler... 6540, Silentone DIY Muffler... 5522

NA-Not Available. NR-Not Required. FL-Remove and Re-Use Old Flange. ● Golden Warehouse. O.E.-Original Equipment.
Airtube Kit [4948] may be required to complete installation. EFI-Electronic Fuel Injection.

[1] OE system was a welded assembly. It is recommended that all parts noted [1] should be replaced. [958] Federal & California Emission vehicles. Not legal for sale for vehicles licensed in California.

1984 8 Cyl. Cutlass, 350N Diesel Engine (5.7L)

(7691E)

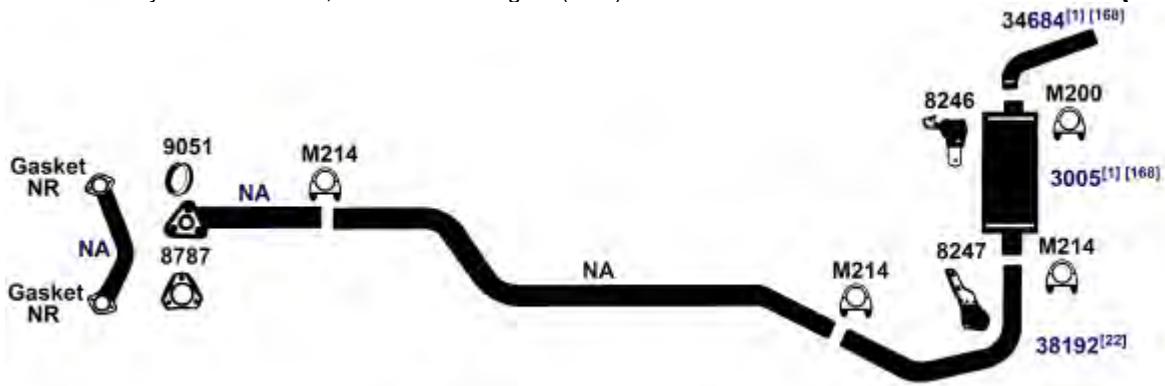

DIRECT FIT MSL/MAXIMUM Muffler... 700057, UNIVERSAL FIT MSL/MAXIMUM Muffler... 6540, Silentone DIY Muffler... 5522

1984 8 Cyl. Cutlass, 5.0L, 305 Engine; Export, Canada

(7686)



DIRECT FIT MSL/MAXIMUM Muffler... 700057, UNIVERSAL FIT MSL/MAXIMUM Muffler... 6540, Silentone DIY Muffler... 5522

1983 6 Cyl. Cutlass, 3.8L, 231 Engine

(7685)

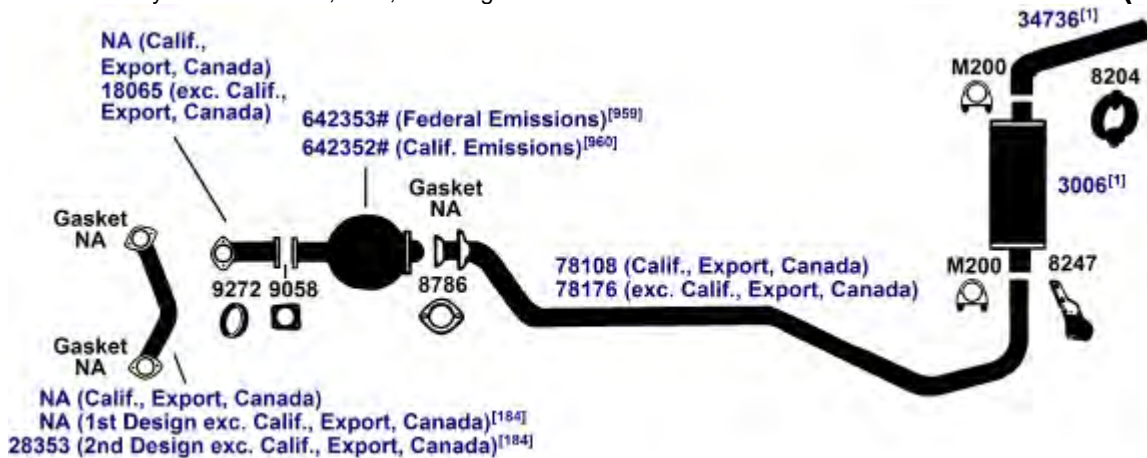

DIRECT FIT MSL/MAXIMUM Muffler... 6540, Silentone DIY Muffler... 5503

NA-Not Available. NR-Not Required. FL-Remove and Re-Use Old Flange. ● Golden Warehouse. O.E.-Original Equipment.
Airtube Kit [4948] may be required to complete installation. EFI-Electronic Fuel Injection.

[1] OE system was a welded assembly. It is recommended that all parts noted [1] should be replaced.
 [22] O.E. exhaust pipe was one piece. Replacement is two pieces.
 [168] Functionally approved Single Outlet System replaces Dual Outlet.
 [184] 1st Design has EFE actuator on left hand manifold. 2nd Design does not.
 [958] Federal & California Emission vehicles. Not legal for sale for vehicles licensed in California.

[959] Federal Emission vehicles. Not legal for sale for vehicles licensed in California.
 [960] California Emission vehicles licensed in states other than California. Not legal for sale for vehicles licensed in California.

OLDSMOBILE CUTLASS, CIERA

(7684) 1983 8 Cyl. Cutlass, 5.0L, 305 Engine; Export, Canada
 1982 8 Cyl. Cutlass, 5.0L, 305H Engine

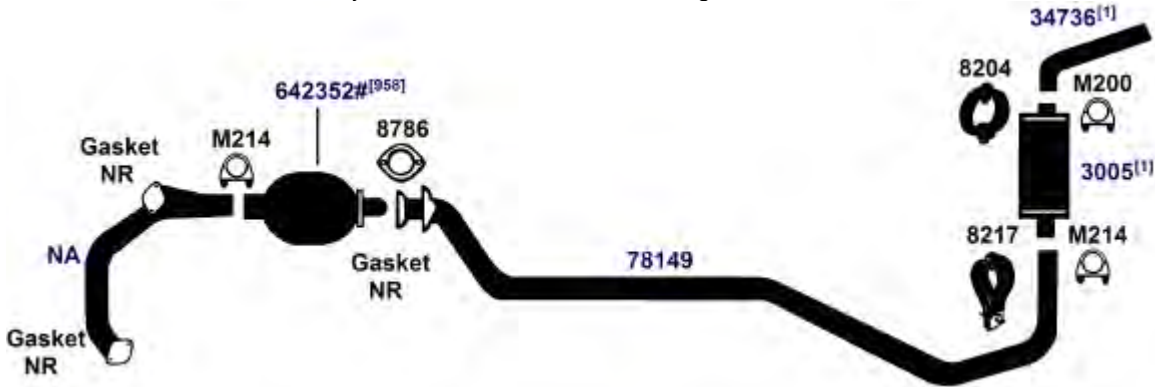

DIRECT FIT MSL/MAXIMUM Muffler... 700057, UNIVERSAL FIT MSL/MAXIMUM Muffler... 6540, Silentone DIY Muffler... 5522

(7683) 1983 8 Cyl. Cutlass, 5.7L, 350N Diesel Engine
 1982 8 Cyl. Cutlass, Cutlass Cruiser; 5.7L, 350N Diesel Engine

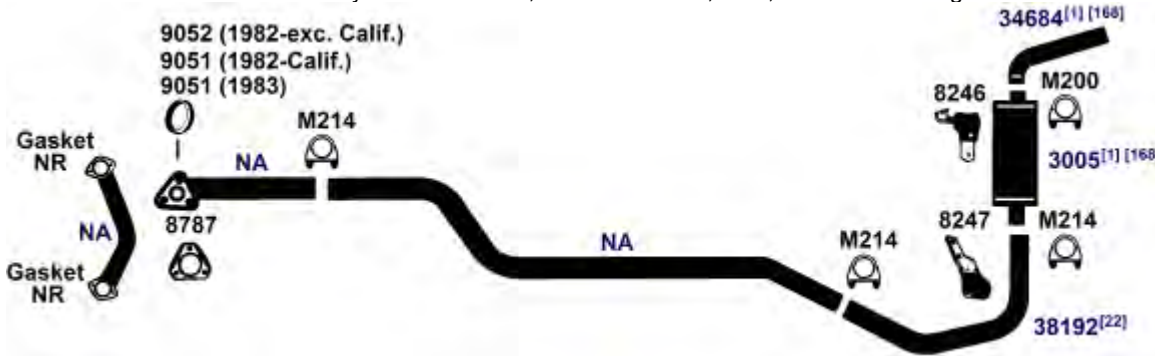

DIRECT FIT MSL/MAXIMUM Muffler... 700057, UNIVERSAL FIT MSL/MAXIMUM Muffler... 6540, Silentone DIY Muffler... 5522

(7682) 82-83 4 Cyl. Cutlas Ciera, 2.5L, 151 Engine

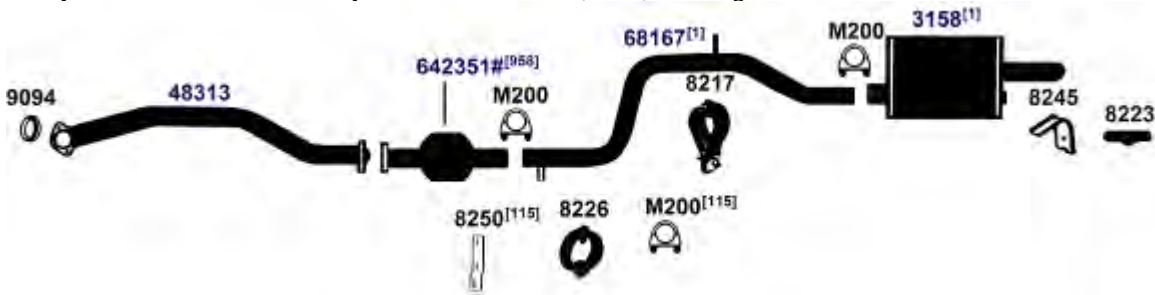

DIRECT FIT MSL/MAXIMUM Muffler... 6573, UNIVERSAL FIT MSL/MAXIMUM Muffler... 6544, 6562, 709014, Silentone DIY Muffler... 5535

NA-Not Available. NR-Not Required. FL-Remove and Re-Use Old Flange. ● Golden Warehouse. O.E.-Original Equipment.
 # Airtube Kit [4948] may be required to complete installation. EFI-Electronic Fuel Injection.

[1] OE system was a welded assembly. It is recommended that all parts noted [1] should be replaced.

[22] O.E. exhaust pipe was one piece. Replacement is two pieces.

[115] Not required for installation if bracket is welded on exhaust pipe.

[168] Functionally approved Single Outlet System replaces Dual Outlet.

[958] Federal & California Emission vehicles. Not legal for sale for vehicles licensed in California.

OLDSMOBILE CUTLASS, CIERA

82-83 6 Cyl. Cutlass Ciera, 3.0L, 181 Engine**(7681)**

DIRECT FIT MSL/MAXIMUM Muffler... 6573, UNIVERSAL FIT MSL/MAXIMUM Muffler... 6544, 6562, 709014, Silentone DIY Muffler... 5535

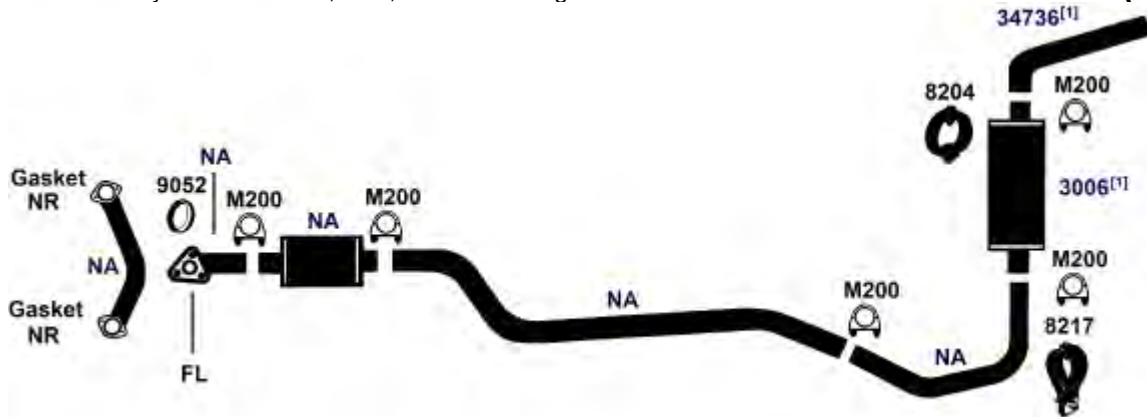
82-83 6 Cyl. Cutlass, 4.3L, 260 Diesel Engine**(7680)**

DIRECT FIT MSL/MAXIMUM Muffler... 6540, Silentone DIY Muffler... 5503

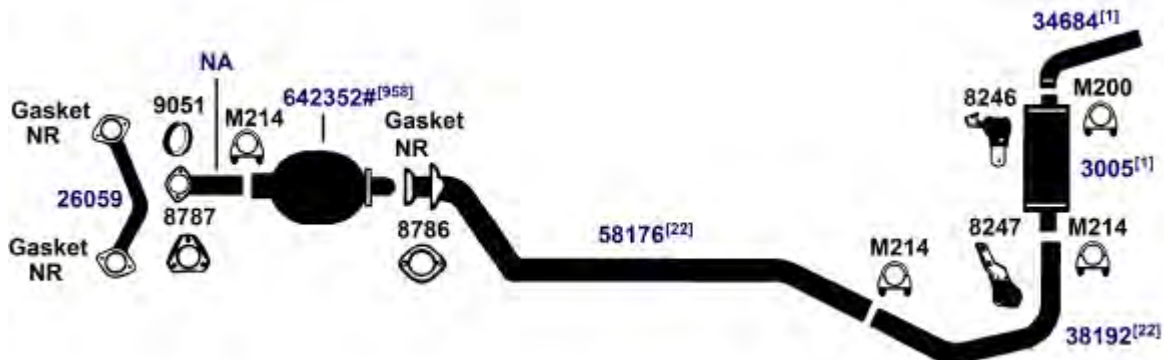
82-83 8 Cyl. Cutlass, 5.0L, 307 Engine; except Models with High Performance (W40)**(7679)**

DIRECT FIT MSL/MAXIMUM Muffler... 700057, UNIVERSAL FIT MSL/MAXIMUM Muffler... 6540, Silentone DIY Muffler... 5522

NA-Not Available. NR-Not Required. FL-Remove and Re-Use Old Flange. ● Golden Warehouse. O.E.-Original Equipment.
Airtube Kit [4948] may be required to complete installation. EFI-Electronic Fuel Injection.

- [1] OE system was a welded assembly. It is recommended that all parts noted [1] should be replaced. [958] Federal & California Emission vehicles. Not legal for sale for vehicles licensed in California.
- [22] O.E. exhaust pipe was one piece. Replacement is two pieces.

OLDSMOBILE CUTLASS, CIERA

(7677) 1982 6,8 Cyl. Cutlass, Cutlass Cruiser; 231 (3.8L), 260 (4.3L) Engine; except Diesel
 1981 8 Cyl. Cutlass, Cutlass Cruiser; 260F (4.3L) Engine

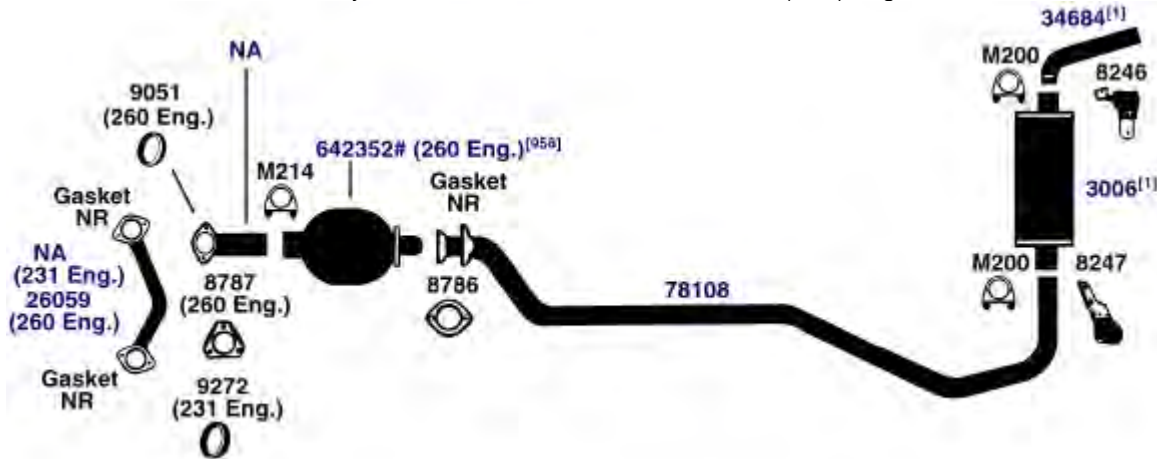

DIRECT FIT MSL/MAXIMUM Muffler... 6540, Silentone DIY Muffler... 5503

(7676) 1982 8 Cyl. Cutlass, 4.4L, 267 Engine



DIRECT FIT MSL/MAXIMUM Muffler... 6540, Silentone DIY Muffler... 5503

NA-Not Available. NR-Not Required. FL-Remove and Re-Use Old Flange. ● Golden Warehouse. O.E.-Original Equipment.
 # Airtube Kit [4948] may be required to complete installation. EFI-Electronic Fuel Injection.

[1] OE system was a welded assembly. It is recommended that all parts noted [1] should be replaced.

[22] O.E. exhaust pipe was one piece. Replacement is two pieces.

[98] Refer to current Catalytic Converter catalog or Website catalog for availability.
 [958] Federal & California Emission vehicles. Not legal for sale for vehicles licensed in California.

OLDSMOBILE CUTLASS, CIERA

1981 8 Cyl. Cutlass, 4.4L, 267 Engine

(7673)

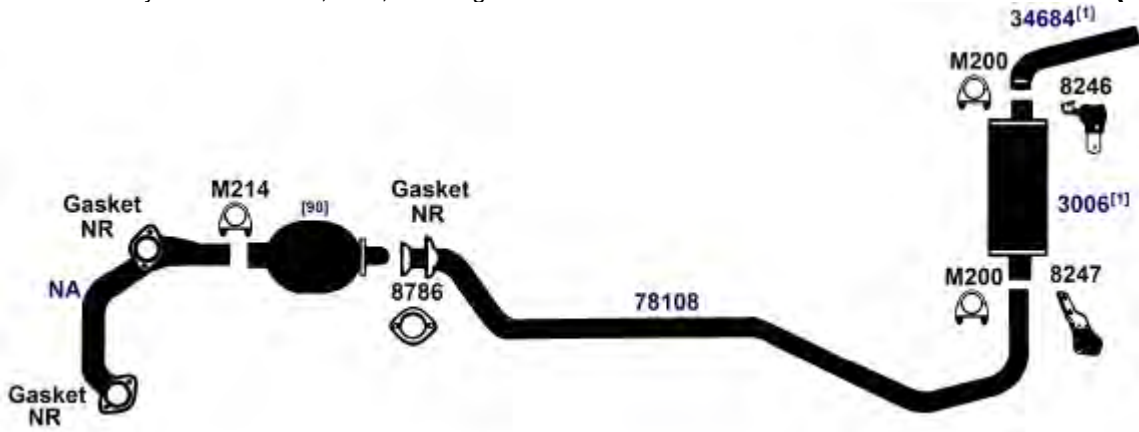

DIRECT FIT MSL/MAXIMUM Muffler... 6540, Silentone DIY Muffler... 5503

80-81 6 Cyl. Cutlass, Cutlass Cruiser; 3.8L, 231 Engine

(7672)

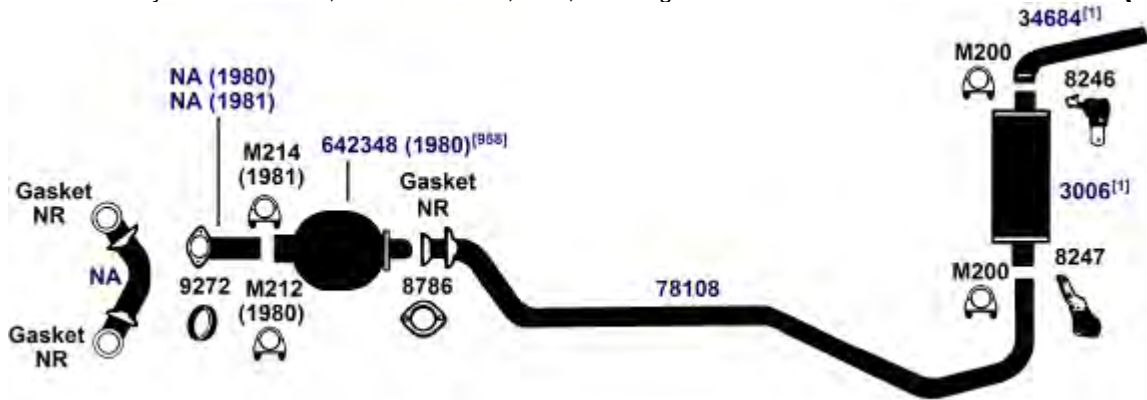

DIRECT FIT MSL/MAXIMUM Muffler... 6540, Silentone DIY Muffler... 5503

NA-Not Available. NR-Not Required. FL-Remove and Re-Use Old Flange. ● Golden Warehouse. O.E.-Original Equipment.
Airtube Kit [4948] may be required to complete installation. EFI-Electronic Fuel Injection.

[1] OE system was a welded assembly. It is recommended that all parts noted [1] should be replaced.

[958] Federal & California Emission vehicles. Not legal for sale for vehicles licensed in California.

[98] Refer to current Catalytic Converter catalog or Website catalog for availability.

OLDSMOBILE CUTLASS, CIERA

(7724) 80-81 8 Cyl. Cutlass, Cutlass Cruiser; 307, 350R Engine; except Diesel

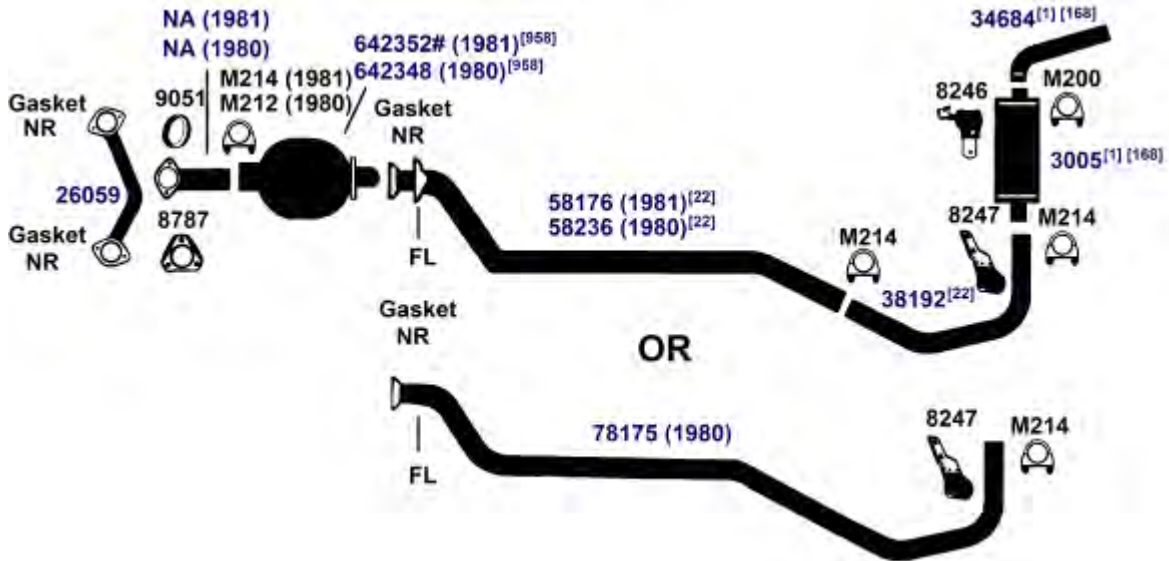

DIRECT FIT MSL/MAXIMUM Muffler... 700057, UNIVERSAL FIT MSL/MAXIMUM Muffler... 6540, Silentone DIY Muffler... 5522

(7723) 80-81 8 Cyl. Cutlass, Cutlass Cruiser; 260P, 350N Diesel Engine
1979 8 Cyl. Cutlass, All Models with 260P, 350N Diesel Engine



DIRECT FIT MSL/MAXIMUM Muffler... 700057, UNIVERSAL FIT MSL/MAXIMUM Muffler... 6540, Silentone DIY Muffler... 5522

NA-Not Available. NR-Not Required. FL-Remove and Re-Use Old Flange. ● Golden Warehouse. O.E.-Original Equipment.
Airtube Kit [4948] may be required to complete installation. EFI-Electronic Fuel Injection.

[1] OE system was a welded assembly. It is recommended that all parts noted [1] should be replaced.

[22] O.E. exhaust pipe was one piece. Replacement is two pieces.

[168] Functionally approved Single Outlet System replaces Dual Outlet.

[169] Functionally approved Single Outlet System may replace Dual Outlet.

[958] Federal & California Emission vehicles. Not legal for sale for vehicles licensed in California.

OLDSMOBILE CUTLASS, CIERA

80-81 8 Cyl. Cutlass, Cutlass Cruiser Station Wagon; 5.0L, 305H Engine

(7669)



DIRECT FIT MSL/MAXIMUM Muffler... 700057, UNIVERSAL FIT MSL/MAXIMUM Muffler... 6540, Silentone DIY Muffler... 5522

1980 8 Cyl. Cutlass, Cutlass Cruiser; 260F (4.3L) Engine

(7671)

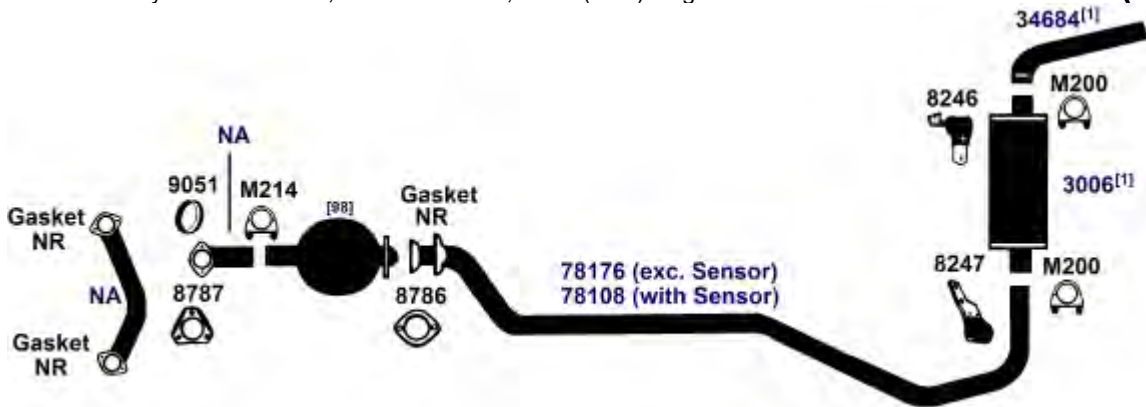

DIRECT FIT MSL/MAXIMUM Muffler... 6540, Silentone DIY Muffler... 5503

1979 6 Cyl. Cutlass, Vista Cruiser; 231 Engine

(7666)

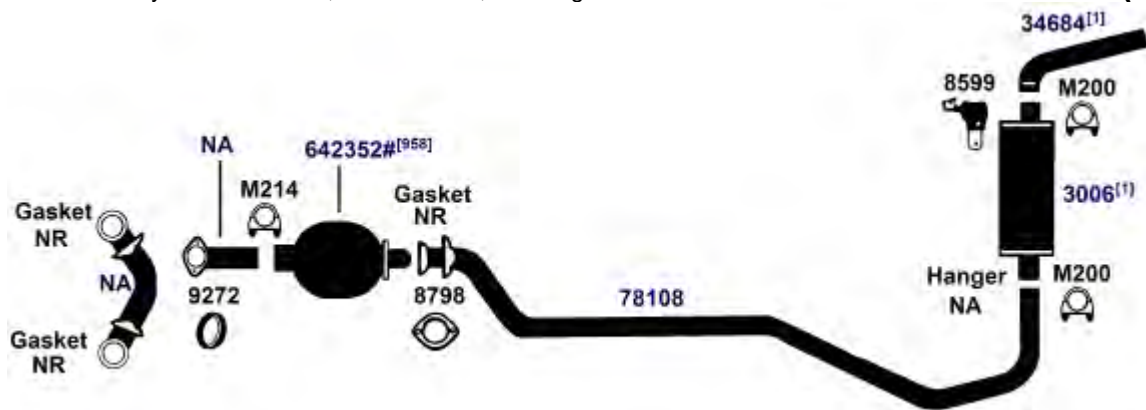

DIRECT FIT MSL/MAXIMUM Muffler... 6540, Silentone DIY Muffler... 5503

NA-Not Available. NR-Not Required. FL-Remove and Re-Use Old Flange. ● Golden Warehouse. O.E.-Original Equipment.
Airtube Kit [4948] may be required to complete installation. EFI-Electronic Fuel Injection.

[1] OE system was a welded assembly. It is recommended that all parts noted [1] should be replaced.

[22] O.E. exhaust pipe was one piece. Replacement is two pieces.

[98] Refer to current Catalytic Converter catalog or Website catalog for availability.
[958] Federal & California Emission vehicles. Not legal for sale for vehicles licensed in California.

OLDSMOBILE CUTLASS, CIERA

(7663) 1979 8 Cyl. Cutlass, 350R Engine (Hurst)

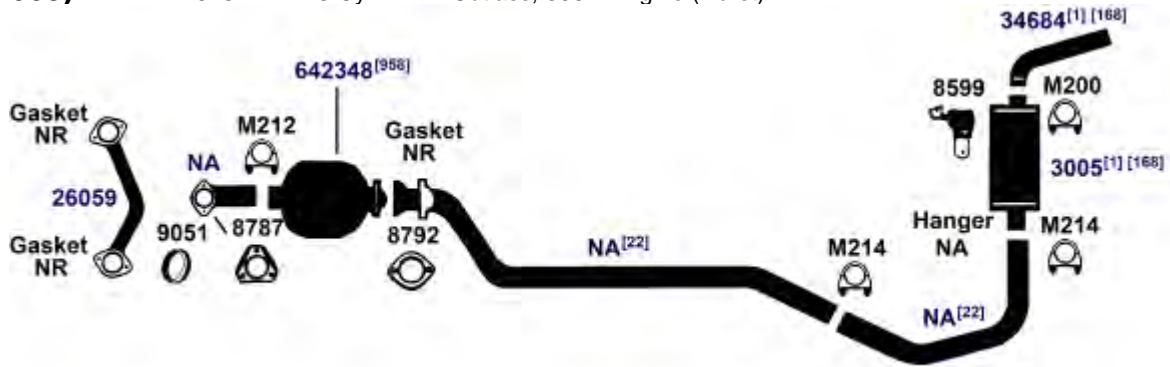

DIRECT FIT MSL/MAXIMUM Muffler... 700057, UNIVERSAL FIT MSL/MAXIMUM Muffler... 6540, Silentone DIY Muffler... 5522

(7662) 1979 8 Cyl. Cutlass, Vista Cruiser; 260 Engine, 1st Design with 2" I.D. Muffler Inlet

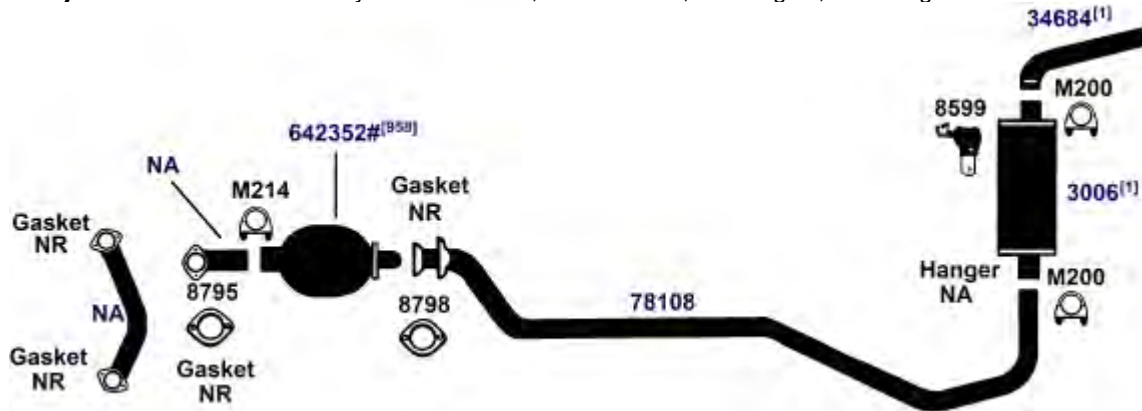

DIRECT FIT MSL/MAXIMUM Muffler... 6540, Silentone DIY Muffler... 5503

(7665) 1979 8 Cyl. Cutlass, Vista Cruiser; 260 Engine, 2nd Design with 1 3/4" I.D. Muffler Inlet



UNIVERSAL FIT MSL/MAXIMUM Muffler... 6540

NA-Not Available. NR-Not Required. FL-Remove and Re-Use Old Flange. ● Golden Warehouse. O.E.-Original Equipment.
Airtube Kit [4948] may be required to complete installation. EFI-Electronic Fuel Injection.

[1] OE system was a welded assembly. It is recommended that all parts noted [1] should be replaced.

[22] O.E. exhaust pipe was one piece. Replacement is two pieces.

[168] Functionally approved Single Outlet System replaces Dual Outlet.

[958] Federal & California Emission vehicles. Not legal for sale for vehicles licensed in California.

OLDSMOBILE CUTLASS, CIERA

1979 8 Cyl. Cutlass Cruiser Station Wagon, 305H (4-barrel Carb.), 350L Engine

(7660)



DIRECT FIT MSL/MAXIMUM Muffler... 700057, UNIVERSAL FIT MSL/MAXIMUM Muffler... 6540, Silentone DIY Muffler... 5522

OLDSMOBILE FIRENZA

87-88 4 Cyl. Firenza, Sedan, Station Wagon; 121 Engine (2.0L)
1987 6 Cyl. Firenza, 173 Engine (2.8W); except Sta. Wagon

(7755)

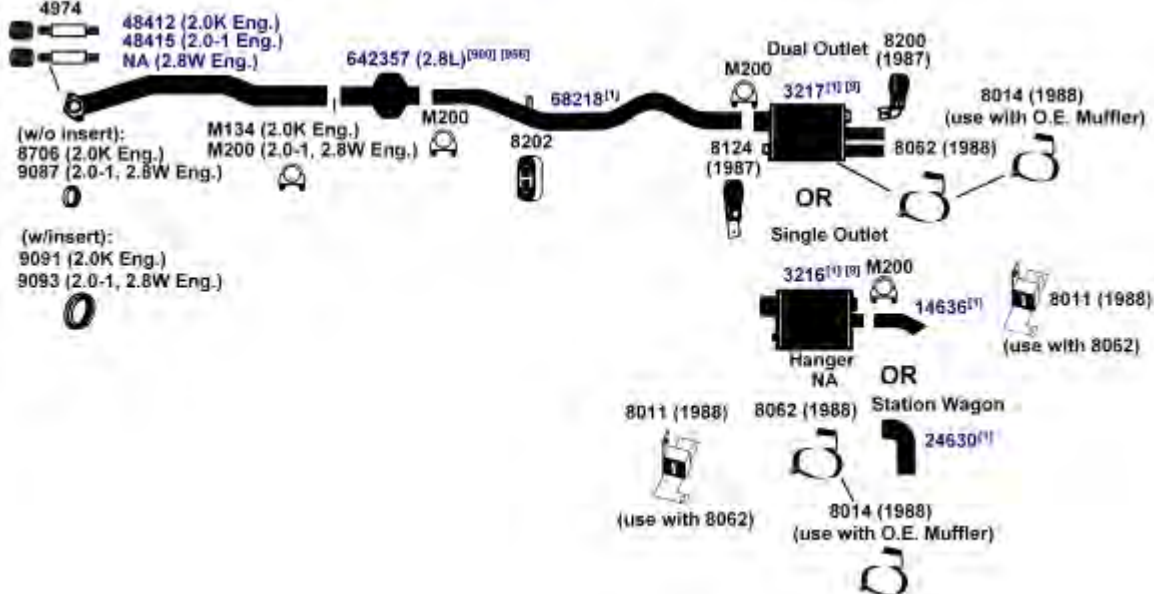

DIRECT FIT MSL/MAXIMUM Muffler... Dual Outlet (1987) (3217)- 6575, Single Outlet (3216)- 6560, 700060 with spout on muffler (rear exit only), UNIVERSAL FIT MSL/MAXIMUM Muffler... Dual Outlet (1987) (3217)- 709015, 6561, 709015, Single Outlet (3216)- 6536, 700060 with spout on muffler (rear exit only), Silentone DIY Muffler... Dual Outlet (1987) (3217)- 5545 two 14636 Spouts and 8062 Hanger, Single Outlet (3216)- 5555

NA-Not Available. NR-Not Required. FL-Remove and Re-Use Old Flange. ● Golden Warehouse. O.E.-Original Equipment.
Airtube Kit [4948] may be required to complete installation. EFI-Electronic Fuel Injection.

- [1] OE system was a welded assembly. It is recommended that all parts noted [1] should be replaced.
[9] Brackets on heads of muffler are not used on 88-90 applications.
[22] O.E. exhaust pipe was one piece. Replacement is two pieces.
[98] Refer to current Catalytic Converter catalog or Website catalog for availability.
[168] Functionally approved Single Outlet System replaces Dual Outlet.

- [900] Direct fit converter may require resizing, cutting or bushing.
[958] Federal & California Emission vehicles. Not legal for sale for vehicles licensed in California.

OLDSMOBILE FIRENZA

(7751) 85-86 4,6 Cyl. Firenza 4 Door Sedan; 2.0-P (Vin Code P), 2.8 (Vin Code W) Engine; with Converter

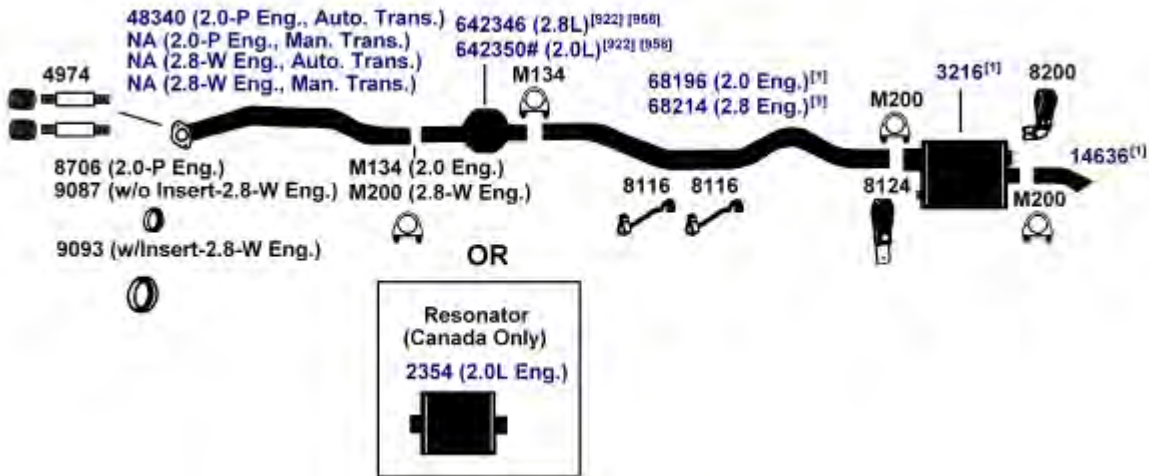

DIRECT FIT MSL/MAXIMUM Muffler... Rear Muffler- 6560, 700060 with spout on muffler (rear exit only)., UNIVERSAL FIT MSL/MAXIMUM Muffler... Rear Muffler- 6536, Silentone DIY Muffler... Rear Muffler- 5555

(7753) 85-86 4,6 Cyl. Firenza, Sedan, Station Wagon; 1.8 Engine (Vin Code O); 2.0 Engine (Vin Code P), 2.8 Engine (Vin Code W), Hatchback Models; with Converter

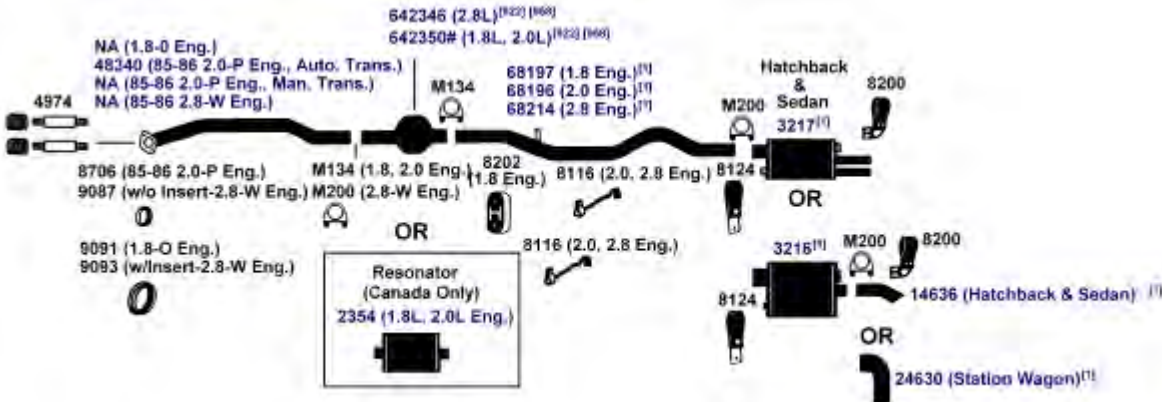

DIRECT FIT MSL/MAXIMUM Muffler... Dual Outlet Muffler (3217)- 6575, Single Outlet Muffler (3216)- 6560, 700060 with spout on muffler (rear exit only)., UNIVERSAL FIT MSL/MAXIMUM Muffler... Dual Outlet Muffler (3217)- 6561, 709015, Single Outlet Muffler (3216)- 6536, Silentone DIY Muffler... Dual Outlet Muffler (3217)- 5545 two 14636 Spouts and 8062 Hanger, Single Outlet Muffler (3216)- 5555

NA-Not Available. NR-Not Required. FL-Remove and Re-Use Old Flange. ● Golden Warehouse. O.E.-Original Equipment.
Airtube Kit [4948] may be required to complete installation. EFI-Electronic Fuel Injection.

[1] OE system was a welded assembly. It is recommended that all parts noted [1] should be replaced. [958] Federal & California Emission vehicles. Not legal for sale for vehicles licensed in California.

[922] Trim Outlet pipe to fit length required

1984 4 Cyl. Firenza, Includes Station Wagon; 1.8-O Engine (Vin Code O); 2.0-P Engine (Vin Code P), Hatchback Models; 2nd Design only (with Brackets on Muffler Heads); with Converter **(7753E)**

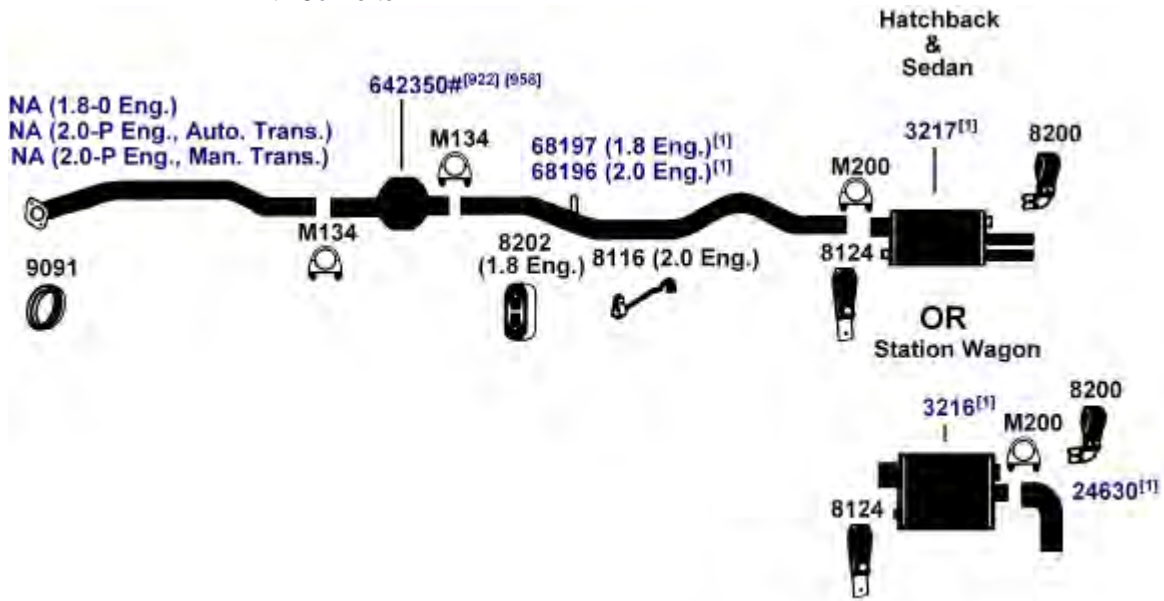

DIRECT FIT MSL/MAXIMUM Muffler... Dual Outlet Muffler (3217)- 6575, Single Outlet Muffler (3216)- 6560, 700060 with spout on muffler (rear exit only)., UNIVERSAL FIT MSL/MAXIMUM Muffler... Dual Outlet Muffler (3217)- 6561, 709015, Single Outlet Muffler (3216)- 6536, Silentone DIY Muffler... Dual Outlet Muffler (3217)- 5545 two 14636 Spouts and 8062 Hanger, Single Outlet Muffler (3216)- 5555

1984 4 Cyl. Firenza 4-Door Sedan, 2.0-P (VIN Code P) Engine, 2nd Design only (with Brackets on Muffler Heads), with Converter **(7751E)**

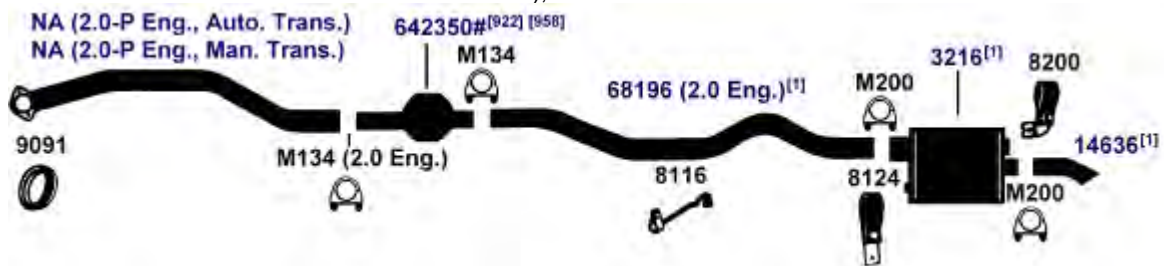

DIRECT FIT MSL/MAXIMUM Muffler... 6560, 700060 with spout on muffler (rear exit only)., UNIVERSAL FIT MSL/MAXIMUM Muffler... 6536, Silentone DIY Muffler... 5555

NA-Not Available. NR-Not Required. FL-Remove and Re-Use Old Flange. ● Golden Warehouse. O.E.-Original Equipment.
Airtube Kit [4948] may be required to complete installation. EFI-Electronic Fuel Injection.

[1] OE system was a welded assembly. It is recommended that all parts noted [1] should be replaced. [958] Federal & California Emission vehicles. Not legal for sale for vehicles licensed in California.
[922] Trim Outlet pipe to fit length required

OLDSMOBILE FIRENZA

(7748) 1984 4 Cyl. Firenza, 2.0L Engine, 1st Design only, except Station Wagon (VIN Code P)
 1983 4 Cyl. Firenza, 2.0L Engine, except Station Wagon (VIN Code P)

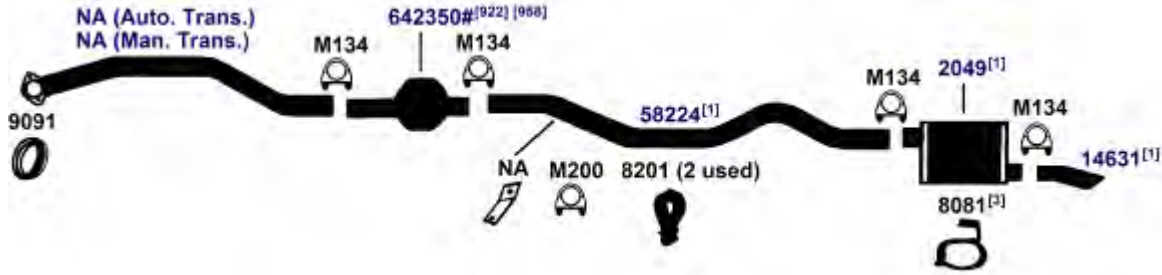

DIRECT FIT MSL/MAXIMUM Muffler... 700047, UNIVERSAL FIT MSL/MAXIMUM Muffler... 6544, 709011, Silentone DIY Muffler... 5535

(7747) 1984 4 Cyl. Firenza Station Wagon, 2.0L Engine, 1st Design only (VIN Code P)
 1983 4 Cyl. Firenza Station Wagon, 2.0L Engine (VIN Code P)

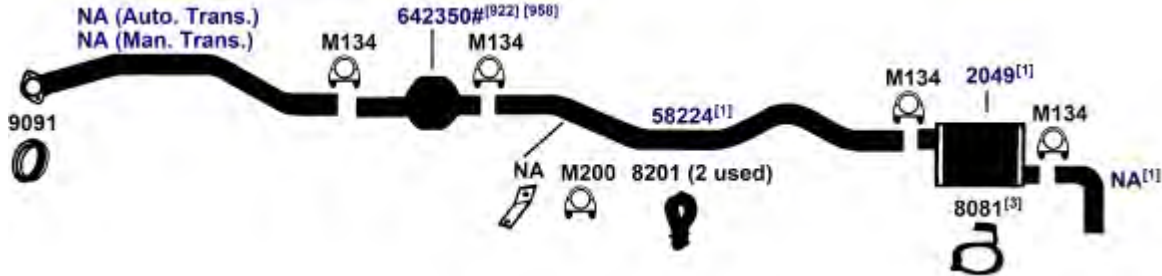

DIRECT FIT MSL/MAXIMUM Muffler... 700047, UNIVERSAL FIT MSL/MAXIMUM Muffler... 6544, 709011, Silentone DIY Muffler... 5535

(7749) 83-84 4 Cyl. Firenza Station Wagon, 1.8L Engine, 1984 1st Design (VIN Code O)



DIRECT FIT MSL/MAXIMUM Muffler... 700047, UNIVERSAL FIT MSL/MAXIMUM Muffler... 6544, 709011, Silentone DIY Muffler... 5535

NA-Not Available. NR-Not Required. FL-Remove and Re-Use Old Flange. ● Golden Warehouse. O.E.-Original Equipment.
 # Airtube Kit [4948] may be required to complete installation. EFI-Electronic Fuel Injection.

[1] OE system was a welded assembly. It is recommended that all parts noted [1] should be replaced.

[3] Required for installation.

[168] Functionally approved Single Outlet System replaces Dual Outlet.

[218] From O.E. resonator inlet weld, measure along pipe 3-3/4" to cut-off.

[922] Trim Outlet pipe to fit length required

[958] Federal & California Emission vehicles. Not legal for sale for vehicles licensed in California.

OLDSMOBILE FIRENZA

1982 4 Cyl. Firenza, 1.8G Engine

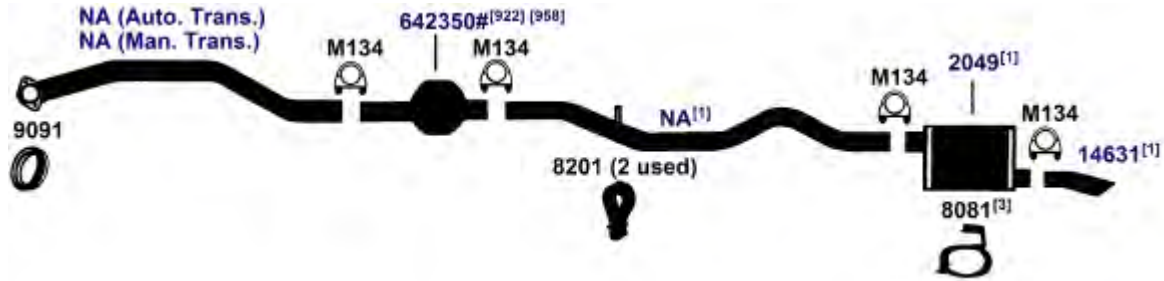
(7746)

DIRECT FIT MSL/MAXIMUM Muffler... 700047, UNIVERSAL FIT MSL/MAXIMUM Muffler... 6544, 709011, Silentone DIY Muffler... 5535

OLDSMOBILE OMEGA

82-84 4 Cyl. Omega, 2.5L, 151 Engine

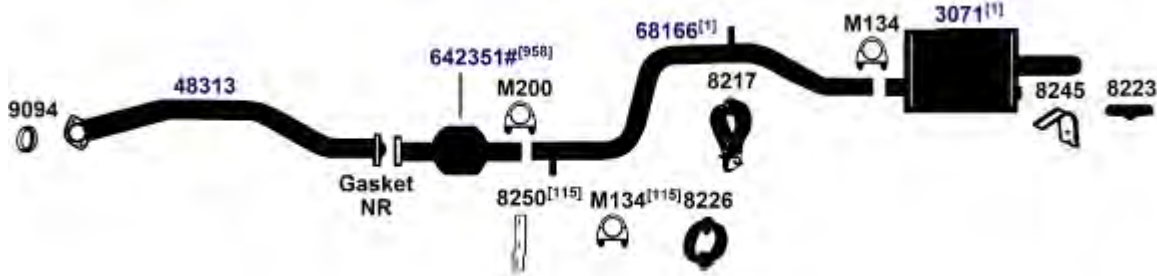
(7820)

DIRECT FIT MSL/MAXIMUM Muffler... 700063, UNIVERSAL FIT MSL/MAXIMUM Muffler... 6544, 709010, Silentone DIY Muffler... 5535

82-84 6 Cyl. Omega, 2.8X, 173 Engine

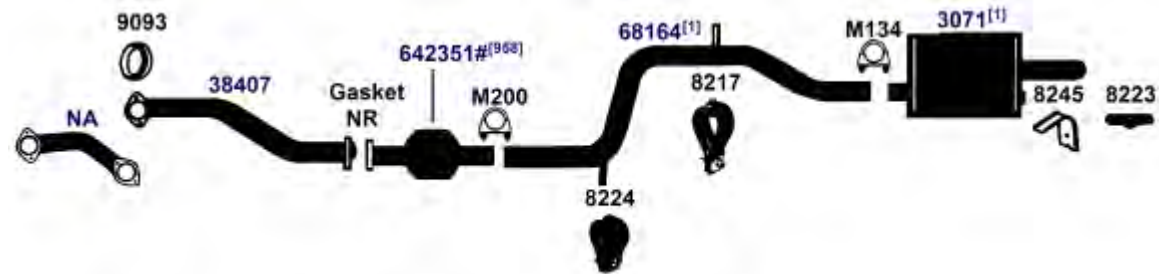
(7819)

DIRECT FIT MSL/MAXIMUM Muffler... 700063, UNIVERSAL FIT MSL/MAXIMUM Muffler... 6544, 709010, Silentone DIY Muffler... 5535

NA-Not Available. NR-Not Required. FL-Remove and Re-Use Old Flange. ● Golden Warehouse. O.E.-Original Equipment.
Airtube Kit [4948] may be required to complete installation. EFI-Electronic Fuel Injection.

[1] OE system was a welded assembly. It is recommended that all parts noted [1] should be replaced.

[3] Required for installation.

[115] Not required for installation if bracket is welded on exhaust pipe.

[218] From O.E. resonator inlet weld, measure along pipe 3-3/4" to cut-off.

[922] Trim Outlet pipe to fit length required

[958] Federal & California Emission vehicles. Not legal for sale for vehicles licensed in California.

OLDSMOBILE OMEGA

(7818) 1981 4 Cyl. Omega, 2.5L, 151 Engine

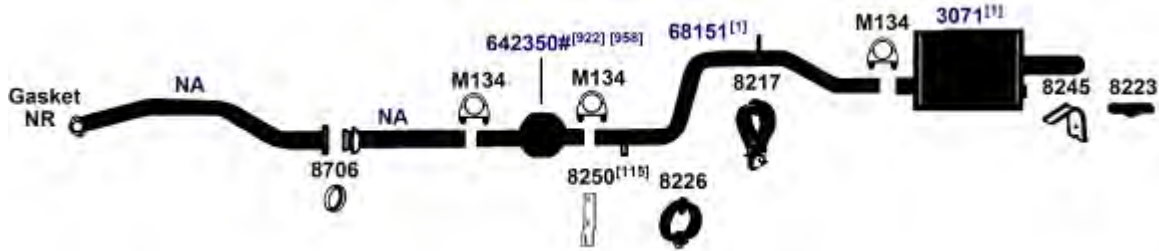

DIRECT FIT MSL/MAXIMUM Muffler... 700063, UNIVERSAL FIT MSL/MAXIMUM Muffler... 6544, 709010, Silentone DIY Muffler... 5535

(7817) 1981 6 Cyl. Omega, 2.8X, 2.8Z, 173 Engine



DIRECT FIT MSL/MAXIMUM Muffler... 700063, UNIVERSAL FIT MSL/MAXIMUM Muffler... 6544, 709010, Silentone DIY Muffler... 5535

(7816) 1980 4 Cyl. Omega, 151 Engine

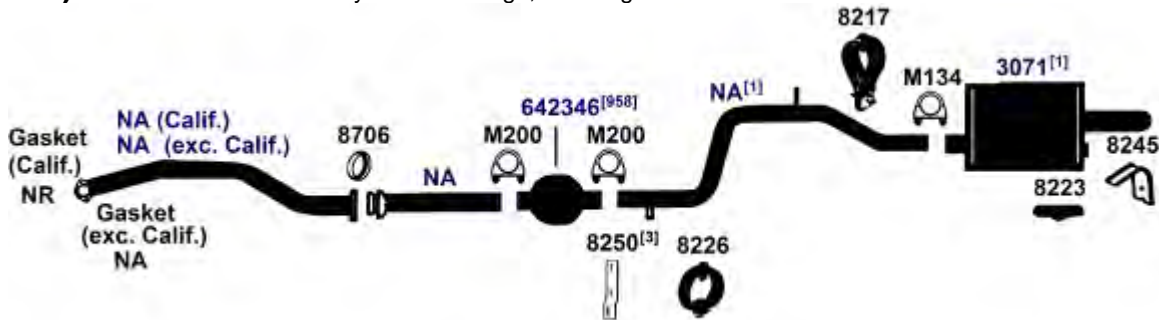

DIRECT FIT MSL/MAXIMUM Muffler... 700063, UNIVERSAL FIT MSL/MAXIMUM Muffler... 6544, 709010, Silentone DIY Muffler... 5535

NA-Not Available. NR-Not Required. FL-Remove and Re-Use Old Flange. ● Golden Warehouse. O.E.-Original Equipment.
Airtube Kit [4948] may be required to complete installation. EFI-Electronic Fuel Injection.

[1] OE system was a welded assembly. It is recommended that all parts noted [1] should be replaced.

[3] Required for installation.

[115] Not required for installation if bracket is welded on exhaust pipe.

[922] Trim Outlet pipe to fit length required

[958] Federal & California Emission vehicles. Not legal for sale for vehicles licensed in California.

1980 6 Cyl. Omega, 173 Engine (2nd Design-Bracket 3" from inlet end of exhaust pipe) **(7815)**
1980 6 Cyl. Omega, 173 Engine (1st Design-Bracket 20" from Inlet end of Exhaust Pipe)

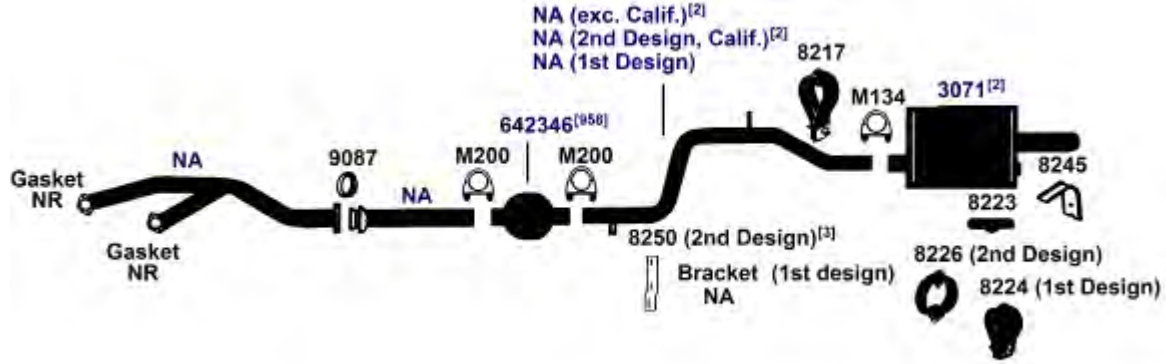

DIRECT FIT MSL/MAXIMUM Muffler... 700063, UNIVERSAL FIT MSL/MAXIMUM Muffler... 6544, 709010, Silentone DIY Muffler... 5535

1979 8 Cyl. Omega, All Models with 305, 350L Engine; Dual Outlet Muffler **(7809)**

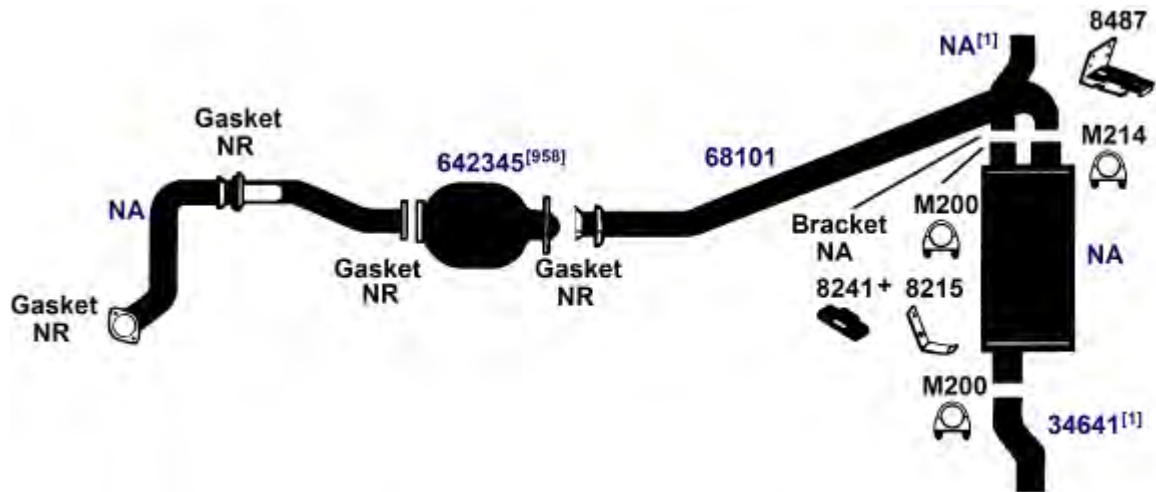

DIRECT FIT MSL/MAXIMUM Muffler... 6537

NA-Not Available. NR-Not Required. FL-Remove and Re-Use Old Flange. ● Golden Warehouse. O.E.-Original Equipment.
 # Airtube Kit [4948] may be required to complete installation. EFI-Electronic Fuel Injection.

- [1] OE system was a welded assembly. It is recommended that all parts noted [1] should be replaced.
- [2] May be necessary to replace all noted [2] parts.
- [3] Required for installation.
- [958] Federal & California Emission vehicles. Not legal for sale for vehicles licensed in California.

OLDSMOBILE SILHOUETTE

(33902) 92-94 6 Cyl. Silhouette; 189 (3.1L) Engine

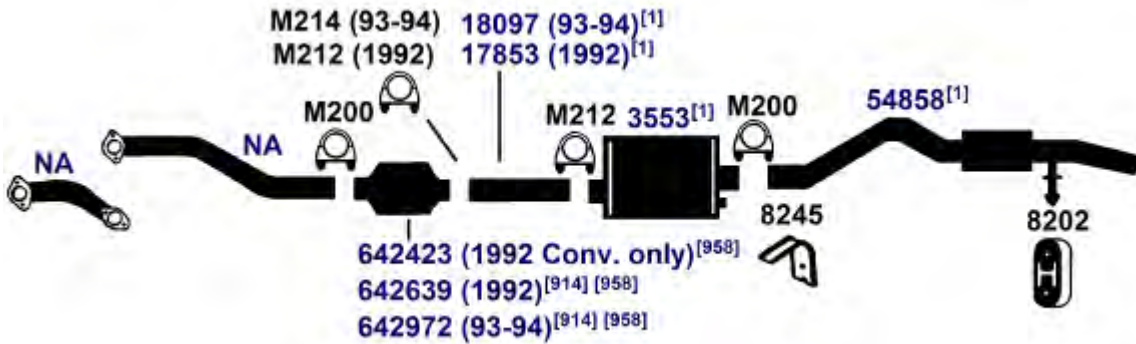

DIRECT FIT MSL/MAXIMUM Muffler... 700321

(33901) 92-94 6 Cyl. Silhouette; 231 (3.8L) Engine

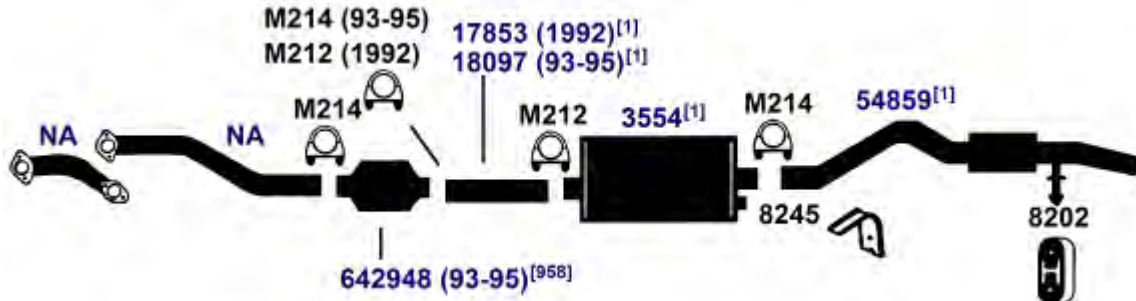

DIRECT FIT MSL/MAXIMUM Muffler... 700286, UNIVERSAL FIT MSL/MAXIMUM Muffler... 6592, Silentone DIY Muffler... 5557 and 8506 Bracket, M214 Clamp and 8245 hanger

(33900) 90-91 6 Cyl. Silhouette; 189 (3.1L) Engine

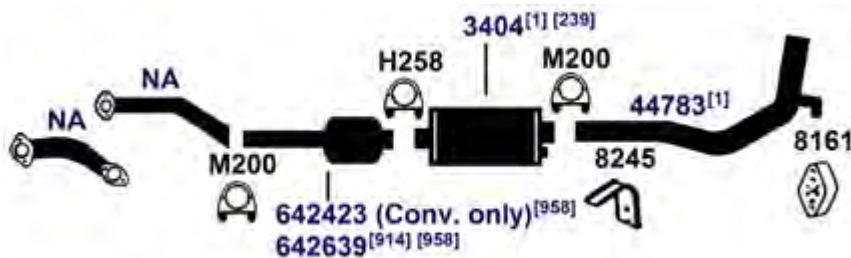

DIRECT FIT MSL/MAXIMUM Muffler... 700123

NA-Not Available. NR-Not Required. FL-Remove and Re-Use Old Flange. ● Golden Warehouse. O.E.-Original Equipment.

Airtube Kit [4948] may be required to complete installation. EFI-Electronic Fuel Injection.

[1] OE system was a welded assembly. It is recommended that all parts noted [1] should be replaced.

[239] O.E. muffler must be cut off 1-1/2" behind the muffler nipple to converter weld.

[914] Direct fit converter includes front (Exhaust) pipe, (1) piece assembly.

[958] Federal & California Emission vehicles. Not legal for sale for vehicles licensed in California.

91-92 6 Cyl. Toronado Trofeo, 231 Engine (3.8L), Dual Exhaust (7924)

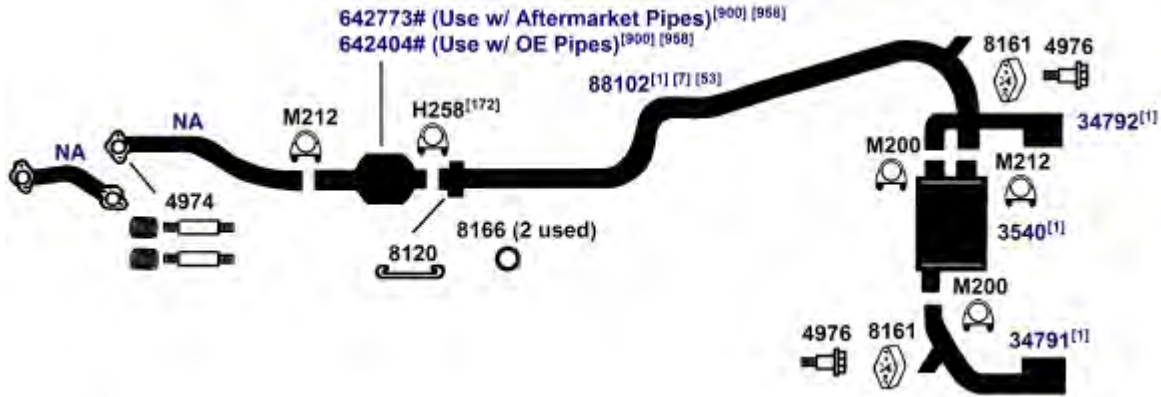

91-92 6 Cyl. Toronado, 231 Engine (3.8L), Single Exhaust (7923)

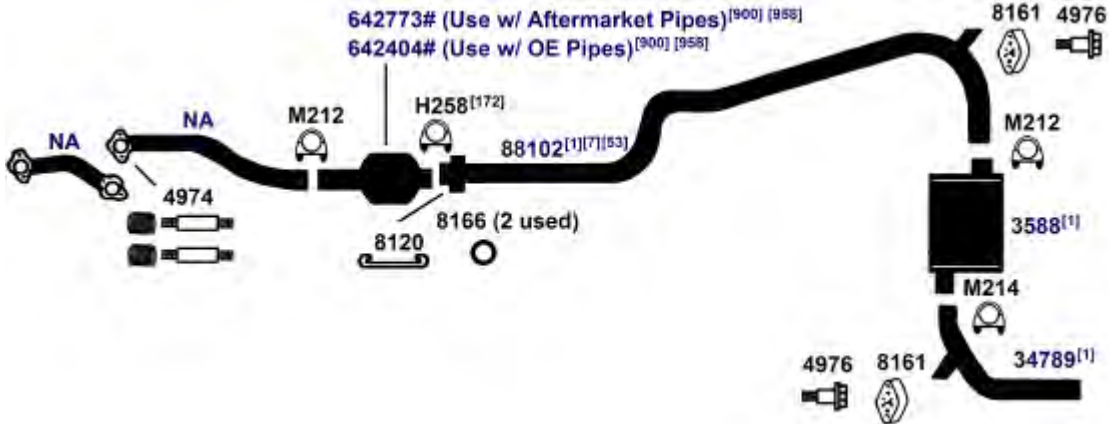

DIRECT FIT MSL/MAXIMUM Muffler... Muffler (option for 3588)- 700360, UNIVERSAL FIT MSL/MAXIMUM Muffler... Muffler (option for 3588)- 6598

NA-Not Available. NR-Not Required. FL-Remove and Re-Use Old Flange. ● Golden Warehouse. O.E.-Original Equipment.
Airtube Kit [4948] may be required to complete installation. EFI-Electronic Fuel Injection.

- [1] OE system was a welded assembly. It is recommended that all parts noted [1] should be replaced.
- [7] The O.E. extension pipe must be cut off 1 3/8" behind the pipe to converter weld.
- [53] To Install 83026 or 88102, the RH side of the rear suspension must be lowered. The muffler heat shield should also be removed. When pipe is in place, heat shield and suspension must then be re-attached.
- [172] Special O.E. style clamp designed for this application.
- [900] Direct fit converter may require resizing, cutting or bushing.
- [958] Federal & California Emission vehicles. Not legal for sale for vehicles licensed in California.

OLDSMOBILE TORONADO

(7919) 86-90 6 Cyl. Toronado, 231 Engine (3.8L), Single Exhaust

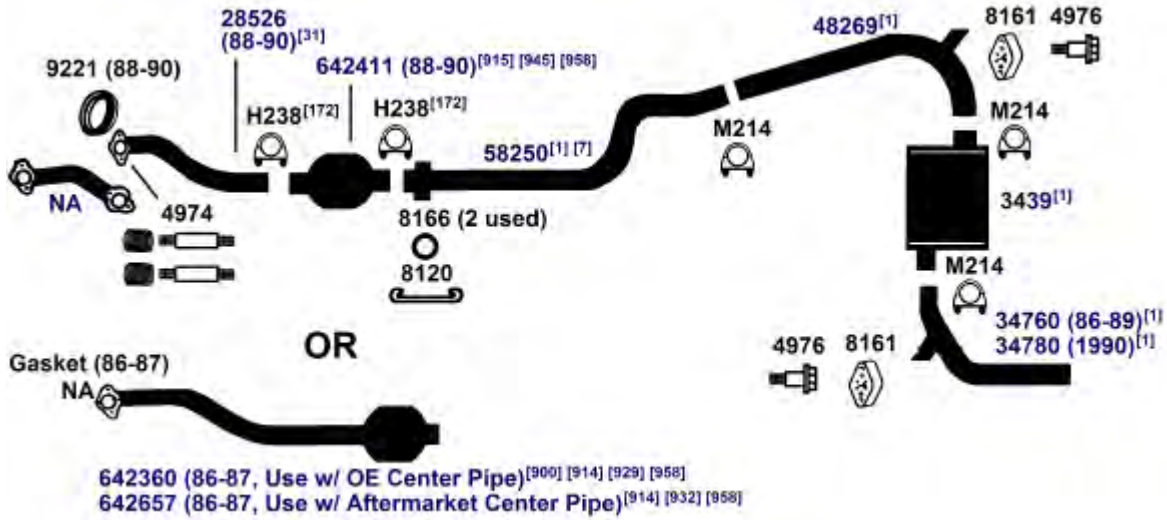

DIRECT FIT MSL/MAXIMUM Muffler... 6578, UNIVERSAL FIT MSL/MAXIMUM Muffler... 709012, Silentone DIY Muffler... 5528

(7911) 1985 8 Cyl. Toronado, 350N Diesel Engine (5.7L); with 2 1/4" Exhaust Pipe

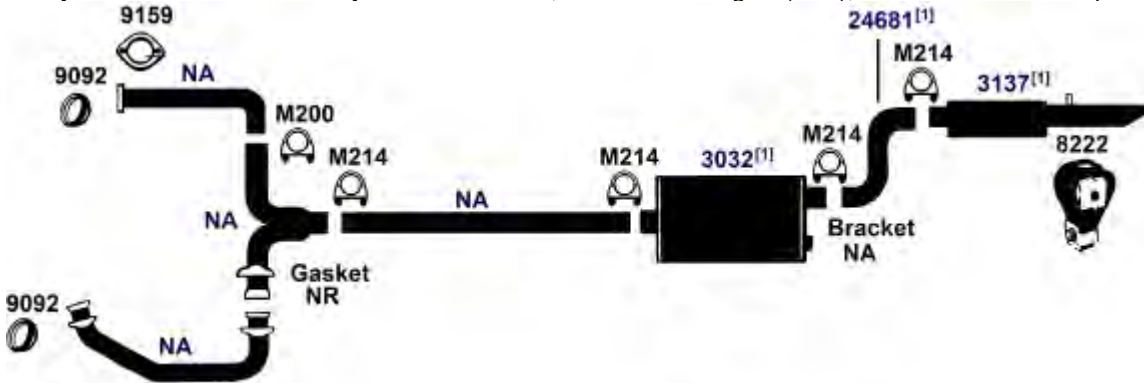

DIRECT FIT MSL/MAXIMUM Muffler... Front Muffler- 6541, Rear Muffler- 700066, UNIVERSAL FIT MSL/MAXIMUM Muffler... Front Muffler- 709014, 709992, Rear Muffler- 6526, Silentone DIY Muffler... Front Muffler- 5543, Rear Muffler- 5559 and 24840 Spout

NA-Not Available. NR-Not Required. FL-Remove and Re-Use Old Flange. ● Golden Warehouse. O.E.-Original Equipment.
Airtube Kit [4948] may be required to complete installation. EFI-Electronic Fuel Injection.

[1] OE system was a welded assembly. It is recommended that all parts noted [1] should be replaced.

[7] The O.E. extension pipe must be cut off 1 3/8" behind the pipe to convert weld.

[31] The O.E. front exhaust pipe must be cut off 1 1/4" in front of the pipe to convert weld.

[172] Special O.E. style clamp designed for this application.

[900] Direct fit converter may require resizing, cutting or bushing.

[914] Direct fit converter includes front (Exhaust) pipe, (1) piece assembly.

[915] Does not include complete front pipe.

[929] Use AP #6 bushing w/aftermarket piping.

[932] For use with 2 3/8" I.D. intermediate pipe.

[945] Two #6 bushings may be required (1 at inlet and 1 at outlet).

[958] Federal & California Emission vehicles. Not legal for sale for vehicles licensed in California.

1985 8 Cyl. Toronado, 307 Engine (5.0L)

(7918)

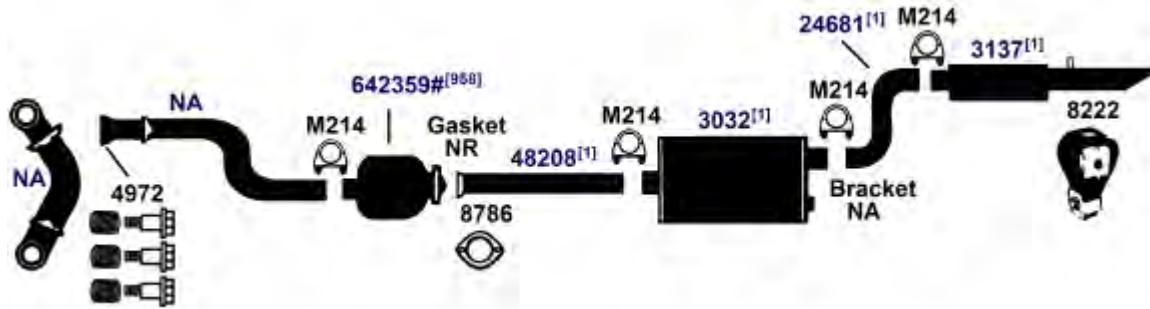

DIRECT FIT MSL/MAXIMUM Muffler... Front Muffler- 6541, Rear Muffler- 700066, UNIVERSAL FIT MSL/MAXIMUM Muffler... Front Muffler- 709014, 709992, Rear Muffler- 6526, Silentone DIY Muffler... Front Muffler- 5543, Rear Muffler- 5559 and 24840 Spout

1984 6 Cyl. Toronado, 252 Engine (4.1-4)

(7916)

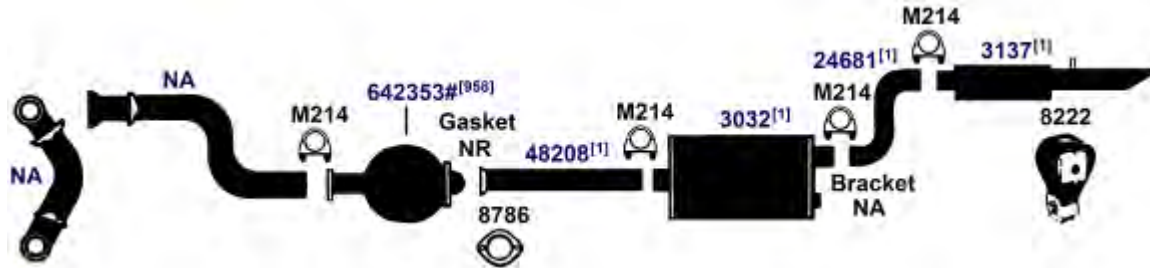

DIRECT FIT MSL/MAXIMUM Muffler... Front Muffler- 6541, Rear Muffler- 700066, UNIVERSAL FIT MSL/MAXIMUM Muffler... Front Muffler- 709014, 709992, Rear Muffler- 6526, Silentone DIY Muffler... Front Muffler- 5543, Rear Muffler- 5559 and 24840 Spout

1984 8 Cyl. Toronado, 307 Engine (5.0L)

(7918E)

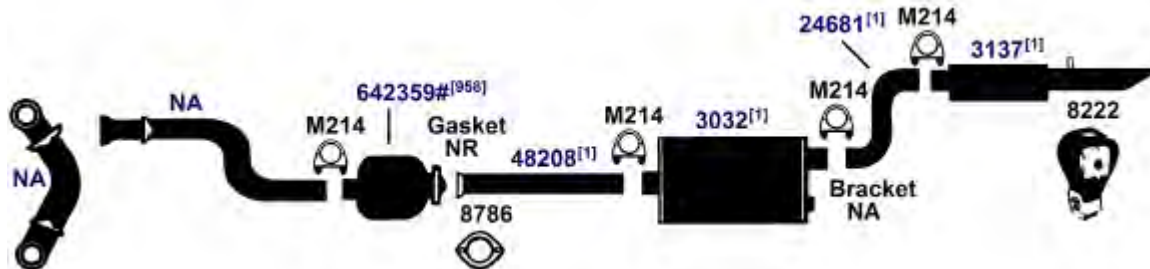

DIRECT FIT MSL/MAXIMUM Muffler... Front Muffler- 6541, Rear Muffler- 700066, UNIVERSAL FIT MSL/MAXIMUM Muffler... Front Muffler- 709014, 709992, Rear Muffler- 6526, Silentone DIY Muffler... Front Muffler- 5543, Rear Muffler- 5559 and 24840 Spout

NA-Not Available. NR-Not Required. FL-Remove and Re-Use Old Flange. ● Golden Warehouse. O.E.-Original Equipment.
Airtube Kit [4948] may be required to complete installation. EFI-Electronic Fuel Injection.

[1] OE system was a welded assembly. It is recommended that all parts noted [1] should be replaced. [958] Federal & California Emission vehicles. Not legal for sale for vehicles licensed in California.

OLDSMOBILE TORONADO

(7911E) 81-84 8 Cyl. Toronado, 350N Diesel Engine (5.7L); with 2 1/4" Exhaust Pipe

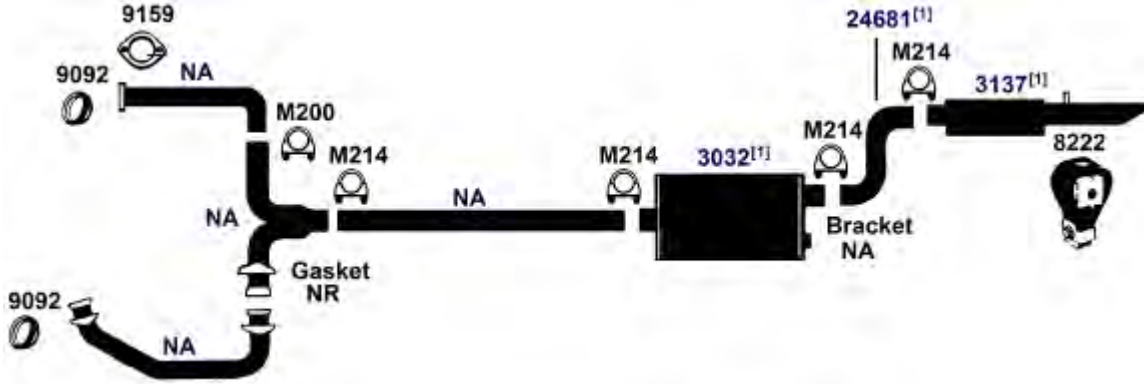

DIRECT FIT MSL/MAXIMUM Muffler... Front Muffler- 6541, Rear Muffler- 700066, UNIVERSAL FIT MSL/MAXIMUM Muffler... Front Muffler- 709014, 709992, Rear Muffler- 6526, Silentone DIY Muffler... Front Muffler- 5543, Rear Muffler- 5559 and 24840 Spout

(7912) 82-83 8 Cyl. Toronado, 5.0L, 307 Engine
81-83 6 Cyl. Toronado, 4.1L, 252 Engine

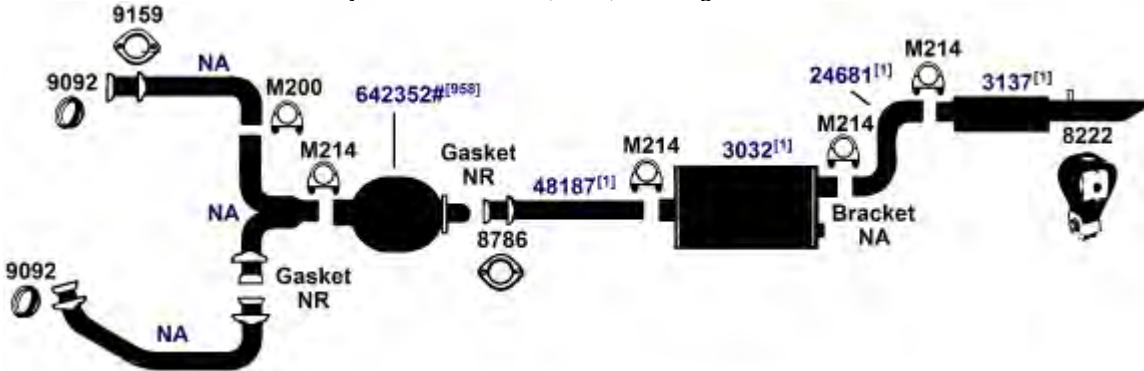

DIRECT FIT MSL/MAXIMUM Muffler... Front Muffler- 6541, Rear Muffler- 700066, UNIVERSAL FIT MSL/MAXIMUM Muffler... Front Muffler- 709014, 709992, Rear Muffler- 6526, Silentone DIY Muffler... Front Muffler- 5543, Rear Muffler- 5559 and 24840 Spout

(7922) 80-81 8 Cyl. Toronado, 307 (5.0L), 350R (5.7L) Engine
1979 8 Cyl. Toronado, 5.7L, 350R Engine

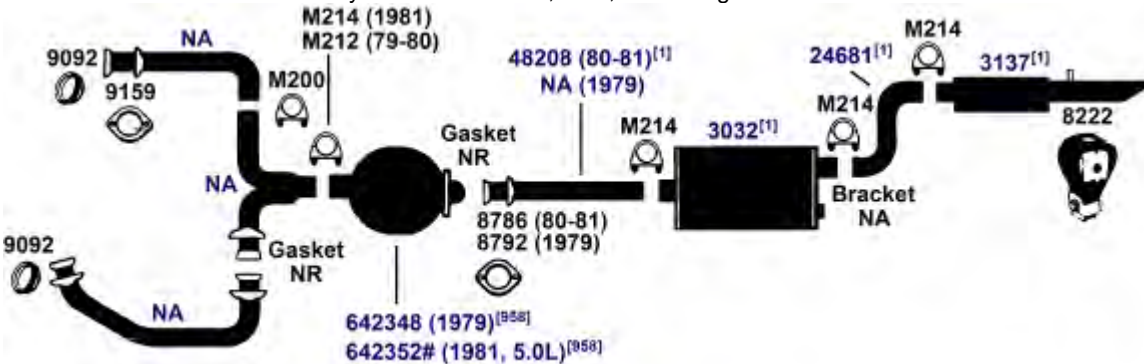

DIRECT FIT MSL/MAXIMUM Muffler... Front Muffler- 6541, Rear Muffler- 700066, UNIVERSAL FIT MSL/MAXIMUM Muffler... Front Muffler- 709014, 709992, Rear Muffler- 6526, Silentone DIY Muffler... Front Muffler- 5543, Rear Muffler- 5559 and 24840 Spout

NA-Not Available. NR-Not Required. FL-Remove and Re-Use Old Flange. ● Golden Warehouse. O.E.-Original Equipment.
Airtube Kit [4948] may be required to complete installation. EFI-Electronic Fuel Injection.

[1] OE system was a welded assembly. It is recommended that all parts noted [1] should be replaced. [958] Federal & California Emission vehicles. Not legal for sale for vehicles licensed in California.

79-81 8 Cyl. Toronado, 5.7.L, 350N Diesel Engine; with 2 1/2" Exhaust Pipe **(7921)**

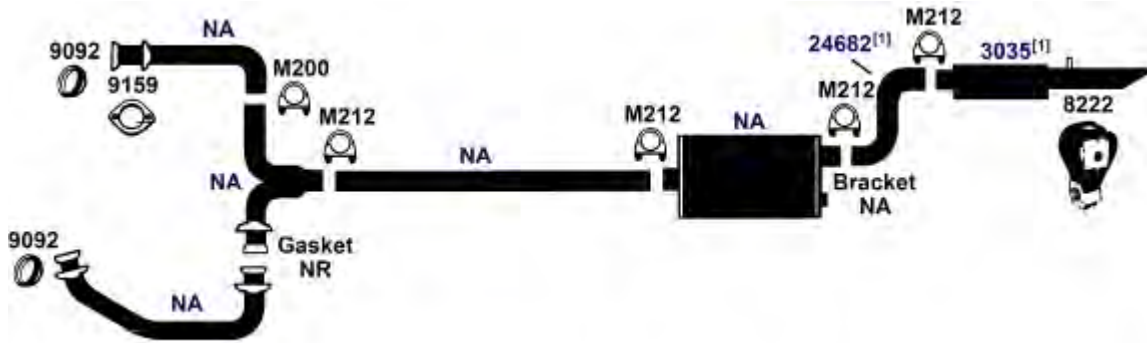

DIRECT FIT MSL/MAXIMUM Muffler... Rear Muffler- 700061, UNIVERSAL FIT MSL/MAXIMUM Muffler... Rear Muffler- 6526

PLYMOUTH CARS - (TRUCKS - SEE DODGE)

PLYMOUTH ACCLAIM

92-94 6 Cyl. Acclaim, 3.0L EFI Engine (181), with Catalytic Converter **(12004)**

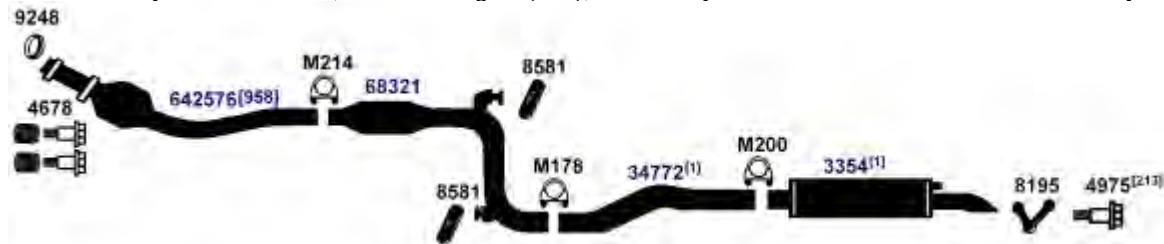

DIRECT FIT MSL/MAXIMUM Muffler... 700026, UNIVERSAL FIT MSL/MAXIMUM Muffler... 6582, Silentone DIY Muffler... 5563 and 14663 Spout

91-94 4 Cyl. Acclaim, 2.5L EFI Engine (153); with Catalytic Converter, without Resonator; **(12003)** except Turbo

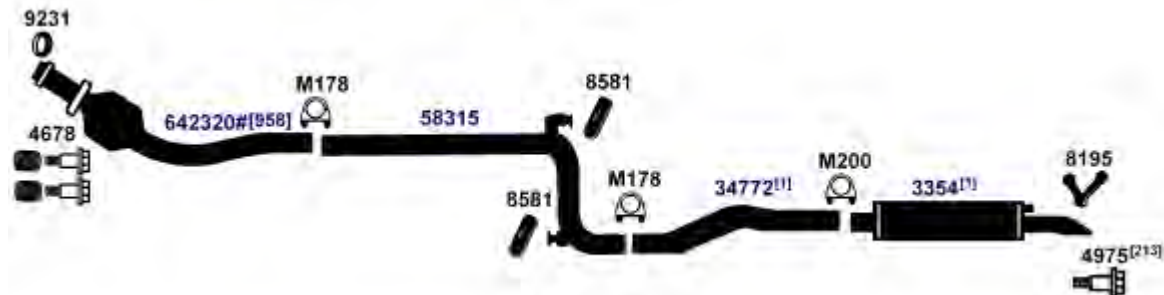

DIRECT FIT MSL/MAXIMUM Muffler... 700026, UNIVERSAL FIT MSL/MAXIMUM Muffler... 6582, Silentone DIY Muffler... 5563 and 14663 Spout

NA-Not Available. NR-Not Required. FL-Remove and Re-Use Old Flange. ● Golden Warehouse. O.E.-Original Equipment.
Airtube Kit [4948] may be required to complete installation. EFI-Electronic Fuel Injection.

[1] OE system was a welded assembly. It is recommended that all parts noted [1] should be replaced. [958] Federal & California Emission vehicles. Not legal for sale for vehicles licensed in California.
[213] Required for installation on 1993 models.

PLYMOUTH ACCLAIM

(12000) 89-91 6 Cyl. Acclaim, 3.0L EFI Engine (181), with Catalytic Converter

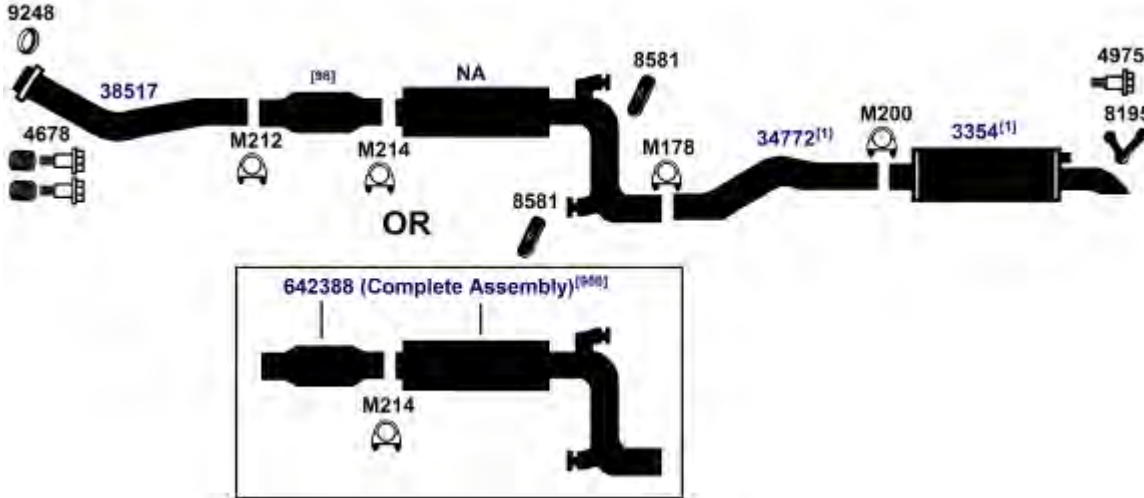

DIRECT FIT MSL/MAXIMUM Muffler... 700026, UNIVERSAL FIT MSL/MAXIMUM Muffler... 6582, Silentone DIY Muffler... 5563 and 14663 Spout

(12002) 89-90 4 Cyl. Acclaim, 2.5L EFI Engine (153), with Catalytic Converter and Resonator; except Turbo

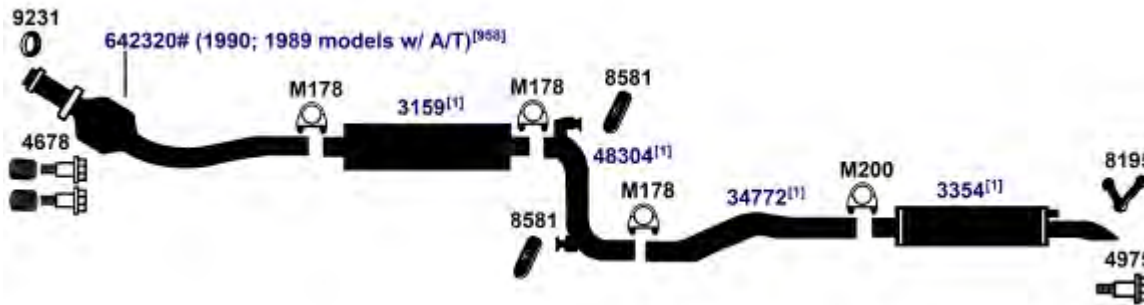

DIRECT FIT MSL/MAXIMUM Muffler... Front Muffler- 700067, Rear Muffler- 700026, UNIVERSAL FIT MSL/MAXIMUM Muffler... Rear Muffler- 6582, Silentone DIY Muffler... Rear Muffler- 5563 and 14663 Spout

(12001) 89-90 4 Cyl. Acclaim, 2.5L EFI Turbo Engine (153), with Catalytic Converter



DIRECT FIT MSL/MAXIMUM Muffler... 700026, UNIVERSAL FIT MSL/MAXIMUM Muffler... 6582, Silentone DIY Muffler... 5563 and 14663 Spout

NA-Not Available. NR-Not Required. FL-Remove and Re-Use Old Flange. ● Golden Warehouse. O.E.-Original Equipment.
Airtube Kit [4948] may be required to complete installation. EFI-Electronic Fuel Injection.

[1] OE system was a welded assembly. It is recommended that all parts noted [1] should be replaced. [958] Federal & California Emission vehicles. Not legal for sale for vehicles licensed in California.
[98] Refer to current Catalytic Converter catalog or Website catalog for availability.

87-88 4 Cyl. Caravelle, 2.2L EFI Turbocharged Engine; with Catalytic Converter, without Resonator **(8294)**

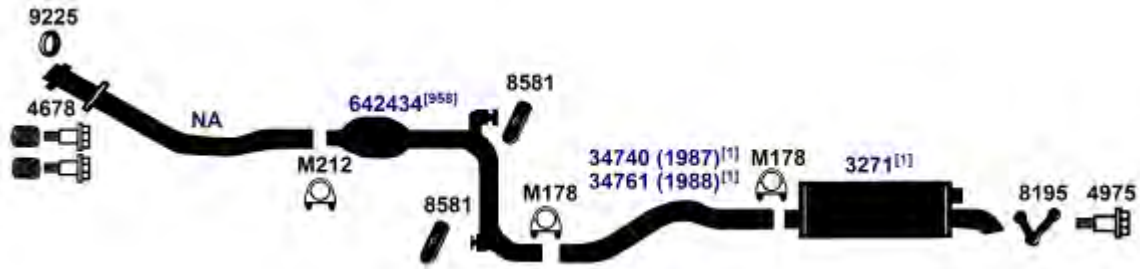

UNIVERSAL FIT MSL/MAXIMUM Muffler... 6582

86-88 4 Cyl. Caravelle, 2.2L EFI (except Turbocharger), 2.5L EFI Engine; with Catalytic Converter, with Resonator **(8293)**

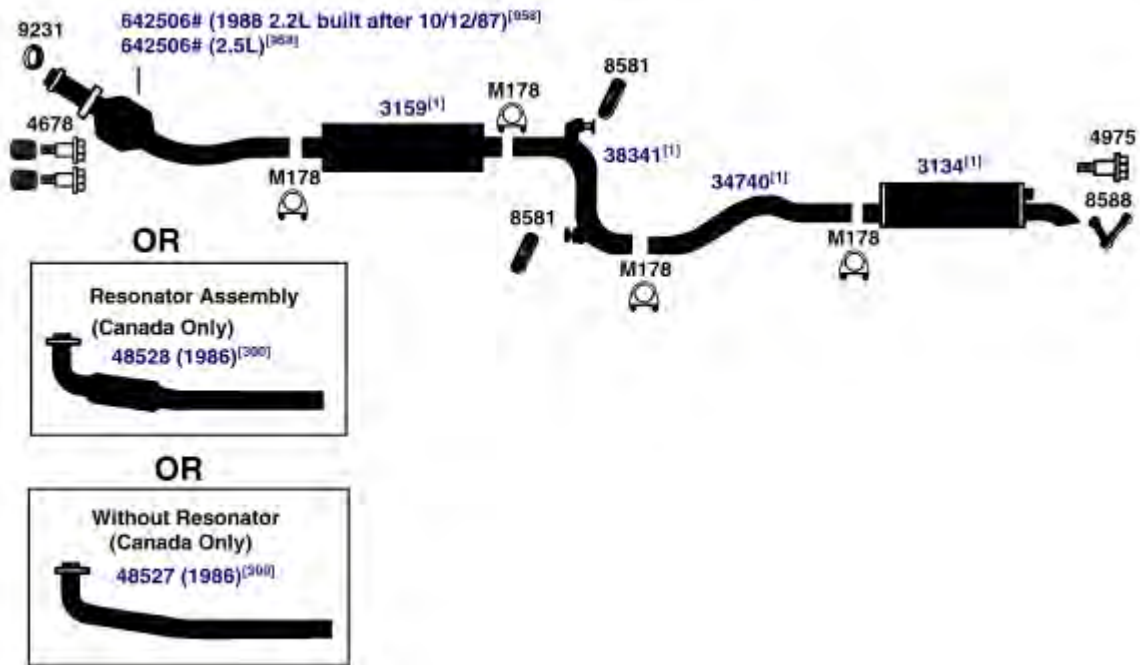

DIRECT FIT MSL/MAXIMUM Muffler... Front Muffler- 700067, Rear Muffler- 6550, Silentone DIY Muffler... Rear Muffler- 5537

NA-Not Available. NR-Not Required. FL-Remove and Re-Use Old Flange. ● Golden Warehouse. O.E.-Original Equipment.
Airtube Kit [4948] may be required to complete installation. EFI-Electronic Fuel Injection.

[1] OE system was a welded assembly. It is recommended that all parts noted [1] should be replaced. [958] Federal & California Emission vehicles. Not legal for sale for vehicles licensed in California.

[300] For use when resonator originated from O.E. manufacturer.

PLYMOUTH CARAVELLE

(8290) 1985 4 Cyl. Caravelle 4-Door (Front Wheel Drive), 2.2L EFI, 2.6L 2-barrel Engine; with Catalytic Converter, with Resonator

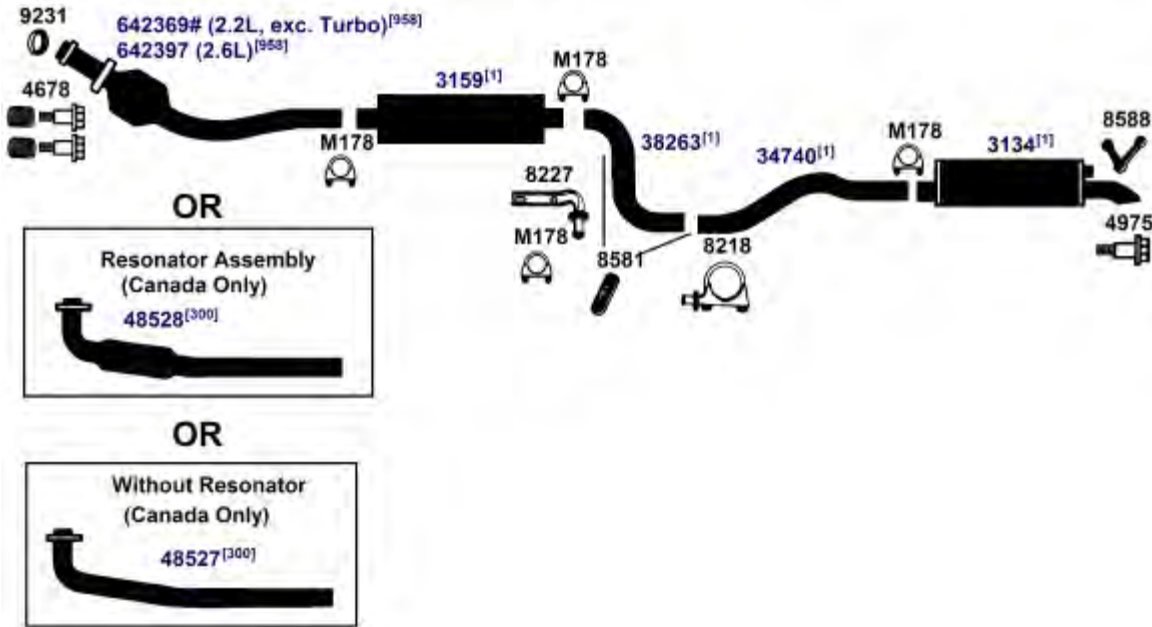

DIRECT FIT MSL/MAXIMUM Muffler... Front Muffler- 700067, Rear Muffler- 6550, Silentone DIY Muffler... Rear Muffler- 5537

PLYMOUTH COLT, COLT VISTA

(8335) 93-94 4 Cyl. Colt Notchback; 1.5L, 1.8L SOHC Engine

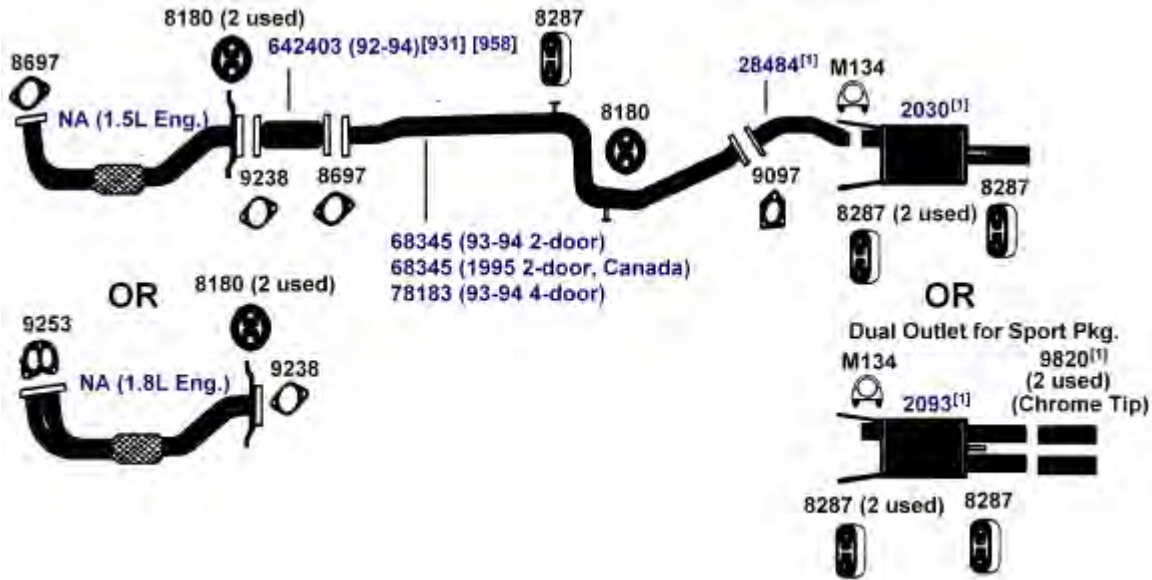

UNIVERSAL FIT MSL/MAXIMUM Muffler... Single Outlet Muffler- 6676

NA-Not Available. NR-Not Required. FL-Remove and Re-Use Old Flange. ● Golden Warehouse. O.E.-Original Equipment.
Airtube Kit [4948] may be required to complete installation. EFI-Electronic Fuel Injection.

[1] OE system was a welded assembly. It is recommended that all parts noted [1] should be replaced.

[300] For use when resonator originated from O.E. manufacturer.

[931] This unit was designed to fit many applications. Measurement of the old unit and cutting of new unit is required.

[958] Federal & California Emission vehicles. Not legal for sale for vehicles licensed in California.

PLYMOUTH COLT, COLT VISTA

92-94 4 Cyl. Colt Vista; 1.8L Engine; 2WD

(8336)

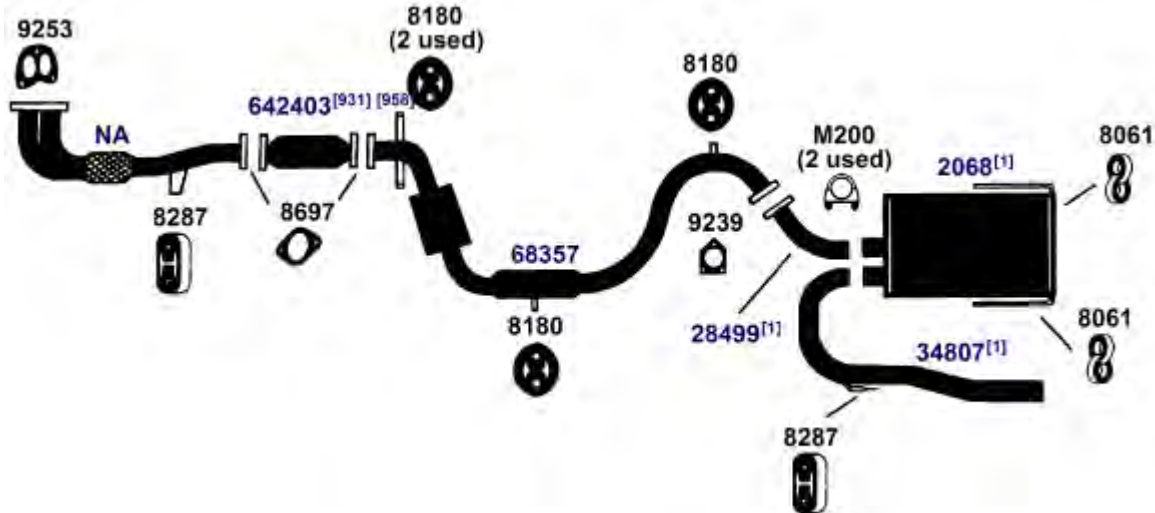

89-92 4 Cyl. Colt Hatchback; 1.5L Engine

(8334)

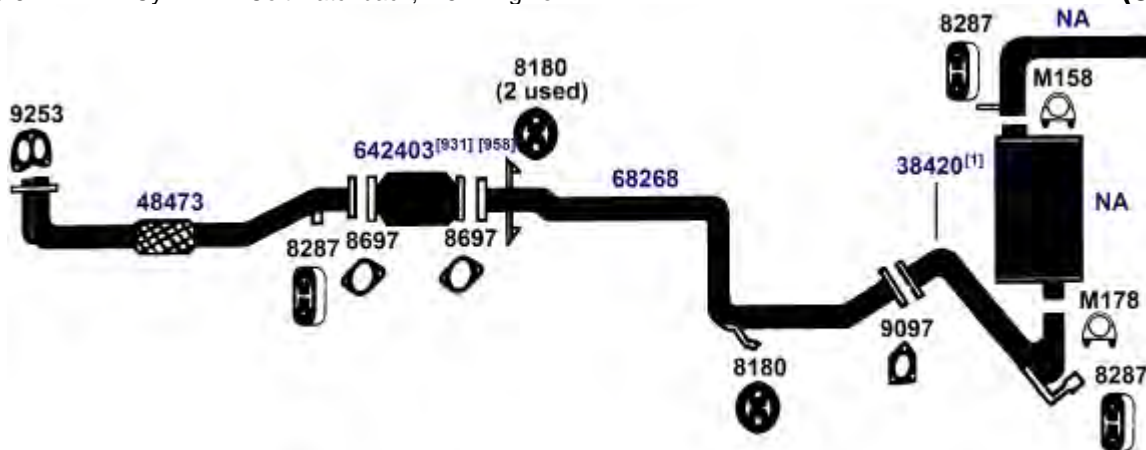

87-91 4 Cyl. Colt Vista; 2.0L Engine, 2WD (from 12/86)

(8329)



UNIVERSAL FIT MSL/MAXIMUM Muffler... 6651, 709007, 709010

NA-Not Available. NR-Not Required. FL-Remove and Re-Use Old Flange. ● Golden Warehouse. O.E.-Original Equipment.
Airtube Kit [4948] may be required to complete installation. EFI-Electronic Fuel Injection.

[1] OE system was a welded assembly. It is recommended that all parts noted [1] should be replaced.

[931] This unit was designed to fit many applications. Measurement of the old unit and cutting of new unit is required.

[958] Federal & California Emission vehicles. Not legal for sale for vehicles licensed in California.

PLYMOUTH COLT, COLT VISTA

(8331) 87-91 4 Cyl. Colt Vista; 2.0L Engine, 4WD (from 12/86)

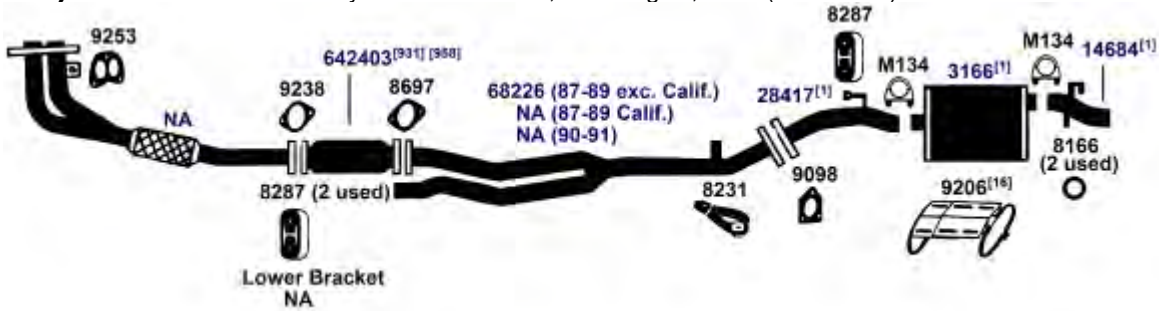

DIRECT FIT MSL/MAXIMUM Muffler... Split System- 709010, UNIVERSAL FIT MSL/MAXIMUM Muffler... Split System- 709007, 6651

(8332) 89-90 4 Cyl. Colt Hatchback; 1.6L DOHC and Turbo Engine

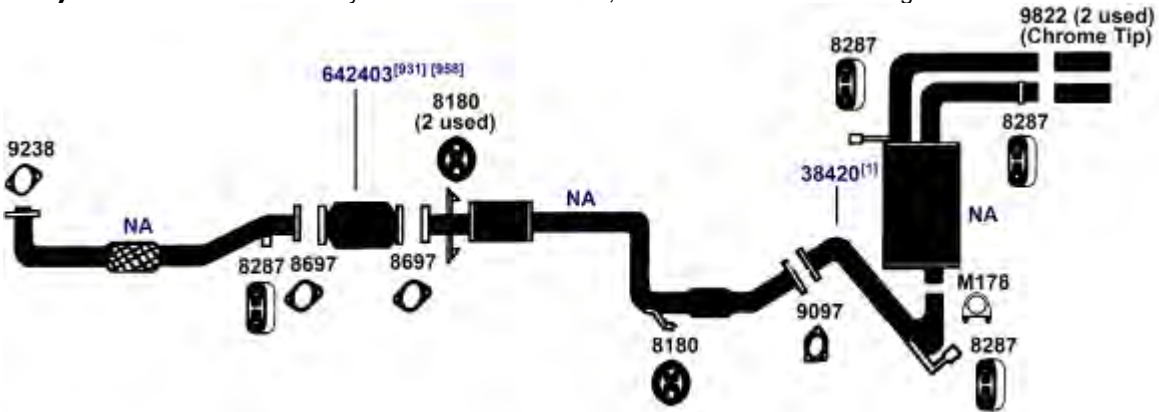

(8330) 87-88 4 Cyl. Colt 2-Door Hatchback; 4-Door Sedan; 1.5L Engine, 1.6L Fuel Injection Turbo Engine

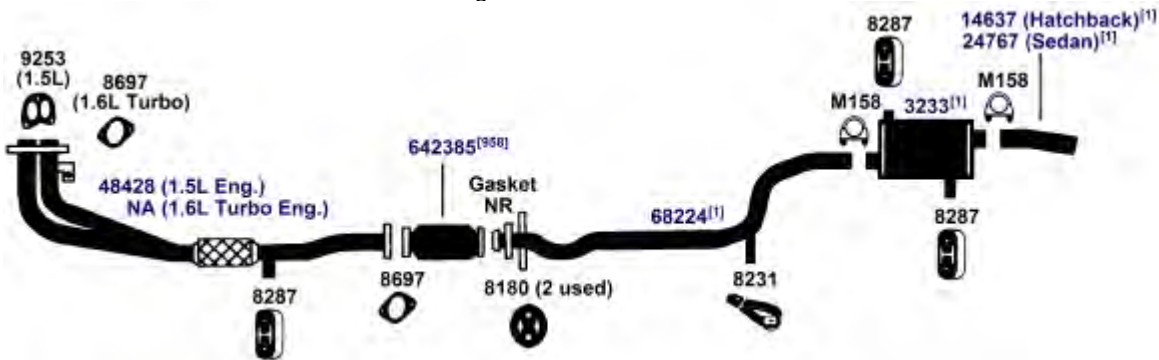

DIRECT FIT MSL/MAXIMUM Muffler... 6684, UNIVERSAL FIT MSL/MAXIMUM Muffler... 6658

NA-Not Available. NR-Not Required. FL-Remove and Re-Use Old Flange. ● Golden Warehouse. O.E.-Original Equipment.
Airtube Kit [4948] may be required to complete installation. EFI-Electronic Fuel Injection.

[1] OE system was a welded assembly. It is recommended that all parts noted [1] should be replaced.

[16] 9206 Heat Shield required on 88-91 models only.

[931] This unit was designed to fit many applications. Measurement of the old unit and cutting of new unit is required.

[958] Federal & California Emission vehicles. Not legal for sale for vehicles licensed in California.

PLYMOUTH COLT, COLT VISTA

86-87 4 Cyl. Colt Vista, 2.0L Engine, 4WD (up to 12/86)

(8328)

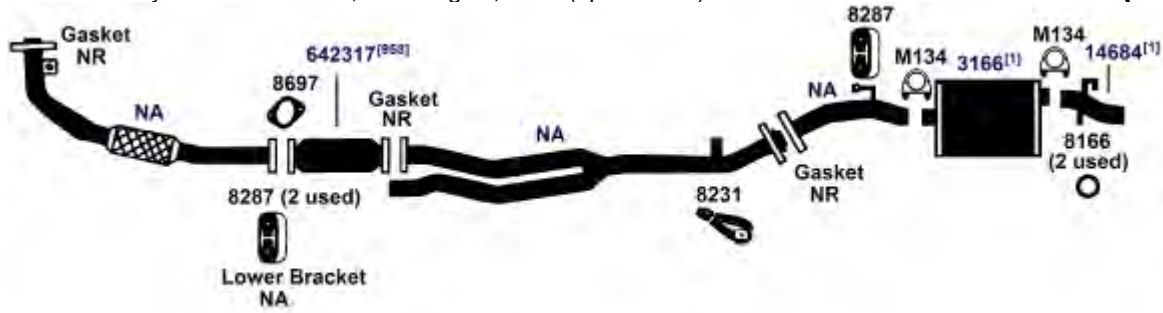

DIRECT FIT MSL/MAXIMUM Muffler... Split System- 709010, UNIVERSAL FIT MSL/MAXIMUM Muffler... Split System- 6651, 709007

85-86 4 Cyl. Colt, 2, 4-Door Hatchback, 4-Door Sedan; 1500cc

(8326)

85-86 4 Cyl. Colt 2-Door Hatchback, 4-Door Sedan, 1600cc, Turbo

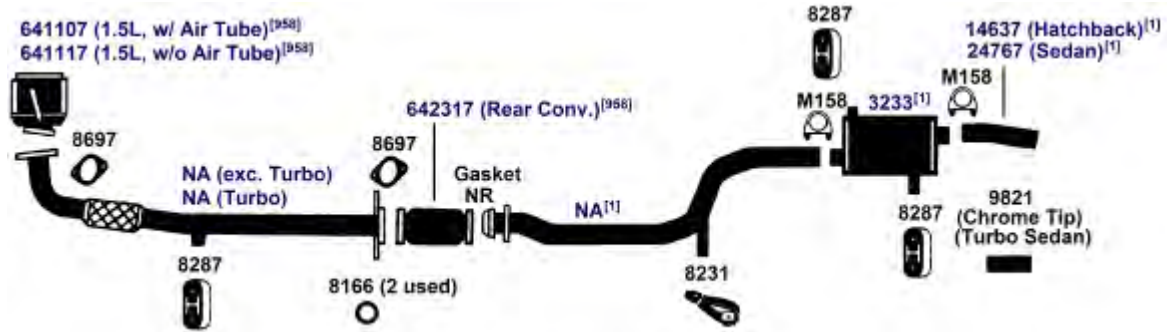

DIRECT FIT MSL/MAXIMUM Muffler... 6684, UNIVERSAL FIT MSL/MAXIMUM Muffler... 6658

NA-Not Available. NR-Not Required. FL-Remove and Re-Use Old Flange. ● Golden Warehouse. O.E.-Original Equipment.
 # Airtube Kit [4948] may be required to complete installation. EFI-Electronic Fuel Injection.

[1] OE system was a welded assembly. It is recommended that all parts noted [1] should be replaced. [958] Federal & California Emission vehicles. Not legal for sale for vehicles licensed in California.

PLYMOUTH GRAN FURY

(8206) 85-89 8 Cyl. Gran Fury, 318 Engine (5.2L); with Catalytic Converter

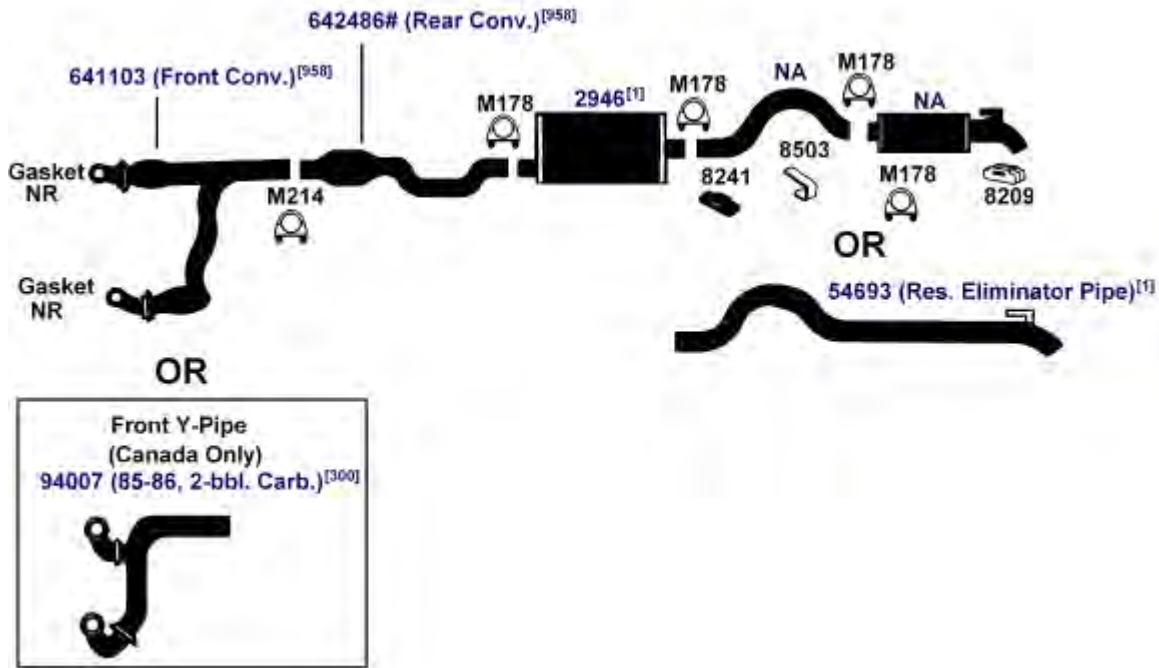

DIRECT FIT MSL/MAXIMUM Muffler... Front Muffler (2946)- 700053, UNIVERSAL FIT MSL/MAXIMUM Muffler... Front Muffler (2946)- 6503, 709008, Silentone DIY Muffler... Front Muffler (2946)- 5511

NA-Not Available. NR-Not Required. FL-Remove and Re-Use Old Flange. ● Golden Warehouse. O.E.-Original Equipment.
Airtube Kit [4948] may be required to complete installation. EFI-Electronic Fuel Injection.

[1] OE system was a welded assembly. It is recommended that all parts noted [1] should be replaced.

[958] Federal & California Emission vehicles. Not legal for sale for vehicles licensed in California.

[300] For use when resonator originated from O.E. manufacturer.

82-84 8 Cyl. Gran Fury, 318 Engine (5.2L); with Catalytic Converter

(8206E)

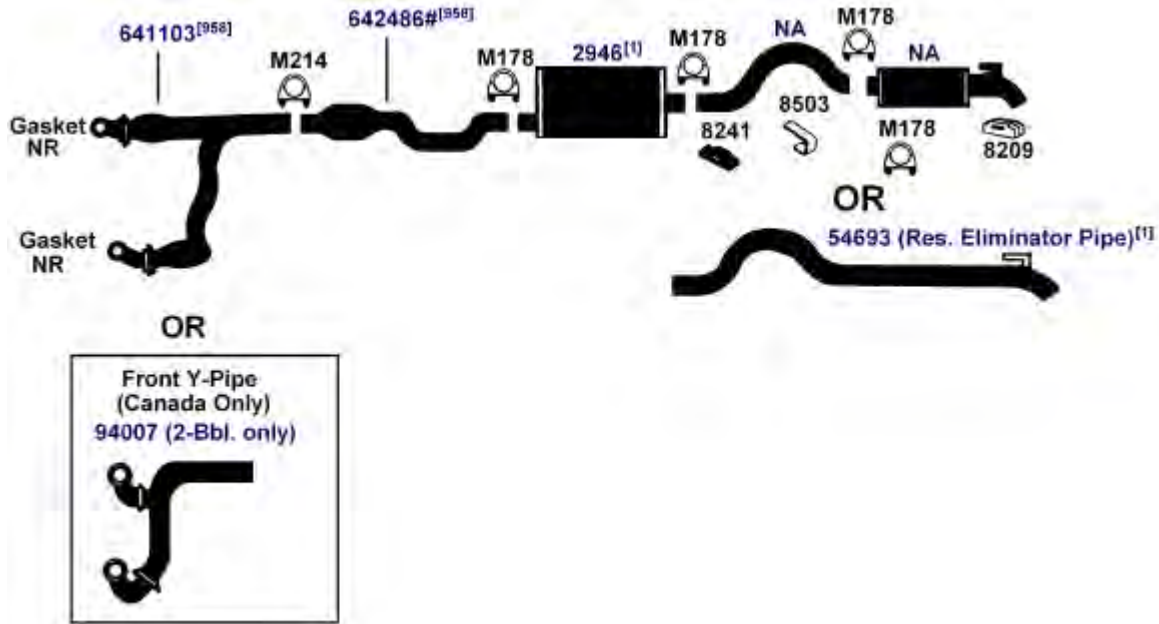

DIRECT FIT MSL/MAXIMUM Muffler... Front Muffler (2946)- 700053, UNIVERSAL FIT MSL/MAXIMUM Muffler... Front Muffler (2946)- 6503, 709008, Silentone DIY Muffler... Front Muffler (2946)- 5511

82-83 6 Cyl. Gran Fury, 3.7L, 225 Engine; with Catalytic Converter

(8204)

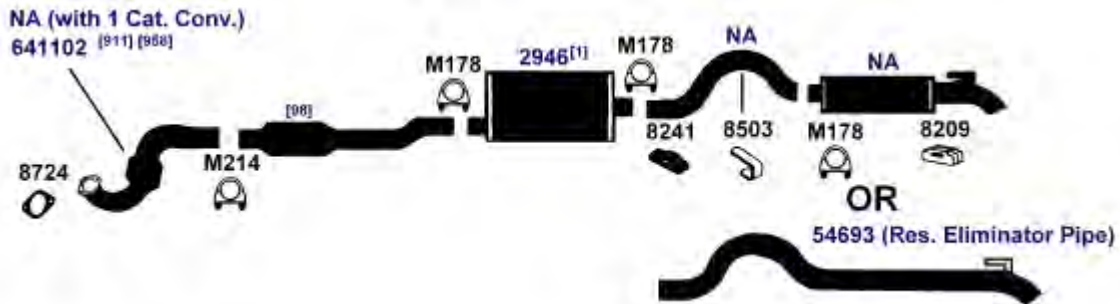

DIRECT FIT MSL/MAXIMUM Muffler... Front Muffler- 700053, UNIVERSAL FIT MSL/MAXIMUM Muffler... Front Muffler- 6503, 709008, Silentone DIY Muffler... Front Muffler- 5511

NA-Not Available. NR-Not Required. FL-Remove and Re-Use Old Flange. ● Golden Warehouse. O.E.-Original Equipment.
 # Airtube Kit [4948] may be required to complete installation. EFI-Electronic Fuel Injection.

[1] OE system was a welded assembly. It is recommended that all parts noted [1] should be replaced.
 [98] Refer to current Catalytic Converter catalog or Website catalog for availability.

[911] Semi-Direct Fit converter. Fabrication required.
 [958] Federal & California Emission vehicles. Not legal for sale for vehicles licensed in California.

PLYMOUTH HORIZON

(8347)	88-90	4 Cyl.	Horizon, Horizon America; 4-Door, 2.2L EFI Engine, with Catalytic Converter (US Only)
	85-87	4 Cyl.	Horizon 4-Door; 1.6L, 2.2L EFI Engine (96 H.P.); with Catalytic Converter (US Only)

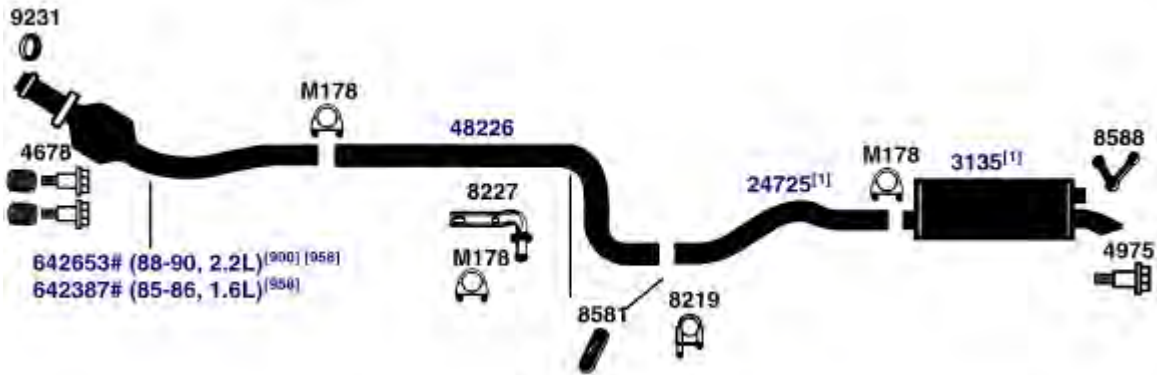

DIRECT FIT MSL/MAXIMUM Muffler... 6569, Silentone DIY Muffler... 5529

(8560)	85-87	4 Cyl.	Horizon, Turismo; 2-Door, 1.6L, 2.2L 2-barrel Engine; with Catalytic Converter, without Resonator
---------------	--------------	--------	---



DIRECT FIT MSL/MAXIMUM Muffler... 6569, Silentone DIY Muffler... 5529

NA-Not Available. NR-Not Required. FL-Remove and Re-Use Old Flange. ● Golden Warehouse. O.E.-Original Equipment.

Airtube Kit [4948] may be required to complete installation. EFI-Electronic Fuel Injection.

[1] OE system was a welded assembly. It is recommended that all parts noted [1] should be replaced. [958] Federal & California Emission vehicles. Not legal for sale for vehicles licensed in California.

[900] Direct fit converter may require resizing, cutting or bushing.

1986 4 Cyl. Horizon, Turismo; 2-Door, 2.2L High Performance Engine; with Catalytic Converter (8556)

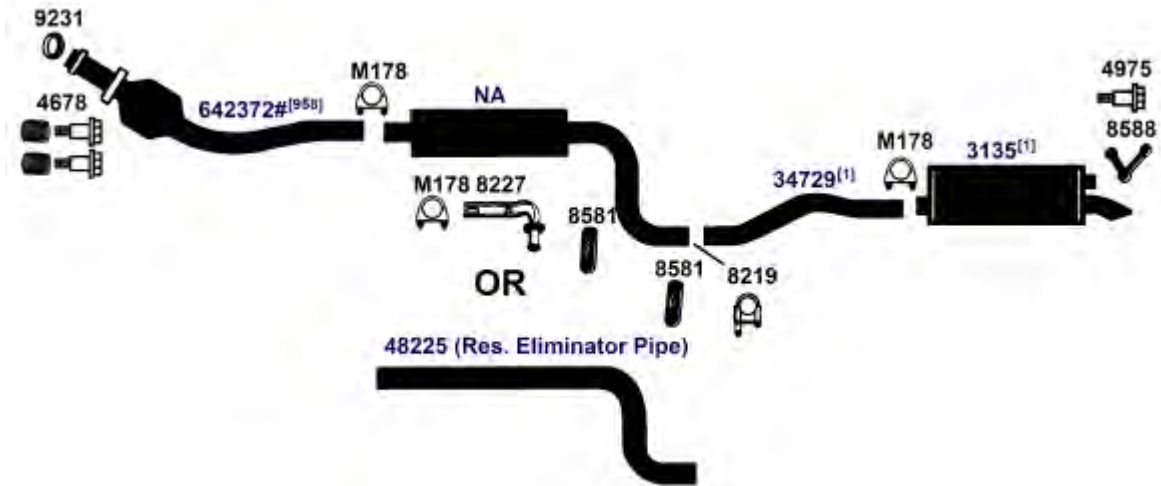

DIRECT FIT MSL/MAXIMUM Muffler... Rear Muffler- 6569, Silentone DIY Muffler... Rear Muffler- 5529

1985 4 Cyl. Horizon 4-Door; 2.2L Engine (101, 110 H.P.); with Catalytic Converter, with Resonator (8346)



DIRECT FIT MSL/MAXIMUM Muffler... Rear Muffler- 6569, Silentone DIY Muffler... Rear Muffler- 5529

NA-Not Available. NR-Not Required. FL-Remove and Re-Use Old Flange. ● Golden Warehouse. O.E.-Original Equipment.
 # Airtube Kit [4948] may be required to complete installation. EFI-Electronic Fuel Injection.

[1] OE system was a welded assembly. It is recommended that all parts noted [1] should be replaced. [958] Federal & California Emission vehicles. Not legal for sale for vehicles licensed in California.

PLYMOUTH HORIZON

(8346E) 1984 4 Cyl. Horizon 4-Door; 2.2L Engine (101, 110 H.P.); with Catalytic Converter, with Resonator

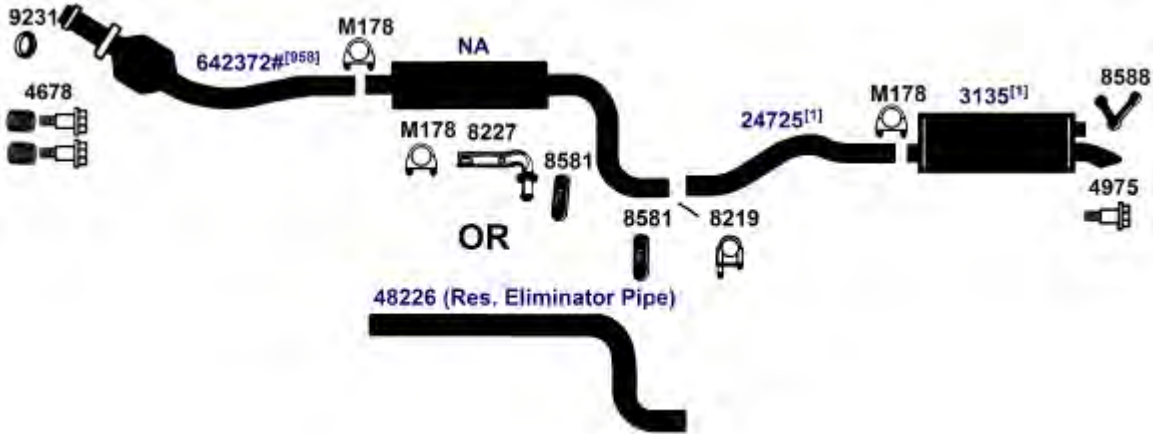

DIRECT FIT MSL/MAXIMUM Muffler... Rear Muffler- 6569, Silentone DIY Muffler... Rear Muffler- 5529

(8347E) 1984 4 Cyl. Horizon; 1.6L, 2.2L Engine (96 H.P.); with Catalytic Converter (4 Door, US Only) (2 & 4-Door, Canada Only)

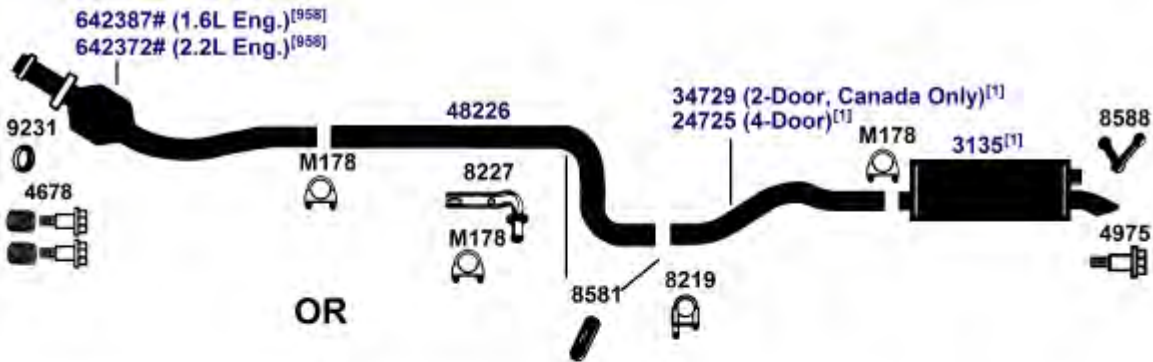

DIRECT FIT MSL/MAXIMUM Muffler... Front 700067, Rear 6569, Silentone DIY Muffler... Rear 5529

NA-Not Available. NR-Not Required. FL-Remove and Re-Use Old Flange. ● Golden Warehouse. O.E.-Original Equipment.
Airtube Kit [4948] may be required to complete installation. EFI-Electronic Fuel Injection.

[1] OE system was a welded assembly. It is recommended that all parts noted [1] should be replaced. [958] Federal & California Emission vehicles. Not legal for sale for vehicles licensed in California.

[300] For use when resonator originated from O.E. manufacturer.

1983 4 Cyl. Horizon, 4-Door, 1.6L, 1.7L Engine; with two Catalytic Converters

(8345)

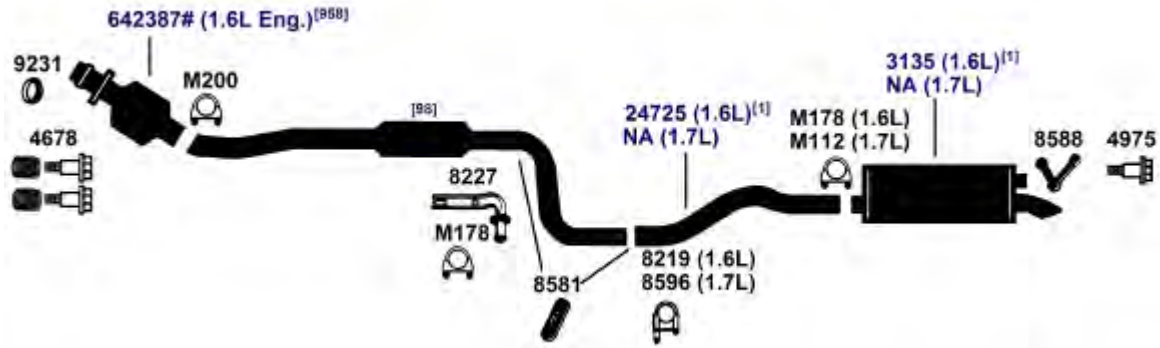

DIRECT FIT MSL/MAXIMUM Muffler... 1.6L Engine- 6569, Silentone DIY Muffler... 1.6L Engine- 5529

1983 4 Cyl. Horizon, 2.2L Engine, with one Catalytic Converter, (4-Door, US Only) (2 & 4-Door, Canada Only)

(8343)

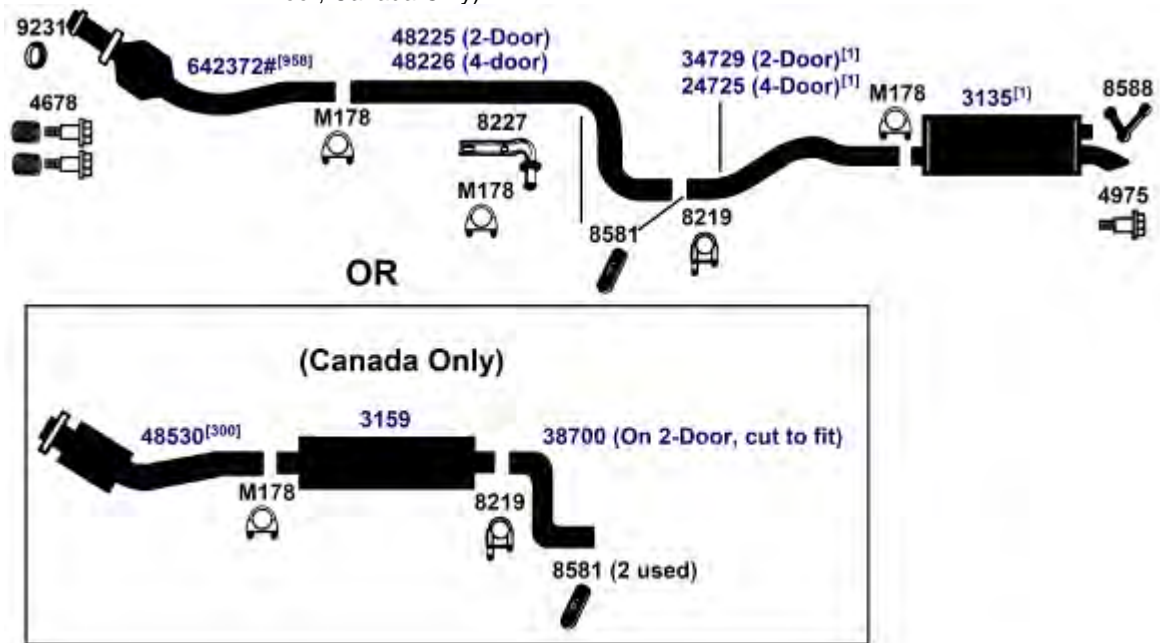

DIRECT FIT MSL/MAXIMUM Muffler... Front 700067, Rear 6569, Silentone DIY Muffler... Rear 5529

NA-Not Available. NR-Not Required. FL-Remove and Re-Use Old Flange. ● Golden Warehouse. O.E.-Original Equipment.
Airtube Kit [4948] may be required to complete installation. EFI-Electronic Fuel Injection.

[1] OE system was a welded assembly. It is recommended that all parts noted [1] should be replaced.

[98] Refer to current Catalytic Converter catalog or Website catalog for availability.

[300] For use when resonator originated from O.E. manufacturer.

[958] Federal & California Emission vehicles. Not legal for sale for vehicles licensed in California.

PLYMOUTH HORIZON

(8341) 81-82 4 Cyl. Horizon, TC-3, 2.2L Engine, without Catalytic Converter

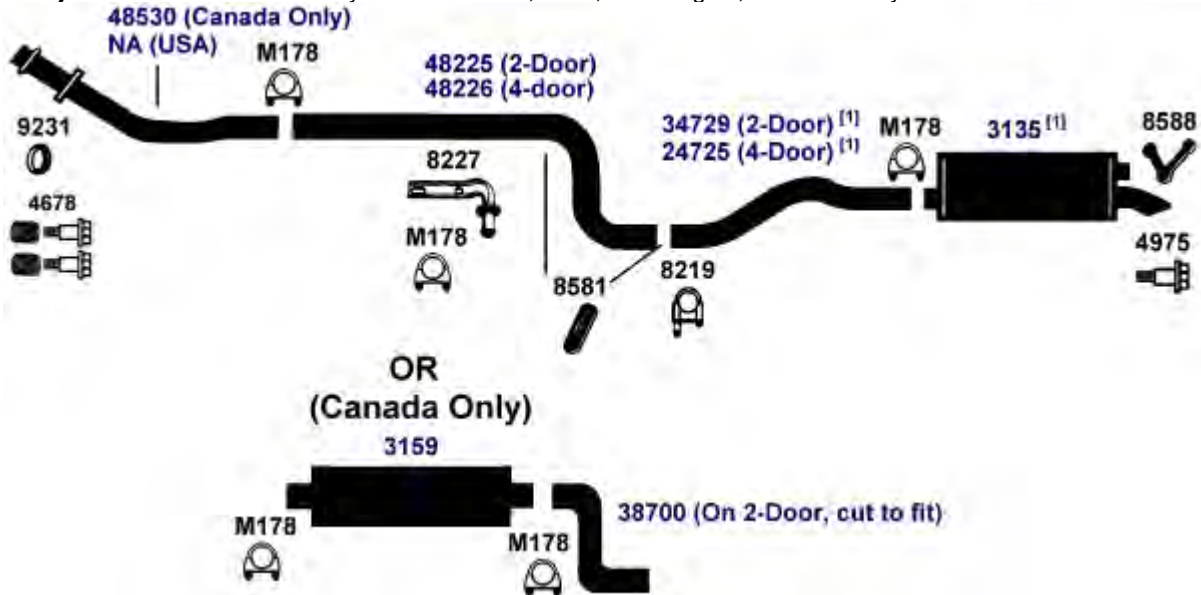

DIRECT FIT MSL/MAXIMUM Muffler... Front 700067, Rear 6569, Silentone DIY Muffler... Rear 5529

(8340) 81-82 4 Cyl. Horizon TC-3, 2.2L Engine, with Catalytic Converter

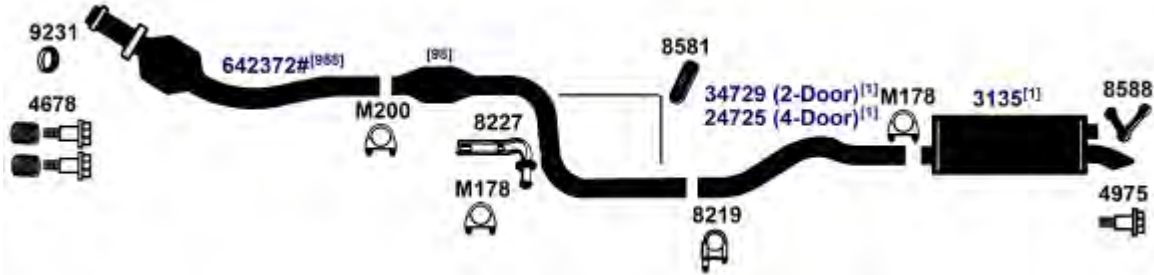

DIRECT FIT MSL/MAXIMUM Muffler... 6569, Silentone DIY Muffler... 5529

NA-Not Available. NR-Not Required. FL-Remove and Re-Use Old Flange. ● Golden Warehouse. O.E.-Original Equipment.
Airtube Kit [4948] may be required to complete installation. EFI-Electronic Fuel Injection.

[1] OE system was a welded assembly. It is recommended that all parts noted [1] should be replaced.

[958] Federal & California Emission vehicles. Not legal for sale for vehicles licensed in California.

[98] Refer to current Catalytic Converter catalog or Website catalog for availability.

92-94 4 Cyl. Laser, 1.8L SOHC Engine

(13256)

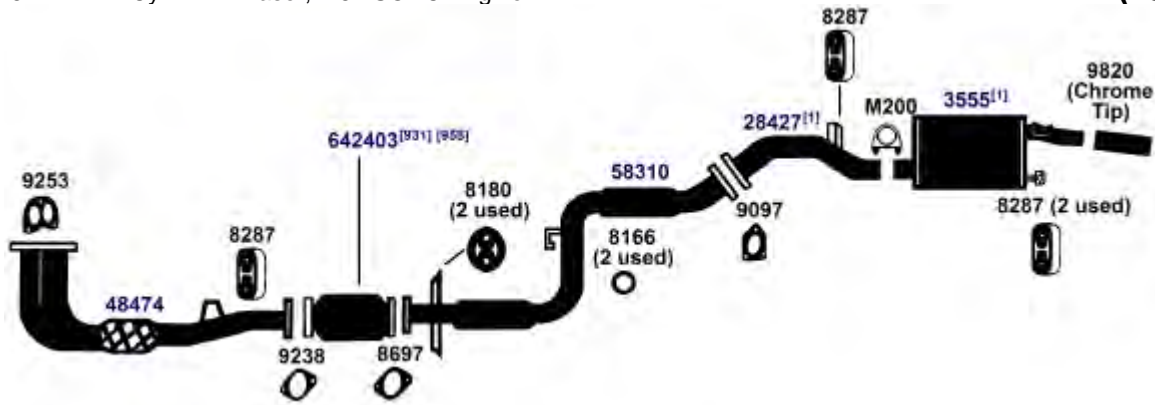

UNIVERSAL FIT MSL/MAXIMUM Muffler... 6563

92-94 4 Cyl. Laser, 2.0L DOHC Engine; except Turbo and All Wheel Drive

(13255)

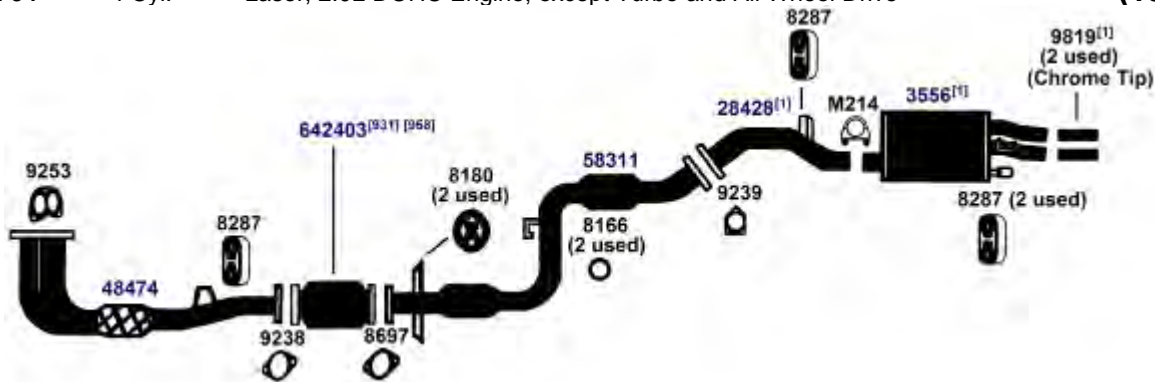

92-94 4 Cyl. Laser, 2.0L DOHC Turbo Engine; except All Wheel Drive

(13254)

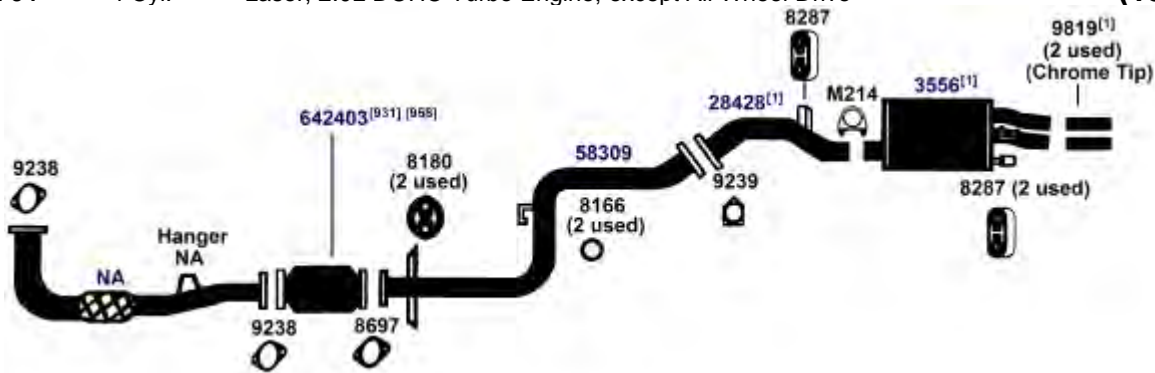

NA-Not Available. NR-Not Required. FL-Remove and Re-Use Old Flange. ● Golden Warehouse. O.E.-Original Equipment.
Airtube Kit [4948] may be required to complete installation. EFI-Electronic Fuel Injection.

[1] OE system was a welded assembly. It is recommended that all parts noted [1] should be replaced.

[958] Federal & California Emission vehicles. Not legal for sale for vehicles licensed in California.

[931] This unit was designed to fit many applications. Measurement of the old unit and cutting of new unit is required.

PLYMOUTH LASER

(13253) 92-94 4 Cyl. Laser, 2.0L DOHC Turbo Engine; All Wheel Drive

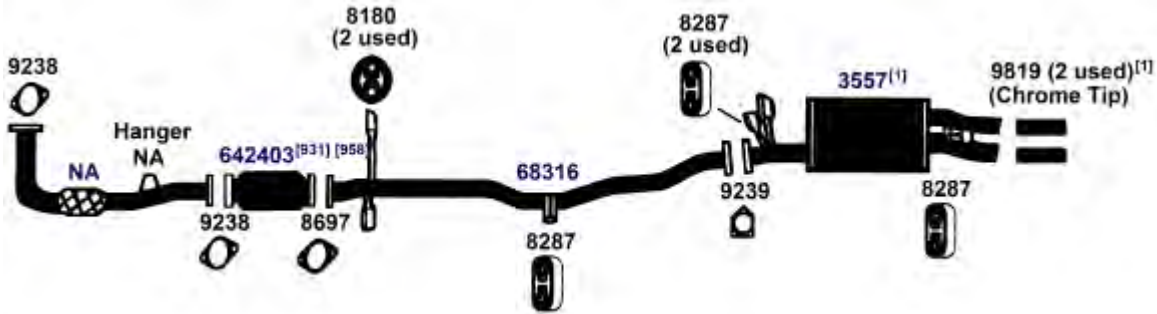

(13252) 90-91 4 Cyl. Laser, 1.8L SOHC Engine

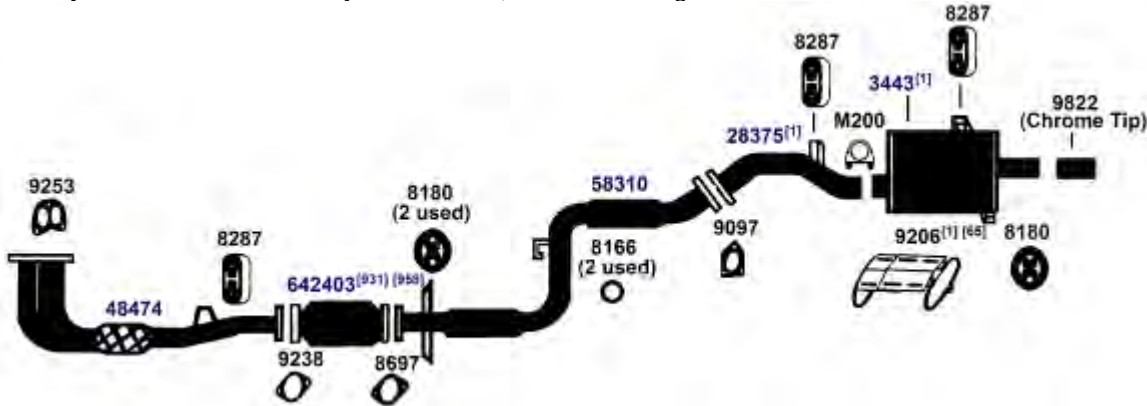

UNIVERSAL FIT MSL/MAXIMUM Muffler... 6549, 6676, 709011

(13251) 90-91 4 Cyl. Laser, 2.0L DOHC Engine; except Turbo

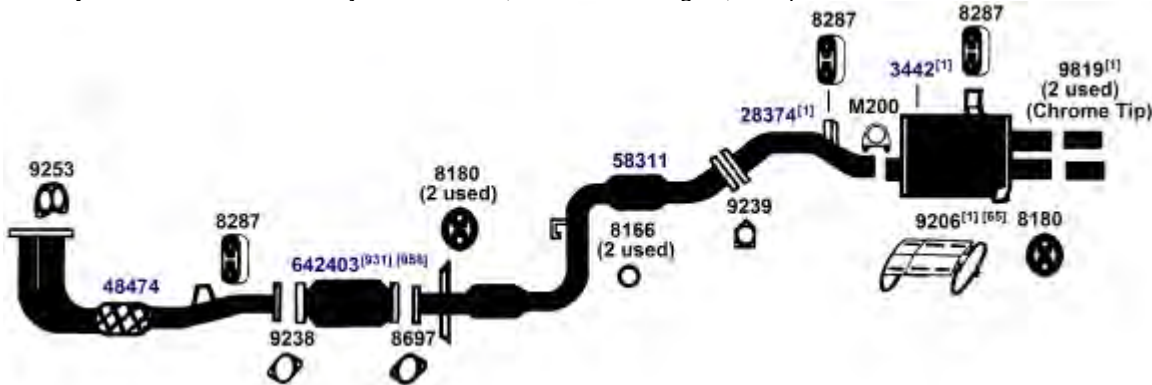

NA-Not Available. NR-Not Required. FL-Remove and Re-Use Old Flange. ● Golden Warehouse. O.E.-Original Equipment.
Airtube Kit [4948] may be required to complete installation. EFI-Electronic Fuel Injection.

[1] OE system was a welded assembly. It is recommended that all parts noted [1] should be replaced.

[65] Heat Shield 9206 is required for installation.

[931] This unit was designed to fit many applications. Measurement of the old unit and cutting of new unit is required.

[958] Federal & California Emission vehicles. Not legal for sale for vehicles licensed in California.

PLYMOUTH LASER

90-91 4 Cyl. Laser, 2.0L DOHC Turbo Engine

(13250)

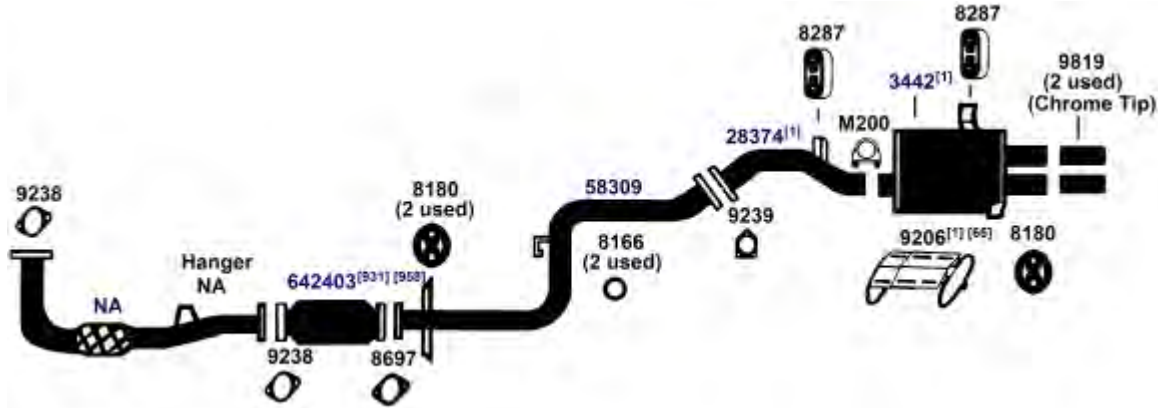

PLYMOUTH RELIANT

1989 4 Cyl. Reliant, Reliant America; 2.2L, 2.5L EFI Engine (135, 153); with Catalytic Converter

(8406)

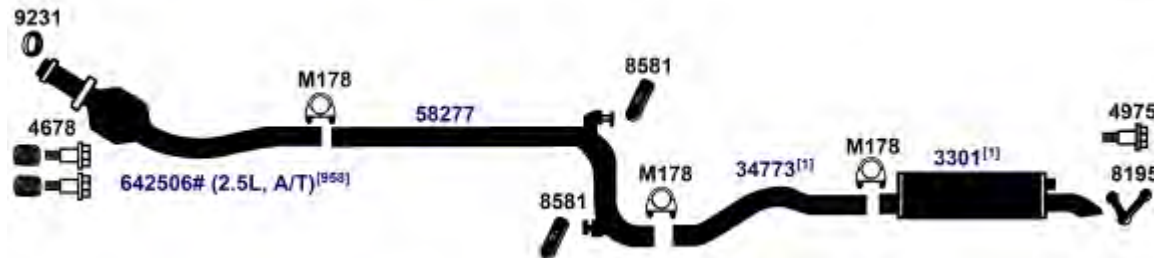

DIRECT FIT MSL/MAXIMUM Muffler... 700105, UNIVERSAL FIT MSL/MAXIMUM Muffler... 6582, Silentone DIY Muffler... 5563 and 14636 Spout

1988 4 Cyl. Reliant, Reliant America; 2.2L Engine; with Catalytic Converter, without Resonator
 86-87 4 Cyl. Reliant, 2.2L EFI Engine; with Catalytic Converter, without Resonator

(8405)

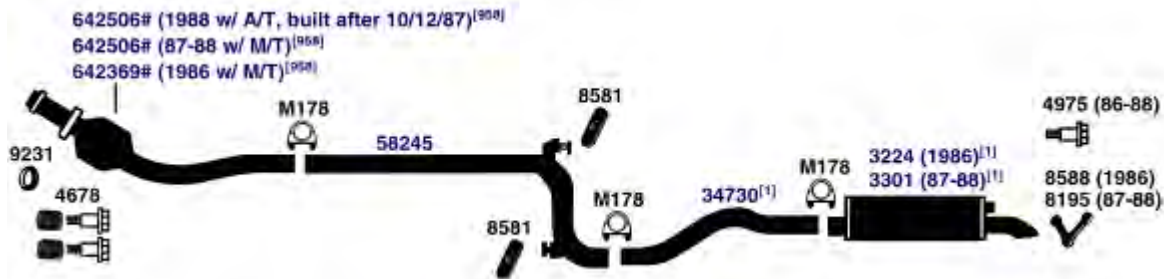

DIRECT FIT MSL/MAXIMUM Muffler... 1986- 700089 (1986), 87-88- 700105 (87-88), UNIVERSAL FIT MSL/MAXIMUM Muffler... 1986- 6568 (1986), 87-88- 6582 (87-88), Silentone DIY Muffler... 1986- 5563 and 14636 Spout, 87-88- 5563 and 14636 Spout

NA-Not Available. NR-Not Required. FL-Remove and Re-Use Old Flange. ● Golden Warehouse. O.E.-Original Equipment.
 # Airtube Kit [4948] may be required to complete installation. EFI-Electronic Fuel Injection.

[1] OE system was a welded assembly. It is recommended that all parts noted [1] should be replaced.
 [65] Heat Shield 9206 is required for installation.

[931] This unit was designed to fit many applications. Measurement of the old unit and cutting of new unit is required.
 [958] Federal & California Emission vehicles. Not legal for sale for vehicles licensed in California.

PLYMOUTH RELIANT

(8404)	1988	4 Cyl.	Reliant, Reliant America; 2.5L EFI Engine; with Catalytic Converter, with Resonator
	86-87	4 Cyl.	Reliant, 2.5L EFI Engine; with Catalytic Converter, with Resonator

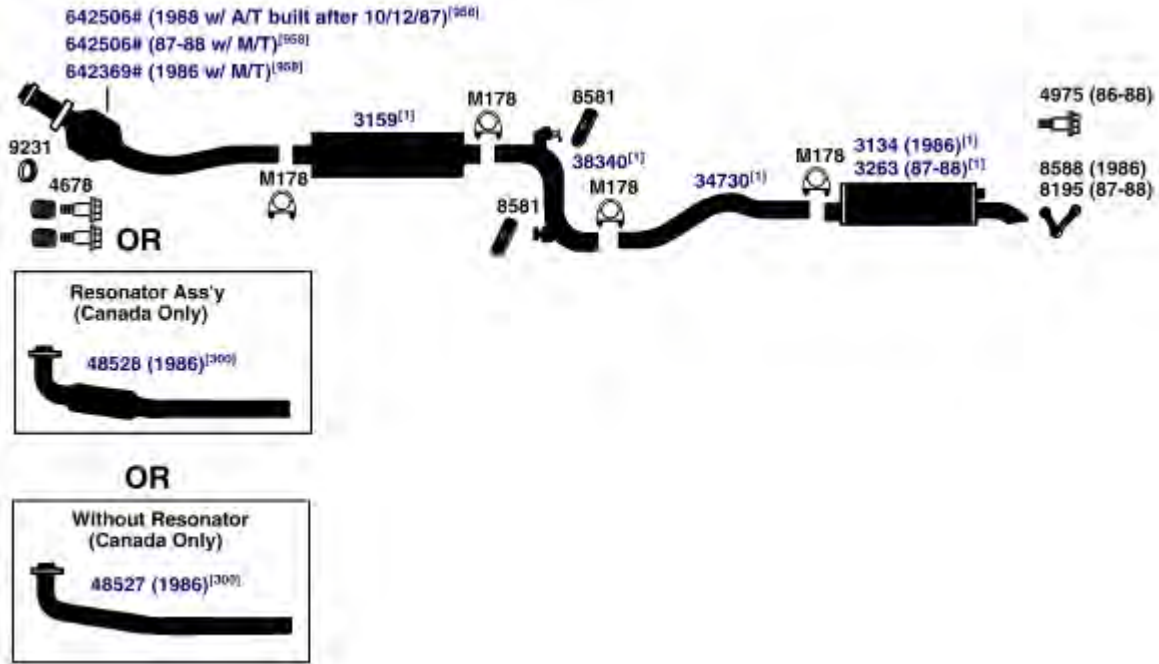

DIRECT FIT MSL/MAXIMUM Muffler... Front Muffler- 700067, Rear Muffler (87-88)- 700101 (87-88), 700101, Rear Muffler (1986)- 6550 (1986), UNIVERSAL FIT MSL/MAXIMUM Muffler... Rear Muffler (87-88)- 6582 (87-88), 6582, Silentone DIY Muffler... Rear Muffler (1986)- 5537 (1986)

NA-Not Available. NR-Not Required. FL-Remove and Re-Use Old Flange. ● Golden Warehouse. O.E.-Original Equipment.
 # Airtube Kit [4948] may be required to complete installation. EFI-Electronic Fuel Injection.

[1] OE system was a welded assembly. It is recommended that all parts noted [1] should be replaced. [958] Federal & California Emission vehicles. Not legal for sale for vehicles licensed in California.

[300] For use when resonator originated from O.E. manufacturer.

1985 4 Cyl. Reliant, 2.2L 2-barrel Engine; with Catalytic Converter

(8403)

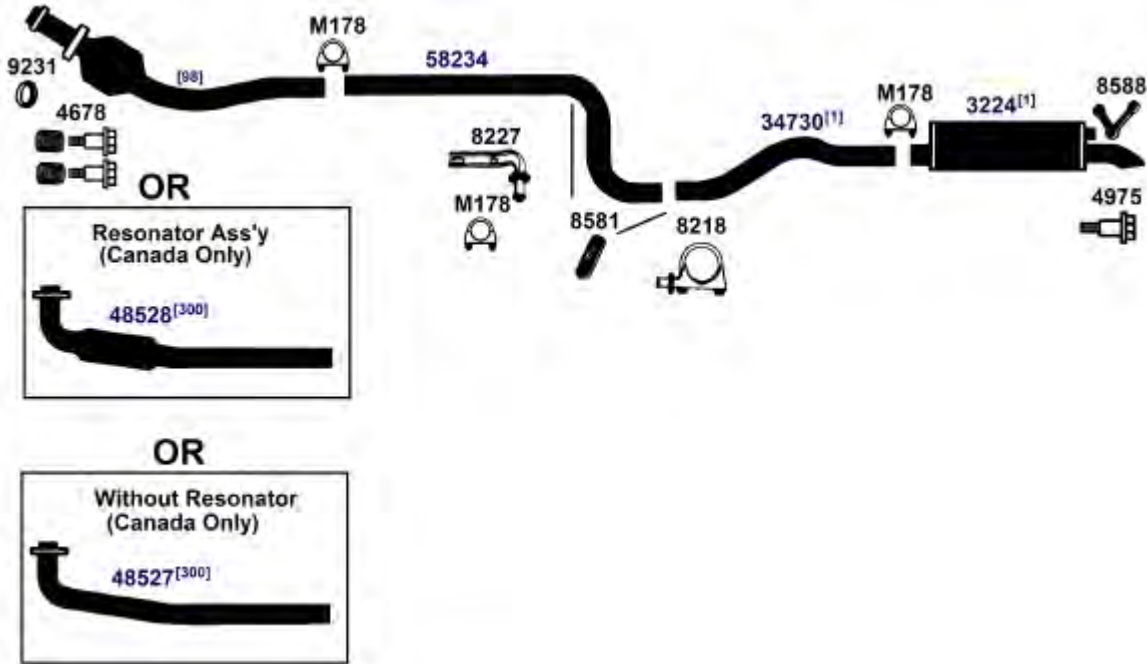

DIRECT FIT MSL/MAXIMUM Muffler... 700089, UNIVERSAL FIT MSL/MAXIMUM Muffler... 6568, Silentone DIY Muffler... 5563 and 14636 Spout

NA-Not Available. NR-Not Required. FL-Remove and Re-Use Old Flange. ● Golden Warehouse. O.E.-Original Equipment.
Airtube Kit [4948] may be required to complete installation. EFI-Electronic Fuel Injection.

[1] OE system was a welded assembly. It is recommended that all parts noted [1] should be replaced.
[98] Refer to current Catalytic Converter catalog or Website catalog for availability.

[300] For use when resonator originated from O.E. manufacturer.
[958] Federal & California Emission vehicles. Not legal for sale for vehicles licensed in California.

PLYMOUTH RELIANT

(8402) 1985 4 Cyl. Reliant, 2.2L EFI 2.6L 2-barrel Engine; with Catalytic Converter; with Resonator

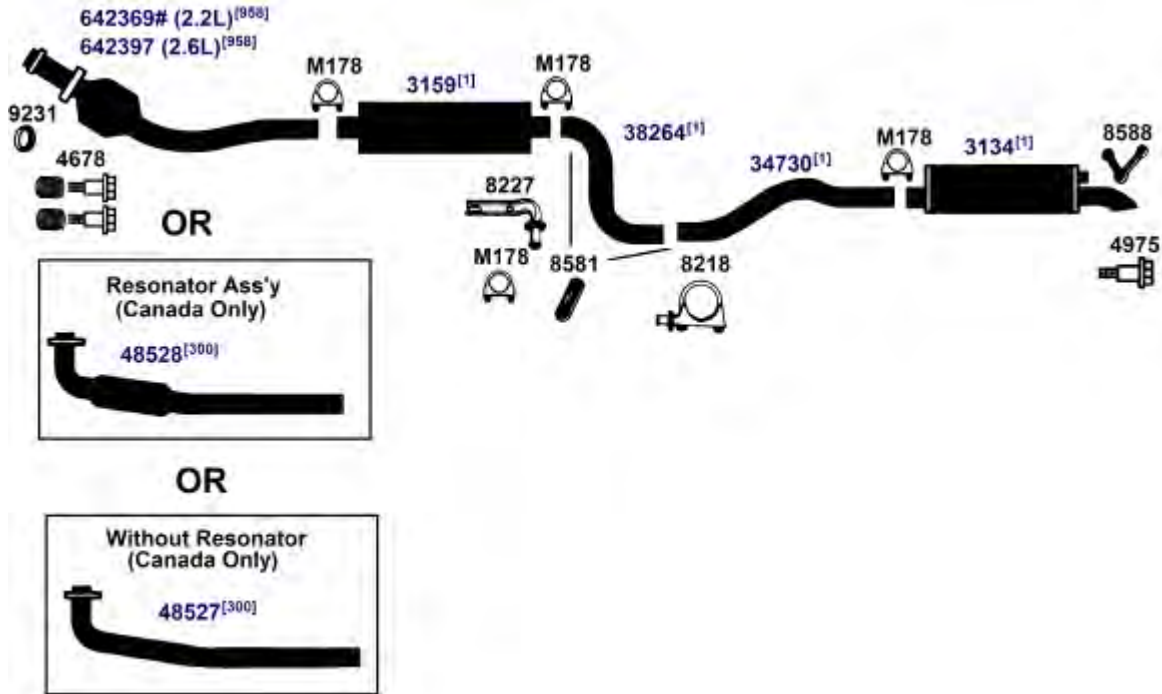

DIRECT FIT MSL/MAXIMUM Muffler... Front Muffler- 700067, Rear Muffler- 6550, Silentone DIY Muffler... Rear Muffler- 5537

NA-Not Available. NR-Not Required. FL-Remove and Re-Use Old Flange. ● Golden Warehouse. O.E.-Original Equipment.
 # Airtube Kit [4948] may be required to complete installation. EFI-Electronic Fuel Injection.

[1] OE system was a welded assembly. It is recommended that all parts noted [1] should be replaced. [958] Federal & California Emission vehicles. Not legal for sale for vehicles licensed in California.

[300] For use when resonator originated from O.E. manufacturer.

83-84 4 Cyl. Reliant, 2.2L, 2.6L Engine; with Catalytic Converter, with Resonator **(8401)**
1982 4 Cyl. Reliant, 2.2L Engine; with Catalytic Converter, with 4" Round Resonator, Late Design

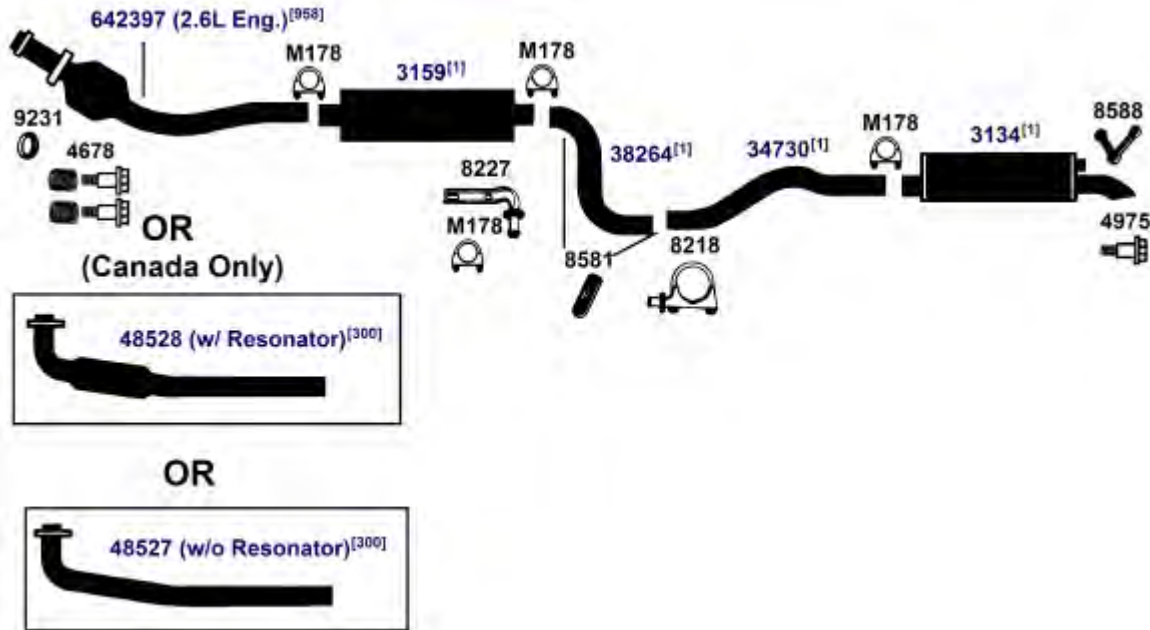

DIRECT FIT MSL/MAXIMUM Muffler... Front Muffler- 70067, Rear Muffler- 6550, Silentone DIY Muffler... Rear Muffler- 5537

81-82 4 Cyl. Reliant, 2.6L Engine; with one Catalytic Converter, with one Resonator **(8398)**

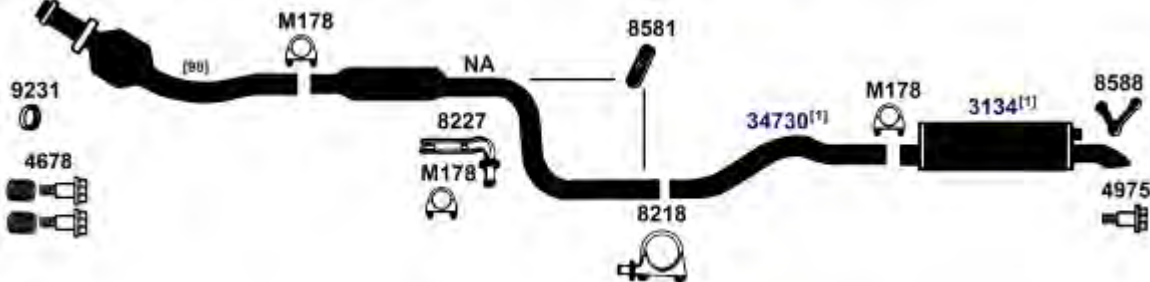

DIRECT FIT MSL/MAXIMUM Muffler... 6550, Silentone DIY Muffler... 5537

NA-Not Available. NR-Not Required. FL-Remove and Re-Use Old Flange. ● Golden Warehouse. O.E.-Original Equipment.
 # Airtube Kit [4948] may be required to complete installation. EFI-Electronic Fuel Injection.

[1] OE system was a welded assembly. It is recommended that all parts noted [1] should be replaced.
 [98] Refer to current Catalytic Converter catalog or Website catalog for availability.

[300] For use when resonator originated from O.E. manufacturer.
 [958] Federal & California Emission vehicles. Not legal for sale for vehicles licensed in California.

PLYMOUTH RELIANT

(8399) 81-82 4 Cyl. Reliant, 2.2L, 2.6L Engine; without Catalytic Converter, with two Resonators; Canada and Export Models

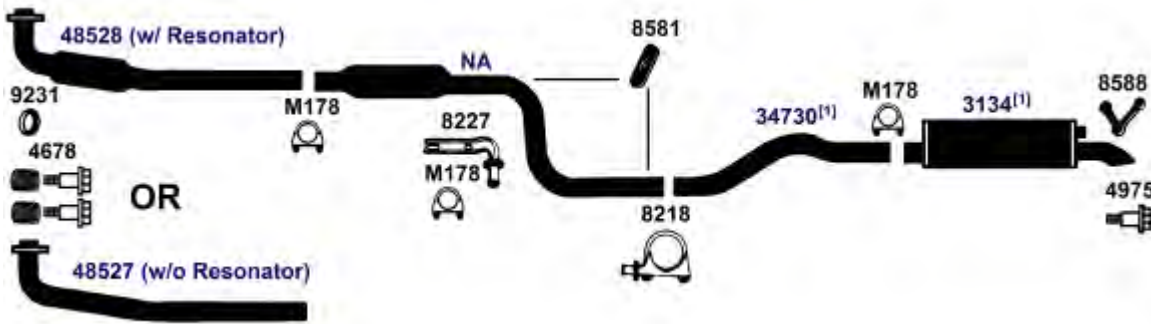

DIRECT FIT MSL/MAXIMUM Muffler... 6550, Silentone DIY Muffler... 5537

(8400) 81-82 4 Cyl. Reliant, 2.2L Engine; with two Catalytic Converters, 1982 Early Design



DIRECT FIT MSL/MAXIMUM Muffler... 6550, Silentone DIY Muffler... 5537

(8397) 1981 4 Cyl. Reliant, 2.6L Engine, with two Catalytic Converters

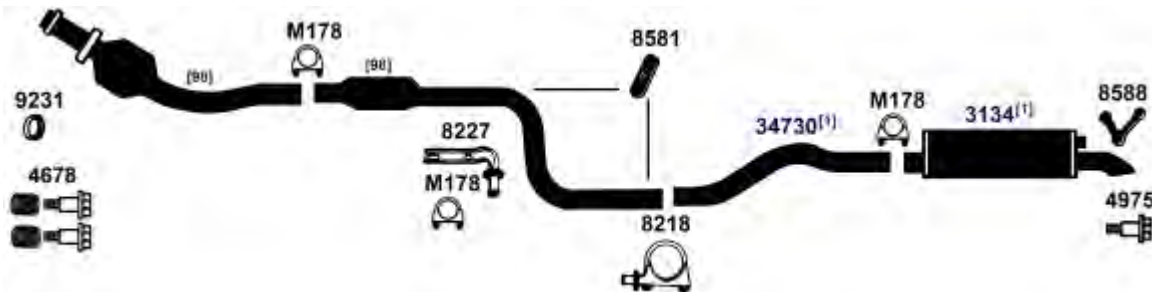

DIRECT FIT MSL/MAXIMUM Muffler... 6550, Silentone DIY Muffler... 5537

NA-Not Available. NR-Not Required. FL-Remove and Re-Use Old Flange. ● Golden Warehouse. O.E.-Original Equipment.
Airtube Kit [4948] may be required to complete installation. EFI-Electronic Fuel Injection.

[1] OE system was a welded assembly. It is recommended that all parts noted [1] should be replaced.

[958] Federal & California Emission vehicles. Not legal for sale for vehicles licensed in California.

[98] Refer to current Catalytic Converter catalog or Website catalog for availability.

PLYMOUTH SUNDANCE

92-94 6 Cyl. Sundance, Sundance Duster; 3.0L EFI Engine, with Catalytic Converter **(8479)**

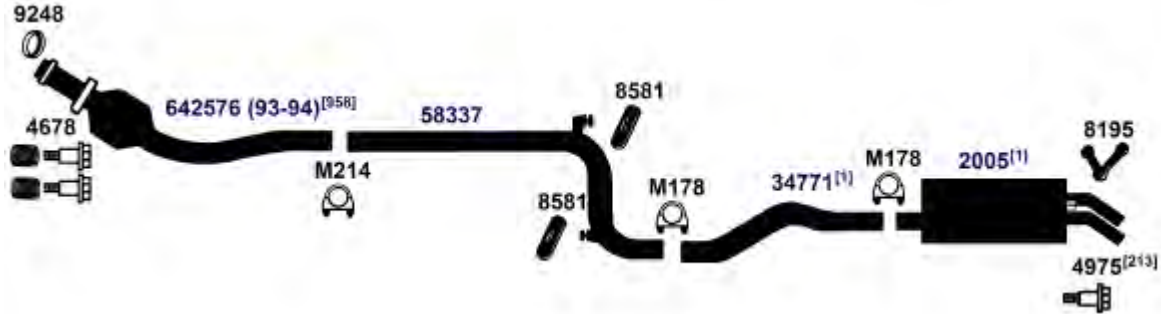

DIRECT FIT MSL/MAXIMUM Muffler... 700208

89-94 4 Cyl. Sundance, Sundance America, Sundance Duster; 2.2L, 2.5L EFI Engine (135,153); with Catalytic Converter; except Turbo **(8478)**



DIRECT FIT MSL/MAXIMUM Muffler... 700103, Silentone DIY Muffler... 5562

87-88 4 Cyl. Sundance, 2.2L EFI Turbocharged Engine, with Catalytic Converter **(8475)**

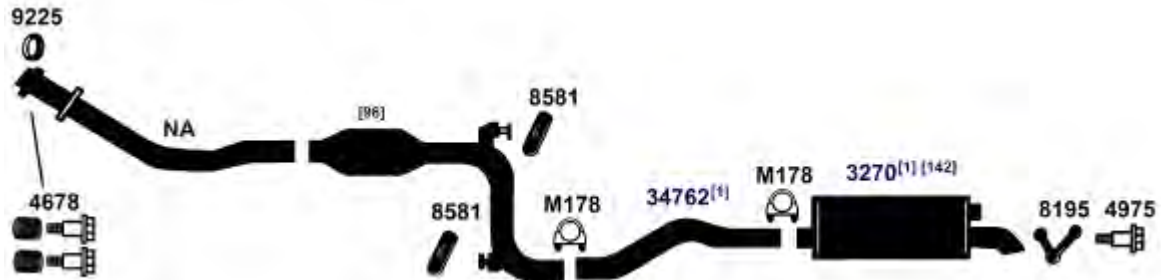

UNIVERSAL FIT MSL/MAXIMUM Muffler... 6581

NA-Not Available. NR-Not Required. FL-Remove and Re-Use Old Flange. ● Golden Warehouse. O.E.-Original Equipment.
Airtube Kit [4948] may be required to complete installation. EFI-Electronic Fuel Injection.

[1] OE system was a welded assembly. It is recommended that all parts noted [1] should be replaced.

[142] O.E. muffler has dual spouts that angle toward corner of vehicle. Replacement muffler has dual spouts that exit straight.

[213] Required for installation on 1993 models.

[958] Federal & California Emission vehicles. Not legal for sale for vehicles licensed in California.

PLYMOUTH SUNDANCE

(8476)	1988	4 Cyl.	Sundance, 2.5L EFI Engine; with Catalytic Converter
	87-88	4 Cyl.	Sundance, 2.2L EFI Engine; except Turbocharged; with Catalytic Converter

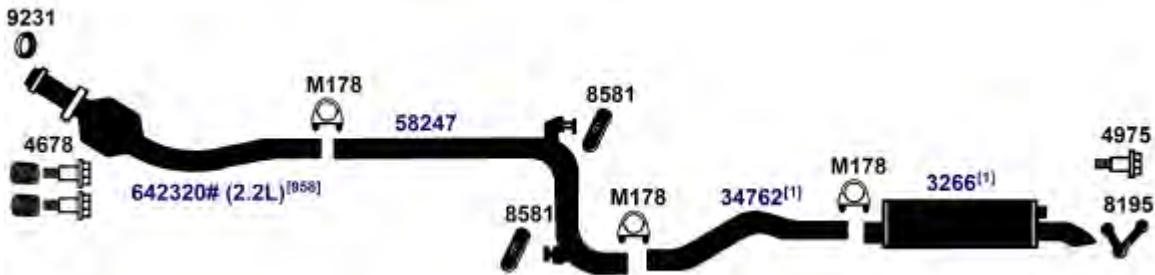

DIRECT FIT MSL/MAXIMUM Muffler... 700103, Silentone DIY Muffler... 5562

PLYMOUTH TURISMO

(8560E)	1984	4 Cyl.	Turismo, Duster; 2-Door, 1.6L, 2.2L 2-barrel Engine; with Catalytic Converter, without Resonator
	1983	4 Cyl.	Turismo, Duster, 2-Door; 2.2L Engine, with Catalytic Converter.

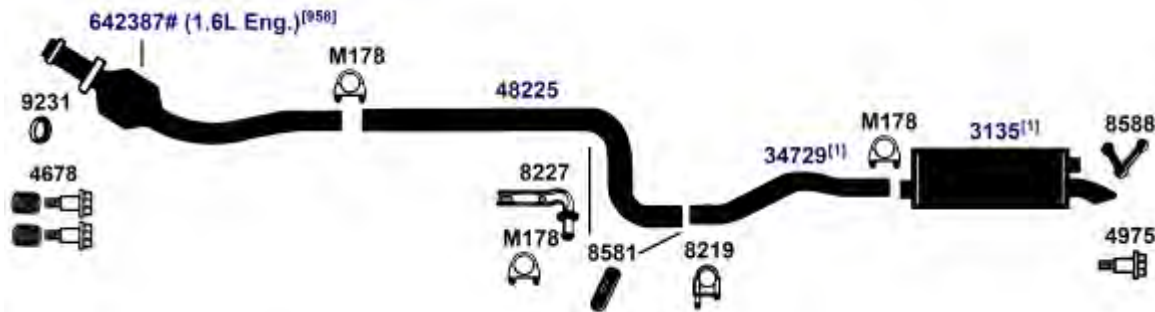

DIRECT FIT MSL/MAXIMUM Muffler... 6569, Silentone DIY Muffler... 5529

NA-Not Available. NR-Not Required. FL-Remove and Re-Use Old Flange. ● Golden Warehouse. O.E.-Original Equipment.
Airtube Kit [4948] may be required to complete installation. EFI-Electronic Fuel Injection.

[1] OE system was a welded assembly. It is recommended that all parts noted [1] should be replaced.

[98] Refer to current Catalytic Converter catalog or Website catalog for availability.

[958] Federal & California Emission vehicles. Not legal for sale for vehicles licensed in California.

PLYMOUTH TURISMO

83-84 4 Cyl. Turismo, 2-Door, 2.2L High Performance Engine; with Catalytic Converter (8556E)

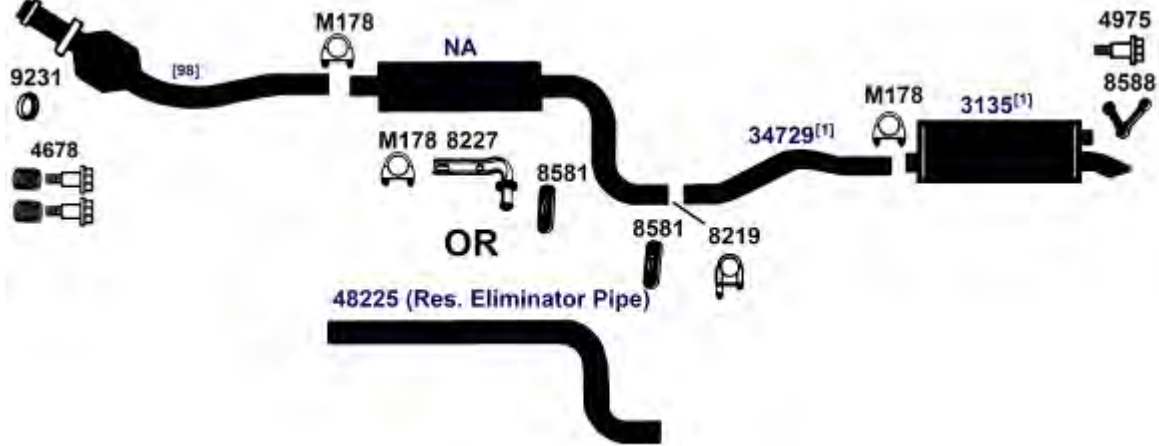

DIRECT FIT MSL/MAXIMUM Muffler... Rear Muffler- 6569, Silentone DIY Muffler... Rear Muffler- 5529

1983 4 Cyl. Turismo, 2-Door; 1.6L, 1.7L Engine; with two Catalytic Converters (8555)

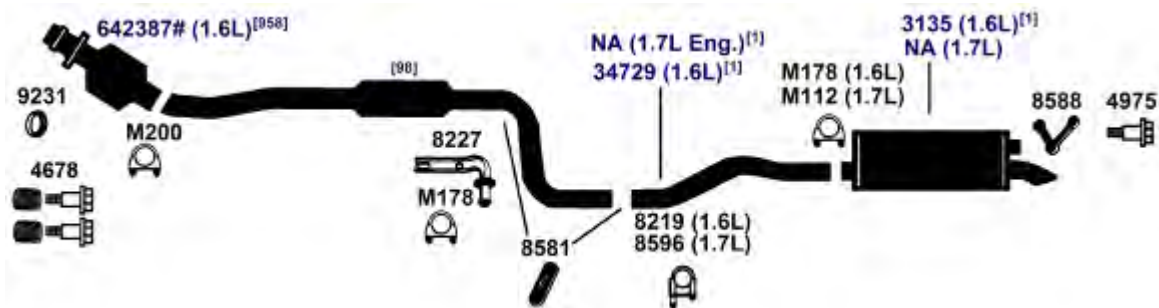

DIRECT FIT MSL/MAXIMUM Muffler... 1.6L Engine- 6569, Silentone DIY Muffler... 1.6L Engine- 5529

PLYMOUTH VOLARE

79-80 6 Cyl. Volare, 225 Engine, without Catalytic Converter (8697)

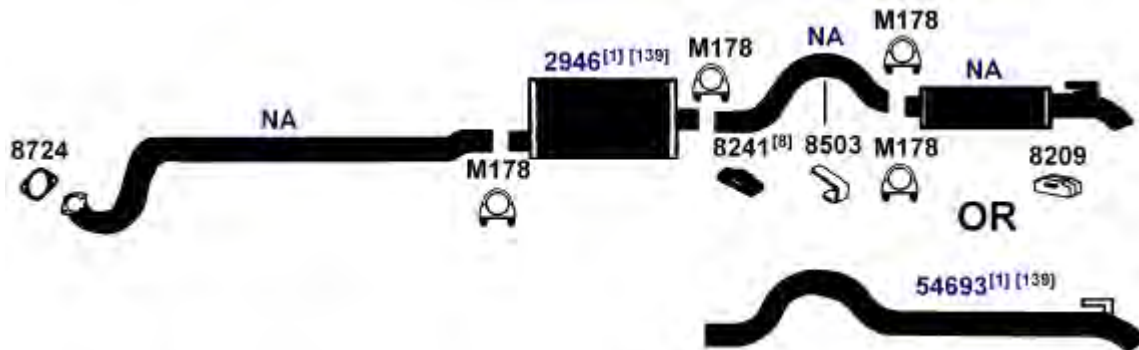

DIRECT FIT MSL/MAXIMUM Muffler... Front Muffler- 700053, UNIVERSAL FIT MSL/MAXIMUM Muffler... Front Muffler- 6503, 709008, Silentone DIY Muffler... Front Muffler- 5511

NA-Not Available. NR-Not Required. FL-Remove and Re-Use Old Flange. ● Golden Warehouse. O.E.-Original Equipment.
Airtube Kit [4948] may be required to complete installation. EFI-Electronic Fuel Injection.

[1] OE system was a welded assembly. It is recommended that all parts noted [1] should be replaced.

[8] Replaces rubber portion only.

[98] Refer to current Catalytic Converter catalog or Website catalog for availability.

[139] May be necessary to replace all noted parts on 1979 1-barrel Carb. models.
[958] Federal & California Emission vehicles. Not legal for sale for vehicles licensed in California.

PLYMOUTH VOLARE

(8700) 79-80 6 Cyl. Volare, 225 Engine, with Catalytic Converter



DIRECT FIT MSL/MAXIMUM Muffler... Front Muffler- 700053, UNIVERSAL FIT MSL/MAXIMUM Muffler... Front Muffler- 6503, 709008, Silentone DIY Muffler... Front Muffler- 5511

(8699) 79-80 8 Cyl. Volare, 318 Engine, without Catalytic Converter
 1979 8 Cyl. Volare, 360 Engine, 2-barrel Carb., without Catalytic Converter

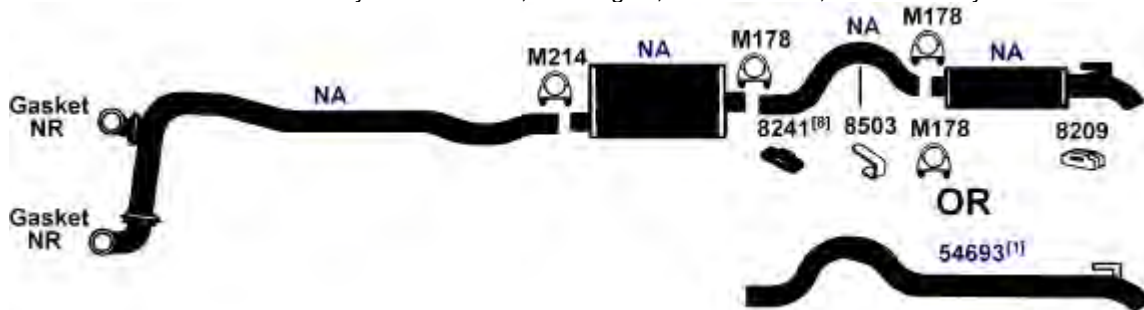

UNIVERSAL FIT MSL/MAXIMUM Muffler... Front Muffler- 6504, Silentone DIY Muffler... Front Muffler- 5502

(8698) 79-80 8 Cyl. Volare, 318 Engine, with Catalytic Converter

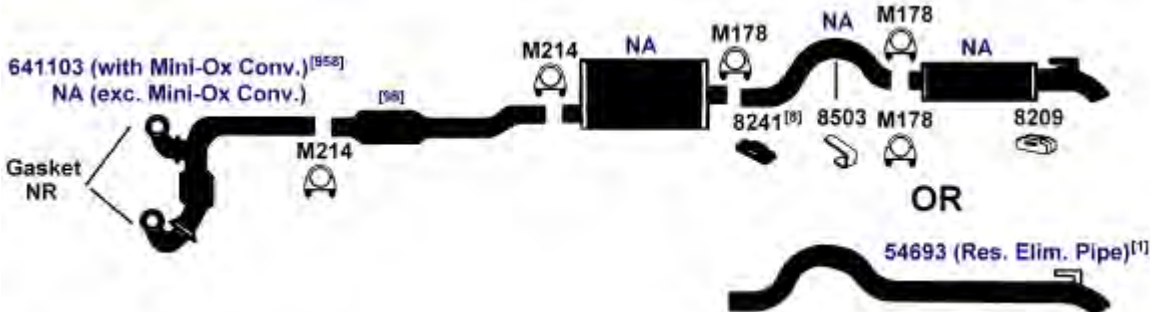

UNIVERSAL FIT MSL/MAXIMUM Muffler... Front Muffler- 6504, Silentone DIY Muffler... Front Muffler- 5502

NA-Not Available. NR-Not Required. FL-Remove and Re-Use Old Flange. ● Golden Warehouse. O.E.-Original Equipment.
 # Airtube Kit [4948] may be required to complete installation. EFI-Electronic Fuel Injection.

[1] OE system was a welded assembly. It is recommended that all parts noted [1] should be replaced.
 [8] Replaces rubber portion only.
 [98] Refer to current Catalytic Converter catalog or Website catalog for availability.

[139] May be necessary to replace all noted parts on 1979 1-barrel Carb. models.
 [911] Semi-Direct Fit converter. Fabrication required.
 [958] Federal & California Emission vehicles. Not legal for sale for vehicles licensed in California.

1979 8 Cyl. Volare, 360 Engine, 2-barrel Carb. with Catalytic Converter

(8688)

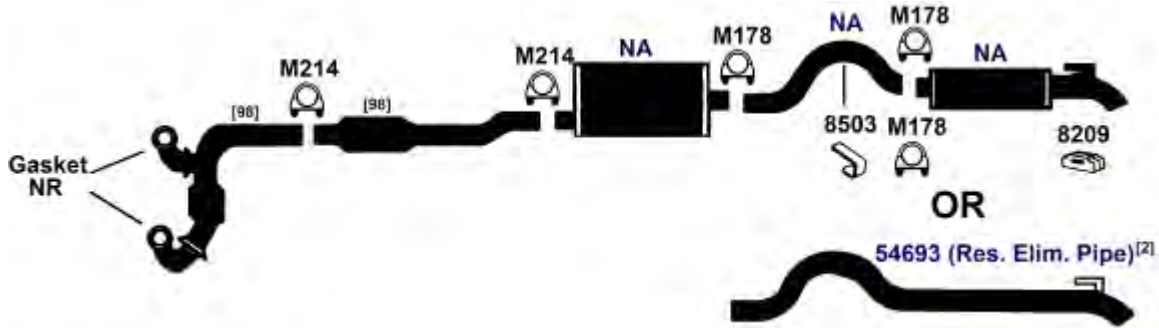

UNIVERSAL FIT MSL/MAXIMUM Muffler... Front Muffler- 6504, Silentone DIY Muffler... Front Muffler- 5502

PONTIAC
PONTIAC 6000

90-91 6 Cyl. 6000 S/E, 189 Engine (3.1L), except Sta. Wagon; except All Wheel Drive
1989 6 Cyl. 6000 S/E, 173 Engine, (2.8W), except Sta. Wagon

(9415)

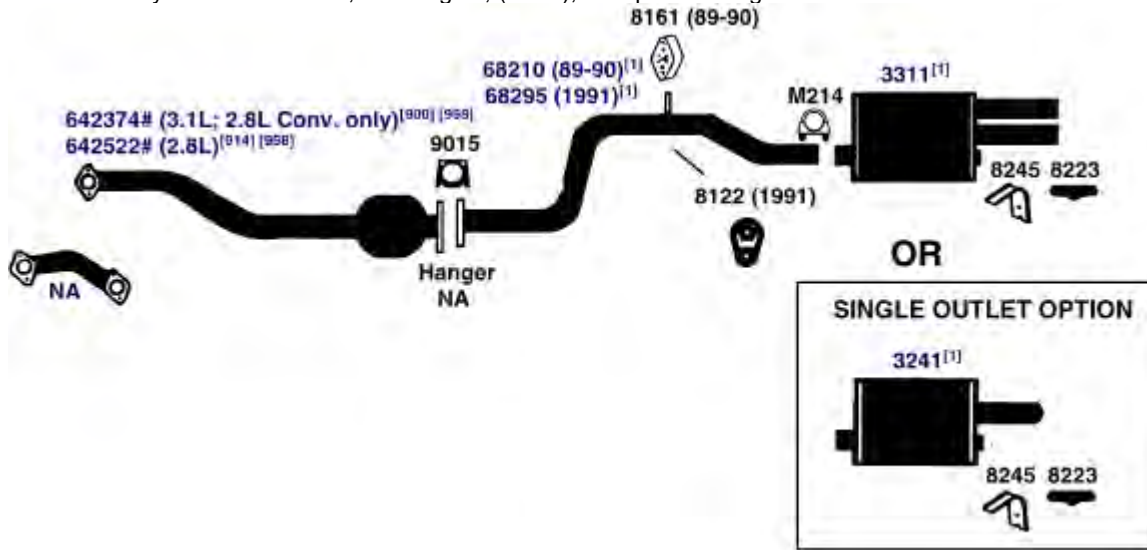

DIRECT FIT MSL/MAXIMUM Muffler... Single Outlet- 6591, UNIVERSAL FIT MSL/MAXIMUM Muffler... Dual Outlet- 6570, 709015, Single Outlet- 6562, 709014, Silentone DIY Muffler... Single Outlet- 5556 and 14636 Spout and 8506 Bracket, 8245 hanger

NA-Not Available. NR-Not Required. FL-Remove and Re-Use Old Flange. ● Golden Warehouse. O.E.-Original Equipment.
Airtube Kit [4948] may be required to complete installation. EFI-Electronic Fuel Injection.

- [1] OE system was a welded assembly. It is recommended that all parts noted [1] should be replaced.
- [2] May be necessary to replace all noted [2] parts.
- [98] Refer to current Catalytic Converter catalog or Website catalog for availability.

- [900] Direct fit converter may require resizing, cutting or bushing.
- [914] Direct fit converter includes front (Exhaust) pipe, (1) piece assembly.
- [958] Federal & California Emission vehicles. Not legal for sale for vehicles licensed in California.

PONTIAC 6000

(9414) 88-91 4 Cyl. 6000, 151 Engine (2.5L), except Sta. Wagon

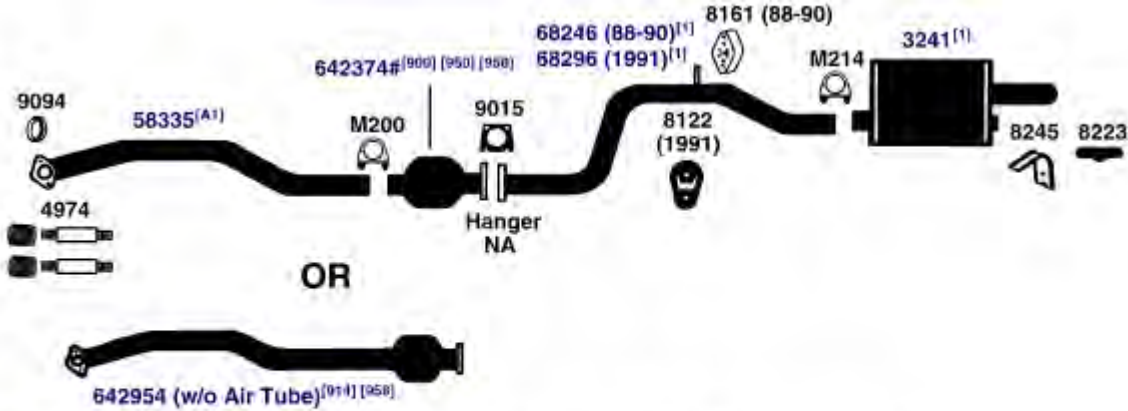

[A1] Cut O.E. Manifold Pipe directly behind pipe to converter weld. Remove any portion of original Manifold Pipe that is in converter inlet. 58335 is then installed inside O.E.M. converter. Use with O.E.M. Converter only.

DIRECT FIT MSL/MAXIMUM Muffler... 6591, UNIVERSAL FIT MSL/MAXIMUM Muffler... 6562, 709014, Silentone DIY Muffler... 5556 and 14636 Spout and 8506 Bracket, 8245 hanger

(9409) 90-91 6 Cyl. 6000, 189 Engine (3.1L), except Sta. Wagon (models with single outlet muffler)
86-89 6 Cyl. 6000, 173 Engine (2.8V), except Sta. Wagon (models with single outlet muffler)

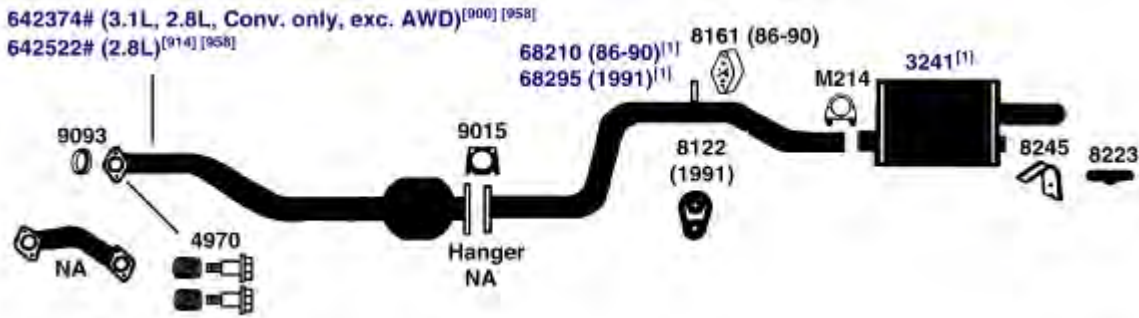

DIRECT FIT MSL/MAXIMUM Muffler... 6591, UNIVERSAL FIT MSL/MAXIMUM Muffler... 6562, 709014, Silentone DIY Muffler... 5556 and 14636 Spout and 8506 Bracket, 8245 hanger

NA-Not Available. NR-Not Required. FL-Remove and Re-Use Old Flange. ● Golden Warehouse. O.E.-Original Equipment.
Airtube Kit [4948] may be required to complete installation. EFI-Electronic Fuel Injection.

[1] OE system was a welded assembly. It is recommended that all parts noted [1] should be replaced.

[900] Direct fit converter may require resizing, cutting or bushing.

[914] Direct fit converter includes front (Exhaust) pipe, (1) piece assembly.

[915] Does not include complete front pipe.

[950] Conv. only, w/o front pipe.

[958] Federal & California Emission vehicles. Not legal for sale for vehicles licensed in California.

90-91 6 Cyl. 6000 Sta. Wagon, 189 Engine (3.1L)
 86-89 6 Cyl. 6000 Sta. Wagon, 173 Engine (2.8W)

(9408)

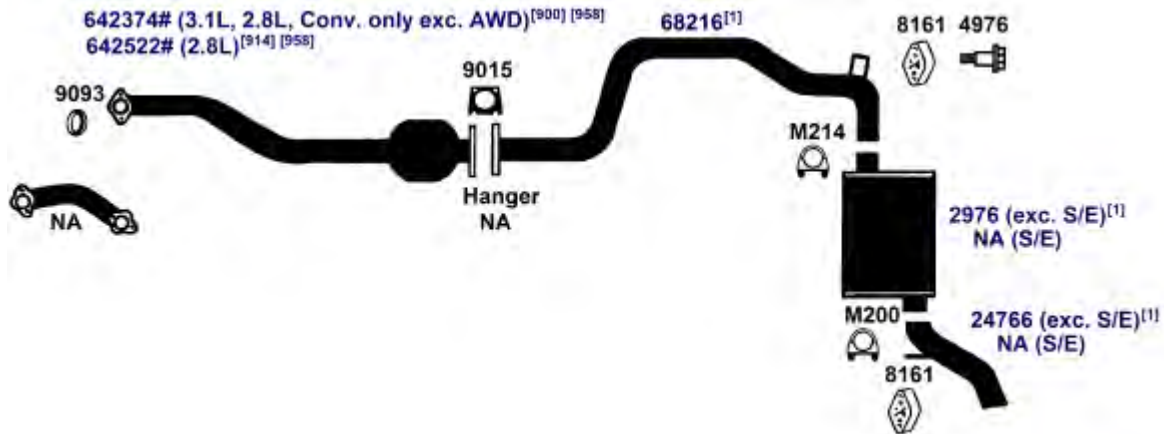

DIRECT FIT MSL/MAXIMUM Muffler... Option For Muffler (2976) exc.S/E- 6543, UNIVERSAL FIT MSL/MAXIMUM Muffler... Option For Muffler (2976) exc.S/E- 709012, Silentone DIY Muffler... Option For Muffler (2976) exc.S/E- 5528

88-89 4 Cyl. 6000 Sta. Wagon, 151 Engine (2.5L)

(9413)

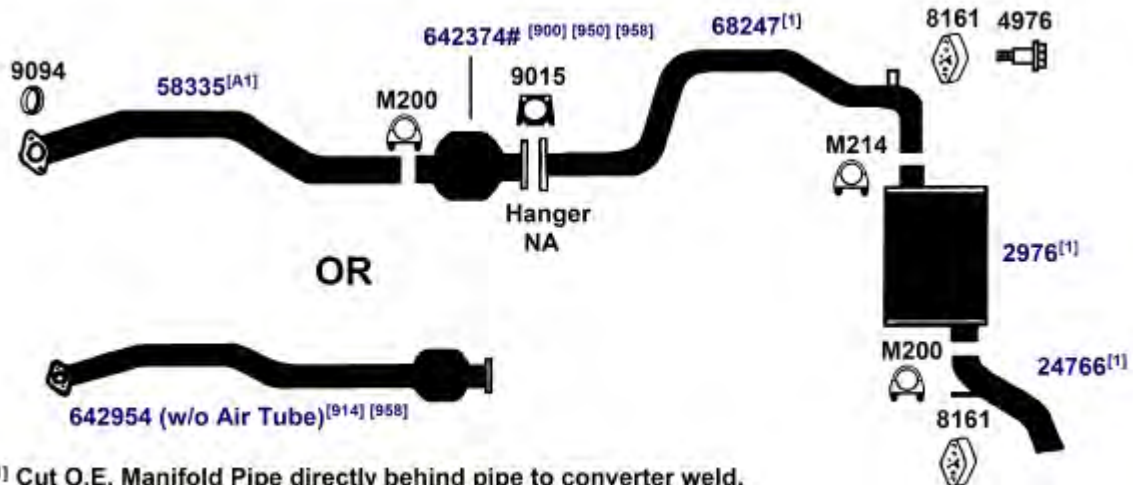

[A1] Cut O.E. Manifold Pipe directly behind pipe to converter weld. Remove any portion of original Manifold Pipe that is in converter inlet. 58335 is then installed inside O.E.M. converter inlet. Use with O.E.M. converter only.

DIRECT FIT MSL/MAXIMUM Muffler... 6543, UNIVERSAL FIT MSL/MAXIMUM Muffler... 709012, Silentone DIY Muffler... 5528

NA-Not Available. NR-Not Required. FL-Remove and Re-Use Old Flange. ● Golden Warehouse. O.E.-Original Equipment.
 # Airtube Kit [4948] may be required to complete installation. EFI-Electronic Fuel Injection.

[1] OE system was a welded assembly. It is recommended that all parts noted [1] should be replaced.
 [900] Direct fit converter may require resizing, cutting or bushing.
 [914] Direct fit converter includes front (Exhaust) pipe, (1) piece assembly.

[915] Does not include complete front pipe.
 [950] Conv. only, w/o front pipe.
 [958] Federal & California Emission vehicles. Not legal for sale for vehicles licensed in California.

PONTIAC 6000

(9410) 86-88 6 Cyl. 6000, S/E, STE; 173 Engine (2.8W), except Sta. Wagon

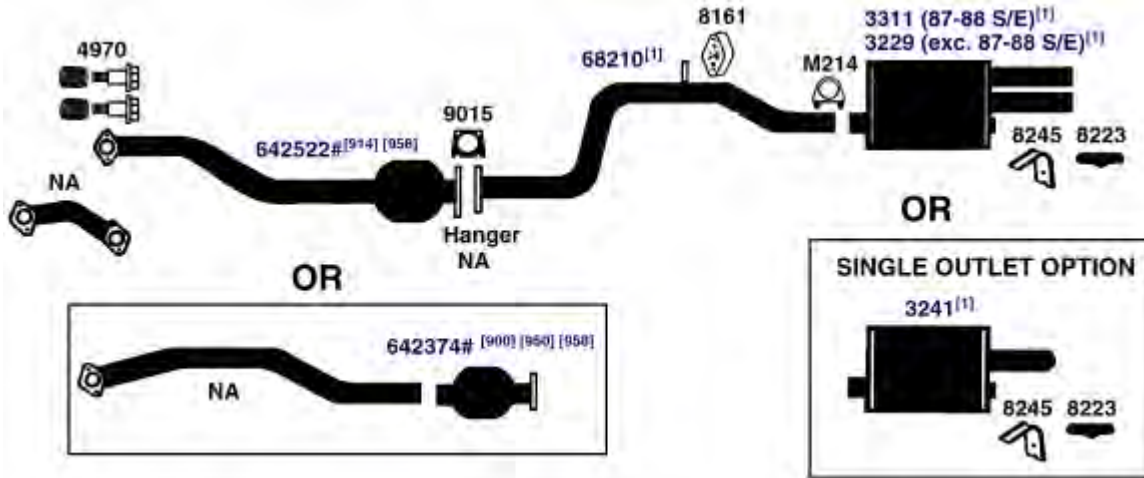

DIRECT FIT MSL/MAXIMUM Muffler... 700091, Single Outlet- 6591, UNIVERSAL FIT MSL/MAXIMUM Muffler... 709015, 6570, Single Outlet- 6562, 709014, Silentone DIY Muffler... Single Outlet- 5556 and 14636 Spout and 8506 Bracket, 8245 hanger

(9411) 1987 4 Cyl. 6000 Sta. Wagon, 151 Engine (2.5L)

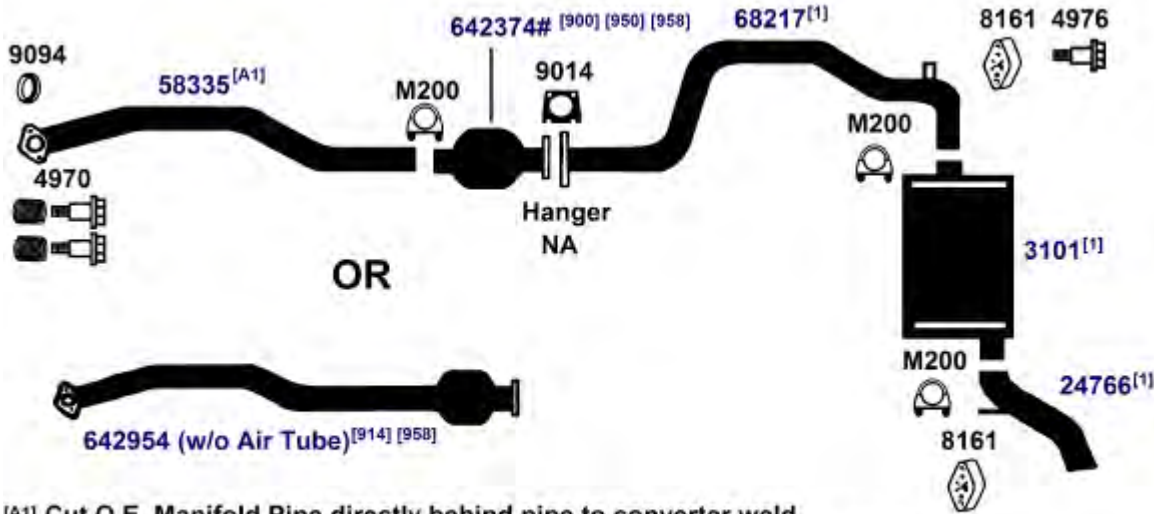

[A1] Cut O.E. Manifold Pipe directly behind pipe to converter weld. Remove any portion of original Manifold Pipe that is in converter inlet. 58335 is then installed inside O.E.M. converter inlet. Use with O.E.M. converter only.

DIRECT FIT MSL/MAXIMUM Muffler... 6538, UNIVERSAL FIT MSL/MAXIMUM Muffler... 709011, Silentone DIY Muffler... 5528

NA-Not Available. NR-Not Required. FL-Remove and Re-Use Old Flange. ● Golden Warehouse. O.E.-Original Equipment.
Airtube Kit [4948] may be required to complete installation. EFI-Electronic Fuel Injection.

[1] OE system was a welded assembly. It is recommended that all parts noted [1] should be replaced.

[900] Direct fit converter may require resizing, cutting or bushing.

[914] Direct fit converter includes front (Exhaust) pipe, (1) piece assembly.

[915] Does not include complete front pipe.

[950] Conv. only, w/o front pipe.

[958] Federal & California Emission vehicles. Not legal for sale for vehicles licensed in California.

86-87 4 Cyl. 6000, 151 Engine (2.5L), except Sta. Wagon

(9405)

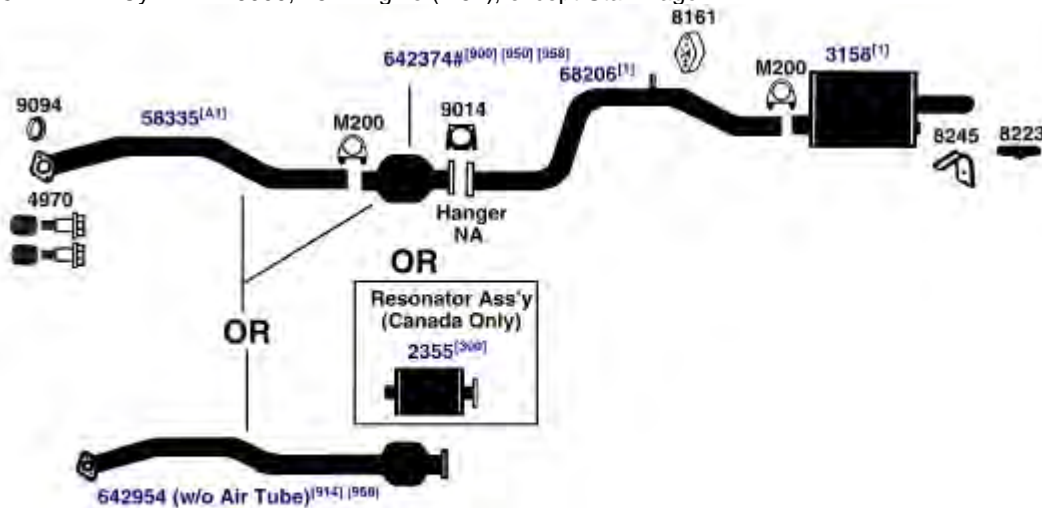

[A1] Cut O.E. Manifold Pipe directly behind pipe to converter weld. Remove any portion of original Manifold Pipe that is in converter inlet. 58335 is then installed inside O.E.M. converter inlet. Use with O.E.M. converter only.

DIRECT FIT MSL/MAXIMUM Muffler... Rear Muffler- 6573, UNIVERSAL FIT MSL/MAXIMUM Muffler... Rear Muffler- 6544, 6562, 709014, Silentone DIY Muffler... Rear Muffler- 5535

1986 4 Cyl. 6000 Sta. Wagon, 151 Engine (2.5L)

(9404)

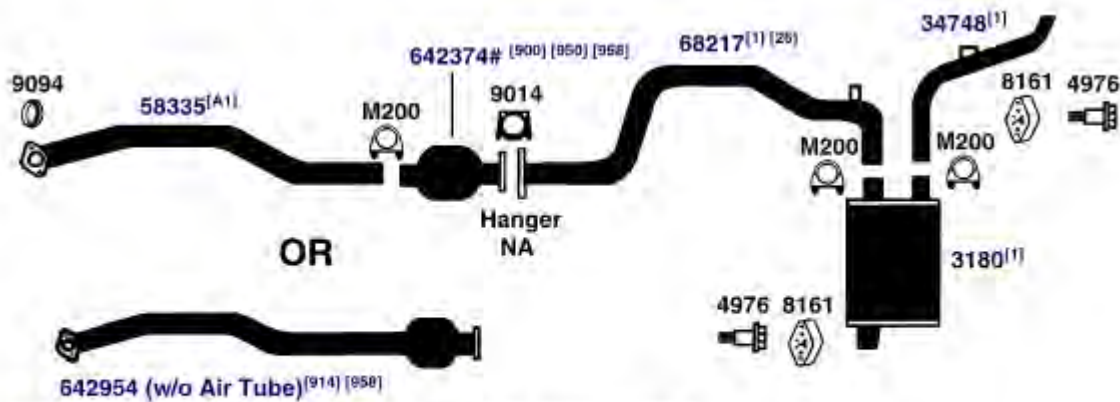

[A1] Cut O.E. Manifold Pipe directly behind pipe to converter weld. Remove any portion of original Manifold Pipe that is in converter inlet. 58335 is then installed inside O.E.M. converter inlet. Use with O.E.M. converter only.

DIRECT FIT MSL/MAXIMUM Muffler... 6564

NA-Not Available. NR-Not Required. FL-Remove and Re-Use Old Flange. ● Golden Warehouse. O.E.-Original Equipment.
Airtube Kit [4948] may be required to complete installation. EFI-Electronic Fuel Injection.

- [1] OE system was a welded assembly. It is recommended that all parts noted [1] should be replaced.
- [26] Bracket on pipe is not required on all applications.
- [300] For use when resonator originated from O.E. manufacturer.
- [900] Direct fit converter may require resizing, cutting or bushing.

- [914] Direct fit converter includes front (Exhaust) pipe, (1) piece assembly.
- [915] Does not include complete front pipe.
- [950] Conv. only, w/o front pipe.
- [958] Federal & California Emission vehicles. Not legal for sale for vehicles licensed in California.

PONTIAC 6000

(9402) 1986 6 Cyl. 6000, 173 Engine, (2.8 X), except Sta. Wagon

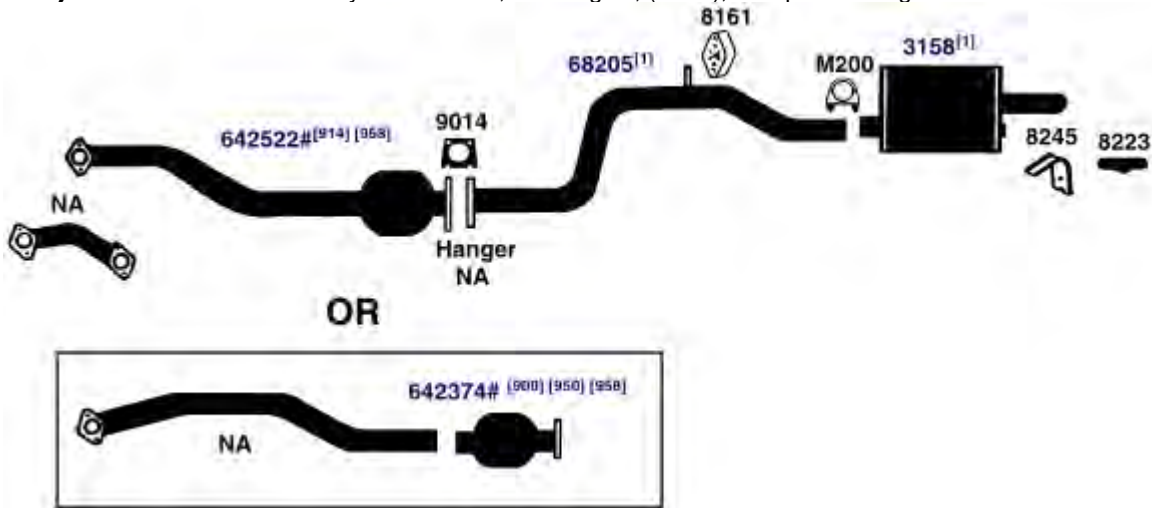

DIRECT FIT MSL/MAXIMUM Muffler... 6573, UNIVERSAL FIT MSL/MAXIMUM Muffler... 6544, 6562, 709014, Silentone DIY Muffler... 5535

(9401) 1986 6 Cyl. 6000 Sta. Wagon, 173 Engine (2.8 X)

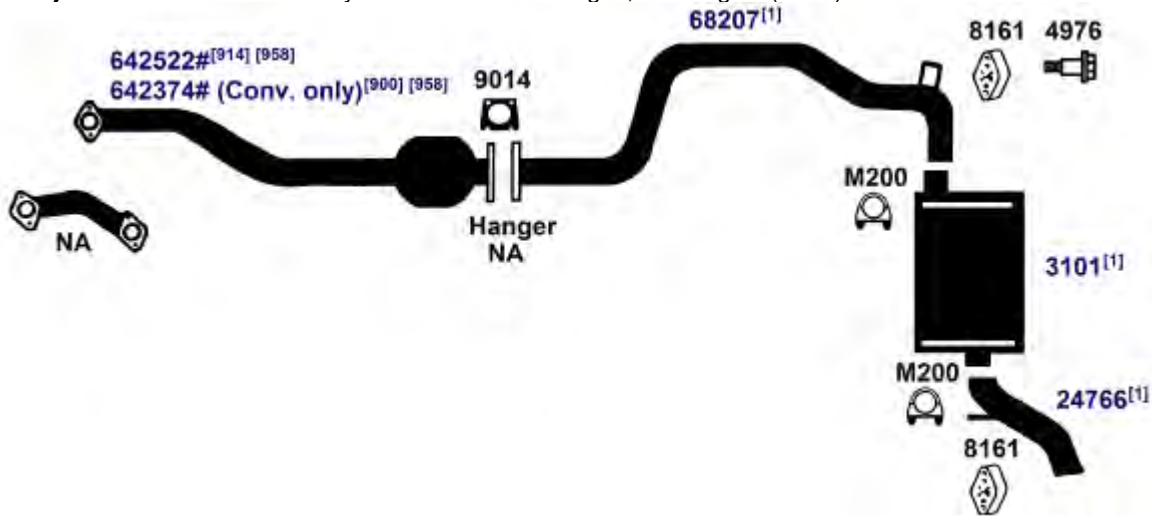

DIRECT FIT MSL/MAXIMUM Muffler... 6538, UNIVERSAL FIT MSL/MAXIMUM Muffler... 709011, Silentone DIY Muffler... 5528

NA-Not Available. NR-Not Required. FL-Remove and Re-Use Old Flange. ● Golden Warehouse. O.E.-Original Equipment.
Airtube Kit [4948] may be required to complete installation. EFI-Electronic Fuel Injection.

[1] OE system was a welded assembly. It is recommended that all parts noted [1] should be replaced.

[900] Direct fit converter may require resizing, cutting or bushing.

[914] Direct fit converter includes front (Exhaust) pipe, (1) piece assembly.

[915] Does not include complete front pipe.

[950] Conv. only, w/o front pipe.

[958] Federal & California Emission vehicles. Not legal for sale for vehicles licensed in California.

1985 4 Cyl. 6000 Sta. Wagon, 151 Engine (2.5L)

(9397)

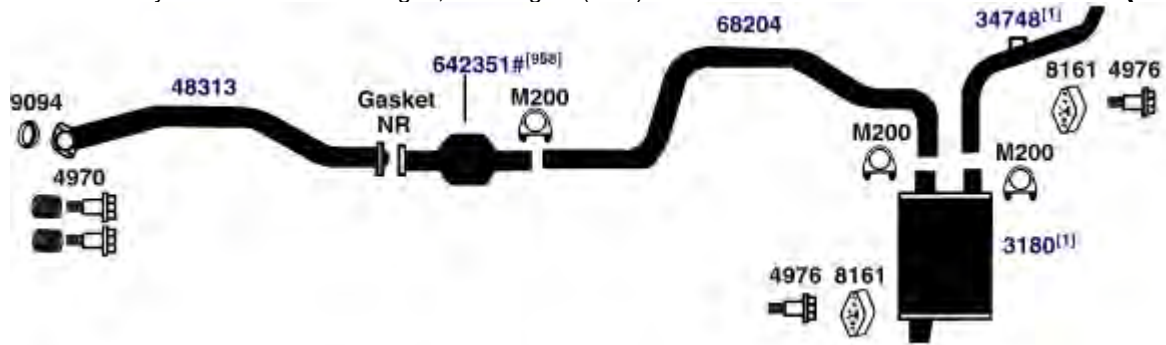

DIRECT FIT MSL/MAXIMUM Muffler... 6564

1985 4 Cyl. 6000, 151 Engine (2.5L), except Sta. Wagon

(9396)

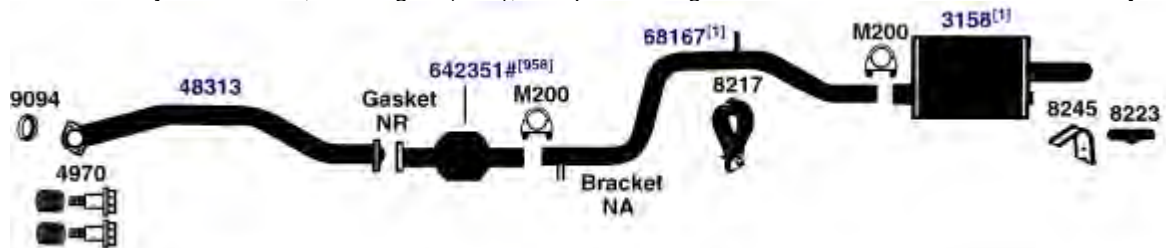

DIRECT FIT MSL/MAXIMUM Muffler... 6573, UNIVERSAL FIT MSL/MAXIMUM Muffler... 6544, 6562, 709014, Silentone DIY Muffler... 5535

1985 6 Cyl. 6000 Sta. Wagon, 173 Engine (2.8W)

(9412)

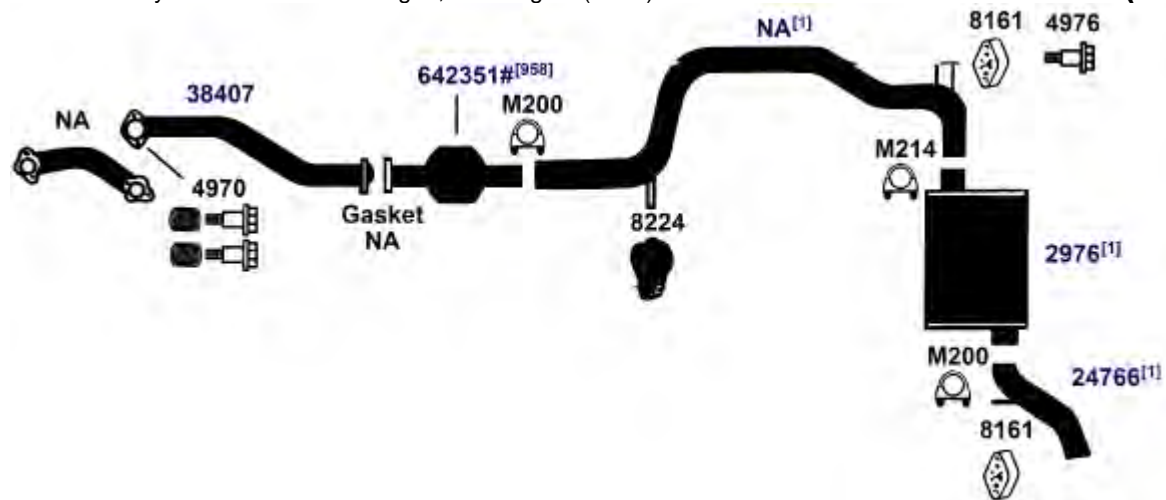

DIRECT FIT MSL/MAXIMUM Muffler... 6543, UNIVERSAL FIT MSL/MAXIMUM Muffler... 709012, Silentone DIY Muffler... 5528

NA-Not Available. NR-Not Required. FL-Remove and Re-Use Old Flange. ● Golden Warehouse. O.E.-Original Equipment.

Airtube Kit [4948] may be required to complete installation. EFI-Electronic Fuel Injection.

[1] OE system was a welded assembly. It is recommended that all parts noted [1] should be replaced.

[958] Federal & California Emission vehicles. Not legal for sale for vehicles licensed in California.

PONTIAC 6000

(9417) 1985 6 Cyl. 6000 Sta. Wagon, 173 Engine (2.8X)

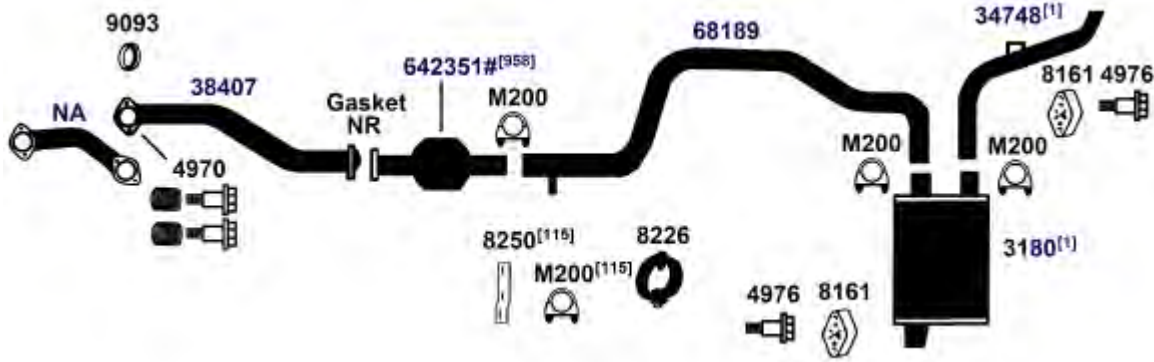

DIRECT FIT MSL/MAXIMUM Muffler... 6564

(9400) 1985 6 Cyl. 6000, STE; 173 Engine (2.8W, 2.8Z); except Sta. Wagon

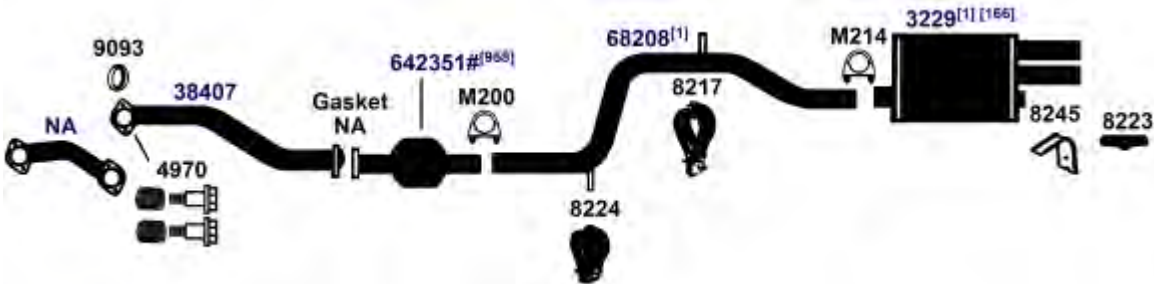

DIRECT FIT MSL/MAXIMUM Muffler... 700091, UNIVERSAL FIT MSL/MAXIMUM Muffler... 6570, 709015

(9395) 1985 6 Cyl. 6000, 173 Engine (2.8X), except Sta. Wagon

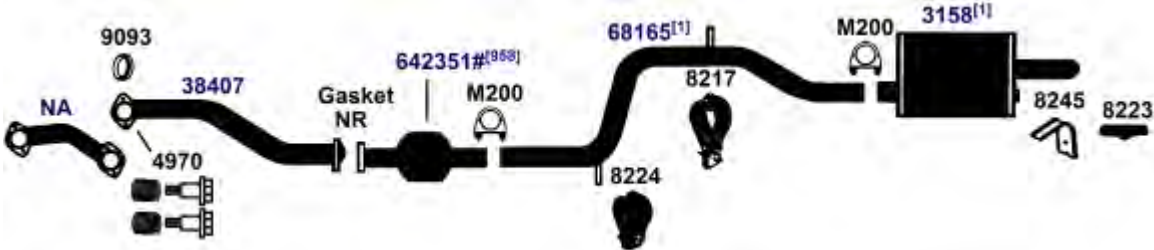

DIRECT FIT MSL/MAXIMUM Muffler... 6573, UNIVERSAL FIT MSL/MAXIMUM Muffler... 6544, 6562, 709014, Silentone DIY Muffler... 5535

NA-Not Available. NR-Not Required. FL-Remove and Re-Use Old Flange. ● Golden Warehouse. O.E.-Original Equipment.
Airtube Kit [4948] may be required to complete installation. EFI-Electronic Fuel Injection.

[1] OE system was a welded assembly. It is recommended that all parts noted [1] should be replaced.

[115] Not required for installation if bracket is welded on exhaust pipe.

[166] O.E. muffler is 5" x 9 1/4" oval that is mounted flat. Replacement muffler is a 4 1/16" x 10 1/2" oval that is mounted on an angle.

[958] Federal & California Emission vehicles. Not legal for sale for vehicles licensed in California.

1985 6 Cyl. 6000 Sta. Wagon, 260 Diesel Engine (4.3L)

(9393)

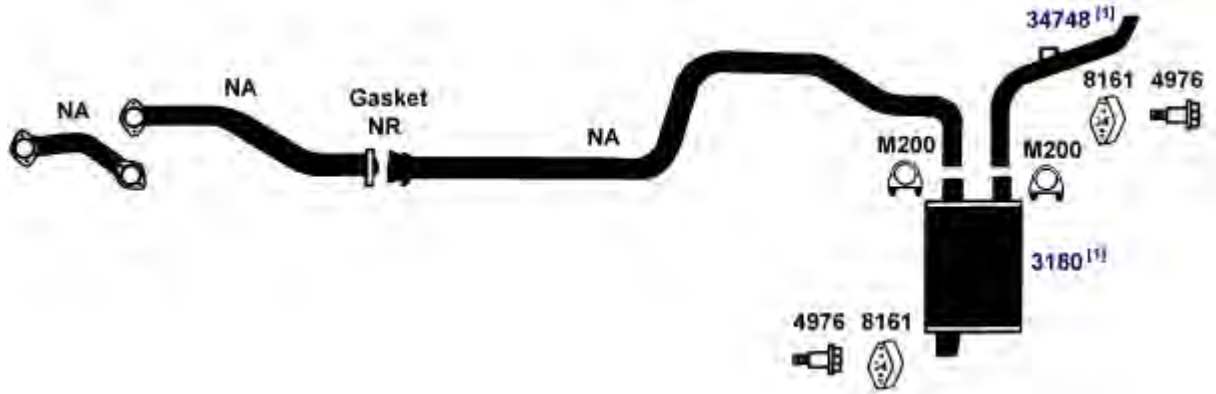

DIRECT FIT MSL/MAXIMUM Muffler... 6564

1985 6 Cyl. 6000, 260 Diesel Engine (4.3); except Sta. Wagon

(9416)

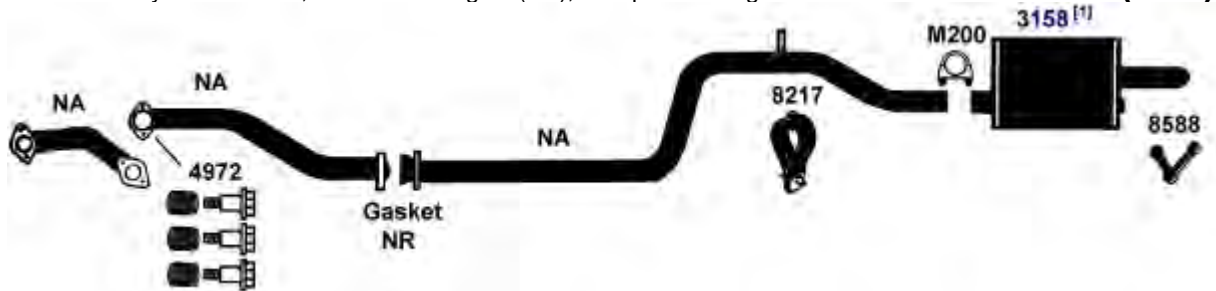

DIRECT FIT MSL/MAXIMUM Muffler... 6573, UNIVERSAL FIT MSL/MAXIMUM Muffler... 6544, 6562, 709014, Silentone DIY Muffler... 5535

1984 4 Cyl. 6000 Sta. Wagon, 151 Engine (2.5L)

(9397E)

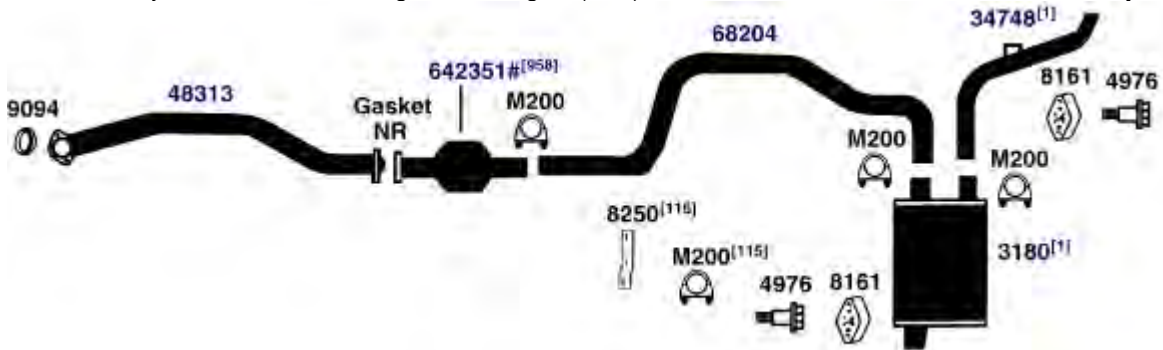

DIRECT FIT MSL/MAXIMUM Muffler... 6564

NA-Not Available. NR-Not Required. FL-Remove and Re-Use Old Flange. ● Golden Warehouse. O.E.-Original Equipment.

Airtube Kit [4948] may be required to complete installation. EFI-Electronic Fuel Injection.

[1] OE system was a welded assembly. It is recommended that all parts noted [1] should be replaced.

[958] Federal & California Emission vehicles. Not legal for sale for vehicles licensed in California.

[115] Not required for installation if bracket is welded on exhaust pipe.

PONTIAC 6000

(9417E) 1984 6 Cyl. 6000 Sta. Wagon, 173 Engine (2.8 X), 1984 2nd Design[111]

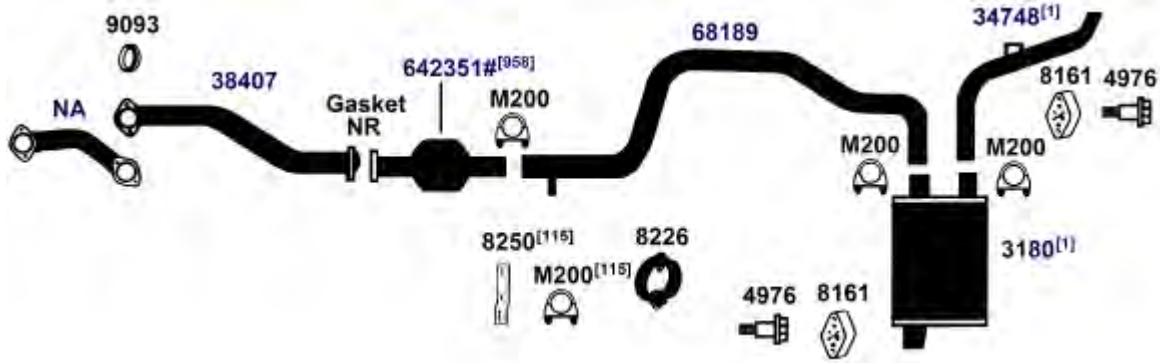

DIRECT FIT MSL/MAXIMUM Muffler... 6564

(9394) 1984 6 Cyl. 6000 Station Wagon, 2.8X, 173 Engine; 1st Design

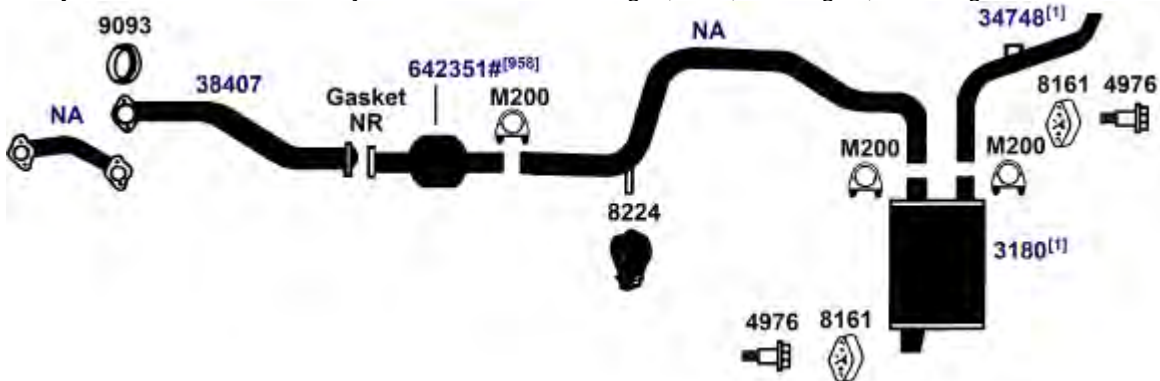

DIRECT FIT MSL/MAXIMUM Muffler... 6564

(9393E) 1984 6 Cyl. 6000 Sta. Wagon, 260 (4.3L) Diesel Engine

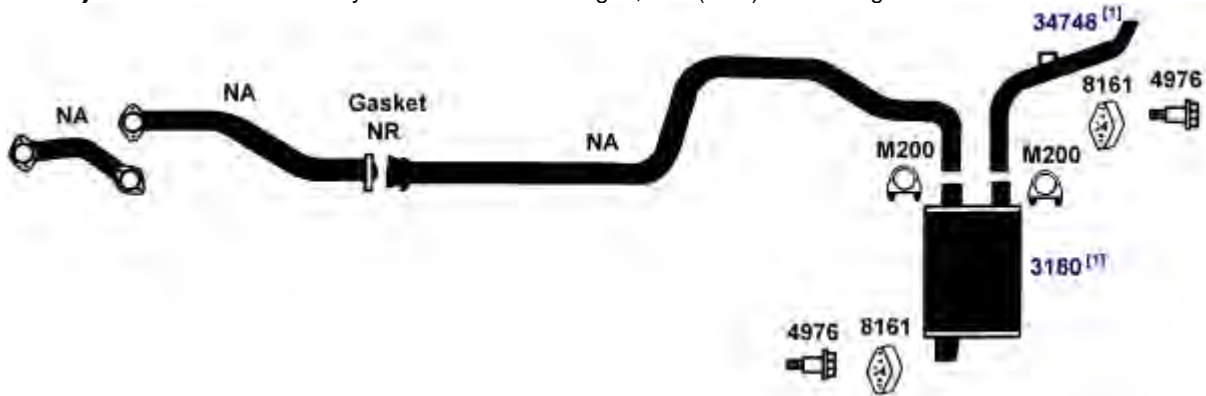

DIRECT FIT MSL/MAXIMUM Muffler... 6564

NA-Not Available. NR-Not Required. FL-Remove and Re-Use Old Flange. ● Golden Warehouse. O.E.-Original Equipment.
Airtube Kit [4948] may be required to complete installation. EFI-Electronic Fuel Injection.

- [1] OE system was a welded assembly. It is recommended that all parts noted [1] should be replaced. [958] Federal & California Emission vehicles. Not legal for sale for vehicles licensed in California.
[115] Not required for installation if bracket is welded on exhaust pipe.

83-84 6 Cyl. 6000, STE; 173 Engine (2.8W, 2.8Z); except Sta. Wagon

(9400E)

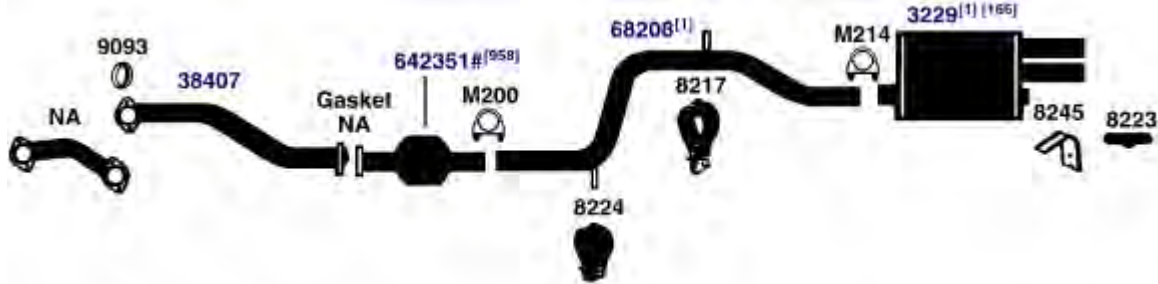

DIRECT FIT MSL/MAXIMUM Muffler... 700091, UNIVERSAL FIT MSL/MAXIMUM Muffler... 6570, 709015

82-84 4 Cyl. 6000, 151 Engine (2.5L), except Sta. Wagon

(9396E)

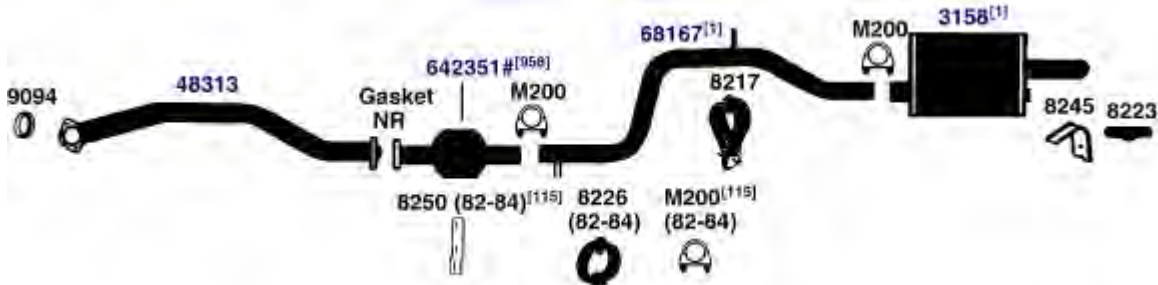

DIRECT FIT MSL/MAXIMUM Muffler... 6573, UNIVERSAL FIT MSL/MAXIMUM Muffler... 6544, 6562, 709014, Silentone DIY Muffler... 5535

82-84 6 Cyl. 6000, 260 Diesel Engine (4.3); except Sta. Wagon

(9416E)



DIRECT FIT MSL/MAXIMUM Muffler... 6573, UNIVERSAL FIT MSL/MAXIMUM Muffler... 6544, 6562, 709014, Silentone DIY Muffler... 5535

82-84 6 Cyl. 6000, 173 Engine (2.8X), except Sta. Wagon

(9395E)



DIRECT FIT MSL/MAXIMUM Muffler... 6573, UNIVERSAL FIT MSL/MAXIMUM Muffler... 6544, 6562, 709014, Silentone DIY Muffler... 5535

NA-Not Available. NR-Not Required. FL-Remove and Re-Use Old Flange. ● Golden Warehouse. O.E.-Original Equipment.
Airtube Kit [4948] may be required to complete installation. EFI-Electronic Fuel Injection.

[1] OE system was a welded assembly. It is recommended that all parts noted [1] should be replaced.

[115] Not required for installation if bracket is welded on exhaust pipe.

[166] O.E. muffler is 5" x 9 1/4" oval that is mounted flat. Replacement muffler is a 4 1/16" x 10 1/2" oval that is mounted on an angle.

[958] Federal & California Emission vehicles. Not legal for sale for vehicles licensed in California.

PONTIAC BONNEVILLE, CATALINA, PARISIENNE (INCL. SAFARI)

(8856) 1994 6 Cyl. Bonneville, 3.8L Engine; except Supercharged Engine

642771 (Use w/ Aftermarket Center Pipe, Models w/o O2 Sensor)^{[900] [958]}

642475 (Use w/ OE Center Pipe, Models w/o O2 Sensor)^{[900] [923] [958]}

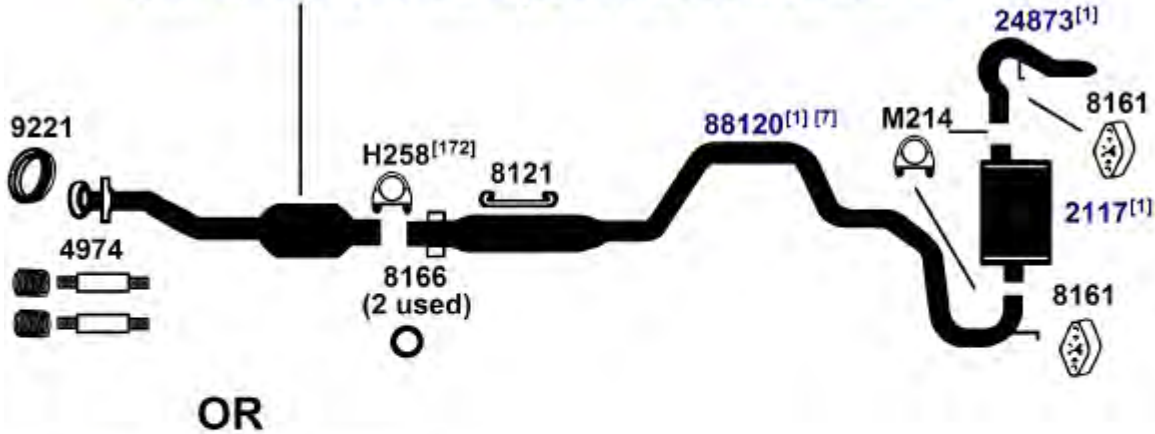

DIRECT FIT MSL/MAXIMUM Muffler... 700234, UNIVERSAL FIT MSL/MAXIMUM Muffler... 709014

(8854) 92-93 6 Cyl. Bonneville SE, 231 Engine (3.8L); Single Outlet

642771 (exc. Supercharged, Use w/ Aftermarket Center Pipe)^{[900] [958]}
 642475 (exc. Supercharged, Use w/ OE Center Pipe)^{[900] [923] [958]}

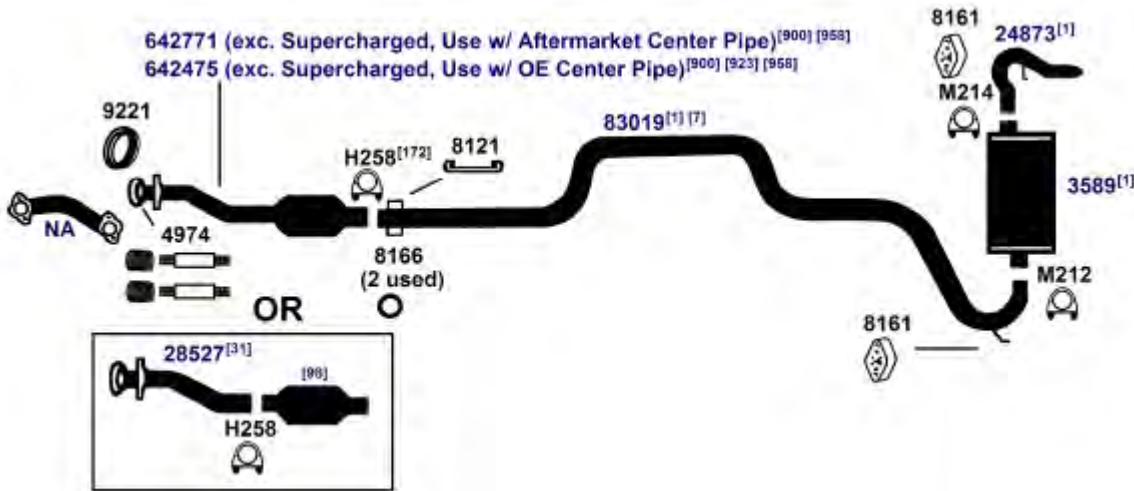

DIRECT FIT MSL/MAXIMUM Muffler... 700197

NA-Not Available. NR-Not Required. FL-Remove and Re-Use Old Flange. ● Golden Warehouse. O.E.-Original Equipment.
 # Airtube Kit [4948] may be required to complete installation. EFI-Electronic Fuel Injection.

- [1] OE system was a welded assembly. It is recommended that all parts noted [1] should be replaced.
- [7] The O.E. extension pipe must be cut off 1 3/8" behind the pipe to converter weld.
- [31] The O.E. front exhaust pipe must be cut off 1 1/4" in front of the pipe to converter weld.
- [172] Special O.E. style clamp designed for this application.

- [900] Direct fit converter may require resizing, cutting or bushing.
- [923] #3 bushing may be required
- [957] Front pipe is not required when ordering converter.
- [958] Federal & California Emission vehicles. Not legal for sale for vehicles licensed in California.

PONTIAC BONNEVILLE, CATALINA, PARISIENNE (INCL. SAFARI)

88-91 6 Cyl. Bonneville, 231 Engine (3.8L), except Sport Exhaust **(8849)**

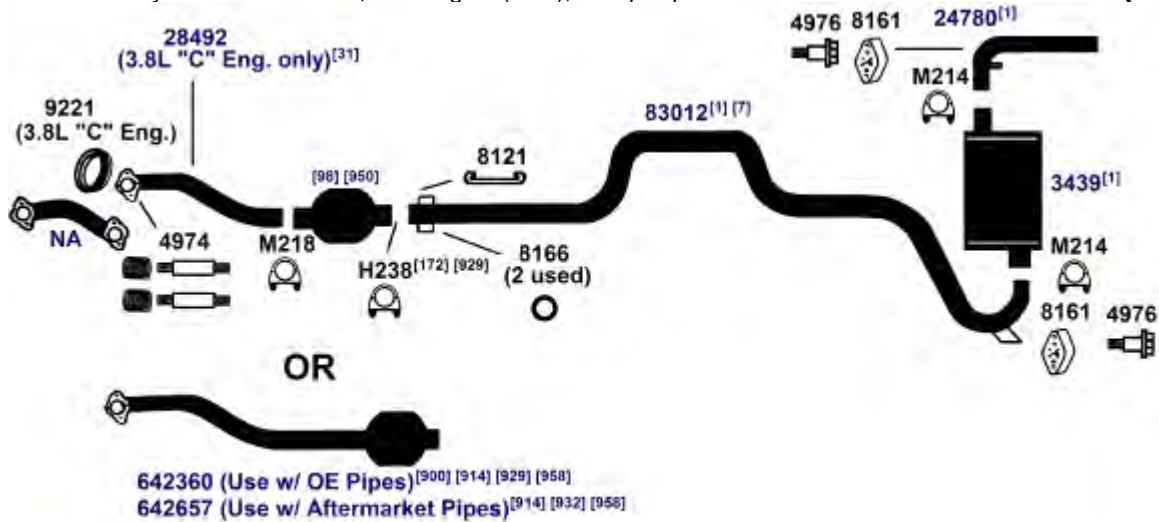

DIRECT FIT MSL/MAXIMUM Muffler... 6578, UNIVERSAL FIT MSL/MAXIMUM Muffler... 709012, Silentone DIY Muffler... 5528

87-89 8 Cyl. Safari Sta. Wagon, 307Y Engine (5.0L) **(8845)**
1986 8 Cyl. Parisienne Sta. Wagon, 307Y Engine (5.0L)

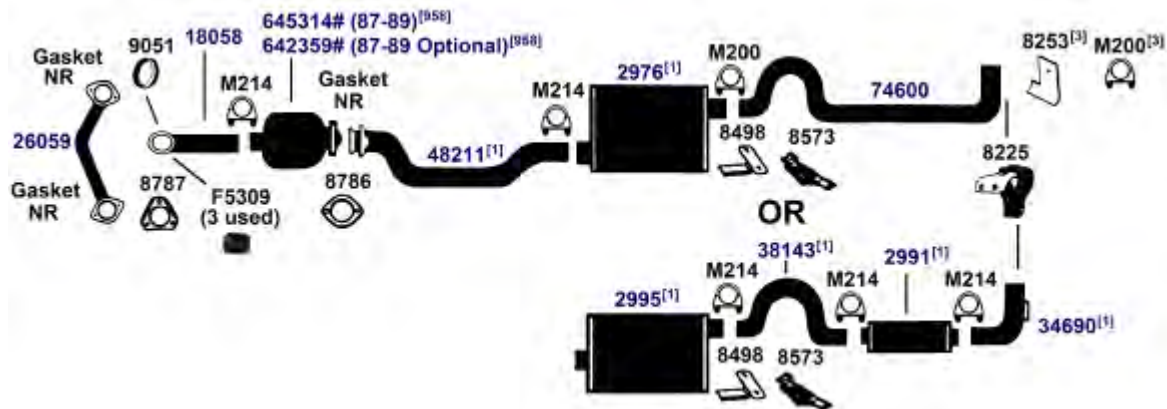

DIRECT FIT MSL/MAXIMUM Muffler... Front Muffler-#2976- 6543, Front Muffler-#2995- 700056 (System With Rear Resonator), Rear Muffler- 700054, UNIVERSAL FIT MSL/MAXIMUM Muffler... Front Muffler-#2976- 709012, Front Muffler-#2995- 6543 (System With Rear Resonator), 709012 (System With Rear Resonator), Rear Muffler- 6526, Silentone DIY Muffler... Front Muffler-#2976- 5528, Front Muffler-#2995- 5528 (System With Rear Resonator), Rear Muffler- 5559

NA-Not Available. NR-Not Required. FL-Remove and Re-Use Old Flange. ● Golden Warehouse. O.E.-Original Equipment.
 # Airtube Kit [4948] may be required to complete installation. EFI-Electronic Fuel Injection.

- [1] OE system was a welded assembly. It is recommended that all parts noted [1] should be replaced.
- [3] Required for installation.
- [7] The O.E. extension pipe must be cut off 1 3/8" behind the pipe to converter weld.
- [31] The O.E. front exhaust pipe must be cut off 1 1/4" in front of the pipe to converter weld.
- [98] Refer to current Catalytic Converter catalog or Website catalog for availability.
- [172] Special O.E. style clamp designed for this application.
- [900] Direct fit converter may require resizing, cutting or bushing.
- [914] Direct fit converter includes front (Exhaust) pipe, (1) piece assembly.
- [929] Use AP #6 bushing w/aftermarket piping.
- [932] For use with 2 3/8" I.D. intermediate pipe.
- [950] Conv. only, w/o front pipe.
- [958] Federal & California Emission vehicles. Not legal for sale for vehicles licensed in California.

PONTIAC BONNEVILLE, CATALINA, PARIISIENNE (INCL. SAFARI)

(8855) 1986 6 Cyl. Bonneville, 262 Engine (4.3L)



DIRECT FIT MSL/MAXIMUM Muffler... 700057, UNIVERSAL FIT MSL/MAXIMUM Muffler... 6540, Silentone DIY Muffler... 5522

(8846) 1986 8 Cyl. Parisienne, 307Y Engine (5.0L); except Sta. Wagon



DIRECT FIT MSL/MAXIMUM Muffler... Front Muffler- 700056, Rear Muffler- 700055, UNIVERSAL FIT MSL/MAXIMUM Muffler... Front Muffler- 6543, 709012, Rear Muffler- 6526, Silentone DIY Muffler... Front Muffler- 5528, Rear Muffler- 5559 and 14677 Spout

(8841) 85-86 6 Cyl. Bonneville, 231 Engine (3.8L)



DIRECT FIT MSL/MAXIMUM Muffler... 6540, Silentone DIY Muffler... 5503

NA-Not Available. NR-Not Required. FL-Remove and Re-Use Old Flange. ● Golden Warehouse. O.E.-Original Equipment.
Airtube Kit [4948] may be required to complete installation. EFI-Electronic Fuel Injection.

[1] OE system was a welded assembly. It is recommended that all parts noted [1] should be replaced. [958] Federal & California Emission vehicles. Not legal for sale for vehicles licensed in California.

PONTIAC BONNEVILLE, CATALINA, PARISIENNE (INCL. SAFARI)

85-86 6 Cyl. Parisienne, 262 Engine (4.3L); with Converter **(8844)**

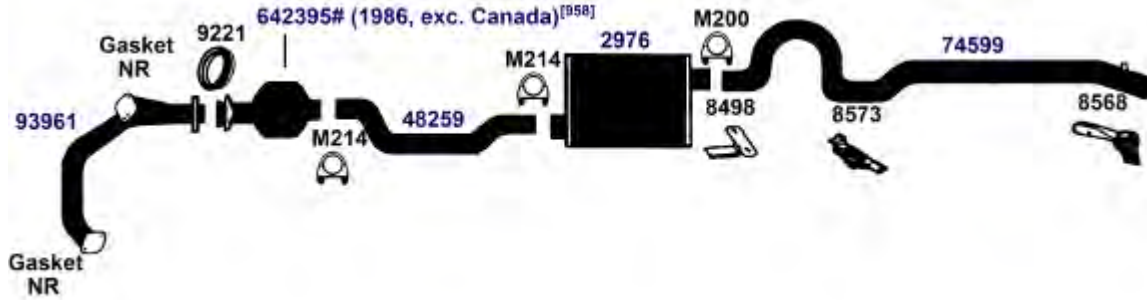

DIRECT FIT MSL/MAXIMUM Muffler... 6543, UNIVERSAL FIT MSL/MAXIMUM Muffler... 709012, Silentone DIY Muffler... 5528

85-86 8 Cyl. Bonneville, 305 Engine (5.0L); Single Bed Bead, Dual Bed Monolithic Converter [233] **(8840)**

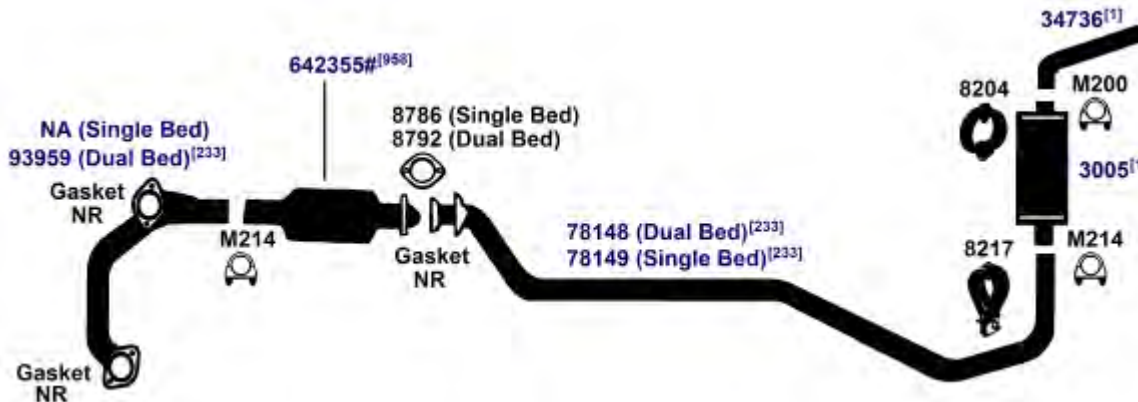

DIRECT FIT MSL/MAXIMUM Muffler... 700057, UNIVERSAL FIT MSL/MAXIMUM Muffler... 6540, Silentone DIY Muffler... 5522

85-86 8 Cyl. Parisienne, 305H Engine (5.0L), except Sta. Wagon; with Converter **(8843)**

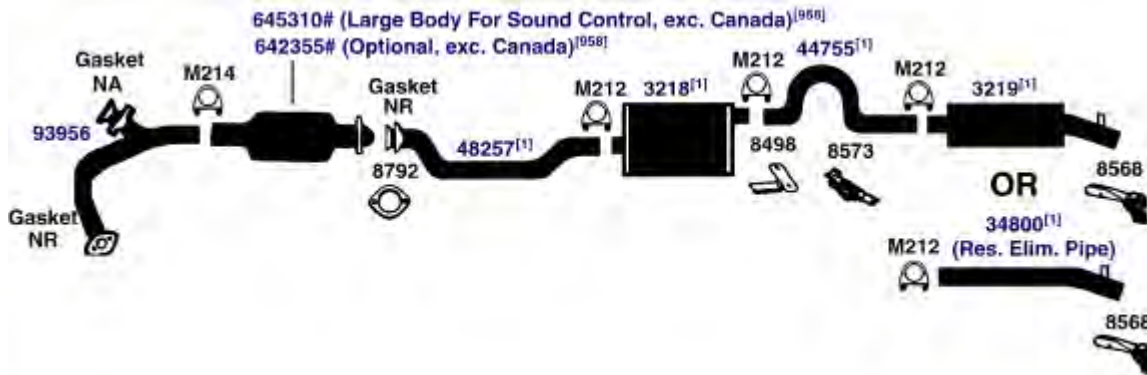

DIRECT FIT MSL/MAXIMUM Muffler... Front Muffler- 700087, Rear Muffler- 700088, UNIVERSAL FIT MSL/MAXIMUM Muffler... Front Muffler- 6543, Rear Muffler- 6526, Silentone DIY Muffler... Front Muffler- 5508 and 8913 Adapter and M212 Clamp

NA-Not Available. NR-Not Required. FL-Remove and Re-Use Old Flange. ● Golden Warehouse. O.E.-Original Equipment.
Airtube Kit [4948] may be required to complete installation. EFI-Electronic Fuel Injection.

[1] OE system was a welded assembly. It is recommended that all parts noted [1] should be replaced. [958] Federal & California Emission vehicles. Not legal for sale for vehicles licensed in California.
[233] See General Information section of catalog for explanation

PONTIAC BONNEVILLE, CATALINA, PARIISIENNE (INCL. SAFARI)

(8842) 85-86 8 Cyl. Parisienne Sta. Wagon, 305H Engine (5.0L); with Converter

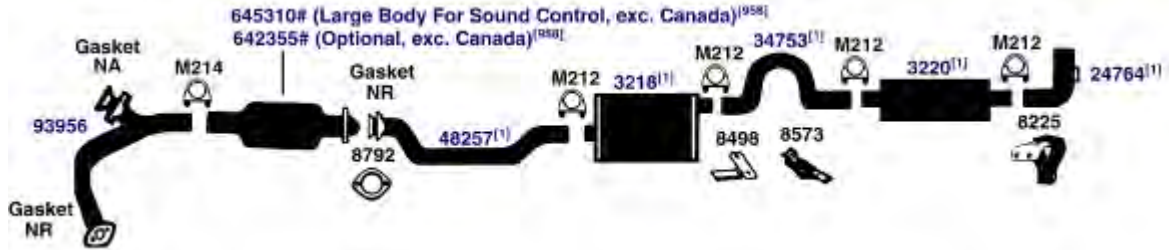

DIRECT FIT MSL/MAXIMUM Muffler... Front Muffler- 700087, Rear Muffler- 700196, UNIVERSAL FIT MSL/MAXIMUM Muffler... Front Muffler- 6543, Rear Muffler- 6527, Silentone DIY Muffler... Front Muffler- 5508 and 8913 Adapter and M212 Clamp

(8839) 1985 8 Cyl. Parisienne, 350N Diesel Engine (5.7L), except Sta. Wagon

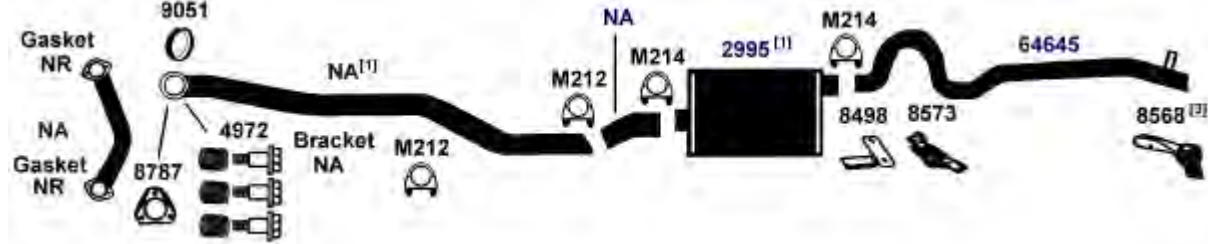

DIRECT FIT MSL/MAXIMUM Muffler... 700056, UNIVERSAL FIT MSL/MAXIMUM Muffler... 6543, 709012, Silentone DIY Muffler... 5528

(8838) 1985 8 Cyl. Parisienne Sta. Wagon, 350N Diesel Engine (5.7L)

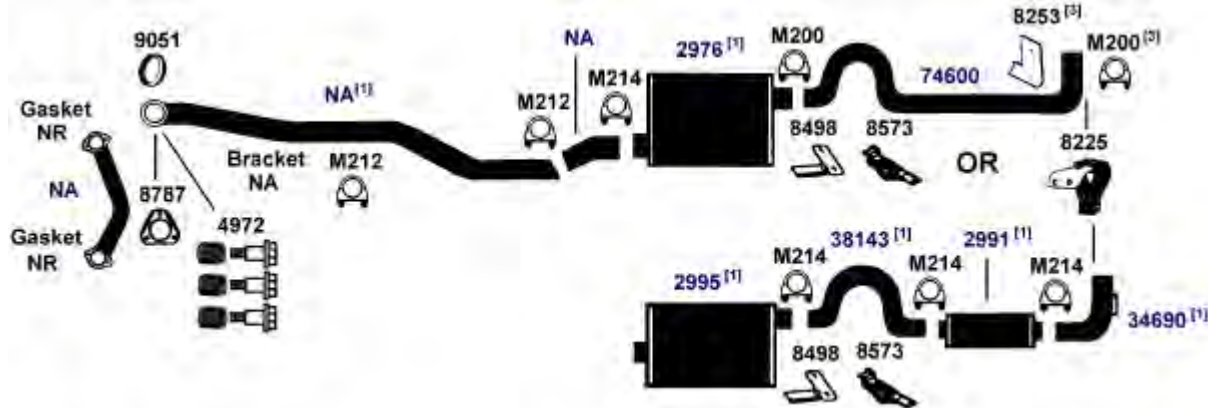

DIRECT FIT MSL/MAXIMUM Muffler... Front Muffler-#2976- 6543, Front Muffler-#2995- 700056 (System With Rear Resonator), Rear Muffler- 700054, UNIVERSAL FIT MSL/MAXIMUM Muffler... Front Muffler-#2976- 709012, Front Muffler-#2995- 6543 (System With Rear Resonator), 709012 (System With Rear Resonator), Rear Muffler- 6526, Silentone DIY Muffler... Front Muffler-#2976- 5528, Front Muffler-#2995- 5528 (System With Rear Resonator), Rear Muffler- 5559

NA-Not Available. NR-Not Required. FL-Remove and Re-Use Old Flange. ● Golden Warehouse. O.E.-Original Equipment.
Airtube Kit [4948] may be required to complete installation. EFI-Electronic Fuel Injection.

- [1] OE system was a welded assembly. It is recommended that all parts noted [1] should be replaced. [958] Federal & California Emission vehicles. Not legal for sale for vehicles licensed in California.
- [3] Required for installation.

PONTIAC BONNEVILLE, CATALINA, PARISIENNE (INCL. SAFARI)

1984 6 Cyl. Parisienne, 3.8L, 231 Engine **(8837)**

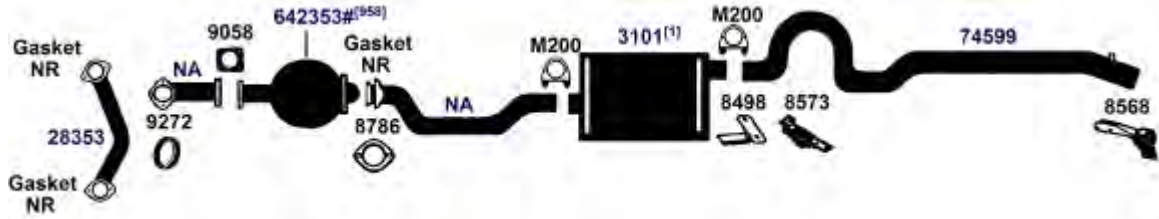

DIRECT FIT MSL/MAXIMUM Muffler... 6538, UNIVERSAL FIT MSL/MAXIMUM Muffler... 709011, Silentone DIY Muffler... 5528

1984 8 Cyl. Bonneville, 305 Engine (5.0L); Single and Dual Bed Monolithic Converter **(8840E)**

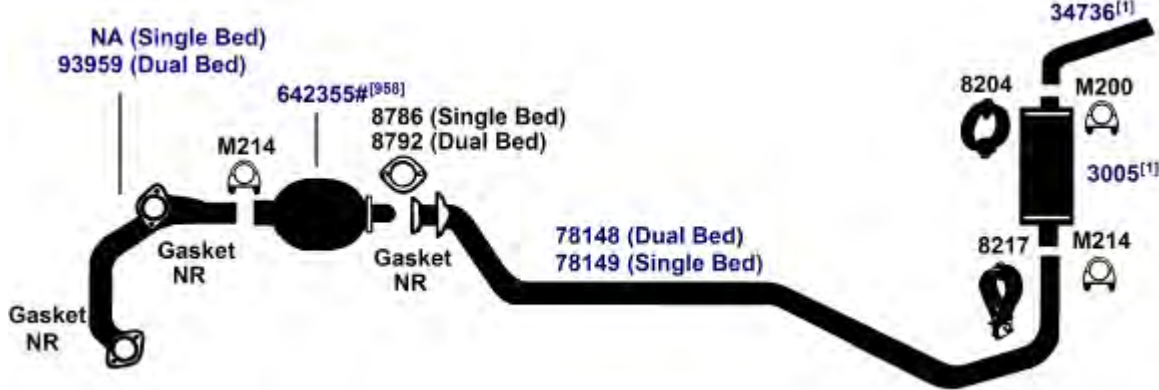

DIRECT FIT MSL/MAXIMUM Muffler... 700057, UNIVERSAL FIT MSL/MAXIMUM Muffler... 6540, Silentone DIY Muffler... 5522

83-84 6 Cyl. Bonneville, 231 (3.8L) Engine **(8841E)**



DIRECT FIT MSL/MAXIMUM Muffler... 6540, Silentone DIY Muffler... 5503

NA-Not Available. NR-Not Required. FL-Remove and Re-Use Old Flange. ● Golden Warehouse. O.E.-Original Equipment.

Airtube Kit [4948] may be required to complete installation. EFI-Electronic Fuel Injection.

[1] OE system was a welded assembly. It is recommended that all parts noted [1] should be replaced.

[184] 1st Design has EFE actuator on left hand manifold. 2nd Design does not.

[958] Federal & California Emission vehicles. Not legal for sale for vehicles licensed in California.

[959] Federal Emission vehicles. Not legal for sale for vehicles licensed in California.

[960] California Emission vehicles licensed in states other than California. Not legal for sale for vehicles licensed in California.

PONTIAC BONNEVILLE, CATALINA, PARIISIENNE (INCL. SAFARI)

(8833) 83-84 8 Cyl. Parisienne Station Wagon, 5.0L, 305 Engine; Single Bed and Dual Bed Monolithic Converter

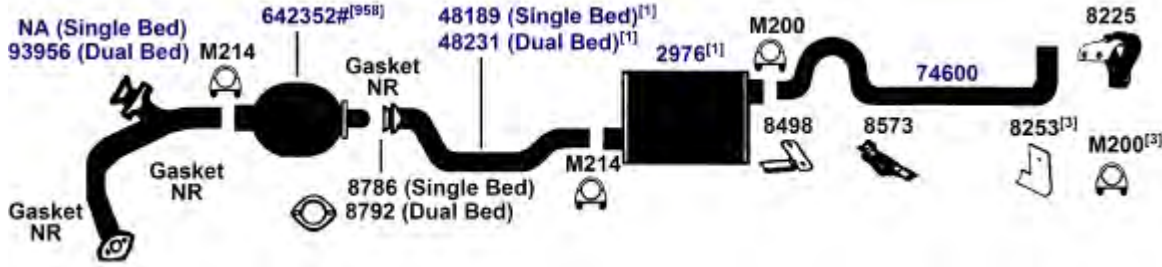

DIRECT FIT MSL/MAXIMUM Muffler... 6543, UNIVERSAL FIT MSL/MAXIMUM Muffler... 709012, Silentone DIY Muffler... 5528

(8834) 83-84 8 Cyl. Parisienne, 5.0L, 305 Engine; Single Bed and Dual Bed Monolithic Converter; except Station Wagon

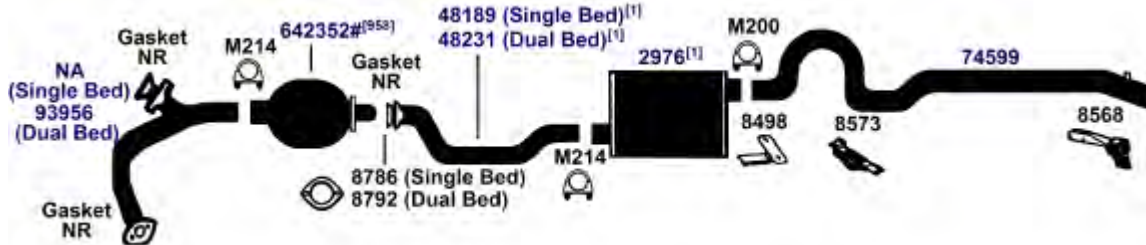

DIRECT FIT MSL/MAXIMUM Muffler... 6543, UNIVERSAL FIT MSL/MAXIMUM Muffler... 709012, Silentone DIY Muffler... 5528

(8839E) 83-84 8 Cyl. Parisienne, 350N Diesel Engine (5.7L), except Sta. Wagon

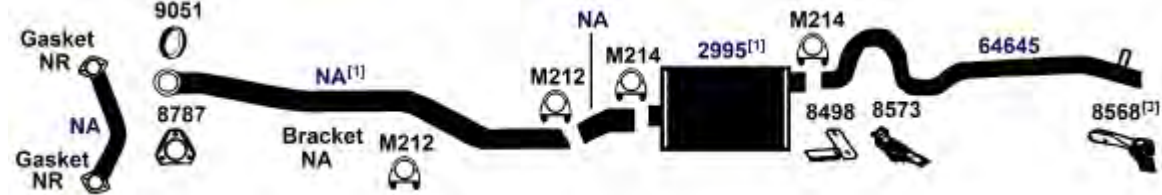

DIRECT FIT MSL/MAXIMUM Muffler... 700056, UNIVERSAL FIT MSL/MAXIMUM Muffler... 6543, 709012, Silentone DIY Muffler... 5528

NA-Not Available. NR-Not Required. FL-Remove and Re-Use Old Flange. ● Golden Warehouse. O.E.-Original Equipment.
Airtube Kit [4948] may be required to complete installation. EFI-Electronic Fuel Injection.

- [1] OE system was a welded assembly. It is recommended that all parts noted [1] should be replaced. [958] Federal & California Emission vehicles. Not legal for sale for vehicles licensed in California.
- [3] Required for installation.

PONTIAC BONNEVILLE, CATALINA, PARISIENNE (INCL. SAFARI)

83-84 8 Cyl. Parisienne Sta. Wagon, 350N Diesel Engine (5.7L) **(8838E)**

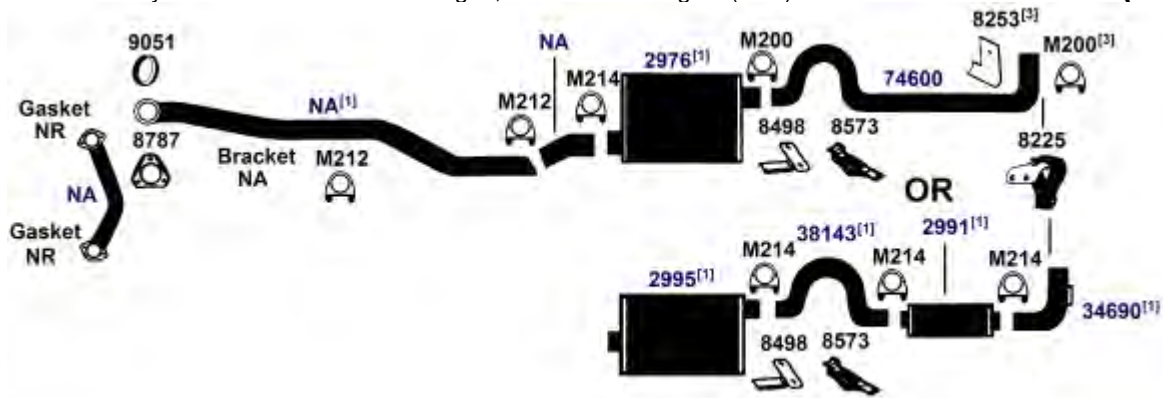

DIRECT FIT MSL/MAXIMUM Muffler... Front Muffler-#2976- 6543, Front Muffler-#2995- 700056 (System With Rear Resonator), Rear Muffler- 700054, UNIVERSAL FIT MSL/MAXIMUM Muffler... Front Muffler-#2976- 709012, Front Muffler-#2995- 6543 (System With Rear Resonator), 709012 (System With Rear Resonator), Rear Muffler- 6526, Silentone DIY Muffler... Front Muffler-#2976- 5528, Front Muffler-#2995- 5528 (System With Rear Resonator), Rear Muffler- 5559

83-84 8 Cyl. Bonneville, 5.7L, 350N Diesel Engine **(8830)**

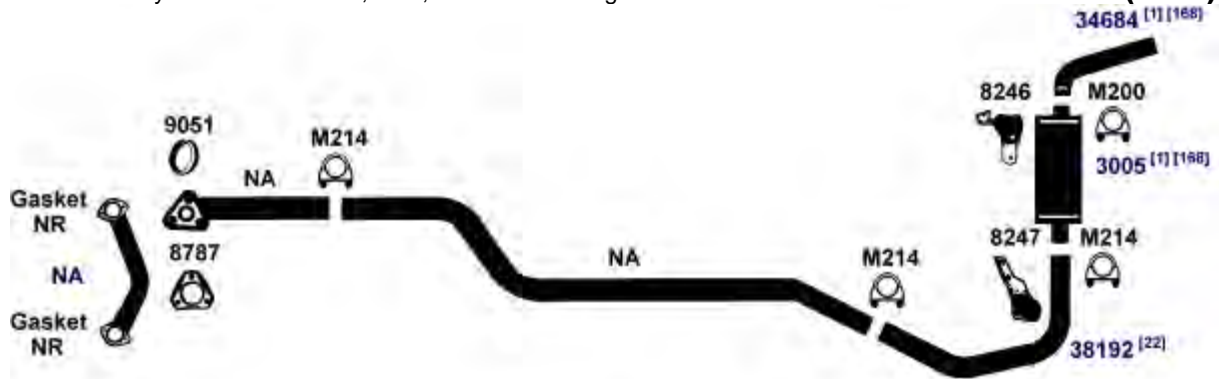

DIRECT FIT MSL/MAXIMUM Muffler... 700057, UNIVERSAL FIT MSL/MAXIMUM Muffler... 6540, Silentone DIY Muffler... 5522

1983 6 Cyl. Parisienne, 3.8L, 229 Engine; Single Bed and Dual Bed Monolithic Converter **(8828)**



DIRECT FIT MSL/MAXIMUM Muffler... 6543, UNIVERSAL FIT MSL/MAXIMUM Muffler... 709012, Silentone DIY Muffler... 5528

NA-Not Available. NR-Not Required. FL-Remove and Re-Use Old Flange. ● Golden Warehouse. O.E.-Original Equipment.
Airtube Kit [4948] may be required to complete installation. EFI-Electronic Fuel Injection.

- [1] OE system was a welded assembly. It is recommended that all parts noted [1] should be replaced.
- [2] O.E. exhaust pipe was one piece. Replacement is two pieces.
- [3] Required for installation.
- [98] Refer to current Catalytic Converter catalog or Website catalog for availability.
- [168] Functionally approved Single Outlet System replaces Dual Outlet.

PONTIAC BONNEVILLE, CATALINA, PARIISIENNE (INCL. SAFARI)

(8827) 1983 6 Cyl. Bonneville, 252 Engine (4.1-4)

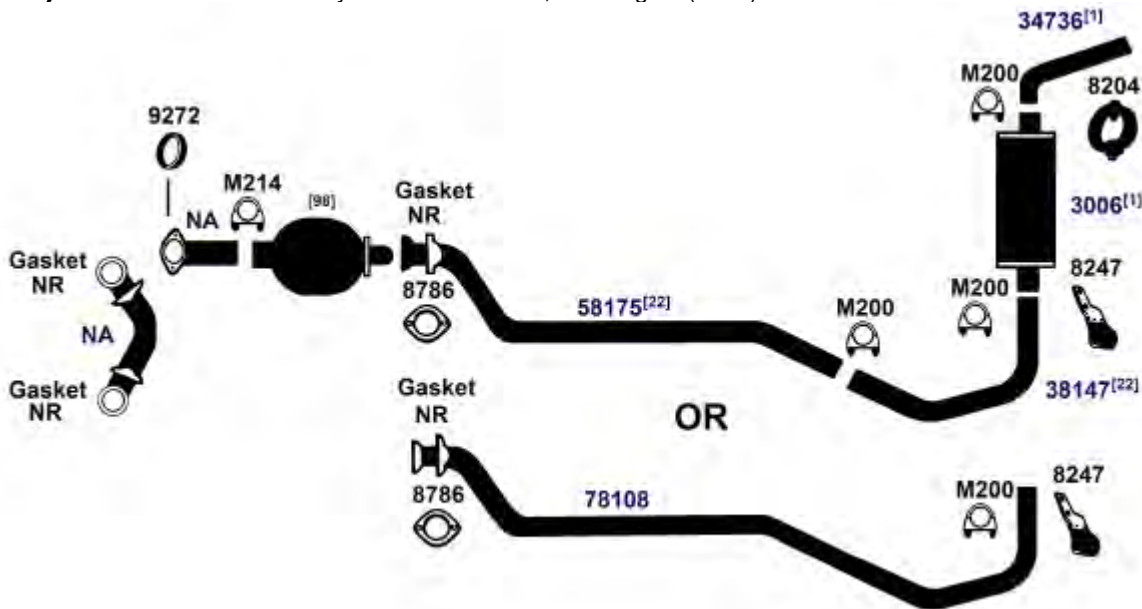

DIRECT FIT MSL/MAXIMUM Muffler... 6540, Silentone DIY Muffler... 5503

(8826) 1983 8 Cyl. Bonneville, 5.0L, 305 Engine; Single Bed and Dual Bed Monolithic Converter

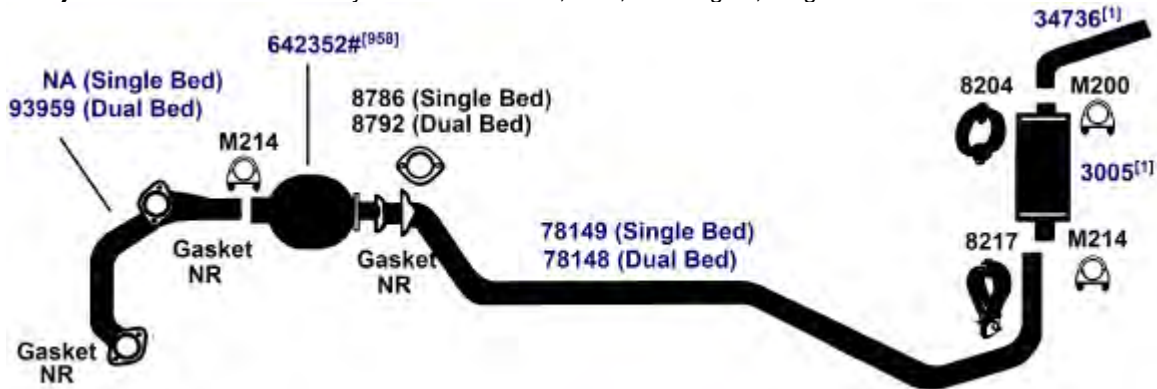

DIRECT FIT MSL/MAXIMUM Muffler... 700057, UNIVERSAL FIT MSL/MAXIMUM Muffler... 6540, Silentone DIY Muffler... 5522

NA-Not Available. NR-Not Required. FL-Remove and Re-Use Old Flange. ● Golden Warehouse. O.E.-Original Equipment.
 # Airtube Kit [4948] may be required to complete installation. EFI-Electronic Fuel Injection.

[1] OE system was a welded assembly. It is recommended that all parts noted [1] should be replaced.

[22] O.E. exhaust pipe was one piece. Replacement is two pieces.

[98] Refer to current Catalytic Converter catalog or Website catalog for availability.
 [958] Federal & California Emission vehicles. Not legal for sale for vehicles licensed in California.

PONTIAC BONNEVILLE, CATALINA, PARISIENNE (INCL. SAFARI)

1982 6 Cyl. Bonneville 3.8L - 231, 4.1 - 4L - 252 Engine

(8825)

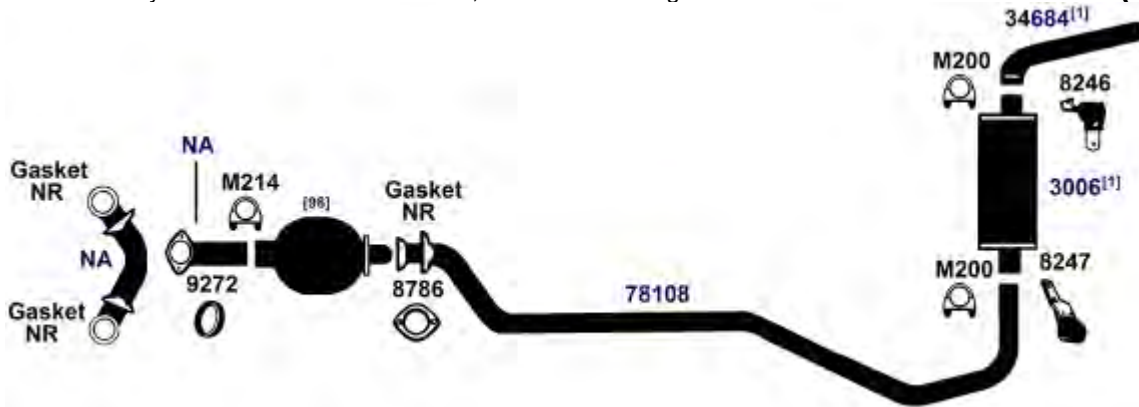

DIRECT FIT MSL/MAXIMUM Muffler... 6540, Silentone DIY Muffler... 5503

1982 8 Cyl. Bonneville 4.4L, 267 Engine

(8824)

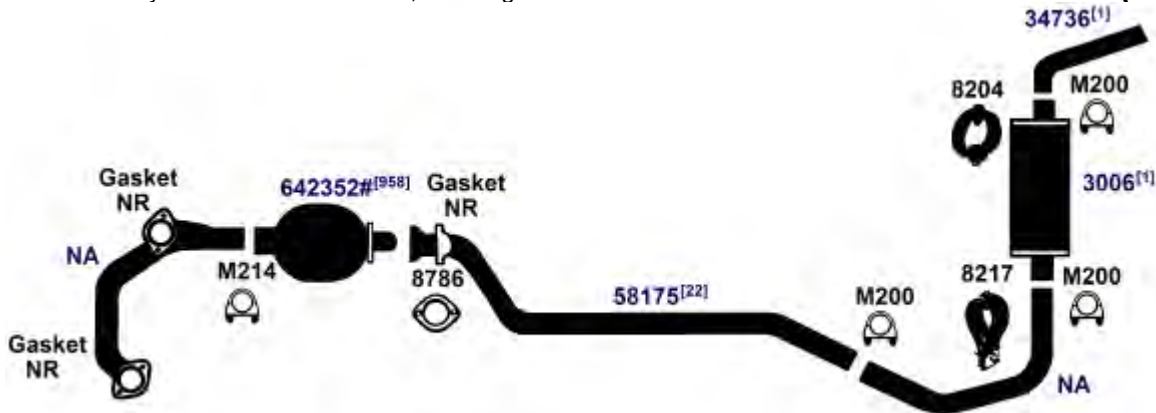

DIRECT FIT MSL/MAXIMUM Muffler... 6540, Silentone DIY Muffler... 5503

1982 8 Cyl. Bonneville, 5.7L, 350N Diesel Engine

(8822)

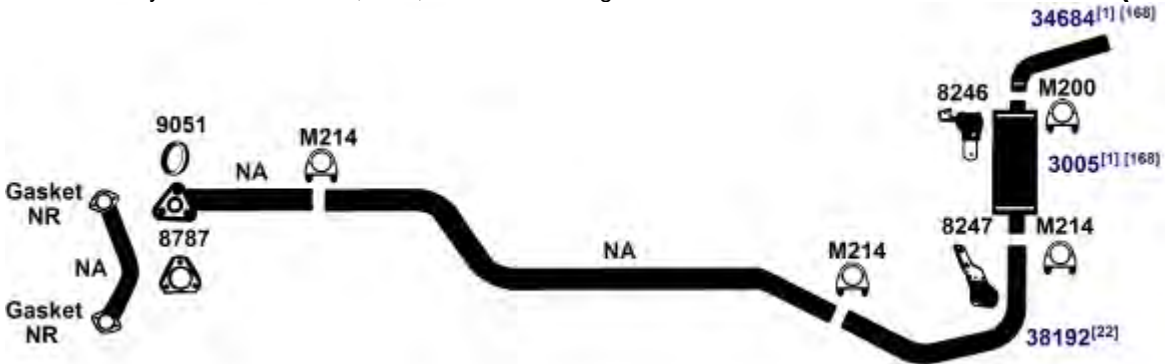

DIRECT FIT MSL/MAXIMUM Muffler... 700057, UNIVERSAL FIT MSL/MAXIMUM Muffler... 6540, Silentone DIY Muffler... 5522

NA-Not Available. NR-Not Required. FL-Remove and Re-Use Old Flange. ● Golden Warehouse. O.E.-Original Equipment.
Airtube Kit [4948] may be required to complete installation. EFI-Electronic Fuel Injection.

[1] OE system was a welded assembly. It is recommended that all parts noted [1] should be replaced.

[22] O.E. exhaust pipe was one piece. Replacement is two pieces.

[98] Refer to current Catalytic Converter catalog or Website catalog for availability.

[168] Functionally approved Single Outlet System replaces Dual Outlet.

[958] Federal & California Emission vehicles. Not legal for sale for vehicles licensed in California.

PONTIAC BONNEVILLE, CATALINA, PARIISIENNE (INCL. SAFARI)

(8815) 1981 8 Cyl. Catalina, Bonneville; 307, 350R Engine; except Sta. Wagon

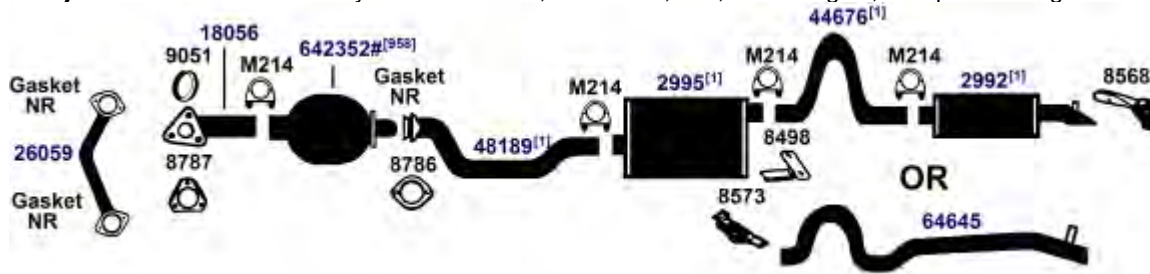

DIRECT FIT MSL/MAXIMUM Muffler... Front Muffler- 700056, Rear Muffler- 700055, UNIVERSAL FIT MSL/MAXIMUM Muffler... Front Muffler- 6543, 709012, Rear Muffler- 6526, Silentone DIY Muffler... Front Muffler- 5528, Rear Muffler- 5559 and 14677 Spout

(8821) 1981 8 Cyl. Catalina, Bonneville; 5.7L, 350N Diesel Engine; except Station Wagon

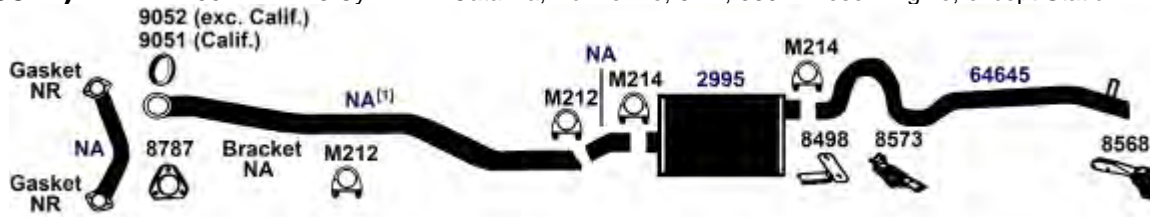

DIRECT FIT MSL/MAXIMUM Muffler... 700056, UNIVERSAL FIT MSL/MAXIMUM Muffler... 6543, 709012, Silentone DIY Muffler... 5528

(8814) 1981 8 Cyl. Catalina, Bonneville, Safari Station Wagon; 307, 350R Engine

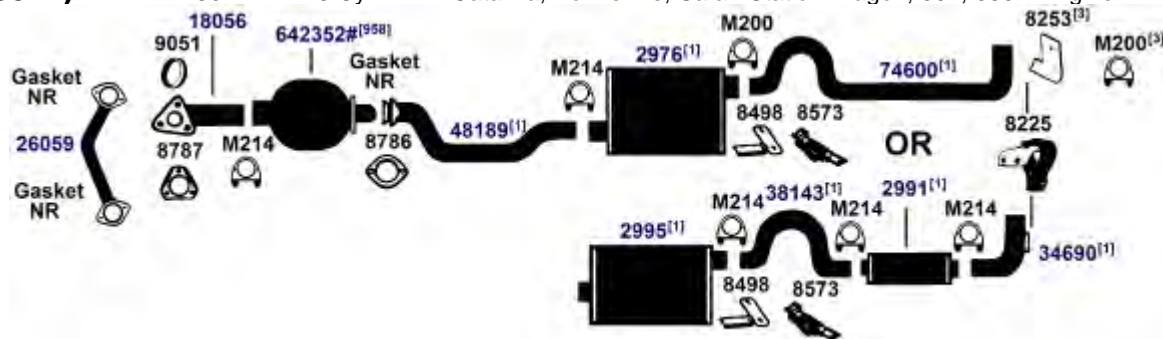

DIRECT FIT MSL/MAXIMUM Muffler... Front Muffler-#2976- 6543, Front Muffler-#2995- 700056 (System With Rear Resonator), Rear Muffler- 700054, UNIVERSAL FIT MSL/MAXIMUM Muffler... Front Muffler-#2976- 709012, Front Muffler-#2995- 6543 (System With Rear Resonator), 709012 (System With Rear Resonator), Rear Muffler- 6526, Silentone DIY Muffler... Front Muffler-#2976- 5528, Front Muffler-#2995- 5528 (System With Rear Resonator), Rear Muffler- 5559

NA-Not Available. NR-Not Required. FL-Remove and Re-Use Old Flange. ● Golden Warehouse. O.E.-Original Equipment.
Airtube Kit [4948] may be required to complete installation. EFI-Electronic Fuel Injection.

- [1] OE system was a welded assembly. It is recommended that all parts noted [1] should be replaced. [958] Federal & California Emission vehicles. Not legal for sale for vehicles licensed in California.
[3] Required for installation.

PONTIAC BONNEVILLE, CATALINA, PARISIENNE (INCL. SAFARI)

80-81 6 Cyl. Catalina, Bonneville; 231 Engine **(8819)**

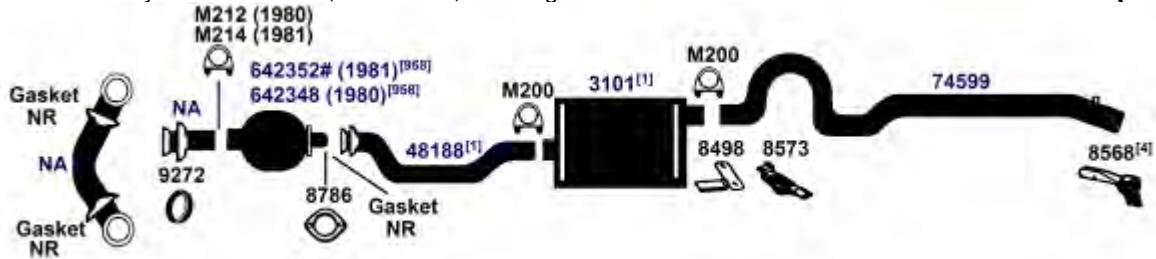

DIRECT FIT MSL/MAXIMUM Muffler... 6538, UNIVERSAL FIT MSL/MAXIMUM Muffler... 709011, Silentone DIY Muffler... 5528

80-81 8 Cyl. Catalina, Bonneville, Safari Station Wagon; 5.7L, 350N Diesel Engine **(8820)**

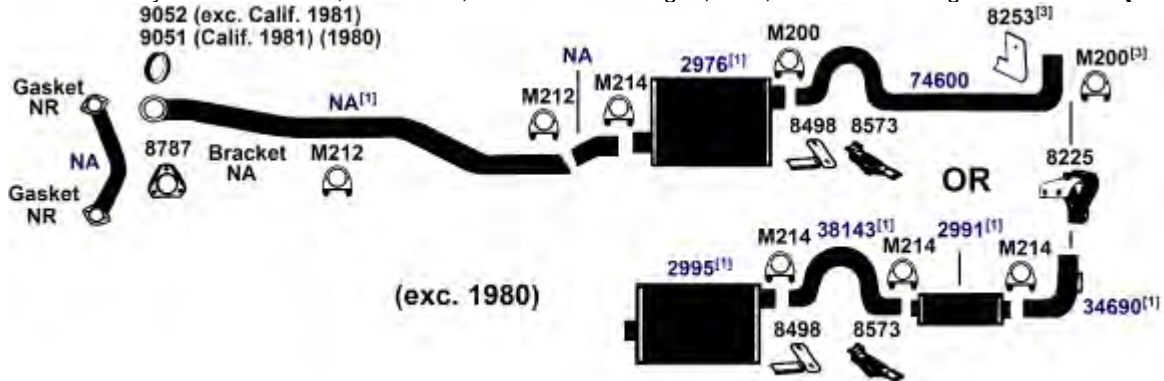

DIRECT FIT MSL/MAXIMUM Muffler... Front Muffler-#2976- 6543, Front Muffler-#2995- 700056 (System With Rear Resonator), Rear Muffler- 700054 (1981), UNIVERSAL FIT MSL/MAXIMUM Muffler... Front Muffler-#2976- 709012, Front Muffler-#2995- 6543 (System With Rear Resonator), 709012 (System With Rear Resonator), Rear Muffler- 6526 (1981), Silentone DIY Muffler... Front Muffler-#2976- 5528, Front Muffler-#2995- 5528 (System With Rear Resonator), Rear Muffler- 5559 (1981)

80-81 8 Cyl. Catalina, Bonneville; 265 Engine **(8818)**

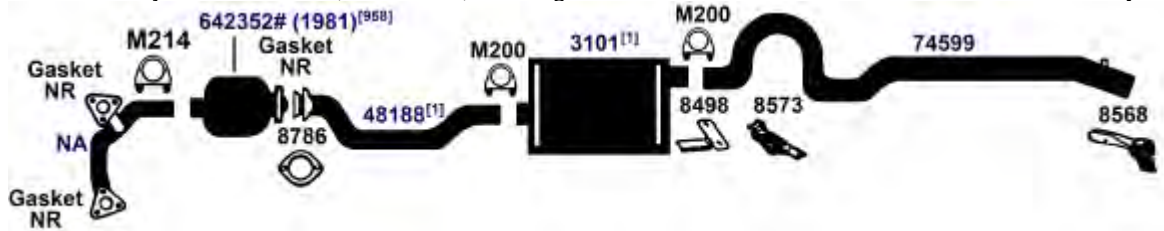

DIRECT FIT MSL/MAXIMUM Muffler... 6538, UNIVERSAL FIT MSL/MAXIMUM Muffler... 709011, Silentone DIY Muffler... 5528

NA-Not Available. NR-Not Required. FL-Remove and Re-Use Old Flange. ● Golden Warehouse. O.E.-Original Equipment.
Airtube Kit [4948] may be required to complete installation. EFI-Electronic Fuel Injection.

- [1] OE system was a welded assembly. It is recommended that all parts noted [1] should be replaced.
- [2] Required for installation.
- [3] Required for installation.
- [4] Required for installation with 74599 tail pipe.
[958] Federal & California Emission vehicles. Not legal for sale for vehicles licensed in California.

PONTIAC BONNEVILLE, CATALINA, PARIISIENNE (INCL. SAFARI)

(8816) 1980 8 Cyl. Catalina, Bonneville, Safari Station Wagon; 301 Engine

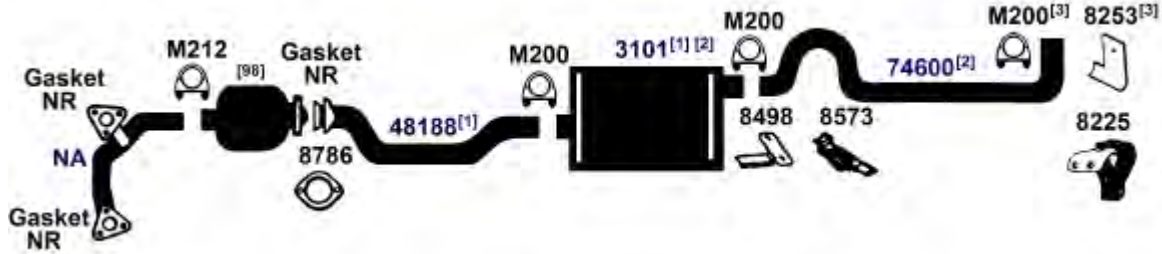

DIRECT FIT MSL/MAXIMUM Muffler... 6538, UNIVERSAL FIT MSL/MAXIMUM Muffler... 709011, Silentone DIY Muffler... 5528

(8850) 1980 8 Cyl. Catalina, Bonneville; Safari Station Wagon; 305, 350R Engine

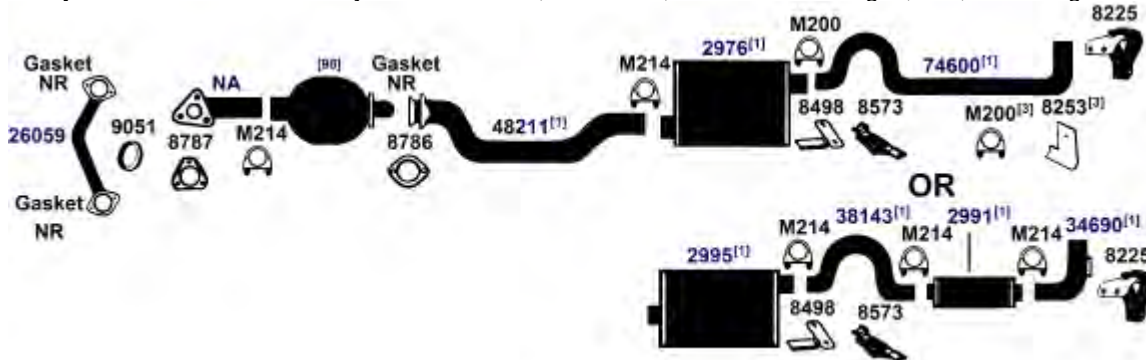

DIRECT FIT MSL/MAXIMUM Muffler... Front Muffler-#2976- 6543, Front Muffler-#2995- 700056 (System With Rear Resonator), Rear Muffler- 700054, UNIVERSAL FIT MSL/MAXIMUM Muffler... Front Muffler-#2976- 709012, Front Muffler-#2995- 6543 (System With Rear Resonator), 709012 (System With Rear Resonator), Rear Muffler- 6526, Silentone DIY Muffler... Front Muffler-#2976- 5528, Front Muffler-#2995- 5528 (System With Rear Resonator), Rear Muffler- 5559

(8813) 1980 8 Cyl. Catalina, Bonneville; 350N Diesel Engine; except Station Wagon

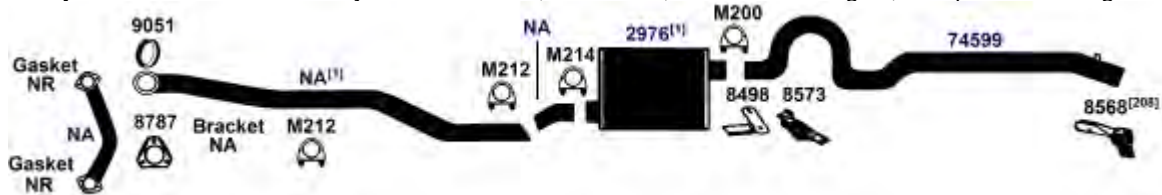

DIRECT FIT MSL/MAXIMUM Muffler... 6543, UNIVERSAL FIT MSL/MAXIMUM Muffler... 709012, Silentone DIY Muffler... 5528

NA-Not Available. NR-Not Required. FL-Remove and Re-Use Old Flange. ● Golden Warehouse. O.E.-Original Equipment.
Airtube Kit [4948] may be required to complete installation. EFI-Electronic Fuel Injection.

- [1] OE system was a welded assembly. It is recommended that all parts noted [1] should be replaced. [98] Refer to current Catalytic Converter catalog or Website catalog for availability.
- [2] May be necessary to replace all noted [2] parts. [208] Required for installation with 74599 tail pipe for models with front mounted bracket.
- [3] Required for installation.

PONTIAC BONNEVILLE, CATALINA, PARISIENNE (INCL. SAFARI)

1980 8 Cyl. Catalina, Bonneville; 301 Engine, except Station Wagon **(8817)**

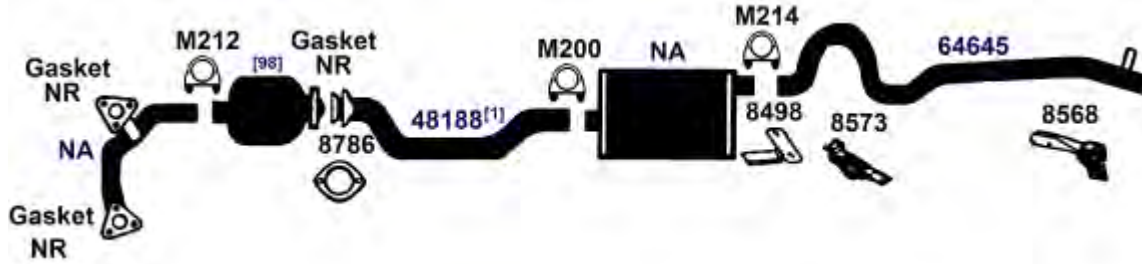

UNIVERSAL FIT MSL/MAXIMUM Muffler... 6538

1980 8 Cyl. Catalina, Bonneville; 305, 350R Engine; except Station Wagon **(8851)**

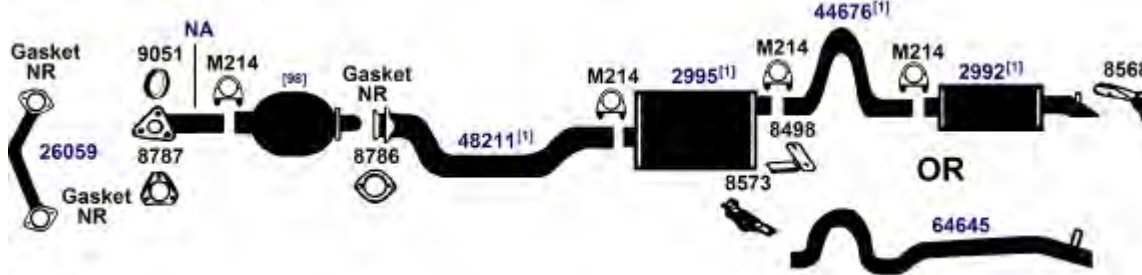

DIRECT FIT MSL/MAXIMUM Muffler... Front Muffler- 700056, Rear Muffler- 700055, UNIVERSAL FIT MSL/MAXIMUM Muffler... Front Muffler- 6543, 709012, Rear Muffler- 6526, Silentone DIY Muffler... Front Muffler- 5528, Rear Muffler- 5559 and 14677 Spout

1979 6 Cyl. Catalina, 231 Engine **(8811)**

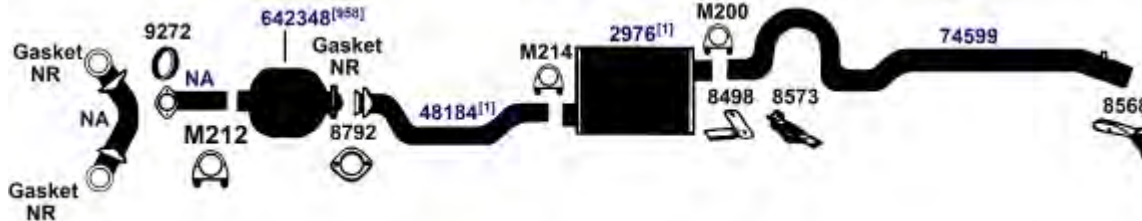

DIRECT FIT MSL/MAXIMUM Muffler... 6543, UNIVERSAL FIT MSL/MAXIMUM Muffler... 709012, Silentone DIY Muffler... 5528

1979 8 Cyl. Catalina Station Wagon, 403 Engine **(8804)**

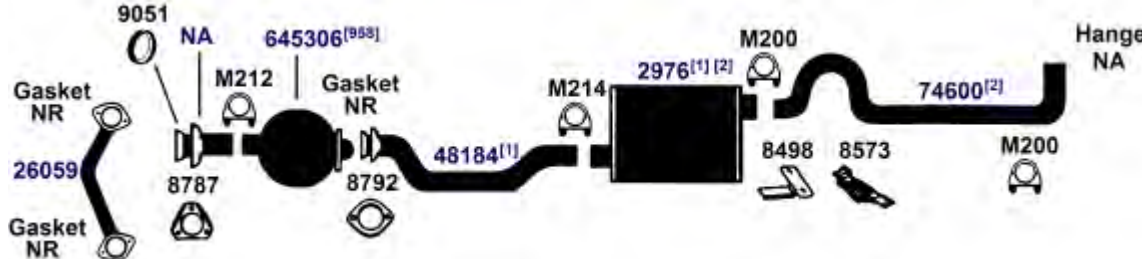

DIRECT FIT MSL/MAXIMUM Muffler... 6543, UNIVERSAL FIT MSL/MAXIMUM Muffler... 709012, Silentone DIY Muffler... 5528

NA-Not Available. NR-Not Required. FL-Remove and Re-Use Old Flange. ● Golden Warehouse. O.E.-Original Equipment.
Airtube Kit [4948] may be required to complete installation. EFI-Electronic Fuel Injection.

- [1] OE system was a welded assembly. It is recommended that all parts noted [1] should be replaced.
- [2] May be necessary to replace all noted [2] parts.
- [98] Refer to current Catalytic Converter catalog or Website catalog for availability.
- [958] Federal & California Emission vehicles. Not legal for sale for vehicles licensed in California.

PONTIAC BONNEVILLE, CATALINA, PARIENNE (INCL. SAFARI)

(8806) 1979 8 Cyl. Catalina, Safari Station Wagon, 350X Engine

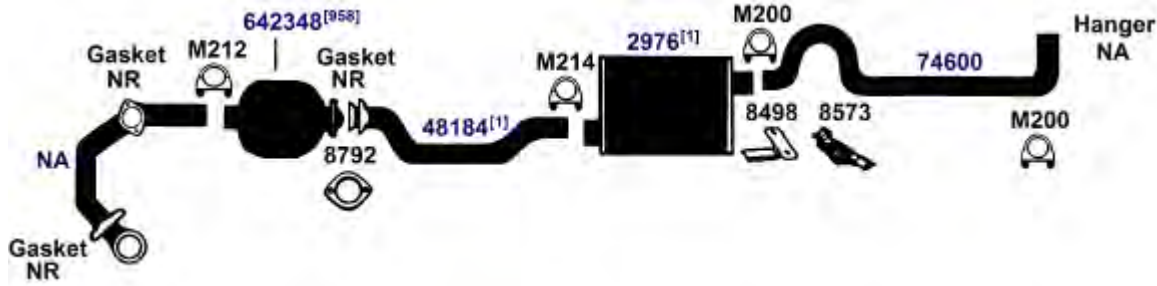

DIRECT FIT MSL/MAXIMUM Muffler... 6543, UNIVERSAL FIT MSL/MAXIMUM Muffler... 709012, Silentone DIY Muffler... 5528

(8807) 1979 8 Cyl. Catalina, Safari Station Wagon; 301 Engine

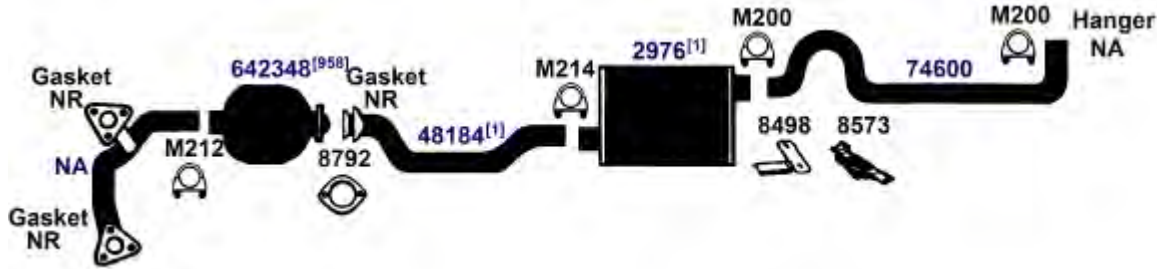

DIRECT FIT MSL/MAXIMUM Muffler... 6543, UNIVERSAL FIT MSL/MAXIMUM Muffler... 709012, Silentone DIY Muffler... 5528

(8809) 1979 8 Cyl. Catalina, Bonneville; 350X Engine, except Station Wagon

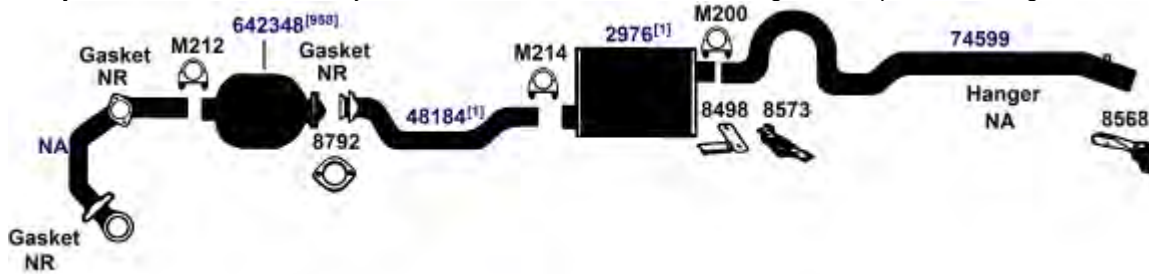

DIRECT FIT MSL/MAXIMUM Muffler... 6543, UNIVERSAL FIT MSL/MAXIMUM Muffler... 709012, Silentone DIY Muffler... 5528

(8810) 1979 8 Cyl. Catalina, Bonneville; 301 Engine, except Station Wagon

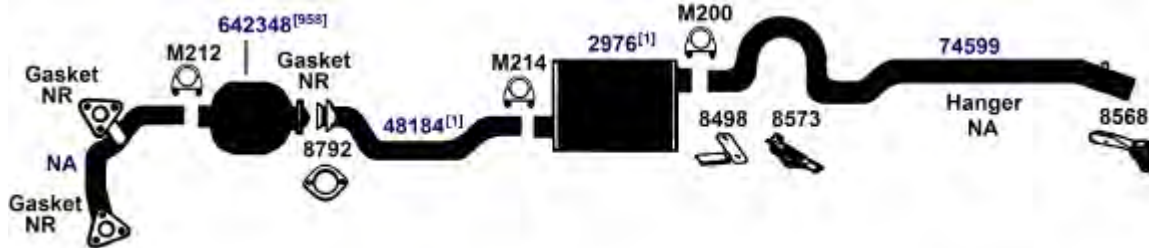

DIRECT FIT MSL/MAXIMUM Muffler... 6543, UNIVERSAL FIT MSL/MAXIMUM Muffler... 709012, Silentone DIY Muffler... 5528

NA-Not Available. NR-Not Required. FL-Remove and Re-Use Old Flange. ● Golden Warehouse. O.E.-Original Equipment.
Airtube Kit [4948] may be required to complete installation. EFI-Electronic Fuel Injection.

[1] OE system was a welded assembly. It is recommended that all parts noted [1] should be replaced. [958] Federal & California Emission vehicles. Not legal for sale for vehicles licensed in California.

PONTIAC BONNEVILLE, CATALINA, PARISIENNE (INCL. SAFARI)

1979 8 Cyl. Catalina, Safari Station Wagon; 350R Engine (8805)

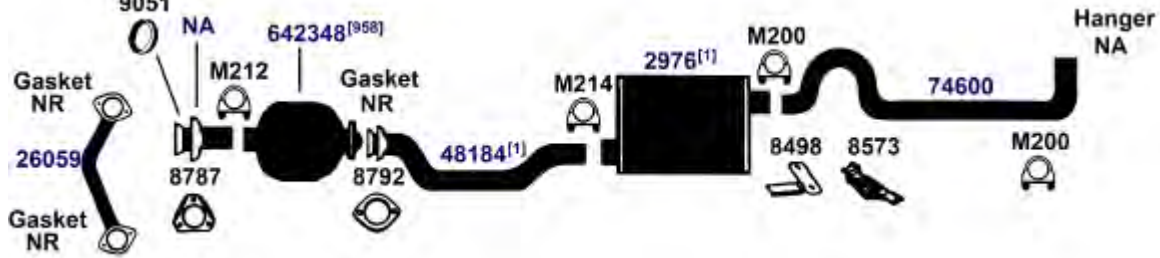

DIRECT FIT MSL/MAXIMUM Muffler... 6543, UNIVERSAL FIT MSL/MAXIMUM Muffler... 709012, Silentone DIY Muffler... 5528

1979 8 Cyl. Bonneville; 403 Engine, except Station Wagon (8795)

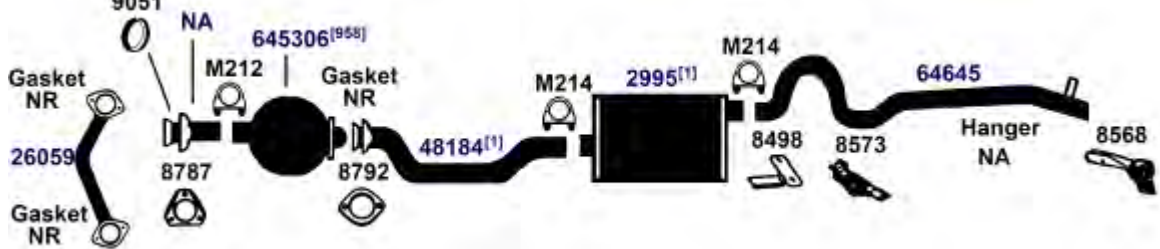

DIRECT FIT MSL/MAXIMUM Muffler... 700056, UNIVERSAL FIT MSL/MAXIMUM Muffler... 6543, 709012, Silentone DIY Muffler... 5528

1979 8 Cyl. Catalina, Bonneville; 350R Engine, except Station Wagon (8796)

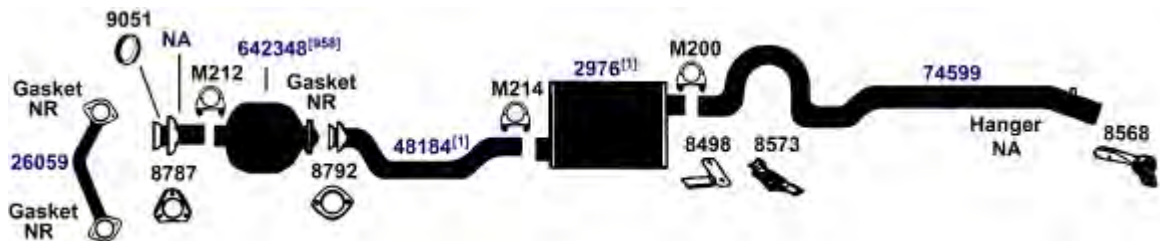

DIRECT FIT MSL/MAXIMUM Muffler... 6543, UNIVERSAL FIT MSL/MAXIMUM Muffler... 709012, Silentone DIY Muffler... 5528

NA-Not Available. NR-Not Required. FL-Remove and Re-Use Old Flange. ● Golden Warehouse. O.E.-Original Equipment.

Airtube Kit [4948] may be required to complete installation. EFI-Electronic Fuel Injection.

- [1] OE system was a welded assembly. It is recommended that all parts noted [1] should be replaced. [958] Federal & California Emission vehicles. Not legal for sale for vehicles licensed in California.

PONTIAC FIREBIRD

(8973) 93-94 6 Cyl. Firebird, 207 Engine (3.4L)

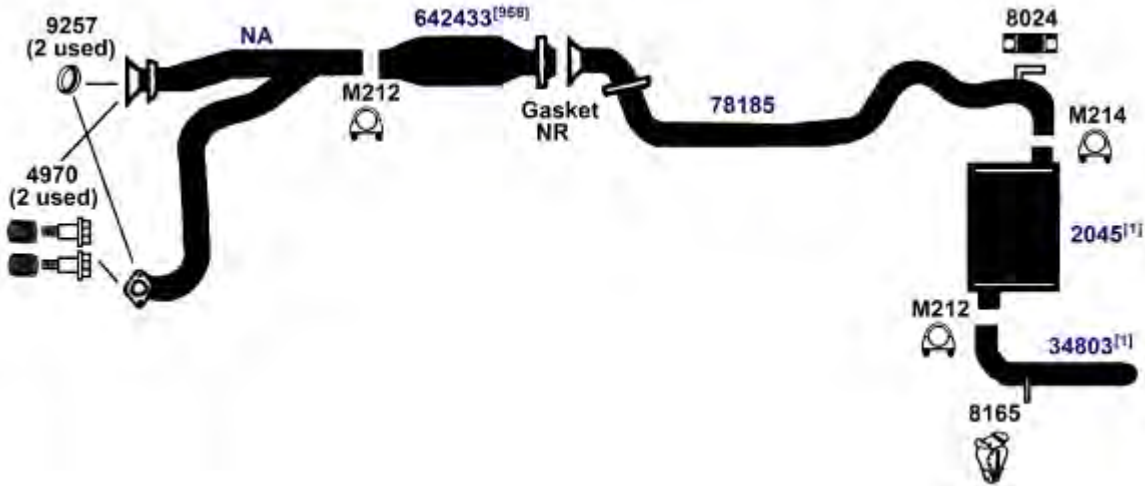

DIRECT FIT MSL/MAXIMUM Muffler... 700218

(8972) 93-94 8 Cyl. Firebird, 350 Engine (5.7L)

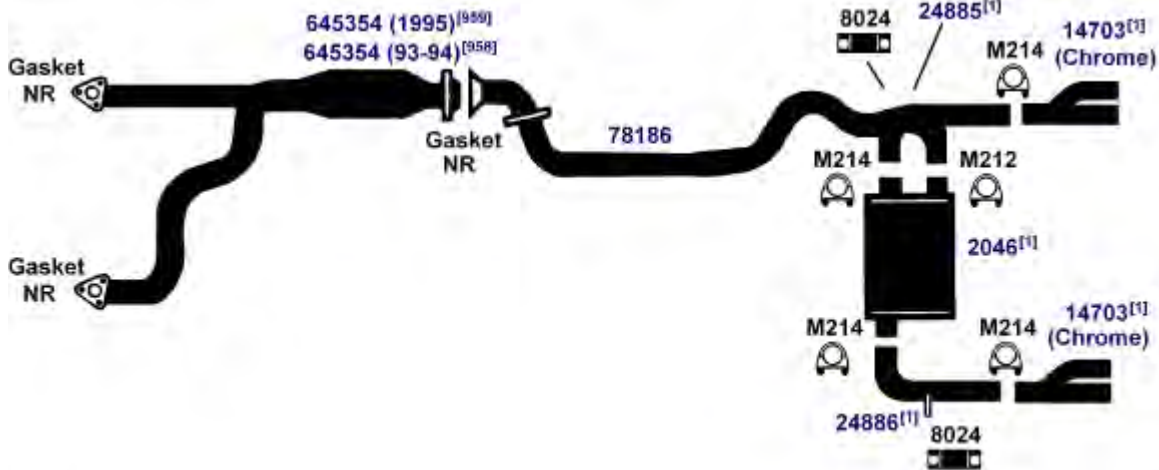

DIRECT FIT MSL/MAXIMUM Muffler... 700219

NA-Not Available. NR-Not Required. FL-Remove and Re-Use Old Flange. ● Golden Warehouse. O.E.-Original Equipment.
 # Airtube Kit [4948] may be required to complete installation. EFI-Electronic Fuel Injection.

[1] OE system was a welded assembly. It is recommended that all parts noted [1] [959] Federal Emission vehicles. Not legal for sale for vehicles licensed in California. should be replaced.

[958] Federal & California Emission vehicles. Not legal for sale for vehicles licensed in California.

1992 8 Cyl. Firebird, Formula, Trans AM, GTA; 305F, 350 Engine (5.0L, 5.7-8); Dual Exhaust (8971)



DIRECT FIT MSL/MAXIMUM Muffler... 700359, UNIVERSAL FIT MSL/MAXIMUM Muffler... 6584, Silentone DIY Muffler... 5546

91-92 6 Cyl. Firebird, 189 Engine (3.1L); with Converter (8970)



DIRECT FIT MSL/MAXIMUM Muffler... 700276, UNIVERSAL FIT MSL/MAXIMUM Muffler... 6537

NA-Not Available. NR-Not Required. FL-Remove and Re-Use Old Flange. ● Golden Warehouse. O.E.-Original Equipment.
Airtube Kit [4948] may be required to complete installation. EFI-Electronic Fuel Injection.

[1] OE system was a welded assembly. It is recommended that all parts noted [1] should be replaced.
[900] Direct fit converter may require resizing, cutting or bushing.

[934] Replaces multiple OE Converters. Only failed converters may be replaced.
[958] Federal & California Emission vehicles. Not legal for sale for vehicles licensed in California.

PONTIAC FIREBIRD

(8965) 90-92 8 Cyl. Firebird, Formula, Trans AM, GTA; 305F Engine (5.0L); except Models with 2 3/4" Diameter Extension Pipe
 88-92 8 Cyl. Firebird, 305E Engine (5.0L)

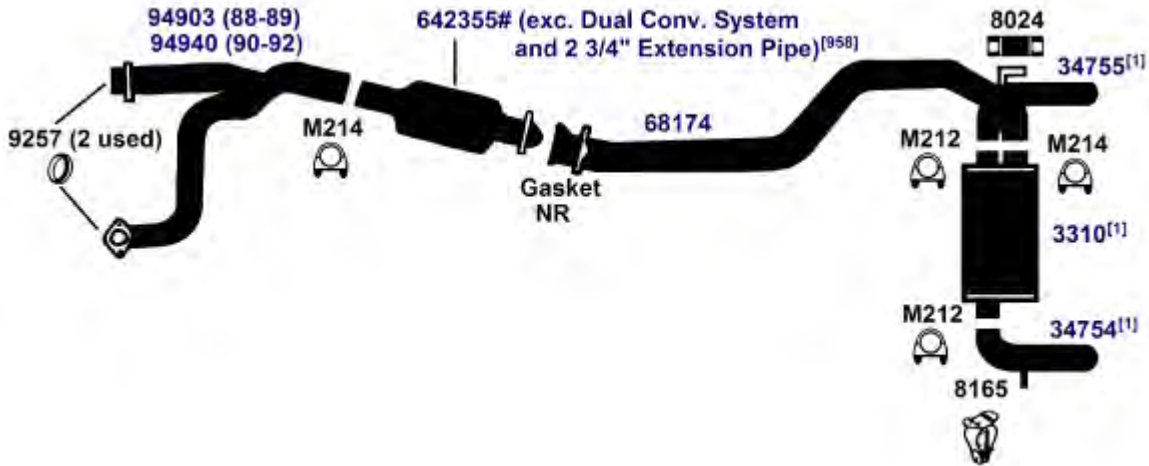

DIRECT FIT MSL/MAXIMUM Muffler... 6584, Silentone DIY Muffler... 5546

(8968) 89-91 8 Cyl. Firebird, Formula, Trans AM, GTA; 305F, 350 Engine (5.0L, 5.7L-8); Dual Exhaust

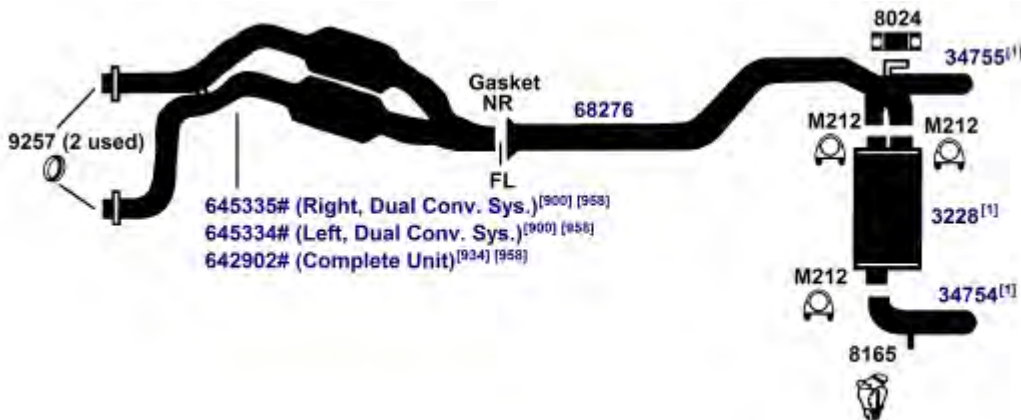

DIRECT FIT MSL/MAXIMUM Muffler... 700359, UNIVERSAL FIT MSL/MAXIMUM Muffler... 6584, Silentone DIY Muffler... 5546

NA-Not Available. NR-Not Required. FL-Remove and Re-Use Old Flange. ● Golden Warehouse. O.E.-Original Equipment.
 # Airtube Kit [4948] may be required to complete installation. EFI-Electronic Fuel Injection.

[1] OE system was a welded assembly. It is recommended that all parts noted [1] should be replaced.

[900] Direct fit converter may require resizing, cutting or bushing.

[934] Replaces multiple OE Converters. Only failed converters may be replaced.

[958] Federal & California Emission vehicles. Not legal for sale for vehicles licensed in California.

1990 6 Cyl. Firebird, 189 Engine (3.1L); with Converter
 85-89 6 Cyl. Firebird, 173 Engine (2.8S); with Converter

(8961)

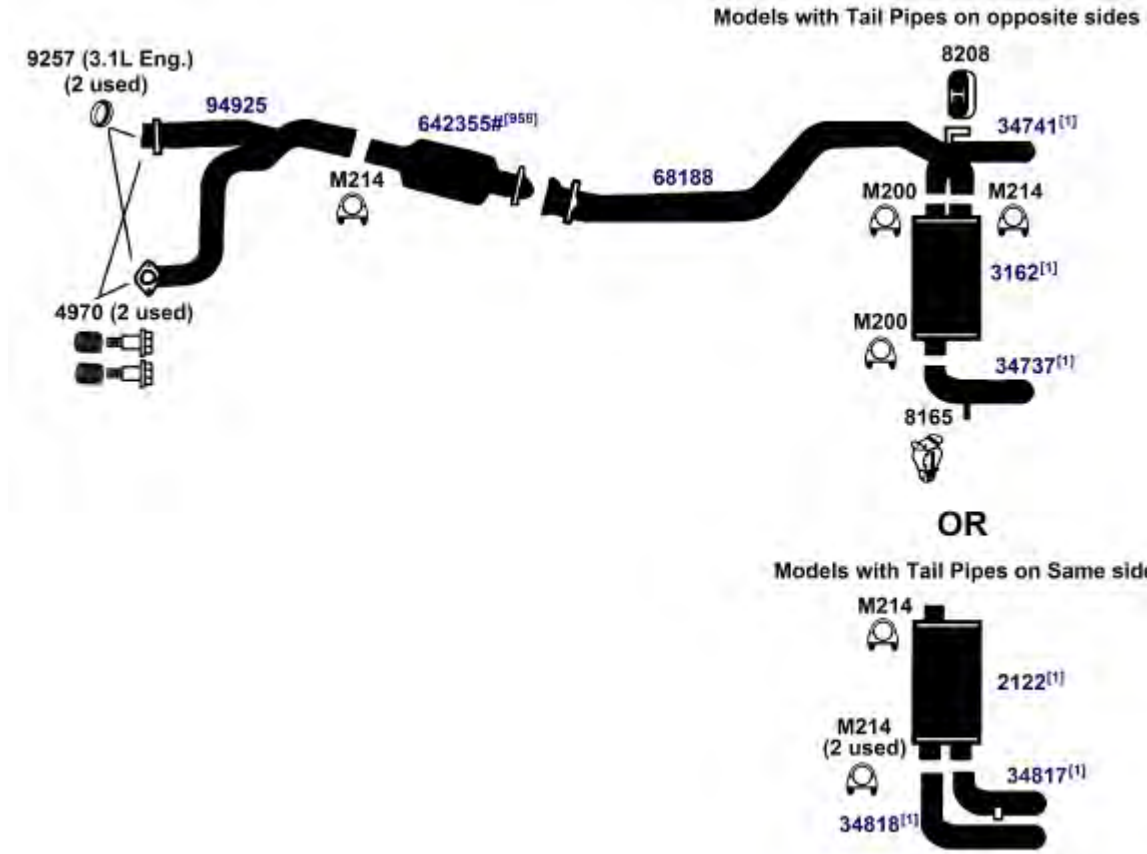

DIRECT FIT MSL/MAXIMUM Muffler... Muffler (3162)- 700069 (Left and Right Exit), UNIVERSAL FIT MSL/MAXIMUM Muffler... Muffler (3162)- 6537 (Left and Right Exit), Muffler (2122)- 709015 (Left Exit), Silentone DIY Muffler... Muffler (3162)- 5560 (Left and Right Exit)

NA-Not Available. NR-Not Required. FL-Remove and Re-Use Old Flange. ● Golden Warehouse. O.E.-Original Equipment.
 # Airtube Kit [4948] may be required to complete installation. EFI-Electronic Fuel Injection.

[1] OE system was a welded assembly. It is recommended that all parts noted [1] should be replaced. [958] Federal & California Emission vehicles. Not legal for sale for vehicles licensed in California.

PONTIAC FIREBIRD

(8969) 1990 8 Cyl. Firebird, Formula, Trans AM, GTA; 305F, 350 Engine (5.0L, 5.7L-8); Models with 2 3/4" Diameter Extension Pipe; Dual Exhaust



DIRECT FIT MSL/MAXIMUM Muffler... 700359, UNIVERSAL FIT MSL/MAXIMUM Muffler... 6584, Silentone DIY Muffler... 5546

(100529) 1989 6 Cyl. Firebird, Trans AM, GTA, SE; 231-7 Engine (3.8L) Turbo

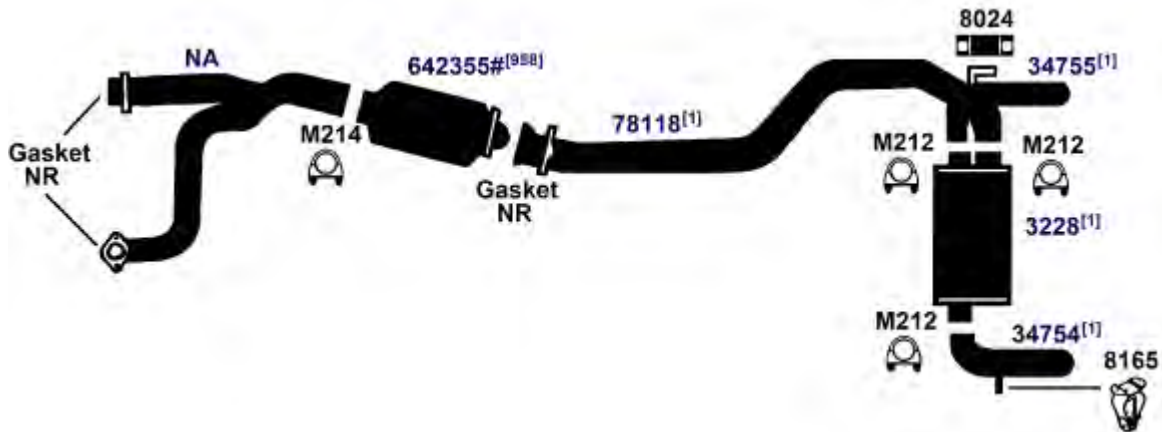

DIRECT FIT MSL/MAXIMUM Muffler... 700359, UNIVERSAL FIT MSL/MAXIMUM Muffler... 6584, Silentone DIY Muffler... 5546

NA-Not Available. NR-Not Required. FL-Remove and Re-Use Old Flange. ● Golden Warehouse. O.E.-Original Equipment.
Airtube Kit [4948] may be required to complete installation. EFI-Electronic Fuel Injection.

[1] OE system was a welded assembly. It is recommended that all parts noted [1] should be replaced.

[98] Refer to current Catalytic Converter catalog or Website catalog for availability.

[958] Federal & California Emission vehicles. Not legal for sale for vehicles licensed in California.

PONTIAC FIREBIRD

87-89 8 Cyl. Firebird, Trans AM, GTA; 305-F, 350-8 Engine (5.0L, 5.7L)
1986 8 Cyl. Firebird, Trans AM, 305-F, 305G Engine (5.0L)

(8964)

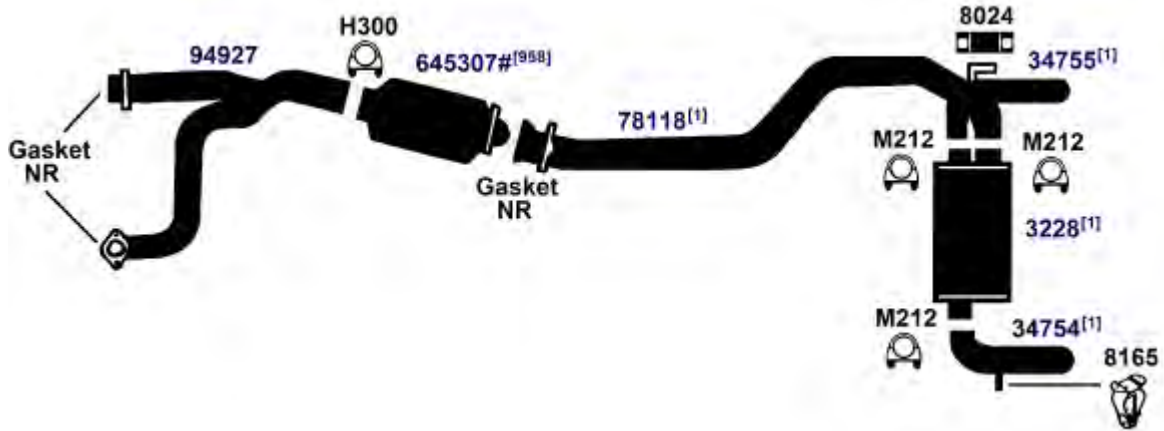

DIRECT FIT MSL/MAXIMUM Muffler... 700359, 6584, UNIVERSAL FIT MSL/MAXIMUM Muffler... 6584, Silentone DIY Muffler... 5546

85-87 8 Cyl. Firebird, 305H Engine (5.0L); Single Bed Bead Converter, Dual Bed Monolithic Converter[233]

(8958)

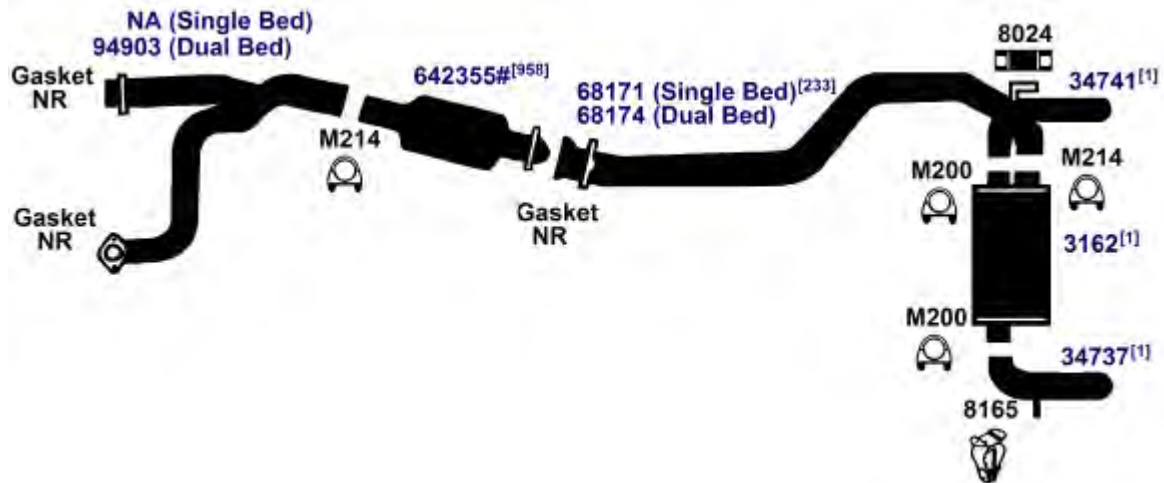

DIRECT FIT MSL/MAXIMUM Muffler... 700069, UNIVERSAL FIT MSL/MAXIMUM Muffler... 6537, Silentone DIY Muffler... 5560

NA-Not Available. NR-Not Required. FL-Remove and Re-Use Old Flange. ● Golden Warehouse. O.E.-Original Equipment.
 # Airtube Kit [4948] may be required to complete installation. EFI-Electronic Fuel Injection.

[1] OE system was a welded assembly. It is recommended that all parts noted [1] should be replaced. [958] Federal & California Emission vehicles. Not legal for sale for vehicles licensed in California.
 [233] See General Information section of catalog for explanation

PONTIAC FIREBIRD

(8960) 85-86 4 Cyl. Firebird, All Models, 151 Engine (2.5L)

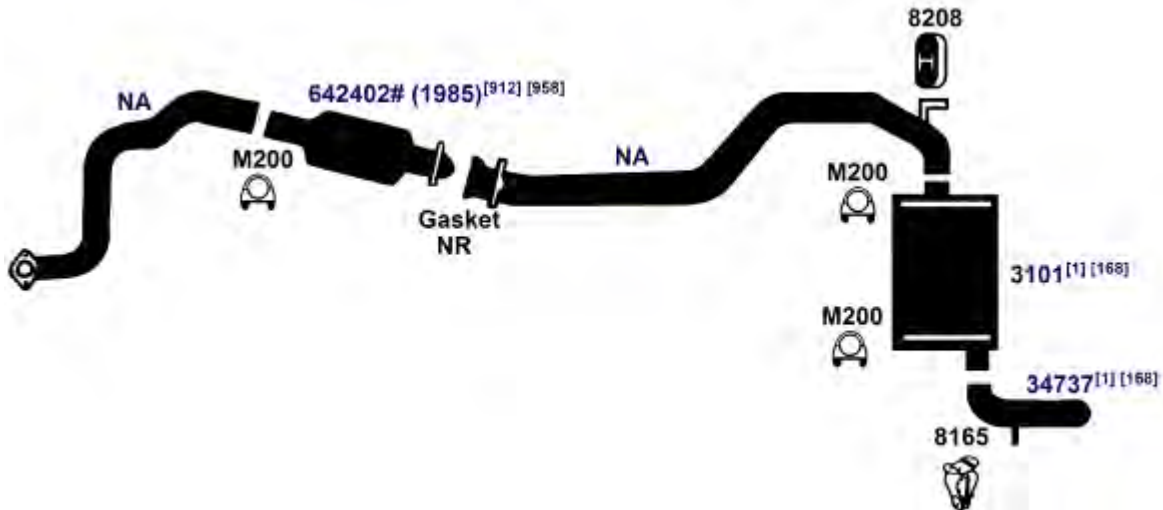

DIRECT FIT MSL/MAXIMUM Muffler... 6538, UNIVERSAL FIT MSL/MAXIMUM Muffler... 709011, Silentone DIY Muffler... 5528

(8962) 1985 8 Cyl. Firebird, Trans AM; 305-7, 305F, 305G Engine (5.0L)

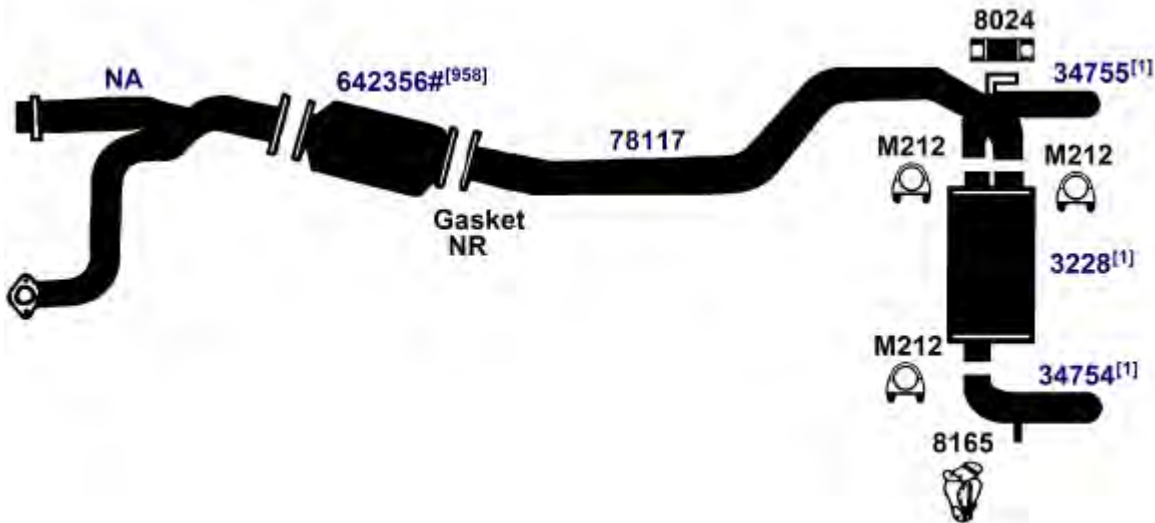

DIRECT FIT MSL/MAXIMUM Muffler... 700359, UNIVERSAL FIT MSL/MAXIMUM Muffler... 6584, Silentone DIY Muffler... 5546

NA-Not Available. NR-Not Required. FL-Remove and Re-Use Old Flange. ● Golden Warehouse. O.E.-Original Equipment.
Airtube Kit [4948] may be required to complete installation. EFI-Electronic Fuel Injection.

[1] OE system was a welded assembly. It is recommended that all parts noted [1] should be replaced.

[168] Functionally approved Single Outlet System replaces Dual Outlet.

[912] When using with aftermarket piping, direct fit converter may require INLET/OUTLET pipe resizing.

[958] Federal & California Emission vehicles. Not legal for sale for vehicles licensed in California.

83-84 8 Cyl. Firebird, Trans AM; 305-7, 305F, 305G (5.0L) Engine

(8962E)

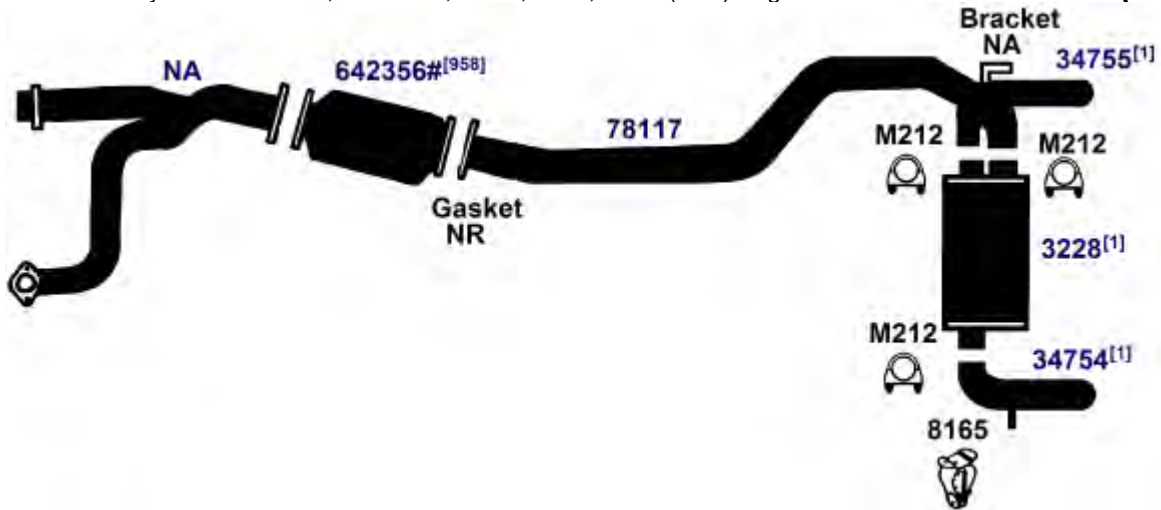

DIRECT FIT MSL/MAXIMUM Muffler... 700359, UNIVERSAL FIT MSL/MAXIMUM Muffler... 6584, Silentone DIY Muffler... 5546

82-84 4 Cyl. Firebird, All Models, 151 (2.5L) Engine

(8960E)

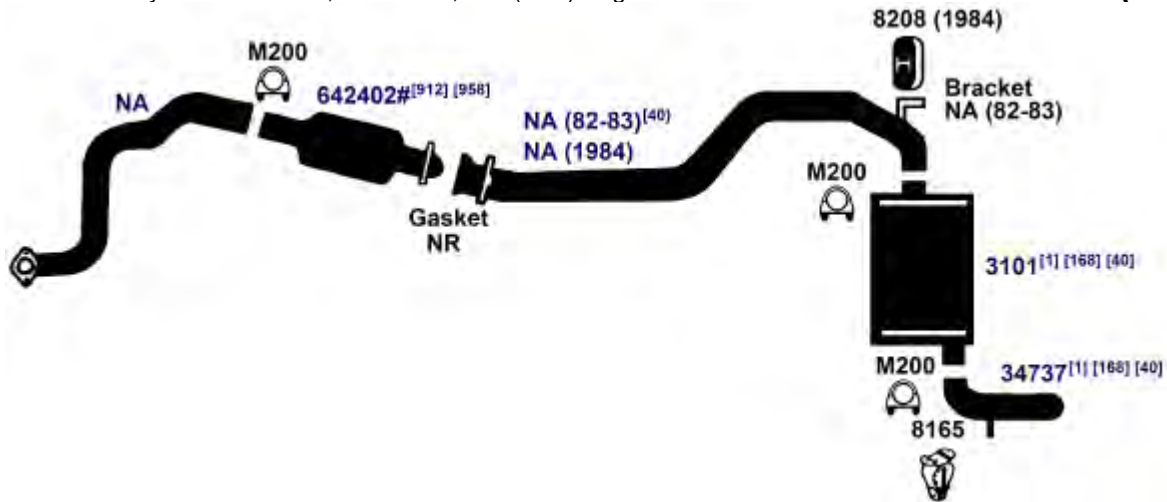

DIRECT FIT MSL/MAXIMUM Muffler... 6538, UNIVERSAL FIT MSL/MAXIMUM Muffler... 709011, Silentone DIY Muffler... 5528

NA-Not Available. NR-Not Required. FL-Remove and Re-Use Old Flange. ● Golden Warehouse. O.E.-Original Equipment.
Airtube Kit [4948] may be required to complete installation. EFI-Electronic Fuel Injection.

- [1] OE system was a welded assembly. It is recommended that all parts noted [1] should be replaced.
- [40] O.E. system has a 5" round muffler on 82-83 models. Replacement system has an oval muffler and complete system must be replaced together.
- [168] Functionally approved Single Outlet System replaces Dual Outlet.

- [912] When using with aftermarket piping, direct fit converter may require INLET/OUTLET pipe resizing.
- [958] Federal & California Emission vehicles. Not legal for sale for vehicles licensed in California.

PONTIAC FIREBIRD

(8959) 82-84 6 Cyl. Firebird, All Models with 2.8L, 173 Engine

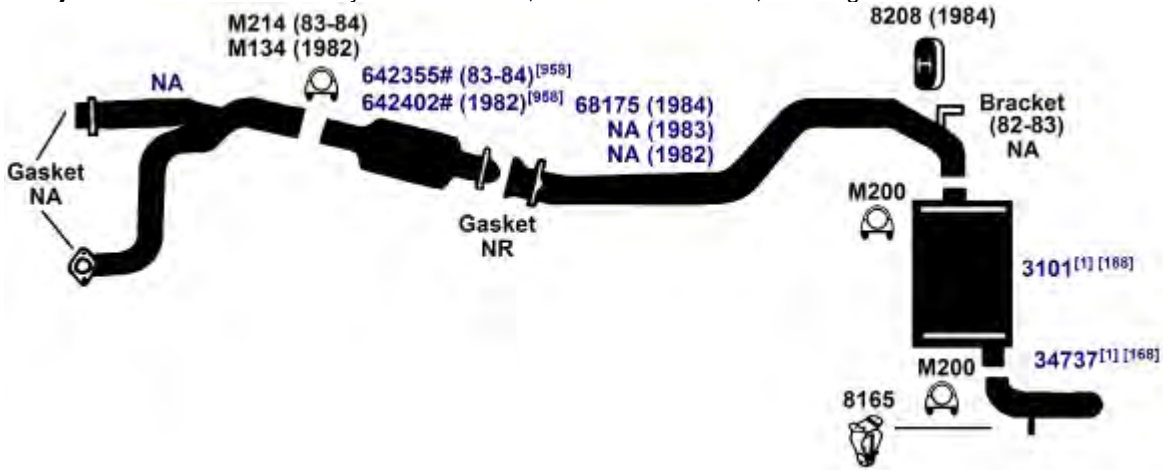

DIRECT FIT MSL/MAXIMUM Muffler... 6538, UNIVERSAL FIT MSL/MAXIMUM Muffler... 709011, Silentone DIY Muffler... 5528

(8958E) 82-84 8 Cyl. Firebird, 305H Engine (5.0L); Single Bed Converter and Dual Bed Monolithic Converter

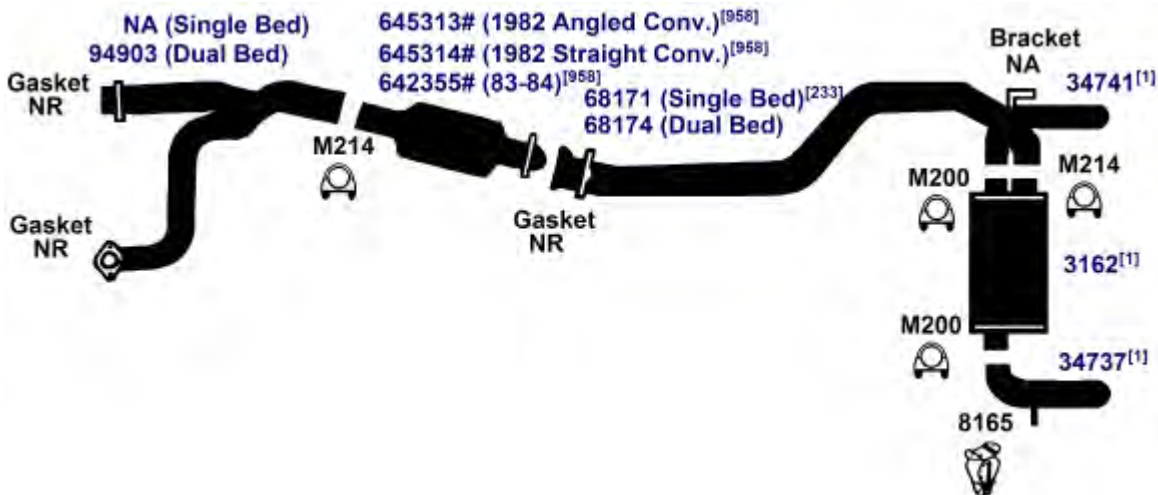

DIRECT FIT MSL/MAXIMUM Muffler... 700069, UNIVERSAL FIT MSL/MAXIMUM Muffler... 6537, Silentone DIY Muffler... 5560

NA-Not Available. NR-Not Required. FL-Remove and Re-Use Old Flange. ● Golden Warehouse. O.E.-Original Equipment.
Airtube Kit [4948] may be required to complete installation. EFI-Electronic Fuel Injection.

[1] OE system was a welded assembly. It is recommended that all parts noted [1] should be replaced.

[168] Functionally approved Single Outlet System replaces Dual Outlet.

[233] See General Information section of catalog for explanation
[958] Federal & California Emission vehicles. Not legal for sale for vehicles licensed in California.

1981 8 Cyl. Firebird, 4.9L, 301 Engine; without Performance Option (W72) and Turbo Engine, Dual Outlet Muffler (8954)

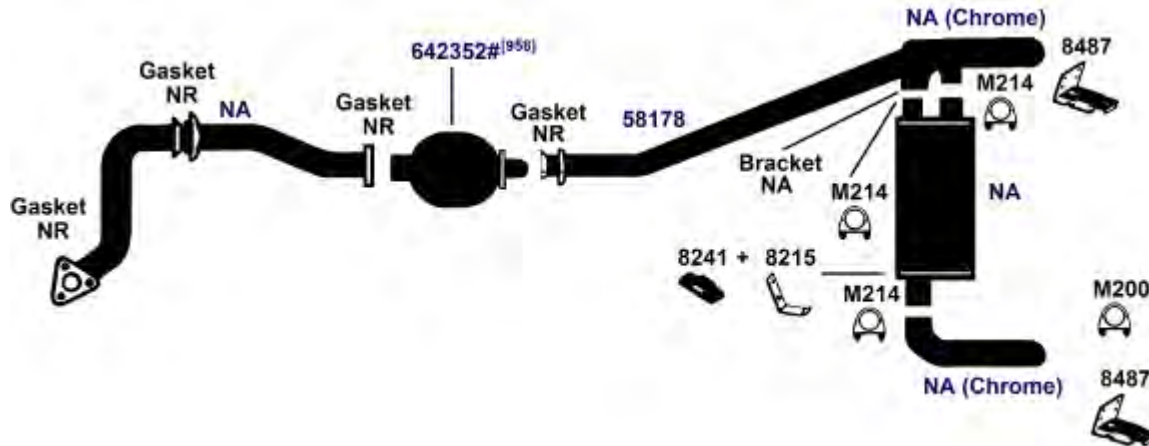

UNIVERSAL FIT MSL/MAXIMUM Muffler... 6537

80-81 6,8 Cyl. Firebird; 231, 265, 267 (1981 only) Engine; Single Outlet Muffler (8956)

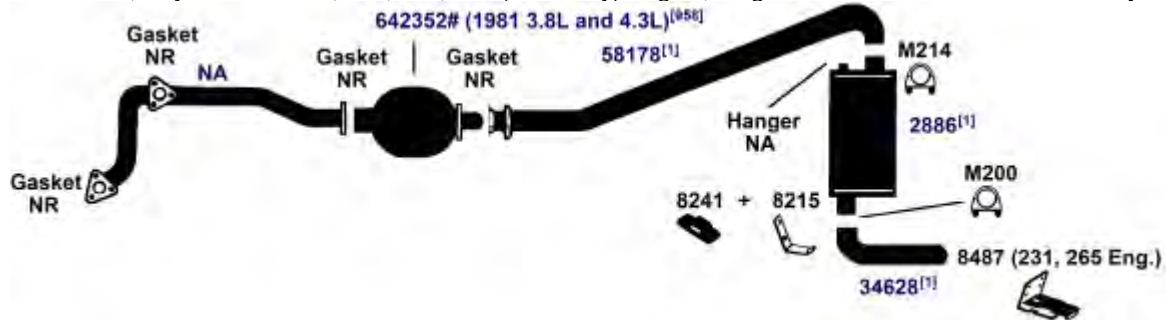

UNIVERSAL FIT MSL/MAXIMUM Muffler... 6508, 709016

80-81 8 Cyl. Firebird, 305H Engine, Formula, Trans AM (8952)

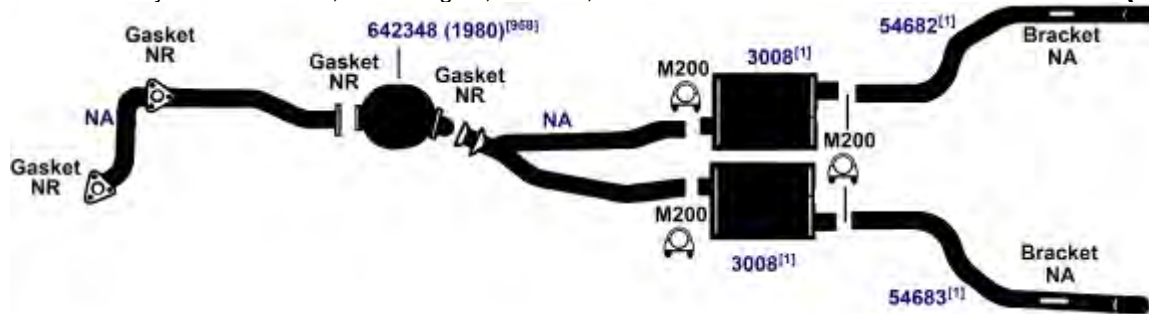

DIRECT FIT MSL/MAXIMUM Muffler... Left Muffler- 6555, Right Muffler- 6555, UNIVERSAL FIT MSL/MAXIMUM Muffler... Left Muffler- 709006, Right Muffler- 709006, Silentone DIY Muffler... Left Muffler- 5539, Right Muffler- 5539

NA-Not Available. NR-Not Required. FL-Remove and Re-Use Old Flange. ● Golden Warehouse. O.E.-Original Equipment.
Airtube Kit [4948] may be required to complete installation. EFI-Electronic Fuel Injection.

[1] OE system was a welded assembly. It is recommended that all parts noted [1] should be replaced.

[98] Refer to current Catalytic Converter catalog or Website catalog for availability.

[958] Federal & California Emission vehicles. Not legal for sale for vehicles licensed in California.

PONTIAC FIREBIRD

(8967) 80-81 8 Cyl. Firebird, 4.9L, 301 Engine; with Performance Option (W72) and Turbo Engine

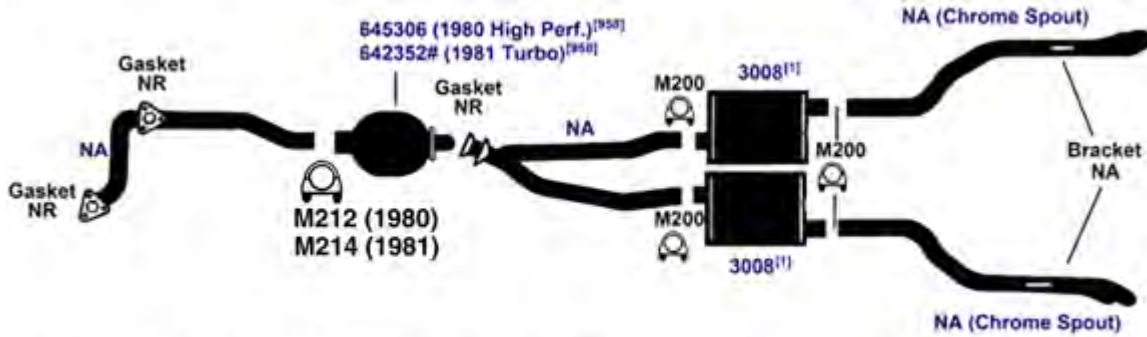

DIRECT FIT MSL/MAXIMUM Muffler... Left- 6555, Right- 6555

DIRECT FIT MSL/MAXIMUM Muffler... Left Muffler- 6555, Right Muffler- 6555, UNIVERSAL FIT MSL/MAXIMUM Muffler... Left Muffler- 709006, Right Muffler- 709006, Silentone DIY Muffler... Left Muffler- 5539, Right Muffler- 5539

(8953) 80-81 8 Cyl. Firebird, 305H Engine, except Formula, Trans AM

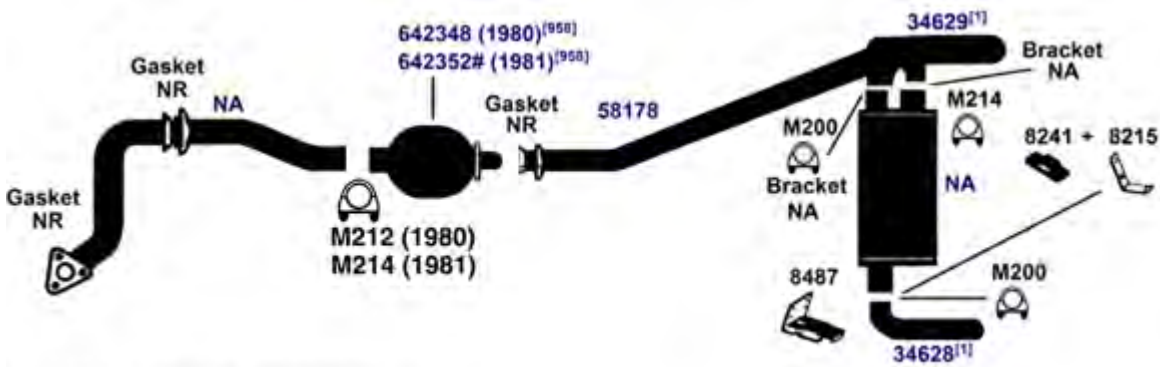

DIRECT FIT MSL/MAXIMUM Muffler... 6537

DIRECT FIT MSL/MAXIMUM Muffler... 6537

(8945) 1979 8 Cyl. Firebird, 403 Engine, with Special Performance

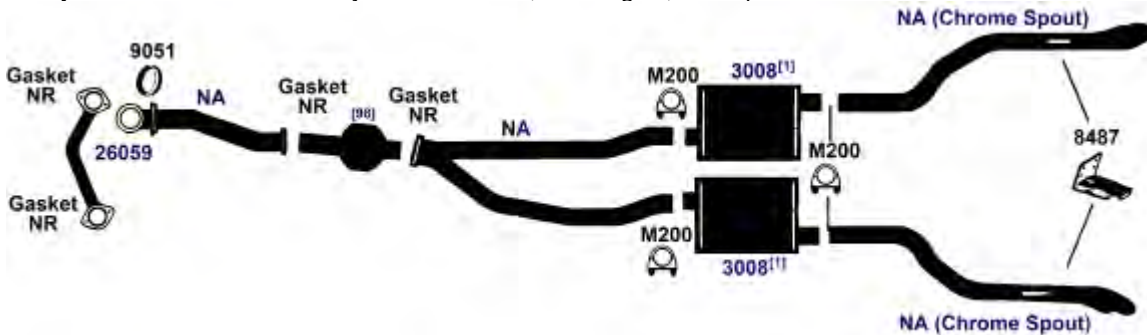

DIRECT FIT MSL/MAXIMUM Muffler... Left Muffler- 6555, Right Muffler- 6555, UNIVERSAL FIT MSL/MAXIMUM Muffler... Left Muffler- 709006, Right Muffler- 709006, Silentone DIY Muffler... Left Muffler- 5539, Right Muffler- 5539

NA-Not Available. NR-Not Required. FL-Remove and Re-Use Old Flange. ● Golden Warehouse. O.E.-Original Equipment.

Airtube Kit [4948] may be required to complete installation. EFI-Electronic Fuel Injection.

[1] OE system was a welded assembly. It is recommended that all parts noted [1] should be replaced.

[98] Refer to current Catalytic Converter catalog or Website catalog for availability.

[958] Federal & California Emission vehicles. Not legal for sale for vehicles licensed in California.

1979 8 Cyl. Firebird, 305, 350 Engine; except Trans AM

(8948)

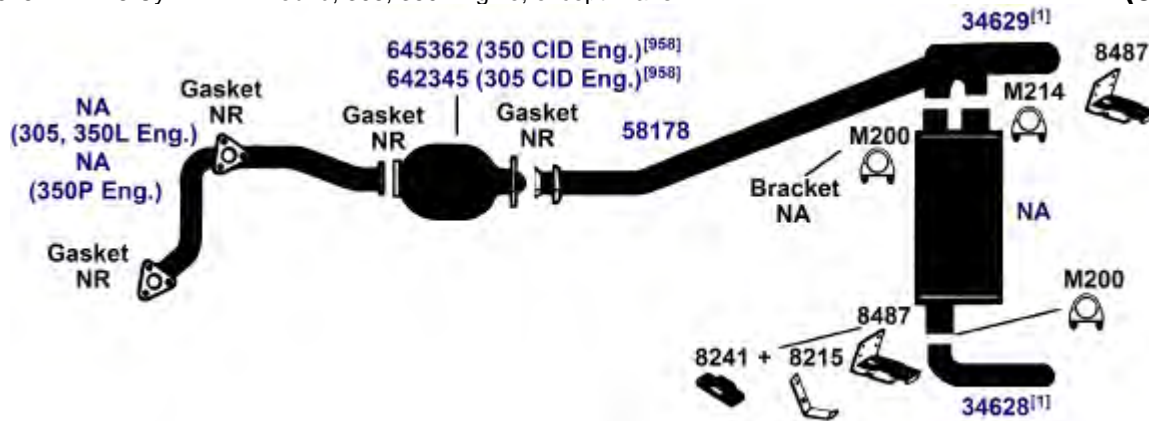

DIRECT FIT MSL/MAXIMUM Muffler... 6537

1979 8 Cyl. Firebird, 403 Engine, Formula, Trans AM; except Special Performance

(8946)

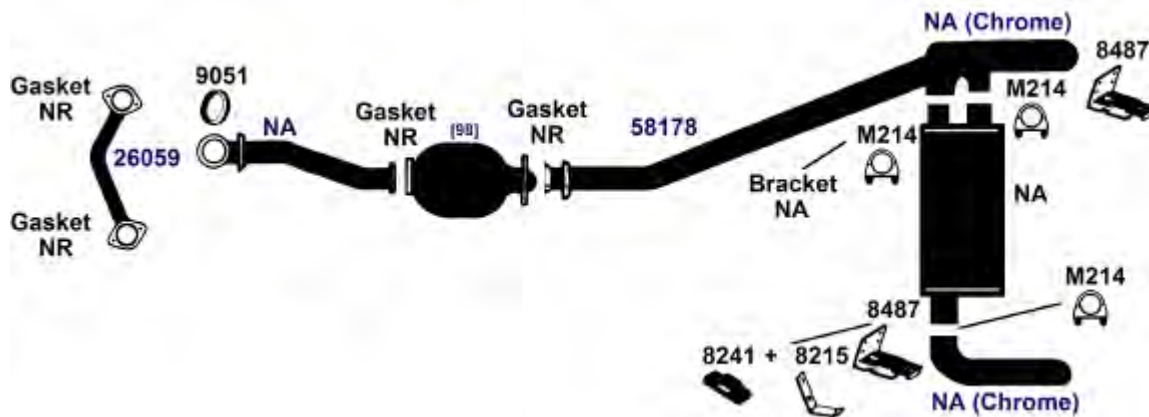

UNIVERSAL FIT MSL/MAXIMUM Muffler... 6537

1979 8 Cyl. Firebird, 400 Engine, with Special Performance

(8947)

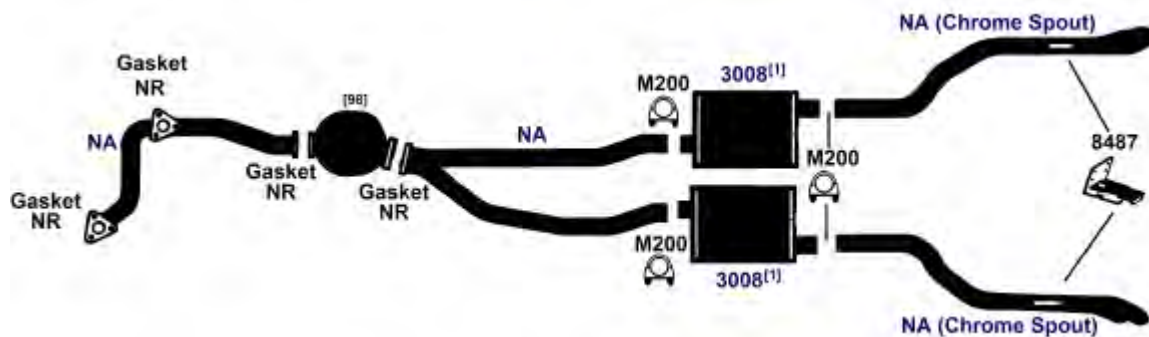

DIRECT FIT MSL/MAXIMUM Muffler... Left Muffler- 6555, Right Muffler- 6555, UNIVERSAL FIT MSL/MAXIMUM Muffler... Left Muffler- 709006, Right Muffler- 709006, Silentone DIY Muffler... Left Muffler- 5539, Right Muffler- 5539

NA-Not Available. NR-Not Required. FL-Remove and Re-Use Old Flange. ● Golden Warehouse. O.E.-Original Equipment.
Airtube Kit [4948] may be required to complete installation. EFI-Electronic Fuel Injection.

[1] OE system was a welded assembly. It is recommended that all parts noted [1] should be replaced.
[98] Refer to current Catalytic Converter catalog or Website catalog for availability.
[958] Federal & California Emission vehicles. Not legal for sale for vehicles licensed in California.

PONTIAC FIREFLY

(100303) 89-91 4 Cyl. Firefly, 2-Door and 4-Door Hatchback, 1.3L Engine; except GT, GTI with DOHC Engine (CANADA ONLY)



DIRECT FIT MSL/MAXIMUM Muffler... 700003, UNIVERSAL FIT MSL/MAXIMUM Muffler... 6653

(100304) 87-88 3 Cyl. Firefly, 1.0L Engine; except Turbo (CANADA ONLY)

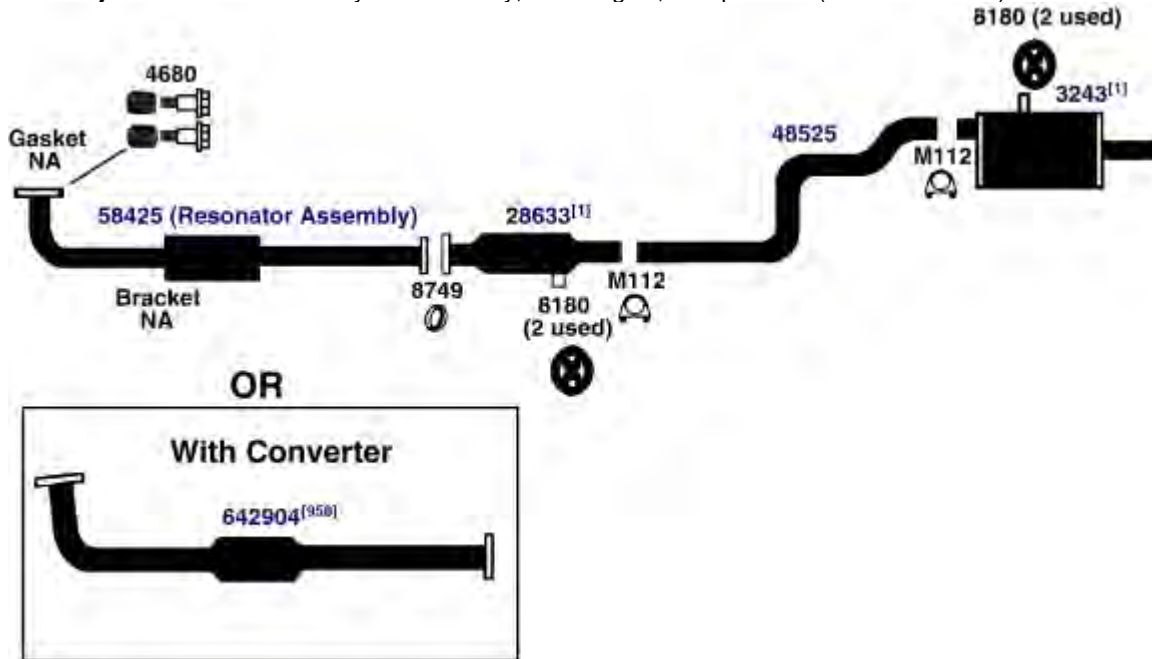

DIRECT FIT MSL/MAXIMUM Muffler... 700095, UNIVERSAL FIT MSL/MAXIMUM Muffler... 6654

NA-Not Available. NR-Not Required. FL-Remove and Re-Use Old Flange. ● Golden Warehouse. O.E.-Original Equipment.
Airtube Kit [4948] may be required to complete installation. EFI-Electronic Fuel Injection.

[1] OE system was a welded assembly. It is recommended that all parts noted [1] should be replaced.

[98] Refer to current Catalytic Converter catalog or Website catalog for availability.

[112] Required for installation except when a black triangle appears on muffler carton label.

[958] Federal & California Emission vehicles. Not legal for sale for vehicles licensed in California.

85-86 3 Cyl. Firefly, 4-Door Hatchback, 1.0L Engine (CANADA ONLY)

(100305)

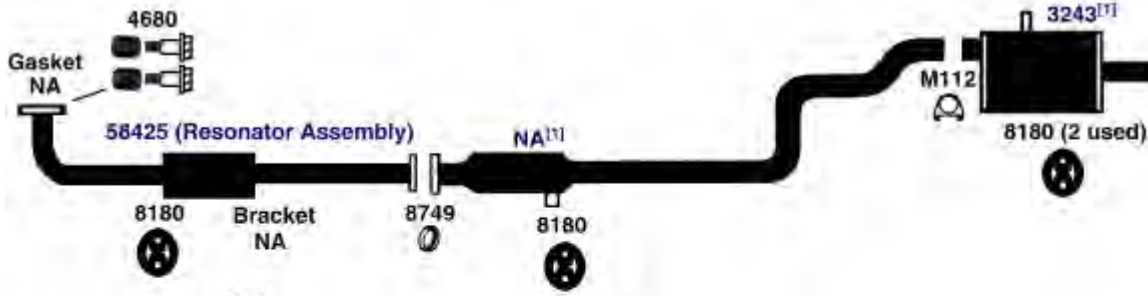

OR

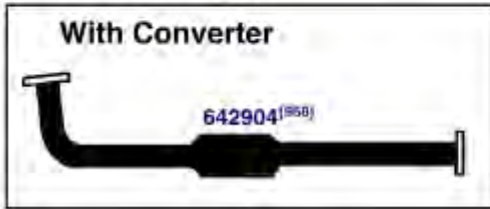

DIRECT FIT MSL/MAXIMUM Muffler... 700095, UNIVERSAL FIT MSL/MAXIMUM Muffler... 6654

85-86 3 Cyl. Firefly, 2-Door Hatchback, 1.0L Engine (CANADA ONLY)

(100306)

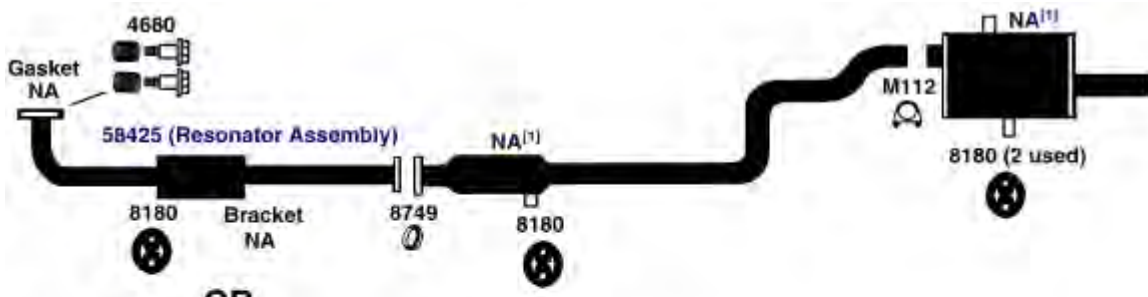

OR

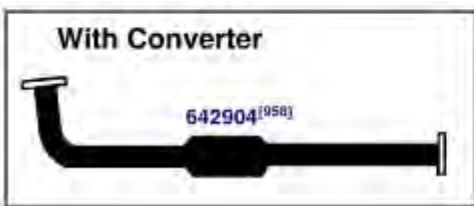

UNIVERSAL FIT MSL/MAXIMUM Muffler... 6654

NA-Not Available. NR-Not Required. FL-Remove and Re-Use Old Flange. ● Golden Warehouse. O.E.-Original Equipment.
Airtube Kit [4948] may be required to complete installation. EFI-Electronic Fuel Injection.

[1] OE system was a welded assembly. It is recommended that all parts noted [1] should be replaced. [958] Federal & California Emission vehicles. Not legal for sale for vehicles licensed in California.

PONTIAC GRAND AM

(9001) 93-94 4 Cyl. Grand AM, 138 Engine (2.3-3) (Quad OHC)

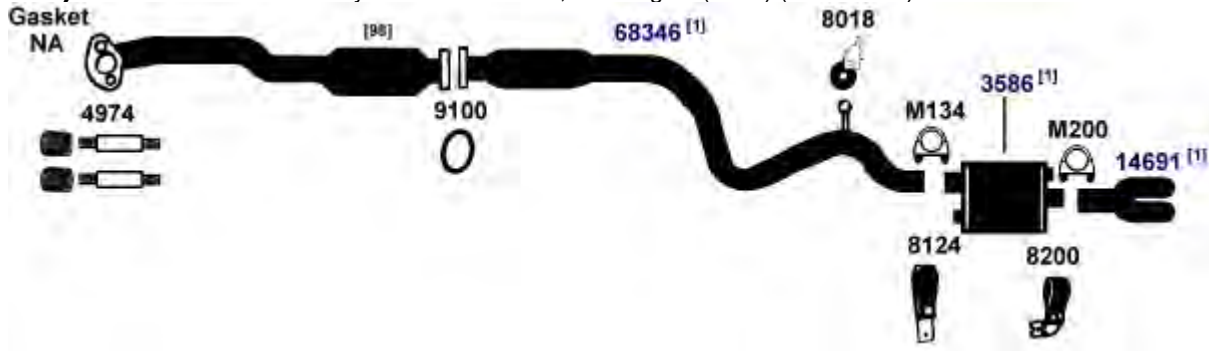

DIRECT FIT MSL/MAXIMUM Muffler... 700180, UNIVERSAL FIT MSL/MAXIMUM Muffler... 709001, 709013

(9000) 1994 6 Cyl. Grand AM, 3.1L Engine, Single Exhaust
 93-94 4 Cyl. Grand AM, 138 Engine (2.3D) (Quad 4), Single Exhaust

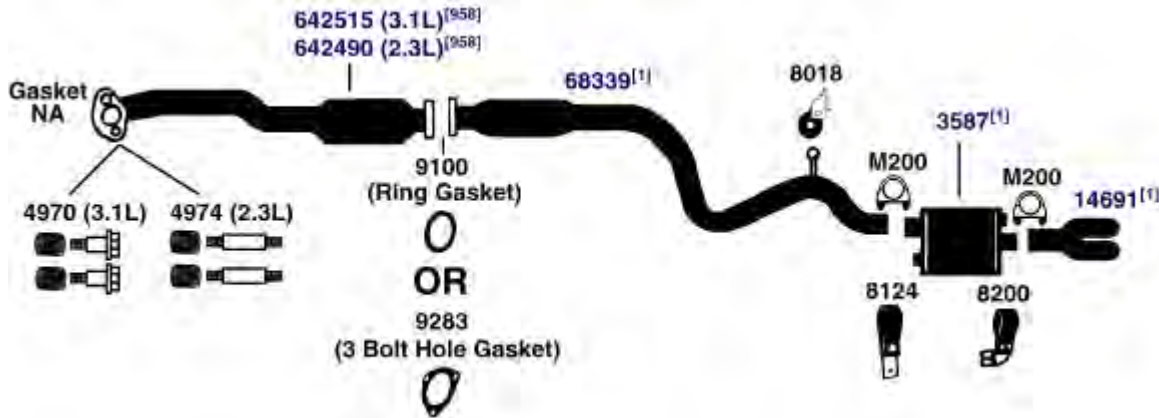

DIRECT FIT MSL/MAXIMUM Muffler... 700162, UNIVERSAL FIT MSL/MAXIMUM Muffler... 709001, 709013, 709014

NA-Not Available. NR-Not Required. FL-Remove and Re-Use Old Flange. ● Golden Warehouse. O.E.-Original Equipment.
 # Airtube Kit [4948] may be required to complete installation. EFI-Electronic Fuel Injection.

[1] OE system was a welded assembly. It is recommended that all parts noted [1] should be replaced.

[958] Federal & California Emission vehicles. Not legal for sale for vehicles licensed in California.

[98] Refer to current Catalytic Converter catalog or Website catalog for availability.

PONTIAC GRAND AM

1994 6 Cyl. Grand AM, 3.1L Engine, Dual Exhaust **(8999)**
93-94 4 Cyl. Grand AM, 138 Engine (2.3L-D) (Quad 4), Dual Exhaust

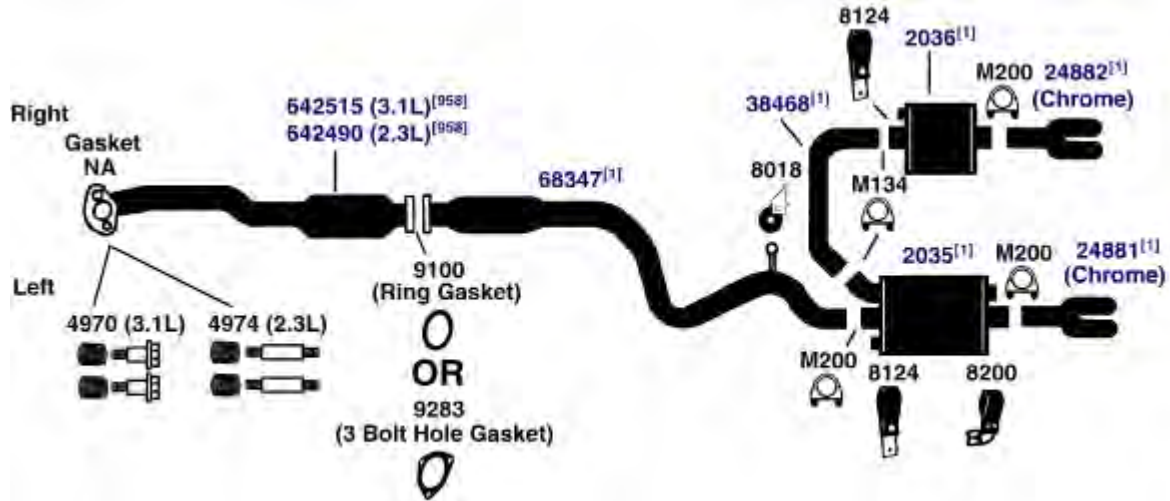

DIRECT FIT MSL/MAXIMUM Muffler... Left Muffler (2035)- 700198, Right Muffler (2036)- 700199, UNIVERSAL FIT MSL/MAXIMUM Muffler... Right Muffler (2036)- 709004

92-93 6 Cyl. Grand AM, 204 Engine (3.3L) Single Exhaust **(8994)**

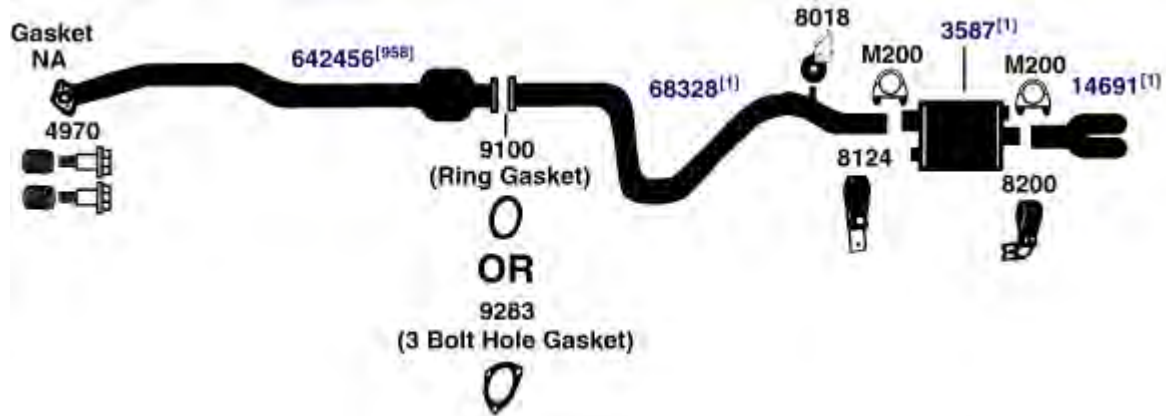

DIRECT FIT MSL/MAXIMUM Muffler... 700162, UNIVERSAL FIT MSL/MAXIMUM Muffler... 709001, 709013, 709014

NA-Not Available. NR-Not Required. FL-Remove and Re-Use Old Flange. ● Golden Warehouse. O.E.-Original Equipment.
 # Airtube Kit [4948] may be required to complete installation. EFI-Electronic Fuel Injection.

[1] OE system was a welded assembly. It is recommended that all parts noted [1] should be replaced. [958] Federal & California Emission vehicles. Not legal for sale for vehicles licensed in California.

PONTIAC GRAND AM

(8998) 92-93 6 Cyl. Grand AM, 204 Engine (3.3L) Dual Exhaust

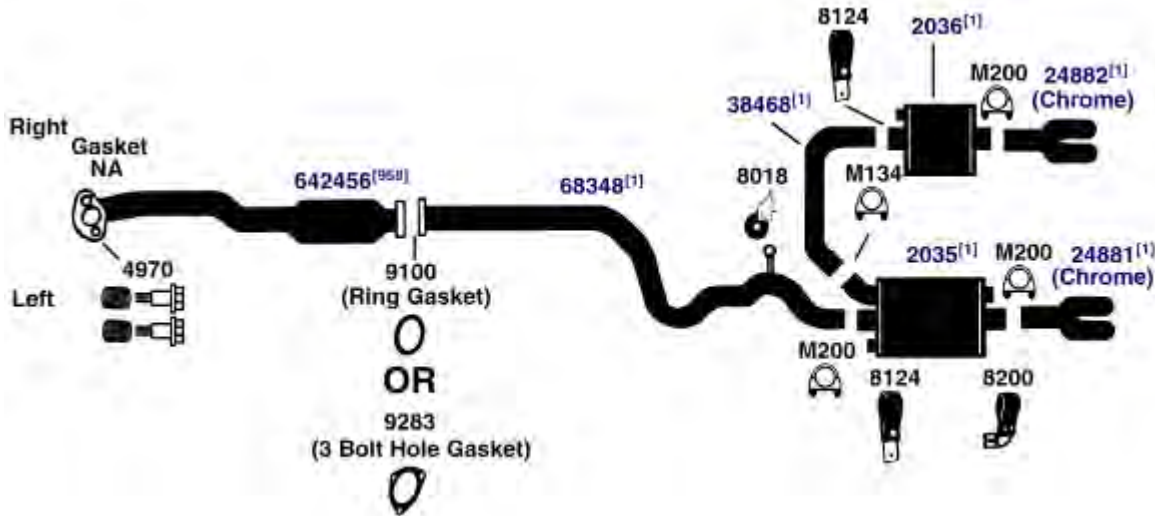

DIRECT FIT MSL/MAXIMUM Muffler... Left Muffler (2035)- 700198, Right Muffler (2036)- 700199, UNIVERSAL FIT MSL/MAXIMUM Muffler... Right Muffler (2036)- 709004

(8996) 1992 4 Cyl. Grand AM, 138 Engine (2.3-3) (Quad OHC)

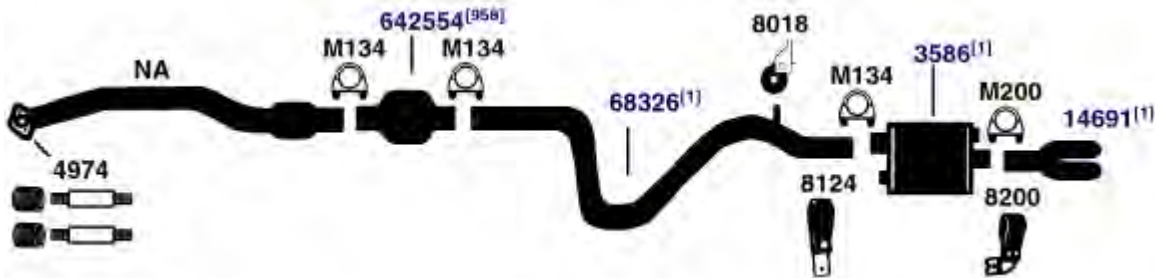

DIRECT FIT MSL/MAXIMUM Muffler... 700180, UNIVERSAL FIT MSL/MAXIMUM Muffler... 709001, 709013

(8995) 1992 4 Cyl. Grand AM, 138 Engine (2.3D) (Quad 4), Single Exhaust

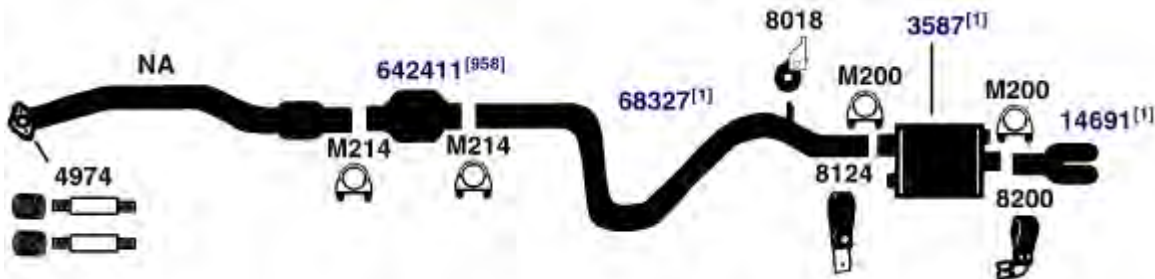

DIRECT FIT MSL/MAXIMUM Muffler... 700162, UNIVERSAL FIT MSL/MAXIMUM Muffler... 709001, 709013, 709014

NA-Not Available. NR-Not Required. FL-Remove and Re-Use Old Flange. ● Golden Warehouse. O.E.-Original Equipment.
Airtube Kit [4948] may be required to complete installation. EFI-Electronic Fuel Injection.

[1] OE system was a welded assembly. It is recommended that all parts noted [1] should be replaced. [958] Federal & California Emission vehicles. Not legal for sale for vehicles licensed in California.

1992 4 Cyl. Grand AM, 138 Engine, (2.3L-A), (2.3L-D) (Quad 4), Dual Exhaust

(8997)

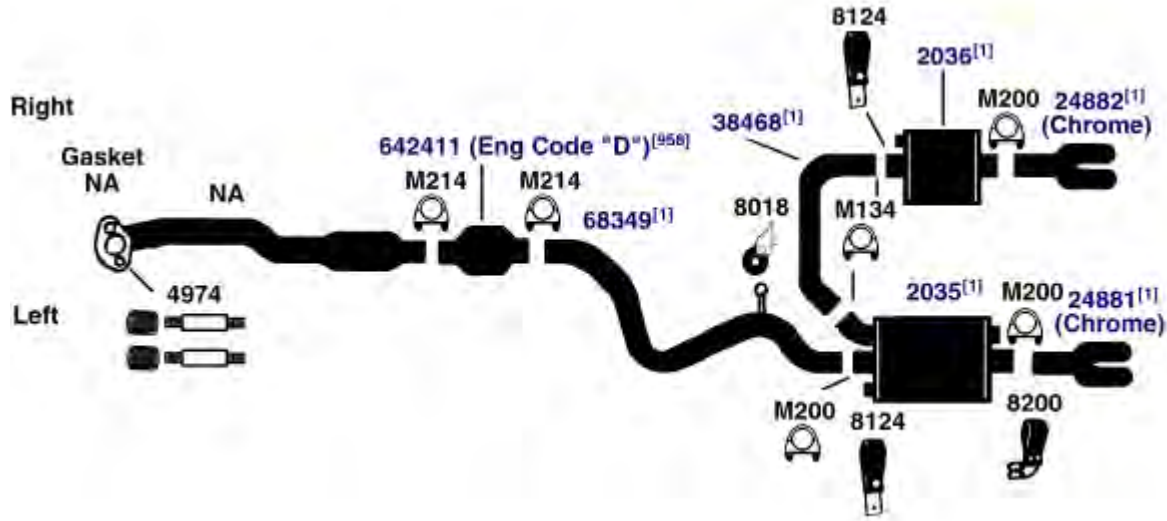

DIRECT FIT MSL/MAXIMUM Muffler... Left Muffler (2035)- 700198, Right Muffler (2036)- 700199, UNIVERSAL FIT MSL/MAXIMUM Muffler... Right Muffler (2036)- 709004

1991 4 Cyl. Grand AM, 138 Engine (2.3L) (Quad 4), Single Exhaust

(8993)

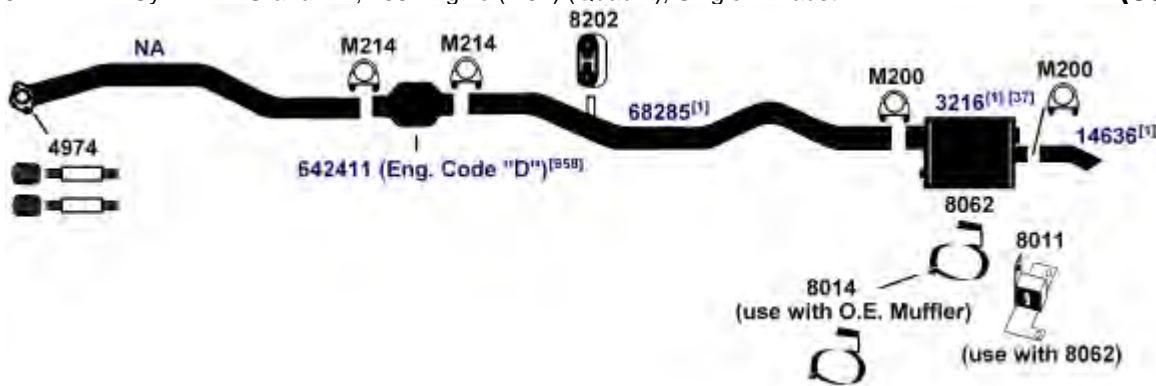

DIRECT FIT MSL/MAXIMUM Muffler... 6560, 700060 with spout on muffler (rear exit only)., UNIVERSAL FIT MSL/MAXIMUM Muffler... 6536, Silentone DIY Muffler... 5555

NA-Not Available. NR-Not Required. FL-Remove and Re-Use Old Flange. ● Golden Warehouse. O.E.-Original Equipment.
Airtube Kit [4948] may be required to complete installation. EFI-Electronic Fuel Injection.

- [1] OE system was a welded assembly. It is recommended that all parts noted [1] should be replaced. [958] Federal & California Emission vehicles. Not legal for sale for vehicles licensed in California.
- [37] Brackets on heads of muffler are not used on this application.

PONTIAC GRAND AM

(8992) 90-91 4 Cyl. Grand AM, 138 Engine (2.3L) (Quad 4), Dual Exhaust

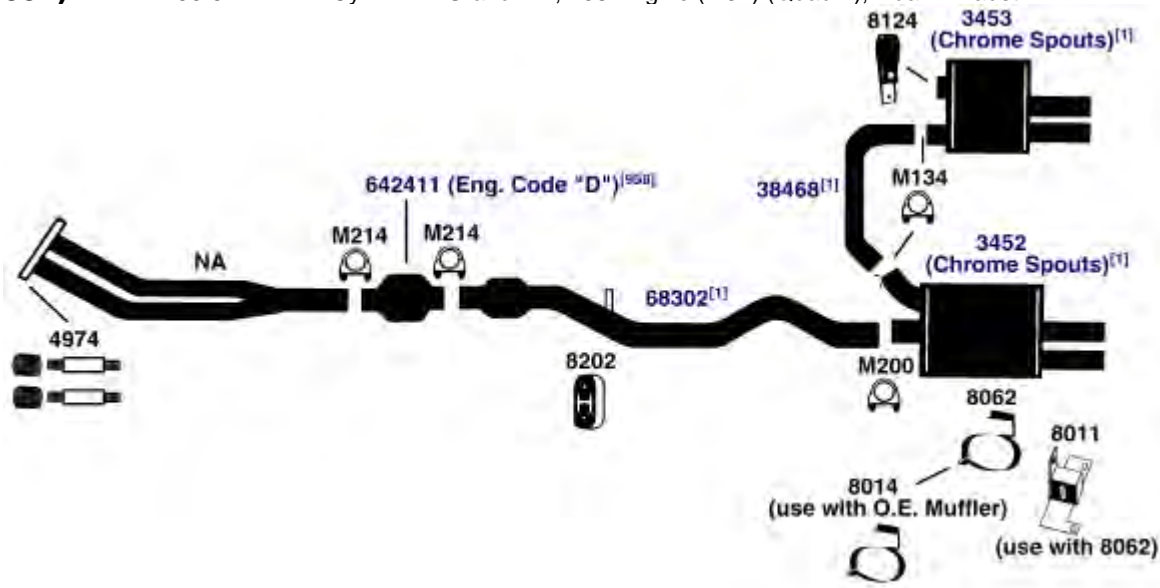

(8989) 90-91 4 Cyl. Grand AM, 151 Engine (2.5L)

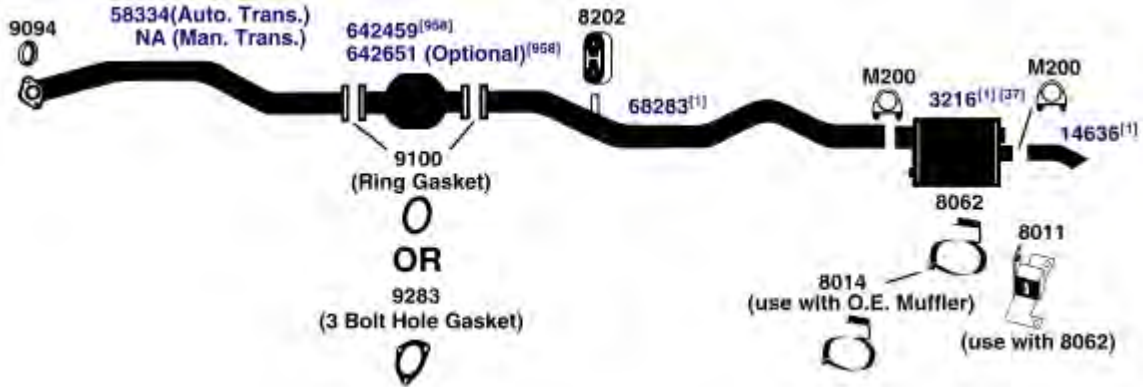

DIRECT FIT MSL/MAXIMUM Muffler... 6560, 700060 with spout on muffler (rear exit only)., UNIVERSAL FIT MSL/MAXIMUM Muffler... 6536, Silentone DIY Muffler... 5555

NA-Not Available. NR-Not Required. FL-Remove and Re-Use Old Flange. ● Golden Warehouse. O.E.-Original Equipment.
Airtube Kit [4948] may be required to complete installation. EFI-Electronic Fuel Injection.

[1] OE system was a welded assembly. It is recommended that all parts noted [1] should be replaced. [958] Federal & California Emission vehicles. Not legal for sale for vehicles licensed in California.
[37] Brackets on heads of muffler are not used on this application.

1990 4 Cyl. Grand AM, 138 Engine (2.3D) (Quad 4), Single Exhaust

(8990)

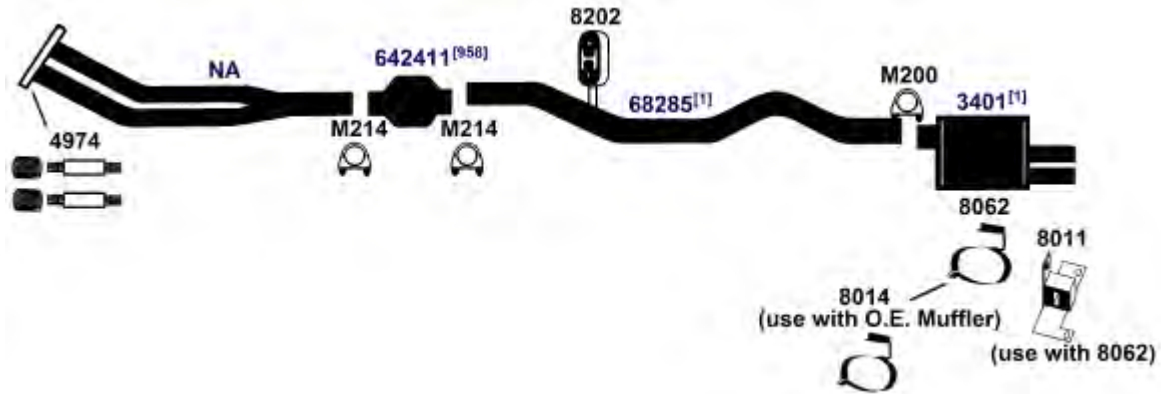

DIRECT FIT MSL/MAXIMUM Muffler... 700122, UNIVERSAL FIT MSL/MAXIMUM Muffler... 6561, 709015, Silentone DIY Muffler... 5545 two 14636 Spouts and 8062 Hanger

1989 4 Cyl. Grand AM, 138 Engine (2.3L) (Quad 4), Dual Exhaust

(8991)

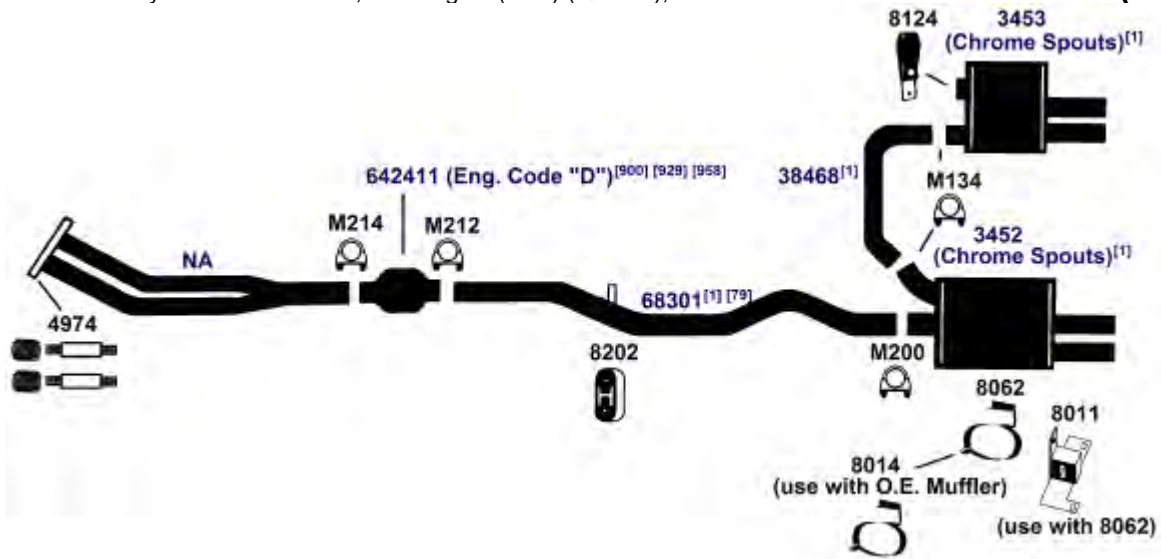

NA-Not Available. NR-Not Required. FL-Remove and Re-Use Old Flange. ● Golden Warehouse. O.E.-Original Equipment.
Airtube Kit [4948] may be required to complete installation. EFI-Electronic Fuel Injection.

[1] OE system was a welded assembly. It is recommended that all parts noted [1] should be replaced.

[79] The O.E. extension pipe must be cut off 1 3/4" behind the pipe to converter weld.

[900] Direct fit converter may require resizing, cutting or bushing.

[929] Use AP #6 bushing w/aftermarket piping.

[958] Federal & California Emission vehicles. Not legal for sale for vehicles licensed in California.

PONTIAC GRAND AM

(8988) 88-89 4 Cyl. Grand AM, 138 Engine (2.3L) (Quad 4), Single Exhaust

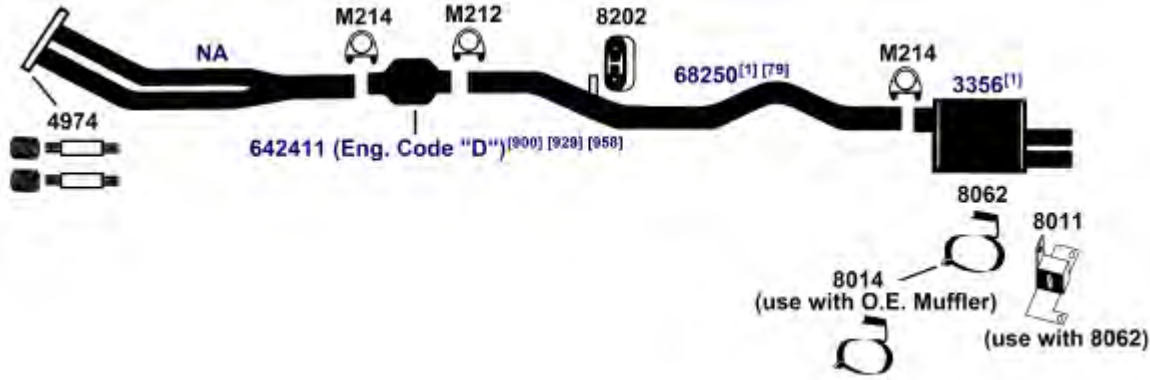

DIRECT FIT MSL/MAXIMUM Muffler... 700115, UNIVERSAL FIT MSL/MAXIMUM Muffler... 6570, 709015

(8986) 85-89 4 Cyl. Grand AM, 151 Engine (2.5L)

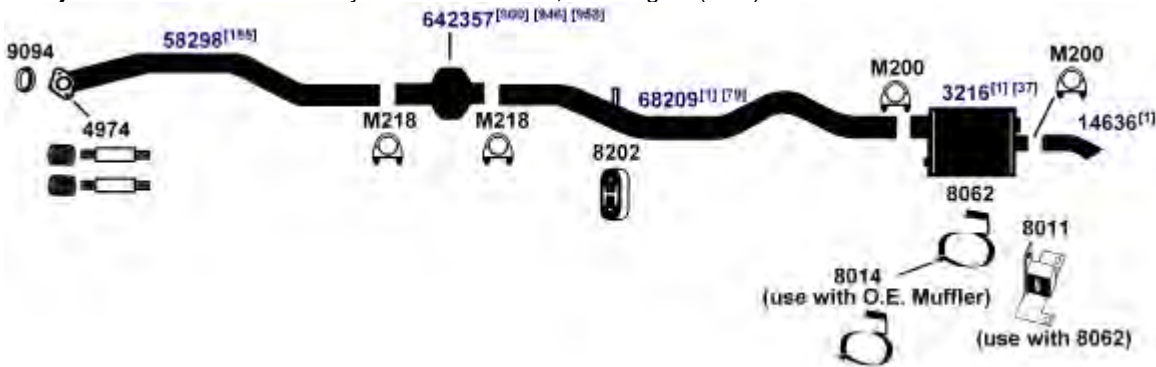

DIRECT FIT MSL/MAXIMUM Muffler... 6560, 700060 with spout on muffler (rear exit only), UNIVERSAL FIT MSL/MAXIMUM Muffler... 6536, Silentone DIY Muffler... 5555

(8987) 87-88 4 Cyl. Grand AM, 121 Turbocharged Engine (2.0L)

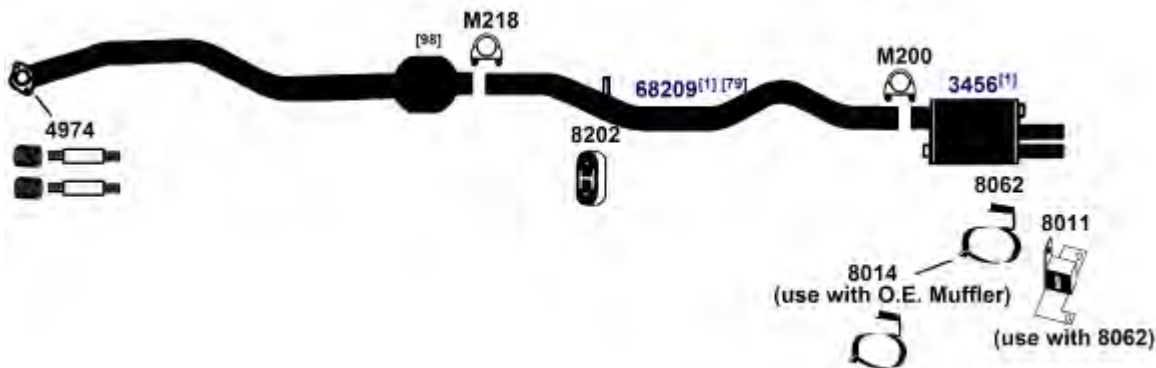

UNIVERSAL FIT MSL/MAXIMUM Muffler... 709015, Silentone DIY Muffler... 5545 two 14636 Spouts and 8062 Hanger

NA-Not Available. NR-Not Required. FL-Remove and Re-Use Old Flange. ● Golden Warehouse. O.E.-Original Equipment.
Airtube Kit [4948] may be required to complete installation. EFI-Electronic Fuel Injection.

[1] OE system was a welded assembly. It is recommended that all parts noted [1] should be replaced.

[37] Brackets on heads of muffler are not used on this application.

[79] The O.E. extension pipe must be cut off 1 3/4" behind the pipe to converter weld.

[98] Refer to current Catalytic Converter catalog or Website catalog for availability.

[185] The O.E. front exhaust pipe must be cut off 1 3/4" in front of the pipe to converter weld.

[900] Direct fit converter may require resizing, cutting or bushing.

[929] Use AP #6 bushing w/aftermarket piping.

[946] Two #8 bushings may be required.

[958] Federal & California Emission vehicles. Not legal for sale for vehicles licensed in California.

PONTIAC GRAND AM

85-87 6 Cyl. Grand AM, 181 Engine (3.0L)

(8985)

DIRECT FIT MSL/MAXIMUM Muffler... exc. SE Models- 6575, UNIVERSAL FIT MSL/MAXIMUM Muffler... SE Models- 6561, 709015, exc. SE Models- 6561, 709015, Silentone DIY Muffler... exc. SE Models- 5545 two 14636 Spouts and 8062 Hanger

PONTIAC GRAND PRIX

1994 6 Cyl. Grand Prix 3.1L Engine; Single Exhaust

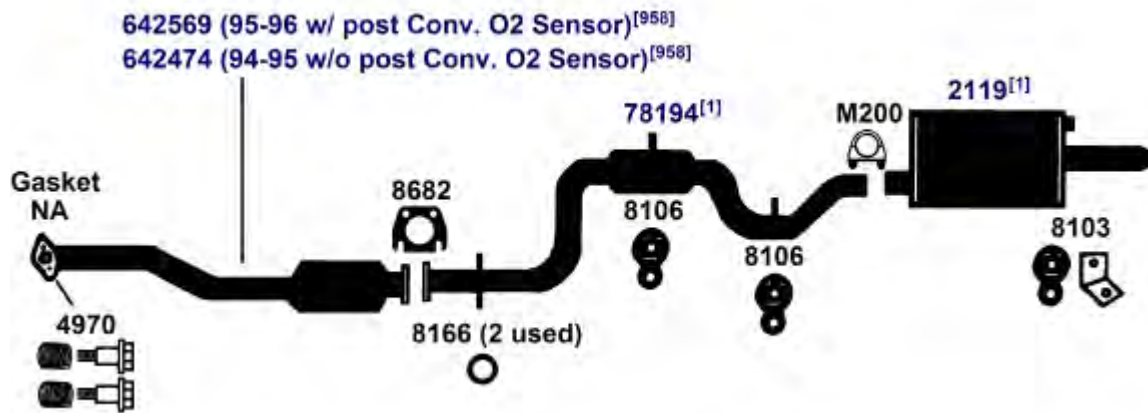
(9059)

DIRECT FIT MSL/MAXIMUM Muffler... 700235

NA-Not Available. NR-Not Required. FL-Remove and Re-Use Old Flange. ● Golden Warehouse. O.E.-Original Equipment.
Airtube Kit [4948] may be required to complete installation. EFI-Electronic Fuel Injection.

[1] OE system was a welded assembly. It is recommended that all parts noted [1] should be replaced.

[79] The O.E. extension pipe must be cut off 1 3/4" behind the pipe to converter weld.

[185] The O.E. front exhaust pipe must be cut off 1 3/4" in front of the pipe to converter weld.

[900] Direct fit converter may require resizing, cutting or bushing.

[946] Two #8 bushings may be required.

[958] Federal & California Emission vehicles. Not legal for sale for vehicles licensed in California.

PONTIAC GRAND PRIX

(9058) 1994 6 Cyl. Grand Prix; 3.1L Engine; Dual Exhaust
 1994 6 Cyl. Grand Prix; 3.4L Engine; Dual Exhaust

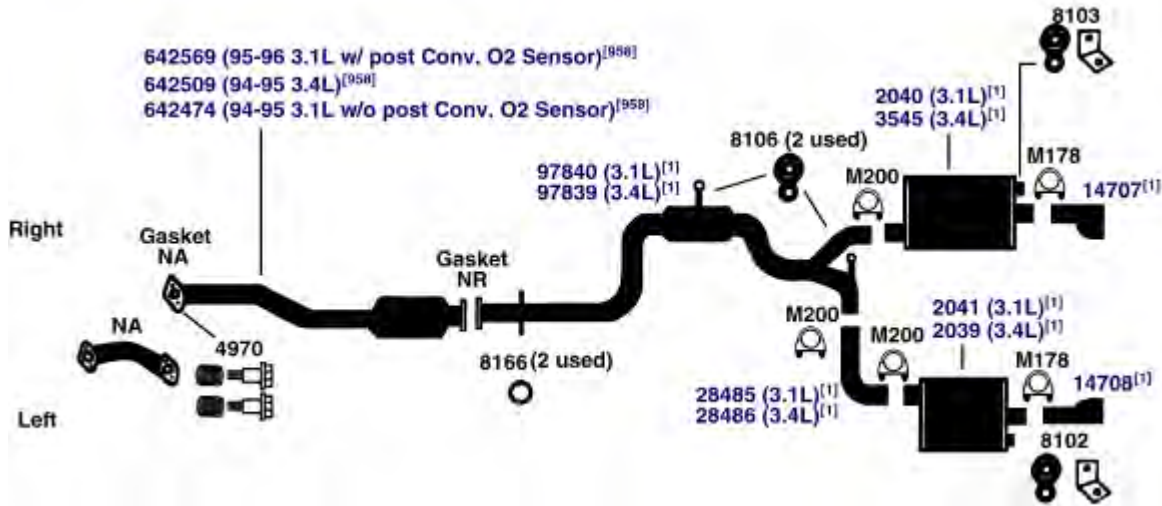

DIRECT FIT MSL/MAXIMUM Muffler... Right Muffler (3545)- 700285, Right Muffler (2040)- 700215, Left Muffler (2039)- 700214, Left Muffler (2041)- 700216, UNIVERSAL FIT MSL/MAXIMUM Muffler... Right Muffler (2040)- 709007, 709010, Left Muffler (2041)- 709005, 709010

(9057) 1993 6 Cyl. Grand Prix, 189 Engine (3.1L); Single Exhaust; except California

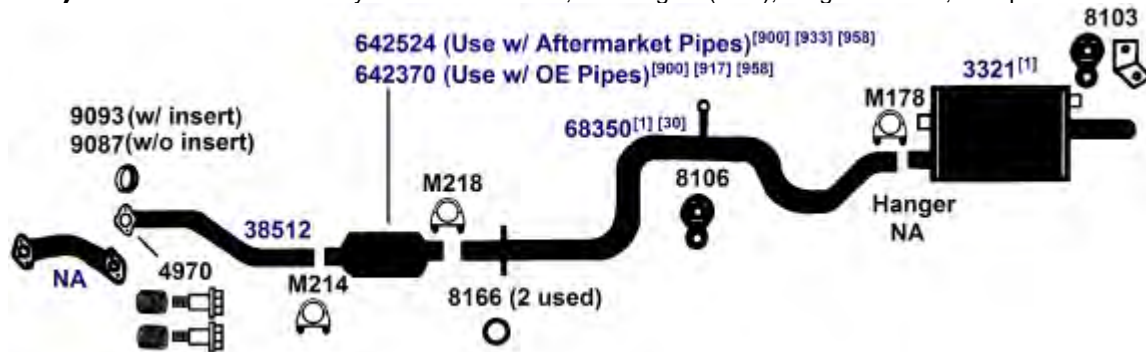

DIRECT FIT MSL/MAXIMUM Muffler... 6579, UNIVERSAL FIT MSL/MAXIMUM Muffler... 709010, Silentone DIY Muffler... 5569 and 14663 Spout

NA-Not Available. NR-Not Required. FL-Remove and Re-Use Old Flange. ● Golden Warehouse. O.E.-Original Equipment.
 # Airtube Kit [4948] may be required to complete installation. EFI-Electronic Fuel Injection.

[1] OE system was a welded assembly. It is recommended that all parts noted [1] should be replaced.

[30] The O.E. extension pipe must be cut off 1 1/2" behind the pipe to converter weld.

[900] Direct fit converter may require resizing, cutting or bushing.

[917] # 6 bushing may be required at inlet & # 8 bushing may be required at outlet for use w/aftermarket pipe.

[933] For use with 2 1/8" I.D. intermediate pipe.

[958] Federal & California Emission vehicles. Not legal for sale for vehicles licensed in California.

1993 6 Cyl. Grand Prix, 189 Engine (3.1L); Dual Exhaust

(9056)

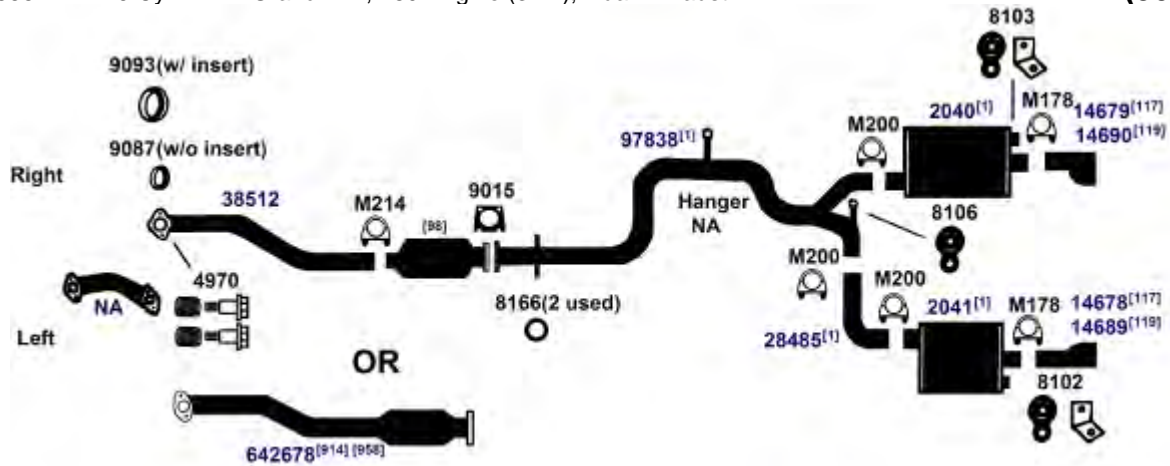

DIRECT FIT MSL/MAXIMUM Muffler... Muffler (2041)-, Left 700216, Muffler (2040)-, Right 700215, UNIVERSAL FIT MSL/MAXIMUM Muffler... Muffler (2041)-, Left 709005, 709010, Muffler (2040)-, Right 709007, 709010

1993 6 Cyl. Grand Prix 207 Engine (3.4L); Dual Exhaust; with Sport Performance Package

(9054)

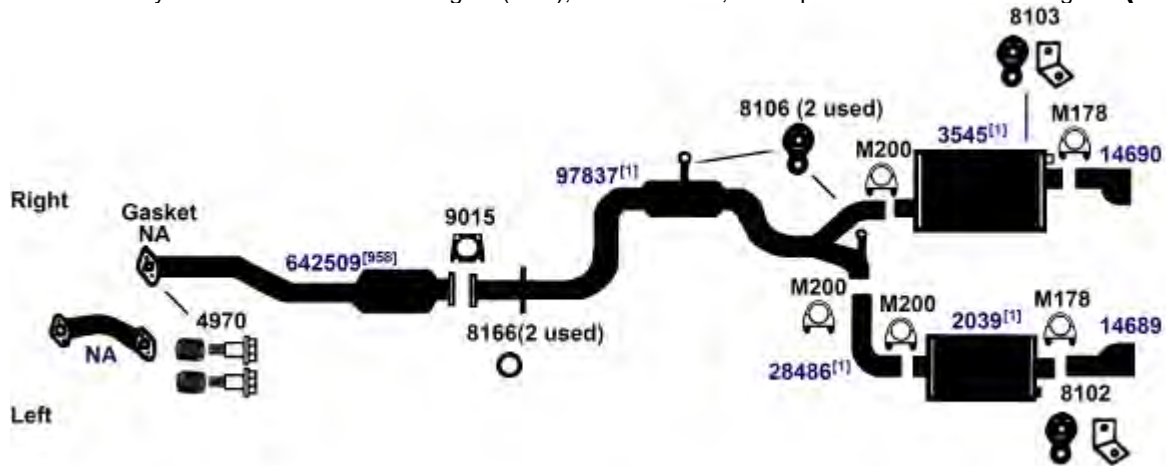

DIRECT FIT MSL/MAXIMUM Muffler... Right Muffler- 700285, Left Muffler- 700214

NA-Not Available. NR-Not Required. FL-Remove and Re-Use Old Flange. ● Golden Warehouse. O.E.-Original Equipment.
Airtube Kit [4948] may be required to complete installation. EFI-Electronic Fuel Injection.

[1] OE system was a welded assembly. It is recommended that all parts noted [1] should be replaced.
[98] Refer to current Catalytic Converter catalog or Website catalog for availability.
[117] Without Sport Performance Package.

[119] With Sport Performance Package.
[914] Direct fit converter includes front (Exhaust) pipe, (1) piece assembly.
[958] Federal & California Emission vehicles. Not legal for sale for vehicles licensed in California.

PONTIAC GRAND PRIX

(9055) 1993 6 Cyl. Grand Prix 207 Engine (3.4L); Dual Exhaust; without Sport Performance Package

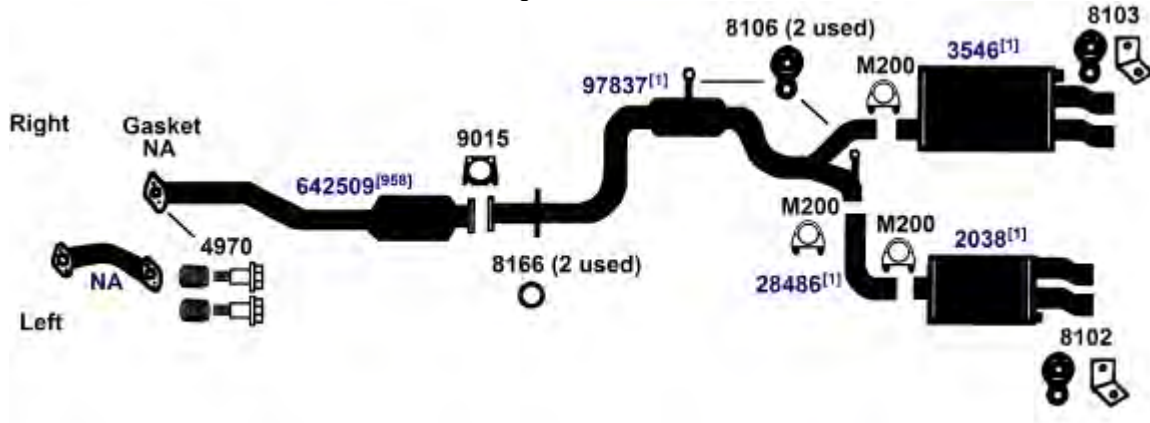

DIRECT FIT MSL/MAXIMUM Muffler... Right Muffler (3546)- 700444, Left Muffler (2038)- 700355

(9047) 1992 6 Cyl. Grand Prix 189 Engine (3.1L); Single Exhaust
89-91 6 Cyl. Grand Prix 189 Engine (3.1L); except 89-90 Turbo



DIRECT FIT MSL/MAXIMUM Muffler... 6579, UNIVERSAL FIT MSL/MAXIMUM Muffler... 709010, Silentone DIY Muffler... 5569 and 14663 Sport

NA-Not Available. NR-Not Required. FL-Remove and Re-Use Old Flange. ● Golden Warehouse. O.E.-Original Equipment.
Airtube Kit [4948] may be required to complete installation. EFI-Electronic Fuel Injection.

[1] OE system was a welded assembly. It is recommended that all parts noted [1] should be replaced.

[30] The O.E. extension pipe must be cut off 1 1/2" behind the pipe to converter weld.

[900] Direct fit converter may require resizing, cutting or bushing.

[917] # 6 bushing may be required at inlet & # 8 bushing may be required at outlet for use w/aftermarket pipe.

[933] For use with 2 1/8" I.D. intermediate pipe.

[958] Federal & California Emission vehicles. Not legal for sale for vehicles licensed in California.

91-92 6 Cyl. Grand Prix 207 Engine (3.4L); Dual Exhaust; with Sport Performance Package (9052)

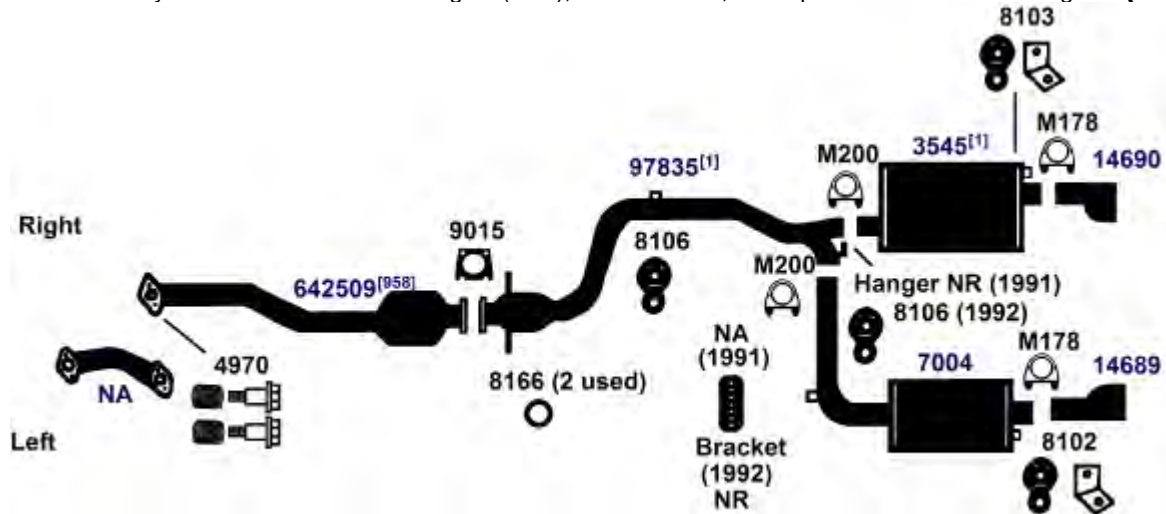

DIRECT FIT MSL/MAXIMUM Muffler... Right Muffler- 700285

91-92 6 Cyl. Grand Prix 207 Engine (3.4L); Dual Exhaust; without Sport Performance Package (9053)

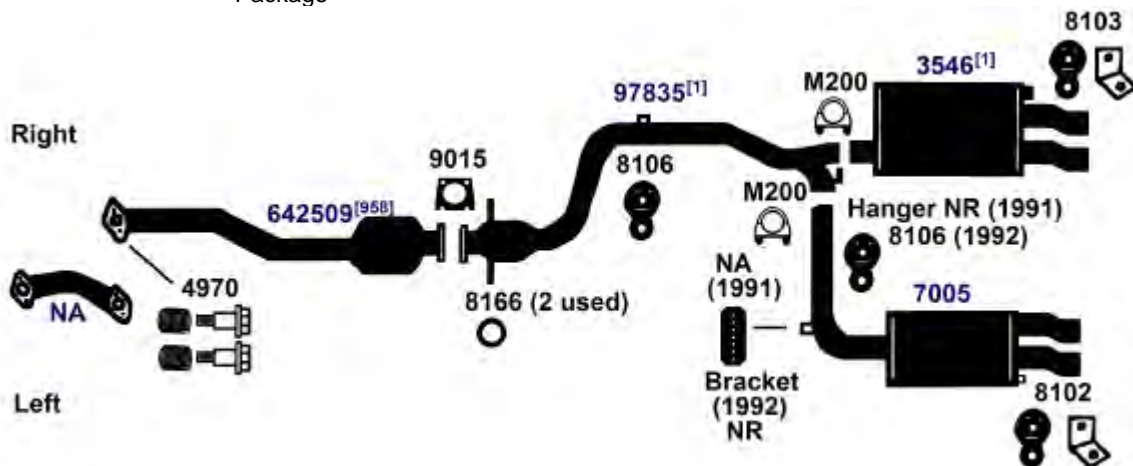

DIRECT FIT MSL/MAXIMUM Muffler... Right Muffler (3546)- 700444

NA-Not Available. NR-Not Required. FL-Remove and Re-Use Old Flange. ● Golden Warehouse. O.E.-Original Equipment.
 # Airtube Kit [4948] may be required to complete installation. EFI-Electronic Fuel Injection.

[1] OE system was a welded assembly. It is recommended that all parts noted [1] should be replaced. [958] Federal & California Emission vehicles. Not legal for sale for vehicles licensed in California.

PONTIAC GRAND PRIX

(9051) 90-92 6 Cyl. Grand Prix 189 Engine (3.1L); Dual Exhaust (1990 2nd Design)

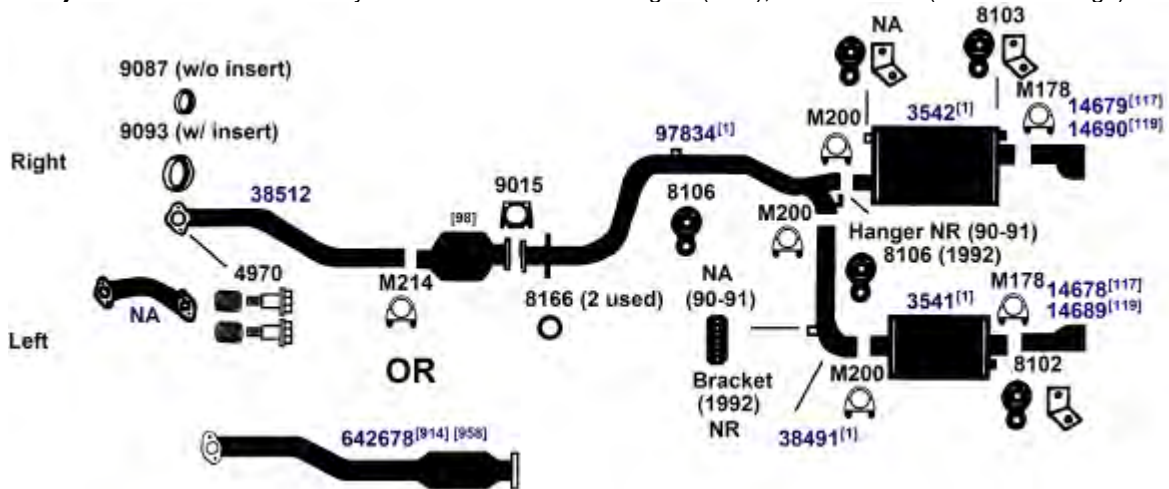

DIRECT FIT MSL/MAXIMUM Muffler... Right Muffler (3542)- 700192, Left Muffler (3541)- 700193, UNIVERSAL FIT MSL/MAXIMUM Muffler... Right Muffler (3542)- 709007, 709010

(9050) 90-91 4 Cyl. Grand Prix, 138 Engine (2.3L), Quad 4

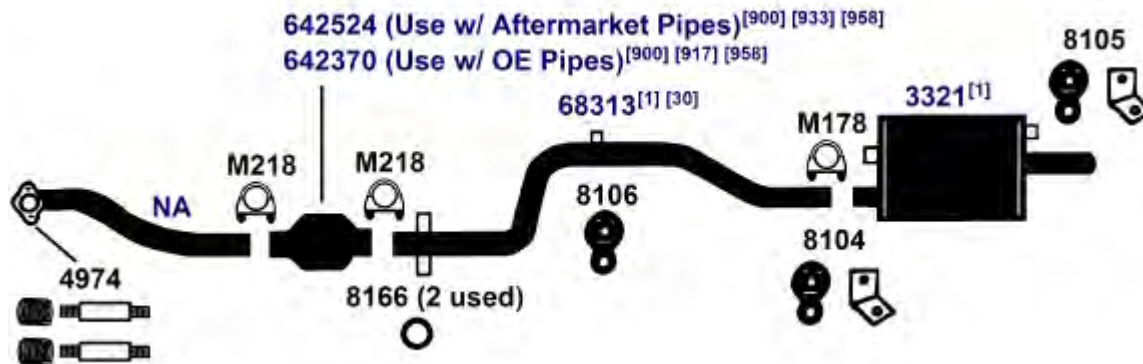

DIRECT FIT MSL/MAXIMUM Muffler... 6579, UNIVERSAL FIT MSL/MAXIMUM Muffler... 709010, Silentone DIY Muffler... 5569 and 14663 Spout

NA-Not Available. NR-Not Required. FL-Remove and Re-Use Old Flange. ● Golden Warehouse. O.E.-Original Equipment.
Airtube Kit [4948] may be required to complete installation. EFI-Electronic Fuel Injection.

[1] OE system was a welded assembly. It is recommended that all parts noted [1] should be replaced.

[30] The O.E. extension pipe must be cut off 1 1/2" behind the pipe to converter weld.

[98] Refer to current Catalytic Converter catalog or Website catalog for availability.

[117] Without Sport Performance Package.

[119] With Sport Performance Package.

[900] Direct fit converter may require resizing, cutting or bushing.

[914] Direct fit converter includes front (Exhaust) pipe, (1) piece assembly.

[917] # 6 bushing may be required at inlet & # 8 bushing may be required at outlet for use w/aftermarket pipe.

[933] For use with 2 1/8" I.D. intermediate pipe.

[950] Conv. only, w/o front pipe.

[958] Federal & California Emission vehicles. Not legal for sale for vehicles licensed in California.

PONTIAC GRAND PRIX

1990	6 Cyl.	Grand Prix STE; 189 Engine (3.1L); Dual Exhaust; except Turbo (1990 1st Design)	(9049)
89-90	6 Cyl.	Grand Prix SE; 189 Engine (3.1L); Dual Exhaust; except Turbo (1990 1st Design)	

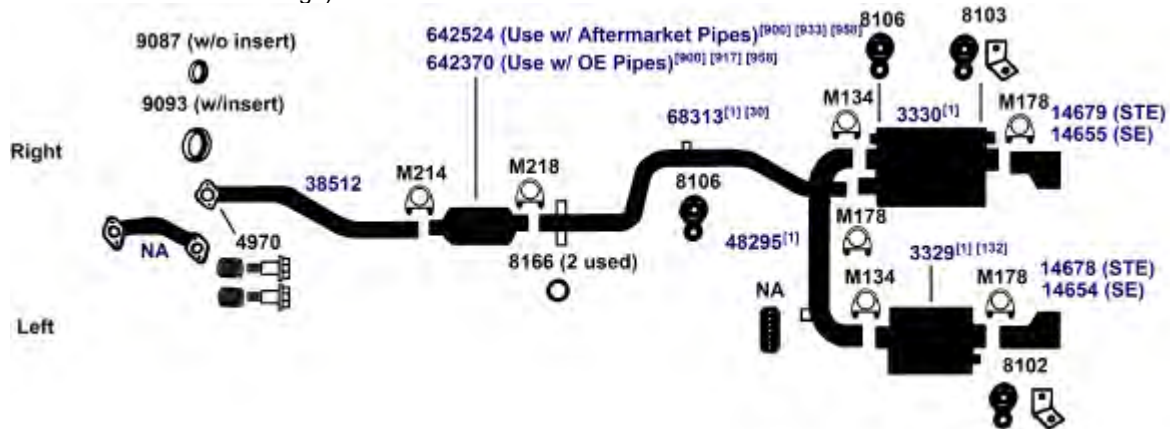

DIRECT FIT MSL/MAXIMUM Muffler... Right Muffler (3330)- 700268, Left Muffler (3329)- 700267, UNIVERSAL FIT MSL/MAXIMUM Muffler... Left Muffler (3329)- 709004

88-89	6 Cyl.	Grand Prix SE; 173 Engine (2.8L); Dual Exhaust	(9046)
-------	--------	--	---------------

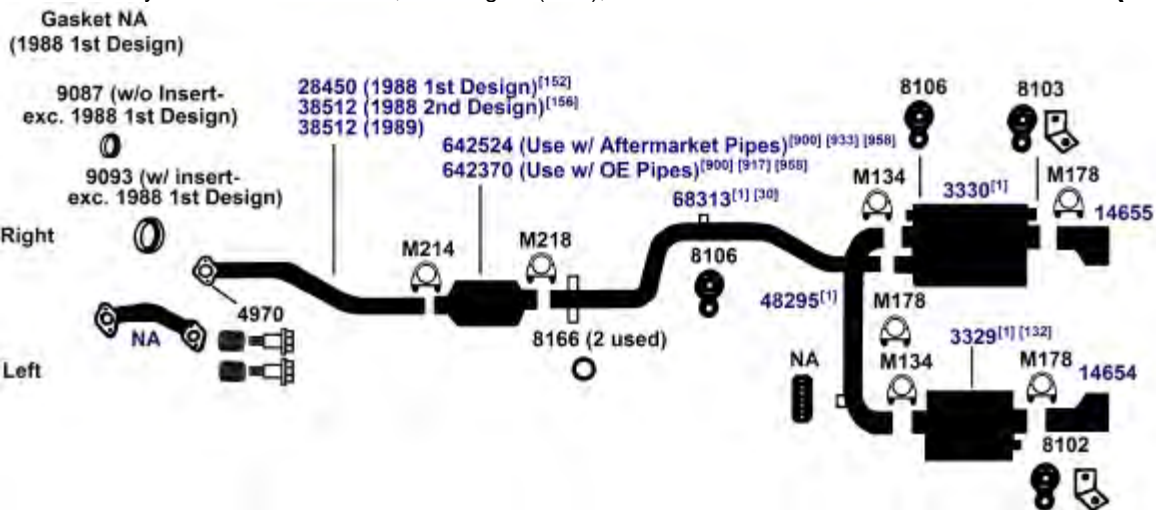

DIRECT FIT MSL/MAXIMUM Muffler... Right Muffler (3330)- 700268, Left Muffler (3329)- 700267, UNIVERSAL FIT MSL/MAXIMUM Muffler... Left Muffler (3329)- 709004

NA-Not Available. NR-Not Required. FL-Remove and Re-Use Old Flange. ● Golden Warehouse. O.E.-Original Equipment.
Airtube Kit [4948] may be required to complete installation. EFI-Electronic Fuel Injection.

- [1] OE system was a welded assembly. It is recommended that all parts noted [1] should be replaced.
- [30] The O.E. extension pipe must be cut off 1 1/2" behind the pipe to converter weld.
- [132] If black triangle appears on muffler label, remove and re-use O.E. heat shield or fabricate heat shield.
- [152] With Tubular Manifold.
- [156] With Cast Manifold.

- [900] Direct fit converter may require resizing, cutting or bushing.
- [917] # 6 bushing may be required at inlet & # 8 bushing may be required at outlet for use w/aftermarket pipe.
- [933] For use with 2 1/8" I.D. intermediate pipe.
- [958] Federal & California Emission vehicles. Not legal for sale for vehicles licensed in California.

PONTIAC GRAND PRIX

(9045) 88-89 6 Cyl. Grand Prix; 173 Engine (2.8L); except SE Models and Dual Exhaust

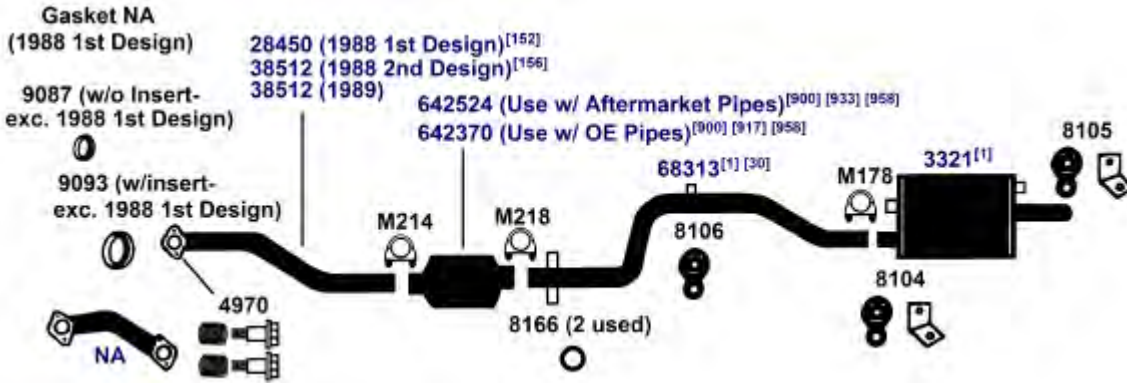

DIRECT FIT MSL/MAXIMUM Muffler... 6579, UNIVERSAL FIT MSL/MAXIMUM Muffler... 709010, Silentone DIY Muffler... 5569 and 14663 Spout

(9044) 1987 6 Cyl. Grand Prix, 262 Engine (4.3L)

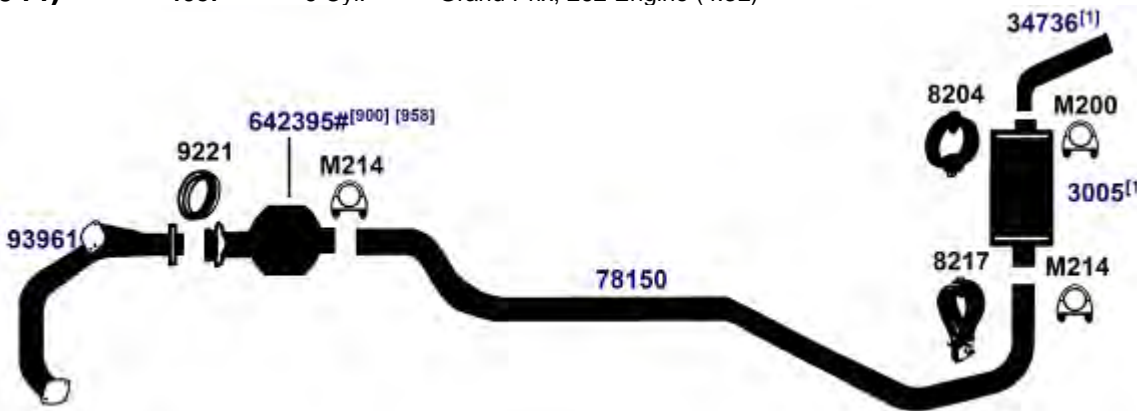

DIRECT FIT MSL/MAXIMUM Muffler... 700057, UNIVERSAL FIT MSL/MAXIMUM Muffler... 6540, Silentone DIY Muffler... 5522

(9043) 85-87 6 Cyl. Grand Prix, 231 Engine (3.8L)

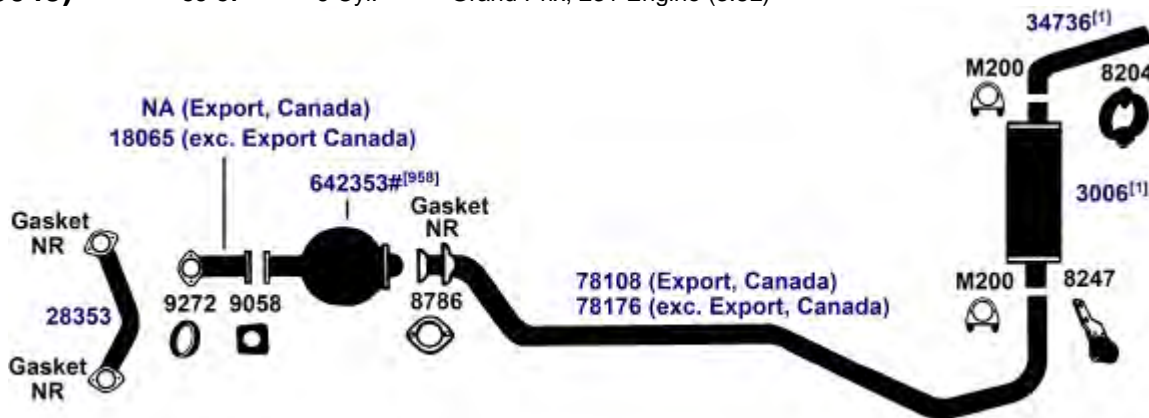

DIRECT FIT MSL/MAXIMUM Muffler... 6540, Silentone DIY Muffler... 5503

NA-Not Available. NR-Not Required. FL-Remove and Re-Use Old Flange. ● Golden Warehouse. O.E.-Original Equipment.
Airtube Kit [4948] may be required to complete installation. EFI-Electronic Fuel Injection.

[1] OE system was a welded assembly. It is recommended that all parts noted [1] should be replaced.

[30] The O.E. extension pipe must be cut off 1 1/2" behind the pipe to converter weld.

[152] With Tubular Manifold.

[156] With Cast Manifold.

[900] Direct fit converter may require resizing, cutting or bushing.

[917] # 6 bushing may be required at inlet & # 8 bushing may be required at outlet for use w/aftermarket pipe.

[933] For use with 2 1/8" I.D. intermediate pipe.

[958] Federal & California Emission vehicles. Not legal for sale for vehicles licensed in California.

85-87 8 Cyl. Grand Prix, 305 Engine (5.0L), Single Bed Bead, Dual Bed Monolithic Converter[233] (9042)

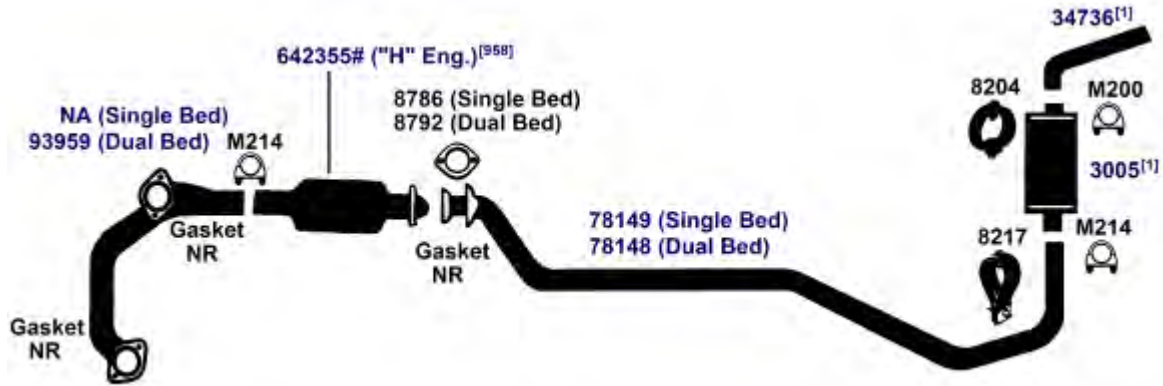

DIRECT FIT MSL/MAXIMUM Muffler... 700057, UNIVERSAL FIT MSL/MAXIMUM Muffler... 6540, Silentone DIY Muffler... 5522

1984 6 Cyl. Grand Prix, 3.8L, 231 Engine (9043E)



DIRECT FIT MSL/MAXIMUM Muffler... 6540, Silentone DIY Muffler... 5503

NA-Not Available. NR-Not Required. FL-Remove and Re-Use Old Flange. ● Golden Warehouse. O.E.-Original Equipment.
Airtube Kit [4948] may be required to complete installation. EFI-Electronic Fuel Injection.

- [1] OE system was a welded assembly. It is recommended that all parts noted [1] should be replaced. ^[958] Federal & California Emission vehicles. Not legal for sale for vehicles licensed in California.
- [22] O.E. exhaust pipe was one piece. Replacement is two pieces.

PONTIAC GRAND PRIX

(9042E) 82-84 8 Cyl. Grand Prix, 305 Engine (5.0L), Single Bed and Dual Bed Monolithic Converter

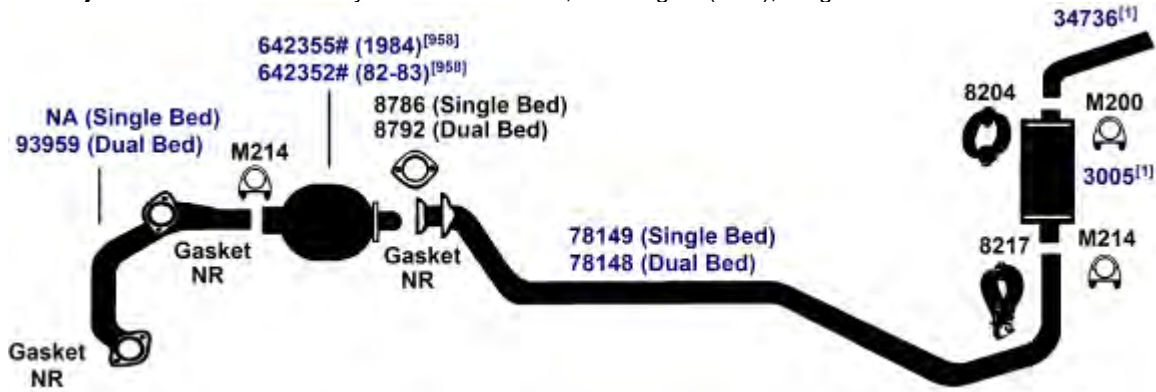

DIRECT FIT MSL/MAXIMUM Muffler... 700057, UNIVERSAL FIT MSL/MAXIMUM Muffler... 6540, Silentone DIY Muffler... 5522

(9041) 81-84 8 Cyl. Grand Prix, 5.7L, 350N Diesel Engine



DIRECT FIT MSL/MAXIMUM Muffler... 700057, UNIVERSAL FIT MSL/MAXIMUM Muffler... 6540, Silentone DIY Muffler... 5522

NA-Not Available. NR-Not Required. FL-Remove and Re-Use Old Flange. ● Golden Warehouse. O.E.-Original Equipment.
Airtube Kit [4948] may be required to complete installation. EFI-Electronic Fuel Injection.

[1] OE system was a welded assembly. It is recommended that all parts noted [1] should be replaced.

[22] O.E. exhaust pipe was one piece. Replacement is two pieces.

[168] Functionally approved Single Outlet System replaces Dual Outlet.

[958] Federal & California Emission vehicles. Not legal for sale for vehicles licensed in California.

PONTIAC GRAND PRIX

1983 6 Cyl. Grand Prix, 3.8L - 231, 4.1-4L - 252 Engine

(9040)

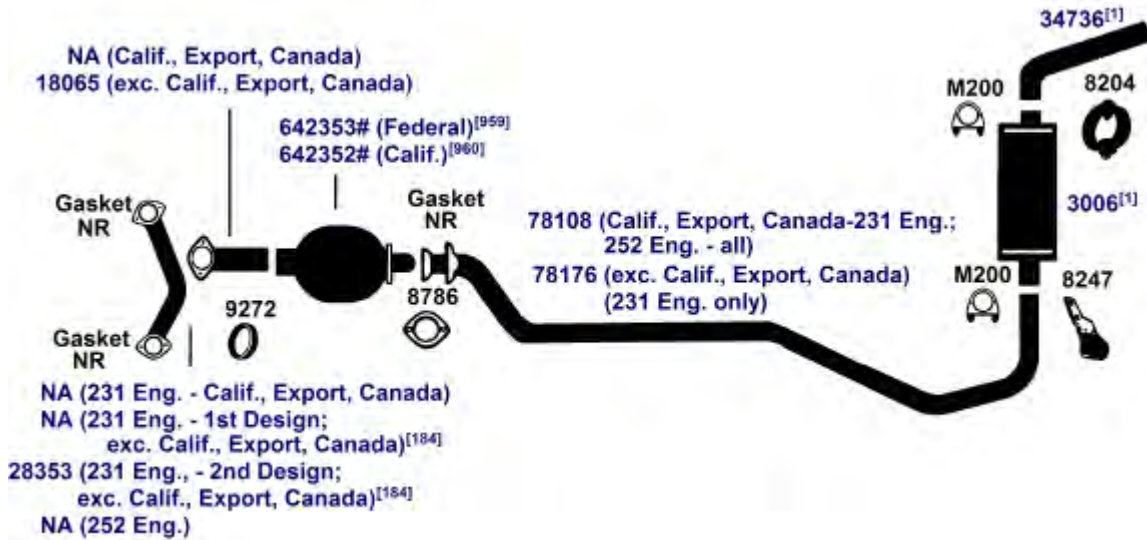

DIRECT FIT MSL/MAXIMUM Muffler... 6540, Silentone DIY Muffler... 5503

81-82 8 Cyl. Grand Prix, 4.4L, 267 Engine

(9032)

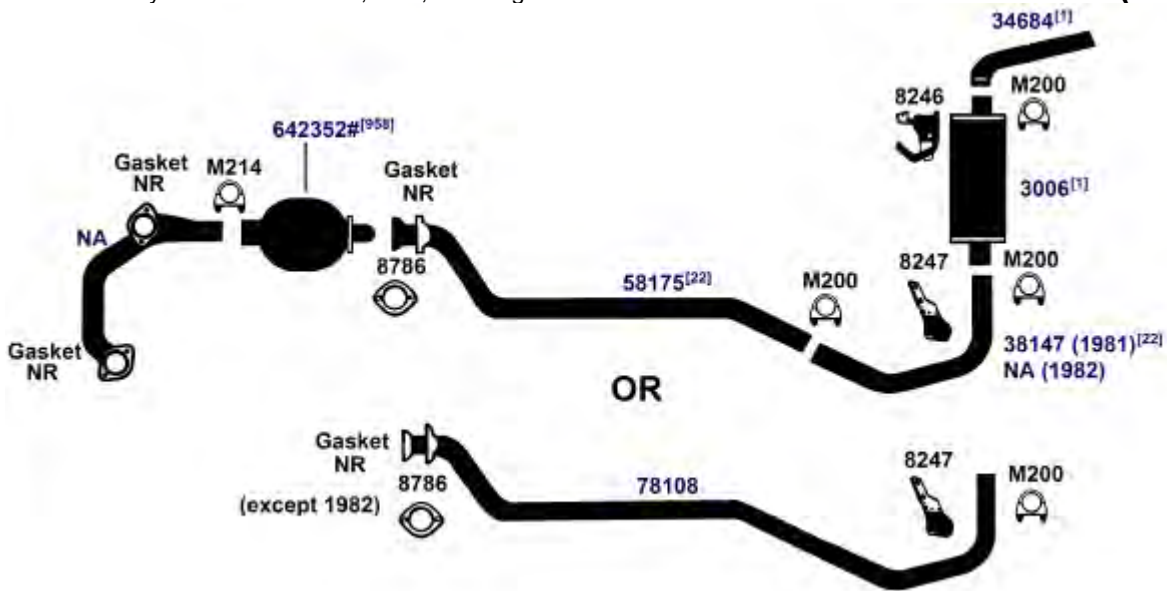

DIRECT FIT MSL/MAXIMUM Muffler... 6540, Silentone DIY Muffler... 5503

NA-Not Available. NR-Not Required. FL-Remove and Re-Use Old Flange. ● Golden Warehouse. O.E.-Original Equipment.
Airtube Kit [4948] may be required to complete installation. EFI-Electronic Fuel Injection.

[1] OE system was a welded assembly. It is recommended that all parts noted [1] should be replaced.
[22] O.E. exhaust pipe was one piece. Replacement is two pieces.
[184] 1st Design has EFE actuator on left hand manifold. 2nd Design does not.

[958] Federal & California Emission vehicles. Not legal for sale for vehicles licensed in California.
[959] Federal Emission vehicles. Not legal for sale for vehicles licensed in California.
[960] California Emission vehicles licensed in states other than California. Not legal for sale for vehicles licensed in California.

PONTIAC GRAND PRIX

(9031) 1981 6 Cyl. Grand Prix, 229, 231,252 Engine

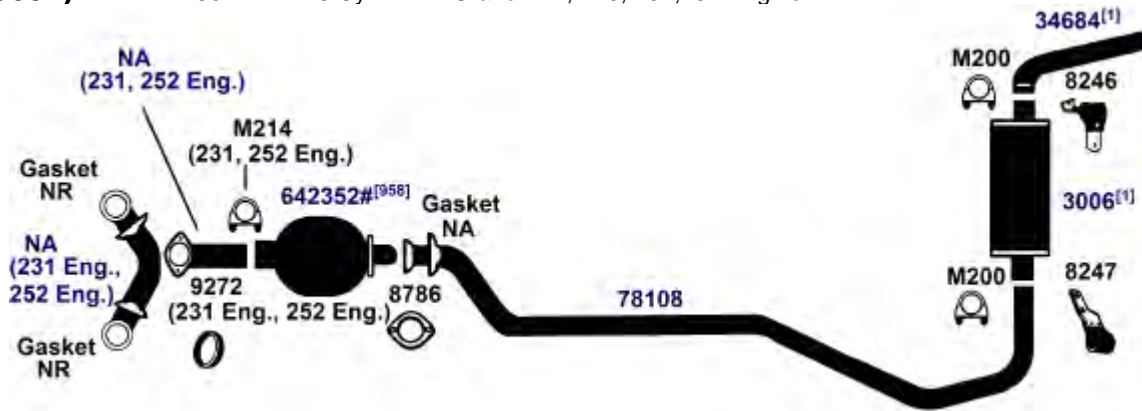

DIRECT FIT MSL/MAXIMUM Muffler... 6540, Silentone DIY Muffler... 5503

(9030) 80-81 8 Cyl. Grand Prix, 265 (4.3L), 301 (4.9L) Engine; except High Performance Option (W72)

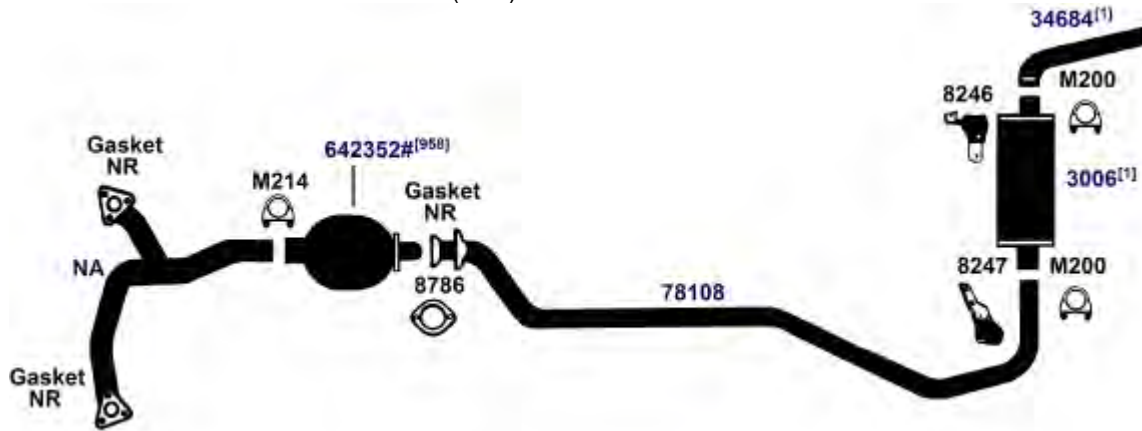

DIRECT FIT MSL/MAXIMUM Muffler... 6540, Silentone DIY Muffler... 5503

NA-Not Available. NR-Not Required. FL-Remove and Re-Use Old Flange. ● Golden Warehouse. O.E.-Original Equipment.
 # Airtube Kit [4948] may be required to complete installation. EFI-Electronic Fuel Injection.

[1] OE system was a welded assembly. It is recommended that all parts noted [1] should be replaced. [958] Federal & California Emission vehicles. Not legal for sale for vehicles licensed in California.

PONTIAC GRAND PRIX

80-81 8 Cyl. Grand Prix, 301 Engine; with High Performance Option (W72) **(9029)**

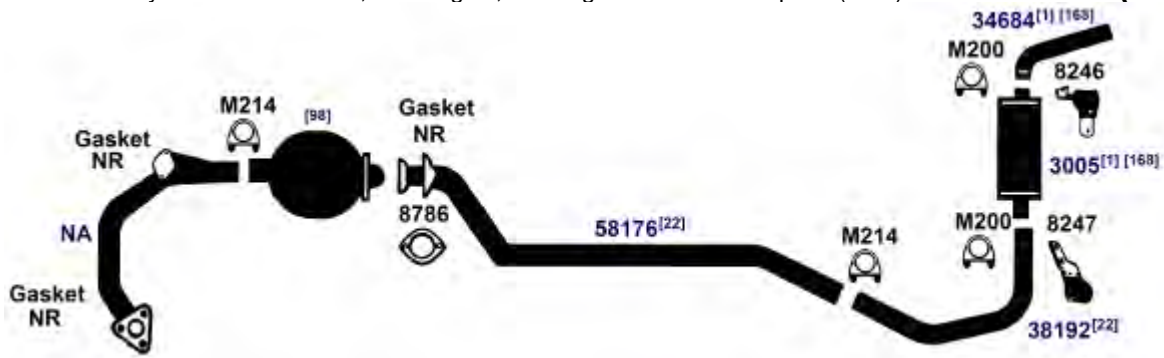

DIRECT FIT MSL/MAXIMUM Muffler... 700057, UNIVERSAL FIT MSL/MAXIMUM Muffler... 6540, Silentone DIY Muffler... 5522

1980 6 Cyl. Grand Prix, 231 Engine **(9048)**

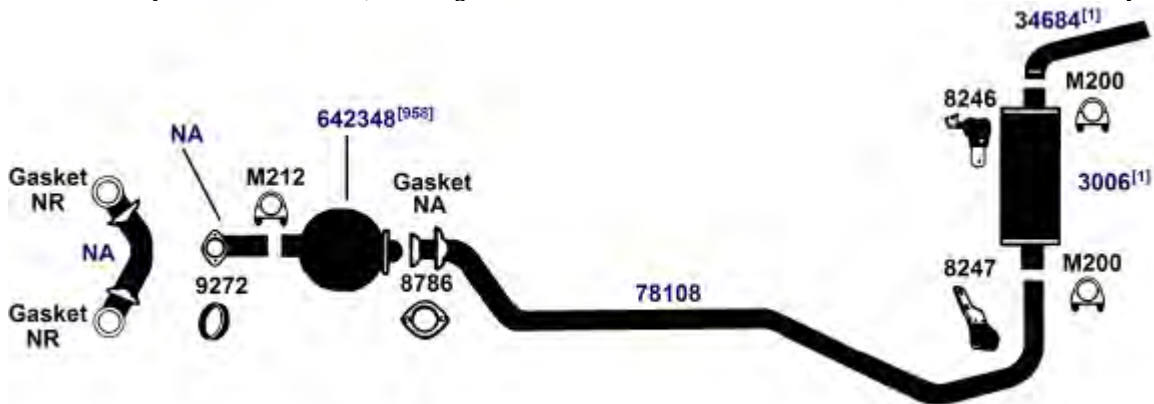

DIRECT FIT MSL/MAXIMUM Muffler... 6540, Silentone DIY Muffler... 5503

1980 8 Cyl. Grand Prix, 305H Engine **(9028)**

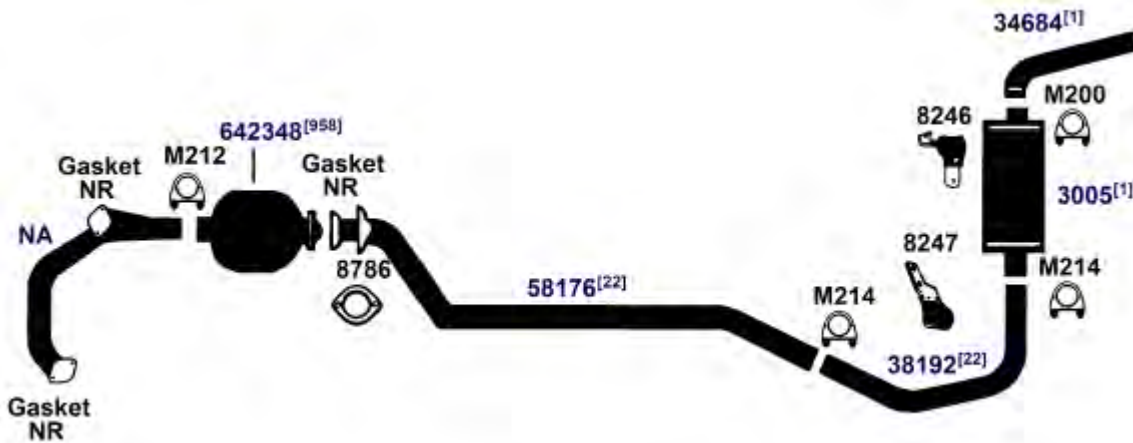

DIRECT FIT MSL/MAXIMUM Muffler... 700057, UNIVERSAL FIT MSL/MAXIMUM Muffler... 6540, Silentone DIY Muffler... 5522

NA-Not Available. NR-Not Required. FL-Remove and Re-Use Old Flange. ● Golden Warehouse. O.E.-Original Equipment.
Airtube Kit [4948] may be required to complete installation. EFI-Electronic Fuel Injection.

- [1] OE system was a welded assembly. It is recommended that all parts noted [1] should be replaced.
- [22] O.E. exhaust pipe was one piece. Replacement is two pieces.
- [98] Refer to current Catalytic Converter catalog or Website catalog for availability.

- [168] Functionally approved Single Outlet System replaces Dual Outlet.
- [958] Federal & California Emission vehicles. Not legal for sale for vehicles licensed in California.

PONTIAC GRAND PRIX

(9027) 1979 6 Cyl. Grand Prix, 231 Engine

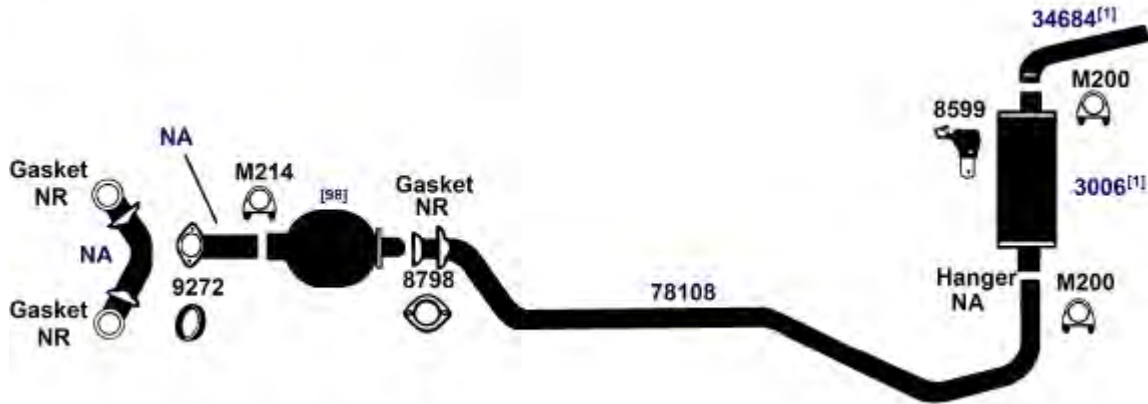

DIRECT FIT MSL/MAXIMUM Muffler... 6540, Silentone DIY Muffler... 5503

(9025) 1979 8 Cyl. Grand Prix, All Models with 305H Engine



DIRECT FIT MSL/MAXIMUM Muffler... 700057, UNIVERSAL FIT MSL/MAXIMUM Muffler... 6540, Silentone DIY Muffler... 5522

NA-Not Available. NR-Not Required. FL-Remove and Re-Use Old Flange. ● Golden Warehouse. O.E.-Original Equipment.
Airtube Kit [4948] may be required to complete installation. EFI-Electronic Fuel Injection.

[1] OE system was a welded assembly. It is recommended that all parts noted [1] should be replaced.

[22] O.E. exhaust pipe was one piece. Replacement is two pieces.

[98] Refer to current Catalytic Converter catalog or Website catalog for availability.

[169] Functionally approved Single Outlet System may replace Dual Outlet.

[958] Federal & California Emission vehicles. Not legal for sale for vehicles licensed in California.

PONTIAC GRAND PRIX

1979 8 Cyl. Grand Prix, 301 Engine

(9023)

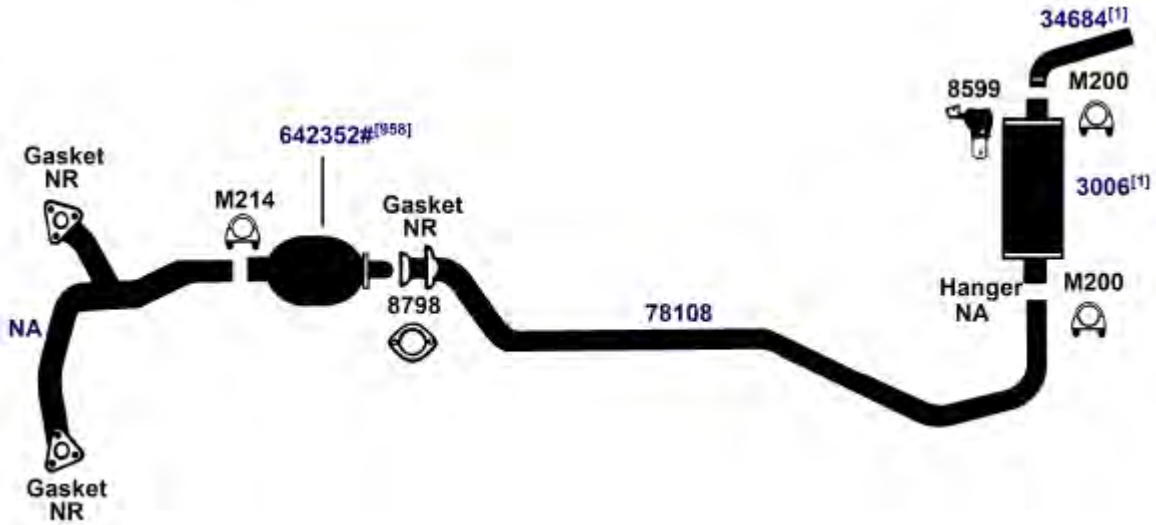

DIRECT FIT MSL/MAXIMUM Muffler... 6540, Silentone DIY Muffler... 5503

PONTIAC J2000, SUNBIRD, SUNFIRE

93-94 4 Cyl. Sunbird, 2.0L Engine

(9115)

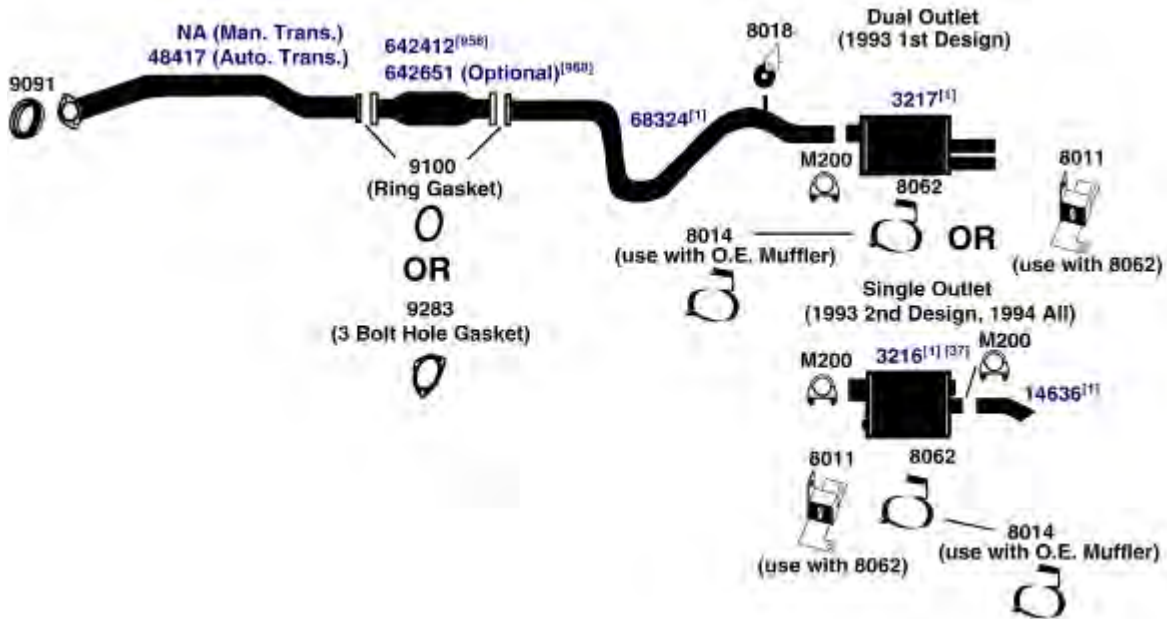

DIRECT FIT MSL/MAXIMUM Muffler... Dual Outlet- 6575, Single Outlet- 6560, 700060 with spout on muffler (rear exit only)., UNIVERSAL FIT MSL/MAXIMUM Muffler... Dual Outlet- 6561, 709015, Single Outlet- 6536, Silentone DIY Muffler... Dual Outlet- 5545 two 14636 Spouts and 8062 Hanger, Single Outlet- 5555

NA-Not Available. NR-Not Required. FL-Remove and Re-Use Old Flange. ● Golden Warehouse. O.E.-Original Equipment.
Airtube Kit [4948] may be required to complete installation. EFI-Electronic Fuel Injection.

[1] OE system was a welded assembly. It is recommended that all parts noted [1] should be replaced. [958] Federal & California Emission vehicles. Not legal for sale for vehicles licensed in California.
[37] Brackets on heads of muffler are not used on this application.

PONTIAC J2000, SUNBIRD, SUNFIRE

(9111) 92-94 6 Cyl. Sunbird, 189 Engine (3.1L); except GT (1992 2nd Design with bracket on extension pipe behind gas tank)

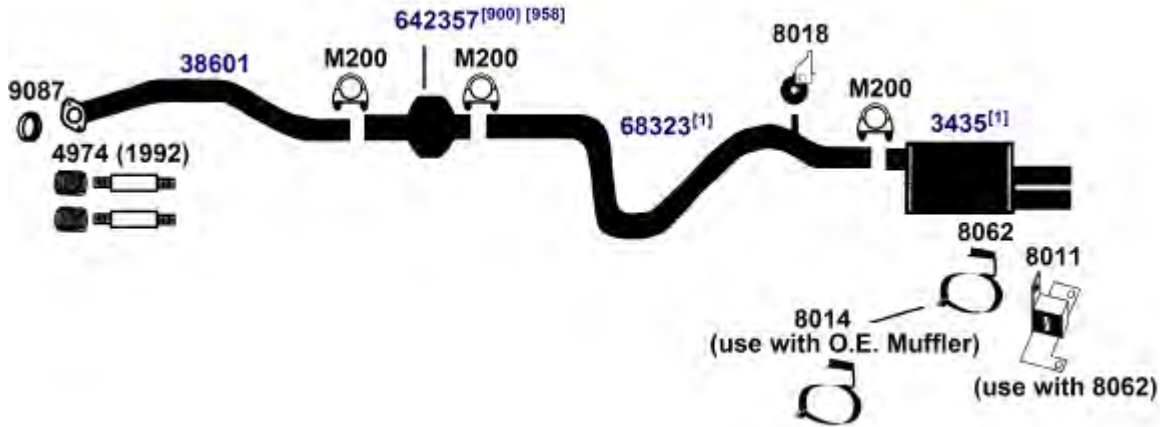

UNIVERSAL FIT MSL/MAXIMUM Muffler... 709015, Silentone DIY Muffler... 5545 two 14636 Spouts and 8062 Hanger

(9114) 1992 4 Cyl. Sunbird, 2.0 Engine (1st Design with bracket on extension pipe in front of gas tank)

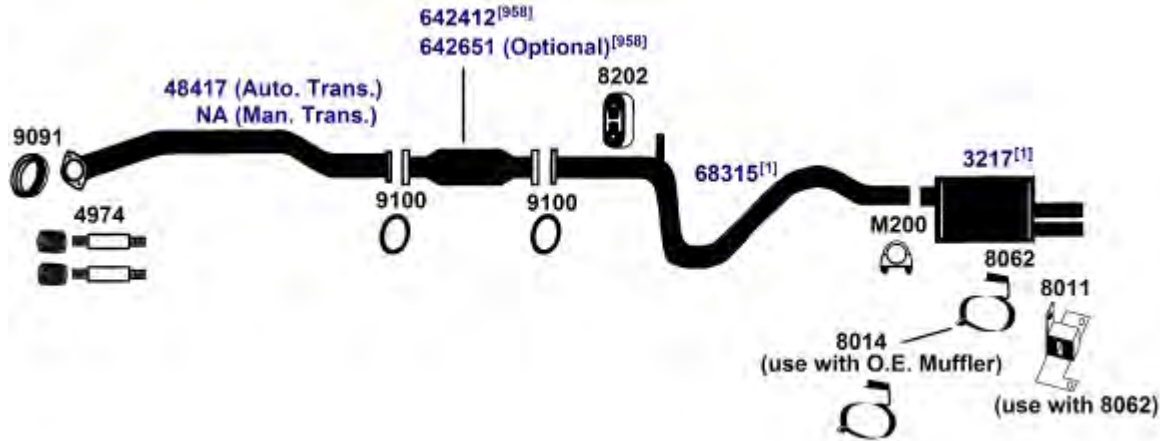

DIRECT FIT MSL/MAXIMUM Muffler... 6575, UNIVERSAL FIT MSL/MAXIMUM Muffler... 6561, 709015, Silentone DIY Muffler... 5545 two 14636 Spouts and 8062 Hanger

NA-Not Available. NR-Not Required. FL-Remove and Re-Use Old Flange. ● Golden Warehouse. O.E.-Original Equipment.
Airtube Kit [4948] may be required to complete installation. EFI-Electronic Fuel Injection.

[1] OE system was a welded assembly. It is recommended that all parts noted [1] should be replaced. [958] Federal & California Emission vehicles. Not legal for sale for vehicles licensed in California.

[900] Direct fit converter may require resizing, cutting or bushing.

1992 4 Cyl. Sunbird, 2.0L Engine (2nd Design with bracket on extension pipe behind gas tank) (9113)

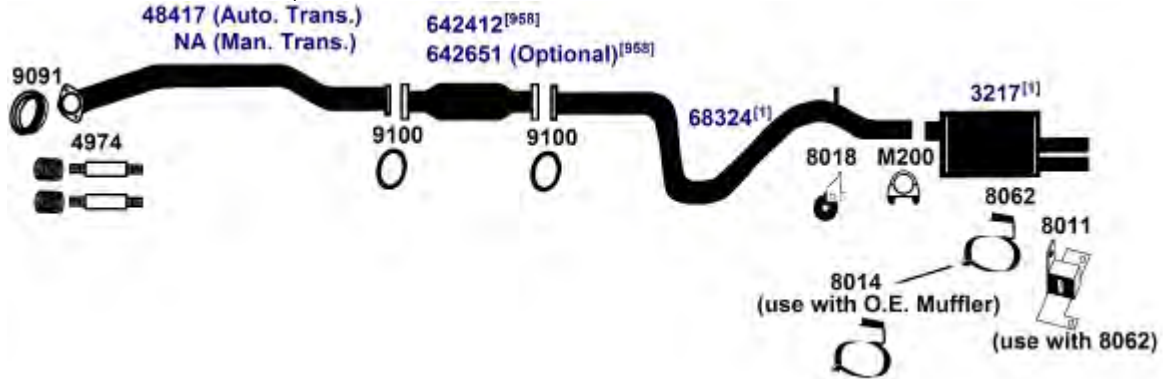

DIRECT FIT MSL/MAXIMUM Muffler... 6575, UNIVERSAL FIT MSL/MAXIMUM Muffler... 6561, 709015, Silentone DIY Muffler... 5545 two 14636 Spouts and 8062 Hanger

1992 6 Cyl. Sunbird, 189 Engine (3.1L); except GT (1st Design with bracket on extension pipe in front of gas tank) (9112)

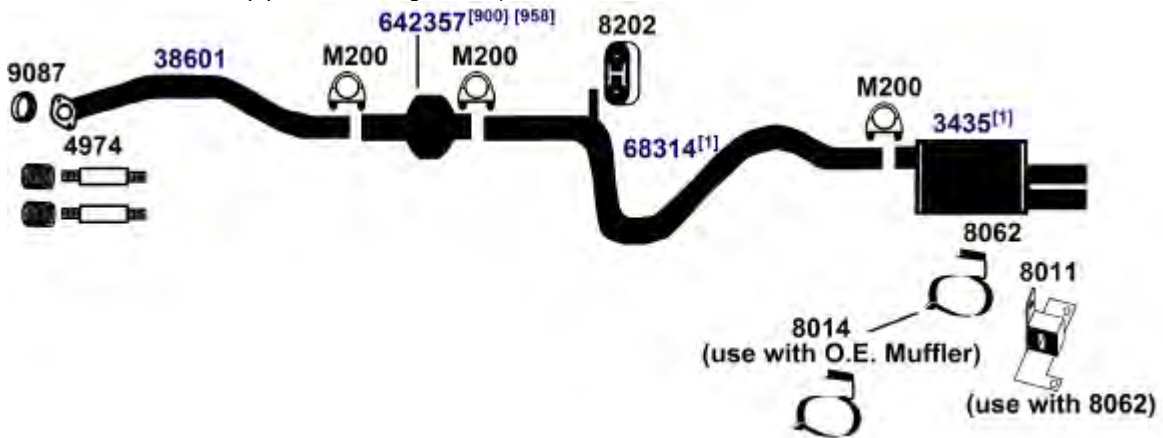

UNIVERSAL FIT MSL/MAXIMUM Muffler... 709015, Silentone DIY Muffler... 5545 two 14636 Spouts and 8062 Hanger

NA-Not Available. NR-Not Required. FL-Remove and Re-Use Old Flange. ● Golden Warehouse. O.E.-Original Equipment.
Airtube Kit [4948] may be required to complete installation. EFI-Electronic Fuel Injection.

[1] OE system was a welded assembly. It is recommended that all parts noted [1] should be replaced. [958] Federal & California Emission vehicles. Not legal for sale for vehicles licensed in California.
[900] Direct fit converter may require resizing, cutting or bushing.

PONTIAC J2000, SUNBIRD, SUNFIRE

(9107) 1991 6 Cyl. Sunbird, 189 Engine (3.1L); except GT

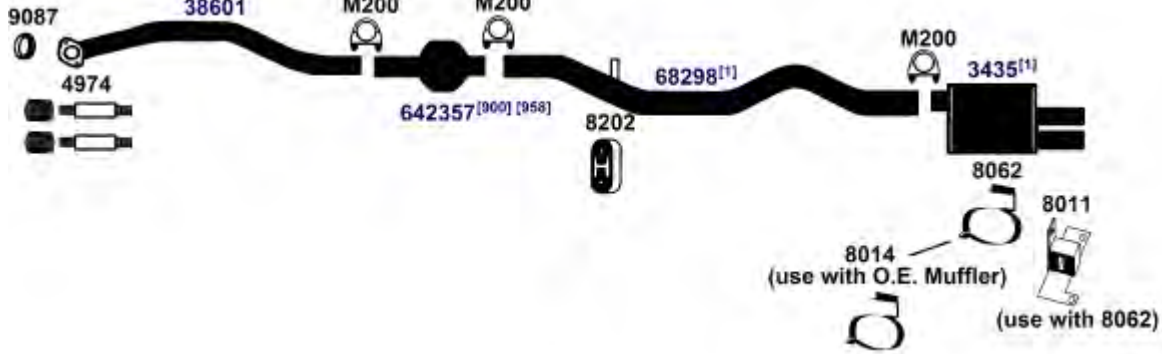

UNIVERSAL FIT MSL/MAXIMUM Muffler... 709015, Silentone DIY Muffler... 5545 two 14636 Spouts and 8062 Hanger

(9104) 90-91 4 Cyl. Sunbird, 121 Engine (2.0K); except 1990 Turbocharged Engine

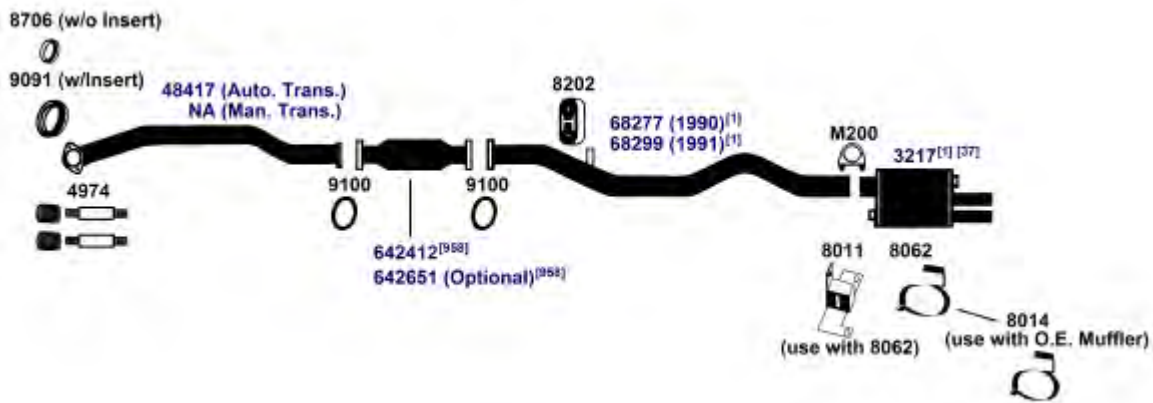

DIRECT FIT MSL/MAXIMUM Muffler... 6575, UNIVERSAL FIT MSL/MAXIMUM Muffler... 6561, 709015, Silentone DIY Muffler... 5545 two 14636 Spouts and 8062 Hanger

NA-Not Available. NR-Not Required. FL-Remove and Re-Use Old Flange. ● Golden Warehouse. O.E.-Original Equipment.
Airtube Kit [4948] may be required to complete installation. EFI-Electronic Fuel Injection.

[1] OE system was a welded assembly. It is recommended that all parts noted [1] should be replaced.

[37] Brackets on heads of muffler are not used on this application.

[900] Direct fit converter may require resizing, cutting or bushing.

[958] Federal & California Emission vehicles. Not legal for sale for vehicles licensed in California.

PONTIAC J2000, SUNBIRD, SUNFIRE

87-89 4 Cyl. Sunbird, Coupe & Sedan, 121 Engine (2.0L); except Turbo **(9103)**
87-88 4 Cyl. Sunbird Station Wagon, 121 Engine (2.0L); except Turbo

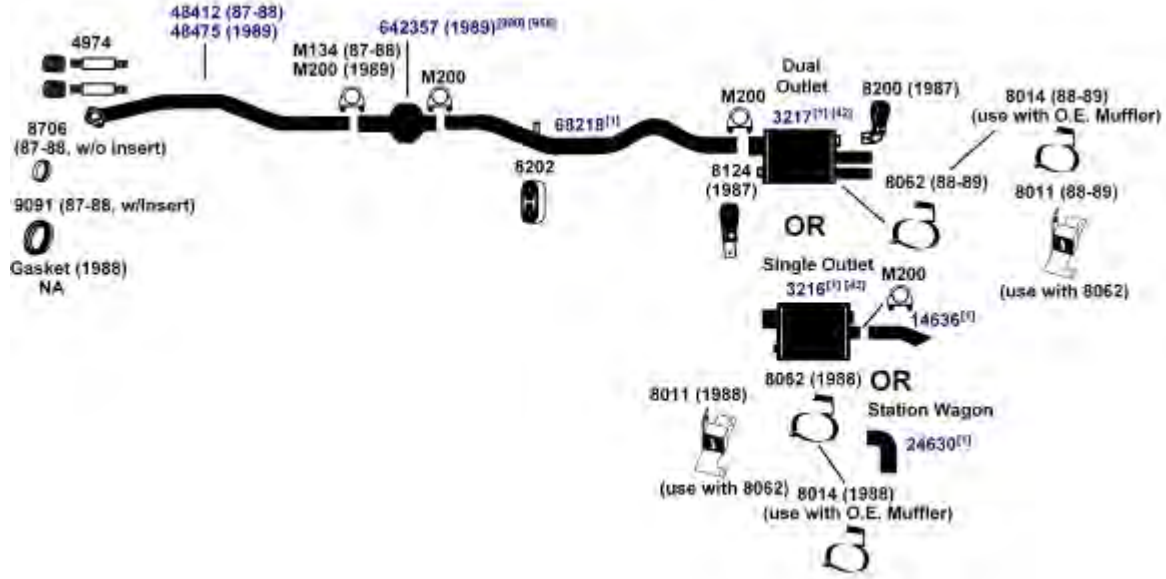

DIRECT FIT MSL/MAXIMUM Muffler... Dual Outlet- 6575, Single Outlet- 700660 with spout on muffler (rear exit only), 6560, UNIVERSAL FIT MSL/MAXIMUM Muffler... Dual Outlet- 6561, 709015, Single Outlet- 6536, Silentone DIY Muffler... Dual Outlet- 5545 two 14636 Spouts and 8062 Hanger, Single Outlet- 5555

87-89 4 Cyl. Sunbird, 121 Turbocharged Engine (2.0M) **(9105)**
85-86 4 Cyl. Sunbird 1.8L Turbocharged Engine (1.8J)

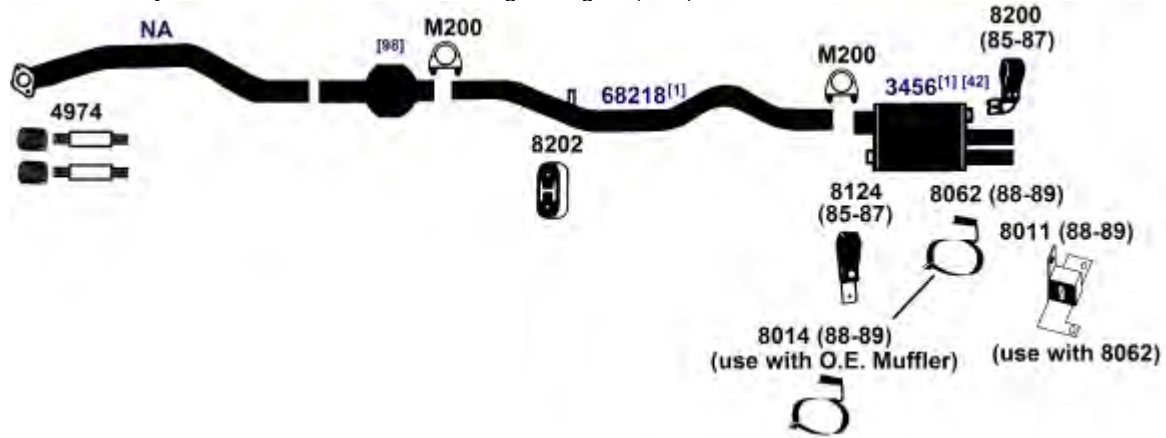

UNIVERSAL FIT MSL/MAXIMUM Muffler... 709015, Silentone DIY Muffler... 5545 two 14636 Spouts and 8062 Hanger

NA-Not Available. NR-Not Required. FL-Remove and Re-Use Old Flange. ● Golden Warehouse. O.E.-Original Equipment.
 # Airtube Kit [4948] may be required to complete installation. EFI-Electronic Fuel Injection.

- [1] OE system was a welded assembly. It is recommended that all parts noted [1] should be replaced.
- [42] Brackets on heads of muffler are not used on 88-89 applications.
- [98] Refer to current Catalytic Converter catalog or Website catalog for availability.
- [900] Direct fit converter may require resizing, cutting or bushing.
- [958] Federal & California Emission vehicles. Not legal for sale for vehicles licensed in California.

PONTIAC J2000, SUNBIRD, SUNFIRE

(9101) 85-86 4 Cyl. Sunbird, 2-Door, Hatchback and Sta. Wagon; 1.8-O Engine (Vin Code O); 2.0-P Engine (Vin Code P), with Converter

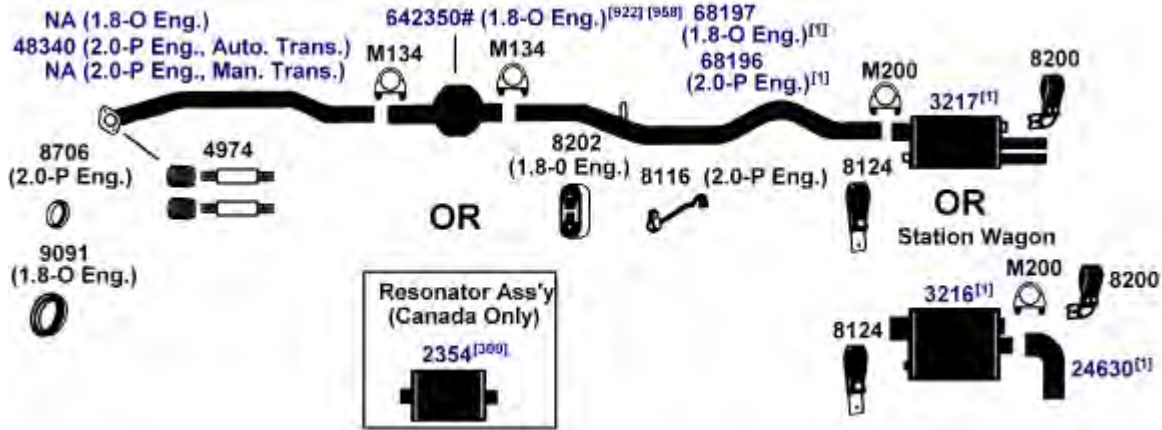

DIRECT FIT MSL/MAXIMUM Muffler... Dual Outlet (3217)- 6575, Single Outlet (3216)- 6560, 700060 with spout on muffler (rear exit only)., UNIVERSAL FIT MSL/MAXIMUM Muffler... Dual Outlet (3217)- 6561, 709015, Single Outlet (3216)- 6536, Silentone DIY Muffler... Dual Outlet (3217)- 5545 two 14636 Spouts and 8062 Hanger, Single Outlet (3216)- 5555

(9099) 85-86 4 Cyl. Sunbird 4-Door Sedan; 2.0-P Engine (Vin Code P); with Converter

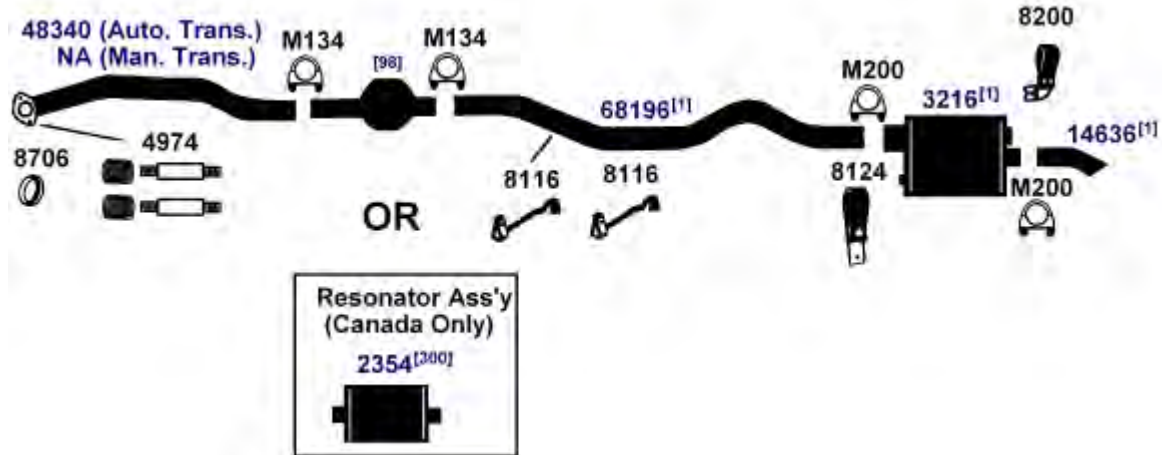

DIRECT FIT MSL/MAXIMUM Muffler... Rear Muffler- 6560, 700060 with spout on muffler (rear exit only)., UNIVERSAL FIT MSL/MAXIMUM Muffler... Rear Muffler- 6536, Silentone DIY Muffler... Rear Muffler- 5555

NA-Not Available. NR-Not Required. FL-Remove and Re-Use Old Flange. ● Golden Warehouse. O.E.-Original Equipment.
Airtube Kit [4948] may be required to complete installation. EFI-Electronic Fuel Injection.

[1] OE system was a welded assembly. It is recommended that all parts noted [1] should be replaced.

[98] Refer to current Catalytic Converter catalog or Website catalog for availability.

[300] For use when resonator originated from O.E. manufacturer.

[922] Trim Outlet pipe to fit length required

[958] Federal & California Emission vehicles. Not legal for sale for vehicles licensed in California.

PONTIAC J2000, SUNBIRD, SUNFIRE

1984 4 Cyl. Sunbird 4-Door Sedan; 2.0-P Engine (Vin Code P); 2nd Design Only (with Brackets on Muffler Heads), with Converter. **(9099E)**

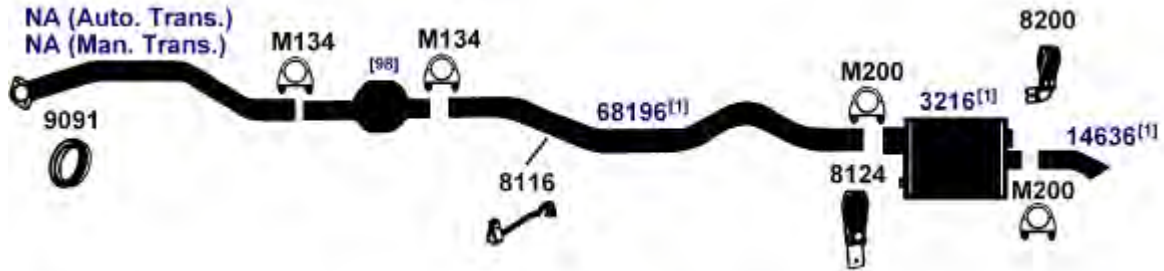

DIRECT FIT MSL/MAXIMUM Muffler... Rear Muffler- 6560, 700060 with spout on muffler (rear exit only). UNIVERSAL FIT MSL/MAXIMUM Muffler... Rear Muffler- 6536, Silentone DIY Muffler... Rear Muffler- 5555

1984 4 Cyl. 2000 Sunbird, 2.0L, 121 Engine; 1st Design only, Sedan, Station Wagon; (VIN Code P) **(9098)**

1983 4 Cyl. 2000, 2.0L, 121 Engine; Sedan, Station Wagon; (Vin Code P)

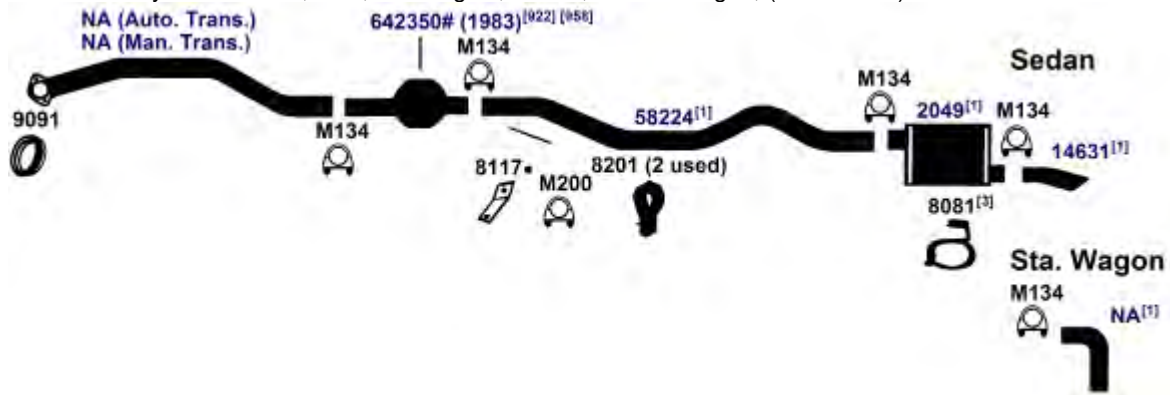

DIRECT FIT MSL/MAXIMUM Muffler... 700047, UNIVERSAL FIT MSL/MAXIMUM Muffler... 6544, 709011, Silentone DIY Muffler... 5535

NA-Not Available. NR-Not Required. FL-Remove and Re-Use Old Flange. ● Golden Warehouse. O.E.-Original Equipment.
Airtube Kit [4948] may be required to complete installation. EFI-Electronic Fuel Injection.

- [1] OE system was a welded assembly. It is recommended that all parts noted [1] should be replaced.
- [2] From O.E. resonator inlet weld, measure along pipe 3-3/4" to cut-off.
- [3] Required for installation.
- [922] Trim Outlet pipe to fit length required
- [958] Federal & California Emission vehicles. Not legal for sale for vehicles licensed in California.
- [98] Refer to current Catalytic Converter catalog or Website catalog for availability.

PONTIAC J2000, SUNBIRD, SUNFIRE

(9101E) 1984 4 Cyl. Sunbird, 1.8-0 Engine (Vin Code O), Sedan, Station Wagon; 2.0-P Engine (Vin Code P), 2-Door and Hatchback Models; 2nd Design Only (with Brackets on Muffler Heads) with Converter.

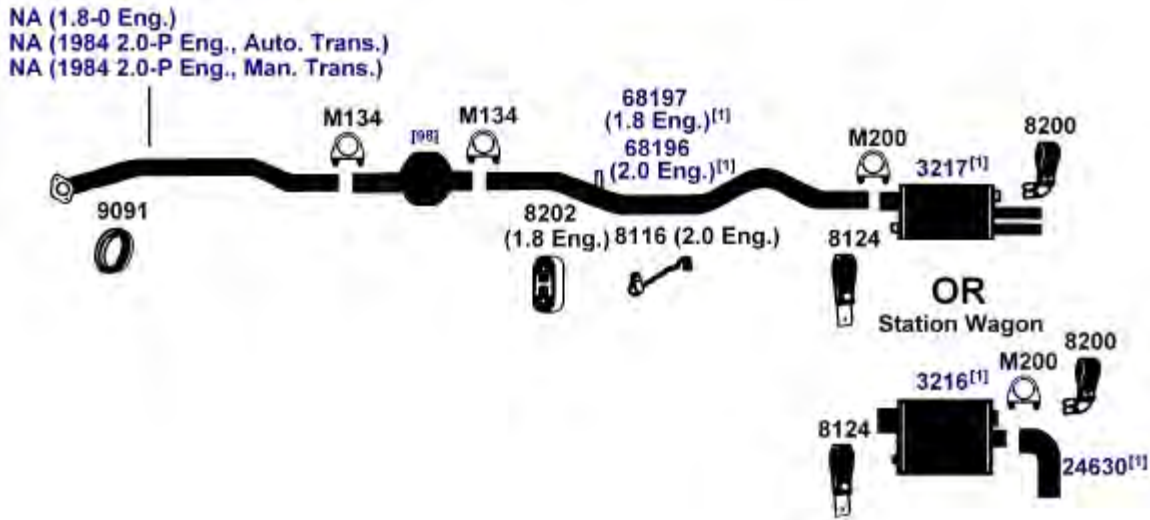

DIRECT FIT MSL/MAXIMUM Muffler... Dual Outlet (3217)- 6575, Single Outlet (3216)- 6560, 700060 with spout on muffler (rear exit only)., UNIVERSAL FIT MSL/MAXIMUM Muffler... Dual Outlet (3217)- 6561, 709015, Single Outlet (3216)- 6536, Silentone DIY Muffler... Dual Outlet (3217)- 5545 two 14636 Spouts and 8062 Hanger, Single Outlet (3216)- 5555

(9096) 82-84 4 Cyl. J2000, 2000, 2000 Sunbird; 1.8L Engine, includes Station Wagon (VIN Code O)

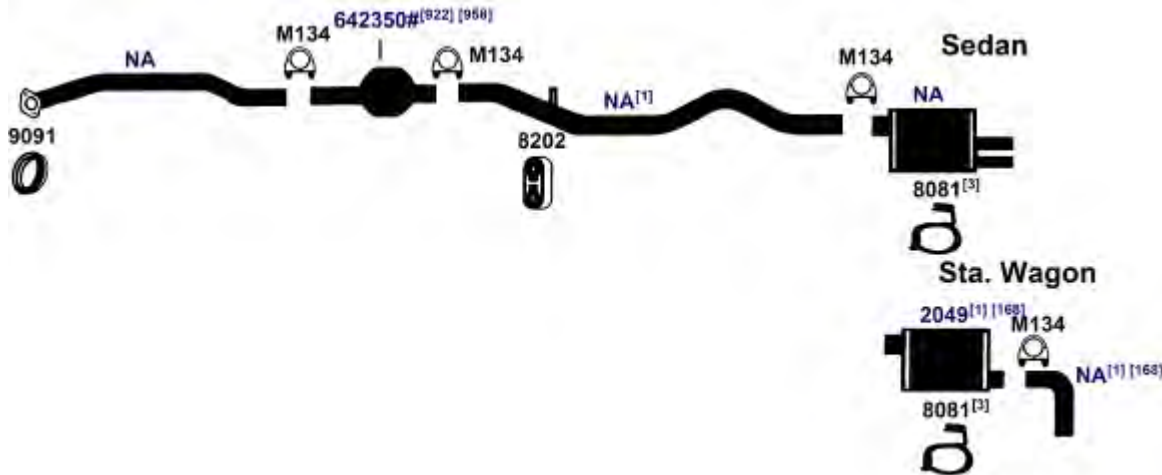

DIRECT FIT MSL/MAXIMUM Muffler... Single Outlet- 700047, UNIVERSAL FIT MSL/MAXIMUM Muffler... Dual Outlet- 6561, Single Outlet- 6544, 709011, Silentone DIY Muffler... Dual Outlet- 5545 and two 14636 Spouts, Single Outlet- 5535

NA-Not Available. NR-Not Required. FL-Remove and Re-Use Old Flange. ● Golden Warehouse. O.E.-Original Equipment.
Airtube Kit [4948] may be required to complete installation. EFI-Electronic Fuel Injection.

[1] OE system was a welded assembly. It is recommended that all parts noted [1] should be replaced.

[3] Required for installation.

[98] Refer to current Catalytic Converter catalog or Website catalog for availability.

[168] Functionally approved Single Outlet System replaces Dual Outlet.

[218] From O.E. resonator inlet weld, measure along pipe 3-3/4" to cut-off.

[922] Trim Outlet pipe to fit length required

[958] Federal & California Emission vehicles. Not legal for sale for vehicles licensed in California.

PONTIAC J2000, SUNBIRD, SUNFIRE

1982 4 Cyl. J2000, 1.8G Engine, includes Station Wagon (9094)

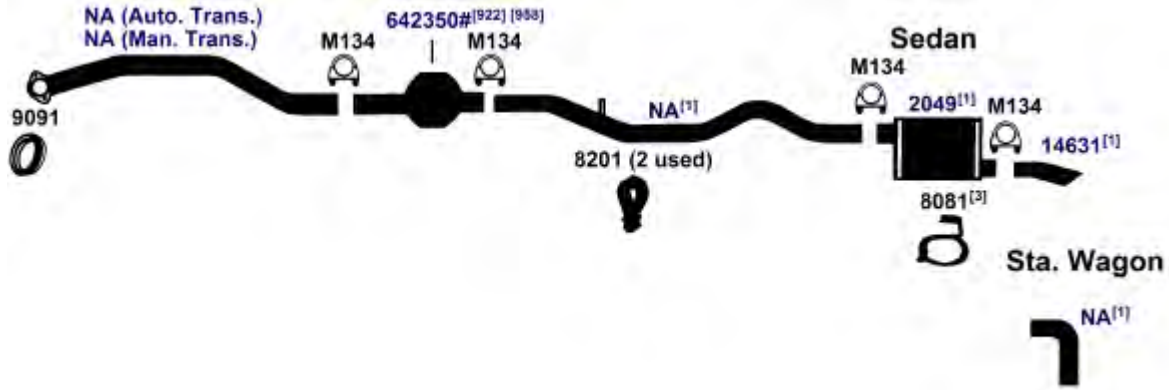

DIRECT FIT MSL/MAXIMUM Muffler... 700047, UNIVERSAL FIT MSL/MAXIMUM Muffler... 6544, 709011, Silentone DIY Muffler... 5535

79-80 4 Cyl. Sunbird, 151 Engine, except Station Wagon (9239)

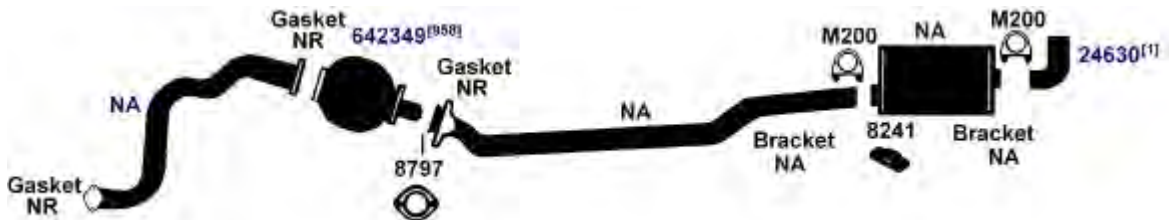

DIRECT FIT MSL/MAXIMUM Muffler... 6536

PONTIAC LEMANS (FWD)

92-93 4 Cyl. LeMans, 1.6L Engine (11752)

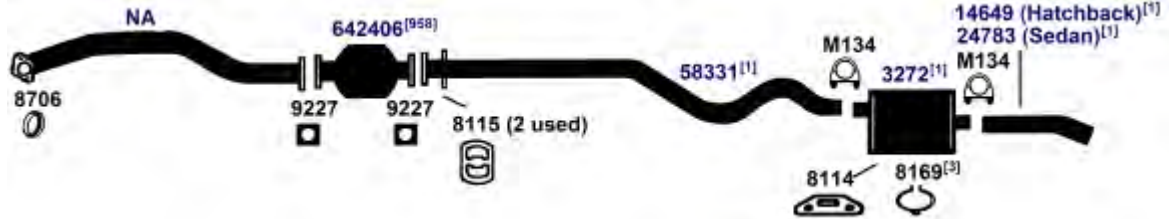

DIRECT FIT MSL/MAXIMUM Muffler... 700021

NA-Not Available. NR-Not Required. FL-Remove and Re-Use Old Flange. ● Golden Warehouse. O.E.-Original Equipment.
Airtube Kit [4948] may be required to complete installation. EFI-Electronic Fuel Injection.

- [1] OE system was a welded assembly. It is recommended that all parts noted [1] should be replaced.
- [2] Trim Outlet pipe to fit length required
- [3] Required for installation.
- [922] Federal & California Emission vehicles. Not legal for sale for vehicles licensed in California.
- [958] From O.E. resonator inlet weld, measure along pipe 3-3/4" to cut-off.

PONTIAC LEMANS (FWD)

(11751) 90-91 4 Cyl. LeMans, 1.6L Engine
 1990 4 Cyl. LeMans, 2.0L Engine

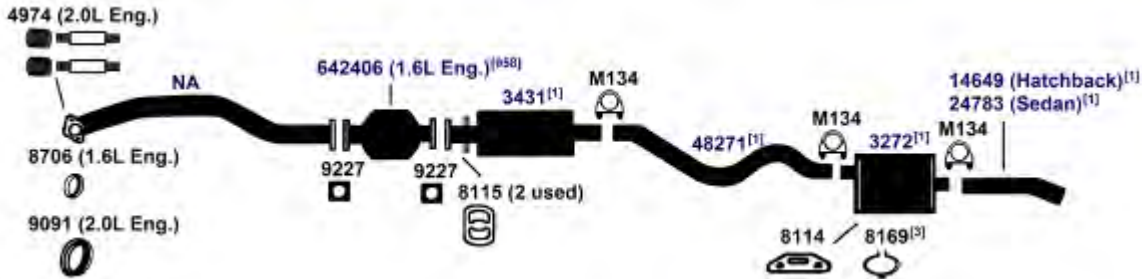

DIRECT FIT MSL/MAXIMUM Muffler... Front Muffler- 709999, Rear Muffler- 700021, UNIVERSAL FIT MSL/MAXIMUM Muffler... Front Muffler- 709999

(11750) 88-89 4 Cyl. LeMans, 1.6L, 2.0L Engine

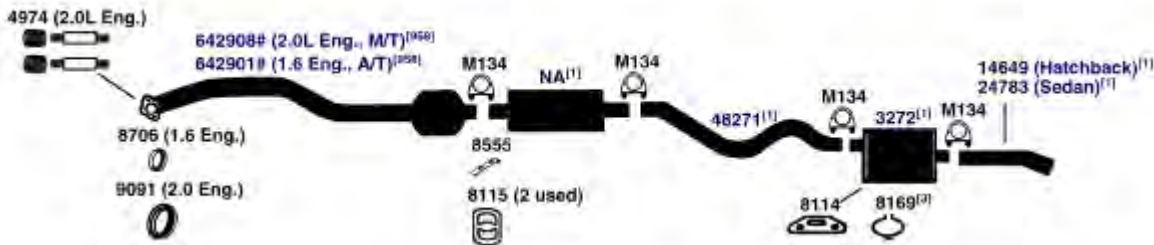

DIRECT FIT MSL/MAXIMUM Muffler... Front Muffler- 709999, Rear Muffler- 700021

PONTIAC LEMANS (RWD), GRAND AM, TEMPEST, GTO

(9204) 1981 6 Cyl. 231 C.I.D., (Exc. Canada)

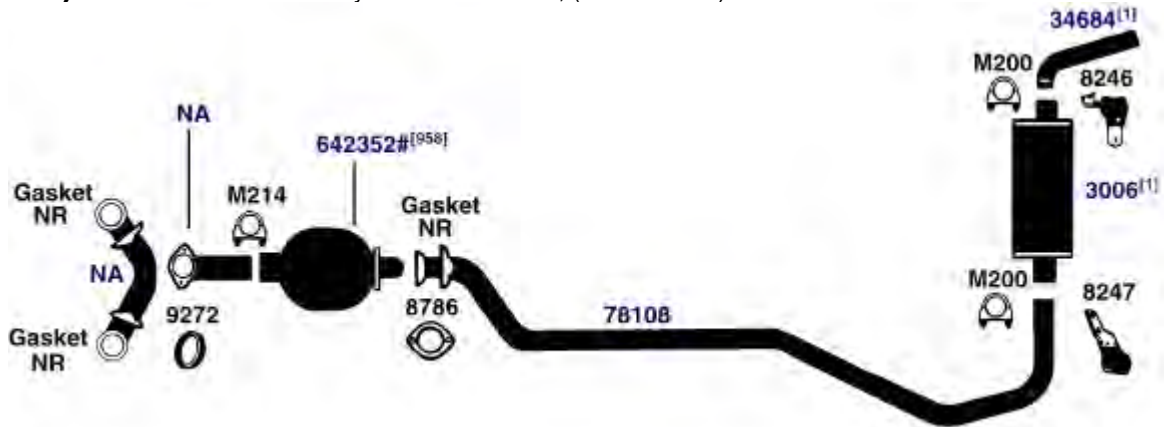

DIRECT FIT MSL/MAXIMUM Muffler... 6540, Silentone DIY Muffler... 5503

NA-Not Available. NR-Not Required. FL-Remove and Re-Use Old Flange. ● Golden Warehouse. O.E.-Original Equipment.

Airtube Kit [4948] may be required to complete installation. EFI-Electronic Fuel Injection.

- [1] OE system was a welded assembly. It is recommended that all parts noted [1] [958] Federal & California Emission vehicles. Not legal for sale for vehicles licensed in California.
 [3] Required for installation.

PONTIAC LEMANS (RWD), GRAND AM, TEMPEST, GTO

1981 8 Cyl. LeMans, 4.4L, 267 Engine

(9205)

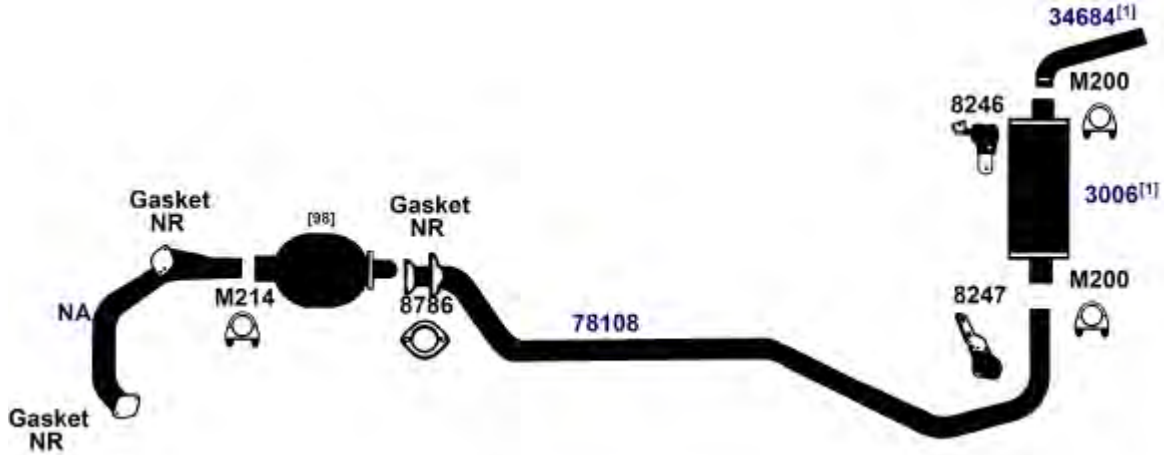

DIRECT FIT MSL/MAXIMUM Muffler... 6540, Silentone DIY Muffler... 5503

80-81 8 Cyl. LeMans, Grand AM; 301 Engine, with High Performance Option (W72)

(9202)

79-80 8 Cyl. LeMans, Grand AM; 305H Engine

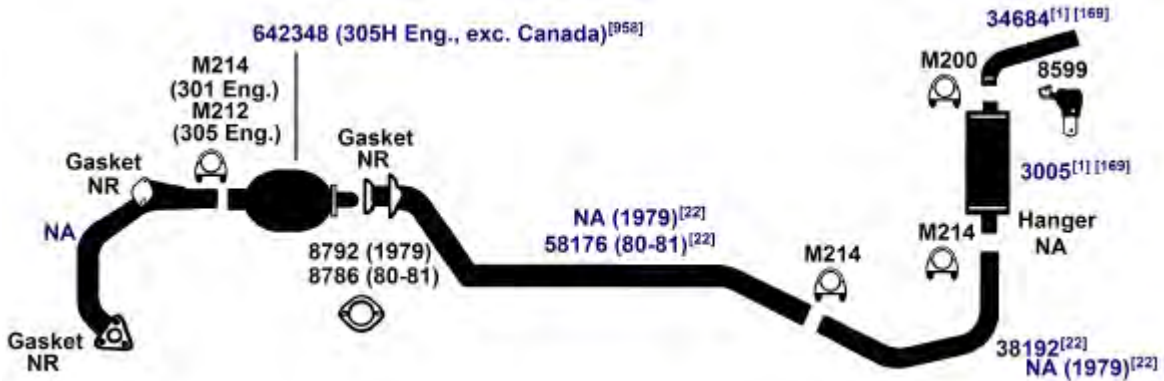

DIRECT FIT MSL/MAXIMUM Muffler... 700057, UNIVERSAL FIT MSL/MAXIMUM Muffler... 6540, Silentone DIY Muffler... 5522

NA-Not Available. NR-Not Required. FL-Remove and Re-Use Old Flange. ● Golden Warehouse. O.E.-Original Equipment.
Airtube Kit [4948] may be required to complete installation. EFI-Electronic Fuel Injection.

[1] OE system was a welded assembly. It is recommended that all parts noted [1] should be replaced.

[22] O.E. exhaust pipe was one piece. Replacement is two pieces.

[98] Refer to current Catalytic Converter catalog or Website catalog for availability.

[169] Functionally approved Single Outlet System may replace Dual Outlet.

[958] Federal & California Emission vehicles. Not legal for sale for vehicles licensed in California.

PONTIAC LEMANS (RWD), GRAND AM, TEMPEST, GTO

(9203) 79-81 8 Cyl. LeMans, Grand AM; 265 (4.3L), 301 (4.9L) Engine; except High Performance

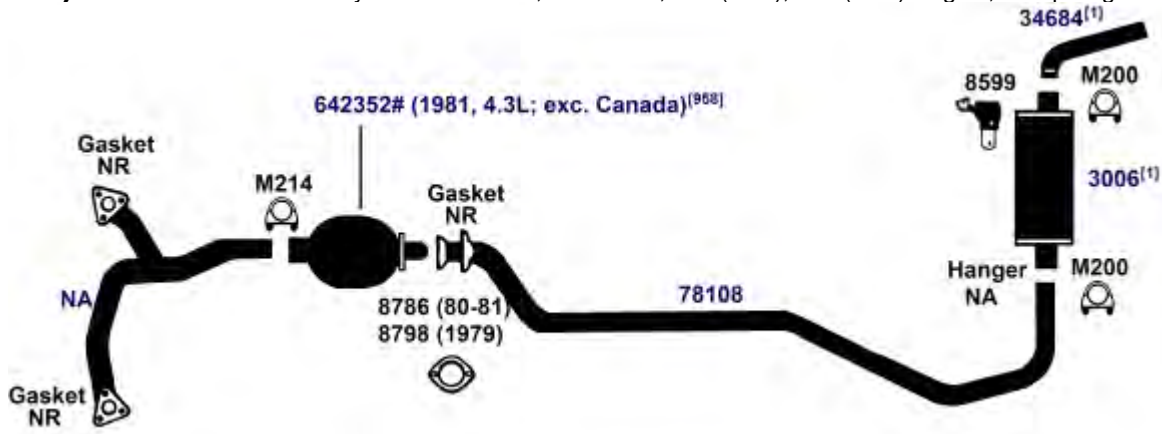

DIRECT FIT MSL/MAXIMUM Muffler... 6540, Silentone DIY Muffler... 5503

(9207) 1980 6 Cyl. LeMans, Grand AM; 231 Engine

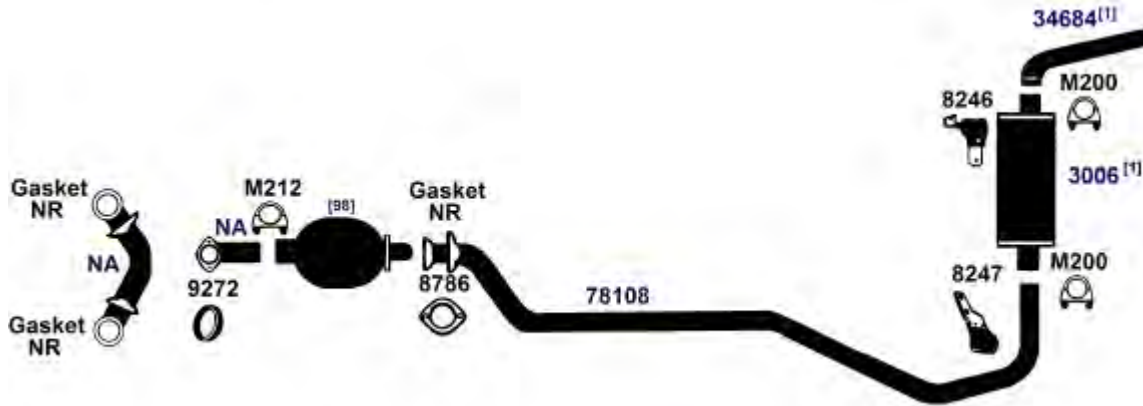

DIRECT FIT MSL/MAXIMUM Muffler... 6540, Silentone DIY Muffler... 5503

NA-Not Available. NR-Not Required. FL-Remove and Re-Use Old Flange. ● Golden Warehouse. O.E.-Original Equipment.
Airtube Kit [4948] may be required to complete installation. EFI-Electronic Fuel Injection.

[1] OE system was a welded assembly. It is recommended that all parts noted [1] should be replaced.

[958] Federal & California Emission vehicles. Not legal for sale for vehicles licensed in California.

[98] Refer to current Catalytic Converter catalog or Website catalog for availability.

PONTIAC LEMANS (RWD), GRAND AM, TEMPEST, GTO

1980 6 Cyl. LeMans, Grand AM; 229 Engine

(9208)

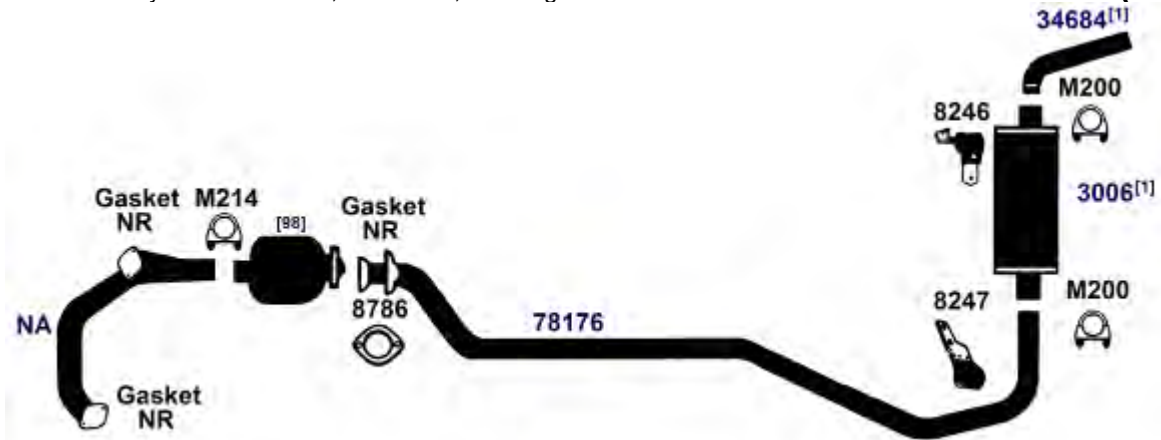

DIRECT FIT MSL/MAXIMUM Muffler... 6540, Silentone DIY Muffler... 5503

1979 6 Cyl. LeMans, Grand AM; 231 Engine

(9200)

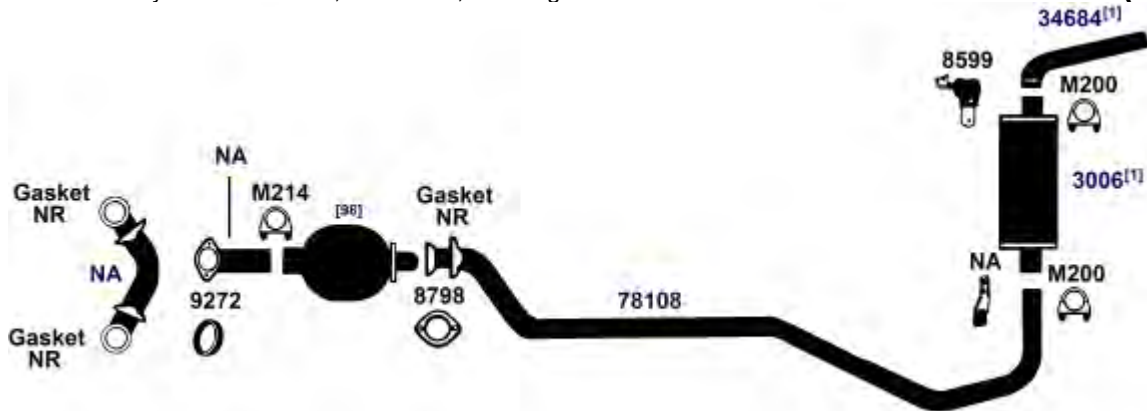

DIRECT FIT MSL/MAXIMUM Muffler... 6540, Silentone DIY Muffler... 5503

NA-Not Available. NR-Not Required. FL-Remove and Re-Use Old Flange. ● Golden Warehouse. O.E.-Original Equipment.
Airtube Kit [4948] may be required to complete installation. EFI-Electronic Fuel Injection.

[1] OE system was a welded assembly. It is recommended that all parts noted [1] should be replaced.
[98] Refer to current Catalytic Converter catalog or Website catalog for availability.

[958] Federal & California Emission vehicles. Not legal for sale for vehicles licensed in California.

PONTIAC LEMANS (RWD), GRAND AM, TEMPEST, GTO

(9195) 1979 8 Cyl. LeMans Station Wagon, 350L Engine



DIRECT FIT MSL/MAXIMUM Muffler... 700057, UNIVERSAL FIT MSL/MAXIMUM Muffler... 6540, Silentone DIY Muffler... 5522

PONTIAC T1000

(9265) 85-87 4 Cyl. T1000, All Models; 98 Engine (1.6L) Single Bed Bead Converter[233]

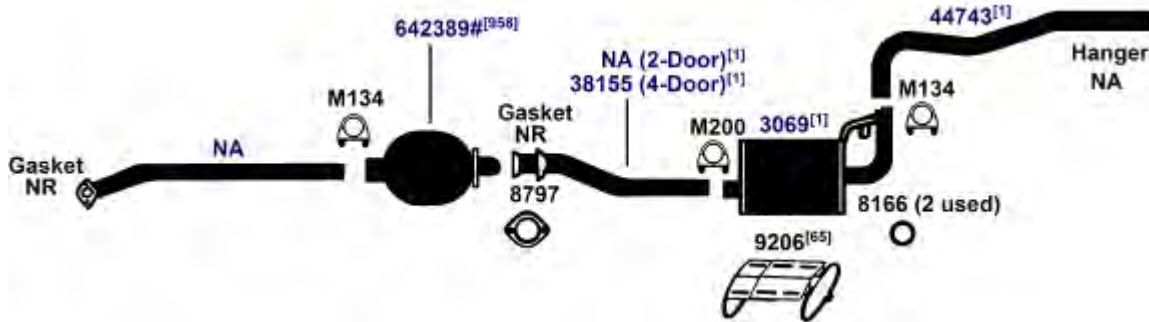

DIRECT FIT MSL/MAXIMUM Muffler... 6551

(9266) 85-87 4 Cyl. T1000, All Models; 98 Engine (1.6L), Dual Bed Monolithic Converter[233]

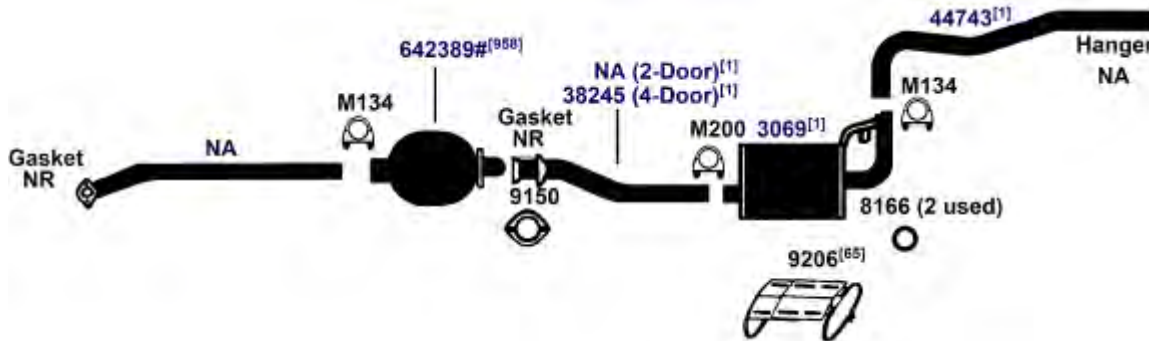

DIRECT FIT MSL/MAXIMUM Muffler... 6551

NA-Not Available. NR-Not Required. FL-Remove and Re-Use Old Flange. ● Golden Warehouse. O.E.-Original Equipment.
 # Airtube Kit [4948] may be required to complete installation. EFI-Electronic Fuel Injection.

- [1] OE system was a welded assembly. It is recommended that all parts noted [1] should be replaced.
- [22] O.E. exhaust pipe was one piece. Replacement is two pieces.
- [65] Heat Shield 9206 is required for installation.
- [168] Functionally approved Single Outlet System replaces Dual Outlet.
- [958] Federal & California Emission vehicles. Not legal for sale for vehicles licensed in California.

85-86 4 Cyl. T1000, All Models; 110 Diesel Engine (1.8L)

(9267)

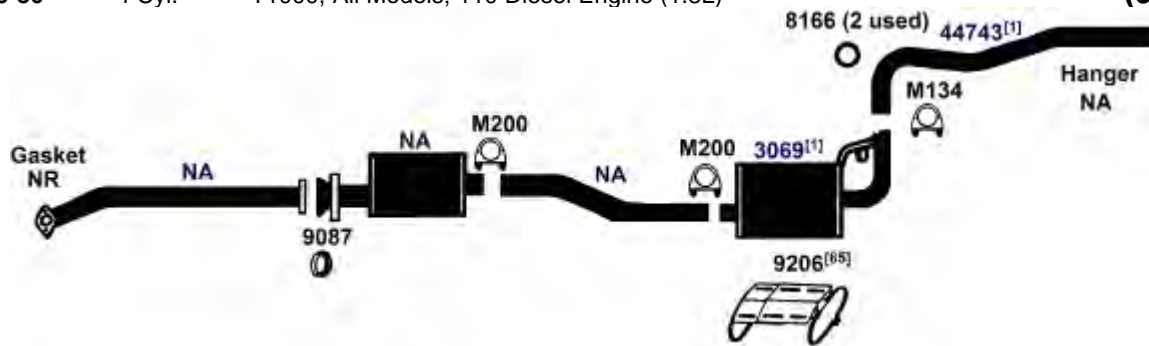

DIRECT FIT MSL/MAXIMUM Muffler... Rear Muffler- 6551, UNIVERSAL FIT MSL/MAXIMUM Muffler... Front Muffler- 709005, 709010

83-84 4 Cyl. T1000, All Models; 110 Diesel Engine (1.8L)

(9267E)

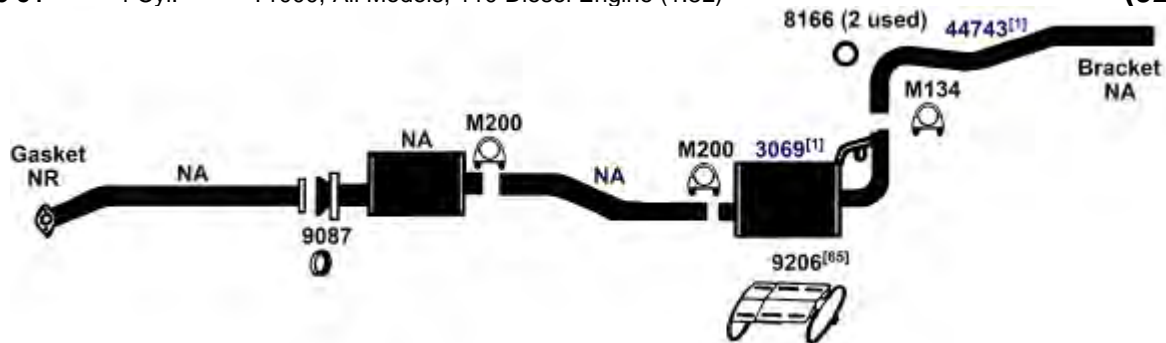

DIRECT FIT MSL/MAXIMUM Muffler... Rear Muffler- 6551, UNIVERSAL FIT MSL/MAXIMUM Muffler... Front Muffler- 709005, 709010

82-84 4 Cyl. T1000, All Models; 98 Engine (1.6L), Dual Bed Monolithic Converter[233]

(9266E)

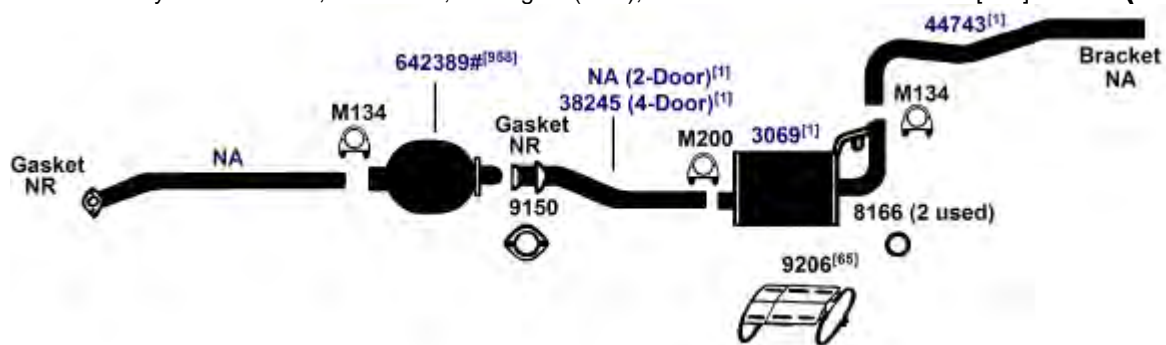

DIRECT FIT MSL/MAXIMUM Muffler... 6551

NA-Not Available. NR-Not Required. FL-Remove and Re-Use Old Flange. ● Golden Warehouse. O.E.-Original Equipment.
Airtube Kit [4948] may be required to complete installation. EFI-Electronic Fuel Injection.

- [1] OE system was a welded assembly. It is recommended that all parts noted [1] should be replaced. [958] Federal & California Emission vehicles. Not legal for sale for vehicles licensed in California.
- [65] Heat Shield 9206 is required for installation.

PONTIAC T1000

(9265E) 82-84 4 Cyl. T1000, All Models; 98 Engine (1.6L) Single Bed Bead Converter[233]

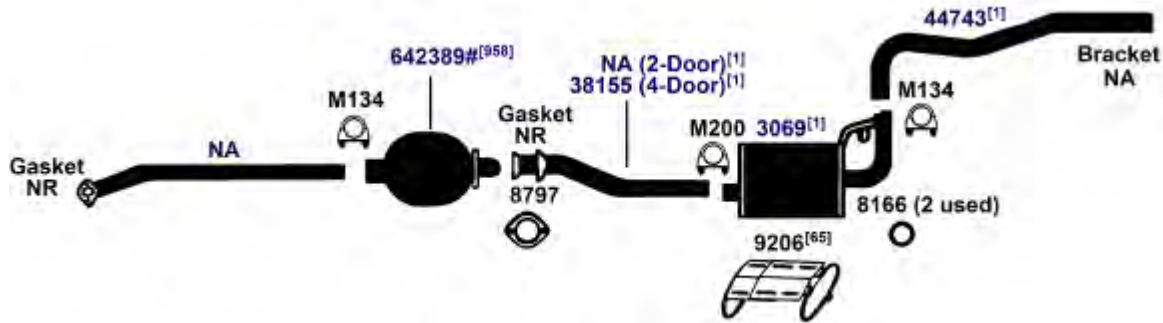

DIRECT FIT MSL/MAXIMUM Muffler... 6551

(9264) 1981 4 Cyl. T1000, All Models with 1.6L, 98 Engine

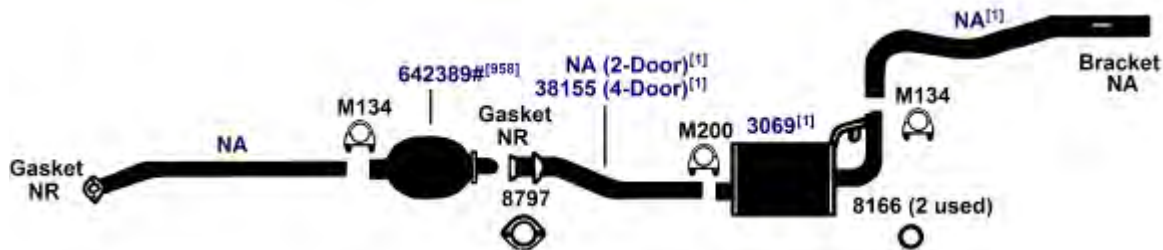

DIRECT FIT MSL/MAXIMUM Muffler... 6551

PONTIAC TEMPEST

(100586) 90-91 4 Cyl. Tempest, 2.2L Engine (CANADA ONLY)
87-89 4 Cyl. Tempest, 2.0L Engine (CANADA ONLY)

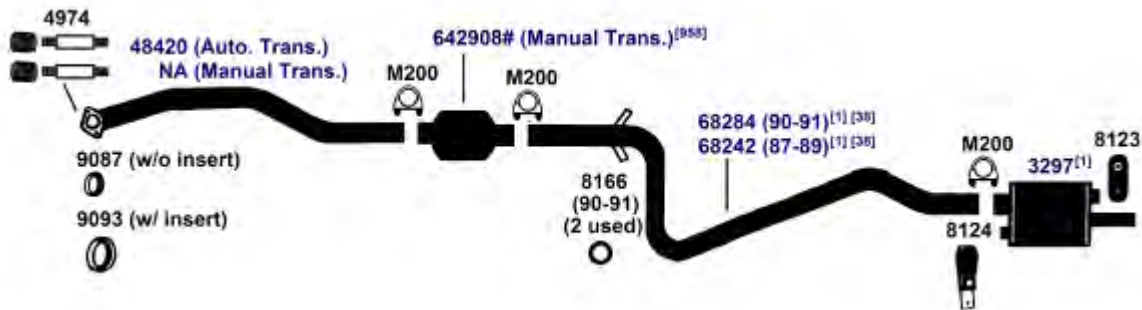

DIRECT FIT MSL/MAXIMUM Muffler... 6588, UNIVERSAL FIT MSL/MAXIMUM Muffler... 6562, Silentone DIY Muffler... 5555 and 24888 Pipe

NA-Not Available. NR-Not Required. FL-Remove and Re-Use Old Flange. ● Golden Warehouse. O.E.-Original Equipment.
Airtube Kit [4948] may be required to complete installation. EFI-Electronic Fuel Injection.

[1] OE system was a welded assembly. It is recommended that all parts noted [1] should be replaced.

[38] The O.E. extension pipe must be cut off immediately in front of the pipe to converter weld.

[65] Heat Shield 9206 is required for installation.

[958] Federal & California Emission vehicles. Not legal for sale for vehicles licensed in California.

PONTIAC TEMPEST

90-91 6 Cyl. Tempest, 189 Engine (3.1L); (CANADA ONLY)

(100585)

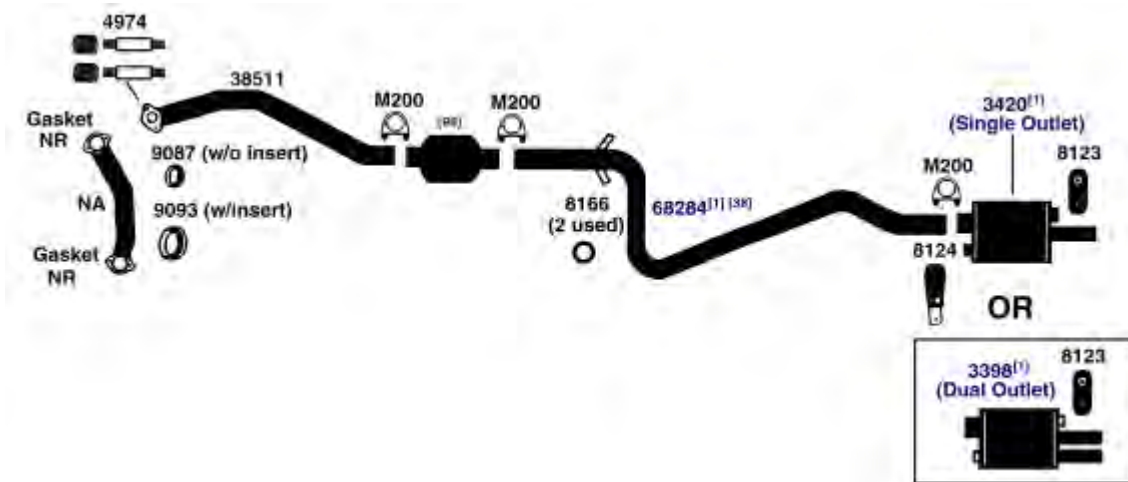

DIRECT FIT MSL/MAXIMUM Muffler... Single Outlet- 6588, Dual Outlet- 6589, UNIVERSAL FIT MSL/MAXIMUM Muffler... Single Outlet- 6562, 709992, Dual Outlet- 6561, 709015, Silentone DIY Muffler... Single Outlet- 5555 and 24888 Pipe

PONTIAC TRANSPORT

92-94 6 Cyl. Trans Sport; 189 (3.1L) Engine

(34002)

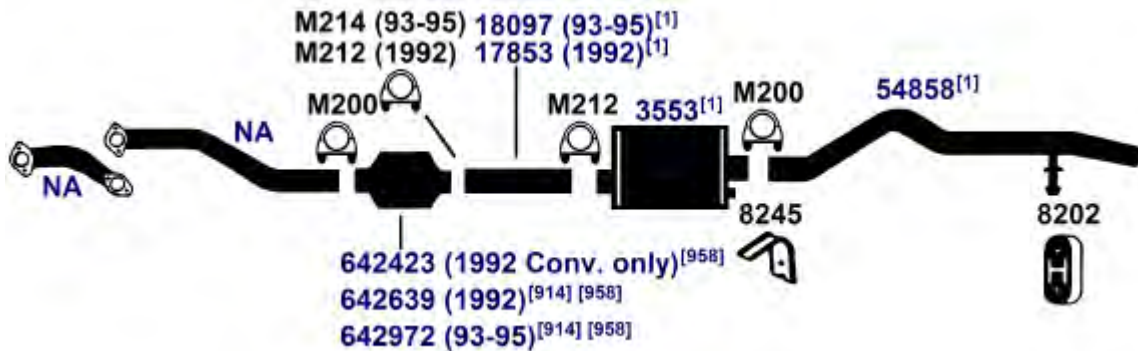

DIRECT FIT MSL/MAXIMUM Muffler... 700321

92-94 6 Cyl. Trans Sport; 231 (3.8L) Engine

(34001)

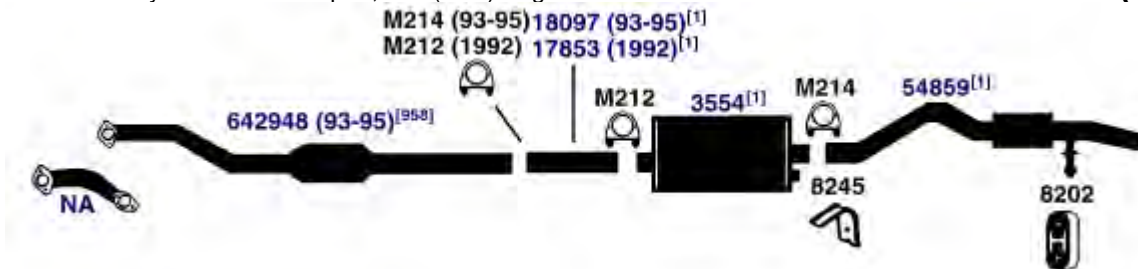

DIRECT FIT MSL/MAXIMUM Muffler... 700286, UNIVERSAL FIT MSL/MAXIMUM Muffler... 6592, Silentone DIY Muffler... 5557 and 8506 Bracket, M214 Clamp and 8245 hanger

NA-Not Available. NR-Not Required. FL-Remove and Re-Use Old Flange. ● Golden Warehouse. O.E.-Original Equipment.
Airtube Kit [4948] may be required to complete installation. EFI-Electronic Fuel Injection.

- [1] OE system was a welded assembly. It is recommended that all parts noted [1] should be replaced.
- [38] The O.E. extension pipe must be cut off immediately in front of the pipe to converter weld.
- [98] Refer to current Catalytic Converter catalog or Website catalog for availability.

- [914] Direct fit converter includes front (Exhaust) pipe, (1) piece assembly.
- [958] Federal & California Emission vehicles. Not legal for sale for vehicles licensed in California.

PONTIAC TRANS SPORT

(34000) 90-91 6 Cyl. Trans Sport; 189 (3.1L) Engine

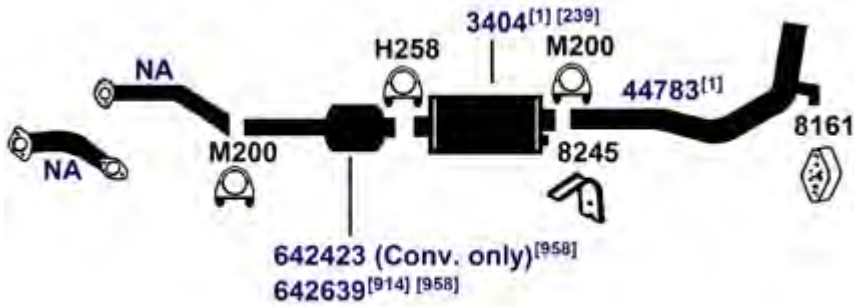

DIRECT FIT MSL/MAXIMUM Muffler... 700123

PONTIAC VENTURA II, PHOENIX

(9341) 82-84 4 Cyl. Phoenix, 2.5L, 151 Engine

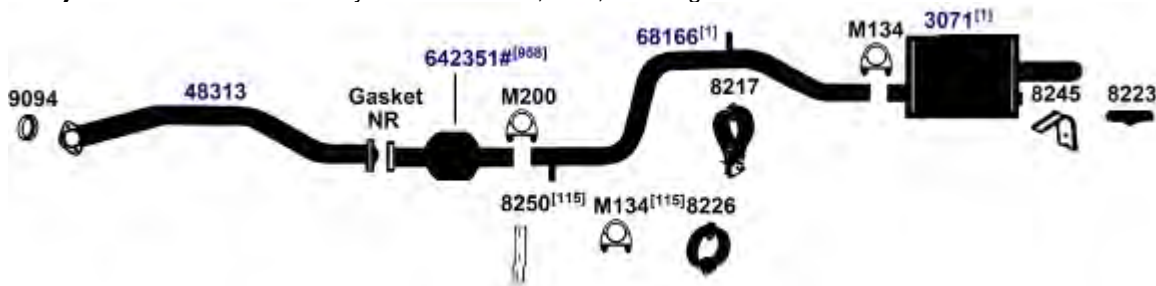

DIRECT FIT MSL/MAXIMUM Muffler... 700063, UNIVERSAL FIT MSL/MAXIMUM Muffler... 6544, 709010, Silentone DIY Muffler... 5535

(9340) 82-84 6 Cyl. Phoenix, 2.8X, 173 Engine

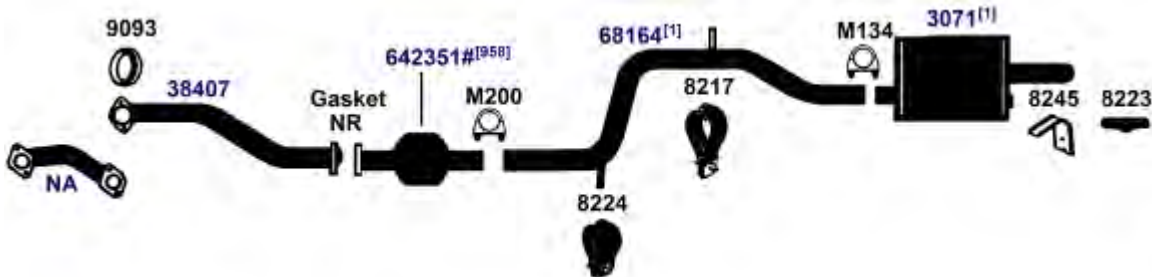

DIRECT FIT MSL/MAXIMUM Muffler... 700063, UNIVERSAL FIT MSL/MAXIMUM Muffler... 6544, 709010, Silentone DIY Muffler... 5535

NA-Not Available. NR-Not Required. FL-Remove and Re-Use Old Flange. ● Golden Warehouse. O.E.-Original Equipment.

Airtube Kit [4948] may be required to complete installation. EFI-Electronic Fuel Injection.

[1] OE system was a welded assembly. It is recommended that all parts noted [1] should be replaced.

[115] Not required for installation if bracket is welded on exhaust pipe.

[239] O.E. muffler must be cut off 1-1/2" behind the muffler nipple to converter weld.

[914] Direct fit converter includes front (Exhaust) pipe, (1) piece assembly.

[958] Federal & California Emission vehicles. Not legal for sale for vehicles licensed in California.

PONTIAC VENTURA II, PHOENIX

1981 4 Cyl. Phoenix, 2.5L, 151 Engine (9339)

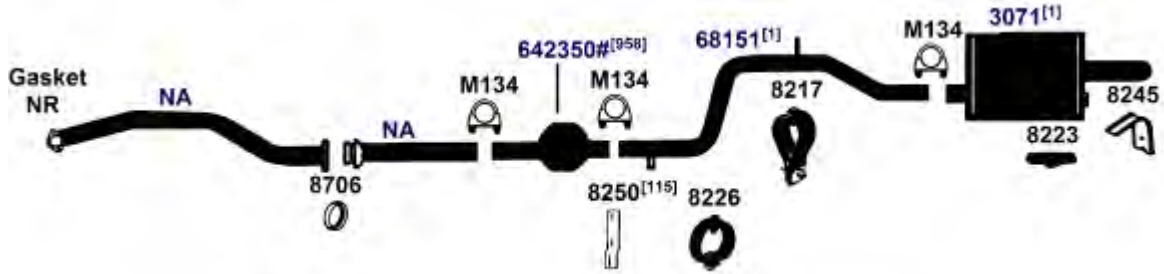

DIRECT FIT MSL/MAXIMUM Muffler... 700063, UNIVERSAL FIT MSL/MAXIMUM Muffler... 6544, 709010, Silentone DIY Muffler... 5535

1981 6 Cyl. Phoenix, 2.8Z, 2.8X, 173 Engine (9338)

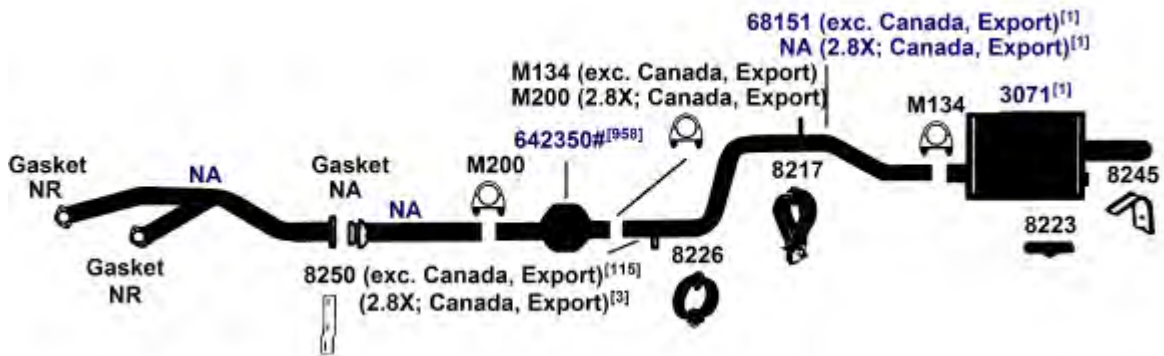

DIRECT FIT MSL/MAXIMUM Muffler... 700063, UNIVERSAL FIT MSL/MAXIMUM Muffler... 6544, 709010, Silentone DIY Muffler... 5535

1980 4 Cyl. Phoenix, 151 Engine (9337)



DIRECT FIT MSL/MAXIMUM Muffler... 700063, UNIVERSAL FIT MSL/MAXIMUM Muffler... 6544, 709010, Silentone DIY Muffler... 5535

NA-Not Available. NR-Not Required. FL-Remove and Re-Use Old Flange. ● Golden Warehouse. O.E.-Original Equipment.
Airtube Kit [4948] may be required to complete installation. EFI-Electronic Fuel Injection.

- [1] OE system was a welded assembly. It is recommended that all parts noted [1] should be replaced.
- [2] Trim Outlet pipe to fit length required
- [3] Required for installation.
- [922] Federal & California Emission vehicles. Not legal for sale for vehicles licensed in California.
- [958] Not required for installation if bracket is welded on exhaust pipe.

PONTIAC VENTURA II, PHOENIX

(9335) 1980 6 Cyl. Phoenix, 173 Engine (1st Design-Bracket 20" from inlet end of Exhaust Pipe)

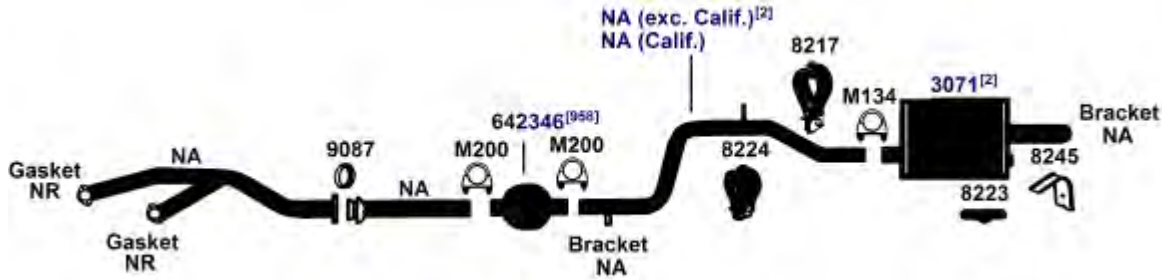

DIRECT FIT MSL/MAXIMUM Muffler... 700063, UNIVERSAL FIT MSL/MAXIMUM Muffler... 6544, 709010, Silentone DIY Muffler... 5535

(9336) 1980 6 Cyl. Phoenix, 173 Engine (2nd Design-Bracket 3" from inlet end of Exhaust Pipe)

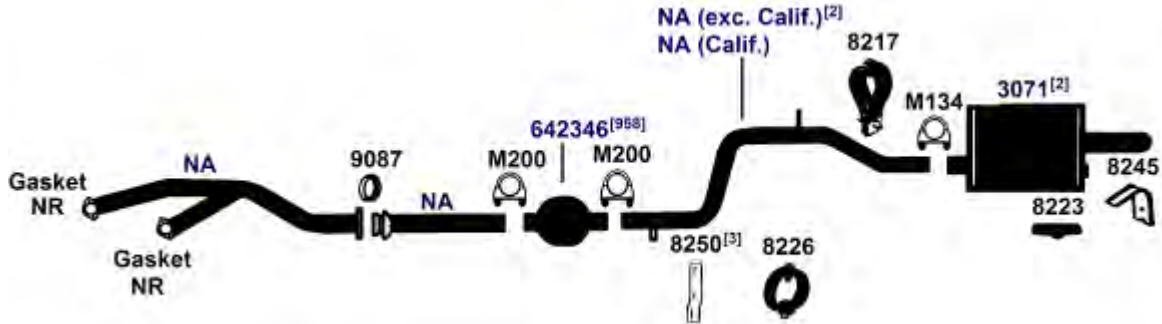

DIRECT FIT MSL/MAXIMUM Muffler... 700063, UNIVERSAL FIT MSL/MAXIMUM Muffler... 6544, 709010, Silentone DIY Muffler... 5535

(9331) 1979 8 Cyl. Ventura, Phoenix; 305, 350L Engine; Dual Outlet Muffler

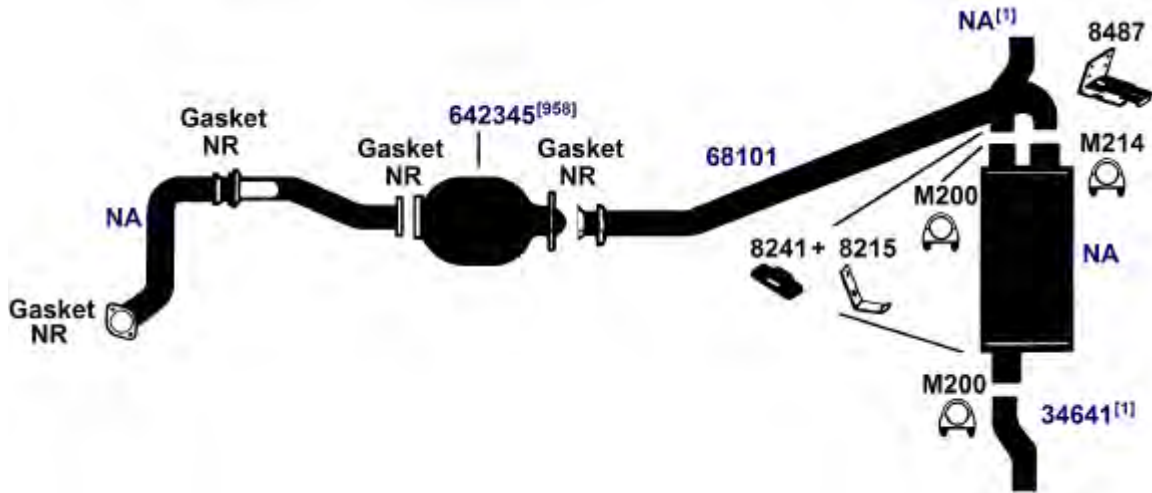

DIRECT FIT MSL/MAXIMUM Muffler... 6537

NA-Not Available. NR-Not Required. FL-Remove and Re-Use Old Flange. ● Golden Warehouse. O.E.-Original Equipment.
Airtube Kit [4948] may be required to complete installation. EFI-Electronic Fuel Injection.

[1] OE system was a welded assembly. It is recommended that all parts noted [1] should be replaced.

[2] May be necessary to replace all noted [2] parts.

[3] Required for installation.

[958] Federal & California Emission vehicles. Not legal for sale for vehicles licensed in California.

1994 4 Cyl. 900; 2.3L Engine (Eng: B234I) (100261)

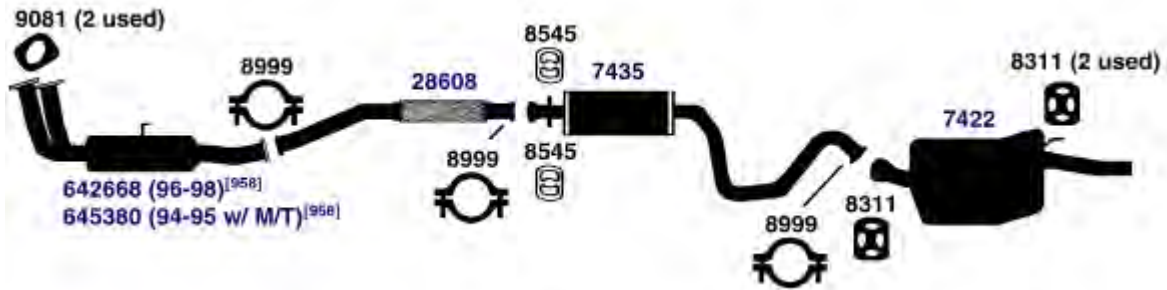

1994 4 Cyl. 900 Turbo; 2.0L Engine (Eng: B204) (100262)

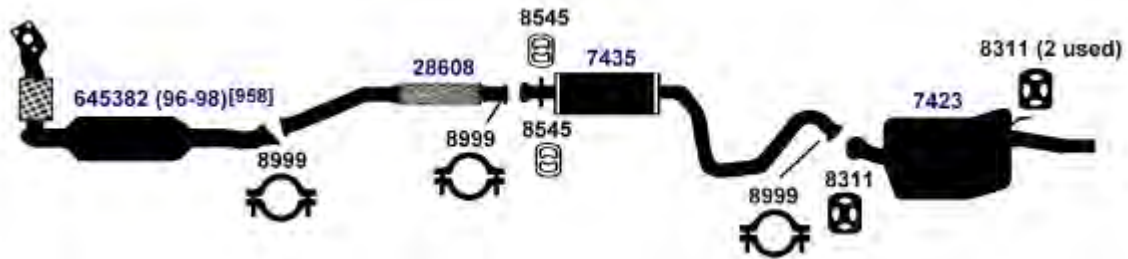

86-93 4 Cyl. 900S; 2.0L, 2.1L Engine; except Turbo (9745)
89-92 4 Cyl. 900; 2.0L, 2.1L Engine; except Turbo

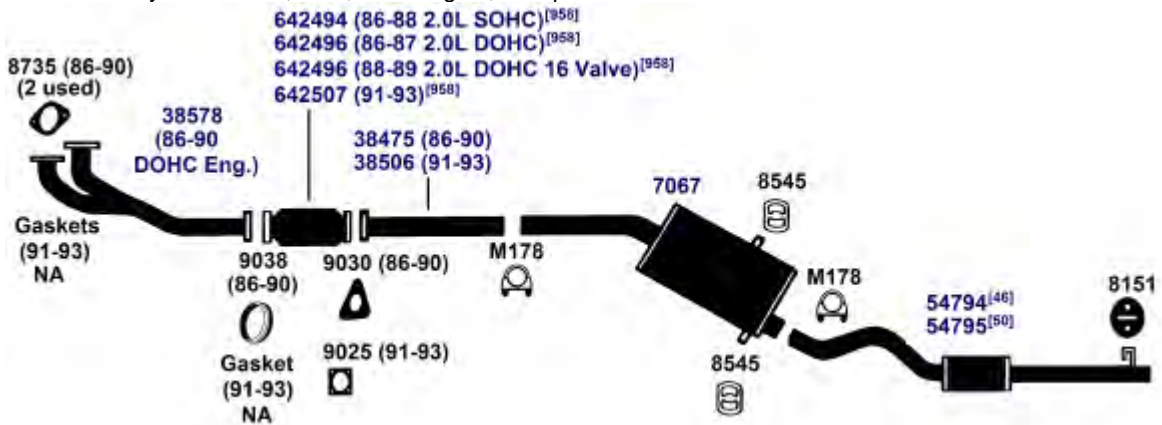

UNIVERSAL FIT MSL/MAXIMUM Muffler... 709008

NA-Not Available. NR-Not Required. FL-Remove and Re-Use Old Flange. ● Golden Warehouse. O.E.-Original Equipment.
Airtube Kit [4948] may be required to complete installation. EFI-Electronic Fuel Injection.

[46] Up to Chassis G2021147/G3015681/G7024052.
[50] From Chassis G2021147/G3015681/G7024052.

[958] Federal & California Emission vehicles. Not legal for sale for vehicles licensed in California.

SAAB 900

(9742) 85-93 4 Cyl. 900, 2.0L Turbo Engine

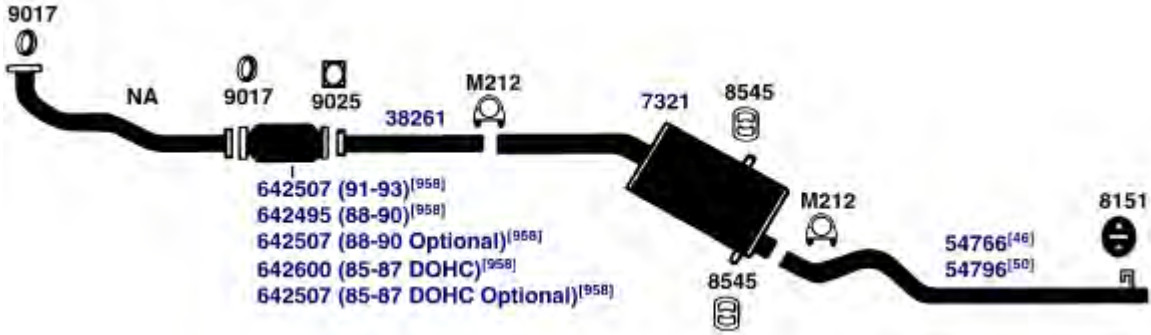

(9742E) 1984 4 Cyl. 900, 2.0L Turbo Engine

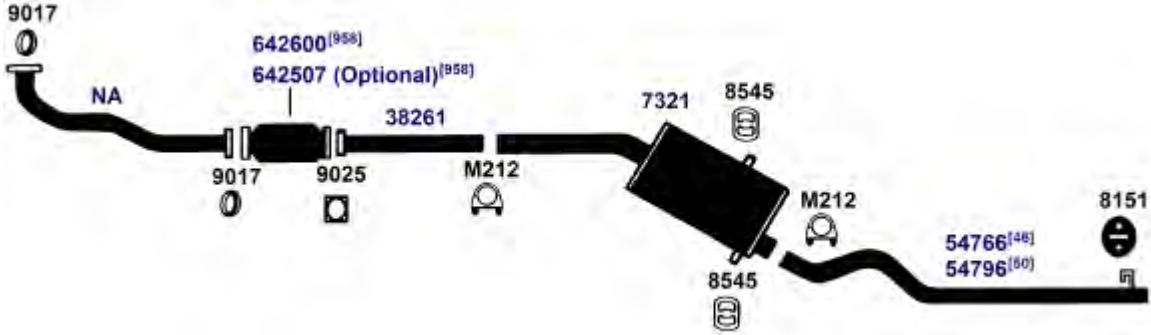

(9740) 81-83 4 Cyl. 900 Turbo

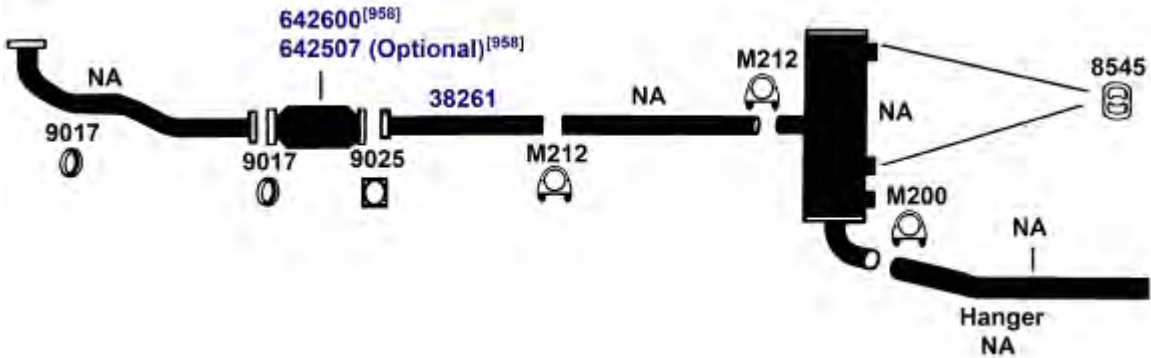

NA-Not Available. NR-Not Required. FL-Remove and Re-Use Old Flange. ● Golden Warehouse. O.E.-Original Equipment.
Airtube Kit [4948] may be required to complete installation. EFI-Electronic Fuel Injection.

[1] OE system was a welded assembly. It is recommended that all parts noted [1] should be replaced.

[45] Excluding 1983 vehicles with Chassis no. D2000000-D2003192.

[46] Up to Chassis G2021147/G3015681/G7024052.

[50] From Chassis G2021147/G3015681/G7024052.

[958] Federal & California Emission vehicles. Not legal for sale for vehicles licensed in California.

1994 4 Cyl. 9000, All Models; 2.3L Engine, exc. Turbo

(100263)

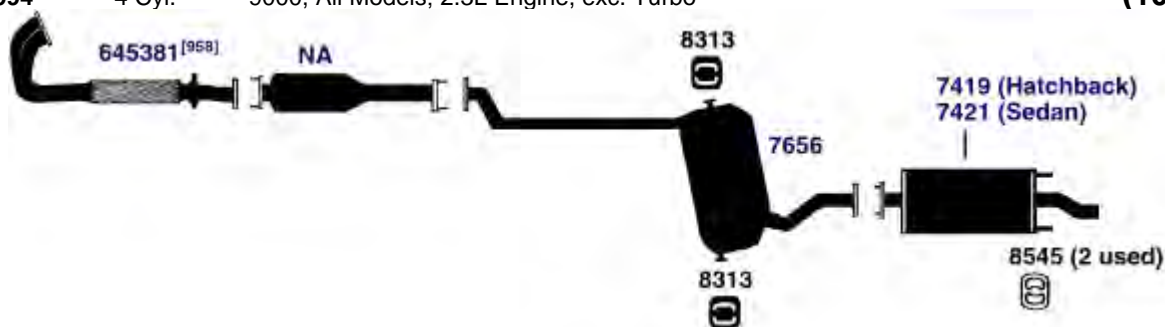

92-94 4 Cyl. 9000 Turbo, Excluding Aero; 2.3L Engine

(100264)



1993 4 Cyl. 9000, All Models; 2.3L Engine

(100265)

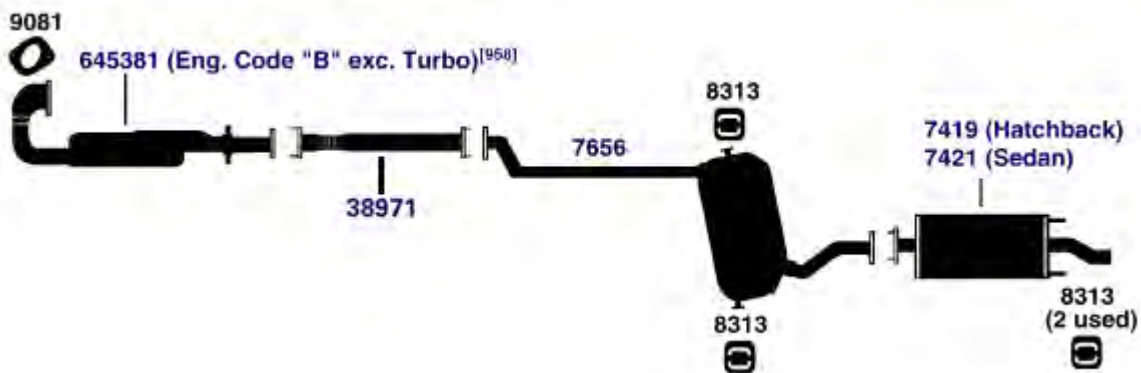

NA-Not Available. NR-Not Required. FL-Remove and Re-Use Old Flange. ● Golden Warehouse. O.E.-Original Equipment.
 # Airtube Kit [4948] may be required to complete installation. EFI-Electronic Fuel Injection.

[958] Federal & California Emission vehicles. Not legal for sale for vehicles licensed in California.

SAAB 9000

(11802) 89-92 4 Cyl. 9000, 2.0L, 2.3L Engine

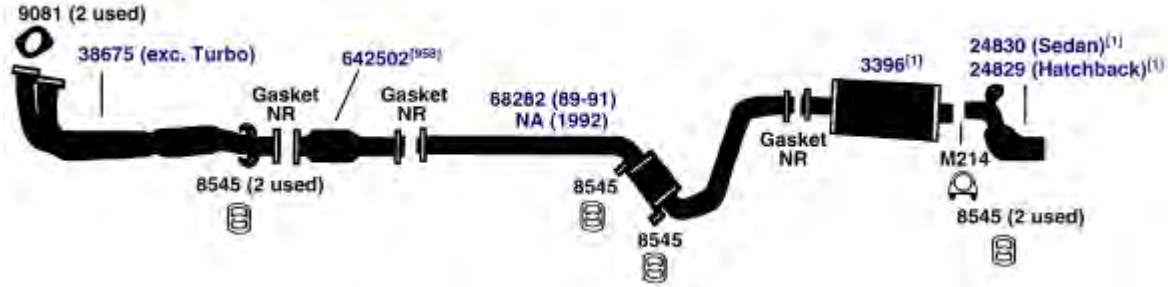

SATURN SATURN COUPE, SEDAN, STATION WAGON

(13728) 93-94 4 Cyl. Saturn Coupe, Sedan, Sta. Wagon; 1.9L SOHC Engine

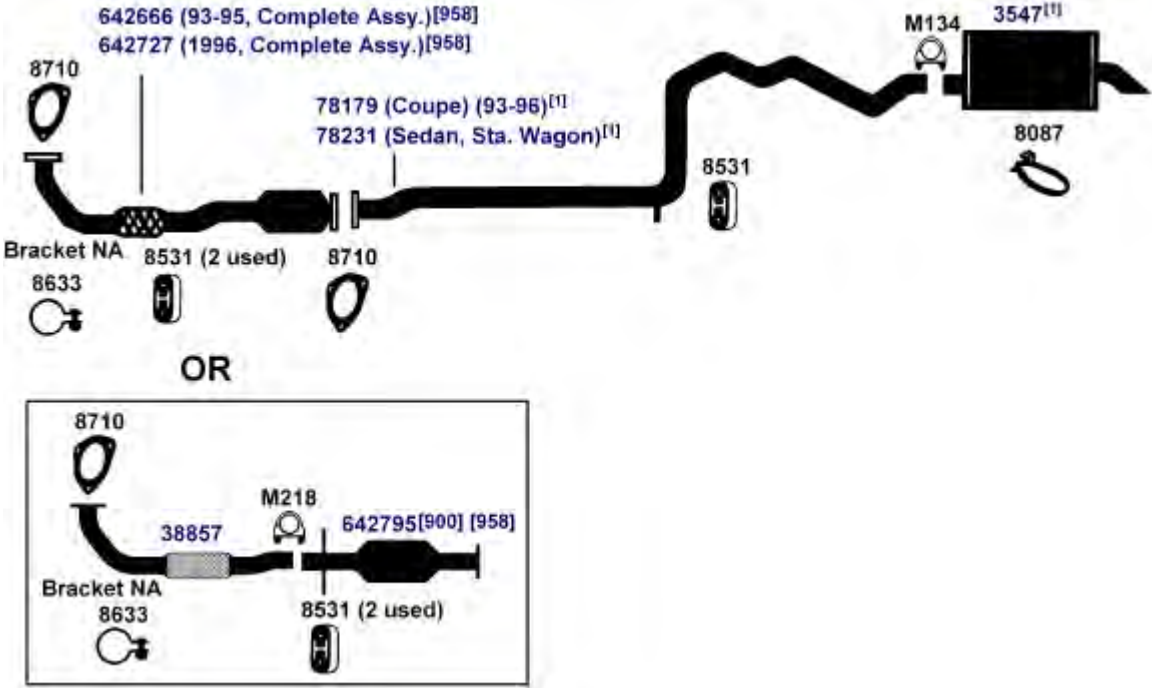

DIRECT FIT MSL/MAXIMUM Muffler... 700160

NA-Not Available. NR-Not Required. FL-Remove and Re-Use Old Flange. ● Golden Warehouse. O.E.-Original Equipment.
Airtube Kit [4948] may be required to complete installation. EFI-Electronic Fuel Injection.

[1] OE system was a welded assembly. It is recommended that all parts noted [1] should be replaced. [958] Federal & California Emission vehicles. Not legal for sale for vehicles licensed in California.
[900] Direct fit converter may require resizing, cutting or bushing.

SATURN COUPE, SEDAN, STATION WAGON

93-94 4 Cyl. Saturn Coupe, Sedan, Sta. Wagon; 1.9L DOHC Engine

(13727)

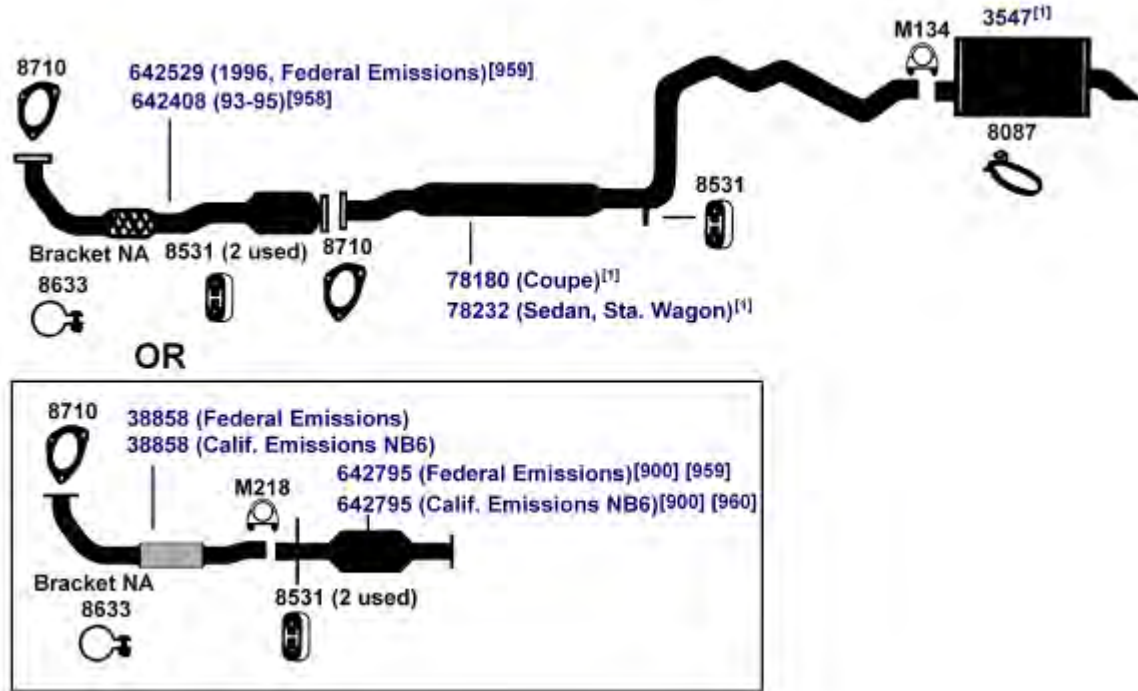

DIRECT FIT MSL/MAXIMUM Muffler... 700160

91-92 4 Cyl. Saturn SL, SL1; Sedan; 1.9L SOHC Engine

(13726)



DIRECT FIT MSL/MAXIMUM Muffler... 700160

NA-Not Available. NR-Not Required. FL-Remove and Re-Use Old Flange. ● Golden Warehouse. O.E.-Original Equipment.
Airtube Kit [4948] may be required to complete installation. EFI-Electronic Fuel Injection.

[1] OE system was a welded assembly. It is recommended that all parts noted [1] should be replaced.
[124] Up to VIN 117346.
[127] From VIN 117347.
[134] The O.E. extension pipe must be cut off 2 3/4" behind the pipe to converter weld.

[900] Direct fit converter may require resizing, cutting or bushing.
[958] Federal & California Emission vehicles. Not legal for sale for vehicles licensed in California.
[959] Federal Emission vehicles. Not legal for sale for vehicles licensed in California.
[960] California Emission vehicles licensed in states other than California. Not legal for sale for vehicles licensed in California.

SATURN COUPE, SEDAN, STATION WAGON

(13725) 91-92 4 Cyl. Saturn SL2; SC; 1.9L DOHC Engine

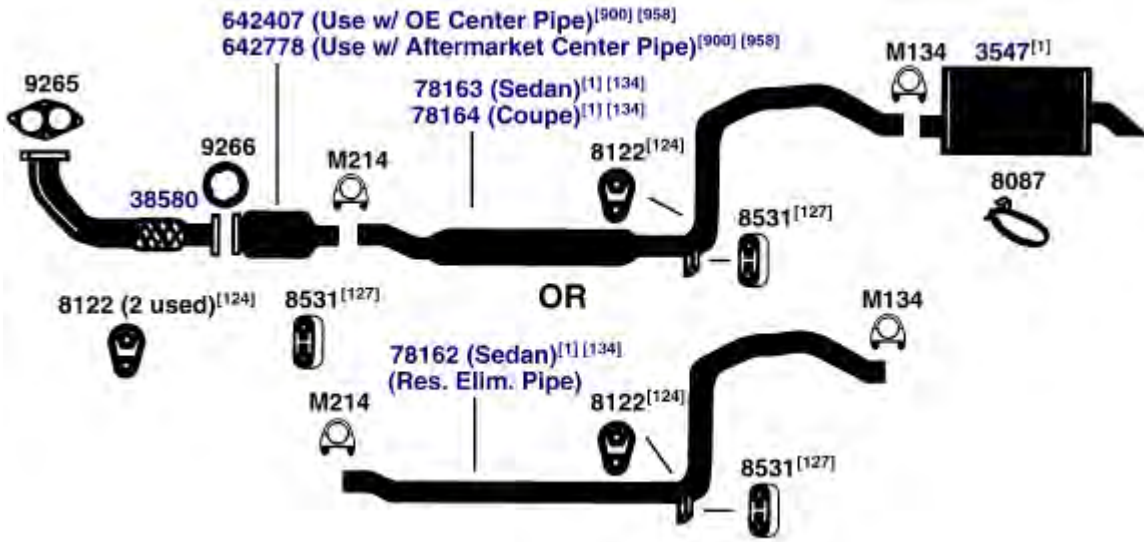

DIRECT FIT MSL/MAXIMUM Muffler... 700160

STERLING

(13300) 87-88 6 Cyl. 825S, 825SL; 2.5 L Engine

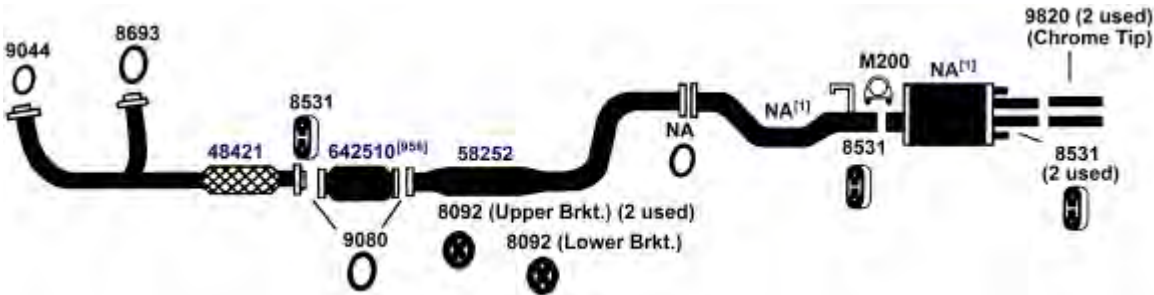

NA-Not Available. NR-Not Required. FL-Remove and Re-Use Old Flange. ● Golden Warehouse. O.E.-Original Equipment.
 # Airtube Kit [4948] may be required to complete installation. EFI-Electronic Fuel Injection.

[1] OE system was a welded assembly. It is recommended that all parts noted [1] should be replaced.
 [124] Up to VIN 117346.
 [127] From VIN 117347.

[134] The O.E. extension pipe must be cut off 2 3/4" behind the pipe to converter weld.
 [900] Direct fit converter may require resizing, cutting or bushing.
 [958] Federal & California Emission vehicles. Not legal for sale for vehicles licensed in California.

85-89 4 Cyl. Sta. Wagon, 1.8L Engine; 2 WD, 4 WD; except Turbo **(13929)**

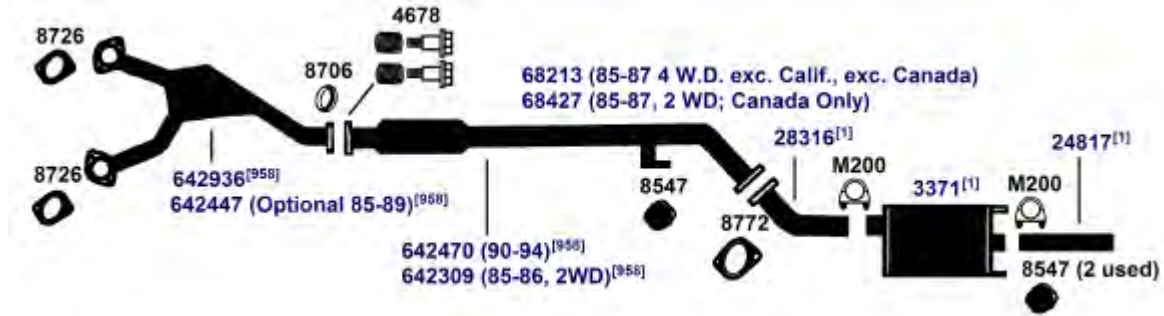

DIRECT FIT MSL/MAXIMUM Muffler... 6689, UNIVERSAL FIT MSL/MAXIMUM Muffler... 709017, Silentone DIY Muffler... 5596 and 24910 Spout

85-89 4 Cyl. Sta. Wagon, 1.8L Turbo Engine; 2 WD, 4WD **(13928)**

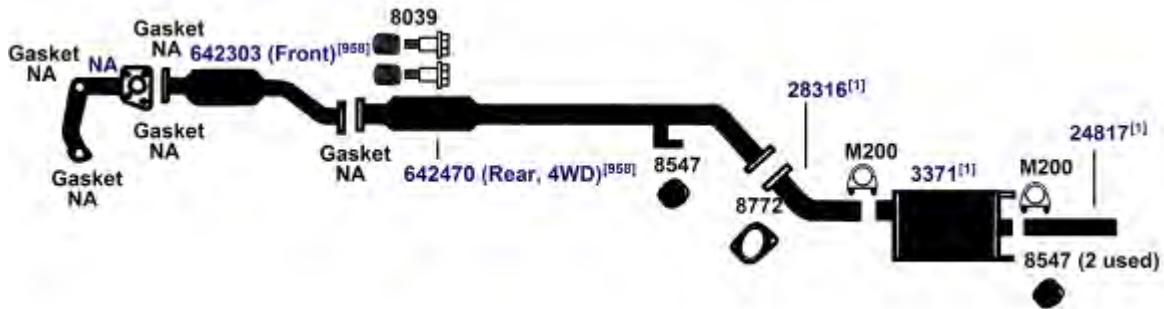

DIRECT FIT MSL/MAXIMUM Muffler... 6689, UNIVERSAL FIT MSL/MAXIMUM Muffler... 709017, Silentone DIY Muffler... 5596 and 24910 Spout

NA-Not Available. NR-Not Required. FL-Remove and Re-Use Old Flange. ● Golden Warehouse. O.E.-Original Equipment.
 # Airtube Kit [4948] may be required to complete installation. EFI-Electronic Fuel Injection.

[1] OE system was a welded assembly. It is recommended that all parts noted [1] should be replaced.
 [98] Refer to current Catalytic Converter catalog or Website catalog for availability.

[958] Federal & California Emission vehicles. Not legal for sale for vehicles licensed in California.
 [960] California Emission vehicles licensed in states other than California. Not legal for sale for vehicles licensed in California.

SUBARU COUPE, HARDTOP, SEDAN

(100416) 85-89 4 Cyl. 3-Door Coupe, 4-Door Sedan; 1.8L Engine; 2WD; except Turbo

- 642936 (4-door Sedan)^[958]
- 642447 (Optional, 4-door Sedan)^[958]
- 642310 (87-89, 3-door Coupe)^[958]
- 642447 (87-89, Optional, 3-door Coupe)^[958]
- 642312 (1986, 3-door Coupe w/Heat Stove Pipe)^[958]
- 642310 (1986, 3 Door Coupe w/o Heat Stove Pipe)^[958]

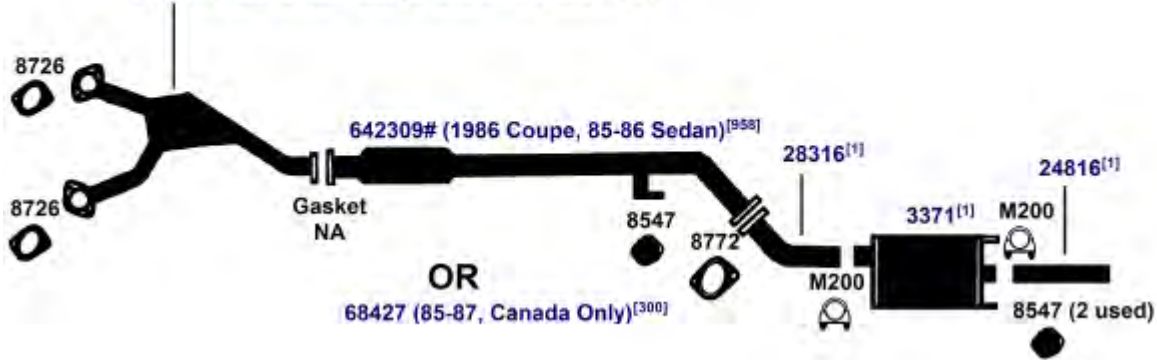

DIRECT FIT MSL/MAXIMUM Muffler... 6689, UNIVERSAL FIT MSL/MAXIMUM Muffler... 709017, Silentone DIY Muffler... 5596 and 24910 Spout

(100417) 85-89 4 Cyl. 3-Door Coupe, 4-Door Sedan; 1.8L Engine; 4WD; except Turbo

- 642936 (4-door Sedan)^[958]
- 642447 (Optional, 4-door Sedan)^[958]
- 642310 (87-89, 3-door Coupe)^[958]
- 642447 (Optional, 87-89, 3-door Coupe)^[958]
- 642312 (1986, 3-door Coupe w/Heat Stove Pipe)^[958]
- 642310 (1986, 3-door Coupe w/o Heat Stove Pipe)^[958]

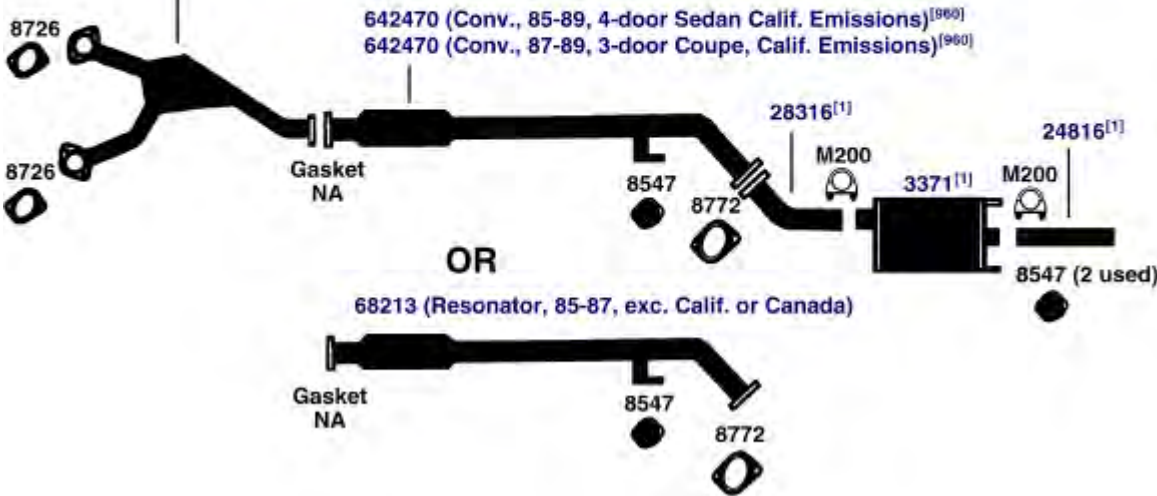

DIRECT FIT MSL/MAXIMUM Muffler... 6689, UNIVERSAL FIT MSL/MAXIMUM Muffler... 709017, Silentone DIY Muffler... 5596 and 24910 Spout

NA-Not Available. NR-Not Required. FL-Remove and Re-Use Old Flange. ● Golden Warehouse. O.E.-Original Equipment.
Airtube Kit [4948] may be required to complete installation. EFI-Electronic Fuel Injection.

[1] OE system was a welded assembly. It is recommended that all parts noted [1] should be replaced.

[98] Refer to current Catalytic Converter catalog or Website catalog for availability.

[300] For use when resonator originated from O.E. manufacturer.

[958] Federal & California Emission vehicles. Not legal for sale for vehicles licensed in California.

[960] California Emission vehicles licensed in states other than California. Not legal for sale for vehicles licensed in California.

SUBARU COUPE, HARDTOP, SEDAN

85-89

4 Cyl.

3-Door, 4-Door; 1.8L Engine; 2WD, 4WD; Turbo

(9833)

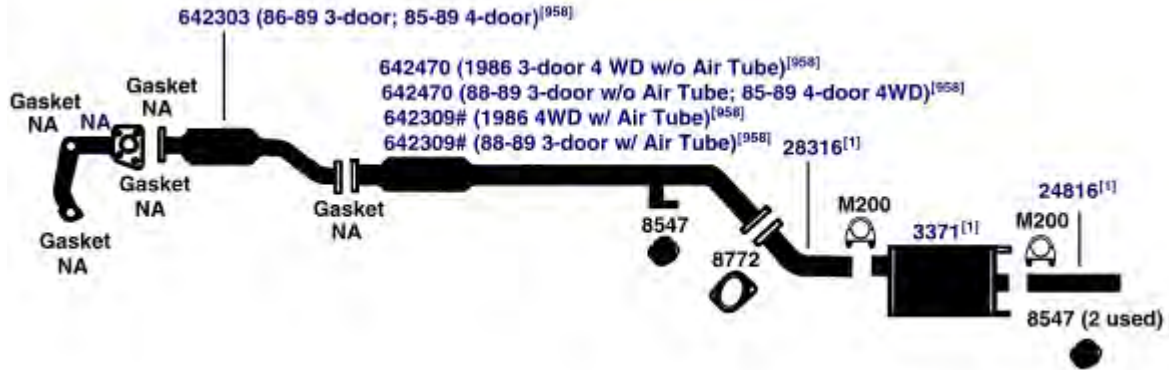

DIRECT FIT MSL/MAXIMUM Muffler... 6689, UNIVERSAL FIT MSL/MAXIMUM Muffler... 709017, Silentone DIY Muffler... 5596 and 24910 Spout

SUBARU HATCHBACK

85-89

4 Cyl.

2-Door Hatchback Sedan; 1.6L, 1.8L Engine; 2 WD, 4 WD

(9838)



UNIVERSAL FIT MSL/MAXIMUM Muffler... 6655

NA-Not Available. NR-Not Required. FL-Remove and Re-Use Old Flange. ● Golden Warehouse. O.E.-Original Equipment.
Airtube Kit [4948] may be required to complete installation. EFI-Electronic Fuel Injection.

[1] OE system was a welded assembly. It is recommended that all parts noted [1] should be replaced.

[98] Refer to current Catalytic Converter catalog or Website catalog for availability.

[958] Federal & California Emission vehicles. Not legal for sale for vehicles licensed in California.

SUBARU IMPREZA

(13528) 93-94 4 Cyl. Impreza 2-Door Coupe, 4-Door Sedan; 1.8L Engine

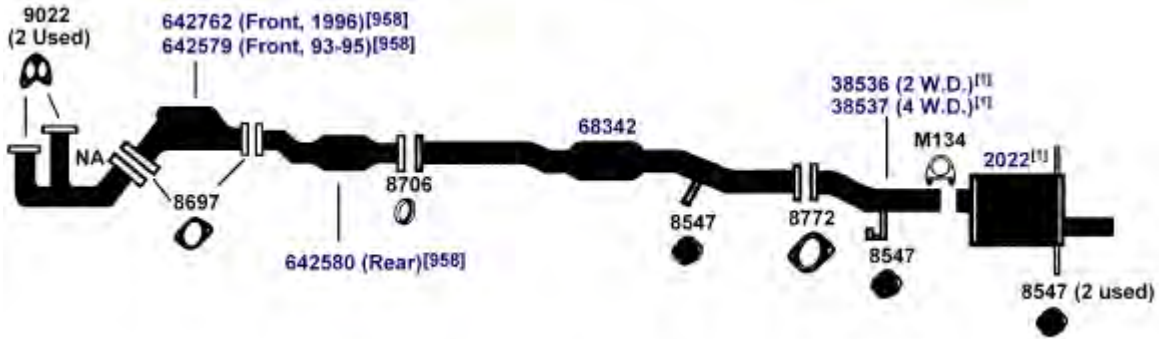

DIRECT FIT MSL/MAXIMUM Muffler... 700405

(13931) 93-94 4 Cyl. Impreza Sta. Wagon, 1.8L Engine

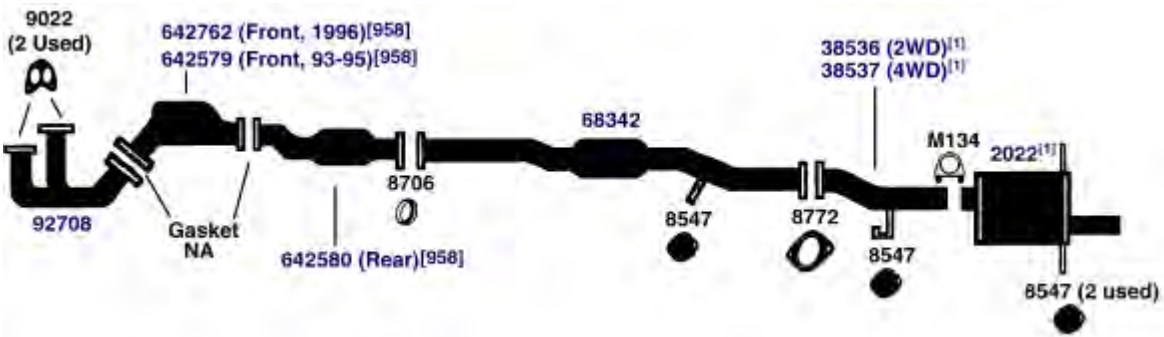

DIRECT FIT MSL/MAXIMUM Muffler... 700405

NA-Not Available. NR-Not Required. FL-Remove and Re-Use Old Flange. ● Golden Warehouse. O.E.-Original Equipment.
 # Airtube Kit [4948] may be required to complete installation. EFI-Electronic Fuel Injection.

[1] OE system was a welded assembly. It is recommended that all parts noted [1] should be replaced. [958] Federal & California Emission vehicles. Not legal for sale for vehicles licensed in California.

SUBARU JUSTY

87-94 3 Cyl. Justy, 1.2L Engine

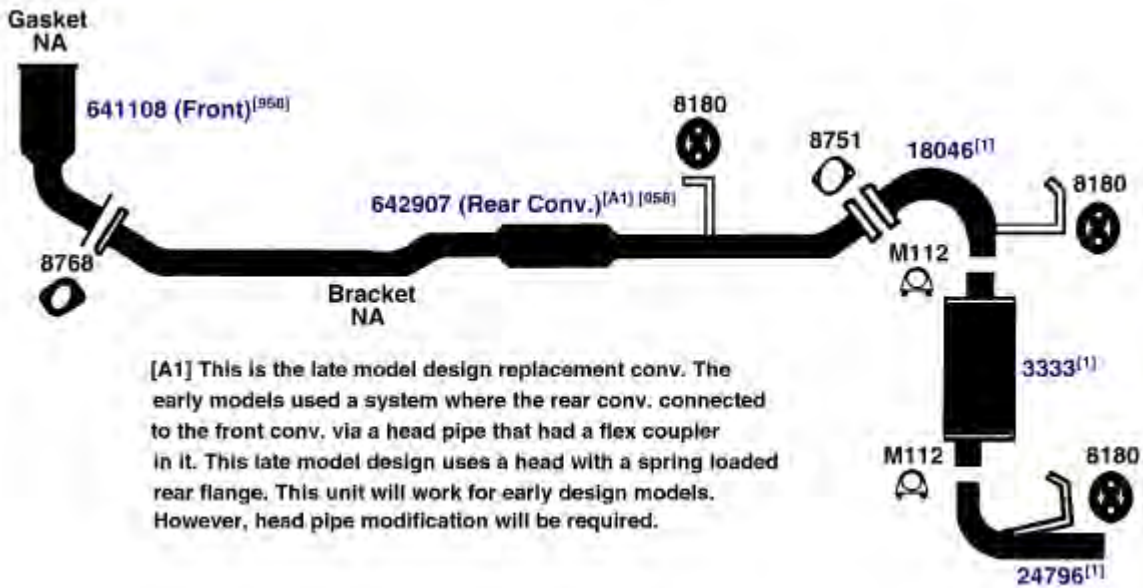
(13450)

UNIVERSAL FIT MSL/MAXIMUM Muffler... 6655

SUBARU LEGACY

1994 4 Cyl. Legacy 4-Door Sedan 2.2L Engine (From 3/94)

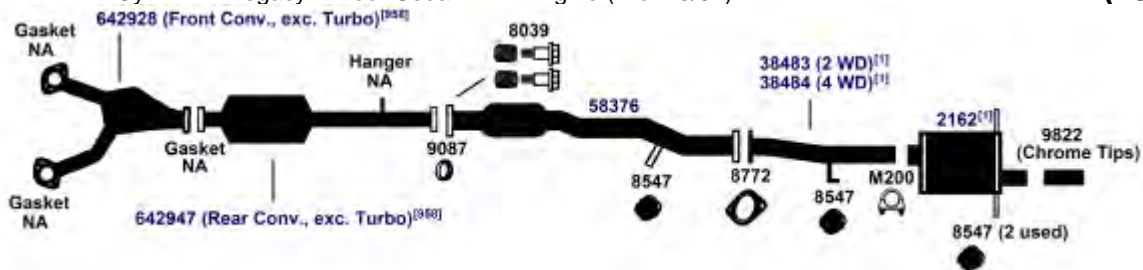
(13529)

DIRECT FIT MSL/MAXIMUM Muffler... 700408

NA-Not Available. NR-Not Required. FL-Remove and Re-Use Old Flange. ● Golden Warehouse. O.E.-Original Equipment.
Airtube Kit [4948] may be required to complete installation. EFI-Electronic Fuel Injection.

[1] OE system was a welded assembly. It is recommended that all parts noted [1] should be replaced. [958] Federal & California Emission vehicles. Not legal for sale for vehicles licensed in California.

SUBARU LEGACY

(13932) 1994 4 Cyl. Legacy Sta. Wagon, 2.2L and 2.5L Engine (From 3/94); Except Outback Models

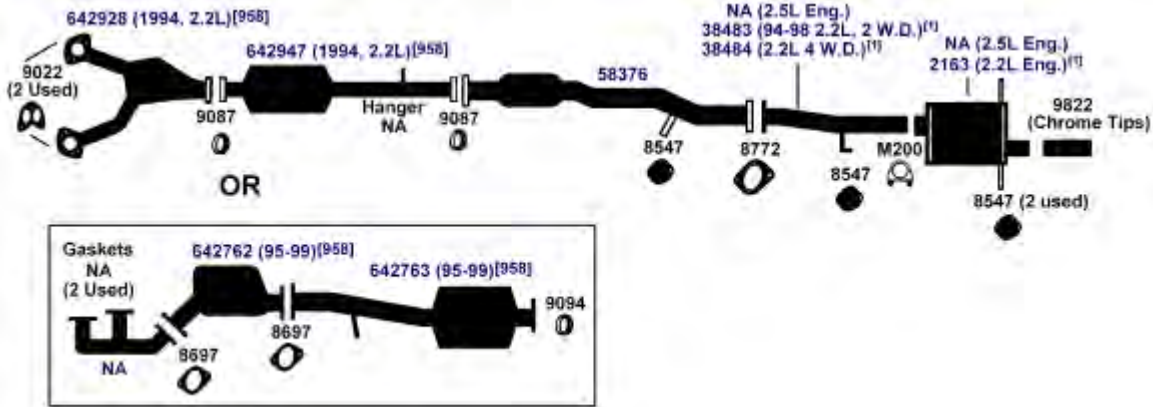

DIRECT FIT MSL/MAXIMUM Muffler... 700413 (2.2L Engine)

(13475) 90-94 4 Cyl. Legacy 4-Door Sedan; 2.2L Engine; except Turbo (through Feb, 1994)



DIRECT FIT MSL/MAXIMUM Muffler... 700284

(13930) 90-94 4 Cyl. Legacy Sta. Wagon, 2.2L Engine; 2 WD, 4 WD; except Turbo (through Feb., 1994)

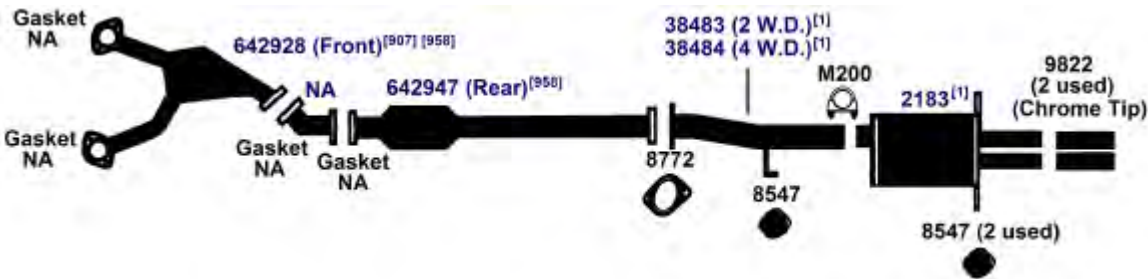

DIRECT FIT MSL/MAXIMUM Muffler... 700253

NA-Not Available. NR-Not Required. FL-Remove and Re-Use Old Flange. ● Golden Warehouse. O.E.-Original Equipment.
Airtube Kit [4948] may be required to complete installation. EFI-Electronic Fuel Injection.

[1] OE system was a welded assembly. It is recommended that all parts noted [1] should be replaced. [958] Federal & California Emission vehicles. Not legal for sale for vehicles licensed in California.

[907] Direct fit unit includes pipe between front and rear converters.

90-93 4 Cyl. Loyale; 3-Door Coupe, 4-Door Sedan; 1.8L Engine; 2WD, 4WD; except Turbo **(9837)**

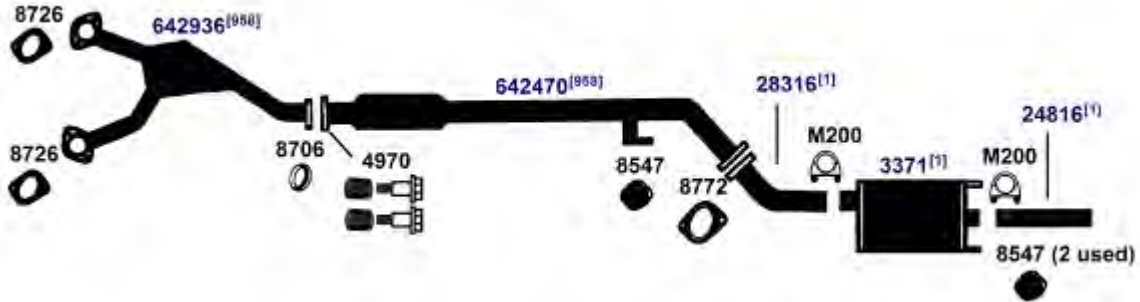

DIRECT FIT MSL/MAXIMUM Muffler... 6689, UNIVERSAL FIT MSL/MAXIMUM Muffler... 709017, Silentone DIY Muffler... 5596 and 24910 Spout

90-94 4 Cyl. Loyale Sta. Wagon, 1.8L Engine; 2 WD, 4 WD; Except Turbo **(13929)**

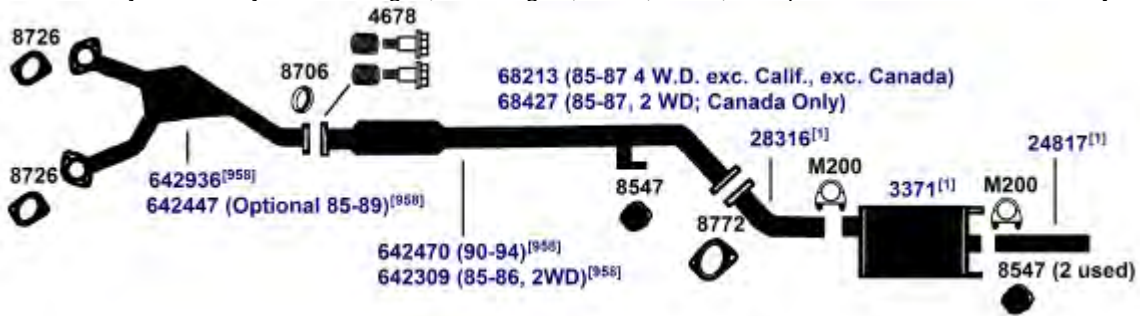

DIRECT FIT MSL/MAXIMUM Muffler... 6689, UNIVERSAL FIT MSL/MAXIMUM Muffler... 709017, Silentone DIY Muffler... 5596 and 24910 Spout

1990 4 Cyl. Loyale; 3-Door, 4-Door; 1.8L Engine; 2WD, 4WD; Turbo **(9833)**



DIRECT FIT MSL/MAXIMUM Muffler... 6689, UNIVERSAL FIT MSL/MAXIMUM Muffler... 709017, Silentone DIY Muffler... 5596 and 24910 Spout

NA-Not Available. NR-Not Required. FL-Remove and Re-Use Old Flange. ● Golden Warehouse. O.E.-Original Equipment.
Airtube Kit [4948] may be required to complete installation. EFI-Electronic Fuel Injection.

- [1] OE system was a welded assembly. It is recommended that all parts noted [1] should be replaced.
- [98] Refer to current Catalytic Converter catalog or Website catalog for availability.
- [958] Federal & California Emission vehicles. Not legal for sale for vehicles licensed in California.

SUBARU XT

(13526) 88-91 6 Cyl. XT6, 2-Door Coupe, 2.7L Engine
 85-91 4 Cyl. XT, 2-Door Coupe, 1.8L Engine; except Turbo

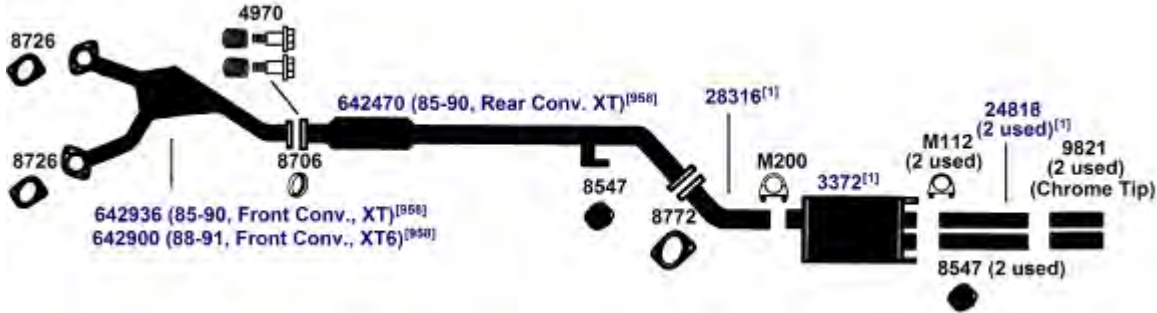

DIRECT FIT MSL/MAXIMUM Muffler... 700116, Silentone DIY Muffler... 5596 and 24910 Spout

(13525) 85-88 4 Cyl. XT, 2-Door Coupe, 1.8L Turbo Engine

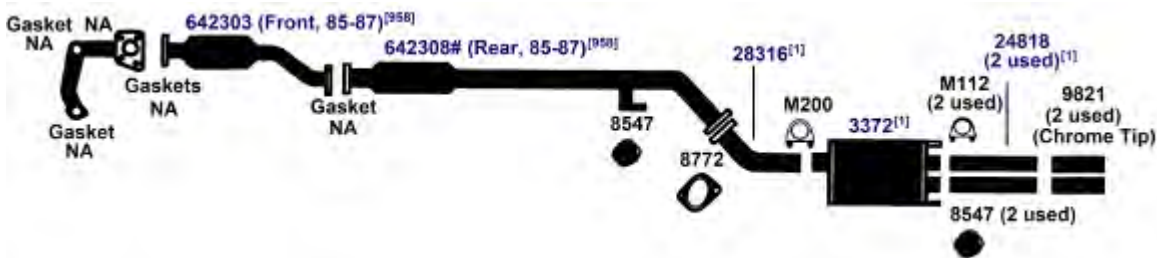

DIRECT FIT MSL/MAXIMUM Muffler... 700116, Silentone DIY Muffler... 5596 and 24910 Spout

SUZUKI SUZUKI FORSA

(100307) 87-88 3 Cyl. Forsa, 1.0L Engine, except Turbo. (CANADA ONLY)

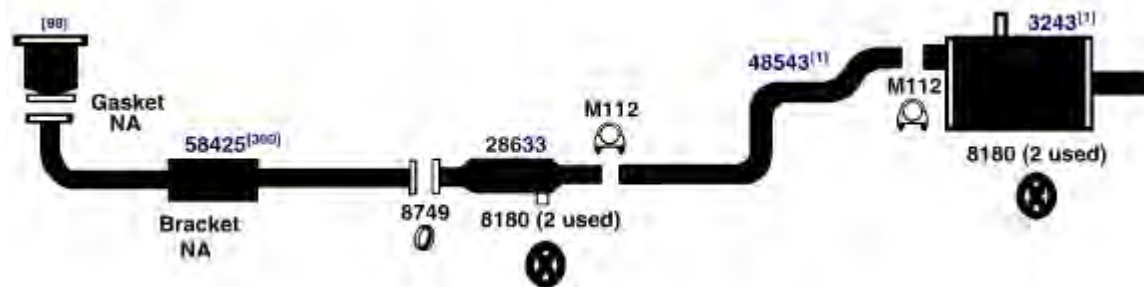

DIRECT FIT MSL/MAXIMUM Muffler... 700095, UNIVERSAL FIT MSL/MAXIMUM Muffler... 6654

NA-Not Available. NR-Not Required. FL-Remove and Re-Use Old Flange. ● Golden Warehouse. O.E.-Original Equipment.
 # Airtube Kit [4948] may be required to complete installation. EFI-Electronic Fuel Injection.

[1] OE system was a welded assembly. It is recommended that all parts noted [1] should be replaced.

[98] Refer to current Catalytic Converter catalog or Website catalog for availability.

[300] For use when resonator originated from O.E. manufacturer.

[958] Federal & California Emission vehicles. Not legal for sale for vehicles licensed in California.

SUZUKI SAMURAI

86-94 4 Cyl. Samurai, 1.3L Engine

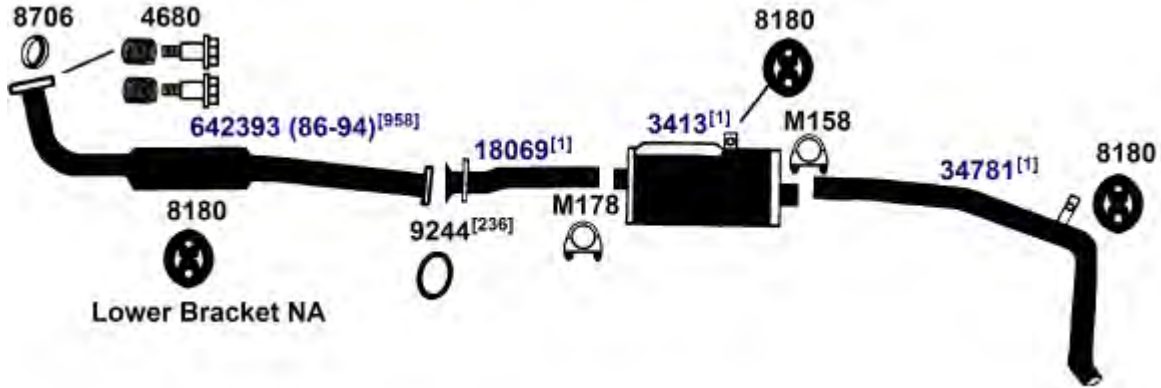
(30950)

DIRECT FIT MSL/MAXIMUM Muffler... 700125

SUZUKI SIDEKICK

1994 4 Cyl. Sidekick; 1.6L Engine; Convertible 1.6L (16 Valve Engine), 2 W.D.

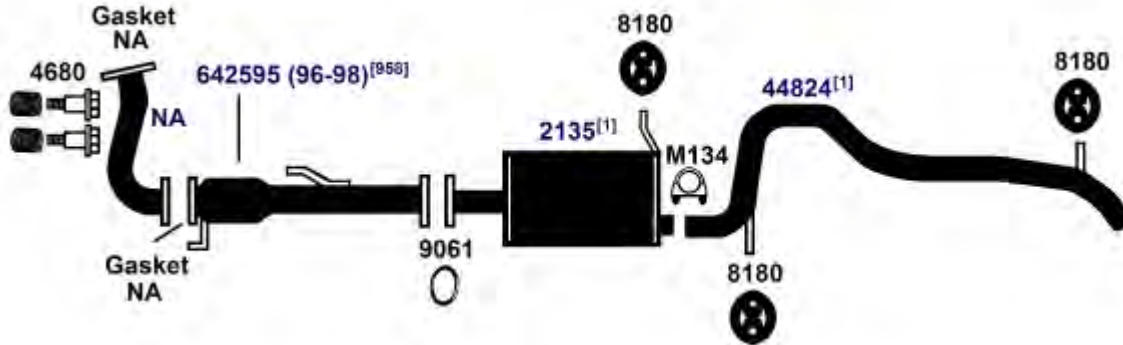
(34106)

DIRECT FIT MSL/MAXIMUM Muffler... 700242, UNIVERSAL FIT MSL/MAXIMUM Muffler... 6651

1994 4 Cyl. Sidekick; 4-Door Hardtop, 1.6L (16 Valve Engine)

(34105)

1993 4 Cyl. Sidekick, 4-Door Hardtop, 1.6L (16 Valve Engine), California

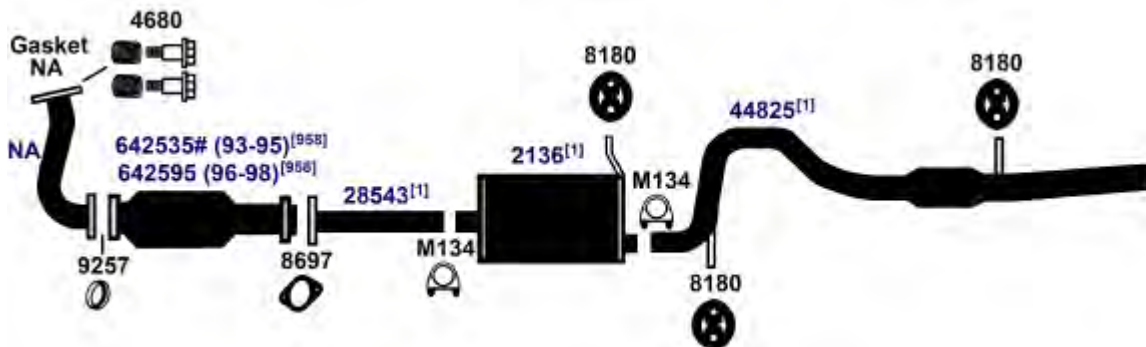

DIRECT FIT MSL/MAXIMUM Muffler... 700243

NA-Not Available. NR-Not Required. FL-Remove and Re-Use Old Flange. ● Golden Warehouse. O.E.-Original Equipment.

Airtube Kit [4948] may be required to complete installation. EFI-Electronic Fuel Injection.

[1] OE system was a welded assembly. It is recommended that all parts noted [1] should be replaced.

[958] Federal & California Emission vehicles. Not legal for sale for vehicles licensed in California.

[236] Not Required with aftermarket Converter

SUZUKI SIDEKICK

(34102) 1994 4 Cyl. Sidekick; 1.6L Engine (except 16 Valve Engine), Convertible; 2 W.D.
 91-93 4 Cyl. Sidekick; 1.6L Engine; Convertible

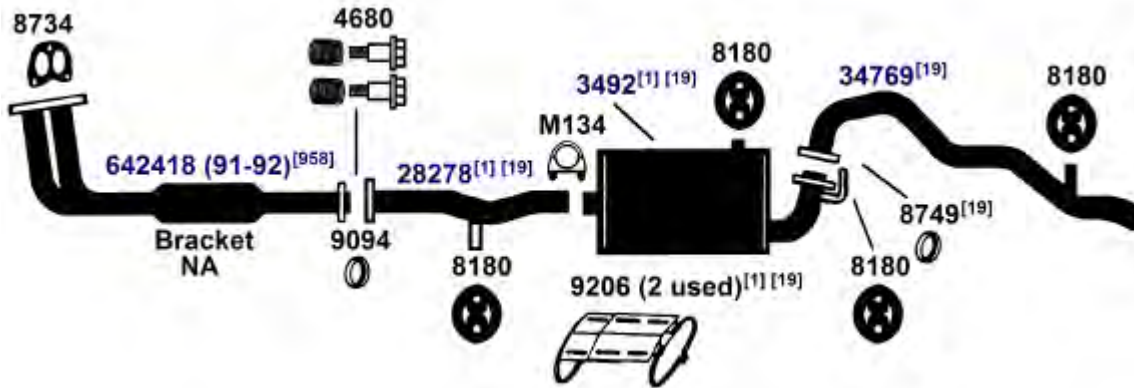

DIRECT FIT MSL/MAXIMUM Muffler... 700024, UNIVERSAL FIT MSL/MAXIMUM Muffler... 709008

(34104) 92-93 4 Cyl. Sidekick; 1.6L Engine; 4-Door Hardtop; except 1993 California

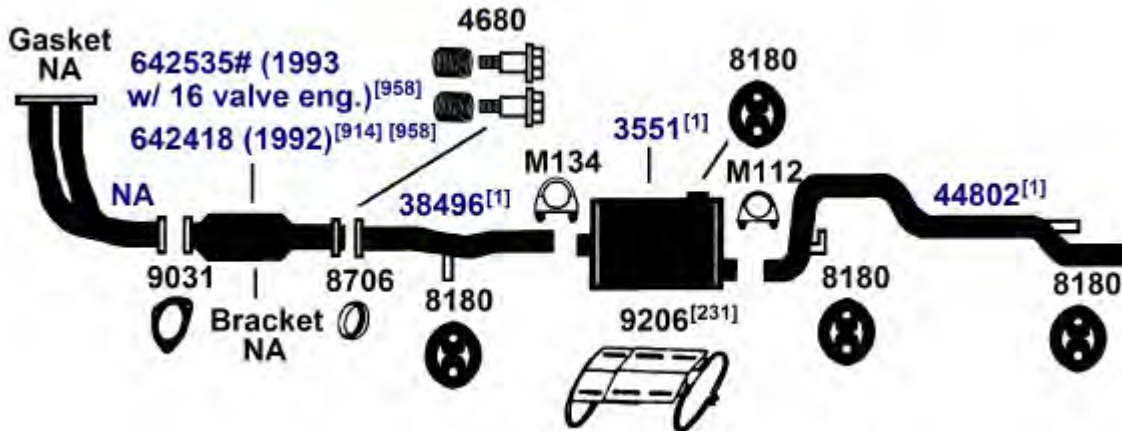

NA-Not Available. NR-Not Required. FL-Remove and Re-Use Old Flange. ● Golden Warehouse. O.E.-Original Equipment.
 # Airtube Kit [4948] may be required to complete installation. EFI-Electronic Fuel Injection.

[1] OE system was a welded assembly. It is recommended that all parts noted [1] should be replaced.

[19] On vehicles that have an O.E. one piece exhaust pipe-muffler-tail pipe assembly, all parts noted [19] must be used in combination to replace the O.E. assembly.

[98] Refer to current Catalytic Converter catalog or Website catalog for availability.

[231] If muffler is equipped with a heat shield (does not have a black triangle on the carton label), purchase of 9206 is not required.

[914] Direct fit converter includes front (Exhaust) pipe, (1) piece assembly.

[958] Federal & California Emission vehicles. Not legal for sale for vehicles licensed in California.

SUZUKI SIDEKICK

1991 4 Cyl. Sidekick; 1.6L Engine 4-Door Hardtop

(34103)

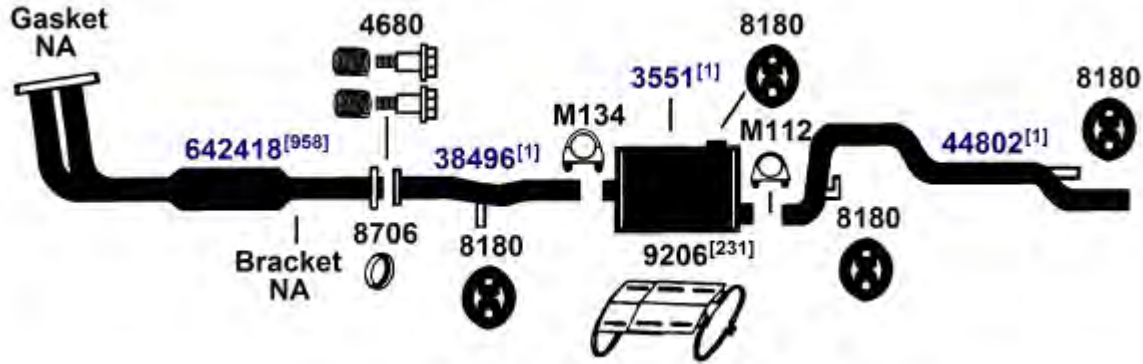

89-90 4 Cyl. Sidekick; 1.6L Engine
1989 4 Cyl. Sidekick; 1.3L Engine

(34101)

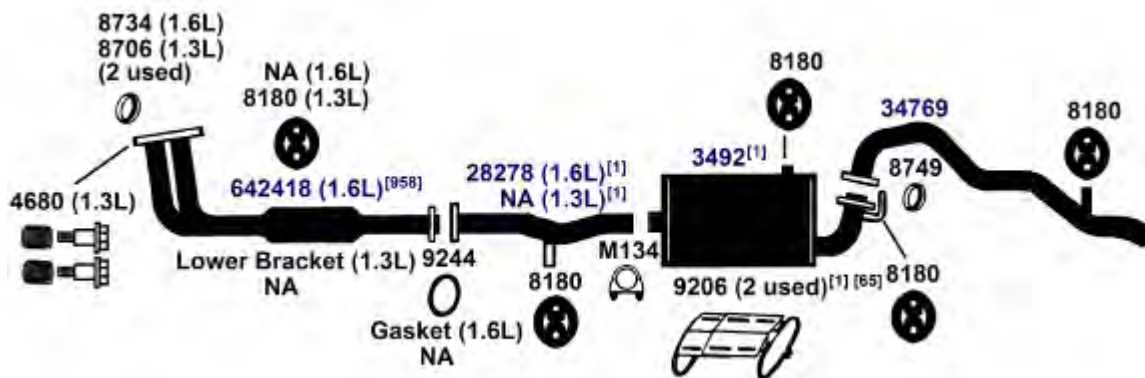

DIRECT FIT MSL/MAXIMUM Muffler... 700024, UNIVERSAL FIT MSL/MAXIMUM Muffler... 709008

SUZUKI SWIFT

90-94 4 Cyl. Swift 4-Door Sedan, 1.3L Engine

(12951)

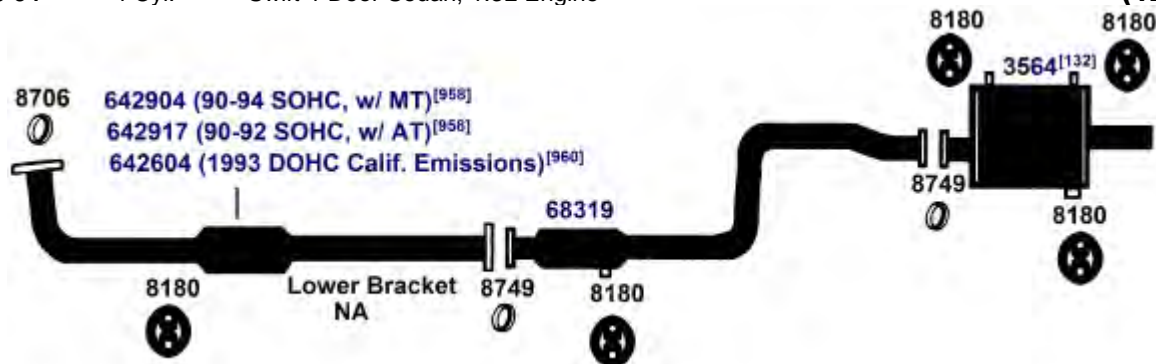

NA-Not Available. NR-Not Required. FL-Remove and Re-Use Old Flange. ● Golden Warehouse. O.E.-Original Equipment.
Airtube Kit [4948] may be required to complete installation. EFI-Electronic Fuel Injection.

[1] OE system was a welded assembly. It is recommended that all parts noted [1] should be replaced.

[65] Heat Shield 9206 is required for installation.

[98] Refer to current Catalytic Converter catalog or Website catalog for availability.

[132] If black triangle appears on muffler label, remove and re-use O.E. heat shield or fabricate heat shield.

[231] If muffler is equipped with a heat shield (does not have a black triangle on the carton label), purchase of 9206 is not required.

[958] Federal & California Emission vehicles. Not legal for sale for vehicles licensed in California.

[960] California Emission vehicles licensed in states other than California. Not legal for sale for vehicles licensed in California.

SUZUKI SWIFT

(12950) 89-94 4 Cyl. Swift 2-Door Hatchback, 1.3L Engine; except GT & GTi with DOHC Engine
 89-90 4 Cyl. Swift 4-Door Hatchback, 1.3L Engine



DIRECT FIT MSL/MAXIMUM Muffler... 700003, UNIVERSAL FIT MSL/MAXIMUM Muffler... 6653

(12952) 89-94 4 Cyl. Swift GT, GTi, 1.3L DOHC Engine

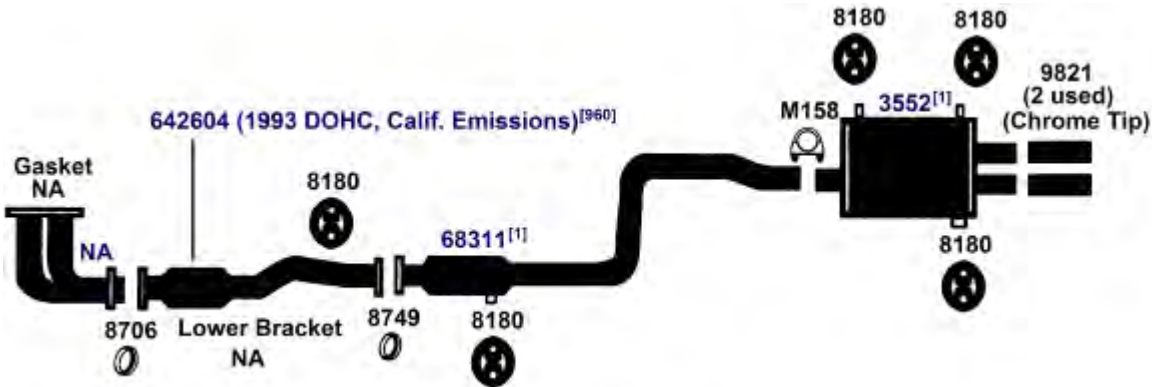

NA-Not Available. NR-Not Required. FL-Remove and Re-Use Old Flange. ● Golden Warehouse. O.E.-Original Equipment.
 # Airtube Kit [4948] may be required to complete installation. EFI-Electronic Fuel Injection.

[1] OE system was a welded assembly. It is recommended that all parts noted [1] should be replaced.

[112] Required for installation except when a black triangle appears on muffler carton label.

[958] Federal & California Emission vehicles. Not legal for sale for vehicles licensed in California.

[960] California Emission vehicles licensed in states other than California. Not legal for sale for vehicles licensed in California.

90-94 4 Cyl. 4-Runner; 2.4L Fuel Inj. Engine; 2 W.D., 4 W.D.; except California

(31504)

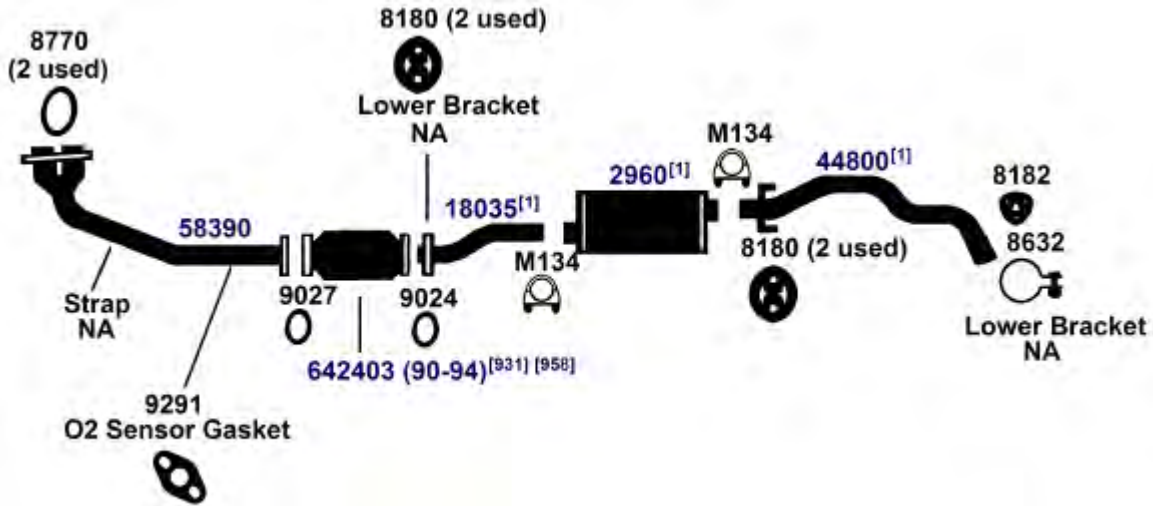

DIRECT FIT MSL/MAXIMUM Muffler... 6672, UNIVERSAL FIT MSL/MAXIMUM Muffler... 709994, Silentone DIY Muffler... 5580

90-94 6 Cyl. 4-Runner; 3.0L Fuel Inj. Engine; 2 W.D., 4 W.D.

(31503)

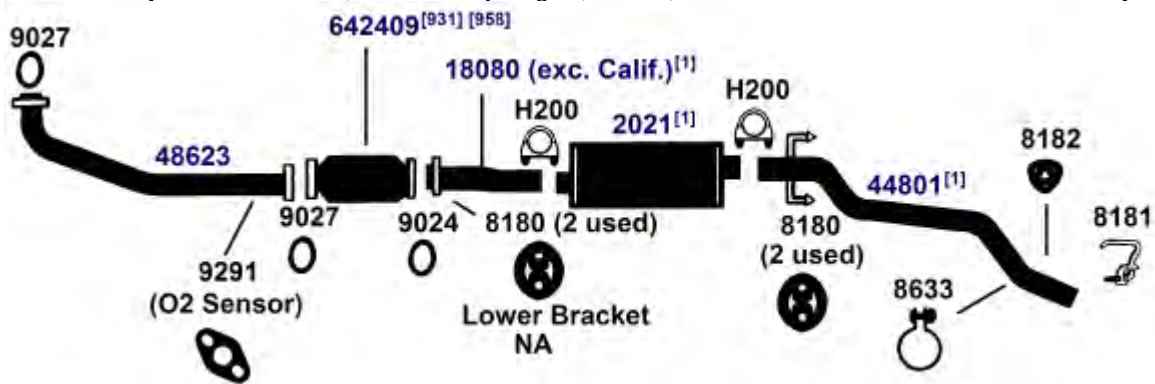

DIRECT FIT MSL/MAXIMUM Muffler... 700152, UNIVERSAL FIT MSL/MAXIMUM Muffler... 709993, 709994

NA-Not Available. NR-Not Required. FL-Remove and Re-Use Old Flange. ● Golden Warehouse. O.E.-Original Equipment.
Airtube Kit [4948] may be required to complete installation. EFI-Electronic Fuel Injection.

[1] OE system was a welded assembly. It is recommended that all parts noted [1] should be replaced.

[931] This unit was designed to fit many applications. Measurement of the old unit and cutting of new unit is required.

[958] Federal & California Emission vehicles. Not legal for sale for vehicles licensed in California.

TOYOTA 4-RUNNER

(31502) 88-89 6 Cyl. 4-Runner; 3.0L Engine; 2 W.D., 4 W.D.

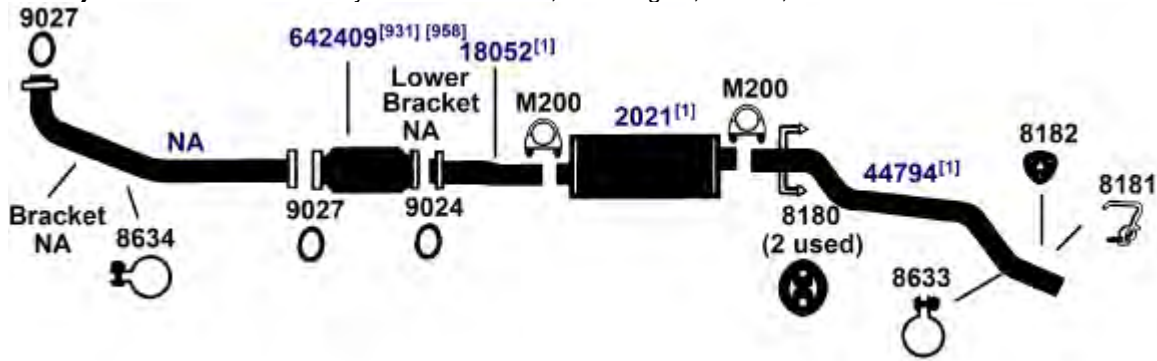

DIRECT FIT MSL/MAXIMUM Muffler... 700152, UNIVERSAL FIT MSL/MAXIMUM Muffler... 709993, 709994

(31501) 86-89 4 Cyl. 4-Runner; 2.4L Fuel Inj., 2.4L Turbo Engine; 4 W.D.

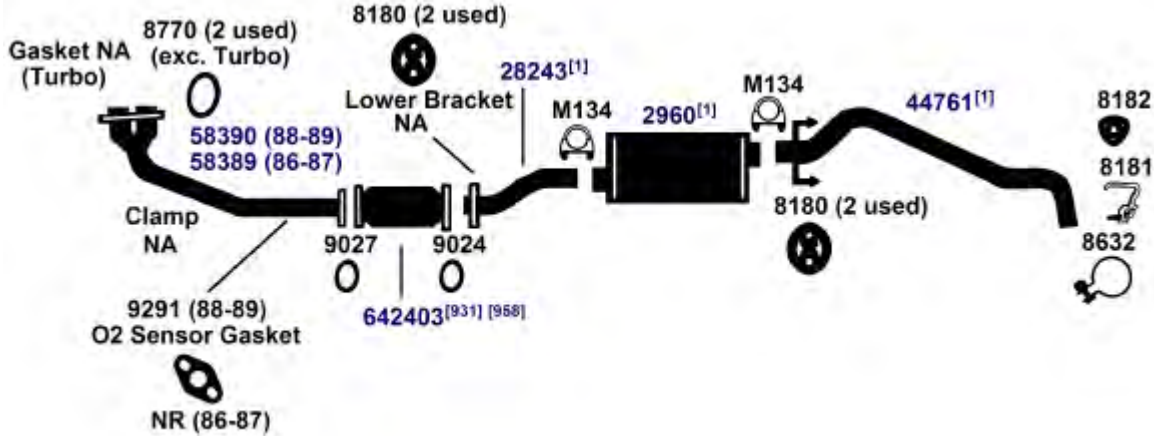

DIRECT FIT MSL/MAXIMUM Muffler... 6672, UNIVERSAL FIT MSL/MAXIMUM Muffler... 709994, Silentone DIY Muffler... 5580

(31500) 1985 4 Cyl. 4-Runner; 2.4L Carb., 2.4L Fuel Inj. Engine; 4 W.D.

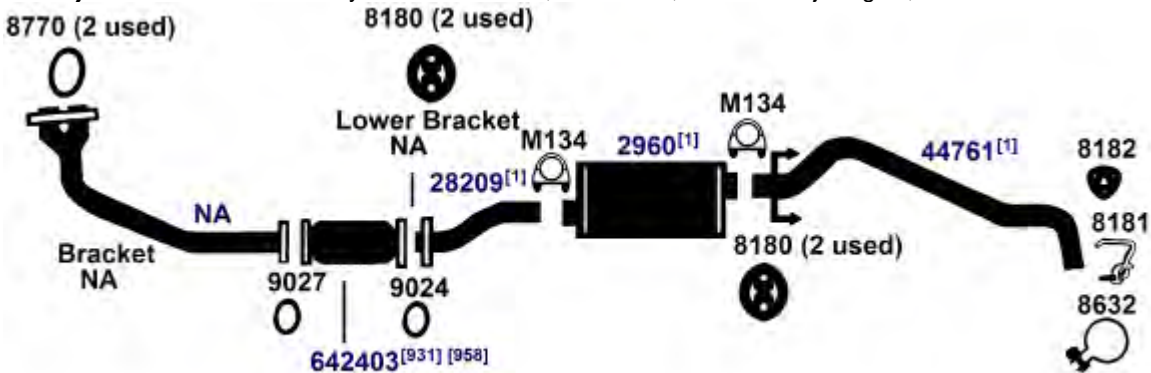

DIRECT FIT MSL/MAXIMUM Muffler... 6672, UNIVERSAL FIT MSL/MAXIMUM Muffler... 709994, Silentone DIY Muffler... 5580

NA-Not Available. NR-Not Required. FL-Remove and Re-Use Old Flange. ● Golden Warehouse. O.E.-Original Equipment.
Airtube Kit [4948] may be required to complete installation. EFI-Electronic Fuel Injection.

[1] OE system was a welded assembly. It is recommended that all parts noted [1] should be replaced.

[958] Federal & California Emission vehicles. Not legal for sale for vehicles licensed in California.

[931] This unit was designed to fit many applications. Measurement of the old unit and cutting of new unit is required.

TOYOTA 4-RUNNER

1984 4 Cyl. 4-Runner; 2.4L Carb., 2.4L Fuel Inj. Engine; 4 W.D.

(31500E)

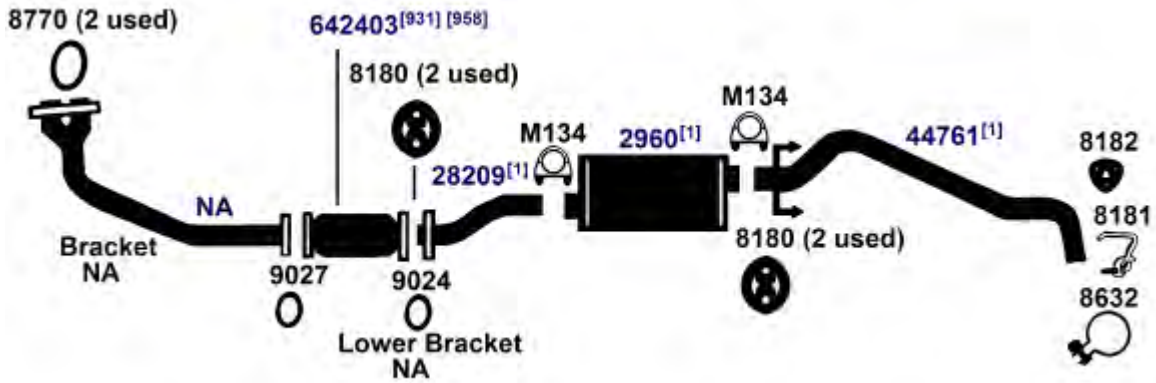

DIRECT FIT MSL/MAXIMUM Muffler... 6672, UNIVERSAL FIT MSL/MAXIMUM Muffler... 709994, Silentone DIY Muffler... 5580

TOYOTA CAMRY

1994 4 Cyl. Camry Coupe, Sedan; 2.2L EFI Engine

(9887)

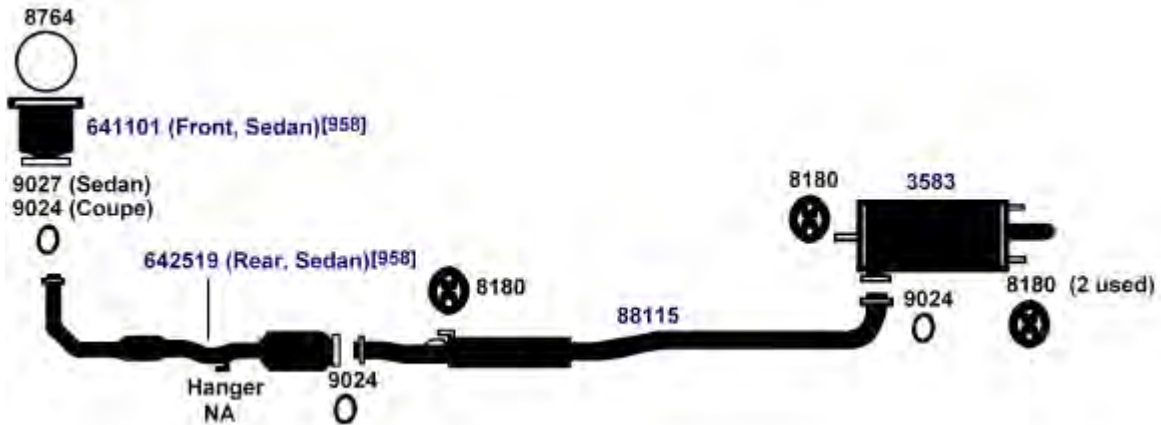

DIRECT FIT MSL/MAXIMUM Muffler... 700448

NA-Not Available. NR-Not Required. FL-Remove and Re-Use Old Flange. ● Golden Warehouse. O.E.-Original Equipment.
Airtube Kit [4948] may be required to complete installation. EFI-Electronic Fuel Injection.

[1] OE system was a welded assembly. It is recommended that all parts noted [1] should be replaced.

[931] This unit was designed to fit many applications. Measurement of the old unit and cutting of new unit is required.

[958] Federal & California Emission vehicles. Not legal for sale for vehicles licensed in California.

TOYOTA CAMRY

(9885) 1994 6 Cyl. Camry Coupe, Sedan; 3.0L EFI Engine
 92-93 6 Cyl. Camry, 3.0L EFI Engine



DIRECT FIT MSL/MAXIMUM Muffler... 700447

(9886) 92-93 4 Cyl. Camry 2.2L EFI Engine; except California

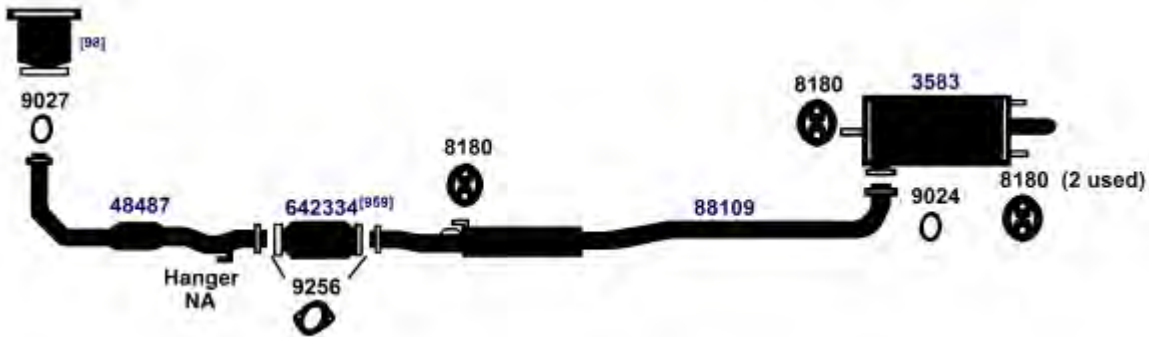

DIRECT FIT MSL/MAXIMUM Muffler... 700448

NA-Not Available. NR-Not Required. FL-Remove and Re-Use Old Flange. ● Golden Warehouse. O.E.-Original Equipment.
 # Airtube Kit [4948] may be required to complete installation. EFI-Electronic Fuel Injection.

[98] Refer to current Catalytic Converter catalog or Website catalog for availability.
 [958] Federal & California Emission vehicles. Not legal for sale for vehicles licensed in California.

[959] Federal Emission vehicles. Not legal for sale for vehicles licensed in California.

88-91 6 Cyl. Camry Sedan, Sta. Wagon; 2.5L Engine; except All Wheel Drive (9884)

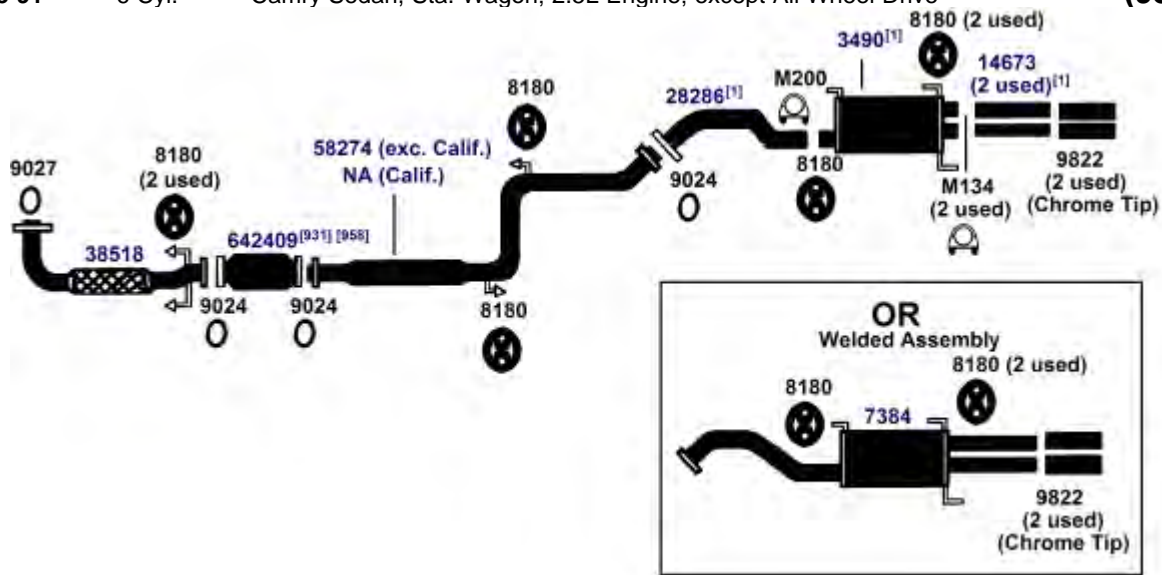

DIRECT FIT MSL/MAXIMUM Muffler... Split System- 700135, UNIVERSAL FIT MSL/MAXIMUM Muffler... Split System- 709015, Welded Assembly- 709015

87-91 4 Cyl. Camry Sedan, Sta. Wagon; 2.0L Fuel Injection Engine; 2WD (9883)

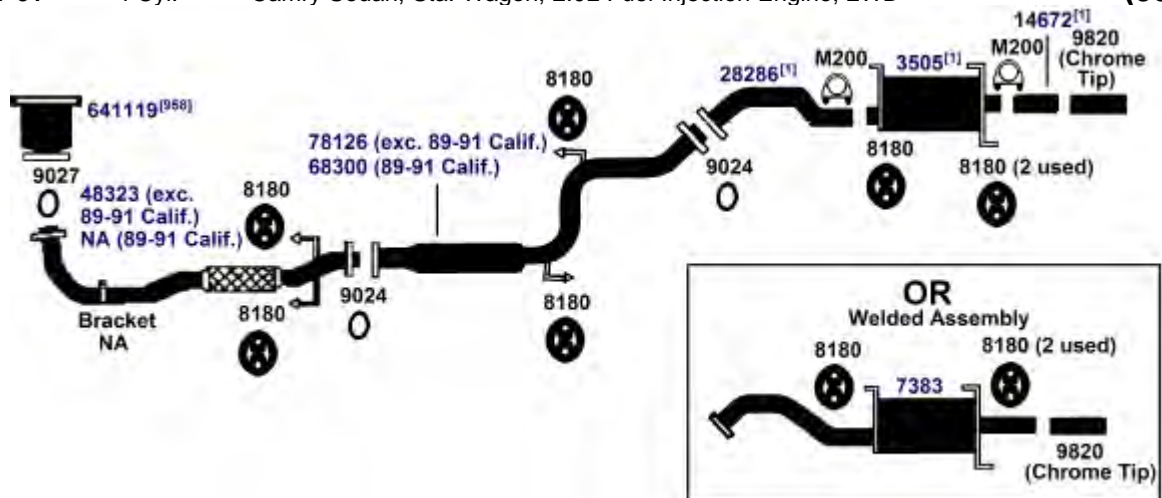

DIRECT FIT MSL/MAXIMUM Muffler... Split System- 6691, UNIVERSAL FIT MSL/MAXIMUM Muffler... Split System- 6544, 709992, Welded Assembly- 709992, Silentone DIY Muffler... Split System- 5598 and 14636 Spout

NA-Not Available. NR-Not Required. FL-Remove and Re-Use Old Flange. ● Golden Warehouse. O.E.-Original Equipment.
Airtube Kit [4948] may be required to complete installation. EFI-Electronic Fuel Injection.

[1] OE system was a welded assembly. It is recommended that all parts noted [1] should be replaced.

[931] This unit was designed to fit many applications. Measurement of the old unit and cutting of new unit is required.

[958] Federal & California Emission vehicles. Not legal for sale for vehicles licensed in California.

TOYOTA CAMRY

(9882) 85-86 4 Cyl. Camry, except Diesel

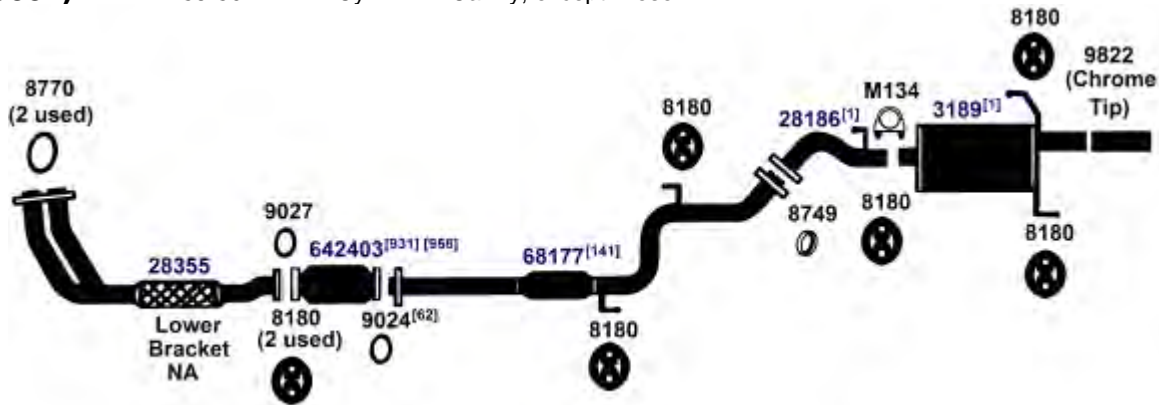

DIRECT FIT MSL/MAXIMUM Muffler... 6682, UNIVERSAL FIT MSL/MAXIMUM Muffler... 6503, 709008

(9881) 1985 4 Cyl. Camry, Turbo Diesel

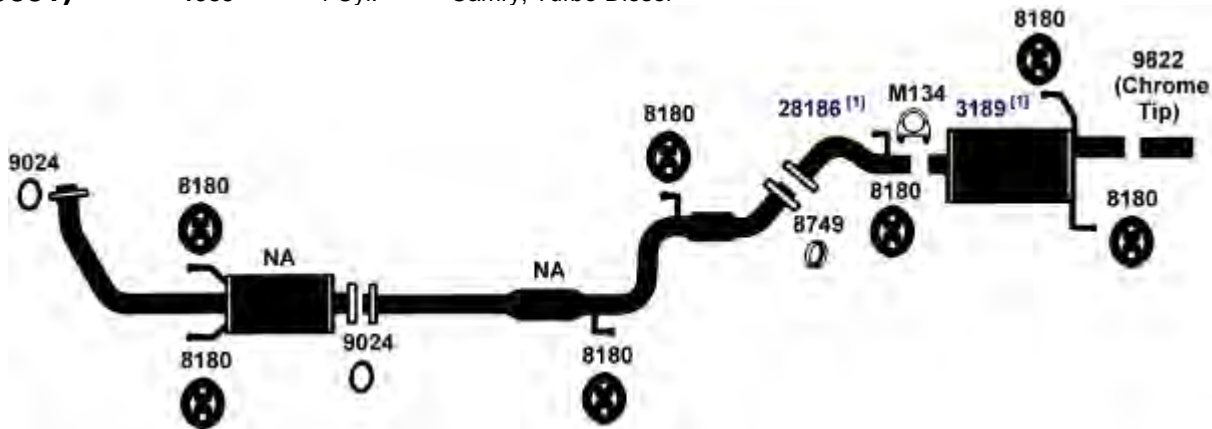

DIRECT FIT MSL/MAXIMUM Muffler... Rear Muffler- 6682, UNIVERSAL FIT MSL/MAXIMUM Muffler... Rear Muffler- 6503, 709008

NA-Not Available. NR-Not Required. FL-Remove and Re-Use Old Flange. ● Golden Warehouse. O.E.-Original Equipment.
Airtube Kit [4948] may be required to complete installation. EFI-Electronic Fuel Injection.

[1] OE system was a welded assembly. It is recommended that all parts noted [1] should be replaced.

[62] O.E. gasket must be replaced with 9024 on 1986 models.

[141] Remove and re-use O.E. heat shield, if required.

[931] This unit was designed to fit many applications. Measurement of the old unit and cutting of new unit is required.

[958] Federal & California Emission vehicles. Not legal for sale for vehicles licensed in California.

1984 4 Cyl. Camry, Turbo Diesel

(9881E)

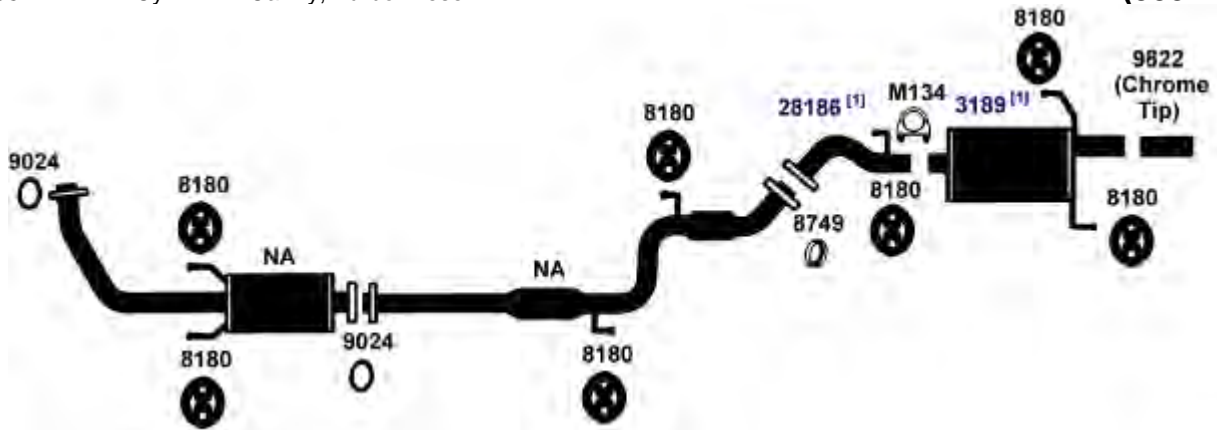

DIRECT FIT MSL/MAXIMUM Muffler... Rear Muffler- 6682, UNIVERSAL FIT MSL/MAXIMUM Muffler... Rear Muffler- 6503, 709008

83-84 4 Cyl. Camry, except Diesel

(9882E)

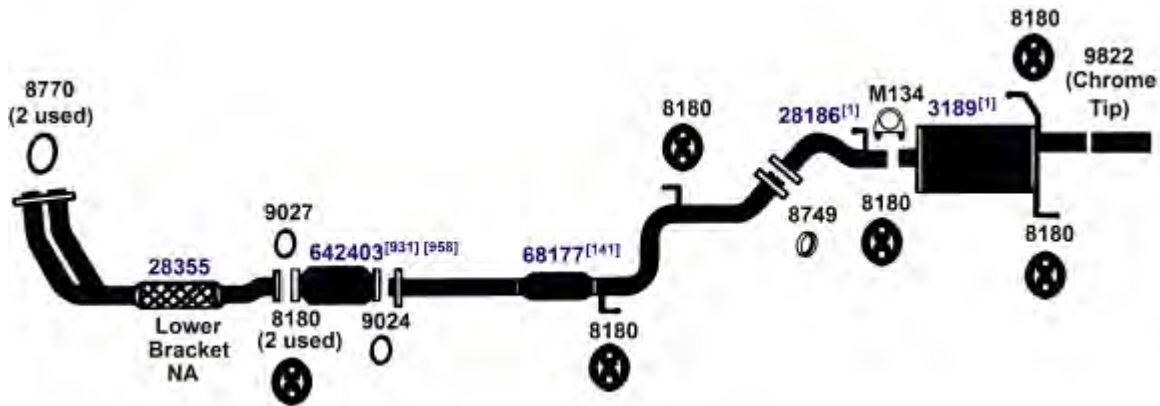

DIRECT FIT MSL/MAXIMUM Muffler... 6682, UNIVERSAL FIT MSL/MAXIMUM Muffler... 6503, 709008

NA-Not Available. NR-Not Required. FL-Remove and Re-Use Old Flange. ● Golden Warehouse. O.E.-Original Equipment.
Airtube Kit [4948] may be required to complete installation. EFI-Electronic Fuel Injection.

[1] OE system was a welded assembly. It is recommended that all parts noted [1] should be replaced.

[141] Remove and re-use O.E. heat shield, if required.

[931] This unit was designed to fit many applications. Measurement of the old unit and cutting of new unit is required.

[958] Federal & California Emission vehicles. Not legal for sale for vehicles licensed in California.

TOYOTA CELICA, SUPRA

(9985) 1994 4 Cyl. Celica GT; Liftback, Coupe and Convertible; 2.2L EFI Eng., Federal & Calif.

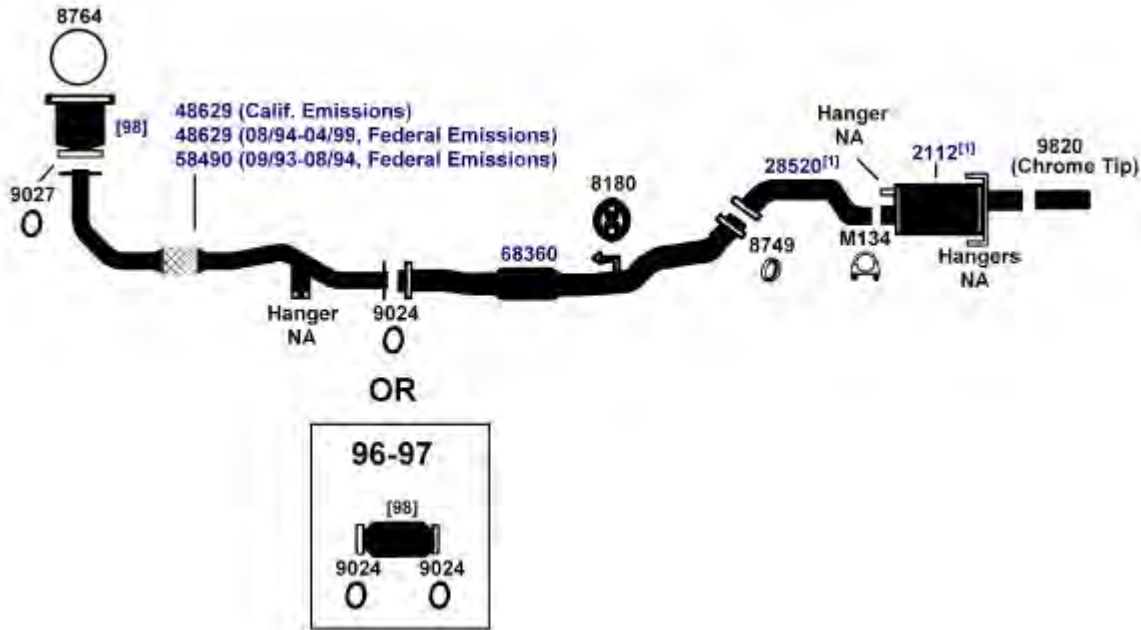

(9986) 1994 4 Cyl. Celica ST; Liftback, Coupe and Convertible; 1.8L EFI Engine

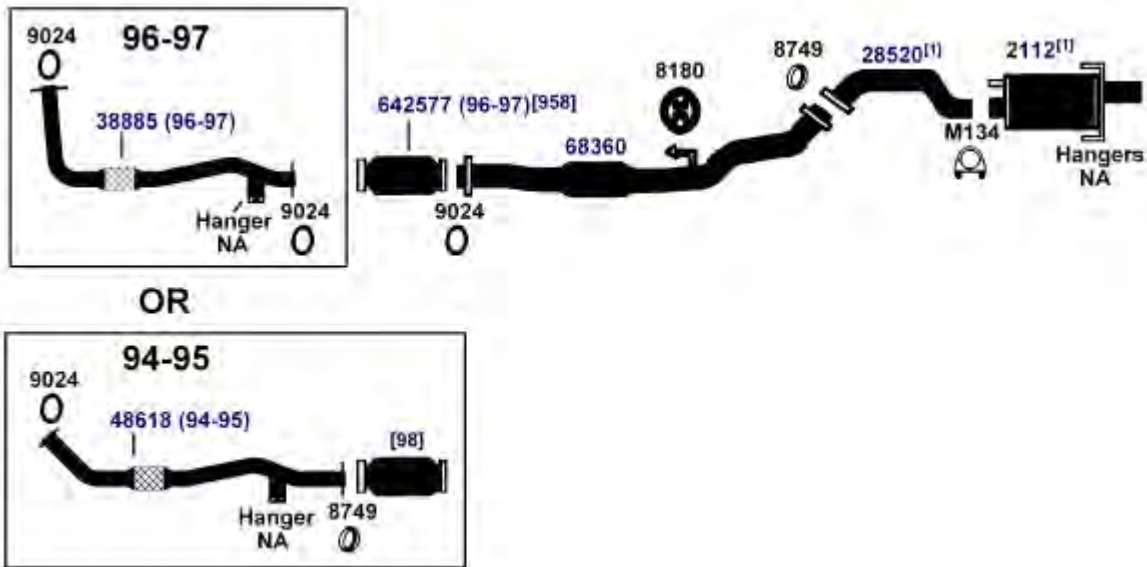

NA-Not Available. NR-Not Required. FL-Remove and Re-Use Old Flange. ● Golden Warehouse. O.E.-Original Equipment.

Airtube Kit [4948] may be required to complete installation. EFI-Electronic Fuel Injection.

[1] OE system was a welded assembly. It is recommended that all parts noted [1] should be replaced.

[98] Refer to current Catalytic Converter catalog or Website catalog for availability.

[958] Federal & California Emission vehicles. Not legal for sale for vehicles licensed in California.

90-93 4 Cyl. Celica ST; 1.6L EFI Engine

(9983)

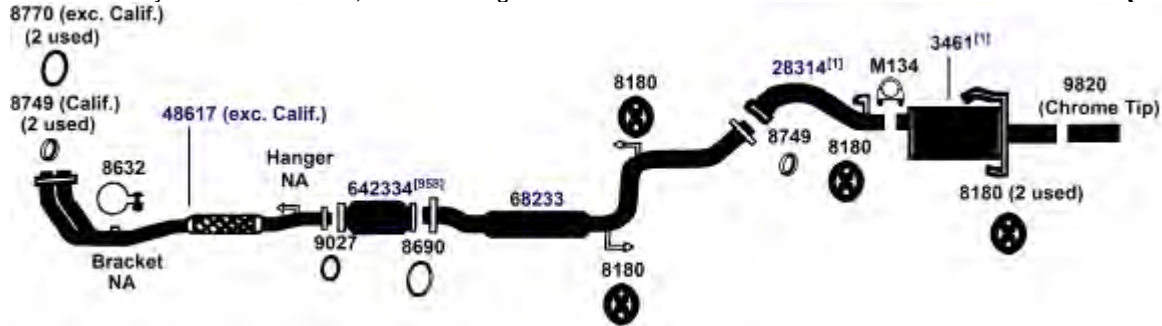

DIRECT FIT MSL/MAXIMUM Muffler... 6697, UNIVERSAL FIT MSL/MAXIMUM Muffler... 6503

90-93 4 Cyl. Celica GT; 2.2L EFI Engine

(9982)

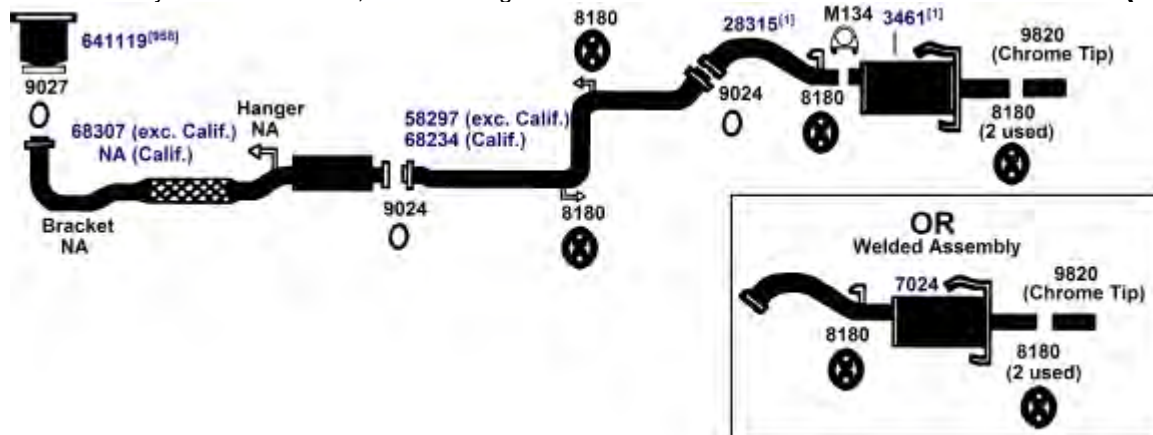

DIRECT FIT MSL/MAXIMUM Muffler... Split System- 6697, UNIVERSAL FIT MSL/MAXIMUM Muffler... Split System- 6503

90-92 4 Cyl. Celica GT-S; 2.2L Engine

(9984)

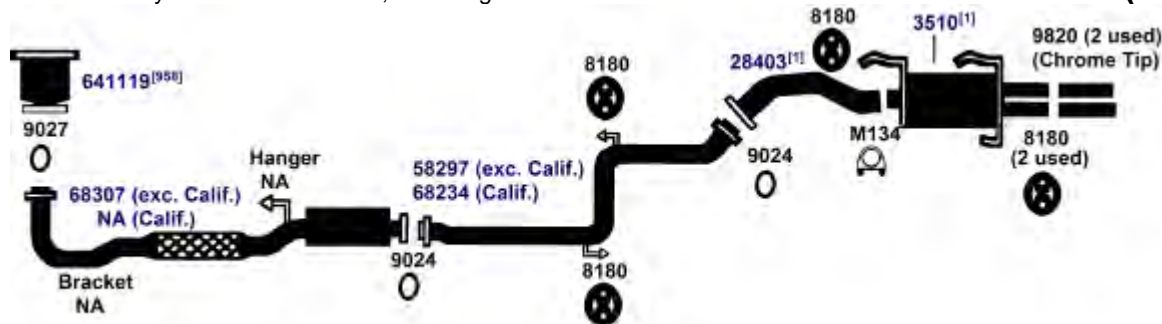

DIRECT FIT MSL/MAXIMUM Muffler... 700033, UNIVERSAL FIT MSL/MAXIMUM Muffler... 6688

NA-Not Available. NR-Not Required. FL-Remove and Re-Use Old Flange. ● Golden Warehouse. O.E.-Original Equipment.
Airtube Kit [4948] may be required to complete installation. EFI-Electronic Fuel Injection.

[1] OE system was a welded assembly. It is recommended that all parts noted [1] should be replaced. [958] Federal & California Emission vehicles. Not legal for sale for vehicles licensed in California.

TOYOTA CELICA, SUPRA

(9979) 87-91 6 Cyl. Supra, 3.0L Turbo Engine

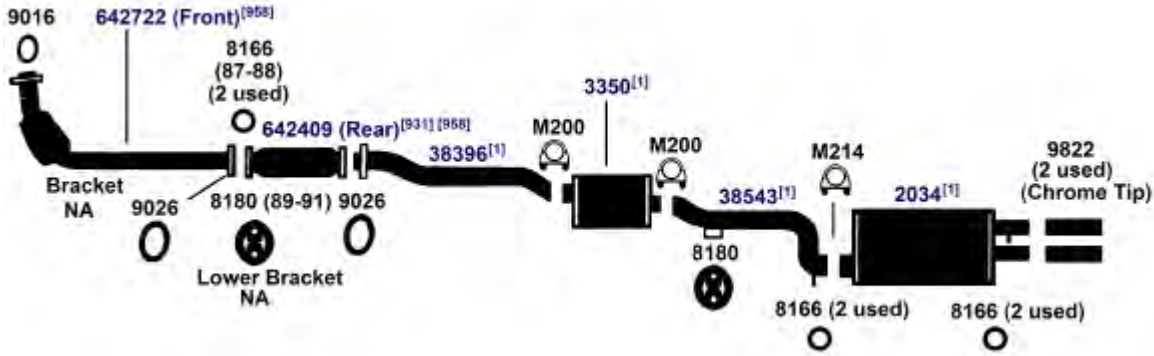

UNIVERSAL FIT MSL/MAXIMUM Muffler... Muffler (2034)- 6575, 709015

(9976) 87-91 6 Cyl. Supra, 3.0L Engine, except Turbo and 1988 California
1986 6 Cyl. Supra, 3.0L Engine (from 1/86)

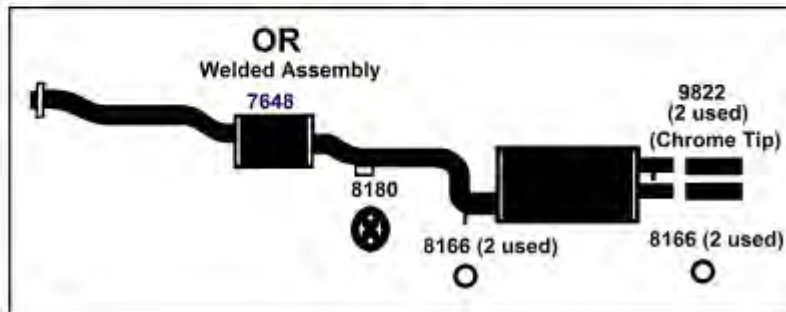
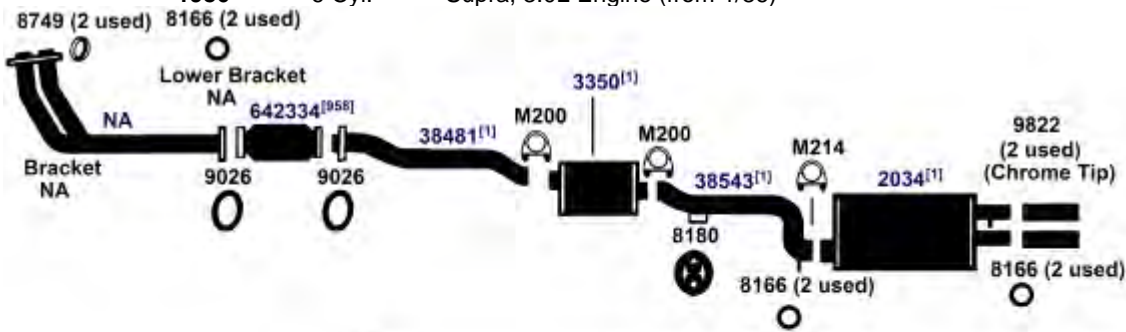

DIRECT FIT MSL/MAXIMUM Muffler... Split System-Muffler (2034)- 6575, UNIVERSAL FIT MSL/MAXIMUM Muffler... Split System-Muffler (2034)- 6575, 709015, Welded Assembly (7648)- 709015

NA-Not Available. NR-Not Required. FL-Remove and Re-Use Old Flange. ● Golden Warehouse. O.E.-Original Equipment.
Airtube Kit [4948] may be required to complete installation. EFI-Electronic Fuel Injection.

[1] OE system was a welded assembly. It is recommended that all parts noted [1] should be replaced.

[931] This unit was designed to fit many applications. Measurement of the old unit and cutting of new unit is required.

[958] Federal & California Emission vehicles. Not legal for sale for vehicles licensed in California.

87-89 4 Cyl. Celica, 2.0L Engine, except GT-S & 4WD (9977)

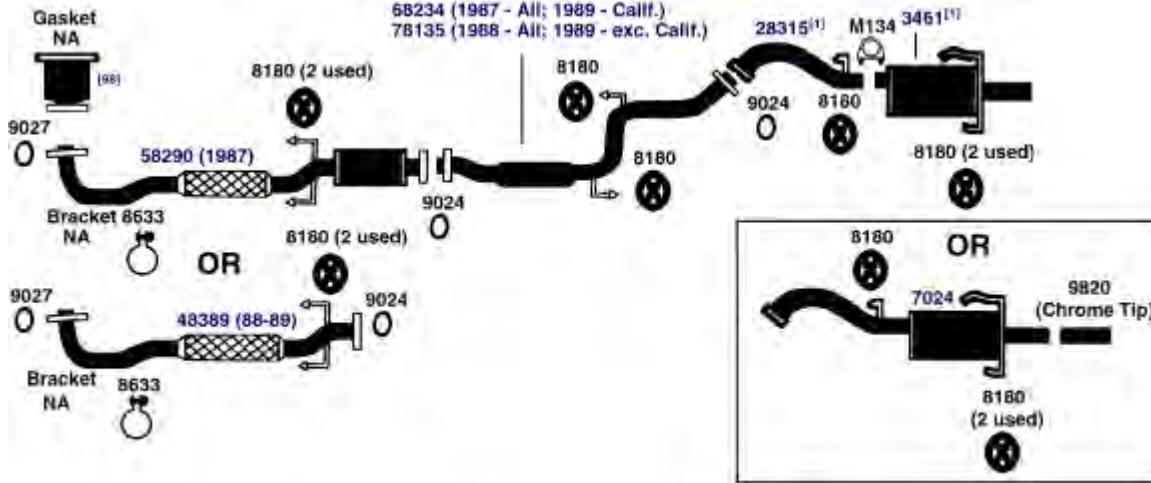

DIRECT FIT MSL/MAXIMUM Muffler... Split System- 6697, UNIVERSAL FIT MSL/MAXIMUM Muffler... Split System- 6503

86-89 4 Cyl. Celica GT-S, 2.0L Engine (9978)

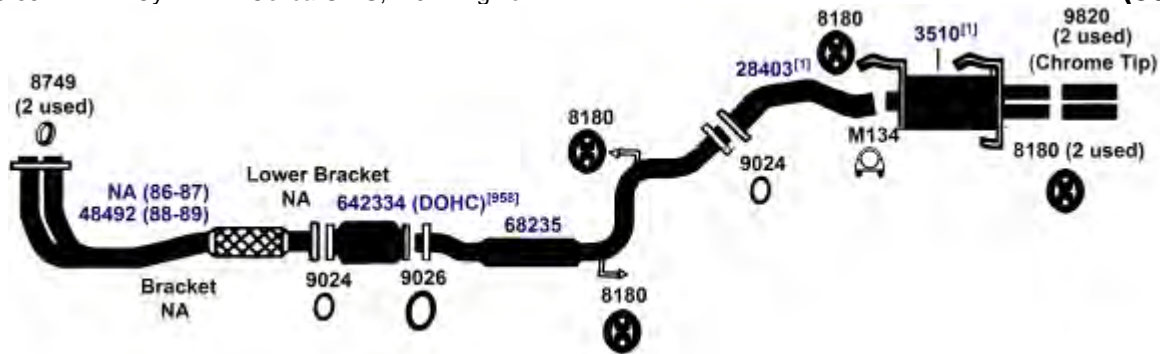

DIRECT FIT MSL/MAXIMUM Muffler... 700033, UNIVERSAL FIT MSL/MAXIMUM Muffler... 6688

1986 4 Cyl. Celica, 2.0L Engine; except GT-S (9975)

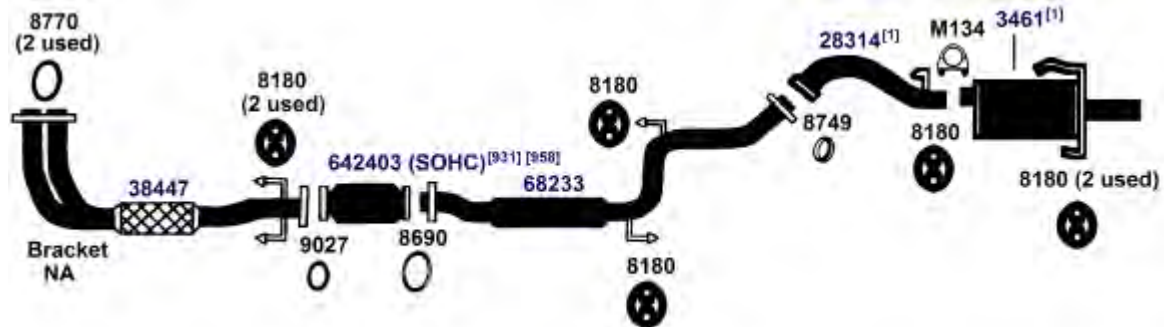

DIRECT FIT MSL/MAXIMUM Muffler... 6697, UNIVERSAL FIT MSL/MAXIMUM Muffler... 6503

NA-Not Available. NR-Not Required. FL-Remove and Re-Use Old Flange. ● Golden Warehouse. O.E.-Original Equipment.
Airtube Kit [4948] may be required to complete installation. EFI-Electronic Fuel Injection.

[1] OE system was a welded assembly. It is recommended that all parts noted [1] should be replaced.
[98] Refer to current Catalytic Converter catalog or Website catalog for availability.

[931] This unit was designed to fit many applications. Measurement of the old unit and cutting of new unit is required.
[958] Federal & California Emission vehicles. Not legal for sale for vehicles licensed in California.

TOYOTA CELICA, SUPRA

(9971) 1985 4 Cyl. Celica, except GT-S Models with Independent Rear Suspension

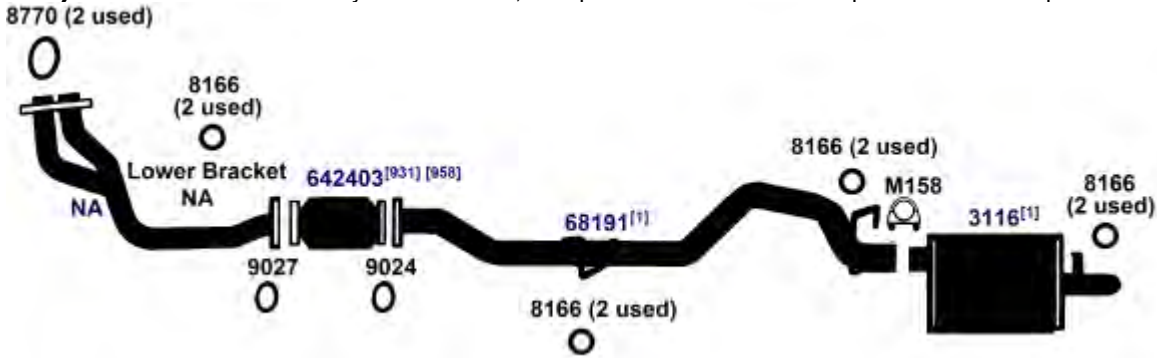

DIRECT FIT MSL/MAXIMUM Muffler... 6679, UNIVERSAL FIT MSL/MAXIMUM Muffler... 6651, 709008, 709010, Silentone DIY Muffler... 5587

(9972) 83-84 4 Cyl. Celica GT-S, 2.4L Engine, with Independent Rear Suspension

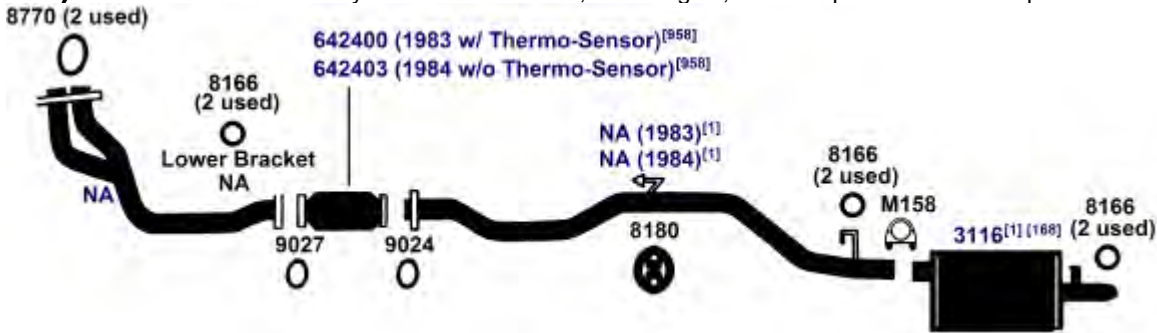

DIRECT FIT MSL/MAXIMUM Muffler... 6679, UNIVERSAL FIT MSL/MAXIMUM Muffler... 6651, 709008, 709010, Silentone DIY Muffler... 5587

(9970) 82-84 6 Cyl. Celica, Supra



DIRECT FIT MSL/MAXIMUM Muffler... 6679, UNIVERSAL FIT MSL/MAXIMUM Muffler... 6651, 709008, 709010, Silentone DIY Muffler... 5587

NA-Not Available. NR-Not Required. FL-Remove and Re-Use Old Flange. ● Golden Warehouse. O.E.-Original Equipment.
Airtube Kit [4948] may be required to complete installation. EFI-Electronic Fuel Injection.

[1] OE system was a welded assembly. It is recommended that all parts noted [1] should be replaced.

[168] Functionally approved Single Outlet System replaces Dual Outlet.

[931] This unit was designed to fit many applications. Measurement of the old unit and cutting of new unit is required.

[958] Federal & California Emission vehicles. Not legal for sale for vehicles licensed in California.

81-84 4 Cyl. Celica, except GT-S Models with Independent Rear Suspension

(9971E)

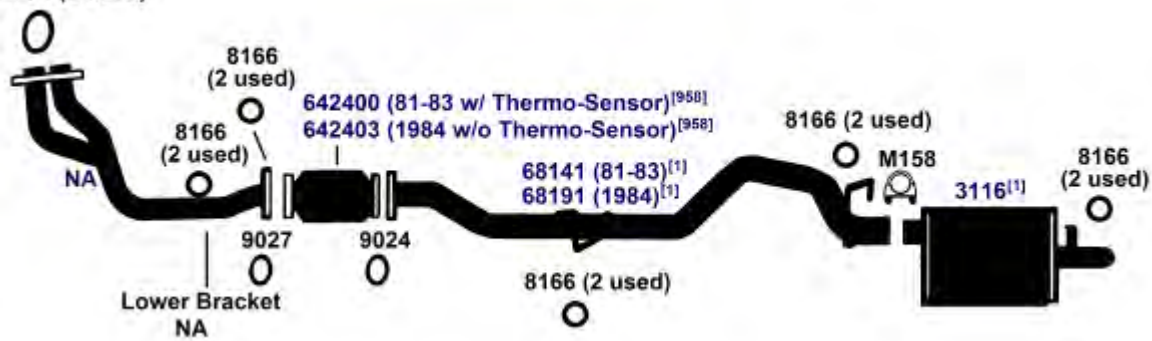

DIRECT FIT MSL/MAXIMUM Muffler... 6679, UNIVERSAL FIT MSL/MAXIMUM Muffler... 6651, 709008, 709010, Silentone DIY Muffler... 5587

80-81 6 Cyl. Celica, Supra; 4M-E, 5M-E Engine

(9968)

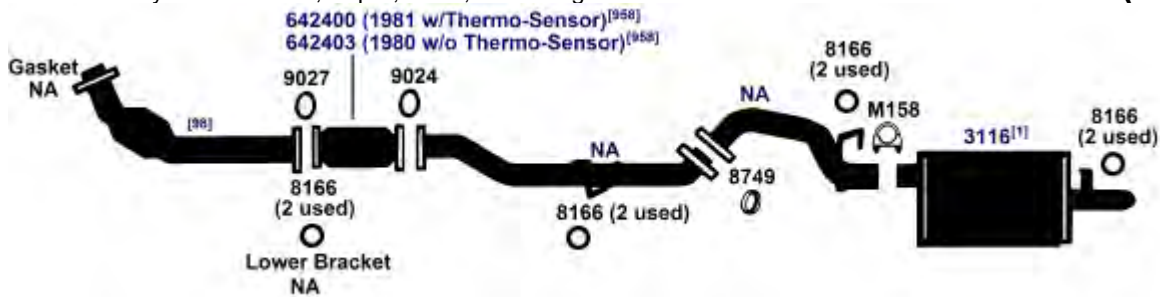

DIRECT FIT MSL/MAXIMUM Muffler... 6679, UNIVERSAL FIT MSL/MAXIMUM Muffler... 6651, 709008, 709010, Silentone DIY Muffler... 5587

1980 4 Cyl. Celica, except GT-S Models with Independent Rear Suspension

(9981)

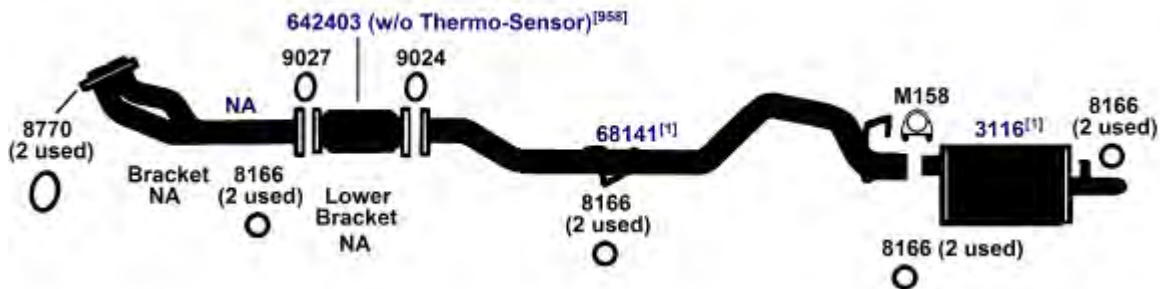

DIRECT FIT MSL/MAXIMUM Muffler... 6679, UNIVERSAL FIT MSL/MAXIMUM Muffler... 6651, 709008, 709010, Silentone DIY Muffler... 5587

NA-Not Available. NR-Not Required. FL-Remove and Re-Use Old Flange. ● Golden Warehouse. O.E.-Original Equipment.

Airtube Kit [4948] may be required to complete installation. EFI-Electronic Fuel Injection.

[1] OE system was a welded assembly. It is recommended that all parts noted [1] should be replaced. [958] Federal & California Emission vehicles. Not legal for sale for vehicles licensed in California.

TOYOTA CELICA, SUPRA

(9967)

1979

Celica, 2200cc, 20R Engine; All Models

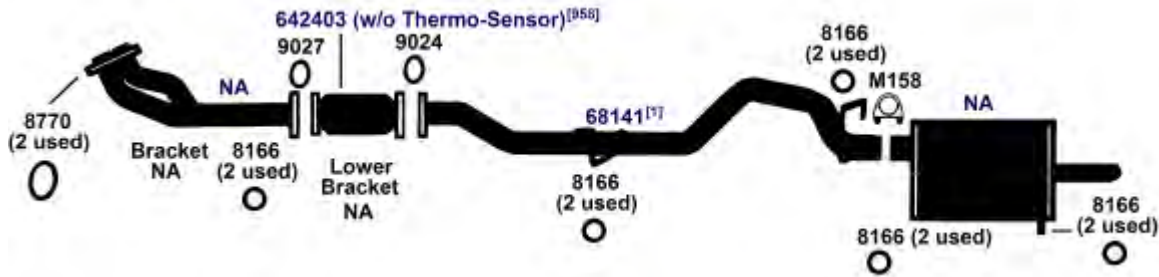

UNIVERSAL FIT MSL/MAXIMUM Muffler... 6651, 709008, 709010

TOYOTA COROLLA

(10054)

93-94

4 Cyl.

Corolla, 1.6L, 1.8L EFI Engine

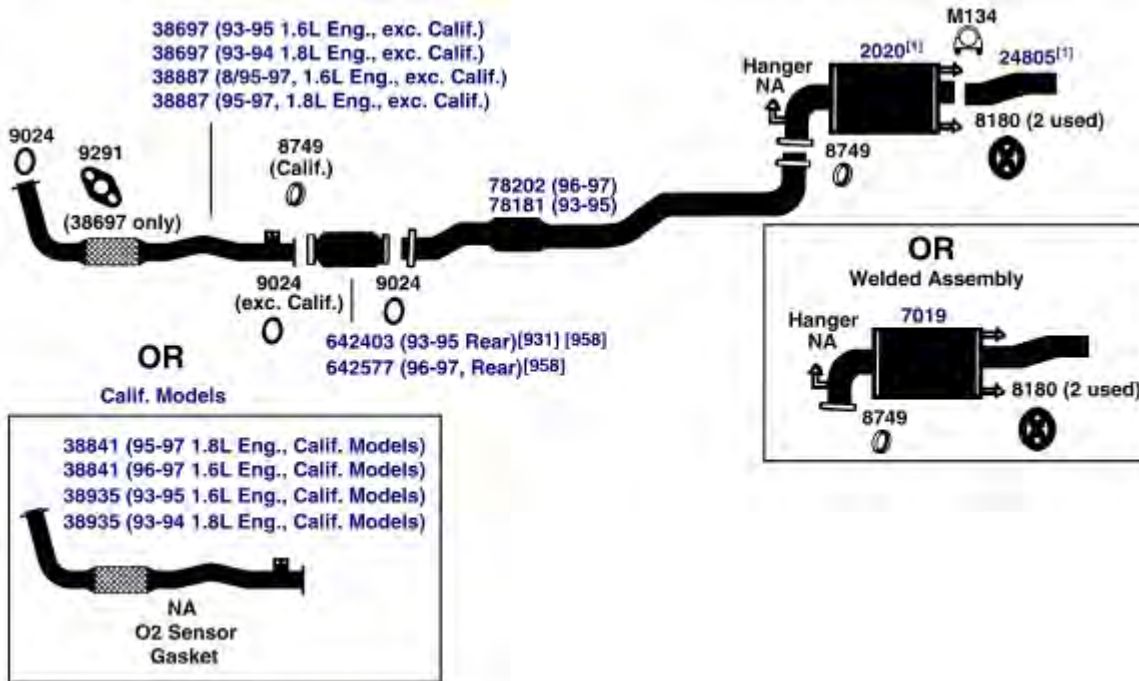

DIRECT FIT MSL/MAXIMUM Muffler... Split System- 700211

NA-Not Available. NR-Not Required. FL-Remove and Re-Use Old Flange. ● Golden Warehouse. O.E.-Original Equipment.
Airtube Kit [4948] may be required to complete installation. EFI-Electronic Fuel Injection.

[1] OE system was a welded assembly. It is recommended that all parts noted [1] should be replaced.

[931] This unit was designed to fit many applications. Measurement of the old unit and cutting of new unit is required.

[958] Federal & California Emission vehicles. Not legal for sale for vehicles licensed in California.

1992 4 Cyl. Corolla 4-Door Sedan, 2WD Wagon; 1.6L Engine; except All Trac (4 WD) (10052)
 90-91 4 Cyl. Corolla Coupe, Sedan, Wagon; 1.6L Engine; except GTS and All Trac (4WD)

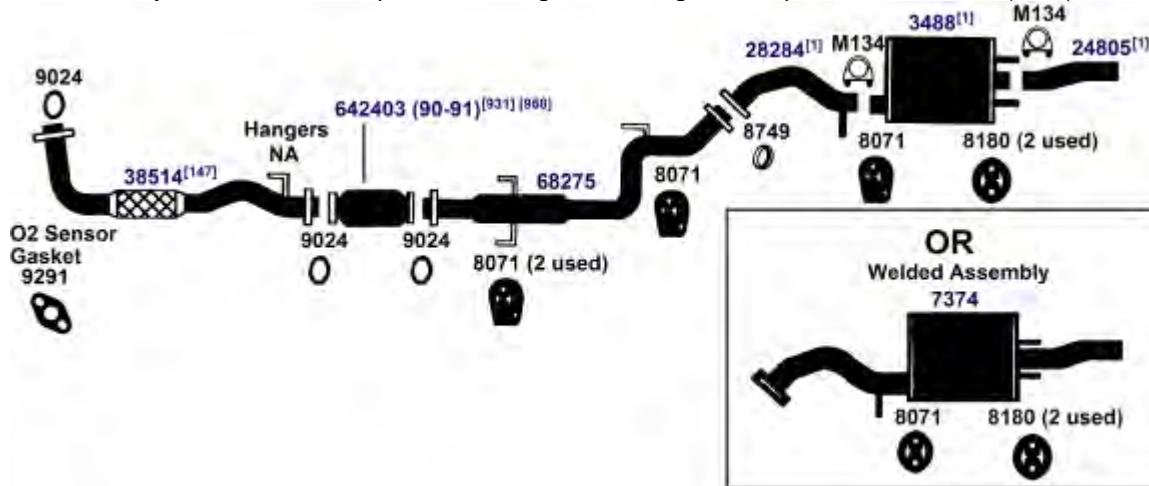

DIRECT FIT MSL/MAXIMUM Muffler... Split System- 6694, UNIVERSAL FIT MSL/MAXIMUM Muffler... Split System- 6677, Silentone DIY Muffler... Split System- 5595 and 24906 Spout

90-92 4 Cyl. Corolla; All Trac 4WD Wagon; 1.6L Engine (10050)

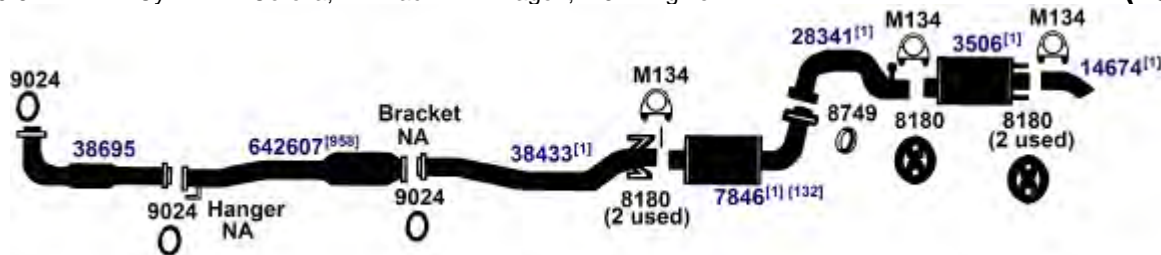

UNIVERSAL FIT MSL/MAXIMUM Muffler... Front Muffler (7846)- 709004, Rear Muffler (3506)- 709007, 709010

90-91 4 Cyl. Corolla GTS, 1.6L Engine (10051)

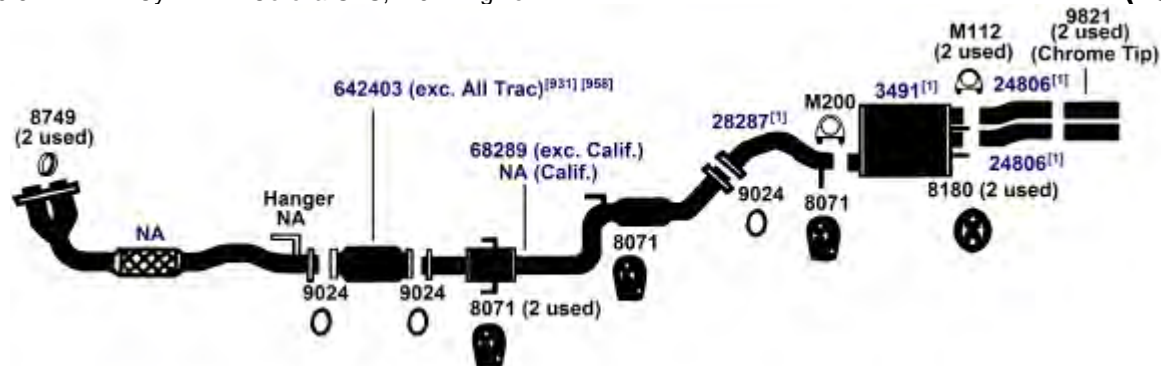

NA-Not Available. NR-Not Required. FL-Remove and Re-Use Old Flange. ● Golden Warehouse. O.E.-Original Equipment.
 # Airtube Kit [4948] may be required to complete installation. EFI-Electronic Fuel Injection.

- [1] OE system was a welded assembly. It is recommended that all parts noted [1] should be replaced.
- [132] If black triangle appears on muffler label, remove and re-use O.E. heat shield or fabricate heat shield.
- [147] For vehicles where oxygen sensor is attached to flange in exhaust pipe, drill 5/8" diameter hole through center hole of flange into exhaust pipe.

- [931] This unit was designed to fit many applications. Measurement of the old unit and cutting of new unit is required.
- [958] Federal & California Emission vehicles. Not legal for sale for vehicles licensed in California.

TOYOTA COROLLA

(10053) 88-89 4 Cyl. Corolla; All Trac 4WD Sedan, Wagon; 1.6L Engine

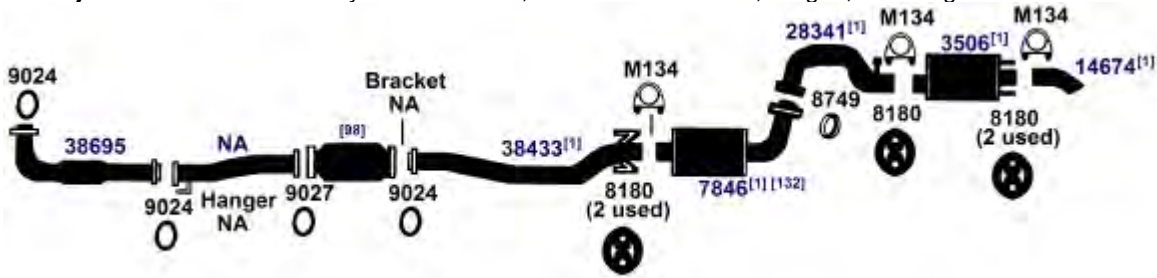

UNIVERSAL FIT MSL/MAXIMUM Muffler... Front Muffler (7846)- 709004, Rear Muffler (3506)- 709007, 709010

(10049) 88-89 4 Cyl. Corolla GTS, 1.6L Engine

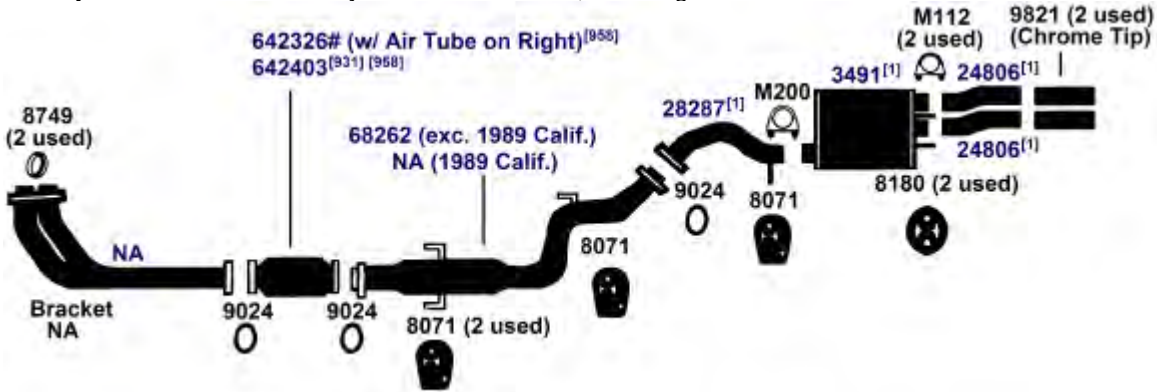

(10048) 88-89 4 Cyl. Corolla, 1.6L Engine; except GTS and 4WD

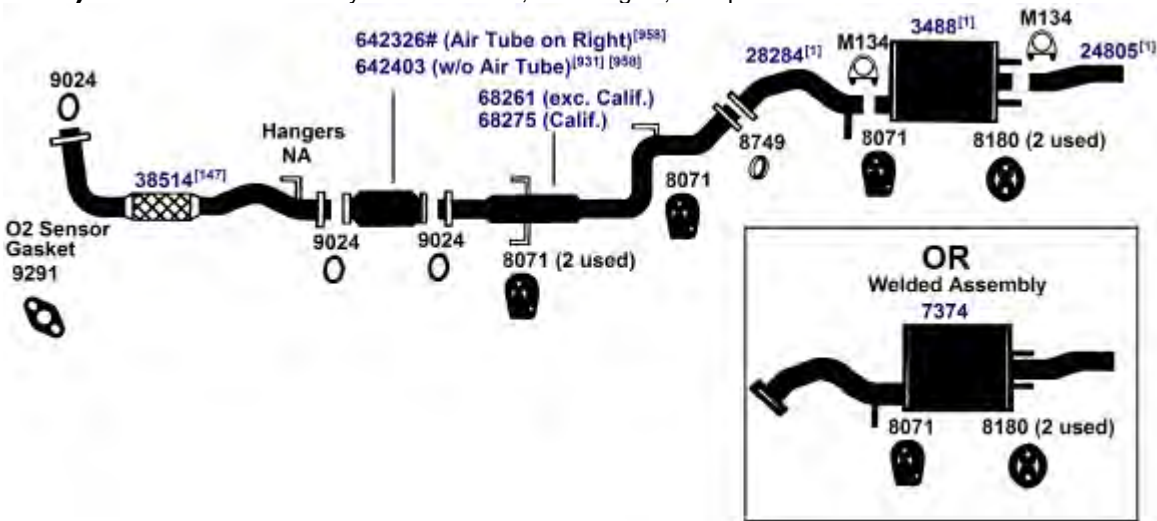

DIRECT FIT MSL/MAXIMUM Muffler... Split System- 6694, UNIVERSAL FIT MSL/MAXIMUM Muffler... Split System- 6677, Silentone DIY Muffler... Split System- 5595 and 24906 Spout

NA-Not Available. NR-Not Required. FL-Remove and Re-Use Old Flange. ● Golden Warehouse. O.E.-Original Equipment.
Airtube Kit [4948] may be required to complete installation. EFI-Electronic Fuel Injection.

[1] OE system was a welded assembly. It is recommended that all parts noted [1] should be replaced.

[132] If black triangle appears on muffler label, remove and re-use O.E. heat shield or fabricate heat shield.

[147] For vehicles where oxygen sensor is attached to flange in exhaust pipe, drill 5/8" diameter hole through center hole of flange into exhaust pipe.

[931] This unit was designed to fit many applications. Measurement of the old unit and cutting of new unit is required.

[958] Federal & California Emission vehicles. Not legal for sale for vehicles licensed in California.

87-88 4 Cyl. Corolla FX, 1.6L Engine

(10047)

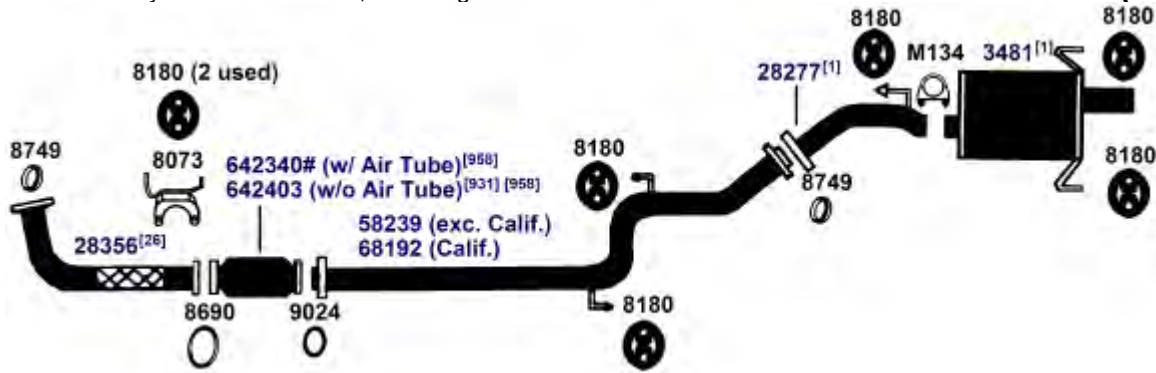

DIRECT FIT MSL/MAXIMUM Muffler... 700133, UNIVERSAL FIT MSL/MAXIMUM Muffler... 6676, 709006

87-88 4 Cyl. Corolla FX16, FX16-GTS; 1.6L Engine

(10046)

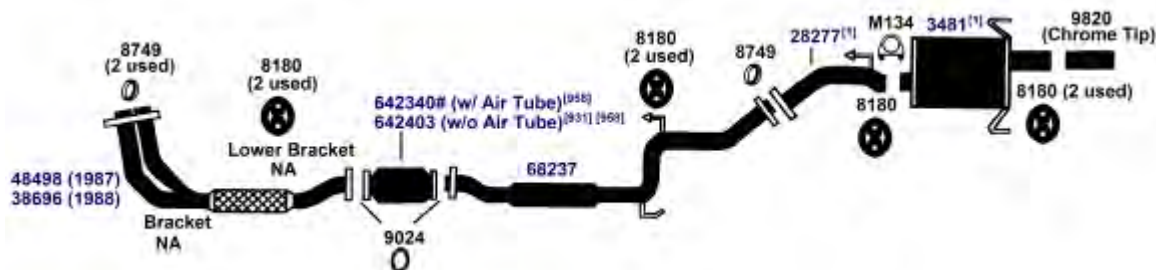

DIRECT FIT MSL/MAXIMUM Muffler... 700133, UNIVERSAL FIT MSL/MAXIMUM Muffler... 6676, 709006

85-87 4 Cyl. Corolla GTS, 1.6L Engine

(10045)



DIRECT FIT MSL/MAXIMUM Muffler... 6671, UNIVERSAL FIT MSL/MAXIMUM Muffler... 709008, 709010, Silentone DIY Muffler... 5587

NA-Not Available. NR-Not Required. FL-Remove and Re-Use Old Flange. ● Golden Warehouse. O.E.-Original Equipment.
Airtube Kit [4948] may be required to complete installation. EFI-Electronic Fuel Injection.

[1] OE system was a welded assembly. It is recommended that all parts noted [1] should be replaced.

[26] Bracket on pipe is not required on all applications.

[931] This unit was designed to fit many applications. Measurement of the old unit and cutting of new unit is required.

[958] Federal & California Emission vehicles. Not legal for sale for vehicles licensed in California.

TOYOTA COROLLA

(10043) 85-87 4 Cyl. Corolla 2-Door Coupe, 2-Door Liftback; except GTS

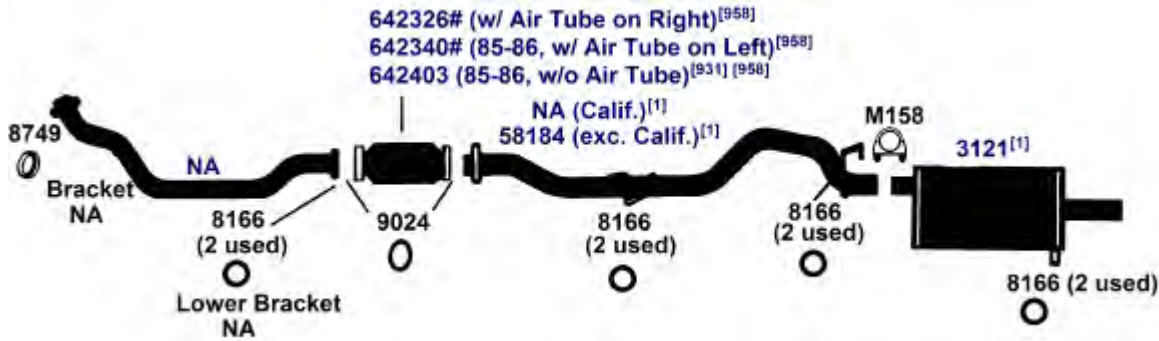

DIRECT FIT MSL/MAXIMUM Muffler... 6671, UNIVERSAL FIT MSL/MAXIMUM Muffler... 709008, 709010, Silentone DIY Muffler... 5587

(10044) 85-87 4 Cyl. Corolla 4-Door Sedan, 4-Door Liftback; except Diesel, (exc. Canada)
 85-87 4 Cyl. Corolla, 1.6L 4ALC Engine, F.W.D.; exc. Coupe, GTS, (Canada Only)

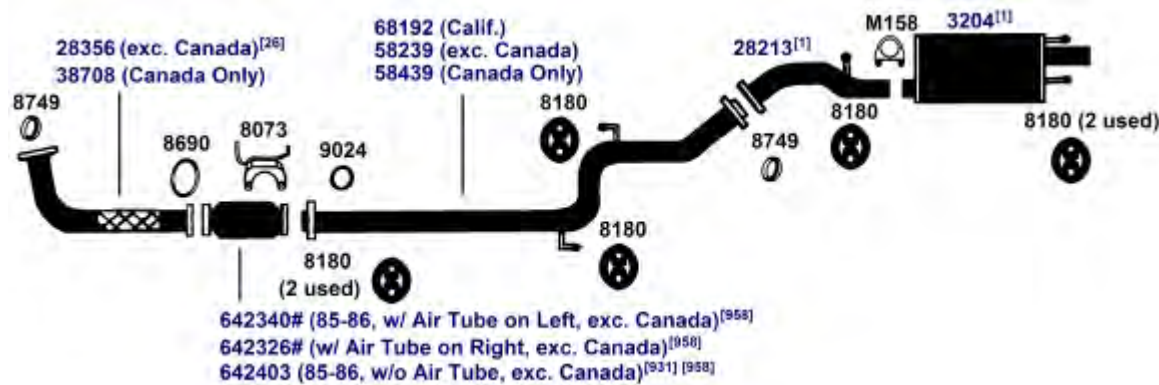

DIRECT FIT MSL/MAXIMUM Muffler... 700081, UNIVERSAL FIT MSL/MAXIMUM Muffler... 6676, 709006, 709011, Silentone DIY Muffler... 5593 and 14646 Pipe

(10043E) 1984 4 Cyl. Corolla 2-Door Coupe, 2-Door Liftback; except GTS

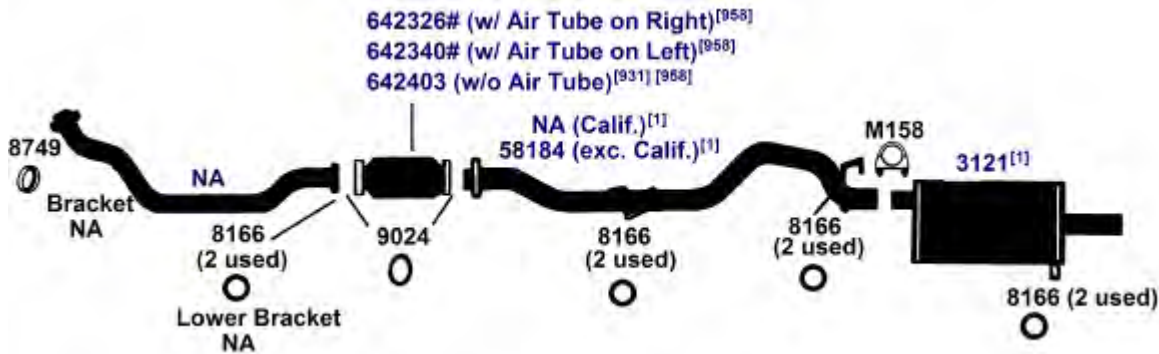

DIRECT FIT MSL/MAXIMUM Muffler... 6671, UNIVERSAL FIT MSL/MAXIMUM Muffler... 709008, 709010, Silentone DIY Muffler... 5587

NA-Not Available. NR-Not Required. FL-Remove and Re-Use Old Flange. ● Golden Warehouse. O.E.-Original Equipment.
 # Airtube Kit [4948] may be required to complete installation. EFI-Electronic Fuel Injection.

[1] OE system was a welded assembly. It is recommended that all parts noted [1] should be replaced.

[26] Bracket on pipe is not required on all applications.

[931] This unit was designed to fit many applications. Measurement of the old unit and cutting of new unit is required.

[958] Federal & California Emission vehicles. Not legal for sale for vehicles licensed in California.

1984 4 Cyl. Corolla, 1.6L 4ALC Engine, F.W.D.; exc. Coupe, GTS, (Canada Only) (10044E)
 1984 4 Cyl. Corolla 4-Door Sedan, 4-Door Liftback; except Diesel, (exc. Canada)



DIRECT FIT MSL/MAXIMUM Muffler... 700081, UNIVERSAL FIT MSL/MAXIMUM Muffler... 6676, 709006, 709011, Silentone DIY Muffler... 5593 and 14646 Pipe

1983 4 Cyl. Corolla Sedan, Coupe, Liftback, Station Wagon, Hardtop (10042)

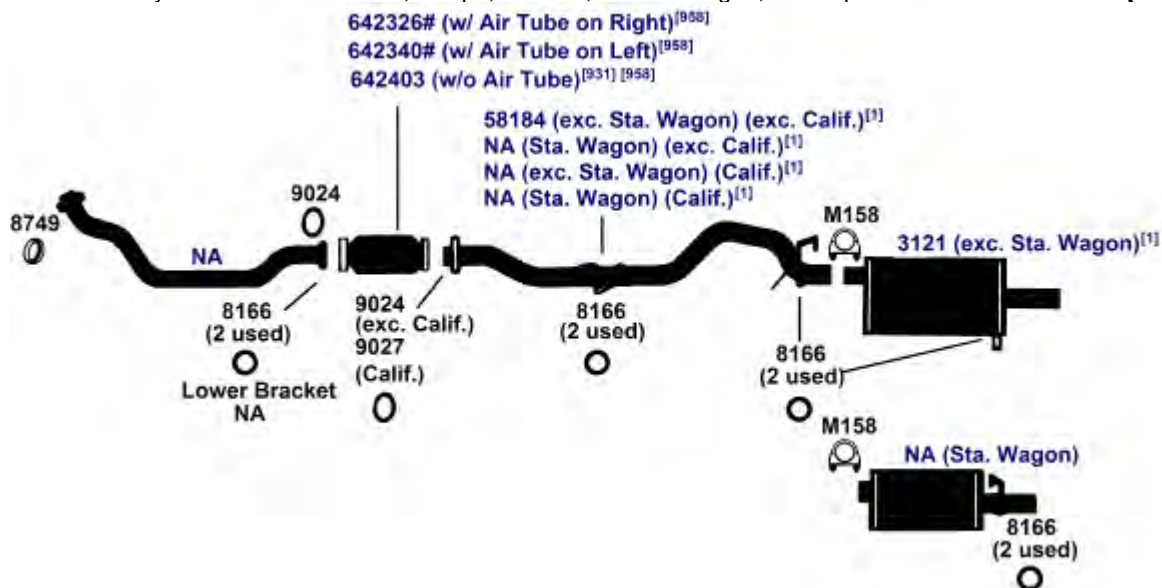

DIRECT FIT MSL/MAXIMUM Muffler... exc. Sta. Wagon- 6671, UNIVERSAL FIT MSL/MAXIMUM Muffler... exc. Sta. Wagon- 709008, 709010, Sta. Wagon- 6651, 709008, Silentone DIY Muffler... exc. Sta. Wagon- 5587, Sta. Wagon- 5587

NA-Not Available. NR-Not Required. FL-Remove and Re-Use Old Flange. ● Golden Warehouse. O.E.-Original Equipment.
 # Airtube Kit [4948] may be required to complete installation. EFI-Electronic Fuel Injection.

- [1] OE system was a welded assembly. It is recommended that all parts noted [1] should be replaced.
- [26] Bracket on pipe is not required on all applications.
- [931] This unit was designed to fit many applications. Measurement of the old unit and cutting of new unit is required.
- [958] Federal & California Emission vehicles. Not legal for sale for vehicles licensed in California.

TOYOTA COROLLA

(10038) 81-82 4 Cyl. Corolla Sedan, Coupe, Liftback
 1980 4 Cyl. Corolla Sedan, Coupe, Liftback; California

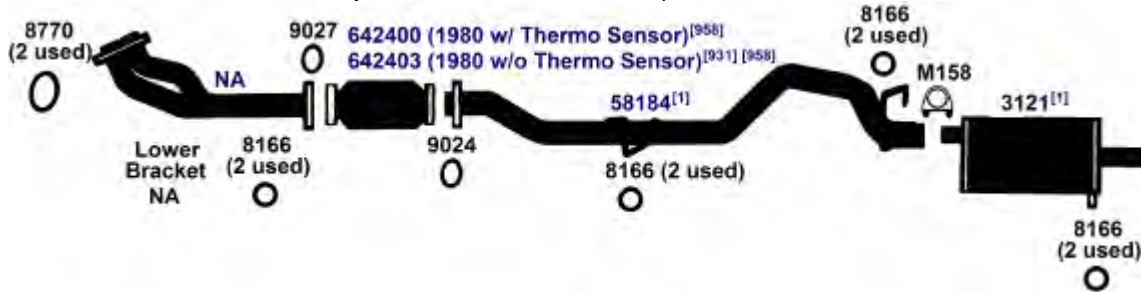

DIRECT FIT MSL/MAXIMUM Muffler... 6671, UNIVERSAL FIT MSL/MAXIMUM Muffler... 709008, 709010, Silentone DIY Muffler... 5587

(10039) 1980 4 Cyl. Corolla Sedan, Coupe, Liftback; except California

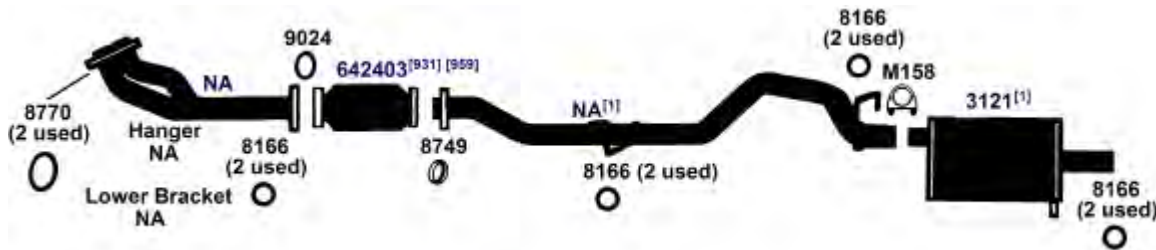

DIRECT FIT MSL/MAXIMUM Muffler... 6671, UNIVERSAL FIT MSL/MAXIMUM Muffler... 709008, 709010, Silentone DIY Muffler... 5587

TOYOTA CORONA

(10105) 80-82 4 Cyl. Corona Sedan, Hatchback

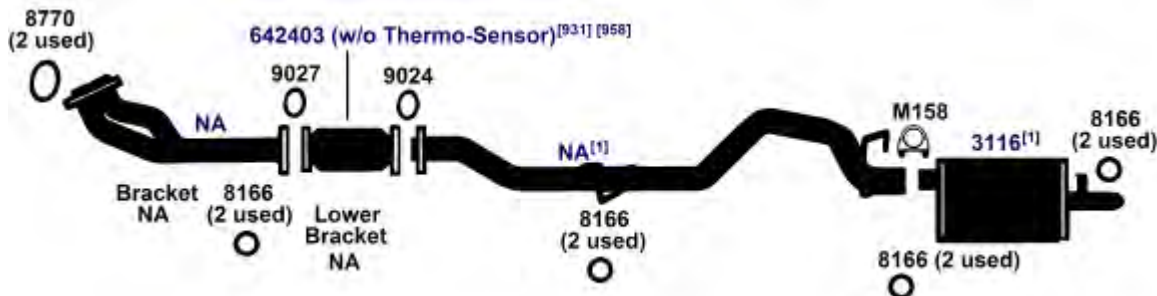

DIRECT FIT MSL/MAXIMUM Muffler... 6679, UNIVERSAL FIT MSL/MAXIMUM Muffler... 6651, 709008, 709010, Silentone DIY Muffler... 5587

NA-Not Available. NR-Not Required. FL-Remove and Re-Use Old Flange. ● Golden Warehouse. O.E.-Original Equipment.
 # Airtube Kit [4948] may be required to complete installation. EFI-Electronic Fuel Injection.

[1] OE system was a welded assembly. It is recommended that all parts noted [1] should be replaced.

[931] This unit was designed to fit many applications. Measurement of the old unit and cutting of new unit is required.

[958] Federal & California Emission vehicles. Not legal for sale for vehicles licensed in California.

[959] Federal Emission vehicles. Not legal for sale for vehicles licensed in California.

[960] California Emission vehicles licensed in states other than California. Not legal for sale for vehicles licensed in California.

TOYOTA CRESSIDA

89-92 6 Cyl. Cressida, 3.0L Engine

(10172)

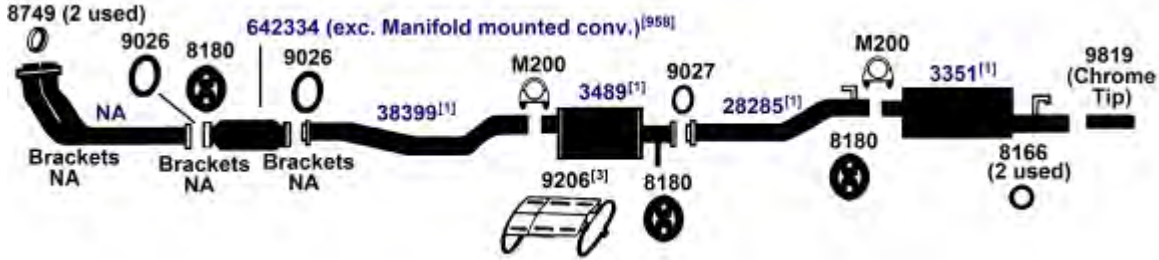

DIRECT FIT MSL/MAXIMUM Muffler... Front Muffler- 700372, Rear Muffler- 700269, UNIVERSAL FIT MSL/MAXIMUM Muffler... Rear Muffler- 6530, 6571, 709993

85-88 6 Cyl. Cressida Sedan, 2.8L Engine

(10170)



DIRECT FIT MSL/MAXIMUM Muffler... 700269, UNIVERSAL FIT MSL/MAXIMUM Muffler... 6530, 6571, 709993

TOYOTA LAND CRUISER

88-90 6 Cyl. Landcruiser, 4.0L Engine

(30606)

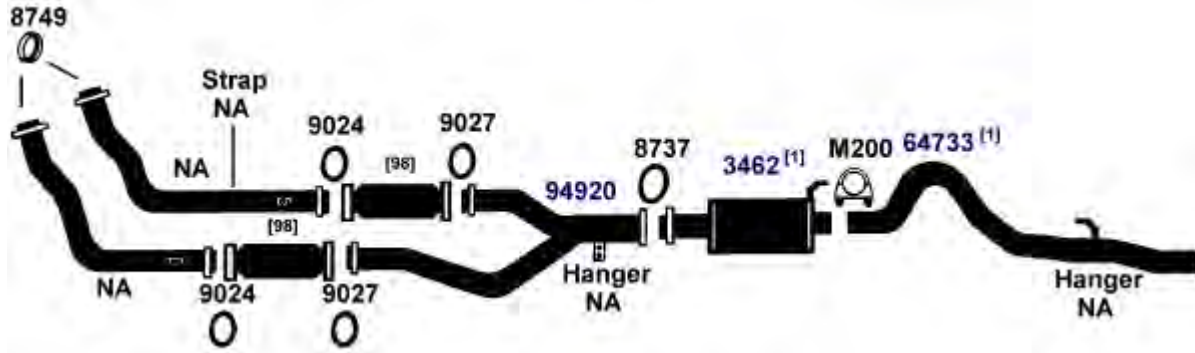

NA-Not Available. NR-Not Required. FL-Remove and Re-Use Old Flange. ● Golden Warehouse. O.E.-Original Equipment.
Airtube Kit [4948] may be required to complete installation. EFI-Electronic Fuel Injection.

- [1] OE system was a welded assembly. It is recommended that all parts noted [1] should be replaced.
- [3] Required for installation.
- [98] Refer to current Catalytic Converter catalog or Website catalog for availability.

- [931] This unit was designed to fit many applications. Measurement of the old unit and cutting of new unit is required.
- [958] Federal & California Emission vehicles. Not legal for sale for vehicles licensed in California.

TOYOTA MR2

(10185) 88-89 4 Cyl. MR2, 1.6L Engine, without Supercharger
 85-87 4 Cyl. MR2, 1.6L Engine

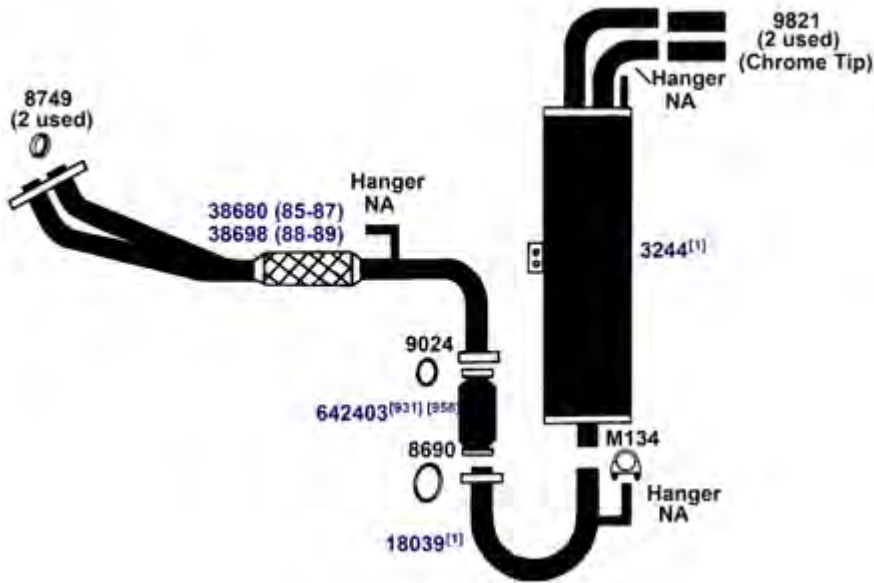

TOYOTA PASEO

(13575) 92-94 4 Cyl. Paseo, 1.5L EFI Engine



DIRECT FIT MSL/MAXIMUM Muffler... 700275

NA-Not Available. NR-Not Required. FL-Remove and Re-Use Old Flange. ● Golden Warehouse. O.E.-Original Equipment.
 # Airtube Kit [4948] may be required to complete installation. EFI-Electronic Fuel Injection.

[1] OE system was a welded assembly. It is recommended that all parts noted [1] should be replaced.

[958] Federal & California Emission vehicles. Not legal for sale for vehicles licensed in California.

[931] This unit was designed to fit many applications. Measurement of the old unit and cutting of new unit is required.

TOYOTA PICKUP, CAB AND CHASSIS

1994	4 Cyl.	Pickup, Cab and Chassis; 2.4L Fuel Inj; 2 W.D.; 103", 121.5", 121.9" W.B.; except California	(30526)
92-93	4 Cyl.	Pickup, Cab and Chassis; 2.4L Fuel Inj; 2 W.D.; 103", 112", 121.5" W.B.; except California	

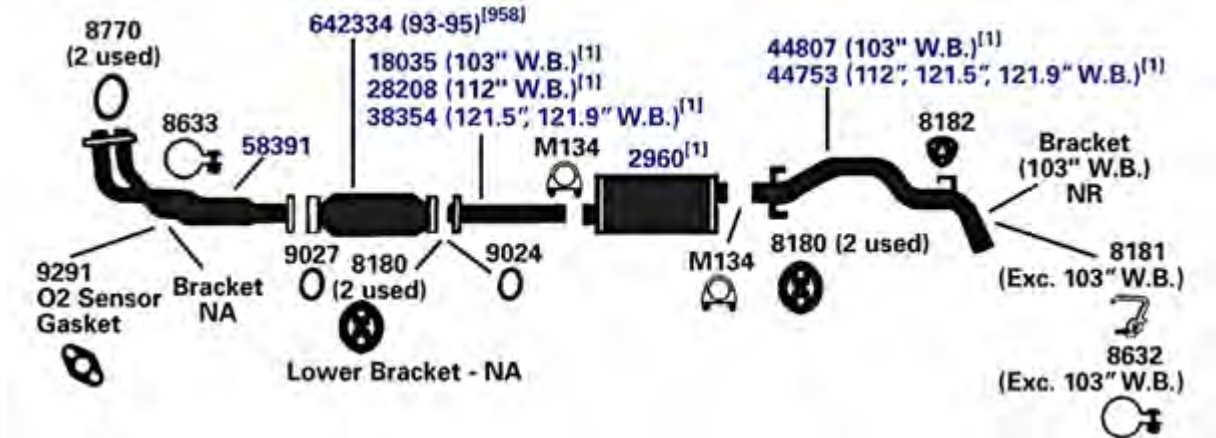

DIRECT FIT MSL/MAXIMUM Muffler... 6672, UNIVERSAL FIT MSL/MAXIMUM Muffler... 709994, Silentone DIY Muffler... 5580

1994	4 Cyl.	Pickup, Cab and Chassis; 2.4L Fuel Inj; 4 W.D.; 103", 121.5", 121.9" W.B.; except California	(30523)
89-93	4 Cyl.	Pickup, Cab and Chassis; 2.4L Fuel Inj; 4 W.D.; 103", 112", 121.5" W.B.; except California	

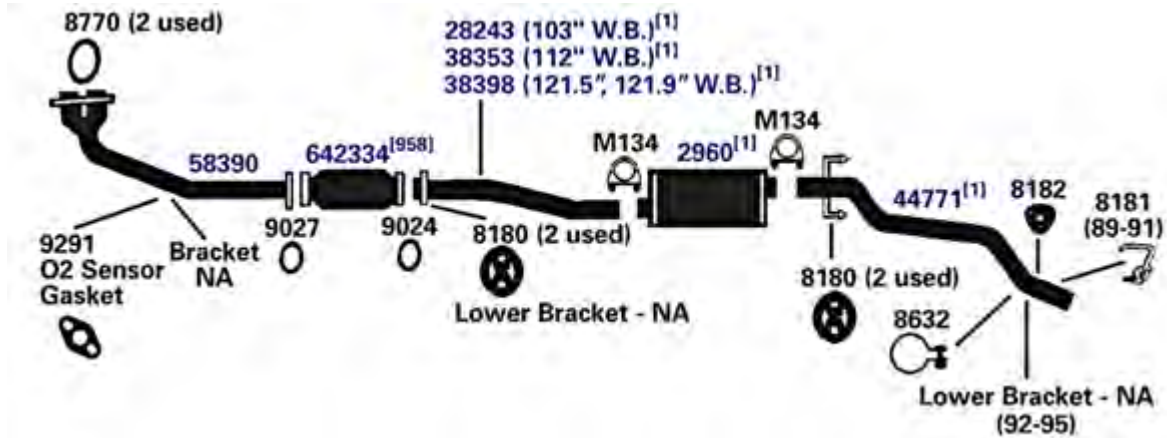

DIRECT FIT MSL/MAXIMUM Muffler... 6672, UNIVERSAL FIT MSL/MAXIMUM Muffler... 709994, Silentone DIY Muffler... 5580

NA-Not Available. NR-Not Required. FL-Remove and Re-Use Old Flange. ● Golden Warehouse. O.E.-Original Equipment.
 # Airtube Kit [4948] may be required to complete installation. EFI-Electronic Fuel Injection.

[1] OE system was a welded assembly. It is recommended that all parts noted [1] should be replaced. [958] Federal & California Emission vehicles. Not legal for sale for vehicles licensed in California.

TOYOTA PICKUP, CAB AND CHASSIS

(30525) 89-94 6 Cyl. Pickup, Cab and Chassis; 3.0L Engine; 121.5", 121.9" W.B.; 2 W.D., 4 W.D.; except California

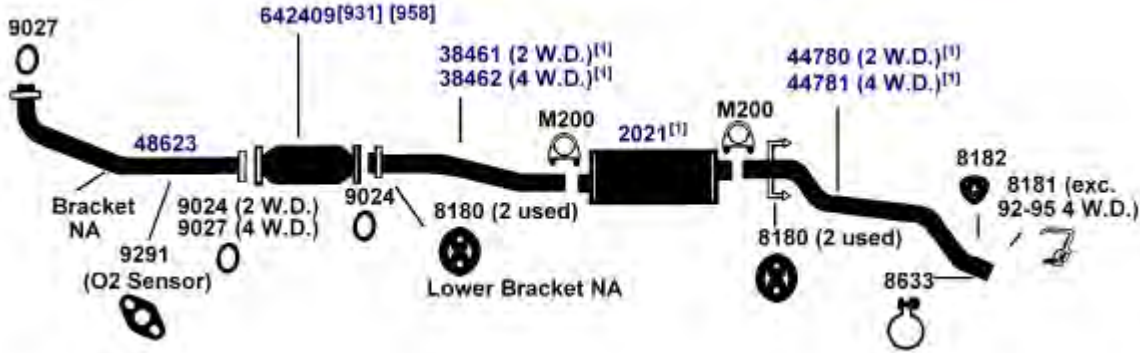

DIRECT FIT MSL/MAXIMUM Muffler... 700152, UNIVERSAL FIT MSL/MAXIMUM Muffler... 709993, 709994

(30527) 92-94 4 Cyl. Pickup, Cab and Chassis; 2.4L Fuel Inj.; 2 W.D.; 103" W.B.; California

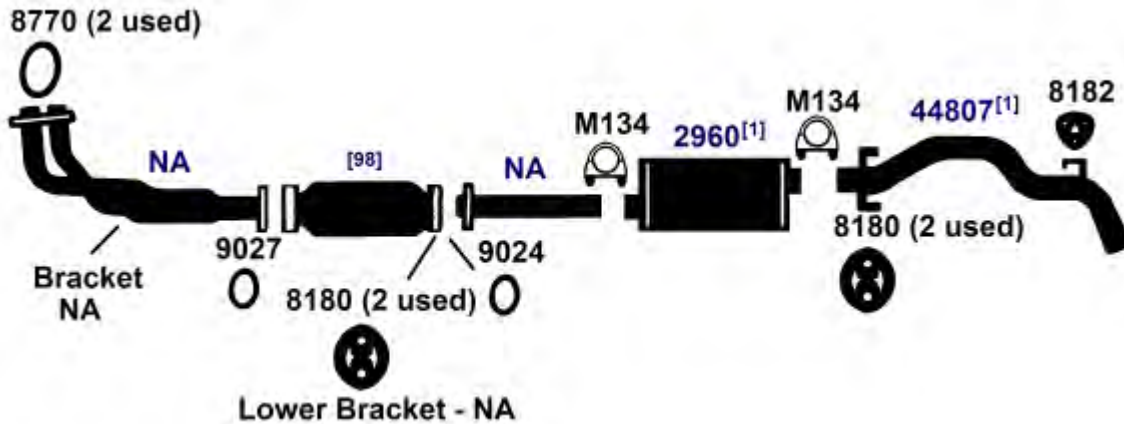

DIRECT FIT MSL/MAXIMUM Muffler... 6672, UNIVERSAL FIT MSL/MAXIMUM Muffler... 709994, Silentone DIY Muffler... 5580

(30522) 88-93 6 Cyl. Pickup, Cab and Chassis; 3.0L Fuel Inj.; 103" W.B.; 4 W.D.

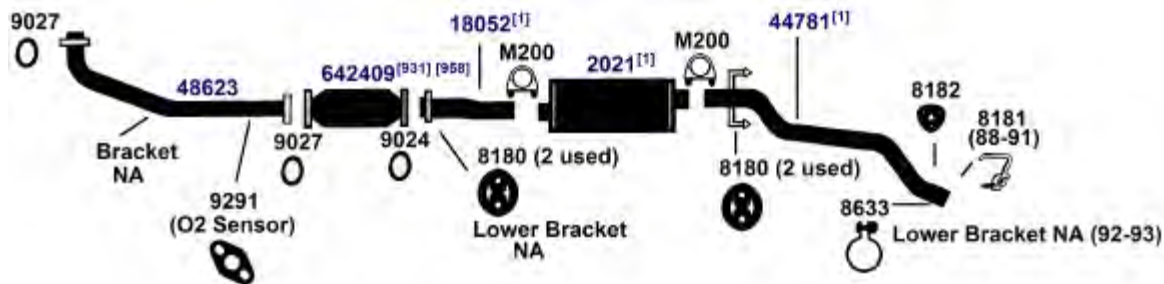

DIRECT FIT MSL/MAXIMUM Muffler... 700152, UNIVERSAL FIT MSL/MAXIMUM Muffler... 709993, 709994

NA-Not Available. NR-Not Required. FL-Remove and Re-Use Old Flange. ● Golden Warehouse. O.E.-Original Equipment.

Airtube Kit [4948] may be required to complete installation. EFI-Electronic Fuel Injection.

[1] OE system was a welded assembly. It is recommended that all parts noted [1] should be replaced.

[98] Refer to current Catalytic Converter catalog or Website catalog for availability.

[931] This unit was designed to fit many applications. Measurement of the old unit and cutting of new unit is required.

[958] Federal & California Emission vehicles. Not legal for sale for vehicles licensed in California.

TOYOTA PICKUP, CAB AND CHASSIS

89-93 6 Cyl. Pickup, Cab and Chassis; 3.0L Fuel Inj.; 112" W.B.; 2 W.D., 4 W.D. **(30521)**

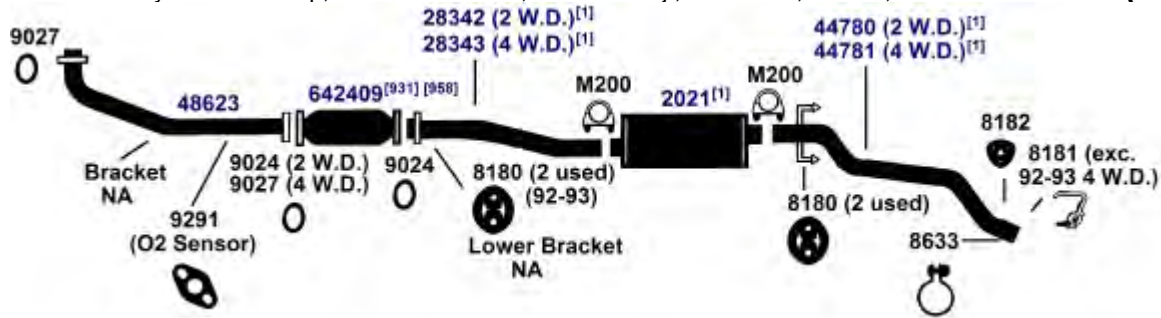

DIRECT FIT MSL/MAXIMUM Muffler... 700152, UNIVERSAL FIT MSL/MAXIMUM Muffler... 709993, 709994

89-91 4 Cyl. Pickup, Cab and Chassis; 2.4L Carb., 2.4L Fuel Inj.; 2 W.D.; except California **(30520)**

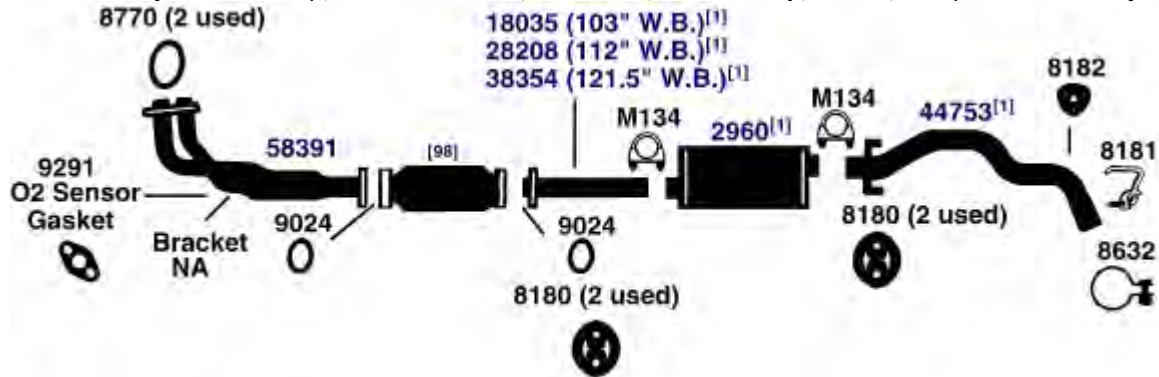

DIRECT FIT MSL/MAXIMUM Muffler... 6672, UNIVERSAL FIT MSL/MAXIMUM Muffler... 709994, Silentone DIY Muffler... 5580

86-88 4 Cyl. Pickup, Cab and Chassis, Camper; 2.4L Carb., 2.4L Fuel Inj.; 2 W.D.; (RN70) 121.5" W.B.; (RN75) 137" W.B. **(30518)**

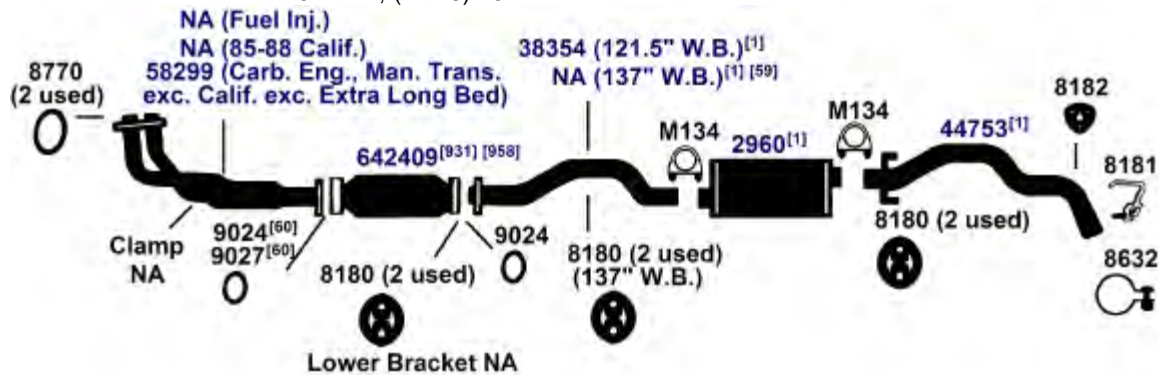

DIRECT FIT MSL/MAXIMUM Muffler... 6672, UNIVERSAL FIT MSL/MAXIMUM Muffler... 709994, Silentone DIY Muffler... 5580

NA-Not Available. NR-Not Required. FL-Remove and Re-Use Old Flange. ● Golden Warehouse. O.E.-Original Equipment.

Airtube Kit [4948] may be required to complete installation. EFI-Electronic Fuel Injection.

[1] OE system was a welded assembly. It is recommended that all parts noted [1] should be replaced.

[59] Cab and Chassis only.

[60] If the pipe extension (Gasket Retainer) at the front exhaust pipe outlet or catalytic converter inlet is 1 7/8" O.D., use 9024 gasket; If 2 1/8" O.D., use 9027 gasket.

[98] Refer to current Catalytic Converter catalog or Website catalog for availability.

[931] This unit was designed to fit many applications. Measurement of the old unit and cutting of new unit is required.

[958] Federal & California Emission vehicles. Not legal for sale for vehicles licensed in California.

TOYOTA PICKUP, CAB AND CHASSIS

(30519) 86-88 4 Cyl. Pickup, Cab and Chassis; 2.4L Carb., 2.4L Fuel Inj.; 4 W.D.

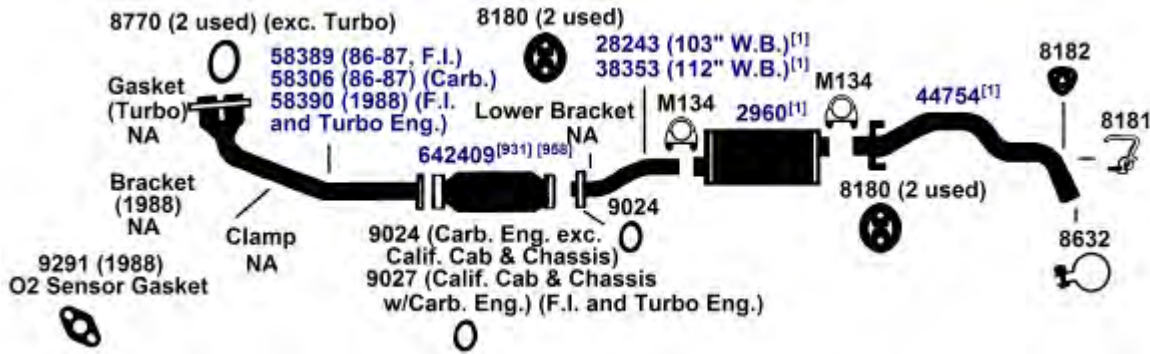

DIRECT FIT MSL/MAXIMUM Muffler... 6672, UNIVERSAL FIT MSL/MAXIMUM Muffler... 709994, Silentone DIY Muffler... 5580

(30516) 85-88 4 Cyl. Pickup, Cab and Chassis; 2 W.D.; 22R (Carb.), 22R-EC (EFI), and 22R-TEC (Turbo) Engines; except Diesel and RN70 (121.5" W.B.), RN75 (137" W.B) Models

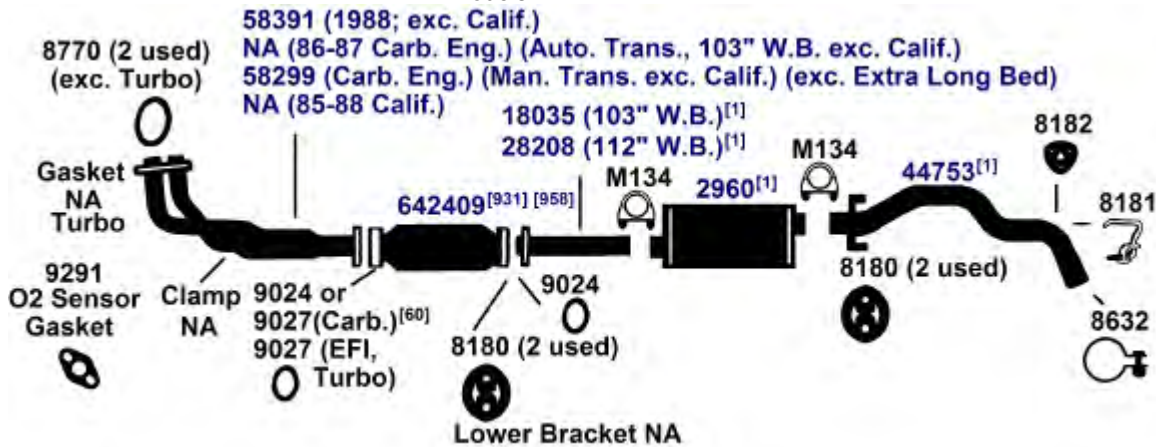

DIRECT FIT MSL/MAXIMUM Muffler... 6672, UNIVERSAL FIT MSL/MAXIMUM Muffler... 709994, Silentone DIY Muffler... 5580

NA-Not Available. NR-Not Required. FL-Remove and Re-Use Old Flange. ● Golden Warehouse. O.E.-Original Equipment.

Airtube Kit [4948] may be required to complete installation. EFI-Electronic Fuel Injection.

[1] OE system was a welded assembly. It is recommended that all parts noted [1] should be replaced.

[60] If the pipe extension (Gasket Retainer) at the front exhaust pipe outlet or catalytic converter inlet is 1 7/8" O.D., use 9024 gasket; If 2 1/8" O.D., use 9027 gasket.

[931] This unit was designed to fit many applications. Measurement of the old unit and cutting of new unit is required.

[958] Federal & California Emission vehicles. Not legal for sale for vehicles licensed in California.

TOYOTA PICKUP, CAB AND CHASSIS

1985 4 Cyl. Pickup, Cab and Chassis; 4 W.D.; 22R (Carb.) and 22R-EC (EFI) Engine; except **(30517)**
 Diesel

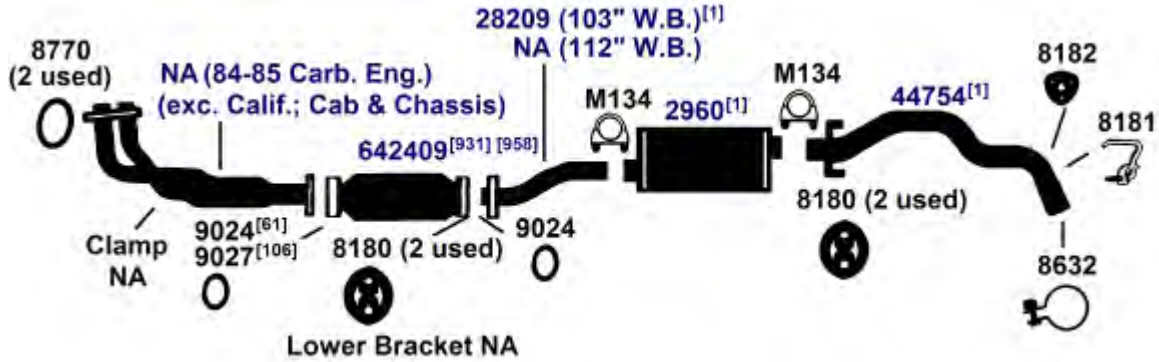

DIRECT FIT MSL/MAXIMUM Muffler... 6672, UNIVERSAL FIT MSL/MAXIMUM Muffler... 709994, Silentone DIY Muffler... 5580

1985 4 Cyl. Pickup, Cab and Chassis; 2 W.D.; 2.4L Diesel Engine, except Turbo; 103" W.B., **(100557)**
 112" W.B.

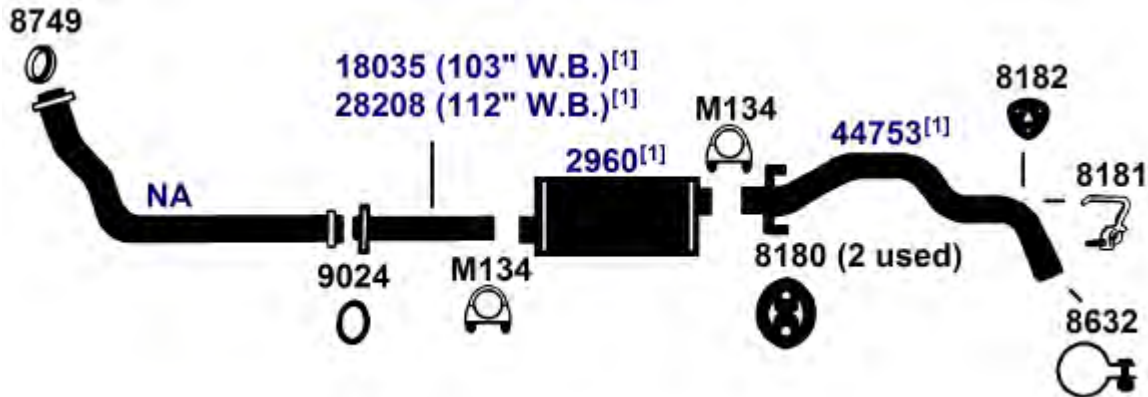

DIRECT FIT MSL/MAXIMUM Muffler... 6672, UNIVERSAL FIT MSL/MAXIMUM Muffler... 709994, Silentone DIY Muffler... 5580

NA-Not Available. NR-Not Required. FL-Remove and Re-Use Old Flange. ● Golden Warehouse. O.E.-Original Equipment.
 # Airtube Kit [4948] may be required to complete installation. EFI-Electronic Fuel Injection.

[1] OE system was a welded assembly. It is recommended that all parts noted [1] should be replaced.

[61] Carb. models except California Cab and Chassis.

[106] EFI models; California Cab and Chassis with Carb.

[931] This unit was designed to fit many applications. Measurement of the old unit and cutting of new unit is required.

[958] Federal & California Emission vehicles. Not legal for sale for vehicles licensed in California.

TOYOTA PICKUP, CAB AND CHASSIS

(100592) 1985 4 Cyl. Pickup, Cab and Chassis; 4 W.D.; 2.4L Diesel Engine, Including Turbo

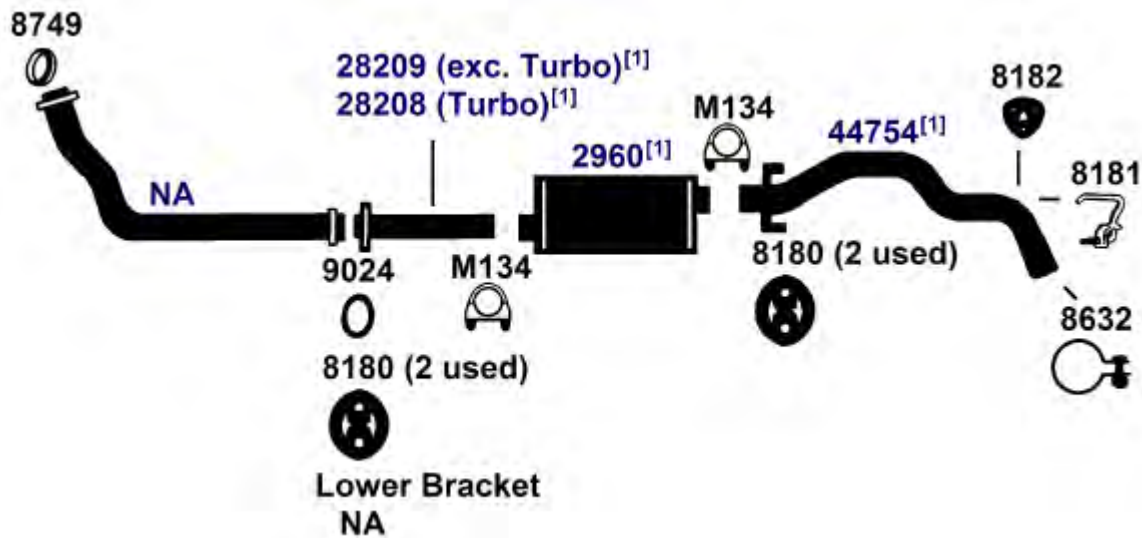

DIRECT FIT MSL/MAXIMUM Muffler... 6672, UNIVERSAL FIT MSL/MAXIMUM Muffler... 709994, Silentone DIY Muffler... 5580

(100593) 1984 4 Cyl. Pickup, Cab and Chassis; 4 W.D.; 2.4L Diesel Engine

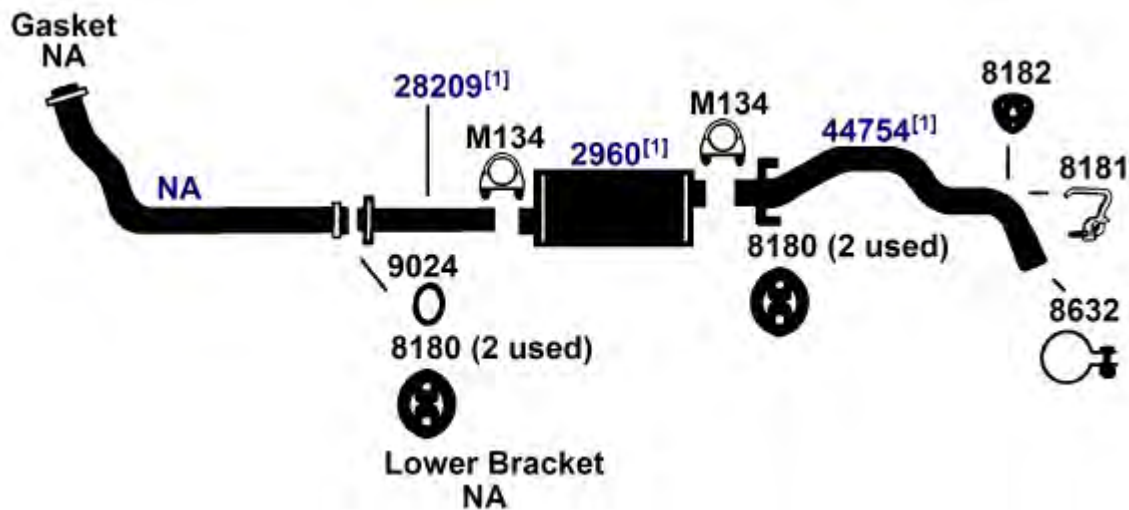

DIRECT FIT MSL/MAXIMUM Muffler... 6672, UNIVERSAL FIT MSL/MAXIMUM Muffler... 709994, Silentone DIY Muffler... 5580

NA-Not Available. NR-Not Required. FL-Remove and Re-Use Old Flange. ● Golden Warehouse. O.E.-Original Equipment.
Airtube Kit [4948] may be required to complete installation. EFI-Electronic Fuel Injection.

[1] OE system was a welded assembly. It is recommended that all parts noted [1] should be replaced.

TOYOTA PICKUP, CAB AND CHASSIS

1984 4 Cyl. Pickup, Cab and Chassis; 4 W.D.; 22R (Carb.) and 22R-EC (EFI) Engine; except **(30517E)** Diesel

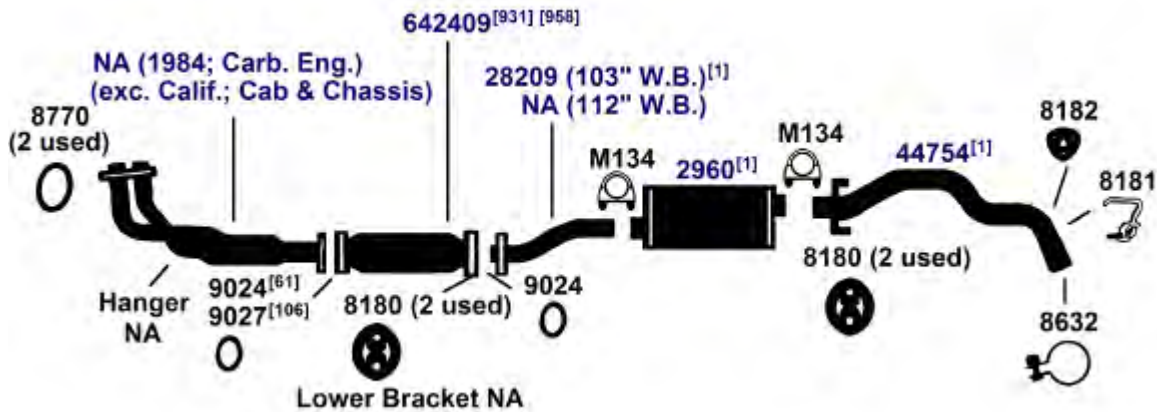

DIRECT FIT MSL/MAXIMUM Muffler... 6672, UNIVERSAL FIT MSL/MAXIMUM Muffler... 709994, Silentone DIY Muffler... 5580

1984 4 Cyl. Pickup, Cab and Chassis; 2 W.D.; 22R (Carb.), 22R-EC (EFI), and 22R-TEC (Turbo) Engines; except Diesel and RN70 (121.5\"/>

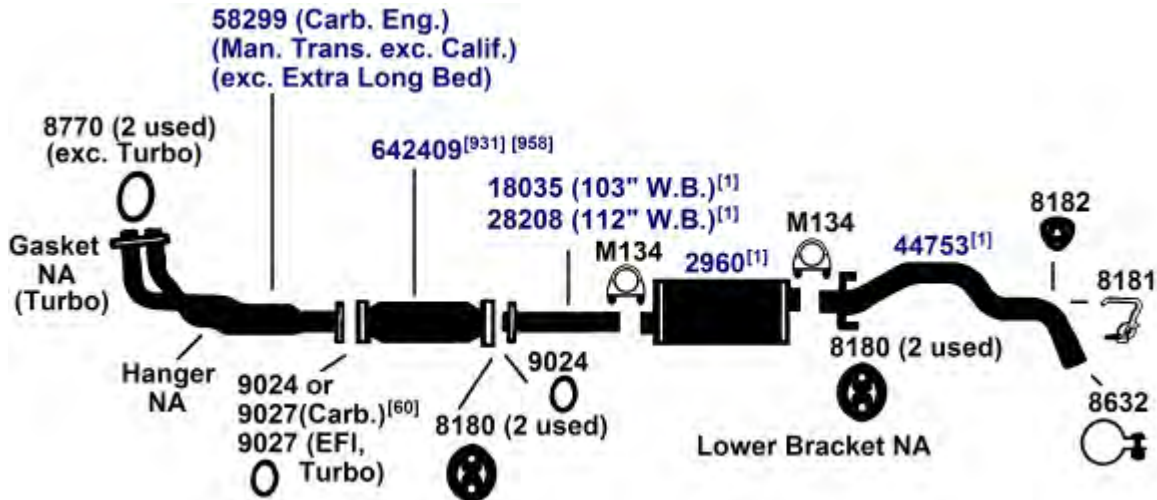

DIRECT FIT MSL/MAXIMUM Muffler... 6672, UNIVERSAL FIT MSL/MAXIMUM Muffler... 709994, Silentone DIY Muffler... 5580

NA-Not Available. NR-Not Required. FL-Remove and Re-Use Old Flange. ● Golden Warehouse. O.E.-Original Equipment.
Airtube Kit [4948] may be required to complete installation. EFI-Electronic Fuel Injection.

- [1] OE system was a welded assembly. It is recommended that all parts noted [1] should be replaced.
- [60] If the pipe extension (Gasket Retainer) at the front exhaust pipe outlet or catalytic converter inlet is 1 7/8\"/>

- [106] EFI models; California Cab and Chassis with Carb.
- [931] This unit was designed to fit many applications. Measurement of the old unit and cutting of new unit is required.
- [958] Federal & California Emission vehicles. Not legal for sale for vehicles licensed in California.

TOYOTA PICKUP, CAB AND CHASSIS

(30515) 1983 4 Cyl. Pickup, Cab and Chassis; 2 W.D., 4 W.D.; except Diesel and Heavy Duty Cab and Chassis

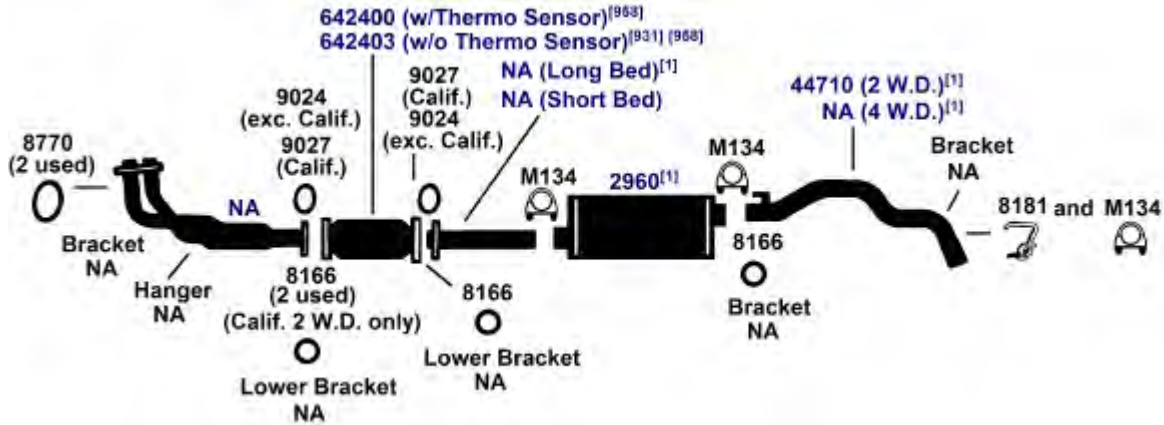

DIRECT FIT MSL/MAXIMUM Muffler... 6672, UNIVERSAL FIT MSL/MAXIMUM Muffler... 709994, Silentone DIY Muffler... 5580

(30514) 81-83 4 Cyl. Pickup, Cab and Chassis; Diesel Engine

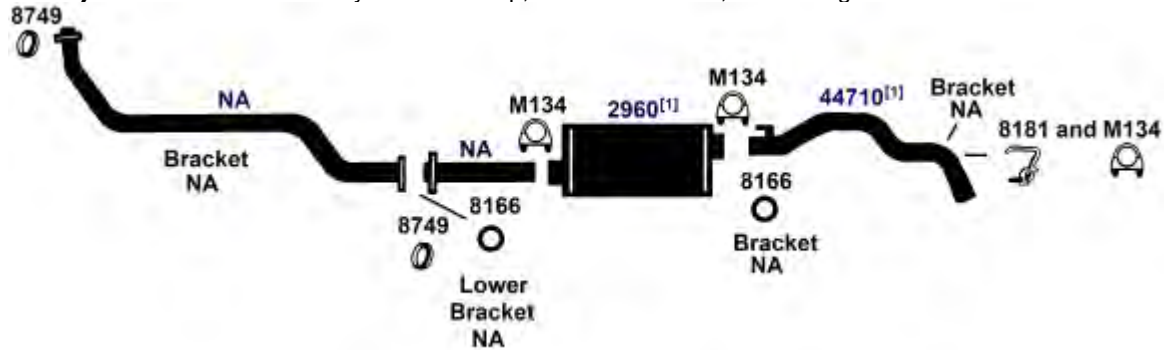

DIRECT FIT MSL/MAXIMUM Muffler... 6672, UNIVERSAL FIT MSL/MAXIMUM Muffler... 709994, Silentone DIY Muffler... 5580

NA-Not Available. NR-Not Required. FL-Remove and Re-Use Old Flange. ● Golden Warehouse. O.E.-Original Equipment.
Airtube Kit [4948] may be required to complete installation. EFI-Electronic Fuel Injection.

[1] OE system was a welded assembly. It is recommended that all parts noted [1] should be replaced.

[931] This unit was designed to fit many applications. Measurement of the old unit and cutting of new unit is required.

[958] Federal & California Emission vehicles. Not legal for sale for vehicles licensed in California.

TOYOTA PICKUP, CAB AND CHASSIS

81-82 4 Cyl. Pickup, Cab and Chassis; 2 W.D., 4 W.D.; except Diesel and Heavy Duty Cab **(30513)**
and Chassis

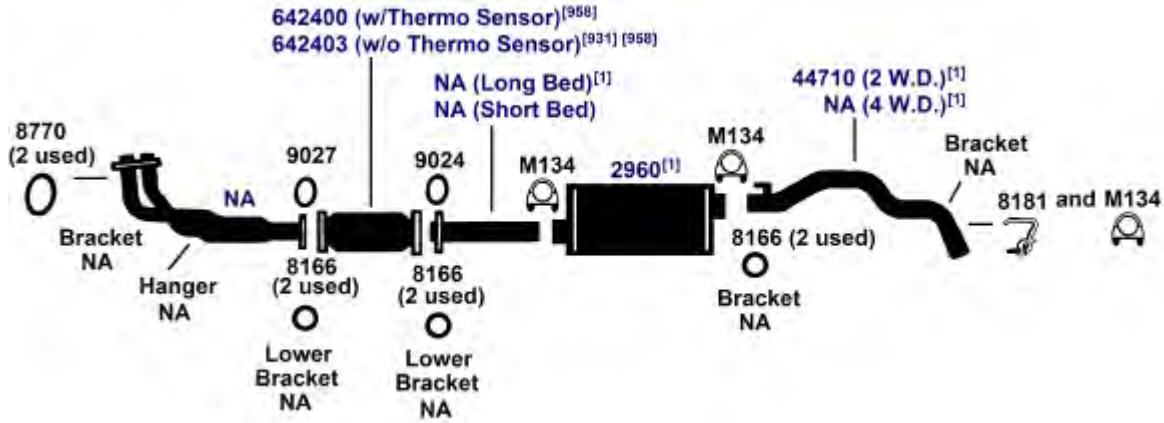

DIRECT FIT MSL/MAXIMUM Muffler... 6672, UNIVERSAL FIT MSL/MAXIMUM Muffler... 709994, Silentone DIY Muffler... 5580

79-80 4 Cyl. Pickup, Cab and Chassis; 2189cc, 20R Engine; 4 W.D., (RN37) Short Wheel Base, (RN47) Long Wheel Base; 1/2 Ton; without Converter **(30510)**

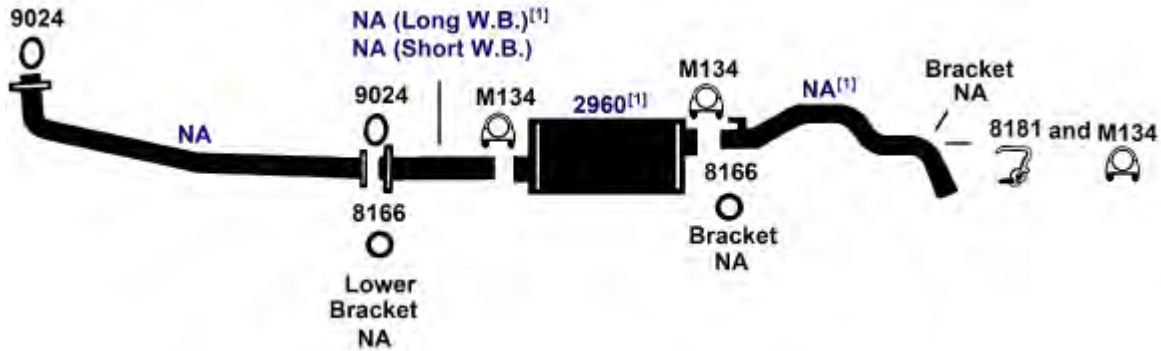

DIRECT FIT MSL/MAXIMUM Muffler... 6672, UNIVERSAL FIT MSL/MAXIMUM Muffler... 709994, Silentone DIY Muffler... 5580

NA-Not Available. NR-Not Required. FL-Remove and Re-Use Old Flange. ● Golden Warehouse. O.E.-Original Equipment.
Airtube Kit [4948] may be required to complete installation. EFI-Electronic Fuel Injection.

[1] OE system was a welded assembly. It is recommended that all parts noted [1] should be replaced.

[931] This unit was designed to fit many applications. Measurement of the old unit and cutting of new unit is required.

[958] Federal & California Emission vehicles. Not legal for sale for vehicles licensed in California.

TOYOTA PICKUP, CAB AND CHASSIS

(30509) 79-80 4 Cyl. Pickup, Cab and Chassis; 2189cc, 20R Engine; 4 W.D., (RN37) Short Wheel Base, (RN47) Long Wheel Base; 1/2 Ton; with Converter

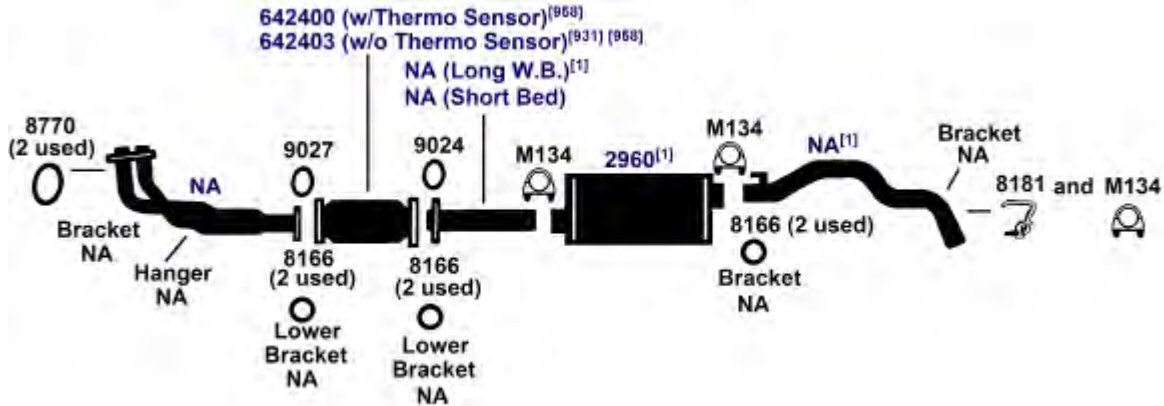

DIRECT FIT MSL/MAXIMUM Muffler... 6672, UNIVERSAL FIT MSL/MAXIMUM Muffler... 709994, Silentone DIY Muffler... 5580

(30511) 79-80 4 Cyl. Pickup, Cab and Chassis; 2189cc, 20R Engine; 2 W.D., (RN32) Short Wheel Base, (RN42) Long Wheel Base; 1/2-3/4 Ton, with Converter; except Heavy Duty Cab and Chassis

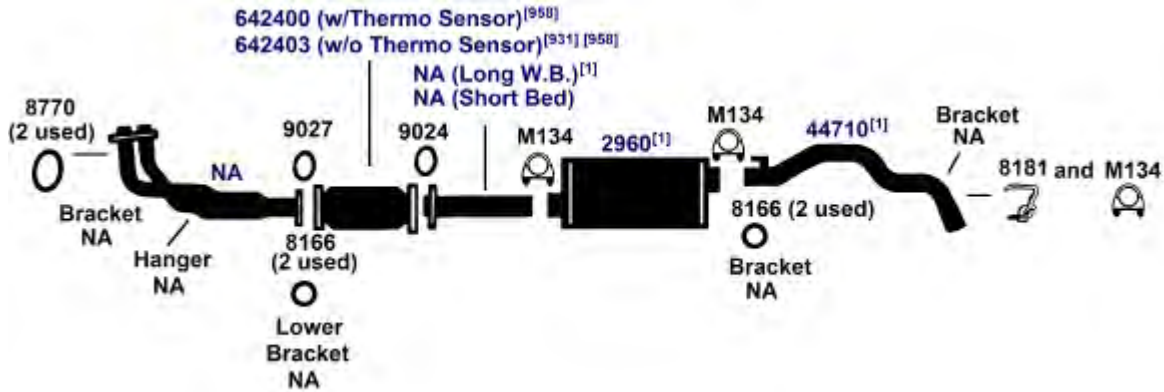

DIRECT FIT MSL/MAXIMUM Muffler... 6672, UNIVERSAL FIT MSL/MAXIMUM Muffler... 709994, Silentone DIY Muffler... 5580

NA-Not Available. NR-Not Required. FL-Remove and Re-Use Old Flange. ● Golden Warehouse. O.E.-Original Equipment.
Airtube Kit [4948] may be required to complete installation. EFI-Electronic Fuel Injection.

[1] OE system was a welded assembly. It is recommended that all parts noted [1] should be replaced.

[931] This unit was designed to fit many applications. Measurement of the old unit and cutting of new unit is required.

[958] Federal & California Emission vehicles. Not legal for sale for vehicles licensed in California.

TOYOTA PICKUP, CAB AND CHASSIS

79-80 4 Cyl. Pickup, Cab and Chassis; 2189cc, 20R Engine; 2 W.D., (RN32) Short Wheel Base, (RN42) Long Wheel Base; 1/2-3/4 Ton, without Converter **(30512)**

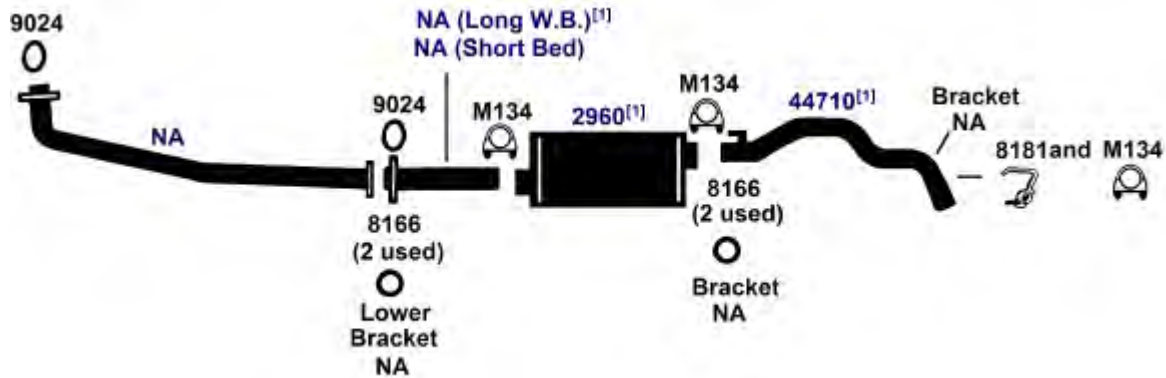

DIRECT FIT MSL/MAXIMUM Muffler... 6672, UNIVERSAL FIT MSL/MAXIMUM Muffler... 709994, Silentone DIY Muffler... 5580

TOYOTA PREVIA

91-94 4 Cyl. Previa; 2.4L EFI Engine (2TZFE), All Trac 94-95; except Supercharged Engine **(34700)**

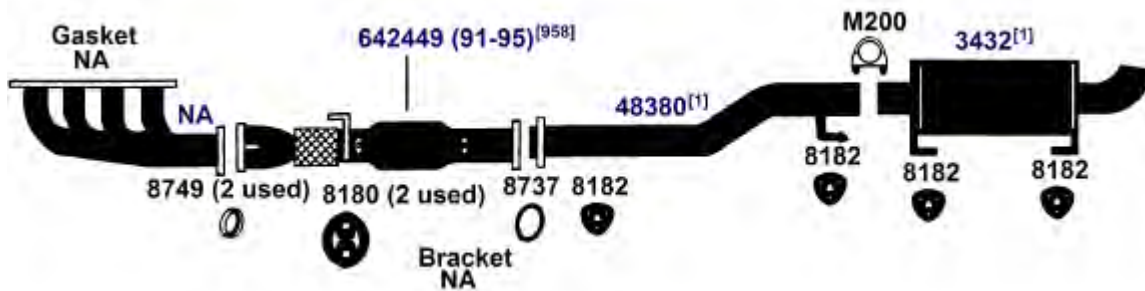

DIRECT FIT MSL/MAXIMUM Muffler... 700354

TOYOTA T100 PICKUP

1994 6 Cyl. T100 Pickup, 3.0L Fuel Inj.; 2 W.D., 4 W.D. **(30528)**
1993 6 Cyl. T100 Pickup, 3.0L Engine; 2 W.D. (except California); 4 W.D.

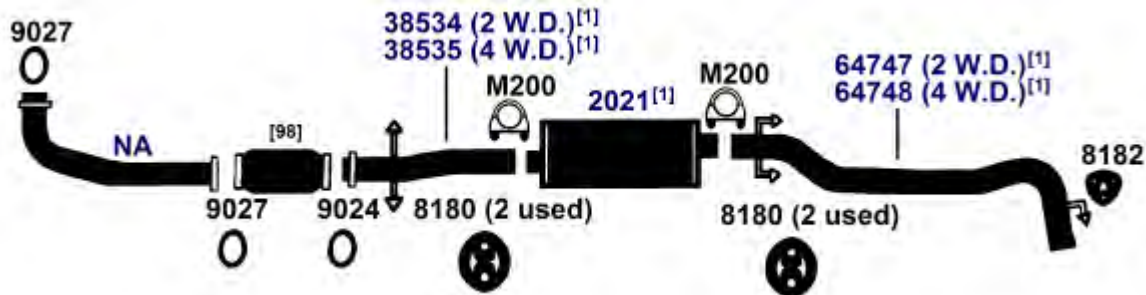

DIRECT FIT MSL/MAXIMUM Muffler... 700152, UNIVERSAL FIT MSL/MAXIMUM Muffler... 709993, 709994

NA-Not Available. NR-Not Required. FL-Remove and Re-Use Old Flange. ● Golden Warehouse. O.E.-Original Equipment.
 # Airtube Kit [4948] may be required to complete installation. EFI-Electronic Fuel Injection.

[1] OE system was a welded assembly. It is recommended that all parts noted [1] should be replaced.

[958] Federal & California Emission vehicles. Not legal for sale for vehicles licensed in California.

[98] Refer to current Catalytic Converter catalog or Website catalog for availability.

TOYOTA TERCEL

(10280) 91-94 4 Cyl. Tercel, 1.5L EFI Engine

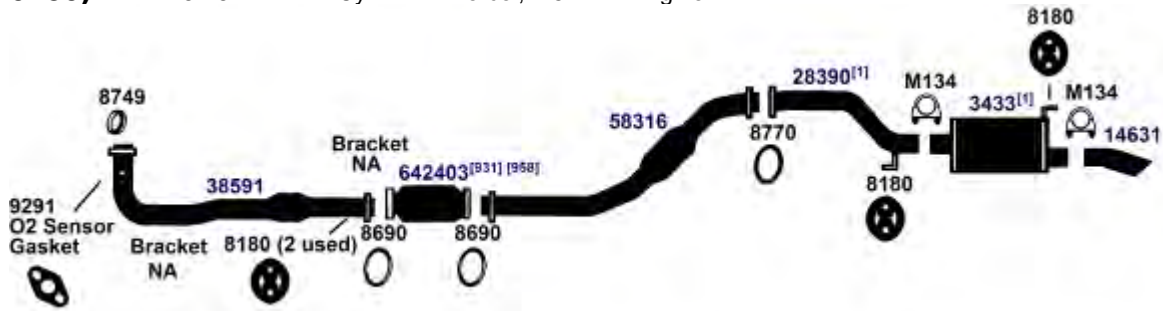

DIRECT FIT MSL/MAXIMUM Muffler... 700275

(10279) 1990 4 Cyl. Tercel 2-Door Sedan, 3-Door Hatchback; 1.5L Fuel Injected Engine; Auto. Trans., California (exc. Canada)
 1990 4 Cyl. Tercel 2-Door Sedan, 3-Door Hatchback; 1.5L Carb. Engine; except California (exc. Canada)
 87-89 4 Cyl. Tercel 2-Door Sedan, 2,4 Door Hatchback; 1.5L Engine (exc. Canada)

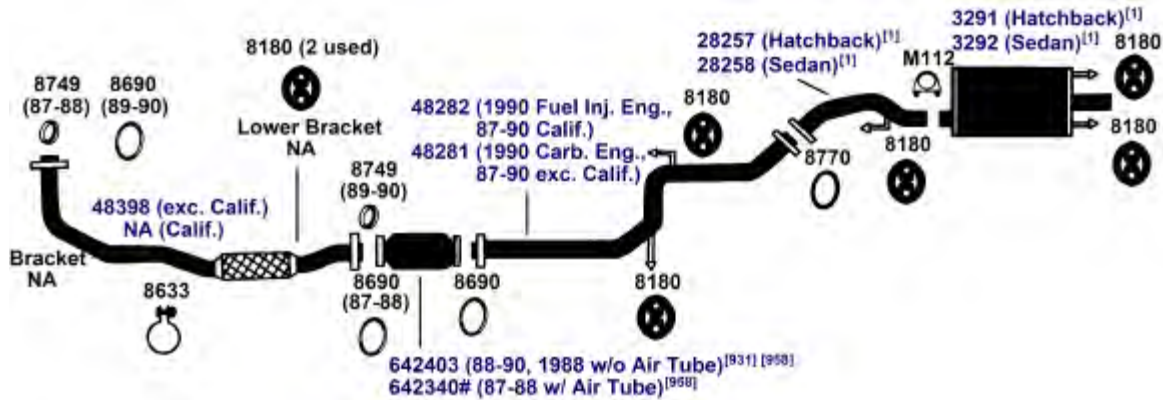

DIRECT FIT MSL/MAXIMUM Muffler... Hatchback- 6698 (Hatchback), Sedan- 6696 (Sedan)

NA-Not Available. NR-Not Required. FL-Remove and Re-Use Old Flange. ● Golden Warehouse. O.E.-Original Equipment.
 # Airtube Kit [4948] may be required to complete installation. EFI-Electronic Fuel Injection.

[1] OE system was a welded assembly. It is recommended that all parts noted [1] should be replaced.

[958] Federal & California Emission vehicles. Not legal for sale for vehicles licensed in California.

[931] This unit was designed to fit many applications. Measurement of the old unit and cutting of new unit is required.

1990 4 Cyl. Tercel, 2-Door Sedan, 3-Door Hatchback; 1.5L Carb. Engine (CANADA ONLY) **(100308)**
87-89 4 Cyl. Tercel, 2-Door Sedan, 2 and 4-Door Hatchback; 1.5L Engine (CANADA ONLY)

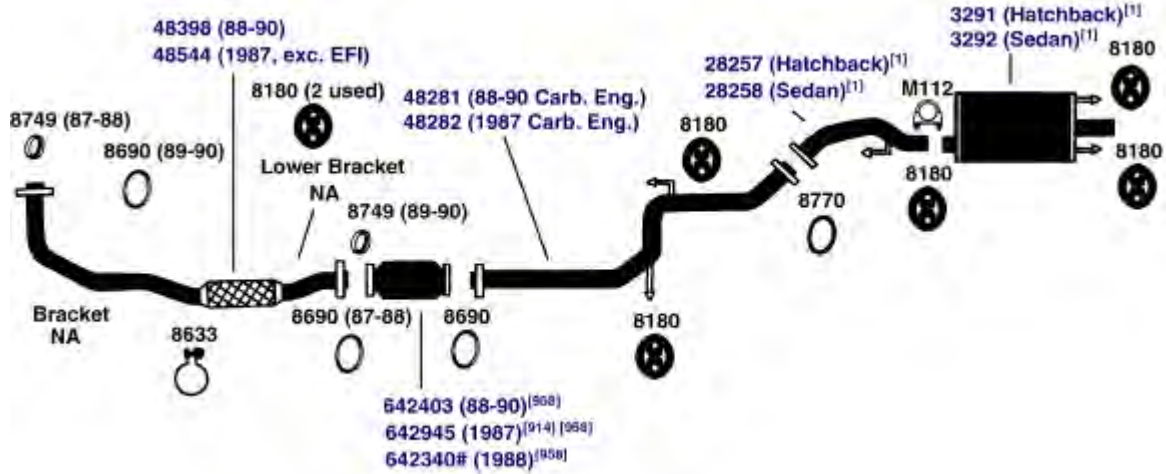

DIRECT FIT MSL/MAXIMUM Muffler... 6698 (Hatchback), 6696 (Sedan)

85-88 4 Cyl. Tercel Sta. Wagon, 4WD (exc. Canada) **(10273)**

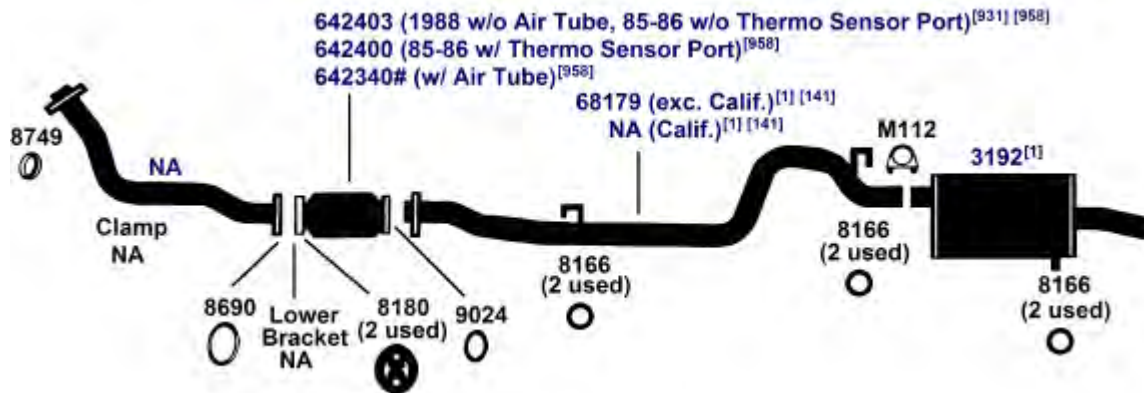

UNIVERSAL FIT MSL/MAXIMUM Muffler... 6651, Silentone DIY Muffler... 5587

NA-Not Available. NR-Not Required. FL-Remove and Re-Use Old Flange. ● Golden Warehouse. O.E.-Original Equipment.
 # Airtube Kit [4948] may be required to complete installation. EFI-Electronic Fuel Injection.

[1] OE system was a welded assembly. It is recommended that all parts noted [1] should be replaced.

[141] Remove and re-use O.E. heat shield, if required.

[914] Direct fit converter includes front (Exhaust) pipe, (1) piece assembly.

[931] This unit was designed to fit many applications. Measurement of the old unit and cutting of new unit is required.

[958] Federal & California Emission vehicles. Not legal for sale for vehicles licensed in California.

TOYOTA TERCEL

(10276) 85-87 4 Cyl. Tercel Sta. Wagon, 2WD

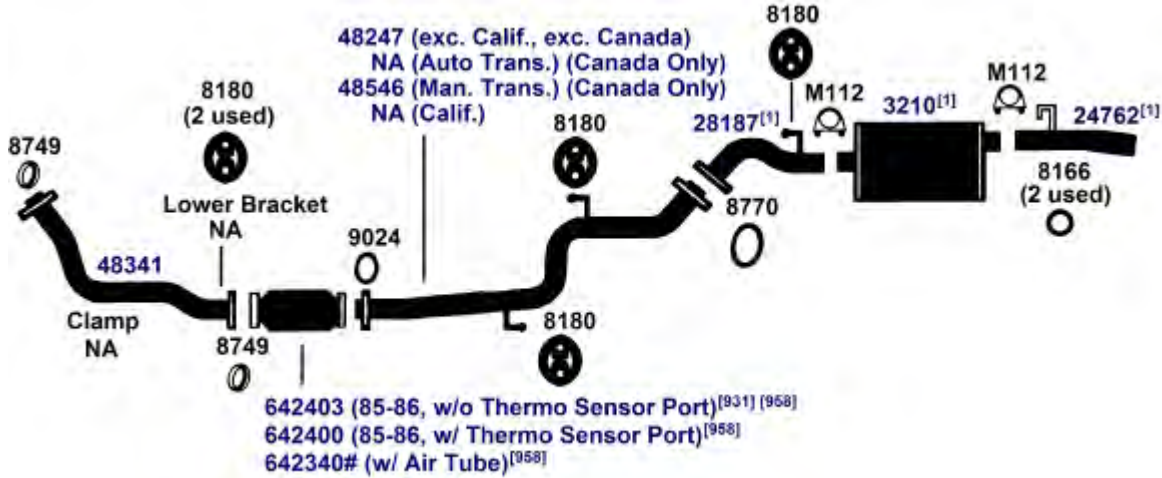

UNIVERSAL FIT MSL/MAXIMUM Muffler... 6653, Silentone DIY Muffler... 5594

(100309) 85-86 4 Cyl. Tercel, 1.5L Engine (CANADA ONLY)

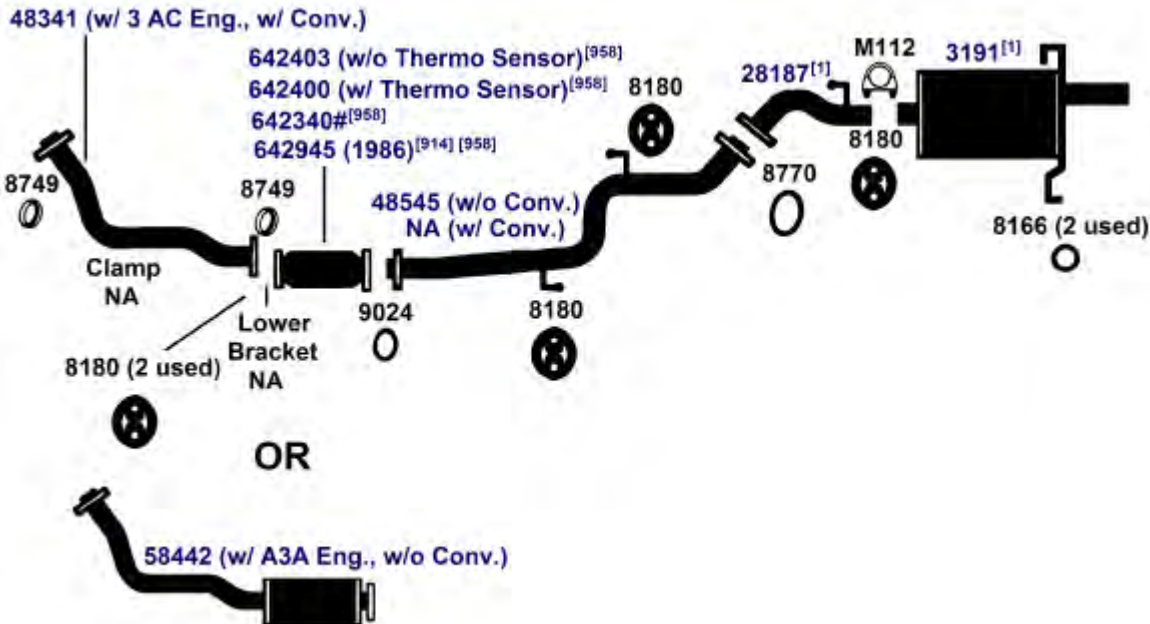

DIRECT FIT MSL/MAXIMUM Muffler... Rear Muffler (3191)- 6670, UNIVERSAL FIT MSL/MAXIMUM Muffler... Rear Muffler (3191)- 6653

NA-Not Available. NR-Not Required. FL-Remove and Re-Use Old Flange. ● Golden Warehouse. O.E.-Original Equipment.
Airtube Kit [4948] may be required to complete installation. EFI-Electronic Fuel Injection.

[1] OE system was a welded assembly. It is recommended that all parts noted [1] should be replaced.

[914] Direct fit converter includes front (Exhaust) pipe, (1) piece assembly.

[931] This unit was designed to fit many applications. Measurement of the old unit and cutting of new unit is required.

[958] Federal & California Emission vehicles. Not legal for sale for vehicles licensed in California.

TOYOTA TERCEL

(10273E) 83-84 4 Cyl. Tercel Sta. Wagon, 4WD (exc. Canada)

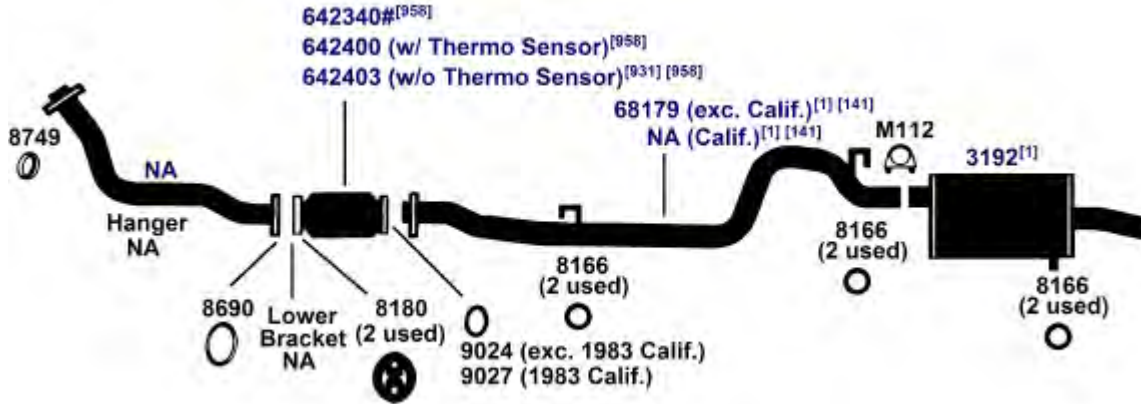

UNIVERSAL FIT MSL/MAXIMUM Muffler... 6651, Silentone DIY Muffler... 5587

(100309E) 83-84 4 Cyl. Tercel, 1.5L Engine (CANADA ONLY)

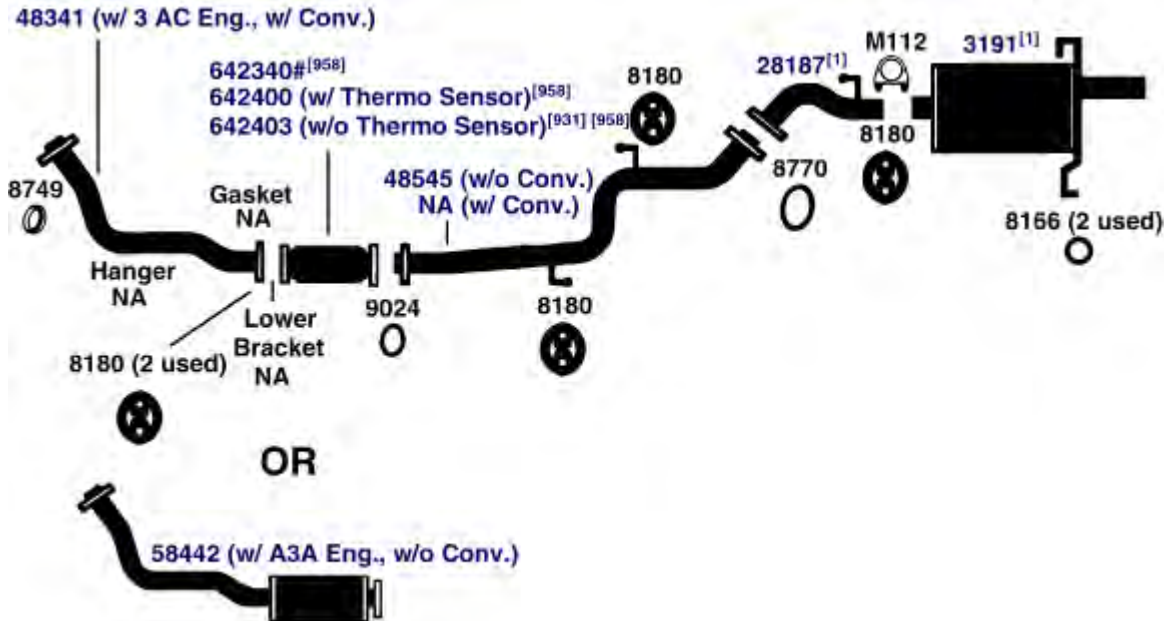

DIRECT FIT MSL/MAXIMUM Muffler... Rear Muffler (3191)- 6670, UNIVERSAL FIT MSL/MAXIMUM Muffler... Rear Muffler (3191)- 6653

NA-Not Available. NR-Not Required. FL-Remove and Re-Use Old Flange. ● Golden Warehouse. O.E.-Original Equipment.

Airtube Kit [4948] may be required to complete installation. EFI-Electronic Fuel Injection.

[1] OE system was a welded assembly. It is recommended that all parts noted [1] should be replaced.

[141] Remove and re-use O.E. heat shield, if required.

[931] This unit was designed to fit many applications. Measurement of the old unit and cutting of new unit is required.

[958] Federal & California Emission vehicles. Not legal for sale for vehicles licensed in California.

TOYOTA TERCEL

83-84 4 Cyl. Tercel 2-Door, 4-Door Hatchback Sedan (exc. Canada)

(10274E)

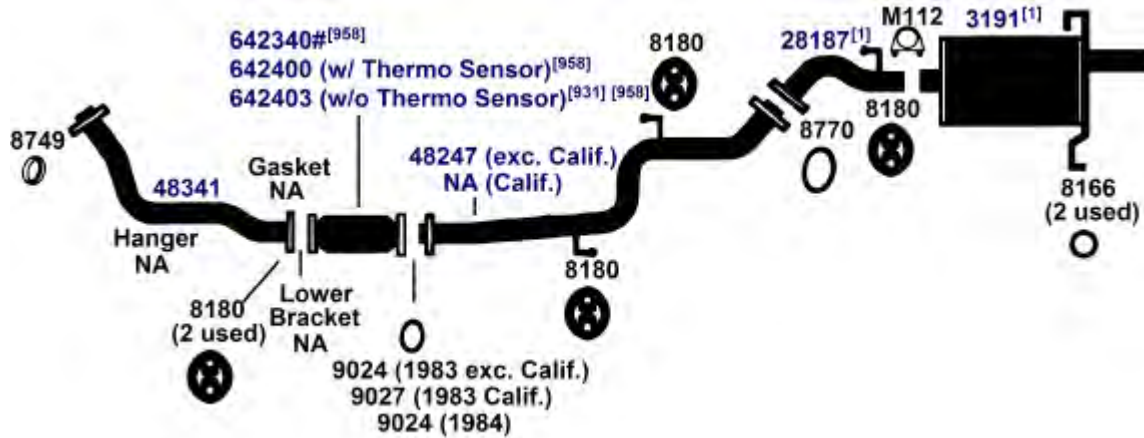

DIRECT FIT MSL/MAXIMUM Muffler... 6670, UNIVERSAL FIT MSL/MAXIMUM Muffler... 6653

TOYOTA VAN, VAN WAGON

88-90 4 Cyl. Van; Cargo and Conversion; 2.2L Engine; 2 W.D.

(30754)

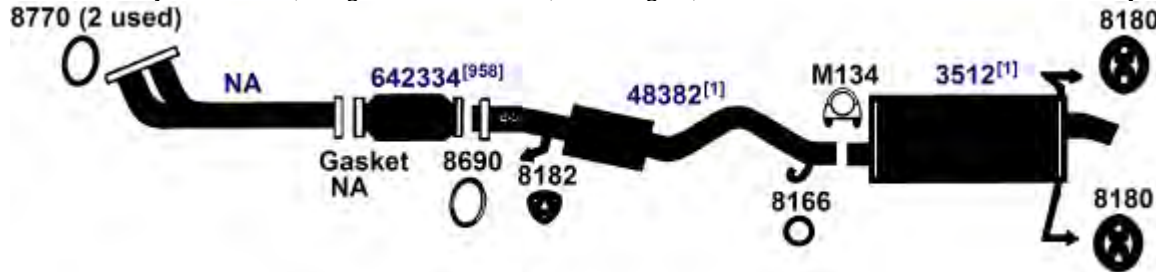

UNIVERSAL FIT MSL/MAXIMUM Muffler... Rear Muffler- 6655, 709018

88-90 4 Cyl. Van, Wagon; 2.2L Engine; 2 W.D.; except Cargo and Conversion Van

(30753)

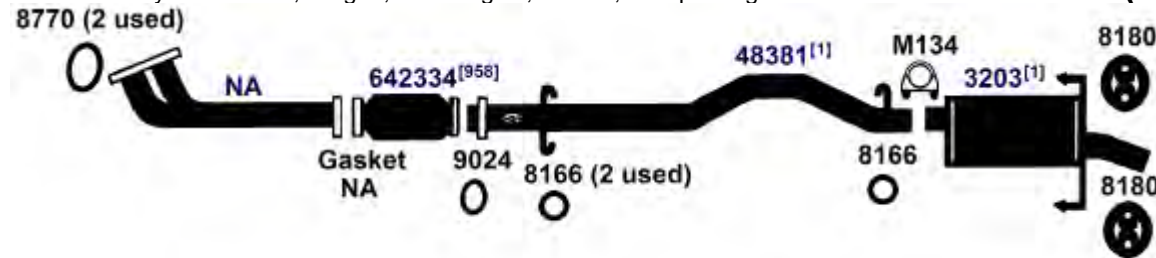

UNIVERSAL FIT MSL/MAXIMUM Muffler... 6655, 709018

NA-Not Available. NR-Not Required. FL-Remove and Re-Use Old Flange. ● Golden Warehouse. O.E.-Original Equipment.
Airtube Kit [4948] may be required to complete installation. EFI-Electronic Fuel Injection.

[1] OE system was a welded assembly. It is recommended that all parts noted [1] should be replaced.

[931] This unit was designed to fit many applications. Measurement of the old unit and cutting of new unit is required.

[958] Federal & California Emission vehicles. Not legal for sale for vehicles licensed in California.

TOYOTA VAN, VAN WAGON

(30751) 86-87 4 Cyl. Van; Cargo and Conversion; 2.2L Engine; 2 W.D.; with Rear Leaf Springs

8770 (2 used)

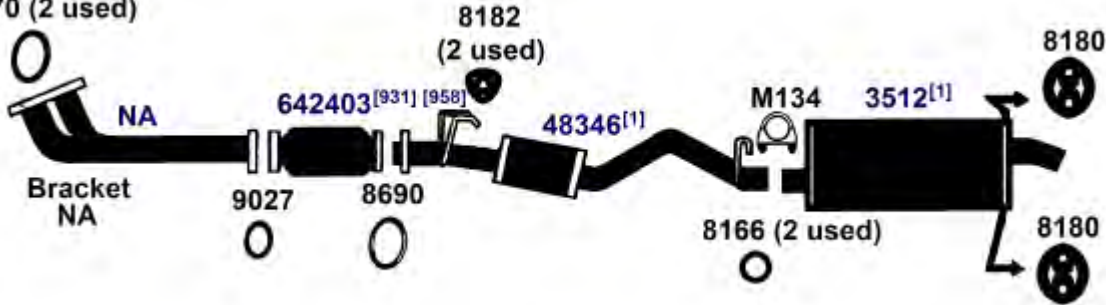

UNIVERSAL FIT MSL/MAXIMUM Muffler... Rear Muffler- 6655, 709018

(30750) 85-87 4 Cyl. Van, Wagon; 2.0L, 2.2L Engine; 2 W.D.; except 1986-87 Vans with Rear Leaf Springs

8770 (2 used)

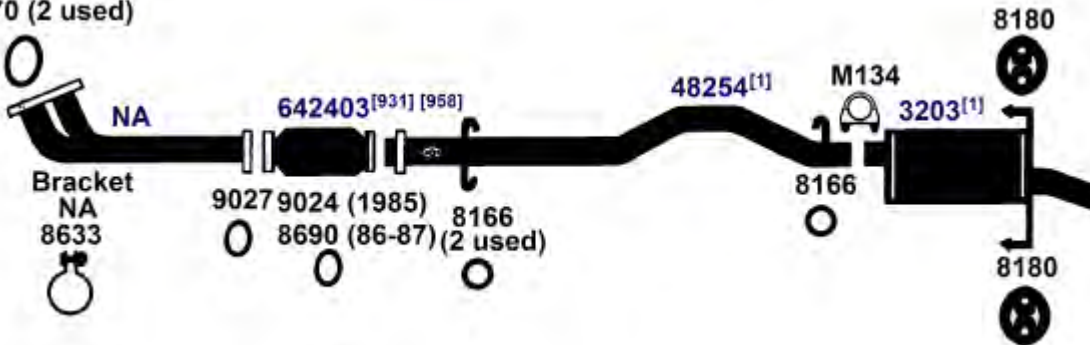

UNIVERSAL FIT MSL/MAXIMUM Muffler... 6655, 709018

(30750E) 1984 4 Cyl. Van, Wagon; 2.0L, 2.2L Engine; 2 W.D.

8770 (2 used)

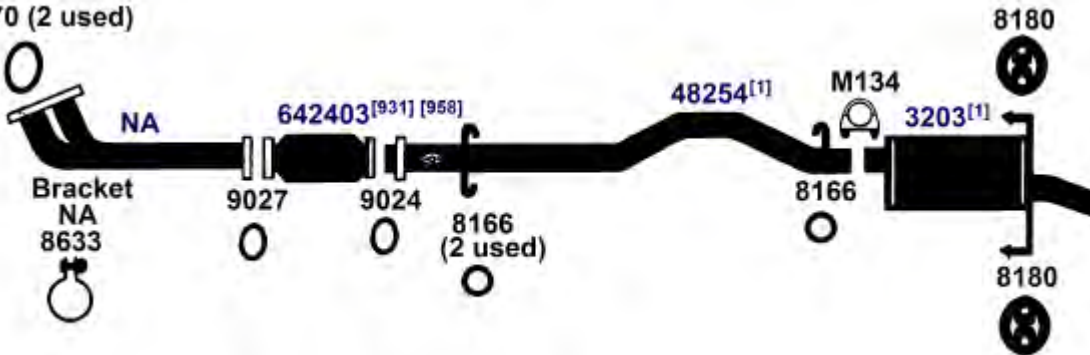

UNIVERSAL FIT MSL/MAXIMUM Muffler... 6655, 709018

NA-Not Available. NR-Not Required. FL-Remove and Re-Use Old Flange. ● Golden Warehouse. O.E.-Original Equipment.

Airtube Kit [4948] may be required to complete installation. EFI-Electronic Fuel Injection.

[1] OE system was a welded assembly. It is recommended that all parts noted [1] should be replaced.

[931] This unit was designed to fit many applications. Measurement of the old unit and cutting of new unit is required.

[958] Federal & California Emission vehicles. Not legal for sale for vehicles licensed in California.

VOLKSWAGEN VOLKSWAGEN CABRIOLET

90-93 4 Cyl. Cabriolet, 1.8L Engine

(10434)



DIRECT FIT MSL/MAXIMUM Muffler... 700402, UNIVERSAL FIT MSL/MAXIMUM Muffler... 6503, 709008, 709010

85-89 4 Cyl. Cabriolet, 1.8L Engine (1984 from CH. 15-E-011303)

(10431)

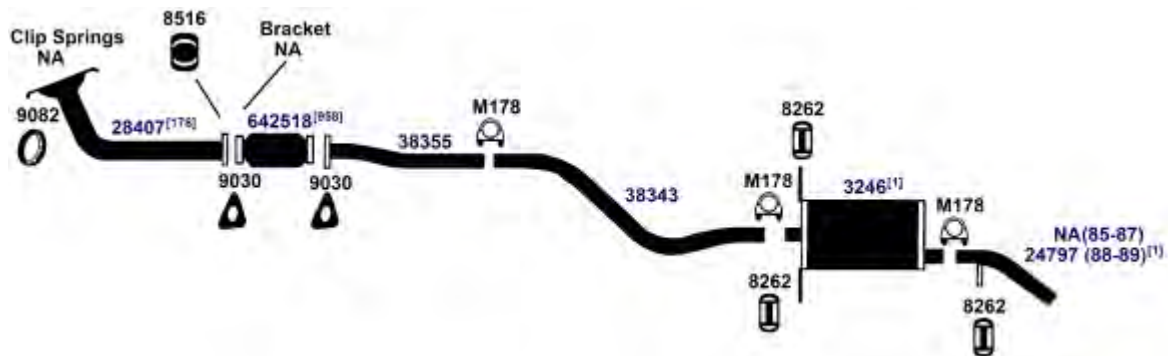

DIRECT FIT MSL/MAXIMUM Muffler... 700402, UNIVERSAL FIT MSL/MAXIMUM Muffler... 6503, 709008, 709010

VOLKSWAGEN FOX

87-93 4 Cyl. Fox, 1.8L Engine

(12250)

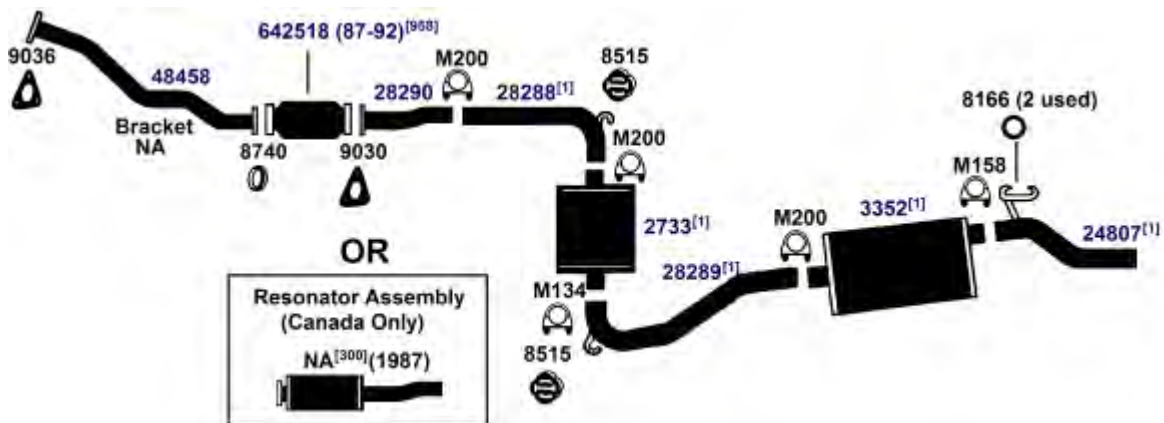

DIRECT FIT MSL/MAXIMUM Muffler... Front Muffler- 700049, Rear Muffler- 700113, UNIVERSAL FIT MSL/MAXIMUM Muffler... Front Muffler- 709004, Rear Muffler- 6674, 709008

NA-Not Available. NR-Not Required. FL-Remove and Re-Use Old Flange. ● Golden Warehouse. O.E.-Original Equipment.
Airtube Kit [4948] may be required to complete installation. EFI-Electronic Fuel Injection.

[1] OE system was a welded assembly. It is recommended that all parts noted [1] should be replaced.

[178] Installation Note: Special inlet installation tool is required to install this pipe.

[300] For use when resonator originated from O.E. manufacturer.

[958] Federal & California Emission vehicles. Not legal for sale for vehicles licensed in California.

VOLKSWAGEN GOLF

(10352) 93-94 4 Cyl. Golf III, 2.0L Engine

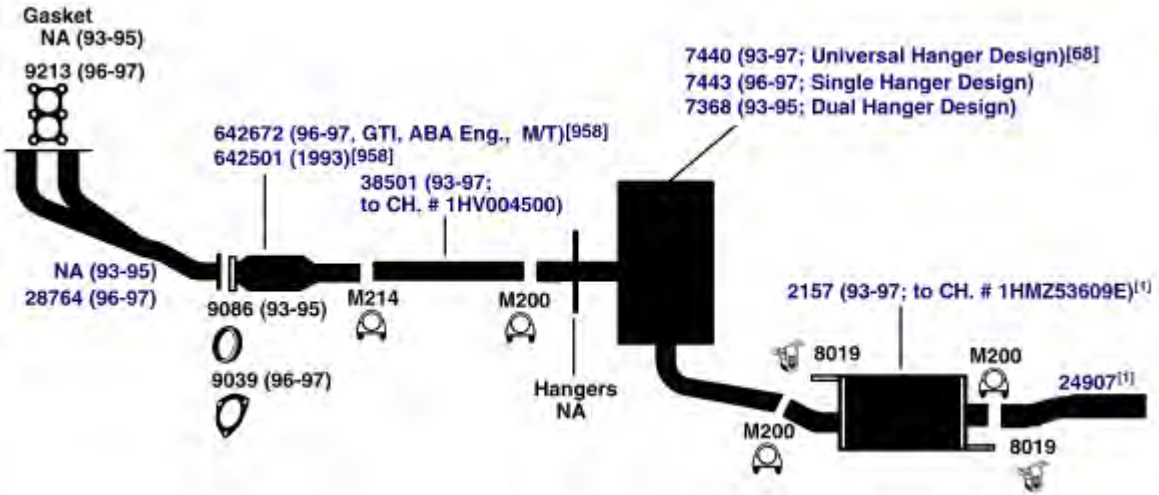

DIRECT FIT MSL/MAXIMUM Muffler... Rear Muffler- 700183, UNIVERSAL FIT MSL/MAXIMUM Muffler... Rear Muffler- 709008

(100310) 93-94 4 Cyl. Golf, 1.8L Engine ACC (CANADA ONLY)

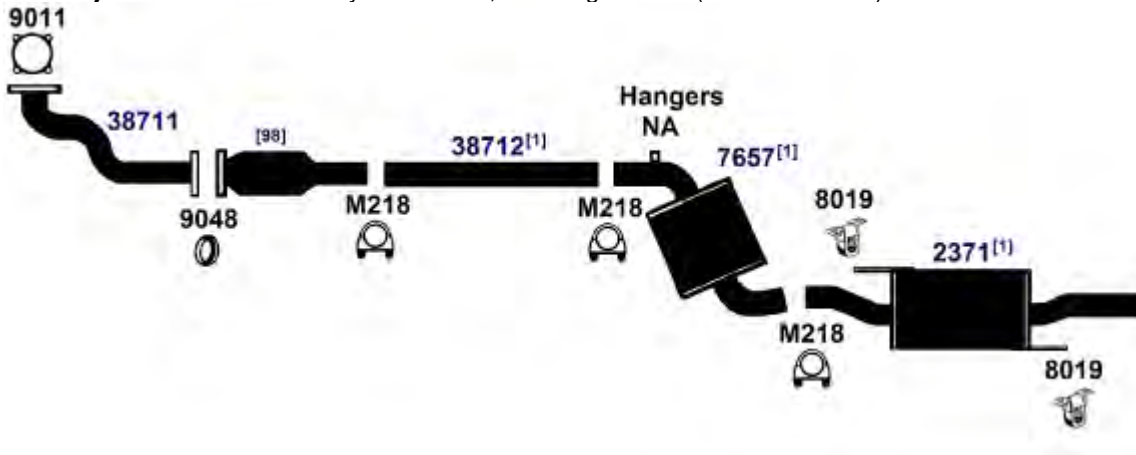

NA-Not Available. NR-Not Required. FL-Remove and Re-Use Old Flange. ● Golden Warehouse. O.E.-Original Equipment.
Airtube Kit [4948] may be required to complete installation. EFI-Electronic Fuel Injection.

[1] OE system was a welded assembly. It is recommended that all parts noted [1] should be replaced.

[68] Hanger modification may be required for some models.

[98] Refer to current Catalytic Converter catalog or Website catalog for availability.
[958] Federal & California Emission vehicles. Not legal for sale for vehicles licensed in California.

93-94 4 Cyl. Golf, Turbo Diesel (CANADA ONLY)

(100311)

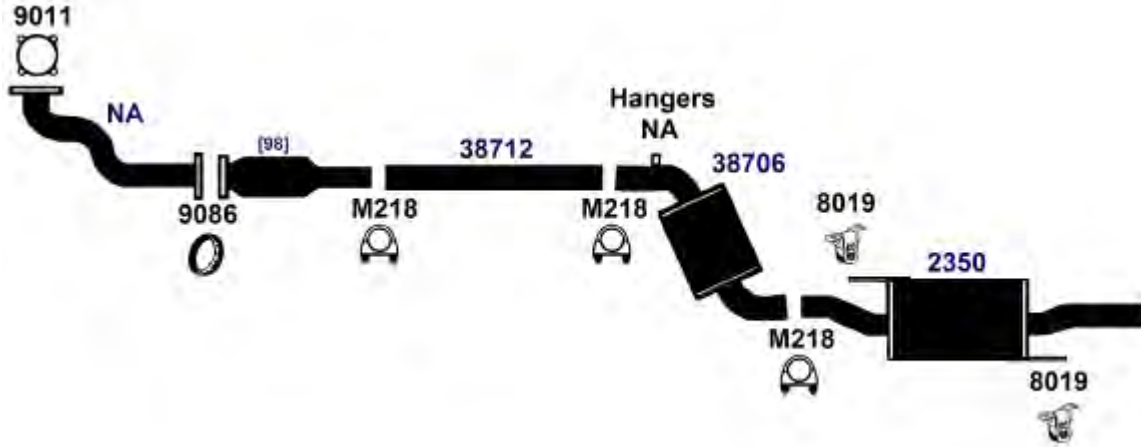

89-92 4 Cyl. Golf, 1.8L (RV) Engine; except GTI and California Models

(10351)



DIRECT FIT MSL/MAXIMUM Muffler... Rear Muffler (3235)- 700093, UNIVERSAL FIT MSL/MAXIMUM Muffler... Front Muffler (7054)- 709004, Rear Muffler (3235)- 6503, 6671, 6679, 709007, 709008

90-92 4 Cyl. Golf, Golf GTI; 1.8L (RV) Engine, California; except GTI with 16 Valve Engine

(10350)

90-92 4 Cyl. Golf, Golf GTI; 1.8L (PF) Engine; except GTI with 16 Valve Engine

89-92 4 Cyl. Golf, 1.8L (PF) Engine, California

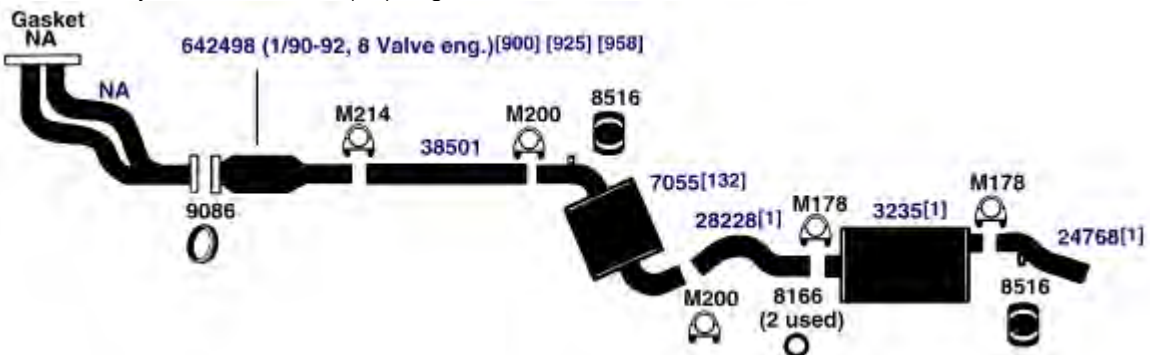

DIRECT FIT MSL/MAXIMUM Muffler... Front Muffler- 700032, Rear Muffler- 700093, UNIVERSAL FIT MSL/MAXIMUM Muffler... Front Muffler- 709004, Rear Muffler- 6503, 6671, 6679, 709007, 709008

NA-Not Available. NR-Not Required. FL-Remove and Re-Use Old Flange. ● Golden Warehouse. O.E.-Original Equipment.
Airtube Kit [4948] may be required to complete installation. EFI-Electronic Fuel Injection.

[1] OE system was a welded assembly. It is recommended that all parts noted [1] should be replaced.

[98] Refer to current Catalytic Converter catalog or Website catalog for availability.

[132] If black triangle appears on muffler label, remove and re-use O.E. heat shield or fabricate heat shield.

[178] Installation Note: Special inlet installation tool is required to install this pipe.

[900] Direct fit converter may require resizing, cutting or bushing.

[925] If 50mm OD outlet pipe required use Pipe Kit 651154

[958] Federal & California Emission vehicles. Not legal for sale for vehicles licensed in California.

VOLKSWAGEN GOLF

(10349) 90-92 4 Cyl. Golf GTI; 2.0L 16 Valve Engine
 87-89 4 Cyl. Golf GTI; 1.8L 16 Valve Engine



UNIVERSAL FIT MSL/MAXIMUM Muffler... Front Muffler (7837)- 709004

(10348) 1988 4 Cyl. Golf GT, 1.8L Engine



DIRECT FIT MSL/MAXIMUM Muffler... Front Muffler- 700032, Rear Muffler- 700093, UNIVERSAL FIT MSL/MAXIMUM Muffler... Front Muffler- 709004, Rear Muffler- 6503, 6671, 6679, 709007, 709008

NA-Not Available. NR-Not Required. FL-Remove and Re-Use Old Flange. ● Golden Warehouse. O.E.-Original Equipment.
 # Airtube Kit [4948] may be required to complete installation. EFI-Electronic Fuel Injection.

[1] OE system was a welded assembly. It is recommended that all parts noted [1] should be replaced.

[98] Refer to current Catalytic Converter catalog or Website catalog for availability.

[132] If black triangle appears on muffler label, remove and re-use O.E. heat shield or fabricate heat shield.

[958] Federal & California Emission vehicles. Not legal for sale for vehicles licensed in California.

85-88 4 Cyl. Golf, except GT, GTI, Diesel (US Only)
85-87 4 Cyl. Golf, GX Engine, exc. GT, GTI, Diesel (Canada Only)

(10347)

- 642500 (86-87 exc. RV or PL Eng., w/2" Funnel Flange, 2" OD Outlet)^[958]
- 642523 (86-87 exc. RV or PL Eng., w/2" Funnel Flange, 1 3/4" OD Outlet)^[958]
- 642656 (86-87 exc. RV or PL Eng., w/2" Funnel Flange, 1 7/8" OD Outlet)^[958]
- 642497 (85-87 w/1 3/4" Funnel Flange, 2" OD Outlet)^[958]
- 642654 (85-87 w/1 3/4" Funnel Flange, 1 3/4" OD Outlet)^[958]
- 642655 (85-87 w/1 3/4" Funnel Flange, 1 7/8" OD Outlet)^[958]

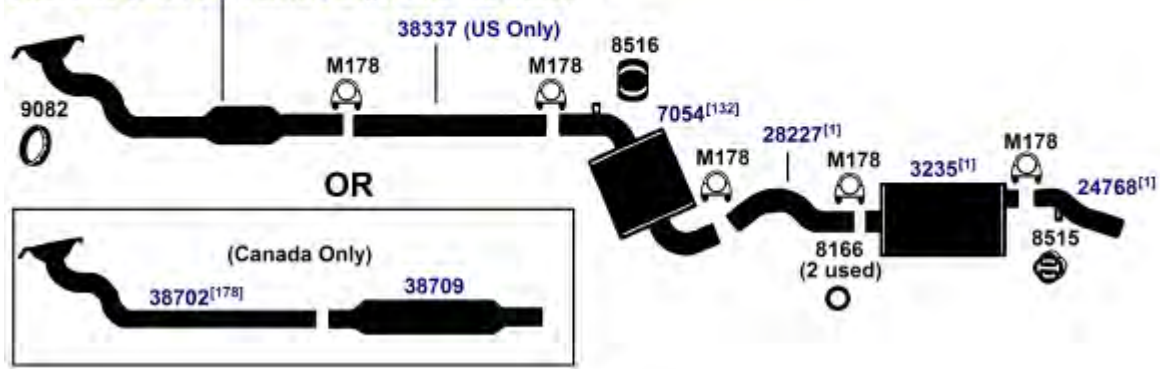

DIRECT FIT MSL/MAXIMUM Muffler... Rear Muffler (3235)- 700093, UNIVERSAL FIT MSL/MAXIMUM Muffler... Front Muffler (7054)- 709004, Rear Muffler (3235)- 6503, 6671, 6679, 709007, 709008

1987 4 Cyl. Golf GTI; except 16 Valve Engine
1987 4 Cyl. Golf GT
85-86 4 Cyl. Golf GTI

(10346)

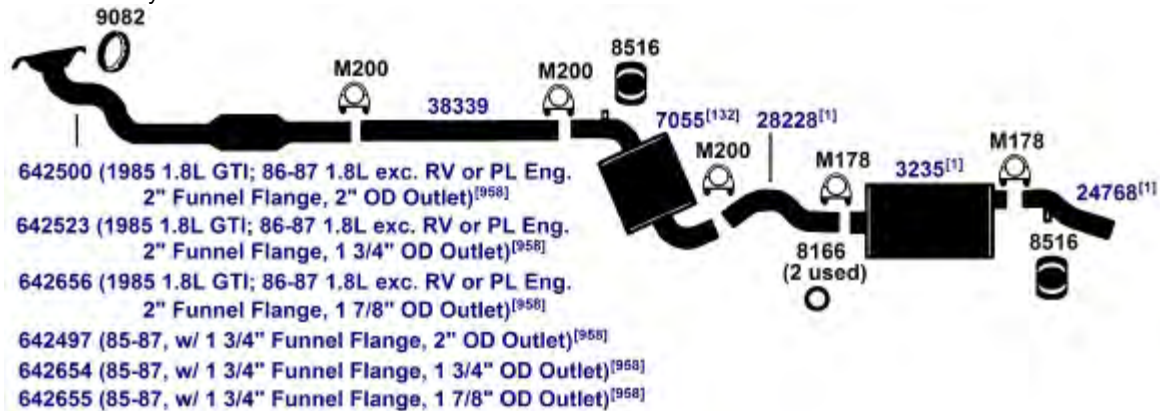

DIRECT FIT MSL/MAXIMUM Muffler... Front Muffler- 700032, Rear Muffler- 700093, UNIVERSAL FIT MSL/MAXIMUM Muffler... Front Muffler- 709004, Rear Muffler- 6503, 6671, 6679, 709007, 709008

NA-Not Available. NR-Not Required. FL-Remove and Re-Use Old Flange. ● Golden Warehouse. O.E.-Original Equipment.
 # Airtube Kit [4948] may be required to complete installation. EFI-Electronic Fuel Injection.

[1] OE system was a welded assembly. It is recommended that all parts noted [1] should be replaced.
 [132] If black triangle appears on muffler label, remove and re-use O.E. heat shield or fabricate heat shield.

[178] Installation Note: Special inlet installation tool is required to install this pipe.
 [958] Federal & California Emission vehicles. Not legal for sale for vehicles licensed in California.

VOLKSWAGEN GOLF

(10345) 85-87 4 Cyl. Golf, 1.6L Diesel Engine

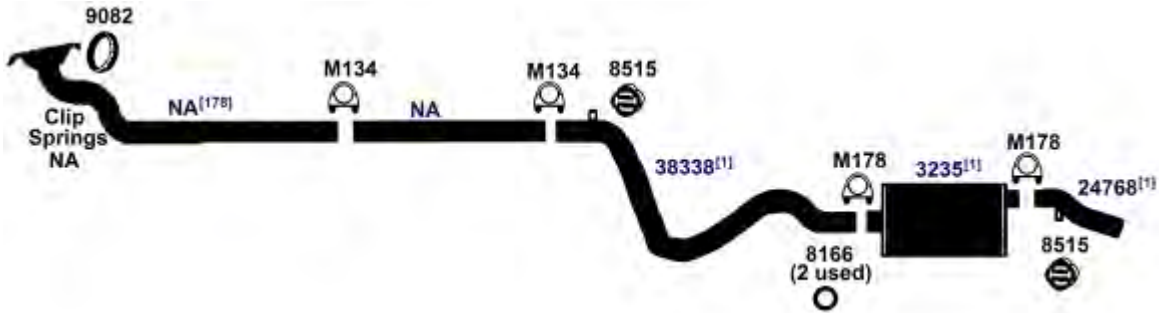

DIRECT FIT MSL/MAXIMUM Muffler... 700093, UNIVERSAL FIT MSL/MAXIMUM Muffler... 6503, 6671, 6679, 709007, 709008

VOLKSWAGEN JETTA

(100312) 93-94 4 Cyl. Jetta, 1.8L Engine ACC (CANADA ONLY)

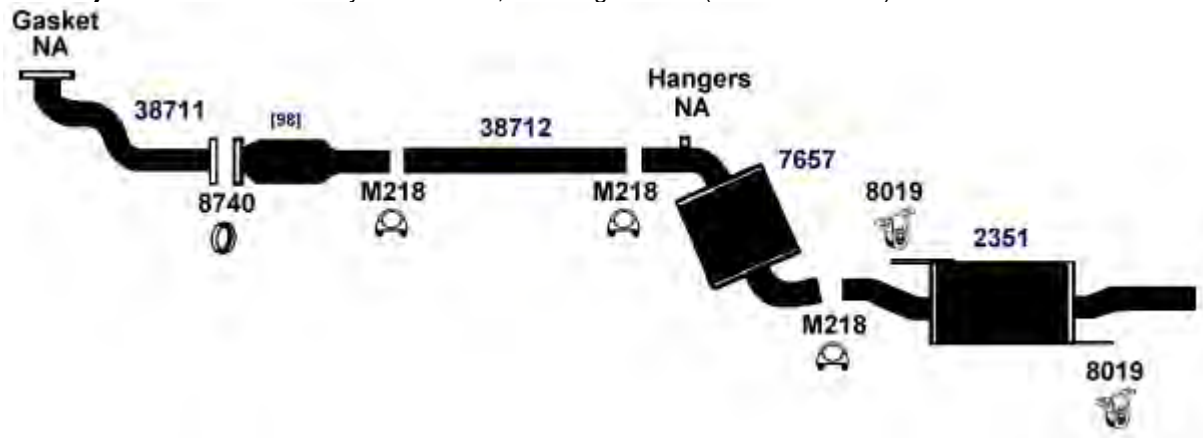

NA-Not Available. NR-Not Required. FL-Remove and Re-Use Old Flange. ● Golden Warehouse. O.E.-Original Equipment.
Airtube Kit [4948] may be required to complete installation. EFI-Electronic Fuel Injection.

- [1] OE system was a welded assembly. It is recommended that all parts noted [1] should be replaced. [178] Installation Note: Special inlet installation tool is required to install this pipe.
[98] Refer to current Catalytic Converter catalog or Website catalog for availability.

93-94 4 Cyl. Jetta III, 2.0L Engine (1999 Engine Code ABA)

(10377)

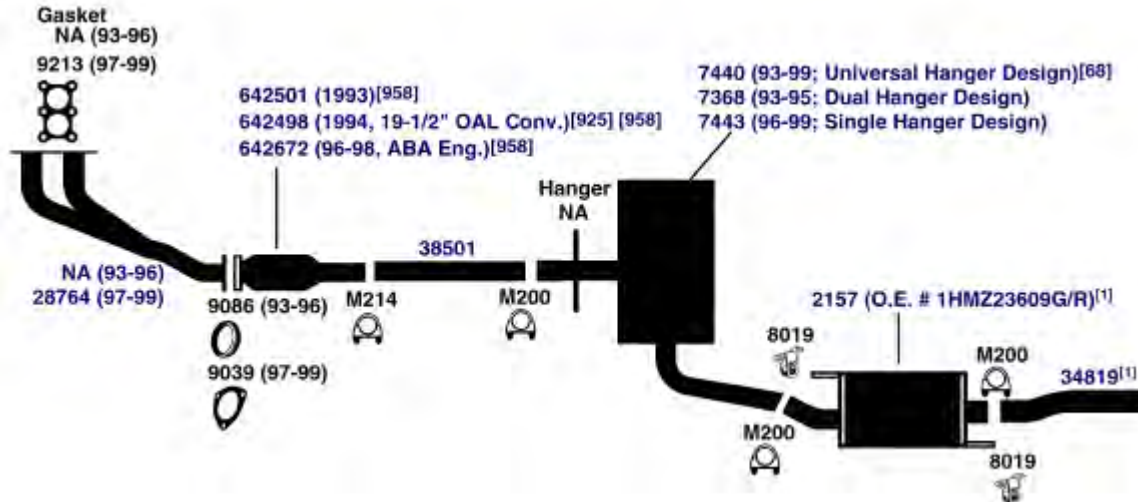

DIRECT FIT MSL/MAXIMUM Muffler... Rear Muffler- 700183, UNIVERSAL FIT MSL/MAXIMUM Muffler... Rear Muffler- 709008

90-92 4 Cyl. Jetta GLI, 2.0L 16 Valve Engine (from VIN IG-L-352-903)

(10376)

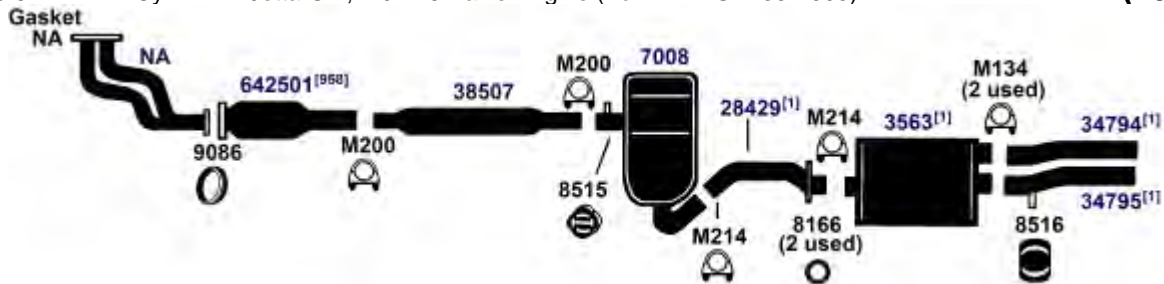

88-92 4 Cyl. Jetta, 1.8L (RV, PF) Engine; except GLI

(10373)

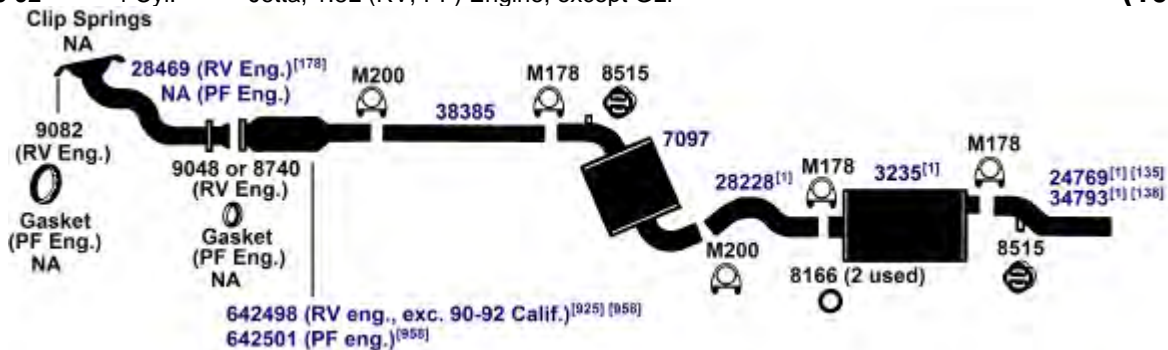

DIRECT FIT MSL/MAXIMUM Muffler... Rear Muffler- 700093, UNIVERSAL FIT MSL/MAXIMUM Muffler... Front Muffler- 709004, Rear Muffler- 6503, 6671, 6679, 709007, 709008

NA-Not Available. NR-Not Required. FL-Remove and Re-Use Old Flange. ● Golden Warehouse. O.E.-Original Equipment.
Airtube Kit [4948] may be required to complete installation. EFI-Electronic Fuel Injection.

[1] OE system was a welded assembly. It is recommended that all parts noted [1] should be replaced.

[68] Hanger modification may be required for some models.

[135] Up to 1990 VIN IG-L-352-902.

[138] From 1990 VIN IG-L-352-903.

[178] Installation Note: Special inlet installation tool is required to install this pipe.

[925] if 50mm OD outlet pipe required use Pipe Kit 651154

[958] Federal & California Emission vehicles. Not legal for sale for vehicles licensed in California.

VOLKSWAGEN JETTA

(10371) 85-91 4 Cyl. Jetta, 1.6L Diesel Engine, except Turbo Diesel

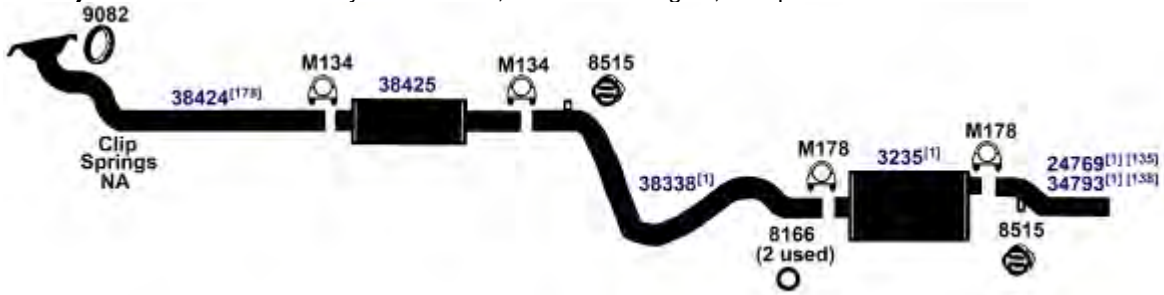

DIRECT FIT MSL/MAXIMUM Muffler... Rear Muffler- 700093, UNIVERSAL FIT MSL/MAXIMUM Muffler... Rear Muffler- 6503, 6671, 6679, 709007, 709008

(10375) 87-90 4 Cyl. Jetta GLI, 1.8L 16 Valve Engine (up to VIN IG-L-352-902)

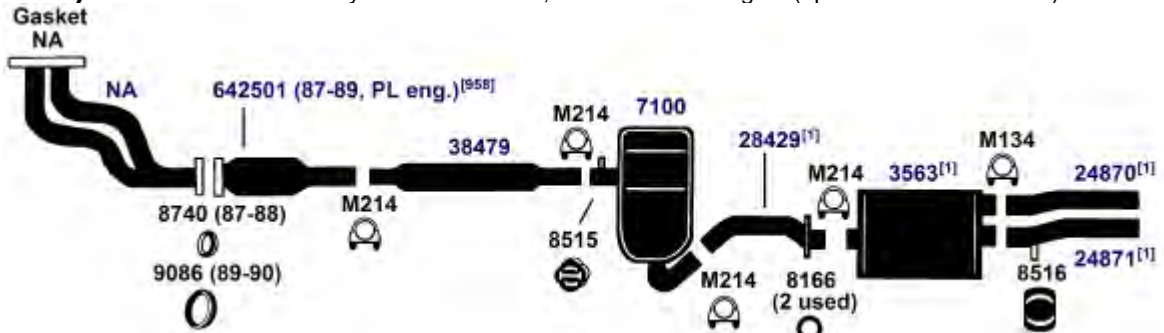

NA-Not Available. NR-Not Required. FL-Remove and Re-Use Old Flange. ● Golden Warehouse. O.E.-Original Equipment.
Airtube Kit [4948] may be required to complete installation. EFI-Electronic Fuel Injection.

[1] OE system was a welded assembly. It is recommended that all parts noted [1] should be replaced.

[135] Up to 1990 VIN IG-L-352-902.

[138] From 1990 VIN IG-L-352-903.

[178] Installation Note: Special inlet installation tool is required to install this pipe.

[958] Federal & California Emission vehicles. Not legal for sale for vehicles licensed in California.

1987	4 Cyl.	Jetta, Jetta GLI, except 16 Valve GLI and Diesel (exc. Canada)	(10372)
85-87	4 Cyl.	Jetta, 1.8L Engine, exc. 16 Valve (Canada Only)	
1986	4 Cyl.	Jetta, Jetta GLI; except Diesel (exc. Canada)	

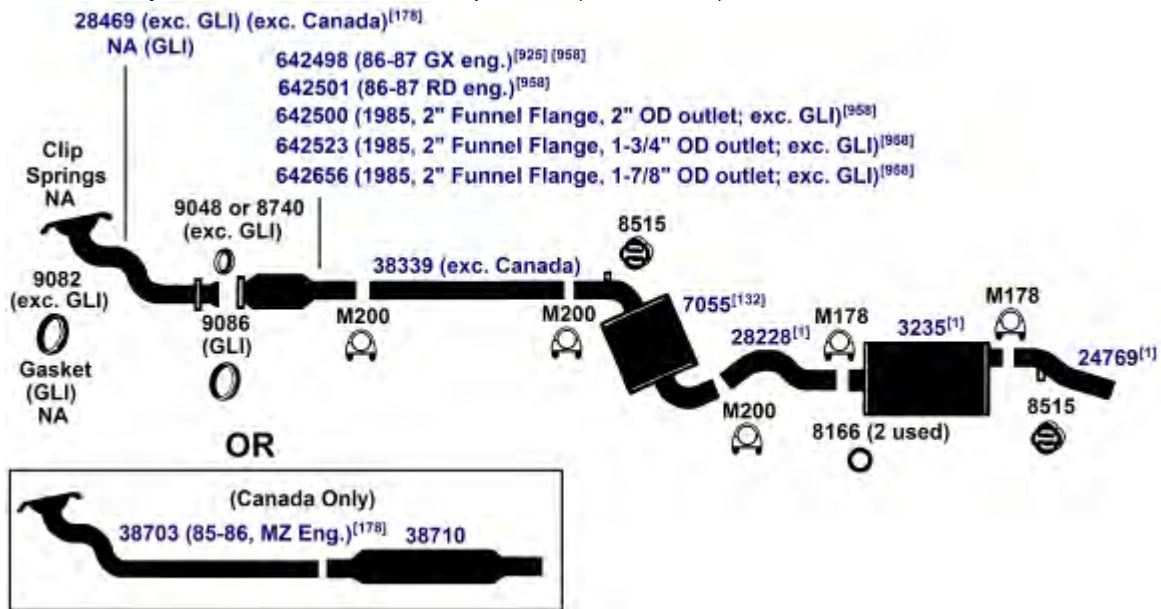

DIRECT FIT MSL/MAXIMUM Muffler... Front Muffler- 700032, Rear Muffler- 700093, UNIVERSAL FIT MSL/MAXIMUM Muffler... Front Muffler- 709004, Rear Muffler- 6503, 6671, 6679, 709007, 709008

1985	4 Cyl.	Jetta, except Diesel (exc. Canada)	(10370)
------	--------	------------------------------------	---------

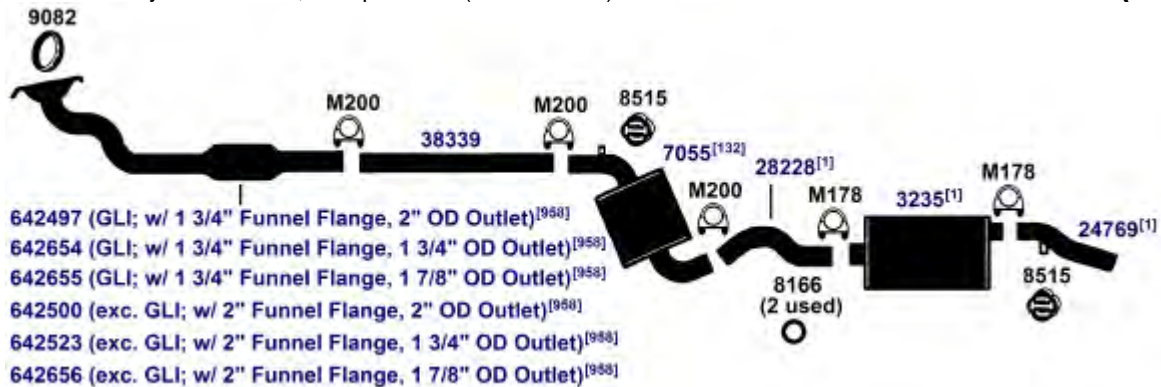

DIRECT FIT MSL/MAXIMUM Muffler... Front Muffler- 700032, Rear Muffler- 700093, UNIVERSAL FIT MSL/MAXIMUM Muffler... Front Muffler- 709004, Rear Muffler- 6503, 6671, 6679, 709007, 709008

NA-Not Available. NR-Not Required. FL-Remove and Re-Use Old Flange. ● Golden Warehouse. O.E.-Original Equipment.
 # Airtube Kit [4948] may be required to complete installation. EFI-Electronic Fuel Injection.

[1] OE system was a welded assembly. It is recommended that all parts noted [1] should be replaced.
 [132] If black triangle appears on muffler label, remove and re-use O.E. heat shield or fabricate heat shield.
 [178] Installation Note: Special inlet installation tool is required to install this pipe.

[925] If 50mm OD outlet pipe required use Pipe Kit 651154
 [958] Federal & California Emission vehicles. Not legal for sale for vehicles licensed in California.

VOLKSWAGEN JETTA

(10374) 1984 4 Cyl. Jetta GLI, 1.8L Engine

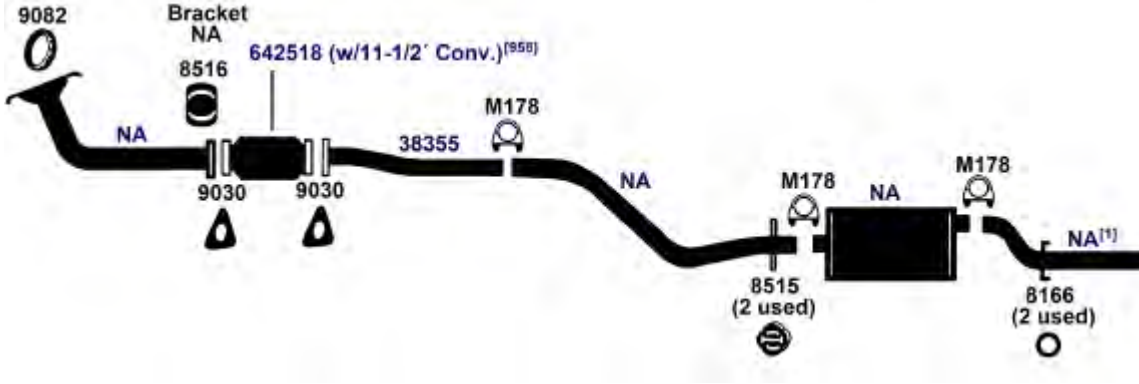

UNIVERSAL FIT MSL/MAXIMUM Muffler... 6503, 709008, 709010

(10368) 83-84 4 Cyl. Jetta, except Diesel and GLI Models

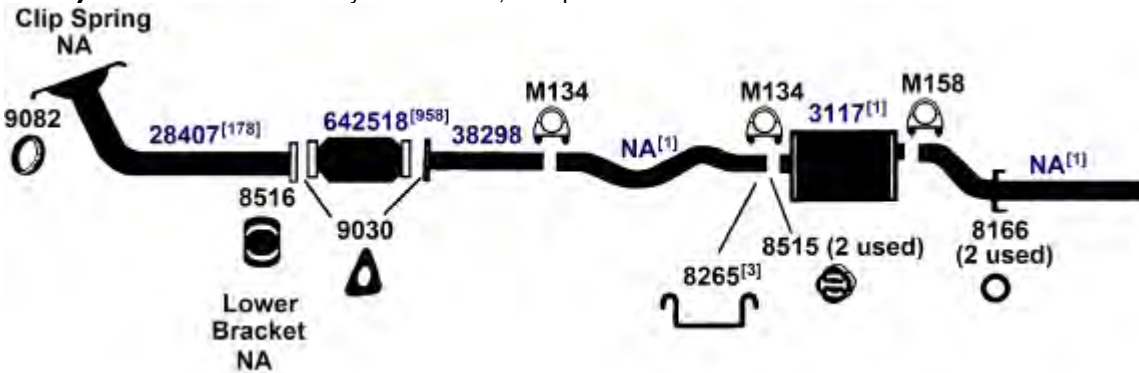

DIRECT FIT MSL/MAXIMUM Muffler... 6674, UNIVERSAL FIT MSL/MAXIMUM Muffler... 709008

(100338) 80-84 4 Cyl. Jetta, 1.7L Engine EN (CANADA ONLY)

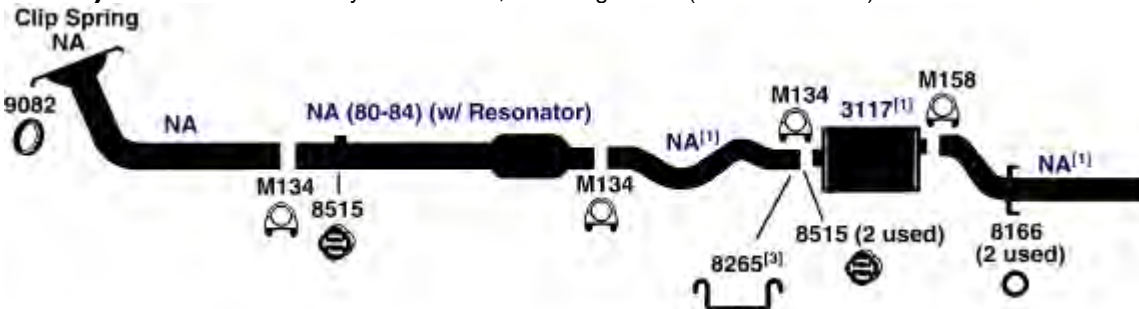

DIRECT FIT MSL/MAXIMUM Muffler... 6674, UNIVERSAL FIT MSL/MAXIMUM Muffler... 709008

NA-Not Available. NR-Not Required. FL-Remove and Re-Use Old Flange. ● Golden Warehouse. O.E.-Original Equipment.
Airtube Kit [4948] may be required to complete installation. EFI-Electronic Fuel Injection.

- [1] OE system was a welded assembly. It is recommended that all parts noted [1] should be replaced.
[3] Required for installation.

- [178] Installation Note: Special inlet installation tool is required to install this pipe.
[958] Federal & California Emission vehicles. Not legal for sale for vehicles licensed in California.

VOLKSWAGEN QUANTUM

(10451E) 83-84 5 Cyl. Quantum Sedan, Sta. Wagon; except 4WD
 82-84 4 Cyl. Quantum Sedan, Station Wagon; except Diesel



UNIVERSAL FIT MSL/MAXIMUM Muffler... Rear 6503, 6552

VOLKSWAGEN RABBIT, CABRIOLET, SCIROCCO

(10430) 86-87 4 Cyl. Scirocco, 1.8L Engine; except 16 Valve Engine
 1985 4 Cyl. Scirocco, 1.8L Engine



DIRECT FIT MSL/MAXIMUM Muffler... 700402, UNIVERSAL FIT MSL/MAXIMUM Muffler... 6503, 709008, 709010

(10430E) 1984 4 Cyl. Scirocco, 1.8L Engine (1984 from CH. 53-E-022075)



DIRECT FIT MSL/MAXIMUM Muffler... 700402, UNIVERSAL FIT MSL/MAXIMUM Muffler... 6503, 709008, 709010

NA-Not Available. NR-Not Required. FL-Remove and Re-Use Old Flange. ● Golden Warehouse. O.E.-Original Equipment.
 # Airtube Kit [4948] may be required to complete installation. EFI-Electronic Fuel Injection.

- [1] OE system was a welded assembly. It is recommended that all parts noted [1] should be replaced. [958] Federal & California Emission vehicles. Not legal for sale for vehicles licensed in California.
- [178] Installation Note: Special inlet installation tool is required to install this pipe.

VOLKSWAGEN RABBIT, CABRIOLET, SCIROCCO

1984 4 Cyl. Rabbit, Cabriolet; 1.8L Engine, Convertible (up to CH. 15-E-011303) (10429)
 83-84 4 Cyl. Scirocco, 1.8L Engine (1984 up to CH. 53-E-022075)



UNIVERSAL FIT MSL/MAXIMUM Muffler... 6503, 709008, 709010

1984 4 Cyl. Cabriolet, 1.8L Engine (1984 from CH. 15-E-011303) (10431E)



DIRECT FIT MSL/MAXIMUM Muffler... 700402, UNIVERSAL FIT MSL/MAXIMUM Muffler... 6503, 709008, 709010

83-84 4 Cyl. Rabbit Sedan, except GTI, Diesel and 1983 Sedans with 1.7L Fuel Injection Engine having CH. No. 024813 thru 045274 (10427)
 1983 4 Cyl. Rabbit Convertible

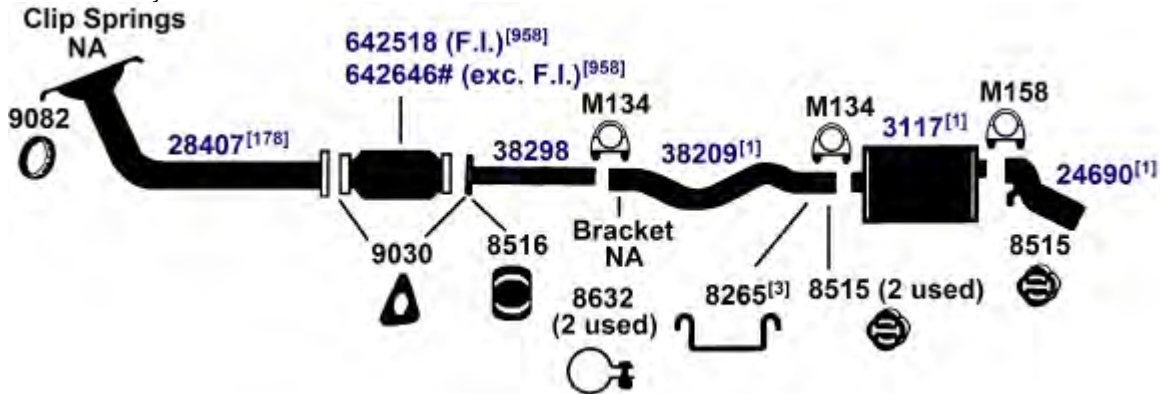

DIRECT FIT MSL/MAXIMUM Muffler... 6674, UNIVERSAL FIT MSL/MAXIMUM Muffler... 709008

NA-Not Available. NR-Not Required. FL-Remove and Re-Use Old Flange. ● Golden Warehouse. O.E.-Original Equipment.
 # Airtube Kit [4948] may be required to complete installation. EFI-Electronic Fuel Injection.

[1] OE system was a welded assembly. It is recommended that all parts noted [1] should be replaced.
 [3] Required for installation.
 [98] Refer to current Catalytic Converter catalog or Website catalog for availability.

[178] Installation Note: Special inlet installation tool is required to install this pipe.
 [958] Federal & California Emission vehicles. Not legal for sale for vehicles licensed in California.

VOLKSWAGEN RABBIT, CABRIOLET, SCIROCCO

(10432) 83-84 4 Cyl. Rabbit GTI, 1.8L Engine

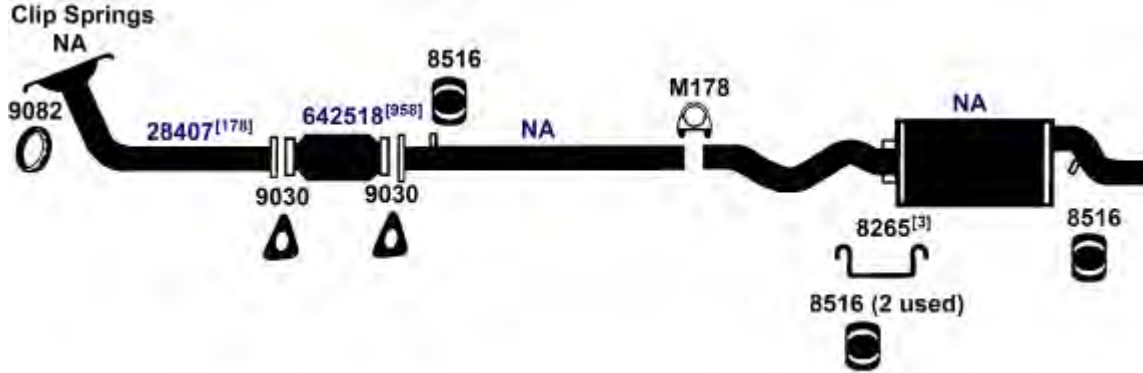

UNIVERSAL FIT MSL/MAXIMUM Muffler... 6503, 6519, 709007, 709008

(10424) 81-84 4 Cyl. Rabbit Sedan, 1600cc, Diesel Engine; except Turbo Diesel

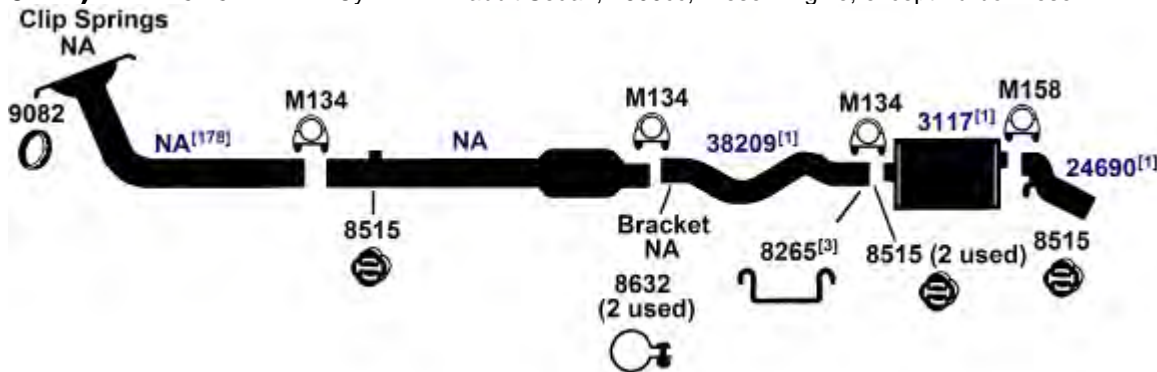

DIRECT FIT MSL/MAXIMUM Muffler... 6674, UNIVERSAL FIT MSL/MAXIMUM Muffler... 709008

(10428) 1983 4 Cyl. Rabbit Sedan, 1.7L Fuel Injection Engine (CH. 024813 thru 045274)

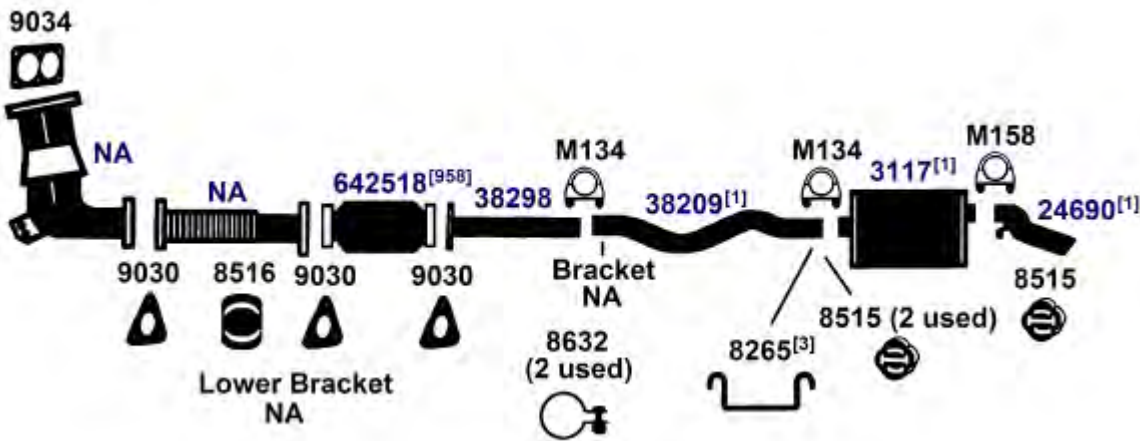

DIRECT FIT MSL/MAXIMUM Muffler... 6674, UNIVERSAL FIT MSL/MAXIMUM Muffler... 709008

NA-Not Available. NR-Not Required. FL-Remove and Re-Use Old Flange. ● Golden Warehouse. O.E.-Original Equipment.
Airtube Kit [4948] may be required to complete installation. EFI-Electronic Fuel Injection.

[1] OE system was a welded assembly. It is recommended that all parts noted [1] should be replaced.
[3] Required for installation.

[178] Installation Note: Special inlet installation tool is required to install this pipe.
[958] Federal & California Emission vehicles. Not legal for sale for vehicles licensed in California.

VOLKSWAGEN RABBIT, CABRIOLET, SCIROCCO

82-83 4 Cyl. Scirocco, 1.7L Engine

(10426)

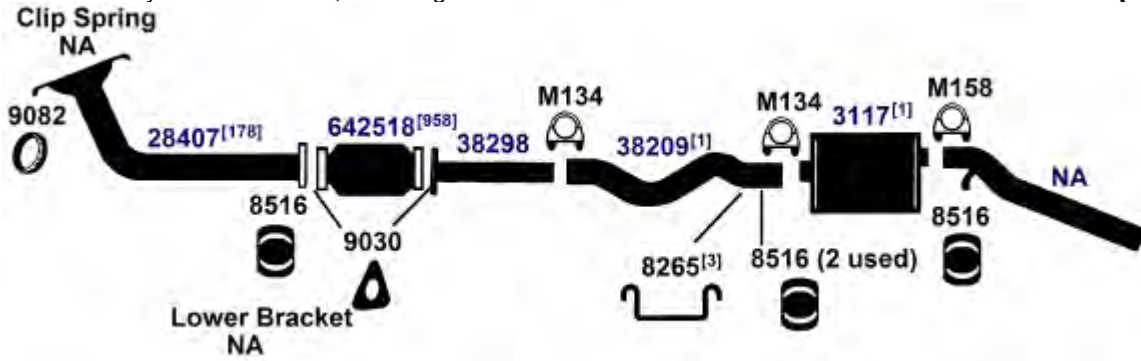

DIRECT FIT MSL/MAXIMUM Muffler... 6674, UNIVERSAL FIT MSL/MAXIMUM Muffler... 709008

1982 4 Cyl. Rabbit Sedan, Convertible; except Diesel

(10425)

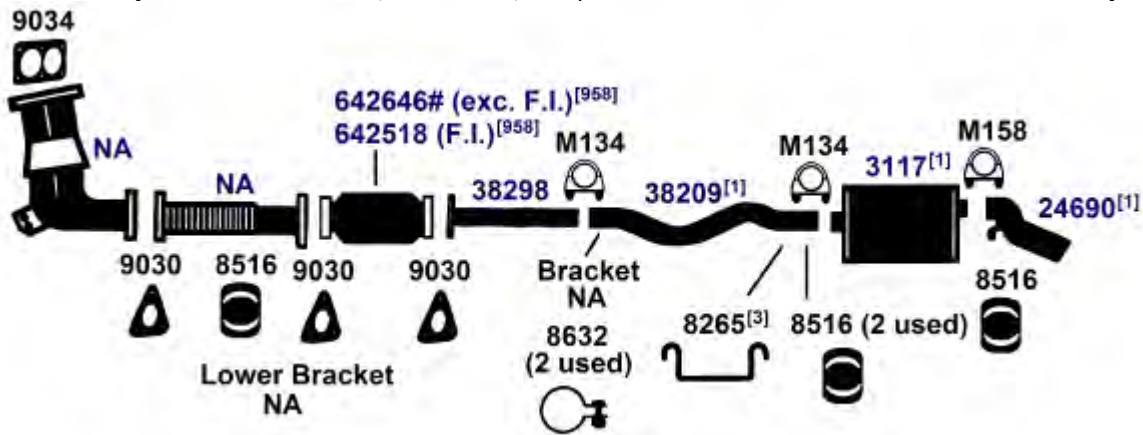

DIRECT FIT MSL/MAXIMUM Muffler... 6674, UNIVERSAL FIT MSL/MAXIMUM Muffler... 709008

NA-Not Available. NR-Not Required. FL-Remove and Re-Use Old Flange. ● Golden Warehouse. O.E.-Original Equipment.
Airtube Kit [4948] may be required to complete installation. EFI-Electronic Fuel Injection.

- [1] OE system was a welded assembly. It is recommended that all parts noted [1] should be replaced.
- [3] Required for installation.

- [178] Installation Note: Special inlet installation tool is required to install this pipe.
- [958] Federal & California Emission vehicles. Not legal for sale for vehicles licensed in California.

VOLKSWAGEN RABBIT, CABRIOLET, SCIROCCO

(10433) 79-81 4 Cyl. Rabbit, Sedan, Conv., Scirocco; 1500cc, 1600cc, 1700cc; with Converter, Carb. and Fuel Injection Models

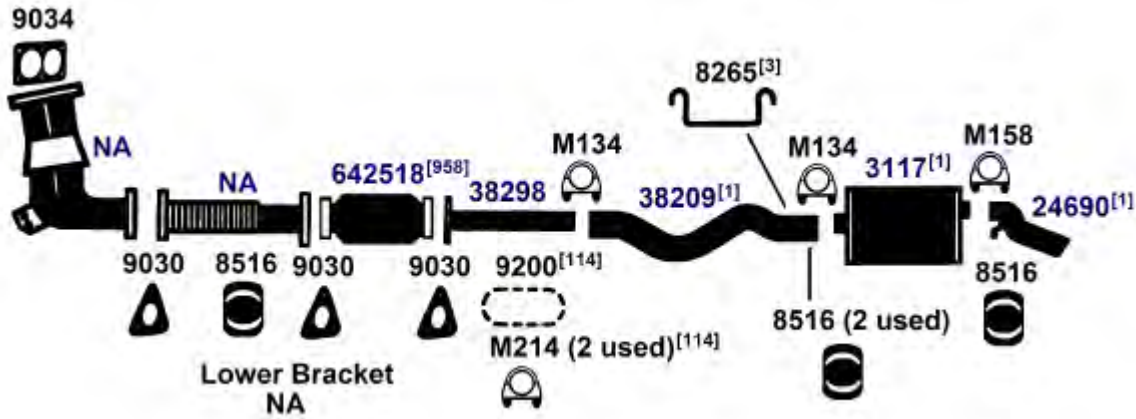

DIRECT FIT MSL/MAXIMUM Muffler... 6674, UNIVERSAL FIT MSL/MAXIMUM Muffler... 709008

(10422) 79-80 4 Cyl. Rabbit Sedan, 1500cc, Diesel

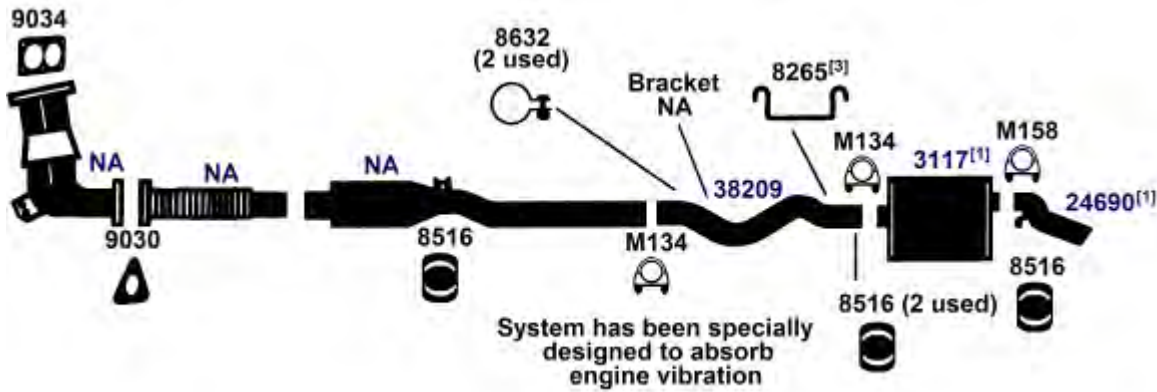

DIRECT FIT MSL/MAXIMUM Muffler... Rear Muffler- 6674, UNIVERSAL FIT MSL/MAXIMUM Muffler... Rear Muffler- 709008

NA-Not Available. NR-Not Required. FL-Remove and Re-Use Old Flange. ● Golden Warehouse. O.E.-Original Equipment.
Airtube Kit [4948] may be required to complete installation. EFI-Electronic Fuel Injection.

[1] OE system was a welded assembly. It is recommended that all parts noted [1] should be replaced.

[3] Required for installation.

[114] Required for installation with 38298 for 75-76 models and for 77-79 Calif. Models.

[958] Federal & California Emission vehicles. Not legal for sale for vehicles licensed in California.

VOLKSWAGEN RABBIT, CABRIOLET, SCIROCCO

1979 4 Cyl. Rabbit Sedan, Rabbit Convertible, Scirocco; 1500cc, 1600cc; without Converter, (10421)
with Fuel Injection, except Diesel

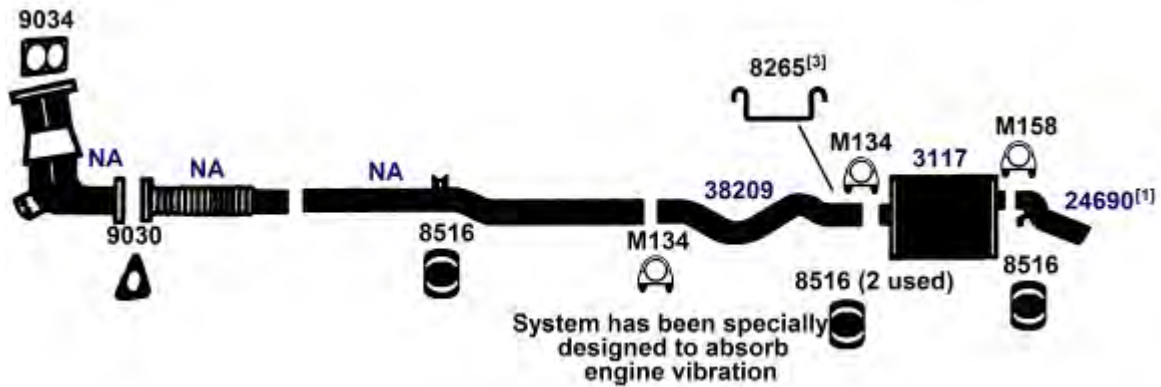

DIRECT FIT MSL/MAXIMUM Muffler... 6674, UNIVERSAL FIT MSL/MAXIMUM Muffler... 709008

VOLKSWAGEN RABBIT PICKUP

1983 4 Cyl. Rabbit Pickup; except Diesel (30703)

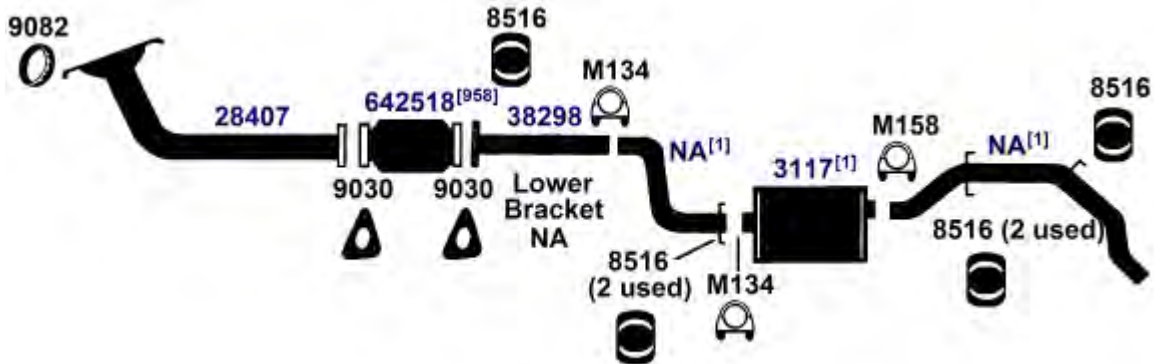

DIRECT FIT MSL/MAXIMUM Muffler... 6674, UNIVERSAL FIT MSL/MAXIMUM Muffler... 709008

81-83 4 Cyl. Rabbit Pickup; 1600cc; Diesel Engine (30702)

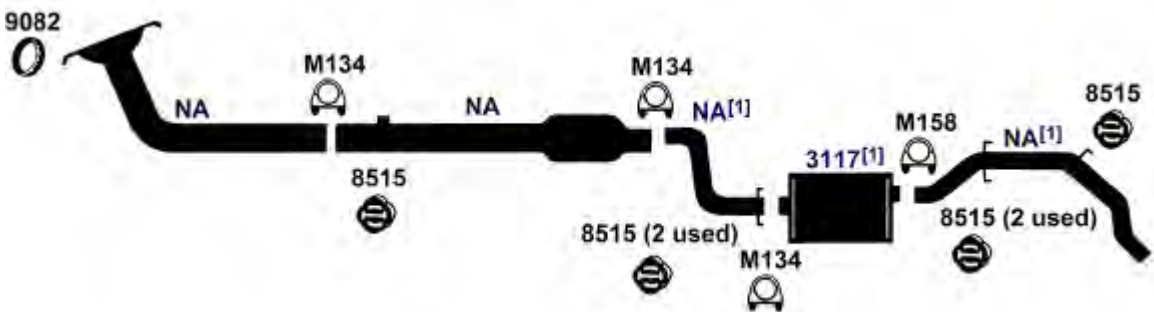

DIRECT FIT MSL/MAXIMUM Muffler... 6674, UNIVERSAL FIT MSL/MAXIMUM Muffler... 709008

NA-Not Available. NR-Not Required. FL-Remove and Re-Use Old Flange. ● Golden Warehouse. O.E.-Original Equipment.
Airtube Kit [4948] may be required to complete installation. EFI-Electronic Fuel Injection.

- [1] OE system was a welded assembly. It is recommended that all parts noted [1] should be replaced. [958] Federal & California Emission vehicles. Not legal for sale for vehicles licensed in California.
- [3] Required for installation.

VOLKSWAGEN RABBIT PICKUP

(30701) 81-82 4 Cyl. Rabbit Pickup; 1700cc
 1980 4 Cyl. Rabbit Pickup; 1600cc, with Converter

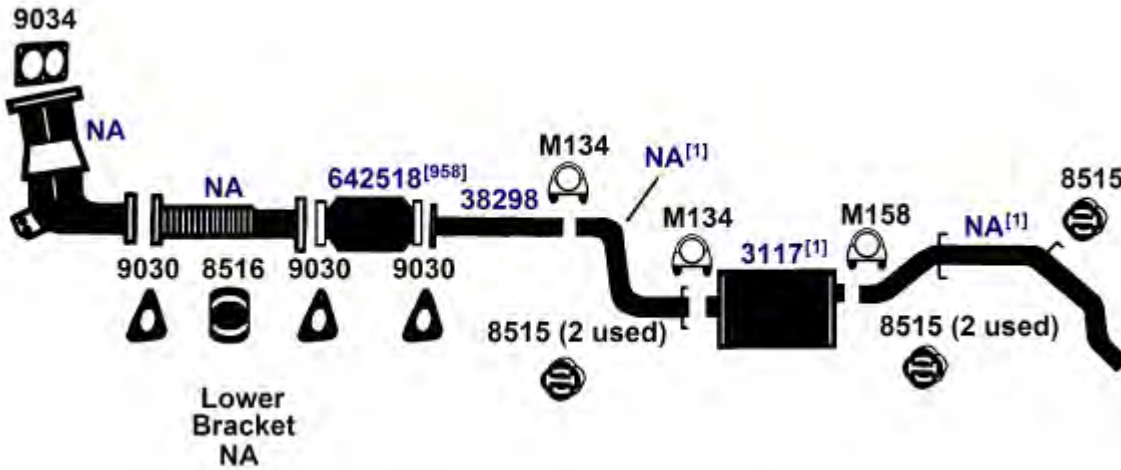

DIRECT FIT MSL/MAXIMUM Muffler... 6674, UNIVERSAL FIT MSL/MAXIMUM Muffler... 709008

(30700) 1980 4 Cyl. Rabbit Pickup; 1600cc; without Converter
 1980 4 Cyl. Rabbit Pickup; 1500cc, Diesel Converter

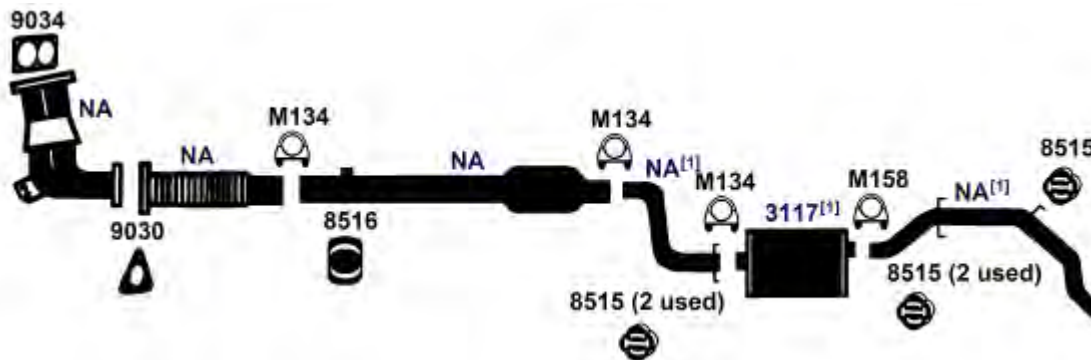

DIRECT FIT MSL/MAXIMUM Muffler... 6674, UNIVERSAL FIT MSL/MAXIMUM Muffler... 709008

NA-Not Available. NR-Not Required. FL-Remove and Re-Use Old Flange. ● Golden Warehouse. O.E.-Original Equipment.
 # Airtube Kit [4948] may be required to complete installation. EFI-Electronic Fuel Injection.

[1] OE system was a welded assembly. It is recommended that all parts noted [1] should be replaced. [958] Federal & California Emission vehicles. Not legal for sale for vehicles licensed in California.

85-93 4 Cyl. 240 DL, GL; 2.3L Engine; 240 Series; except Turbo

(10696)

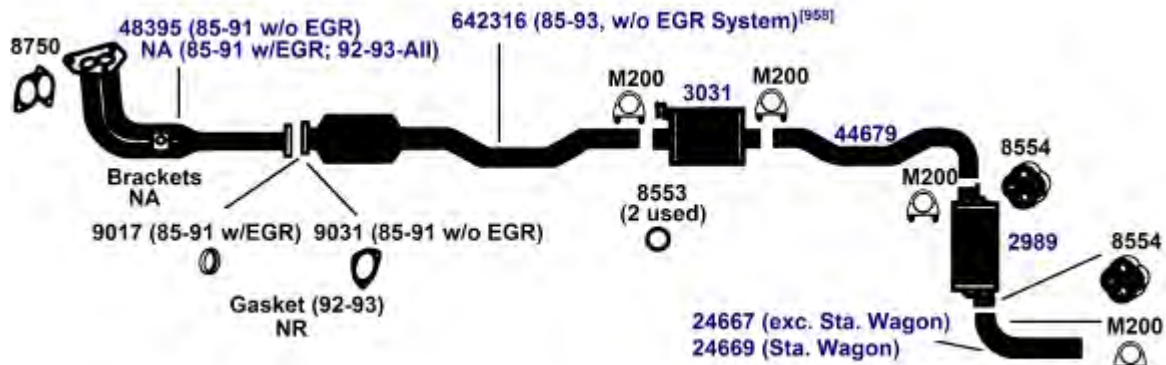

DIRECT FIT MSL/MAXIMUM Muffler... Front Muffler- 700058, Rear Muffler- 6678, UNIVERSAL FIT MSL/MAXIMUM Muffler... Front Muffler- 709999, Rear Muffler- 6656, 709993

1985 6 Cyl. 4-Door Sedan, Sta. Wagon; Diesel (D24) Engine, except Turbo Diesel

(10694)

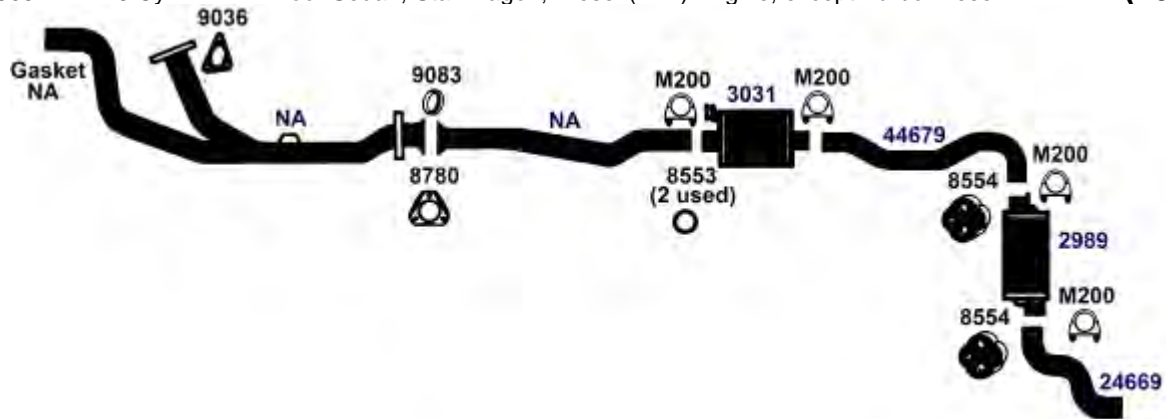

DIRECT FIT MSL/MAXIMUM Muffler... Front Muffler- 700058, Rear Muffler- 6678, UNIVERSAL FIT MSL/MAXIMUM Muffler... Front Muffler- 709999, Rear Muffler- 6656, 709993

NA-Not Available. NR-Not Required. FL-Remove and Re-Use Old Flange. ● Golden Warehouse. O.E.-Original Equipment.
Airtube Kit [4948] may be required to complete installation. EFI-Electronic Fuel Injection.

[958] Federal & California Emission vehicles. Not legal for sale for vehicles licensed in California.

VOLVO 200 SERIES

(10696E) 1984 4 Cyl. 240 Series DL, GL; 2.3L Engine; except Turbo

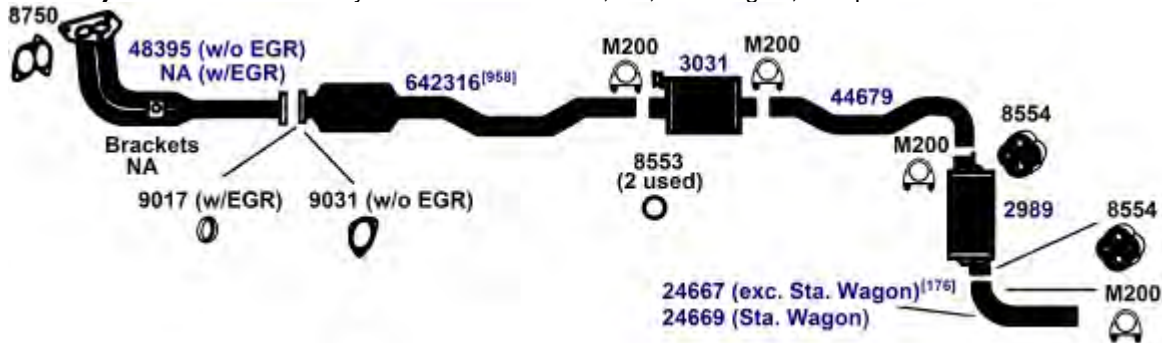

DIRECT FIT MSL/MAXIMUM Muffler... Front Muffler- 700058, Rear Muffler- 6678, UNIVERSAL FIT MSL/MAXIMUM Muffler... Front Muffler- 709999, Rear Muffler- 6656, 709993

(10694E) 80-84 6 Cyl. 4-Door Sedan, Sta. Wagon; Diesel (D24) Engine, except Turbo Diesel

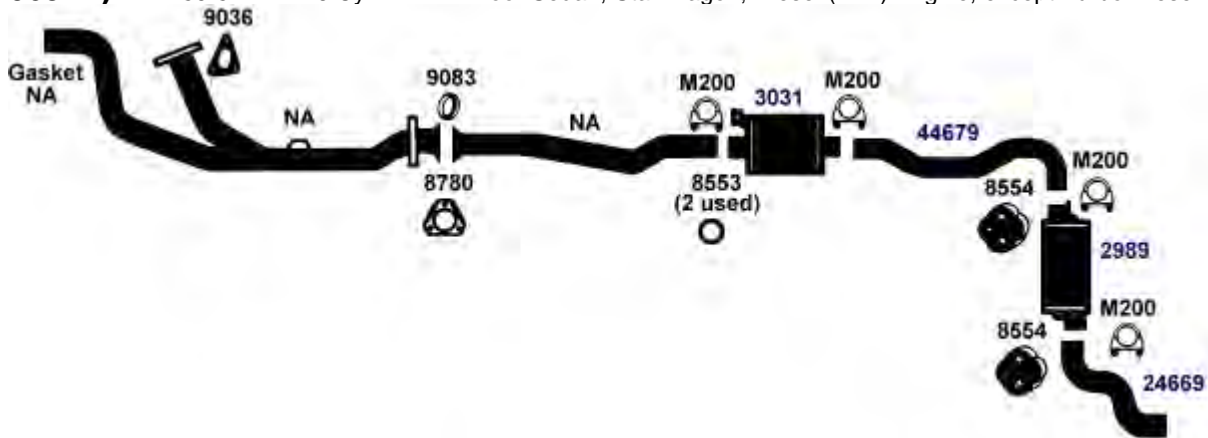

DIRECT FIT MSL/MAXIMUM Muffler... Front Muffler- 700058, Rear Muffler- 6678, UNIVERSAL FIT MSL/MAXIMUM Muffler... Front Muffler- 709999, Rear Muffler- 6656, 709993

(10693) 80-83 4 Cyl. 2, 4-Door Sedan, Station Wagon; B21F, B23F Engine; except Turbo

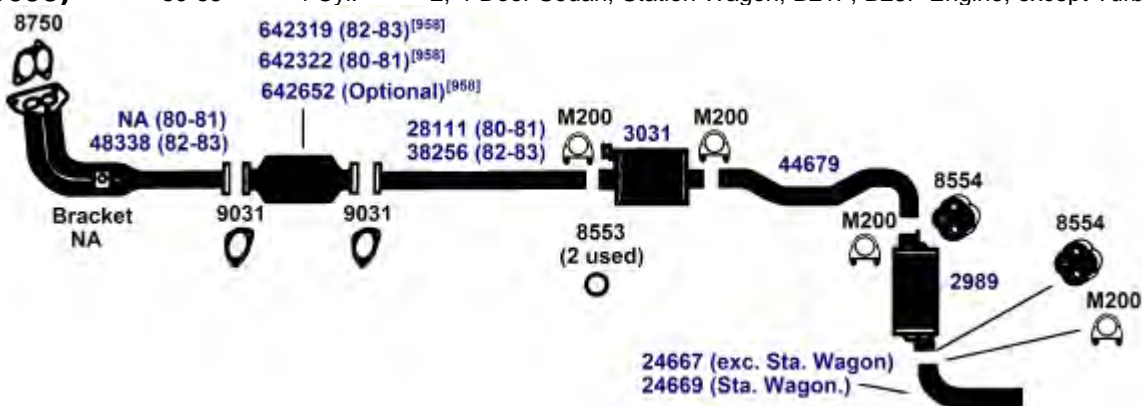

DIRECT FIT MSL/MAXIMUM Muffler... Front Muffler- 700058, Rear Muffler- 6678, UNIVERSAL FIT MSL/MAXIMUM Muffler... Front Muffler- 709999, Rear Muffler- 6656, 709993

NA-Not Available. NR-Not Required. FL-Remove and Re-Use Old Flange. ● Golden Warehouse. O.E.-Original Equipment.

Airtube Kit [4948] may be required to complete installation. EFI-Electronic Fuel Injection.

[176] 24669 can be used in place of 24667.

[958] Federal & California Emission vehicles. Not legal for sale for vehicles licensed in California.

VOLVO 200 SERIES

(10691) 1979 262 Sedan, Coupe (from 4330), 264 Sedan (from 62105), 265 Station Wagon (from 15735); with B27F Engine

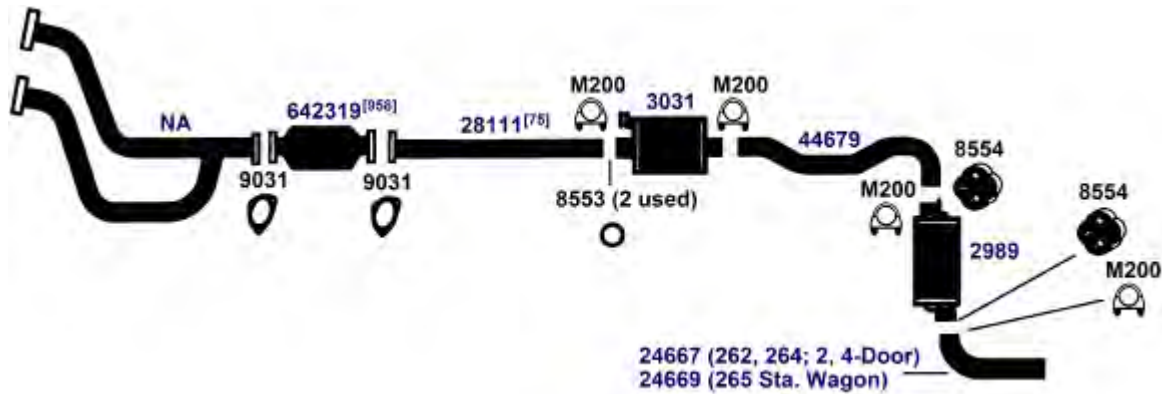

DIRECT FIT MSL/MAXIMUM Muffler... Front Muffler- 700058, Rear Muffler- 6678, UNIVERSAL FIT MSL/MAXIMUM Muffler... Front Muffler- 709999, Rear Muffler- 6656, 709993

VOLVO 700 SERIES

(10706) 88-92 4 Cyl. 740, 2.3L Engine; except Turbo and 16 Valve Engine

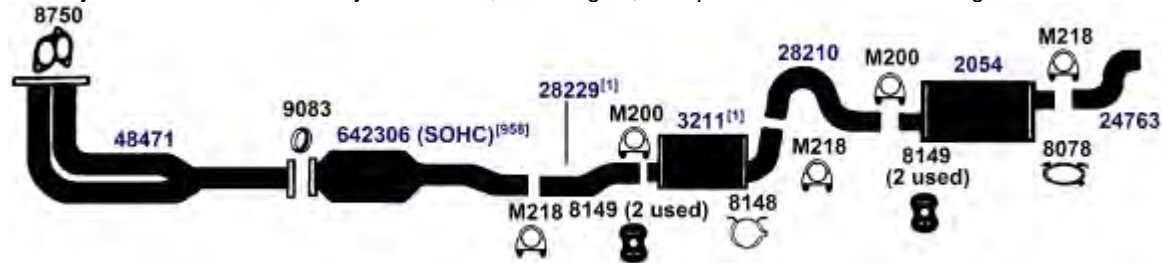

DIRECT FIT MSL/MAXIMUM Muffler... Front Muffler- 700085, Rear Muffler- 700177

(10708) 88-92 4 Cyl. 740 Sedan, Sta. Wagon; 2.3L Turbo Engine
88-90 4 Cyl. 760 Sta. Wagon, 2.3L Turbo Engine

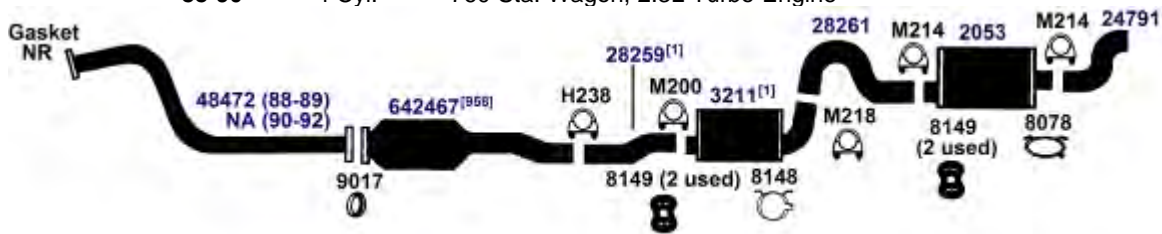

DIRECT FIT MSL/MAXIMUM Muffler... Front Muffler- 700085, Rear Muffler- 700309, UNIVERSAL FIT MSL/MAXIMUM Muffler... Rear Muffler- 6536

NA-Not Available. NR-Not Required. FL-Remove and Re-Use Old Flange. ● Golden Warehouse. O.E.-Original Equipment.
Airtube Kit [4948] may be required to complete installation. EFI-Electronic Fuel Injection.

[1] OE system was a welded assembly. It is recommended that all parts noted [1] should be replaced. [958] Federal & California Emission vehicles. Not legal for sale for vehicles licensed in California.

[75] 262 (from Ch. 4971); 264 (from Ch. 66394); 265 (from Ch. 16958).

89-91 4 Cyl. 780, 2.3L Turbo Engine
88-90 4 Cyl. 760 Sedan, 2.3L Turbo Engine

(10712)

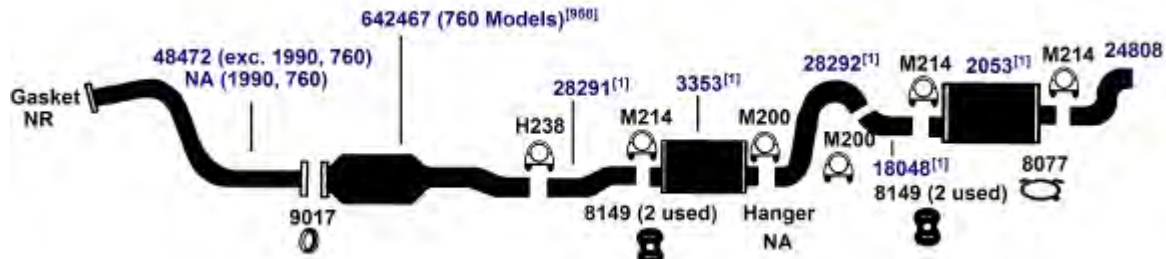

DIRECT FIT MSL/MAXIMUM Muffler... Rear Muffler- 700309, UNIVERSAL FIT MSL/MAXIMUM Muffler... Rear Muffler- 6536

89-90 4 Cyl. 740, 2.3L DOHC 16 Valve Engine

(10709)

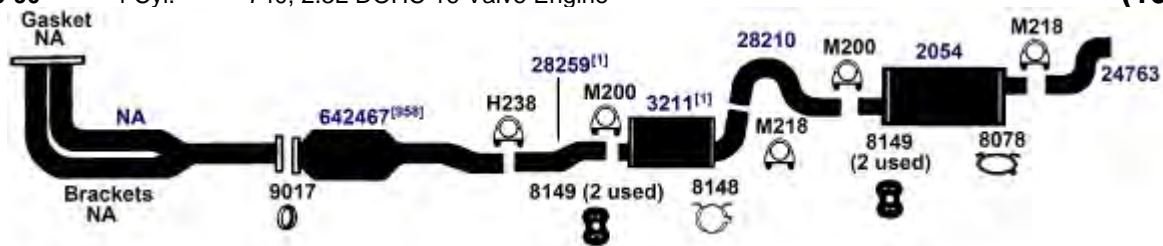

DIRECT FIT MSL/MAXIMUM Muffler... Front Muffler- 700085, Rear Muffler- 700177

88-90 6 Cyl. 780, 2.8L Engine
88-90 6 Cyl. 760 Sedan, 2.8L Engine

(10711)

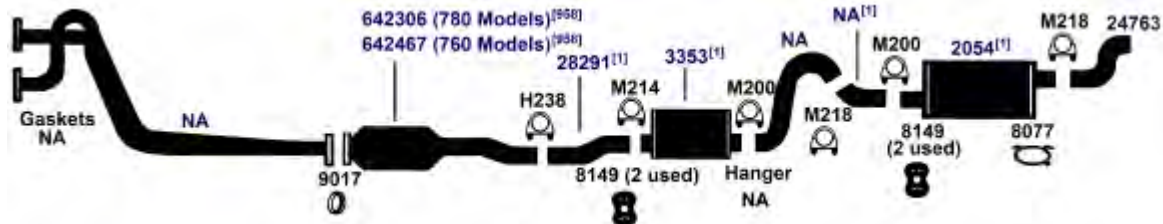

DIRECT FIT MSL/MAXIMUM Muffler... Rear Muffler- 700177

88-89 6 Cyl. 760 Sta. Wagon, 2.8L Engine

(10707)

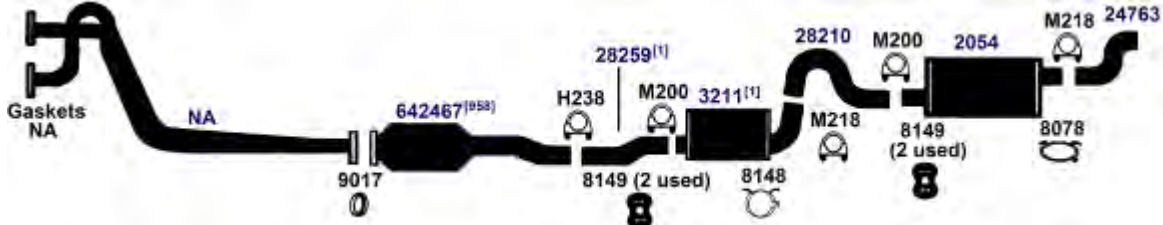

DIRECT FIT MSL/MAXIMUM Muffler... Front Muffler- 700085, Rear Muffler- 700177

NA-Not Available. NR-Not Required. FL-Remove and Re-Use Old Flange. ● Golden Warehouse. O.E.-Original Equipment.
 # Airtube Kit [4948] may be required to complete installation. EFI-Electronic Fuel Injection.

[1] OE system was a welded assembly. It is recommended that all parts noted [1] should be replaced.

[958] Federal & California Emission vehicles. Not legal for sale for vehicles licensed in California.

[98] Refer to current Catalytic Converter catalog or Website catalog for availability.

VOLVO 700 SERIES

(10705) 1987 4 Cyl. 740, 760; 2.3L Turbo Engine

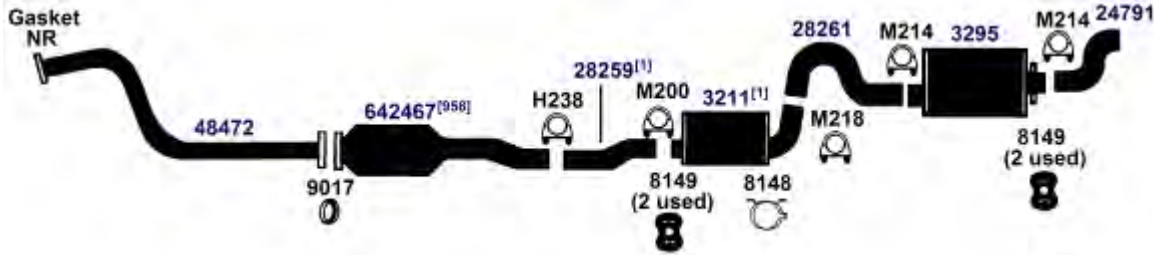

DIRECT FIT MSL/MAXIMUM Muffler... Front Muffler- 700085, UNIVERSAL FIT MSL/MAXIMUM Muffler... Rear Muffler- 6536

(10704) 1987 6 Cyl. 780, 2.8L Engine

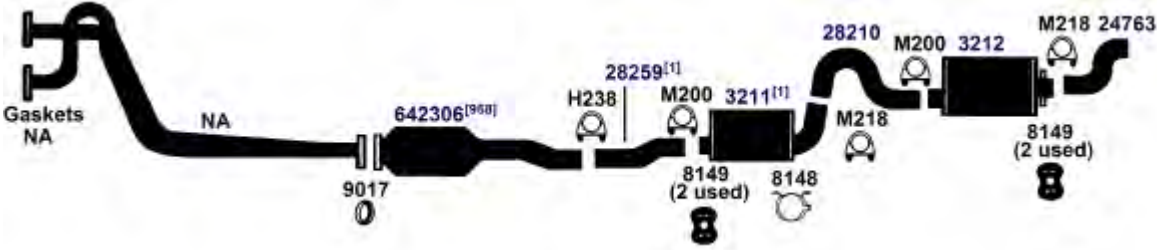

DIRECT FIT MSL/MAXIMUM Muffler... Front Muffler- 700085, UNIVERSAL FIT MSL/MAXIMUM Muffler... Rear Muffler- 6536

(10700) 85-87 4 Cyl. 740, except Turbo and Turbo Diesel

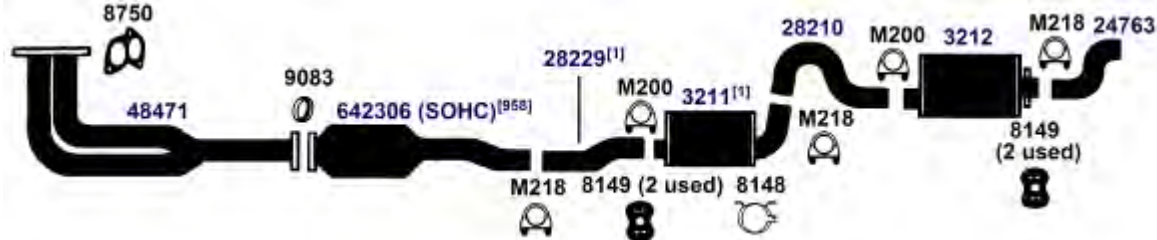

DIRECT FIT MSL/MAXIMUM Muffler... Front Muffler- 700085, UNIVERSAL FIT MSL/MAXIMUM Muffler... Rear Muffler- 6536

(10699) 85-87 6 Cyl. 760, except Turbo and Turbo Diesel

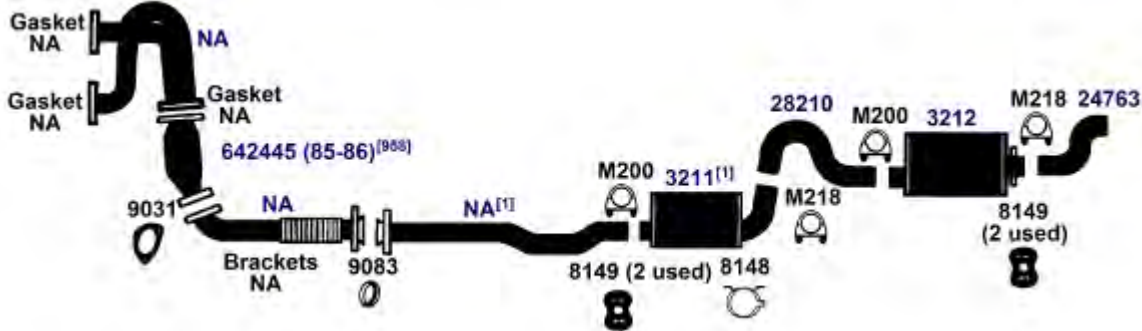

DIRECT FIT MSL/MAXIMUM Muffler... Front Muffler- 700085, UNIVERSAL FIT MSL/MAXIMUM Muffler... Rear Muffler- 6536

NA-Not Available. NR-Not Required. FL-Remove and Re-Use Old Flange. ● Golden Warehouse. O.E.-Original Equipment.
Airtube Kit [4948] may be required to complete installation. EFI-Electronic Fuel Injection.

[1] OE system was a welded assembly. It is recommended that all parts noted [1] should be replaced. [958] Federal & California Emission vehicles. Not legal for sale for vehicles licensed in California.

1986 6 Cyl. 740, 2.4L, Turbo Diesel Engine

(10703)

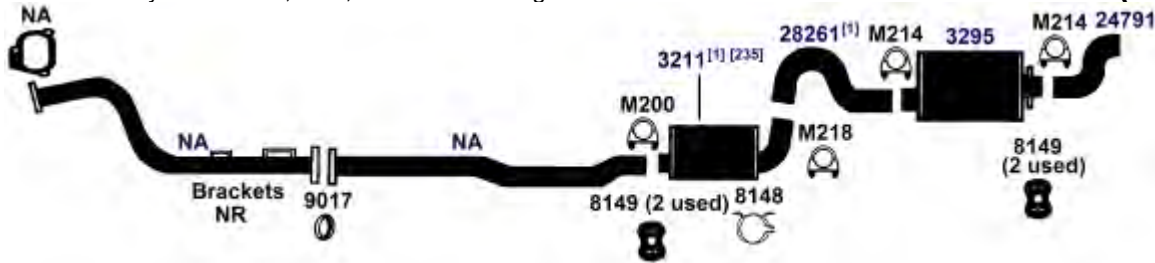

DIRECT FIT MSL/MAXIMUM Muffler... Front Muffler- 700085, UNIVERSAL FIT MSL/MAXIMUM Muffler... Rear Muffler- 6536

85-86 4 Cyl. 760, 740, 2.3L Turbo Engine

(10702)

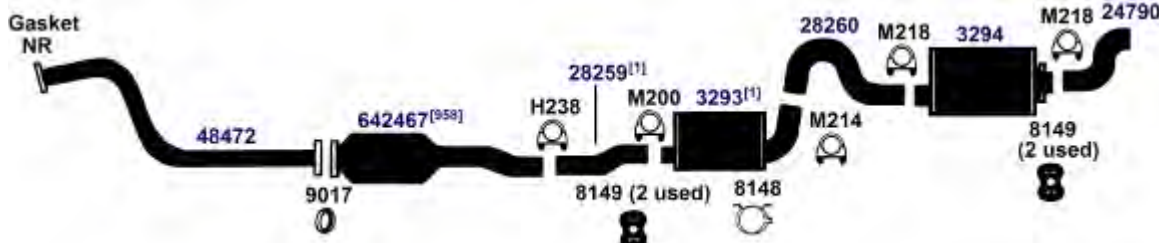

UNIVERSAL FIT MSL/MAXIMUM Muffler... Rear Muffler- 6536

1984 4 Cyl. 760, 2.3L Turbo Engine

(10702E)

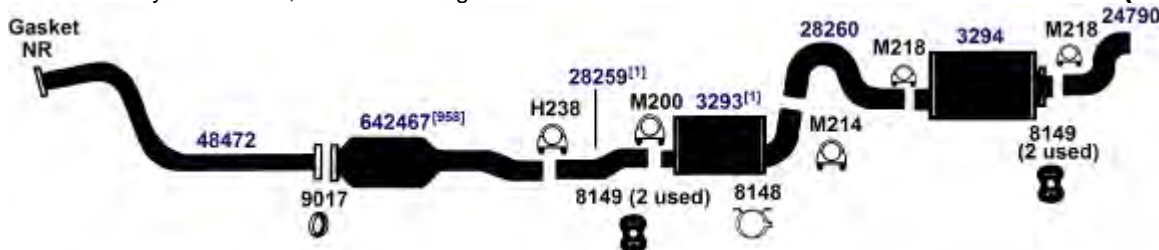

UNIVERSAL FIT MSL/MAXIMUM Muffler... Rear Muffler- 6536

83-84 4,6 Cyl. 760, except Turbo and Turbo Diesel

(10699E)

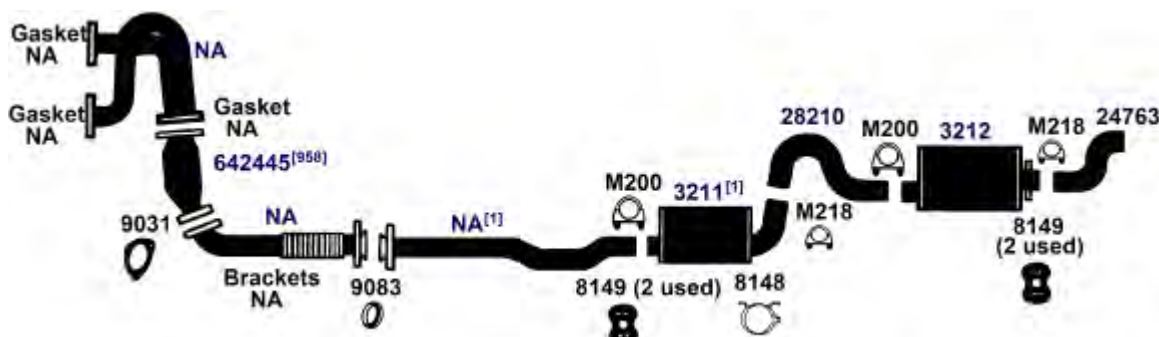

DIRECT FIT MSL/MAXIMUM Muffler... Front Muffler- 700085, UNIVERSAL FIT MSL/MAXIMUM Muffler... Rear Muffler- 6536

NA-Not Available. NR-Not Required. FL-Remove and Re-Use Old Flange. ● Golden Warehouse. O.E.-Original Equipment.
Airtube Kit [4948] may be required to complete installation. EFI-Electronic Fuel Injection.

[1] OE system was a welded assembly. It is recommended that all parts noted [1] should be replaced. [958] Federal & California Emission vehicles. Not legal for sale for vehicles licensed in California.
[235] Modifications at inlet may be required.

VOLVO 800 SERIES

(15025) 93-94 5 Cyl. 850, 2.4L Engine, except Turbo

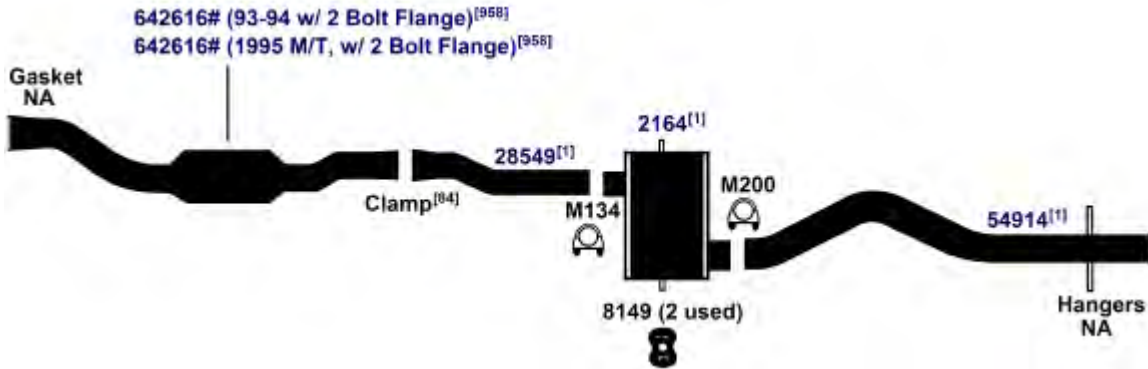

DIRECT FIT MSL/MAXIMUM Muffler... 700397

VOLVO 900 SERIES

(10763) 92-94 4 Cyl. 940, 2.3L Engine, except Turbo

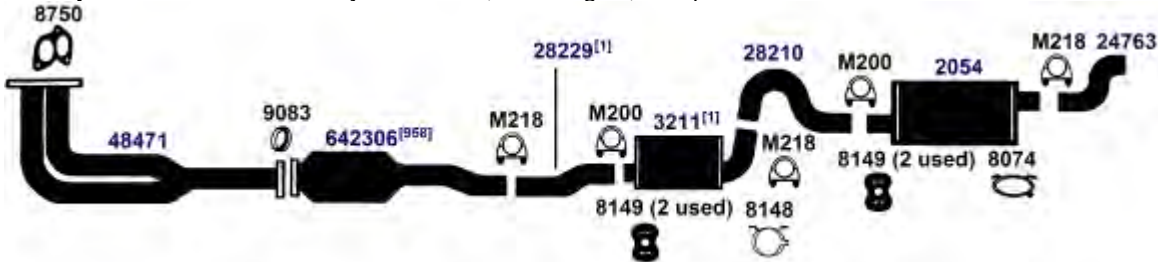

DIRECT FIT MSL/MAXIMUM Muffler... Front Muffler- 700085, Rear Muffler- 700177

(10762) 91-94 4 Cyl. 940, 2.3L Turbo Engine, without Multilink Suspension

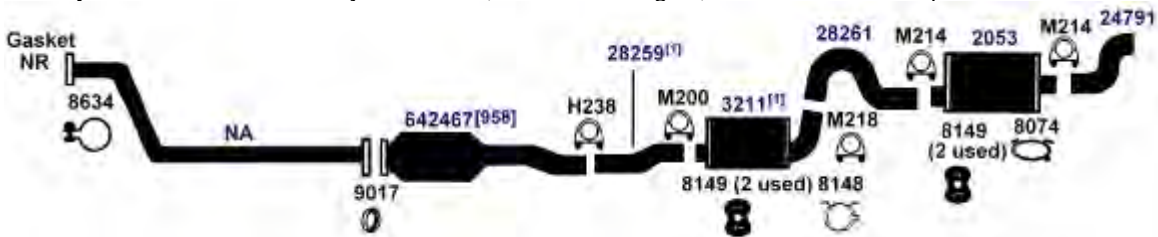

DIRECT FIT MSL/MAXIMUM Muffler... Front Muffler- 700085, Rear Muffler- 700309, UNIVERSAL FIT MSL/MAXIMUM Muffler... Rear Muffler- 6536

NA-Not Available. NR-Not Required. FL-Remove and Re-Use Old Flange. ● Golden Warehouse. O.E.-Original Equipment.
Airtube Kit [4948] may be required to complete installation. EFI-Electronic Fuel Injection.

[1] OE system was a welded assembly. It is recommended that all parts noted [1] should be replaced. [958] Federal & California Emission vehicles. Not legal for sale for vehicles licensed in California.

[84] Remove and re-use original clamp.

91-94 4 Cyl. 940, 2.3L Turbo Engine, with Multilink Suspension **(10760)**

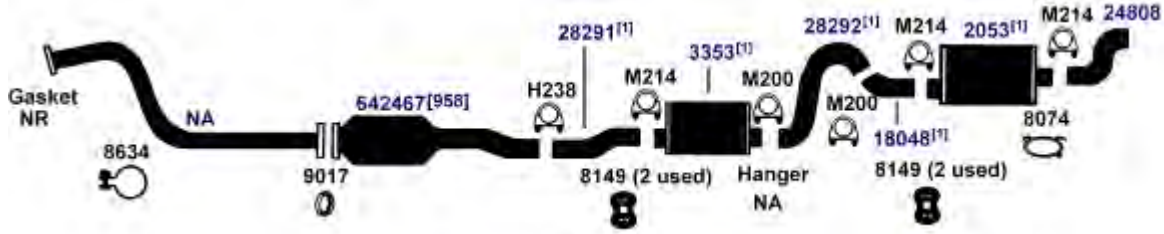

DIRECT FIT MSL/MAXIMUM Muffler... Rear Muffler- 700309, UNIVERSAL FIT MSL/MAXIMUM Muffler... Rear Muffler- 6536

1992 4 Cyl. 960, 2.3L Turbo Engine, with Multilink Suspension **(100556)**

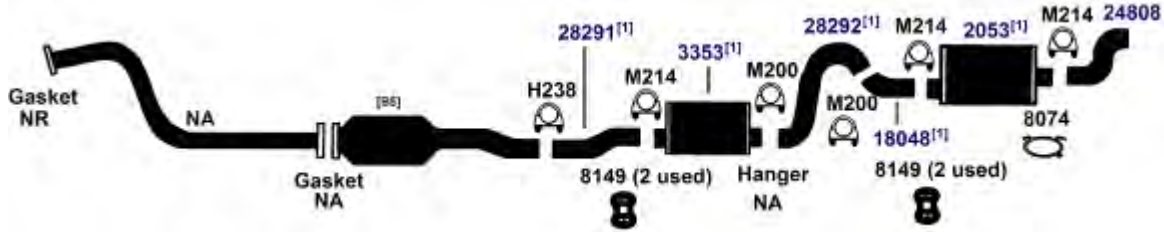

DIRECT FIT MSL/MAXIMUM Muffler... Rear Muffler- 700309, UNIVERSAL FIT MSL/MAXIMUM Muffler... Rear Muffler- 6536

1991 4 Cyl. 940 GLE, 2.3L 16 Valve Engine **(10761)**

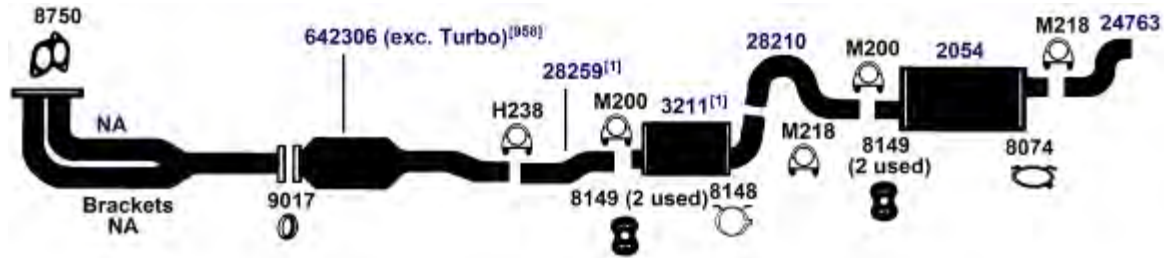

DIRECT FIT MSL/MAXIMUM Muffler... Front Muffler- 700085, Rear Muffler- 700177

NA-Not Available. NR-Not Required. FL-Remove and Re-Use Old Flange. ● Golden Warehouse. O.E.-Original Equipment.
Airtube Kit [4948] may be required to complete installation. EFI-Electronic Fuel Injection.

[1] OE system was a welded assembly. It is recommended that all parts noted [1] should be replaced.
[98] Refer to current Catalytic Converter catalog or Website catalog for availability.

[958] Federal & California Emission vehicles. Not legal for sale for vehicles licensed in California.