



# AIRCHARGER® HIGH-FLOW INTAKE KITS

## INSTALLATION INSTRUCTIONS

### 63-6015

#### NISSAN

2004-08 Maxima

2004-06 Altima

V6-3.5L

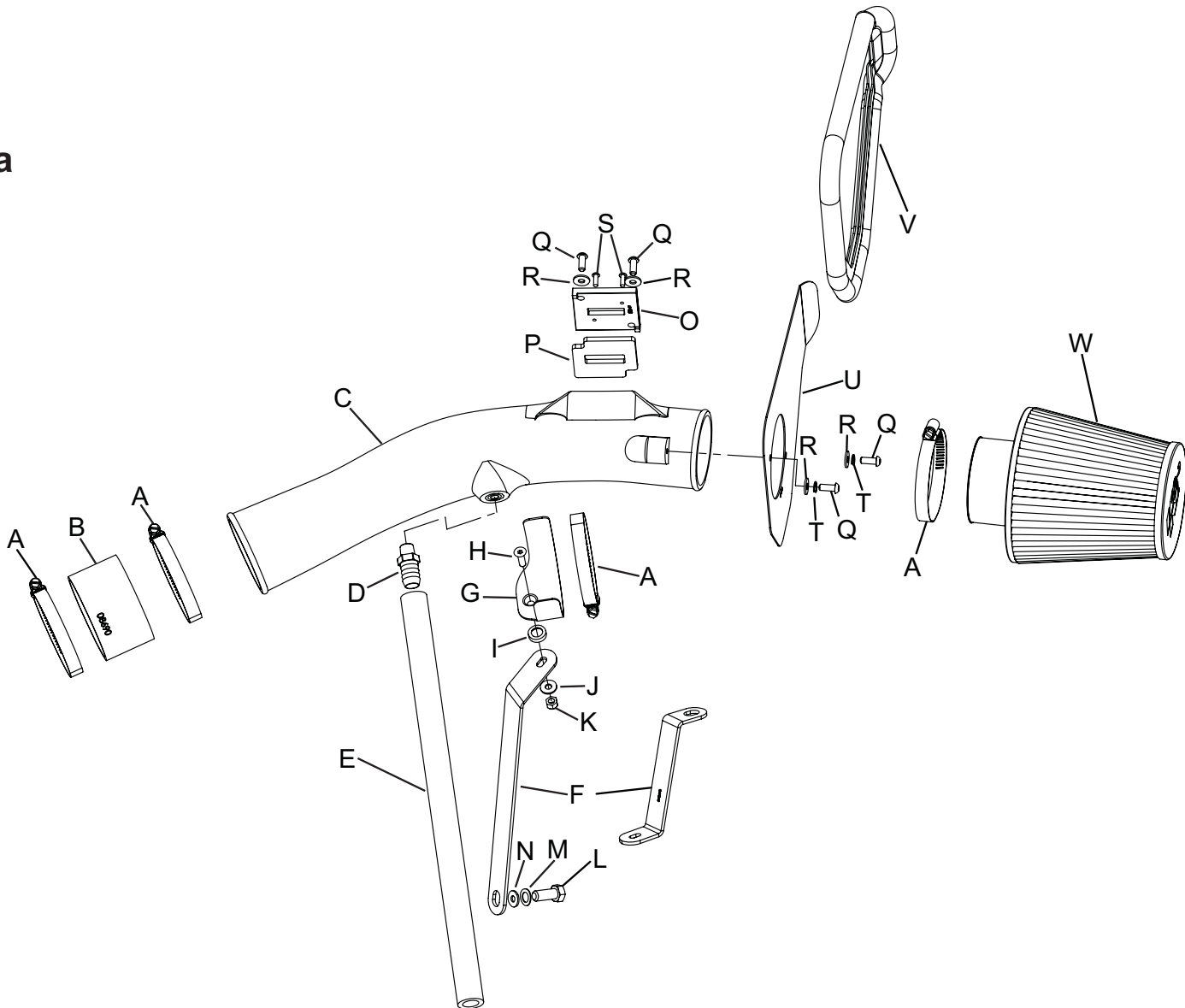

#### TOOLS NEEDED:

Ratchet  
Extension  
10mm Socket,  
3/4" Wrench  
17mm Wrench  
10mm Wrench  
Flat Blade Screw Driver  
Pliers  
T20 Torx Wrench  
5mm Allen Wrench  
4mm Allen Wrench  
3mm Allen Wrench

#### Parts List:

Description	Qty	Part #	Description	Qty	Part #	Description	Qty	Part #
A Hose Clamp #48	4	08601	I Washer; Conical, Nylon, Black	1	08180	Q Bolt; M6 X 1.00 X 16MM , Button Head	4	07730
B Hose; 3.25"ID X 2"L, Black Silicone	1	08690	J Washer; 1/4"ID X 5/8"OD - SAE	1	08275	R Washer; 6MM Flat, SS	4	08269
C Intake Tube	1	087213	K Nut; 6MM Nylock, Hex Head, SS	1	07512	S Screw; M4- .7 X 12, Button Head SS	2	07726
D Vent; STRT, 5/8 Barbed 1/4 NPT, Nylon	1	08911	L Bolt; M10-1.5 X 25MM Hex HD.	1	07702	T Washer; 1/4" Lock, ZN	2	08198
E Hose; 5/8"ID X 17"L, Silicone	1	08681	M Washer; 10MM Wave	1	08175	U Heat Shield	1	07652
F Bracket; Mild STL, FB/PC	1	06489/ 070090	N Washer; 3/8" Flat Washer, SS	1	08134	V Edge Trim	1	102489
G Bracket; Saddle, S/S	1	078855	O Adaptor; Nylon 6/6 GF, Black	1	21515	W Air Filter	1	RC-4180
H Bolt; 6MM-1.00 X 20MM F/H/A, SS	1	08376	P Gasket; 3/16 Poron	1	09069			

**NOTE: FAILURE TO FOLLOW INSTALLATION INSTRUCTIONS AND NOT USING THE PROVIDED HARDWARE MAY DAMAGE THE INTAKE TUBE, THROTTLE BODY AND ENGINE.**

#### TO START:

1. Turn the ignition off and disconnect the vehicle's negative battery cable.



2. Remove the four bolts that retain the engine cover, then remove the engine cover from the engine.

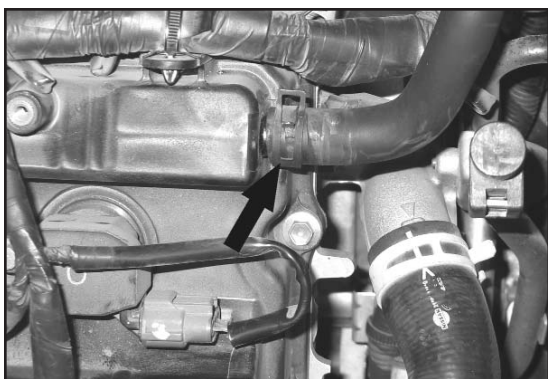

3. Release the spring clamp and disconnect the crank case vent hose.



4. Disconnect the mass air sensor electrical connection.



5. Loosen the two hose clamps that secure the stock intake tube to the throttle body and stock mass air sensor.



6. Remove the stock intake tube from the vehicle.

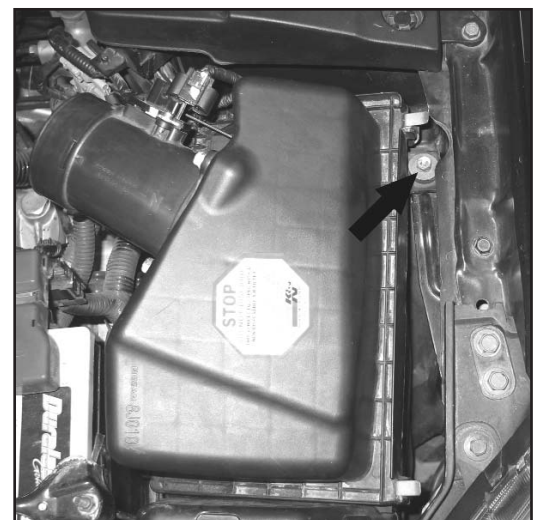

7. Remove the bolt that secures the air box to the inner fender.





8. Lift the air box up from the mounting grommets. Detach the air box from the fresh air duct, then remove the air box from the vehicle.

**Note: K&N recommends that customers do not discard factory air intake.**



9. Install silicone hose (#08690) onto the throttle body and secure with the provided hose clamp.

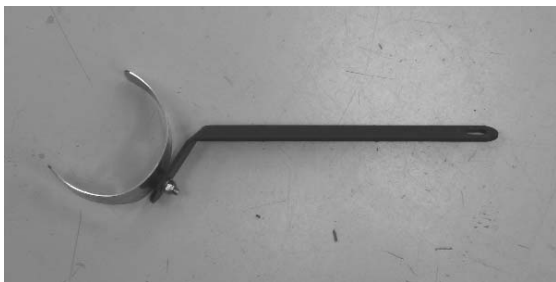

10. On 2005/2006 model vehicles, secure the saddle clamp to the tube mounting bracket (06489) with the provided hardware as shown.



10a. On 2007 and later model vehicles, Secure the saddle clamp to the tube mounting bracket (070090) with the provided hardware as shown.

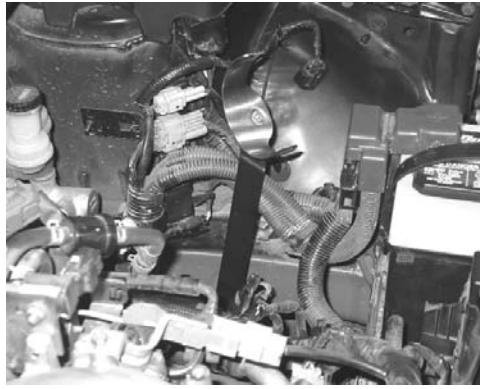

11. On 2005/2006 model vehicles, secure the tube mounting bracket assembly (06489) to the threaded boss on the transmission with the provided hardware.



11a. On 2007 and later model vehicles, secure the tube mounting bracket assembly (070090).



12. Install the 1/4" NPT fitting into the K&N intake tube as shown.

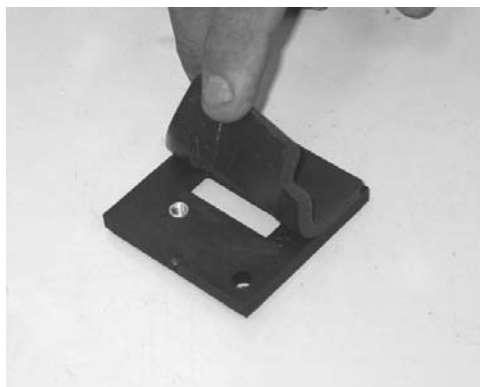

13. Install the provided gasket onto the K&N mass air sensor adapter.



14. Remove the mass air sensor mounting screws. Then, remove the mass air sensor from the stock mass air sensor housing.

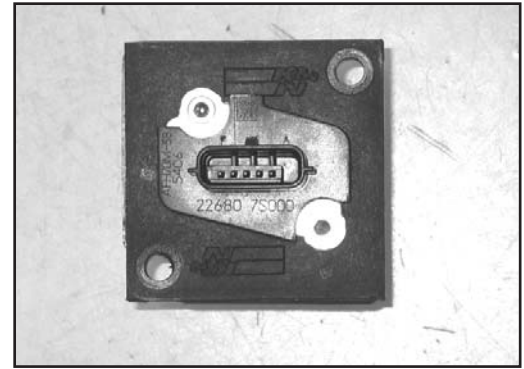

15. Install the mass air sensor into the K&N mass air sensor adapter. Secure with the provided hardware.

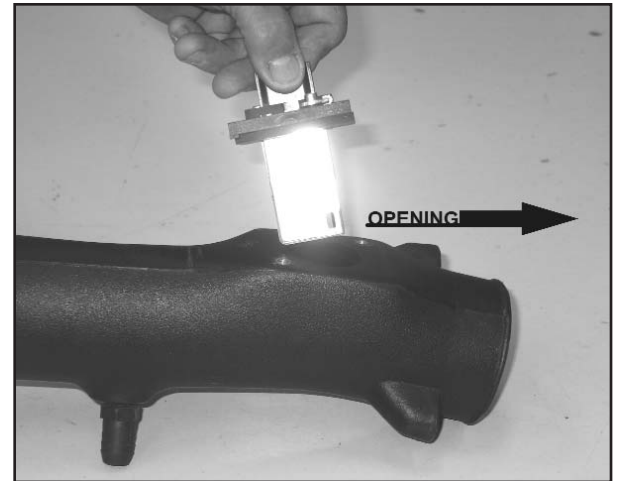

16. Install the mass air sensor assembly into the K&N intake tube and secure with the provided hardware.  
**Note: The opening in the mass air sensor must be installed facing towards the inlet end of the tube as shown.**



17. Install the provided edge trim onto the heat shield as shown.  
**Note: Some trimming of the edge trim may be necessary.**



18. Secure the heat shield assembly to the K&N intake tube with the provided hardware.





19. Install the K&N intake tube assembly into the silicone hose at the throttle body and align with the saddle bracket installed in step #11. Secure the K&N intake tube assembly with the provided hose clamps.



20. Install the provided crank case vent hose onto the vent port on the valve cover. Connect the open end to the 1/4" NPT fitting installed into the K&N intake tube.



21. Re-install the engine cover and secure with the stock bolts.



22. Install the K&N air filter and secure with the provided hose clamp.



23. Re-connect the mass air sensor electrical connection.



24. Re-connect the vehicle's negative battery cable. Double check to ensure everything is tight and properly adjusted before starting the vehicle.

25. It will be necessary for all K&N intake kits to be checked periodically for re-alignment, clearance, and tightening of all connections. Failure to follow the above instructions may void the warranty.

#### ROAD TESTING:

1. Start the engine with the transmission in neutral or park, and the parking brake engaged. Listen for air leaks or odd noises. For air leaks secure hoses and connections. For odd noises, find cause and repair before proceeding. This kit will function identically to the factory system except for being louder and much more responsive.

2. Test drive the vehicle. Listen for odd noises or rattles and fix as necessary.

3. If road test is fine, you can now enjoy the added power and performance from your kit.

4. K&N suggests checking the air filter element periodically for excessive dirt build-up. When the element becomes covered in dirt (or once a year), service it according to the instructions on the Recharger service kit, part number 99-5050 or 99-5000.